

UNIVERSITY OF TORONTO



3 1761 01215509 9

Digitized by the Internet Archive
in 2007 with funding from
Microsoft Corporation

HIGHER PLANE CURVES.



A TREATISE

ON THE

HIGHER PLANE CURVES:

INTENDED AS A SEQUEL

TO

A TREATISE ON CONIC SECTIONS.

BY

GEORGE SALMON, D.D., D.C.L., LL.D., F.R.S.,

REGIUS PROFESSOR OF DIVINITY IN THE UNIVERSITY OF DUBLIN.

THIRD EDITION.

Dublin:

HODGES, FOSTER, AND FIGGIS, GRAFTON STREET,

BOOKSELLERS TO THE UNIVERSITY.

MDCCCLXXIX.

S-16, S-3

Sa 3



CAMBRIDGE:

PRINTED BY W. METCALFE AND SON, TRINITY STREET.

QA

565

S28

1879

PREFACE TO THE SECOND EDITION.

THE first edition of this treatise has been for several years out of print, and I had for sometime given up the idea of reprinting it. The work, having been written at a time when the Modern Higher Algebra was still in its infancy, required extensive alterations in order to bring it up to the present state of the science; and, as I had failed to bring out a new edition before my appointment to the office which I now hold, I judged it impossible to do so, now that other engagements left me no leisure to make acquaintance with recent mathematical discoveries, or even to keep up my memory of what I had previously known. When, however, years passed and mine still remained the only work in English professing to give a systematic account of the modern theory of curves, I began to consider whether republication might not be possible, if I could obtain the assistance of some younger mathe-

matician competent to contribute additional sections representing the later progress of the science. Consulting Professor Cayley on this subject I was much and agreeably surprised by his offering himself to give me the help I required. It is needless to say how gladly I embraced a proposal calculated to add so much to the value of my book; and the only scruple I have felt in profiting by it is lest the time and labour which Professor Cayley has devoted to the work of another may, for a time at least, have deprived the mathematical world of a better work on the same subject by himself. My original plan for the division of the labour was that Professor Cayley should contribute certain new sections or chapters, of which he should take the entire responsibility, while I should content myself with revising the older part of the book; and accordingly the first chapter is entirely Professor Cayley's. But I found it would be impossible in this method to give the book the unity it ought to possess; and actually our work has been combined in a manner that makes it not easy to separate our respective shares. Professor Cayley has carefully gone over the whole, and there is scarcely a page that has not in some way been influenced by his suggestions; on the other hand, I have completely re-written many of his contributions either for the

purpose of making them fit in better with the rest of the book, or if I thought I could make some simplification in his process or some addition to his results. I have in fact dealt in the same manner with some of the manuscript materials which he was so good as to place at my disposal, as I have done with published memoirs of his, the results of which I have incorporated in the work. On looking through the pages the parts which I recognize as taken from Professor Cayley, with but slight or with no alteration, are Chap. I.; the account of the forms of triple points, Art. 40; Art. 47, the view taken in which I have not myself in other places fully accepted; Ex. 6, p. 43; and Arts. 56—58, 87—89, 138, 139, 151, 198, 243, 270, 282—291, 407, 408. Besides these I have worked into Chap. III. a manuscript of his on envelopes, including the theory of evolutes and quasi-evolutes and of parallel curves; from another manuscript of his I obtained my knowledge of Sylvester's theory of residuation; and I have used one on the classification of quartics and one on the bitangents of quartics. The additions made to the chapter in the former edition on the transformation of curves are almost entirely derived from a manuscript of Professor Cayley's, from which Arts. 370 to the end are taken nearly without alteration;

Arts. 401—406 are founded on a manuscript of his on Steiner's theory of polar curves.

The first edition of this work contained a chapter on the application of the Integral Calculus to the theory of curves; this I have now omitted principally on account of the extension which this subject has since received. Such a chapter now, in order to have any pretensions to completeness, ought to contain an account of the applications which the lamented Clebsch, in continuation of Riemann's researches, made of elliptic and Abelian integrals to the theory of curves. But it seems impossible that those subjects could be done justice to, except in a work having the Integral Calculus as its main object; and as such works ordinarily contain chapters on the theory of curves, I have thought that this branch of the theory might safely be omitted from the present treatise.

The causes which delayed the publication of the Second Edition have also retarded the issue of this Third, and have prevented me from doing all that might be desired in the way of including recent investigations. My friend Mr. Cathcart, to whose help in correcting the press on this as on former occasions I am greatly indebted, had called

my attention while the printing was in progress to various points which needed fuller treatment. These I had hoped to deal with in an Appendix at the end, but all I have found time to do has reduced itself to the addition of a few references. Professor Cayley, it will be observed, has kindly given me one or two new contributions.

TRINITY COLLEGE, DUBLIN,
July, 1879.

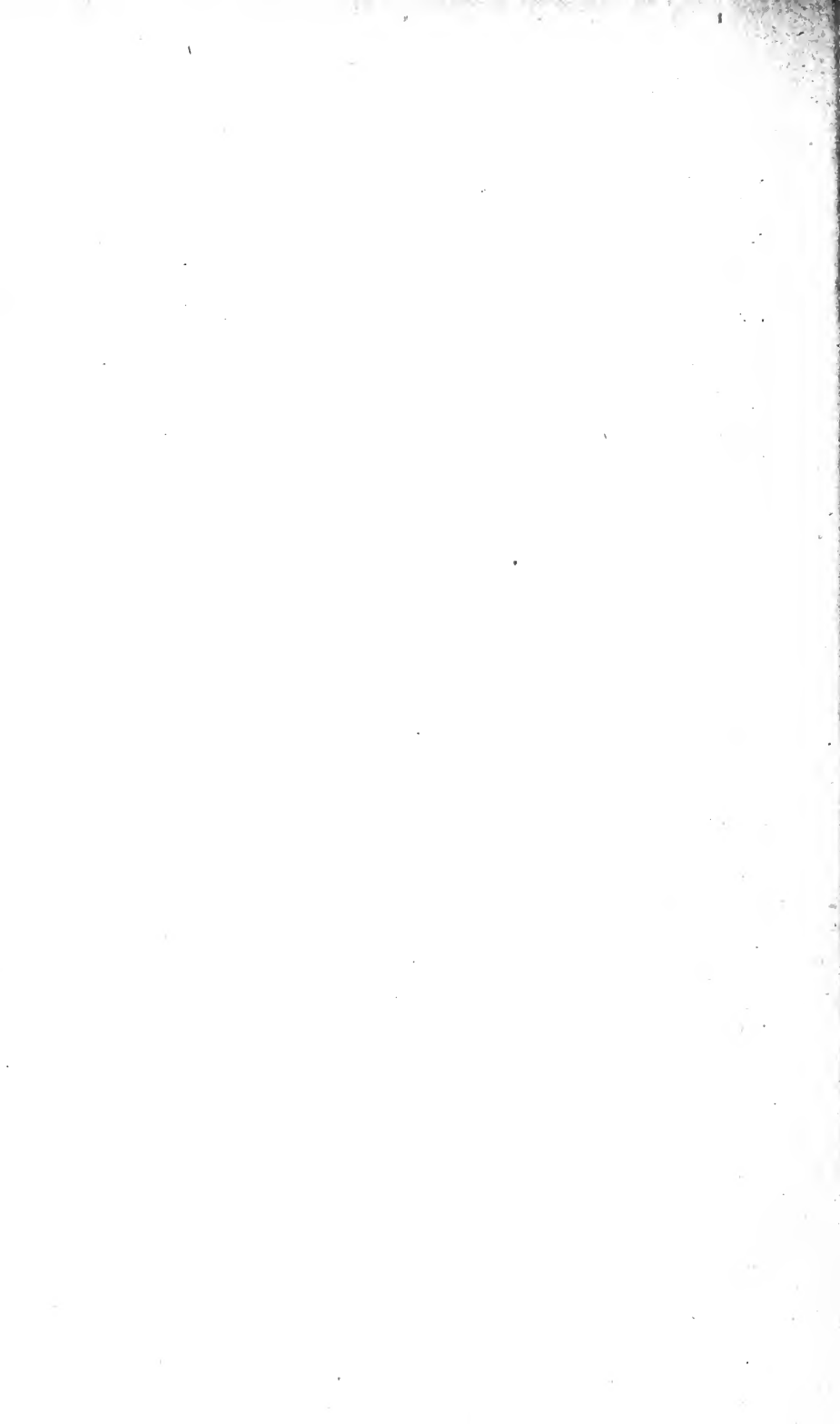

CONTENTS.

CHAPTER I.

COORDINATES.

	PAGE
Descriptive and metrical theorems	1
General definition of trilinear coordinates	2
Relation between point (1, 1, 1) and line $x + y + z = 0$	4
Particular case of trilinear coordinates	5
circular coordinates	6
Circular points at infinity	7
LINE COORDINATES	9
Their relation to trilinear coordinates	10
Particular cases of line-coordinates	11
Geometrical duality	12

CHAPTER II.

GENERAL PROPERTIES OF ALGEBRAIC CURVES.

SECTION I. NUMBER OF TERMS IN THE EQUATION	13
All forms which are general must have as many independent constants as the general equation	13
Number of terms in the general equation	15
Number of points which determine a n -ic	15
A single curve determined by these conditions	16
In what cases this number of points fails to determine a n -ic	17
If one less than this number of points be given, the curve passes through other fixed points	18
If of intersections of two n -ic's, np lie on a p -ic, the remainder lie on a $(n - p)$ -ic	18
Extension of Páscal's theorem	19

	PAGE
Steiner's and Kirkman's theorems on the hexagon	19
Theorems concerning the intersections of two curves	20
SECTION II. MULTIPLE POINTS AND TANGENTS	22
Equation of tangent at origin	23
The origin, a double point	24
Three kinds of double points	24
Their relation illustrated	26
Triple points, their species	27
Number of nodes equivalent to a multiple point	28
Multiple point equivalent to how many conditions	29
Limit to number of nodes on a proper curve	29
Deficiency of a curve	30
Fundamental property of unicursal curves	31
Consideration of the case where the axis is a multiple tangent	32
Stationary tangents and inflexions	34
Two consecutive tangents coincide at a stationary tangent	34
Correspondence of reciprocal singularities	34
Curve crosses the tangent at an inflexion	35
Measure of inclination of curve to the axis	36
Points of undulation	37
Relation between points where tangents meet the curve again	38
Equation of asymptotes, how formed	39
Examples	41
SECTION III. TRACING OF CURVES	42
Newton's process for determining form of curve at a singular point	46
Keratoid and ramphoid cusps	48
SECTION IV. POLES AND POLARS	49
Joachimsthal's method of determining points where a line meets a curve	49
Polar curves	50
of origin	51
Every right line has $(n - 1)^2$ poles	51
Multiple points and cusps, how related to polar curves	52
SECTION V. GENERAL THEORY OF MULTIPLE POINTS AND TANGENTS	52
All polars of point on curve touch at that point	53
Points of contact of tangents from a point how determined	53
Degree of reciprocal of a curve	54
Effect of singularities on degree of reciprocal	55
Discriminant of a curve	55
If the first polar of A has a double point B , polar conic of B has a double point A	56
Hessian and Steinerian defined	57
Conditions for a cusp	58
Number of points of inflexion	59
how affected by multiple points	60
Equation of system of tangents from a point	61
Application to the case of a cubic	62
Number of tangents from a multiple point	63
SECTION VI. RECIPROCAL CURVES	63
What singularities to be counted ordinary	64
Plücker's equations	65
Number of conditions, the same for curve and its reciprocal	66
Deficiency, the same for both	66
Cayley's modification of Plücker's equations	66

CHAPTER III.

ENVELOPES.

	PAGE
Two forms in which problem of envelopes presents itself	67
Envelope of curve whose equation contains a single parameter	68
Envelope of $a \cos^2 \theta + b \sin^2 \theta = c$	69
Equation of parallel to a conic	70
Envelope of right line containing a single parameter algebraically : its characteristics	70
Envelope of curve with related parameters	72
Method of indeterminate multipliers	73
Envelope of curve whose equation contains independent parameters	74
Explanation of difficulty in theory of envelopes	74
RECIPROCAL CURVES	76
Method of finding equation of reciprocal	77
Reciprocal of a cubic	77
Symbolical form of equation of reciprocal	78
Reciprocal of a quartic	78
Equation of system of tangents from a point	79
Equation of reciprocal in polar coordinates	79
TACT-INVARIANT of two curves	80
Its order in the coefficients of each curve	81
EVOLUTES	82
Defined as envelope of normals	83
Coordinates of centre of curvature	84
General expression for radius of curvature	87
Length of arc of evolute	88
Radius of curvature in polar coordinates	88
Evolutes of curves given by tangential equation	89
Quasi-normals and quasi-evolutes	90
Quasi-evolute of conic	91
General form of equation of quasi-normal	92
Quasi-evolute when the absolute is a conic	93
Normal of a point at infinity	94
Characteristics of evolute	94
Deficiency of evolute	97
Condition that four consecutive points on a curve should be concircular	97
CAUSTICS	98
Caustic by reflection of a circle	98
Queletelet's method	98
Pedal of a curve	99
Caustic by refraction of right line and circle	100
Evolute of Cartesian	101
PARALLEL CURVES AND NEGATIVE PEDALS	101
Cayley's formulæ for characteristics of parallel curves	102
Problem of negative pedals	105
Roberts's method	105
Method of inversion	106
Characteristics of inverse curve and of pedal	106
Caustic by reflexion of parabola	107
Negative pedal of central and focal ellipse	107

CHAPTER IV.

METRICAL PROPERTIES.

	PAGE
Newton's theorem of constant ratio of rectangles	108
Carnot's theorem of transversals	109
Three inflexions of cubics lie on a right line	110
Two kinds of bitangents of quartic	111
DIAMETERS	112
Newton's generalization of notion of diameters	112
Theorem concerning intercept made between curves and asymptotes	113
Curvilinear diameters	113
Centres	115
POLES AND POLARS	115
Cotes's theorem of harmonic means of radii	115
Polar curves	116
Polars of points at infinity	117
Pole of line at infinity	117
MacLaurin's extension of Newton's theorem	117
Pole of line at infinity with respect to curve of n^{th} class	118
Its metrical property : centre of mean distances of contacts of parallel tangents	119
FOCI	119
General definition of foci	119
Number of foci possessed by a curve	120
Antipoints	122
Coordinates of foci how found	122
Locus of a point the tangents from which make with a fixed line angles whose sum is constant	123
Every focus of a curve is a focus of its evolute	124
Theorems concerning focal perpendiculars on tangents	124
concerning angles between focal radii and tangent	125
concerning focal distances of point on curve	126
Locus of double focus of circular curve determined by $N - 3$ points	127
Locus of focus of curve of n^{th} class determined by $N - 1$ tangents	127
Miquel's theorem as to foci of parabolas touching 4 of 5 given lines	128

CHAPTER V.

CUBICS.

General division of cubics	129
SECTION I. INTERSECTION OF A CUBIC WITH OTHER CURVES	130
Tangential of a point and satellite of a line defined	130
Asymptotes meet curve in three collinear finite points	131
Three points of inflexion lie on a right line	131
Four points of contact of tangents from any point on curve, how related	132
MacLaurin's theory of correspondence of points on a cubic	133
Co-residual of four points on a cubic	134
To draw a conic having four-point contact and elsewhere touching a cubic	135
Conic of 5-point contact, how constructed	135
Sextactic points on cubic, how found	135
Sylvester's theory of residuation	136

	PAGE
Two coresidual points must coincide	137
Two systems coresidual to the same are coresidual to each other	138
Analogue in theory of cubics to anharmonic theorems of conics	140
Locus of common vertex of two triangles whose bases are given and vertical angles equal, or having a given difference	142
SECTION II. POLES AND POLARS.	142
Construction for polar of a point with respect to a triangle	143
Construction by the ruler for polar of a point with respect to a cubic	143
Anharmonic ratio constant of pencil of four tangents from any point on a cubic	144
Two classes of non-singular cubics	145
Sixteen foci of a circular cubic lie on four circles	145
Chords through a point on cubic cut harmonically by polar conic	146
Harmonic polar of point of inflexion	146
All cubics through nine points of inflexion have these for inflexions	148
Correspondence of two points on Hessian	149
Steinerian of a cubic identical with its Hessian	150
Cayleyan, different definitions of	151
Polar line with respect to cubic of point on Hessian touches Hessian	152
Common tangents of cubic and Hessian	152
Stationary tangents touch the Hessian	152
Tangents to Hessian at corresponding points meet on Hessian	153
Three cubics have common Hessian	153
Rule for finding point of contact of any tangent to Cayleyan	154
Points of contact of stationary tangents with Cayleyan	155
Coordinates of tangential of point on cubic, how found	156
Polar conic of line with respect to cubic	156
How related to triangle formed by tangents where line meets cubic	157
Double points, how situated with regard to polar conics of lines	157
Polar conic of line infinity	158
Another method of obtaining tangential equation of cubic	158
Polar conic of a line when reduces to a point	158
Points, whose polar with respect to two cubics are the same	159
Critic centres of system of cubics	160
Locus of nodes of nodal cubics through seven points	160
Plücker's classification of cubics	161
SECTION III. CLASSIFICATION OF CUBICS	162
Every cubic may be projected into one of five divergent parabolas	164
and into one of five central cubics	164
Classification of cubic cones	165
No real tangents can be drawn from oval	167
Unipartite and bipartite cubics	168
Species of cubics	169
Newton's method of reducing the general equation	177
Plücker's groups	178
SECTION IV. UNICURSAL CUBICS	179
Inscription of polygons in unicursal cubics	181
Cisoid, its properties	182
Acnodal cubic has real inflexions, crunodal imaginary	184
Construction for acnode given three inflexional tangents	184
General expression for coordinates in terms of parameter	185
SECTION V. INVARIANTS AND COVARIANTS OF CUBICS	188
Canonical form of cubic	188

	PAGE
Notation for general equation	189
General equation of Hessian and of Cayleyan	190
Invariant S , and its symbolical form	191
Invariant T	192
General equation of reciprocal	193
Calculation of invariants by the differential equation	194
Discriminant expressed in terms of fundamental invariants	196
Hessian of $\lambda U + \mu H$	196
Conditions that general equation should represent three right lines	197
Reduction of general equation to canonical form	198
Expression of discriminant in terms of fundamental invariants	199
Of anharmonic ratio of four tangents from any point on curve	199
Covariant cubics expressed in form $\lambda U + \mu H$	201
Sextic covariants	202
The skew covariant	202
Equation of nine inflexional tangents	203
Equation of Cayleyan in point coordinates	203
Identical equation in theory of cubics	205
Conic through five consecutive points on cubic	207
Equation expressed in four line coordinates	209
Conditions that cubic should represent conic and line	210
Discriminant of cubic expressed as determinant	211
Hessian of PU and UV	212

CHAPTER VI.

QUARTICS.

Genera of quartics	213
Special forms of quartics	214
Illustration of the different forms	215
Distinction of real and imaginary	217
Flecnodes and biflecnodes	217
Quartic may have four real points of undulation	218
Quartics may be quadripartite	219
Zeuthen's classification of quartics	220
Number of real bitangents	220
Inflexions of quartics, how many real	221
Classification of quartics in respect of their infinite branches	222
THE BITANGENTS	223
Discussion of equation $UW = V^2$	224
There are 315 conics passing through eight contacts of bitangents	227
Scheme of these conics	228
Hesse's algorithm for the bitangents	230
Geiser's method of connecting bitangents with solid geometry	231
Cayley's rule of bifid substitution	232
Bitangents whose contacts lie on a cubic	234
Aronhold's discussion of the bitangents	234
From 7 bitangents the rest can be found by linear constructions	237
Aronhold's algebraic investigation	238
BINODAL AND BICIRCULAR QUARTICS	240
Tangents from nodes of a binodal are homographic	241
Foci of bicircular quartic lie on four circles	242

CONTENTS.

XVII

	PAGE
Casey's generation of bicircular quartics	243
Two classes of bicircular quartics	246
Relations connecting focal distances of point on bicircular	246
Confocal bicirculars cut at right angles	247
Hart's investigation	248
Cartesians	250
The limaçon and the cardioide	252
Focal properties obtained by inversion	252
Inscription of polygons in binodal quartics	253
UNICURSAL QUARTICS	254
Correspondence between conics and trinodal quartics	254
Tangents at or from nodes touch the same conic	256
Tacnodal and oscnodal quartics	258
Triple points	259
Expression of coordinates by a parameter	260
INVARIANTS AND COVARIANTS OF QUARTICS	263
General quartic cannot be reduced to sum of five fourth powers	265
Covariant quartics	269
Examination of special case	269
Covariant conics	273

CHAPTER VII.

TRANSCENDENTAL CURVES.

The cycloid	275
Geometric investigation of its properties	276
Epicycloids and epitrochoids	278
Their evolutes are similar curves	281
Examples of special cases	282
Limaçon generated as epicycloid	282
Steiner's envelope	283
Reciprocal of epicycloid	283
Radius of curvature of roulettes	284
Trigonometric curves	285
Logarithmic curves	286
Catenary	287
Tractrix and synttractrix	288
Curves of pursuit	290
Involute of circle	290
Spirals	291

CHAPTER VIII.

TRANSFORMATION OF CURVES.

LINEAR TRANSFORMATION	295
Anharmonic ratio unaltered by linear transformation	296
Three points unaltered by linear transformation	297
Projective transformation	298

	PAGE
Homographic transformation may be reduced to projection	299
INTERCHANGE OF LINE AND POINT COORDINATES	301
Method of skew reciprocals	303
Skew reciprocals reducible to ordinary reciprocals	306
QUADRIC TRANSFORMATIONS	308
Inversion, a case of quadric transformation	310
Applications of method of inversion	312
RATIONAL TRANSFORMATION	313
Roberts's transformation	313
Cremona's rational transformation	316
If three curves have common point their Jacobian passes through it	319
Deficiency unaltered by Cremona transformation	321
Every Cremona transformation may be reduced to a succession of quadric transformations	322
TRANSFORMATION OF A GIVEN CURVE	324
Rational transformation between two curves	324
Deficiency unaltered by rational transformation	326
Transformation, so that the order of the transformed curve may be as low as possible	329
Expression of coordinates by means of elliptic functions when $D = 1$	330
and by means of hyper-elliptic functions when $D = 2$	330
Theorem of constant deficiency derived from theory of elimination	331
CORRESPONDENCE OF POINTS ON A CURVE	331
Collinear correspondence of points	331
Correspondence on a unicursal curve	332
Number of united points	333
Correspondence on curves in general	334
Inscription of polygons in conics	337
in cubics	337

CHAPTER IX.

GENERAL THEORY OF CURVES.

Cayley's method of solving the general problem of bitangents	341
Order of bitangential curve	342
Hesse's reduction of bitangential equation	344
Bitangential of a quartic	349
Second method of solving problem of double tangents	351
Formation of equation of tangential curve	355
Application to quartic	356
POLES AND POLARS	357
Jacobian, properties of	357
Steiner's theorems on systems of curves	360
Tact-invariants	360
Discriminant of discriminant of $\lambda u + \mu v$ and of $\lambda u + \mu v + \nu w$	362
Condition for point of undulation	362
For coincidence of double and stationary tangent	362
Steinerian of a curve	363
Its characteristics	363
The Cayleyan or Steiner-Hessian	364
Its characteristics	365

CONTENTS.

xix

	PAGE
Generalization of the theory	365
OSCULATING CONICS	368
Aberrancy of curvature	368
Investigation of conic of 5-point contact	370
Determination of number of sextactic points	372
SYSTEMS OF CURVES	372
Chasles' method	373
Characteristics of systems of conics	374
Number of conics which touch five given curves	375
Zeuthen's method	377
Degenerate curves	377
Cayley's table of results	380
Number of conics satisfying five conditions of contact with other curves	382
Professor Cayley's note on degenerate forms of curves	383

NOTES.

Professor Cayley on the bitangents of a quartic	387
---	-----

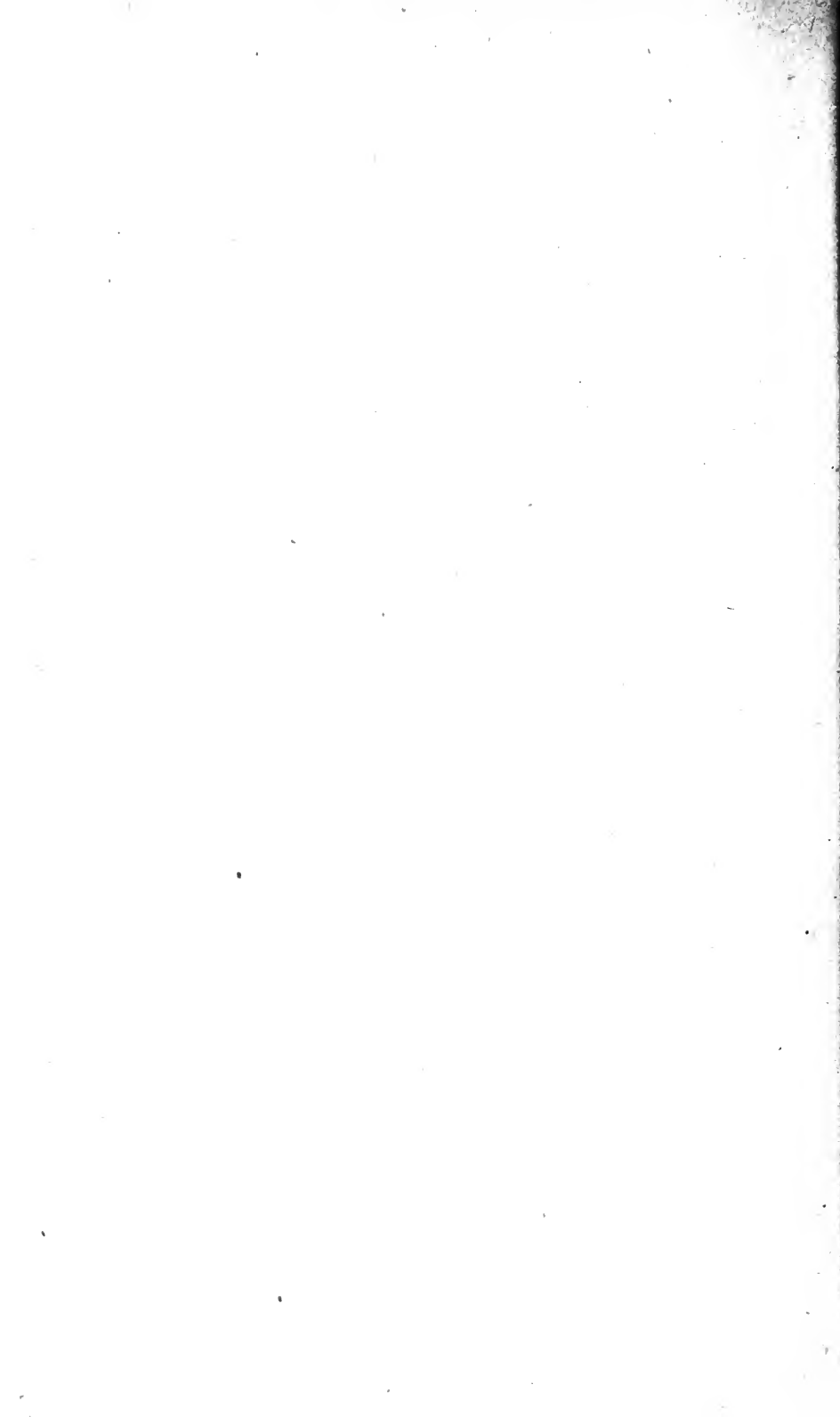

HIGHER PLANE CURVES.

CHAPTER I.*

COORDINATES.

POINT-COORDINATES.

1. WE have in the plane a special line, the line infinity; and on this line two special (imaginary) points, the circular points at infinity. A geometrical theorem has either no relation to the special line and points, and it is then *descriptive*; or it has a relation to them, and it is then *metrical*.

2. The coordinates used for determining the position of a point in the plane are Cartesian (rectangular or oblique) or else trilinear; the latter, however, including as a particular case the former. Speaking generally we may say that the Cartesian (rectangular) coordinates are best adapted for the discussion of metrical properties; trilinear coordinates for that of descriptive properties; but for metrical properties there is often great convenience in using the notation of trilinear coordinates, the equation of a curve being presented as a homogeneous equation in (x, y, z) , where x, y are ordinary rectangular coordinates, and z is $= 1$.

It is proper to consider in some detail the theory of the foregoing kinds of coordinates.

3. As defined *Conics*, Art. 62, the trilinear coordinates of a point are its perpendicular distances (p, q, r) from three given lines: it is assumed that the lines form a triangle (viz. that

* This chapter is by Professor Cayley.

no two of them are parallel), and then if (a, b, c) are the sides of this triangle, and Δ its area, and if, moreover, the coordinates (p, q, r) are taken to be positive for a point within the triangle, the coordinates p, q, r satisfy the relation (*Conics*, Art. 63)

$$ap + bq + cr = 2\Delta.$$

By means of this relation, an equation, not originally homogeneous, can be made homogeneous; and it is always assumed that this has been done, and, in fact, the equations made use of are always homogeneous.

4. But a more general definition of trilinear coordinates is advantageous; viz., without in anywise fixing the absolute magnitudes of the coordinates (x, y, z) , we may take them to be proportional to given multiples $(\alpha p, \beta q, \gamma r)$ of the original trilinear coordinates (p, q, r) .

Observing that the distance measured in a given direction is a given multiple of the perpendicular distance of a point from a line, the definition may be stated with equivalent generality in several forms as follows: the trilinear coordinates (x, y, z) of a point in the plane are proportional to

given multiples of the perpendicular distances—

given multiples of the distances measured in given directions—

given multiples of the distances measured in one and the same given direction—

the distances measured in given directions—
of the point from three given lines.

The three given lines, say the lines $x = 0, y = 0, z = 0$, are said to be the axes of coordinates, or simply the axes; and the triangle formed by them, the fundamental triangle, or simply the triangle.

Observe that while the quantities (x, y, z) remain indeterminate as regards absolute magnitude, there can be no identical relation connecting them; and the equations which we use, being necessarily homogeneous, express relations between the mutual ratios of the coordinates.

5. It is not in general desirable to do so, but we may, if we please, fix the absolute magnitudes of the coordinates, and say (x, y, z) are equal to $(\alpha p, \beta q, \gamma r)$ respectively; the coordinates are in this case connected by the relation

$$\frac{\alpha x}{\alpha} + \frac{\beta y}{\beta} + \frac{\gamma z}{\gamma} = 2\Delta,$$

which relation serves to determine the absolute magnitudes of the coordinates (x, y, z) of any particular point when their ratios are known.

It is scarcely necessary to remark that the distance of a point from a line is considered to change its sign as the point passes from one to the other side of the line. The selection of the positive and negative sides might be made at pleasure for each of the three lines, but it is in general convenient to fix them in suchwise that for a point within the triangle the ratios $(x : y : z)$, or (when these are determinate in absolute magnitude) the coordinates (x, y, z) , shall be positive.

6. Taking the lines $x = 0, y = 0, z = 0$ to be given lines, the values of the ratios $x : y : z$ depend upon those of the implicit constants α, β, γ , and are thus not as yet completely defined; but we can fix them so that for a given point the ratios $(x : y : z)$ shall have given values. Thus, if for the given point whose perpendicular distances are p_1, q_1, r_1 the ratios are to have the given values $x_1 : y_1 : z_1$, this completes the determination of the coordinates, viz., we have

$$x : y : z = \frac{x_1}{p_1} p : \frac{y_1}{q_1} q : \frac{z_1}{r_1} r.$$

Again, what is nearly the same thing, we can choose our coordinates so that a given linear equation $Ax + By + Cz = 0$ shall represent a given line. In fact, if the equation of the given line in terms of the coordinates (p, q, r) is $ap + bq + cr = 0$, then we have thus the determination

$$x : y : z = \frac{a}{A} p : \frac{b}{B} q : \frac{c}{C} r.$$

It is not in general desirable to make any use of the equations just written down; the convenient course is to consider the

coordinates to have been fixed in suchwise that the point $(1 : 1 : 1)$ shall be a given point of the figure, or that the line $x + y + z = 0$ shall be a given line of the figure.

7. It is to be observed that we may properly speak of the point (α, β, γ) , meaning thereby the point, the coordinates of which have the mutual ratios $x : y : z$ equal to $\alpha : \beta : \gamma$. And when we speak of the coordinates of a point as being (α, β, γ) , or of (x, y, z) as being equal to (α, β, γ) , we mean the same thing; that is to say, we only assert the equality of ratios, for the very reason that the absolute magnitudes are indeterminate. Thus, in the last paragraph, instead of the point $(1 : 1 : 1)$, we might have spoken of the point $(1, 1, 1)$.

8. The point $(1, 1, 1)$ and line $x + y + z = 0$ (or generally the point (α, β, γ) and line $\frac{x}{\alpha} + \frac{y}{\beta} + \frac{z}{\gamma} = 0$) stand in a well-known geometrical relation to the fundamental triangle, viz. if the point be O , the line will be LMN which joins the intersections with the sides of the fundamental triangle ABC of the corresponding sides of the triangle DEF formed by the points where the lines joining O to the vertices of the fundamental triangle meet the opposite sides; or, conversely, if the line LMN is given, we geometrically construct the point O by joining the points L, M, N where the line intersects the sides of the fundamental triangle to the opposite vertices of that triangle; the joining lines form a new triangle, and the lines joining its vertices to the corresponding vertices of the fundamental triangle meet in the point O . The line and point are in fact "harmonics," or, as will be hereafter explained, they are "pole and polar" in regard to the triangle considered as a cubic curve, or we may say simply in regard to the triangle. Thus, if either the point or the line be given, the other is known, and it is the same

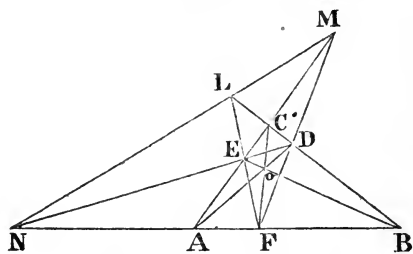

thing whether we assume the point $(1, 1, 1)$ to be a given point, or the line $x + y + z = 0$ to be a given line.

Considering the line $x + y + z = 0$ as a given line, we have in all four given lines, and writing for convenience $x + y + z + w = 0$ (that is, considering w as standing for $-x - y - z$), the determination of the coordinates is such that $x = 0$, $y = 0$, $z = 0$, $w = 0$ are given lines.

9. The coordinates may be such that the point $(1, 1, 1)$ shall be the centre of gravity of the triangle; or, what is the same thing, that the line $x + y + z = 0$ shall be the line infinity. Reverting to the equation $ap + bq + cr = 2\Delta$, this comes to assuming $x : y : z = ap : bq : cr$; viz. if we join the point to the three vertices, so dividing the fundamental triangle into three triangles, then the coordinates x, y, z are proportional to the three component triangles (or, what is the same thing, each coordinate is proportional to the perpendicular distance from a side, divided by the perpendicular distance of the opposite vertex from the same side). And it may be noticed that if, fixing the absolute magnitudes of the coordinates, we assume

$$x, y, z = \frac{ap}{2\Delta}, \frac{bq}{2\Delta}, \frac{cr}{2\Delta};$$

that is, take x, y, z to be *equal* to the component triangles, each divided by the fundamental triangle; then the relation satisfied by the coordinates will be $x + y + z = 1$.

10. A particular case is when the fundamental triangle is equilateral; here if x, y, z be proportional to the perpendicular distances from the sides, $(1, 1, 1)$ is the centre of the figure, and $x + y + z = 0$ is the line infinity; if, fixing the absolute magnitudes, we take (x, y, z) to be equal to the perpendicular distances, and moreover take as unity the perpendicular distance of a vertex from the opposite side, then the coordinates of the centre of the figure are $(\frac{1}{3}, \frac{1}{3}, \frac{1}{3})$, and the relation between the coordinates is $x + y + z = 1$.

In this case, where the fundamental triangle is equilateral and $x + y + z = 0$ the line infinity, the coordinates of the circular points at infinity are $x : y : z = 1 : \omega : \omega^2$ and $1 : \omega^2 : \omega$,

where ω is an imaginary cube root of unity; in fact, taking X, Y as Cartesian (rectangular) coordinates, the origin being at the vertex ($x=0, y=0$) of the triangle, and the coordinate X being along the side $x=0$, we have

$$x, y, z = Y, \frac{X\sqrt{3}-Y}{2}, \frac{2-X\sqrt{3}-Y}{2} \text{ respectively.}$$

But for the circular points at infinity X and Y are infinite and $X \pm iY = 0$ (where $i = \sqrt{-1}$), as usual; wherefore

$$x : y : z = 1 : \frac{-1 \mp i\sqrt{3}}{2} : \frac{-1 \pm i\sqrt{3}}{2},$$

or taking ω to be $= \frac{-1 - i\sqrt{3}}{2}$, and therefore $\omega^2 = \frac{-1 + i\sqrt{3}}{2}$, this is $x : y : z = 1 : \omega : \omega^2$ or $= 1 : \omega^2 : \omega$.

11. Let one of the axes, say that of z , be the line infinity: the distance r has here the value ∞ , which must be regarded as an infinite constant; γr is therefore a constant, which may be made finite, and without loss of generality put $= 1$; we have therefore $x : y : z = \alpha p : \beta q : 1$, where the coefficients α, β may be so determined that $\alpha p, \beta q$ shall represent the distances from the line $x=0$ and from the line $y=0$, each measured in the direction parallel to the other of these lines; that is, if X, Y are the Cartesian coordinates of the point, then $x : y : z = Y : X : 1$; or, what is the same thing, fixing the absolute magnitudes of the coordinates, x, y and $z=1$, will be the Cartesian coordinates of the point referred to any two axes of coordinates.

12. In what just precedes we have used only the line infinity, not the circular points at infinity; and the resulting Cartesian coordinates are in general oblique, but they may be rectangular; viz. taking the lines $x=0, y=0$ as any two lines harmonically related to the circular points at infinity; or, what is the same thing, at right angles to each other, then the coordinates will be rectangular. The harmonic relation referred to is that the two lines meet the line infinity in a pair of points forming with the circular points at infinity a range

of four harmonic points; or, what is the same thing, the two lines and the lines from their intersection to the circular points at infinity form a harmonic pencil. (See *Conics*, Art. 356).

13. It is in some cases convenient to use the imaginary coordinates $\xi = x + iy$, $\eta = x - iy$, and $z = 1$: these may be called circular coordinates.

CIRCULAR POINTS AT INFINITY.

14. For a given system of trilinear coordinates, the coordinates of the circular points at infinity may be obtained as follows. Suppose, first, that the coordinates x, y, z denote the perpendicular distances from the sides of the fundamental triangle; then taking an arbitrary origin O and system of rectangular axes OX, OY , if p, q, r are the perpendicular distances of O from the sides of the triangle, and λ, μ, ν the inclinations of these distances to the axis OX , the relations between the two sets of coordinates (x, y, z) and (X, Y) , are

$$x = X \cos \lambda + Y \sin \lambda - p,$$

$$y = X \cos \mu + Y \sin \mu - q,$$

$$z = X \cos \nu + Y \sin \nu - r.$$

Write for shortness $\cos \lambda + i \sin \lambda$, $\cos \mu + i \sin \mu$, $\cos \nu + i \sin \nu$ (or $e^{i\lambda}$, $e^{i\mu}$, $e^{i\nu}$) = L, M, N respectively; then taking X and Y infinite, and $X \pm iY = 0$, we have for the two circular points respectively

$$x : y : z = L : M : N \text{ and } x : y : z = \frac{1}{L} : \frac{1}{M} : \frac{1}{N}.$$

Writing A, B, C for the angles of the fundamental triangle, we have between A, B, C and λ, μ, ν a set of relations such as

$$A = \pi + \mu - \nu,$$

$$B = -\pi + \nu - \lambda,$$

$$C = \pi + \lambda - \mu,$$

and hence writing $\cos A + i \sin A$, $\cos B + i \sin B$, $\cos C + i \sin C$ (or e^{iA} , e^{iB} , e^{iC}) = α, β, γ respectively, we find

$$\alpha = -\frac{M}{N}, \beta = -\frac{N}{L}, \gamma = -\frac{L}{M}; \alpha\beta\gamma = -1,$$

and the coordinates of the circular points at infinity are thus

$$\begin{aligned} x : y : z &= -1 : \frac{1}{\gamma} : \beta, \quad \text{and} \quad x : y : z = -1 : \gamma : \frac{1}{\beta}, \\ &= \gamma : -1 : \frac{1}{\alpha}, \quad \quad \quad = \frac{1}{\gamma} : -1 : \alpha, \\ &= \frac{1}{\beta} : \alpha : -1, \quad \quad \quad = \beta : \frac{1}{\alpha} : -1, \end{aligned}$$

the three expressions for each set of coordinates being of course identical in virtue of the relation $\alpha\beta\gamma = -1$.

The same formulæ obviously apply to the case where the coordinates x, y, z , instead of being equal, are only proportional to the perpendicular distances from the sides of the triangle; and they are thus the formulæ belonging to the system of coordinates for which the equation to the line infinity is

$$x \sin A + y \sin B + z \cos C = 0.$$

15. It may be added, that the original system of relations between x, y, z and X, Y , gives

$$\begin{aligned} (y+q)(z+r) \sin A + (z+r)(x+p) \sin B + (x+p)(y+q) \sin C \\ = \sin A \sin B \sin C (X^2 + Y^2), \end{aligned}$$

or, what is the same thing, we have

$$\begin{aligned} yz \sin A + zx \sin B + xy \sin C = \sin A \sin B \sin C (X^2 + Y^2) \\ + \text{linear function of } X, Y, 1, \end{aligned}$$

viz. the equation $yz \sin A + zx \sin B + xy \sin C = 0$ is the equation of a circle, and this being so, it is obviously the equation of the circle circumscribed about the fundamental triangle; and the formula holds good in the case where x, y, z are proportional to the perpendicular distances; the circular points at infinity are therefore the intersections of the circle

$$yz \sin A + zx \sin B + xy \sin C = 0,$$

by the line infinity

$$x \sin A + y \sin B + z \sin C = 0,$$

(compare *Conics*, Art. 359), and it is easy to verify that the foregoing expressions of the coordinates of the circular points at

infinity in fact satisfy these two equations. It is to be remarked also, that the general equation of a circle is

$$(yz \sin A + zx \sin B + xy \sin C)$$

$$+ (Px + Qy + Rz)(x \sin A + y \sin B + z \sin C) = 0,$$

where P, Q, R are arbitrary coefficients.

16. In the system of coordinates wherein x, y, z are proportional to the perpendicular distances, each multiplied by the corresponding side, or where the equation of the line infinity is $x + y + z = 0$, we have only in place of the foregoing x, y, z to write $\frac{x}{\sin A}, \frac{y}{\sin B}, \frac{z}{\sin C}$; the coordinates of the circular points are therefore given by

$$\frac{x}{\sin A} : \frac{y}{\sin B} : \frac{z}{\sin C} = -1 : \frac{1}{\gamma} : \beta,$$

$$= \gamma : -1 : \frac{1}{\alpha},$$

$$= \frac{1}{\beta} : \alpha : -1,$$

and
$$\frac{x}{\sin A} : \frac{y}{\sin B} : \frac{z}{\sin C} = -1 : \gamma : \frac{1}{\beta},$$

$$= \frac{1}{\gamma} : -1 : \alpha,$$

$$= \beta : \frac{1}{\alpha} : -1,$$

and the general equation of a circle is

$$(yz \sin^2 A + zx \sin^2 B + xy \sin^2 C) + (Px + Qy + Rz)(x + y + z) = 0.$$

LINE-COORDINATES.

17. The coordinates above considered are coordinates for determining the position of a point; say they are point-coordinates. We have also line-coordinates (tangential coordinates, see *Conics*, Art. 70) for determining the position of a line; viz. if with any given system of trilinear coordinates (x, y, z) , the equation of the line is $\xi x + \eta y + \zeta z = 0$, then we have a corresponding system of line-coordinates, wherein

(ξ, η, ζ) are said to be the coordinates (line-coordinates) of the line in question. Observe that according to this definition (ξ, η, ζ) are given as to their ratios only, their absolute magnitudes are indeterminate; herein resembling point-coordinates according to their most general definition.

18. The coordinates (ξ, η, ζ) belong to a line; a linear equation $a\xi + b\eta + c\zeta = 0$ between these coordinates refers to the whole series of lines, the coordinates of any one of which satisfy this equation; but all these lines pass through a point, viz. the point whose coordinates in the corresponding system of point-coordinates (x, y, z) are (a, b, c) ; the linear equation $a\xi + b\eta + c\zeta = 0$ in fact expresses that the equation in point-coordinates $\xi x + \eta y + \zeta z = 0$ is satisfied on writing therein (a, b, c) for (x, y, z) . The conclusion is, that in the line-coordinates (ξ, η, ζ) , the equation $a\xi + b\eta + c\zeta = 0$ represents a point, viz. the point whose trilinear coordinates in the corresponding system are (a, b, c) . And, generally, any homogeneous equation in the line-coordinates (ξ, η, ζ) represents the curve which is the envelope of all the lines $\xi x + \eta y + \zeta z = 0$, which are such that the coefficients (ξ, η, ζ) satisfy the relation in question; and this relation is said to be the line- or tangential equation of this envelope; in other words, the line-equation of a curve is the equation between (ξ, η, ζ) , which expresses that the line $\xi x + \eta y + \zeta z = 0$ is a tangent to the curve.

19. In what precedes the line-coordinates (ξ, η, ζ) are defined by means of a corresponding system of trilinear coordinates (x, y, z) , the signification of the ratios $\xi : \eta : \zeta$ being thereby in effect completely determined. This is the most convenient course; but, not so much for any application thereof, as in order to more fully establish the analogy between the two kinds of coordinates, it is proper to give an independent quantitative definition of line-coordinates. We may say that the trilinear coordinates (ξ, η, ζ) of a line are proportional to given multiples of the distances measured in given directions of the line from three given points. Suppose, to fix the ideas, we take them proportional to the perpendicular distances of the line from the three given points. If referring the figure

to Cartesian coordinates, the coordinates of the points are (α, β) , (α', β') , (α'', β'') , and the equation of the line is

$$AX + BY + C = 0,$$

then we have

$$\xi : \eta : \zeta = A\alpha + B\beta + C : A\alpha' + B\beta' + C : A\alpha'' + B\beta'' + C,$$

or, what is the same thing, the equation of the line is

$$\begin{vmatrix} X, & Y, & 1 \\ \xi, & \alpha, & \beta, & 1 \\ \eta, & \alpha', & \beta', & 1 \\ \zeta, & \alpha'', & \beta'', & 1 \end{vmatrix} = 0;$$

the coefficients of ξ , η , ζ are here given linear functions of $(X, Y, 1)$, and denoting these coefficients by (x, y, z) we shall have (x, y, z) a system of trilinear coordinates, and the equation will be $\xi x + \eta y + \zeta z = 0$; the definition thus agrees with the one given above.

We may in like manner, as in Art. 6, determine the line-coordinates (ξ, η, ζ) , so that the line $(1 : 1 : 1)$ shall be a given line of the figure, or that the point $\xi + \eta + \zeta = 0$ shall be a given point of the figure.

20. Some particular systems may be mentioned. Let α, β, γ denote respectively the distances in a given direction of the variable line from the points A, B, C , viz. $(\alpha = Aa, \beta = Bb, \gamma = Cc)$; then the coordinates ξ, η, ζ may be taken proportional to these distances, $\xi : \eta : \zeta = \alpha : \beta : \gamma$.

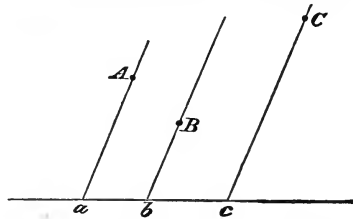

Imagine the point C to move off to infinity in the given direction; γ has an infinite value which must be regarded as a constant; and writing $\xi : \eta : \frac{\zeta}{\gamma} = \alpha : \beta : 1$, we may, instead of the original coordinates, ξ, η, ζ , take as coordinates $\xi, \eta, \frac{\zeta}{\gamma}$; that is, $\alpha, \beta, 1$. We have here a system of two coordinates α, β , which are respectively equal to the distances in a given direction of the line from two fixed points.

21. Again, in the annexed figure we have

$$\frac{\alpha}{\gamma} = \frac{Ap}{Cp}, \quad \frac{\beta}{\gamma} = \frac{Bq}{Cq};$$

or, what is the same thing,

$$\frac{\alpha}{Ap} : \frac{\beta}{Bq} : \gamma = \frac{1}{Cp} : \frac{1}{Cq} : 1.$$

Imagine A, B to go off to infinity in the given directions pC, qC respectively;

Ap, Bq have infinite values which must be regarded as *constants*; and instead of coordinates proportional to α, β, γ , we may take coordinates proportional to $\frac{\alpha}{Ap}, \frac{\beta}{Bq}, \gamma$; that is, we may take as coordinates $\frac{1}{Cp}, \frac{1}{Cq}, 1$; we have thus a system of two coordinates, which are respectively the reciprocals of the distances in two given directions of the line from a fixed point.

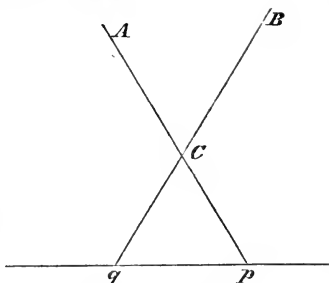

22. There is little occasion for any explicit use of line-coordinates, but the theory is very important; it serves in fact to show that in demonstrating by point-coordinates any descriptive theorem whatever, we demonstrate the correlative theorem deducible from it by the theory of reciprocal polars (or that of geometrical duality), viz. we do not demonstrate the first theorem and deduce from it the other, but we do at one and the same time demonstrate the two theorems; our (x, y, z) instead of meaning point-coordinates may mean line-coordinates, and the demonstration is in every step thereof a demonstration of the correlative theorem.

23. And in like manner when any theorem is demonstrated by line-coordinates, this is also a demonstration of the correlative theorem; the only difference is that we here pass from the somewhat less familiar theory of line-coordinates to the more familiar one of point-coordinates; the transition is rendered clearer if we consider the original line-coordinates (ξ, η, ζ) as being the point-coordinates of the point which is the pole of the line in regard to the conic $x^2 + y^2 + z^2 = 0$.

CHAPTER II.

ON THE GENERAL PROPERTIES OF CURVES OF THE n^{th} DEGREE.

SECT. I.—ON THE NUMBER OF TERMS IN THE GENERAL EQUATION.

24. The first step towards obtaining a knowledge of the general properties of curves of the n^{th} degree is the ascertaining the number of terms in the general equation. We should thereby be enabled, on being given any equation of the n^{th} degree, by simply counting the number of independent constants in the equation, to know whether or not the given form were one to which all equations of the n^{th} degree could be reduced. For example, the general equation of the second degree contains five independent constants. If, then, we were given any other equation of the second degree, containing five constants, for instance,

$$(x - \alpha)^2 + (y - \beta)^2 = (ax + by + c)^2,$$

or $\{(x - \alpha)^2 + (y - \beta)^2\}^{\frac{1}{2}} + \{(x - \alpha')^2 + (y - \beta')^2\}^{\frac{1}{2}} = c,$

we could expand, and comparing the equation (as at *Conics*, Art. 77) with the general equation of the second degree, should obtain a sufficient number of equations to determine α , β , &c., in terms of the coefficients of the general equation. We see, then, that any equation of the second degree may, in general, be reduced to either of the above forms, and we might thus obtain a proof of the properties of the foci and of the directrix. The equation

$$(ax + by + c)^2 = (a'x + b'y + c')(a''x + b''y + c'')$$

contains seven independent constants. The problem, therefore, to express these in terms of the coefficients in the general equation is indeterminate, as is also geometrically evident, since the equation may be thrown into this form by taking

$$a'x + b'y + c', \quad a''x + b''y + c''$$

to represent any two tangents, and $ax + by + c$ their chord of contact. The equations

$$(ax + by)^2 = cx + dy + e,$$

$$(ax + by + 1)(a'x + b'y + 1) = 0,$$

contain each but four independent constants, and must, therefore, implicitly involve one other condition; or, in other words, the general equation cannot be thrown into either of these forms, unless one other condition be fulfilled. This is geometrically evident, since the first equation denotes a parabola and the second two right lines. The general equation of a circle,

$$(x - \alpha)^2 + (y - \beta)^2 = r^2,$$

containing but three expressed constants, must implicitly involve two conditions, or the general equation cannot be thrown into this form unless two conditions be fulfilled. And so, again, the equation

$$S - kS' = 0,$$

(where S, S' are given quadric functions of the coordinates) containing but one expressed constant must imply four conditions; as we otherwise know, since the conic expressed by this equation passes through four fixed points.

25. Some caution must be used in the application of these principles. Thus, the equation

$$(x - \alpha)^2 + (y - \beta)^2 = ax + by + c$$

appears to contain five constants, and, therefore, to be a form to which every equation of the second degree is reducible. But if we expand, we shall see that the constants do not enter into the highest terms of the equation, and that there are but three equations available to determine $\alpha, \beta,$ &c. The equation can, therefore, not be thrown into this form unless two other conditions be fulfilled. In like manner, the equation

$$aS_1 + bS_2 + cS_3 + dS_4 + eS_5 + fS_6 = 0,$$

where $S_1,$ &c., are six conics, is a form to which the equation of any conic may be reduced; but suppose three of the equations of these conics to be connected by the relation $S_3 = kS_1 + lS_2$; substituting this value, the equation would be found to contain but four independent constants, and the general equation could

not be reduced to this form unless some one condition were fulfilled.

26. Having thus endeavoured to give the reader an idea of the nature of the advantage to be gained by a knowledge of the number of terms in the general equation of the n^{th} degree, we proceed to an investigation of this problem. The general equation of the n^{th} degree between two variables may be written,

$$\begin{aligned}
 & A \\
 & + Bx + Cy \\
 & + Dx^2 + Exy + Fy^2 \\
 & + \dots\dots\dots \\
 & + Px^n + Qx^{n-1}y + \dots + Rxy^{n-1} + Sy^n = 0.
 \end{aligned}$$

And the number of terms in this equation is plainly the sum of the series $1 + 2 + 3 + \dots + (n + 1)$, and is therefore equal to $\frac{1}{2}(n + 1)(n + 2)$, as has been already proved (*Conics*, Art. 78).

We shall sometimes write the general equation in the abbreviated form,

$$u_0 + u_1 + u_2 + \dots + u_n = 0,$$

where u_0 denotes the absolute term, and u_1, u_2, u_n , &c., denote the terms of the first, second, n^{th} , &c., degrees in x and y .

We shall also sometimes employ the equation in trilinear coordinates, which only differs from that just written in having a third variable z introduced, so as to make the equation homogeneous, viz.,

$$u_0z^n + u_1z^{n-1} + u_2z^{n-2} + \dots + u_{n-1}z + u_n = 0.$$

The number of terms is evidently the same as in the preceding case (*Conics*, Art. 289).

27. The number of conditions necessary to determine a curve of the n^{th} degree is one less than the number of terms in the general equation, or is equal to $\frac{1}{2}n(n + 3)$. For the equation represents the same curve if it be multiplied or divided by any constant; we may therefore divide by A , and the curve is completely determined if we can determine the $\frac{1}{2}n(n + 3)$

quantities $\frac{B}{A}, \frac{C}{A}$, &c.

Thus a curve of the n^{th} degree is in general determined when we are given $\frac{1}{2}n(n+3)$ points on it; for the coordinates of each point through which the curve passes, substituted in the general equation, give a linear relation between the coefficients. We have, therefore, $\frac{1}{2}n(n+3)$ equations of the first degree to determine the same number of unknown quantities, a problem which admits in general of but one solution. We learn, then, that a curve of the third degree can be described through nine points, one of the fourth degree through fourteen points, and in general through $\frac{1}{2}n(n+3)$ points can be described one, and but one, curve of the n^{th} degree.

28. When we say that $\frac{1}{2}n(n+3)$ points determine a curve of the n^{th} degree, we would not be understood to mean that they always determine a *proper* curve of that degree. All that we have proved is, that there exists an equation of the n^{th} degree satisfied for the given points, but this equation may be the product of two or more others of lower dimensions. Thus, five points in general determine a conic, but if three of them lie on a right line, the conic is the improper quadric curve formed by this right line and the line joining the other two points. And, in general, it is evident that, if of the $\frac{1}{2}n(n+3)$ points more than np lie on a curve of the p^{th} degree (p being less than n), a *proper* curve of the n^{th} degree cannot be described through the points, for we should then have the absurdity of two curves of the n^{th} and p^{th} degrees intersecting in more than np points (*Conics*, Art. 238). The system of the n^{th} degree through such a set of points is the curve of the p^{th} degree, together with a curve of the $(n-p)^{\text{th}}$ degree through the remaining points.

We may even fix a lower limit to the number of points determining a proper curve of the n^{th} degree which can lie on a curve of the p^{th} degree, and can show that this number cannot be greater than $np - \frac{1}{2}(p-1)(p-2)$. For if we suppose that one more of the points (*viz.* $np - \frac{1}{2}(p-1)(p-2) + 1$) lie on a curve of the p^{th} degree, subtracting this number from $\frac{1}{2}n(n+3)$, it will be found that the number of remaining points is $\frac{1}{2}(n-p)(n-p+3)$, and that, therefore, a curve of the $(n-p)^{\text{th}}$ degree can be described through them. This with the curve of the p^{th} degree forms a system of the n^{th} degree through

the points; and it follows from the last Article that it is in general impossible to describe through them any other.

29. There are cases, however, in which the solution of Art. 27 fails: a very simple instance will show that this is so. The number of points required for the determination of a cubic curve is nine; but nine points do not in *every* case determine a single cubic, for any two cubics intersect in nine points; and through *these* nine points there pass the two cubics; as will presently appear, there are in fact through the nine points an infinity of cubics. The explanation is that although m linear equations are in general sufficient to determine m unknown quantities, the equations may be not all of them independent, and they will in this case be insufficient for the determination of the unknown quantities. The given points are then insufficient to determine the curve, and through them can be described an infinity of curves of the n^{th} degree. The geometrical reason why such cases occur requires to be further explained.

Let us, for simplicity, commence with the example of curves of the third degree. Let $U=0$, $V=0$, be the equations of two such curves, both passing through eight given points; then the equation of any curve of the third degree passing through these points must be of the form $U-kV=0$. For this equation, from its form, denotes a curve of the third degree passing through the eight given points, and it contains an arbitrary constant k which can be so determined that the curve shall pass through any ninth point. We should, in fact, have $k = \frac{U'}{V'}$, where U' , V' are the results of substituting the coordinates of the ninth point in U and V . This gives a determinate value for k in every case but one, viz. when the ninth point lies on both U and V ; for since two curves of the m^{th} and n^{th} degrees intersect in mn points, U and V intersect not only in the eight given points, but also in one other. For the coordinates of this point k takes the value $\frac{0}{0}$; and indeed the form of the equation sufficiently shows that every curve represented by the equation $U-kV=0$ passes through *all* the intersections of U and V .

Hence we have the important theorem, *All curves of the third degree which pass through eight fixed points pass also through a ninth.* And we perceive that nine points are not always sufficient to *determine* a curve of the third degree; for we can describe a curve of the third degree through the intersections of two such curves, and through any tenth point.

30. The same reasoning applies to curves of any degree. If there be given a number of points one less than that which will determine the curve $\{\frac{1}{2}n(n+3)-1\}$, then $U-kV=0$ (where U and V are any two particular curves of the system) is the most general equation of a curve of the n^{th} degree passing through these points. For the equation contains one arbitrary constant, to which we can assign such a value that the curve shall pass through any remaining point, and be therefore completely determined. But the form of the equation shows that the curve must pass through *all* the n^2 points common to U and V , and therefore not only through the $\frac{1}{2}n(n+3)-1$ given points, but also through as many more as will make up the entire number to n^2 . Hence, *All curves of the n^{th} degree which pass through $\frac{1}{2}n(n+3)-1$ fixed points pass also through $\frac{1}{2}(n-1)(n-2)$ other fixed points.*

31. The following is a useful deduction from the preceding theorem: *If of the n^2 points of intersection of two curves of the n^{th} degree, np lie on a curve of the p^{th} degree (p being less than n), the remaining $n(n-p)$ will lie on a curve of the $(n-p)^{\text{th}}$ degree.* For describe a curve of the $(n-p)^{\text{th}}$ degree through $\frac{1}{2}(n-p)(n-p+3)$ of these remaining points, and this, together with the curve of the p^{th} degree, form a curve of the n^{th} degree passing through $\frac{1}{2}(n-p)(n-p+3)+np$ points; and since this number {being equal to $\frac{1}{2}n(n+3)-1+\frac{1}{2}(p-1)(p-2)$ } cannot be less than $\frac{1}{2}n(n+3)-1$, this curve will pass through all the remaining points; but, obviously, the remaining points do not any of them lie on the curve of the p^{th} degree, and therefore they lie all of them on the curve of the $(n-p)^{\text{th}}$ degree.

It is to be understood in these theorems concerning the intersections of curves of the n^{th} degree, that the curves need not be proper curves of that degree, for the demonstration in Art. 30

holds equally even though U or V be resolvable into factors. As an illustration of the theorem of this Article, we add the following: *If a polygon of $2n$ sides be inscribed in a conic, the $n(n-2)$ points, where each odd side intersects the non-adjacent even sides, will lie on a curve of the $(n-2)^{\text{th}}$ degree.* For the product of all the odd sides forms one system of the n^{th} degree, and the product of all the even sides another; these systems intersect in n^2 points, viz. since each odd side has two adjacent and $n-2$ non-adjacent even sides, in the $2n$ vertices of the polygon, and the $n(n-2)$ points, which are the subject of the present theorem. But since, by hypothesis, the $2n$ vertices lie on a conic, the remaining $n(n-2)$ points, by this Article, lie on a curve of the $(n-2)^{\text{th}}$ degree.

32. Pascal's theorem is a particular case of the theorem just given, but on account of the importance that the learner should clearly understand the principle of the foregoing demonstrations, we think it advisable to repeat in other words the proof already given.

Denote the sides of the hexagon by the first six letters of the alphabet $A=0$, &c.; then $ACE-kBDF=0$ is the equation of a system of curves of the third degree passing through AB, BC, CD, DE, EF, FA , and also through AD, BE, CF . If the first six points lie on a conic S , then the curve of the system determined by the condition that it shall pass through any seventh point of the conic S must give $ACE-k'BDF=SL$. For it cannot be a proper curve of the third degree, since no such curve can have more than six points common with S . The right line L will therefore contain the three points AD, BE, CF .

We may add, that it is this proof of Pascal's theorem which leads most readily to Steiner's and Kirkman's theorems (*Conics*, p. 361). Thus, let

$$12.34.56 - 45.61.23 = SL,$$

where 12 denotes the line joining the vertices 1, 2, &c.; and where L consequently denotes the line through the intersections of the opposite sides, 12, 45; 34, 61; 56, 23; and let

$$12.34.56 - 36.25.14 = SM;$$

then, obviously,

$$45.61.23 - 36.25.14 = S(M - L);$$

or the Pascal line indicated by the latter equation passes through the intersection of the other two.

It may, however, be remarked that the theorem of Art. 31, in the case in question $n = 3$, is a particular case of the theorem of Art. 30; viz., the system of the three odd sides is one of the cubics, and the system of the three even sides the other of the cubics $U = 0$, $V = 0$ of Art. 30. And we may deduce Pascal's theorem directly from that theorem; viz., considering the conic through the six vertices, and the line joining two of the three points of intersection of the opposite sides, the conic and line form a cubic through eight of these nine points, and therefore through the ninth point; that is, the line passes through the remaining one of the three points of intersection of the opposite sides; viz., these three points lie in a line.

33. It has been proved that, although two curves of the n^{th} degree intersect in n^2 points, yet n^2 points, taken arbitrarily, will not be the intersections of two such curves; but that $n^2 - \frac{1}{2}(n-1)(n-2)$ of them being given, the rest will be determined. A similar theorem holds with regard to the np points of intersection of two curves of the n^{th} and p^{th} degrees. Thus, though a curve of the third degree intersects one of the fourth in twelve points, yet through twelve points taken arbitrarily on a curve of the third degree, it will, in general, be impossible to describe a proper curve of the fourth degree. For the system of the fourth degree through these twelve and any other two points will, in general, be no other than the curve of the third degree and the line joining the two points. And, generally, *Every curve of the n^{th} degree which is drawn through $np - \frac{1}{2}(p-1)(p-2)$ points on a curve of the p^{th} degree (p being less than n) meets this curve in $\frac{1}{2}(p-1)(p-2)$ other fixed points.* For we had occasion in Art. 31 to see that

$$np - \frac{1}{2}(p-1)(p-2) + \frac{1}{2}(n-p)(n-p+3) = \frac{1}{2}n(n+3) - 1;$$

therefore, by Art. 30, every system of the n^{th} degree described through the given points, and $\frac{1}{2}(n-p)(n-p+3)$ others, passes through $\frac{1}{2}(n-1)(n-2)$ other fixed points. But one system of

the n^{th} degree which can be described through the points is the given curve of the p^{th} degree and one of the $(n-p)^{\text{th}}$ through the additional assumed points. The $\frac{1}{2}(n-1)(n-2)$ new points must therefore lie, some on one, some on the other of these two curves. And it is evident that these points must be so distributed between them as to make up the total number of points, in the first case, to np , in the second to $n(n-p)$. Hence the truth of the theorem enunciated is manifest.

34. A further extension of this theorem has been given by Prof. Cayley: "*Any curve of the r^{th} degree (r being greater than m or n , but not greater than $m+n-3$), which passes through all but $\frac{1}{2}(m+n-r-1)(m+n-r-2)$ of the mn intersections of two curves of the m^{th} and n^{th} degree, will pass also through the remaining intersections.*"

The reader will more easily understand the spirit of the general proof we are about to give by applying it first to a particular example. "Any curve of the fifth degree which passes through fifteen of the intersections of two curves of the fourth degree will also pass through the remaining intersection." For take two arbitrary points on each of the curves of the fourth degree. These four, with the fifteen given points, make nineteen points, through which, if several curves of the fifth degree pass, they will (by Art. 30) pass through six other fixed points. But each curve of the fourth degree, together with the line joining the two arbitrary points on the other curve, forms a system of the fifth degree through the nineteen points. Hence *all* the intersections of the given curves of the fourth degree lie on every curve of the fifth degree through the points. Q. E. D.

So, in general, take $\frac{1}{2}(r-m)(r-m+3)$ arbitrary points on the curve of the n^{th} degree, and through them draw a curve of the $(r-m)^{\text{th}}$ degree; and take $\frac{1}{2}(r-n)(r-n+3)$ points on the curve of the m^{th} degree, and through them draw a curve of the $(r-n)^{\text{th}}$ degree; take as many of the mn points of intersection as with the arbitrary points make up $\frac{1}{2}r(r+3)-1$; then, since the curves of the $(r-m)^{\text{th}}$ and m^{th} degree make one system of the r^{th} degree through the points, and the curves of the $(r-n)^{\text{th}}$ and n^{th} make another, the intersection of these two

systems will be common to every curve of the r^{th} degree through the points. But

$$\begin{aligned} \frac{1}{2}r(r+3) - 1 - \frac{1}{2}(r-m)(r-m+3) - \frac{1}{2}(r-n)(r-n+3) \\ = mn - \frac{1}{2}(m+n-r-1)(m+n-r-2), \end{aligned}$$

as the reader may verify without difficulty. Hence the truth of the theorem appears. To make the proof applicable r must be at least equal to the greater of m or n ; and also $r-m$ must be less than n , since otherwise it would not be possible to describe, through the assumed points on the curve of the n^{th} degree, a curve of the $(r-m)^{\text{th}}$ degree, distinct from or not including as part of itself the curve of the n^{th} degree; and, since the theorem is nugatory for $r=m+n-1$ or $m+n-2$, the condition is r not greater than $m+n-3$.*

SECT. II.—ON THE NATURE OF THE MULTIPLE POINTS AND TANGENTS OF CURVES.

35. The simplest method of introducing to the reader the subject of the singular points and lines connected with curves seems to be, first, to illustrate by particular examples the nature of these points and lines, and afterwards to lay down rules by which their existence may be detected in general.

We shall employ the Cartesian equation given in Art. 26.

* Euler appears first to have noticed the paradox, that two curves of the n^{th} degree may intersect in a greater number of points than are sufficient to determine such a curve (see a Memoir in the *Berlin Transactions* for 1748, "On an apparent Contradiction in the Theory of Curves"). The same difficulty is pointed out by Cramer, in his "Introduction à l'Analyse des Lignes courbes algébriques," published in the year 1750. It was only comparatively recently, however, that the important geometrical theorems were observed, which are derived from this principle. In the year 1827 M. Gergonne gave the theorem of Art. 31 (*Annales*, vol. XVII., p. 220). The general theorem of Art. 30 was given about the same time by M. Plücker (*Entwicklungen*, vol. I., p. 228; and Gergonne's *Annales*, vol. XIX., pp. 97, 129). It was some years afterwards that the cases were discussed of the relation which exists between the points of intersection of curves and surfaces of different degrees (as in Art. 33). These cases were discussed in two papers sent at the same time for publication in Crelle's *Journal*, one by M. Jacobi (vol. XV., p. 285), the other by M. Plücker (vol. XVI., p. 47). Besides the papers just mentioned, the reader may also consult a Memoir by Prof. Cayley (*Cambridge Math. Journal*, vol. III., p. 211). The historical sketch given in the present note is taken from Plücker's *Theorie der Algebraischen Curven*, p. 13.

If we transform this equation to polar coordinates, by substituting $\rho \cos \theta$, $\rho \sin \theta$ for x and y (or if the axes be not rectangular, $m\rho$, $n\rho$, as at *Conics*, Art. 136), we get an equation of the n^{th} degree in ρ , whose roots are the distances from the origin of the n points, where the curve is met by a line drawn through the origin, making an angle θ with the axis of x .

36. If in the general equation the absolute term $A = 0$, then the origin is a point on the curve; for the equation is evidently satisfied by the values $x = 0$, $y = 0$, that is, by the coordinates of the origin.

The same thing appears from the equation expressed in polar coordinates,

$$(B \cos \theta + C \sin \theta) \rho + (D \cos^2 \theta + E \cos \theta \sin \theta + F \sin^2 \theta) \rho^2 + \&c. = 0;$$

for this equation being divisible by ρ , one of its roots must be $\rho = 0$, whatever be the value of θ , and therefore one of the n points, in which every line drawn through the origin meets the curve, will, in this case, coincide with the origin itself.

The other $(n - 1)$ points will in general be distinct from the origin; there is, however, one value of θ , for which a second point will coincide with the origin, viz., if θ be such that

$$B \cos \theta + C \sin \theta = 0.$$

The equation then becoming

$$(D \cos^2 \theta + E \sin \theta \cos \theta + F \sin^2 \theta) \rho^2 + \&c. = 0,$$

is divisible by ρ^2 , and has, therefore, for two of its roots, $\rho = 0$. The line, therefore, answering to this value of θ , meets the curve in two coincident points, or is the *tangent* at the origin.

Since we have a simple equation to determine $\tan \theta$, we see that at a given point on a curve there can, in general, be drawn but one tangent. Its equation is evidently

$$\rho (B \cos \theta + C \sin \theta) = 0, \text{ or } Bx + Cy = 0.$$

Hence if the equation of a curve be $u_1 + u_2 + \&c. = 0$ (the origin being a point on the curve), then $u_1 = 0$ is the equation of the tangent.

If $B = 0$, the axis of x is a tangent; if $C = 0$, the axis of y .

37. Let us now, however, suppose that A, B, C are all $= 0$; the coefficients of ρ will then $= 0$, whatever be the value of θ ; in this case, therefore, *every* right line drawn through the origin meets the curve in two points which coincide with the origin. The origin is then said to be a *double* point.

We may see now, exactly as in the last Article, that it is in this case possible to draw through the origin lines which meet the curve in three coincident points. For let θ be such as to render the coefficient of $\rho^2 = 0$, or $D \cos^2 \theta + E \sin \theta \cos \theta + F \sin^2 \theta = 0$, then the equation becomes divisible by ρ^3 , and three values of ρ are $= 0$. Since we have a quadratic to determine $\tan \theta$, it follows that there can be drawn through a double point *two* right lines, each of which meets the curve in three coincident points; their equation is

$$\rho^2 (D \cos^2 \theta + E \sin \theta \cos \theta + F \sin^2 \theta) = 0, \text{ or } Dx^2 + Exy + Fy^2 = 0.$$

We learn hence that although every line through a double point meets the curve in two coincident points, yet there are two of these lines which have besides contact (*viz.*, a consecutive point common) with the curve at that point; so that it is usual to say that at a double point on a curve there can be drawn two tangents. If the equation of the curve (the origin being a double point) be written $u_2 + u_3 + \&c. = 0$, then $u_2 = 0$ is the equation of the pair of tangents at the origin.

38. It is necessary to distinguish three species of double points, according as the lines represented by $u_2 = 0$ are real, imaginary, or coincident.

I. In the first case the tangents are both real; the double point or *node* is such as that represented in the second figure (Art. 39); an inspection of the curve shows that there are at the node two branches each with its own proper tangent; and the foregoing quadratic equation in fact determines the directions of these two tangents: such a point is termed a *crunode*.

A simple illustration of such double points occurs when the given equation is the product of two equations of lower dimensions, or $U = PQ$. The equation $U = 0$ then represents the two curves denoted by $P = 0$ and $Q = 0$. But if these two be considered as making up a complex curve of the n^{th} degree, this

curve must be said to have pq double points (the points, namely, where P intersects Q); and at each of these points there are evidently two tangents (viz., the tangents to P and Q).

II. The equation $u_2 = 0$ may have both its roots imaginary.

In this case no real point is consecutive to the origin, which is then called a *conjugate point* or *acnode*. Its coordinates satisfy the equation of the curve, but it does not appear to lie on the curve, and, in fact, the existence of such points can only be made manifest geometrically by showing that there are points, no line through which can meet the curve in more than $n - 2$ points.

III. The equation u_2 may be a perfect square; in this case the tangents at the double point coincide, and the curve takes the form represented in the fourth figure (Art. 39). Such points are called *cusps* or *spinodes*. They are also sometimes called *stationary points*; for if we imagine the curve to be generated by the motion of a point, at every such cusp the motion in one direction is brought to a stop, and is exchanged for a motion in the opposite direction.

The reader might suppose that we could illustrate these points, as in the last paragraph, by supposing the curve U to break up into two, P and Q , which touch; for every point of contact will be a double point, the tangents at which coincide. But such a point must be classed among singularities of a higher order than those which we are now considering; for the tangent has at it four points along the complex curve, viz., two on each of the simple curves, while at the cusps we are considering we have seen that the tangent generally meets the curve in only three consecutive points. In order that the tangent at a cusp should meet the curve in four consecutive points, it is necessary not merely that u_2 should be a perfect square, but further, that its square root should be a factor in u_3 ; that is to say, that the equation should be of the form

$$v_1^2 + v_1 v_2 + u_3 + \&c. = 0.$$

Such points arise from the union of two double points, as the reader will readily perceive from the example which we

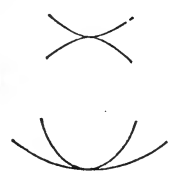

have already given, for when the curves P and Q touch, the point of contact takes the place of two points of intersection.

It is proper to remark that the crunode and the acnode are varieties of the node, and varieties of the same generality, the difference being that of real and imaginary. The cusp has in the investigation presented itself as a particular case of the node, but it is really a distinct singularity; the force of this remark will appear in the sequel.

39. As the learner may probably find some difficulty in conceiving the relation of conjugate points to the curve, we shall illustrate the subject by the following example. Let us take the curve

$$y^2 = (x-a)(x-b)(x-c),$$

where a is less, and c greater than b . This curve is evidently symmetrical on both sides of the axis of x , since every value of x gives equal and opposite values to y . The curve meets the axis of x at the three points $x=a$, $x=b$, $x=c$. When x is less than a , y^2 is negative, and therefore y imaginary; y^2 becomes positive for values of x between a and b ; negative again for values between b and c ; and, finally, positive for all values of x exceeding c . The curve therefore consists of an oval lying between A and B , and a branch commencing at C , and extending indefinitely beyond it.

Let us now suppose $b=c$ and the equation will become

$$y^2 = (x-a)(x-b)^2,$$

where b is greater than a . The point B has now closed up to C ; as B approaches to C , the oval and infinite branch sharpen out towards each other, and when ultimately the two points are united together the oval has joined the infinite branch, and the point B has become a double point, with branches cutting at an angle.

But, on the other hand, let $b=a$, then the equation becomes

$$y^2 = (x-a)^2(x-b),$$

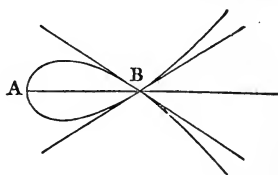
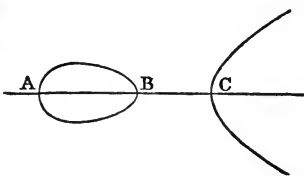

where a is less than b ; the oval has shrunk into the point A , and the curve is of the annexed form.

This example sufficiently shows the analogy between conjugate points and double points, the tangents at which are real.

If we suppose $a=b=c$, the equation becomes $y^2=(x-a)^3$, the point A becomes a cusp, as in III. of last Article, and the tangent at the cusp meets the curve in three coincident points A, B, C .

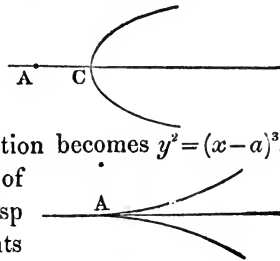

40. If in the general equation A, B, C, D, E, F were all $= 0$, then the origin would be a triple point, every line through the origin meeting the curve in three coincident points; and it is easy to see, as before, that at a triple point there are three tangents, which are the three lines represented by the equation $u_3 = 0$.

We may also, as before, distinguish four species of triple points, according as the three tangents are (a) all three real and (1) all three distinct, (2) two coincident, (3) all three coincident, or (b) one real and two imaginary. A triple point may be regarded as arising from the union of three double points: viz. in the cases (a) these are (1) three crunodes, (2) two crunodes and a cusp, (3) a crunode and two cusps; as illustrated in the annexed figures, which exhibit the three double points as they are about to unite

into a triple point. The case (3) scarcely differs visibly from an ordinary point on the curve, but

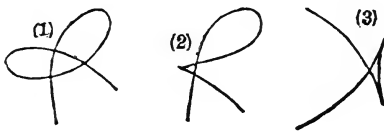

when the figure is drawn accurately there is a certain sharpness of bend at the singular point. In the case (b), there is in like manner a real branch which comes to pass through an acnode: to the eye the singular point does not appear to differ from any other point on the curve.

We may, in like manner, investigate the conditions that the origin should be a multiple point of any higher degree (k). The coefficients of all terms of a degree below k will vanish, and the equation will be of the form

$$u_k + u_{k+1} + \&c. = 0.$$

At the multiple point there can be drawn k tangents, represented by the equation $u_k = 0$; and the nature of the multiple point varies according as the roots of this equation are all real and unequal, or two or more of them equal or imaginary.

A multiple point of the order k may be considered as resulting from the union of $\frac{1}{2}k(k-1)$ double points. This may be illustrated by the case of k right lines, which must be regarded as a system having $\frac{1}{2}k(k-1)$ double points, namely, the mutual intersections of the lines. But if all the lines pass through the same point, this is in the system a multiple point of the order k , and takes the place of all the double points. And the principle is the same whether the lines which intersect be straight or curved. A curve by the mutual crossing of k branches may have $\frac{1}{2}k(k-1)$ double points, but if all the branches pass through the same point, these double points are replaced by a multiple point of the order k ,

41. To be given that a particular point is a double point of a curve is equivalent to three conditions. For if we take it for the origin, three terms of the equation vanish (Art. 37), and the constants at our disposal are three less than in the general case. If we are further given the tangents at the double point, this is equivalent to two conditions more; for in addition to $A = 0$, $B = 0$, $C = 0$, we are now also given the ratios $D : E$, $D : F$.

Being given a triple point is equivalent to six conditions; for, making it the origin, the six lowest terms of the equation vanish; and so in general if it is given that a certain point is a multiple point of the order k , this is equivalent to $\frac{1}{2}k(k+1)$ conditions,

42. There is a limit to the number of double points which a curve of the n^{th} degree can possess, when it does not break up into others of lower dimensions.

For example, a curve of the third degree cannot have two double points; for if it had, the line joining them must be considered as meeting the curve in four points; but more than three points of a curve of the third degree cannot lie on a right line, unless the curve consist of this right line and a conic.

Again, a curve of the fourth degree cannot have four double points; for if it had, the conic determined by these and any fifth point of the curve must be considered as meeting the curve in nine* points; whereas no conic, distinct from the curve, can meet it in more than 2×4 points. And, in general, a curve of the n^{th} degree cannot have more than $\frac{1}{2}(n-1)(n-2)$ double points; for if it had one more, through these $\frac{1}{2}(n-1)(n-2) + 1$ and $n-3$ other points of the curve, we could describe a curve of the degree $n-2$ (Art. 27), which must be considered as meeting the given curve in $2\{\frac{1}{2}(n-1)(n-2) + 1\} + n-3$ points, or in $n(n-2) + 1$ points, which is impossible if the given curve be a proper curve. Of course, the demonstration given only shows that curves cannot have more than a certain number of double points, and does not show (what in fact is the case) that they can always have so many.

43. If the curve have multiple points of higher order, the same criterion applies, each multiple point of order k being counted as equivalent to $\frac{1}{2}k(k-1)$ double points. But there are limitations to the possibility of substituting for a certain number of double points a multiple point of higher order. Thus a curve of the fifth degree may have six double points, and three of these may be replaced by a triple point; but in this case the other three cannot be replaced by a second

* If a point of intersection of two curves be a double point on one of them, that intersection must be reckoned as two, and the curves can only intersect in $np - 2$ other points. If it be a double point on both, the intersection must be reckoned as four. And in general if it be on the one curve a multiple point of the degree k , and on the other of the degree l , that intersection must be counted as kl . Thus, for example, a system of k right lines meets a system of l right lines in kl points; but if all the lines of the first system pass through a point on a line of the second system, that point clearly counts as k intersections, and the lines intersect only in $k(l-1)$ other points. And if every line of both systems pass through the same point, that point counts as kl intersections, and the lines meet nowhere else.

If two curves touch at their point of intersection, the point of contact will, of course, count as two intersections, since they have two coincident points common. If the point of intersection be a multiple point on one or both curves, and if one of the tangents at the multiple point be common to both curves, we must add one to the number of intersections to which it has been already shown that the multiple point is equivalent; for, besides the points just proved to be common, they have a consecutive point in common on one of the branches through the multiple point.

The reader will have no difficulty in seeing the effect of any combination of tangents and multiple points.

triple point, since the line joining the two would meet the curve in more points than five. Or, generally, if a curve have a multiple point of the order $n - 2$, it can have no other higher than a double point, and of these according to the criterion not more than $n - 2$.

44. We call the *deficiency* of a curve the number D , by which its number of double points is short of the maximum; this number playing a very important part in the theory of curves. If $D = 0$, that is, *if a curve have its maximum number of double points, the coordinates of any point on the curve can be expressed as rational algebraic functions of a variable parameter.* For the $\frac{1}{2}(n - 1)(n - 2)$ double points, and $n - 3$ other assumed points on the curve, making together $\frac{1}{2}(n + 1)(n - 2) - 1$ points, or one less than enough to determine a curve of degree $n - 2$, we can describe through these points a system of such curves included in the equation $U = \lambda V$. Now if we eliminate either variable between this equation and that of the given curve, we get to determine the other coordinate for their points of intersection, an equation of the $n(n - 2)$ degree in which λ enters in the n^{th} degree. But of this equation all the roots but one are known; for the intersections of the curves consist of the double points counted twice, of the $n - 3$ assumed points, and only of one other point, since

$$(n - 1)(n - 2) + (n - 3) + 1 = n(n - 2).$$

Dividing out, then, the known factors of the equation, the only unknown root remains determined as an algebraic function of the n^{th} degree in λ .

It is true, conversely, that if the coordinates can be expressed as rational functions of a parameter, the curve has the maximum number of double points. Curves of this sort are called *unicursal* curves. When we are given x, y, z respectively proportional to $a\lambda^n + \&c.$, $a'\lambda^n + \&c.$, $a''\lambda^n + \&c.$, the actual elimination of λ is easily performed dialytically. Writing down the three equations

$$\theta x = a\lambda^n + \&c., \quad \theta y = a'\lambda^n + \&c., \quad \theta z = a''\lambda^n + \&c.,$$

and multiplying each successively by $\lambda, \lambda^2, \dots, \lambda^{n-1}$, we shall have $3n$ equations, exactly enough to eliminate linearly all the quantities $\theta, \theta\lambda, \&c., \lambda, \lambda^2, \&c.$ The equation of the curve,

then, appears in the form of a determinant of the order $3n$, but only n rows will contain the variables; the curve therefore will be of the n^{th} order, and its equation will involve the coefficients $a, b, \&c.$, in the $2n^{\text{th}}$ degree. All this will be more clearly understood if we actually write down the result for the case $n=2$. We have, then, the three equations

$$\theta x = a\lambda^2 + b\lambda + c, \quad \theta y = a'\lambda^2 + b'\lambda + c', \quad \theta z = a''\lambda^2 + b''\lambda + c''.$$

Multiplying each by λ , and then eliminating linearly from the six equations the quantities $\theta, \theta\lambda, \lambda^3, \lambda^2, \lambda$, the result appears as the determinant

$$\begin{vmatrix} x, & a, & b, & c, \\ y, & a', & b', & c', \\ z, & a'', & b'', & c'', \\ & x, & a, & b, & c \\ & y, & a', & b', & c' \\ & z, & a'', & b'', & c'' \end{vmatrix} = 0.$$

This is the same as the final equation, *Higher Algebra*, Art. 193.

45. It appears from Art. 41, that any three points taken arbitrarily may be double points on a curve of the fourth degree; for the three are equivalent to but nine conditions. But the tangents at all these double points cannot also be assumed arbitrarily; for being given the three double points and these three pairs of tangents is equivalent to fifteen conditions, one more than enough to determine the curve. There must then be some relation connecting these tangents; and in fact, we shall prove afterwards that these six tangents all touch the same conic section, so that, given five, the sixth is determined.

Twenty conditions determine a curve of the fifth degree. We may then assume arbitrarily its six double points, and also the pair of tangents at any one of them; but the curve is then completely determined, and therefore also the pairs of tangents at the other five.

Twenty-seven conditions determine a curve of the sixth degree. It would therefore, at first sight, appear that such a curve might be described, having for double points nine points assumed arbitrarily. But this is not so, for there is through the nine points a determinate cubic curve $U=0$; and then

a curve of the sixth order having the nine points for double points, *and in general the only such curve is $U^2 = 0$* , viz. the cubic twice repeated.

And so in like manner for curves of higher degrees, when they have their maximum, or even some number less than their maximum, number of double points there must be relations connecting them. Except in the case of curves of the fourth degree, we are not aware that any attempt has been made to express these relations geometrically, but there must remain an extensive class of theorems of this nature still to be discovered.

46. What has been said is sufficient to enable the reader to form a conception of the nature of multiple points on curves. We shall now proceed to show that a curve may in like manner have multiple tangents; or, in other words, that there may be lines which touch the curve in two or more points, or which have with the curve a contact of the second or higher order. What are commonly called the "singular points" of curves may be reduced to the two classes, either of multiple points, or of points of contact of multiple tangents. As we introduced multiple points to the reader by an examination of the particular case where the origin was a multiple point, so it will be more simple to commence our discussion of multiple tangents by examining the condition that the axis ($y=0$) should be a multiple tangent.

We find in general the points where this line meets the curve by making $y=0$ in the general equation, whence we get

$$A + Bx + Dx^2 + Gx^3 + \dots Px^n = 0,$$

an equation which can be reduced to the form

$$P(x-a)(x-b)(x-c)(x-d) \&c. = 0,$$

where $a, b, \&c.$, are the values of x for the points where the axis meets the curve.

The axis will be a tangent when two of these points coincide, that is, when there is between the roots a single equality $a=b$. The equation here is

$$P(x-a)^2(x-c) \&c. = 0.$$

The axis then touches the curve at the point $y=0, x=a$. If $A=0, B=0$, the axis touches the curve at the origin. We

consider only the case a real, because the equation being real, an equality $a=b$ between two imaginary roots would imply another equality $c=d$ between two other imaginary roots.

The axis is a double tangent if we have between the roots two equalities $c=a, d=b$; the equation is then

$$P(x-a)^2(x-b)^2(x-e) \&c. = 0.$$

We have here the two cases

I. a and b each of them real, when the axis is a tangent at the two real points, $x=a, x=b$. It is evident that such a tangent, meeting the curve in two pairs of coincident points, cannot occur in any curve of a degree lower than the fourth.

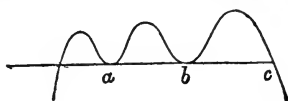

II. a and b imaginary, viz., the equation is here

$$P(x^2+px+q)^2(x-e) \&c. = 0,$$

and we have a double tangent with two imaginary points of contact.

Again, we may have between the roots an equality $a=b=c$. Here the equation is of the form, a being supposed real,

$$P(x-a)^3(x-d) \&c. = 0.$$

The axis then meets the curve in three consecutive points. In general, taking three consecutive points on a curve, the line joining the first and second of these is a tangent, and the line joining the second and third is the consecutive tangent. In the present case, therefore, two consecutive tangents coincide. Hence too, in such a case, the axis may be called a *stationary tangent*; for if we consider the curve as the *envelope* of a moveable line, in this case two consecutive positions of the moveable line coincide. The point of contact of a stationary tangent is called a *point of inflexion*.

If $A=0, B=0, D=0$, the origin is a point of inflexion, and $y=0$ the tangent at it, since then the equation is of the form

$$Px^3(x-c) \&c. = 0.$$

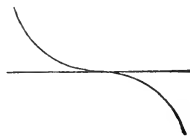

47. The crunode and acnode (Art. 38) correspond precisely to the double tangent with real contacts and the double tangent

with imaginary contacts; the cusp or stationary point also corresponds precisely with the stationary tangent. But there is no correspondence in the analytical theories; for the cusp we have an equality $a = b$, which is a particular case of the unequal values (a, b) , which belong to the crunode and to the acnode; for the inflexion we have a double equality $a = b = c$, which is a relation distinct in kind from the equalities $a = b, c = d$, which belong to the double tangent with real or imaginary contacts. The double point was discussed with point-coordinates; to make the analytical theories agree, the double tangent should have been discussed with line-coordinates—the stationary tangent would then have presented itself as a particular case of the double tangent. But in what precedes the stationary tangent presents itself as a distinct singularity from the double tangent: so with line-coordinates the cusp would have presented itself as a distinct singularity from the double point; and in reference hereto the remark was made, Art 38, that the cusp was really a distinct singularity. The singularities then mutually correspond as follows:

To a double point or node (crunode or acnode),	A double tangent (contacts, real or imaginary),
To a cusp, spinode, or sta- tionary point,	A stationary tangent, or tan- gent at inflexion;

and it is only in a certain point of view that the cusp is a particular case of the double point, and in a different point of view (the reciprocal one) that the stationary tangent is a particular case of the double tangent.

Considering the curve as described by a point which moves along a line at the same time that the line revolves round the point: there is at the cusp a real peculiarity in the motion, the point first becomes stationary, and then reverses the sense of its motion; and so at the inflexion, the line first becomes stationary and then reverses the sense of its motion. At a double point there is no peculiarity in the motion, all that happens is that the point in its course comes twice into the same position; and so, for the double tangent, there is no peculiarity in the motion; all that happens is, that the line in its course comes twice into the same position. The cusp and

stationary tangent are singularities in a more precise sense than are the double point and the double tangent.

48. In ordinary cases the curve lies altogether at the same side of the tangent, but at a point of inflexion the curve crosses the tangent, and lies part on one side and part on the other.

This is a particular case of the following more general theorem: *Two curves which have common an even number of consecutive points touch without cutting; those which have common an odd number of consecutive points cross one another at their point of meeting.*

Let the equations of the two curves be $y = \phi x$, $y = \psi x$; let them intersect at the point $x = a$; then, by Taylor's theorem, the values of the ordinates of the two curves, for the point $x = a + h$, are

$$y_1 = \phi + \frac{d\phi}{dx} \frac{h}{1} + \frac{d^2\phi}{dx^2} \frac{h^2}{1.2} + \frac{d^3\phi}{dx^3} \frac{h^3}{1.2.3} + \&c.$$

$$y_2 = \psi + \frac{d\psi}{dx} \frac{h}{1} + \frac{d^2\psi}{dx^2} \frac{h^2}{1.2} + \frac{d^3\psi}{dx^3} \frac{h^3}{1.2.3} + \&c.$$

where ϕ , ψ , $\frac{d\phi}{dx}$, $\&c.$, are the values of ϕx , ψx , $\frac{d\phi x}{dx}$, $\&c.$, when $x = a$. Now, by hypothesis, $\phi = \psi$, since the curves intersect at the point $x = a$; therefore

$$y_1 - y_2 = \left(\frac{d\phi}{dx} - \frac{d\psi}{dx} \right) \frac{h}{1} + \left(\frac{d^2\phi}{dx^2} - \frac{d^2\psi}{dx^2} \right) \frac{h^2}{1.2} + \left(\frac{d^3\phi}{dx^3} - \frac{d^3\psi}{dx^3} \right) \frac{h^3}{1.2.3} + \&c.$$

Now, by the principles of the differential calculus, when h is indefinitely small, the sign of the sum of this series is the same as the sign of its first term, but the sign of this term is changed when the sign of h is changed; therefore, if at the infinitely near point ($x = a + h$), the ordinate of the curve ϕ be greater than that of the curve ψ , it will be less at the point ($x = a - h$). Hence if two curves have one point common, in general, that which is uppermost at one side of the point will be undermost at the other.

But now suppose that $\frac{d\phi}{dx} = \frac{d\psi}{dx}$, the first term of the series will then be $\left(\frac{d^2\phi}{dx^2} - \frac{d^2\psi}{dx^2} \right) \frac{h^2}{1.2}$, which does *not* change sign when h changes sign. The same curve, therefore, which is

uppermost on one side of the given point, will be uppermost also on the other. But when $\frac{d\phi}{dx} = \frac{d\psi}{dx}$, the curves are manifestly closer to each other than in the previous case, since the difference of the ordinates no longer involves the first power of h ; which is equivalent to what is expressed geometrically, by saying that the curves have two consecutive points common. Or the same thing may be shown thus: $x'y', x''y''$ being the coordinates to rectangular axes of any two points on a curve, $\frac{y' - y''}{x' - x''}$ is plainly the tangent of the angle which the chord joining them makes with the axis of x ; but if the points coincide, we learn that the value of $\frac{dy}{dx}$ for the given point expresses the tangent of the angle which the line joining it to the consecutive point (i.e. the tangent) makes with the axis of x ; consequently, if two curves have a point common, and $\frac{dy}{dx}$ for that point the same for both curves, it follows that the consecutive point is also common.

49. When the curves have three consecutive points common, we shall have $\frac{d^2\phi}{dx^2} = \frac{d^2\psi}{dx^2}$; the first term of the series for $y, -y_{..}$ is $\left(\frac{d^3\phi}{dx^3} - \frac{d^3\psi}{dx^3}\right) \frac{h^3}{1.2.3}$, which does change its sign with h , and therefore, as before, the curves cross at the given point. And so, in general, if the expansion of $y, -y_{..}$ commence with an even power of h , it will not change sign with h , and therefore the curves touch without crossing; but if it commence with an odd power of h , the sign will change with h , and therefore the curves cross at the given point.

The reader has already had an illustration of this, in the case of the circle which osculates a conic at any point, and which, in general, having three points common with the curve, touches and crosses the curve (*Conics*, Art. 239); but at the extremities of the axes the osculating circle passes through four consecutive points, and touches without crossing.

The same investigation applies when one of the curves becomes a right line. A tangent, therefore, at a point of in-

flexion, or any line meeting the curve in an odd number of consecutive points, is crossed by the curve; but a tangent which meets the curve in an even number of consecutive points has the neighbouring part of the curve all at the same side of it.

50. The axis $y=0$ will be a triple tangent when the equation which determines the points where it meets the curve is of the form

$$P(x-a)^2(x-b)^2(x-c)^2(x-d) \&c. = 0.$$

It is evident such a tangent cannot occur in a curve of any degree lower than the sixth. We may, as in Art. 40, distinguish four species of triple tangents according as the points of contact are real and distinct, one real and two imaginary, one real and two coincident, or all three coincident. The last will be the case when the equation is of the form

$$P(x-a)^4(x-b) \&c. = 0;$$

and the axis meets the curve in four coincident points: the point of contact of such a tangent is called a *point of undulation*. In like manner there may be multiple tangents of still higher orders, or again, points of undulation of higher orders, arising when a line meets the curve in more than four coincident points. Cramer calls those points at which the tangent meets the curve in an odd number of consecutive points, points of *visible inflexion*, to distinguish them from those *points de serpentement*, or points of undulation, which do not, to the eye, differ from ordinary points on the curve.

51. We have hitherto only illustrated the case where the origin is a multiple point, or one of the axes a multiple tangent; it is evident, however, that the form of the equation might, in like manner, show the existence of multiple points and tangents situated anywhere.

I. For instance, if the equation be of the form

$$\alpha\phi + \beta\psi = 0,$$

where α, β are linear functions of the coordinates, and ϕ, ψ are any functions of the coordinates, then $\alpha\beta$ is one point on the curve. The equation of the tangent at this point is

$$\alpha\phi' + \beta\psi' = 0,$$

where ϕ' , ψ' are the values which ϕ and ψ assume when we introduce the conditions $\alpha = 0$, $\beta = 0$. For if we seek the $n - 1$ points, in which any line through $\alpha\beta$, ($\alpha = k\beta$) meets the curve, we get an equation of the form

$$\beta \{k(\phi' + M\beta + N\beta^2 + \&c.) + (\psi' + M'\beta + N'\beta^2 + \&c.)\} = 0;$$

and in order that a second root of this should be $\beta = 0$, we must have $k\phi' + \psi' = 0$; whence, substituting for k its value $\frac{\alpha}{\beta}$, we get for the equation of the tangent

$$\alpha\phi' + \beta\psi' = 0.$$

II. In general the curve represented by

$$\alpha\beta\gamma\delta \&c. = \alpha,\beta,\gamma,\delta, \&c.$$

passes through the points

$$\alpha\alpha, \alpha\beta, \alpha\gamma, \&c., \beta\alpha, \beta\beta, \beta\gamma, \&c., \gamma\alpha, \gamma\beta, \gamma\gamma, \&c.$$

III. If the equation be of the form

$$\alpha\phi + \beta^2\psi = 0,$$

we see (as at *Conics*, Art. 252), that α is the tangent at the point $\alpha\beta$, for two of the points in which this line meets the curve coincide.

Or again, if the curve be

$$t_1 t_2 t_3 \dots t_n + \beta^2 \phi = 0,$$

t_1 , &c. are the tangents at the n points, where β meets the curve.

The form of the equation shows that *if the points of contact of n tangents lie on a right line β , the remaining points where these tangents meet the curve lie on the curve of the $(n - 2)^{\text{th}}$ degree ϕ .*

IV. If the equation be of the form

$$\alpha^2\phi + \alpha\beta\psi + \beta^2\chi = 0,$$

and if we seek the points where any line ($\alpha = k\beta$) through $\alpha\beta$ meets the curve, we find that two of these always coincide with $\alpha\beta$, and therefore that this is a double point. It appears precisely as in I., and in Art. 37, that the tangents at this double point are

$$\alpha^2\phi' + \alpha\beta\psi' + \beta^2\chi' = 0,$$

where ϕ' , ψ' , χ' are the values which these functions take for the coordinates of the point $\alpha = 0$, $\beta = 0$.

V. So again, if the equation be of the form

$$\alpha^3\phi + \alpha^2\beta\psi + \alpha\beta^2\chi + \beta^3\omega = 0,$$

the point $\alpha\beta$ is a triple point; the three tangents being given by the equation

$$\alpha^3\phi' + \alpha^2\beta\psi' + \alpha\beta^2\chi' + \beta^3\omega' = 0.$$

VI. If the equation be of the form

$$\alpha\phi + \beta^2\gamma^2\psi = 0,$$

α is a double tangent at the points $\alpha\beta, \alpha\gamma$.

VII. If the equation be of the form

$$\alpha\phi + \beta^3\psi = 0,$$

$\alpha\beta$ is a point of inflexion, and α the tangent at it.

52. We shall first illustrate the last Article by showing how the equation enables us to discern the nature of the points of the curve at an infinite distance. The trilinear equation is (Art. 26)

$$u_n + u_{n-1}z + u_{n-2}z^2 + \&c. = 0.$$

Writing herein $z = 0$, the directions of the n points at infinity are found from the equation $u_n = 0$, which, solved for $y : x$, is of the form

$$(y - m_1x)(y - m_2x)(y - m_3x)(\&c.)(y - m_nx) = 0.$$

A curve of the n^{th} degree has, in general, n asymptotes, namely, the tangents at the n points, where z , the line at infinity, meets the curve. We can find their equations readily as follows, when the equation $u_n = 0$ has been solved for $y : x$. It appears, from III. of the last Article, that if the equation were reduced to the form

$$t_1t_2\dots t_n + z^2\phi = 0,$$

$t_1, \&c.$ would be the n asymptotes. But the given equation

$$(y - m_1x)(y - m_2x)\&c. + zu_{n-1} + z^2u_{n-2} + \&c. = 0$$

may always be reduced to the form

$$(y - m_1x + \lambda_1z)(y - m_2x + \lambda_2z)\&c. = z^2\phi; .$$

for the terms of the n^{th} degree in x and y are obviously the same for both equations, and the n arbitraries, $\lambda_1, \&c.$, in the second, can be so determined as to make the n terms of the $(n - 1)^{\text{th}}$ degree the same for both equations.

The reader will have no difficulty in understanding this method, if he tries to apply it to a particular example; for instance,

$(x+y)(2x+y)(3x+y) + 17x^2 + 11xy + 2y^2 + 12x + 10y + 36 = 0$,
which it is desired to throw into the form

$$(x+y+\lambda_1)(2x+y+\lambda_2)(3x+y+\lambda_3) + Ax + By + C = 0.$$

To determine $\lambda_1, \lambda_2, \lambda_3$ we should then have the three equations

$$6\lambda_1 + 3\lambda_2 + 2\lambda_3 = 17, \quad 5\lambda_1 + 4\lambda_2 + 3\lambda_3 = 11, \quad \lambda_1 + \lambda_2 + \lambda_3 = 2;$$

and the equation may be reduced to the form

$$(x+y+4)(2x+y-3)(3x+y+1) + 43x + 21y + 48 = 0.$$

Observe that the values $\lambda_1, \lambda_2, \lambda_3$ are such that we have identically

$$\frac{17x^2 + 11xy + 2y^2}{(x+y)(2x+y)(3x+y)} = \frac{\lambda_1}{x+y} + \frac{\lambda_2}{2x+y} + \frac{\lambda_3}{3x+y},$$

and so in general the values $\lambda_1, \lambda_2, \dots$ are determined by decomposing $u_{n-1} \div u_n$ into its simple fractions.

53. If two roots of the equation $u_n = 0$ be equal ($m_1 = m_2$), the general equation takes the form $(y - m_1x)^2 \phi + z\psi = 0$; two of the points where z meets the curve coincide, and the line at infinity is therefore a tangent to the curve. But if the factor $y - m_1x$ is also a factor in u_{n-1} , then the curve has a double point at infinity; for the equation is of the form

$$(y - m_1x)^2 \phi + z(y - m_1x)\psi + z^2\chi = 0.$$

Should three roots of the equation $u_n = 0$ be equal, the line at infinity meets the curve in three coincident points, and therefore touches at a point of inflexion.

If in the general equation the coefficient of y^n be $= 0$, the axis of y passes through a point at infinity, and we have evidently only an equation of the $(n-1)^{\text{th}}$ degree to determine the remaining points where it meets the curve.

Should the coefficient of y^{n-1} also vanish, the axis of y will be an asymptote.

54. We shall in a future section show how the singular points of a curve may, in general, be found. But the application of the general methods being usually a work of some difficulty,

the examples given in works on the differential calculus are, for the most part, cases where the existence of the singular points more readily appears from mere inspection of the equations; a selection, including all the most difficult of these examples, will therefore serve to illustrate the preceding Articles. (See Gregory's *Examples*, p. 170, &c.)

Ex. 1. $x^4 - ax^2y + by^3 = 0$.

Ex. 2. $x^4 - 2ax^2y + 2x^2y^2 + ay^3 + y^4 = 0$.

In both cases the origin is a triple point. The tangents of the first are given by the equation $ax^2y = by^3$; and of the second by the equation $2x^2y = y^3$. By Art. 43 neither curve can have any other multiple point.

Ex. 3. $ay^2 - x^3 \pm bx^2 = 0$.

The origin is a double point, whose tangents are given by the equation $ay^2 \pm bx^2 = 0$. If the sign be given positive, the origin is a conjugate point.

Ex. 4. $(x^2 - a^2)^2 = ay^2(2y + 3a)$, or $(x - a)^2(x + a)^2 = ay^2(2y + 3a)$.

Here evidently $(x - a, y)$ and $(x + a, y)$ are double points. To get the tangents at the first, we are to make $x = a, y = 0$ in the parts which multiply $(x - a)^2, y^2$, and we get

$$4(x - a)^2 = 3y^2.$$

In like manner for the tangents at the other double point,

$$4(x + a)^2 = 3y^2.$$

The curve has a third double point, whose existence can be shown by throwing the equation into the form

$$x^2(x^2 - 2a^2) = a(2y - a)(y + a)^2.$$

Hence, $(x, y + a)$ is a double point, and the tangents at it are

$$2x^2 = 3(y + a)^2.$$

Having found these three, we know, by Art. 42, that the curve can have no other multiple point.

Ex. 5. $(by - cx)^2 = (x - a)^3$.

The point $(by - cx, x - a)$ is a cusp of such a nature that the tangent at it meets the curve in five consecutive points.

Ex. 6. $x^4(x + b) = a^3y^2$.

The origin is a double point, the tangent at which meets the curve in four consecutive points. There is a triple point at infinity, to which the line at infinity is the only tangent. The line $x + b$ touches the curve where it meets the axis of x , and also at a point of inflexion at infinity.

Ex. 7. $x^{\frac{2}{3}} + y^{\frac{2}{3}} + z^{\frac{2}{3}} = 0$.

This equation, cleared of radicals, becomes

$$(x^2 + y^2 + z^2)^3 = 27x^2y^2z^2;$$

and in this form the existence of six cusps is manifest, for each of the points where x meets $y^2 + z^2$ is a double point, and x the only tangent at it. Similarly for $(y, x^2 + z^2)$ and $(z, x^2 + y^2)$. But the cusps are all imaginary.

The curve has also four double points, viz. $(x \pm y = 0, x \pm z = 0)$.

This can be proved by putting $y \mp x = u, z \mp x = v$; and therefore

$$y = u \pm x, z = v \pm x.$$

Substituting these values in the given equation, it is of the form

$$u^2\phi + uv\psi + v^2\chi.$$

The tangents at any of the double points will be found to be given by the equation

$$u^2 \pm uv + v^2 = 0,$$

and therefore the double points in question are conjugate points; and, in fact, these are the only real points of the curve.

Or again, the equation may be written

$$9x^2 \{x^4 - x^2(y^2 + z^2) + y^4 - y^2z^2 + z^4\} - (2x^2 - y^2 - z^2)^3 = 0,$$

which is one of three like forms, viz. writing $\xi, \eta, \zeta = y^2 - z^2, z^2 - x^2, x^2 - y^2$, the form is $9x^2(\eta^2 + \eta\zeta + \zeta^2) - (\eta - \zeta)^3 = 0$; putting in evidence the double points $\eta = 0, \zeta = 0$; or, what is the same thing, $\xi = 0, \eta = 0, \zeta = 0$, that is, $x^2 = y^2 = z^2$.

SECT. III.—TRACING OF CURVES.

55. It is proper to give some examples of the method of tracing the figure of a curve from its equation. If we give any value (a) to either of the variables x , the resulting numerical equation can be solved (at least approximately) for y , and will determine the points in which the line $x = a$ meets the curve, By repeating this process for different values of x , as at *Conics*, Art. 16, we can obtain a number of points on the curve; and, by drawing a line freely through them, can obtain a good idea of its figure. By taking notice what values of x render any of the values of y imaginary, we can perceive the existence of ovals, or can observe whether the curve is limited in any direction; and we have already shown (Art. 52) how to find whether the curve has infinite branches, and how to determine its asymptotes. It will be shewn in the next section how to find its multiple points and points of inflexion. The value of $\frac{dy}{dx}$ at any point gives the direction of the tangent at that point (Art. 48); and if we examine for what points $\frac{dy}{dx} = 0$, or $= \infty$, we shall have the points at which the course of the curve is parallel or perpendicular to the axis of x .

In practice we must, of course, take advantage of any simplifications which the equation of the curve suggests. Thus, if we consider a series of lines parallel to one of the asymptotes (or a series of lines passing through a point on the curve), the equation which determines the other points in which each of them meets the curve is of a degree one lower than the degree of the curve. If the equation shows that the curve has a double

or other multiple point, it is advantageous to consider a series of lines drawn through this point, since then the equation in question will lose two or more dimensions.

There is scarcely any exercise more instructive for a student than the tracing of curves, and more particularly those in which the equation contains one or more parameters which assume a succession of different values. In the case of a single parameter, this may be conceived of as an ordinate z in the third dimension of space, and the problem thus, in effect, is to find the form of the several parallel sections of a surface.

It will suffice to add a few examples to those which will incidentally occur in the course of these pages. We refer the reader who may wish for further illustration, to Gregory's *Examples*, Chap. XI.; or, if still unsatisfied, to the source whence all later writers on the subject have drawn largely. Cramer's *Introduction to the Analysis of Curves*.

Ex. 1. $x^4 - ax^2y + by^3 = 0$ (see Ex. 1, p. 41).

Here, the origin being a triple point, it is advantageous to consider a series of lines drawn through it. Substituting $y = mx$, we find $x = m(a - bm^2)$, a function which, as m passes from 0 to $\pm \infty$, increases from 0, when $m = 0$, to a maximum value when $a - 3bm^2 = 0$; then decreases, and vanishes when $a - bm^2 = 0$, and has an indefinitely increasing negative value as m increases further. The curve is manifestly symmetrical in regard to the axis of y . Hence the figure is that here represented.

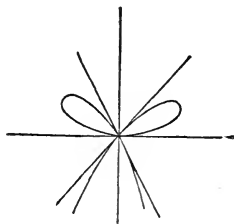

Ex. 2. $(x^2 - a^2)^2 = ay^2(3a + 2y)$, (see Ex. 4, p. 41).

Hence $x^2 = a^2 \pm \sqrt{ay^2(3a + 2y)}$. The curve is plainly symmetrical in regard to the axis of y . It has on each side two branches, corresponding to the two signs which may be given to the radical. The two branches intersect when $y = 0$, and accordingly we have seen that there are on the axis of x two double points at the distance $x = \pm a$. As y increases positively, the radical increases indefinitely; hence the value of x , corresponding to the one branch, increases indefinitely; that corresponding to the other decreases, until we come to the value of y corresponding to the single positive root of the equation $2ay^3 + 3a^2y^2 = a^4$, ($2y = a$), beyond which this branch can extend no higher. For negative values of y , the radical increases to a maximum value when $y + a = 0$; the one pair of branches then intersect in a double point on the axis of y , and the other pair is at its furthest distance from that axis. Evidently neither branch can proceed lower

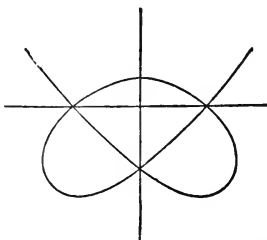

than the value $3a + 2y = 0$. Hence the shape of the curve is that represented in the figure.

Ex. 3. Given base of a triangle $2c$ and rectangle under sides m^2 , the locus of vertex is Cassini's oval, whose equation is, the origin being the middle point of base,

$$(x^2 + y^2 - c^2)^2 - 4c^2x^2 = m^4.$$

The accompanying diagram represents the figure for different values of m . The dark curve represents the figure for $m = c$, the curve being then known as the lemniscate of Bernoulli. When m is less than c , Cassini's curve consists of two conjugate ovals within the parts of this figure: when m is greater than c , of one continuous oval outside it.

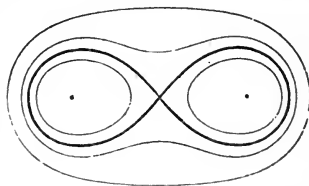

Ex. 4. On the radius vector from a fixed point O to a fixed line MN a portion RP of given length is taken on either side of the right line. The locus of P is a curve called the *conchoid of Nicomedes*, invented by that geometer for the solution of the problem of finding two mean proportionals.

If $OA = p$, $RP = m$, the polar equation is $(\rho \pm m) \cos \omega = p$, and the rectangular equation

$$m^2y^2 = (p - y)^2 (x^2 + y^2),$$

The line MN ($p = y$) touches at a singular point at infinity, and there meets the curve in four consecutive points.

The point O is also a double point, the tangents at which are given by the equations

$$p^2x^2 + (p^2 - m^2)y^2 = 0,$$

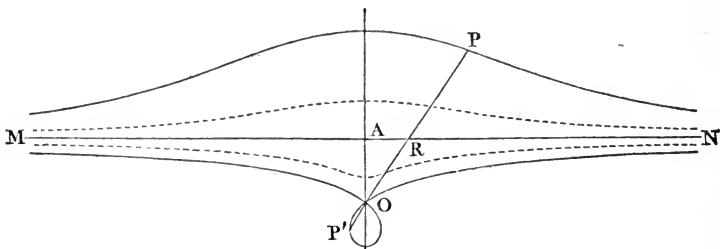

It will therefore be a node, conjugate point, or cusp, according as m is greater, less than, or equal to p . The continuous line represents the case when m is greater than p ; the dotted line that when m is less than p .

Ex. 5. In like manner on the radius vector to a fixed circle from a fixed point on it a portion of fixed length is taken on either side of the circle. The curve is called *Pascal's limaçon*. The polar equation is $\rho = p \cos \omega \pm m$; and the rectangular $(x^2 + y^2 - px)^2 = m^2 (x^2 + y^2)$. The origin is evidently a double point and is a node or conjugate point according as p is greater or less than m . When $p = m$, the origin is a cusp, and the curve is of the form of a heart, and is called the *cardioid*. This is represented by the dark curve in the figure, the inner and outer curves representing the forms with a node and with a conjugate point respectively.

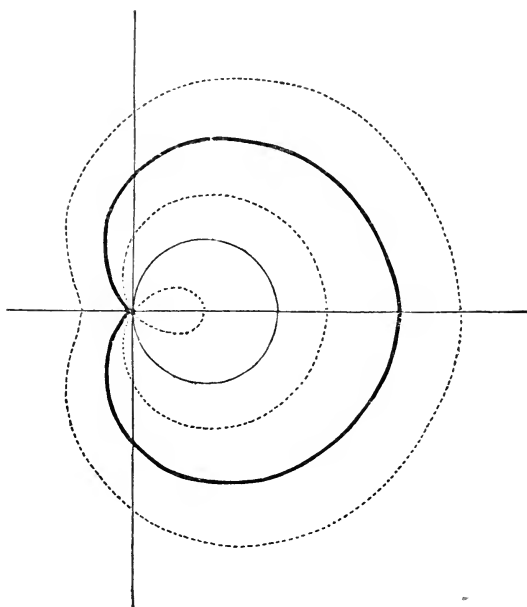

Ex. 6. $(x^2 - a^2)^2 + (y^2 - b^2)^2 = c^4$, where b is supposed less than a . When $c = 0$, the curve consists of the four conjugate points $\pm a, \pm b$. The figures represent the cases, (1) c less than b , (2) $c = b$, (3) c intermediate between b and a , (4) $c = a$, (5) $c > a, < \sqrt[4]{(a^4 + b^4)}$, (6) $c = \sqrt[4]{(a^4 + b^4)}$. When c has a greater value, the curve is of similar form, but without the conjugate point at the origin. When $c = a = b$, the double points of (2) and (4) present themselves simultaneously, and the curve in fact breaks up into two ellipses as in (7).

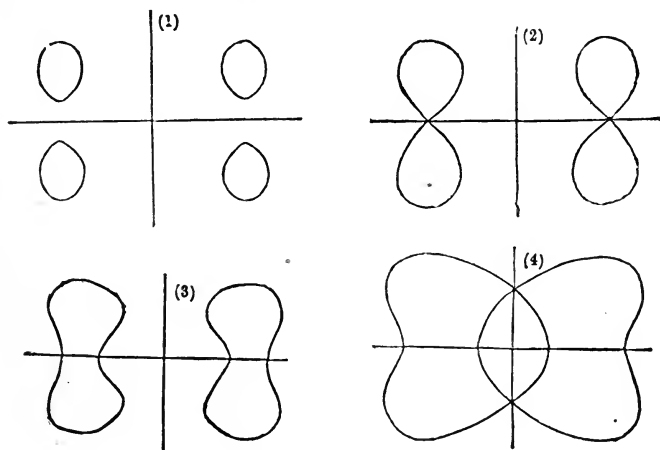

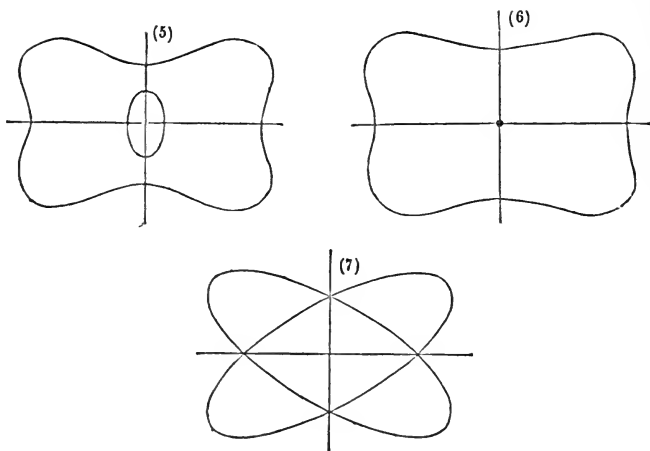

56. If a curve pass through the origin, then if this be an ordinary point on the curve, y may be developed in the form $y = Ax + Bx^2 + \dots$; when the origin is a singular point, the form is $y = Ax^\alpha + Bx^\beta + \&c.$, where α is positive and β and all the indices which follow are greater than α ; it is for determining the nature of the singular point, and the form of the curve in its neighbourhood, very convenient to find even the first term of this development; in fact, in the neighbourhood of the origin the figure resembles that of the curve $y = Ax^\alpha$, which can easily be constructed. In order to effect such a development, we can employ the process given by Newton,* which is most conveniently used in the following form. Write in the equation $y = Ax^\alpha$, and determine the positive quantity α by the condition that the indices of two or more terms shall be equal, and less than the index of any other of the terms. This can always be done by trial, by equating the indices of each pair of terms, and observing whether the resulting value of α is positive, and the equal indices not greater than the indices of some other term. Having thus found α , we determine A by equating to zero the quantity multiplying the terms with equal index.

* See *Methodus Fluxionum et Serierum infinitarum, &c.*, under the heading *De reductione affectarum equationum* (*Opusc.* ed. Castillon, vol. I., p. 37). See also a paper by Professor De Morgan, *Quarterly Journal*, vol. I., p. 1, and *Transactions of the Cambridge Philosophical Society*, vol. IX., p. 608. Newton gives the rule by means of a diagram of squares, in a form different from that given above.

We can then carry on the expansion by substituting $y = Ax^\alpha + Bx^\beta$, where A and α have the values already found; and β and B are determined, if need be, by a similar process; but it usually happens that after the first term or terms the indices will proceed in a regular order, and the coefficients will be each of them linearly determined. Thus, for example, let the curve be $x^3 + y^3 - 3axy = 0$, where the origin is a double point having the two axes for tangents; then, writing $y = Ax^\alpha$ the equation becomes

$$x^3 + A^3x^{3\alpha} - 3aAx^{\alpha+1} = 0.$$

We are now to make two indices equal. Trying first $3 = 3\alpha$, or $\alpha = 1$, we reject this value because it makes the equal indices greater than the index $\alpha + 1$ of the other term. Trying next $3 = \alpha + 1$, or $\alpha = 2$, we find that this value will make the equal indices less than that of the third term. The equation will become $(1 - 3aA)x^3 + A^3x^6 = 0$, and determining A so as to make the coefficient of x^3 vanish, we see that the equation may

be expressed in the form $y = \frac{1}{3a}x^2 + \&c.$, where the indices of the remaining terms are greater than 2; and we learn that the form of one branch of the curve at the origin resembles that of the parabola $3ay = x^2$. And in the third place equating the indices 3α , $\alpha + 1$, we find $\alpha = \frac{1}{2}$. Here again, the equal indices are the lowest and the coefficients of the two terms are A^3 , $-3aA$, whence $A = \sqrt{3a}$, and the branch is $y = \sqrt{3a}x^{\frac{1}{2}} + \&c.$, wherefore near the origin the form approaches to that of the parabola $y^2 = 3ax$. It is not necessary for our present purpose, but if we desire to continue the expansion we should substitute

$y = \frac{1}{3a}x^2 + Bx^\beta$. The lowest terms would then be

$$\frac{1}{27a^3}x^6 + \frac{B}{3a^2}x^{4+\beta} - 3aBx^{\beta+1} = 0.$$

We can then make the indices of two terms equal, and lower than the remaining one, by making $\beta = 5$, whence $B = \frac{1}{81a^4}$.

We have shown, then, that if we trace in the neighbourhood of the origin the two parabolas $3ay = x^2$, $y^2 = 3ax$, we have approximately the figure in that neighbourhood of the curve we wish to construct.

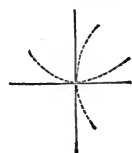

57. The same process will lead to a determination of the infinite branches of the curve. We must then expand y in descending powers of x , and the only difference in the process is that we now make the equal indices greater than that of any other term. Thus, in the example already given, equating the indices $3, 3\alpha$, we have $\alpha=1$, and their coefficient A^3+1 . Attending only to the real value for $A (= -1)$ we substitute $y = -x + Bx^2$, and find in like manner $\beta = 0, B = -a$. We thus get the expression $y = -x - a + \&c.$, and we see that the line $x + y + a = 0$ is an asymptote. The figure is as in the diagram.

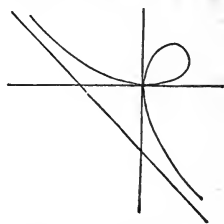

58. In the case of the simple cusp of which we have had an example, see Art. 39, the two branches which meet at the cusp lie on opposite sides of the common tangent, and have their convexities opposed to each other; but there is a cusp (which is a singularity of higher order) in which the branches lie on the same side of the tangent. Thus, in the curve $m(ay-x^2)^2=x^5$, it is plain that any positive values of x give real values for y ; and if we write the equation in the form $ay = x^2 \pm \frac{x^{\frac{5}{2}}}{m^{\frac{1}{2}}}$, then since the last term is less than the preceding when x is small, we see that, whether we use the upper or lower sign, the value of y will be positive for small values of x . The axis of x , then, is a tangent and both branches lie on the upper side of it. The figure is as here represented. These two kinds of cusps have been called keratoid and ramphoid from a fancied resemblance to the forms of a horn and a beak. We have seen (p. 27) that ordinary multiple points of higher order may be regarded as resulting from the union of a number of double points. Professor Cayley has shewn (*Quarterly Journal*, vol. VII. p. 212) that any higher singularity whatever may be considered as equivalent to a certain number of the simple singularities, the node, the ordinary cusp, the double tangent, and the in-

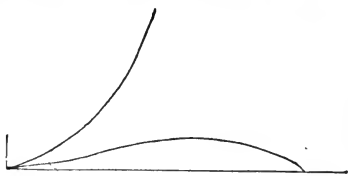

flexion. Thus, a cusp of the kind described in this article is equivalent to one node, one cusp, one double tangent, and one inflexion, as will appear from the annexed figure which exhibits the node and

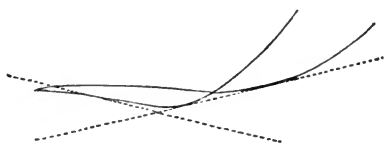

cusp on the point of uniting themselves into the higher singularity in question.

SECT. IV.—POLES AND POLARS.

59. The method that we shall presently use in investigating the conditions that a curve should have multiple points or tangents, and in ascertaining their position, is the same as that already employed in the case of the origin. We shall consider a series of radius vectors drawn through a given point; we shall form the equation which determines the coordinates of the n points where any such radius vector meets the curve, and we shall examine the conditions that one or more of these points may coincide with the given point itself. In order to determine the coordinates of these n points we shall use Joachimsthal's method explained *Conics*, Art. 290. Since the trilinear coordinates of any point on the line joining two points $x'y'z'$, $x''y''z''$ are of the form $\lambda x' + \mu x''$, $\lambda y' + \mu y''$, $\lambda z' + \mu z''$, the points where the joining line meets any curve are found by substituting these values for x, y, z , and then determining the ratio $\lambda : \mu$ by the resulting equation. And it will be a necessary preliminary to the following investigation to discuss carefully the functions which present themselves in this substitution.

If then in U , which is a homogeneous function of the n^{th} order in x, y, z , we substitute $\lambda x + \mu x'$, $\lambda y + \mu y'$, $\lambda z + \mu z'$ for x, y, z , it is evident by Taylor's theorem that the coefficient of λ^n will be U , and that of $\lambda^{n-1}\mu$ will be

$$x' \frac{dU}{dx} + y' \frac{dU}{dy} + z' \frac{dU}{dz}, \text{ or } x'U_1 + y'U_2 + z'U_3, \text{ or } x'L + y'M + z'N,$$

using the abbreviations U_1, U_2, U_3 or L, M, N (as the case may be) for the differential coefficients. We shall use the symbol Δ

to denote the operation $x' \frac{d}{dx} + y' \frac{d}{dy} + z' \frac{d}{dz}$, and the coefficient of $\lambda^{n-1} \mu$ may thus be written ΔU . In like manner the coefficient of $\lambda^{n-2} \mu^2$ will be half

$$x'^2 \frac{d^2 U}{dx^2} + y'^2 \frac{d^2 U}{dy^2} + z'^2 \frac{d^2 U}{dz^2} + 2y'z' \frac{d^2 U}{dydz} + 2z'x' \frac{d^2 U}{dzdx} + 2x'y' \frac{d^2 U}{dxdy},$$

which may be written

$$\left(x' \frac{d}{dx} + y' \frac{d}{dy} + z' \frac{d}{dz} \right)^2 U \text{ or } \Delta^2 U.$$

The second differential coefficients are often written with double suffixes U_{11} , U_{22} , U_{33} , U_{23} , U_{31} , U_{12} , but we find it more convenient to use the letters, a, b, c, f, g, h , and so to write $\Delta^2 U$ in the form we have used in expressing the general equation of a conic

$$ax^2 + by^2 + cz^2 + 2fyz + 2gzx + 2hxy.$$

In like manner the coefficient of $\lambda^{n-3} \mu^3$ in the expansion is $\frac{1}{1.2.3} \Delta^3 U$, and so on; the last coefficient being $\frac{1}{1.2\dots n} \Delta^n U$.

It is evident however from the symmetry of the substitution that this coefficient will be U' , and in general, that the coefficients of any two corresponding terms $\lambda^a \mu^b$, $\lambda^b \mu^a$, only differ by an interchange of accented and unaccented letters. We see thus that $\Delta^{n-1} U$ only differs by a numerical factor from $xU'_1 + yU'_2 + zU'_3$, and generally that

$$\left(x' \frac{d}{dx} + y' \frac{d}{dy} + z' \frac{d}{dz} \right)^{n-p} U, \left(x \frac{d}{dx'} + y \frac{d}{dy'} + z \frac{d}{dz'} \right)^p U,$$

only differ by a numerical factor. We may write the last function $\Delta^p U'$, the accent on the U serving to mark the interchange of accented and unaccented letters.

60. The curve of the $(n-1)$ th degree $\Delta U = 0$ is called the first polar of the point $x'y'z'$, with respect to U . In like manner $\Delta^2 U = 0$ is called the second polar, and so on, the degrees of the successive polar curves regularly diminishing by one, the $(n-2)$ th polar being a conic, and the $(n-1)$ th a right line. And, from the remark just made, it is plain that the equations of the polar line and conic are respectively

$$\left(x \frac{d}{dx'} + y \frac{d}{dy'} + z \frac{d}{dz'} \right) U' = 0, \left(x \frac{d}{dx'} + y \frac{d}{dy'} + z \frac{d}{dz'} \right)^2 U' = 0.$$

Since $\Delta^2 U$ is obtained by performing the operation Δ upon ΔU , it is plain that the second polar of $x'y'z'$, with respect to U , is the first polar of the same point with respect to ΔU ; and generally that the polar curve of any rank is also a polar of the same point with respect to all polar curves of a rank lower than its own; as is evident from the equation $\Delta^k(\Delta^l U) = \Delta^{k+l} U$.

For the origin, for which x' and y' vanish, the operation Δ reduces to differentiating with respect to z . If the ordinary Cartesian equation be made homogeneous by the introduction of the linear unit z (*Conics*, Art. 69), it may be written

$$u_0 z^n + u_1 z^{n-1} + u_2 z^{n-2} + \&c. = 0,$$

and we find without difficulty, by differentiating with respect to z , that the equations of the polar line, conic, &c. of the origin are

$$nu_0 z + u_1 = 0, \quad \frac{1}{2}n(n-1)u_0 z^2 + (n-1)u_1 z + u_2 = 0, \quad \&c.$$

61. *The locus of all the points whose polar lines pass through a given point is the first polar of that point.*

The equation $xU'_1 + yU'_2 + zU'_3 = 0$ expresses a relation between xyz the coordinates of any point on the polar line, and $x'y'z'$ those of the pole. And, as in *Conics*, Art. 89, we indicate that the former coordinates are known and the latter variable, by accentuating the former and removing the accent from the latter coordinates, when the equation becomes $x'U_1 + y'U_2 + z'U_3 = 0$. There are $(n-1)^2$ points, whose polar lines with respect to U will coincide with any given line, or, more briefly, *every right line has $(n-1)^2$ poles*. For take any two points on it, the poles of the right line must lie on the first polar of each of these points; therefore they are the intersections of these curves. Also *the first polars of all the points of a right line have $(n-1)^2$ common points, viz. the $(n-1)^2$ poles of the right line*.

In like manner, the locus of points whose polar conics pass through a given point is the second polar of the point; and so on.

If the polar line (or any other polar) of a point pass through the point, that point will be on the curve. For if we substitute $x'y'z'$ for xyz in the equation of the polar, it becomes identical with the equation of the curve, since the operation

$x \frac{d}{dx} + y \frac{d}{dy} + z \frac{d}{dz}$ performed on a homogeneous function only affects it with a numerical factor.

62. If a curve have a multiple point of the order k , that point will be a multiple point of the order $k-1$ on every first polar, of the order $k-2$ on every second polar, and so on. For if the origin be at the multiple point, the lowest terms in x and y will be of the degree k ; in the first polar, which involves only first differentials of U , the lowest terms in x and y will be of the degree $k-1$, and therefore the origin will be a multiple point of that order; the equation of the second polar, involving second differentials of U , will contain x and y at lowest in the degree $k-2$, and so on.

If two tangents at the multiple point in the curve coincide, the coincident tangent will be a tangent to the first polar. For the lowest term u_k is of the form $a^2bcd\dots$, where a, b, \dots represent linear functions of the coordinates, and hence its differentials will contain a as a factor, and therefore the lowest terms in the equation of the polar contain a as a factor. And, in general, if l tangents to the multiple point on the curve coincide, $l-1$ of them will be coincident tangents at the multiple point on the first polar, $l-2$ at the multiple point on the second polar, and so on. For if u_k have any factor in the l^{th} degree, that factor will be one of the $(l-1)^{\text{th}}$ degree in all the first differentials of u_k ; of the $(l-2)^{\text{th}}$ in all the second differentials, &c.

SECT. V.—GENERAL THEORY OF MULTIPLE POINTS AND TANGENTS.

63. We proceed now to apply the method indicated in Art. 59 to the investigation of the multiple points and tangents of curves. In order to find where the line joining the points $x'y'z'$, $x''y''z''$ meets the curve, we substitute in the equation $\lambda x' + \mu x''$ for x , &c., and we get in order to determine the ratio $\lambda : \mu$, an equation which we may refer to as $\Lambda = 0$, and which may be written

$$\lambda^n U' + \lambda^{n-1} \mu \Delta U' + \frac{1}{2} \lambda^{n-2} \mu^2 \Delta^2 U' + \&c. = 0,$$

it being supposed that in $\Delta U'$, &c., as previously written, $x''y''z''$

have been substituted for xyz . In order that one of the points $\lambda x' + \mu x''$, $\lambda y' + \mu y''$, $\lambda z' + \mu z''$ should coincide with $x'y'z'$, it is obviously necessary that one of the roots of the equation $\Lambda = 0$ should be $\mu = 0$. But this clearly will not be the case unless $U' = 0$; and it is otherwise evident that the condition that $x'y'z'$ should be on the curve is, that its coordinates substituted in the equation of the curve should satisfy it.

64. Two of the points in which the line meets the curve will coincide with $x'y'z'$, if the above equation be divisible by μ^2 ; that is, if not only $U' = 0$ but also $\Delta U' = 0$: now it is plain that if the line joining $x'y'z'$ a point on the curve to $x''y''z''$ meet the curve in two points which coincide with $x'y'z'$, then $x''y''z''$ must lie on the tangent (or tangents if more than one) which can be drawn to the curve at $x'y'z'$: but we have now proved that in this case $x''y''z''$ must satisfy the equation $xU'_1 + yU'_2 + zU'_3 = 0$. Hence, in general, at a given point on the curve there is but one tangent, whose equation is that just written. It appears thus that *the polar line of a point on the curve is the tangent*.

All the other polar curves of the point $x'y'z'$ will touch the curve at that point. For it was proved (Art. 60) that the polar line with respect to the curve U will also be the polar line with respect to each of the polar curves; and (Art. 61) the coordinates $x'y'z'$ satisfy the equation of each of the polar curves; and therefore, by what has been just proved, the polar line with respect to any of them will coincide with the tangent.

65. *The points of contact of tangents drawn to a curve from any point lie on the first polar of that point.* This is a particular case of what was proved in Art. 61, or it may be established directly in the same way. The equation of the tangent at the point $x'y'z'$ having been shewn to be $xU'_1 + yU'_2 + zU'_3 = 0$, then by an interchange of accented and unaccented letters we indicate that the coordinates of a point on the tangent are supposed to be known, and those of the point of contact unknown; and we see that the latter coordinates must satisfy the equation $x'U_1 + y'U_2 + z'U_3 = 0$. The curve and its first polar clearly intersect in $n(n-1)$ points, and since at each of these intersections $U = 0$, $\Delta U = 0$ will be satisfied, we see *that from a*

given point there can be drawn $n(n-1)$ tangents to a curve of the n^{th} degree. Or, again, (*Conics*, Art. 305) the degree of the reciprocal of a curve of the n^{th} degree is in general $n(n-1)$.

66. If, however, the curve have a double point, it was proved (Art. 62) that the first polar of any given point must pass through that double point. The double point, therefore (see note, p. 29), counts for two among the intersections of the curve with its first polar. But the line joining the point $x''y''z''$ to the double point is not a tangent in the ordinary sense of the word, though it is indeed included among the solutions to the problem we have been discussing (*viz.*, to draw a line through $x''y''z''$, so as to meet the curve in two coincident points); for we have shewn that every line through the double point must be considered as there meeting the curve in two coincident points. Now the entire number of solutions to this problem being always $n(n-1)$ (*viz.*, the intersections of U and ΔU), the number of tangents, properly so called, which can be drawn to the curve is diminished by two for every double point on the curve; or the degree of the reciprocal of a curve of the n^{th} degree having δ double points is $n(n-1) - 2\delta$.

67. If the curve have a cusp, we have proved (Art. 62) that the first polar not only passes through the cusp, but also has its tangent the same with the tangent at the cusp. Hence (see note, p. 29) this cusp counts as three among the intersections of the curve with its first polar, and the remaining intersections are consequently diminished by three for every cusp on the curve. Hence the degree of the reciprocal of a curve having δ ordinary double points and κ cusps, is

$$n(n-1) - 2\delta - 3\kappa.*$$

* According to Poncelet, Waring was the first who investigated the problem of the number of tangents which can be drawn from a given point to a curve of the n^{th} degree. (*Miscellanea Analytica*, p. 100). This number he fixed as at most n^2 . Poncelet shewed (Gergonne's *Annales*, vol. VIII. p. 213) that this limit was fixed too high; that the points of contact lie on a curve of the $(n-1)^{\text{th}}$ degree, and that their number cannot exceed $n(n-1)$. Finally, Plücker established the formula in the text, and thereby fully explained (as we shall do further on) why it is that only n tangents can be drawn to the reciprocal of a curve of the n^{th} degree, though that reciprocal is, in general, of the degree $n(n-1)$.

68. The same principles would shew the effect of any higher multiple point on the degree of the reciprocal. A multiple point of the order k would (Art. 62) be a multiple point of the order $k-1$ on the first polar, and therefore the number of remaining intersections, and consequently the degree of the reciprocal, would be diminished by $k(k-1)$.

We have shewn (p. 28) that a multiple point of the order k is equivalent to $\frac{1}{2}k(k-1)$ double points, each of which would diminish the degree of the reciprocal by two. And the result we have now obtained may be stated: *the effect of a multiple point on the degree of the reciprocal is the same as that of the equivalent number of double points.* And so generally (see Art. 58) for a multiple point equivalent to δ' double points, κ' cusps, τ' double tangents, and ι' inflexions, the effect on the degree of the reciprocal is $= 2\delta' + 3\kappa'$.

69. We have already seen that the line joining $x'y'z'$ and $x''y''z''$ will meet the curve in two points which coincide with $x'y'z'$ if $U' = 0$, and if $x''y''z''$ be so taken as to satisfy the equation $x''U'_1 + y''U'_2 + z''U'_3 = 0$. But if it should happen that the coordinates $x'y'z'$ satisfy the three equations $U_1 = 0$, $U_2 = 0$, $U_3 = 0$, then the second condition $x''U'_1 + y''U'_2 + z''U'_3 = 0$ is satisfied, no matter what $x''y''z''$ may be. The point $x'y'z'$ is then a double point, and every line drawn through it meets the curve in two coincident points.

We see then that the curve expressed by the general equation in Cartesian or trilinear coordinates will not have any double point unless the coefficients be connected by a certain relation. For the three curves $U_1 = 0$, $U_2 = 0$, $U_3 = 0$ will not in general have any point common to all three, and therefore the functions U_1 , U_2 , U_3 cannot all be made to vanish together. If between these three equations we eliminate $x:y:z$, we shall have a relation between the coefficients, which will be the condition that these three polars should intersect, or that the curve U should have a double point. This condition is called the *discriminant* of the equation of the curve. Thus (Conics, Art. 292) we found the discriminant of a conic by eliminating $x:y:z$ between the three equations

$$ax + hy + gz = 0, \quad hx + by + fz = 0, \quad gx + fy + cz = 0,$$

each of which must be satisfied by the coordinates of the double point if the curve have one, and we found

$$abc + 2fgh - af^2 - bg^2 - ch^2 = 0.$$

In general the discriminant will be of the degree $3(n-1)^2$ in the coefficients of the given equation; for (see *Higher Algebra*, Art. 76) since the three derived equations are each of the degree $n-1$, their resultant contains the coefficients of *each* in the degree $(n-1)^2$, but the coefficients of the derived equations are each of the first degree in the coefficients of the original equation. See also *Higher Algebra*, Art. 105.

70. We may apply these principles to examine the conditions which must be satisfied when the first polar of any point A , $x'y'z'$, has a double point. Differentiating the equation $x'U_1 + y'U_2 + z'U_3 = 0$, and using for the second differentials the notation of Art. 59, we see that if there be a double point B , its coordinates must satisfy the three equations

$$ax' + hy' + gz' = 0, \quad hx' + by' + fz' = 0, \quad gx' + fy' + cz' = 0.$$

These are three relations connecting $x'y'z'$, the coordinates of the point A with xyz , the coordinates of the double point B , of which coordinates $a, b, \&c.$ are functions each of the $(n-2)^{\text{th}}$ degree. But on comparing these equations with those cited in the last article, we see that if we write the polar conic of the point B

$$ax^2 + by^2 + cz^2 + 2fyz + 2gzx + 2hxy = 0,$$

the three relations are exactly the conditions that must be fulfilled when A or $x'y'z'$ is a double point on the polar conic. Hence we infer, *if the first polar of any point A has a double point B , then the polar conic of B has a double point A ; and vice versa.*

Between the three equations we can eliminate $x'y'z'$, and obtain as a relation which must be satisfied by xyz ,

$$abc + 2fgh - af^2 - bg^2 - ch^2 = 0.$$

This equation then is the equation of the locus of points B , and it appears from what has been said, that it may be described either as the locus of points which are double points on first polar curves, or as the locus of points whose polar conics break

up into two right lines. Since the second differentials $a, b, \&c.$ are each of the order $n - 2$ in xyz , the equation just written is of the order $3(n - 2)$. The curve which it represents has important relations to the given curve, of which it is a covariant (*Higher Algebra*, p. 124). On account of its having been first studied by Hesse, it is called the Hessian of U .

If between the three equations we eliminated xyz , the resulting equation in $x'y'z'$ would give the locus of points A , which may be described either as the locus of points whose first polar has a double point, or of points which are double points on polar conics. This locus we shall call after the geometer Steiner, the Steinerian of U . In order actually to perform the elimination in any case, it would be necessary to write out $a, b, \&c.$, explicitly; but we can easily see that the degree of the resulting equation is $3(n - 2)^2$, since it is the resultant of three equations each of the degree $n - 2$, and each containing x, y, z in the first degree.

71. Returning now to the equation $\Lambda = 0$, we see that it will have three roots $\mu = 0$, or that the line in question will meet the curve in three points coincident with $x'y'z'$, if the three conditions are satisfied $U' = 0, \Delta U' = 0, \Delta^2 U' = 0$. Let us consider first the case when $x'y'z'$ is a double point; then, as we have seen, U' and $\Delta U'$ vanish independently of $x''y''z''$, and the third condition expresses that $x''y''z''$ must be on the polar conic of $x'y'z'$. But clearly the point $x''y''z''$ may be any point on either of the two tangents at the double point, since each of these meets the curve in three coincident points. Hence the polar conic of $x'y'z'$ must be identical with these two lines; or, in other words, the equation of the pair of tangents at the double point is $\Delta^2 U' = 0$, or

$$a'x^2 + b'y^2 + c'z^2 + 2f'yz + 2g'zx + 2h'xy = 0.$$

The double point, being one whose polar conic has thus been proved to break up into two right lines, is a point in the Hessian; and we shew directly that it satisfies its equation. For, by the theorem of homogeneous functions, the three equations $U'_1 = 0, U'_2 = 0, U'_3 = 0$, which are satisfied for the double point, may be written

$$a'x' + h'y' + g'z' = 0, h'x' + b'y' + f'z' = 0, g'x' + f'y' + c'z' = 0,$$

whence eliminating $x'y'z'$ we see that the equation of the Hessian is satisfied for the double point.

72. The double point will be a cusp if the equation which represents the two tangents be a perfect square; that is, if $bc=f^2$, $ca=g^2$, $ab=h^2$. These three are only equivalent to one new condition, for if any one of these be satisfied, and the coordinates $x'y'z'$ of the double point have any finite magnitude, the others must also be satisfied. For, solving for the ratios $x':z'$, $y':z'$, successively from each pair of the equations at the end of the last article, we have

$$\frac{x'}{z'} = \frac{hf - bg}{ab - h^2} = \frac{bc - f^2}{hf - bg} = \frac{fg - ch}{gh - af},$$

$$\frac{y'}{z'} = \frac{gh - af}{ab - h^2} = \frac{fg - ch}{hf - bg} = \frac{ca - g^2}{gh - af}.$$

Hence if $ab=h^2$, and neither of the ratios is infinite, both numerator and denominator of every one of these fractions must vanish.

73. The origin will be a triple point if all the second differential coefficients a , b , &c., vanish; for then $\Delta^2 U'$ vanishes independently of $x''y''z''$, and if the second differential coefficients vanish, the theorem of homogeneous functions shews that the first differential coefficients vanish likewise, and therefore $\Delta U'$ also vanishes. Hence *every* line through $x'y'z'$ meets the curve in three coincident points; and it is obvious that the three tangents at that point are given by the equation $\Delta^3 U' = 0$.

There is no difficulty in extending the same considerations to higher multiple points. The point $x'y'z'$ is a multiple point of the order k , if all the differential coefficients of the order $k-1$ vanish for that point, and the tangents at the multiple point are given by the equation $\Delta^k U' = 0$.

74. Let us now examine in what case a line can be drawn through a point $x'y'z'$ on the curve (but which is not a double point) so as to meet the curve in three points coincident with $x'y'z'$: to fix the ideas we may in the first instance assume that the curve has no multiple points. We have seen, Art. 71, that every point on such a line must fulfil the conditions $\Delta U' = 0$, $\Delta^2 U' = 0$.

The first condition expresses that the line must coincide with the tangent at $x'y'z'$, as is geometrically evident; the second condition expresses that every point on it satisfies the equation of the polar conic. The polar conic $\Delta^2 U'$ must therefore, in this case, contain the line $\Delta U'$ as a factor; and therefore the point $x'y'z'$ must be one of the points whose polar conics break up into factors; that is to say, it must be a point on the Hessian (Art. 70). And, conversely, every point where the Hessian meets U is a point at which a line can be drawn to meet the curve in three coincident points; in other words, is a point of inflexion. For (Art. 64) the polar conic of every point on U touches U at that point; and if the point be also on the Hessian H , and the polar conic consequently break up into factors, one of these factors must be the tangent at $x'y'z'$. Any point on that tangent will then satisfy both the conditions $\Delta U' = 0$, $\Delta^2 U' = 0$. It follows, then, that every one of the intersections of the curves U , H will be a point of inflexion on U , and since H is of the degree $3(n-2)$, that a curve of the n^{th} degree has in general $3n(n-2)$ points of inflexion.

75. If the curve, however, have multiple points, the number of points of inflexion will be reduced. We have already shewn (Art. 71) that every double point on the curve is a point on the Hessian, but we shall now shew that it is a double point on that curve, and more generally that every multiple point on the curve of the order k is a multiple point of the order $3k-4$ on the Hessian. The easiest way to shew this is to suppose that the multiple point has been taken for the origin, and consequently that the equation contains no terms in x and y below the degree k . Let us examine, then, the degree of the lowest terms in x and y in the second differential coefficients; then evidently where there have been two differentiations with respect to x or y , the order of the lowest terms will be $k-2$; where there has been one differentiation with respect to x or y and one with respect to z , the order will be $k-1$, and where both have been with respect to z , the order will be k ; that is to say, the order of the lowest terms will be

$$k-2, \quad k-2, \quad k, \quad k-1, \quad k-1, \quad k-2$$

in $a, \quad b, \quad c, \quad f, \quad g, \quad h$ respectively.

And combining these, we see that the order of the lowest terms in x and y , in every term of

$$abc + 2fgh - af^2 - bg^2 - ch^2,$$

will be $3k - 4$.

But further, we say that every tangent at a multiple point on U will be also a tangent at the multiple point on H . For suppose the line x to be a tangent at the origin, and therefore (Art. 40), that the lowest terms in x and y all contain x as a factor, then evidently x will also be a factor in the lowest terms of each of the second differential coefficients in which there has been no differentiation with respect to x ; that is to say, it will be a factor in b , c , and f . But, on inspection, it appears that every term of

$$abc + 2fgh - af^2 - bg^2 - ch^2$$

contains either b , c , or f .

76. We are now in a position to calculate the amount of reduction in the number of points of inflexion which occurs when U has multiple points. If U has a double point, this will also be a double point on H , and the two tangents will be common to both curves; but (see note, p. 29) when two curves have a common double point and the tangents at it also common, this point counts for six in the number of their intersections. The number of intersections therefore of U and H distinct from the double point will be reduced by 6, and we infer that if a curve have δ double points, the number of its points of inflexion will be $3n(n-2) - 6\delta$.

Similarly, if U have a multiple point of order k , we have seen that it is a multiple of the order $3k-4$ on H , and that there are k tangents common to the two curves. The multiple point therefore counts among the intersections as

$$k(3k-4) + k = 6 \times \frac{1}{2}k(k-1).$$

But we have seen (Art. 40) that the multiple point is equivalent to $\frac{1}{2}k(k-1)$ double points; hence our present result may be stated, *the multiple point has exactly the same effect in re-*

* It is a useful exercise on the method of Art. 56 to show that at a double point the Hessian and the curve touch the tangents on opposite sides (Clebsch, *Vorlesungen*, p. 325).

ducing the number of points of inflexion as the equivalent number of double points.

77. The case of a cusp on U requires special consideration. Let it be taken for origin and let $x=0$ be the tangent at it, so that the equation is of the form $x^2z^{n-2} + u_3z^{n-3} + \&c. = 0$; then it will be seen that the orders of the lowest terms in the second differential coefficients are 0, 1, 2, 2, 1, 1 respectively; the terms in fact being

$$a = 2z^{n-2}, \quad b = \frac{d^2u_3}{dy^2} z^{n-3}, \quad c = (n-2)(n-3)x^2z^{n-4},$$

$$f = (n-3) \frac{du_3}{dy} z^{n-4}, \quad g = 2(n-2)xz^{n-3}, \quad h = \frac{d^2u_3}{dxdy} z^{n-3}.$$

It will be found then that the order of the lowest terms in

$$abc + 2fgh - af^2 - bg^2 - ch^2$$

is three, and that only in the terms abc and bg^2 is the order so low, but each of these terms contains x^2 as a factor. The point on H is thus a triple point arising from a cuspidal point with a simple branch passing through it; and the two coincident tangents (or cuspidal tangent) coincide with the cuspidal tangent of U . Now when two curves have a common point which is double on one and triple on the other, that point counts for six intersections; and if, moreover, two tangents at the double point are also tangents at the triple point, the curves have two more consecutive points common, and therefore this point counts for eight intersections. Hence if a curve have δ double points and κ cusps, the number of its inflexions will be $= 3(n-2) - 6\delta - 8\kappa$.

78. We shall hereafter shew how to use the equation $\Lambda = 0$ to discuss the conditions for double tangents; but the investigation being a little difficult, we postpone it for the present. We shall shew presently that the results already obtained, combined with the theory of reciprocal curves, are sufficient to determine indirectly the number of double tangents of a curve of the n^{th} order.

The equation of the system of tangents which can be drawn to the curve from any point $x'y'z'$, may be derived from the equation $\Lambda = 0$ by the method used (*Conics*, Arts. 92, 294). Any

point on one of these tangents is obviously such that the line joining it to $x'y'z'$ meets the curve in two consecutive points, and in such a case the equation $\Lambda = 0$ will have two equal roots. We obtain then the equation of the system of tangents, by equating to zero the discriminant of Λ considered as a binary quantic in λ, μ .

Thus, for example, let U be of the third order. Then Λ is

$$\lambda^3 U' + \lambda^2 \mu \Delta' + \lambda \mu^2 \Delta + \mu^3 U = 0,$$

where, for brevity, we have written Δ' and Δ for $\Delta U'$ and ΔU . The discriminant of Λ equated to zero is

$$(27 U U'^2 + 4 \Delta'^3 - 18 \Delta \Delta' U') U = (\Delta'^2 - 4 \Delta U') \Delta^2.$$

Now U, Δ, Δ' are respectively of the third, second, and first degrees in xyz ; the preceding equation then, being of the sixth degree, shews that six tangents can be drawn from $x'y'z'$ to U , as we know already.

The form of the equation shews that it represents a locus touching U in the points where U meets Δ . The other points where U meets the locus lie on the curve $\Delta'^2 - 4 \Delta U' = 0$. Hence, *if from any point six tangents be drawn to a curve of the third order, their six points of contact lie on a conic $\Delta = 0$, and the six remaining points, where these tangents meet the curve, lie on another conic $\Delta'^2 - 4 \Delta U' = 0$, which two conics have evidently double contact with each other in the points $\Delta = 0, \Delta' = 0$.*

If $x'y'z'$ be on the curve $U' = 0$, then Λ reduces itself to $\lambda^2 \Delta' + \lambda \mu \Delta + \mu^2 U$: equating the discriminant to zero, we have $\Delta^2 = 4 \Delta' U$, an equation of the fourth degree in xyz . Hence through a point on a curve of the third order can be drawn in general only four tangents. The tangent at the point in fact counts for two.

79. And so in like manner in general. The discriminant of Λ or of $\mu^n U + \mu^{n-1} \lambda \Delta + \mu^{n-2} \lambda^2 \Delta^2 + \&c.$ is of the degree $n(n-1)$ in xyz , and (*Higher Algebra*, Art. 111) is of the form $kU + (\Delta)^2 \phi$, where ϕ is the discriminant of Λ deprived of the first term. Hence the locus touches U at its points of intersection with Δ , as it plainly ought to do.

Each of the $n(n-1)$ tangents meets the curve again in $n-2$ points, and the form of the discriminant shews that these $n(n-1)(n-2)$ points lie on a curve ϕ of the order $(n-1)(n-2)$.

Moreover, ϕ is itself of the form $k'\Delta + (\Delta')^2\psi$. Hence the two curves ϕ and ψ touch each other at the points where the first and second polars of $x'y'z'$ intersect.

Writing $\Lambda, \lambda^n U' + \lambda^{n-1}\mu\Delta' + \&c.$ we see that the discriminant may also be written in the form $kU' + (\Delta')^2\phi$; hence if $x'y'z'$ is on the curve, and therefore $U' = 0$, the discriminant contains the double factor Δ'^2 , or the system of tangents consists of the tangent at $x'y'z'$ counted twice, and $n^2 - n - 2$ other tangents represented by $\phi = 0$. In the same way ϕ is itself of the form $h\Delta' + (\Delta'')^2\psi$. If then $x'y'z'$ be a double point, and therefore not only U' but $\Delta' = 0$, ϕ , which was already of the degree $n^2 - n - 2$, contains the double factor $(\Delta'')^2$; that is to say, among the $n^2 - n - 2$ tangents are included the two tangents at the double point, each counted twice, and therefore only $n^2 - n - 6$ other tangents represented by $\psi = 0$. And so, in like manner, we can prove that the number of tangents which can be drawn from a multiple point of the order k is $n^2 - n - k(k + 1)$.

The theory already given of the effect of multiple points upon the number of tangents which can be drawn from any point to a curve shews that the discriminant of Λ , which in general represents the $n(n - 1)$ tangents, will include as factors the square of the line joining $x'y'z'$ to every double point of the curve, the cube of the line joining it to every cusp, the sixth power of the line joining it to every triple point, and so on.

SECT. VI.—RECIPROCAL CURVES.

80. We have seen (*Conics*, Art. 303) that the degree of the reciprocal curve is always the same as the class of the given curve, and *vice versa*. It is evident also, that to a double point, on either curve will correspond a double tangent on the other; that to a stationary point on one curve corresponds a stationary tangent on the other; and, in general, that to a multiple point of the k^{th} order corresponds a multiple tangent of the same order; that the k points of contact of the multiple tangent correspond to the k tangents at the multiple point; and that if two or more of these last coincide, so will the corresponding points of contact.

81. We have seen that the general equation in Cartesian

or trilinear coordinates represents a curve which has no double or other multiple point, unless certain conditions be fulfilled. But the general equation represents a curve which ordinarily must have double and stationary tangents. For the abscissæ of the points, where the curve is met by any line $y = ax + b$, are found by substituting the value for y in the equation of the curve; and since we have two arbitrary constants a and b at our disposal, we can determine them so that the resulting equation shall fulfil any two conditions we please. With one constant at our disposal, we could make the equation fulfil any one condition; for instance, have a pair of equal roots. The problem "given a to determine b , so that the resulting equation should have a pair of equal roots," is no other than the problem to draw a tangent parallel to $y = ax$. With the two constants at our disposal, we can either cause the resulting equation to have two distinct pairs of equal roots, or three roots all equal to each other. The first is the problem of double tangents, the second that of stationary tangents and points of inflexion. Thus the double and stationary tangents may be counted as the ordinary singularities of a curve whose equation is expressed in point coordinates; all higher multiple tangents and all multiple points being extraordinary singularities which a curve will not possess except for special values of the coefficients of its equation. But this is reversed if the equation be expressed in tangential coordinates. Then the curve represented by the general equation ordinarily has double and stationary points and cusps, but no singular tangents. Hence double and stationary points on the one hand, and double and stationary tangents on the other hand, are equally entitled to be ranked among the ordinary singularities of curves; they are such, that if any curve possess the one its reciprocal will possess the other.

82. We shall now denote

the degree of a curve	by m ,
its class	„ n ,
the number of its double points	„ δ ,
..... double tangents	„ τ ,
..... stationary points	„ κ ,
..... stationary tangents	„ ι ,

and the corresponding numbers for the reciprocal curve are found by interchanging m and n , δ and τ , ι and κ . We have already obtained (Arts. 67, 77) the values of n and ι in terms of m , δ , κ ; hence, from the reciprocal curve we have the values of m and κ in terms of n , τ , ι ; and from these four equations (equivalent, as will presently be seen, to three equations only) we can obtain the value of τ in terms of m , δ , κ , and that of δ in terms of n , τ , ι . We have thus Plücker's six equations, viz. these are

- (1) $n = m^2 - m - 2\delta - 3\kappa$.
- (2) $\iota = 3m^2 - 6m - 6\delta - 8\kappa$.
- (3) $2\tau = m(m-2)(m^2-9) - 2(m^2-m-6)(2\delta+3\kappa) + 4\delta(\delta-1) + 12\delta\kappa + 9\kappa(\kappa-1)$.
- (4) $m = n^2 - n - 2\tau - 3\iota$.
- (5) $\kappa = 3n^2 - 6n - 6\tau - 8\iota$.
- (6) $2\delta = n(n-2)(n^2-9) - 2(n^2-n-6)(2\tau+3\iota) + 4\tau(\tau-1) + 12\tau\iota + 9\iota(\iota-1)$.

If from (1) and (2) we eliminate δ , or from (3) and (4) we eliminate τ , the result is in each case

$$(7) \quad \iota - \kappa = 3(n - m),$$

shewing that the four equations are equivalent to three only. This may also be written in the forms

$$3m - \kappa = 3n - \iota, \text{ and } 3m + \iota = 3n + \kappa.$$

By taking the difference of the equations (1) and (4), we obtain

$$m^2 - 2\delta - 3\kappa = n^2 - 2\tau - 3\iota.$$

Whence, replacing $\iota - \kappa$ by its value from (7), we obtain

$$(8) \quad 2(\tau - \delta) = (n - m)(n + m - 9).$$

The last preceding equation, substituting therein for n and ι , or for m and κ their values, gives the foregoing equations (3) and (6). From (7) and (8) we obtain also

$$(9) \quad \frac{1}{2}m(m+3) - \delta - 2\kappa = \frac{1}{2}n(n+3) - \tau - 2\iota.$$

$$(10) \quad \frac{1}{2}(m-1)(m-2) - \delta - \kappa = \frac{1}{2}(n-1)(n-2) - \tau - \iota.$$

$$(11) \quad m^2 - 2\delta - 3\kappa = n^2 - 2\tau - 3\iota = m + n.$$

The entire system of equations is, of course, equivalent to

three equations only, and by means of it given any three of the six quantities $m, n, \delta, \kappa, \tau, \iota$, we can determine the remaining three; thus m, δ, κ being given, n is given by (1), ι by (2), or more easily by (7), and τ by (3), or more easily by (8).

Ex. Suppose we were given $m = 6, \delta = 4, \kappa = 6$; then, by (1), $n = 4$; therefore $m - n = 2, n - m = -2$.

Hence (5) $\iota - \kappa = 6, \text{ or } \iota = 0$;

$n + m - 9 = 1$; therefore $\tau - \delta = -1$; therefore $\tau = 3$.

83. Since when a curve is given its reciprocal is determined, it is evident that the same number of conditions must suffice to determine each. Now to be given that a curve has δ double points is equivalent to δ conditions. Thus, for example, a conic is determined by five conditions; but if it have a double point, that is, if it reduce to a system of two right lines, it is determined by four conditions; by two points for instance on each of the right lines. So, again, to be given that a curve has a cusp is equivalent to two conditions. Hence (and Art. 27) a curve of the m^{th} degree with δ double points and κ cusps is determined by $\frac{1}{2}m(m+3) - \delta - 2\kappa$ conditions, and its reciprocal by $\frac{1}{2}n(n+3) - \tau - 2\iota$ conditions. And the foregoing equation (9) shews that these two numbers are in fact equal.

The foregoing equation (10) shews that the *deficiency* (Art. 44) is the same for a curve and its reciprocal. In a subsequent chapter it will be proved that this is true for all curves derived one from the other in such a way that to any point of one answers a single point or tangent of the other.

If (with Prof. Cayley) we write $3m + \iota, = 3n + \kappa, = \alpha$, then everything may be expressed in terms of (m, n, α) , viz. we have

$$\kappa = \alpha - 3n,$$

$$\iota = \alpha - 3m,$$

$$2\delta = m^2 - m + 8n - 3\alpha,$$

$$2\tau = n^2 - n + 8m - 3\alpha.$$

The meaning of equation (11) will appear in the following chapter.

CHAPTER III.

ENVELOPES.

84. If a curve depend in any manner upon a single variable parameter, so that giving to the parameter a series of values, we have a series of curves; these all touch a certain curve, which is called the *envelope* of the system. Each curve is intersected by the consecutive curve in a set of points depending on the parameter, and the locus of these points is the envelope. See *Conics*, Arts. 283, &c., where the problem of envelopes is considered in the case where the variable curve is a right line.

Analytically, the equation of the curve may contain a single variable parameter, or it may contain two or more variable parameters connected by an equation or equations, so as to represent a single variable parameter. The two cases are essentially equivalent, but it is often convenient to treat the second in a different manner, by a method of indeterminate multipliers, which we shall presently explain. The form of the second case, which is of most frequent occurrence, is when the equation of a curve contains the coordinates of a variable point, limited however to a fixed curve; or, as we may say, when the variable curve depends on a parametric point moving on a given parametric curve. For example, it was shewn (*Conics*, Art. 321) that the problem to find the reciprocal, with respect to $x^2 + y^2 + z^2$, of a given curve, is the same as to find the envelope of $ax + \beta y + \gamma z$, where α, β, γ satisfy the equation of the given curve. Here the equation of the variable line contains the two variable parameters $\alpha : \gamma, \beta : \gamma$, these two ratios being connected by the equation of the given curve.

85. Suppose, first, that the equation of the curve, say $T=0$, contains a single variable parameter t . The curves belonging

to the consecutive values t , $t + dt$, may be represented by the equations $T = 0$, $T_1 = 0$. These equations, or the equivalent equations $T = 0$, $T_1 - T = 0$, determine therefore the coordinates of the points of intersection of the two consecutive curves. We have $T_1 = T + d_t T \cdot dt + \&c.$, or $T_1 - T = d_t T \cdot dt + \&c.$, where dt being infinitesimal, the terms after the first are to be neglected. The equations become therefore $T = 0$, $d_t T = 0$, which equations determine a set of points depending on the parameter t ; and eliminating t from these equations we get the equation of the locus of all points of intersection of consecutive curves of the system; that is to say, the equation of the envelope.

An important case is where the equation contains t rationally; we may then, without loss of generality, take T to be an integral as well as rational function of t , and the process described for finding the equation of the envelope is equivalent to forming the discriminant of T considered as a function of t , and equating it to zero. Thus, if a , b , c , &c. be any functions of the coordinates, and if T be

$$at^n + nb't^{n-1} + \frac{1}{2}n(n-1)ct^{n-2} + \&c.,$$

the equations of the envelope for the cases of most common occurrence, viz. $n = 2, 3$, and 4 , are respectively (see *Higher Algebra*, Arts. 193, 195, 207),

$$(2) \quad ac - b^2 = 0,$$

$$(3) \quad a^2d^2 + 4ac^3 + 4b^3d - 6abcd - 3b^2c^2 = 0,$$

$$(4) \quad (ae - 4bd + 3c^2)^3 - 27(ace + 2bcd - ad^2 - b^2e - c^3)^2 = 0,$$

and in using the last of these equations, when we desire to infer its order in the coordinates from knowing the order in which they enter into a , b , &c., it is useful to remember that when the equation is developed, the terms containing c^6 and c^4bd respectively cancel each other, so that the order of the envelope may happen to be lower than that of either of the two members of which the equation, as written above, consists.

If we substitute in T the coordinates of any point, and solve for t the resulting equation $a't^n + nb't^{n-1} + \&c. = 0$, there will evidently be n solutions; that is to say, the system of curves represented by T is such, that n of them can be drawn to pass through any fixed point; and, from what has been just said, it

appears that if the fixed point be on the envelope two of these n curves will coincide.

The case where T depends on a parametric point may be reduced to that just considered if the parametric curve be a line, conic, or any other unicursal curve; for then (Art. 44) the coordinates of the parametric point can be expressed as rational functions of a parameter.

Ex. 1. To find the envelope of $at^n + bt^p + c = 0$, where, as well as in the other examples a, b , &c. are supposed to be any functions of the coordinates. Combining the given equation with its differential with respect to t , we have

$$nat^{n-p} + pb = 0, \quad (n-p)bt^p + nc = 0,$$

whence, eliminating t , we have

$$n^n a^p c^{n-p} \pm p^p (n-p)^{(n-p)} b^n = 0,$$

where the sign $+$ is to be used when n is odd and $-$ when it is even.

Ex. 2. To find the envelope of $a \cos^n \theta + b \sin^n \theta = c$, where θ is the parameter.

We have $\frac{1}{n} d_\theta T = -a \cos^{n-1} \theta \sin \theta + b \sin^{n-1} \theta \cos \theta = 0;$

whence $\tan \theta = \frac{\frac{1}{a^{n-2}}}{\frac{1}{b^{n-2}}}, \quad \cos \theta = \frac{\frac{1}{b^{n-2}}}{\sqrt{(\frac{1}{a^{n-2}} + \frac{1}{b^{n-2}})}}, \quad \sin \theta = \frac{\frac{1}{a^{n-2}}}{\sqrt{(\frac{1}{a^{n-2}} + \frac{1}{b^{n-2}})}}.$

Substituting these values, and reducing, we find the equation of the envelope

$$\frac{2}{a^{2-n}} + \frac{2}{b^{2-n}} = \frac{2}{c^{2-n}}.$$

In particular (as we saw, *Conics*, Art. 283), the envelope of $a \cos \theta + b \sin \theta = c$ is $a^2 + b^2 = c^2$. Conversely, any tangent to the curve $x^m + y^m = c^m$ may be expressed by

$$x \cos^{\frac{2(m-1)}{m}} \theta + y \sin^{\frac{2(m-1)}{m}} \theta = c,$$

the coordinates of the point of contact being $x = c \cos^{\frac{2}{m}} \theta, y = c \sin^{\frac{2}{m}} \theta$.

This example might have been stated as an example of an envelope depending on a parametric point lying on a unicursal curve. For if we write $\cos \theta = \alpha, \sin \theta = \beta$, then α, β are the coordinates of a point lying on the circle $\alpha^2 + \beta^2 = 1$, and the circle being a unicursal curve, these coordinates can be expressed rationally in terms of a parameter. Thus if t be $\cos \theta + i \sin \theta$, we may write for α or $\cos \theta, \frac{1}{2} \left(t + \frac{1}{t} \right)$, and for β or $\sin \theta, \frac{1}{2i} \left(t - \frac{1}{t} \right)$, and the equation, for example, $a\alpha + b\beta = c$, becomes

$$(a - bi) t^2 - 2ct + (a + bi) = 0,$$

whose envelope, as before, is

$$(a + bi)(a - bi) = c^2, \text{ or } a^2 + b^2 = c^2.$$

If we desired to avoid the introduction of imaginaries we might write $\tan \frac{1}{2} \theta = t$, and (as at *Conics*, Art. 283) express $\cos \theta, \sin \theta$ rationally in terms of t .

Ex. 3. Let the curve be

$$a \cos 2\theta + b \sin 2\theta + c \cos \theta + d \sin \theta + e = 0.$$

Putting $t = \cos \theta + i \sin \theta$, this becomes

$$a \left(t^2 + \frac{1}{t^2} \right) - bi \left(t^2 - \frac{1}{t^2} \right) + c \left(t + \frac{1}{t} \right) - di \left(t - \frac{1}{t} \right) + 2e = 0,$$

$$\text{or} \quad (a - bi)t^4 + (c - di)t^3 + 2e^2 + (c + di)t + (a + bi) = 0.$$

And applying to this the form already given for the discriminant of a quartic written with binomial coefficients, we have

$$\{a^2 + b^2 - \frac{1}{4}(c^2 + d^2) + \frac{3}{4}e^2\}^3 = 27 \left\{ \frac{3}{4}(a^2 + b^2)e + \frac{1}{4}(c^2 + d^2)e - \frac{1}{4}(c^2 - d^2) - \frac{1}{4}bcd - \frac{1}{4}e^3 \right\}^2;$$

or, clearing of fractions,

$$\{12(a^2 + b^2) - 3(c^2 + d^2) + 4e^2\}^3 = \{72(a^2 + b^2)e + 9(c^2 + d^2)e - 27a(c^2 - d^2) - 54bcd - 8e^3\}^2;$$

and, again, it is useful to remark that the expanded result will contain neither of the terms e^5 , $(c^2 + d^2)e^4$.

Ex. 4. To find the envelope of the chords of curvature of the points of a conic. The equation of the chord is (*Conics*, Art. 244, Ex. 1)

$$\frac{x}{a} \cos \alpha - \frac{y}{b} \sin \alpha = \cos 2\alpha.$$

$$\text{The envelope is therefore } \left(\frac{x^2}{a^2} + \frac{y^2}{b^2} - 4 \right)^3 + 27 \left(\frac{x^2}{a^2} - \frac{y^2}{b^2} \right)^2 = 0.$$

Ex. 5. To find the equation of the curve *parallel* to a conic; that is to say, the curve obtained by measuring from the conic on each normal a distance equal to r . This problem has been already solved (*Conics*, Art. 372, Ex. 2) by considering the parallel curve as the locus of the centre of a circle of constant radius touching the given conic. But it is easy to see that the parallel curve may also be considered as the envelope of a circle of constant radius whose centre is on the given conic; that is to say, we are to seek the envelope of $(x - \alpha)^2 + (y - \beta)^2 - r^2$, where the parametric point $\alpha\beta$ lies on the conic; and the conic being a unicursal curve, this may be reduced to the case already discussed. Thus, let the conic be $\frac{x^2}{a^2} + \frac{y^2}{b^2} = 1$, and write for α , $a \cos \theta$, for β , $b \sin \theta$, when

$$a^2 + \beta^2 - 2ax - 2\beta y + x^2 + y^2 - r^2$$

$$\text{becomes } (a^2 - b^2) \cos 2\theta - 4ax \cos \theta - 4by \sin \theta + 2(x^2 + y^2) + a^2 + b^2 - 2r^2,$$

a form included under the last example, by the help of which we should obtain a result which, when expanded, is identical with that given, *Conics*, Art. 372.

86. A little further notice may fitly be given to the case where T is algebraic in t , and of the first degree in the coordinates, so as to denote a right line; that is to say, to the envelope of $at^n + nbt^{n-1} + \&c.$ where a , b , &c. are all linear in the coordinates. In this case the envelope is clearly a curve of the n^{th} class, being such that n tangents can be drawn through any assumed point (Art. 85); and since the discriminant of $at^n + \&c.$ is of the order $2(n-1)$ in the coefficients a , b , &c. (*Higher Algebra*, Art. 105), which each contain the coordinates in the first degree, the order of the envelope is $2(n-1)$. Two other characteristics of the envelope can easily be obtained. It has ordinarily no points of inflexion. At a point of inflexion two consecutive tangents coincide; and therefore T and $d_t T$ represent the same right line; but in order that two linear

equations should represent the same right line, two conditions must be fulfilled, and it will generally not be possible to determine the single parameter t at our disposal, so as to satisfy both conditions.

The number of cusps on the envelope is $3(n-2)$. As the tangent at a point of inflexion on a curve contains three consecutive points, so reciprocally a cusp is the point of intersection of three consecutive tangents. At a cusp, therefore, on the envelope the three equations will be satisfied, $T=0$, $d_t T=0$, $d_t^2 T=0$, which may easily be reduced to

$$T_{11} = at^{n-2} + (n-2)bt^{n-3} + \frac{1}{2}(n-2)(n-3)ct^{n-4} + \&c. = 0,$$

$$T_{12} = bt^{n-2} + (n-2)ct^{n-3} + \frac{1}{2}(n-2)(n-3)dt^{n-4} + \&c. = 0,$$

$$T_{22} = ct^{n-2} + (n-2)dt^{n-3} + \frac{1}{2}(n-2)(n-3)et^{n-4} + \&c. = 0,$$

T_{11} , T_{12} , T_{22} being the three second differential coefficients if T , considered as a binary quantic, had been made homogeneous by the introduction of a second variable. Now, if from these equations we eliminate x and y , which enter in the first degree into each, the resulting equation in t will be of the degree $3(n-2)$. If in fact we write $T, xU + yV + zW$, where U, V, W contain only t and constants, we have obviously the determinant

$$\begin{vmatrix} U_{11}, & V_{11}, & W_{11} \\ U_{12}, & V_{12}, & W_{12} \\ U_{22}, & V_{22}, & W_{22} \end{vmatrix} = 0,$$

which gives the values of t corresponding to the $3(n-2)$ cusps.

The problem of finding the number of double points on the envelope is the same as that of finding the order of the system of conditions that T should have two distinct pairs of equal roots (*Higher Algebra*, Art. 264), and the problem of finding the number of double tangents is the same as that of finding the order of the system of conditions that T should represent the same line for different values of t ; or, in other words, the number of ways in which it is possible to find a pair of values t', t'' , for which we shall have the equality of ratios

$$U' : V' : W' = U'' : V'' : W''.$$

It is not necessary for us, however, to deal with these problems directly, since we have already more than enough of conditions to determine δ and τ , by Plücker's equations, Art. 82. Sub-

stituting in these equations $2(n-1)$ and n for the order and class of the curve, and putting $\iota=0$, we find

$$\kappa = 3(n-2), \quad \delta = 2(n-2)(n-3), \quad \tau = \frac{1}{2}(n-1)(n-2).$$

87. Let us now consider the case where the equation contains k parameters connected by $k-1$ equations. To fix the ideas, suppose that we have the equation $U=0$ containing the three parameters α, β, γ connected by the two equations $V=0, W=0$. We may, if we please, regard β, γ , as functions of α , determined by the two equations $V=0, W=0$. The process, in its original form, would then consist in the elimination of α from the given equation, and

$$\frac{dU}{d\alpha} + \frac{dU}{d\beta} \frac{d\beta}{d\alpha} + \frac{dU}{d\gamma} \frac{d\gamma}{d\alpha} = 0.$$

Here $\frac{d\beta}{d\alpha}, \frac{d\gamma}{d\alpha}$ are functions of α determined by

$$\frac{dV}{d\alpha} + \frac{dV}{d\beta} \frac{d\beta}{d\alpha} + \frac{dV}{d\gamma} \frac{d\gamma}{d\alpha} = 0,$$

$$\frac{dW}{d\alpha} + \frac{dW}{d\beta} \frac{d\beta}{d\alpha} + \frac{dW}{d\gamma} \frac{d\gamma}{d\alpha} = 0;$$

and from these three equations we have $\nabla=0$, where

$$\nabla = \begin{pmatrix} \frac{dU}{d\alpha}, & \frac{dU}{d\beta}, & \frac{dU}{d\gamma} \\ \frac{dV}{d\alpha}, & \frac{dV}{d\beta}, & \frac{dV}{d\gamma} \\ \frac{dW}{d\alpha}, & \frac{dW}{d\beta}, & \frac{dW}{d\gamma} \end{pmatrix} = 0,$$

and the final result is got by eliminating α, β, γ between $U=0, V=0, W=0, \nabla=0$.

But $\nabla=0$ is obviously the result of eliminating λ, μ between the equations

$$\frac{dU}{d\alpha} + \lambda \frac{dV}{d\alpha} + \mu \frac{dW}{d\alpha} = 0,$$

$$\frac{dU}{d\beta} + \lambda \frac{dV}{d\beta} + \mu \frac{dW}{d\beta} = 0,$$

$$\frac{dU}{d\gamma} + \lambda \frac{dV}{d\gamma} + \mu \frac{dW}{d\gamma} = 0;$$

so that the result may be got by eliminating $\alpha, \beta, \gamma, \lambda, \mu$ between the last three equations and those originally given. This is the method of indeterminate multipliers referred to (Art. 84).

88. An important case is where U is homogeneous in $k+1$ parameters connected by $k-1$ other homogeneous equations. This is really equivalent to the foregoing, since the $k+1$ parameters may be replaced by the ratios which any k of them bear to the remaining one. But it is more symmetrical to retain all the $k+1$ equations given by the method of indeterminate multipliers, which equations in virtue of the theorem of homogeneous equations are connected by a relation making them really equivalent to only k equations. Thus, let U contain homogeneously α, β, γ the coordinates of a parametric point moving on the parametric curve $V=0$; the method of indeterminate multipliers gives us, in addition to the two original equations,

$$\frac{dU}{d\alpha} + \lambda \frac{dV}{d\alpha} = 0, \quad \frac{dU}{d\beta} + \lambda \frac{dV}{d\beta} = 0, \quad \frac{dU}{d\gamma} + \lambda \frac{dV}{d\gamma} = 0.$$

But these three are really equivalent to two, since if we multiply them by α, β, γ respectively, we get $mU + \lambda nV = 0$, which is included in the equations $U=0, V=0$. We have then four equations from which on account of the homogeneity we can eliminate the four quantities $\alpha, \beta, \gamma, \lambda$, and so obtain the equation of the envelope.

Ex. To find the envelope of $U = (A\alpha)^m + (B\beta)^m + (C\gamma)^m = 0$, where α, β, γ are connected by the relation $V = (a\alpha)^n + (b\beta)^n + (c\gamma)^n = 0$.

The method of indeterminate multipliers gives us

$$mA^m\alpha^{m-1} + \lambda na^n\alpha^{n-1} = 0, \quad mB^m\beta^{m-1} + \lambda nb^n\beta^{n-1} = 0, \quad mC^m\gamma^{m-1} + \lambda nc^n\gamma^{n-1} = 0;$$

whence, writing for shortness $\frac{\lambda n}{m} = -\mu^{m-n}$, we have

$$A\alpha = \mu \left(\frac{a}{A}\right)^{\frac{n}{m-n}}, \quad B\beta = \mu \left(\frac{b}{B}\right)^{\frac{n}{m-n}}, \quad C\gamma = \mu \left(\frac{c}{C}\right)^{\frac{n}{m-n}};$$

and substituting these values in U , we have the envelope required, viz.

$$\left(\frac{a}{A}\right)^{\frac{mn}{m-n}} + \left(\frac{b}{B}\right)^{\frac{mn}{m-n}} + \left(\frac{c}{C}\right)^{\frac{mn}{m-n}} = 0.$$

89. Prof. Cayley has considered the case of a curve $U=0$, the equation of which contains two or more *independent* parameters. If, for instance, there are the two parameters α, β , then from the equations

$$U=0, \frac{dU}{d\alpha}=0, \frac{dU}{d\beta}=0,$$

eliminating α, β , we have the equation of an envelope. But observe that we can from these same equations eliminate the coordinates (x, y) , and that the equations thus imply a relation $\phi(\alpha, \beta)=0$ between the parameters. This gives in the double system of curves $U=0$, a single system wherein the parameters satisfy this relation. Taking any curve of the double system and the consecutive curve belonging to the values $\alpha+d\alpha, \beta+d\beta$ of the parameters, the two curves intersect in a set of points depending in general on the value of the ratio $d\beta:d\alpha$ of the increments. But if the curve belong to the single system, then the set of points will be independent of the ratio in question; the coordinates of the points of intersection satisfy the equations $U=0, \frac{dU}{d\alpha}=0, \frac{dU}{d\beta}=0$, and consequently the equation $U + \frac{dU}{d\alpha}d\alpha + \frac{dU}{d\beta}d\beta = 0$, whatever be the value of the ratio $d\beta \div d\alpha$. And we thus see that a curve of the single series is intersected by every consecutive curve of the double series in one and the same set of points, and that the locus of these points is the envelope. In the case of a single parameter, the envelope is the locus of a set of points on *every* curve of the system, and it may be termed a "general envelope"; in the case of the two parameters, the envelope is the locus of a set of points not on *every* curve of the system, but *only* on the curves of the single system wherein the parameters satisfy the equation $\phi(\alpha, \beta)=0$, and it may be termed a "special envelope." And the like theory applies to the case of any number whatever of parameters: there is always a resulting single system of curves.

89 (a). A difficulty in the theory of envelopes as given in Art. 84 has been explained by Prof. Cayley. In that article we

have considered an envelope as the locus of the intersections of a variable curve with consecutive curves of the system. But each curve has with the consecutive a number of common tangents depending on its parameter, and the envelope of these lines is also the envelope; viz., each common tangent of the curve and its consecutive curve is at a common point of the same two curves a tangent of the envelope. But if the variable curve be of the order m and the class n , the number of common points is $= m^2$, and the number of common tangents $= n^2$; and yet the common points and common tangents have to correspond to each other in pairs. The explanation depends on the singularities of the variable curve. Suppose this has in general δ double points, κ cusps τ double tangents and ι inflexions; then, as is easily seen, the curve meets the consecutive curve in 2 points contiguous to each double point and in 3 points contiguous to each cusp (viz. there are thus $2\delta + 3\kappa$ intersections), and besides in $m^2 - 2\delta - 3\kappa$ points, and reciprocally the curve has with the consecutive curve 2 common tangents contiguous to each double tangent and 3 common tangents contiguous to each stationary tangent (viz., there are thus $2\tau + 3\iota$ common tangents), and there are besides $n^2 - 2\tau - 3\iota$ common tangents: we have, see Art. 82, $m^2 - 2\delta - 3\kappa = n^2 - 2\tau - 3\iota = m + n$; each of the $m^2 - 2\delta - 3\kappa$ points is (not a point of contact but) an ordinary intersection of the two curves, but it has contiguous to it one of the $n^2 - 2\tau - 3\iota$ common tangents of the two curves; and the envelope is thus cotemporaneously the locus of the $m^2 - 2\delta - 3\kappa$ ($= m + n$) points, and the envelope of the $n^2 - 2\tau - 3\iota$ ($= m + n$) tangents.

It may be added that the complete envelope of the variable curve consists of the proper envelope as just explained together with (1) the locus of the double points twice, (2) the locus of the cusps three times, (3) the envelope of the double tangents twice, and (4) the envelope of the stationary tangents three times.

In what precedes, the numbers $m, n, \delta, \kappa, \tau, \iota$ apply to the curve corresponding to the general value of the variable parameter; for particular values of the parameter, the variable curve may acquire or lose point- or line- singularities, and the several numbers be thus altered.

RECIPROCAL CURVES.

90. Let it be required to find the envelope of a line $\alpha x + \beta y + \gamma z$, being given that α, β, γ are connected by a relation $\Sigma = 0$. In other words, let there be given $\Sigma = 0$ the tangential equation of a curve, or its equation in line coordinates, and let it be required to pass to the equation in point-coordinates. Here then we have the two equations $\Sigma = 0$, $\alpha x + \beta y + \gamma z = 0$, and the method of Art. 88 shews that the result is to be obtained by eliminating $\alpha, \beta, \gamma, \lambda$ from the two given equations combined with

$$\frac{d\Sigma}{d\alpha} + \lambda x = 0, \quad \frac{d\Sigma}{d\beta} + \lambda y = 0, \quad \frac{d\Sigma}{d\gamma} + \lambda z = 0.$$

The solution of the reciprocal problem, given the point-equation $S = 0$, to pass to the tangential equation, depends on a precisely similar elimination; namely, to eliminate x, y, z, λ between $S = 0, \alpha x + \beta y + \gamma z = 0$, and

$$\frac{dS}{dx} + \lambda \alpha = 0, \quad \frac{dS}{dy} + \lambda \beta = 0, \quad \frac{dS}{dz} + \lambda \gamma = 0,$$

a system of equations which would also present itself naturally from the consideration that if $\alpha x + \beta y + \gamma z$ be identical with the tangent at the point xyz , then the well-known form of the equation of the tangent (Art. 64) shews that α, β, γ must be respectively proportional to $\frac{dS}{dx}, \frac{dS}{dy}, \frac{dS}{dz}$.

It has been mentioned (Art. 84, and *Conics*, Art. 321) that the problem of passing from the point equation of a curve to its tangential equation is the same as that of finding its polar reciprocal with regard to $x^2 + y^2 + z^2 = 0$.

Ex. To find the tangential equation of $(ax)^m + (by)^m + (cz)^m = 0$, We have here

$$(ax)^{m-1} + \frac{\lambda}{m} \frac{\alpha}{a} = 0, \quad (by)^{m-1} + \frac{\lambda}{m} \frac{\beta}{b} = 0, \quad (cz)^{m-1} + \frac{\lambda}{m} \frac{\gamma}{c} = 0,$$

whence immediately

$$\left(\frac{\alpha}{a}\right)^{\frac{m}{m-1}} + \left(\frac{\beta}{b}\right)^{\frac{m}{m-1}} + \left(\frac{\gamma}{c}\right)^{\frac{m}{m-1}} = 0.$$

91. The method just indicated, however, is not always the most convenient one for finding the equation of the reciprocal. Let the equation of the curve be $u_n + u_{n-1}z + u_{n-2}z^2 + \&c. = 0$,

then we eliminate z by the equation $\alpha x + \beta y + \gamma z = 0$, and get

$$\gamma^n u_n - \gamma^{n-1} (\alpha x + \beta y) u_{n-1} + \gamma^{n-2} (\alpha x + \beta y)^2 u_{n-2} - \&c. = 0,$$

which is now homogeneous in x and y ; and the discriminant of this considered as a binary quantic, equated to zero gives the equation of the reciprocal curve, multiplied however by the irrelevant factor $\gamma^{n(n-1)}$.

Thus, for example, if it were required to find the reciprocal of

$$x^3 + y^3 + z^3 + 6mxyz = 0,$$

eliminating z , it becomes

$$(\alpha x + \beta y)^3 + 6mxy\gamma^2 (\alpha x + \beta y) - \gamma^3 (x^3 + y^3) = 0,$$

or $(\alpha^3 - \gamma^3, \alpha^2\beta + 2m\alpha\gamma^2, \alpha\beta^2 + 2m\beta\gamma^2, \beta^3 - \gamma^3)(x, y)^3 = 0$,*

the discriminant of which is divisible by γ^6 , the quotient being

$$\alpha^6 + \beta^6 + \gamma^6 - (2 + 32m^3) (\beta^3\gamma^3 + \gamma^3\alpha^3 + \alpha^3\beta^3)$$

$$- 24m^2\alpha\beta\gamma (\alpha^3 + \beta^3 + \gamma^3) - (24m + 48m^4) \alpha^2\beta^2\gamma^2 = 0.$$

In precisely the same way may be found the reciprocals of the cubic or quartic given by the general equation, the results of which are given at full length in subsequent chapters.

92. One chief advantage of the foregoing method of obtaining the equation of the reciprocal is that it enables us immediately to write down the equation of the reciprocal in the symbolical form explained, *Higher Algebra*, chap. XIV. If a ternary quantic be reduced to a binary by eliminating z by the help of the equation $\alpha x + \beta y + \gamma z$, we have immediately the following rules for the differentials of the binary quantic with respect to x and y ,

$$\frac{d}{dx} = \frac{d}{dx} - \frac{\alpha}{\gamma} \frac{d}{dz}, \quad \frac{d}{dy} = \frac{d}{dy} - \frac{\beta}{\gamma} \frac{d}{dz}.$$

Applying these rules to the symbol (12) which denotes

$$\frac{d}{dx_1} \frac{d}{dy_2} - \frac{d}{dx_2} \frac{d}{dy_1},$$

* We use the notation $(a, b, c, \dots)(x, y)^n$ for the binary quantic written with binomial coefficients $ax^n + nbx^{n-1}y + \frac{1}{2}n(n-1)cx^{n-2}y^2 + \&c.$; using the notation $(a, b, c, \dots)(x, y)^n$ when the quantic is written without binomial coefficients (see *Higher Algebra*, Art. 104).

it becomes

$$\frac{1}{\gamma} \left\{ \alpha \left(\frac{d}{dy_1} \frac{d}{dz_2} - \frac{d}{dy_2} \frac{d}{dz_1} \right) + \beta \left(\frac{d}{dz_1} \frac{d}{dx_2} - \frac{d}{dz_2} \frac{d}{dx_1} \right) + \gamma \left(\frac{d}{dx_1} \frac{d}{dy_2} - \frac{d}{dx_2} \frac{d}{dy_1} \right) \right\},$$

or, in other words, the symbol applied to the binary quantic differs only by the factor γ from the contravariant symbol $(\alpha 12)$ applied to the ternary. Hence, if a line $\alpha x + \beta y + \gamma z$ cut a curve so that the points of section satisfy any invariant relation whose symbolical form is known, we can at once write down in the same form the tangential equation of its envelope. For instance, the symbolical form of the discriminant of a binary cubic is known to be $(12)^2(34)^2(13)(24)$; hence, if a line $\alpha x + \beta y + \gamma z$ cut a cubic curve in three points whose discriminant vanishes, that is to say, if it touch the curve, we must have $(\alpha 12)^2(\alpha 34)^2(\alpha 13)(\alpha 24) = 0$. In like manner the discriminant of a binary quartic is known to be of the form $S^3 = 27T^2$, where S and T are two invariants, whose symbolical form is $(12)^4$, and $(12)^2(23)^2(31)^2$ respectively. It follows that the equation of the reciprocal of a quartic is of the form $S^3 = 27T^2$, where S is $(\alpha 12)^4$, and T is $(\alpha 12)^2(\alpha 23)^2(\alpha 31)^2$, where $S=0$ denotes the curve of the fourth class which is the envelope of lines cutting the quartic in four points for which the invariant S vanishes, and $T=0$ denotes the curve of the sixth class which is the envelope of lines cut harmonically by the curve, and for which therefore the invariant T vanishes.

93. We have already (Art. 78) given one method of forming the equation of tangents drawn from any point $x'y'z'$ to the curve, but the problem is in effect solved when we are in possession of the equation of the reciprocal, or, in other words, of the condition that $\alpha x + \beta y + \gamma z$ should touch the curve. For we have only to substitute in that condition for α, β, γ respectively $yz' - zy', zx' - xz', xy' - yx'$, when we shall have the condition that the line joining the points $xyz, x'y'z'$ shall touch the curve, a condition which obviously must be satisfied when xyz is a point on any tangent through $x'y'z'$ (see *Conics*, Art. 294).

Conversely, the equation of the system of tangents as found by the process explained (Art. 63), is readily obtained in the form, homogeneous function of $(yz' - y'z, zx' - z'x, xy' - x'y) = 0$; and then, substituting for these quantities α, β, γ , we have the equation of the reciprocal curve.

94. We have then immediately a theorem corresponding to that of Art. 92, that when we are in possession of the tangential equation of a curve, we can at once write down symbolically the equation of the locus of a point, such that the system of tangents from it to the curve shall satisfy any given invariant relation. If we make $z = 0$ in the equation of the system of tangents, we have the equation of a system of lines parallel to the tangents through the point xy , which will satisfy the same invariant relation. But from the method just given for forming the equation of the system of tangents we have

$$\frac{d}{dx} = y' \frac{d}{d\gamma} - z' \frac{d}{d\beta}, \quad \frac{d}{dy} = -x' \frac{d}{d\gamma} + z' \frac{d}{d\alpha},$$

whence, as before

$$\begin{aligned} \frac{d}{dx_1} \frac{d}{dy_2} - \frac{d}{dx_2} \frac{d}{dy_1} &= z' \left\{ x' \left(\frac{d}{d\beta_1} \frac{d}{d\gamma_2} - \frac{d}{d\beta_2} \frac{d}{d\gamma_1} \right) \right. \\ &\quad \left. + y' \left(\frac{d}{d\gamma_1} \frac{d}{d\alpha_2} - \frac{d}{d\gamma_2} \frac{d}{d\alpha_1} \right) + z' \left(\frac{d}{d\alpha_1} \frac{d}{d\beta_2} - \frac{d}{d\alpha_2} \frac{d}{d\beta_1} \right) \right\}, \end{aligned}$$

so that we have at once the rule, for every factor (12) in the invariant symbol required to be satisfied by the system of tangents to substitute $(x'12)$ and operate on the equation of the reciprocal curve.

95. When the equation of a curve is given in polar coordinates, that of its reciprocal with regard to a circle whose centre is the pole may be found directly. If on any radius vector OP there be taken a portion OP' equal to the consecutive radius vector OQ , then obviously $PP' = d\rho$, $P'Q = \rho d\omega$, $\tan OPQ = \frac{\rho d\omega}{d\rho}$, and $\rho \sin OPQ$ is the perpendicular on the tangent. Thus let the curve be $\rho^m = a^m \cos m\omega$; take the logarithmic differential, and we have

$$\frac{d\rho}{\rho} = -\tan m\omega d\omega; \quad \frac{\rho d\omega}{d\rho} = -\cot m\omega,$$

and if θ be the acute angle made by the radius vector with the tangent $\theta = 90^\circ - m\omega$, and the perpendicular on the tangent $= \rho \sin \theta = \rho \cos m\omega$. The angle between the perpendicular and the radius vector $= m\omega$, and between the perpendicular and the line from which ω is measured is $(m+1)\omega$. But the radius vector of the reciprocal curve is the reciprocal of the perpendicular on the tangent; hence it is easy to see that the equation of the reciprocal curve is also of the form $\rho^m = a^m \cos m\omega$, the new m being equal to $-\frac{m}{m+1}$. This family of curves includes several important species; for instance, the circle ($m=1$), the right line ($m=-1$), the common lemniscate ($m=2$), the equilateral hyperbola ($m=-2$), the cardioide ($m=\frac{1}{2}$), the parabola ($m=-\frac{1}{2}$) &c.

THE TACT-INVARIANT OF TWO CURVES.

96. It was remarked (Art. 90) that the problem of finding the equation of the reciprocal curve is the same as that of finding the condition that a right line should touch the given curve, both being solved by finding the envelope of $\alpha x + \beta y + \gamma z$, where α, β, γ are parameters satisfying the equation of the curve. More generally, the problem of finding the condition that two curves U, V should touch (which condition is called their *tact-invariant*) is the same as that of finding the envelope of either, the coordinates being regarded as variable parameters satisfying also the equation of the other. For if the two curves touch, the coordinates of the point of contact $\alpha\beta\gamma$ satisfy the equation of both; and also since the tangents are the same, we must have at that point the differential coefficients of U , respectively proportional to those of V . The condition of contact is then found by eliminating $\alpha, \beta, \gamma, \lambda$, between $U=0, V=0$, and

$$\frac{dU}{d\alpha} = \lambda \frac{dV}{d\alpha}, \quad \frac{dU}{d\beta} = \lambda \frac{dV}{d\beta}, \quad \frac{dU}{d\gamma} = \lambda \frac{dV}{d\gamma};$$

but these are the equations given (Art. 88) for solving the problem of the envelope.

97. Let the degrees of U and V be m, m' respectively, and let it be required to determine the order in which the coefficients of either curve, say V , enter into the condition of contact. Let the coefficients in V be $a', b', c', \&c.$, and let us take another curve W of the same order whose coefficients are $a'', b'', c'', \&c.$ Then if in the condition of contact we substitute for each coefficient $a', a' + ka'', \&c.$, we shall have the condition that $V + kW$ should touch U , which will plainly contain k in the same degree as the order in which the coefficients of V enter into the condition of contact. This latter order, therefore, is the same as the number of curves of the form $V + kW$, which can be drawn so as to touch U . But, as before, the point of contact must satisfy the equations

$$V_1 + kW_1 = \lambda U_1, \quad V_2 + kW_2 = \lambda U_2, \quad V_3 + kW_3 = \lambda U_3,$$

whence eliminating k, λ ,

$$\nabla = \begin{vmatrix} U_1, & V_1, & W_1 \\ U_2, & V_2, & W_2 \\ U_3, & V_3, & W_3 \end{vmatrix} = 0,$$

and the intersections of ∇ with U determine the points on U which can be points of contact with curves of the form $V + kW$. Since the orders of $U_1, V_1, W_1, \&c.$, are respectively $m - 1, m' - 1, m' - 1$, the order of ∇ is $m + 2m' - 3$, and the number of intersections is $m(m + 2m' - 3)$. This then is the order in which the coefficients of V enter into the tact-invariant, and in like manner the coefficients of U enter in the order $m'(2m + m' - 3)$. By making $m' = 1$ we have the result already obtained that the condition that $ax + \beta y + \gamma z$ should touch a curve contains α, β, γ , in the degree $m(m - 1)$, and the coefficients of the curve in the degree $2(m - 1)$. See also *Conics*, Art. 372.

If U have a double point, then since we have already seen that U_1, U_2, U_3 pass through that point, and that if that point be a cusp they have there the same tangent, the same things are true for ∇ ; and we see that the order of the condition of contact in the coefficients of V must be diminished by two for every double point, and by three for every cusp on U . The order is therefore $m(m + 2m' - 3) - 2\delta - 3\kappa$ or $n + 2m(m' - 1)$.

98. These results might have been otherwise obtained thus: Take any arbitrary line $ax + by + cz$, and equate to zero the determinant

$$\nabla = \begin{vmatrix} a, & b, & c \\ U_1, & U_2, & U_3 \\ V_1, & V_2, & V_3 \end{vmatrix}.$$

This equation represents the locus of a point, such that its polars with respect to U and V intersect on the assumed line. Now at a point common to U and V , the polars are the two tangents intersecting in the common point; there are, therefore, plainly only two cases in which a point common to U and V can lie also on ∇ ; viz. either the assumed line passes through an intersection of U , V , or at that point the two curves have a common tangent. If then we eliminate between ∇ , U , V , the resultant will contain as factors the condition that $ax + by + cz$ should pass through an intersection of U , V , and the condition that U and V should touch. But since in the resultant of three equations, the order in which the coefficients of each enter is the product of the orders of the other two equations, and since the orders of ∇ , U , V are respectively $m + m' - 2$, m , m' , the order of a, b, c in the resultant is mm' , of the coefficients of U , is $mm' + m'(m + m' - 2) = m'(2m + m' - 2)$, and of the coefficients of V , $m(2m' + m - 2)$. Similarly the orders of the resultant of $ax + by + cz$, U , V , in the several coefficients are respectively mm' , m' , m . Subtracting these numbers from the preceding, we find, as before, that the orders of the condition of contact are $m'(2m + m' - 3)$, and $m(2m' + m - 3)$ in the coefficients of U and V .

EVOLUTES.

99. We have hitherto only dealt with descriptive theorems, and have postponed the consideration of any questions belonging to the class described as metrical (Art. 1). The relation of perpendicularity belongs to the latter class, since, as explained (*Conics*, Art. 356), two perpendicular lines may be considered as lines which cut harmonically the line joining the two imaginary circular points at infinity. It is convenient not to exclude from this chapter the discussion of some important cases of envelopes

which involve the relation of perpendicularity, and the theorems may be made descriptive if we substitute for the two circular points at infinity any assumed points I, J , and wherever, in our theorems lines at right angles occur, substitute lines cutting I, J harmonically.

One of the most important and the earliest investigated class of envelopes is that of the *evolutes* of curves. We have defined the evolute of a curve (*Conics*, Art. 248) as the locus of the centres of curvature of the curve; but the evolute may also be defined as *the envelope of all the normals of the curve*. For the circle of curvature is that which passes through three consecutive points of the curve, and its centre is the intersection of perpendiculars at the middle points of the sides of the triangle formed by the points. But the lines joining the first and second, and the second and third points, are two consecutive tangents to the curve; and the perpendiculars to them just mentioned are two consecutive normals; the centre of curvature is therefore the intersection of two consecutive normals; and the locus of all the centres of curvature must be the same as the envelope of all the normals.

Ex. 1. To find the evolute of $\frac{x^2}{a^2} + \frac{y^2}{b^2} = 1$.

The normal is (*Conics*, Art. 180) $\frac{a^2x}{x'} - \frac{b^2y}{y'} = c^2$,

or, writing $x' = a \cos \phi$, $y' = b \sin \phi$,

$$\frac{ax}{\cos \phi} - \frac{by}{\sin \phi} = c^2,$$

an equation of the class considered Art. 85, Ex. 2, whose envelope is therefore

$$a^{\frac{2}{3}}x^{\frac{2}{3}} + b^{\frac{2}{3}}y^{\frac{2}{3}} = c^{\frac{2}{3}}.$$

Ex. 2. The normal to a parabola is (*Conics*, Art. 213).

$$p(y - y') + 2y'(x - x') = 0,$$

or

$$2y'^3 + (p^2 - 2px)y' - p^2y = 0,$$

an equation of the class considered Art. 85, Ex. 1, whose envelope, y' being the parameter, is

$$2(p - 2x)^3 + 27py^2 = 0.$$

Ex. 3. To find the evolute of the semicubical parabola $py^2 = x^3$.

The equation of the normal is

$$3x'^2(y - y') + 2py'(x - x') = 0,$$

Substitute for y' in terms of x' from the equation of the curve, divide by $x'^{\frac{3}{2}}$, and (putting $x'^{\frac{1}{2}} = t$), the equation becomes

$$3t^4 + 2pt^2 - 3p^{\frac{1}{2}}yt - 2px = 0,$$

whose envelope is

$$p(p - 18x)^2 = (54px + 7\frac{1}{2}p^{\frac{3}{2}}y^2 + p^2)^2.$$

Ex. 4. To find the evolute of the cubical parabola $p^2y = x^3$.

The equation of the normal is

$$3x'^2(y - y') + p^2(x - x') = 0,$$

or

$$3x'^3 - 3p^2yx'^2 + p^4x' - p^4x = 0.$$

Now the envelope of

$$at^5 + 10dt^2 + 5et + f = 0$$

is

$$(af^2 - 12d^2e)^2 + 128(2e^2 - 3df)(ae^3 - ad^2ef - 9d^4) = 0.$$

Therefore the envelope in the present case is

$$3p^2(x^2 - \frac{9}{12}xy^2)^2 + \frac{12}{12}p^2(3p^2 - \frac{9}{12}xy)(\frac{1}{12}p^4 - \frac{9}{12}p^2xy - \frac{24}{12}y^4) = 0.$$

Ex. 5. To find the evolute of the cissoid $(x^2 + y^2)x = ay^2$.

This is a unicursal curve, and writing the equation in the form $(a-x)y^2 = x^3$, it is at once seen that this is satisfied by the values $x = \frac{a}{1 + \theta^2}$, $y = \frac{a}{\theta(1 + \theta^2)}$. The equation of the tangent at the point in question is easily seen to be

$$2\theta^2y - 3\theta^2x + a - x = 0,$$

equation of the normal is therefore

$$2\theta x^3 + (1 + 3\theta^2)y = \frac{a(1 + 2\theta^2)}{\theta},$$

or

$$2\theta^4x + 3\theta^2y - 2\theta^2a + \theta y - a = 0.$$

Forming the discriminant of this it will be found to contain as a factor $(x + \frac{1}{2}a)^2 + y^2$, the remaining factor giving the equation of the evolute proper, viz.

$$y^4 + \frac{3}{2}a^2y^2 + \frac{3}{4}a^3x = 0.$$

Ex. 6. To find the evolute of $x^3 + y^3 = a^3$. For any point of this curve we may write (see Art. 85, Ex. 2) $x' = a \cos^3 \phi$, $y' = a \sin^3 \phi$. The tangent at that point will be

$$\frac{x}{\cos \phi} + \frac{y}{\sin \phi} = a,$$

and the normal

$$x \cos \phi - y \sin \phi = a \cos 2\phi,$$

or

$$(x + y)(\cos \phi - \sin \phi) + (x - y)(\cos \phi + \sin \phi) = 2a(\cos^2 \phi - \sin^2 \phi),$$

or

$$\frac{x + y}{\sin(\phi + \frac{1}{4}\pi)} + \frac{x - y}{\cos(\phi + \frac{1}{4}\pi)} = 2^{\frac{3}{2}}a,$$

whose envelope is (Art. 85, Ex. 2)

$$(x + y)^{\frac{3}{2}} + (x - y)^{\frac{3}{2}} = 2a^{\frac{3}{2}}.$$

100. The following investigation leads to the expressions for the coordinates of the centre of curvature, and for the radius of curvature ordinarily given in books on the Differential Calculus. In this and the next article we use Cartesian rectangular coordinates. If α , β be the coordinates of any point on the tangent, x and y those of its point of contact, the equation of the tangent is $\beta - y = \frac{dy}{dx}(\alpha - x)$; where $\frac{dy}{dx}$, which

we shall call for shortness p , is to be found from the equation of the curve. For the tangent passes through the point xy , and makes with the axis of x an angle whose tangent is p (Art. 38). The normal then being a perpendicular to this at the point xy , has for its equation

$$(\alpha - x) + p(\beta - y) = 0 \dots\dots\dots(1).$$

We have now to find the envelope of this line which contains the parameters x and y , which is given in terms of x by the equation of the curve. Differentiating then with respect to x , and writing $\frac{d^2y}{dx^2} = q$, we see that the point of contact of the line with its envelope is found by combining the equation with its differential

$$-1 - p^2 + (\beta - y)q = 0 \dots\dots\dots(2).$$

Solving for $\alpha - x$ and $\beta - y$ from these equations, we have

$$\alpha - x = \frac{-p(1 + p^2)}{q}, \quad \beta - y = \frac{1 + p^2}{q},$$

and the radius of curvature is given by the equation

$$R = \sqrt{(\alpha - x)^2 + (\beta - y)^2} = \frac{(1 + p^2)^{\frac{3}{2}}}{q}.$$

The values which have been obtained for the intersection of two consecutive normals might have been found for the same point considered as the centre of curvature.

Take the equation of any circle

$$(x - \alpha)^2 + (y - \beta)^2 = R^2,$$

and differentiate it twice, when we have

$$(x - \alpha) + (y - \beta) \frac{dy}{dx} = 0,$$

$$1 + \left(\frac{dy}{dx}\right)^2 + (y - \beta) \frac{d^2y}{dx^2} = 0.$$

But if the circle osculate a curve at any point, then (Art. 48) at that point $\frac{dy}{dx}$, $\frac{d^2y}{dx^2}$, have the same values for both. We may therefore in these equations write for the differential coefficients, the values p and q obtained from the equation of the curve, when they become identical with equations (1) and (2) already obtained from other considerations.

101. Since in practice y is not given explicitly in terms of x , but both are connected by an equation $U=0$, it is convenient to substitute for these expressions in terms of p and q , expressions in terms of the differential coefficients of U . Let us write as before

$$\frac{dU}{dx} = L, \quad \frac{dU}{dy} = M, \quad \frac{d^2U}{dx^2} = a, \quad \frac{d^2U}{dy^2} = b, \quad \frac{d^2U}{dx dy} = h,$$

then, since the coefficients of x and y in the equation of the tangent are L and M respectively, the equation of the normal is

$$M(\alpha - x) - L(\beta - y) = 0 \dots \dots \dots (1),$$

whence differentiating

$$\left(h + b \frac{dy}{dx}\right)(\alpha - x) - \left(a + h \frac{dy}{dx}\right)(\beta - y) - M + L \frac{dy}{dx} = 0.$$

But from the equation of the curve, $L + M \frac{dy}{dx} = 0$, whence substituting for $\frac{dy}{dx}$ we have

$$(Lb - Mh)(\alpha - x) - (Lh - Ma)(\beta - y) + L^2 + M^2 = 0 \dots (2).$$

Solving, then, between equations (1) and (2), we have

$$\alpha - x = \frac{-L(L^2 + M^2)}{aM^2 - 2hLM + bL^2}, \quad \beta - y = \frac{-M(L^2 + M^2)}{aM^2 - 2hLM + bL^2},$$

whence
$$R = \frac{\pm(L^2 + M^2)^{\frac{1}{2}}}{aM^2 - 2hLM + bL^2}.$$

102. This expression can be made to assume a more symmetrical form by introducing the linear unit z , so as to give the equation the trilinear form. For, by the theorem of homogeneous functions,

$$(n-1)L = ax + hy + gz, \quad (n-1)M = hx + by + fz, \\ (n-1)N = gx + fy + cz,$$

whence
$$(n-1)(bL - hM) = (ab - h^2)x + (bg - fh)z, \\ (n-1)(aM - hL) = (ab - h^2)y + (af - gh)z.$$

Multiplying the first equation by L , the second by M , and adding
$$(n-1)(bL^2 - 2hLM + aM^2) = (ab - h^2)(xL + yM) \\ + z\{(bg - fh)L + (af - gh)M\},$$

or since, by the equation of the curve $xL + yM + zN = 0$,

$$= -z \{(fh - bg) L + (gh - af) M + (ab - h^2) N\}.$$

Substitute for L, M, N their values given above, and we have

$$(n-1)^2(bL^2 - 2hLM + aM^2) = -z^2(abc - af^2 - bg^2 - ch^2 + 2fgh) = -Hz^2,$$

and the expression for the radius of curvature becomes

$$R = \pm \frac{(n-1)^2(L^2 + M^2)^{\frac{3}{2}}}{z^2 H}.$$

For any point whose coordinates satisfy the equation $H=0$, the radius of curvature becomes infinite, and the centre of curvature at an infinite distance. This will take place when three consecutive points of the curve are on a right line, for then the circle through them becomes a right line, and its centre becomes at an infinite distance. We might then, from this value of the radius of curvature, arrive, independently of Art. 74, at the conclusion that the intersections of U and H are points of inflexion. The above equation gives us as conditions that two curves should osculate, that we should have in addition to the condition for ordinary contact $L = \theta L', M = \theta M'$, also

$$\frac{H}{(n-1)^2} = \frac{\theta^3 H'}{(n'-1)^2}.$$

The double sign in the value of the radius of curvature is analogous to that in the value of the perpendicular on a right line (*Conics*, Art. 34); and, of course, if we agree to use the sign + when the radius of curvature, and therefore the concavity of the curve, is turned in one direction, we must use the sign - when it is turned in the opposite direction. Since every algebraic function changes sign in passing through zero, we see that at a point of inflexion the radius of curvature changes sign, and that as we pass such a point the concavity of the curve changes to convexity, and *vice versâ* (see fig. Art. 45). At a double point the radius of curvature assumes the form $\frac{0}{0}$, and its value must be determined by the ordinary rules in such cases. In fact, each branch of the curve has its own curvature at the point. At a cusp it will be found that the radius of curvature vanishes.

103. *The length of any arc of the evolute is equal to the difference of the radii of curvature at its extremities.*

For, draw any three consecutive normals to the original curve: let C be the point of intersection of the first and second, C' of the second and third; then since, ultimately, $CR = CS$, $C'S = C'T$; CC' , which is the increment of the arc of the evolute, is also the increment of the radius of curvature.

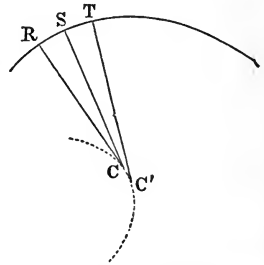

Hence, if a flexible thread be supposed rolled round the evolute, and wound off, any point of it will describe an *involute* of the curve CC' ; that is, a curve of which CC' is the evolute. It was from this point of view that Huyghens, the inventor of evolutes, first considered them, and it was hence that the name *evolute* was given.

104. We add here a formula which is sometimes useful for finding the radius of curvature of a curve given by polar coordinates. The polar equation $\rho = f(\omega)$, can be transformed into one of the form $\rho = f(p)$, where p is the perpendicular from the pole on the tangent, and is given by the equations (Art. 95),

$$p = \rho \sin \theta, \quad \tan \theta = \rho \frac{d\omega}{d\rho}.$$

Let the distance from the pole to the centre of curvature be ρ_1 , and the radius of curvature R , then (Euclid II. 13)

$$\rho_1^2 = \rho^2 + R^2 - 2Rp.$$

If we pass to the consecutive point of the given curve, ρ_1 and R remain constant, and differentiating, we have $R = \rho \frac{d\rho}{dp}$, which is the required expression for the radius of curvature.

When R has been thus expressed in terms of ρ , p , if we eliminate ρ , p between the equations

$$\rho = f(p), \quad \rho_1^2 = \rho^2 + R^2 - 2Rp, \quad p_1^2 = \rho^2 - p^2,$$

the last of which is obviously true, we shall have the relation which subsists between the ρ_1 and p_1 of the evolute; but it is not always easy to pass hence to the relation between the ρ , and the ω , of the evolute.

As an example take the curve $\rho^m = a^m \cos m\omega$, we find here $p = \rho \cos m\omega$, and hence $\rho^{m+1} = a^m p$, for the relation between ρ and p . And we then have $R = \frac{\rho^2}{(m+1)p} = \frac{a^m}{(m+1)\rho^{m-1}}$ for the radius of curvature.

The equations

$$\rho_1^2 = \rho^2 + R^2 - 2Rp,$$

$$p_1^2 = \rho^2 - p^2$$

give at once ρ_1^2, p_1^2 each as a function of ρ , and thus virtually the equation of the evolute in the form $\rho_1 = \phi(p_1)$, but the elimination cannot be actually performed.

It is however easy to find the equation of the reciprocal of the evolute in regard to a circle described about the pole as its centre. Taking for convenience the radius of the circle to be $= a$; then if ρ_2 is the radius vector for the reciprocal curve, and ω_2 the inclination to a line at right angles to that from which ω is measured, we have $p_1 = \rho \sin m\omega$, and then

$$\rho_2 = \frac{a^2}{p_1} = \frac{a}{\cos \frac{1}{m} m\omega \sin m\omega}$$

Moreover (Art. 95), $\omega_2 = (m+1)\omega$; wherefore the relation between ρ_2, ω_2 , or equation of the reciprocal of the evolute is

$$\rho_2^m \cos \frac{m\omega_2}{m+1} \sin^m \frac{m\omega_2}{m+1} = a^m.$$

It will readily appear that the locus of the extremity of the *polar subtangent* (see *Conics*, Art. 192) of any curve is the reciprocal of the evolute of the reciprocal curve. Thus this locus is a right line for the focal conics, since the evolute of the reciprocal then reduces to a point.

105. When we are given the tangential equation of a curve $u=0$, we can obtain directly the line coordinates of the normal and the tangential equation of the evolute. For if $\alpha'\beta'\gamma'$ be the line coordinates of any tangent, then $\alpha \frac{du'}{d\alpha'} + \beta \frac{du'}{d\beta'} + \gamma \frac{du'}{d\gamma'} = 0$ is the equation of the point of contact; and if $v=0$ be the tangential equation of any pair of points IJ , then $\alpha \frac{dv'}{d\alpha'} + \beta \frac{dv'}{d\beta'} + \gamma \frac{dv'}{d\gamma'} = 0$

is the equation of the pole of the given tangent with respect to IJ ; or, in other words, of the harmonic conjugate in respect to these points of the point where IJ is met by the given tangent. When IJ are the circular points at infinity, the second equation represents the point at infinity on the normal; the two together determine the line coordinates of the normal; and if between them and the equation of the curve we eliminate $\alpha'\beta'\gamma'$, we shall have the equation of the evolute. In the system of tangential coordinates which answers to ordinary rectangular coordinates, the equation which represents the circular points IJ is $\alpha^2 + \beta^2 = 0$, (see *Conics*, Art. 385), and the second equation $\alpha \frac{dv'}{d\alpha} + \beta \frac{dv'}{d\beta} + \gamma \frac{dv'}{d\gamma}$ is the well-known condition of perpendicularity $\alpha\alpha' + \beta\beta' = 0$.

Ex. To find the equation of the evolute of a central conic given by its tangential equation (see *Conics*, Art. 169, Ex. 1) $a^2a^2 + b^2\beta^2 = 1$. Here the two equations which determine the coordinates of the normal are $a^2\alpha\alpha' + b^2\beta\beta' = 1$, $\alpha\alpha' + \beta\beta' = 0$, whence $\alpha\alpha' = -\beta\beta' = \frac{1}{c^2}$. Substituting for α' and β' in $a^2a^2 + b^2\beta^2 = 1$, we get the tangential equation of the evolute $\frac{a^2}{\alpha^4} + \frac{b^2}{\beta^2} = c^4$.

106. We give next some examples of the more general problem in which that of evolutes is included, viz. (see Art, 99) to find the envelope of the harmonic conjugate of the tangent to a curve with respect to the lines joining its point of contact to two fixed points I, J . This line may be called the quasi-normal and its envelope the quasi-evolute.

Ex. 1. Let the curve be a conic. Take the line IJ as the base of the triangle of reference, and let its vertex be the pole of this line with respect to the conic, then the equation of the conic will be of the form $(ax + y)(x + by) = z^2$, and that of any tangent will be

$$\theta^2 (ax + y) - 2\theta z + (x + by) = 0.$$

The equation then of any line which together with this and the lines x, y , divides z harmonically will be of the form

$$\theta^2 (ax - y) + (x - by) = Mz.$$

We determine M from the consideration that the line is to pass through the point of contact, for which we have $\theta(ax + y) = z$, $\theta z = x + by$, whence

$$x = \frac{z(b - \theta^2)}{\theta(ab - 1)}, y = \frac{z(\alpha\theta^2 - 1)}{\theta(ab - 1)};$$

and we find

$$M = \frac{2(b - \alpha\theta^4)}{(ab - 1)\theta}.$$

If we write then $ax - y = Y$, $x - by = X$, $8z = (ab - 1)Z$, the equation of the quasi-normal becomes

$$a\theta^4 Z + 4\theta^3 Y + 4\theta X - bZ = 0,$$

and the envelope is a curve of the fourth class whose equation is

$$(abZ^2 + 4XY)^2 + 27Z^2(aX^2 - bY^2)^2 = 0,$$

which represents a curve of the sixth degree having the points XZ , YZ for cusps, Z being their common tangent, and besides four other cusps at the intersections of $abZ^2 + 4XY$, $aX^2 - bY^2$.

EX. 2. Let the conic pass through one of the points I, J ; or, as we may say, let it be semicircular. Then we have say $b = 0$, and xz is on the curve, x being the tangent. The equation of the quasi-normal then becomes

$$a\theta^3 Z + 4\theta^2 Y + 4X = 0,$$

and the envelope is only of the third class, its equation being $64Y^3 + 27a^2XZ^2 = 0$, which represents a cubic having YZ for a cusp and XY for a point of inflexion.

If the curve pass through both I and J ; making a and b both $= 0$, we see that the equation of the quasi-normal reduces to $\theta^2 Y + X$, and that the line therefore passes through a fixed point; namely, the intersection of X, Y , the tangents at I, J .

EX. 3. Let the conic touch the line IJ . The most convenient lines of reference then to choose are this line together with the two other tangents through I, J , and the equation of the conic is

$$x^2 + y^2 + z^2 - 2yz - 2zx - 2xy = 0,$$

or

$$z(2x + 2y - z) = (x - y)^2.$$

The equation of the tangent then is

$$2x + 2y - z - 2\theta(x - y) + \theta^2 z = 0,$$

and we have for the point of contact

$$x - y = \theta z, \quad 2x + 2y - z = \theta^2 z.$$

The equation of the quasi-normal then is

$$x - y - \theta(x + y) = z\{\theta - \frac{1}{2}\theta(1 + \theta^2)\},$$

or

$$\theta^3 z - \theta(2x + 2y + z) + 2(x - y) = 0,$$

and the envelope is also of the third class, viz. the cuspidal cubic whose equation is

$$27z(x - y)^2 = (2x + 2y + z)^3.$$

EX. 4. The three preceding examples might also have been investigated by supposing the conic to have been given by its general equation. The tangent then at any point $a\theta\gamma$ being

$$(aa + h\beta + g\gamma)x + (ha + b\beta + f\gamma)y + (ga + f\beta + c\gamma)z = 0,$$

the quasi-normal is

$$\gamma\{(aa + h\beta + g\gamma)x - (ha + b\beta + f\gamma)y\} = (aa^2 - b\beta^2 + ga\gamma - f\beta\gamma)z.$$

We have then to find the envelopes of

$$aa^2 - b\beta^2 + (f\gamma - gx)\gamma^2 + (by - fz - hx)\beta\gamma + (hy + gz - ax)\gamma\alpha,$$

where α, β, γ , are parameters, also satisfying the condition

$$aa^2 + b\beta^2 + c\gamma^2 + 2f\beta\gamma + 2g\gamma\alpha + 2ha\beta = 0.$$

And (Art. 96) the envelope is formed by the process given (*Conics*, Art. 372) for finding the condition of contact of two conics. We must form then the invariants

of this system of quadratic functions, and the discriminant of the first is $2zS$, where S is

$$(ab - h^2)(ax^2 - by^2) + (bg^2 - af^2)z^2 + 2b(gh - af)yz - 2a(hf - bg)xz.$$

We have

$$\Theta = -(ab - h^2)(ax^2 - 2hxy + by^2) + (3af^2 + 3bg^2 - 4abc - 2fgh)z^2 \\ + (4bgh - 2abf - 2fh^2)yz + (4abf - 2abg - 2gh^2)xz.$$

Θ' vanishes and the envelope is therefore $27 \Delta z^2 S^2 = \Theta^3$, which, as before, is of the sixth degree having six cusps, two of which lie on z . But first let z touch the conic, then $ab - h^2 = 0$, and S and Θ take the form Lz, Mz where L and M are linear and the envelope takes the form $zL^2 = M^3$, and is a cuspidal cubic having z as a stationary tangent. Secondly, let the conic pass, say through I or yz , then $a = 0$, S becomes $b(hy + gz)^2$, and Θ takes the form $(hy + gz)M$. The equation then becomes divisible by $(hy + gz)^3$, and the envelope is of the form $z^2(hy + gz) = M^3$. It will be observed that $hy + gz$ is the tangent to the conic at the point I , and that it is an inflexional tangent of the envelope.

107. In general, as Professor Cayley has remarked, if $Lx + My + Nz$ be the tangent at any point $x'y'z'$, and $\alpha\beta\gamma, \alpha'\beta'\gamma'$ the coordinates of I, J , the equation of the quasi-normal is

$$(L\alpha' + M\beta' + N\gamma') \begin{vmatrix} x, y, x \\ x', y', z' \\ \alpha, \beta, \gamma \end{vmatrix} + (L\alpha + M\beta + N\gamma) \begin{vmatrix} x, y, z \\ x', y', z' \\ \alpha', \beta', \gamma' \end{vmatrix} = 0.$$

For the two determinants, which we shall call for the moment Δ, Δ' , severally represent the lines joining $x'y'z'$ to I and J , and since the tangent passes through their intersection we must have an identity of the form $Lx + My + Nz = A\Delta - B\Delta'$. Substitute successively in this identity $\alpha'\beta'\gamma'$ and $\alpha\beta\gamma$ for xyz , and we determine A and B as proportional to $L\alpha' + M\beta' + N\gamma'$ and $L\alpha + M\beta + N\gamma$, and therefore the equation of the harmonic conjugate of the tangent with respect to Δ, Δ' is of the form written above.

108. Let us examine more particularly the case where one of the points $\alpha\beta\gamma$ is in the curve, and, for simplicity, we take its coordinates $1, 0, 0$; that is to say, we suppose the point to be yz ; and we take the line z to be the tangent at it; and we shall prove that the envelope contains z as a factor. We may also without loss of generality take the second point as $0, 0, 1$ or xy . Making β and γ, α' and $\beta' = 0$ in the preceding equation, it becomes

$$N(yz' - zy') + L(xy' - yx') = 0.$$

Let us suppose now that x', y', z' are expressed in terms of a parameter t , the point α, β, γ answering to the value $t=0$, and we must have t as a factor in the expression for y' , and t^2 in that for z' , in order that the equation of the tangent may reduce to $z=0$. In general, since the tangent is the line joining the point $x'y'z'$ to the consecutive $x'+dx', y'+dy', z'+dz'$, its equation is

$$x(y'dz' - z'dy') + y(z'dx' - x'dz') + z(x'dy' - y'dx') = 0.$$

L, M, N are the coefficients of x, y, z in this equation, and t is a factor in M , and t^2 in L . If then the equation of the quasi-normal be arranged according to the powers of t , it will be found that there is no term independent of t , and that z is a factor in the coefficients both of t and of t^2 . Now the discriminant of a function $A + Bt + Ct^2 + \&c.$ is of the form $A\phi + B^2\psi$ (*Higher Algebra*, Art. 107), and therefore a factor which enters into both A and B will be a factor in the discriminant. Also if in the discriminant we make $B=0$, the remainder will be of the form $A(A\phi + C^2\psi)$: thus it appears that the envelope will have z for an inflexional tangent (compare Art. 99, Ex. 4).

109. It has been remarked (*Conics*, Art. 385) that the relation of perpendicularity may be further extended by substituting for the points I, J , a fixed conic, and by regarding two lines as perpendicular if each pass through the pole of the other with regard to that conic. In this extension then, what answers to the normal, is the line joining any point on a curve to the pole of its tangent with respect to the fixed conic; or, in other words, the line joining the point to the corresponding point on the reciprocal curve with regard to the fixed conic. Thus the curve and its reciprocal have the same normals. For example, taking the fixed conic as $x^2 + y^2 + z^2$, the coordinates of the pole of any tangent to a curve are L, M, N , and the equation of the line answering to the normal is

$$x(Mz' - Ny') + y(Nx' - Lz') + z(Ly' - Mx') = 0.$$

If the curve were a conic, this equation would be of the second degree in $x'y'z'$, and the envelope would be found as in Ex. 4, Art. 106.

110. The following remarks are a useful preliminary to the investigation of the characteristics of the evolute of any curve. *The normal at any point of a curve at infinity coincides with the line at infinity itself.* It has been already remarked (Art. 105) that we may generalize the conception of a normal by substituting for the two circular points at infinity two finite points I, J , and that then if the tangent at any point P meet IJ in M , and if M' be the harmonic conjugate of M with respect to I, J , the line PM' may be regarded as the normal. From this construction it appears at once, that if the point P be on the line IJ , then PM' will coincide with that line. An exception occurs where the point P coincides with either I or J ; then the points M, M' coincide, and the normal coincides with the tangent (see *Conics*, Art. 382, note). Thus, then, *if the curve pass through either of the circular points at infinity, the normal at that point will coincide with the tangent.*

111. We proceed now to determine the *class* of the evolute of a given curve; or in other words, the number of normals to the curve (tangents to the evolute) which can be drawn through any point. By the law of continuity, the number of normals is the same, whatever be the point through which they pass. It is enough, therefore, to examine the case when the point is at infinity. But the number of normals, distinct from the line at infinity itself, which can be drawn parallel to a given line, is equal to the number of tangents which can be drawn parallel to a given line, that is, to the class of the curve. And we have seen in the last article that the m normals, corresponding to the m points of the curve at infinity, coincide with the line at infinity, and therefore also pass through the assumed point. Thus then *the number of normals which can be drawn to the curve from any point, is equal to the sum of the order and class of the curve—or, what is the same thing, the sum of the orders of the curve and its reciprocal.* If the line at infinity be a tangent to the curve, then the number of finite tangents which can be drawn through a point at infinity, is plainly one less than in the general case, and therefore the number of normals is also one less. Thus four normals can be drawn from a given point to a conic in general, but only three to a parabola.

Again, if the curve pass through either circular point, we saw (Art. 110) that the normal at that point does not coincide with the line at infinity, and therefore, that for every passage through a circular point, the number of normals is one less than in general. Thus in the case of the circle which passes through the two points I, J , the number of normals through a point is reduced by two, and is two instead of four. Thus then if m and n be the degree and class of a curve which passes f times through a circular point, and touches the line at infinity g times, the class of the evolute is

$$n' = m + n - f - g.$$

These results might equally have been obtained from the consideration that if in the equation of the normal $M(\alpha-x) = L(\beta-y)$ we suppose α, β given and x, y variable, we shall have the equation of a curve of the m^{th} degree, whose intersection with the given curve determines the points the normals at which pass through α, β . If the curve have no multiple points, the number of intersections will be evidently m^2 or $m+n$: and there is no difficulty in showing, that in the general case of δ double points and κ cusps, the order is $m^2 - 2\delta - 3\kappa$, that is $m+n$.

112. We next examine the *degree* of the evolute, and again it suffices to examine the number of points in which the line at infinity meets the evolute. Now if two consecutive normals to the original curve be parallel, the corresponding tangents will coincide; the points at infinity therefore on the evolute arise in general from the points of inflexion on the given curve. But to these must be added those arising from points at infinity on the given curve, which points (Art. 111) also give rise to points at infinity on the evolute. But we say, moreover, that these will be cusps on the evolute having the line at infinity for their tangent. Let M be any point on the line IJ , and M' its harmonic conjugate, then we saw that the line answering to the normal at M is the line IJ : but if the consecutive points of the curve, antecedent and subsequent to M be L and N , their normals are LM', NM' . Hence M' is a point through which three consecutive tangents to the evolute pass, and is therefore a cusp having IJ for its tangent. Since then the tangent at a cusp meets the curve in three consecutive points, the m points

at infinity of the given curve, give rise to the same number of cusps on the evolute which are met by the line at infinity in $3m$ points. If we add these to those already obtained, we find the degree of the evolute $= \iota + 3m$, or the number which we have called α (Art. 83).

If the curve pass through either point I, J , we have seen that these give rise to no points at infinity on the evolute, and therefore the degree will be less by three.

If the line IJ touch the curve, the normals for the two consecutive points in which it meets the curve coincide with IJ ; we have therefore two consecutive tangents to the evolute coincident, or a point of inflexion on the evolute having IJ for its tangent. As this takes the place of two cusps which we have when IJ meets the curve in distinct points, the degree of the evolute is reduced by three; and if we use f and g in the same sense as in the last article, we have for the degree of the evolute

$$m' = \alpha - 3(f + g).^{*}$$

The values given show that the degree and class are the same of the evolute of a curve and of its reciprocal as Art. 109 might lead us to expect.

113. There will in general be no points of inflexion on the evolute. For if there be such a point, two consecutive tangents to the evolute (normals to the curve) coincide; but it is plain, on considering the figure, that two consecutive normals cannot coincide unless the corresponding tangents coincide with their normals and with each other, which could only happen in the exceptional case where the original curve had an inflexional tangent passing through I or J .

If, however, the curve touch IJ , we have seen (Art. 112) that there is a point of inflexion at infinity, and if the curve pass through I or J (Art. 108), that the evolute has an inflexional tangent passing through the same point. We have thus conditions enough to determine all the characteristics of the evolute, viz.

$$m' = \alpha - 3(f + g), \quad n' = m + n - (f + g), \quad \iota' = (f + g);$$

* Some particular examples show that these formulæ must be modified when I or J is a multiple point at which two or more tangents coincide. Thus if either be a cusp, the diminution of degree is 4 not 6.

whence by Plücker's formula $\kappa' = 3\alpha - 3(m+n) - 5(f+g)$, $\alpha' = 3\alpha - 8(f+g)$; and we can in like manner write down the number of double points of the evolute, and of its double tangents; these double tangents are, it is clear, double normals of the original curve.

The "deficiency" (Art 44) of the evolute is the same as that of the original curve, as may be verified by using the expression for the deficiency $\frac{1}{2} \{\alpha - 2(m+n)\} + 1$.*

114. The number of cusps on the evolute may also be investigated directly. We shall have a cusp on the evolute, when three of its consecutive tangents (normals to the curve) meet in a point; or, in other words, when four consecutive points of the curve lie on a circle. If this be the case the radius of curvature remains constant when we pass to a consecutive point. Differentiating then the expression given (Art. 102) we have

$$(L^2 + M^2) \left(\frac{dH}{dx} dx + \frac{dH}{dy} dy \right) = 3H \{ (aL + hM) dx + (hL + bM) dy \},$$

and eliminating $dx : dy$ by the equation $Ldx + Mdy = 0$, we have

$$(L^2 + M^2) \left(M \frac{dH}{dx} - L \frac{dH}{dy} \right) = 3H \{ (a-b) LM + h(M^2 - L^2) \}.$$

Since H is of the order $3(m-2)$, L and M of the order $m-1$, and a, b, h of order $m-2$, this equation represents a curve of the order $6m-10$, whose intersections with the given curve are the points where the osculating circle has contact of the third order.† If the curve have no multiple points, these $m(6m-10)$ points together with m points at infinity give rise to $m(6m-9)$ cusps on the evolute, a number in accordance with the preceding formulæ.

We might, in like manner, investigate the characteristics of

* In general the deficiency of two curves is the same, if one is derived from the other by such a process that to one point on either curve answers one point on the other.

† In a subsequent part of the work the question of conics having with the curve contact of a higher order than the second is more fully considered, and a formula given for the *aberrancy of curvature* or deviation of the curve from the circular form.

the evolute in the more general sense of the word indicated Art. 109, and we should find that the formulæ we have already obtained will apply, f being now the number of contacts of the curve with the fixed conic, and there being no singularity answering to g .

CAUSTICS.

115. As a further illustration of envelopes, we add some mention of caustics, the investigation of which, though suggested to mathematicians by the science of optics, belongs purely to the theory of curves. The subject has some historical interest, caustics being among the earliest questions, involving the problem of envelopes, actually discussed.*

If light be incident on a curve from any point, the reflected ray is found by drawing a line, making with the normal the same angle which is made with it by the incident ray; the envelope of all these reflected rays is the *caustic by reflection*.

It is easy to form the general equation of the reflected ray. Let the equations of the tangent and normal at the point of incidence be $T=0$, $N=0$; then the equation of the incident ray is $T'N - TN' = 0$, where $T'N'$ are the results of substituting the coordinates of the radiant point in T and N ; the reflected ray then, which is the fourth harmonic to these three lines, will have for its equation

$$T'N + TN' = 0,$$

and the envelope can then be found by the preceding rules.

Ex. To find the caustic by reflexion of a circle.

The reflected ray is, by the preceding ($a\beta$ being the coordinates of the radiant point, and the tangent and normal being $x \cos \theta + y \sin \theta - r$, and $x \sin \theta - y \cos \theta$),
 $(\alpha \cos \theta + \beta \sin \theta - r)(x \sin \theta - y \cos \theta) + (x \cos \theta + y \sin \theta - r)(\alpha \sin \theta - \beta \cos \theta) = 0$,
 or $(\alpha y + \beta x) \cos 2\theta + (\beta y - \alpha x) \sin 2\theta + r(x + \alpha) \sin \theta - r(y + \beta) \cos \theta = 0$,
 whose envelope is (Ex. 3, Art. 85)

$$[4(a^2 + \beta^2)(x^2 + y^2) - r^2\{(x + a)^2 + (y + \beta)^2\}]^3 = 27(\beta x - \alpha y)^2(x^2 + y^2 - a^2 - \beta^2)^2.$$

116. Instead of finding directly the envelope of the reflected ray, M. Quetelet has given a method, which is more convenient in practice, of reducing the problem to that of evolutes; since the caustic would be sufficiently determined if we knew the curve of which it was the evolute.

* The subject of caustics was introduced by Tschirnhausen, Acta Eruditorum 1682, referred to by Gregory, Examples, p. 224.

“If with each point successively of the reflecting curve as centre, and its distance from the radiant point as radius, we describe a series of circles, the envelope of all these circles will be a curve, the evolute of which will be the caustic required.” The following (due to M. Dandelin) is a more convenient form of stating the same theorem: *If we let fall from the radiant point O the perpendicular OP on the tangent, and produce it so that $PR = OP$, then the caustic is the evolute of the locus of R .*

For RT is evidently the direction of the reflected ray, and if we draw the consecutive ray, then, since $OT, TV; OT', T'V$, make equal angles with TT' , $OT + TV = OT' + T'V$ (*Conics*, Art. 392); therefore $VR = VR'$, and therefore VR is normal to the locus of R .

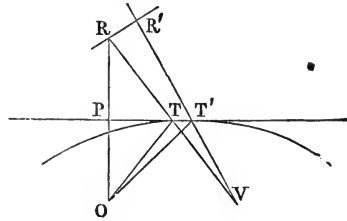

The locus of P , the foot of the perpendicular on the tangent, we call the *pedal* of the given curve. The locus of R is plainly a similar curve, and its equation can always be written down when the equation of the reciprocal of the given curve with regard to O is known, by substituting $\frac{2}{\rho}$ for ρ in the polar equation of that reciprocal. Thus the caustic by reflexion, of a circle, is the evolute of the *limaçon*, (see Ex. 5, Art. 55), since its equation (the radiant point being pole) as found by the rule just given is of the form

$$\rho = p(1 + e \cos \omega).$$

117. If light be incident from any point on a curve, the *refracted ray* is found by drawing a line, making with the normal an angle whose sine is in a constant ratio to that of the angle made with the normal by the incident ray, and the envelope of all these rays is the *caustic by refraction*.

M. Quetelet has reduced in like manner these caustics to evolutes by the following theorem, the truth of which it is easy to see. “If with each point successively of the refracting curve as centre, and a length *in a constant ratio* to its distance from the radiant point as radius, we describe a series of circles, the envelope of all these circles will be a curve whose evolute is the

caustic by refraction." In fact, the method of infinitesimals readily shows that, in consequence of the law of refraction, the increments of the incident and refracted rays are connected by the relation $md\rho + d\rho' = 0$, it follows then that if, on the refracted ray produced, TR be taken $=mOT$, $T'R' = mOT'$, then $VR = VR'$, and therefore the refracted ray is normal to the locus of R .

We add geometrical investigations in relation to two interesting cases of caustics by refraction.

(1) *To find the caustic by refraction of a right line.*

Let fall a perpendicular on the line, and produce it so that $AP = PB$; and let a circle be described through A, B , and the point of incidence R ; let LR be the refracted ray; then obviously the angle ALB is bisected, and

$$AL + LB : AB :: AL : AO$$

$$:: \sin AOL : \sin ALO;$$

but AOL is the angle which the refracted ray makes with the perpendicular to the line, and $ALO = BLO = BAR$ is the angle which the incident ray makes with the perpendicular; the ratio of $AL + LB$ to AB is therefore given; the locus of L is an ellipse, of which A and B are the foci, to which LR is normal, and of which, therefore, the caustic is the evolute.

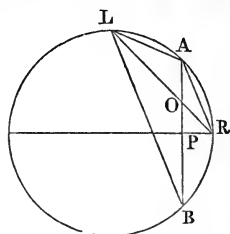

(2) *To find the caustic by refraction of a circle.*

Let a circle be described through A , the radiant point, and R , the point of incidence, to touch OR ; then the point B is given, since $OA \cdot OB = OR^2$. The ratio $RA : RB$ is by similar triangles equal to the given ratio $OA : OR$. The ratio $RA : RM$ is equal to $\sin RBA : \sin RBM$; but $RBA = PRA$, the angle which the incident ray makes with the normal to the curve, and $RBM = PRM$, the angle which the refracted ray makes with the same normal; hence the ratio $RA : RM$ is also given. Now since

$$AM \cdot RB + MB \cdot AR = RM \cdot AB,$$

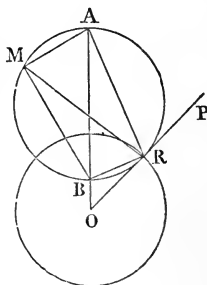

if we denote the distances of M from A and B by, ρ, ρ' , these distances are connected by the relation

$$\frac{RB}{RM} \rho + \frac{RA}{RM} \rho' = AB.$$

Now, a Cartesian is defined as the locus of a point whose distances from two given foci are connected by the relation $m\rho + n\rho' = c$; and it is proved precisely as at *Conics*, Art. 392, that the normal to such a curve divides the angle between the focal radii into parts whose sines are in the ratio $m : n$. Hence the locus of M is a Cartesian, of which A and B are foci, and it is obvious that MR is normal to the locus, and therefore the caustic is the evolute of this curve.*

The ellipse in (1) and the Cartesian in (2) are curves cutting at right angles the refracted rays; the curve cutting at right angles the reflected or refracted rays is termed the secondary caustic.

PARALLEL CURVES AND NEGATIVE PEDALS.

117 (a). It remains briefly to notice one or two other classes of envelopes. We have already mentioned the problem of finding the curve parallel to a given one. This may either be treated as that of finding the envelope of a tangent parallel to each tangent of the given curve, and at a fixed distance from it, and so of finding the envelope of

$$Lx + My + Nz = kz \sqrt{(L^2 + M^2)},$$

or else, as we have already seen, it may be regarded as that of finding the envelope of the circle of given radius $(x - \alpha)^2 + (y - \beta)^2 = k^2$, whose centre α, β satisfies the equation of the curve, or, what is the same thing, of finding the condition that this circle should touch the given curve. The result will evidently be a function of k^2 . In some exceptional cases to be mentioned presently, the result can be resolved into factors, as for instance, the parallel at a distance k to a circle of radius a consists of a pair of circles of radii $a \pm k$. But, ordinarily, such a resolution is not possible, and the two tangents at the distance

* This proof was communicated to me by Dr. Atkins.

$\pm k$ from any tangent will touch the same parallel curve. Hence, the number of tangents which can be drawn parallel to any given line is double that which can be so drawn to the original curve, or $n' = 2n$. In like manner, to each inflexional tangent on the original correspond two on the parallel curve, or $i' = 2i$. To find the order of the parallel it suffices to make $k = 0$ in its equation, which will not affect the terms of highest dimensions in the equation; but what was proved for the conic (*Conics*, Art. 372, Ex. 2) is true in general, that the result of writing $k = 0$ in the equation of the parallel is the original curve counted twice, together with the two sets of n tangents drawn from the points I, J to the curve. The order then is $2(m + n)$. There is no difficulty in seeing how these numbers are modified if the original curve touch the line at infinity or pass through the points I, J . We arrive in this way at Professor Cayley's formulæ

$$n' = 2(m + n) - 2(f + g), \quad n' = 2n, \quad i' = 2i = -6m + 2\alpha,$$

$$\kappa' = 2\alpha - 6(f + g) : f' = 2(n - g), \quad g' = 2g.$$

The parallel curve and the original have the same normals and the same evolute, but every normal to the parallel curve is so generally in two places, answering to the values $\pm k$.

Ex. 1. To find the parallel to the ellipse or parabola. See *Conics*, Art. 372.

Ex. 2. To find the parallel to $x^{\frac{2}{3}} + y^{\frac{2}{3}} = a^{\frac{2}{3}}$. The equation of any tangent is (see Art. 99, Ex. 6)

$$x \cos \phi + y \sin \phi = a \sin \phi \cos \phi.$$

Hence, that of a parallel at the distance k is

$$x \cos \phi + y \sin \phi = k + a \sin \phi \cos \phi,$$

whose envelope is (see Art. 85, Ex. 3)

$$\{3(x^2 + y^2 - a^2) - 4k^2\}^3 + \{27axy - 9k(x^2 + y^2) - 18a^2k + 8k^3\}^2 = 0.$$

This is one of the cases where the parallels answering to the values $\pm k$ are different curves and not different branches of the same curve.

The curve whose equation has been just obtained is the envelope of a line on which a constant intercept is made by two fixed lines. If the lines are at right angles, taking them for axes it is seen immediately that the equation of a line whose length is a inclined at an angle ϕ to the axis of x is $x \sin \phi + y \cos \phi = a \cos \phi \sin \phi$, whose envelope is $x^{\frac{2}{3}} + y^{\frac{2}{3}} = a^{\frac{2}{3}}$. But consider for a moment a diameter and a parallel chord of a circle, and it is evident that if a line whose length is a subtend a right angle at any point, a parallel line at a distance $\frac{1}{2}a \cos \phi$ will make an intercept $a \sin \phi$ on a pair of lines including an angle ϕ , and equally inclined to the rectangular lines. Hence, obviously the envelope of a line whose length is $a \sin \phi$ intercepted between the oblique lines is a parallel (answering to the value $k = \frac{1}{2}a \cos \phi$) to the envelope for the rectangular lines, $x^{\frac{2}{3}} + y^{\frac{2}{3}} = a^{\frac{2}{3}}$.

118. If $\alpha x + \beta y + \gamma$ be a tangent to a curve (the equation being expressed in ordinary rectangular coordinates), then evidently $\alpha x + \beta y + \gamma + k\sqrt{\alpha^2 + \beta^2}$ is a tangent to the parallel curve; and it follows at once, that if we have the tangential equation of the given curve, we obtain that of the parallel by writing in it for γ , $\gamma + k\rho$ where ρ is $\sqrt{\alpha^2 + \beta^2}$. Hence the tangential equation of the parallel to a curve whose tangential equation is $V = 0$ is

$$V + k\rho \frac{dV}{d\gamma} + \frac{1}{1.2} k^2 \rho^2 \frac{d^2 V}{d\gamma^2} + \&c. = 0.$$

The equation is cleared of radicals by transposing to one side the terms containing the odd powers of ρ and squaring, when we obtain an equation the order of which is double that of the original tangential equation, in conformity with what was proved in the last article.

Ex. 1. To find the tangential equation of the parallel to $\frac{x^2}{a^2} + \frac{y^2}{b^2} = 1$. The tangential equation of the ellipse is (see *Conics*, Art. 169, Ex. 1) $a^2\alpha^2 + b^2\beta^2 = \gamma^2$, whence that of the parallel is

$$a^2\alpha^2 + b^2\beta^2 = (\gamma + k\rho)^2,$$

or
$$\{(a^2 - k^2)\alpha^2 + (b^2 - k^2)\beta^2 - \gamma^2\}^2 = 4k^2(\alpha^2 + \beta^2)\gamma^2$$

Ex. 2. To find the tangential equation of the parallel to the parabola $y^2 = px$. The corresponding tangential equation is $p\beta^2 = 4a\gamma$; hence that of the parallel is

$$(p\beta^2 - 4a\gamma)^2 = 16k^2a^2(\alpha^2 + \beta^2).$$

Ex. 3. To find the tangential equation of the parallel to a circle. The tangential equation to the circle whose centre is the point a , b , and radius c , is (*Conics*, Art. 86) $(a\alpha + b\beta + \gamma)^2 = c^2(\alpha^2 + \beta^2)$; therefore that of the parallel is

$$(a\alpha + b\beta + \gamma + k\rho)^2 = c^2\rho^2,$$

which breaks up into factors, and gives

$$a\alpha + b\beta + \gamma + k\rho = \pm c\rho;$$

whence, clearing of radicals,

$$(a\alpha + b\beta + \gamma)^2 = (c \pm k)^2(\alpha^2 + \beta^2),$$

representing a pair of concentric circles whose radii are $c \pm k$, as is geometrically evident.

119. In precisely the same manner, as in the last example, it is proved that if the tangential equation of a curve be of the form $u^2(\alpha^2 + \beta^2) = v^2$, the parallel will break up into two factors of like form with the original, the parallels answering to the

values $\pm k$ being distinct curves, and not different branches of the same curve. For suppose that by the substitution of $\gamma + k\rho$ for γ , u becomes $u + u'k\rho + u''k^2\rho^2 + \&c.$, and similarly for v ; then $u^2\rho^2 = v^2$ becomes

$$(u + u'k\rho + u''k^2\rho^2 + \&c.)^2 \rho^2 = (v + v'k\rho + v''k^2\rho^2 + \&c.)^2,$$

which is at once resolvable into factors which can be rationalized separately, giving the result

$$\begin{aligned} \{u + u''k^2\rho^2 + \&c. \pm (v'k + v'''k^3\rho^2 + \&c.)\}^2 \rho^2 \\ = \{v + v''k^2\rho^2 + \&c. \pm (u'k\rho^2 + u'''k^3\rho^4 + \&c.)\}^2. \end{aligned}$$

Thus the equation given for the parallel of a conic is of the form considered in this article, and it can be now easily verified that the parallel to that parallel at the distance k' consists of the two parallels to the conic at the distances $k \pm k'$, as manifestly ought to be the case. Take again the curve already mentioned, $x^{\frac{2}{3}} + y^{\frac{2}{3}} = a^{\frac{2}{3}}$, whose tangential equation is $(\alpha^2 + \beta^2)v^2 = a^2\alpha^2\beta^2$, which being of the form here considered, shows that the parallel breaks up into factors. The tangential equation of the parallel is in fact $(\alpha^2 + \beta^2)\gamma^2 = \{a\alpha\beta \pm k(\alpha^2 + \beta^2)\}^2$.

If we take for u and v respectively the most general functions of the first and second degrees in α, β, γ , $u^2\rho^2 = v^2$ denotes a curve of the fourth class having two double tangents, and which is therefore of the eighth order. But these functions may be so taken that the double tangents shall become stationary tangents, and that the curve may have another double or stationary tangent, and in this way we can form the equation of a curve of the third or fourth order whose parallels break up into factors. Of this kind is the reciprocal of a Cartesian, as will afterwards be shown.

120. If we had been using trilinear instead of rectangular equations, it follows, from *Conics*, Art. 61, that the equation of a parallel to $\alpha x + \beta y + \gamma z$, at a constant distance from it, is of the form

$$\alpha x + \beta y + \gamma z + m(x \sin A + y \sin B + z \sin C) \sqrt{S} = 0,$$

where S is

$$\alpha^2 + \beta^2 + \gamma^2 - 2\beta\gamma \cos A - 2\gamma\alpha \cos B - 2\alpha\beta \cos C,$$

and we see that if in the tangential equation of a curve we write for $\alpha, \beta, \gamma,$

$$\alpha + m \sin A \sqrt{(S)}, \beta + m \sin B \sqrt{(S)}, \gamma + m \sin C \sqrt{(S)},$$

we shall have the tangential equation of a parallel curve. We saw, *Conics*, Art. 382, that $S=0$ is the tangential equation of the points IJ ; and it is at once suggested, that if $S=0$ be the tangential equation of any two points, and $ax + by + cz = 0$ the line joining them, then considering the circular points at infinity as replaced by the two points in question, the envelope of $ax + \beta y + \gamma z$, and of $ax + \beta y + \gamma z + (ax + by + cz) \sqrt{(S)}$ are quasi-parallel curves.

121. We called (Art. 116) the locus of the foot of the perpendicular on the tangent from a given pole or centre, the *pedal* of the given curve. Having found the pedal we may find its pedal again, &c., and so have a series of second, third, &c., pedals of the given curve. Or we may continue the series the other way, the curve of which the given curve is the pedal being the first negative pedal, and so on. The problem of finding the negative pedal is that of finding the envelope of a line drawn perpendicular to the radius vector through its extremity; or, in other words, it is that of finding the envelope of

$$\alpha x + \beta y = \alpha^2 + \beta^2,$$

where α, β satisfy the equation of the curve. We have just seen that the problem of finding the parallel curve is that of finding the envelope of

$$2\alpha x + 2\beta y + k^2 - x^2 - y^2 = \alpha^2 + \beta^2,$$

subject to the same conditions; and accordingly Mr. Roberts has remarked that the two geometrical problems are both reducible to the same analytical problem, viz. that of finding an envelope of the form

$$A\alpha + B\beta + C = \alpha^2 + \beta^2,$$

and that if we had the equation of the parallel curve we could deduce that of the negative pedal, by writing in it $k^2 = x^2 + y^2$, and then writing $\frac{1}{2}x, \frac{1}{2}y$ for x and y . Ordinarily, indeed, the problem of finding the parallel curve is the more difficult of the two; but this method gives immediately the negative pedal of

the right line or circle. For the parallel to a right line is a pair of equidistant parallel lines, and the parallel to a circle of radius a is two concentric circles of radii $a \pm k$. In either of these cases, then, the equation of the parallel curve can be written down without calculation, and the negative pedal thence derived by the process just indicated.

122. If for any curve there is taken on each radius vector OP from an arbitrary origin or centre of inversion a portion OP' equal to the reciprocal of OP , the locus of P' is said to be the *inverse* of the given curve. From this definition it is easily inferred that the pedal of a curve is the inverse of its polar reciprocal, and that the first negative pedal is the polar reciprocal of its inverse; the reciprocation being performed in regard to a circle described about the origin or centre of inversion as its centre.

There is no difficulty in deducing, by reasoning similar to that used in other similar cases, the characteristics of the curve inverse to a given one, and hence those of the pedal and of the negative pedal respectively, and it is sufficient to give the results. We use f and g in the same sense as before to denote the number of times that the curve passes through a point I or J , or that it touches the line IJ ; f' and g' denote the reciprocal singularities, viz. the number of times the curve touches a line OI or OJ , or that it passes through the origin; p and q denote the number of coincidences of tangents when the origin or when a point I or J is a multiple point [for example, we should have $p = 1$, if the origin were a cusp], and p' , q' denote the reciprocal singularities; then for the inverse curve we have

$$M = 2m - f - g', \quad N = n + 2m - 2(f + g') - (f' + g) + (p + q), \\ F = 2m - f - 2g', \quad G = p, \quad F' = q, \quad G' = m - f, \quad P = g, \quad Q = f'.$$

Hence we must have for the pedal

$$M = 2n - f' - g, \quad N = m + 2n - 2(g + f') - (g' + f) + p' + q', \\ F = 2n - 2g - f', \quad G = p', \quad F' = q', \quad G' = n - f', \quad P = g', \quad Q = f,$$

and for the negative pedal

$$M = n + 2m - 2(f + g') - (f' + g) + p + q, \quad N = 2m - f - g', \\ F = q, \quad G = m - f, \quad F' = 2m - f - 2g', \quad G' = p, \quad P' = g, \quad Q' = f'.$$

Ex. 1. To find the negative pedal of the parabola, the pole being at the focus.*

Let the equation be $y^2 = 4 (mx + m^2)$. We may then express any point on the curve by $x + m = \lambda^2 m$, $y = 2\lambda m$, and the equation $ax + \beta y = \alpha^2 + \beta^2$ becomes

$$(\lambda^2 - 1) x + 2\lambda y = (\lambda^2 + 1)^2 m.$$

The invariants of this quartic in λ are

$$S = 3 (x + 4m)^2, T = (x + 4m)^3 - 54m (x^2 + y^2).$$

The discriminant therefore $S^3 - 27T^2$ becomes divisible by $x^2 + y^2$ and gives the equation

$$(x + 4m)^3 = 27m (x^2 + y^2).$$

This is equivalent to the polar equation $\rho^{\frac{1}{3}} \cos \frac{1}{3} \omega = m^{\frac{1}{3}}$, which might have been otherwise obtained, since it immediately follows, from Art. 95, that if the equation of any curve can be expressed in the form $\rho^m = a^m \cos m\omega$, the equations of its pedal and negative pedal are of the same form, the new m being $\frac{m}{1+m}$ and $\frac{m}{1-m}$ respectively.

It may be remarked that the equation of the tangent to a parallel to this curve is

$$(\lambda^2 - 1) x + 2\lambda y = (\lambda^2 + 1)^2 m + (\lambda^2 + 1) k,$$

the envelope of which is of the fifth order, the curves answering to the values $\pm k$ being distinct. And so in general the parallels will be unicursal of curves, the equation of whose tangent is

$$(\lambda^2 - 1) x + 2\lambda y = \phi (\lambda).$$

If we take $\phi (\lambda) = m\lambda^3$ we get a curve of the third class and fourth order touched by the line at infinity and passing through the points I, J .

Ex. 2. To find the negative pedal of $\frac{x^2}{a^2} + \frac{y^2}{b^2} = 1$, the pole being at the centre.

Writing as usual for the coordinates of any point $a \cos \phi$ and $b \sin \phi$, we have to find the envelope of

$$ax \cos \phi + by \sin \phi = a^2 \cos^2 \phi + b^2 \sin^2 \phi = \frac{1}{2} (a^2 + b^2) + \frac{1}{2} (a^2 - b^2) \cos 2\phi.$$

Hence, writing for the moment $\frac{1}{2} (a^2 + b^2) = m$, $\frac{1}{2} (a^2 - b^2) = n$, the envelope is (see Art. 85, Ex. 3).

$$\{3 (a^2 x^2 + b^2 y^2) - 4 (m^2 + 3n^2)\}^2 + \{9 (m - 3n) a^2 x^2 + 9 (m + 3n) b^2 y^2 - 8m (m^2 - 9n^2)\}^2 = 0.$$

For Professor Cayley's solution of the same problem, see *Geometry of Three Dimensions*, (Art. 481).

Ex. 3. To find the negative pedal of the ellipse, the pole being at the focus. The x measured from the focus is $c + a \cos \phi$ and the focal radius vector $a + c \cos \phi$. We have therefore to find the envelope of

$$x (c + a \cos \phi) + y b \sin \phi = (a + c \cos \phi)^2,$$

$$\text{or of } c^2 \cos 2\phi + a (4c - 2x) \cos \phi - 2by \sin \phi + (2a^2 + c^2 - 2cx) = 0$$

and the envelope is

$$\{3b^2 (x^2 + y^2) - (2b^2 + cx)^2\}^2 + 9b^2 (a^2 - cx + 2c^2) (x^2 + y^2) - (2b^2 + cx)^3 = 0,$$

which, when expanded, will plainly be divisible by $x^2 + y^2$ and will represent a curve of the fourth degree, having the lines $x^2 + y^2$ as stationary tangents.

* It may easily be seen that this is the same problem as to find the caustic by reflexion, the rays being perpendicular to the axis.

CHAPTER IV.

METRICAL PROPERTIES OF CURVES.

123. In this chapter we shall give some of the more important of the metrical properties of curves. In the investigation of such properties Cartesian rectangular coordinates are most advantageously employed; then, as we saw in Art. 35, by substituting $\rho \cos \theta$ and $\rho \sin \theta$ for x and y , we obtain the lengths of the segments made by the curve on any line through the origin; and so on any line whatever, since by transformation of coordinates any point may be taken for origin.

The theorem given (*Conics*, Art. 148) may be generalized as follows: *If through any point O two chords be drawn, meeting a curve of the n^{th} degree in the points $R_1, R_2, \dots, R_n, S_1, S_2, \dots, S_n$, then the ratio of the products $\frac{OR_1 \cdot OR_2 \dots OR_n}{OS_1 \cdot OS_2 \dots OS_n}$ will be constant, whatever be the position of the point O, provided that the directions of the lines OR, OS be constant.**

And the proof is the same as that already given in the case of conic sections. From the polar equation of the curve, Art. 26, we see that the product of all the values of the radius vector on a line through the origin making an angle θ with the axis of x is

$$= \frac{A}{P \cos^n \theta + Q \cos^{n-1} \theta \sin \theta + \&c.},$$

and the same product for any other line is

$$= \frac{A}{P \cos^n \theta_1 + Q \cos^{n-1} \theta_1 \sin \theta_1 + \&c.}.$$

The ratio is therefore

$$\frac{P \cos^n \theta + Q \cos^{n-1} \theta \sin \theta + \&c.}{P \cos^n \theta_1 + Q \cos^{n-1} \theta_1 \sin \theta_1 + \&c.}.$$

* This theorem was first given by Newton, in his *Enumeratio Linearum Tertiae Ordinis*.

But we have seen (*Conics*, Art. 134) that, by a transformation to any parallel axes, the coefficients of the highest powers of the variables, and therefore this ratio, will be unaltered.

We may (as at *Conics*, Art. 148) express the same theorem thus: *If through two fixed points, O and o, any two parallel lines be drawn, then the ratio of the products $OR_1 \cdot OR_2 \cdot OR_3 \dots \&c.$: $or_1 \cdot or_2 \cdot or_3, \&c.$ will be constant, whatever be the common direction of these lines.*

For the value of the second product is $\frac{A'}{P \cos^n \theta + \&c.}$, where A' is the absolute term when o is made the origin; and the ratio of the products is $A : A'$, and independent of θ . We have seen (*Conics*, Art. 134) that the new absolute term will be the result of substituting the coordinates of o in the given equation. We see, therefore, that the result of such a substitution is always proportional to the product of the segments intercepted between o and the curve on a line whose direction is given (*Conics*, Art. 262).

124. From the preceding theorem is deduced at once Carnot's theorem, of which we have given a particular case (*Conics*, Art. 313). Let each of the sides of a polygon $ABC, \&c.$, meet a curve of the n^{th} degree in n real points. We shall denote by $(B)'$ the continued product of the n segments made on the side BC between B and the curve; by $'(B)$ the product of the segments made on the side BA . Then

$$(A)' (B)' (C)' (D)' \&c. = '(A) '(B) '(C) '(D) \&c.$$

For through any point draw radii vectores parallel to the sides of the polygon, and denote the continued product of the segments on each of these lines by $(a), (b), (c), \&c.$, then, disregarding signs,

$$'(B) : (B)' :: (a) : (b),$$

$$'(C) : (C)' :: (b) : (c),$$

$$'(D) : (D)' :: (c) : (d),$$

&c.,

and, compounding all these ratios, the truth of the theorem is evident.

125. Some ambiguity will be avoided by attention to the sign \pm . Considering the segments on the line AB , we have $(A)'$ the product of n segments measured from A to B ; and $'(B)$ the product of n segments measured from B to A , and therefore according to the rule of signs (*Conics*, Art. 7), each term in the latter product is to be regarded as of an opposite sign from each term in the former, so that if we give to $(A)'$ the sign $+$, we must give to $'(B)$ the sign $(-)^n$; that is to say, $+$ when n is even and $-$ when it is odd. And if k be the number of sides of the polygon, then since each side of the equation of the last article consists of k factors such as $(A)'$, that equation must be written

$$(A)' (B)' (C)' \&c. = (-)^{nk} '(A)' (B)' (C)' \&c.;$$

that is to say, the right-hand side will have the sign $+$ when either the degree of the curve or the number of sides of the polygon is even; but when both are odd, the sign $-$ is to be used.*

EX. 1. Let a right line meet the sides of a triangle AB, BC, CA , in the points c, a, b . Then

$$Ac . Ba . Cb = - Ab . Bc . Ca \text{ (Conics, Art. 42),}$$

and the sign shows that, if it cut two sides internally, it must cut the third externally. The equation

$$Ac, . Ba . Cb = + Ab . Bc, . Ca \text{ (Conics, Art. 43)}$$

will be fulfilled if the three lines $Aa, Bb, Cc,$ meet in a point; and the line AB is cut harmonically in the points e and $e,$

EX. 2. Let each side of the triangle touch a conic in the points a, b, c . Carnot's theorem gives us

$$Ac^2 . Ba^2 . Cb^2 = + Ab^2 . Bc^2 . Ca^2;$$

and, therefore,

$$Ac . Ba . Cb = \pm Ab . Bc . Ca.$$

The lower sign cannot be used, since no line can meet a conic in three points: we learn then that if a conic be inscribed in a triangle, the lines joining each vertex to the opposite point of contact meet in a point.

EX. 3. Let a, b, c be points of inflexion on a curve of the third degree, at which $BC, CA, AB,$ are tangents; then by Carnot's theorem,

$$Ac^3 . Ba^3 . Cb^3 = - Ab^3 . Bc^3 . Ca^3,$$

the only real root of which is

$$Ac . Ba . Cb = - Ab . Bc . Ca.$$

Hence, if a curve of the third degree have three real points of inflexion, they must lie on one right line. Hence, too, a curve of the third degree can have only three

* See Plücker's *System der Analytischen Geometrie*, p. 44.

real points of inflexion; for this argument would show that *all* the real points of inflexion must lie on a right line; and a right line can only meet the curve in three points.

The same reasoning proves that if any curve of an odd degree n have three real points, at each of which the tangent meets the curve in n points, these three points must lie on one right line.

Ex. 4. Let a curve of the fourth degree have three double tangents; we have

$$Ac^2 \cdot Ac'^2 \cdot Ba^2 \cdot Ba'^2 \cdot Cb^2 \cdot Cb'^2 = Ab^2 \cdot Ab'^2 \cdot Bc^2 \cdot Bc'^2 \cdot Ca^2 \cdot Ca'^2,$$

whence $Ac \cdot Ac' \cdot Ba \cdot Ba' \cdot Cb \cdot Cb' = \pm Ab \cdot Ab' \cdot Bc \cdot Bc' \cdot Ca \cdot Ca';$

but on account of the double sign we can only infer that "if a curve of the fourth degree have three double tangents, the conic through five of the points of contact will either pass through the sixth, or through the point which, with the sixth, divides harmonically the side of the triangle on which the sixth lies." There are thus two distinct kinds of triads of double tangents, according as one or the other of these geometrical relations holds good.

126. There are some particular cases for which Carnot's theorem requires to be modified. First, if one of the angles (A) of the polygon were at infinity, that is to say, if two adjacent sides be parallel, then (A)' ultimately = ' (A) , and we still have the equation

$$(B)' (C)' \&c. = '(B)' '(C)' \&c.$$

Secondly, if one of the angles (A) were on the curve; then one of the n terms vanishes in each of the products (A)' and ' (A) ; but now, since the ratio of any two lines $\frac{AR}{AR'} = \frac{\sin RR'A}{\sin R'RA}$, we may substitute for the ratio of these two vanishing sides the ratio of the sines of the angles which the sides of the polygon at A' make with the tangent at A , and the theorem becomes

$$\frac{(A)' (B)' (C)' \&c.}{\sin \alpha} = \frac{'(A)' '(B)' '(C)' \&c.}{\sin \alpha'},$$

where (A)', ' (A) have each but $n - 1$ factors, and where α, α' are the angles which the sides on which (A)', ' (A) are measured make with the tangent at A . In this manner we can deduce that, "if any polygon be inscribed in a conic the continued product of the sines of the angles, which each side makes with the tangent at its right-hand extremity, is equal to the similar product of the sines of the angles made with the tangent at the other extremity."

DIAMETERS.

127. If there be n points in a right line, a point on the line, such that the algebraic sum of its distances from these points shall vanish, is called the *centre of mean distances* of the given points. Let the distance of the centre from any assumed point on the line be y , let that of the other points be $y_1, y_2, y_3, \&c.$, then the distances of the centre from the given points are $y - y_1, y - y_2, \&c.$, and the condition given by the definition is

$$\Sigma (y - y_1) = 0, \text{ or } ny - \Sigma (y_1) = 0;$$

whence we learn that the distance of any assumed point from the centre is equal to the sum of the distances of the assumed point from the given points, divided by the number of these points; or is equal to the *mean distance* of the assumed point from the given points. Thus, if there be only two given points, the centre of mean distances is the middle point of the line joining them, and the distance of any point on the line from the middle point is half the sum of its distances from the two given points.

The well-known properties of the diameters of conics have been generalized by Newton into the following theorem, true for all algebraic curves: *If on each of a system of parallel chords of a curve of the n^{th} degree there be taken the centre of mean distances of the n points where the chord meets the curve, the locus of this centre is a right line, which may be called the diameter corresponding to the given system of parallel chords.*

To prove this theorem, we adopt the same method of investigation as in the case of conic sections (*Conics*, Art. 141). The origin would be the centre of mean distances for a chord making an angle θ with the axis of x , if, when we transform to polar coordinates by substituting $\rho \cos \theta, \rho \sin \theta$ (or in case of oblique axes, $m\rho, n\rho$), for x and y , θ be such as to cause the coefficient of ρ^{n-1} to vanish. If we seek then the condition that any other point $x'y'$ should be the centre of mean distances for a parallel chord, we must examine what relation should exist between x', y' , in order that when we transform the axes to this point the new coefficient of ρ^{n-1} should vanish for the same value of θ . But when the given equation $U=0$ is transformed to

parallel axes by substituting $x + x'$, $y + y'$, for x and y , it becomes

$$U + x' \frac{dU}{dx} + y' \frac{dU}{dy} + \frac{1}{2} \left(x'^2 \frac{d^2U}{dx^2} + 2x'y' \frac{d^2U}{dxdy} + y'^2 \frac{d^2U}{dy^2} \right) + \&c. = 0;$$

only the three first terms can contain powers of the variables as high as the $(n-1)^{\text{th}}$, and since these involve $x'y'$ only in the first degree, the required locus must be a right line. Its equation is, in fact,

$$x \frac{du_n}{dx} + y \frac{du_n}{dy} + u_{n-1} = 0,$$

where, in u_n , u_{n-1} , $\cos \theta$ and $\sin \theta$ (or, if the axes be oblique, m and n) have been substituted for x and y .

128. Newton has also remarked, that if any chord cut the curve and its asymptotes, the same point will be the centre of mean distances for both, and that therefore the algebraic sum of the intercepts between the curve and its asymptotes = 0. This is the extension of the well-known theorem (*Conics*, Art. 197). The truth of it follows at once from the equation of a diameter given in the last Article, and from what was proved (Art. 52) that the terms u_n , u_{n-1} , are the same in the equation of the curve and in that of its n asymptotes.

129. We may in like manner seek the locus of a point such that the sum of the products in pairs of the intercepts, measured in a given direction between it and the curve, shall vanish. The origin would be such a point if the coefficient of ρ^{n-2} vanished for the given value of θ , and the locus is found, as in Art. 127, by examining what relation must exist between x' and y' in order that the coefficient of ρ^{n-2} in the transformed equation should vanish. But since the terms of the $(n-2)^{\text{th}}$ degree in x and y involve no powers higher than the second of x' and y' , the locus will be a conic section, which we shall call the *diametral conic*.

Its equation is readily seen to be

$$u_{n-2} + x \frac{du_{n-1}}{dx} + y \frac{du_{n-1}}{dy} + \frac{1}{2} \left(x^2 \frac{d^2u_n}{dx^2} + 2xy \frac{d^2u_n}{dxdy} + y^2 \frac{d^2u_n}{dy^2} \right) = 0,$$

where, in u_{n-2} , &c., $\cos \theta$ and $\sin \theta$ have been substituted for

x and y . The distance of any point from either point on the diametral conic being y , and from the curve $y_1, y_2, \&c.$, we have, by the definition,

$$\Sigma (y - y_1) (y - y_2) = 0.$$

The number of terms in this sum is the same as the number of combinations in pairs of n things, and is therefore $= \frac{1}{2}n(n-1)$. This, therefore, will be the coefficient of y^2 when we multiply out each of these products and add them together. In the same case the coefficient of y will consist of $\frac{1}{2}n(n-1)$ terms, each of the form $-(y_1 + y_2)$, and since it must involve the n quantities $y_1, y_2, \&c.$, symmetrically, it must be $-(n-1)\Sigma(y)$. Hence

$$\Sigma (y - y_1) (y - y_2) = \frac{1}{2}n(n-1)y^2 - (n-1)y\Sigma(y) + \Sigma(y_1y_2) = 0.$$

This quadratic gives the distances of any point from the diametral conic when we know its distances from the curve. $\frac{1}{2}n(n-1)$ times the product of these two distances $= \Sigma(y_1y_2)$, or *the product of the distances from the diametral conic is equal to the mean product in pairs of the distances from the curve*, since there are $\frac{1}{2}n(n-1)$ such products. The sum of the distances from the diametral conic $= \frac{2}{n}\Sigma(y)$. The mean distance is then the same for both curves, since there are two such distances in the one case, and n in the other; and the two curves have the same diameter.

130. There is no difficulty in seeing that a curve of the n^{th} degree may have other *curvilinear diameters* of any degree up to the $(n-1)^{\text{th}}$. Thus the locus of a point such that the sum of the products in threes of its distances from the curve should vanish, is found by putting the coefficient of ρ^{n-3} in the transformed equation $= 0$; and since this coefficient involves no higher than the third powers of the variables, the locus will be of the third degree. We may see too, in like manner, that

$$\Sigma (y - y_1) (y - y_2) (y - y_3) = \frac{1}{6}n(n-1)(n-2)y^3 - \frac{1}{2}(n-1)(n-2)y^2\Sigma(y) + (n-2)y\Sigma(y_1y_2) - \Sigma(y_1y_2y_3),$$

and we can readily infer hence that the curve and its cubical diameter will have the same mean distance, mean product in pairs, and mean product in threes of the distances; so in like manner for diameters of higher dimensions. More light will

be thrown on the subject of these curvilinear diameters by considerations which we shall explain presently.

131. To the mention we have made of diameters we may add some notice of centres. If all the terms of the degree $n - 1$ were wanting in the equation, then the algebraic sum of all the radii vectores through the origin would vanish, and the origin might in one sense be called a centre.

The name *centre*, however, is ordinarily only applied to the case where every value of the radius vector is accompanied by an equal and opposite one. In this case, if the equation be transformed to polar coordinates, it must be a function of ρ^2 only. If the curve then be of an even degree, its equation in x and y , referred to the centre, can contain none of the odd powers of the variables, and must be of the form

$$u_0 + u_2 + u_4 + \&c. = 0.$$

If the curve be of an odd degree, its polar equation must be reducible to a function of ρ^2 by dividing by ρ ; and the x and y equation can contain none of the even powers of the variables, but must be of the form

$$u_1 + u_3 + u_5 + \&c. = 0.$$

This form shows that if a curve of an odd degree have a centre, that centre must be a point of inflexion. It is also evident that it is only in exceptional cases that a curve of any degree above the second will have a centre; since it is not generally possible, by transformation of coordinates, to remove so many terms from the equation as to bring it to either of the forms given above.

POLES AND POLARS.

132. We pass now to an important theorem, first given by Cotes in his *Harmonia Mensurarum*: *If on each radius vector, through a fixed point O, there be taken a point R, such that*

$$\frac{n}{OR} = \frac{1}{OR_1} + \frac{1}{OR_2} + \frac{1}{OR_3} + \&c.,$$

then the locus of R will be a right line.

For, making O the origin, the equation which determines OR_1 , &c., is of the form

$$A \frac{1}{\rho^n} + (B \cos \theta + C \sin \theta) \frac{1}{\rho^{n-1}} \\ + (D \cos^2 \theta + E \cos \theta \sin \theta + F \sin^2 \theta) \frac{1}{\rho^{n-2}} + \&c. = 0.$$

Hence
$$\frac{n}{OR} = - \frac{(B \cos \theta + C \sin \theta)}{A},$$

or, returning to x and y coordinates,

$$Bx + Cy + nA = 0.$$

This is the equation found (Art. 60) for the polar line of the origin, and the property just proved is the extension of the well-known harmonic property of poles and polars of conic sections (see *Conics*, Art. 146).

133. The preceding property may also be established without taking the point O as the origin, by a method corresponding to that used, *Conics*, Art. 92. We have seen (Art. 63) that given two points O , $x'y'z'$, and R , xyz , then the equation $\Lambda = 0$, or

$$\lambda^n U' + \lambda^{n-1} \mu \Delta U' + \frac{1}{2} \lambda^{n-2} \mu^2 \Delta^2 U' + \&c. = 0,$$

determines the ratios $RR_1 : OR_1$, &c., in which the line joining these two points is cut by the curve. It follows then from the theory of equations, that $\Delta U' = 0$ expresses the condition that the sum of the roots of the equation $\Lambda = 0$ should vanish: that is to say, $\Delta U' = 0$ is the locus of a point R , such that

$$\frac{RR_1}{OR_1} + \frac{RR_2}{OR_2} + \&c. = 0.$$

But writing for RR_1 , $OR_1 - OR$, &c., this equation is at once seen to be

$$\frac{n}{OR} = \frac{1}{OR_1} + \frac{1}{OR_2} + \&c.$$

134. It can be seen in like manner that the polar conic $\Delta^2 U' = 0$ is the locus of a point, such that

$$\Sigma \left(\frac{RR_1}{OR_1} \cdot \frac{RR_2}{OR_2} \right) = 0, \text{ or } \Sigma \left(\frac{1}{OR} - \frac{1}{OR_1} \right) \left(\frac{1}{OR} - \frac{1}{OR_2} \right) = 0,$$

and similarly for polar curves of higher order. The polar curve

of the k^{th} order possesses the properties (if OR denote a radius vector to the curve, and Or to the polar curve)

$$\frac{1}{n} \Sigma \frac{1}{OR} = \frac{1}{k} \Sigma \frac{1}{Or},$$

$$\frac{1.2}{n(n-1)} \Sigma \frac{1}{OR_1 \cdot OR_2} = \frac{1.2}{k(k-1)} \Sigma \frac{1}{Or_1 \cdot Or_2},$$

$$\frac{1.2.3}{n(n-1)(n-2)} \Sigma \frac{1}{OR_1 \cdot OR_2 \cdot OR_3} = \frac{1.2.3}{k(k-1)(k-2)} \Sigma \frac{1}{Or_1 \cdot Or_2 \cdot Or_3}, \&c.$$

135. If the point O be at infinity, then the distances $OR_1, OR_2, \&c.$, may be regarded as having to each other the ratio of equality, and the denominators in all the fractions $\frac{RR_1}{OR_1}, \frac{RR_2}{OR_2}, \&c.$, may be considered as equal. The property then of the polar line $\Sigma \frac{RR_1}{OR_1} = 0$, reduces, when O is at infinity, to $\Sigma (RR_1) = 0$; or the sum vanishes of the intercepts between the polar and the curve on the parallel chords which meet at O . Thus then *the polar line of a point at an infinite distance is the diameter of the system of parallel chords which are directed to that infinitely distant point.*

So again for the polar conic. The equation $\Sigma \left(\frac{RR_1}{OR_1} \cdot \frac{RR_2}{OR_2} \right) = 0$ reduces when O is infinitely distant to $\Sigma (RR_1 \cdot RR_2) = 0$, or $\Sigma (OR - OR_1) (OR - OR_2) = 0$, the equation (Art. 129) which determines the diametral conic. And so in general, *the curvilinear diameter of any order is identical with the polar curve of the same order of the infinitely distant point on the system of parallel chords to which the given diametral curve corresponds.*

136. Mac Laurin has given a theorem, which is the extension of Newton's theorem (Art. 128): "*If through any point O a line be drawn meeting the curve in n points, and at these points tangents be drawn, and if any other line through O cut the curve in $R_1, R_2, \&c.$, and the system of n tangents in $r_1, r_2, \&c.$, then*

$$\Sigma \frac{1}{OR} = \Sigma \frac{1}{Or}.$$

It is evident that two points determine the polar line; that, therefore, if two lines through O meet two curves in the same

points, $R_1, R_2, \&c., S_1, S_2, \&c.$, the polar of O , with regard to both curves, must be the same, since two points of it, R and S , are the same for both. This will be equally true if the two lines OR, OS coincide, that is to say: "If two curves of the n^{th} degree touch each other at n points in a right line, then the polar of any point on that right line will be the same for both curves; and therefore if any radius vector through such a point meet both curves, we must have $\Sigma \frac{1}{OR} = \Sigma \frac{1}{Or}.$ "

137. We know that the centre of a conic may be regarded as the pole of the line at infinity with respect to the curve. With respect to curves of higher order, however, every right line has $(n-1)^2$ poles (Art. 61), and there is therefore no unique point for a curve of higher order answering to the centre of a conic section. But it is different if we consider curves of higher class. The preceding investigations are evidently applicable also to tangential coordinates; and thus every right line has a pole, a polar curve of the second, third, &c. class, and, finally, a polar curve of the $(n-1)^{\text{th}}$ class, touched by the n tangents at the points where the right line meets the curve. And if we thus by tangential coordinates seek the pole of the line at infinity we find a unique point.

Let us examine what metrical property is possessed by the pole of a line expressed in tangential coordinates, and, in particular, by the pole of the line at infinity. We take the system of Art. 19, in which the coordinates of a line are proportional to the perpendiculars let fall on it from three fixed points; and then it may be seen, without difficulty, that $l : m$ denotes the ratio of the sines of the angles, into which the angle between two lines $\alpha\beta\gamma, \alpha'\beta'\gamma'$ is divided by the line $l\alpha + m\alpha', l\beta + m\beta', l\gamma + m\gamma'$. The equation then which answers to $\Lambda = 0$ determines the ratio of the sines of the parts into which the angle between any two lines is divided by each of the tangents which can be drawn through their intersection to a curve of the n^{th} class. And, as in Art. 133, the pole R of any line possesses the property $\Sigma \left(\frac{\sin RPR_1}{\sin R_1PO} \right) = 0$, where P is a variable point on the given line; $R_1, R_2, \&c.$, the points of contact of tangents from

the point P , O any fixed point on the given line. Thus for a curve of the second class the relation is

$$\frac{\sin RPR_1}{\sin R_1PO} + \frac{\sin RPR_2}{\sin R_2PO} = 0,$$

that is to say, "if from any point P , on a fixed line OP , we draw tangents PR_1 , PR_2 , to a conic, and draw PR so that $\{P. OR_1R_2\}$ shall be a harmonic pencil, then OR passes through a fixed point." This is the fundamental definition of pole and polar with regard to a conic considered as a curve of the second class.

We may write the relation

$$\Sigma \left(\frac{\sin RPR_1}{\sin R_1PO} \right) = 0 \text{ in the form } \Sigma \left(\frac{M_1R_1}{R_1O_1} \right) = 0,$$

where M_1 is the foot of the perpendicular from R_1 on the line RP , and O_1 the foot of the perpendicular from the same point on the line OP . Now let the line OP go off to infinity, then all the denominators in this latter sum tend to equality, and we have simply $\Sigma (M_1R_1) = 0$; or the sum vanishes of the perpendiculars let fall from the points of contact of any system of parallel tangents on a parallel line through R . In other words then, *the centre of mean distances of the points of contact of any system of parallel tangents to a given curve is a fixed point, which may be regarded as a centre of the curve.* Thus in a conic the middle point of the line joining the points of contact of parallel tangents is a fixed point; in a curve of the third class, the centre of gravity of the triangle formed by them, &c. This theorem is due to M. Chasles (*Queletelet*, VI. 8).

FOCI.

138. It was shown (*Conics*, p. 228) that the foci of conics possess the property that the lines joining them to the circular points at infinity touch the curve. Hence we are led to the following definition of foci in general: A point F is said to be a focus of a curve, if the lines FI , FJ both touch the curve, or, as we may say, when it is the intersection of an I -tangent with a J -tangent.* A curve of the n^{th} class has in general n^2

* This conception is Plücker's, *Crelle*, vol. x. p. 84.

foci, namely the points of intersection of the n I -tangents with the n J -tangents. But the curve being real, n and only n of these foci are real; in fact the equation of one of the I -tangents being $A + iB = 0$ (where A and B are linear functions of the coordinates), that of one of the J -tangents will be $A - iB = 0$, and these intersect in the real point $A = 0, B = 0$, and there is not on either of these tangents any other real point. Thus a conic ($n = 2$) has 4 foci, two of them real.

In what precedes it is assumed that the points I, J have no special position with respect to the curve. Let us now suppose that the line IJ is an ordinary, or singular, tangent at one or more points $A, B, \&c.$, which for the present we suppose to be distinct from the points I, J ; say that IJ reckons g times among the tangents from I or J to the curve; then the I -tangents are made up of the line IJ counting g times, and of $n - g$ other tangents; and similarly for the J -tangents. Then the only foci which do not lie at infinity evidently consist of the intersections of the $n - g$ I -tangents with the $n - g$ J -tangents, and there are $(n - g)^2$ finite foci, of which, as before, only $n - g$ are real. The total number of n^2 foci is made up of these $(n - g)^2$ foci, together with the point I counting $g(n - g)$ times (namely, as the intersection of each of the $n - g$ I -tangents with each of the g J -tangents which coincide with IJ); similarly, of the point J counting $g(n - g)$ times, and lastly of the g^2 intersections of the g I -tangents coincident with IJ with the g J -tangents coincident with IJ . In this last case any I -tangent IA must be regarded as intersecting the corresponding J -tangent JA at the point of contact A , but its intersection with any other J -tangent JB will be indeterminate. Thus, if the line at infinity touch the curve in g real points, there will still be n real foci, viz. $n - g$ finite foci, and the g points of contact of IJ with the curve.* For instance, the parabola ($n = 2, g = 1$) has one finite focus, the other real focus being infinitely distant in the direction of the axis.

Again, let the point I be on the curve; then assuming the curve to be real, the point J is also on the curve, and if I

* Prof. Cayley thinks that the preferable view is that the only foci are the $(n - g)z$ foci, and consequently that the only real foci are the $(n - g)$ foci.

be a singular point, J will have the same kind of singularity. Confining our attention for the moment to the case where both are ordinary points, the $n-g$ I -tangents consist of the tangent at I counted twice, together with $n-g-2$ other tangents; and similarly for the J -tangents. Then the $(n-g)^2$ foci are made up as follows: the real intersection of the tangents at I and J counting as four; the $n-g-2$ imaginary intersections of the tangent at I with the $n-g-2$ J -tangents, each counting for two; the $n-g-2$ imaginary intersections of the tangent at J with the $n-g-2$ I -tangents, each counting for two; and lastly, the $(n-g-2)^2$ intersections of the two sets of $n-g-2$ tangents. Of these last, as before, $n-g-2$ and only $n-g-2$ are real, and the intersection of the tangents at I and J takes the place of two of the $n-g$ real foci. Paying attention then only to real foci, this point is commonly called a double focus; and we find it convenient to use this language, though, as we have just seen, if we considered imaginary as well as real foci, it ought to be called a quadruple focus. Thus, in the case of the circle, the only focus is the centre, which must be regarded as a quadruple focus, if we consider that it takes the place of the four foci which conics in general possess, but which may be spoken of as a double focus if we only pay attention to the two real foci.

Similarly, if each of the points I, J is an f -tuple point on the curve, it is seen in the same way that there are f^2 foci, which each count for four and of which f are real; $2f(n-g-2f)$ imaginary foci which each count as two, and $(n-g-2f)^2$ single foci of which $n-g-2f$ are real. Considering then both real and imaginary foci, we should say that there are f^2 quadruple, $2f(n-g-2f)$ double, and $(n-g-2f)^2$ single foci; but considering real foci only, we may say that there are f double, $n-g-2f$ single foci, and g foci at infinity.

If I and J be each of them an inflexion, or each a cusp, then the tangent at I or J counts three times among the I or J -tangents; and there are from each point $n-g-3$ other tangents. The $(n-g)^2$ foci are then as before seen to be made up of one which counts as nine, of $(n-g-3) + (n-g-3)$ which each count as three, and $(n-g-3)^2$ single foci. Of these last $n-g-3$ are real, and the only other real focus is the intersection of the tangents at I and J , which is commonly called a

triple focus as counting for three among the real foci, though if we took into account imaginary as well as real foci, it ought to be regarded as a 9-tuple focus. There is no difficulty in extending the theory to the cases where I and J are multiple points of higher order at which several tangents coincide, or where they are points at which the tangent has contact with the curve of a higher order than the second, or where they are ordinary or singular points having IJ for their common tangent.

139. Given any two real foci A, A' of a curve, the lines $AI, AJ; A'I, A'J$, meet in two imaginary points B, B' which are also foci of the curve; and the relation between the two pairs of points is, that the lines AA', BB' bisect each other at right angles in a point O , such that $OA (= OA')$ is equal to $iOB (= iOB')$. The points A, A' and B, B' have been termed "anti-points." The relation is one of frequent occurrence in plane geometry; thus a conic has two pairs of foci, which are anti-points of each other; any circle through A, A' cuts at right angles any circle through B, B' , &c. It is to be added, that being given the n real foci, we form with these $\frac{1}{2}n(n-1)$ pairs, each giving rise to a pair of anti-points, and thus obtain the remaining $n^2 - n$ foci.

140. The coordinates of the foci of a curve are obtained by forming the equation of the tangents which can be drawn from the point I to the curve. This will be of the form $P + iQ = 0$, the corresponding equation for the point J will be $P - iQ = 0$, and the intersection of the two systems of tangents are given by the equations $P = 0, Q = 0$. Thus denoting the first differential coefficients with respect to x and y by U_1, U_2 ; the second by U_{11}, U_{12}, U_{22} , &c.; then, by Art. 78, the equation of the system of tangents from $1, i, 0$ is got by forming the discriminant of $\lambda^n U + \lambda^{n-1}(U_1 + iU_2) + \frac{1}{2}\lambda^{n-2}(U_{11} + 2iU_{12} - U_{22}) + \&c. = 0$. Thus, if the curve be a conic, the discriminant is

$$\{U_1^2 - U_2^2 - 2U(U_{11} - U_{22})\} + 2i(U_1 U_2 - 2UU_{12}),$$

and the foci are got by equating the real and imaginary parts separately to zero. By combining these equations, we get the equation of the two right lines, the axes, on which the foci lie, viz.

$$U_{12}(U_1^2 - U_2^2) - (U_{11} - U_{22})U_1 U_2 = 0.$$

The very same equations determine the foci of a cubic passing through the points I, J ; of a quartic having these points for double points, &c.; for in any of these cases it is easy to see that all the terms but those written above vanish of the equation whose discriminant is to be found.

141. We can also determine the foci, as at *Conics*, Art. 258, Ex., by expressing the condition that $x - x' + i(y - y')$ should touch the curve; or, in other words, by substituting in the tangential equation, 1, i , $-(x' + iy')$ for α, β, γ . The real and imaginary parts of the equation then separately equated to zero determine the coordinates of the foci. It is not difficult to find a real geometric interpretation of each of these equations. Let the condition that $x - x' + p(y - y')$ should touch the curve be written

$$ap^n + bp^{n-1} + cp^{n-2} + \&c. = 0,$$

where $a, b, \&c.$ are functions of x', y' ; then by the theory of equations $-\frac{b}{a}, \frac{c}{a}, \&c.$ are the sum, sum of products in pairs, &c. of the tangents of the angles, which the tangents to the curve through $x'y'$ make with the axis of x . If now we write $p = i$, and equate to zero the real and imaginary parts of the equation, we get the two equations

$$a - c + e - \&c. = 0, \quad b - d + f - \&c. = 0;$$

the second of which, by the well-known formula for the tangent of the sum of several angles, expresses that the sum of the angles made with the axis of x by the tangents through $x'y'$ is either zero or is some multiple of π ; and the first of the equations expresses that the sum of the angles is some odd multiple of $\frac{1}{2}\pi$. Hence the locus of a point such that the sum of the angles made with a fixed line by the tangents through it to a curve of the n^{th} class shall be given is a curve of the n^{th} degree, whose equation, the fixed line being taken for axis of x , is easily seen to be

$$(a - c + e - \&c.) \tan \theta = b - d + f - \&c.$$

Whatever be the fixed line or the angle, the locus will pass through the foci of the curve. This may appear paradoxical, since it follows hence, that the sum of the angles made with

any line by the tangents from a focus may be equal to any given quantity. The reason of this is that the tangents of two of these angles are $\pm i$, and the tangent of their difference assumes the form $\frac{0}{0}$, and may be any assignable quantity. In fact, if $\tan \phi = i$, ϕ may be regarded as an infinite angle, since it possesses the properties $\sin \phi = \cos \phi = \infty$ and $\tan(\phi + \alpha) = \tan \phi$, and the difference of two infinities is indeterminate.

We have seen (Art. 110) that a tangent through one of the points I, J coincides with the normal; and hence every focus of a curve is also a focus of its involutes and evolute.

142. An important property of the perpendiculars let fall from the foci on any tangent is at once derived from the equation expressed in that system of line-coordinates (Art. 19 and *Conics*, p. 364) in which the variables are the perpendiculars let fall from three fixed points on any line. Let $\alpha, \beta, \gamma, \delta$, &c. be the n foci: let $\omega\omega'$ denote the points I, J ; then, since the lines $\alpha\omega, \alpha\omega'$, &c. are to be tangents to the curve, the tangential equation must be of the form $\alpha\beta\gamma\delta$ &c. $= \omega\omega'\phi$, where ϕ is a function of the order $n-2$ in the line-coordinates. For curves of the second class, this at once gives the property that the product of the perpendiculars from the two foci on any tangent is constant, since it was proved (*Conics*, p. 363) that for $\omega\omega'$ we may substitute a constant.

Similarly, replacing $\omega\omega'$ by a constant, the general equation of curves of the third class is $\alpha\beta\gamma = k\delta$, where α, β, γ denote the three foci, and δ a certain fourth point: viz., we may from each focus draw to the curve (besides the two tangents through I, J respectively) a single tangent; and the form of the equation shows that the three tangents from the points α, β, γ respectively meet in a point δ .* We learn, then, that the product of the three focal perpendiculars on any tangent to a curve of the third class is in a constant ratio to the perpendicular on the same tangent from the point δ . If the curve pass through the points I, J , there is a double focus,

* The reciprocal theorem for curves of the third order cut by any two lines is given *post*, Art. 148.

and the equation takes the form $\alpha^2\beta = k\delta$, the interpretation of which is obvious. If a focus A is at infinity, we can see how the formula is to be modified, by first using for the coordinate α the perpendicular distance of A from any tangent divided by AB ; and then, when A goes to infinity in the direction AB , it is easy to see that α will be $\cos\theta$ where θ is the angle made by AB with the direction of the perpendiculars on the tangent. Thus the formula for a conic, $\alpha\beta = k^2$, becomes in the case of the parabola where A passes to infinity, $\beta \cos\theta = k$, showing that the locus of the foot of the perpendicular from the focus β in a tangent is a right line. In like manner for a curve of the third class the formula $\alpha\beta\gamma = k\delta$ becomes $\beta\gamma \cos\theta = k\delta$, which may be written $\beta\gamma = k\delta'$, if we understand by δ' the intercept made by the variable tangent on a line drawn through D parallel to AB .

For curves of the fourth class the equation is $\alpha\beta\gamma\delta = k^2\phi$ where ϕ is the conic section which, as the equation shows, is touched by the eight focal tangents which do not pass through I, J . But if the foci of this conic be ϵ, ζ , the equation may be put into the form $\alpha\beta\gamma\delta = k^2\epsilon\zeta + l^4$, the geometrical interpretation of which is obvious. This equation includes the form $\alpha\beta\gamma\delta = l^4$ or $= \omega^2\omega'^2$, which represents a curve on which the foci $\alpha, \beta, \gamma, \delta$ are double foci; the form $\alpha^2\beta = \omega^2\omega'^2$ in which I, J are points of inflexion, &c.

And so in general the tangential equation of a curve of the n^{th} class gives a relation of the first degree connecting the product of the n focal perpendiculars, of $n-2$ other perpendiculars, of $n-4$ other perpendiculars, &c., and so on until we come either to a single perpendicular or a constant term.

143. From relations connecting the focal perpendiculars on the tangent can be deduced relations connecting the angles between the focal radii and the tangent. For if AP be the perpendicular α on the tangent at any point R of the curve, and if $d\phi$ be the angle between two consecutive tangents, we have $d\alpha = RPd\phi$. Similarly $d\beta = RP'd\phi$, &c. So that if we differentiate the relation connecting the perpendiculars, we may substitute for each $d\alpha, RP$ the corresponding intercept on the tangent between the foot of the focal per-

pendicular and the point of contact. Thus from $\alpha\beta\gamma = k^2\delta$ we deduce

$$\frac{d\alpha}{\alpha} + \frac{d\beta}{\beta} + \frac{d\gamma}{\gamma} - \frac{d\delta}{\delta} = 0,$$

whence
$$\frac{RP}{AP} + \frac{RP'}{BP'} + \frac{RP''}{CP''} - \frac{RP'''}{DP'''} = 0,$$

or
$$\cot\theta + \cot\theta' + \cot\theta'' - \cot\theta''' = 0,$$

where θ is ARP , the angle of inclination of the tangent to the focal radius vector AR , &c.

144. The example of conics would lead us to expect to find simple relations connecting the distances of any point on the curve from the foci. There does not appear to be any general theory of such relations, but we can without difficulty find particular curves for which they exist, for we have only to write down any relation connecting the distances of a variable point from fixed points, and find the locus for which it is satisfied. Each distance, if expressed in terms of the coordinates, involves a square root; and if, as will commonly happen, the equation when cleared of radicals is of the form $u\rho^2 = wv^2$, the two imaginary lines denoted by $\rho^2 = 0$ are tangents to the curve, and the fixed point F' is a focus. In this way we might study the relations $\rho + m\rho' = d$, for which the locus is an ellipse or hyperbola when $m = \pm 1$, a circle when $d = 0$, and in other cases a Cartesian: $l\rho + m\rho' + n\rho'' = 0$ for which the locus is in general a quartic having the points IJ for double points, or, as we may say, a bicircular quartic; but when $l \pm m \pm n = 0$, the curve is a cubic passing through the points IJ , or, as we may say, a circular cubic: $\rho\rho' = d^2$, for which the locus is a Cassinian (see Art. 55, Ex. 3); or, more generally, $a\rho^2 + b\rho\rho' + c\rho'^2 = d^2$, which is in general a quartic, but is a cubic if $a \pm b + c = 0$, that is to say, if the left-hand side of the equation is divisible by $\rho \pm \rho'$, &c. We postpone the further discussion of this subject until we come to treat of the curves referred to.

From a relation connecting the focal distances we can infer a relation connecting the angles which the focal radii make with the tangent; for it is proved, as in Art. 95, that each $d\rho = \cos\theta ds$, where θ is the angle between the focal radius and

the tangent. Thus from $\rho + m\rho' = d$ we infer $\cos\theta + m\cos\theta' = 0$, &c. From the value given in the last article for $d\alpha$, &c. we may infer $Rd\alpha = \rho d\rho$, &c., where R is the radius of curvature. Thus, for example, if we are given that $l\alpha + m\beta + \&c.$ is constant, we can infer that $l\rho^2 + m\rho'^2 + \&c.$ is constant.

145. Denoting by N the number of conditions (Art. 27) necessary to determine a curve of the n^{th} order, then if we are given that such a curve is circular, that is to say, that it passes through the points I, J ; and if we are given $N-3$ other points on the curve, the locus of the double focus (or intersection of the tangents at I, J) is a circle. For since but one curve of the n^{th} order can be described to pass through N points, if in addition to the above conditions we are given a consecutive point at I , that is to say, if we are given FI the tangent at I , the curve will be completely determined, and therefore FJ the tangent at J is determined. The point F is then the intersection of corresponding lines of two homographic pencils (*Conics*, Art. 331), that is to say, two pencils such that to any line of one answers one and only one line of the other. The locus of F is therefore a conic passing through the vertices of the pencils I, J , that is to say, it is a circle. This conic breaks up into the line IJ and another line, when to the line IJ of one pencil answers the line JI of the other. This will be the case in the present example when $n=2$, since IJ cannot be a tangent to a conic passing through the points I, J , unless the conic break up into two right lines, and the theorem then is that for the circles which pass through two fixed points, the locus of the centres is a line; but when n is greater than 2, the locus will in general be a circle.

146. In like manner if we are given $N-1$ tangents to a curve of the n^{th} class, the curve is completely determined if one more tangent FI be given. The reasoning of the last article will apply, and the locus of the focus will be a circle, if the conditions are such that when the curve is determined, only one tangent can be drawn to it from the point J . This will be the case, if among the given conditions is, that the line IJ is a tangent of the multiplicity $n-1$, since then but one more tangent

can be drawn to the curve from any point on that line. We have seen, Art. 41, that to be given that a point is a multiple point of the order k , is the same as if $\frac{1}{2}k(k+1)$ points were given. Similarly to be given that IJ is an $(n-1)$ -tuple tangent, is equivalent to being given $\frac{1}{2}n(n-1)$ tangents. Observing then that $N - \frac{1}{2}n(n-1) = 2n$, we infer that if we are given $2n-1$ tangents of a curve of the n^{th} class, and also that the line at infinity is an $(n-1)$ -tuple tangent, the locus of the focus (in this case there being but one focus) is a circle. Thus being given three tangents to a parabola, the locus of the focus is a circle. Again, the locus of the focus is a circle if we are given five tangents to a curve of the third class, among whose tangents the line at infinity counts for two. A particular curve of this system is the complex made up of the point at infinity on any of the five tangents, and the parabola touching the other four; the focus of the parabola being the focus of the complex. Hence we have Miquel's theorem (*Conics*, Art. 268, Note) that the foci of the five parabolas which touch any four of five given lines lie on a circle.*

* This proof of Miquel's theorem is Mr. Clifford's, for whose other inferences from the same principle, see *Messenger of Mathematics*, Vol. v., p. 137.

CHAPTER V.

CURVES OF THE THIRD ORDER.

147. It has been proved (Art. 42) that a curve of the third order, or, as we shall for shortness call it, a *cubic*, may have one double point, but cannot have any other multiple point. Hence is suggested the fundamental division of cubics into *non-singular*, having no double point; *nodal*, having a double point at which the tangents are distinct, and *cuspidal*, having a double point at which the tangents coincide. Plücker's numbers (Art. 82) for the three cases respectively are:

m	δ	κ	n	τ	ι
3	0	0	6	0	9
3	1	0	4	0	3
3	0	1	3	0	1.

It thus appears that the curves are of the sixth, fourth, and third class respectively, or are such that six, four, or three tangents respectively can be drawn to the curve from an arbitrary point. If the point be on the curve, the tangent at the point counts for two among these tangents (Art. 79), and the number of tangents distinct from the tangent at the point is four, two, or one. If the point be a point of inflexion, the stationary tangent counts for three, and the number of other tangents which can be drawn through the point of inflexion is further reduced by one.

Nodal cubics may obviously be subdivided (Art. 38) into *crunodal* and *acnodal*, according as the tangents at the double point are real or imaginary. We shall hereafter see that there is a parallel subdivision of non-singular cubics. But for the present we postpone the further discussion of the classification of cubics, as the reader will be able to follow it with more intelligence when he has first been put in possession of some of the general properties of these curves. We likewise postpone

the discussion of the general equation and the examination of its invariants, and we commence by applying to the case of cubics theorems we have already obtained for curves of any degree, beginning with the theorems on the intersection of curves established in the first Section of Chapter II.

SECT. I.—INTERSECTION OF A GIVEN CUBIC WITH OTHER CURVES.

148. It has been proved (Art. 29) that all cubics which pass through eight fixed points on a given cubic also pass through a ninth fixed point on the curve. This is a fundamental theorem leading to the greater part of the properties of cubic curves. In particular we infer that if two right lines whose equations are $A=0$, $B=0$, meet a cubic in points a, a', a'' , b, b', b'' respectively, and if the lines $ab, a'b', a''b''$ (whose equations we write $D=0, E=0, F=0$), meet the cubic in points c, c', c'' , then the line cc' ($C=0$) joining two of those points will pass through the third. For the lines D, E, F make up a cubic passing through the nine points; the lines A, B, C make up a cubic passing through eight of these points, therefore it will pass through the ninth c'' , and since this point cannot lie on either of the lines A, B which already meet the curve each in three points, it must lie on C . Since the given cubic passes through the intersection of the cubics $ABC=0, DEF=0$, its equation must be capable of being written in the form $DEF - kABC = 0$.

149. Let us suppose that the lines A, B coincide, then we deduce as a particular case of the preceding theorem, that if a right line, $A=0$, meet the curve in three points a, a', a'' , the tangents at these points, $D=0, E=0, F=0$, meet the curve in points c, c', c'' respectively, which lie on a right line $C=0$, and the equation of the curve may in that case be written $DEF - kA^2C = 0$. The point c , in which the tangent at any point a meets the curve again is called the *tangential* of the point a ; and the line C on which lie the tangentials of the three points a is called the *satellite* of the line A . We shall hereafter show how when the equation of A is given, $\alpha x + \beta y + \gamma z = 0$, the equation of C can be formed. The line A will have a real satellite, even though instead of meeting the curve in three real

points it meets it in one real and two imaginary points. The equations of the tangents at the imaginary points will be of the form $P \pm iQ = 0$; their product will be real; and the equation of the curve can be written in the form $D(P^2 + Q^2) = kA^2C$.

Two cases of the theorem of this article deserve to be noticed. First, let the line A be at infinity, then the tangents D, E, F at the points where it meets the curve are the three asymptotes; each asymptote meets the curve in one finite point, and we learn that these three points lie on a right line C , the satellite of the line at infinity. In this case the equation of the curve is reducible to the form $DEF = kC$, and we have the theorem that the product of the perpendiculars from any point of the curve on the three asymptotes is in a constant ratio to the perpendicular from the same point on the line C .

Secondly, let the points a, a' be points of inflexion; then evidently the tangentials of these points coincide with the points themselves; the satellite line C therefore coincides with A , and consequently the third point a'' in which it meets the curve is also a point of inflexion (see Art. 125, Ex. 3). The equation of the curve is thus reducible to the form $DEF = kA^3$, where $A = 0$ is the equation of the line through the three inflexions, and $D = 0, E = 0, F = 0$ are the equations of the tangents at these three points respectively.

150. The theorem of Art. 149 may be otherwise stated, starting with the line C instead of with A ; viz. given three collinear points c, c', c'' of a cubic, the line joining a the point of contact of any of the tangents from c , to a' the point of contact of any of the tangents from c' will pass through the point of contact of one of the tangents from c'' . Only one tangent can be drawn at a point of a curve, and therefore to any position of A corresponds but one position of C ; but in the case of a non-singular cubic four tangents can be drawn from any point on the curve, and therefore to any position of C correspond sixteen positions of A . The twelve points of contact lie on the sixteen lines A , viz. each line A contains three points of contact, and through each point of contact there pass four lines A .

Let us consider more particularly the case where C touches

the curve, and let us suppose the points c, c' to coincide. Then we see that the line joining a_1'' , one of the points of contact of tangents drawn from c' , to a_1 , one of the points of contact of tangents from c , must pass through one of the other points of contact from c , say a_2 . In like manner, the line joining $a_1''a_3$ passes through a_4 . We have then the following theorem: *The four points $a_1a_2a_3a_4$ which are the points of contact of tangents from any point c of the curve are the vertices of a quadrangle, the three centres of which are also points on the curve, and are such that the tangents at these points and the tangent at c all meet the curve in the same point.*

151. Returning to the case where C does not touch the curve, we have the tangents from c touching at the points a_1, a_2, a_3, a_4 , and the tangents from c' touching at the points a_1', a_2', a_3', a_4' . Attending only to two points, say a_1, a_2 of the first tetrad, it appears that separating the points of the second tetrad into pairs in a definite manner, say these are a_1', a_2' and a_3', a_4' , then combining the pair a_1, a_2 first with the pair a_1', a_2' , the lines a_1a_1', a_2a_2' meet in a point on the curve, and also the lines a_1a_2', a_2a_1' meet in a point on the curve; and secondly with the pair a_3', a_4' , the lines a_1a_3', a_2a_4' meet in a point on the curve, and also the lines a_1a_4', a_2a_3' meet in a point on the curve: viz. the four new points are the points of contact of the tangents from c' to the curve. Any two points such that the tangents at these points respectively meet on the curve may be said to be "corresponding points;" thus any two of the points a_1, a_2, a_3, a_4 are corresponding points; and so any two of the points a_1', a_2', a_3', a_4' are corresponding points. But starting with the two points a_1, a_2 , the points a_1', a_2' (as also the points a_3', a_4') may be said to be corresponding points of the same kind with a_1, a_2 : viz. the property is that, given two pairs of the same kind, if we form a quadrilateral by joining each point of the one pair with each point of the other pair, the two new vertices of the quadrilateral are points on the curve (they are in fact corresponding points of the same kind with the original two pairs). It is obvious that there are three kinds of corresponding points, viz. those of the kind a_1a_2 or a_3a_4 , the kind a_1a_3 or a_2a_4 , and the kind a_1a_4 or a_2a_3 . And, moreover, starting with the

pair $a_1 a_2$, to obtain the whole system of corresponding points of the same kind, we have only to take on the curve a variable point K , and joining it with the two points a_1, a_2 respectively, these lines again meet the curve in a pair of corresponding points of the kind $a_1 a_2$. It may be mentioned that the envelope of the line joining two corresponding points of a given kind is a curve of the third class. The theory is, for the most part, due to Maclaurin (see the "De Linearum Geometricarum Proprietatibus Generalibus Tractatus," published with the 5th edition of his *Algebra*), and it may appropriately be called Maclaurin's Theory of corresponding points on a cubic curve.

152. In further consideration of the case where C does not touch the curve, let D_1, E_1, F_1 be tangents through the points c, c', c'' respectively, and we have seen that the equation of the curve may be written in the form $D_1 E_1 F_1 - A_1^2 C = 0$. Let D_2, E_2 be another pair of tangents through c, c' , such that their chord of contact passes through the point of contact of F_1 , and the equation of the curve may also be written in the form $D_2 E_2 F_1 - A_2^2 C = 0$. Hence we can deduce an identity $(D_1 E_1 - D_2 E_2) F_1 = (A_1^2 - A_2^2) C$. The right-hand side of the equation denotes three right lines, therefore the left-hand side must denote the same three lines. One of the factors therefore of $D_1 E_1 - D_2 E_2$ must be C , which passes through the points $D_1 D_2, E_1 E_2$. The other factor which joins the points $D_1 E_2, D_2 E_1$ must be $A_1 \pm A_2$, F_1 being $A_1 \mp A_2$. We see, then, that the latter two lines and the two chords A_1, A_2 form a harmonic pencil, whose vertex is the point of contact of F_1 . We shall afterwards apply this theorem to the case where the points c, c' are the imaginary points at infinity I, J ; the points $D_1 E_2, D_2 E_1$ are then foci, and F_1 is a tangent parallel to the single real asymptote of the curve.

If the points c, c' coincide, the line joining c to the point of contact of F_1, F_1 itself, and the two chords A_1, A_2 form a harmonic pencil.

153. Hence can be deduced another theorem of Maclaurin's. Any line drawn through a point A on a cubic is cut harmonically in the two points β, γ , where it meets the cubic again, and the

two points δ, δ' , where it meets a pair of chords joining the points of contact of tangents from A . Let the line meet the tangent C in the point e , then, since it meets A_1 and B_1 at A , by Art. 136,

$$\frac{1}{\delta A} + \frac{1}{\delta \beta} + \frac{1}{\delta \gamma} = \frac{2}{\delta A} + \frac{1}{\delta e},$$

or
$$\frac{1}{\delta \beta} + \frac{1}{\delta \gamma} = \frac{1}{\delta A} + \frac{1}{\delta e}.$$

But, by the last Article, $\delta \delta'$ is a harmonic mean between δA and δe , therefore also between $\delta \beta$ and $\delta \gamma$. Q. E. D.

When the curve has a double point, only two tangents can be drawn to the curve; but the theorem of this Article will be still true, if for the chord D' we substitute the line joining the double point to the point where the chord D meets the curve again.

154. We add one more application of the theorem, that all cubics which pass through eight fixed points on a cubic pass also through a ninth fixed point. *If any conic be described through four fixed points on a cubic, the chord joining the two remaining intersections of the conic with the cubic will pass through a fixed point on the cubic.* Consider any conic through the four points (α) and meeting the curve in two other points (β), and a second conic through the points (α) and two other points (β'), then the conic through α, β and the right line joining the two points β' make up a cubic system through the eight points α, β, β' ; the conic through α, β' and the right line joining β make up a second system through the same eight points; hence the ninth point of intersection with the curve must be common to both systems; that is to say, the lines joining the points β, β' meet the curve in the same point, Q. E. D. This point was in the first edition called the *opposite* of the system of four given points; but now, in conformity with the nomenclature of Prof. Sylvester's remarkable theory of residuation, which will be presently explained, is called the *coresidual* of the system of four points. This point is easily constructed by taking for the conic through the four points a pair of lines. Let the line joining the points 1, 2 and the line joining the points 3, 4 meet the cubic in points 5 and 6

respectively, then the line joining 5, 6 meets the curve in the coresidual required. And since the grouping of the four points is arbitrary, the construction can, it is clear, be performed in three different ways.

Hence, for example, we infer that through four points on a cubic four conics can be drawn to touch the curve elsewhere, viz. the conics passing through the points of contact of the four tangents which can be drawn from the coresidual.

155. Let us apply the rule just given to construct the point coresidual to four consecutive points on the curve. The line joining the points 1, 2 is then a tangent, and the point 5 in which it meets the curve is the tangential of the point 1; similarly, the line 34 meets the curve in a point 6, which is consecutive to the point 5; it follows that the coresidual required is the point where the tangent at the tangential point 5 meets the curve again; that is to say, it is the tangential of the tangential, or, as we shall say, the second tangential.

If then, for example, it be required to draw a conic passing through the four consecutive points, or, as we may say, having a four-point contact with the curve, and elsewhere touching the curve, the point of contact is, as we have seen, a point of contact of tangents from the second tangential to the curve. One of these is the tangential of the point (1), and the corresponding conic degenerates into two right lines; the remaining three give solutions of the problem.

Again, if it be required to describe a conic passing through five consecutive points of the curve (or having a five-point contact with the curve), this is done by constructing the sixth point in which the conic meets the cubic, viz. this is the point where the line joining the point (1) to its second tangential meets the curve again. In order that this point should coincide with the point (1) it is necessary that the line last named should touch the curve at (1); or, what is the same thing, it is necessary that the first and second tangential should coincide. Now a point which coincides with its tangential is a point of inflexion; hence, *on a non-singular cubic there are twenty-seven points at each of which a conic can be drawn, having a six-point contact with the curve; viz. these are the points of contact*

of the three tangents which can be drawn from the nine points of inflexion.

156. The theorem (Art. 29) as to the intersection of two cubics was generalized in Art. 33. The theorem there given is applied to the case of the cubic by writing $p=3$, and it then becomes *every curve of the n^{th} degree which passes through $3n-1$ fixed points on a cubic passes through one other fixed point on the cubic.* It is to be observed, that for $n=1$, or $n=2$, one and only one curve of the n^{th} degree can be described passing through $3n-1$ points on a cubic, and the theorem asserts nothing; when n is greater than 2, more than one such curve can be described, and the curves all pass through one other fixed point on the curve, as has been just stated. And, as was explained in Art. 33, if it were attempted to describe a curve of the n^{th} order through $3n$ points taken arbitrarily on a cubic, n being greater than 2, the curve so described would in general not be a proper curve, but would be a complex consisting of the cubic itself, and a curve of the order $n-3$.

157. *If of the $3(m+n)$ intersections of a curve of the $(m+n)^{\text{th}}$ order with a cubic, $3m$ lie on a curve of the m^{th} order U_m , the remaining $3n$ lie on a curve of the n^{th} order.* For, as has been just remarked, through $3n-1$ of these $3n$ points, a curve of the n^{th} order U_n can always be described; and this, together with U_m makes up a system of the order $m+n$ which (Art. 156) passes through the remaining point, and since this point cannot lie on U_m , which already meets the cubic in $3m$ points, it must lie on U_n .

158. We shall now explain the nomenclature introduced by Prof. Sylvester, and in conformity with it re-state and extend some of the preceding propositions. If two systems of points α, β , together make up the complete intersection with the cubic of a curve of any order, one of these systems is said to be the *residual* of the other. Since the total number of intersections of a cubic with any curve must be a multiple of three, it is evident that if the number of points in the system α be of the form $3p+1$, that in the system β must be of the form $3q-1$, and *vice versa*. We may call these positive and negative

systems respectively, and say that the residual of a positive system is a negative system, and *vice versa*. The simplest positive system consists of a single point, answering to $p = 0$; the simplest negative system of a pair of points, answering to $q = 1$. In this case, evidently the one is the residual of the other when the three points are on a right line. Since through a given system of points α , an infinity of curves of different orders may be described, it is evident that a given system of points α has an infinity of residuals $\beta, \beta', \beta'', \&c.$ Two systems of points β, β' are said to be *coresidual* if both are residuals of the same system α . For example, in Art. 154 through four points α on a cubic we supposed conics to be described meeting the curve again in pairs of points $\beta, \beta', \&c.$; then any one of these pairs is a residual of α , and any two of them are coresidual. Again, if the line joining the pair β meet the curve again in a point α' , this point, as well as the four original points, is a residual of the group β , and this point α' is therefore, as we already called it, coresidual with the four points α . It is obvious that two coresidual systems of points must either be both positive or both negative.

The theorem of Art. 156 may be stated thus: *two points which are coresidual must coincide*. In fact, we there saw that if through $3p - 1$ points α we describe a curve U_p meeting the cubic in the residual point β , and if through the same points α we describe a second curve of the p^{th} order meeting the cubic again in a point β' , the coresidual points β, β' arrived at by the two processes, are one and the same point.

159. *If two systems β, β' be coresidual, any system α' which is a residual of one will be a residual of the other*. Say that through any system α two curves U_p, U_q are described meeting the cubic again in systems β, β' , then these two systems are by definition coresidual; and what is now asserted is that if through β' be drawn any curve U_r meeting the cubic again in a system of points α' , then the points β and α' also make up the complete intersection of a curve with the cubic. For since the systems α and β together make up the intersection of a curve U_p , with the cubic, and α' and β' make up its intersection with a curve U_r , the four together make up the intersection

with the cubic of a curve whose order is $p+r$: but the systems α and β' together make up the intersection with the curve U_q of the order q , therefore (Art. 157) the systems α' and β together make up the complete intersection of the cubic with a curve whose order is $p+r-q$.

Hence also *two systems which are coresidual to the same are coresidual to each other*. If β and β' are coresidual as having a common residual α , and if β' and β'' have a common residual α' , then by what has been just proved α is a residual also of β'' , and α' of β : that is, if β, β'' are each of them coresidual with β' , then β, β'' are coresidual with each other, for α, α' are each of them a common residual of β, β'' .

160. We can now give for the theorem of Art. 154 a proof which will at once suggest Prof. Sylvester's generalization of that theorem. The conic through four points α on a cubic meets the curve in two points β , which are a residual of the system α . The line through the two points β meets the curve in a point α' which is residual to β , and therefore coresidual to α . If the same process were repeated with a different conic we should arrive at a point α'' , also coresidual to the system α , and therefore to the point α' ; and the two points α', α'' being coresidual must coincide (Art. 158).

Now, in the first place, it is evident that the same proof would hold good, if instead of four points we started with any positive system of $3p+1$ points P . A curve through them of order $p+1$ meets the cubic again in two other points, and the line joining these meets the curve in a point coresidual to P , and which is the same point whatever be the curve of order $p+1$. But, in the second place, instead of proceeding from the group P to the coresidual point by two stages, we might employ any *even* number of stages. Thus through the $3p+1$ points P describe a curve U_{p+r} , and the residual is the negative system N of $3r-1$ points. Through N describe a curve U_{r+t} , and we get a residual P' of $3s+1$ points. In like manner, from P' we can derive a residual of $3t-1$ points, and so on. And at this or any subsequent stage where we have a negative system of $3t-1$ points, by describing through them a curve U , we can obtain a residual of a single point. Prof. Sylvester's

theorem is, that this point is in all cases the same, no matter what the process of residuation by which it is arrived at. In fact, the system N is a residual of P ; P' is a residual of N , and is coresidual of P ; N' is a residual of P' , coresidual therefore with N , and therefore residual also to P , and so on. Any positive system in the series is residual to every negative system, and coresidual to every positive system. The point therefore at which we ultimately arrive, is coresidual to the original positive system, and must be identical with the point coresidual of the same system obtained by any other process. For example, if through four points we describe a cubic meeting the curve in five other points; through these five another cubic giving a residual of four other points, through these four a quartic giving a residual of eight points; finally, through these eight a cubic meeting the curve in one other point, this point is the same as that obtained from the original four by the process of Art. 154. And similarly, starting with any negative system of $3q - 1$ points N , we may after any *odd* number of stages arrive at a single point, which will be the residual of the original system, and as such, independent of the particular process of residuation.

161. The principles just established, enable us to find by linear constructions, the point residual or coresidual to a given negative or positive system. For example, if it were required to find the point residual to eight given points, join them any way in pairs, and the joining lines form a quartic system meeting the curve in four new points residual to the given eight: join these again in pairs, and we obtain a system of two points coresidual to the given eight; the point where the line joining these meets the curve is the residual point required. Or, again, we may replace any four of the given points by their coresidual point, constructed as in Art. 154, and the problem is reduced to finding the residual of a system of five points; and similarly, replacing any four of these by their coresidual, reduce the problem to finding the residual of a system of two. It is in any of these ways easily seen, that the residual of a system of eight consecutive points at a given point of the cubic is the third tangential of the given point.

In this method of finding by linear construction the ninth point common to all cubics which pass through eight given points, it is assumed that one cubic through the eight points is given; and thus the question is not the same as that of finding the ninth point when *only* the eight points are given. Dr. Hart has shown, that in the latter question the ninth point can also be found by linear construction, though by a more difficult process.*

162. We conclude this section with a few remarks as to systems of cubics having several points common. If we are given eight points on a cubic, or eight linear relations between the coefficients in the general equation, we can eliminate all the coefficients but one, so as to bring the equation to the form $U+kV=0$. Similarly, if we are given seven points, or seven linear relations, the general form of the equation can be reduced to $U+kV+lW=0$, U, V, W being three cubics fulfilling the seven given conditions, and the two constants k, l still at our disposal, enabling us to fulfil any two other conditions. And so again if we are given six points, the general form of the equation is $U+kV+lW+mS=0$. We may take for $U, V, \&c.$ systems of three lines passing each through two of the given points. Thus, the six points being a, b, c, d, e, f , and $ab=0$ denoting the equation of the line joining a, b , one form of the equation of the required cubic is

$$ab.cd.ef+k.ac.be.df+l.ad.bf.ce+m.ae.bd.cf=0.$$

Since this equation contains three indeterminates, every other cubic through the six points (for example, $af.bc.de$) must be capable of being expressed in the above form, and the preceding equation would gain no generality if we were to add to it a term $n.af.bc.de$, since this itself must be the sum of the preceding four terms multiplied each by some factor.

In precisely the same manner as (*Conics*, Art. 259) we derived the anharmonic property of the points of a conic from the equation $ab.cd=k.ac.bd$, we can derive from the equation just written the following, which is the extension of the anharmonic theorem to curves of the third degree: "If six given points on

* *Cambridge and Dublin Mathematical Journal*, vol. vi. p. 181.

such a curve be joined to any seventh, and if any transversal meet this pencil in points a, b, c, d, e, f , then the relation holds

$$ab.cd.ef + k.ac.be.df + l.ad.bf.ce + m.ae.bd.cf = 0,$$

where k, l, m are constants, whose value is the same for each particular curve through the six points." The reader can easily conceive the number of particular theorems which may be derived from this (as in *Conics*, Art. 326), by examining the cases where some of the points are at an infinite distance.

163. We saw (Art. 41) that to be given a double point was equivalent to three conditions. If then we have a double point and five other points, one more condition will determine the curve, which may, therefore, be expressed by an equation of the form $S - kS' = 0$, where S, S' are two particular curves of the system. We may write it in the form

$$(abcd)oe - k(oabce)od = 0,$$

where $(abcd)$ denotes the conic through the double point o and the four points $abcd$.

In like manner we may write the equation of the cubic through the double point and four other points

$$oa.ob.cd + k.ob.oc.ad + l.oc.oa.bd = 0;$$

and, as in the last Article, the same relation holds between the intercepts on any transversal by the line joining these points to any point of the curve.

164. By the help of the same method (*Conics*, Art. 259) of expressing the anharmonic ratio of a pencil in terms of the perpendiculars let fall from its vertex on the sides of any quadrilateral whose vertices lie each on a leg of the pencil, we can find the locus of the common vertex of two pencils, whose anharmonic ratio is the same, and whose legs pass through fixed points, two of the fixed points being common to both pencils. For if $ab=0$ denote the equation of the line joining the points ab , we get an equation of the form

$$\frac{ao.bp}{ab.po} = \frac{co.dp}{cd.op},$$

or

$$ao.bp.cd = ab.co.dp.$$

When o, p are the two circular points at infinity, this gives us (*Conics*, Art. 358) the locus of the common vertex of two triangles whose bases are given and vertical angles are equal, and we see that it is a curve of the third degree passing through those circular points.

If the difference of the vertical angles were given, this would be equivalent (*Conics*, Art. 358) to the ratio of two anharmonic functions, and we should be led to an equation of the form

$$\frac{ao \cdot bp}{ap \cdot bo} = k \frac{co \cdot dp}{cp \cdot do},$$

which represents a curve of the fourth degree, having the two circular points for double points.

SECT. II.—POLES AND POLARS.

165. We next recapitulate and apply to the cubic the theorems about poles and polars which we have already obtained. Every point $O(x', y', z')$ has, with respect to a cubic, a polar line and a polar conic, whose equations respectively are

$$x \frac{dU'}{dx'} + y \frac{dU'}{dy'} + z \frac{dU'}{dz'} = 0, \quad x' \frac{dU}{dx} + y' \frac{dU}{dy} + z' \frac{dU}{dz} = 0.$$

The equation of the polar conic may also be arranged according to the powers of x, y, z , and will then be

$$a'x^2 + b'y^2 + c'z^2 + 2f'yz + 2g'zx + 2h'xy = 0,$$

where $a', b',$ &c. represent the second differential coefficients written with the accented letters.

The polar conic is the locus of the poles of all right lines which can be drawn through O , and thus every right line has, with respect to a non-singular cubic, four poles, namely the intersections of the polar conics of any two points on the line. The polar conic passes through the points of contact of the six tangents which can in general be drawn from O . In the case of a nodal cubic, the polar conic passes through the double point and meets the curve elsewhere only in four points; and every line has but three poles; since the two polar conics (each passing through the double point) intersect in only three other points. In the case of a cuspidal cubic, the polar conic passes through the cusp, touches the cuspidal tangent and meets the

curve elsewhere only in three points; and every line has but two poles. If the cubic break up into a conic and a right line, the polar conic of a point O passes through their intersections, and every line has but two poles. The polar conic also passes through the intersection of the conic with the polar of O with respect to it; for it is easily seen that if we perform on LS , the operation Δ or $x' \frac{d}{dx} + y' \frac{d}{dy} + z' \frac{d}{dz}$, the result is $L'S + L\Delta S$.

If the cubic reduce to three right lines, $xyz=0$, every polar conic passes through the vertices of the triangle formed by them, and every right line has but one pole. In this case the equations of the polar line and polar conic are respectively

$$xy'z' + yz'x' + zx'y' = 0, \quad x'y'z + y'zx + z'xy = 0,$$

or
$$\frac{x}{x'} + \frac{y}{y'} + \frac{z}{z'} = 0, \quad \frac{x'}{x} + \frac{y'}{y} + \frac{z'}{z} = 0.$$

The equation just given affords at once a geometrical construction for the polar line, since it appears from *Conics*, Art. 60, that if the point O in the figure be $x'y'z'$, the line LMN will be that whose equation has been just written. The tangent to the polarconic at any vertex

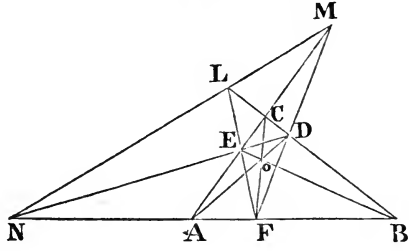

xy is (*Conics*, Art. 127) $\frac{x}{x'} + \frac{y}{y'} = 0$, and is therefore constructed by joining the vertex xy to the point where the polar line meets the opposite side z .

166. If any line through O meet the cubic in points A, B, C , the point P in which it meets the polar line is determined, since (Art. 132) we have $\frac{3}{OP} = \frac{1}{OA} + \frac{1}{OB} + \frac{1}{OC}$. If a second line through O meet the cubic in points A', B', C' , the point P' in which the polar meets this line is also determined, and therefore the polar line itself, which must be the same for all cubics passing through the six points A, B, C, A', B', C' . Thus then we can by the ruler alone construct the polar line of O with respect to the cubic; for we have only to draw two radii through O ,

and construct, by Art. 165, the polar of O with respect to the triangle formed by AA' , BB' , CC' .

The metrical relations, given Art. 134, shew also that when the points A , B , C are given the two points in which the line OA meets the polar conic are likewise given. We see then, as before, that if we draw three radii through the origin meeting the curve in A , B , C , A' , B' , C' , A'' , B'' , C'' , the polar conic of O is the same with regard to all cubics passing through these nine points. The points A , A' , A'' may be taken as the points in which any transversal meets the curve, and the problem of constructing the polar conic of O with respect to a cubic may be reduced to constructing it with regard to the system made up of the line $AA'A''$, and the conic through the six remaining points.

We consider now in more detail the cases (1) where O is a point on the curve, (2) where it is a point on the Hessian.

167. If from two consecutive points O , O' of the curve we draw the two sets of tangents OA , OB , OC , OD ; $O'A$, $O'B$, $O'C$, $O'D$, any tangent OA intersects the consecutive tangent $O'A$ in its point of contact. Now the four points of contact A , B , C , D lie on the polar conic of O , which also touches the cubic at the point O (Art. 64); hence the six points $OO'ABCD$ lie on the same conic, and therefore the anharmonic ratio of the pencil $\{O.ABCD\}$ is the same as that of the pencil $\{O'.ABCD\}$. Since then this ratio remains the same when we pass from one point of the curve to the consecutive one, we learn that the anharmonic ratio is constant of the pencil formed by the four tangents which can be drawn from any point of the curve.

We shall afterwards give an algebraical proof of this theorem, by shewing that the anharmonic ratio of four lines given by a homogeneous biquadratic in x and y , can be expressed in terms of the ratio of the invariants S^3 and T^2 of the biquadratic, and that when the four lines are tangents drawn from a point on a cubic, this absolute invariant of the pencil can be expressed in terms of an absolute invariant of the cubic, so as to be the same, no matter where the point be taken. This invariant is a numerical characteristic of the cubic unaltered by projection or any other linear transformation. It was shown

(*Higher Algebra*, Art. 213) that by the value of this invariant of a biquadratic, we can discriminate those whose roots are two real and two imaginary, from those whose roots are either all real or all imaginary. Consequently, if from any point of a cubic the four tangents which can be drawn to the curve are two real and two imaginary, the same will be the case from every point of the curve; and, in like manner, if the tangents from any point are either all real or all imaginary, the tangents from every point are either all real or all imaginary. On this is founded a fundamental division of non-singular cubics into two classes, those to which from each of their points can be drawn two and only two real tangents, and those to which the tangents may be either all real or all imaginary. This remark will be further developed in the section on the classification of cubics, and it will there be shewn that, in the second case the cubic consists of two distinct portions, from every point on one of which portions the tangents are all real, and on the other portion are all imaginary.

168. It follows, from Art. 167, that, if O, P be any two points of the curve, through these points can be drawn a conic passing through the four points where each of the tangents from the first point meets the corresponding tangent from the second. The anharmonic ratio of four points $abcd$ is unaltered by writing them in the order $badc$ or $cdab$ or $dcba$; hence, by taking the legs of the second pencil successively in each of these four orders, we see that the sixteen points of intersection of the first set of tangents with the second, lie on four conics, each passing through the points OP .

Let the cubic be circular, that is to say, let it pass through the imaginary points I, J at infinity; then by taking these for the points O, P we see that the sixteen foci of a circular cubic lie on four circles, four on each circle.*

169. *When O is a point on the curve, every chord through it is cut harmonically by the curve and by the polar conic of O .*

* This theorem was first otherwise obtained by Dr. Hart, and thence was suggested to me the theorem of Art. 167.

We saw (Art. 78) that the intersections with the curve of the line joining any two points are determined by the equation

$$\lambda^3 U' + \lambda^2 \mu \Delta' + \lambda \mu^2 \Delta + \mu^3 U = 0.$$

When $x'y'z'$ is on the curve, $U' = 0$, and the preceding equation becomes divisible by μ , and if further, the points xyz , $x'y'z'$ are connected by the relation $\Delta = 0$, the remaining quadratic is of the form $\lambda^2 \Delta' + \mu^2 U = 0$, the roots of which being equal and opposite, we see, as at *Conics*, Art. 91, that the line joining the two points is cut harmonically by the curve. The same thing may also be proved by taking the point O for the origin, and finding the locus of harmonic means of all radii vectores through O . We proceed exactly as in Art. 132, making first $A = 0$, and we find immediately

$$2(Bx + Cy) + Dx^2 + Exy + Fy^2 = 0,$$

which is the equation of the polar conic of the origin.

It is proved (as in Art. 136) that the tangent to the polar conic at the point where any chord meets it passes through the intersection of the tangents to the cubic at the points where it is met by the same chord, and is the harmonic conjugate to the line joining their intersection to the point O .

170. Let us now consider more particularly the case where O is a point of inflexion. It was shewn (Art. 74) that the polar conic of a point of inflexion breaks up into two right lines, one of them being the tangent at the point. And the same thing would appear from the equation of the polar conic of the origin just given. For, in order that the origin should be a point of inflexion and the axis of y the tangent at it, we must have (see Art. 46) $A = 0$, $B = 0$, $D = 0$, when the equation of the polar conic (Art. 169) reduces to

$$2Cy + Exy + Fy^2 = 0.$$

The factor y is evidently irrelevant to the problem of the locus of harmonic means; we learn therefore that if radii vectores be drawn through a point of inflexion, the locus of harmonic means will be a right line.* And, conversely, if the locus of harmonic

* This theorem is Maclaurin's; *De Linearum Geometricarum Proprietatibus Generalibus*, Sec. III. Prop. 9.

means be a right line, the point O is a point of inflexion. For, Art. 74, the only other case in which the polar conic can break up into two right lines is when O is a double point, and that case does not apply to the present problem, since a line through the double point must meet the curve only in one other point.

We shall call the line just found the *harmonic polar* of the point O , to distinguish it from the ordinary polar line which is the tangent at O .

171. The point O possesses, with regard to the harmonic polar, properties precisely analogous to those of poles and polars in the conic sections. Thus if two lines be drawn through O , and their extremities be joined directly and transversely, the joining lines must intersect on the harmonic polar. This is an immediate consequence of the harmonic properties of a quadrilateral.

Hence again, as a particular case of the last, tangents at the extremities of any radius vector through O must meet on the harmonic polar.

The harmonic polar must pass through the points of contact of tangents which can be drawn through O , for, since $ORRR''$ is cut harmonically, if R' coincide with R'' , it must coincide with R . Hence through a point of inflexion but three tangents can be drawn, and their points of contact lie on a right line.

If the curve have a double point, it is proved, in precisely the same way, that it must lie on the harmonic polar.

The first theorem of this Article may be otherwise stated thus: if three points $A'B'C'$ lie on a right line, and the lines joining O to them meet the curve again in $A''B''C''$, these will also lie on a right line, and the two lines will meet the harmonic polar in the same point. If now we suppose A', B', C' to coincide, we arrive again at the theorems that the line joining two points of inflexion must pass through a third, and that the tangents at any two meet on the harmonic polar of the remaining one.

172. *If through any point of inflexion O there be drawn three right lines meeting the curve in $A_1, A_2; B_1, B_2; C_1, C_2$,*

then every curve of the third degree through the seven points $OA_1A_2B_1B_2C_1C_2$ will have O for a point of inflexion. For let the three lines meet the harmonic polar in A, B, C , then these points are also common to the loci of harmonic means of the point O , with regard to all curves through the seven points. This locus, then, which would in general be a conic, must, since these three points of it are in a right line, be for all these curves this same right line; and therefore (Art. 170) the point O must be a point of inflexion.

173. We have seen (Art. 74) that the points of inflexion of a curve of the third degree are the intersections of the curve U with the curve H , which is also a curve of the third degree. Every curve of the third degree has therefore, in general, nine points of inflexion, only three of which, however, are real (see Art. 125, Ex. 3). Since, also, we have proved that the line joining two points of inflexion must pass through a third, through each point of inflexion can be drawn four lines, which will contain the other eight points. It follows then, as a particular case of the last Article, that any curve of the third degree, described through the nine points of inflexion, will have these points for points of inflexion.*

174. Of the lines which each contain three points of inflexion, since four pass through each point of inflexion, there must be in all $\frac{1}{3}(4 \times 9) = 12$.†

If we attempt to form a scheme of these lines, it will be found that it can only differ in notation from the following :

123, 456, 789 ; 147, 258, 369 ; ‡

159, 267, 348 ; 168, 249, 357.

Hence it will follow that any cubic passing through any seven

* This theorem is due to Hesse, who showed that if U be a cubic, H its Hessian, $aU + bH = 0$ the equation of any cubic through their intersections, then the equation of its Hessian is of the same form. The method of proof here adopted is Dr. Hart's.

† It is easy to see that we may have nine real points lying by threes in ten lines, but not in a greater number of lines: thus the nine points of inflexion cannot be all real, which agrees with the remark, Art. 173.

‡ Clebsch has remarked that if we arrange the nine elements 1, 2, 3 the systems
4, 5, 6
7, 8, 9

of lines are the three rows, the three columns, those forming positive, and those forming negative, elements of the determinants.

of the points of inflexion will have one of these for a point of inflexion; for, take any seven (say the first seven), and it will appear from the above table that they lie on three right lines (147, 267, 357), intersecting in a common point on the curve, and therefore, by Art. 172, that common point (7) is a point of inflexion on them all.

From the manner in which these lines have been written, it appears that they may be divided into four sets of three lines, each set passing through all the nine points; or that, if we form the equation $U + \lambda H = 0$, there are four values of λ , for which the equation reduces itself to a system of three right lines. For a direct proof of this, see the last section of this Chapter.

175. Let us now consider the case (2) where $x'y'z'$ is on the *Hessian*, and where its polar conic therefore breaks up into two right lines. It was proved in general (Art. 70) that if the first polar of any point A has a double point B , the polar conic of B has a double point A . But in the case of cubics, the first polar is the polar conic, and this theorem becomes, *If the polar conic of A breaks up into two lines intersecting in B , the polar conic of B breaks up into two right lines intersecting in A .* In fact, if the polar conic of $x'y'z'$ breaks up into two right lines, the coordinates of their intersection xyz satisfy the three equations got by differentiating the equation of the polar conic. But (Art. 165) this last equation may be written in either of the equivalent forms

$$U_1x' + U_2y' + U_3z' = 0,$$

or
$$a'x^2 + b'y^2 + c'z^2 + 2f'yz + 2g'zx + 2h'xy = 0,$$

and the differentials may therefore be written in either of the equivalent forms

$$ax' + hy' + gz' = 0, \quad hx' + by' + fz' = 0, \quad gx' + fy' + cz' = 0,$$

$$a'x + h'y + g'z = 0, \quad h'x + b'y + f'z = 0, \quad g'x + f'y + c'z = 0,$$

whence we see that these equations are symmetrical between xyz and $x'y'z'$, and therefore that the relation between those points is reciprocal. Both A and B are evidently points on the *Hessian*, on which they are said to be corresponding points, and it will presently be shewn that they are so also in the sense explained, Art. 151, that is, the tangents to the *Hessian*

at the points A, B respectively meet in a point of the Hessian.* In the case of the cubic, therefore, the curve called the Steinerian (Art. 70) is identical with the Hessian.

176. The equation of the polar conic of any point whatever $\xi\eta\zeta$ being $\xi U_1 + \eta U_2 + \zeta U_3 = 0$, the whole system of polar conics form a system of conics such as that discussed, *Conics*, Art. 388, viz. the equation of which involves linearly two indeterminates. The equation of the polar of the point A with regard to any conic of the system is

$$\xi(ax' + hy' + gz') + \eta(hx' + by' + fz') + \zeta(gx' + fy' + cz') = 0,$$

which is satisfied by the coordinates of B , whence we see that the polar of either point A, B passes through the other, and that therefore the Hessian of the cubic is the Jacobian (*Conics*, Art. 388) of the system of polar conics. Since A and B are conjugate with regard to any conic of the system, the line joining them is cut harmonically by every one of these conics, and the points in which the conics meet that line form a system in involution of which A and B are the foci. The two points in which any of these conics meets the line AB can only coincide at either of the points A, B ; and, consequently, if any of the conics break up into two right lines intersecting on AB , the point of intersection must be either A or B , unless AB be itself one of the lines. Now since the Hessian of a cubic is itself a cubic, AB meets it in three points; that is to say, in a third point C besides the points A, B . Every point on the Hessian is, as we have seen, the intersection of the two lines into which some polar conic of the system breaks up, and it follows from what has been just proved, that of the two lines which intersect in C one must be AB . Thus, then, from the system of points whose locus is the Hessian we may derive a system of lines, viz. by taking the pairs of lines which are the polar conics of each point on the Hessian. Each line of the system meets the Hessian in three points; two of them

* It will subsequently be shown that there are three cubic curves having each of them the same Hessian: the correspondence of the points A, B on the Hessian is of one or another of the three kinds of correspondence according as the cubic curve is one or another of the three cubics.

A, B are corresponding points on the Hessian, and the third, C , which we may call the complementary point, is the point in which the line meets the conjugate line.

177. The curve which is the envelope of the system of lines just mentioned has been studied by Prof. Cayley, and has on that account been called by Cremona the *Cayleyan* of the cubic.* It is of the third class, as we see by examining how many of these lines can pass through an arbitrary point P . Any point M whose polar conic passes through P must lie on the polar line of P (Art. 61), and in order that the polar conic should break up into lines, M must be on the Hessian. There are then evidently three points M , whose polar conic reduces to a pair of lines, one of which passes through P . There is not any double or stationary tangent, and the curve is therefore of the sixth order.

Every line of the system joins corresponding points on the Hessian (Art. 176); therefore the Cayleyan may at pleasure be considered as the envelope of the lines into which the polar conics of the points of the Hessian break up, or as the envelope of the lines joining corresponding points on the Hessian. In the case, however, of curves of higher degree, the envelope of the lines joining the corresponding points A, B (Art. 70) is distinct from the envelope of the lines into which polar conics may break up.

The Cayleyan may also be regarded (Art. 176) as the envelope of lines which are cut in involution by the system of polar conics. It was shewn, *Conics* (Art. 388*a*), how the equation of the envelope regarded from this point of view may be written down, and that the curve is of the third class.

178. Let us now examine what are the four poles with respect to the cubic of the tangent to the Hessian at any point A . The four poles in question are the intersections of the polar conic of A with the polar conic of the consecutive point A' on the Hessian. The polar conic of A is the pair of lines BL, BN (see fig. p. 153), and the polar conic of A' is a pair of lines consecutive

* It was denoted by Prof. Cayley himself by the letter P , and called by him the Pippian.

to these. Now BL meets the line consecutive to BN in the point B ; BN meets the line consecutive to BL in the same point; and BL , BN meet the lines respectively consecutive to them in their points of contact with their envelope. The four poles in question are thus the point B counted twice, and the points of contact with the Cayleyan of the lines BL , BN . Thus, in particular, *the polar line with respect to the cubic of any point on the Hessian is the tangent to the Hessian at the corresponding point.* It may be directly inferred from what has been said, that the Cayleyan is, as stated above, of the sixth order. For the equation of the locus of the poles with respect to the cubic of the tangents to the Hessian, is found by expressing the condition that $xU_1 + yU_2 + zU_3$ should touch the Hessian. This condition involves the quantities U_1 , U_2 , U_3 in the sixth degree, and the locus is therefore of the twelfth order. But, from what has been proved, the Hessian must enter doubly as a factor into this equation; the remaining factor therefore, which is the Cayleyan, is of the sixth order.

179. The locus of points whose polar lines with regard to one curve U touch another curve V , evidently meets U at its points of contact with the common tangents to U and V ; for the polar of any point on U is the tangent to U at the point, and if it is also a point on the locus, the polar by hypothesis touches V . We have just seen that when U is a cubic and V its Hessian, the locus consists of the Cayleyan together with the Hessian itself counted twice. The cubic and the Hessian being each of the sixth class have thirty-six common tangents. And we now see that these common tangents consist of the tangents to U at the 18 points where it is met by the Cayleyan, and of the tangents to U at the points where it is met by the Hessian; (that is to say, of the nine stationary tangents) these last tangents each counting for two; and in fact it was remarked (Art. 46, p. 33), that each stationary tangent to a curve may be regarded as a double tangent, as joining both the first to the second, and the second to the third of three consecutive points.*

* Reasons were given (Art. 47) for treating the cusp and the node, the stationary and double tangent, as distinct singularities; but in counting the intersections of

The polar conic of a point of inflexion A consists (Art. 170) of the inflexional tangent itself, together with the harmonic polar of A ; and the point B corresponding to A is therefore the point in which the inflexional tangent meets the harmonic polar. And the tangent to the Hessian at B is the polar of A with respect to the cubic; that is to say, is the inflexional tangent itself. Hence, then, the nine points where the stationary tangents touch the Hessian are the points where each stationary tangent meets the corresponding harmonic polar.

It may be inferred from what has been just proved, and it will afterwards be shewn independently (see note p. 150), that the problem to find a cubic, of which a given cubic shall be the Hessian, admits of three solutions. For the points of inflexion being common to both curves (Art. 173), we are given nine points (equivalent to eight conditions) through which the required cubic is to pass, and if we were given the tangent at any of these points A , the cubic would be completely determined. But what has been just proved shews that this tangent may be any one of the *three* tangents (Art. 171) which can be drawn from A to the curve.

180. *The tangents to the Hessian at corresponding points A, B , meet on the Hessian.* Let the

polar conic of A be BL, BN , and of B be AR, AN ; then L, M, N, R are the four poles of the line AB , and the polar conic of every point of AB passes through these four points. If, therefore, this polar conic breaks

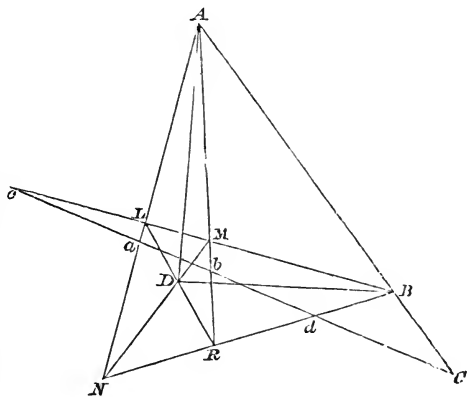

up into two right lines, these lines must be LR, MN ; and

two curves, a cusp or node on one of them alike counts for two; and a stationary or double tangent to one of them alike counts for two among their common tangents.

we see that D is a point on the Hessian, and that it corresponds to the point C in which AB meets the Hessian again. But the tangent at B to the Hessian is the polar of A with respect to the cubic, which must also be its polar (Art. 60) with respect to the polar conic of A (BL, BN); therefore, by the harmonic properties of a quadrilateral, this tangent is the line BD ; and in like manner the tangent at A is the line AD .

If we are given the Hessian and a point on it A , the problem to find the corresponding point B admits of three solutions (see Art. 151). For if we draw the tangent at A meeting the curve again in D , B may be the point of contact of any of the three other tangents besides AD , which can be drawn from D to the curve. These three solutions answer to the three different cubics, of which the given curve may be the Hessian.

181. *The points of contact with the Cayleyan of the four lines BL, BN, AR, AN lie on a right line.* The poles of AD with respect to the cubic are the intersections of the polar conics of A and D ; the former is the pair of lines BL, BN ; the latter consists of the line AB and a conjugate line passing through C . The four poles are therefore the point B counted twice, and the two points where Ca meets BL, BN . But AD being a tangent to the Hessian, it appears, from Art. 178, that the latter two poles are the points of contact of the lines BL, BN , with their envelopes. In like manner the points of contact of AR, AN with their envelope lie on the same right line. This right line is itself a tangent to the Cayleyan, therefore the six points where it meets the Cayleyan are completely accounted for. In other words, any tangent to the Cayleyan is one of a pair of lines into which some polar conic breaks up; the other line of the pair joins two corresponding points on the Hessian; the four lines which make up the polar conics of these two points pass respectively through the four points where the given tangent meets the Cayleyan again.

Again, to find the point of contact of any given tangent with the Cayleyan, the rule we have arrived at is to take what we have called the complementary point on the given tangent, and join it to the corresponding point on the Hessian; the line

conjugate to this meets the given tangent in the point required. But we may hence deduce a simpler rule: for since the two lines last mentioned make up a polar conic, and since every polar conic divides harmonically the line joining two corresponding points, the rule is to take the three points in which the given tangent meets the Hessian, consisting of two corresponding points and one complementary, and to take the harmonic conjugate of the complementary point with respect to the two corresponding points.

182. Let us apply the preceding rules to the case where A is a point of inflexion, and B , the corresponding point, is the point in which the inflexional tangent meets the harmonic polar. The polar conic of B is then a pair of lines through A , and the polar conic of A is the inflexional tangent together with the harmonic polar. In order to find the points in which these four lines touch the Cayleyan, we take the point in which the line AB meets the Hessian again; but this is the point B , since AB touches the Hessian; and the line through B conjugate to AB , on which the four points of contact lie, is the harmonic polar. Thus, then, the point of contact of the inflexional tangent with the Cayleyan is the point where it meets the harmonic polar; or (Art. 179) the Cayleyan and the Hessian touch each other, having the nine inflexional tangents for their common tangents. The Cayleyan, as a non-singular curve of the third class, has nine cusps, and the construction just given shews that the harmonic polars are the nine cuspidal tangents.

183. It has been shown that the tangent to the Hessian at any point A meets the Hessian again in the point D , where it meets the polar of A with respect to the cubic. It follows that the tangent to a cubic at any point A meets the cubic again in the point where it meets the polar of A with respect to a cubic having the given cubic for its Hessian. Now such a cubic passes through the inflexions of the given cubic, and therefore its equation will be of the form $aU + bH = 0$, and the equation of the polar of any point with respect to it will be of the form

$$a \left(x \frac{dU'}{dx'} + y \frac{dU'}{dy'} + z \frac{dU'}{dz'} \right) + b \left(x \frac{dH'}{dx'} + y \frac{dH'}{dy'} + z \frac{dH'}{dz'} \right) = 0.$$

It follows, then, that the point where any tangent meets the cubic again is found by combining the equations

$$x \frac{dU'}{dx'} + y \frac{dU'}{dy'} + z \frac{dU'}{dz'} = 0, \quad x \frac{dH'}{dx'} + y \frac{dH'}{dy'} + z \frac{dH'}{dz'} = 0.$$

In other words, the *tangential* of a point $x'y'z'$ on the cubic is the intersection of the tangent to the cubic at that point with the polar of the same point with regard to the Hessian; and hence may immediately be derived expressions for the coordinates x, y, z of the tangential in terms of x', y', z' , viz. they are proportional to $U_2H_3 - U_3H_2, U_3H_1 - U_1H_3, U_1H_2 - U_2H_1$, functions of the fourth degree in x', y', z' .

184. The polar lines of the points on a given line $\alpha x + \beta y + \gamma z$ envelope a conic, which we call the polar conic of the given line. The equation of the polar of any point $x'y'z'$ may be written

$$\alpha x'^2 + \beta y'^2 + \gamma z'^2 + 2fy'z' + 2gz'x' + 2hx'y' = 0,$$

and the problem of finding the envelope of this, subject to the condition $\alpha x' + \beta y' + \gamma z' = 0$, is the same (Art. 96) as that of finding the condition that a line should touch a conic. The equation of the envelope required is therefore

$$A\alpha^2 + B\beta^2 + C\gamma^2 + 2F\beta\gamma + 2G\gamma\alpha + 2H\alpha\beta = 0,$$

where $A, B, \&c.$ have the same meaning as in the *Conics*, viz. $bc - f^2, ca - g^2, \&c.$ They are therefore functions of the second degree in the coordinates x, y, z . It is obvious that the polar conic of a line might have also been defined as the locus of points whose polar conics touch the given line.

If the method of Art. 88 had been applied to find this envelope, the solution would be found to depend on the equations

$$\alpha x' + h y' + g z' = \lambda \alpha, \quad h x' + \beta y' + f z' = \lambda \beta, \quad g x' + f y' + \gamma z' = \lambda \gamma.$$

But these are the equations by which (*Conics*, Art. 293) we should determine the pole of the given line with regard to $x'U_1 + y'U_2 + z'U_3$. Hence, as might also be seen from geometrical considerations, the polar conic of a line is also the locus of the poles of the line with respect to the polar conics of all the points of the line.

185. Since the polar line of any point on a line is the same as if taken with regard to the three tangents at the points where that line meets the curve, the polar conic of a line is the same as if taken with regard to those three tangents. Let their equation be $xyz = 0$. Then to find the polar conic of a line is (Art. 165) to find the envelope of $xy'z' + yz'x' + zx'y' = 0$, subject to the condition $\alpha x' + \beta y' + \gamma z' = 0$; and this is (see *Conics*, Art. 127)

$$\sqrt{(\alpha x)} + \sqrt{(\beta y)} + \sqrt{(\gamma z)} = 0.$$

It follows that if the given line meet the cubic in the points P, Q, R , the tangents at these points forming the triangle ABC , then the polar conic of the line touches the sides of this triangle in the points D, E, F , which are the harmonics of the points P, Q, R in respect to the point-pairs BC, CA, AB respectively. It is evident *a priori* that the polar conic is touched by the tangents to the cubic at P, Q, R , these being particular positions of the line whose envelope is sought.

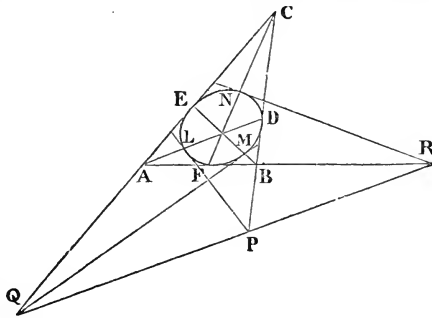

186. It follows from the definition that the tangents which can be drawn from any point to the polar conic of a right line are the polars of the two points where the polar conic of the point meets the right line. Hence the polar conic of a point meets a right line in real or imaginary points according as the point is outside or inside the polar conic of the line; a point being said to be outside a conic when from it real tangents can be drawn to the conic. It has been already remarked, that if a point lie on the polar conic of a line, its polar conic touches the line.

In particular, since the polar conic of a double point is the pair of tangents at that double point, the polar conic of every line with regard to a crunodal cubic has the node outside the conic, and with regard to an acnodal cubic has the conjugate

point within it. If the cubic be cuspidal, the polar conic of every line passes through the cusp.

187. It follows from the foregoing definitions, and from Art. 135, that if the given line be at infinity, its polar conic may be defined either as the envelope of the diameters of the cubic, or as the locus of the centres of the diametral conics of the cubic, or as the locus of points whose polar conic is a parabola. Its equation is found by making α and $\beta = 0$ in the formula of Art. 184, and is $C = 0$, or $ab - h^2 = 0$; that is to say,

$$\frac{d^2 U}{dx^2} \cdot \frac{d^2 U}{dy^2} = \left(\frac{d^2 U}{dx dy} \right)^2.$$

And it appears, from Art. 185, that this is the equation of the ellipse touching at their middle points the three sides of the triangle formed by the asymptotes.

188. If the given line touch the cubic, then since the polar of the point of contact is the line itself, that line coincides with one of the positions of the enveloped line of Art. 184, and therefore touches the polar conic; and in no other case can a line be touched by its polar conic with regard to a non-singular cubic. Accordingly this principle has been used to form the tangential equation of a cubic. Since $A, B, \&c.$ are functions in the coordinates of the second degree, the equation of the polar conic, $Ax^2 + \&c. = 0$, may be written in the form

$$A'x^2 + B'y^2 + C'z^2 + 2F'yz + 2G'zx + 2H'xy = 0,$$

where $A', \&c.$ are functions of the second degree in α, β, γ , and then the condition that this should touch the given line is $(B'C' - F'^2)\alpha^2 + \&c. = 0$, which is of the sixth degree in α, β, γ , and is the required condition that the given line should touch the cubic.

If the given line touch the Cayleyan, then since it, together with another line makes up the polar conic of a certain point, the polar line of every point on the line passes through that point, and the envelope of Art. 184 accordingly reduces to a point.

189. We next consider two cubics U, V , and investigate the problem to find a point whose polar with respect to each shall be the same; or, what is the same thing, whose polar with regard to any cubic $U + \lambda V = 0$ shall be the same. In order that $xU_1 + yU_2 + zU_3$ and $xV_1 + yV_2 + zV_3$ may represent the same line, we must have

$$\frac{U_1}{V_1} = \frac{U_2}{V_2} = \frac{U_3}{V_3},$$

or $U_1V_2 - U_2V_1 = 0, U_2V_3 - U_3V_2 = 0, U_3V_1 - U_1V_3 = 0.$

From the first form in which the equations were written, it is plain that the three equations are equivalent to two; and that the curves of the fourth degree represented by the equations written in the second form have common points. But *all* their points of intersection are not common, for any values which make the numerator and denominator of any of the three fractions to vanish, satisfy two of the resulting equations but not the third. Subtracting then from the sixteen points common to the quartics represented by the first two equations the four points common to U_2, V_2 , there remain twelve points common to all three quartics,* and these are the points required.

190. Since the discriminant of a cubic is of the twelfth degree in the coefficients (Art. 69), there are in general twelve values of λ , for which the discriminant of $U + \lambda V$ will vanish; for if in the general expression for the discriminant we substitute for each coefficient $a, a + \lambda a'$, we have evidently an equation of the twelfth degree to determine λ (see *Conics*, Art. 250). The coordinates of the double point on any of these cubics satisfy the three equations (Art. 69)

$$U_1 + \lambda V_1 = 0, U_2 + \lambda V_2 = 0, U_3 + \lambda V_3 = 0.$$

And the system of equations obtained by eliminating λ between each pair of these equations is the same as that considered

* So generally if U_1, U_2, U_3 be functions of the m th degree in the coordinates, and V_1, V_2, V_3 functions of the n th degree, the system of equations

$$\frac{U_1}{V_1} = \frac{U_2}{V_2} = \frac{U_3}{V_3}$$

represents three curves of the order $m + n$, having $m^2 + mn + n^2$ common points (see *Higher Algebra*, Art. 257).

in the last article. Hence, *through the intersections of two cubics* U, V there can be drawn twelve nodal cubics, and the polar of any of the twelve double points will be the same with regard to all cubics of the system $U + \lambda V$. These points have been called the *critic centres* of the system of cubics.

191. If we are given three cubics U, V, W , then the coordinates of the double point of any cubic of the system, $\lambda U + \mu V + \nu W = 0$, satisfy the equations

$\lambda U_1 + \mu V_1 + \nu W_1 = 0, \lambda U_2 + \mu V_2 + \nu W_2 = 0, \lambda U_3 + \mu V_3 + \nu W_3 = 0$; therefore eliminating λ, μ, ν we see that the locus of the double points is the Jacobian

$$U_1(V_2W_3 - V_3W_2) + U_2(V_3W_1 - V_1W_3) + U_3(V_1W_2 - V_2W_1) = 0.$$

If the three cubics have a common point, this is a double point on the Jacobian; for if the lowest terms in x and y be in U, V, W respectively $ax + by, a'x + b'y, a''x + b''y$, the terms in the Jacobian below the second degree in x and y are easily seen to be

$$\begin{vmatrix} a, b, ax + by \\ a', b', a'x + b'y \\ a'', b'', a''x + b''y \end{vmatrix},$$

which vanishes identically. Thus, then, the locus of double points on all nodal cubics passing through seven fixed points is a sextic having these seven points for double points, since U, V, W may be taken for any three cubics through the seven given points. So likewise the double points on the nodal cubics, which can be drawn through eight points, are determined as the intersections of the two sextic loci, which we get by leaving out first one and then another of the eight given points. And since these sextics have six double points common, the number of their other intersections is $36 - 24$ or 12 , which agrees with the result of the last article.

192. Of some of the twelve critic centres, the position can in some cases be at once perceived. Thus, in the system $\lambda xyz + uvw = 0$, where u, v, w represent right lines, it is obvious that xyz is one cubic of the system, having for double points xy, yz, zx ; in like manner uv, vw, wu are double points; there

are therefore but six other critic centres. We shall more particularly study the system $\lambda xyz + u^2v = 0$, and will presently show that this system has but three critic centres, exclusive of the points xy, yz, zx, uv . Plücker's classification of cubics was derived from the study of this equation for the case where u is the line at infinity, and consequently v its satellite, and x, y, z the three asymptotes. We may then for any position of the lines x, y, z, v , study the forms which the curve assumes as we give different values to the parameter λ ; and it will be readily understood, that each nodal curve in the series corresponds to a change from one form of the curve to another. Thus we have seen (Art. 39) that an acnodal cubic is the limiting form of a cubic including an oval as part of the curve; and again, if for one value of the constant, a cubic has two real branches intersecting in a node, the example of conics makes it easily understood, that for a small increase in the value of the constant, the cubic will have separated portions in two of the vertically opposite angles formed by the intersecting branches, while for a small decrease in the constant it will have portions in the other pair of vertically opposite angles. Hence the importance of the critic centres in this mode of studying the form of the cubic.

193. Since the polar of any point with regard to u^2v passes through the point uv , any point which has the same polar with regard to xyz must lie on the polar conic of uv with regard to xyz , and it is therefore evident *a priori*, that this is a locus on which the critic centres lie. In order completely to determine them, let us suppose that we have $u = x + y + z, v = ax + by + cz$; and we get our result in a more convenient form, if before differentiating $\lambda xyz + u^2v$ we first divide all by u^2 . We then have, differentiating successively with respect to x, y, z ,

$$\frac{\lambda yz(x - y - z)}{(x + y + z)^3} = a, \quad \frac{\lambda zx(y - z - x)}{(x + y + z)^3} = b, \quad \frac{\lambda xy(z - x - y)}{(x + y + z)^3} = c,$$

whence
$$\frac{ax}{x - y - z} = \frac{by}{y - z - x} = \frac{cz}{z - x - y},$$

and the form of the equations shows that the problem has been reduced to that of finding the critic centres of a system of two

conics, and that the three points required are the vertices of the common self-conjugate triangle of the conics

$$ax^2 + by^2 + cz^2 = 0, \text{ and } x^2 + y^2 + z^2 - 2yz - 2zx - 2xy = 0,$$

where it will be observed that the latter conic is the polar conic of u with respect to xyz ; that is to say, when u is at infinity, it is the conic touching at their middle points the sides of the triangle formed by the asymptotes. Two critic centres will coincide in the point of contact when $ax^2 + by^2 + cz^2 = 0$ touches this conic; hence, if v be regarded as variable, the locus of double critic centres is the polar conic of u with respect to xyz . The condition of contact of these two conics is easily seen, by the ordinary rule, to be

$$(bc + ca + ab)^3 = 27 a^2 b^2 c^2, \text{ or } a^{-\frac{1}{3}} + b^{-\frac{1}{3}} + c^{-\frac{1}{3}} = 0,$$

which is the tangential equation of the envelope of the satellite of u when two critic centres coincide. This answers (Ex. Art. 90) to the equation in point coordinates $x^{\frac{1}{3}} + y^{\frac{1}{3}} + z^{\frac{1}{3}} = 0$.*

194. Any point on $\lambda xyz + u^2 v$ may be determined as the intersection of $z = \theta v$ with $\theta \lambda xy + u^2 = 0$. When u is at infinity, the latter equation denotes a system of hyperbolas having x, y for their asymptotes, and by the property of the hyperbola, the chords intercepted by these hyperbolas on any line $z = \theta v$ have a common middle point; namely, the point of contact of this line with one of the hyperbolas of the system. Evidently, if $z = \theta v$ either touch the cubic or pass through a double point on it, it must touch the hyperbola, the critic centre being in the latter case the point of contact. Hence, if any of the critic centres be joined to the finite points where the asymptotes meet the curve, the critic centres are the middle points of the chords intercepted by the cubic on the joining lines.

SECT. III.—CLASSIFICATION OF CUBICS.

195. We shall shew in the first place that the equation of every cubic may be brought to the form

$$zy^2 = ax^3 + 3bx^2z + 3cxz^2 + dz^3.$$

* For a fuller discussion of this theory, see papers by Prof. Cayley, "On a case of the involution of cubic curves," and "On the classification of cubic curves," *Transactions of Cambridge Philosophical Society*, vol. XI., 1864.

Every real cubic has at least one real point of inflexion, for imaginaries enter by pairs, and the total number of points of inflexion is odd, viz. either nine, three, or one (Art. 147). If we take for the line z the tangent at the point of inflexion, and for x any other line through that point, the equation of the curve (Art. 51, VII.) will be of the form $z\phi = ax^3$, where ϕ is a function of the second degree, say

$$y^2 + 2lyz + 2myx + px^2 + 2qzx + rz^2.$$

But now if we transform the lines of reference so as to take $y + lz + mx$ for the new y , the terms in ϕ containing y only in the first degree are made to disappear, and the equation takes the form first written in this article. The geometric meaning of the transformation we have made is that we take for z as above stated the tangent at a real point of inflexion zx , and for y , the harmonic polar (Art. 170) of that point: for if we examine where any line through the point of inflexion meets the curve represented by the above equation, we find, on making the substitution $z = \lambda x$, that we obtain for y values of the form $\pm \mu x$, shewing that the points where the line meets the curve are harmonically conjugate with respect to the point where it meets the line y , and to the point of inflexion.

196. In classifying curves those distinctions may be regarded as fundamental which are unaffected by projection; or, in other words, which separate not only curves, but cones, of the same order. Among curves of the second order there is no such distinction, for there is but one species of cone. In order to ascertain whether such distinctions exist among cubics, it suffices to take the form to which, as shown in the last article, the equation of every cubic may be reduced, and to examine whether any and what varieties, unaffected by projection, exist among the curves capable of being represented by it. And since we are now only concerned with varieties unaffected by projection, we may suppose the line z to be at infinity, and discuss the form

$$y^2 = ax^3 + 3bx^2 + 3cx + d,$$

as one capable of representing a projection of any given cubic. It will be observed that when a point of inflexion is at infinity,

a system of lines through it becomes a system of parallel ordinates, and the harmonic polar becomes a diameter bisecting them; and, in fact, for every value of x , the above equation gives equal and opposite values of y .

The preceding equation has already been partially discussed (Art. 39), and from what was there said, it appears that the curves represented by it may be divided into the five following principal classes:

The right-hand side of the equation may be resolvable into three unequal factors, and (I.) these factors are all real. The curve then consists (Art. 39) of an oval and an infinite branch. Or (II.) the factors are one real and two imaginary. The oval then disappears and the infinite branch alone remains.

The right-hand side of the equation may be resolvable into two equal and one unequal factors, being of the form $(x - \alpha)^2(x - \beta)$. Then we have the cases (III.), α less than β when the curve is acnodal (Art. 39), the oval being reduced to a conjugate point; or (IV.), α greater than β , when the curve is crunodal, the oval and the infinite branch being each sharpened out so as to form a continuous self-intersecting curve; (V.) the factors of the right-hand side may be all equal, and the curve is cuspidal (Art. 39).

Newton has given the name "divergent parabolas" to the curves considered in this article; and his theorem, which we have just established, is that every cubic may be projected into one of the five divergent parabolas.

197. Instead of, as in the last article, supposing the stationary tangent to be projected to infinity, we may suppose the harmonic polar to be so projected. The point of inflexion will then become a centre, and every chord through it will be bisected. Interchanging z and y in the equation of Art. 195, and then putting $z = 1$, the equation for this case becomes

$$y = ax^3 + 3bx^2y + 3cxy^2 + dy^3,$$

which is the equation of a central curve (Art. 131). As in Art. 196, there are five kinds of central curves according to the nature of the factors of the right-hand side of the equation, and in this way is established Chasles's supplement of Newton's

theorem, viz. that every cubic may be projected into one of the five central cubics.

198. Corresponding to these five kinds of cubic, there are five essentially distinct species of cubic cones. A cone of any order may comprise two forms of sheet, viz. (1) a twin-pair sheet, or sheet which meets a concentric sphere in a pair of closed curves, such that each point of the one curve is opposite to a point of the other curve (a cone of the second order affords an example of such a sheet); and (2) a single sheet, viz. one which meets a concentric sphere in a closed curve, such that each point of the curve is opposite to another point of the curve (the plane affords an example of such a cone). Now corresponding to the parabola I. of Art. 196, we have a cone consisting of a twin-pair sheet and a single sheet, and corresponding to II., we have a cone consisting of a single sheet only. It is evident that the crunodal, acnodal, and cuspidal singularities are reproduced in the corresponding cones.

The classification of cubic cones just made might, if we pleased, be carried further. Not only is there but one *species* of cone of the second order, but, with some limitations, any two curves of that order may be regarded as sections of one and the same cone. This is not so as regards cubics; for it has been proved (Art. 167) that every cubic curve has a certain numerical characteristic, expressing the anharmonic ratio of the four tangents which can be drawn from any point on the curve, and represented by the ratio of the invariants $S^3 : T^2$ of the biquadratic, which determines those tangents. This characteristic being unaltered by projection, two curves, for which it is different, cannot be cut from the same cone; and the parameter in question may be regarded as a characteristic, not only of a cubic curve, but also of every cone from which it can be cut. The five kinds of cone we have enumerated might, therefore, be further subdivided at pleasure, according to the values of this parameter. Such subdivisions have in fact been made, but it is not thought necessary to notice them here. In the last section of this chapter, however, the cases $S = 0$, $T = 0$ will be discussed; and it is now pointed out that these represent families not only of curves but of cones.

199. Let us now examine, more minutely than in Art. 39, the figure of the cubic represented by the equation considered in Art. 196, and it will be convenient to take the origin at the middle point of the diameter of the oval, so that the equation may be written

$$ay^2 = (x^2 - m^2)(x - n),$$

where n is greater than m . Differentiating, we find that the values of x which correspond to maximum values of y , or to points where the tangent is parallel to the axis of x , are given by the equation

$$3x^2 - 2nx - m^2 = 0; \text{ whence } x = \frac{1}{3} \{n \pm \sqrt{(n^2 + 3m^2)}\}.$$

If we give the negative value to the radical, we get the value of x corresponding to the highest point of the oval, and since this is negative, we see that the highest point on the oval is on the side remote from the infinite branch, and that the oval is therefore not, like the ellipse, symmetrical with regard to two axes. This oval is symmetrical with regard to the axis of x , and not with regard to the axis of y , but rises more steeply on the one side and slopes more gradually on the other. The greater n is for any given value of m , that is to say, the greater in proportion the distance between the oval and the infinite part the more nearly does the oval approach to the elliptic form; while on the other hand, the difference is greatest when the oval closes up to the infinite part, that is to say, when the curve is crunodal. In this case the highest point of the loop corresponds to the point of trisection of its axis. If we give the positive value to the radical, the corresponding value of x is intermediate between m and n , and the corresponding value of y is imaginary. The form of the equation shews that the point of contact with the curve of the line at infinity is on the line $x=0$, unlike the common parabola $y^2 = px$, which is touched by the line at infinity on $y=0$. The infinite branches of the cubic, therefore, tend to become parallel to the axis of y and not to the axis of x ; and there must be a finite point of inflexion on each side of the diameter where the curve changes from being concave to being convex towards the axis of x . Hence the name "divergent parabola."

The form of the curve is then represented by the oval and the right-hand infinite branch on the figure. If, however, we have in the equation $+m^2$ instead of $-m^2$, then there will be no real oval, and the infinite branch will be either of the left-hand or right-hand form, that is to say, there will or will not be points for which y is a maximum, and at which the tangent is parallel to the axis, according as $3m^2$ is less or greater than n^2 ; and there is of course the intermediate case $3m^2 = n^2$, where there is on each side of the axis of x a point of inflexion, the tangent at which is parallel to this axis.

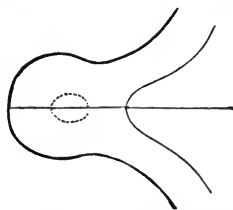

The figures of the crunodal, acnodal, and cuspidal forms do not seem to require further discussion than was given in Art. 39.

200. Returning to the case where the curve has an oval, it is plain that in general every right line must meet any closed figure in an even number of real points, and therefore that every line which meets the oval part of the cubic once, must meet it once again and not oftener; since when a line crosses to the inside of the oval, it must cross it again to come out, and cannot meet the oval in four points. Every line, therefore, must meet the infinite part of the curve once. It follows that no tangent to the curve can meet the oval again, and therefore that none of the points of inflexion can lie on the oval. It is easy to see, on inspection of the figure, that from any point outside the oval two tangents can be drawn to it.

Thus, then, the oval is a continuous series of points, from none of which can any real tangent, distinct from the tangent at the point, be drawn to the curve. The cubic then, which includes an oval, is of the class (Art. 167), the four tangents from every point of which are either all real or all imaginary. The tangents from every point on the oval are all imaginary, and from every point on the infinite branch are all real; viz. two can be drawn to the oval and two to the infinite branch itself. In fact, the tangent at any point on the infinite branch must meet that branch again, since the third point in which it meets the curve cannot be on the oval.

201. What has been just said, may be used to illustrate the essential property of unicursal curves (Art. 44). The coordinates of any point on such a curve can be expressed rationally as functions of a parameter, so that by giving to this parameter values continuously increasing from negative to positive infinity, we obtain all the points of the curve in a continuous series, the coordinates being always real. In the present example, on the contrary, it is geometrically evident that if we commence with any point on the oval and proceed on continuously, we return to the point whence we set out, without passing through any point on the infinite branch; and it is algebraically impossible to express the coordinates of any point in terms of a parameter without including a radical in the expression. For instance, we might take $z=1$, $x=\theta$, $y=\sqrt{(a\theta^3+3b\theta^2+3c\theta+d)}$. We shall then call the curve we have been considering a *bipartite* curve, as consisting of two distinct continuous series of points.

A curve of the second kind considered, Art. 196, has no oval, and is *unipartite*, all the real points of the curve being included in one continuous series; but the curve is not on that account unicursal, for the coordinates of any point cannot be rationally expressed in terms of a parameter, and a unipartite curve is not necessarily unicursal, just as an equation having only one real root is not necessarily a simple equation. A crunodal cubic, on the other hand, is unicursal and unipartite; all the points of the curve succeed each other in a definite order forming a single series. The curve may, however, be regarded as comprising a loop and an infinite branch consisting of two parts separated by the loop. The argument used, Art. 200, shews that no point of inflexion can lie on the loop, neither can any tangent meet the loop. The loop, therefore, includes a series of points from none of which can any real tangent be drawn to the curve, while from every other point on the curve, two real tangents to it can be drawn, one of them to the loop, the other to the infinite branch. So also an acnodal cubic and a cuspidal cubic are each of them unicursal and unipartite.

202. Having thus divided cubics into five genera, we proceed to subdivide these genera into species, according to the nature

of their infinite branches. And, obviously, we must have at least four species under each genus, according as the line infinity meets the curve, (*a*) in three real and distinct points, (*b*) in one real and two imaginary points, (*c*) in one real and two coincident points, (*d*) in three coincident points. But in the case of crunodal, acnodal, and cuspidal cubics, we must distinguish under (*c*) whether the line infinity be properly a tangent, or whether it pass through a double point; and in the case of crunodal and cuspidal cubics we must distinguish under (*d*) whether the line infinity be a tangent at a point of inflexion or at the node or cusp. Further, in the case of a bipartite or a crunodal cubic it is important to distinguish under (*a*) and (*c*) whether the three points in which infinity meets the curve all belong to the infinite branch or whether two of them belong to the oval or loop and only the remaining one to the infinite branch. The differences thence resulting in the figures of the curves are so great that the two cases may properly be classed as distinct species. These are the only differences which are made in what follows, grounds of distinction of species. The only other differences which would seem to have equal claims to be put on the same level are that the points of the curve at infinity may either all be ordinary points, or else one or three of them may be points of inflexion. But as the changes thus made in the figure of the curves are slighter, and as it is desirable not to have more species than can be easily remembered, I have preferred to class curves differing only in the respect last mentioned, not as distinct species, but as different varieties of the same species. It is obviously a good deal arbitrary how many varieties of cubics may be counted, and much depends on the point of view from which these curves are discussed.

203. The figures for the case where the line infinity is a stationary tangent have already been discussed, and the figure for any other case may be regarded as a projection of one of the figures for this case. Let us commence with *bipartite cubics*, and consider first the projection of the oval. And it will be readily understood that if the line projected to infinity do not meet the oval, the projection of the oval will remain a closed

curve, while if the line touch the oval, or if it meet it in two real points, the projection will have the same kind of rough resemblance to a parabola or a hyperbola respectively that the oval itself has to an ellipse; that is to say, while the figures have not the symmetry of the conic sections, the projection is in the former case, like the parabola, a single curve whose branches proceed to infinity in a common direction without approaching to contact with any finite asymptote, and in the latter case consists of a pair of curves having two common asymptotes, and lying in two of the vertically opposite angles formed by them. Such a pair we shall briefly refer to as a *hyperbolic pair*. It will be observed that an ordinary asymptote to a curve has a positive and negative branch at opposite sides of it. The theory of projection teaches us to regard the extremities of a line at positive and negative infinity as projections of the same point, and similarly to regard the branches of a curve which touch an asymptote at positive and negative infinity as continuous with each other. Thus, then, as when the oval is a closed curve, its points form a continuous series, such that commencing with any point we can proceed continuously round the curve till we return to the point whence we set out; so this is equally true of all projections of the oval, and the twin hyperbolic branches are to be regarded as forming one continuous curve, the part where one branch touches an asymptote at its positive extremity being regarded as continuous with the part where the other branch touches the same asymptote at its negative extremity.

204. Let us next consider the projection of the infinite part of the curve (Art. 196) which must be met by every line either in one or three real points. First, let the line projected to infinity meet it only in one, and then the branches of the projected curve, instead of spreading out indefinitely, will approach to contact with a finite asymptote, as in the left-hand curve on the figure. The curve, which will hereafter be briefly referred to as the *serpentine*, must obviously have three points of inflexion; for it is convex towards the asymptote at positive infinity (since every

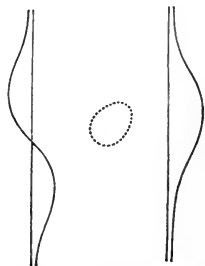

curve is convex towards its tangent on both sides of the point of contact); it must change this convexity into concavity in order to cut the asymptote once again: having cut it, it must bend again, else it would continually recede from the asymptote; and it must bend once more in order to become convex towards the asymptote at negative infinity. The points in the curve represented in the figure form a continuous series, since it appears, from what was said in the last article, that the branches of the curve in contact with the asymptote at its opposite extremities are to be regarded as continuous with each other.

In the above it was assumed that the point at infinity on the serpentine is an ordinary point on the curve. If, however, it be a point of inflexion, the difference is that instead of the positive and negative infinite branches lying as usual on opposite sides of the asymptote, they lie on the same side, as in the right-hand curve on the figure. It is obvious that the curve has then but two finite points of inflexion. We refer to this as the *conchoidal* form.

205. Next, let the line projected to infinity meet the infinite branch in three ordinary points. It may be seen that it will always divide the curve into three parts, one of which has no points of inflexion, another one, and the other two. The projection will consist of three infinite branches; one, which we shall call a *simple hyperbola*, having no point of inflexion, and not intersecting its asymptotes; the second, which we shall call an *inflected hyperbola*, crossing one asymptote, and consequently having one point of inflexion; and the last, which we shall call a *doubly inflected hyperbola* crossing both asymptotes, and having therefore two inflexions.* No two of these parts form

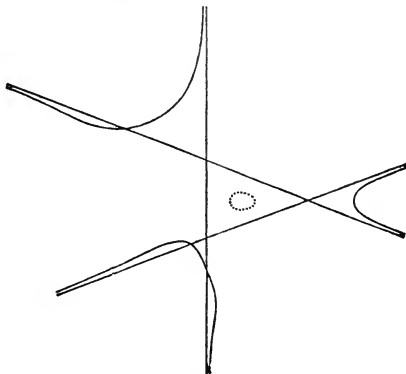

* Newton calls the first of these an inscribed, the third a circumscribed, and the second an ambigenous hyperbola.

a hyperbolic pair, but the three together form a continuous series. Thus, in the figure, if we commence by descending the vertical branch of the doubly inflected hyperbola, the path, after passing through negative infinity on the vertical asymptote, is continued from positive infinity on the same asymptote along the singly inflected branch, until having passed to infinity on the other asymptote it returns along the simple hyperbola, and so back to the doubly inflected hyperbola.

If one of the points at infinity be a point of inflexion, either the singly inflected hyperbola becomes simple or the doubly inflected becomes singly inflected. If all three inflexions be at infinity, the curve consists of three simple hyperbolas.

Cubics having three hyperbolic branches are called by Newton redundant hyperbolas, as having one more than the conic sections; those having but one infinite branch, as in the last article, are called by him defective hyperbolas; and those touched by the line at infinity, and having besides one finite asymptote, are called parabolic hyperbolas.

206. We now enumerate the following species of bipartite cubics. (1) The line projected to infinity meets the oval twice and the other part of the curve once. If the last point of meeting be (*a*) an ordinary point, the curve consists of a serpentine and a hyperbolic pair, as in the figure. If it be (*b*) an inflexion, the only difference is, that the serpentine is exchanged for the conchoidal form.

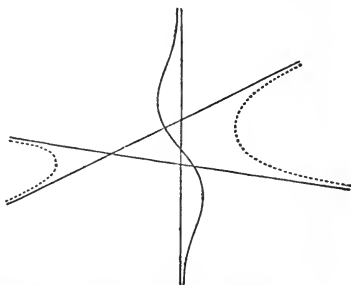

(2) The line infinity meets the curve in three real points, none of which belong to the oval. If the points be (*a*) all ordinary points, the figure is that of Art. 205. If one of the points be an inflexion, the curve consists either (*b*) of an oval with two simple and one doubly inflected hyperbolas, or else (*c*) of an oval with one simple and two singly inflected hyperbolas. (*d*) If the three inflexions be at infinity, the curve consists of an oval with three simple hyperbolas. In all these cases the oval lies within the triangle formed by the asymptotes,

and the curves may be further distinguished according as the hyperbolas lie in the angles which contain the asymptotic triangle, or, as in the figure, in the vertically opposite angles.

(3) Infinity meets the curve in two imaginary points; and we have an oval (*a*) with a serpentine, or (*b*) with a conchoidal branch (see Art. 204).

(4) Infinity touches the oval, which then assumes the parabolic form, and is accompanied (*a*) with a serpentine, (*b*) with a conchoidal branch.

(5) Infinity touches the other part of the curve. The oval then remains a closed figure, while the other part of the curve spreads into a parabolic form. If (*a*) the remaining point at infinity be ordinary, one branch crosses the asymptote and has two inflexions, while the other branch has only one. If (*b*) it be a point of inflexion, the branches are both at the same side of the asymptote, and each has only one inflexion.

(6) Infinity meets the curve in three coincident points. This is the case with which we set out (Art. 199).

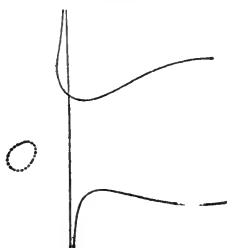

207. We come next to the division of *non-singular unipartite cubics*, and it is evident that we have now nothing corresponding to the species 1 and 4 of the last article. We have, therefore, only four species of such unipartite cubics, viz. redundant, defective, and parabolic hyperbolas, and the divergent parabola; according as the points of the curve at infinity are all real and distinct, two imaginary, two coincident, or all three coincident. The same varieties of each may be counted as in the last article, and the figures of the last article will serve by omission of the oval; but for further illustration we give a figure for a case where the satellite cuts the sides of the asymptotic triangle, and where two critic centres (Art. 192) lie within that triangle. We have, then, a portion of the doubly inflected hyperbola in a purse-shaped form within that triangle; and it is easy to conceive that by a change in the value of

the constant the mouth of the purse closes, and we have a double point at one of the critic centres, while, by a further change, we have a separate oval, at last shrinking into a conjugate point at the other critic centre.

In like manner we have the same four species of acnodal cubics, together with a fifth, for which the acnode is at infinity. The figures for bipartite cubics suffice to illustrate this class if we suppose the oval to shrink into a conjugate point.

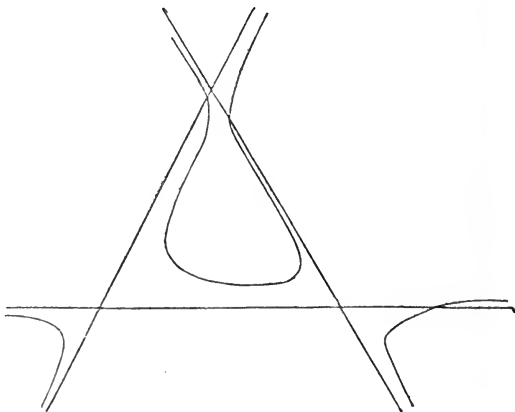

The figures for the case where the acnode is at infinity do not strikingly differ from those where infinity meets the curve in one real and two imaginary points.

208. Of *crunodal cubics* we have the following species: (1) Infinity cuts the loop in two real points. We have, then, two simple and one inflected hyperbola as in the left-hand figure. It will be observed by tracing the curve in its passages through infinity that the curve is unicursal. There

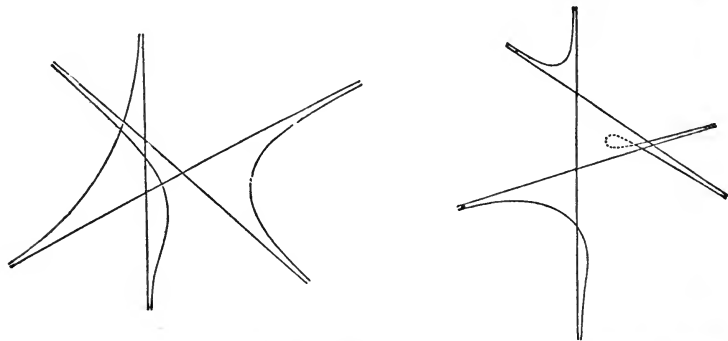

are two varieties according, as the remaining point is ordinary

or an inflexion. In the latter case, all the hyperbolas are simple.

(2) There are three real points at infinity, none of which are on the loop. There are an inscribed, ambigenous, and circumscribing hyperbola, the last forming a loop within the asymptotic triangle. There are two varieties, according as there is, or is not, an inflexion at infinity.

(3) Infinity meets the curve in two imaginary points. There are, as before, two varieties.

(4) Infinity touches the loop, and (5) infinity touches the spreading part of the curve. The figures explain themselves, and in the former case there are two varieties, the curve lying all on the same side of the asymptote when there is an inflexion at infinity.

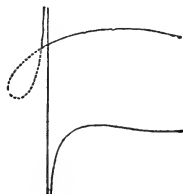
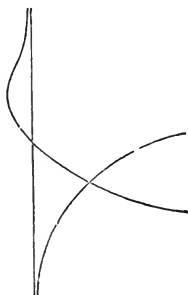

There is a double point at infinity, and consequently two parallel asymptotes; and the remaining point at infinity is (6) on the spreading part, (7) on the loop. In the former case, the point of inflexion is outside the parallel asymptotes, in the latter, between them. If the inflexion were also at infinity, the two branches in the former case would lie on the same side of the asymptote.

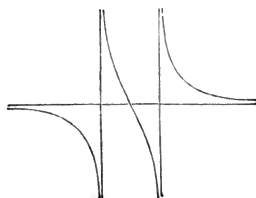
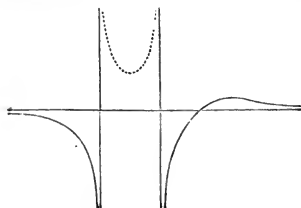

(8) Infinity touches at an inflexion, and we have the divergent parabola of Art. 199.

(9) Infinity is a tangent at a double point, and we have a curve called the *trident*, whose figure is here given.



209. Of cuspidal cubics there are evidently no species answering to 1, 4, 7 of the last article. The species, then, are (1) Three real points at infinity; two varieties. (2) One real and two imaginary points at infinity; two varieties. (3) Infinity an ordinary tangent; two varieties. (4) The cusp at infinity; two varieties. (5) Infinity, a stationary tangent. (6) Infinity, a cuspidal tangent. The figures for the cases 1, 2, 3 can easily be conceived with the help of the figures of the last article, by supposing the loop removed which is dotted in those figures, and the double point replaced by a cusp. The figure for case 4 is obtained from the left-hand figure (Art. 208) for the case of two parallel asymptotes, by imagining those asymptotes united and the branch between them suppressed. We have then a single asymptote with two infinite branches on opposite sides, but at the same end of it. The figure for case 5, the *semi-cubical parabola*, $my^2 = x^3$, is given, Art. 39. Finally, the figure for case 6, the *cubical parabola*, $m^2y = x^3$, is here represented.

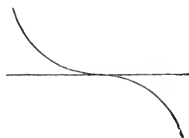

210. Though we have here counted as many as thirty species of cubics, it is not difficult to remember the classification, if it is borne in mind that nothing has been done, but combine the five-fold division of Art. 196 with the division of Art. 202, depending on the nature of the points at infinity. It remains to say something as to previous classifications of cubics. The first was made by Newton, *Enumeratio Linearum tertii ordinis*, whose classification is substantially the same as that here given, except that what we have counted as varieties are made by him distinct species; and that whereas in the case of a hyperbolic branch, touched by two asymptotes, we do not regard in which of the vertically opposite angles formed by them the

branch lies, Newton discriminates the cases where it lies in the angle crossed by the third asymptote, or in the opposite angle. The cases where three real asymptotes meet in a point are treated as distinct species. By attending to these distinctions the number of species is made up to seventy-eight. Also, whereas we have made the five-fold division primary, and that depending on the infinite branches secondary, Newton's course of proceeding is the reverse.

Newton's method of reducing the general equation is as follows: one of the axes being taken parallel to the real asymptote, the coefficient say of y^3 vanishes, and the equation of the curve is of the form

$$y^2(ax + b) + y(fx^2 + gx + h) + px^3 + qx^2 + rx + s = 0.$$

Now the locus of middle points of chords parallel to the asymptote is obviously

$$2axy + 2by + fx^2 + gx + h = 0;$$

and if we suppose the axes transformed to the asymptotes of this hyperbola, the terms b, f, g evidently vanish, shewing that the same transformation will bring the equation of the cubic to the form

$$xy^2 + hy = px^3 + qx^2 + rx + s,$$

or with Newton's letters

$$xy^2 + ey = ax^3 + bx^2 + cx + d.$$

This is Newton's most general form. If, however, in the equation, as we have written it a and b vanish, the locus is not a hyperbola but a right line, and according as this is (1) the line $x = 0$, (2) an arbitrary line which may be taken for $y = 0$, or (3) the line at infinity, the equation of the cubic is similarly brought to the forms

$$xy = ax^3 + bx^2 + cx + d,$$

$$y^2 = ax^3 + bx^2 + cx + d,$$

$$y = ax^3 + bx^2 + cx + d.$$

The only apparently different case is when in the equation, as we have written it, $a = 0$, and the locus a parabola; but in this case there is another real asymptote, the locus of middle points of chords parallel to which is a hyperbola, and the reduction

proceeds as in the first case, only that the coefficient of x^3 vanishes in the transformed equation. Newton's results are obtained from a discussion of these four forms. If $y = \phi(x)$ be the equation of any curve, Newton calls the curve $xy = \phi(x)$ a hyperbolism of that curve. Thus then he calls cubics which have a double point at infinity, and whose equation can therefore be brought to the form

$$xy^2 + ey = cx + d,$$

hyperbolisms of the ellipse, hyperbola, or parabola, since the equation just written is brought to that of a conic by writing y for xy .

211. We have already noticed Plücker's discussion of cubic curves, contained in his *System der Analytischen Geometrie*. In this discussion the nature of the points at infinity is the primary ground of classification. Commencing with the case of three real asymptotes, when the equation is of the form $xyz = ku^2v$, the cases when the asymptotes meet in a point, or form a triangle, are first distinguished; then all possible positions of the satellite line v are examined; whether for instance it crosses the triangle, pass through a vertex, or meet all the sides produced, whether two critic centres (Art. 192) coincide, and so forth. All the curves capable of being represented by the above equation for any given position of the lines x, y, z, v , are said to form a *group*, and by giving all possible values to k , the different species included under the same group are distinguished. This will be more readily understood from the figure of Plücker's first group, which we reproduce on the next page, and which answers to the case where the satellite line meets the sides produced of the asymptotic triangle, and where we have three real critic centres, one inside, two outside the triangle. Fig. 1 represents a bipartite curve of the species in this volume numbered I., 2. By a change in the value of k the oval shrinks into a point, and we have (2) the acnodal curve III., 1. As k is further changed, the curve becomes (3) unipartite II., 1; and the branches recede further from their asymptotes. In (4) the branches cross to the other asymptotes, and the curve becomes crunodal, IV., 2. Fig. 5 is bipartite, I., 1. Fig. 6 is in our enumeration of the same species as 5, 7 as 4, and 8 as 3, but the

position of the branches with regard to the asymptotic triangle

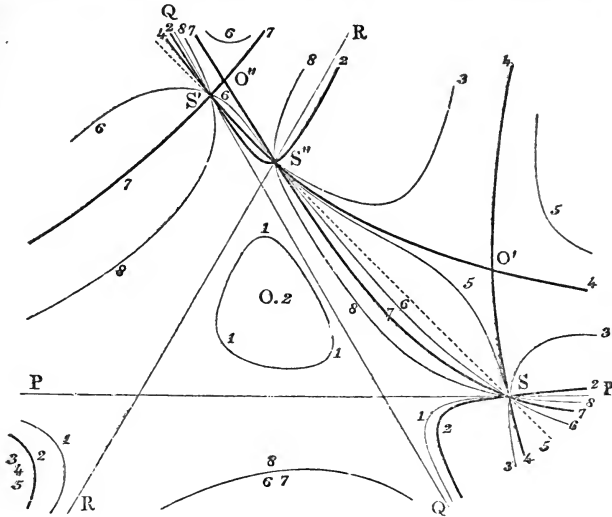

is different. Plücker's division into groups has been carefully re-examined by Prof. Cayley, *Transactions of the Cambridge Philosophical Society*, 1864, who also gives a comparison of Newton's species with those of Plücker, of which there are two hundred and nineteen. It does not enter into the plan of this treatise to give a more minute account of this classification. It will suffice to mention, that in the case of the parabolic curves an important part is played by the osculating asymptotic parabola, or parabola which passes through five consecutive points of the curve where it touches the line infinity. The equation of the curve may be brought to the form

$$x(y^2 + 2zx + z^2) = z^2(ay + bz),$$

where obviously the parabola $y^2 + 2zx + z^2$ meets the curve in the point yz reckoned five times. The groups are then determined by the position of the osculating parabola with respect to the linear asymptote x , and to the satellite line $ay + bz$.

SECT. IV.—UNICURSAL CUBICS.

212. We have seen (*Conics*, Art. 270) that computation is facilitated when the coordinates of a point on a curve can be

expressed in terms of a single parameter, and it has been proved (Art. 44) that this is always possible in the case of a unicursal curve. Of the application of this principle to cubics we now give some examples. The equation of a cuspidal cubic can always be reduced to the form $x^2z = y^3$, where xy is the cusp, x the cuspidal tangent, and z the stationary tangent. Any point on the curve may then be expressed as the intersection of $\theta x = y$, $\theta^2 y = z$;* or, in other words, the coordinates of any point on the curve may be taken as $1, \theta, \theta^3$, where θ is a variable parameter. The line joining any two points on the curve will then have for its equation, as may be easily verified,

$$\theta\theta'(\theta + \theta')x - (\theta^2 + \theta\theta' + \theta'^2)y + z = 0.$$

Let θ and θ' coincide, and we have the equation of the tangent

$$2\theta^3x - 3\theta^2y + z = 0.$$

If we seek the points where any line $ax + by + cz = 0$ meets the curve, substituting $1, \theta, \theta^2$ for x, y, z , we have the equation $a + b\theta + c\theta^3 = 0$, and as this equation in θ wants the second term, the sum of its roots vanishes, and we learn that the parameters of three points on a right line are connected by the relation $\theta + \theta' + \theta'' = 0$. Hence, in particular, the tangential of the point θ is -2θ , and the point of contact of the tangent from θ is $-\frac{1}{2}\theta$.

In like manner, if we make the substitution $1, \theta, \theta^3$ for x, y, z , in the equation of a curve of the p^{th} order, the term θ^{3p-1} will be wanting in the equation, and the relation connecting the parameters of the $3p$ points of intersection of the curve with the cubic is that their sum vanishes. Thus, then, the θ of the residual of a system of points is the negative sum, and of the coresidual is the sum of the θ 's of the several points; and generally the theorems concerning residuation, Art. 158, &c., are thus intuitively evident for cuspidal cubics. For instance, denoting the parameters of the points by a, b , &c., the condition that six points shall lie on a conic is

$$a + b + c + d + e + f = 0,$$

* These equations considered as belonging to tangential coordinates give the theorem "If I be the inflexion, C the cusp, and T the intersection of tangents at these points, any tangent AB cuts the sides of the triangle ICT , so that $\frac{IA^2}{AT^2} = k \frac{TB}{BC}$, and when the line at infinity is a tangent $k = 1$." Compare *Conics*, Art. 327.

which at once gives the theorem (Art. 154), that given four points on a cubic, the line joining the points e, f , where any conic through them meets the curve again, passes through the fixed point $(a + b + c + d)$; and that this point may be constructed by joining ab, cd , and joining the points where these lines meet the curve again, since

$$-(a + b) - (c + d) + (a + b + c + d) = 0.$$

So, again, various constructions for the ninth point where the cubic through eight points meets the curve again are obtained by inspection of the equation

$$(a + b + c + d) + (e + f + g + h) + i = 0.$$

213. The parameters of the points whose tangents pass through a given point are found by substituting the coordinates of that point in $2\theta^3x - 3\theta^2y + z = 0$; and since in the resulting cubic the coefficient of θ vanishes, the sum of the reciprocals of the roots vanishes; or, three points whose tangents

meet in a point are connected by the relation $\frac{1}{\theta} + \frac{1}{\theta'} + \frac{1}{\theta''} = 0$.

In like manner, since the condition that $2\theta^3x - 3\theta^2y + z = 0$ should touch a curve of the p^{th} class is a relation of the p^{th} order between the coefficients $2\theta^3, 3\theta^2, 1$, and since such a relation obviously does not contain the term θ , it follows that the $3p$ points where tangents touch a curve of the p^{th} class

are connected by the relation $\Sigma \left(\frac{1}{\theta} \right) = 0$. We give some illustrations of this application of the method to examples.

Ex. 1. To find the locus of the intersection of tangents whose chord of contact passes through a fixed point on a cuspidal cubic.

This is to eliminate α and β between the three equations

$$2\alpha^2x - 3\alpha^2y + z = 0, \quad 2\beta^2x - 3\beta^2y + z = 0, \quad \alpha + \beta + \gamma = 0,$$

where γ is known. We easily find $\gamma(2\gamma x + 3\gamma y)^2 + 2xz = 0$, the equation of a conic.

Ex. 2. If a polygon of an even number of sides be inscribed in a cubic, and all the sides but one pass through fixed points on the curve, the last side will also pass through a fixed point on the curve.

Denote the parameters of the vertices by $a_1, a_2, \&c.$, and of the fixed points by $b_1, b_2, \&c.$ We take the case of the quadrilateral for simplicity, but the proof is general. We have then the equations

$$\begin{aligned} a_1 + b_1 + a_2 &= 0, & a_2 + b_2 + a_3 &= 0, \\ a_3 + b_3 + a_4 &= 0, & a_4 + b_4 + a_1 &= 0. \end{aligned}$$

Adding, we have $b_1 + b_3 = b_2 + b_4$, shewing that the lines joining $b_1, b_3; b_2, b_4$ meet on the curve, and that, when three of the points are known, the fourth is known also. The theorem is true for all cubics, for the proof here given may easily be translated into the language of the theory of residuation, shewing that the pairs of points $b_1, b_3; b_2, b_4$ are coresidual, a common residual being the system of vertices a_1, a_2, a_3, a_4 .

It follows, as a particular case of this theorem, that if the sides of a polygon of an odd number of sides pass through fixed points on the curve, the tangent at any vertex passes through a fixed point on the curve; and hence, that the problem to construct such a polygon whose sides pass through fixed points on a non-singular cubic admits of four solutions.

Ex. 3. To find the quasi-evolute, the two fixed points being on the curve (see also Ex. 5, Art. 99). The equation of the quasi-normal (Art. 107) is

$$(\beta^2 + \beta\theta - 2\theta^2) \{\theta\alpha(\theta + \alpha)x - (\theta^2 + \theta\alpha + \alpha^2)y + z\} \\ + (\alpha^2 + \alpha\theta - 2\theta^2) \{\theta\beta(\theta + \beta)x - (\theta^2 + \theta\beta + \beta^2)y + z\} = 0.$$

If we transform this by writing $\theta = \frac{\alpha - \beta\lambda}{1 - \lambda}$, we get then, in conformity with Art. 108, a biquadratic in λ , in which the two extreme terms at each end respectively differ only by a constant factor, and the discriminant, having as factors the equations of the tangents at α and β , represents besides a curve only of the 4th degree.

214. It remains to mention a few of the more remarkable examples of cubics of the third class. We have already noticed the *semi-cubical parabola*, which is the evolute of the parabola of the second degree. In its equation, $py^2 = x^3$, the cusp is at the origin, and the point of inflexion at infinity. In the *cubical parabola*, on the other hand, $p^2y = x^3$, the point of inflexion is at the origin and the cusp at infinity. In the cubical parabola the origin is a centre, and all the diameters of the curve coincide with the axis of y ; for if we draw any line $y = mx + n$, the sum of the values of x is = 0.

To the cusped class also belongs the *Cissoïd of Diocles*, a curve imagined by that geometer for the solution of the problem of finding two mean proportionals. It may be defined as the locus of a point M' , where the radius vector to the circle AM is cut by an ordinate, such that $AP' = BP$. We must have

$AM' = RM$, and therefore $\rho = AR - AM$,
or $\rho = 2r \sec \omega - 2r \cos \omega = 2r \tan \omega \sin \omega$;
or, in rectangular coordinates,

$$x(x^2 + y^2) = 2ry^2, \text{ or } (2r - x)y^2 = x^3.$$

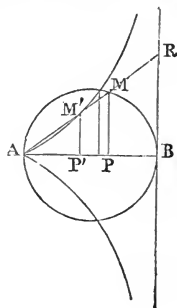

The origin is therefore a cusp, and $2r - x$ an asymptote meeting the curve at an infinitely distant point of inflexion.

Newton has given the following elegant construction for the description of this curve by continuous motion: A right angle has the side GF of fixed length, the point F moves along the fixed line CI , while the side GH passes through the fixed point E ; a pencil at the middle point of GF will describe the cissoid. The proof we leave to the reader. (Lardner's *Algebraic Geometry*, pp. 196, 472).

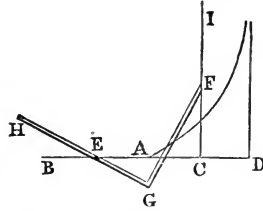

The cissoid is also the locus which we should find if we take on each of the radii vectores from the vertex of a parabola a portion equal to the reciprocal of its length. It is consequently also the locus of the foot of a perpendicular let fall from the vertex of a parabola on the tangent; or, in other words, if a parabola roll on an equal one, the locus of the vertex of the moving parabola will be the cissoid.

215. We can in like manner express in terms of a single parameter the coordinates of any point on a crunodal or acnodal cubic. The double point being the origin, the equation is of the form

$$ax^3 + 3bx^2y + 3cxy^2 + dy^3 + 3fx^2 + 6gxy + 3hy^2 = 0,$$

and if we put $y = \theta x$, we have immediately rational expressions for x and y in terms of θ . The discussion will, however, be simpler if we suppose the equation transformed, as it always may be, to the form $(x^2 \pm y^2)z = x^3$. Here z is the tangent at the one real point of inflexion which the curve *must* have: x is the line joining the point of inflexion to the double point, and $x^2 \pm y^2$ are the tangents at the double point, the upper sign belonging to the case of the acnodal, and the lower to that of the crunodal cubic. The coordinates then of any point on the curve may be taken proportional to $(1 \pm \theta^2)$, $\theta(1 \pm \theta^2)$, 1. If we substitute these values in the equation of an arbitrary line $\lambda x + \mu y + \nu z = 0$, we get, in order to determine the parameters of the points where this line meets the cubic,

$$(\lambda + \nu) + \mu\theta \pm \lambda\theta^2 \pm \mu\theta^3 = 0,$$

and these parameters are connected by the relation

$$\theta' \theta'' + \theta'' \theta''' + \theta''' \theta' = \pm 1.$$

If the line touch at a point of inflexion $\theta' = \theta'' = \theta'''$, and therefore $\theta^2 = \pm \frac{1}{3}$. Hence, *an acnodal cubic has three real points of inflexion, and a crunodal cubic one real and two imaginary.*

The equation of the line joining two points will be found to be

$$(\theta^2 + \theta \theta' + \theta'^2 \pm 1) x - (\theta + \theta') y = \pm (1 \pm \theta^2) (1 \pm \theta'^2) z,$$

and therefore the equation of a tangent is

$$(3\theta^2 \pm 1) x - 2\theta y = \pm (1 \pm \theta^2)^2 z,$$

whence we see that if four tangents meet in a point, the sum of the corresponding parameters vanishes, and if two of the points be given, we can at once form the quadratic which determines the parameters of the other two. There is no difficulty in applying this method to examples.

At Art. 122, Ex. 1 we have noticed the crunodal cubic, whose polar equation is $\rho^{\frac{1}{3}} \cos \frac{1}{3} \omega = m^{\frac{1}{3}}$, and whose rectangular equation is $27(x^2 + y^2)m = (4m - x)^3$; a curve having three points of inflexion at infinity, one real and the others being the two circular points. The node is on the axis of x at the point $x = -8m$.

216. *When a nodal cubic has three real points of inflexion, the conjugate point is the pole of the line joining these three points, with regard to the triangle formed by the three tangents.* Let the equation of a cubic be

$$(x + y + z)^3 = mxyz;$$

then, if this has a double point, its coordinates must satisfy the equations got by differentiation, viz.

$$3(x + y + z)^2 = myz = mzx = mxy.$$

From these equations we get $x = y = z$, which (Art. 165) proves the theorem enunciated, and we then have for the nodal cubic $m = 27$, and the equation of the curve may be written in the form

$$x^{\frac{1}{3}} + y^{\frac{1}{3}} + z^{\frac{1}{3}} = 0.$$

In this case the coordinates of any point on the curve may be taken proportional to $\theta^3, (1 - \theta)^3, -1$, and the equation of the corresponding tangent is $(1 - \theta)^2 x + \theta^2 y + \theta^2 (1 - \theta)^2 z = 0$.

216(a). The subject of unicursal cubics may be otherwise treated.* We may start with the most general expression for the coordinates in terms of a parameter $\lambda : \mu$, viz.

$$x = a \lambda^3 + 3b \lambda^2 \mu + 3c \lambda \mu^2 + d \mu^3,$$

$$y = a' \lambda^3 + 3b' \lambda^2 \mu + 3c' \lambda \mu^2 + d' \mu^3,$$

$$z = a'' \lambda^3 + 3b'' \lambda^2 \mu + 3c'' \lambda \mu^2 + d'' \mu^3,$$

and we can at once (as in Art. 44) write down in the form of a determinant the equation of the resulting cubic. But again, there are in general three linear functions of x, y, z , whose expressions in λ, μ are perfect cubes. For if in the equation

$$Lx + My + Nz = (\alpha\lambda + \beta\mu)^3,$$

we substitute for x, y, z their expressions in $\lambda : \mu$, equate coefficients of $\lambda^3, \lambda^2\mu$, &c. and linearly eliminate L, M, N from the resulting equations, we get

$$\begin{vmatrix} \alpha^3, & a, & a', & a'' \\ \alpha^2\beta, & b, & b', & b'' \\ \alpha\beta^2, & c, & c', & c'' \\ \beta^3, & d, & d', & d'' \end{vmatrix} = 0;$$

that is to say, we have a cubic for the determination of $\alpha : \beta$, which we may write

$$A\alpha^3 + 3B\alpha^2\beta + 3C\alpha\beta^2 + D\beta^3 = 0,$$

$A, 3B, 3C, D$ being the determinants of the system

$$\begin{vmatrix} a, & b, & c, & d \\ a', & b', & c', & d' \\ a'', & b'', & c'', & d'' \end{vmatrix}.$$

Corresponding to the three values of $\alpha : \beta$, there are three values of $Lx + My + Nz$; and if, writing down the three equations

$$L'x + M'y + N'z = (\alpha'\lambda + \beta'\mu)^3, \text{ \&c.,}$$

we take the cube roots of both sides, and linearly eliminate $\lambda : \mu$, we get the equation of the curve in the form of a linear relation

* For further developments of the method here explained see Igel, *Math. Annal.*, vi. 633; Haase, *Math. Annal.* ii. 526.

between the cube roots of three linear functions. This is expressed in the simplest form by writing

$$X = (\alpha' \lambda + \beta' \mu)^3 (\alpha'' \beta''' - \alpha''' \beta'')^3,$$

$$Y = (\alpha'' \lambda + \beta'' \mu)^3 (\alpha''' \beta' - \alpha' \beta''')^3,$$

$$Z = (\alpha''' \lambda + \beta''' \mu)^3 (\alpha' \beta'' - \alpha'' \beta')^3,$$

when we have the equation of the curve in the form (Art. 216) $X^{\frac{1}{3}} + Y^{\frac{1}{3}} + Z^{\frac{1}{3}} = 0$, which denotes a nodal cubic, X, Y, Z being the three inflexional tangents, $X + Y + Z$ the line joining the three inflexions, and $X = Y = Z$ the node.

216 (b). We might arrive by another process at a cubic identical with the Canonizant cubic of the last article. The general condition that three points should be on a right line being got by equating to zero the determinant formed with the constituents x', y', z' , &c., if we substitute for $x', a\lambda^3 + \&c.$, we get the condition that three points of the curve should be on a right line. This is easily seen to be resolvable into partial determinants, each of which is divisible by

$$(\lambda' \mu'' - \lambda'' \mu') (\lambda'' \mu''' - \lambda''' \mu'') (\lambda''' \mu' - \lambda' \mu''');$$

and the condition in question may be written

$$A\mu' \mu'' \mu''' + B(\lambda' \mu'' \mu''' + \lambda'' \mu''' \mu' + \lambda''' \mu' \mu'') \\ + C(\lambda'' \lambda''' \mu' + \lambda''' \lambda' \mu'' + \lambda' \lambda'' \mu''') + D\lambda' \lambda'' \lambda''' = 0,$$

where $A, B, \&c.$, have the same meaning as in the last article. In other words, if the $\lambda : \mu$ of three points be determined by the cubic

$$A'\lambda^3 + 3B'\lambda^2\mu + 3C'\lambda\mu^2 + D'\mu^3 = 0,$$

then the condition that these three points should be on a right line is

$$(AD' - A'D) - 3(BC' - B'C) = 0.$$

The $\lambda : \mu$ of a point of inflexion we get by writing $\lambda' = \lambda'' = \lambda'''$, $\mu' = \mu'' = \mu'''$ in the preceding equation, and we thus fall back on the cubic

$$A\mu^3 + 3B\lambda\mu^2 + 3C\lambda^2\mu + D\lambda^3 = 0.$$

We might arrive at the same cubic in a somewhat different form. From the general determinant form of the equation of the line joining two points, it follows that for a unicursal cubic,

in which we are given expressions for x, y, z in terms of a parameter, the equation of the tangent at any point is

$$\begin{vmatrix} x, y, z \\ x_\lambda, y_\lambda, z_\lambda \\ x_\mu, y_\mu, z_\mu \end{vmatrix} = 0,$$

where the suffixes denote differentiation with regard to λ or μ of the expressions for $x, y,$ or z ; and, in like manner, that the condition that three consecutive points shall lie on a right line is

$$\begin{vmatrix} x_{\lambda\lambda}, y_{\lambda\lambda}, z_{\lambda\lambda} \\ x_{\lambda\mu}, y_{\lambda\mu}, z_{\lambda\mu} \\ x_{\mu\mu}, y_{\mu\mu}, z_{\mu\mu} \end{vmatrix} = 0.$$

Thus, then, for the case of the cubic which we are considering, the $\lambda : \mu$ of the inflexions is given by the equation

$$\begin{vmatrix} a\lambda + b\mu, b\lambda + c\mu, c\lambda + d\mu \\ a'\lambda + b'\mu, b'\lambda + c'\mu, c'\lambda + d'\mu \\ a''\lambda + b''\mu, b''\lambda + c''\mu, c''\lambda + d''\mu \end{vmatrix} = 0,$$

which may be seen (as *Higher Algebra*, Art. 169) to be identical with the cubic already mentioned.

216 (c). A node on the curve will arise when the same point answers to two different values of the ratio $\lambda : \mu$. If $\lambda' : \mu', \lambda'' : \mu''$ be two values answering to the same point, then, no matter what other point $\lambda''' : \mu'''$ we take on the curve, the condition of the last article (that it shall be on a right line with the two coincident points of the node) must be fulfilled. Thus, equating separately to zero the parts in that condition multiplied by λ''', μ''' respectively, we have

$$A\mu'\mu'' + B(\lambda'\mu'' + \lambda''\mu') + C\lambda\lambda'' = 0,$$

$$B\mu'\mu'' + C(\lambda'\mu'' + \lambda''\mu') + D\lambda\lambda'' = 0,$$

and since, from the theory of equations, if the two values of $\lambda : \mu$, corresponding to the node be given by a quadratic equation; that equation must be

$$\lambda^2\mu'\mu'' - \lambda\mu(\lambda'\mu'' + \lambda''\mu') + \mu^2\lambda\lambda'' = 0;$$

eliminating $\mu'\mu''$, &c., we get the quadratic, which determines the values of the nodal parameter

$$\begin{vmatrix} \lambda^2, & -\lambda\mu, & \mu^2 \\ A, & B, & C \\ B, & C, & D \end{vmatrix} = 0.$$

In other words (see *Higher Algebra*, Art. 195), the quadratic which determines the two values of the nodal parameter is the Hessian of the canonizant cubic.

If in the condition of the last article we write $\lambda'' : \mu'' = \lambda' : \mu'$, we get the relations connecting the parameter of any point with that of its tangential, and it will be observed that the factors multiplying λ''' , μ''' are the differentials of the cubic with regard to λ , μ .

216 (*d*). In the preceding it has been assumed that the roots of the canonizant cubic are unequal. To consider in the simplest form the case where there are two equal roots let x and y be two of the linear functions, which, expressed in terms of the parameter, are perfect cubes; that is to say, let us take $x = \lambda^3$, $y = \mu^3$, and if $z = a''\lambda^3 + 3b''\lambda^2\mu + 3c''\lambda\mu^2 + d''\mu^3$, the canonizant cubic becomes $\alpha\beta(b''\beta - c''\alpha) = 0$, which will have two equal roots only, on the supposition that b'' or $c'' = 0$. In this case we can, by linear transformation, bring the third equation to the form $z = \lambda^2\mu$, and the cubic will be $z^3 = x^2y$; or, in other words, it will have a cusp. Clebsch has shown (*Crelle*, LXIV. 43), that in general the equation of the $3(n-2)$ degree, which determines the parameters of the points of inflexion, will have a pair of equal roots for every double point which becomes a cusp.

If the canonizant have three equal roots, the curve breaks up into a right line and a conic.

SECT. V.—INVARIANTS AND COVARIANTS OF CUBICS.

217. The equation of a non-singular cubic can always be reduced to the canonical form

$$x^3 + y^3 + z^3 + 6mxyz = 0.$$

In this form x , y , z contain each implicitly three constants; and these, together with the one expressed constant, make up

ten, the number of constants, which, according to the test of Art. 24, a form must contain if it be general enough to represent any cubic. We shall presently shew how the equation of any cubic can be reduced to the form just given. We may write it $(x+y-2mz)(\omega x + \omega^2 y - 2mz)(\omega^2 x + \omega y - 2mz) + (1 + 8m^3)z^3 = 0$, where ω is an imaginary cube root of unity. In this form it is apparent that the line z joins three points of inflexion, and the same thing is proved in like manner for the lines x and y . Hence these three lines constitute one of the four systems of three lines which we saw (Art. 174) can be drawn through the nine points of inflexion; and we can foresee that the problem to reduce the equation of any cubic to the canonical form admits of four solutions.

The form here given is that which we shall generally use in our investigation concerning cubics; but it is necessary first to obtain the invariants for the equation in its general form, which we write

$$*ax^3 + by^3 + cz^3 + 3a_2x^2y + 3a_3x^2z + 3b_1y^2x + 3b_2y^2z + 3c_1z^2x + 3c_2z^2y + 6mxyz = 0.$$

218. We form now first the equation of the Hessian. The second differential coefficients of the cubic, omitting the factor 6 common to all, are

$$\begin{aligned} a &= ax + a_2y + a_3z; & f &= mx + b_3y + c_2z; \\ b &= b_1x + by + b_3z; & g &= a_3x + my + c_1z; \\ c &= c_1x + c_2y + cz; & h &= a_2x + b_1y + mz. \end{aligned}$$

* In Prof. Cayley's Memoirs the coefficients of the terms $y^2z, z^2x, x^2y, yz^2, zx^2, xy^2$, are written respectively f, g, h, i, j, k . In German Memoirs the variables are usually denoted by x_1, x_2, x_3 , and the coefficients in question are written $a_{23}, a_{31}, a_{12}, a_{23}, a_{31}, a_{12}$. The first notation has greatly the advantage in compactness; the advantage of the second is that each coefficient shews on the face of it to which term it belongs. In formulæ which we have much occasion to work with, the use of suffixes is less convenient than a notation in which each coefficient is denoted by a single character; but since the general equation of the cubic is only used in the articles immediately following, and there chiefly for purposes of reference, I have thought the second advantage to be that which in this instance it was most important to secure. The notation used in the text agrees with the German, replacing a_{11}, a_{22}, a_{33} by a, b, c , respectively. On the same principle the coefficients of x^3, y^3, z^3 , might be written a_1, b_2, c_3 , and were so written in the first edition. I now omit suffixes in the case of these three coefficients, not only for brevity but also to diminish the risk of confounding any of them with one of the group of six coefficients.

Forming then $H = abc + 2fgh - af^2 - bg^2 - ch^2$,

H is the cubic, the coefficients of which are respectively

$$a = ab_1c_1 - am^2 + 2ma_2a_3 - b_1a_3^2 - c_1a_2^2,$$

$$b = ba_2c_2 - bm^2 + 2mb_3b_1 - a_2b_3^2 - c_2b_1^2,$$

$$c = ca_3b_3 - cm^2 + 2mc_2c_1 - a_3c_2^2 - b_3c_1^2,$$

$$3a_2 = abc_1 - 2amb_3 + ab_1c_2 - ba_3^2 + m^2a_2 - b_1c_1a_2 + 2a_2a_3b_3 - c_2a_2^2,$$

$$3a_3 = acb_1 - 2amc_2 + ab_3c_1 - ca_2^2 + m^2a_3 - b_1c_1a_3 + 2a_2a_3c_2 - b_3a_3^2,$$

$$3b_1 = bac_2 - 2bma_3 + ba_2c_1 - ab_3^2 + m^2b_1 - c_2a_2b_1 + 2b_1b_3a_3 - c_1b_1^2,$$

$$3b_3 = bca_2 - 2bmc_1 + ba_3c_2 - cb_1^2 + m^2b_3 - c_2a_2b_3 + 2b_1b_3c_1 - a_3b_3^2,$$

$$3c_1 = cab_3 - 2cma_2 + ca_3b_1 - ac_2^2 + m^2c_1 - a_3b_3c_1 + 2c_1c_2a_2 - b_1c_1^2,$$

$$3c_2 = cba_3 - 2cmb_1 + ca_2b_3 - bc_1^2 + m^2c_2 - a_3b_3c_2 + 2c_1c_2b_1 - a_2c_2^2,$$

$$6m = abc - (ab_3c_2 + bc_1a_3 + ca_2b_1) + 2m^3 - 2m(b_1c_1 + c_2a_2 + a_3b_3) \\ + 3(a_2b_3c_1 + a_3b_1c_2).$$

As a particular case of the preceding, the Hessian of

$$x^3 + y^3 + z^3 + 6mxyz = 0 \text{ is } -m^2(x^3 + y^3 + z^3) + (1 + 2m^3)xyz = 0.$$

219. We are also able to form the equation of the Cayleyan. This contravariant expresses the condition that the line $\alpha x + \beta y + \gamma z$ shall be cut in involution by the system of conics U_1, U_2, U_3 , where

$$U_1 = a x^2 + b_1 y^2 + c_1 z^2 + 2myz + 2a_2 zx + 2a_3 xy,$$

$$U_2 = a_2 x^2 + b y^2 + c_2 z^2 + 2b_3 yz + 2mzx + 2b_1 xy,$$

$$U_3 = a_3 x^2 + b_3 y^2 + c z^2 + 2c_2 yz + 2c_1 zx + 2mxy.$$

The method of forming this contravariant is given, *Conics*, Art. 388a; and the result is there found in terms of the coefficients of the three conics. Applying the formulæ to the present example, we find

$$P = A\alpha^3 + B\beta^3 + C\gamma^3 + 3A_2\alpha^2\beta + 3A_3\alpha^2\gamma + 3B_1\beta^2\alpha + 3B_3\beta^2\gamma \\ + 3C_1\gamma^2\alpha + 3C_2\gamma^2\beta + 6M\alpha\beta\gamma,$$

where

$$A = bcm - bc_1c_2 - cb_1b_3 - mb_3c_2 + b_1c_2^2 + c_1b_3^2,$$

$$B = cam - ca_2a_3 - ac_1c_2 - ma_2c_1 + a_2c_1^2 + c_2a_3^2,$$

$$C = abm - ab_1b_3 - ba_2a_3 - mb_1a_2 + b_3a_2^2 + a_2b_1^2,$$

$$\begin{aligned}
3A_2 &= -bca_3 - cmb_1 + bc_1^2 + 2ca_2b_3 + 2m^2c_2 - 3mb_3c_1 + c_3a_3b_3 + b_1c_1c_2 - 2a_2c_2^2, \\
3A_3 &= -bca_2 - bmc_1 + cb_1^2 + 2ba_3c_2 + 2m^2b_3 - 3mc_2b_1 + b_3a_2c_2 + b_1c_1b_3 - 2a_3b_3^2, \\
3B_1 &= -cab_3 - cma_2 + ac_2^2 + 2ca_3b_1 + 2m^2c_1 - 3ma_3c_2 + c_1a_3b_3 + a_2c_1c_2 - 2b_1c_1^2, \\
3B_3 &= -cab_1 - amc_2 + ca_2^2 + 2ab_3c_1 + 2m^2a_3 - 3mc_1a_3 + a_3b_1c_1 + a_2c_2a_3 - 2b_3a_3^2, \\
3C_1 &= -abc_2 - bma_3 + ab_3^2 + 2ba_2c_1 + 2m^2b_1 - 3ma_2b_3 + b_1a_2c_2 + a_3b_1b_3 - 2c_1b_1^2, \\
3C_2 &= -abc_1 - amb_3 + ba_3^2 + 2ab_1c_2 + 2m^2a_2 - 3ma_3b_1 + a_2b_1c_1 + a_2a_3b_3 - 2c_2a_2^2, \\
6M &= abc - (ab_3c_2 + bc_1a_3 + ca_2b_1) - 4m^3 + 4m(b_1c_1 + c_2a_2 + a_3b_3) \\
&\quad - 3(a_2b_3c_1 + a_3b_1c_2).
\end{aligned}$$

In particular, the Cayleyan of $x^3 + y^3 + z^3 + 6mxyz$ is

$$m(\alpha^3 + \beta^3 + \gamma^3) + (1 - 4m^3)\alpha\beta\gamma = 0.$$

220. If in the contravariant just found we substitute for α, β, γ , symbols of differentiation with respect to x, y, z respectively, and then operate on the given cubic U , the result will be an invariant (*Higher Algebra*, Art. 139).

This invariant, which we denote by S , is of the fourth degree in the coefficients, and is

$$\begin{aligned}
S &= abcm - (bca_2a_3 + cab_1b_3 + abc_1c_2) - m(ab_3c_2 + bc_1a_3 + ca_2b_1) \\
&+ (ab_1c_2^2 + ac_1b_3^2 + ba_2c_1^2 + bc_2a_3^2 + cb_3a_2^2 + ca_3b_1^2) - m^4 + 2m^2(b_1c_1 + c_2a_2 + a_3b_3) \\
&- 3m(a_2b_3c_1 + a_3b_1c_2) - (b_1^2c_1^2 + c_2^2a_2^2 + a_3^2b_3^2) + (c_2a_2a_3b_3 + a_3b_3b_1c_1 + b_1c_1c_2a_2).
\end{aligned}$$

It amounts to the same thing to say that the equation of the Cayleyan may be written

$$\begin{aligned}
\left(\alpha^3 \frac{d}{da} + \beta^3 \frac{d}{db} + \gamma^3 \frac{d}{dc} + \alpha^2\beta \frac{d}{da_2} + \alpha^2\gamma \frac{d}{da_3} + \beta^2\gamma \frac{d}{db_3} \right. \\
\left. + \beta^2\alpha \frac{d}{db_1} + \gamma^2\alpha \frac{d}{dc_1} + \gamma^2\beta \frac{d}{dc_2} + \alpha\beta\gamma \frac{d}{dm} \right) S = 0.
\end{aligned}$$

We have explained, *Higher Algebra*, Art. 162, the symbolical method by which Aronhold originally obtained this invariant S ; its symbolical notation being (123)(234)(341)(412), that of its *evectant*, the Cayleyan, being (123)(\alpha 23)(\alpha 31)(\alpha 12). For the canonical form S is $m - m^4$, and since S vanishes when $m = 0$; that is to say, when the equation is of the form $x^3 + y^3 + z^3 = 0$, it follows that S vanishes when the cubic function equated to zero can be reduced to the sum of three cubes.

221. When we have a quantic $U = ax^n + by^n + cz^n + \&c.$, and a covariant V of the same degree $ax^n + by^n + cz^n + \&c.$, then if we have any invariant of U , and if we form the corresponding invariant of $U + \lambda V$, the coefficients of the several powers of λ will obviously be invariants. We learn hence that, in the case supposed, from any invariant of U we can form a new invariant by performing on it the operation $a \frac{d}{da} + b \frac{d}{db} + c \frac{d}{dc} + \&c.$

Applying this principle to the cubic and its Hessian we can from the invariant S derive a new invariant T of the sixth order in the coefficients; or, what amounts to the same thing, we can obtain T by writing differential symbols for α, β, γ in the Cayleyan, and then operating on the Hessian. We thus find for T the value

$$\begin{aligned}
 & a^2 b^2 c^2 - 6abc(ab_3c_2 + bc_1a_3 + ca_2b_1) - 20abc m^3 + 12abc m(b_1c_1 + c_2a_2 + a_3b_3) \\
 & + 6abc(a_2b_3c_1 + a_3b_1c_2) + 4(a^2bc_2^3 + a^2cb_3^3 + b^2ca_3^3 + b^2ac_1^3 + c^2ab_1^3 + c^2ba_3^3) \\
 & + 36m^2(bca_2a_3 + cab_1b_3 + abc_1c_2) \\
 & - 24m(bcb_1a_3^2 + bcc_1a_2^2 + cac_2b_1^2 + caa_2b_3^2 + aba_3c_2^2 + abb_3c_1^2) \\
 & - 3(a^2b_3^2c_2^2 + b^2c_1^2a_3^2 + c^2a_2^2b_1^2) + 18(bcb_1c_1a_2a_3 + cac_2a_2b_3b_1 + aba_3b_3c_1c_2) \\
 & - 12(bcc_2a_3a_2^2 + bcb_3a_2a_3^2 + cac_1b_3b_1^2 + caa_3b_1b_3^2 + aba_2c_1c_2^2 + abb_1c_2c_1^2) \\
 & - 12m^3(ab_3c_2 + bc_1a_3 + ca_2b_1) \\
 & + 12m^2(ab_1c_2^2 + ac_1b_3^2 + ba_2c_1^2 + bc_2a_3^2 + cb_3a_2^2 + ca_3b_1^2) \\
 & - 60m(ab_1b_3c_1c_2 + bc_1c_2a_2a_3 + ca_2a_3b_1b_3) \\
 & + 12m(aa_2b_3c_2^2 + aa_3c_2b_3^2 + bb_3c_1a_3^2 + bb_1a_3c_1^2 + cc_1a_2b_1^2 + cc_2b_1a_2^2) \\
 & + 6(ab_3c_2 + bc_1a_3 + ca_2b_1)(a_2b_3c_1 + a_3b_1c_2) \\
 & + 24(ab_1b_3^2c_1^2 + ac_1c_2^2b_1^2 + bc_2c_1^2a_2^2 + ba_2a_3^2c_2^2 + ca_3a_2^2b_3^2 + cb_3b_1^2a_3^2) \\
 & - 12(aa_2b_1c_2^3 + aa_3c_1b_3^3 + bb_3c_2a_3^3 + bb_1a_2c_1^3 + cc_1a_3b_1^3 + cc_2b_3a_2^3) \\
 & - 8m^6 + 24m^4(b_1c_1 + c_2a_2 + a_3b_3) - 36m^3(a_2b_3c_1 + a_3b_1c_2) \\
 & - 12m^2(b_1c_1c_2a_2 + c_2a_2a_3b_3 + a_3b_3b_1c_1) - 24m^2(b_1^2c_1^2 + c_2^2a_2^2 + a_3^2b_3^2) \\
 & + 36m(a_2b_3c_1 + a_3b_1c_2)(b_1c_1 + c_2a_2 + a_3b_3) + 8(b_1^3c_1^3 + c_2^3a_2^3 + a_3^3b_3^3) \\
 & - 27(a_2^2b_3^2c_1^2 + a_3^2b_1^2c_2^2) - 6b_1c_1c_2a_2a_3b_3 \\
 & - 12(b_1^2c_1^2c_2a_2 + b_1^2c_1^2a_3b_3 + c_2^2a_2^2a_3b_3 + c_2^2a_2^2b_1c_1 + a_3^2b_3^2b_1c_1 + a_3^2b_3^2c_2a_2).
 \end{aligned}$$

For the canonical form this invariant reduces to $1 - 20m^3 - 8m^5$. Its symbolical form is (123)(124)(235)(316)(456)². We can derive from the invariant T an evectant $\alpha^3 \frac{dT}{da} + \beta^3 \frac{dT}{db} + \gamma^3 \frac{dT}{dc} = 0$, the coefficients of which it is needless to write at length. For the canonical form, this contravariant, which we denote by Q , is

$$(1 - 10m^3)(\alpha^3 + \beta^3 + \gamma^3) - (30m^2 + 24m^5)\alpha\beta\gamma = 0.$$

Every invariant of the cubic can be expressed as a rational function of S and T . This can be proved in the same way as the corresponding theorem is proved (*Higher Algebra*, Art. 215) for a binary quartic, there being much resemblance between the theory of the binary quartic and that of the ternary cubic.

222. The method of finding the equation of the reciprocal of a cubic has been explained (Arts. 91, 188). We give the result for the general equation, only writing at length, however, those terms the form of which is really distinct. The other coefficients may be obtained from those we give by symmetrical interchange of letters.

$$\begin{aligned} & \alpha^6 \{b^2c^2 - 6bcb_3c_2 + 4bc_2^3 + 4cb_3^3 - 3b_3^2c_2^2\}, \\ & 6\alpha^5\beta \{-bc^2b_1 + 2bcmc_2 + bcb_3c_1 - 4mcb_3^2 + 3cc_2b_3b_1 - 2bc_1c_2^2 \\ & \qquad \qquad \qquad + 2mb_3c_2^2 + b_3^2c_1c_2 - 2b_1c_2^3\}, \\ & 3\alpha^4\beta^2 \{2bc^2a_2 - 4mbcc_1 + 3c^2b_1^2 - 2bcc_2a_3 + 16m^2cb_3 - 12mcb_1c_2 \\ & \qquad + 4bc_1^2c_2 + 4ca_3b_3^2 - 6ca_2b_3c_2 - 6cb_1b_3c_1 - 4m^2c_2^2 - 8mb_3c_1c_2 \\ & \qquad - b_3^2c_1^2 - 2a_3b_3c_2^2 + 4a_2c_2^3 + 12b_1c_1c_2^2\}, \\ & 6\alpha^4\beta\gamma \{bc(-4m^2 + 5b_1c_1 - 2a_3b_3 - 2c_2a_2) + b(2mc_1c_2 + 4a_3c_2^2 - 3b_3c_1^2) \\ & \qquad + c(2mb_1b_3 + 4a_2b_3^2 - 3c_2b_1^2) - 8m^2b_3c_2 + 10m(b_3^2c_1 + c_2^2b_1) \\ & \qquad - 2a_3c_2b_3^2 - 2a_2b_3c_2^2 - 11b_1b_3c_1c_2\}, \\ & 2\alpha^3\beta^3 \{-abc^2 - 9c^2a_2b_1 + 3bcc_1a_3 + 3acb_3c_2 - 2ac_2^3 - 2bc_1^3 - 16cm^3 \\ & \qquad + cm(18b_1c_1 + 18c_2a_2 - 24a_3b_3) + 9c(a_2b_3c_1 + a_3b_1c_2) + 12m^2c_1c_2 \\ & \qquad + 6m(a_3c_2^2 + b_3c_1^2) + 6a_3b_3c_1c_2 - 18b_1c_1^2c_2 - 18a_2c_1c_2^2\}, \\ & 6\alpha^3\beta^2\gamma \{abcc_2 + 6bcm a_3 - 4bca_2c_1 - 2acb_3^2 + ab_3c_2^2 + 2mbc_1^2 - 5bc_1c_2a_3 \\ & \qquad + 4cm^2b_1 - 10cma_2b_3 + 2cb_1a_3b_3 - 6cb_1^2c_1 + 9ca_2c_2b_1 + 8m^3c_2 \\ & \qquad - 16m^2b_3c_1 + 12ma_3b_3c_2 - 8ma_2c_2^2 - 2mb_1c_1c_2 - 4a_3b_3^2c_1 \\ & \qquad + 10b_1b_3c_1^2 + 13a_2b_3c_1c_2 - 11a_3b_1c_2^2\}, \end{aligned}$$

$$6\alpha^2\beta^2\gamma^2 \{-4abc_m + (bca_2a_3 + cab_1b_3 + abc_2c_2) - 8m(ab_3c_2 + bc_1a_3 + ca_2b_1) \\ + 5(ab_1c_2^2 + ac_1b_3^2 + bc_2a_3^2 + ba_2c_1^2 + cb_3a_2^2 + ca_3b_1^2) \\ - 8m^4 + 4m^2(b_1c_1 + c_2a_2 + a_3b_3) + 18m(\alpha_2b_3c_1 + \alpha_3b_1c_2) \\ + 4(b_1^2c_1^2 + c_2^2a_2^2 + a_3^2b_3^2) - 19(b_1c_1c_2a_2 + c_2a_2a_3b_3 + a_3b_3b_1c_1)\}.$$

The contravariant just formed is the second evectant of T ; that is to say, the equation of the reciprocal may be written

$$\left(\alpha^3 \frac{d}{da} + \beta^3 \frac{d}{db} + \gamma^3 \frac{d}{dc} + \alpha^2\beta \frac{d}{da_2} + \alpha^2\gamma \frac{d}{da_3} + \beta^2\gamma \frac{d}{db_3} \right. \\ \left. + \beta^2\alpha \frac{d}{db_1} + \gamma^2\alpha \frac{d}{dc_1} + \gamma^2\beta \frac{d}{dc_2} + \alpha\beta\gamma \frac{d}{dm}\right)^2 T = 0.$$

It has been mentioned, Art. 91, that the equation for the canonical form is

$$\alpha^6 + \beta^6 + \gamma^6 - (2 + 32m^3)(\beta^3\gamma^3 + \gamma^3\alpha^3 + \alpha^3\beta^3) \\ - 24m^2\alpha\beta\gamma(\alpha^3 + \beta^3 + \gamma^3) - (24m + 48m^4)\alpha^2\beta^2\gamma^2 = 0.$$

223. The invariants of a cubic may also be calculated by means of the differential equations which invariants must satisfy (*Higher Algebra*, Art. 143). For this purpose it is convenient to arrange the equation according to one of the variables, and to write it

$$rz^3 + 3(a_0x + a_1y)z^2 + 3(b_0x^2 + 2b_1xy + b_2y^2)z \\ + (c_0x^3 + 3c_1x^2y + 3c_2xy^2 + c_3y^3) = 0.$$

If we desire then to form an invariant of any given order and weight, the literal part may be written down without calculation. For instance, we can foresee that S is of the form

$$r(c^2b) + (c^2a^2) + (cb^2a) + (b^4),$$

where by (c^2b) we mean a function of the second degree in the c , and of the first in the b coefficients; and we know also that it must be an invariant of that order of $b_0x^2 + \&c.$, $c_0x^3 + \&c.$, considered as a binary quadratic and cubic. The theory, therefore, of binary quantics enables us to foresee the form of this term. Similarly for the others. And the invariant must further satisfy the differential equation

$$r \frac{d}{da_0} + \left(2a_0 \frac{d}{db_0} + a_1 \frac{d}{db_1}\right) + \left(3b_0 \frac{d}{dc_0} + 2b_1 \frac{d}{dc_1} + b_2 \frac{d}{dc_2}\right) = 0.$$

In this way we find S to be

$$-r(c^2b) + (c^2a^2) + (cb^2a) - (b^2)^2,$$

where $(c^2b) = (c_0c_2 - c_1^2)b_2 - (c_0c_3 - c_1c_2)b_1 + (c_1c_3 - c_2^2)b_0$

$$(c^2a^2) = (c_0c_2 - c_1^2)a_1^2 - (c_0c_3 - c_1c_2)a_1a_0 + (c_1c_3 - c_2^2)a_0^2,$$

$$(cb^2a) = a_0c_0b_2^2 - (c_0a_1 + 3c_1a_0)b_2b_1 + (a_0c_2 + a_1c_1)(2b_1^2 + b_0b_2) \\ - (a_0c_3 + 3a_1c_2)b_0b_1 + a_1c_3b_0^2;$$

$$(b^2) = b_0b_2 - b_1^2.$$

In like manner T is

$$r^2(c^4) - 6r(c^3ba) + 4(c^3a^3) + 4r(c^2b^3) - 3(c^2b^2a^2) - 12(b^2)(cb^2a) + 8(b^2)^3,$$

where $(c^4) = c_0^2c_3^2 + 4c_0c_2^3 + 4c_3c_1^3 - 3c_1^2c_2^2 - 6c_0c_1c_2c_3,$

$$(c^3ba) = a_0b_0(c_0c_3^2 + 2c_2^3 - 3c_1c_2c_3)$$

$$+ (a_1b_0 + 2a_0b_1)(2c_3c_1^2 - c_1c_2^2 - c_0c_2c_3)$$

$$+ (a_0b_2 + 2a_1b_1)(2c_0c_2^2 - c_2c_1^2 - c_0c_1c_3)$$

$$+ a_1b_2(c_3c_0^2 + 2c_1^3 - 3c_0c_1c_2),$$

$$(c^3a^3) = a_0^3(c_0c_3^2 + 2c_2^3 - 3c_1c_2c_3)$$

$$+ 3a_0^2a_1(2c_3c_1^2 - c_1c_2^2 - c_0c_2c_3)$$

$$+ 3a_0a_1^2(2c_0c_2^2 - c_2c_1^2 - c_0c_1c_3)$$

$$+ a_1^3(c_3c_0^2 + 2c_1^3 - 3c_0c_1c_2),$$

$$(c^2b^3) - 3(b^2)(c^2b) = c_0^2b_2^3 - 6c_0c_1b_1b_2^2 + 6c_0c_2b_2(2b_1^2 - b_0b_2)$$

$$+ c_0c_3(6b_0b_1b_2 - 8b_1^3) + 9c_1^2b_0b_2^2 - 18c_1c_0b_0b_1b_2$$

$$+ 6c_1c_3b_0(2b_1^2 - b_0b_2) + 9c_2^2b_0^2b_2 - 6c_2c_3b_1b_0^2 + c_3^2b_0^3;$$

$$(c^2b^2a^2) = c_0^2b_2^2a_1^2 - 2c_0c_1(b_2^2a_1a_0 + 2b_1b_2a_1^2)$$

$$- 2c_0c_2(b_0b_2a_1^2 + 2b_1^2a_1^2 - 10b_1b_2a_0a_1 + 4b_2^2a_0^2)$$

$$+ 2c_0c_3(4b_0b_1a_1^2 + 4b_1b_2a_0^2 - 6b_1^2a_0a_1 - 3b_0b_2a_0a_1)$$

$$+ c_1^2(8b_1^2a_1^2 + 9b_2^2a_0^2 - 12b_1b_2a_0a_1 + 4b_0b_2a_1^2)$$

$$+ 2c_1c_2(b_0b_2a_0a_1 + 2b_1^2a_0a_1 - 6b_1b_2a_0^2 - 6b_0b_1a_1^2)$$

$$- 2c_1c_3(b_0b_2a_0^2 + 2b_1^2a_0^2 - 10b_0b_1a_0a_1 + 4b_0^2a_1^2)$$

$$+ c_2^2(8b_1^2a_0^2 + 9b_0^2a_1^2 - 12b_1b_0a_0a_1 + 4b_0b_1a_0^2)$$

$$- 2c_2c_3(b_0^2a_0a_1 + 2b_0b_1a_0^2) + c_3^2b_0^2a_0^2,$$

or, we may write,

$$(c^2b^2a^2) = (cba)^2 + 4(c^2a^2)(b^2) - 8(c^2b)(a^2b),$$

where $(cba) = c_3a_0b_0 - c_2(a_1b_0 + 2a_0b_1) + c_1(a_0b_2 + 2a_1b_1) - c_0a_1b_2$

$$(a^2b) = b_2a_0^2 - 2b_1a_0a_1 + b_0a_1^2.$$

224. If the curve have a double point, this point may be made the origin; when we shall have r, a_0, a_1 all = 0; S reduces to $-(b^2)^2$ and T to $8(b^2)^3$; or, in the notation of Art. 217, S reduces to $-(a_2 b_3 - m^2)^2$ and T to $8(a_2 b_3 - m^2)^3$. We see then that $T^2 + 64S^3$ vanishes when the curve has a double point. This, therefore, is the discriminant, as will afterwards be proved in other ways. If the curve have a cusp (b^2) vanishes, and therefore so do both S and T . For the canonical form, the discriminant $T^2 + 64S^3 = (1 + 8m^3)^3$.

225. In the articles next following we use the canonical form. It has been proved, Art. 218, that the equation of the Hessian of $x^3 + y^3 + z^3 + 6mxyz = 0$ is of the same form with a different value of m , and hence that the system of three lines xyz passes through the intersection of the curve and its Hessian, as was otherwise shown, Art. 217. It appears also that the equation of the Hessian of the Hessian is of the same form, and hence that the points of inflexion of a cubic are inflexions also on its Hessian, as was otherwise proved, Art. 173. Any equation of the form $\alpha(x^3 + y^3 + z^3) + \beta xyz = 0$ can obviously be reduced to the form $\lambda U + \mu H = 0$. In fact we have

$$x^3 + y^3 + z^3 + 6mxyz = U, \quad -m^2(x^3 + y^3 + z^3) + (1 + 2m^3)xyz = H.$$

$$\text{Solving, } (1 + 8m^3)(x^3 + y^3 + z^3) = (1 + 2m^3)U - 6mH,$$

$$(1 + 8m^3)xyz = m^2U + H;$$

$$\text{whence } (1 + 8m^3)\lambda = \alpha(1 + 2m^3) + \beta m^2, \quad (1 + 8m^3)\mu = -6m\alpha + \beta.$$

Let us now form the equation of the Hessian of $\lambda U + 6\mu H$; that is to say, of

$$(\lambda - 6\mu m^2)(x^3 + y^3 + z^3) + 6\{\lambda m + \mu(1 + 2m^3)\}xyz = 0,$$

and the result is

$$-(\lambda - 6\mu m^2)\{\lambda m + \mu(1 + 2m^3)\}^2(x^3 + y^3 + z^3) \\ + [(\lambda - 6\mu m^2)^3 + 2\{\lambda m + \mu(1 + 2m^3)\}^3]xyz = 0;$$

and, by what has been just proved, this is of the form $\lambda'U + \mu'H = 0$, whence

$$(1 + 8m^3)\lambda' = - (1 + 2m^3)(\lambda - 6\mu m^2)\{\lambda m + \mu(1 + 2m^3)\}^2 \\ + m^2[(\lambda - 6\mu m^2)^3 + 2\{\lambda m + \mu(1 + 2m^3)\}^3],$$

$$(1 + 8m^3)\mu' = 6m(\lambda - 6\mu m^2)\{\lambda m + \mu(1 + 2m^3)\}^2 \\ + [(\lambda - 6\mu m^2)^3 + 2\{\lambda m + \mu(1 + 2m^3)\}^3].$$

Expanding, and remembering that we have

$$S = m - m^4, \quad T = 1 - 20m^3 - 8m^6,$$

these values may be written

$$\lambda' = -2S\lambda^2\mu - T\lambda\mu^2 + 8S^2\mu^3, \quad \mu' = \lambda^3 + 12S\lambda\mu^2 + 2T\mu^3.$$

The values of λ' and μ' being expressed in terms of the invariants, the expressions just given will hold good, no matter how the equation be transformed, and therefore the Hessian of $\lambda U + 6\mu H$, where U and H have the general values of Arts. 217, 218 is $\lambda' U + \mu' H$, λ' and μ' having the values just given.*

Thus when $\lambda' : \mu'$ is given, we have a cubic to determine the ratio $\lambda : \mu$; that is to say, there are, as has been already stated, three cubics which have a given cubic as their Hessian.

Since, as a particular case of the foregoing, the second Hessian

$$H(HU) = 8S^2U + 2TH,$$

it follows that $T=0$ expresses the condition that the second Hessian shall be the original curve. If $S=0$; that is to say, (Art. 220) if the equation is reducible to the sum of three cubes, the Hessian coincides with its own Hessian, and therefore consists of three right lines, as the next article will show.

226. The Hessian meets a curve in the points of inflexion; that is to say, in the places where three consecutive points of the curve are on a right line. If, then, the curve be not a proper curve, but a complex, including a right line as part of it, every point on that line is a point on the Hessian; and therefore when the curve consists of three right lines, these lines constitute the Hessian. This may be verified by forming the Hessian of $xyz=0$. Thus, then, the system of conditions that the general equation shall represent three right lines is written down by expressing that the coefficients in the equation of the Hessian (Art. 218) are proportional to the corresponding coefficients in the equation of the cubic, viz.

$$\frac{a}{a} = \frac{b}{b} = \frac{c}{c} = \frac{a_2}{a_2} = \frac{a_3}{a_3} = \frac{b_1}{b_1} = \frac{b_3}{b_3} = \frac{c_1}{c_1} = \frac{c_2}{c_2} = \frac{m}{m};$$

a system of forty-five equations, on the face of them equivalent

* This was proved by direct calculation in the first edition, and it was thus that the values of S and T were there obtained.

to nine, but which can be really equivalent only to three independent equations. For (*Conics*, Art. 78) only three conditions are necessary in order that an equation of the third degree, containing nine independent constants, should represent a system of three lines involving only six constants. It may be verified, by means of the values (Art. 218) of a , b , &c., that the forty-five equations actually are equivalent to three, as has been stated.

227. The Hessian of $\lambda U + 6\mu H$ being $\lambda' U + \mu' H$, the former will represent three right lines if $\frac{6\mu}{\lambda} = \frac{\mu'}{\lambda'}$; which, introducing the values (Art. 225) for λ' , μ' , gives us the equation

$$\lambda^4 + 24S\lambda^2\mu^2 + 8T\lambda\mu^3 - 48S^2\mu^4 = 0.$$

This being a biquadratic, we see that, as has been already more than once stated, four systems of three right lines can be drawn through the intersections of U and H . This biquadratic, solved by the ordinary methods (see Todhunter's *Theory of Equations*, Chap. XIII.), gives

$$\frac{\lambda}{\mu} = \sqrt{(t_1)} + \sqrt{(t_2)} + \sqrt{(t_3)},$$

where t_1, t_2, t_3 are the roots of the equation

$$t^3 + 12St^2 + 48S^2t - T^2 = 0, \text{ or } (t + 4S)^3 = T^2 + 64S^3.$$

Thus, then, the reduction of the equation of any non-singular cubic to the canonical form can be effected. We first form the equation of its Hessian (Art. 218), and calculate the values of the invariants S and T (Arts. 220, 221). The present article then shows how we can form an equation $\lambda U + 6\mu H = 0$, which shall be resolvable into three linear factors. By solving a cubic equation we can find these factors X, Y, Z . And then comparing the given equation with the form

$$aX^3 + bY^3 + cZ^3 + 6mXYZ = 0,$$

we can determine a, b, c, m , by equations of the first degree.

Ex. 1. Calculate the invariants of the cubic

$$ax(y^2 - z^2) + by(z^2 - x^2) + cz(x^2 - y^2) = 0.$$

228. Of the four tangents which can be drawn from any point of a cubic to the curve, two can coincide only when the

curve has a double point, since a cubic has no double tangents. The equation of the four tangents is (Art. 78) $\Delta^2 = 4\Delta'U$, where if $U = x^3 + y^3 + z^3 + 6mxyz$,

$$\Delta = 3 \{x'(x^2 + 2myz) + y'(y^2 + 2mzx) + z'(z^2 + 2mxy)\},$$

$$\Delta' = 3 \{x(x'^2 + 2my'z') + y(y'^2 + 2mz'x') + z(z'^2 + 2mx'y')\}.$$

Making $z = 0$ in $\Delta^2 = 4\Delta'U$, we get the quartic, which determines the four points in which the tangents meet the line z , viz.

$$3(x'x^2 + y'y^2 + 2mz'xy)^2 = 4(x^3 + y^3) \{x(x'^2 + 2my'z') + y(y'^2 + 2mz'x')\},$$

$$\text{or } (x'^2 + 8my'z')x^4 + 4(y'^2 - mz'x')x^3y$$

$$- 6(x'y' + 2m^2z'^2)x^2y^2 + 4(x'^2 - my'z')xy^3 + (y'^2 + 8mz'x')y^4 = 0.$$

From what has been said it appears that the discriminant of this quartic must contain as a factor the discriminant of the cubic. Now remembering that $x^3 + y^3 + z^3 + 6mx'y'z' = 0$, we find for the invariants s and t of the quartic

$$s = 12(m^4 - m)z'^4 = -12z'^4S,$$

$$t = -(1 - 20m^3 - 8m^6)z'^6 = -z'^6T.$$

Hence the discriminant of the quartic, $27t^2 - s^3$, is $27z'^2(T^2 + 64S^3)$; and it is easy thence to see that the discriminant of the cubic is $T^2 + 64S^3$.

229. The anharmonic function of the four points determined by the quartic of the last article evidently is the same as the anharmonic function of the pencil of four tangents. Now if the roots be $\alpha, \beta, \gamma, \delta$, the anharmonic function of these roots is any one of the mutual ratios of the quantities $(\alpha - \beta)(\gamma - \delta)$, $(\alpha - \gamma)(\beta - \delta)$, $(\alpha - \delta)(\beta - \gamma)$. We can form by the method of symmetric functions the equation which determines these quantities; and if the coefficients of the quartic be $a, 4b, 6c, 4d, e$, we find $a^3y^3 - 12asy + 16\sqrt{(s^3 - 27t^2)} = 0$. The mutual ratios of the roots are not altered if we increase them all in the same proportion, by substituting, say $ay = 2zs^{\frac{1}{2}}$, when we see that the anharmonic ratios are the mutual ratios of the roots of

$$z^3 - 3z + 2\sqrt{\left(1 - \frac{27t^2}{s^3}\right)} = 0, \text{ or } z^3 - 3z + 2\sqrt{\left(1 + \frac{T^2}{64S^3}\right)} = 0.$$

Thus, then, the anharmonic function depends solely on the ratio $T^2 : S^3$, and is independent of the point whence the tangents

are drawn (Art. 167). If $T=0$, the equation just given reduces to $z^3 - 3z + 2 = 0$, of which two roots are equal; one, therefore, of the ratios becomes unity, and the anharmonic becomes an ordinary harmonic ratio. If $S=0$, the equation in y wants its second term and becomes of the form $y^3 = m^3$, whose roots are of the form $m, m\omega, m\omega^2$, where ω is an imaginary cube root of unity; and the common ratio of the roots is ω . This has been called equi-anharmonic section.

230. By the help of the canonical form can be calculated, as in Art. 225, the invariants S and T of $\lambda U + 6\mu H$, or of

$$(\lambda - 6\mu m^2)(x^3 + y^3 + z^3) + 6\{m\lambda + \mu(1 + 2m^3)\}xyz,$$

and we find, without difficulty,

$$S(\lambda U + 6\mu H) = S\lambda^4 + T\lambda^3\mu - 24S^2\lambda^2\mu^2 - 4ST\lambda\mu^3 - (T^2 + 48S^3)\mu^4,$$

$$T(\lambda U + 6\mu H) = T\lambda^6 - 96S^2\lambda^5\mu - 60ST\lambda^4\mu^2 - 20T^2\lambda^3\mu^3$$

$$+ 240S^2T\lambda^2\mu^4 - 48(ST^2 + 96S^4)\lambda\mu^5 - 8(72S^6T + T^3)\mu^6.$$

And if, by the help of these, we form the discriminant R or $T^2 + 64S^3$, we find

$$R(\lambda U + 6\mu H) = R(\lambda^4 + 24S\lambda^2\mu^2 + 8T\lambda\mu^3 - 48S^2\mu^4),$$

where the factor multiplying R is the cube of the quartic function of λ, μ , in Art 227; as might have been foreseen, since if the cubic U have not a double point, the only cubics with double points which can be drawn through the points of inflexion are the four systems of right lines. The values just given for the S and T of $\lambda U + 6\mu H$ are covariants of this quartic function of λ, μ ; differing only by the numerical factors 4 and 2 respectively from the Hessian, and the covariant called J , (*Higher Algebra*, Art. 209); and the coefficients of U and H in the value of $H(\lambda U + 6\mu H)$ differ only by numerical factors from the differentials of the same quartic with respect to λ and μ .

All covariant cubics can be expressed in the form $\lambda U + \mu H$, as is illustrated by the following examples:

Ex. 1. If a, b, c , &c. denote the second differential coefficients, and A, B , &c. denote $bc - f^2$, &c., as Art. 184, and if a', U, A', B' , &c. denote the corresponding quantities for the Hessian then

$$Aa' + Bb' + Cc' + 2Ff' + 2Gg' + 2Hh' = 0$$

is a covariant cubic. We use the values

$$a = x, f = mx; A = yz - m^2x^2, F = m^2yz - mx^2,$$

$$b = y, g = my; B = zx - m^2y^2, G = m^2zx - my^2,$$

$$c = z, h = mz; C = xy - m^2z^2, H = m^2xy - mz^2,$$

$$a' = -6m^2x, f' = (1 + 2m^3)x; A' = 36m^4yz - (1 + 2m^3)^2x^2, F' = (1 + 2m^3)^2yz + 6m^2(1 + 2m^3)x^2,$$

$$b' = -6m^2y, g' = (1 + 2m^3)y; B' = 36m^4zx - (1 + 2m^3)^2y^2, G' = (1 + 2m^3)^2zx + 6m^2(1 + 2m^3)y^2,$$

$$c' = -6m^2z, h' = (1 + 2m^3)z; C' = 36m^4xy - (1 + 2m^3)^2z^2, H' = (1 + 2m^3)^2xy + 6m^2(1 + 2m^3)z^2.$$

Hence the covariant in question is found to be $-2SU$. It might have been foreseen that it could only differ by a numerical factor from SU , for it is a covariant of the fifth degree in the coefficients; and, therefore, if it be of the form $aU + bH$, a must be of the fourth, and b of the second degree in the coefficients; but there is no invariant of the second degree, and S is the only one of the fourth.

Ex. 2. Calculate in like manner the covariant

$$A'a + B'b + C'c + 2F'f + 2G'g + 2H'h. \quad \text{Ans.} - TU + 12SH.$$

231. The order in the variables of any covariant of a cubic is a multiple of three; and, generally, if the order of any ternary quantic is a multiple of three, so is that of every covariant. This appears at once from the symbolical method explained, *Higher Algebra*, Chap. XIV., for every symbol (123) diminishes by three the order of the function on which it operates, and in the symbolical method the order of the function operated on is a multiple of that of the given quantic.

It is easy to see that the equation of every cubic covariant to $x^3 + y^3 + z^3 + 6mxyz = 0$ is of the form $\alpha(x^3 + y^3 + z^3) + \beta xyz = 0$, which, as we have seen, is reducible to the form $\lambda U + \mu H = 0$. In order, however, to express covariants of higher order, it is necessary to have a third fundamental covariant. That which we select may be defined as follows: consider the polar conic of a point $ax^2 + \&c.$, and the polar conic of the same point with regard to the Hessian $a'x^2 + \&c.$, then there is (*Conics*, Art. 378) a conic covariant to these two, viz.

$$(BC' + B'C - 2FF')x^2 + \&c. = 0;$$

and the condition that this conic passes through the original point gives a covariant of the cubic. Since $B, C, \&c.$ contain the variables each in the second degree, this covariant is of the sixth degree in these variables; and since B, C are of the second, and B', C' of the sixth degree in the coefficients, it is of the eighth order in the coefficients. The actual value of this covariant for the general equation has not been calculated, but

using the values for A , B , &c. given in the last article, we find that for the canonical form the covariant is 4Θ where Θ is

$$3m^3(1+2m^3)(x^3+y^3+z^3)^2 - m(1-20m^3-8m^6)(x^3+y^3+z^3)xyz \\ - 3m^2(1-20m^3-8m^6)x^2y^2z^2 - (1+8m^3)^2(y^3z^3+z^3x^3+x^3y^3), \\ \text{or } m^3(2+m^3)U^2 - m(1+2m^3)UH \\ + 3m^2H^2 - (1+8m^3)^2(y^3z^3+z^3x^3+x^3y^3).$$

There are two other covariants of the same order in the variables and in the coefficients as Θ , which had equal claims to be selected as the fundamental covariant of the sixth order. The first represents the locus of a point whose polar line with regard to the Hessian touches the polar conic of the same point with regard to the cubic, or

$$AL'^2 + BM'^2 + CN'^2 + 2FM'N' + 2GN'L' + 2HL'M',$$

where L' , M' , N' , are the differential coefficients of the Hessian. This covariant is expressed at once in terms of Θ by the help of the formula (*Conics*, Art. 381, Ex. 1) $\Theta S' - F$. We are here to write for Θ , $-2SU$; for S' , $6H$; for F , 4Θ ; and thus the covariant is found to be $-4(\Theta + 3SUH)$. In like manner there is a covariant which represents the locus of a point, whose polar with respect to the cubic touches the polar conic of the same point with regard to the Hessian, or

$$A'L^2 + B'M^2 + C'N^2 + 2F'MN + 2G'NL + 2H'LM = 0.$$

Calculating this by the formula $\Theta'S - F$ (*Conics*, Art. 381), and writing for Θ' , $-TU + 12SH$; for S , U ; and for F , 4Θ , the covariant in question becomes

$$-(TU^2 - 12SUH + 4\Theta).$$

232. Every covariant of $x^3 + y^3 + z^3 + 6mxyz$ will plainly be a symmetric function of x , y , z , and therefore capable of being expressed in terms of $x^3 + y^3 + z^3$, xyz , $y^3z^3 + z^3x^3 + x^3y^3$; and therefore in terms of U , H , Θ , together with the invariants. But a covariant is not necessarily a rational function of U , H , Θ . In fact, we can, as at *Higher Algebra*, Art. 223, form a covariant of which the square, but not the covariant itself,

is a rational function of these quantities. Let the coefficients of the cubic

$$\rho^3 - (1 + 8m^3)(x^3 + y^3 + z^3)\rho^2 + (1 + 8m^3)^2(y^3z^3 + z^3x^3 + x^3y^3)\rho - (1 + 8m^3)^3x^3y^3z^3 = 0,$$

be p, q, r ; then, by the theory of cubic equations, if J be $(1 + 8m^3)^3(y^3 - z^3)(z^3 - x^3)(x^3 - y^3)$, we have

$$J^2 = p^2q^2 + 18pqr - 27r^2 - 4q^3 - 4rp^3.$$

But p, q, r are each immediately expressible in terms of U, H, Θ , and substituting their values in the equation just written, it becomes

$$\begin{aligned} J^2 &= 4\Theta^3 + TU^2\Theta^2 \\ &+ \Theta(-4S^3U^4 + 2STU^3H - 72S^2U^2H^2 - 18TUH^3 + 108SH^4) \\ &- 16S^4U^5H - 11S^2TU^4H^2 - 4T^2U^3H^3 + 54STU^2H^4 \\ &- 432S^2UH^5 - 27TH^6. \end{aligned}$$

The identity just given may be written in the form

$$4\Theta(\Theta + \lambda U^2)(\Theta + \mu U^2) \equiv J^2 + H\Phi,$$

from which it appears that the system $\Theta(\Theta + \lambda U^2)(\Theta + \mu U^2)$ is touched by H ; that is to say, H either touches each of the curves represented by the three factors, or passes through the intersections of every two. But Θ, U and H have no point common to all three, therefore Θ must be touched by H . The curve J which passes through the points of contact consists of the harmonic polars of the nine points of inflexion. We add an example or two to illustrate the possibility of expressing all other covariants in terms of U, H, Θ .

Ex. 1. To obtain the equation of the nine inflexional tangents. It was shewn (Art. 217) that the inflexional tangents are $U - (1 + 8m^3)x^3, U - (1 + 8m^3)y^3, U - (1 + 8m^3)z^3$. Multiplying together these three factors, we have

$$U^3 - (1 + 8m^3)(x^3 + y^3 + z^3)U^2 + (1 + 8m^3)^2(y^3z^3 + z^3x^3 + x^3y^3)U - (1 + 8m^3)^3x^3y^3z^3 = 0.$$

Substituting for $(1 + 8m^3)(x^3 + y^3 + z^3), (1 + 8m^3)^2(y^3z^3 + z^3x^3 + x^3y^3)$ and $(1 + 8m^3)x^3y^3z^3$ their values previously given, we find, for the required equation of the nine tangents,

$$5SU^2H - H^3 - U\Theta = 0,$$

the form of the equation showing that H and Θ , which have been proved to touch each other, have the nine tangents for their common tangents.

Ex. 2. To find the equation of the Cayleyan in point coordinates. We have to form the reciprocal of the tangential equation of the Cayleyan, viz. (Art. 219)

$$m(\alpha^3 + \beta^3 + \gamma^3) + (1 - 4m^3)\alpha\beta\gamma = 0.$$

The reciprocal of this is formed by Art. 222, and the quantities $x^3 + y^3 + z^3$, &c. then expressed in terms of U, H, Θ . The resulting equation of the Cayleyan is

$$4S\Theta - TH^2 - 16S^2UH = 0.$$

233. In like manner every contravariant of the cubic can be expressed in terms of three fundamental contravariants; and for these three we may employ the three already mentioned, viz. the evectants of S and T (Arts. 219, 221), which we have called P and Q , in terms of which every contravariant cubic can be expressed, and the reciprocal F (Art. 222). We can, as in Art. 230, form the invariants of $\lambda P + \mu Q$, which for the canonical form is

$\{m\lambda + (1 - 10m^3)\mu\}(\alpha^3 + \beta^3 + \gamma^3) + \{(1 - 4m^3)\lambda - 6m^2\mu(5 + 4m^3)\}\alpha\beta\gamma$,
and we find

$$\begin{aligned} S(\lambda P + \mu Q) &= (192S^3 - T^2)\lambda^4 + 768S^2T\lambda^3\mu \\ &\quad + 216(3ST^2 - 64S^4)\lambda^2\mu^2 + 216(T^3 - 64TS^3)\lambda\mu^3 \\ &\quad - 1296(5S^2T^2 + 64S^5)\mu^4, \end{aligned}$$

$$\begin{aligned} T(\lambda P + \mu Q) &= (T^3 + 576S^3T)\lambda^5 + 288(5S^2T^2 - 192S^5)\lambda^5\mu \\ &\quad + 540(3ST^3 - 320S^4T)\lambda^4\mu^2 + 540(T^4 - 448S^3T^2)\lambda^3\mu^3 \\ &\quad - 19440(7S^2T^3 - 64S^5T)\lambda^2\mu^4 \\ &\quad - 11664(3ST^4 - 32S^4T^2 + 2048S^7)\lambda\mu^5 \\ &\quad - 5832(T^5 + 40S^3T^3 + 2560S^6T)\mu^6, \end{aligned}$$

$$\begin{aligned} R(\lambda P + \mu Q) &= \{S\lambda^4 + T\lambda^3\mu + 72S^2\lambda^2\mu^2 + 108ST\lambda\mu^3 \\ &\quad + 27(T^2 - 16S^3)\mu^4\}^3 R^2, \end{aligned}$$

and, as in Art. 230, the quartic and sextic functions of λ, μ which occur in the values of S and T are the covariants of the quartic function whose cube occurs in the value of R .

Again, $H(\lambda P + \mu Q)$

$$\begin{aligned} &= \{T\lambda^3 + 144S^2\lambda^2\mu + 324ST\lambda\mu^2 + 108(T^2 - 16S^3)\mu^3\} P \\ &\quad - \{4S\lambda^3 + 3T\lambda^2\mu + 144S^2\lambda^2\mu + 108ST\mu^3\} Q, \end{aligned}$$

the quantities multiplying P and Q respectively being the differentials with respect to μ and λ of the same quartic function.

234. In like manner we can form the P and Q of $\lambda U + 6\mu H$, and we find

$$\begin{aligned} P(\lambda U + 6\mu H) &= P\lambda^3 + Q\lambda^2\mu - 12SP\lambda\mu^2 + 4(SQ - TP)\mu^3, \\ Q(\lambda U + 6\mu H) &= Q\lambda^5 + 60SP\lambda^4\mu - 30TP\lambda^3\mu^2 - 10TQ\lambda^2\mu^3 \\ &\quad + 120(2S^2Q - STP)\lambda\mu^4 + 24\{STQ - (T^2 + 24S^3)P\}\mu^5. \end{aligned}$$

Now if we denote by s and t the S and T of $\lambda U + 6\mu H$, as given Art. 230, these values differ only by the factors $3(T^2 + 64S^3)$ and $(T^2 + 64S^3)$ respectively from

$$(48S^2P + TQ) \frac{ds}{d\lambda} + (3TP - 4SQ) \frac{ds}{d\mu},$$

$$(48S^2P + TQ) \frac{dt}{d\lambda} + (3TP - 4SQ) \frac{dt}{d\mu}.$$

So again, forming the P and Q of $\lambda P + \mu Q$, the results are

$$P(\lambda P + \mu Q) = \lambda^3(8S^2U - TH) + 18\lambda^2\mu(STU + 8S^2H)$$

$$+ 9\lambda\mu^2\{(T^2 - 32S^3)U + 12STH\} - 54\mu^3\{4S^2TU - (T^2 + 32S^3)H\},$$

$$Q(\lambda P + \mu Q) = \lambda^5\{16S^2TU + (T^2 + 192S^3)H\}$$

$$+ 30\lambda^4\mu\{S(T^2 - 64S^3)U + 16S^2TH\}$$

$$+ 15\lambda^3\mu^2\{T(T^2 - 320S^3)U + 48ST^2H\}$$

$$- 270\lambda^2\mu^3\{16S^2T^2U - T(T^2 - 64S^3)H\}$$

$$- 1620\lambda\mu^4\{ST^3U + 4S^2(T^2 - 64S^3)H\}$$

$$- 324\mu^5\{(T^4 + 24T^3S^3 + 512S^6)U - 6ST(T^2 + 128S^3)H\},$$

and if we now write s and t for the S and T of $\lambda P + \mu Q$, as given Art. 233, these values differ only by factors from

$$(48S^2U + 18TH) \frac{ds}{d\lambda} + (TU - 24SH) \frac{ds}{d\mu},$$

and $(48S^2U + 18TH) \frac{dt}{d\lambda} + (TU - 24SH) \frac{dt}{d\mu}.$

To these formulæ may be added the reciprocal of $\lambda U + 6\mu H$, which is

$$(\lambda^4 + 24S\lambda^2\mu^2 + 8T\lambda\mu^3 - 48S^2\mu^4)F - 24\mu(\lambda^3 + 2T\mu^3)P^2$$

$$- 24\mu^2(\lambda^2 - 4S\mu^2)PQ - 8\lambda\mu^3Q^2,$$

and of $\lambda P + \mu Q$, which is

$$4\{S\lambda^4 + T\lambda^3\mu + 72S^2\lambda^2\mu^2 + 108ST\lambda\mu^3 + 27(T^2 - 16S^3)\mu^4\} \ominus$$

$$- \{T\lambda^4 + 216ST\lambda^2\mu^2 + 108(T^2 - 64S^3)\lambda\mu^3 - 3888TS^2\mu^4\} H^2$$

$$- \{16S^2\lambda^4 + 32ST\lambda^3\mu + 18T^2\lambda^2\mu^2 + 216S(T^2 + 32S^3)\mu^4\} UH$$

$$+ \{64S^3\lambda^3\mu + 144S^2T\lambda^2\mu^2 + 108ST^2\lambda\mu^3 + 27T(T^2 + 16S^3)\mu^4\} U^2.$$

235. We next mention a useful identical equation. If in a

cubic U we substitute $x + \lambda x'$, $y + \lambda y'$, $z + \lambda z'$ for x , y , z , let the result be written

$$U + 3\lambda S + 3\lambda^2 P + \lambda^3 U';$$

that is to say, let S and P denote the polar conic and polar line of $x'y'z'$ with respect to U ; or, for the canonical form, let

$$S = (x^2 + 2myz) x' + (y^2 + 2mzx) y' + (z^2 + 2mxy) z',$$

$$P = (x'^2 + 2my'z') x + (y'^2 + 2mz'x') y + (z'^2 + 2m x'y') z.$$

Similarly, let the result of a similar substitution in H be written

$$H + 3\lambda \Sigma + 3\lambda^2 \Pi + \lambda^3 H',$$

that is to say, let Σ and Π denote the polar conic and polar line of $x'y'z'$ with regard to the Hessian; then, by the help of the canonical form, we can verify the following identical equation

$$3(S\Pi - \Sigma P) = H'U - HU'.$$

It follows hence, that when $x'y'z'$ is on the curve, and therefore $U' = 0$, the equation $U = 0$ may be written in the form

$$S\Pi - \Sigma P = 0.$$

From this form the following consequences immediately follow:

(a) The lines P , Π intersect on the cubic; that is to say, the *tangential* of the point $x'y'z'$, or the point where the tangent P meets the cubic again, is the intersection of P with Π , the polar of $x'y'z'$ with respect to the Hessian (see Art. 183).

(b) The points of contact of tangents from $x'y'z'$ to the cubic, which are known to be the intersections of S with U , are also the intersections of S with Σ , the polar conic of $x'y'z'$ with respect to the Hessian.

(c) The equation $S\Pi - \Sigma P = 0$ is that which would be obtained by eliminating an indeterminate θ between $S + \theta\Sigma = 0$, $P + \theta\Pi = 0$. The first denotes a conic through the intersections of S , Σ ; the second denotes the polar of $x'y'z'$ with regard to the same conic. Hence the given cubic may be generated as the locus of the points of contact of tangents from a point $x'y'z'$ to a system of conics passing through four fixed points.

(d) If $S + \theta\Sigma$ denote two right lines, $P + \theta\Pi$ obviously passes through the intersection of these lines; this intersection

is therefore a point on the cubic, and $P + \theta\Pi$ the tangent at it. Hence the four points of contact of tangents to the cubic from $x'y'z'$ form a quadrangle, the three centres of which are on the cubic, and are the points *cotangential* with $x'y'z'$ (see Art. 150).

(e) If we consider the intersections of the curve and its Hessian by any line, for instance, $z = 0$, the identity of this article gives us

$$ab - ba = 3(a_2b_1 - b_1a_2),$$

that is to say, the invariant P of the two binary cubics vanishes. Hence, again appears that the Hessian meets the curve in its inflexions. For since $P = 0$, the eliminant of the two binaries is $Q = 0$ (*Higher Algebra*, Art. 200); therefore at points of intersection $u + \lambda v$ includes a perfect cube.

236. I have used this identical equation (*Phil. Trans.*, 1858, p. 535) to form the equation of the conic through five consecutive points on the cubic. Since S touches the cubic, and P is the common tangent, the general equation of a conic touching U at $x'y'z'$ is $S - LP = 0$, where $L = \alpha x + \beta y + \gamma z$ is an arbitrary right line. Now by means of the identity established, the equation of the cubic may be written in the form

$$\Pi(S - LP) = P(\Sigma - L\Pi).$$

Hence, the four points where $S - LP$ meets the cubic again are its intersections with $\Sigma - L\Pi$; and if the latter conic pass through $x'y'z'$, the former will pass through three consecutive points on the cubic. But on substituting $x'y'z'$ for xyz , we have $\Sigma' = \Pi' = H'$, and the condition that $\Sigma - L\Pi$ should pass through $x'y'z'$ is $L' = 1$.

Next, in order that $S - LP$ may pass through four consecutive points, $\Sigma - L\Pi$ must have P for a tangent at the point $x'y'z'$. Now the tangent to $\Sigma - L\Pi$ (being the polar of $x'y'z'$ with respect to this function) is

$$2\Pi - L'\Pi - L\Pi',$$

or (since $L' = 1$, and $\Pi' = H'$) is $\Pi - H'L$, and since this is to be proportional to P , we have $L = \theta P + \frac{1}{H'} \Pi$.

The general equation, therefore, of a conic through four consecutive points is

$$S - \theta P^2 - \frac{1}{H'} P\Pi = 0,$$

and
$$\Sigma - \theta P\Pi - \frac{1}{H'} \Pi^2 = 0$$

passes through the two points where the former conic meets the cubic again, the equation of the cubic being reducible to the form

$$\Pi \left(S - \theta P^2 - \frac{1}{H'} P\Pi \right) = P \left(\Sigma - \theta P\Pi - \frac{1}{H'} \Pi^2 \right).$$

237. Since these two conics have P for a common tangent, it will be possible, by adding the equations multiplied by suitable constants, to obtain a result divisible by P , and the quotient will represent the line joining the points where the conic meets the cubic again. It is necessary then to determine μ , so that $\mu S + \Sigma - \frac{1}{H'} \Pi^2$ may be divisible by P , which we do by equating to nothing the discriminant of this quantity. Now this discriminant when calculated will be found to be $\mu^3 H' + 4\mu^2 \frac{\Theta'}{H'}$. This quantity, therefore, will be divisible into factors if $\mu = -\frac{4\Theta'}{H'^2}$, and since one of the factors is P , if we denote the other by M , we have

$$\mu S + \Sigma - \frac{1}{H'} \Pi^2 = MP.$$

By the help of this equation, the equation of the cubic given at the end of the last article is transformed to

$$(\Pi + \mu P) \left(S - \theta P^2 - \frac{1}{H'} P\Pi \right) = P^2 \left\{ M - \frac{\mu}{H'} \Pi - \theta (\Pi + \mu P) \right\}.$$

The form of the equation shews that $\Pi + \mu P$ is the tangent at the tangential of the given point on the cubic, and that $M - \frac{\mu}{H'} \Pi$ passes through the second tangential of the given point (see Art. 155).

238. In order that the conic may pass through five consecutive points, the coordinates x', y', z' must satisfy the equation

$$M - \frac{\mu}{H'} \Pi - \theta (\Pi + \mu P) = 0.$$

The only difficulty is to determine the result of substituting the coordinates x', y', z' in M . Now if we differentiate with regard to x, y , or z , the equation

$$\mu S + \Sigma - \frac{1}{H'} \Pi^2 = MP,$$

and substitute x', y', z' for x, y, z in the result, observing that $\frac{dS'}{dx'} = 2 \frac{dP'}{dx'}$, $\frac{d\Sigma'}{dx'} = 2 \frac{d\Pi'}{dx'}$, we have $M' = 2\mu$, and hence the result of substituting $x'y'z'$ for xyz in

$$M - \frac{\mu}{H'} \Pi - \theta (\Pi + \mu P) = 0$$

is $\mu - \theta H' = 0$, and since μ has been found to be $-\frac{4\Theta'}{H'^2}$, we have $\theta = -\frac{4\Theta'}{H'^3}$, and the problem is completely solved.

239. We next mention another general form to which the equation of a cubic may be brought, viz.

$$ax^3 + by^3 + cz^3 + du^3 = 0, \text{ where } x + y + z + u = 0.$$

The polar conic of any point $x'y'z'u'$ being

$$ax^2x' + by^2y' + cz^2z' + du^2u' = 0,$$

the polar conic of the point for which $x' = 0, y' = 0$, is a pair of lines passing through the point $u = 0, z = 0$, &c.; and hence it appears that the points xy, zu ; xz, yu ; xu, yz are pairs of corresponding points on the Hessian. The form just written contains implicitly eleven constants, and is one to which the general equation of a cubic may be reduced in an infinity of ways. The values of the invariants for this form are $S = -abcd$, $T = b^2c^2d^2 + c^2d^2a^2 + d^2a^2b^2 + a^2b^2c^2 - 2abcd(ab + ac + ad + bc + cd + db)$. The discriminant is formed from the three equations got by differentiating with respect to x, y, z respectively, viz.

$$ax^2 = du^2, \quad by^2 = du^2, \quad cz^2 = du^2,$$

whence we have x, y, z, u respectively proportional to the reciprocals of $\sqrt{(a)}, \sqrt{(b)}, \sqrt{(c)}, \sqrt{(d)}$. Substituting these values in $x + y + z + u = 0$, we have the discriminant in the form

$$\sqrt{(bcd)} + \sqrt{(cda)} + \sqrt{(dab)} + \sqrt{(abc)} = 0,$$

which cleared of radicals is, as before, $R = T^2 + 64S^3 = 0$.*

240. We conclude this chapter with a few remarks on the case where the cubic breaks up into a conic and a right line. If a curve have either two double points, or a cusp, not only does its discriminant vanish, but also the functions obtained by differentiating, with respect to any of the coefficients of the original equation, the general expression for the discriminant in terms of these coefficients. See *Higher Algebra*, Arts. 103, 113. Now the expression for the discriminant of a cubic being of the form $T^2 + 64S^3 = 0$, its differentials are of the form

$$2T \frac{dT}{da} + 192S^2 \frac{dS}{da}, \quad 2T \frac{dT}{db} + 192S^2 \frac{dT}{db}, \quad \&c.$$

If the curve have a cusp, we have $S = 0, T = 0$ (Art. 224), and all these differentials vanish in conformity with the theory. If the curve have two double points, that is to say, if the cubic break up into a conic and right line, we have the equality of ratios

$$\frac{dT}{da} : \frac{dS}{da} = \frac{dT}{db} : \frac{dS}{db} = \frac{dT}{dc} : \frac{dS}{dc}, \quad \&c.$$

These equations if written at length would form a system of equations, each of the eighth order in the coefficients, which are the system of conditions that the general equation of the third degree should be resolvable into factors.

241. There is another form in which the foregoing conditions may be written. In the first place we remark, that since a double point on a curve is also a double point on its Hessian, the coordinates of such a point satisfy the equations got by differentiating with respect to x, y, z , the equations both of the

* For the other covariants and contravariants when the equation is written in this form, see *Phil. Trans.* 1860, p. 252; and for some remarks on the method of forming invariants, &c., when the equation has been written with an additional variable connected by a linear relation with the original variables, see *Geometry of Three Dimensions*, Art. 538.

curve and of the Hessian. In the case of the cubic, these six differential equations are all of the second degree, and we can linearly eliminate from them the six quantities $x^2, y^2, z^2, yz, zx, xy$, so as to obtain the discriminant in the form of the determinant

$$\begin{vmatrix} \alpha, & b_1, & c_1, & m, & a_3, & a_2 \\ \alpha_2, & b, & c_2, & b_3, & m, & b_1 \\ \alpha_3, & b_3, & c, & c_2, & c_1, & m \\ a, & b_1, & c_1, & m, & a_3, & a_2 \\ a_2, & b, & c_2, & b_3, & m, & b_1 \\ a_3, & b_3, & c, & c_2, & c_1, & m \end{vmatrix} = 0.$$

We have seen also (Art. 226) that the conditions that the curve should have three double points are expressed by taking any of the first three rows, and the corresponding one of the second three rows, and then equating to zero the determinant formed with any two columns from these rows. So now in like manner the conditions that the curve should have two double points are expressed by taking any two of the first three rows, and the two corresponding rows of the second set, and equating to zero the determinant formed with any four columns from these rows. In order to prove this it is enough to observe that, as we shall show in the next article, if $U = PV$, where V represents a conic, and P is $\alpha x + \beta y + \gamma z$, then the Hessian of U is of the form $\lambda U + \mu P^2$. Consequently we have

$$\frac{dH}{dx} = \lambda \frac{dU}{dx} + 3\mu\alpha P^2, \quad \frac{dH}{dy} = \lambda \frac{dU}{dy} + 3\mu\beta P^2,$$

whence
$$\beta \frac{dH}{dx} - \alpha \frac{dH}{dy} - \beta\lambda \frac{dU}{dx} + \alpha\lambda \frac{dU}{dy} = 0,$$

showing that the differentials of H and U , with respect to x and y , are connected by a linear identical relation, and therefore that the determinant formed with the coefficients of four corresponding terms in these equations vanishes.

242. The Hessian of PU , where P denotes the right line $\alpha x + \beta y + \gamma z$, and U is a function of any degree, may be found in various ways. The second differential coefficients of PU are

$Pa + 2\alpha L$, $Pb + 2\beta M$, $Pc + 2\gamma N$, $Pf + \beta N + \gamma M$, $Pg + \gamma L + \alpha N$, $Ph + \alpha M + \beta L$, where L , M , N , as before, denote the first, and α , β , &c. the second differential coefficients of U . Using these values in forming the equation of the Hessian, and reducing by means of the equations of homogeneous functions

$$(n-1)L = ax + hy + gz, \text{ \&c.},$$

we get, for the Hessian of PU ,

$$\frac{n^2}{(n-1)^2} P^3 H - \frac{n}{n-1} FPU,$$

where F denotes the quantity $(bc - f^2)\alpha^2 + \text{\&c.}$, Art. 184, which geometrically represents the locus of points whose polar conics touch the given line.

More generally the Hessian of UV is found by the same process to be

$$\frac{(n+n'-1)^2}{(n'-1)^2} U^3 H' + \frac{(n+n'-1)^2}{(n-1)^2} V^3 H \\ - \frac{(n+n'-1)}{(n-1)(n'-1)} (UV^2\Theta + U^2V\Theta') + \frac{(n+n'-1)(n+n'-2)}{(n-1)(n'-1)} UVW,$$

where Θ , Θ' , as at *Conics*, Art. 370, denote $(bc - f^2)\alpha' + \text{\&c.}$, $(b'c' - f'^2)\alpha + \text{\&c.}$, and W denotes the covariant

$$(bc' + b'c - 2ff')LL' + \text{\&c.}$$

The form just written shews that the intersections of U , V are double points on the Hessian, the tangents at any such point being the tangents to U and V respectively.*

* On the general theory of ternary cubic forms, see Aronhold's *Memoirs*, *Crelle*, vol. XXXIX., p. 140, 1850, and vol. LV., p. 97, 1858; Professor Cayley's "Third and Seventh *Memoirs* on Quantics," in the *Philosophical Transactions*, 1856 and 1861, and Clebsch and Gordan's *Memoirs* in the *Mathematische Annalen*, vol. I., p. 56, 1869, and vol. VI., p. 436, 1873; also Gundelfinger, vol. IV., p. 144, 1871.

CHAPTER VI.

CURVES OF THE FOURTH ORDER.

243. It will be remembered that we have classified curves of the third order by combining a division founded on characteristics unaltered by projection, with a division founded on the nature of their infinite branches. The same principles of classification are applicable to curves of the fourth order, or, as we shall call them, *quartics*; but the number of species is so great, and the labour of discussing their figures so enormous, that it seems useless to undertake the task of an enumeration. It will be sufficient here generally to direct attention to the principal points that must be taken into account in a complete enumeration. A quartic may be non-singular having no multiple point; or it may have one, two, or three double points, any or all of which may be cusps. In this way we have ten genera, of which the Plückerian characteristics and the deficiency (Arts. 44, 82) are

	m	δ	κ	n	τ	ι	D
I.	4	0	0	12	28	24	3
II.	4	1	0	10	16	18	2
III.	4	0	1	9	10	16	2
IV.	4	2	0	8	8	12	1
V.	4	1	1	7	4	10	1
VI.	4	0	2	6	1	8	1
VII.	4	3	0	6	4	6	0
VIII.	4	2	1	5	2	4	0
IX.	4	1	2	4	1	2	0
X.	4	0	3	3	1	0	0

viz. in each of the last four cases the curve is unicursal.

Every quartic curve whatever may be considered as coming under one or other of these genera. But there are special forms,

arising from the coincidence of nodes and cusps, which have to be considered.

1°. Two nodes may coincide, giving rise to the singularity called a *tacnode*; this is, in fact, an ordinary (two-pointic) contact of two branches of the curve (see p. 23). It is to be noticed that the common tangent counts twice as a double tangent of the curve; thus, supposing that there is not (besides the tacnode) any node or cusp, the curve belongs to the genus IV., and its characteristics are as stated above; but $\delta=2$ means the tacnode, and $\tau=8$ means that the double tangents are the tangent at the tacnode counting twice, and 6 other double tangents.

2°. A node and cusp may coincide, giving rise to the singularity on that account called node cusp, and called ramphoid-cusp, Art. 58. It is to be noticed that the tangent counts once as a double tangent, and once as a stationary tangent; thus, supposing that there is not any other node or cusp, the curve belongs to the genus V., and the characteristics are as above; but $\delta=1$, $\kappa=1$ means the node-cusp; $\tau=4$ means the tangent at the cusp and 3 other double tangents; $\iota=10$ the tangent at the cusp and 9 other stationary tangents.

3°. Three nodes may coincide as consecutive points of a curve of finite curvature, giving rise, not to a triple point, but to the singularity called an *oscnode*; this is, in fact, an osculation or three-pointic contact of two branches of the curve. The tangent at the oscnode counts 3 times as a double tangent of the curve; the genus is VII., and the characteristics are as above, but $\delta=3$ means here the oscnode; and $\tau=4$ means the tangent at the oscnode counting 3 times, and 1 other double tangent.

4°. Two nodes and a cusp, or a tacnode and a cusp, may coincide as consecutive points of a curve of finite curvature giving rise, not to a triple point, but to the singularity called a tacnode-cusp; this is, in fact, an osculation or four-pointic intersection of the two quasi-branches at a cusp. The genus is VIII., and the characteristics are as above, $\delta=2$, $\kappa=1$ meaning the cusp; $\tau=2$ the tangent at the cusp counting twice as a double tangent; $\iota=4$ the tangent at the cusp, counting

once as a stationary tangent, and three other stationary tangents.

5°. Three nodes may coincide, as vertices of an infinitesimal triangle, giving rise to a triple point (ordinary triple point with three distinct tangents). The curve belongs to the genus VII., and the characteristics are as above, $\delta=3$ meaning the triple point.

6°. Two nodes and a cusp may coincide, giving rise to a special triple point, at which an ordinary branch of the curve passes through a cusp. The curve belongs to the genus VIII., and the characteristics are as above, $\delta=2, \kappa=1$ here meaning the special triple point.

7°. A node and two cusps may coincide, giving rise to a special triple point not visibly different from an ordinary point of the curve. The curve belongs to the genus IX., and the characteristics are as above, $\delta=1, \kappa=2$, here meaning the special triple point.

244. In order to illustrate the distinction between the different kinds of double points which we have enumerated, let us suppose the origin to be a double point at which the two tangents coincide with the line $y=0$, then the equation of the quartic will be of the form $y^2 + u_3 + u_4 = 0$, where $u_3 = ax^3 + bx^2y + cxy^2 + dy^3$, $u_4 = ex^4 + fx^3y + \&c.$

We proceed now as in Art. 56: In order to determine the form of the curve in the neighbourhood of the origin, we substitute $y = mx^\beta$, we determine β , so that two or more of the indices of x shall be equal and less than the index of any other term; and we attend only to the terms of lowest dimension in x . Then let a be not $=0$. We find $\beta = \frac{3}{2}$; the form of the curve near the origin is the same as that of the curve $y^2 + ax^3 = 0$, and the origin is an ordinary cusp.

(1) Let $a=0$. We then have $\beta=2$, and m is determined by the quadratic $m^2 + bm + e = 0$. There are then two branches whose forms near the origin are respectively the same as those of the curves $y = m_1x^2$, $y = m_2x^2$, where m_1, m_2 are the roots of the above equation. The branches touch each other, and the origin is a *tacnode*.

(2) Let this quadratic have equal roots, the form of the equation then is

$$(y - mx^2)^2 + cxy^2 + dy^3 + fx^3y + \&c. = 0,$$

and to the degree of approximation to which we have as yet proceeded the two branches in the neighbourhood of the origin coincide. In order to discriminate them we substitute $y = mx^2 + nx^\gamma$, and determine n and γ as before. We find then $\gamma = \frac{5}{2}$ and $n^2 = -(cm^2 + fm)$. The form then of the curve near the origin approaches to that of the curve $y = mx^2 + nx^{\frac{5}{2}}$, which has been considered, Art. 58. The origin is then a ramphoid-cusp or node-cusp.

(3) If, however, in addition to the preceding conditions we have $f = -cm$, the equation of the curve is of the form

$$(y - mx^2)^2 + cxy(y - mx^2) + dy^3 + gx^2y^2 + \&c. = 0,$$

and on substituting $y = mx^2 + nx^\gamma$ we find $\gamma = 3$, and n is determined by the quadratic

$$n^2 + cmn + m^2(dm + g) = 0;$$

and if n_1, n_2 be the roots of the quadratic, the curve in the neighbourhood of the origin consists of two osculating branches, whose forms are represented by the equations $y = mx^2 + n_1x^3$, $y = mx^2 + n_2x^3$. Since the difference of these values of y commences with an odd power of x , the branches cross as well as touch at the origin. The origin is now an *oscnode*.

(4) If, however, in addition to the former conditions we have the roots of the last-mentioned quadratic equal, or $dm + g = \frac{1}{2}c^2$, the equation of the curve is of the form

$$(y - mx^2 - cxy - dy^2)^2 = Axy^3 + By^4,$$

and, as before, we find that its form near the origin is given by the equation $y = mx^2 + cmx^3 + px^{\frac{7}{2}}$. The origin is then a tac-node-cusp. The node can have no higher singularity in a proper quartic, for the next step would be to suppose A to vanish, in which case the equation would break up into two of the second degree. The case where the origin is a triple point does not seem to require illustration.

245. We have thus far not attended to the distinction of real and imaginary. Assuming that the quartic curve is real, then imaginary nodes or cusps can present themselves only in pairs, and we may distinguish the cases accordingly; thus we may have one real node, two real or two imaginary nodes, three real or one real and two imaginary nodes; and the like for cusps. Again, any real node may be a crunode or an acnode. The distinctions as to real and imaginary scarcely present themselves in regard to the special singularities above referred to (the condition that imaginaries must present themselves in pairs, implying for the most part that these singularities are real); the only distinction seems to be in regard to the ordinary triple point, which may be a point with three real tangents, or with one real and two imaginary tangents, viz. in the former case the point is the common intersection of three real branches of the curve, in the latter case it is the common intersection of one real and two imaginary branches of the curve; or, what is the same thing, we have a real branch passing through an acnode. The point does not visibly differ from an ordinary point of the curve, resembling in this respect the special triple point 7° above referred to. The difference is, that in the case of an ordinary branch through an acnode the tangents are one real and two imaginary; in the case of the special triple point they are all real and coincident.

246. There are yet other specialties which may be taken account of. A node may be in regard to one of the branches through it a point of inflexion; that is, the tangent to the branch at the node may meet the branch in three consecutive points (or the curve in four coincident points); or, again, the node may be in regard to *each* of the branches through it a point of inflexion. Such a node may be considered as the union of an ordinary node with (in the first case) a point of inflexion, and with (in the second case) two points of inflexion; and the node may be termed a flecnode or a biflecnode in the two cases respectively. The point or points of inflexion thus coinciding with the node must be reckoned among the inflexions of the curve, and the number of the remaining inflexions diminished accordingly. A biflecnode has properties analogous

to those established (Art. 170, *et seq.*) for the inflexions of cubics. In general, if we look for the locus of harmonic means on radii-vectores drawn through the origin, which is supposed to be a double point on the quartic $u_4 + u_3 + u_2 = 0$, we find $u_3 + 2u_2 = 0$. When, therefore, u_2 is a factor in u_3 , the locus becomes a right line, and the double point, having a harmonic polar, has the properties established (Art. 170). The points of contact of tangents from it lie on a right line, and the curve may be projected so that this point shall become a centre, or else so that all chords parallel to a given line shall be bisected by a fixed diameter. In the latter case, the form of the equation is in general

$$y^2(x-a)(x-b) = \pm A(x-c)(x-d)(x-e)(x-f).$$

There is no difficulty in discussing, as in Arts. 39, 199, the different possible forms of curves included in this equation, according to the reality, and to the relative magnitude of $a, b, \&c.$; and in deriving thence the different possible forms of the projections of these curves.

247. Once more, a quartic may have another kind of singular point, of which account might be taken in the classification, viz. a point of undulation, that is to say, one in which the tangent meets the curve in four consecutive points. The tangent at such a point replaces two stationary tangents and one ordinary double tangent. A quartic may have four real points of undulation, as we can see by writing down the equation $wxyz = S^2$, where S is any conic touching the four lines w, x, y, z .

248. We have not yet exhausted the list of characteristics unaltered by projection which would have to be taken into account in a complete classification of quartics. It will be remembered that we divided non-singular cubics into unipartite and bipartite according as all the real points of the curve are or are not included in one continuous series; and it is natural to suppose that similar distinctions exist in regard to quartic curves.

The possible forms of non-singular quartics have been studied in detail by Zeuthen (*Math. Annalen*, VII. 411). He remarks that the branches of a curve may be divided into those of odd

order met by any line in an odd number of points, and those of even order. The latter are what we have called ovals (Art. 200), using the word to include not only ovals in the ordinary sense but also their projections. In this sense, for instance, all the forms of conics would be described as ovals. Zeuthen shows that a non-singular curve cannot have more than one branch of odd order, and therefore that a curve of even degree cannot have any. A quartic, therefore, can only have ovals. It is at once apparent that if a quartic have two ovals, one wholly inside the other, it can have no other real point. For if it had, the line joining this to a point inside the interior oval must cut the curve in five points. For the same reason the interior oval cannot have bitangents or inflexions. A quartic of this kind having two ovals, one inside the other, is called an annular quartic. This reasoning does not exclude the case of ovals exterior to each other, but the quartic can at most have four such ovals; for if it had any other real point the conic passing through this and through points inside the four ovals respectively would meet the curve in nine points. That a quartic may actually have four such ovals appears as well from the curve $(x^2 - a^2)^2 + (y^2 - b^2)^2 = c^4$, ($c < b$) considered p. 43, as from the following illustration which Plücker gives in order to show that the 28 tangents which a non-singular quartic can have may be all real. Consider the curve $\Omega = \pm k$, where

$$\Omega = (y^2 - x^2)(x - 1)(x - \frac{3}{2}) - 2\{y^2 + x(x - 2)\}^2.$$

Now the equation $\Omega = 0$ represents a quartic having three double points as shown in the dark curve in the annexed figure; and the equation $\Omega = k$ denotes a curve not meeting Ω in any finite point, which deviates less from the form of the curve Ω the less we suppose k , and which according to the sign we give k is either altogether within or altogether without the curve Ω . When it is altogether without, the curve is unipartite; when it is altogether within, the curve in the first instance consists of four

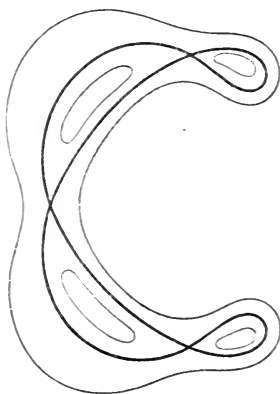

meniscus-shaped ovals, one in each of the compartments into which the curve Ω is divided. Each meniscus has one tangent touching it doubly; and, besides, it will be seen that any two ovals have four common tangents, and that there are six pairs of ovals. It will readily be conceived that, as the value of the constant is supposed to change, first one, then another of these ovals becomes imaginary, so that non-singular quartics may be either unipartite, bipartite, tripartite, or quadripartite. We can in like manner conclude that a quartic having one double point may be either unipartite, bipartite, or tripartite; and one having two double points, either unipartite or bipartite.*

248 (a). Zeuthen takes as the basis of his classification of quartics the real bitangents of the curve, which he divides into two classes. When a quartic has a pair of ovals exterior to each other, it is easy to see that (just as if they were two conics) these ovals have four common tangents and cannot have more. These common tangents are Zeuthen's bitangents of the second kind. If the quartic have two ovals exterior to each other the number of such bitangents is 4; if it have three such ovals the number of such bitangents is 12; if it have four, the number is 24. Zeuthen's bitangents of the first kind may be either (a) lines doubly touching a single branch of the curve; or (b) bitangents, both of whose points of contact are imaginary.

Zeuthen has proved that every quartic has four real bitangents of one or other of these two species, which four we shall call the Zeuthen bitangents. The total number then of real bitangents to a quartic is got by adding to these four the 0, 4, 12, or 24 bitangents of the second kind; and accordingly is either 4, 8, 16 or 28. Zeuthen's method of proof is to consider the series of quartics, $S + \lambda S'$, where S and S' are any two non-singular quartics. The number of real bitangents of a curve of the series will only alter when λ is such that the curve has some singularity. Zeuthen shows that as λ passes through the value for which the curve has a double point, only real bitangents of the second kind are lost or come into existence; and that for no ordinary singularity do bitangents of the first

* In general the maximum number of "parts" of a curve is one more than the "deficiency."

kind change into those of the second, or *vice versâ*. But consider a bitangent of the first kind touched by a branch in two real points. As a parameter in the equation alters, these points may approach each other and the intervening arc of the curve become smaller. At last the points coincide and the curve has a point of undulation; after that the bitangent has imaginary points of contact. Thus we see that at the value of λ , for which the curve has a point of undulation, Zeuthen bitangents of the form (a) may change into the form (b), or *vice versâ*. The only change then that affects bitangents of the first kind being an interchange of these two forms, the total number of such bitangents is the same for the whole series of quartics included in the form $S + \lambda S'$, and therefore is the same for every quartic; and Plücker's example shows that the number is four.

248 (b). When a branch has a tangent touching it in two real points, it is obvious that the arc at each of these points turns its convexity towards the tangent, and that there is an intermediate part of the arc which turns its concavity towards it, this concave part being separated by a point of inflexion at each end from the convex parts. Every such bitangent then implies two real points of inflexion; and it is not difficult to see that the converse of this is also true. Since there can be at most four such tangents, *a quartic can have at most eight real inflexions*. Zeuthen confines the name oval to a branch, having no real bitangent or inflexions: one with a single real bitangent he calls a unifolium; one with 2, 3, or 4 such bitangents, a bifolium, trifolium or quadrifolium. Thus the external curve in Plücker's figure is a quadrifolium; the four internal curves are unifolia. The figure, p. 45 (3), represents two bifolia; p. 46 (5), represents an annular quartic, quadrifolium with internal oval.

248 (c). Zeuthen further shows by the method of Art. 125, Ex. 4, that the points of contact of any three of his bitangents lie on a conic; and further, that it is the same conic which passes through the contacts of all four bitangents. If then w, x, y, z , represent four lines, and V a conic, the equation of the quartic must be of the form $wxyz = V^2$. Zeuthen's analysis of the possible forms of quartics is made by discussing the different

positions which the intersections of the four lines with the conic can have with respect to the quadrilateral found by them. Thus when V meets all the lines in real points, he enumerates the following cases: (1), annular quartic, quadrifolium and internal oval; (2), quadrifolium and 2 ovals; (3), 4 unifolia; (4), trifolium, unifolium and oval; (5), bifolium, 2 unifolia and oval; (6), 2 bifolia and oval; (7), 2 bifolia and 2 ovals; (8), bifolium and 2 unifolia; (9), trifolium, unifolium and 2 ovals. He enumerates thus 36 cases in all, but the figures which he gives for the nine cases just mentioned sufficiently illustrate the rest, a very slight modification being enough to turn a unifolium into an oval, &c. It will be observed that the classification just made rests solely on projective properties and has no reference to the line infinity. In Art. 249 we state the principles on which these classes may be subdivided into species when the nature of the infinite branches is taken account of.

248 (*d*). Zeuthen also applies his method of classification to nodal quartics considered as limiting cases of non-singular quartics. He enumerates and discusses the following cases: (*a*), conjugate points considered as limiting cases of ovals; (*b*), nodes which arise when in limiting cases of annular quartics the inner branch comes to meet the outer;—in neither of these cases are the Zeuthen bitangents affected; (*c*), nodes which arise when two mutually external branches come to meet; (*d*), which arise when a branch of even order breaks up into the intersection of two of odd order; (*e*), the case of two imaginary double points. In the cases where the Zeuthen bitangents are affected, the investigation is carried on by considering the forms represented by the equation $wxyz = V^2$, when V passes through the intersection of two of the lines, or when two of the lines coincide with each other.

249. In order to see how quartics might be classified in respect of their infinite branches, we observe that the line infinity may meet a quartic, (*a*) in four real points, (*b*) in two real and two imaginary, (*c*) in four imaginary points, (*d*) in two coincident and two real points, (*e*) in two coincident and two imaginary points, (*f*) twice in two coincident points, these points being real, or (*g*) these points being imaginary, (*h*) in

three coincident and one real point, (*i*) in four coincident points. Again, the cases (*d*), (*e*), (*f*), (*g*) would have to be further distinguished according as the line infinity when meeting the curve in two coincident points is simply a tangent or a line passing through a double point, which double point may be either crunode or acnode, cusp, or one of the special kinds above mentioned. Similarly in the case (*h*), the line infinity may be either an ordinary stationary tangent, or a tangent at a double point or cusp, or it may pass through a triple point, and in the case (*i*) it may be either a tangent at a point of undulation, a tangent at a double point of the special kind, or a tangent at a triple point. Lastly, any of the points which count only as single intersections of the line infinity with the curve may be on the curve a point of inflexion or undulation, and where this happens a difference in the figure will result which would have to be taken into account in a complete classification of quartics.

250. We have already shown (Art. 70) how to form the equation of the Hessian of a quartic, which is a curve of the sixth degree, intersecting the quartic in the twenty-four points of inflexion. We have also seen (Art. 92) that the equation of the reciprocal of a quartic is of the form $S^2 = T^3$, where S represents a curve of the fourth and T of the sixth class, and the form of the equation shows that both are touched by the twenty-four stationary tangents. We have postponed to another chapter the solution of the problem to form the equation of a curve passing through the points of contact of double tangents of a given curve. It will there be shown that, in the case of the quartic, the equation of such a bitangential curve may be written in the form $\Theta = 3H\Phi$, where Θ is the covariant $AL'^2 + \&c.$, as in Art. 231; that is to say, L' &c. represent the first differential coefficients of the Hessian, and A denotes $bc - f^2$, where a , b , &c. are the second differential coefficients of U . In like manner Φ denotes $Aa' + \&c.$, as in Ex. 1, Art. 230.

THE BITANGENTS.

251. It is convenient to commence by studying a more general theory in which that of the bitangent is included. Let us then consider first the form $UW = V^2$, where U , V , W

represent conics; a form containing implicitly sixteen constants, and therefore one to which the equation of any quartic may be reduced in a variety of ways, as we shall afterwards more fully see. The form of the equation shows that U and W each touch the quartic in four points, namely, the points where they respectively meet V . Now we have already discussed (see *Conics*, Art. 270, &c.) the equation $UW = V^2$, when U, V, W represent right lines, and the results hold good with the proper alterations when they represent conics. It is merely necessary to remember, that two conics represented by equations of the form $\lambda U + \mu V + \nu W = 0$, instead of intersecting in a single point, intersect in four points; and that if we are given one point on a conic whose equation is to be of this form, three other points are necessarily given; for if we have $\lambda U' + \mu V' + \nu W' = 0$, the conic $\lambda U + \mu V + \nu W = 0$ will, it is clear, pass through the four points determined by the equations $\frac{U}{U'} = \frac{V}{V'} = \frac{W}{W'}$. It follows then from the discussion in the

Conics just cited, that the quartic $UW = V^2$ may be considered as the envelope of the variable conic $\lambda^2 U + 2\lambda V + W = 0$ where λ is variable, and which touches the given quartic in the four points determined by $\lambda U + V = 0, \lambda V + W = 0$. The two sets of four points in which any two of the enveloping conics touch the quartic lie on another conic, as appears by writing the given equation in the form

$$(\lambda^2 U + 2\lambda V + W) (\mu^2 U + 2\mu V + W) = \{\lambda\mu U + (\lambda + \mu) V + W\}^2.$$

In like manner, the properties of poles and polars may be extended to the curve under consideration. Through any point (or, if we please, we may say through any set of four points) may be drawn two conics of the system $\lambda^2 U + 2\lambda V + W$, the two sets of four points of contact lying on a conic $UW' + WU' - 2VV'$, which may be called the polar of the given point or set of points, and the symmetry of the equation shows that the polar, in this sense of the word, of any point on the latter conic will pass through the given point. Conversely, any conic $aU + bV + cW$ meets the quartic in two sets of four points, through each of which sets a quadruply tangent conic may be drawn, the two intersecting in a set of points which constitute in this sense the pole of $aU + bV + cW$.

252. It is useful now to recall the properties established (*Conics*, Art. 388, &c.) for a system of conics included in the equation $\alpha U + \beta V + \gamma W = 0$. In the first place, if this equation represents a pair of right lines, their intersection lies on a fixed cubic, the Jacobian of U, V, W ; a curve which may also be defined as the locus of a point, whose polars with respect to all conics of the system $\alpha U + \beta V + \gamma W$ meet in a point. If we consider two conics included in this system, the equation of any conic through their intersections must be of similar form; and hence, the intersection of each of the three pairs of lines joining the four intersections of the two conics must lie on the Jacobian. If the two conics touch, two of these three intersections coincide with the point of contact; and, therefore, if two conics of the system $\alpha U + \beta V + \gamma W$ touch each other, the point of contact lies on the Jacobian.

Secondly, the system $\alpha U + \beta V + \gamma W$ may be regarded as a system of polar conics of the variable point $\alpha\beta\gamma$ with regard to a certain fixed cubic, which has for its Hessian the Jacobian of the system, and the equation of which can be formed when those of the three conics are given.

Thirdly, if $\alpha U + \beta V + \gamma W$ represents a pair of right lines, all such right lines touch a curve of the third class, the Cayleyan of the cubic last mentioned.

253. Hence then, in particular, since any enveloping conic $\lambda^2 U + 2\lambda V + W$, and the conic through the four points of contact are each included in the form $\alpha U + \beta V + \gamma W$, if we draw the three pairs of lines connecting the points of contact of any conic enveloping $UW = V^2$, the intersections of each pair lie on a certain fixed cubic, viz. the Jacobian; and the lines themselves are all touched by a fixed curve of the third class, viz. the Cayleyan.

Again, if the two conics $\lambda U + V, \lambda V + W$ touch each other, then the conic $\lambda^2 U + 2\lambda V + W$, instead of touching the quartic in four distinct points, has ordinary contact with it twice and meets it once in four consecutive points. And from what we have just seen, this point of contact of higher order lies on the Jacobian. We infer then, that twelve conics of the system

$\lambda^2 U + 2\lambda V + W$ have this higher contact with the quartic, namely, the twelve passing each through one of the intersections of the Jacobian with the quartic.

254. Six conics of the system $\lambda^2 U + 2\lambda V + W$ reduce to a pair of right lines; for the discriminant of this form being a function of the third degree in its coefficients will be one of the sixth degree in λ , and therefore six values of λ can be found for which it vanishes. When an enveloping conic reduces to a pair of right lines, the four points of contact lie two on each line, and each line is therefore a double tangent to the quartic. It appears from Art. 249, that if ab, cd be any two of these six pairs of bitangents, the equation of the quartic may be transformed to $abcd = V^2$, the eight points of contact lying on a conic V . Thus we see that the form $\lambda^2 U + 2\lambda V + W$ includes six pairs of the bitangents of the quartic, these twelve bitangents all touching a curve of the third class, viz. the Cayleyan of the system, and the intersections of each pair lying on the Jacobian. So again, if the points of contact of any of these pairs of bitangents be joined directly or transversely, the joining lines also touch the Cayleyan, and the intersection of each pair lies on the Jacobian. This may be stated in a slightly different form by considering the cubic S , of which U, V, W are polar conics. Then if the equation of a quartic is a function of the second degree in U, V, W , since the vanishing of such a function expresses the condition that the line $xU + yV + zW = 0$ should touch a fixed conic, it is easy to see that the quartic may be defined as the locus of a point whose polar with respect to S touches a fixed conic, or, in other words, the locus of the poles with respect to S of the tangents of that fixed conic; or, it will come to the same thing if it be defined as the envelope of the polar conics of the points of that conic. The double tangents of the quartic correspond to the points where the conic meets the Hessian of S .

255. Let us now consider any two of the bitangents of a quartic, which we take for the lines x, y ; then if we make $x = 0$, the equation of the quartic is to reduce to a perfect

square, say $(z^2 + ayz + by^2)^2$, and if we make $y = 0$, the equation is to reduce to, say $(z^2 + cxz + dx^2)^2$. Hence, evidently the equation of the quartic must be of the form

$$xyU = (z^2 + ayz + by^2 + cxz + dx^2)^2;$$

that is to say, of the form $xyU = V^2$, which we have just discussed; an equation which may also be written

$$xy(\lambda^2 U + 2\lambda V + xy) = (xy + \lambda V)^2.$$

There are, as we have seen, beside the value $\lambda = 0$, corresponding to the pair of lines xy , five other values of λ for which $\lambda^2 U + 2\lambda V + xy$ will represent a pair of lines; and thus in five different ways the equation can be reduced to the form $wxyz = V^2$. Hence, *through the four points of contact of any two bitangents we can describe five conics, each of which passes through the four points of contact of two other bitangents.*

A non-singular quartic has 28 bitangents; and there are therefore $\frac{1}{2}(28 \cdot 27)$, or 378 pairs of bitangents; each of these pairs gives rise to five different conics, but each conic may arise from any one of the six different pairs formed by the four bitangents which correspond to that conic, hence *there are in all $\frac{5}{6}(378)$ or 315 conics, each of which passes through the points of contact of four bitangents of a quartic.**

256. We have seen that each pair of bitangents combines with five other pairs to form a group of six pairs, the points of contact of any two of which pairs lie on a conic. It follows that the 378 pairs may be distributed into 63 such groups of six. The twelve bitangents of each group touch the same curve of the third class; and this is touched also by the lines joining directly and transversely the points of contact of each pair. The intersections of each pair of bitangents, and also those of each pair of joining lines, lie on a cubic. Corresponding to each group there are twelve conics, each of which touches the quartic twice with ordinary contact, and once so as to meet it in four

* Plücker first noticed the possibility of bringing the equation of any quartic to the form $wxyz = V^2$, but he hastily inferred that the six points of contact of any three bitangents lie on a conic, and thence drew an erroneous conclusion as to the total number of conics passing through eight points of contact of bitangents (see the *Theorie der Algebraischen Curven*, p. 246).

consecutive points, the twelve points of higher contact lying on the cubic last mentioned. There being 63 groups, 756 such conics may in all be drawn.

257. We shall show how to form a scheme of the 315 conics, and for that purpose we denote provisionally the first 26 bitangents by the letters of the alphabet, adding the symbols ϕ and ψ to denote the other two. We denote by $abcd$ the conic passing through the eight points of contact of the bitangents a, b, c, d . If now $abcd, abef$, be two of the 315 conics, the pairs ab, cd, ef belong to the same group, and from what we have seen, $cdef$ will be another of the conics. This may also be shown directly as follows. Let the equation of the quartic be $abcd = V^2$, or

$$ab(cd + 2\lambda V + \lambda^2 ab) = (V + \lambda ab)^2,$$

and we can determine λ so that $cd + 2\lambda V + \lambda^2 ab = ef$. Solve for V from this equation, and substitute in the equation of the quartic, when it becomes

$$\lambda^4 a^2 b^2 + c^2 d^2 + e^2 f^2 - 2\lambda^2 abcd - 2\lambda^2 abef - 2cdef = 0,$$

or

$$4cdef = (cd + ef - \lambda^2 ab)^2,$$

a form which proves the theorem stated. It appears thus, that given three pairs of lines which are to be pairs of bitangents of the same group of a quartic, the equation of the quartic will be of the form $l\sqrt{ab} + m\sqrt{cd} + n\sqrt{ef} = 0$, so that if two points were given in addition, a single quartic could be found satisfying the prescribed conditions. Corresponding to any group there are 15 conics, passing respectively through the points of contact of each two of the six pairs of which the group consists. There would thus seem to be $63 \times 15 = 945$ conics; but then every conic $abcd$ is counted three times over, as belonging to the three groups $ab, cd, \&c.$, $ac, bd, \&c.$, $ad, bc, \&c.$; the total number is therefore 315 as before.

258. Consider any conic $abcd$, then the group $ab, cd, \&c.$, and the group $ac, bd, \&c.$, can have no other bitangent common, the quartic being supposed to be non-singular. For example,

if $abef$ be a conic of the first group, $aceg$ cannot be a conic of the second. For (Art. 257) the equation of the conic through the points of contact of a, b, c, d may be written in the form

$$\lambda ab + \frac{1}{\lambda}(cd - ef) = 0,$$

and if $aceg$ be another conic, this must be identical with the form

$$\mu ac + \frac{1}{\mu}(bd - eg) = 0.$$

From this identity we at once infer

$$(\lambda b - \mu c) \left(a - \frac{1}{\lambda\mu} d \right) = e \left(\frac{1}{\lambda} f - \frac{1}{\mu} g \right).$$

It follows that e , being identical with one of the factors into which the left-hand side breaks up, passes through the intersection either of b and c or of a and d . But in either case the point through which e is thus proved to pass will be a double point on

$$4\lambda^2 abcd = (\lambda^2 ab + cd - ef)^2,$$

and therefore the quartic could not be non-singular.

In precisely the same way we see that if $abef, acmn$ be two conics, there is an identity

$$(\lambda b - \mu c) \left(a - \frac{1}{\lambda\mu} d \right) = \frac{1}{\lambda} ef - \frac{1}{\lambda} mn,$$

and hence the diagonals of the quadrilateral $efmn$ pass one through ad , the other through bc ; or, in other words, the intersections of each pair of bitangents lie, according to a certain rule, three by three on right lines. When once a scheme of the 315 conics has been made, there is no difficulty in discriminating which diagonal passes through ad and which through bc . For example, if it appears that $aemu, afnv, aduv$ are conics of the system, we infer in like manner that the diagonals of the quadrilateral $emfn$ pass through ad and uv ; and thence we infer that ad lies on the line joining en, fm . Thus then consider any conic $abcd$, this belongs to the three groups $ab, cd, \&c.$, $ac, bd, \&c.$, and $ad, bc, \&c.$, and it appears now that each of the sixteen quadrilaterals formed by combining one of the four other pairs belonging to the group ac, bd with a pair from

the group ad, bc , will have a diagonal passing through ab . Now the pair ab belongs to five different conics, and therefore there are eighty quadrilaterals having a diagonal passing through ab . But it will be found, as we have intimated, that these quadrilaterals may be distributed into pairs having a common diagonal; hence, through each of the 378 points ab can be drawn 40 lines, each passing through two others of these points, and there are in all 5040 such lines.

259. We are now in a position to form a scheme of the 315 tangents, in which nothing but the notation shall be arbitrary. Commence by writing down the group ab, cd, ef, gh, ij, kl ; then since the groups $ac, bd; ad, bc$ can have no bitangent common with the preceding nor with each other, these groups may be written, $ac, bd, mn, op, qr, st; ad, bc, uv, wx, yz, \phi\psi$. Proceed now to write down the group ae, bf ; this must include no bitangent from the group ab ; but in each term one of the bitangents from the group ac will be combined with one from the group ad . Now since it was free to us to write down the pairs of each group in any order we pleased, it is a mere matter of notation, and does not introduce any geometrical condition, if we take this group to be $ae, bf, mu, ow, qy, s\phi$. In like manner, it is a mere matter of notation to suppose that the bitangents have been so lettered, that ag and mx, ai and mz, ak and $m\psi$ shall respectively belong to the same group. This being assumed, it will be found that the group af, be is necessarily $nv, px, rz, t\psi$, and we can thus proceed, step by step, to write out the whole system. A table of the 315 conics was accordingly given in the first edition, but I do not occupy space with it now, because an algorithm has been given by Hesse (*Crelle*, 1855, XLIX, 243), and more minutely discussed by Professor Cayley (*Crelle*, 1868, LXVIII, 176), which exhibits in an easily recognizable form the mutual relations of the 28 tangents. Hesse's method introduces considerations from the geometry of three dimensions. He equates to zero the discriminant of $\alpha U + \beta V + \gamma W$ where U, V, W denote quadric surfaces. This discriminant being a function of the fourth degree in α, β, γ , if these quantities be regarded as variables, the equation denotes a plane quartic.

But for any value of α, β, γ for which the discriminant vanishes, $\alpha U + \beta V + \gamma W$ denotes a cone, so that to every point on the plane quartic corresponds a point in space, namely, the vertex of this cone; and Hesse's method connects the double tangents of the plane quartic with the lines connecting each pair of 8 points in space which are the intersections of three quadric surfaces. We make no use here of any principles of solid geometry, but merely borrow the notation which Hesse's method suggests.*

260. Take then eight symbols 1, 2, 3, 4, 5, 6, 7, 8. Their combination in pairs gives us 28 symbols 12, 13...78, which we use to denote the 28 bitangents. This notation, the symbols being properly applied to the 28 bitangents, enables us correctly to represent their geometrical relations, though it fails completely to exhibit the symmetry of the system. In fact, the notation might suggest that the bitangent 12 was related in a different manner to the bitangents 13, 14, &c., and to the bitangents 34, 56, &c., whereas actually there is no geometric difference between the relations of any pair of bitangents. So again we suppose the symbols so applied, that 12, 34, 56, 78 shall denote bitangents whose 8 points of contact lie on a conic. The same property will then belong to every tetrad of bitangents represented by a like set of duads; that is, by any four duads containing all the eight symbols. But if we count, we shall find that we can only make 105 arrangements of the 8 symbols into sets, such as 12, 34, 56, 78. The remaining 210 conics correspond to four bitangents, whose symbols are such as 12, 23, 34, 41; that is to say, the duads are formed cyclically from any arrangement of four of the eight symbols, and it will be found that we

* Another mode of connecting the theory of 28 bitangents with Solid Geometry is used by Geiser, *Mathematische Annalen* I. 129, as follows: From any point on a cubic surface can be drawn a quartic cone touching the surface. This will be non-singular, its bitangent planes being the tangent plane to the cubic at the vertex, and the planes joining the vertex to the 27 lines on the surface. Zeuthen shows that his classification of quartics with regard to the reality of their bitangents leads by a different process to the results obtained by Schläfli in classifying cubic surfaces with respect to the reality of their right lines.

can have 210 such tetrads. Thus then the group belonging to the pair 12, 34, consists of 56, 78; 57, 68; 58, 67; 13, 24; 14, 23; and the group belonging to a pair such as 12, 13, is 24, 34; 25, 35; 26, 36; 27, 37; 28, 38. Thus the notation shows completely how the bitangents are to be combined in groups. It suggests, however, that the 105 conics of the form 12, 34, 56, 78 differ in their properties from the 210 of the form 12, 23, 34, 41. This is not the case, the whole 315 tetrads forming an indissoluble system.

261. Professor Cayley remarks that Hesse's researches establish the following general rule: *A bifid substitution makes no alteration in the geometrical relations of the bitangents denoted by any set of symbols.* What is meant by a bifid substitution is, that writing down such a symbol of substitution as 1234·5678, we interchange everywhere the duads 12, 34; 13, 24; 14, 23; and again, 56, 78; 57, 68; 58, 67; but leave unchanged such duads as 15, 36, where one of the first set of symbols is combined with one of the second. The number of possible bifid substitutions is 35, or, if we add unity (viz. no alteration of any duad) the number is 36.

For example, now if we apply the bifid substitution 1234·5678 to the pair 12, 34, we get the same pair in opposite order; if we apply it to 12, 13, we get 34, 24, a pair of the same type as 12, 13; if we apply it to 12, 15, we get 34, 15, a pair of apparently a different type, but not different in geometrical relations. Thus, then, if we apply the same bifid substitution as before to the tetrad 15, 67, 28, 34, which is one of the set of 105 already referred to, we get 15, 58, 82, 21, which is one of the set of 210, and which, according to the rule, possesses the same geometrical properties.

262. Professor Cayley has exhibited in the following table the geometrical relations of the bitangents, taken singly in twos, threes, or fours, and the number of terms belonging to each type of arrangement of the symbols.

<i>Representative term.</i>	<i>No. of terms.</i>		<i>Geometrical character.</i>		
I	12	28	28	Bitangents.	
V	12.13	168	378	Pairs of bitangents.	
II	12.34	210			
U	12.23.34	420	1260	Triads of bitangents such that 6 points of contact are on conic.	
III	12.34.56	840			
Δ	12.23.31	56	2016	Triads such that 6 points of contact are not on conic.	
VI	12.23.45	1680			
V	12.13.14	280			3276
	12.34.56.78	105	315	Tetrads of bitangents such that the 8 points of contact are on conic.	
□	12.23.34.41	210			
IV	12.34.56.67	2520	15120	Tetrads such that 6 out of the 8 points of contact are on conic.	
U	12.34.45.56	5040			
U	12.23.34.45	3360			
Δ	12.23.31.14	840			
V	12.13.14.45	3360			
Δ	12.34.45.53	560	5040	Tetrads such that no 6 points of contact are on conic.	
V	12.13.14.15	280			
V	12.34.35.36	1680			
V	12.13.45.46	2520			20475

In the above, for greater clearness, a geometrical symbol has been attached to each term, viz. the symbols 1, 2, 3, 4, 5, 6, 7, 8 being regarded as points, when any two of these are combined into a duad, this is indicated by a line being drawn to join the two points; thus Δ is the symbol of the term 12.23.31. This is very convenient; we can for instance, by mere inspection, see that the symbol of any partial set in the set of 15120 terms, contains as part of itself one of the symbols |||, □, viz. that there are among the 8 bitangents six such that their points of contact lie in a conic; whereas, contrariwise in the symbols of the partial sets belonging to the set of 5040, no one of these symbols contains as part of itself either of the symbols |||, □.

To the foregoing may be joined the following two groups of hexads of bitangents:

	<i>Representative term</i>	<i>No. of terms</i>	
$\triangle\triangle$	12.23.31.45.56.64	280	}
$\nabla\nabla$	12.34.35.36.37.38	168	
$\nabla\nabla$	12.13.14.56.57.58	560	
\square	12.23.31.14.45.51	140	} 5040
\diamond	12.23.34.45.56.61	1680	
$\nabla\nabla$	12 34 35 36 67.68	2520	

These 1008 and 5040 hexads have been studied by Hesse and Steiner as bitangents whose twelve points of contact lie on a proper cubic, the former set having no six contacts on a conic, but the twelve points of contact in the latter case being divisible into two sets of six lying each on a conic. It may be added, that the six tangents of each of the 1008 hexads all touch the same conic, as will appear from Aronhold's investigations, which will be presently given. The six tangents of each of the 5040 hexads may be distributed into three pairs, whose points of intersection lie on a right line (see Art. 258).

263. We conclude this discussion of the bitangents with an account of the method by which Aronhold has shewn (see Berlin *Monatsberichte*, 1864, p. 499), that when seven arbitrary lines are given, a quartic can be found having these lines as bitangents, and of which the other bitangents can be found by linear constructions. The method depends on properties of a system of curves of the third class having seven common tangents, but it seems convenient to state them first in the reciprocal form with which the reader is more familiar, viz. as properties of a system of cubics passing through seven given points. (1) Consider any one cubic of the system, then if the eighth and ninth points in which it is intersected by any other cubic of the system be joined, the joining line passes through a fixed point on the assumed cubic, viz. the coresidual of the seven given points (Art. 160). (2) Through any assumed point 8 can be described one and but one cubic on which

this point shall be the coresidual of the seven given points. For all cubics of the system through the point 8 pass through another fixed point 9, and, by definition, the coresidual is the point where the line joining these points meets the curve again. If, therefore, the coresidual is to coincide with the point 8, the cubic must be that one which is determined by having the line 89 as its tangent at the point 8. (3) Four cubics of the system can be described to touch a given cubic of the system, the points of contact being obviously the points of contact of tangents drawn to the given cubic from the coresidual point on it. (4) If the points 8, 9 coincide, that is to say, if cubics of the system touch, the envelope of the common tangent 89 is a curve of the fourth class. For consider how many such lines can pass through any assumed point P . Suppose a cubic described through P , and through the points 8, 9, then, by definition, P is the coresidual point on that cubic, and by (2) this cubic having P for the coresidual is a determinate known cubic. We see then, from (3), that the envelope in question is of the fourth class, the four tangents from any point P being constructed by finding the cubic which has P for its coresidual, and drawing the four tangents from P to that cubic. (5) The point P will be a point on the envelope curve, if two of the tangents drawn from it coincide; but from the construction just given, it appears that this can only happen when the curve having P for its coresidual has a node; for in this case two tangents coincide with the line joining P to the node. Hence the envelope we are considering may also be defined as the locus of the coresidual of the given system of points on all the nodal cubics of the system. (6) If the cubic through the seven points break up into a conic through five of them, and a line joining the other two, it has two nodes, namely, the intersection of the line and conic. Any other cubic of the system meets this complex cubic in two other points, one on the line, one on the conic, and the coresidual is the point P where the line joining these two meets the conic again. In this case, then, P is a double point, the two tangents at it being the lines joining it to the intersections of line and conic. Now seven points can be divided in 21 different ways into a system of two and of five. The curve we are considering has, therefore,

21 double points, one on each of the 21 conics determined by any five of the given points. (7) In addition, the seven given points themselves are double points on the same curve. For a cubic can be described through six of the given points and having the remaining point for a double point, and it is easy to see that the double point is the coresidual for that cubic. The four tangents from it to the cubic reduce to two pairs of coincident tangents, namely, the tangents to the cubic at the double point. The envelope curve, therefore, has 28 double points, 7 of them being the seven given points, and the pair of tangents at each of these seven points being the same as those of the cubic of the system having that point for a double point.

264. Reciprocally, then, if we have a system of curves of the third class touching seven given lines, and consider any one curve of the system, the eighth and ninth tangents common to it with any other curve of the system, intersect on a fixed tangent of the selected curve, which may be called the coresidual, for that curve, of the seven given tangents. (2) Corresponding to any arbitrary line, there is a curve of the system having that line as the coresidual for it of the given tangents. (3) Any fixed curve of the system is touched by four others, the points of contact being the points where the coresidual tangent again meets the curve, which, being a general curve of the third class, is of the sixth degree. (4) The locus of points where two curves of the system touch is a curve of the fourth degree, the points where any line meets that locus being the four points where it meets the curve for which it is a coresidual tangent. (5) If the curve of the third class have a bitangent, the coresidual for that curve touches the locus, the point of contact being the intersection of the coresidual with the bitangent. (6) If the curve consists of a conic touching five of the given tangents together with a point, the intersection of the other two tangents; the coresidual for that system will then be a bitangent to the locus. There will be 21 such bitangents. (7) In addition, the seven given lines themselves are bitangents, the points of contact being the same as those in which any of them is touched by the curve of the third

class having that line for a bitangent and the six other given lines as ordinary tangents.*

265. We can now, as has been stated, from the seven given bitangents find the rest by linear constructions. We have in fact to construct the coresidual tangents for the several systems 12345, 67, &c., where 12345 denotes the conic touching the first 5 lines, and 67 is the point of intersection of the other two. Now the two systems 12345, 67 and 12346, 57 have obviously seven common tangents, and the remaining common tangents are the tangents to 12345 from the point 57, and to 12346 from 67. But Brianchon's theorem enables us, when one point on a tangent to a conic is given, to find by linear constructions the remaining tangent. These two tangents, then, having been constructed, and their intersection found, the remaining tangents drawn from it to each of the two conics in question will be the two required coresiduals, and therefore two of the bitangents. Or otherwise, if we consider the three systems 12345, 67; 12346, 57; 12347, 56, and determine in the manner just described the remaining eighth and ninth tangent common to each pair of systems, the three intersections of these pairs of tangents will, when joined, give three of the required bitangents. The bitangent which is the coresidual for the system 12345, 67 may be called the bitangent (67); and thus the twenty-one bitangents may be denoted by combinations of the symbols 1, 2, 3, 4, 5, 6, 7. In addition we have the seven given lines; and if introducing for symmetry a new symbol 8, we denote these (18), (28), (38), (48), (58), (68), (78), we are led by Aronhold's method to an algorithm identical with that of Hesse.

266. The intersection of the eighth and ninth tangents common to any two curves of the system is a point through

* The point of contact of each of the seven given lines with the locus being thus given, we have fourteen points on the quartic, which is thus completely determined, and there is but one quartic satisfying the prescribed conditions. There may, however, be several quartics having the seven given lines as bitangents; but the one determined by Aronhold's method has them as unrelated bitangents, viz. such that no three of them belong to the same group.

which passes the coresidual tangent for each of these curves. Consider, then, the complex cubic systems 12, 34567; 34, 12567, and one of the common tangents is the line joining the points 12, 34; that is to say, in the algorithm just referred to, the line joining the intersections of the lines (18), (28); (38), (48); and we now see that this line passes through the intersection of the coresiduals of the two systems under consideration, that is to say, through the point (12), (34). In this way we get the theorem already proved (Art. 258), that the intersections of the lines (18), (28); (38), (48); (12), (34), are in a right line; and Art. 262 shows that by an ordinary or bifid substitution we can find 5040 lines possessing the same property.

267. We conclude with Aronhold's algebraic investigation of the equation of the quartic generated according to his method. Let us use tangential coordinates α, β, γ ; and let u, v, w be any linear functions of them, $\alpha\alpha + b\beta + c\gamma$, &c., then the equations

$$\beta v - \gamma u = 0, \quad \gamma w - \alpha u = 0, \quad \alpha u - \beta v = 0,$$

denote three conics having four tangents common, and of which each touches one of the sides of the triangle of reference. And

$$\alpha(\beta v - \gamma w) = 0, \quad \beta(\gamma w - \alpha u) = 0, \quad \gamma(\alpha u - \beta v) = 0,$$

denote three curves of the third class having seven common tangents, viz. the four common to the two conics, and the sides of the triangle of reference. Any other cubic having the same 7 common tangents will be of the form

$$u'\alpha(\beta v - \gamma w) + v'\beta(\gamma w - \alpha u) + w'\gamma(\alpha u - \beta v) = 0,$$

where u', v', w' are arbitrary constants, which are supposed to be of the form $\alpha\alpha' + b\beta' + c\gamma'$, &c., where α', β', γ' are the coordinates of an arbitrary line. Writing the above equation in the form

$$\begin{vmatrix} u, & u', & \beta\gamma \\ v, & v', & \gamma\alpha \\ w, & w', & \alpha\beta \end{vmatrix} = 0,$$

it is evidently satisfied by the coordinates $\alpha'\beta'\gamma'$, which therefore are those of a tangent to this curve. And further, this tangent is the coresidual for that curve; for we shall find the other two tangents through any point in that line, by substituting in the

above $\lambda\alpha' + \mu\alpha''$ for α , &c. The equation then is divisible by μ , and after division becomes

$$\lambda^2 \begin{vmatrix} u', u'', \beta'\gamma' \\ v', v'', \gamma'\alpha' \\ w', w'', \alpha'\beta' \end{vmatrix} + \lambda\mu \begin{vmatrix} u', u'', \beta'\gamma' + \beta''\gamma' \\ v', v'', \gamma'\alpha'' + \gamma''\alpha' \\ w', w'', \alpha'\beta'' + \alpha''\beta' \end{vmatrix} + \mu^2 \begin{vmatrix} u', u'', \beta''\gamma'' \\ v', v'', \gamma''\alpha'' \\ w', w'', \alpha''\beta'' \end{vmatrix} = 0,$$

and the symmetry of the equation shows that the pairs of tangents are the same which can be drawn from the intersection of the lines $\alpha'\beta'\gamma', \alpha''\beta''\gamma''$ to the curves

$$\begin{vmatrix} u, u', \beta\gamma \\ v, v', \gamma\alpha \\ w, w', \alpha\beta \end{vmatrix} = 0, \quad \begin{vmatrix} u, u'', \beta\gamma \\ v, v'', \gamma\alpha \\ w, w'', \alpha\beta \end{vmatrix} = 0.$$

Thus then the tangents $\alpha'\beta'\gamma', \alpha''\beta''\gamma''$ being respectively the third tangents drawn to each curve from the intersection of the eighth and ninth tangents common to both, are, by definition, the coresidual tangents. The two curves will touch provided that the quadratic equation in λ, μ , has equal roots; or if we write the coefficients of that quadratic P, Q, R , provided we have $Q^2 = 4PR$. If we denote by X, Y, Z the minor determinants $v'w'' - v''w', w'u'' - w''u', u'v'' - u''v'$, we have

$$\begin{aligned} P &= \beta'\gamma' X + \gamma'\alpha' Y + \alpha'\beta' Z, \\ Q &= (\beta'\gamma'' + \beta''\gamma') X + (\gamma'\alpha'' + \gamma''\alpha') Y + (\alpha'\beta'' + \alpha''\beta') Z, \\ R &= \beta''\gamma'' X + \gamma''\alpha'' Y + \alpha''\beta'' Z. \end{aligned}$$

Now for $\beta'\gamma'' - \beta''\gamma', \gamma'\alpha'' - \gamma''\alpha', \alpha'\beta'' - \alpha''\beta'$ we may write x, y, z , these being the point-coordinates of the point of intersection of the two lines $\alpha'\beta'\gamma', \alpha''\beta''\gamma''$. The equation $Q^2 = 4PR$ is then equivalent to

$$x^2 X^2 + y^2 Y^2 + z^2 Z^2 - 2yz YZ - 2zx ZX - 2xy XY = 0,$$

or $\sqrt{(xX)} + \sqrt{(yY)} + \sqrt{(zZ)} = 0.$

It will be remembered that X stands for $v'w'' - v''w'$, and if we put for these their values

$$\begin{aligned} v' &= a'a + b'\beta' + c'\gamma', & w' &= a''a' + b''\beta' + c'\gamma', \\ v'' &= a'a'' + b'\beta'' + c'\gamma'', & w'' &= a''a'' + b''\beta'' + c'\gamma'', \end{aligned}$$

we have $X = (b'c'' - b''c')x + (c'a'' - c'a')y + (a'b'' - a''b')z.$

$$\begin{aligned} \text{Similarly } Y &= (b''c - bc'')x + (c''a - ca'')y + (a''b - ab'')z, \\ Z &= (bc' - b'c)x + (ca' - c'a)y + (ab' - a'b)z. \end{aligned}$$

Thus X, Y, Z represent known lines. They are in fact the sides of the triangle whose vertices are represented by u, v, w . It will be observed that the coefficients in X, Y, Z are the constituents of the determinant reciprocal to that formed by the coefficients of u, v, w ; so that if X, Y, Z had been originally given, u, v, w would be found by similar formulæ.

268. The same investigation would hold if the equations of the three conics had been $lau = m\beta v = n\gamma w$. The values of X, Y, Z would remain as before, but we should have

$$P = mn\beta'\gamma'X + nl\gamma'\alpha'Y + lm\alpha'\beta'Z, \text{ \&c.,}$$

and the equation would be

$$\sqrt{(mnxX)} + \sqrt{(nlyY)} + \sqrt{(lmzZ)} = 0.$$

This is the most general equation of a quartic having three given pairs of lines $x, X, \text{ \&c.,}$ as pairs of bitangents of the same group. If we were given a seventh bitangent, then l, m, n would be completely determined by the equations supposed to be satisfied by the coordinates of that bitangent, viz., $l\alpha'u' = m\beta'v' = n\gamma'w'$, whence mn, nl, lm are respectively proportional to $\alpha'u', \beta'v', \gamma'w'$. Thus, then, if we are required to describe a quartic having seven given lines as bitangents, besides the one quartic determined (Art. 265) on the supposition that no two of the tangents belong to the same group, we can describe $(7 \times 15 =) 105$ others according to the method of this article, by leaving out any one of the seven and dividing the six remaining into three pairs, which can be done in fifteen different ways.

BINODAL AND BICIRCULAR QUARTICS.

269. Except in connection with the bitangents, the theory of non-singular quartics has been little studied, and what else we have to state on this subject will be given in the concluding section of this chapter, that on the Invariants and Covariants. In order to complete the theory of the bitangents, we ought to consider the modifications which that theory receives when

the curve has one or more double points. The case, however, where the quartic has but one node has received no attention, and will not be here discussed. Quartics with two nodes, in the case where these are the circular points at infinity, have been extensively studied under the name of bicircular quartics,* and some of the principal results obtained will be here given. All the projective properties obtained for bicircular quartics may of course be stated and proved as properties of binodal quartics, but we shall find it convenient to give several of them in their original form, as the reader will have no difficulty in making the proper generalization. Quartics having the two circular points as cusps have also been much studied under the name of Cartesians,† the properties of which may similarly be generalized and stated as properties of bicuspidal quartics. If a quartic have one of the circular points as a cusp and the other as a node, it cannot be real; consequently this case has been little studied, and therefore we have little to state as to the properties of quartics having one node and one cusp.

270. From each of the two nodes of a binodal quartic may be drawn four tangents to the curve (Art. 79), and we shall now prove that the anharmonic ratios of these two pencils are equal. The general equation of a quartic having for nodes the intersections of the line z with the lines x and y is

$$x^2y^2 + 2xyz(lx + my) + z^2(ax^2 + by^2 + cz^2 + 2fyz + 2gzx + 2hxy) = 0.$$

The pairs of tangents at the nodes are given by the equations

$$x^2 + 2mxz + bz^2 = 0, \quad y^2 + 2lyz + az^2 = 0,$$

and we lose nothing in generality by supposing l and m to be both $= 0$, which is equivalent to assuming that for the lines x and y have been taken the harmonic conjugate, with respect to the pair of tangents at each node, of the line z which joins the nodes. Arranging now the equation of the quartic

$$y^2(x^2 + bz^2) + 2yz^2(fz + hx) + z^2(ax^2 + 2gzx + cz^2) = 0,$$

* See, in particular, Dr. Casey's paper, *Transactions of the Royal Irish Academy*, vol. xxiv. p. 457, 1869.

† See Chasles' *Aperçu Historique*, p. 350; Quetelet, *Nouveaux Mémoires de Bruxelles*, tom. v.; Cayley, *Liouville*, vol. xv. p. 354.

we see immediately that the four tangents from the node zx are given by the equation

$$(x^2 + bz^2)(ax^2 + 2gzx + cz^2) = z^2(fz + hx)^2,$$

$$\text{or } ax^4 + 2gx^3z + (c + ab - h^2)x^2z^2 + 2(bg - hf)z^3x + (bc - f^2)z^4 = 0.$$

The invariants of this quartic are

$$\begin{aligned} I &= abc - af^2 - bg^2 + fgh + \frac{1}{2}(c + ab - h^2)^2, \\ 6J &= (abc - af^2 - bg^2 - \frac{1}{2}fgh)(c + ab - h^2) - \frac{3}{2}h^2(af^2 + bg^2) \\ &\quad + 3abfgh + \frac{3}{2}f^2g^2 - \frac{1}{6}(c + ab - h^2)^3. \end{aligned}$$

Now these values are symmetrical between a and b , f and g , and we see therefore that they are the same as the invariants of the quartic which corresponds to the pencil of tangents from the node yz , and that therefore the two pencils are homographic.

271. It follows at once, as in Art. 168, that a conic can be drawn passing through the two nodes, and through the four points where each of the tangents from one node meets the corresponding tangent from the other; and further, since there are four orders in which the legs of the second pencil can be taken without altering the anharmonic ratio, that the sixteen points of intersection of the first set of tangents with the second lie on four conics, each passing through the two nodes. When the quartic is bicircular, that is to say, when the two nodes are the circular points at infinity, the theorem becomes that *the sixteen foci of a bicircular quartic lie on four circles, four on each circle.** It is to be noted that any one of the conics through the two nodes may degenerate into a right line together with the line joining the nodes, so that four of the foci of a bicircular quartic may lie on a right line.

272. We have already stated that the equation of any quartic may, in an infinity of ways, be thrown into the form

$$aU^2 + bV^2 + cW^2 + 2fVW + 2gWU + 2hUV = 0,$$

where U , V , W represent three conics. If the quartic is non-singular, the three conics cannot have a common point, since it

* In point of fact, this theorem, which is due to Dr. Hart, was first obtained, and the theorem of Art. 270 thence inferred. The proof given in Art. 270 is in substance the same as Professor Cayley's. See his *Memoir on Polyzomal Curves*, *Edinburgh Trans.*, 1869.

is obvious that any point common to U, V, W must be a double point on the quartic whose equation we have written. In the case of binodal quartics, U, V, W may be taken as three conics passing each through the two nodes, and when these nodes are the circular points at infinity, U, V, W are three circles. We lose nothing in generality by confining our attention to the equation $UW = V^2$, to which, as in the theory of conics, the preceding equation may in a variety of ways be reduced. It may, for instance, be written

$$(aU + gW + hV)^2 = (h^2 - ab)V^2 + 2(gh - af)VW + (g^2 - ac)W^2,$$

where the right-hand side of the equation breaks up into factors.

Bicircular, therefore, and binodal quartics may be discussed by considering the form $UW = V^2$, and by regarding the quartic as the envelope of $\lambda^2 U + 2\lambda V + W = 0$, where U, V, W are in the former case circles, and in the latter case conics passing through the two nodes; and it is only necessary to examine how this limitation modifies the results already obtained, Arts. 251, &c.

273. When three conics have two points common, their Jacobian breaks up into the line joining them, together with a conic passing through the two points; and when the three conics are circles, the Jacobian conic is the circle which cuts them at right angles (*Conics*, Art. 388, Ex. 3). The Jacobian being a determinant, the Jacobian of three conics whose equations are of the form $\alpha U + \beta V + \gamma W = 0$ is the same as that of U, V, W ; and when U, V, W are circles, all circles included in this form have a common orthogonal circle.

If U, V, W are circles, the coordinates of whose centres are $x_1, y_1, z_1, x_2, y_2, z_2, x_3, y_3, z_3$, the coordinates of the centre of $\lambda^2 U + 2\lambda V + W$ will be proportional to

$$\lambda^2 x_1 + 2\lambda x_2 + x_3, \quad \lambda^2 y_1 + 2\lambda y_2 + y_3, \quad \lambda^2 z_1 + 2\lambda z_2 + z_3,$$

and the locus of the centre, as λ varies, is evidently a conic. Hence the quartic $UW = V^2$ may be regarded as the envelope of a circle whose centre moves on a fixed conic* F , and which

* Dr. Casey has shown that the foci of this fixed conic are the same as the double foci of the quartic. In fact, if a tangent from a point I meets the conic F in two consecutive points P, P' , the line IP will be a common normal to the two circles whose centres are P, P' , and which pass through I . If then I be one of the circular points at

cuts a fixed circle J orthogonally. And in the more general case of the binodal quartic, where U, V, W are conics through the fixed points, $UW - V^2$ is the envelope of the variable conic $\lambda^2 U + 2\lambda V + W$, passing through the fixed points; all the variable conics having a common Jacobian conic, and the pole, with regard to any, of the line joining the fixed points moving on a fixed conic F .

274. The nature of the quartic will be modified if any special relations exist between the conic F and the Jacobian. Thus, if F touch the Jacobian, the point of contact will be an additional node on the quartic, and if F touches the Jacobian twice, then each point of contact will be a node; that is, the quartic will break up into two conics, each passing through the fixed points. So if F pass through one of the fixed points, that point instead of being a node of the quartic will be a cusp, and if F pass through both of the points both will be cusps, and we have a bicuspidal quartic. Thus, in the case of bicircular quartics, if the conic F which is the locus of centres be a circle, the quartic, having the points at infinity as cusps, will be a Cartesian.

If the conic F touch the line joining the points, that line becomes part of the quartic. Thus, in the case of bicircular quartics, if the conic F be a parabola, the quartic will degenerate into a circular cubic, together with the line at infinity.

If the centres of U, V, W lie on a right line, the Jacobian reduces to the line joining the centres.

275. Let us now return to the equation $UW = V^2$. We have seen that there are in general six values of λ , for which $\lambda^2 U + 2\lambda V + W$ breaks up into factors, and that the right lines represented by the several factors are bitangents to the quartic $UW = V^2$. Now when U, V, W all pass through fixed points, $\lambda^2 U + 2\lambda V + W$, which denotes a curve passing through the same points, must, if it denote right lines, denote two lines passing one through each of the points, or else the line joining the points together with another line. In the former case the two

infinity, it follows that the tangents from I to F are normals, and therefore tangents to the quartic at I . The same argument holds, whatever be the curve F , or whatever the law according to which the circles are described. Thus, the single foci of any curve are double foci of any parallel curve.

lines are not proper bitangents to the quartic $UV = V^2$, but ordinary tangents passing through a node (any line passing through a node being improperly a tangent); in the latter case one of the two lines is a proper bitangent, the other is the line joining the nodes. Of the six values of λ , only two correspond to the case of proper bitangents; for if L be the chord common to U, V, W , then V and W will be of the forms respectively $aU + LM, bU + LN$; and $\lambda^2 U + 2\lambda V + W$ will have L for a factor if λ be one of the roots of $\lambda^2 + 2\lambda a + b = 0$. Thus, in the case of bicircular quartics, when U, V, W all represent circles, there are evidently two values of λ for which the coefficient of $x^2 + y^2$ vanishes in $\lambda^2 U + 2\lambda V + W = 0$, and for each of these values the equation denotes a right line bitangent to the quartic $UV = V^2$. Or we may see the same thing geometrically from the construction in Art. 273. If the circle $\lambda^2 U + 2\lambda V + W$ becomes a right line, its centre passes to infinity, and must therefore be the point at infinity on one of the two asymptotes of the conic F ; and the two bitangents are therefore the perpendiculars let fall from the centre of the Jacobian on these asymptotes.

In each of the four other cases where the discriminant of $\lambda^2 U + 2\lambda V + W = 0$ vanishes, the equation denotes a pair of tangents to the quartic, passing each through one of the circular points at infinity, and whose intersection therefore is a focus of the quartic; or, what comes to the same thing, $\lambda^2 U + 2\lambda V + W$ is an infinitely small circle whose centre is the focus, and which has double contact with the quartic. If one of two orthogonal circles reduce to a point, that point must lie on the other circle; hence if $\lambda^2 U + 2\lambda V + W$ reduce to a point, that point must be on the Jacobian circle of U, V, W . We have, therefore, obviously four foci, viz. the intersections of this Jacobian circle with the conic F , which is the locus of centres of circles included in the equation $\lambda^2 U + 2\lambda V + W = 0$, and which may, therefore, be called a focal conic.

The four points in which the Jacobian circle meets the quartic will be points in which circles of the system $\lambda^2 U + 2\lambda V + W$ meet the quartic in four consecutive points (Art. 251).

There are four ways in which the equation of a given bicircular quartic can be reduced to the form $UV = V^2$; corresponding to each there are four foci, two bitangents and four

cyclic points, or points on the curve where four consecutive points lie on a circle (see Art. 114); the quartic having in all 16 foci, 8 bitangents, and 16 cyclic points.

276. If one of the foci of the quartic be taken as origin, the equation of the quartic must be of the form $(x^2 + y^2)W = V^2$, where V and W represent circles; and the quartic is the envelope of $x^2 + y^2 + 2\lambda V + \lambda^2 W = 0$. Besides the value $\lambda = 0$, there are three other values of λ , for which this variable circle reduces to a point; and one of these values must be real. We can then write the equation

$$(x^2 + y^2)(x^2 + y^2 + 2\lambda V + \lambda^2 W) = (x^2 + y^2 + \lambda V)^2,$$

or, in other words, when we have a focus we can at once bring the equation of the quartic to the form $AB = V^2$, where A and B are point-circles. Bicircular quartics may be divided into two classes, according as the other two values of λ , for which $A + 2\lambda V + \lambda^2 B$ reduces to a point-circle, are real or imaginary, or, in other words, according as the four real foci do or do not lie on a circle. In the former case let C denote one of the two point-circles, and, as in Art. 257, eliminate V between the equations $AB = V^2$, $A + 2\lambda V + \lambda^2 B = C$, and we see that the equation of the quartic may be written in the form $l\sqrt{A} + m\sqrt{B} + n\sqrt{C} = 0$, that is to say, that the quartic is the locus of a point whose distances from three fixed points are connected by the relation $l\rho + m\rho' + n\rho'' = 0$.

The condition that $l\sqrt{A} + m\sqrt{B} + n\sqrt{C}$ shall be touched by $\lambda A + \mu B + \nu C$ is (*Conics*, Art. 130) $\frac{l^2}{\lambda} + \frac{m^2}{\mu} + \frac{n^2}{\nu} = 0$; and when A, B, C are point-circles, and a, b, c the lengths of the lines joining the points, it is easy to verify that the discriminant of $\lambda A + \mu B + \nu C$ vanishes if $\frac{a^2}{\lambda} + \frac{b^2}{\mu} + \frac{c^2}{\nu} = 0$. The two equations just given determine λ, μ, ν , and therefore the fourth focus.

We have seen (*Conics*, Art. 94) that if A, B, C, D be four point-circles, we have identically $bcd.A + cda.B + dab.C + abc.D = 0$, where abc is the area of the triangle whose vertices are a, b, c , &c. Hence, λ, μ, ν are proportional to the areas of the triangles formed by the fourth focus and each pair of the other three foci. In the

case where the three points a, b, c are in a right line, it can easily be proved that the squares of the distances from any point of four points on a right line are connected by the equation

$$\frac{A}{ab \cdot ac \cdot ad} + \frac{B}{ba \cdot bc \cdot bd} + \frac{C}{ca \cdot cb \cdot cd} + \frac{D}{da \cdot db \cdot dc} = 0.$$

Hence we see that the reciprocals of λ, μ, ν are proportional to $ab \cdot ac \cdot ad, ba \cdot bc \cdot bd, ca \cdot cb \cdot cd$, and that we have the equation

$$l^2 ab \cdot ac \cdot ad + m^2 ba \cdot bc \cdot bd + n^2 ca \cdot cb \cdot cd = 0.$$

If we had $l^2 ab \cdot ac + m^2 ba \cdot bc + n^2 ca \cdot cd = 0$,

the fourth focus would be at infinity, and the curve would be a Cartesian.

277. *When we are given four concyclic foci of a bicircular quartic, two such quartics can be described through any point, and these cut each other at right angles.* If we are given the fourth focus, we are given the values of λ, μ, ν , for which $\lambda A + \mu B + \nu C$ reduces to a point; and evidently two systems of values of l, m, n can be found to satisfy the equations $\frac{l^2}{\lambda} + \frac{m^2}{\mu} + \frac{n^2}{\nu} = 0$, $l\rho + m\rho' + n\rho'' = 0$, where ρ, ρ', ρ'' or $\sqrt{(A)}, \sqrt{(B)}, \sqrt{(C)}$ denote the distances from the three foci of a point on the curve supposed to be given.

Two quartics

$l \sqrt{(A)} + m \sqrt{(B)} + n \sqrt{(C)} = 0$, $l' \sqrt{(A)} + m' \sqrt{(B)} + n' \sqrt{(C)} = 0$
will be confocal if

$$a^2 (m^2 n'^2 - m'^2 n^2) + b^2 (n^2 l'^2 - n'^2 l^2) + c^2 (l^2 m'^2 - l'^2 m^2) = 0,$$

as appears immediately on eliminating λ, μ, ν from the three equations

$$\frac{l^2}{\lambda} + \frac{m^2}{\mu} + \frac{n^2}{\nu} = 0, \quad \frac{l'^2}{\lambda} + \frac{m'^2}{\mu} + \frac{n'^2}{\nu} = 0, \quad \frac{a^2}{\lambda} + \frac{b^2}{\mu} + \frac{c^2}{\nu} = 0.$$

In order next to find the condition that the quartics should cut at right angles, we first premise, and the reader can verify without difficulty, that if A, B, C be point-circles, and a, b, c have the same meaning as before, the condition that $\lambda A + \mu B + \nu C, \lambda' A + \mu' B + \nu' C$ should cut each other at right angles is

$$a^2 (\mu\nu' + \mu'\nu) + b^2 (\nu\lambda' + \nu'\lambda) + c^2 (\lambda\mu' + \lambda'\mu) = 0.$$

We observe further that, as at *Conics*, Art. 130, the quartic $l\sqrt{(A)} + m\sqrt{(B)} + n\sqrt{(C)}$ will be touched at any point for which the values of $\sqrt{(A)}$, $\sqrt{(B)}$, $\sqrt{(C)}$ are ρ , ρ' , ρ'' , by the circle $\frac{l}{\rho}A + \frac{m}{\rho'}B + \frac{n}{\rho''}C = 0$. The condition that this circle should cut orthogonally the tangent circle to $l'\sqrt{(A)} + m'\sqrt{(B)} + n'\sqrt{(C)}$ is

$$a^2 \frac{mn' + m'n}{\rho'\rho''} + b^2 \frac{n'l' + n'l}{\rho''\rho} + c^2 \frac{lm' + l'm}{\rho\rho'} = 0.$$

But, solving between the two equations

$$l\rho + m\rho' + n\rho'' = 0, \quad l'\rho + m'\rho' + n'\rho'' = 0,$$

we find ρ , ρ' , ρ'' respectively proportional to $mn' - m'n$, $n'l' - n'l$, $ln' - l'm$. Substituting in the preceding equation, we find that the condition that the quartics should be mutually orthogonal is

$$a^2 (m^2n'^2 - m'^2n^2) + b^2 (n^2l'^2 - n'^2l^2) + c^2 (l^2m'^2 - l'^2m^2) = 0,$$

the same as the condition already found that the quartics should be confocal; and the theorem stated is therefore proved. It does not appear to be necessary to the validity of this proof that C should be real, and hence the theorem is true that confocal quartics cut at right angles, even though the four real foci should not lie in a circle.

278. The theorem of Art. 277 was originally obtained from geometrical considerations by Dr. Hart for the case of the circular cubic. If we seek the locus of a point whose distances from three fixed points are connected by the relation $l\rho + m\rho' + n\rho'' = 0$, the coefficient of $(x^2 + y^2)^2$ will be found to be

$$(l + m + n)(m + n - l)(n + l - m)(l + m - n).$$

Consequently, the locus, which is ordinarily a bicircular quartic, reduces to a circular cubic if $l \pm m \pm n = 0$, and the theorems already here proved are true for circular cubics, which have also sixteen foci lying in general in four circles. Dr. Hart's proof, which was given at length in the first edition, shews that if O, P, Q be the centres of the quadrangle formed by the four foci A, B, C, D , the cubic must pass through these points, the tangents at any of these points O being one of the bisectors of the angle made by the intersecting lines AC, BD , and being parallel to the real asymptote of the cubic; and that the cubic

also passes through R the centre of the focal circle, the tangent at R being parallel to the same asymptote.*

Since then O, P, Q, R are points of contact of tangents from the same point of the curve, the point where OP meets QR (or the foot of the perpendicular from O on QR) is also a point on the curve (Art. 150), and similarly the points where OQ meets PR , and OR, PQ ; and it can be shewn that the tangents at each of these points to the two cubics which pass

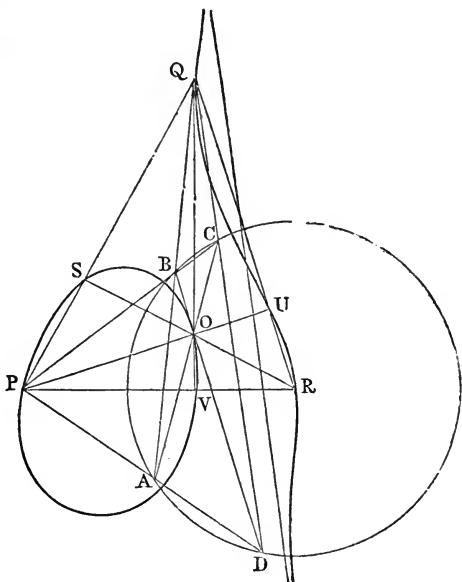

through them cut at right angles. Thus the seven points common to the two cubics having A, B, C, D for their foci, are determined by simple constructions, and we may arrive by projection at theorems, some of which have been already stated; for instance (see Art. 152), if corresponding tangents, taken in any order, from two points I, J mutually intersect in points A, B, C, D , the centres of the quadrangle formed by these points will be also points on the cubic, having for a common tangential point the point where IJ meets the curve again; and the point of contact of the fourth tangent from this point will be the pole of IJ with respect to the conic through the points A, B, C, D, I, J .

279. The method by which Dr. Hart proved these theorems was by shewing that when the foci are given, the relations established Art. 276, combined with the condition $l+n=m$, suffice to determine l, m, n , and that actually, denoting the

* Thus the centres of the four focal circles of a circular cubic are the points of contact of tangents parallel to the real asymptote.

distances of O from the four foci by a, b, c, d , the curve must either have the property

$$(b+c)\rho \pm (a-b)\rho'' = \pm(a+c)\rho', \text{ or } (c-b)\rho \pm (a+b)\rho'' = \pm(a+c)\rho'.$$

Each coefficient is given a double sign, because, when the equation $l\rho + m\rho' + n\rho'' = 0$ is cleared of radicals, it only contains the squares of l, m, n . The two equations answer to two different cubics having the given points as foci; the different signs answer to different branches of the same cubic. The upper signs belong to a branch extending to infinity; for then the equation is satisfied by the values $\rho = \rho' = \rho''$, which are true for an infinitely distant point. The centre of the focal circle obviously lies on this branch. The lower signs belong to an oval, the equations then not being satisfied by $\rho = \rho' = \rho''$. The equations being satisfied by the values a, b, c for ρ, ρ', ρ'' , we see that O is a point on the cubic.

In like manner we have the relations

$$(c-d)\rho \pm (a+d)\rho'' = \pm(a+c)\rho''' \text{ or } (c+d)\rho \pm (a-d)\rho'' = \pm(a+c)\rho''',$$

whence, combining the equations,

$$\frac{\rho + \rho''}{a+c} = \frac{\rho' + \rho'''}{b+d};$$

or the two cubics make up the locus of the intersection of two similar conics whose foci are respectively A and C, B and D . The similar conics which intersect at O have evidently as a common tangent one of the bisectors of the angles at O ; these therefore are, as has been stated, the tangents to the two cubics which constitute the locus, and which therefore cut at right angles.

280. Bicuspidal quartics may be considered as a limiting case of binodal quartics. In the case where the two cusps are the circular points I, J at infinity, the curve is called a Cartesian. Des Cartes studied this curve (thence known as the oval of Des Cartes), as the locus of a point O , whose distances from two fixed points A, B are connected by the relation $l\rho \pm m\rho' = c$. Chasles shewed, and it can be verified without difficulty, that whenever this relation holds good, a third point C can be found on the line AB , whose distance from O satisfies a relation of the form $l\rho \pm n\rho'' = c'$; in other words, that the

oval possesses, besides the two foci considered by Des Cartes, a third possessing the same property. We use the word Cartesian here in a somewhat wider sense. We shall shew that when a quartic has the two points I, J for cusps, it has three foci lying on a right line. When these foci are real, the curve is the same as that studied by Des Cartes; when two are imaginary we still call the curve a Cartesian, though Des Cartes' mode of generation is no longer applicable.

The equation of the Cartesian may generally be brought to the form $S^2 = k^3 L$, where S represents a circle and L a right line, k being a constant (or, what is the same thing, $k = 0$ being the right line at infinity), from which form it is evident that the intersections of S and L are cusps, the cuspidal tangents meeting in the centre of S , which is therefore the triple focus of the Cartesian, while L is evidently a bitangent of the curve.* The curve is then obviously the envelope of the variable circle $\lambda^2 k L + 2\lambda S + k^2 = 0$, the centre of which obviously moves along a right line perpendicular to L ; and equating the discriminant to zero, there are easily seen to be three values of λ , for which the circle reduces to a point, and therefore three foci. From the theory already given, if A, B, C be any three of the variable circles, the equation of the envelope may be written in the form $l\sqrt{A} + m\sqrt{B} + n\sqrt{C} = 0$; and therefore we have the property $l\rho + m\rho' + n\rho'' = 0$, where ρ, ρ', ρ'' denote the distances from the three foci; or, again, since k^2 is a circle of the system answering to the value $\lambda = 0$, we have $l\rho + m\rho' = nk$.

A Cartesian may also be generated as the locus of the vertex of a triangle, whose base angles move on two fixed circles, while the two sides pass through the centres of the circles, and the base passes through a fixed point on the line joining them.

If any chord meet a Cartesian in four points, the sum of their distances from any focus is constant; for the polar equation, the focus being pole, is easily seen to be of the form

$$\rho^2 - 2(a + b \cos \omega) \rho + c^2 = 0,$$

* This equation has been studied by Prof. Cayley under the form

$$(x^2 + y^2 - a^2)^2 + 16A(x - m) = 0.$$

and if we eliminate ω between this and the equation of an arbitrary line, we get for ρ a biquadratic of which $-4a$ is the coefficient of the second term.

When, in the preceding $c=0$, the equation becomes $\rho = a + b \cos \omega$, and in addition to the two cusps I, J , the curve has the origin for a node. It is then called Pascal's *limaçon*, and may evidently be generated by taking a constant length on the radii vectores to a circle from a point on it. If, further, $a=b$, the curve becomes tricuspidal, and is called the *cardioide*, a curve generated by adding or subtracting a portion equal to the diameter, on the radii vectores to a circle from a point on it. The equation may be written in the form $\rho^2 = m^2 \cos \frac{1}{2}\omega$.

281. The focal properties we have been discussing may be investigated by the method of inversion (Art. 122). It is easy to shew, that to a focus of any curve corresponds a focus of the inverse curve, and that the origin or centre of inversion will be a focus if the points I, J at infinity are cusps. Thus, for the Cartesian which has three collinear foci, the inverse with regard to any point is a bicircular quartic having three foci on a circle passing through the origin, which is also a focus. In inverting, if O be the origin, A, B any two points, a, b the inverse points, then for the distance AB we are to substitute $\frac{ab}{Oa \cdot Ob}$. To any relation then of the form $\lambda AP + \mu BP = c$ will correspond one of the form $\lambda' ap + \mu' bp = c' Op$, and thus by considering the bicircular quartic as the inverse of a Cartesian we arrive at the fundamental property of bicircular quartics; and, in like manner, from any relation of the form $\lambda AP + \mu BP + \nu CP = 0$ may be deduced a relation $\lambda' ap + \mu' bp + \nu' cp = 0$. The inverse of a bicircular quartic from any point on the curve is a circular cubic which, therefore, possesses the same focal properties. A circular cubic or bicircular quartic is its own inverse with respect to any of the points O, P, Q, R (p. 249). The angle at which two curves cut is not altered by inversion, and therefore the theorem as to confocal curves cutting at right angles, if proved for cubics, is proved also for quartics. The inverse of a conic is a bicircular quartic having the origin for an additional node, and from

the focal property of conics may be inferred that such quartics have the property

$$\frac{ap}{Oa} + \frac{bp}{Ob} = c.Op,$$

where a and b are two foci and O the node. In like manner, by inverting the focus and directrix property of conics, we arrive at another method, given by Dr. Hart, for generating this kind of quartic. If the radius vector from a fixed point C to P meet a fixed circle passing through C in E , and if A be another fixed point, the quartic is the locus of the point P , for which $PA = PE$.

282. There exists for the binodal quartic* a theory of the inscription of polygons, analogous to Poncelet's theory in regard to conics. Let A, B be the nodes: starting from a point P of the curve, if we join this with A , the line AP meets the curve in one other point, say Q ; joining this with B , the line BQ meets the curve in one other point, say R ; joining this again with A , the line AR meets the curve in one other point, say S ; and so on. We have thus, in general, an unclosed polygon $PQRS\dots$, of which the alternate sides PQ, RS, \dots pass through A , and the other alternate sides QR, \dots pass through B . For a binodal quartic taken at random, it is not possible to find the point P , such that there shall be a closed polygon of a given even number of sides; for instance, a quadrilateral $PQRS$, of which the sides PQ, RS pass through A and the sides QR, SP pass through B . But the quartic may be such that there exists a polygon of the kind in question (as regards the quadrilateral this is obviously the case, since considering a quadrilateral $PQRS$ drawn at pleasure and taking A for the intersection of PQ, RS , and B for that of QR, SP , we can describe a quartic passing through the points P, Q, R, S , and having the points A, B for nodes), and when this is so, that is, when there is one polygon, there are an infinity of polygons; viz. any point P whatever of the curve may be taken as the first summit, and the polygon, constructed as above, will close of itself.

* Steiner, Geometrische Lehrsätze, *Crelle*, vol. XXXII, p. 186 (1846).

UNICURSAL QUARTICS.

283. Taking the nodes to be at the angular points of the triangle of reference, the equation of the curve must be of the form

$$ay^2z^2 + bz^2x^2 + cx^2y^2 + 2fx^2yz + 2gy^2zx + 2hz^2xy = 0,$$

which may be written

$$a \left(\frac{1}{x}\right)^2 + b \left(\frac{1}{y}\right)^2 + c \left(\frac{1}{z}\right)^2 + 2f \frac{1}{yz} + 2g \frac{1}{zx} + 2h \frac{1}{xy} = 0.$$

Thus we see that the quartic may be generated from a conic by writing, in the equation of the latter, for each coordinate its reciprocal; a process which may be called "inversion," using the word in a wider sense than that in which we have already employed it. It is easy to express this transformation by a geometrical construction. Let the coordinates be proportional to the perpendicular distances from the sides of the triangle of reference, and let P, P' be two points, whose coordinates are connected by the reciprocal relations

$$x : y : z = y'z' : z'x' : x'y' ; \quad x' : y' : z' = yz : zx : xy ;$$

then we have seen, *Conics*, Art. 55, that the lines joining P, P' to the vertices of the triangle make equal angles with the sides; or otherwise, *Conics*, p. 263, that if P be one focus of a conic touching x, y, z , then P' will be the other focus. In general, in this method to any position of P corresponds a single definite position of P' . If, however, we have $x' = 0$, or P' anywhere on the line BC , we have y and z both $= 0$, and P coincides with A ; and reciprocally to A corresponds any point on BC . It is to be remarked, however, that when $x' = 0$, the corresponding values of y and z , being respectively $z'x', x'y'$, though evanescent, have to each other the definite ratio $z' : y'$; and therefore to any point P' on BC corresponds a definite element of direction through A . We have, in fact, P indefinitely near to A , but in a given definite direction, viz. such that (as in the general case) AP, AP' make equal angles with the sides. If now P describe any locus, the other point P' will describe a corresponding locus; thus if the locus described by P be the right line $ax + by + cz = 0$, that described by P' will be the conic $ay'z' + bz'x' + cx'y' = 0$, and *vice versa* (compare *Conics*, Art. 297,

Ex. 13); if $a=0$, that is to say, if the line pass through A , the conic reduces to $x'(bz' + cy') = 0$, and leaving out the line x' or BC , we may say that to the line $by + cz$ corresponds the line $bz' + cy'$; and, as already mentioned, if the one locus be any conic, the other will be a trinodal quartic.

284. The correspondence of the conic and quartic may be examined in detail; the conic meets each side of the triangle, say BC in two points; corresponding hereto we have through A two elements of direction, viz. these are the tangents of the quartic at its node A . Hence, according as the conic meets BC in two imaginary points, touches it, or meets it in two real points, the quartic has at A an acnode, cusp, or crunode, and the like for the other sides. Thus, if the conic be an ellipse or, say, a circle, situate wholly within the triangle, the quartic is a triacnodal curve composed of a trigonoid figure within the triangle and of the three vertices as acnodes (fig. 1); if the ellipse is inscribed in the triangle, the quartic is tricuspidal (fig. 2); if the ellipse cuts each side in two real points, then the quartic is tricrunodal; viz. if on each side the intersections are internal we have the fig. 3, whereas if the intersections are external we have the fig. 4. It is to be observed,

Fig. (1).

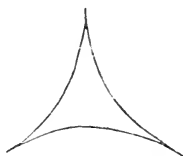

Fig. (2).

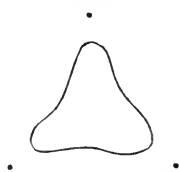

Fig. (3).

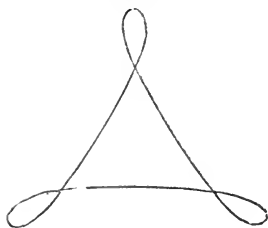
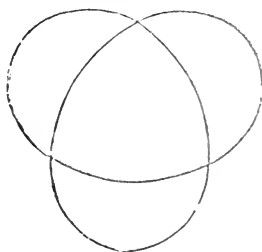

Fig. (4).



that in the transition from the one form to the other the ellipse must pass successively through the vertices of the triangle; and that when the ellipse passes through a vertex the corresponding quartic breaks up into a right line and a cubic; the transition cannot be made (as at first sight it would appear it might) through a quartic having a triple point.

The complete discussion of the different forms would be interesting and not difficult, but it would occupy a good deal of space; it would be necessary (in the present case of plane curves) to consider the conics which in each figure correspond to the line at infinity of the other figure. For the like theory, as regards spherical figures, there are no such conics, and the theory is considerably simplified.

285. The foregoing mode of generation of the trinodal quartic leads at once to various properties of the curve. It is well known that if a conic cuts the sides BC , CA , AB of a triangle, and from each vertex we draw lines to the intersections on the opposite sides, these six lines touch a conic; and it is easy to shew further, that if instead of the two lines through each vertex we consider the two inverse lines, these meet the opposite sides in six points lying on a conic; and consequently that the six inverse lines also touch a conic. In fact, if the lines $(x = \alpha y, x = \alpha' y)$, $(y = \beta z, y = \beta' z)$, $(z = \gamma x, z = \gamma' x)$ meet the sides $x = 0, y = 0, z = 0$ respectively in six points lying on a conic, it is easily seen that $\alpha\alpha'\beta\beta'\gamma\gamma' = 1$, a relation which remains unaltered when $\alpha, \beta, \gamma, \alpha', \beta', \gamma'$ are changed into their reciprocals. Now, if a conic is transformed into a binodal quartic, then by what precedes the tangents at a node A of the quartic are the inverses of the lines from A to the intersections of BC with the conic; hence, *the tangents at the nodes A, B, C , touch one and the same conic*; a theorem which may also be derived directly from the equation of the quartic.

286. Similarly, if from the points A, B, C we draw tangents to a conic, then it may be shewn that the six inverse lines are also tangents to a conic. But transforming the conic into a trinodal quartic, the tangents from A to the conic are trans-

formed into the tangents from the node A to the quartic (for a curve of class n , the number of tangents from a node is $=n-4$, and therefore for a trinodal quartic it is $=2$); and we have thus the theorem, that the six tangents from the three nodes to the quartic touch one and the same conic.

287. To the bitangents of the quartic correspond conics through A, B, C , having double contact with the conic; and to the stationary tangents of the quartic correspond conics through A, B, C , having stationary contact with the conic. It can be shewn, that the numbers of such conics are 4 and 6 respectively, agreeing with $\tau=4, \iota=6$. But the result as to the bitangents can immediately be obtained from the equation of the curve, which may be written in the form

$$\{yz\sqrt{a} + zx\sqrt{b} + xy\sqrt{c}\}^2 = 2xyz [\{\sqrt{bc} - f\}x + \{\sqrt{ca} - g\}y + \{\sqrt{ab} - h\}z],$$

where the factor multiplying $2xyz$ evidently denotes a bitangent, and by changing the signs of the radicals, we have in all four bitangents. Write for a moment $fx + gy + hz = s$, $x\sqrt{bc} = l$, $y\sqrt{ca} = m$, $z\sqrt{ab} = n$, and if $\Theta = 0$ denote the equation of the four bitangents, we have

$$\begin{aligned} \Theta &= (s - l - m - n)(s - l + m + n)(s + l - m + n)(s + l + m - n) \\ &= (s^2 - l^2 - m^2 - n^2)^2 - 4(m^2n^2 + n^2l^2 + l^2m^2 + 2lmns) \\ &= (s^2 - l^2 - m^2 - n^2)^2 - 4abcU. \end{aligned}$$

In other words, the equation of the curve may be written

$$\{(fx + gy + hz)^2 - bcx^2 - cay^2 - abz^2\}^2 - \Theta = 0,$$

shewing that the eight points of contact of the bitangents lie on a conic.

If the four bitangents be denoted by t, u, v, w , the equation of the quartic may be written

$$t^2 + u^2 + v^2 + w^2 = 0,$$

$$\text{or } (t^2 + u^2 + v^2 + w^2 - 2tu - 2tv - 2tw - 2vw - 2wu - 2uv)^2 = 64tuvw.$$

In this form it is evident that t, u, v, w are bitangents whose points of contact lie on a conic, and it can be verified without much difficulty, that $(t - u, v - w)$, $(t - v, u - w)$, $(t - w, u - v)$ are nodes.

288. We have just shewn how in one way the equation of the quartic can be reduced to the form $UW = V^2$; and generally if u, w , and v denote any two tangents to the conic and their chord of contact, since the equation of the conic can be written in the form $uw = v^2$, that of the quartic is thence immediately given in the form $UW = V^2$, where U, V, W are linear functions of yz, zx, xy .

In connecting the trinodal quartic as above with a conic, we have also verified that the curve is unicursal. Since the coordinates x', y', z' of a point on the conic can be expressed as quadratic functions of a parameter θ , the coordinates $y'z', z'x', x'y'$ of the corresponding point on the quartic are immediately given as biquadratic functions of the same parameter.

The preceding theory of trinodal quartics extends to the case when any or all of the singular points are cusps. If all are cusps the equation of the curve is reducible to the form $x^{\frac{1}{2}} + y^{\frac{1}{2}} + z^{\frac{1}{2}} = 0$, and the tangents at the cusps are $x=y=z$, which meet in a point; as we may also see by reciprocation, the reciprocal being a cubic whose equation may be written in the form $x^{\frac{1}{2}} + y^{\frac{1}{2}} + z^{\frac{1}{2}} = 0$. When the curve has two cusps and a node, the line joining the two points of inflexion, the line joining the two cusps, and the bitangent all pass through the same point. The cases of the higher singularities, described Art. 243, require to be separately treated.

289. The equation of a quartic having a tacnode, as given Art. 244, is

$$y^2z^2 + bx^2yz + cxy^2z + dy^3z + ex^4 + fx^3y + gx^2y^2 + hxy^3 + iy^4 = 0.$$

Let it also have a node, and since, in Art. 244, it was only assumed that the point xy was the tacnode and the line y the tangent at it, we may take the point zx as the other node. In order that this point should be a node we must have d, h , and $i = 0$, and the equation becomes

$$(yz)^2 + bx^2.yz + cxy.yz + ex^4 + fx^2.xy + gx^2y^2 = 0.$$

We have written the equation so as to exhibit that it is a quadratic function of xy, x^2, yz . Hence, if in the general equation of a conic we write xy, x^2, yz for x, y, z respectively,

we shall have the equation of a quartic with node and tacnode. It will be seen that the relations

$$x' : y' : z' = xy : x^2 : yz$$

imply reciprocally $x : y : z = x'y' : x'^2 : y'z'$,

so that we have a like theory to that which exists for a quartic with three distinct nodes. The constants may be determined so that the node shall become a cusp, or the tacnode a node-cusp, or that both these changes should take place, and the theory thus extends to quartics having two distinct singular points, one of them a node or cusp, the other a tacnode or node-cusp.

290. The equation of a quartic having an oscnode has been given, Art. 244, as

$$(yz - mx^2)^2 + cxy(yz - mx^2) + dy^3z + gx^2y^2 + hxy^3 + iy^4 = 0.$$

It is obviously a quadratic function of $yz - mx^2$, xy , y^2 . Now the relations

$$x' : y' : z' = xy : y^2 : yz - mx^2$$

will be found to imply

$$x : y : z = x'y' : y'^2 : y'z' + mx'^2,$$

so that there is for the present case a theory analogous to that established for trinodal quartics. The constants may be particularized, so that the oscnode becomes a tacnode-cusp, and the theory thus extends to the case of quartics having a tacnode cusp. In all these foregoing cases we have expressed the coordinates x , y , z of any point on the quartic, as quadratic functions of x' , y' , z' , a variable point on a conic; and since the latter coordinates can be expressed as quadratic functions of a parameter θ , the former coordinates are expressed as quartic functions of the same parameter.

291. In the remaining case of a quartic curve having a triple point (general or of any special form), the mode of treatment used in the last articles is not applicable, but we can otherwise immediately express the coordinates as rational functions of a parameter. Taking the point xy as the triple point, the equation of the curve is of the form $zu_3 = u_4$, where u_3 , u_4

are homogeneous functions of the third and fourth degrees respectively in x, y . If we now substitute $y = \theta x$, we get $z^{\Theta_3} = x^{\Theta_4}$, where Θ_3, Θ_4 denote cubic and quartic functions of θ ; and we have x, y, z respectively proportional to $\Theta_3, \theta\Theta_3, \Theta_4$.

The method here employed is exactly that suggested in Art. 44. A variable line $y = \theta x$ drawn through the triple point meets the curve in but one other point, the coordinates of which are therefore rationally expressible in terms of θ . And we should be led to substantially the same results if we employed the same method in the cases previously considered; for example, if in the case of a trinodal quartic we determine each point of the quartic as the intersection of the curve with a variable conic passing through the three nodes, and through another fixed point on the curve.

The special case of a quartic with a triple point $x^3y = z^4$ may be particularly noticed, as it can be treated by exactly the same method as was used (Art. 212). The curve has, beside the triple point, no singular point but a point of undulation, and its reciprocal is a curve of like nature.

291 (a). Unicursal quartics may also be treated by the method of Art. 216 (a). We may express the coordinates

$$\begin{aligned}x &= a\lambda^4 + 4b\lambda^3\mu + 6c\lambda^2\mu^2 + 4d\lambda\mu^3 + e\mu^4, \\y &= a'\lambda^4 + 4b'\lambda^3\mu + 6c'\lambda^2\mu^2 + 4d'\lambda\mu^3 + e'\mu^4, \\z &= a''\lambda^4 + 4b''\lambda^3\mu + 6c''\lambda^2\mu^2 + 4d''\lambda\mu^3 + e''\mu^4,\end{aligned}$$

and can (Art. 44) write down the equation of the corresponding quartic. The equation determining the parameters of the points of inflexion, and the relation between the parameters of three points which lie in a right line, may be found as in the articles referred to, or else as follows. Substituting the above written values for the coordinates in $lx + my + nz = 0$, we get a quartic determining the parameters of the points in which that line meets the curve.* The theory of equations then enables us

* It is evident that by forming the discriminant of that quartic we get the equation of the reciprocal, or tangential equation, in the form $S^3 = T^2$.

to write down

$$\begin{aligned}
 la + ma' + na'' &= \mu\mu'\mu''\mu''', \\
 -4(lb + mb' + nb'') &= \lambda\mu'\mu''\mu''' + \mu\lambda'\mu''\mu''' + \mu\mu'\lambda''\mu''' + \mu\mu'\mu''\lambda''', \\
 6(lc + mc' + nc'') &= \lambda\lambda'\mu''\mu''' + \mu\mu'\lambda''\lambda''' + \lambda\lambda''\mu'\mu''' + \mu\mu''\lambda'\lambda''' \\
 &\quad + \lambda\lambda''' \mu'\mu'' + \mu\mu''' \lambda'\lambda'', \\
 -4(ld + md' + nd'') &= \mu\lambda'\lambda''\lambda''' + \lambda\mu'\lambda''\lambda''' + \lambda\lambda''\mu'\lambda''' + \lambda\lambda'\lambda''\mu''', \\
 le + me' + ne'' &= \lambda\lambda'\lambda''\lambda'''.
 \end{aligned}$$

From these equations, if we linearly eliminate $l, m, n, \lambda''', \mu'''$, we get the relation connecting the parameters of three points on a right line, viz.

$$\begin{vmatrix}
 a & , & a' & , & a'' & , & A, \\
 -4b & , & -4b' & , & -4b'' & , & B, A \\
 6c & , & 6c' & , & 6c'' & , & C, B \\
 -4d & , & -4d' & , & -4d'' & , & D, C \\
 e & , & e' & , & e'' & , & D
 \end{vmatrix} = 0,$$

where we have written

$$\begin{aligned}
 A &= \mu\mu'\mu'', \quad B = \lambda\mu'\mu'' + \lambda'\mu''\mu + \lambda''\mu\mu', \\
 C &= \mu\lambda'\lambda'' + \mu'\lambda''\lambda + \mu''\lambda\lambda', \quad D = \lambda\lambda'\lambda''.
 \end{aligned}$$

If we make $\lambda : \mu = \lambda' : \mu' = \lambda'' : \mu''$, we find that the parameters of the points of inflexion are determined by

$$\begin{vmatrix}
 a & , & a' & , & a'' & , & \mu^3, \\
 -4b & , & -4b' & , & -4b'' & , & 3\mu^2\lambda, \mu^3 \\
 6c & , & 6c' & , & 6c'' & , & 3\mu\lambda^2, 3\mu^2\lambda \\
 -4d & , & -4d' & , & -4d'' & , & \lambda^3, 3\mu\lambda^2 \\
 e & , & e' & , & e'' & , & \lambda^3
 \end{vmatrix} = 0.$$

The first determinant expanded may be written

$$\begin{aligned}
 24(ab'c'')D^2 + 16(ab'd'')CD + 4(ab'e'')(C^2 - BD) \\
 + 24(ac'd'')BD + 6(ac'e'')(BC - AD) + 96(bc'd'')AD \\
 + 4(ad'e'')(B^2 - AC) + 24(bc'e'')AC + 16(bd'e'')AB \\
 + 24(cd'e'')A^2 = 0;
 \end{aligned}$$

and the second determinant expanded and divided by 24 gives, for determining the inflexions, the sextic

$$\begin{aligned} (ab'c'')\lambda^6 + 2(ab'd'')\lambda^5\mu + \{(ab'e'') + 3(ac'd'')\}\lambda^4\mu^2 \\ + \{2(ac'e'') + 4(bc'd'')\}\lambda^3\mu^3 + \{(ad'e'') + 3(bc'e'')\}\lambda^2\mu^4 \\ + 2(bd'e'')\lambda\mu^5 + (cd'e'')\mu^6 = 0. \end{aligned}$$

If in the preceding relation two of the parameters be made equal, we get the relation connecting the parameter of any point A with that of one of the points B where the tangent at A meets the curve again, viz. writing for D, C, B, A respectively $\lambda^2\lambda', 2\lambda\mu\lambda' + \lambda^2\mu', \mu^2\lambda' + 2\lambda\mu\mu', \mu^2\mu'$, we have

$$\begin{aligned} \lambda'^2 [24(ab'c'')\lambda^4 + 32(ab'd'')\lambda^3\mu + \{12(ab'e'') + 24(ac'd'')\}\lambda^2\mu^2 \\ + 12(ac'e'')\lambda\mu^3 + 4(ad'e'')\mu^4] \\ + 2\lambda'\mu' [8(ab'd'')\lambda^4 \\ + \{4(ab'e'') + 24(ac'd'')\}\lambda^3\mu + \{12(ac'e'') + 48(bc'd'')\}\lambda^2\mu^2 \\ + \{4ad'e'' + 24(bc'e'')\}\lambda\mu^3 + 8(bd'e'')\mu^4] \\ + \mu'^2 \{4(ab'e'')\lambda^4 \\ + 12(ac'e'')\lambda^3\mu + (12ad'e^4 + 24(bc'e''))\lambda^2\mu^2 + 32(bd'e'')\lambda\mu^3 \\ + 24(cd'e'')\mu^3\} = 0, \end{aligned}$$

from which equation we can determine the parameters, either of the two points B answering to any point on the curve A , or of the 4 points A answering to any point B . If we form the condition that the equation in $\lambda' : \mu'$ should have equal roots, we get an octavic in $\lambda : \mu$, determining the parameters of the 8 points of contact of the 4 bitangents of the quartic.

When it has been proved that it is possible to find four linear functions t, u, v, w of x, y, z , which expressed in terms of λ, μ are perfect squares, it is evident by extraction of roots and linear elimination of $\lambda^2, \lambda\mu, \mu^2$, that the equation of the curve can be written in the form $At^2 + Bu^2 + Cv^2 + Dw^2 = 0$.

291 (b). Conditions to be satisfied by the parameters of a node are obtained as in Art. 216 (c), from the consideration that the relation connecting the parameters of three collinear points must be satisfied when two of these parameters correspond to the same node, and the third to any point whatever on the curve. Write $\mu'\mu'' = \alpha, \lambda'\mu'' + \lambda''\mu' = \beta, \lambda'\lambda'' = \gamma$, then we have $A = \mu\alpha$,

$B = \lambda\alpha + \mu\beta$, $C = \lambda\beta + \mu\gamma$, $D = \lambda\gamma$. Substituting these values in the determinant of the last article, and equating separately to zero the coefficients of λ^2 , $\lambda\mu$, μ^2 we have the three conditions

$$\begin{vmatrix} a & a' & a'' & \alpha \\ -4b & -4b' & -4b'' & \beta \\ 6c & 6c' & 6c'' & \gamma \\ -4d & -4d' & -4d'' & \gamma \\ e & e' & e'' & \gamma \end{vmatrix} = 0, \quad \begin{vmatrix} a & a' & a'' \\ -4b & -4b' & -4b'' \\ 6c & 6c' & 6c'' \\ -4d & -4d' & -4d'' \\ e & e' & e'' \end{vmatrix} = 0,$$

$$\begin{vmatrix} a & a' & a'' & \alpha \\ -4b & -4b' & -4b'' & \beta \\ 6c & 6c' & 6c'' & \gamma \\ -4d & -4d' & -4d'' & \beta \\ e & e' & e'' & \gamma \end{vmatrix} = 0.$$

Conditions which expanded are

$$24(ab'c'')\gamma^2 + 16(ab'd'')\beta\gamma + 4(ab'e'')(\beta^2 - \alpha\gamma) + 24(ac'd'')\alpha\gamma + 6(ac'e'')\alpha\beta + 4(ad'e'')\alpha^2 = 0,$$

$$4(ab'e'')\gamma^2 + 6(ac'e'')\beta\gamma + 4(ad'e'')(\beta^2 - \alpha\gamma) + 24(bc'e'')\alpha\gamma + 16(bd'e'')\alpha\beta + 24(cd'e'')\alpha^2 = 0,$$

$$16(ab'd'')\gamma^2 + 4(ab'e'')\beta\gamma + 24(ac'd'')\beta\gamma + 6(ac'e'')\beta^2 + 96(bc'd'')\alpha\gamma + 4(ad'e'')\alpha\beta + 24(bc'e'')\alpha\beta + 16(bd'e'')\alpha^2 = 0.$$

With these equations we combine the three obtained by multiplying the equation $\lambda^2\alpha - \mu\lambda\beta + \mu^2\gamma = 0$ by α , β , γ respectively, and linearly eliminating α^2 , β^2 , γ^2 , $\beta\gamma$, $\gamma\alpha$, $\alpha\beta$ we get a sextic for determining the parameters of the three nodes.

There is no difficulty in analysing, as in Art. 216 (d), the different cases where the sextic of the last article can have equal roots, and so arriving at the different special cases of unicursal quartics already enunciated.

INVARIANTS AND COVARIANTS OF QUARTICS.

292. When we have occasion to write the equation of a quartic at length, we shall write it

$$ax^4 + by^4 + cz^4 + 6fy^2z^2 + 6gz^2x^2 + 6hx^2y^2 + 12lx^2yz + 12my^2zx + 12nz^2xy + 4a_2x^3y + 4a_3x^3z + 4b_1y^3x + 4b_2y^3z + 4c_1z^3x + 4c_2z^3y = 0.$$

The concomitant of lowest order in the coefficients is the contravariant (Art. 92) of the second order in the coefficients, whose symbolical expression is $(\alpha 12)^4$, and whose vanishing expresses that the line $\alpha x + \beta y + \gamma z$ cuts the quartic in four points, for which the invariant S vanishes. We shall call this contravariant σ ; it is of the fourth order in the variables α, β, γ , and its coefficients are

$$A = bc + 3f^2 - 4b_3c_2, \quad B = ca + 3g^2 - 4c_1a_2, \quad C = ab + 3h^2 - 4a_2b_1,$$

$$F = af + gh + 2l^2 - 2a_2n - 2a_3m,$$

$$G = bg + hf + 2m^2 - 2b_3l - 2b_1n,$$

$$H = ch + fg + 2n^2 - 2c_1m - 2c_2l,$$

$$L = 2fl - mn - gb_3 - hc_2 + b_1c_1,$$

$$M = 2gm - nl - hc_1 - fa_3 + c_2a_2,$$

$$N = 2hn - lm - fa_2 - gb_1 + a_3b_3,$$

$$A_2 = 3mc_2 - 3nf - cb_1 + b_3c_1, \quad A_3 = 3nb_3 - 3mf - bc_1 + b_1c_2,$$

$$L_2 = 3na_3 - 3lg - ac_2 + a_2c_1, \quad B_1 = 3lc_1 - 3ng - ca_2 + c_2a_3,$$

$$C_1 = 3lb_1 - 3mh - ba_3 + b_3a_2, \quad C_2 = 3ma_2 - 3lh - ab_3 + a_3b_1.$$

293. The contravariant just mentioned is the evectant of the simplest invariant A , which is of the third order in the coefficients, and has for its symbolical expression $(123)^4$; that is to say, σ is found by performing on A the operation

$$\alpha^4 \frac{d}{d\alpha} + \beta^4 \frac{d}{d\beta} + \gamma^4 \frac{d}{d\gamma} + \beta^2 \gamma^2 \frac{d}{df} + \&c.;$$

and conversely from the values already given for the coefficients of σ the value of A can be inferred. This is

$$\begin{aligned} A = abc + 3 (af^2 + bg^2 + ch^2) - 4 (ab_3c_2 + bc_1a_3 + ca_2b_1) \\ + 12 (f^2l^2 + gm^2 + hn^2) + 6fgh - 12lmn \\ - 12 (a_2nf + a_3mf + b_1ng + b_3lg + c_1mh + c_2lh) \\ + 12 (lb_1c_1 + mc_2a_2 + na_3b_3) + 4 (a_2b_3c_1 + a_3b_1c_2). \end{aligned}$$

If we use the same notation as in Art. 223, the value of A may be written

$$r (d^2) + 4 (dca) + 3 (db^2) - 12 (c^2b),$$

where

$$\begin{aligned}
 (d^2) &= d_0 d_4 - 4d_1 d_3 + 3d_2^2, \\
 (dca) &= a_0 \{d_1 c_3 - 3d_2 c_2 + 3d_3 c_1 - d_4 c_0\} + a_1 \{d_3 c_0 - 3d_2 c_1 + 3d_1 c_2 - d_0 c_3\}, \\
 (db^2) &= d_0 b_2^2 - 4d_1 b_1 b_2 + 4d_2 b_1^2 + 2d_2 b_0 b_2 - 4d_3 b_0 b_1 + d_4 b_0^2, \\
 (c^2 b) &= b_2 (c_0 c_2 - c_1^2) - b_1 (c_0 c_3 - c_1 c_2) + b_0 (c_1 c_3 - c_2^2),
 \end{aligned}$$

the invariants (d^2) , (dca) , &c., being all known in the theory of the binary quantics.

294. The next simplest invariant B is of the sixth order in the coefficients. It may be formed by taking the six equations obtained by twice differentiating the given equation with respect to x, y or z , and from these six equations eliminating dialytically $x^2, y^2, z^2, yz, zx, xy$. We thus have B in the form of a determinant

$$\begin{vmatrix}
 a, & h, & g, & l, & a_3, & a_2 \\
 h, & b, & f, & b_3, & m, & b_1 \\
 g, & f, & c, & c_2, & c_1, & n \\
 l, & b_3, & c_2, & f, & n, & m \\
 a_3, & m, & c_1, & n, & g, & l \\
 a_2, & b_1, & n, & m, & l, & h
 \end{vmatrix}.$$

We shall presently give the developed expression for B . Meanwhile, we remark that Clebsch has used this invariant to shew that the form

$$p^4 + q^4 + r^4 + s^4 + t^4 = 0,$$

where p, q, r, s, t are linear functions of the coordinates, is not one to which the equation of every quartic can be reduced. Since p, q , &c., each implicitly contain three constants, the form just written involves fourteen independent constants, and therefore, at first sight, seems capable of being used as a canonical form sufficiently general to represent any quartic. But on forming for the above equation the invariant B , it will be found to vanish, and therefore this form will only represent quartics for which $B = 0$.*

* This class of quartics has been studied by Lüroth, *Mathematische Annalen*, vol. I. p. 37 (1870).

295. In calculating the value of B , it is convenient to use the following value for a symmetrical determinant of six rows and columns, the constituents of which are denoted by a^2 , ab , ac , &c., ba , b^2 , bc , &c.

$$\begin{aligned} & a^2 b^2 c^2 d^2 e^2 f^2 - \Sigma a^2 b^2 c^2 d^2 (ef)^2 + 2 \Sigma a^2 b^2 c^2 . de . ef . fd + \Sigma a^2 b^2 (cd)^2 (ef)^2 \\ & - 2 \Sigma a^2 b^2 . cd . de . ef . fc + 2 \Sigma a^2 . bc . cd . de . ef . fb - 2 \Sigma a^2 (bc)^2 de . ef . fd \\ & + 2 \Sigma (ab)^2 cd . de . ef . fc - \Sigma (ab)^2 (cd)^2 (ef)^2 - 2 \Sigma ab . bc . cd . de . ef . fa \\ & + 2 \Sigma ab . bc . ca . de . ef . fd. \end{aligned}$$

The expanded value of B is as follows:

$$\begin{aligned} & abc (fgh - fl^2 - gm^2 - hn^2 + 2lmn) \\ & + bc \{ l^4 - l^2 gh + 2 (gm - nl) a_2 l + 2 (hn - ml) a_3 l + (n^2 - fg) a_2^2 \\ & \quad + (m^2 - fh) a_3^2 + 2 (fl - mn) a_2 a_3 \} \\ & + ca \{ m^4 - m^2 fh + 2 (fl - mn) b_1 m + 2 (hn - ml) b_3 m + (n^2 - fg) b_1^2 \\ & \quad + (l^2 - gh) b_3^2 + 2 (gm - nl) b_1 b_3 \} \\ & + ab \{ n^4 - n^2 fg + 2 (fl - mn) c_1 n + 2 (gm - ln) c_3 n + (m^2 - fh) c_1^2 \\ & \quad + (l^2 - gh) c_3^2 + 2 (hn - lm) c_1 c_3 \} \\ & - (af^2 + bg^2 + ch^2) (fgh - fl^2 - gm^2 - hn^2 + 4lmn) \\ & + 3 (afm^2 n^2 + bgn^2 l^2 + chl^2 m^2) \\ & + 2af^2 (b_3 gn + c_1 hm) + 2bg^2 (c_2 hl + a_3 fn) + 2ch^2 (a_3 fm + b_3 gl) \\ & - 2af (b_1 n^3 + c_1 m^3) - 2bg (c_2 l^3 + a_2 n^3) - 2ch (a_3 m^3 + b_3 l^3) \\ & + 2afl (b_3 n^2 + c_2 m^2) + 2bgm (c_1 l^2 + a_3 n^2) + 2chn (a_2 m^2 + b_1 l^2) \\ & - 2afmn (b_3 g + c_2 h) - 2bgl n (c_1 h + a_3 f) - 2chlm (a_2 f + b_1 g) \\ & - 2a (b_3 mn^3 + c_2 m^3 n) - 2b (c_1 nl^3 + a_3 ln^3) - 2c (a_2 lm^3 + b_1 ml^3) \\ & + a (b_3^2 gn^2 + c_2^2 hm^2) + b (c_1^2 hl^2 + a_3^2 fn^2) + c (a_2^2 fm^2 + b_1^2 gl^2) \\ & + 2afl (mb_3 c_1 + nb_1 c_2) + 2bgm (nc_2 a_3 + lc_1 a_2) + 2chn (la_3 b_1 + ma_2 b_3) \\ & + 2amn (mb_3 c_1 + nb_1 c_2) + 2bnl (nc_2 a_3 + lc_1 a_2) + 2clm (la_3 b_1 + ma_2 b_3) \\ & - 2af (hnb_3 c_1 + gmb_1 c_2) - 2bg (flc_2 a_3 + hnc_1 a_2) - 2ch (gma_3 b_1 + fl a_2 b_3) \\ & + 2 (fgh + lmn) (ab_3 c_2 + bc_1 a_3 + ca_2 b_1) - 2af l^2 b_3 c_2 - 2bgm^2 c_1 a_3 - 2chn^2 a_2 b_1 \\ & - 2 (af^2 l b_1 c_1 + bg^2 m c_2 a_2 + ch^2 n a_3 b_3) \\ & - 2ab_3 c_2 (b_3 gn + c_1 hm) - 2bc_1 a_3 (c_2 hl + a_2 fn) - 2ca_2 b_1 (a_3 fm + b_3 gl) \\ & + 2ab_1 c_1 (c_2 m^2 + b_3 n^2) + 2bc_2 a_2 (a_3 n^2 + c_1 l^2) + 2ca_3 b_3 (b_1 l^2 + a_2 m^2) \\ & - 2al (mb_1 c_2^2 + nc_1 b_3^2) - 2bm (nc_2 a_3^2 + la_2 c_1^2) - 2cn (a_3 b_1^2 + b_3 a_2^2) \end{aligned}$$

$$\begin{aligned}
 &+ a (hb_3^2c_1^2 + gb_1^2c_2^2) + b (fc_2^2a_3^2 + hc_1^2a_2^2) + c (ga_3^2b_1^2 + ha_2^2b_3^2) \\
 &+ afb_1^2c_1^2 + bgc_2^2a_2^2 + cha_3^2b_3^2 + 2alb_3c_2b_1c_1 + 2bmc_1a_3c_2a_2 + 2cna_2b_1a_3b_3 \\
 &- 2ab_1c_1(mc_1b_3 + nb_1c_2) - 2bc_2a_2(na_2c_1 + lc_2a_3) - 2ca_3b_3(lb_3a_2 + ma_3b_1) \\
 &+ 2f^2g^2h^2 - fgh(fl^2 + gm^2 + hn^2) + 10fghlmn - (fl^2 + gm^2 + hn^2)^2 \\
 &+ 2lmn(fl^2 + gm^2 + hn^2) - l^2m^2n^2 \\
 &+ 2(b_1gn + c_1hm)(gm^2 + hn^2 - 2fl^2 - fgh - lmn) \\
 &+ 2(a_2fn + c_2hl)(hn^2 + fl^2 - 2gm^2 - fgh - lmn) \\
 &+ 2(a_3fm + b_3gl)(fl^2 + gm^2 - 2hn^2 - fgh - lmn) \\
 &+ (gh - l^2)(b_2g - c_2h)^2 + (hf - m^2)(c_1h - a_3f)^2 + (fg - n^2)(a_2f - b_1g)^2 \\
 &+ 2a_2a_3f^2(2mn - fl) + 2b_1b_3g^2(2nl - gm) + 2c_1c_2h^2(2lm - hn) \\
 &+ 2lb_1c_1(fgh + lmn + fl^2 - gm^2 - hn^2) \\
 &+ 2mc_2a_2(fgh + lmn + gm^2 - hn^2 - fl^2) \\
 &+ 2na_3b_3(fgh + lmn + hn^2 - fl^2 - gm^2) \\
 &- 2ghmnb_1c_1 - 2hfnlc_2a_2 - 2fglma_3b_3 \\
 &+ 2(b_1c_2gm + b_3c_1hn)(gh + 2l^2) + 2(c_2a_3hn + c_1a_2fl)(hf + 2m^2) \\
 &+ 2(a_3b_1fl + b_3a_2gm)(fg + 2n^2) \\
 &- 2(a_2^2c_1f^2m + b_3^2a_2g^2n + c_1^2b_3h^2l + a_3^2b_1f^2n + b_1^2c_2g^2l + c_2^2a_3h^2m) \\
 &+ 2fmn(a_2^2c_2 + a_3^2b_3) + 2gln(b_1^2c_1 + b_3^2a_3) + 2klm(c_1^2b_1 + c_2^2a_2) \\
 &- 2(a_2b_3c_1 + a_3b_1c_2)(fl^2 + gm^2 + hn^2 + lmn) \\
 &- 2fa_2a_3(c_2m^2 + b_3n^2) - 2gb_1b_2(c_1l^2 + a_3n^2) - 2hc_1c_2(b_1l^2 + a_2m^2) \\
 &+ 2(fl - mn)(gb_1c_2a_2 + hc_1a_3b_3) + 2(gm - nl)(hc_2a_3b_3 + fa_2b_1c_1) \\
 &+ 2(hn - lm)(fa_3b_1c_1 + gb_3c_2a_2) \\
 &- (l^2b_1^2c_1^2 + m^2c_2^2a_2^2 + n^2a_3^2b_3^2) \\
 &+ 2(b_3c_1a_2 - c_2a_3b_1)(b_3gl + c_1hm + a_2fn - c_2hl - a_3fm - b_1gn) \\
 &+ 2(b_1c_1a_2a_3f^2 + c_2a_2b_3b_1g^2 + a_3b_3c_1c_2h^2) \\
 &- 2gh(b_3^2a_3c_1 + c_2^2a_2b_1) - 2hf(c_1^2b_1a_2 + a_3^2b_3c_2) - 2fg(a_2^2c_2b_3 + b_1^2c_1a_3) \\
 &+ (4fl - 2mn)c_2a_2a_3b_3 + (4gm - 2nl)a_3b_3b_1c_1 + (4hn - 2lm)b_1c_1c_2a_2 \\
 &+ 2(a_2b_3c_1 + a_3b_1c_2)(lb_1c_1 + mc_2a_2 + na_3b_3) - (a_2b_2c_1 + a_3b_1c_2)^2.
 \end{aligned}$$

296. In the notation of Arts. 223, 293, the value of B is

$$\begin{aligned}
 r(d^3)(b^2) - r(d^2c^2b) + r(dc^4) - (d^3)(ba^2) + (d^2c^2a^2) + 2(d^2cb^2a) \\
 - (b^2)(d^2b^2) - 2(dc^3ba) + (dc^2b^3) - (c^2b)^2,
 \end{aligned}$$

where $(d^3) = d_0d_2d_4 + 2d_1d_2d_3 - d_0d_3^2 - d_4d_1^2 - d_2^3,$

$$\begin{aligned}
 (d^2c^2b) &= b_0 \{c_3^2 (d_0 d_2 - d_1^2) + 2c_3 c_2 (d_1 d_2 - d_0 d_3) + 2c_1 c_3 (d_1 d_3 - d_2^2) \\
 &\quad + c_2^2 (d_0 d_4 - d_2^2) + 2c_1 c_2 (d_2 d_3 - d_1 d_4) + c_1^2 (d_2 d_4 - d_3^2)\} \\
 + b_2 \{c_0^2 (d_2 d_4 - d_3^2) + 2c_0 c_1 (d_3 d_2 - d_1 d_4) + 2c_0 c_2 (d_1 d_3 - d_2^2) \\
 &\quad + c_1^2 (d_0 d_4 - d_2^2) + 2c_1 c_2 (d_1 d_2 - d_0 d_3) + c_2^2 (d_0 d_2 - d_1^2)\} \\
 - 2b_1 \{c_0 c_1 (d_2 d_4 - d_3^2) + c_0 c_2 (d_2 d_3 - d_1 d_4) + c_0 c_3 (d_1 d_3 - d_2^2) \\
 &\quad + c_1^2 (d_2 d_3 - d_1 d_4) + c_1 c_2 (d_0 d_4 + d_1 d_3 - 2d_2^2) \\
 &\quad + c_1 c_3 (d_1 d_2 - d_0 d_3) + c_2^2 (d_1 d_2 - d_0 d_3) + c_2 c_3 (d_0 d_2 - d_1^2)\}, \\
 (d^2c^2a^2) &\text{ is formed from } (d^2c^2b) \text{ by writing } a_0^2, a_1^2, a_0 a_1, \text{ for } b_0, b_2, b_1, \\
 (dc^4) &= d_0 (c_1 c_3 - c_2^2)^2 - 2d_0 (c_0 c_3 - c_1 c_2) (c_1 c_3 - c_2^2) \\
 + d_2 \{(c_0 c_3 - c_1 c_2)^2 + 2(c_0 c_2 - c_1^2)(c_1 c_3 - c_2^2)\} - 2d_3 (c_0 c_2 - c_1^2)(c_0 c_3 - c_1 c_2) \\
 + d_4 (c_0 c_2 - c_1^2)^2,
 \end{aligned}$$

$$(ba^2) = b_2 a_0^2 - 2b_1 a_0 a_1 + b_0 a_1^2,$$

$$\begin{aligned}
 (d^2cb^2a) &= \{b_0 a_1 c_1 - b_1 (a_1 c_0 + a_0 c_1) + b_2 a_0 c_0\} P \\
 &\quad + \{b_0 a_1 c_2 - b_1 (a_1 c_1 + a_0 c_2) + b_2 a_0 c_1\} Q \\
 &\quad + \{b_0 a_1 c_3 - b_1 (a_1 c_2 + a_0 c_3) + b_2 a_0 c_2\} R,
 \end{aligned}$$

$$\begin{aligned}
 \text{where } P &= b_0 (d_2 d_4 - d_3^2) - b_1 (d_1 d_4 - d_2 d_3) + b_2 (d_1 d_3 - d_2^2), \\
 Q &= b_0 (d_2 d_3 - d_1 d_4) - b_1 (d_2^2 - d_0 d_4) + b_2 (d_1 d_2 - d_0 d_3), \\
 R &= b_0 (d_1 d_3 - d_2^2) - b_1 (d_0 d_3 - d_1 d_2) + b_2 (d_0 d_2 - d_1^2),
 \end{aligned}$$

$$\begin{aligned}
 (d^2b^2) &= (d_2 d_4 - d_3^2) b_0^2 + (d_0 d_4 - d_2^2) b_1^2 + (d_0 d_2 - d_1^2) b_2^2 \\
 &\quad + 2b_1 b_2 (d_1 d_2 - d_0 d_3) + 2b_2 b_0 (d_1 d_3 - d_2^2) + 2b_0 b_1 (d_2 d_3 - d_1 d_4),
 \end{aligned}$$

$$\begin{aligned}
 (dc^3ba) &= a_0 \{P(c_1 c_3 - c_2^2) + Q(c_2 c_1 - c_0 c_3) + R(c_0 c_2 - c_1^2)\} \\
 &\quad + a_1 \{P'(c_0 c_2 - c_1^2) + Q'(c_1 c_2 - c_0 c_3) + R'(c_1 c_3 - c_2^2)\},
 \end{aligned}$$

$$\begin{aligned}
 \text{where } P &= b_0 (c_2 d_2 - c_3 d_1) + b_1 (c_3 d_0 - c_1 d_2) + b_2 (c_1 d_1 - c_2 d_0), \\
 Q &= b_0 (c_2 d_3 - c_3 d_2) + b_1 (c_3 d_1 - c_1 d_3) + b_2 (c_1 d_2 - c_2 d_1), \\
 R &= b_0 (c_2 d_4 - c_3 d_3) + b_1 (c_3 d_2 - c_1 d_4) + b_2 (c_1 d_3 - c_2 d_2), \\
 P' &= b_0 (c_2 d_3 - c_1 d_4) + b_1 (c_0 d_4 - c_2 d_2) + b_2 (c_1 d_2 - c_0 d_3), \\
 Q' &= b_0 (c_2 d_2 - c_1 d_3) + b_1 (c_0 d_3 - c_2 d_1) + b_2 (c_1 d_1 - c_0 d_2), \\
 R' &= b_0 (c_2 d_1 - c_1 d_2) + b_1 (c_0 d_2 - c_2 d_0) + b_2 (c_1 d_0 - c_0 d_1),
 \end{aligned}$$

$$\begin{aligned}
 (dc^2b^3) &= d_0 \{c_3^2 b_0 b_1^2 - 2c_3 c_2 (b_0 b_1 b_2 + b_1^3) + 2c_3 c_1 b_1^2 b_2 \\
 &\quad + c_2^2 (b_0 b_2^2 + 3b_2 b_1^2) - 4c_1 c_2 b_1 b_2^2 + b_2^3 c_1^2\} \\
 - 2d_1 \{c_3^2 b_0^2 b_1 - c_3 c_2 (b_0^2 b_2 + 2b_0 b_1^2) + c_3 c_0 b_1^2 b_2 + 2c_2^2 b_0 b_1 b_2 + c_2 c_1 b_1^2 b_2 \\
 &\quad - 2c_0 c_2 b_1 b_2^2 - c_1^2 b_1 b_2^2 + c_0 c_1 b_2^3\}
 \end{aligned}$$

$$\begin{aligned}
 &+ d_2 \{ c_3^2 b_0^3 - 2c_3 c_1 (b_0^2 b_2 + 2b_0 b_1^2) + 2c_3 c_0 (b_1^3 + b_0 b_1 b_2) \\
 &\quad - c_2^2 (b_0^2 b_2 + 2b_0 b_1^2) + 2c_1 c_2 (b_1^3 + 5b_0 b_1 b_2) \\
 &\quad - 2c_2 c_0 (b_0 b_2^2 + 2b_2 b_1^2) - c_1^2 (b_0 b_2^2 + 2b_2 b_1^2) + c_0^2 b_2^3 \} \\
 &- 2d_3 \{ c_0^2 b_2^2 b_1 - c_0 c_1 (b_0 b_2^2 + 2b_2 b_1^2) + c_0 c_3 b_0 b_1^2 + 2c_1^2 b_0 b_1 b_2 + c_1 c_2 b_0 b_1^2 \\
 &\quad - 2c_1 c_3 b_0^2 b_1 - c_2^2 b_1 b_0^2 + c_2 c_3 b_0^3 \} \\
 &+ d_4 \{ c_0^2 b_2 b_1^2 - 2c_0 c_1 (b_0 b_1 b_2 + b_1^3) + 2c_0 c_2 b_1^2 b_0 + c_1^2 (b_0^2 b_2 + 3b_0 b_1^2) \\
 &\quad - 4c_0 c_1 b_1 b_0^2 + b_0^3 c_2^2 \}, \\
 (c^2 b) &= b_2 (c_0 c_2 - c_1^2) - b_1 (c_0 c_3 - c_1 c_2) + b_0 (c_1 c_3 - c_2^2).
 \end{aligned}$$

297. We have seen (Art. 221) that if we had a covariant quartic, we could, from the invariants already obtained, derive a series of others. One such covariant can be at once obtained by forming the equation of the locus of a point whose first polar is a cubic for which the invariant S vanishes; in other words, by equating to nothing the S of the polar cubic. The symbolical expression for this covariant is (123) (234) (314) (124). The covariant S of the quartic

$$ax^4 + by^4 + cz^4 + du^4 + ev^4 = 0$$

is of the form
$$\frac{a}{x} + \frac{b}{y} + \frac{c}{z} + \frac{d}{u} + \frac{e}{v} = 0.$$

Hence, as we have already seen, that the first form, though apparently containing a sufficient number of constants, is a special one to which the equation of a quartic cannot in general be reduced; so is the second form also one to which the equation of a quartic cannot be brought unless a certain relation between its invariants be satisfied.

There are other covariant quartics, but that just described is of the lowest order in the coefficients. Any other covariant quartic of the fourth order in the coefficients must be of the form $S + kAU$, where k is a numerical constant and A the first invariant. This may easily be verified with respect to the covariant obtained by forming the contravariant of the contravariant of Art. 292.

298. The general values of the coefficients of S have not been calculated, nor have any of the higher invariants. I have thought it worth while, however, to examine the special case

$$ax^4 + by^4 + cz^4 + 6fy^2z^2 + 6gz^2x^2 + 6hx^2y^2 = 0.$$

This form only implicitly contains eleven constants, and therefore is a very particular case of the general equation of the quartic; but it lends itself easily to calculation, because the covariant S is of the same form

$$ax^4 + by^4 + cz^4 + 6fy^2z^2 + 6gz^2x^2 + 6hx^2y^2 = 0;$$

and, therefore (Art. 221), from any invariant can be derived another by performing on it the operation $a \frac{d}{da} + b \frac{d}{db} + \&c.$, an operation which we shall denote by the symbol ϕ . Although invariants which exist in general may vanish for the special case here considered, yet invariants, which in this case are distinct, will be distinct in general. By calculating the invariants for the special case, we obtain all the terms of the general invariants which contain only the coefficients a, b, c, f, g, h .

The values of the coefficients of S , for the form in question, are

$$\begin{aligned} a &= 6g^2h^2, & b &= 6h^2f^2, & c &= 6f^2g^2, \\ f &= bcgh - f(bg^2 + ch^2) - f^2gh, \\ g &= cahf - g(ch^2 + af^2) - fg^2h, \\ h &= abfg - h(af^2 + bg^2) - fgh^2. \end{aligned}$$

It is convenient to remember, that for the same form the values of the coefficients of the contravariant σ , Art. 292, are

$$\begin{aligned} A &= bc + 3f^2, & B &= ca + 3g^2, & C &= ab + 3f^2, \\ F &= af + gh, & G &= bg + hf, & H &= ch + fg. \end{aligned}$$

299. We find it convenient to use the abbreviations

$abc = L$, $af^2 + bg^2 + ch^2 = P$, $bcg^2h^2 + cah^2f^2 + abf^2g^2 = Q$, $fgh = R$; then the values of the invariants previously found are, for the special case we are considering,

$$A = L + 3P + 6R, \quad B = LR + 2R^2 - PR; \quad \text{or } B = AR - 4PR - 4R^2.$$

The results of the operation ϕ on these several quantities are

$$\begin{aligned} \phi(L) &= 6Q, & \phi(P) &= 6LR - 2PR - 4Q + 18R^2, \\ \phi(Q) &= -2PQ - 4RQ - 6LR^2 + 12PR^2 + 4LPR, \\ \phi(R) &= Q - 2PR - 3R^2, \end{aligned}$$

whence

$$\phi(A) = 18B.$$

We can then obtain a new invariant of the ninth order in the coefficients by performing on B the operation ϕ . The result is

$$\phi(B) = C_1 = Q(L - P + 14R) - LR(2P + 9R) + R(2P^2 - 3PR - 30R^2).$$

The invariant just found is not, however, the only independent invariant of the ninth order in the coefficients. If we write the general equation of a quartic $u_4 + u_3z + u_2z^2 + u_1z^3 + cz^4 = 0$, then generally the highest power of c which occurs in an invariant of the ninth order will be the third, and c will be multiplied by an invariant of the sixth order in the coefficients of the binary quartic u_4 . This latter invariant must be of the form $s^3 + kt^2$; and any assumed invariant of the ninth order can be resolved into two parts, in one of which c^3 will be multiplied by s^3 , and in the other by t^2 . The former part can be expressed in the form $lA^3 + mAB + nC_1$, where A, B, C_1 are the invariants already calculated; for the expression of the latter a new invariant is necessary, and we proceed to give one of several ways in which it may be obtained. It will first, however, be necessary to mention some other covariants and contravariants.

300. The value of the Hessian for this case is

$$\begin{aligned} &aghx^6 + bhfy^6 + cfzg^6 + (abg + ahf - 3gh^2)x^4y^2 + (ach + afg - 3g^2h)x^4z^2 \\ &+ (abf + bgh - 3fh^2)y^4x^2 + (bch + bfg - 3f^2h)y^4z^2 + (caf + chg - 3fg^2)z^4x^2 \\ &+ (bcg + cfh - 3f^2g)z^4y^2 + (abc - 3af^2 - 3bg^2 - 3ch^2 + 18fgh)x^2y^2z^2. \end{aligned}$$

Again, it has been stated (Art. 92) that a quartic has also a contravariant sextic, the symbol for which is $(\alpha 12)^2 (\alpha 23)^2 (\alpha 31)^2$. The value of this, for the case we are considering, is

$$\begin{aligned} &(bcf - f^3)\alpha^6 + (cag - g^3)\beta^6 + (abh - h^3)\gamma^6 \\ &+ (bcg + 6cfh - 3f^2g)\alpha^4\beta^2 + (bch + 6bfg - 3f^2h)\alpha^4\gamma^2 + (acf + 6cgh - 3g^2f)\beta^4\alpha^2 \\ &+ (ach + 6afg - 3g^2h)\beta^4\gamma^2 + (abf + 6bgh - 3fh^2)\gamma^4\alpha^2 \\ &+ (abg + 6afh - 3gh^2)\gamma^4\beta^2 + \{abc - 3(af^2 + bg^2 + ch^2) + 48fgh\}\alpha^2\beta^2\gamma^2. \end{aligned}$$

If, introducing differential symbols in either of these, we operate on the other, the result is $A^2 + 576B$. If we operate on the Hessian with the contravariant σ , we get a covariant quadratic of the fifth order in the coefficients; and if we operate on the contravariant sextic with the quartic itself, we get a contra-

variant quadratic of the fourth order in the coefficients. The values of these quadratics are respectively

$$\begin{aligned} & (afx^2 + bgy^2 + chz^2)(L + 3P + 30R) \\ & + (ghx^2 + hfy^2 + fgz^2)(10L - 6P - 12R) - 4(a^2f^3x^2 + b^2g^3y^2 + c^2h^3z^2); \\ & (f\alpha^2 + g\beta^2 + h\gamma^2)(3L + 5P + 2R) - 8(af^3\alpha^2 + bg^3\beta^2 + ch^3\gamma^2) \\ & \qquad \qquad \qquad + 4(bceg\alpha^2 + cahf\beta^2 + abfg\gamma^2). \end{aligned}$$

If we introduce differential symbols into either of these two concomitants and operate on the other, the result is a new invariant

$$\begin{aligned} C_2 = & (80L - 32P + 448R)Q + 3P^3 - 6P^2L - 134P^2R \\ & + 3PL^2 + 128PLR - 60PR^2 + 102L^2R + 408LR^2 - 72R^3. \end{aligned}$$

There appears to be for the quartic we are considering no other independent invariant of the ninth order. If, for example, we operate with the contravariant conic on the quartic itself, the result is expressible in terms of the invariants already found, being $3C_2 - 80C_1 - 180AB$. We might perhaps more simply have taken for the second independent invariant $\frac{1}{3}(C_2 - 32C_1)$, or

$$\begin{aligned} C_3 = & 16QL + P^3 - 2P^2L - 66P^2R + PL^2 + 64PLR + 12PR^2 \\ & + 34L^2R + 232LR^2 + 296R^3. \end{aligned}$$

301. We proceed next to form invariants of the twelfth order in the coefficients. We can form the cubic invariant of the quartic S by help of the formulæ

$$\begin{aligned} L' & = 216R^4, \\ P' & = 6\{Q^2 - 2PQR - 4R^2Q + 2P^2R^2 - 2PLR^2 + 4PR^3 + 6LR^3 + 3R^4\}, \\ R' & = Q^2 - 2LRQ - P^2R^2 - 2PR^3 + L^2R^2 + 4LR^3 - R^4, \\ \text{whence } L' + 3P' + 6R' & = 6D_1, \text{ where} \\ D_1 & = 4Q^2 + Q(-6PR - 2LR - 12R^2) \\ & \qquad \qquad \qquad + 5P^2R^2 - 6PLR^2 + 10PR^3 + L^2R^2 + 22LR^3 + 44R^4. \end{aligned}$$

Again, by performing the operation ϕ on C_1 , we get

$$\begin{aligned} D_2 = & 24Q^2 + Q(4P^2 - 4PL - 84PR - 20LR - 248R^2) \\ & - 4P^3R - 14P^2R^2 + 4PL^2R + 144PLR^2 + 444PR^3 \\ & - 18L^2R^2 - 84LR^3 + 216R^4, \end{aligned}$$

and, by combining these, we have $D_2 - 6D_1 = 4D_3$, where

$$D_3 = Q(P^2 - PL - 12PR - 2LR - 44R^2) - P^3R - 11P^2R^2 \\ + PL^2R + 45PLR^2 + 96PR^3 - 6L^2R^2 - 54LR^3 - 12R^4.$$

In terms of these and of the other invariants already given can be expressed the other invariants of the twelfth order, such as $\phi(C_2)$, and the discriminant of the contravariant conic.

So, again, we can express in terms of the preceding the invariants of the contravariant quartic; we have

$$L' = L^2 + 3PL + 9Q + 27R^2, \\ R' = LR + Q + PR + R^2, \\ P' = 3P^2 - 5Q + 6PR + PL + 6LR + 9R^2, \\ Q' = 3Q^2 + Q(3P^2 + 4PL + 24PR + L^2 - 8LR + 6R^2) \\ + 12P^2LR + 18P^2R^2 + 4PL^2R + 10PLR^2 + 36PR^3 - 36LR^3 + 27R^4, \\ \text{whence } A' = A^2 + 12B, \quad B' = 4D_1 + AC_1 + A^2B - 12B^2.$$

302. It is to be noted, that though there is only one contravariant conic of the fourth order in the coefficients, there are two covariant conics of the fifth, viz., in addition to that already given, that obtained by operating with the contravariant conic on the quartic itself, the result being

$$(3L + 9P + 10R)(afx^2 + bgy^2 + chz^2) \\ + (10L + 2P + 4R)(ghx^2 + hfy^2 + fgz^2) - 12(\alpha^2 f^3 x^2 + b^2 g^3 y^2 + c^2 h^3 z^2),$$

and if this be combined with that previously given, we can write it in the simple form

$$4R(afx^2 + bgy^2 + chz^2) + (L - P - 2R)(ghx^2 + hfy^2 + fgz^2).$$

The discriminant of this last conic gives the simplest invariant of the fifteenth order, viz., writing $L - P - 2R = M$,

$$E_1 = 16MR^2Q + 4M^2R^2P + M^3R^2 + 64LR^4;$$

or, at length,

$$E_1 = 16(L - P - 2R)QR^2 + R^2\{3P^3 - 5P^2L + 10P^2R \\ + PL^2 - 4PLR + 4PR^2 + L^3 - 6L^2R + 76LR^2 - 8R^3\}.$$

The other three invariants of the system of conics are, of course, also invariants of the quartic of the same order, besides which

we might also calculate ϕD_1 , ϕD_2 , &c. All these are expressible in terms of E_1 and E_2 ,* where

$$\begin{aligned} E_2 = & 16(L - P - 2R)Q^2 + (3P^3 - 5P^2L - 6P^2R \\ & + PL^2 - 228PLR - 2172PR^2 + L^3 + 298L^2R + 2636LR^2 - 4296R^3)Q \\ & + R(-12P^4 + 44P^3L - 52P^2L^2 + 20PL^3) \\ & + R^2(348P^3 - 852P^2L + 308PL^2 + 324L^3) \\ & + R^3(1320P^2 - 416PL + 216L^2) + 720PR^4 + 11376R^4 - 864R^5. \end{aligned}$$

There are also two independent invariants of the eighteenth order, the first being the C_1 of the contravariant quartic, viz.

$$\begin{aligned} F_1 = & 128Q^3 + Q^2(-48P^2 + 80PL + 368PR + 32L^2 - 528LR - 160R^2) \\ & + Q(9P^4 - 12P^3L - 108P^3R - 2P^2L^2 + 324P^2LR + 240P^2R^2 \\ & + 4PL^3 + 60PL^2R - 288PLR^2 + 528PR^3 + L^4 - 20L^3R - 400L^2R^2 \\ & - 2512LR^3 - 144R^4) + 18P^5R - 24P^4LR + 27P^4R^2 - 4P^3L^2R \\ & + 180P^3LR^2 + 60P^3R^3 + 8P^2L^3R + 114P^2L^2R^2 + 716P^2LR^3 \\ & + 288P^2R^4 + 2PL^4R - 44PL^3R^2 + 52PL^2R^3 - 592PLR^4 \\ & + 288PR^5 - 21L^4R^2 - 60L^3R^2 - 720L^2R^4 - 2076LR^5 + 240R^6. \end{aligned}$$

$$\begin{aligned} F_2 = & 128Q^3 + Q^2(-8P^2 - 240PL - 5312PR + 312L^2 + 9536LR \\ & + 11680R^2) + Q(-18P^4 + 54P^3L + 1146P^3R - 54P^2L^2 - 1978P^2LR \\ & + 7548P^2R^2 + 18PL^3 + 262PL^2R - 4432PLR^2 + 49272PR^3 \\ & + 570L^3R + 1620L^2R^2 + 6648LR^3 + 77808R^4) + 24P^5R \\ & - 76P^4LR - 1224P^4R^2 + 84P^3L^2R + 2622P^3LR^2 - 13032P^3R^3 \\ & - 36P^2L^3R - 946P^2L^2R^2 + 8268P^2LR^3 - 30192P^2R^4 + 4PL^4R \\ & - 822PL^3R^2 - 368PL^2R^3 - 73784PLR^4 - 5472PR^5 + 114L^4R^2 \\ & - 1524L^3R^3 - 14712L^2R^4 - 113904LR^5 + 25920R^6. \end{aligned}$$

It does not appear that, even in the special case we are considering, the invariants of higher order that we have given are linearly expressible in terms of those of lower order; nor have I been able to find that, even in this case, the discriminant is expressible in terms of lower invariants.

* The values of these and of the next two following invariants were calculated for me by Mr. J. J. Walker.

CHAPTER VII.

TRANSCENDENTAL CURVES.

303. WE have hitherto exclusively discussed equations reducible to a finite number of terms involving positive integer powers of x and y ; it remains to mention something of the properties of curves represented by transcendental equations. Since these involve functions only expressible by an infinite series of algebraical terms, all transcendental curves may be considered as curves of infinite degree; they may be cut by any right line in an infinity of points, and must have an infinity of multiple points and multiple tangents. There is, then, no room for a general theory of the singularities of these curves, and it is only necessary to mention the names and principal properties of some of the most remarkable of them. We may notice, in passing, a class of equations, called by Leibnitz *interscendental*, or which involve the variables with exponents not commensurable with any rational number; for example, $y = x^{\sqrt{2}}$. Here, as we successively substitute for $\sqrt{2}$ the series of rational fractions which approximately express the value of the radical, we shall find a series of algebraic curves of constantly increasing degree, more and more nearly resembling the figure of the required curve, but not accurately expressing it as long as the degree of the curve is finite. We pass on to the *cycloid*, which holds the first place among transcendental curves, both for historical interest and for the variety of its physical applications. This curve is generated by the motion of a point on the circumference of a circle which rolls along a right line. Let A be the point where the motion commences; then (see fig. next page), in any position of the generating circle, if p be the generating point, we must have the arc $pm = Am$, and denoting the angle pcm by ϕ , and cm , the radius of the circle, by a , we shall have

$$y = a(1 - \cos \phi), \quad x = a(\phi - \sin \phi);$$

curve is three times the area of the generating circle. For the element of the external area ($pp'rr' = pp'tt' = PP'QQ'$) is equal to the element of the area of the circle; the whole external area therefore, $AENFB$, is equal to the area of the circle; and therefore the internal area ANB is three times the area of the circle.

The arc Np of the cycloid is double NP the chord of the circle.

For it is easy to see that the triangle $PP'L$ is isosceles, and therefore that if a perpendicular, MK , be let fall on the base, PL , the increment of the arc of the cycloid, is double PK , the increment of the chord of the circle.

Hence, if s denote the arc of the cycloid, b the diameter of the generating circle, x the abscissa NQ from the vertex, then the equation of the curve is $s^2 = 4bx$, a form useful in Mechanics.

The radius of curvature is double the normal.

For the triangle formed by two consecutive normals has its sides parallel to those of the triangle MPK' , but the base of the first triangle is equal to PL , and, as we have just proved, is double PK , the base of the second; hence the radius of curvature is double MP .

The evolute of the cycloid is an equal cycloid.

For if we suppose a circle touching the base at m , and passing through R the centre of curvature, it is equal to the generating circle, and the arc nR is equal to $NP = nD$; hence the locus of R is the cycloid described by the circle mRn rolling on the base EF .*

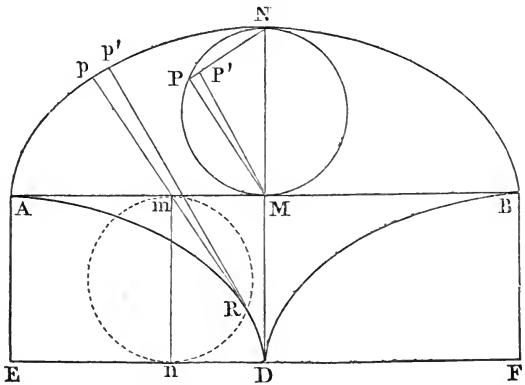

* The properties of the cycloid were much studied by the most eminent mathematicians of Europe during the first half of the seventeenth century. Their attention was first called to these problems by Mersenne; but Galileo claims to have inde-

We might also seek the locus of any point in the plane of the generating circle carried round with it; when the point is inside the circle, the locus is called the prolate cycloid; when it is outside it is called the curtate cycloid; these loci are by some called trochoids. There is no difficulty in calculating their equations or in ascertaining their figures, but it does not seem worth while to devote any space to them here. The method of drawing tangents given for the cycloid applies equally to these curves. These curves may (as the reader can easily see) be generated by a point on the circumference of a circle, rolling so that the arc pm shall be in a constant ratio to the line Am .

305. When the properties of the cycloid had been investigated, it was a natural extension to discuss the curve traced by a point connected with a circle rolling on the circumference of another. When the point is on the circumference of the rolling circle, the curve generated is called an *epicycloid* or *hypocycloid*, according as the circle rolls on the exterior or interior of the fixed circle; if the generating point be not on the circumference, the curve is called an *epitrochoid* or *hypotrochoid*.

Let us take for the axis of x that position of the common diameter of the two circles which passes through the generating point; let CO be any other position of it, Q the generating point; let $CN = a$, $ON = b$, $NCB = \phi$, $PON = \psi$, $OQ = d$; then since $BN = NP$, we have

$$a\phi = b\psi; \quad OQM = 180 - (\phi + \psi);$$

$$\text{and the coordinates of } Q \text{ are}$$

$$y = (a + b) \sin \phi - d \sin(\phi + \psi),$$

$$x = (a + b) \cos \phi - d \cos(\phi + \psi);$$

$$\text{or if } a + b = mb,$$

$$y = mb \sin \phi - d \sin m\phi,$$

$$x = mb \cos \phi - d \cos m\phi.$$

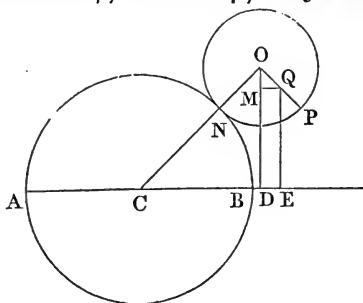

pendently imagined the description of this curve. Galileo, having failed in obtaining the quadrature of the curve by geometrical methods, attempted to solve the problem by weighing the area of the curve against that of the generating circle, and arrived at the conclusion that the former area was nearly, but not exactly, three times the latter. The problem of the quadrature was correctly solved by Roberval in 1634; the method of drawing tangents was discovered by Des Cartes, the rectification by Wren, the evolute by Huyghens; several other important properties by Pascal.

Eliminating ϕ from these equations we obtain the equation of the curve, which is not necessarily transcendental. In fact, when the circumferences of the circles are commensurable, after a certain number of revolutions, the generating point returns to a former position, the curve is closed, and of finite algebraic dimensions; but if they be not commensurable, the generating point will not in any finite number of revolutions return to the same position, and the curve will be transcendental.

To obtain the equations of the epicycloid we have only to make $d = \pm b$, and we have

$$y = b(m \sin \phi \pm \sin m\phi),$$

$$x = b(m \cos \phi \pm \cos m\phi);$$

the lower sign answers to the case when the axis of x passes through the generating point when it is *on* the fixed circle; the upper sign, when it is at its greatest distance from it.

306. The coordinates for the case of the hypotrochoid and hypocycloid are found, as the reader can easily verify, by changing the sign of b in the equations given above. These will be included in the equations which we shall use, by giving negative values to m , or by supposing $m = -n$, where $n = \frac{a-b}{b}$.

The equations given above, if we alter b into mb , and m into $\frac{1}{m}$, become

$$y = mb \left(\frac{1}{m} \sin \phi + \sin \frac{1}{m} \phi \right),$$

$$x = mb \left(\frac{1}{m} \cos \phi + \cos \frac{1}{m} \phi \right);$$

and making $\phi = m\psi$, we see that these equations belong to the same locus as the preceding. We can thus prove that the same hypocycloid is generated whether we take $b = \frac{1}{2}(c \pm a)$. (Euler de duplici genesi Epicycloidum, Acta Petrop. 1784, referred to by Peacock, Examples, p. 194). The hypocycloid, when the radius of the moving circle is greater than that of the fixed circle, may also be generated as an epicycloid, for then $m \left(= -\frac{a-b}{b} \right)$ is positive.

307. Tangents can easily be drawn to these curves, for by the same reasoning as that used in Art. 304 the line NQ is normal to the curve. We can thus see also that when a curve is generated by a point on the circumference of one figure rolling on another, there must be a cusp at every point where the generating point meets the fixed curve. For by this construction, at such a point the generating point approaches the fixed curve in the direction of its normal, and recedes from it in the same direction; hence it is a stationary point. An epicycloid then consists of a number of similar portions, each united to the next by a cusp; and the extreme radii, from the centre of the fixed circle to any such portion, are inclined at an angle $= \frac{2b\pi}{a}$.

When the radii of the circles are commensurable and the curve therefore algebraic, the number of cusps is finite, but when the curve is transcendental, the number of cusps is infinite. Every point of the base is in its turn a cusp, and therefore the base may be said to be the locus of the cusps of the curve; but, obviously, consecutive points of the base are not consecutive points of the locus.

308. These curves have besides, as have epitrochoids in general, a number of double points crunodal or acnodal, the number being finite for algebraic curves and infinite for transcendental, and all the nodal points being ranged in circular loci. Consider the equations (Art. 305)

$$y = mb \sin \phi - d \sin m\phi, \quad x = mb \cos \phi - d \cos m\phi,$$

where $\phi = 0$, corresponds to what we may regard as the initial position of the generating point, viz. that where it is in a line with the two centres, this line being taken as the axis of x , and the initial distance of the origin from the generating point being $mb - d$. But there are other positions of the moving circle for which the generating point lies on the axis, the values of ϕ corresponding to these positions being found by solving the equation $mb \sin \phi = d \sin m\phi$. And setting aside the root $\phi = 0$, the other roots of this equation are obviously distributable into pairs equal with opposite signs, and for each pair the value of x , $mb \cos \phi - d \cos m\phi$, is the same. The corre-

sponding points are therefore double points on the locus. The value $mb \cos \phi - d \cos m\phi$ may, by means of the condition $mb \sin \phi = d \sin m\phi$, be written in the form $x \sin \phi = d \sin (m-1)\phi$. Every time that the generating point returns to a similar position with regard to the two centres we have a line on which double points lie, the number of such lines being, as has been stated, finite for algebraic curves and infinite for transcendental.

309. The equations of the tangents to the epi- or hypocycloids admit of being written in a very simple form. For

$$\frac{dy}{dx} = \frac{\cos \phi \pm \cos m\phi}{-(\sin \phi \pm \sin m\phi)} = -\frac{\cos \frac{1}{2}(m+1)\phi}{\sin \frac{1}{2}(m+1)\phi}, \text{ or else } = \frac{\sin \frac{1}{2}(m+1)\phi}{\cos \frac{1}{2}(m+1)\phi}.$$

And, attending to the condition that the tangent must pass through the point whose coordinates have been given in Art. 305, the equation of the tangent becomes

$x \cos \frac{1}{2}(m+1)\phi + y \sin \frac{1}{2}(m+1)\phi = (m+1)b \cos \frac{1}{2}(m-1)\phi$, when the axis passes through the generating point at its greatest distance from the centre of the fixed circle; and

$x \sin \frac{1}{2}(m+1)\phi - y \cos \frac{1}{2}(m+1)\phi = (m+1)b \sin \frac{1}{2}(m-1)\phi$, when the axis of x passes through the generating point at its least distance from the centre of the fixed circle.

The equation of the normal in the latter case is in the same manner seen to be

$$x \cos \frac{1}{2}(m+1)\phi + y \sin \frac{1}{2}(m+1)\phi = (m-1)b \cos \frac{1}{2}(m-1)\phi.$$

Comparing this with the first form of the equation of the tangent, it follows that *the evolute of an epicycloid is a similar epicycloid*, the radii of the circles being altered in the ratio $\frac{m-1}{m+1}$, and the generating point of the evolute being at its greatest distance from the centre of the fixed circle when on the same diameter on which the generating point of the original curve is at its least distance.

The same remarks, of course, apply to the hypocycloid.

The equation of the tangent to an epitrochoid is in like manner

$$(b \cos \phi - d \cos m\phi)x + (b \sin \phi - d \sin m\phi)y = \{mb^2 + d^2 - (m+1)b d \cos (m-1)\phi\}.$$

310. We give examples of some of the simplest cases where the equations of these curves are algebraic, and can be easily formed. These cases are (a) when the equation of the tangent is included in the form

$$a \cos 2\theta + b \sin 2\theta + c \cos \theta + d \sin \theta + e = 0,$$

the envelope of which is given, Ex. 3, p. 69; (b) when the equation of the tangent is included in the form

$$a \cos 3\theta + b \sin 3\theta + 3c \cos \theta + 3d \sin \theta = 0,$$

an envelope, which when treated by the same method as that just mentioned, is solved by forming the discriminant of a cubic equation, the result being

$$(a^2 + b^2)^2 + 8(ac^3 - bd^3) - 24cd(ad - bc) = 3(c^2 + d^2)^2 + 6(a^2 + b^2)(c^2 + d^2)$$

(c) when m is a fraction whose numerator and denominator differ by one. If we square and add the equations

$$x = mb \cos n\phi - d \cos(n+1)\phi, \quad y = mb \sin n\phi - d \sin(n+1)\phi,$$

we have $x^2 + y^2 = m^2 b^2 + d^2 - 2mbd \cos \phi$,

and by solving for $\cos \phi$ from this equation, and substituting in the value for x , the elimination is performed.

Ex. 1. To find the epitrochoid in general when $d = mb$. The equations are then reducible to the form

$$x = 2d \sin \frac{1}{2}(m-1)\phi \sin \frac{1}{2}(m+1)\phi, \quad y = 2d \sin \frac{1}{2}(m-1)\phi \cos \frac{1}{2}(m+1)\phi,$$

whence obviously $\frac{1}{2}(m+1)\phi$ is the angle ω made by the radius vector with the axis of y ; and the polar equation is $\rho = 2d \sin \frac{m-1}{m+1} \omega$.

Ex. 2. To find the equations of the epitrochoid and epicycloid when the radii of the circles are equal, and therefore $m = 2$. Dealing, as in (c), with the equations

$$x = 2b \cos \phi - d \cos 2\phi, \quad y = 2b \sin \phi - d \sin 2\phi,$$

we find

$$(x^2 + y^2 - 2b^2 - d^2)^2 = 4b^2(b^2 + d^2 - 2dx),$$

the equation of a Cartesian, having, as may be easily verified, $y = 0, x = d$, as a double point; the curve is therefore a *limaçon*. We see from the theory already explained that this point corresponds to the value $\cos \phi = \frac{b}{d}$. When therefore d is greater than b ; that is to say, when the generating point is outside the moving circle, the node corresponds to two real positions of the moving circle and is a crunode; but if the generating point be inside the moving circle, the node corresponds to no real position of that circle, and the curve is acnodal.

The case of the epicycloid is obtained by putting $d = b$, when we have

$$(x^2 + y^2 - 3b^2)^2 = 4b^3(3b - 2x).$$

The double point now becomes a cusp, and the curve is a cardioid. It is plain from what has been said that the evolute of a cardioid is a cardioid.

Ex. 3. To find the equation of the epicycloid when the radius of the rolling circle is half that of the fixed circle. The equation of the tangent is

$$x \cos 2\theta + y \sin 2\theta = 4b \cos \theta,$$

an equation included in the form p. 69, the envelope of which is

$$(x^2 + y^2 - 4b^2)^3 = 108b^4x^2.$$

Ex. 4. To find the hypotrochoid and hypocycloid when the radius of the rolling circle is half that of the fixed circle. We have $m = -1$; the equations are

$$x = b \cos \phi + d \cos \phi, \quad y = b \sin \phi - d \sin \phi,$$

and the hypotrochoid is the ellipse

$$\frac{x^2}{(b+d)^2} + \frac{y^2}{(b-d)^2} = 1,$$

which reduces to the diameter y in the case of the hypocycloid where $b = d$.

Ex. 5. To find the hypocycloid when the radius of the fixed circle is three times that of the moving circle. Here $m = -2$, and the equation of the tangent is of the form

$$x \cos \phi - y \sin \phi = b \cos 3\phi,$$

and the envelope is, by the form (b) given above,

$$(x^2 + y^2)^2 + 8bx^3 - 24bxy^2 + 18b^2(x^2 + y^2) = 27b^4,$$

the equation of a tricuspidal quartic, the tangents at the cusps meeting at the centre of the fixed circle.

This curve has been studied by Steiner as the envelope of the line joining the feet of the three perpendiculars on the sides of a triangle from any point on the circumscribing circle. In fact, taking the centre of the circle as origin, and the coordinates of the vertices $r \cos 2\alpha$, $r \sin 2\alpha$, &c., if the point from which the perpendiculars are let fall is $r \cos 2\phi$, $r \sin 2\phi$, the equation of the line joining the feet is

$$\begin{aligned} &x \sin(\alpha + \beta + \gamma - \phi) - y \cos(\alpha + \beta + \gamma - \phi) \\ &= \frac{1}{2}r \{ \sin(\alpha + \beta + \gamma - 3\phi) + \sin(\beta + \gamma - \alpha - \phi) + \sin(\gamma + \alpha - \beta - \phi) + \sin(\alpha + \beta - \gamma - \phi) \}, \end{aligned}$$

a form easily reducible to that considered in this example.

Ex. 6. To find the hypocycloid when the radius of the fixed circle is four times that of the moving circle. We have here $m = -3$; the equation of the tangent is $x \sin \phi + y \cos \phi = 2b \sin 2\phi$, and that of the envelope $x^3 + y^3 = (4b)^3$.

311. The equation of the reciprocal of an epicycloid is readily obtained, for the tangent being

$$x \cos \frac{1}{2}(m+1)\phi + y \sin \frac{1}{2}(m+1)\phi = (m+1)b \cos \frac{1}{2}(m-1)\phi,$$

it is plain that the perpendicular on the tangent makes an angle $\frac{1}{2}(m+1)\phi$ with the axis of x , and that its length is $(m+1)b \cos \frac{1}{2}(m-1)\phi$; the locus, therefore, of the foot of this perpendicular is

$$p = (m+1)b \cos \left(\frac{m-1}{m+1} \omega \right),$$

and the reciprocal curve is

$$\rho \cos \left(\frac{m-1}{m+1} \omega \right) = (m+1)b.$$

The radius of curvature is found by the formula $R = \frac{\rho d\rho}{d\rho}$.

In the original curve we have

$$\rho^2 = x^2 + y^2 = b^2 \{m^2 + 1 + 2m \cos(m-1)\phi\},$$

or
$$\rho^2 = b^2 (m-1)^2 + 4mb^2 \cos^2 \frac{1}{2}(m-1)\phi,$$

or
$$\rho^2 = a^2 + \frac{4m}{(m+1)^2} p^2.$$

Hence
$$R = \frac{4m}{(m+1)^2} p.^*$$

312. Another general expression for the radius of curvature in *roulettes* (or curves generated by a point on a rolling curve) may be found as follows: Let P, P' be two consecutive points of the curve, M the point of contact of the rolling with the fixed curve, and R the centre of curvature; then PP' , the element of the arc of the roulette, is $= MP \cdot PMP'$; but, by considering the curves as polygons of an infinite number of sides, we can see that PMP' , the angle through which PM turns, is equal to the sum (or difference) of the angles between two consecutive tangents to the fixed and to the rolling curve. Hence, if $d\sigma$ be the element of the arc of the roulette, ds the common element of the arcs of the fixed and generating curves, ρ and ρ' the radius of curvature of each, we have

$$d\sigma = MP \left(\frac{ds}{\rho} + \frac{ds}{\rho'} \right),$$

but this element, $d\sigma$, is also equal to PR , the radius of curvature, multiplied by the angle between two consecutive normals; and if we call ϕ the angle OMP , between the normals to the roulette and to the fixed curve, then the angle between two consecutive normals to the roulette is

$$\frac{\cos \phi ds}{MR}.$$

Hence
$$\frac{MP + MR}{MP \cdot MR} = \frac{1}{\cos \phi} \left(\frac{1}{\rho} + \frac{1}{\rho'} \right),$$

* The invention of epicycloids is attributed to the Danish astronomer, Roemer, who, in the year 1674, was led to consider these curves in examining the best form for the teeth of wheels. The rectification of these curves was given by Newton, *Principia*, Book I., Prop. 49.

and
$$PR = \frac{MP^2 \left(\frac{1}{\rho} + \frac{1}{\rho'} \right)}{MP \left(\frac{1}{\rho} + \frac{1}{\rho'} \right) - \cos \phi} .$$

(See Liouville, vol. x, p. 150.)

313. A large class of transcendental curves is obtained by taking the ordinate some trigonometrical function of the abscissa. There is no difficulty in deriving the shape of such curves from their equation. For example, $y = \sin x$ has positive and constantly increasing ordinates until $x = \frac{1}{2}\pi$; the ordinates then decrease in like manner until $x = \pi$, when the curve crosses the axis at an angle of 45° , and has a similar portion on the negative side of the axis between $x = \pi$ and $x = 2\pi$. The curve, therefore, consists of an infinity of similar portions on alternate sides of the axis.

So again, $y = \tan x$ represents a curve, of which the ordinates increase regularly from $x=0$ to $x=\frac{1}{2}\pi$, when y is infinite, and the line $x = \frac{1}{2}\pi$ an asymptote. For greater values of x , y alters from negative infinity to 0 when $x = \pi$. The curve then consists of an infinity of infinite branches, having an infinity of asymptotes, $x = \frac{1}{2}\pi$, $x = \frac{3}{2}\pi$, &c., and, as may be readily seen, points of inflexion at $x = 0$, $x = \pi$, $x = 2\pi$, &c.

In like manner the reader may discuss the figure of $y = \sec x$, which also consists of a number of infinite branches, only that each branch, instead of crossing the axis, as in the last case, lies altogether at the same side of it. The branches lie alternately on the positive and negative sides of the axis of x . To the same family belongs a curve called the *companion to the cycloid*. It is generated by producing the ordinates of a circle, not as in the case of the cycloid, until the *produced part* be equal to the arc, but until the entire be equal to the arc. If, then, the centre be the origin, the curve is represented by the equations

$$x = a \cos \theta, \quad y = a\theta, \quad x = a \cos \frac{y}{a};$$

a curve of the same family as the curve of sines.

314. Next, after curves depending on trigonometrical, we may mention those depending on exponential functions. The *logarithmic curve* is characterized by the property that the abscissa is

proportional to the logarithm of the ordinate, and its equation therefore is

$$x = m \log y, \text{ or } y = a^x.$$

The curve then has the axis of x for an asymptote, since, if $x = -\infty$; $y = 0$, it cuts the axis of y at a distance equal to the unit of length, and x and y then increase together to positive infinity. The subtangent of the logarithmic curve is constant; for its value, being in general $\frac{y dx}{dy}$, becomes for this curve $= m$.

Some controversy has arisen as to the proper interpretation of the equation of this curve $y = e^x$. Attention was at first only paid to the branch of the curve on the positive side of the axis of x , arising from taking the single real positive value of e^x , which corresponds to every value of x . Euler, in his *Analysis Infinitorum*, II. p. 290, contended for the necessity of attending to the multiplicity of values which the function admits of; and the same subject has been more fully developed by M. Vincent (Gergonne's *Annales*, vol. xv. p. 1). Thus, if x be any fraction with an even denominator, e^x has a real negative as well as a positive value, and therefore there must be a point corresponding to this value of x on the negative side of the axis, but there is no continuous branch on that side of the axis, since, when x is a fraction with an odd denominator, e^x can have only a real positive value. The general expression, including all values of the ordinate, is found by multiplying the numerical expression for e^x , by the imaginary roots of unity, whose general expression is $\cos 2m\pi + i \sin 2m\pi$, where m must be made to receive in succession every integer value, and i , as usual, denotes $\sqrt{-1}$. This is equivalent to saying that the equation $y = e^x$ must be considered as representing not only one real branch, but also an infinity of imaginary branches included in the formula $y = e^{x(1+2mi\pi)}$. Any one of these imaginary branches contains a number of real points where it meets the branch $y = e^{x(1-2mi\pi)}$, and which must be considered as conjugate points on the curve. There are an infinity of such points, all lying either on the real branch of the curve, or on the similar branch on the negative side of the axis of x . The latter branch is curious, since, though every point of it may be considered as belonging to the logarithmic curve, no two points of it are consecutive to each other, for two consecu-

tive points will belong to different branches. There is thus formed what M. Vincent calls a "courbe pointillée." In one point, however, M. Vincent appears to me to have fallen into a grave error. He says that the points of this branch are to be carefully distinguished from conjugate points; for that at a conjugate point the differential coefficients have imaginary values, but that at one of these points, on the negative side of the axis, the differential coefficients, being all equal to e^x , are all real, and only differ in sign from those of the corresponding points on the positive side of the axis. It is truly astonishing that M. Vincent should have failed to observe that if the differential coefficients were all real, it would follow from Taylor's theorem that the next consecutive point must be a real point on the curve, and so that the negative branch would be an ordinary branch of the curve. But, in fact, any one of these negative points must be considered as belonging to a branch whose equation is of the form $y = e^{x(1+2mi\pi)}$, and the corresponding differential coefficient will be $y(1+2mi\pi)$. Considering, then, an acnode in general as the intersection of imaginary branches, in the same manner as a crunode is the intersection of real branches, the points here in question being points of intersection of imaginary branches seem properly regarded as acnodal. We have already seen that a transcendental curve may have an infinity of nodes or acnodes, and, in the case of epitrochoids, that such points may be ranged in a discontinuous manner on certain loci.*

315. The *catenary* is the form assumed by an inelastic chain of uniform density when left at rest. Very simple mechanical considerations lead to the property, which we shall take as the mathematical definition of the curve, viz. that the arc, measured from the lowest point, is proportional to the tangent of the angle made with the horizontal tangent by the tangent at the upper extremity. If, then, the axes be a vertical and a horizontal line through the lowest point, we have $s = c \frac{dy}{dx}$. Now,

* The illustration here used is Dr. Hart's. Some objections to M. Vincent's views, which are worth being considered, will be found in a paper by Mr. Gregory, *Cambridge Mathematical Journal*, vol. i. pp. 231, 264. Prof. Cayley considers that e^x (which he writes by preference $\exp.x$) is a true one-valued function of x , and that there is nothing else than the real branch, the values being those of the function

$$1 + \frac{x}{1} + \frac{x^2}{1.2} + \frac{x^3}{1.2.3} + \&c.$$

PS is parallel to MT . The same values prove also that $PS = MT =$ the arc from P to the lowest point. The locus of the point S is therefore the involute of the catenary, and SN parallel to TC is its tangent, since PS must be normal to the locus of S , being tangent to its evolute. The involute of the catenary is therefore a curve such that the intercept SN , on its tangent between the point of contact and a fixed right line, is constant.* Such a curve is called the *tractrix*.

317. The equation of the tractrix can be obtained without much difficulty. For the length between the foot of the ordinate from S and the point N is $\sqrt{(c^2 - y^2)}$; it also is, by making $y = 0$ in the equation of the tangent, $-\frac{y dx}{dy}$. Hence the differential equation of the curve is

$$-\frac{y dx}{dy} = \sqrt{(c^2 - y^2)},$$

which at once is made rational by putting $z^2 = c^2 - y^2$, and gives

$$dx = \frac{c^2 dz}{c^2 - z^2} - dz.$$

We have then

$$x = c \log \left\{ \frac{c + \sqrt{(c^2 - y^2)}}{y} \right\} - \sqrt{(c^2 - y^2)}.$$

It will be readily seen that the curve consists of four similar portions, as in the dotted curve on the figure; and the construction of the last Article shows at once geometrically how to draw a tangent to the curve.

The *syntractrix* is the locus of a point Q on the tangent to the tractrix, which divides into portions of given length the constant line SN . Let the coordinates of the point on the tractrix be $x'y'$, of those on the required locus xy ; let the length $QN = d$, then we shall have $y'd = yc$; and

$$\sqrt{(c^2 - y'^2)} - \sqrt{(d^2 - y'^2)} = x - x';$$

* The form of equilibrium of a flexible chain was first investigated by Galileo, who pronounced the curve to be a parabola. His error was detected experimentally in 1669 by Joachim Jungius, a German geometer; but the true form of the catenary was only obtained by James Bernoulli in 1691. Gregory (in his *Examples*, p. 234) refers to what would seem to be an interesting memoir by Professor Wallace on this curve (*Edinburgh Transactions*, vol. XIV. p. 625).

and since, by the equation of the tractrix,

$$x' + \sqrt{(c^2 - y'^2)} = c \log \left\{ \frac{c + \sqrt{(c^2 - y'^2)}}{y'} \right\},$$

that of the synttractrix will be

$$x + \sqrt{(d^2 - y^2)} = c \log \left\{ \frac{d + \sqrt{(d^2 - y^2)}}{y} \right\}.$$

The tractrix is a particular case of the general problem of equi-tangential curves, where it is required to find a curve such that the intercept on the tangent between the curve and a fixed directrix shall be constant.

318. The problem of *curves of pursuit* was first presented in the form--To find the path described by a dog which runs to overtake its master. It may be stated mathematically as follows: The point A describes a known curve, and it is required to find the curve described by the point B , the motion of which is always directed toward A . We suppose both points to move with uniform velocities, and A to move along a right line which we take for axis of y .* The intercept made by the tangent on this axis of y is $y - x \frac{dy}{dx}$, and by hypothesis the increment of this is to be proportional to the increment of the arc, or putting $\frac{dy}{dx} = p$,

$$-x dp = h \sqrt{(1 + p^2)} dx,$$

$$\log x^h + \log \{p + \sqrt{(1 + p^2)}\} + \log A = 0,$$

$$2p = A^{-1} x^{-h} - A x^h,$$

$$2y = C - \frac{A}{h+1} x^{h+1} - \frac{A^{-1}}{h-1} x^{-h+1}.$$

This curve will then be algebraic, except in the case when $h = 1$, when we have to substitute $\log x$ for $-\frac{x^{-h+1}}{h-1}$.

319. The *involute of the circle* is another transcendental curve whose equation can be obtained without much difficulty. This

* See Bouguer, *Mémoires de l'Académie*, 1732, *Correspondance sur l'école polytechnique*, II. 275. St. Laurent, *Gergonne's Annales*, XIII. 145.

is equivalent to the following problem: "If on the tangent at any point P of a circle there be taken a portion PQ , such that it shall be equal to the arc AP measured from any fixed point A ; to find the locus of Q ." Let the radius of the circle = a , the centre being C and the radius vector $CQ = \rho$; let $PCA = \phi$, $QCA = \theta$. Then $PQ = \sqrt{(\rho^2 - a^2)}$; and it also = $a\phi$ by hypothesis; but

$$\phi = \theta + \cos^{-1} \frac{a}{\rho}.$$

Hence the polar equation of the locus is

$$\frac{\sqrt{(\rho^2 - a^2)}}{a} = \theta + \cos^{-1} \frac{a}{\rho}.$$

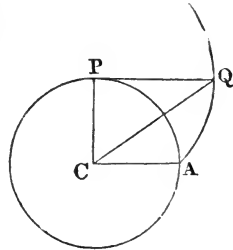

The involute of the circle is the locus of the intersection of tangents drawn at the points where any ordinate to CA meets the circle and the corresponding cycloid having its vertex at A .

320. We shall conclude this Chapter with some account of spirals. In these curves referred to polar coordinates, the radius vector is not a periodic function of the angle, but one which gives an infinity of different values when we substitute $\omega = \theta$, $\omega = 2\pi + \theta$, $\omega = 4\pi + \theta$, &c. The same right line then meets the curve in an infinity of points, and the curve is transcendental. Let us first take the *spiral of Archimedes*, which is the path described by a point receding uniformly from the origin, while the radius vector on which it travels moves also uniformly round the origin. The polar equation of the curve is then

$$\rho = a\omega.$$

This spiral is the locus of the foot of the perpendicular on the tangent to the involute discussed in the last Article. For, from the nature of evolutes, the tangent to the locus of Q is perpendicular to PQ ; and the length of the perpendicular on that tangent from C will = $PQ = a\phi$, and ϕ is the angle this perpendicular makes with a fixed line. Hence, too, the reciprocal of the involute is the *hyperbolic spiral* $\rho\omega = a$, which we shall discuss in the next Article. The spiral of Archimedes is one of a family included in the general equation $\rho = a\omega^n$, in all which the tangent approaches more nearly to being perpendicular

to the radius vector the further the point recedes from the origin. For $\frac{\rho d\omega}{d\rho} = \frac{\omega}{n}$; therefore (Art. 95) the tangent of the angle made by the radius vector with the tangent increases as ω increases, but does not actually become infinite until ω is infinite.

321. We have just mentioned the equation of the hyperbolic spiral $\rho\omega = a$. This spiral has an asymptote parallel to the line from which ω is measured; for the perpendicular from any point of the spiral on this line is $\rho \sin \omega = \frac{a \sin \omega}{\omega}$, which, when ω vanishes, and ρ becomes infinite, has the finite value a . Or, again, we might calculate the length of the perpendicular from the origin on the tangent. The tangent of the angle made by the radius vector with the tangent is $\frac{\rho d\omega}{d\rho} = -\omega$; hence the perpendicular is $\frac{a\rho}{\sqrt{(a^2 + \rho^2)}}$, which, when ρ becomes infinite, is $= a$. The form of the curve is then as here given. The polar subtangent of the hyperbolic spiral is constant. The arc AB of the circle described with the radius OA to any point of the curve is obviously constant.

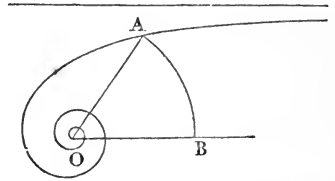

Another spiral worth mentioning is the *lituus* $\rho^2\omega = a^2$; this also has an asymptote, viz., the line from which ω is measured; for the distance of any point of it from this line, $\rho \sin \omega = \frac{a^2 \sin \omega}{\rho\omega}$, decreases indefinitely as ρ increases, and ω consequently diminishes.

322. We shall mention in the last place the *logarithmic spiral*, $\rho = a^\omega$. In this curve ρ increases indefinitely with ω ; when ω is 0 it = 1, and diminishes further for negative values of ω , but it does not vanish until ω becomes negative infinity; hence the curve has an infinity of convolutions before reaching the pole. One of the fundamental properties of this curve is, that it cuts all the radii vectores at a constant angle, for $\frac{\rho d\omega}{d\rho}$ becomes

the modulus of the system of logarithms which has a for its base; the angle, therefore, made by the radius vector with the tangent always has this modulus for its tangent. From this property we at once obtain the rectification of the curve; for if we consider the elementary triangle which has the element of the arc for its hypotenuse, and the increment of the radius vector for one side, we see that the element of the arc is equal to the increment of the radius vector multiplied by the secant of this constant angle, and hence that any arc is equal to the difference of the extreme radii vectores multiplied by the secant of the same angle. The entire length, measured from any point P to the pole being $\rho \sec \theta$, is constructed by erecting at the pole OQ perpendicular to OP to meet the tangent at P ; PQ will then be the required length. The locus of Q will evidently be an involute of the curve, but the angles of the triangle OPQ being constant, OQ is proportional to OP , and it makes with OP a right angle; the locus of Q is therefore also a logarithmic spiral, constructed by turning round the radii vectores of the given curve through a right angle, and altering them in a fixed ratio. Conversely, the evolute of a logarithmic spiral is a logarithmic spiral. The locus of the foot of the perpendicular on the tangent is likewise a logarithmic spiral, for it also bears a fixed ratio to the radius vector, and makes with it a constant angle. The caustics by reflexion and refraction, the light being incident from the pole, are likewise logarithmic spirals.*

* The logarithmic spiral was imagined by Des Cartes, and some of its properties discovered by him. The properties of its reproducing itself in various ways, as stated above, were discovered by James Bernoulli, and excited his warm admiration.

CHAPTER VIII.

TRANSFORMATION OF CURVES.

323. HAVING in former parts of this work explained particular methods by which the properties of one curve may be derived from those of another, such as the methods of Projection, of Reciprocal Polars, of Inversion, &c., we purpose in this chapter to consider the general theory of such methods. In such methods we have in general to consider the correspondence of two points P, P' which may be either in the same plane or in different planes. In the latter case the two planes *may* be regarded as existing in a common space, and the two points P, P' may be connected by geometrical relations in such space. For example, in the method of Projection the line joining the points P, P' is subject to the condition of always passing through a fixed point. O . Similarly, we should have another system of transformation if the line PP' were subject to the condition of always meeting two fixed lines; and so forth. The development of such theories belongs to solid geometry; here we consider the two planes as existing *irrespectively* of any common space. To take the simplest example, suppose that we have a pair of axes in one plane, and another pair of axes in the other plane; and that the coordinates of P referred to the first pair of axes are to be always respectively equal to the corresponding coordinates of P' referred to the second pair of axes, we have evidently a system in which to any point P in the first plane corresponds a point P' in the second, and *vice versa*.

The two planes may be regarded as superimposed one on the other, and so as forming a single plane. Supposing this done, there will be theorems dependent on the superimposition of the two planes; besides these there remain the theorems which existed when the two planes were distinct, and the theory is not really altered. Or, to express this otherwise, instead of two

figures in different planes, we have two figures in the same plane, where by the word figure is meant any system of points, lines, or curves; or, it may be, all the points of the plane. The kind of transformation chiefly studied has been the *rational* transformation; viz., where to a given position of P corresponds in general a single position of P' , and to a single position of P' a single position of P . The most simple instance of this is the linear or homographic transformation, which we proceed to consider in detail.

LINEAR TRANSFORMATION.

324. Let the coordinates of P referred to any system of axes in the first plane be x, y, z ; and let those of P' referred to any system of axes in the other plane be x', y', z' ; then the correspondence of the two points is said to be linear if the latter coordinates are proportional to linear functions of the former

$$x' : y' : z' = ax + by + cz : a'x + b'y + c'z : a''x + b''y + c''z,$$

by solving which equations we have evidently also linear expressions for x, y, z in terms of x', y', z' ,

$$x : y : z = Ax' + By' + Cz' : A'x' + B'y' + C'z' : A''x' + B''y' + C''z'.$$

It is easy to see that, properly assuming as well the fundamental triangles as the ratios of the implicit constants, these equations may, without loss of generality, be written in the form $x' : y' : z' = x : y : z$. Thus then to any position of either point corresponds a single position of the other. If P describes any curve $\phi(x, y, z) = 0$, by substituting in this equation the values of x, y, z just written, we obtain the equation of the curve described by P' . This latter equation is evidently of the same order as the former; therefore, to any curve in one plane corresponds a curve of the same order in the other; in particular, to a right line in one plane corresponds a right line on the other. It is also obvious, that to a node or cusp on one curve will answer a node or cusp on the other, so that two curves corresponding in this method will have the same Plückerian characteristics. Since x', y', z' expressed in terms of x, y, z contain each three constants, there are nine constants employed in this method of

transformation; but since we are only concerned with the mutual ratios of x', y', z' , one constant may be divided out, and the method of homographic transformation is to be regarded as involving eight arbitrary constants.

325. *To a pencil of four lines meeting in a point corresponds a pencil whose anharmonic ratio is the same.* For it was shewn (*Conics*, Art. 59) that the anharmonic ratio of four lines $\alpha - k\beta$, $\alpha - l\beta$, $\alpha - m\beta$, $\alpha - n\beta$, is a function only of k, l, m, n , and therefore is the same as the anharmonic ratio of $\alpha' - k\beta'$, &c. Similarly to four points on a right line correspond four points whose anharmonic function is the same. And it hence appears how given any four points of the first figure and the corresponding points A', B', C', D' of the second figure, we can construct the point P' which corresponds to any other point P of the first figure. For the anharmonic ratio of the pencil $A' (B', C', D', P')$ is equal to that of the pencil $A (B, C, D, P)$, and we can hence construct the line $A'P'$; similarly we can construct $B'P', C'P', D'P'$, and the four lines will of course meet in a point which is the point P' . The construction is applicable whether the two planes are distinct or superimposed.

326. Let us now suppose the planes superimposed, and investigate another geometrical construction to express the relation between corresponding lines and points. Let A, B, C be the vertices of the triangle formed by the lines x, y, z ; and A', B', C' those of the triangle formed by the corresponding lines x', y', z' ; then since all lines through A form a system homographic with the corresponding lines through A' , the locus of the intersection of corresponding lines is a conic. Or, analytically, since the line $y + kz$ corresponds to $y' + kz'$, eliminating k , the locus of intersection is $yz' = y'z$. In like manner all lines through B and through C meet the corresponding lines on the fixed conics $zx' - xz', xy' - yx'$. The construction thus assumes that in addition to three pairs of corresponding points $A, A'; B, B'; C, C'$, we are given three fixed conics each passing through a pair of corresponding points; and the form of the equations $\frac{x}{x'} = \frac{y}{y'} = \frac{z}{z'}$, shows that these three conics have also three

common points. In order then to construct the point of the second system corresponding to any point P of the first, let the line PA meet the curve $yz' - zy'$ in the point F , then $A'F$ is the line corresponding to PA ; similarly, let PB, PC meet respectively the conics $zx' - xz', xy' - yx'$ in points G, H ; and $B'G, C'H$ will be the respectively corresponding lines. The three lines $A'F, B'G, C'H$ will have a common point P' , which will be the required point corresponding to P . The line corresponding to any given one is constructed by constructing for the points corresponding to any two points on it.

327. In the foregoing method the relation between two points is in general not reciprocal; that is to say, if to P in the first system corresponds P' in the second, it will not be true that to P' considered as a point in the first will correspond P in the second. In fact, if we consider P as belonging to the second system, we construct the corresponding point, as in the last article, by joining P to A', B', C' : let the joining lines meet the respective conics in F', G', H' ; then to PA', PB', PC' will correspond lines in the first system AF', BG', CH' meeting in a point P'' which will ordinarily not be identical with P' .

Consider, however, the three points L, M, N which are common to the three conics $y'z - z'y, z'x - x'z, x'y - y'x$, then the construction shews that to the lines LA, LB, LC , answer respectively the lines LA', LB', LC' . It follows that *the two systems have common the three points L, M, N* ; each of these points, considered as belonging to one system, having itself as the corresponding point in the other system. In like manner the lines joining these points are evidently the same for both systems. And starting with the points L, M, N as given, then if we have a single pair of corresponding points we can at once, in virtue of the theorem, Art. 325, construct the point in either system corresponding to any point whatever of the other system.

If we express the equations in trilinear coordinates, assuming these three lines LM, MN, NL as lines of reference, then since the equations in the second system, answering to $x=0, y=0, z=0$ in the first, are still to represent the same lines, they can only differ from these by constant multipliers, and must be of the form $lx=0, my=0, nz=0$. Thus, then, by a suitable choice of lines

of reference, homographic correspondence may always be expressed in the form that to any point x', y', z' in the first system corresponds the point lx', my', nz' in the second; and homographic transformation is then effected by writing in the equation of any curve lx, my, nz instead of x, y, z respectively. We cannot here, as in Art. 324, write $x' : y' : z' = x : y : z$, for the two figures would then be identical.

328. The method of Projection is a case of this homographic transformation. In this method the line joining any two corresponding points passes through a fixed point, viz., the vertex of the projecting cone; and any two corresponding lines intersect on a certain fixed line, viz., the intersection of the two planes of section. If one of the planes were turned about this line so as to be brought to coincide with the other, the figures would still have the property that the line joining two corresponding points would pass through a fixed point; for consider the triangles formed by three pairs of corresponding lines; and since the corresponding sides intersect in a right line, the lines joining corresponding vertices meet in a point. It is easy to form the most general equations of such a system. Let $ax + by + cz = 0$ be the equation of the line on which the corresponding lines intersect, then it is evident that the equations of $x'y'z'$ (the lines corresponding to xyz) will be of the form

$$x' = a'x + by + cz = 0,$$

$$y' = ax + b'y + cz = 0,$$

$$z' = ax + by + c'z = 0,$$

a system involving three constants less than in the general case, and therefore only five in all.

We shall call the point at which the lines joining corresponding points meet, the *pole* of the system, and the line on which corresponding lines intersect, the *axis* of the system. By subtracting one from the other successively each pair of the equations just written, it will be seen that the pole of the system whose equations we have written is given by the equations

$$(a - a')x = (b - b')y = (c - c')z.$$

The simplest forms of the equations of projective transformation are derived as follows: Any line passing through the

pole is the same for the new figure; for any two points of it have corresponding to them two points on the same line. Hence if the pole be taken at the point xy , the two lines x and y are unaltered by transformation; and any other line, $Ax + By + Cz = 0$, has corresponding to it, $Ax + By + Cz = 0$, the two lines intersecting on the fixed axis, $z - \zeta = 0$. Any line $Ax + By = 0$ passing through the pole evidently remains unchanged.

329. Conversely, if two homographic figures in the same plane have the property that any corresponding lines intersect on a fixed axis, one of the figures may be considered as a projection of the other. For let the plane of one of the figures be turned round this axis, and consider any three pairs of corresponding points ABC, abc , the corresponding sides of these triangles intersecting in L, M, N . Then, when the plane is turned round, Aa, Bb must still intersect (since the lines AB, ab intersect in N , and are therefore in the same plane); and by the theory of transversals Aa when produced is cut by Bb in the same ratio as before the figures were turned round. But in like manner Cc , and the line joining any other pair of corresponding points, meets Aa in the very same point.

330. The general homographic method of transformation, containing three constants more than the projective method, appears at first sight a more powerful instrument of research, and we should expect to arrive, by its means, at extensions of known theorems more general than those with which the method of Projection had furnished us. It is obvious, however, that if a figure were transferred bodily to some other position, we should have a linear transformation, in which to every line of the first figure would correspond a line of the second figure, but yet which would give us no new geometrical information. Now we owe to M. Magnus the remark, that the most general transformation may be reduced to a projective transformation by turning the figure round a given angle, and then moving it for a given length along a given direction; these three latter constants being just the number by which the transformation appears to be more general than the projective.

To see this, we must first observe, that if a figure be moved in any direction without twisting, since all lines remain parallel to their first position, the position of every point at infinity remains unaffected by the operation.

Next, let the whole figure be made to turn round any fixed point, and any system of parallel lines will still remain a system of parallel lines, although no longer parallel to its former direction; hence, any point at infinity will still remain at infinity, and therefore the line at infinity is the same for the figure in both its positions. Moreover, since any circle will remain a circle, however it be moved, we see that the two circular points at infinity will not be disturbed, no matter how the figure be moved.

If then it be required to move a figure so as to have a projective position with a given homographic figure, let the two circular points be ω, ω' , the two corresponding points of the second figure o, o' , since no motion of the first figure can alter the position of ω and ω' , the only possible position of the required pole of the two figures is the point λ , where the lines $o\omega, o'\omega'$ intersect. Let then the first figure be moved so as to bring the point l , which corresponds to λ , to coincide with it. Moreover, let the first figure be turned about l so as to bring m, μ (any other pair of corresponding points) into a line with l ; then we say that the two figures will have a projective position, and the line joining any other two corresponding points, n, ν , must also pass through l . For the anharmonic ratio of $\{l.\omega\omega'\mu\nu\} = \{l.oo'mn\}$ (Art. 325), and since three lines of the system are the same for both, the fourth must also be the same for both. M. Magnus's theorem has then been proved.

331. There is no difficulty in expressing analytically the geometrical theory of the last article. Thus if it be required to find the coordinates of the point l in the case of the general transformation, we are, first, by the theory just laid down, to find the line $o\omega$ joining the point $(x + iy, z)$ to

$$[ax + by + cz + i(a_1x + b_1y + c_1z)], \quad a_2x + b_2y + c_2z],$$

this will be

$$(b_2 - ia_2) \{(ax + by + cz) + i(a_1x + b_1y + c_1z)\} \\ - \{a_1 + b + i(b_1 - a)\} (a_2x + b_2y + c_2z) = 0,$$

$$\text{or } (ab_2 - a_2b) x + (a_2b_1 - a_1b_2) y + \{(cb_2 - c_2b) + (c_1a_2 - c_2a_1)\} z \\ + i \{(a_1b_2 - b_1a_2) x + (ab_2 - a_2b) y + (c_1b_2 - b_1c_2) z + (ac_2 - ca_2) z\} = 0.$$

The line joining $\omega'o'$ will only differ from this in the sign of the quantity multiplying i . The point required is therefore the intersection of the two lines found by putting the real and imaginary parts of the equation separately = 0.

It is not necessary to dwell on particular species of linear relation, such, for example, as similarity. We only mention one kind of homographic relation, in which the area of any space on the one figure is equal to that of the corresponding space on the other figure. It is easy to see that such a transformation is possible. For let the triangle formed by xyz be equal to that formed by $x'y'z'$, then, if we take any point O on the first figure, it will be easy to determine a corresponding point o on the second, such that $Oxy = ox'y'$ and $Oxz = ox'z'$; and therefore that $Oyz = oy'z'$; and the triangle formed by any three points OPQ will be equal to that formed by opq , the corresponding points so determined.

This species of homographic relation differs from orthogonal projection just as the general collinear relation differs from projection in general.

INTERCHANGE OF LINE AND POINT COORDINATES.

332. In the method of transformation just described and in the others to be considered in this chapter, point corresponds to point, and line to line; but there are transformations where a point in the one figure corresponds to a curve in the other figure. We have such a transformation in the method of Reciprocal Polars, in which point corresponds to line and *vice versa*. And the like is the case in the more general homographic transformation, or say in the theory of skew reciprocals, which is as follows: Let there be any system of point-coordinates xyz , and a system of line coordinates $\alpha\beta\gamma$, in the same or in a different plane; then a point in the first system corresponds to a line in the second, if the coordinates x, y, z of the point are respectively proportional to α, β, γ , the coordinates of the line. In the same case to any line $lx + my + nz$ in the first system corresponds the point $l\alpha + m\beta + n\gamma$ in the second. Plainly, then, to four points in

a line will correspond a pencil of four lines having the same anharmonic ratio; for the anharmonic ratio of $y - lx$, $y - mx$, $y - nx$, $y - px$, is the same function of l, m, n, p , whether x and y denote point- or line-coordinates. The method now described may be combined with any of the other transformations described in this chapter; that is to say, in any of them, one of the systems of coordinates may be supposed to be changed from point- to line-coordinates; and in this way we can get all possible transformations in which point answers to line and line to point.

333. Let us now suppose the two systems to be in the same plane, and let us endeavour to express the transformation altogether in point-coordinates. To any point $x'y'z'$ is to correspond a line whose coordinates referred to a certain system of line-coordinates $\alpha\beta\gamma$ are x', y', z' . But this is equivalent to saying that its equation is to be $x'X + y'Y + z'Z = 0$, where $X=0, Y=0, Z=0$ denote the lines joining the points represented by $\alpha=0, \beta=0, \gamma=0$. And these being known lines, the equation of the line answering to the point $x'y'z'$ must be of the form

$$x'(a_1x + b_1y + c_1z) + y'(a_2x + b_2y + c_2z) + z'(a_3x + b_3y + c_3z) = 0.$$

This is an equation involving eight constants, and would coincide with the equation of the polar of a point with regard to a conic section, only if $b_1 = a_2, c_1 = a_3, b_3 = c_2$; the equation in this case involving but five constants.

334. In the general case every point has a different line corresponding to it according as the point is considered as belonging to the first or to the second system. Thus the equation just written expresses the relation between any point $x'y'z'$ of the first system and any point xyz on a corresponding line of the second system. If now the latter point be fixed, and the former variable, we have, for the equation of the line of the first system corresponding to any point of the second,

$$(a_1x' + b_1y' + c_1z')x + (a_2x' + b_2y' + c_2z')y + (a_3x' + b_3y' + c_3z')z = 0.$$

In the case of reciprocals with regard to a conic, the same line corresponds to a point, whether that point be considered as belonging to the first or to the second system.

335. In order to give, in the general case, a geometric construction for the line corresponding to any point, we shall first seek for the locus of the points which lie on their corresponding lines. This is obviously

$$a_1x^2 + (a_2 + b_1)xy + b_2y^2 + (b_3 + c_2)yz + (a_3 + c_1)xz + c_3z^2 = U = 0,$$

and is the same conic whether the point be considered as belonging to the first or to the second system. We shall call this the *pole conic*.

Next let us seek the envelope of lines which pass through their corresponding points. The line $\lambda x' + \mu y' + \nu z'$ (where $x'y'z'$ is a point on the conic just written) touches (see *Conics*, Art. 151)

$$\begin{aligned} & (b_3^2 + c_2^2 + 2b_3c_2 - 4b_2c_3)\lambda^2 \\ & \quad + (4a_1b_3 + 4a_1c_2 - 2a_2a_3 - 2a_2c_1 - 2b_1a_3 - 2b_1c_1)\mu\nu \\ & + (a_3^2 + c_1^2 + 2a_3c_1 - 4a_1c_3)\mu^2 \\ & \quad + (4b_2a_3 + 4b_2c_1 - 2a_2b_3 - 2a_2c_2 - 2b_1b_3 - 2b_1c_2)\nu\lambda \\ & + (a_2^2 + b_1^2 + 2a_2b_1 - 4a_1b_2)\nu^2 \\ & \quad + (4a_2c_3 + 4b_1c_3 - 2c_1c_2 - 2a_3b_3 - 2c_1b_3 - 2c_2a_3)\lambda\mu = 0. \end{aligned}$$

The envelope is therefore a conic, which we shall call the *polar conic*, and which is also the same whether the lines in question belong to the first or to the second system.

Using now the words pole and polar to express the kind of correspondence we are here considering, we have at once the polar of any point on the *pole conic*. For from that point draw two tangents to the *polar conic*: one of these is the polar when the given point is considered to belong to the first system; the other, when it is considered to belong to the second system.

Or, conversely, to find the pole of any tangent to the polar conic. We have only to take the two points where this line meets the pole conic; one of these points is its pole in the first, and the other in the second system.

Let it be required now to find the polar of any point O . Draw from it two tangents, OT_1, OT_2 , to the polar conic. Let OT_1 meet the pole conic in the points A_1A_2 , and let OT_2 meet it in the points B_1B_2 . Then if A_1 be the point in the first system which corresponds to OT_1 , and B_1 that which corresponds

to OT_2 , plainly A_1B_1 is the line in the first system which corresponds to O , considered as belonging to the second system; that is, A_1B_1 is one of the polars of O . Similarly, A_2B_2 is the other polar of O .

Or, to find the pole of a given line meeting the pole conic in the points AB , from these draw tangents AP_1, AP_2, BQ_1, BQ_2 to the polar conic; and if AP_1, BQ_1 be the lines in the first system, which are the polars of A, B , their intersection gives the point in the first system, which is the pole of AB . And, in like manner, the intersection of AP_2, BQ_2 gives the point in the second system, which is the pole of AB .

The reader will readily see how these constructions reduce to the ordinary polar reciprocals if $a_2 = b_1, b_3 = c_2, c_1 = a_3$. The pole and polar conic will then coincide; the polar of any point on that conic is the tangent at that point, and the polar of any other point is the same for both systems, and is the line joining the points of contact of tangents from the point to the conic.

336. It follows at once from these principles that in the general case the pole conic and the polar conic have double contact with each other. For, take any point of intersection, its two polars coincide with the tangent at that point to the polar conic; the two poles of this line must therefore coincide, and therefore the two points where it meets the pole conic must coincide, therefore the tangent to the polar conic at their intersection must touch the pole conic also. The same thing is proved for their other point of intersection. Prof. Cayley has proved the same thing analytically, by shewing that if $U=0$ be the equation of the pole conic, that of the polar conic (found by putting for λ, μ, ν their values, in the equation of the last Article) may be thrown into the form

$$\begin{aligned} & \{x(a_1b_3 - a_3b_1 + a_2c_1 - a_1c_2) + y(b_2c_1 - b_1c_2 + b_3a_2 - b_2a_3) \\ & \quad + z(c_3a_2 - c_2a_3 + c_1b_3 - c_3b_1)\}^2 \\ & + 4U \cdot \{a_1(c_2b_3 - b_2c_3) + a_2(b_1c_3 - b_3c_1) + a_3(b_2c_1 - b_1c_2)\} = 0, \end{aligned}$$

a form which shews at once that it has double contact with U .

337. There are, in the general case, three points whose polars are the same with regard to both systems. For let the equations of the polars in each system be

$$\lambda x + \mu y + \nu z = 0, \text{ and } \lambda' x + \mu' y + \nu' z = 0,$$

then the system of equations

$$\frac{\lambda}{\lambda'} = \frac{\mu}{\mu'} = \frac{\nu}{\nu'},$$

is manifestly satisfied for three points; and the theory laid down in the last Article shews at once what the three points are. For the two points of contact of the pole and polar conics have each the same polar in both systems, viz., the common tangents at these points; and the point at which these tangents intersect has also the same polar in both systems, viz., the chord of contact of the conics.

There are then three points which have the same polar in both systems; and two of these points lie on their polars, but the third does not.

338. It is desirable to shew that in the constructions which we have given no ambiguity occurs, and that we need be at no loss to know, of the two poles of a given line, which belongs to the first, and which to the second system.

Since two conics having double contact may always be projected into two similar concentric conics, we use these in the figure for greater simplicity.

Let A, B be the two poles of any tangent to the polar conic, then of the two poles of any other tangent A', B' , A' will belong to the first system, since if AB were moved round to coincide

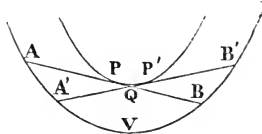

with $A'B'$, A would coincide with A' , and B with B' . The distinction between the points may be readily made by the help of the following theorem: " $A'B$ and AB' are parallel in the case of two concentric conics; and by the method of projections, in the general case, intersect on the chord of contact of the conics."

Reciprocally, if we draw tangents to the polar conic from two points on the pole conic, we must so number them, $oa_1, oa_2, pb_1,$

pb_2 , that the line joining the intersection of oa_1, pb_2 to that of oa_2, pb_1 may pass through the pole of the chord of contact of the conics.

339. The number of constants in the case of skew reciprocals only exceeding by three the number of constants in the case of reciprocals with regard to a conic, it is natural to inquire whether the latter does not only differ from the former by displacement of the figure. It is evident, at any rate, that the skew reciprocal here considered is only a homographic transformation of the reciprocal with regard to a conic, and that therefore the use of skew reciprocals can lead to no geometric theorem which we might not obtain by combining the use of ordinary reciprocals with the method of projections.

It is very easy to see what must be the first step if it be required to move the two figures into such a position that the polar of every point may be the same, no matter to which system that point be considered to belong. For, since the position of the line at infinity is unaffected by any displacement of the figure, we must begin by taking its pole in each system, and then moving the systems so that these points shall be brought to coincide. The pole and polar conics will then become concentric and similar, this point being their common centre.

340. Now we say, that if by turning the figures round their common centre O , they can be given such a position that the polar of any point A at infinity shall be the same line OB for both systems; then if the polar of any other point C at infinity be the line OD for the first system, it must be also so for the second system. For the anharmonic ratio of the four points of the first system $ABCD$ is equal to the corresponding pencil of the second system, viz., $OB.OA.OD.OX$; and since three legs are the same in two pencils, OX must coincide with OC , or the polar of the point D must be the same whether it belong to the first or second system; so also must then the polar of C .

Since now the circular points at infinity are unmoved by any turning of the figure, we have only to take the two polars of either of these points, which in general will not pass through the point, and turn either figure round, so as to bring these

polars to coincide; and then, from what has been just proved, the polars of every other point will coincide.

341. We can readily obtain an expression for the angle through which the figure is to be turned. The two figures being in a concentric position, and the origin being the centre, it is readily seen that the most general equations of the two polars of any point are

$$(a_1x' + b_1y')x + (a_2x' + b_2y')y + c_3 = 0,$$

and
$$(a_1x' + a_2y')x + (b_1x' + b_2y')y + c_3 = 0.$$

The two polars of the point at infinity, for which $y' = ix'$, are

$$(a_1 + ib_1)x + (a_2 + ib_2)y = 0,$$

and
$$(a_1 + ia_2)x + (b_1 + ib_2)y = 0;$$

and the angle through which one of these lines must be turned to coincide with the other is the difference of the angles whose tangents are

$$-\frac{a_1 + ib_1}{a_2 + ib_2} \quad \text{and} \quad -\frac{a_1 + ia_2}{b_1 + ib_2};$$

but this is the real angle whose tangent is $\frac{a_2 - b_1}{a_1 + b_2}$.

342. Or the same result may more simply be obtained as follows: If in general the line of the second system corresponding to the point $x'y'$ in the first be

$$(a_1x' + b_1y')x + (a_2x' + b_2y')y + c_3 = 0;$$

then, when the second system is turned round an angle θ , the equation of this line will become

$$(a_1x' + b_1y')(x \cos \theta - y \sin \theta) + (a_2x' + b_2y')(x \sin \theta + y \cos \theta) + c_3 = 0,$$

or
$$\{(a_1 \cos \theta + a_2 \sin \theta)x' + (b_1 \cos \theta + b_2 \sin \theta)y'\}x$$

$$+ \{(a_2 \cos \theta - a_1 \sin \theta)x' + (b_2 \cos \theta - b_1 \sin \theta)y'\}y + c_3 = 0.$$

But the locus of points of the first system whose polars pass through $x'y'$, that is to say, the line corresponding to $x'y'$, considered as belonging to the transformed system, will be

$$\{(a_1 \cos \theta + a_2 \sin \theta)x' + (a_2 \cos \theta - a_1 \sin \theta)y'\}x$$

$$+ \{(b_1 \cos \theta + b_2 \sin \theta)x' + (b_2 \cos \theta - b_1 \sin \theta)y'\}y + c_3 = 0.$$

This line will always coincide with the other, if we have

$$b_1 \cos \theta + b_2 \sin \theta = a_2 \cos \theta - a_1 \sin \theta;$$

or, as before,
$$\tan \theta = \frac{a_2 - b_1}{b_2 + a_1}.$$

QUADRIC TRANSFORMATION.

343. Before proceeding to the general theory, it will be instructive to consider in detail one other special method, viz. when the coordinates of the point P' are functions of the second degree of the coordinates of P , or say in which $x' : y' : z' = U : V : W$. Thus to the lines $x=0, y=0, z=0$ will answer three conics $U=0, V=0, W=0$; and, in general, to a curve of the n^{th} order will answer one of the $2n^{\text{th}}$, whose equation is found by substituting U, V, W respectively for x, y, z in the given equation. We have already used this method, Arts. 252, 272. A simple example is when the relation between P' and P is expressed by the equations $x' : y' : z' = x^2 : y^2 : z^2$; then to any right line $lx + my + nz$ will answer a conic $lx^2 + my^2 + nz^2$ touching the sides of the triangle xyz , while to a right line in the second figure answers also a conic in the first. To a conic in the first figure $(a, b, c, f, g, h)\chi(x, y, z)^2$ answers the quartic

$$ax + by + cz + 2fy^2z^2 + 2gz^2x^2 + 2hx^2y^2 = 0.$$

And, as the general equation of a conic may be written in the form

$$\frac{x}{f} + \frac{y}{g} + \frac{z}{h} = \left\{ \left(\frac{1}{f^2} - \frac{a}{fgh} \right) x^2 + \left(\frac{1}{g^2} - \frac{b}{fgh} \right) y^2 + \left(\frac{1}{h^2} - \frac{c}{fgh} \right) z^2 \right\}^{\frac{1}{2}},$$

it follows that the equation of the corresponding quartic may be written in the form $ax^2 + by^2 + cz^2 + dw^2 = 0$. It is therefore trinodal and has the lines x, y, z, w for bitangents.

344. The method of transformation just described, wherein $x' : y' : z' = U : V : W$ is in general not *rational*. For, given x, y, z we have x', y', z' rationally, but when x', y', z' are given, then to find x, y, z we have $\frac{U}{x'} = \frac{V}{y'} = \frac{W}{z'}$; equations which represent conics having four common intersections, and therefore

to any position of the point $x'y'z'$ answer *four* positions of the point xyz . If the conics U, V, W had a common point, this point being independent of the position of the variable point $x'y'z'$ might be set aside; and to any position of the one point would answer three of the other. Similarly, if U, V, W had two common points; and finally, if they have three common points, the conics $\frac{U}{x'} = \frac{V}{y'} = \frac{W}{z'}$ have, besides the three fixed points, only one other common point. The transformation is therefore in this case rational, and to any position of either point answers a single position of the other. It would be a mere change of coordinates, if instead of the conics U, V, W we took three conics of the form $lU + mV + nW$, making the corresponding lines $lx + my + nz$ our new lines of reference. There is therefore no loss of generality if we take for U, V, W the three line-pairs got by joining each of the fixed points to the two others. The most general rational quadric transformation is therefore that which we have already used, Art. 283, where two corresponding points are connected by the reciprocal relations

$$x : y : z = y'z' : z'x' : x'y' \text{ and } x' : y' : z' = yz : zx : xy.$$

345. It was stated, Art. 283, that to the point xy will correspond any point on the line $z' = 0$, &c. If we transform any curve, to each of the n points where it meets the line z' will correspond the point xy , which will accordingly be a n -fold point, or, more strictly, to each of the n points corresponds the direction of a tangent at the n -fold point. There will be a coincidence among these tangents should the original curve touch the line z' . To a curve therefore of the n^{th} degree, which does not pass through any of the three fixed points $y'z', z'x', x'y'$, will correspond a curve of the $2n^{\text{th}}$ degree having the three points yz, zx, xy as n -fold points. Let us suppose, however, that the curve passes through the point $y'z'$, then the line x must be part of the corresponding figure, and setting this aside the order of the corresponding curve is reduced by unity. Also since the line x passes once through each of the points zx, xy , the corresponding curve will only pass through each of these points $(n - 1)$ times instead of n . And, in like manner, we

see in general that to a curve of the n^{th} degree which passes through the three principal points, as we shall call them, f , g , and h times respectively, will correspond a curve whose order n' is $2n - f - g - h$, and which passes through the three principal points on the other figure f' , g' , and h' times respectively, where $f' = n - g - h$, $g' = n - h - f$, $h' = n - f - g$.

346. It is easy to verify that the numbers thus assigned satisfy the reciprocal relation which exists between the corresponding curves; that is to say, that we have also

$$n = 2n' - f' - g' - h', \quad f = n' - g' - h', \quad g = n' - h' - f', \quad h = n' - f' - g'.$$

We shall shew also that the two corresponding curves have the same deficiency. For if a curve pass f times through a point, this is equivalent to $\frac{1}{2}f(f-1)$ double points, (Art. 43). Hence the deficiency of the first curve is

$$\frac{1}{2} \{ (n-1)(n-2) - f(f-1) - g(g-1) - h(h-1) \},$$

and using the values just obtained for n' , f' , g' , h' , it is easy to verify that the number just written is equal to

$$\frac{1}{2} \{ (n'-1)(n'-2) - f'(f'-1) - g'(g'-1) - h'(h'-1) \}.$$

347. A particular case of quadric transformation is the method of inversion, or transformation by reciprocal radius vectors, described Art. 122, and *Conics*, Art. 121 (c). In this method we have a fixed point O ; and corresponding points P , P' lie on a line through O , at distances whose product is constant; say $OP \cdot OP' = 1$. Taking O as origin, it is easy to see that the relations between the rectangular coordinates of P and P' are

$$x' = \frac{x}{x^2 + y^2}, \quad y' = \frac{y}{x^2 + y^2}; \quad x = \frac{x'}{x'^2 + y'^2}, \quad y = \frac{y'}{x'^2 + y'^2}.$$

But these equations give

$$x' + iy' = \frac{1}{x - iy}, \quad x' - iy' = \frac{1}{x + iy}.$$

Hence, writing

$X, Y, Z = x - iy, x + iy, 1$; $X', Y', Z' = x' + iy', x' - iy', 1$,
we have $X' : Y' : Z' = YZ : ZX : XY$,

or the transformation is of the kind considered in this section. The point O is called the centre of inversion; and the circle whose radius is the square root of the given value of $OP \cdot OP'$ is called the circle of inversion, and if P describe any curve, the curve described by P' is called the inverse curve.

In particular, the inverse of a right line is a circle passing through O ; viz. if OA is the perpendicular on the line, and A' the point corresponding to A , the circle is that which has OA' for its diameter. The point O corresponds to the point at infinity on the line. Again, the inverse of any circle is a circle (*Conics*, Art. 121(c)), and in particular, the inverse of a circle C which cuts at right angles the circle of inversion is this same circle C ; that is to say, the point P' corresponding to P lies on the same circle, which is therefore its own inverse. We give this example to illustrate a theory which will be more fully considered in a separate section, where the general theory of transformation presents itself as a theory of correspondence of points on a given curve. Here confining our attention to the circle C , the points P, P' on it correspond to each other; and in order to find the point corresponding to a given one P , we have only to join it to a fixed point O , and take the point where OP meets the circle again.

348. To return to the general theory of inversion, it is obvious that two pairs of corresponding points A, A' ; B, B' , lie on a circle which cuts orthogonally the circle of inversion; and by the property of a quadrilateral inscribed in a circle, the line joining two points A, B makes the same angle with the radius vector OA that the line joining the corresponding points A', B' makes with the radius vector OB' . In the limit, if AB be the tangent at any point A , the corresponding tangent to the inverse curve makes the same angle with the radius vector. It follows immediately that the angle which two curves make with each other at any point is equal to the angle which the inverse curves makes with each other at the corresponding point.

The inverse is immediately formed of curves included in the equation $\rho^n = a^n \cos n\omega$. Thus $n=2$, the lemniscate is the inverse of the equilateral hyperbola; $n=\frac{1}{2}$, the cardioide is the

inverse of a parabola having the origin for its focus, &c. The inverse of a conic in general is a trinodal quartic, the nodes being the origin and the circular points at infinity. If the origin be the focus of the conic, the inverse is the *limaçon*; if the origin be on the curve, the inverse is a nodal circular cubic, the origin being the node. Evidently in general to a circle osculating one curve will correspond a circle osculating the inverse curve; but if the circle passes through the origin the inverse will be an inflexional tangent.

Ex. 1. The three points of inflexion of a nodal circular cubic lie on a right line. Hence, through any point on a conic can be drawn three circles elsewhere osculating the curve, and their points of contact lie on a circle passing through the given point. The three points will be all real when the curve is an ellipse, but if it be a hyperbola, two will be imaginary.*

Ex. 2. In like manner, through any point on a circular cubic or bicircular quartic can be described nine circles elsewhere osculating the curve, and of these circles three will be real and their points of contact will lie on a circle passing through the given point.

Ex. 3. "The feet of the perpendiculars on the sides of a triangle from any point on the circumscribing circle lie in one right line." Inversely, if on three chords of a circle, AB, AC, AD as diameters, circles be described, the points of intersection of these circles with each other lie on a right line.

Ex. 4. "The circle circumscribing a triangle whose sides touch a parabola passes through the focus." Inversely, if three circles be described through the cusp to touch a cardioid, their points of intersection with each other lie on a right line.

Ex. 5. "If a right line meet a *limaçon* in four points, the sum of their distances from the node is constant." Inversely, if a circle through the focus meet a conic in four points the sum of the reciprocals of their distances from the focus is constant.

Ex. 6. To find the envelope of circles passing through a fixed point and whose centres lie on a given curve. Take the fixed point for centre of inversion, and the locus of the other extremity of the diameters passing through that point is evidently a curve similar to the given one. It is easy then to see that the negative pedal (Art. 121) of the inverse of this last curve is the inverse of the required envelope, and, therefore (Art. 122), that the envelope is the inverse of the polar reciprocal of that curve.†

349. It remains to mention the cases of rational quadric transformation which cannot be reduced to the substitution $x : y : z = y'z' : z'x' : x'y'$. Of the three points common to the conics U, V, W , two may coincide: let the line y be supposed

* This theorem is Steiner's, see *Conics*, Art. 244, Ex. 3. The proof here given is Dr. Ingram's.

† This example is taken from Dr. Stubbs's paper on this method, *Phil. Mag.* vol. XXIII, 18.

to be the common tangent to the conics at the point yx , and let xz be the third point common to the three conics, then the equation of each must be of the form $ax^2 + 2fyz + 2hxy = 0$; we may take x^2, yz, xy as the three conics, and the substitution is that used Art. 289, $x' : y' : z' = xy : x^2 : yz$, equations which imply reciprocally $x : y : z = x'y' : x'^2 : y'z'$. In this substitution, as in the other, to the point $x'z'$ corresponds the line y ; and to any curve meeting this line in n points will correspond a curve having the point as a n -fold point. To the point $x'y'$ corresponds the line x , but whatever be the point on this line, the corresponding direction of tangency will be $y' = 0$. To a curve therefore meeting the line x in n points will correspond a curve having the point $x'y'$ as a n -fold point, at which all the tangents coincide. The theory, in short, is substantially the same as before, only modified by the coincidence of two of the principal points. Again, let all three points coincide, then (*Conics*, Art. 239) the equations of the three conics must be of the form $by^2 + 2hxy + 2f(yz - mx^2) = 0$, and we are led to the substitution used in Art. 290, viz. $x' : y' : z' = xy : y^2 : yz - mx^2$, implying reciprocally $x : y : z = x'y' : y'^2 : y'z' + mx'^2$.

350. Before discussing the general theory of rational transformation, it is convenient to mention, in extension of what was stated, Art. 347, that the general substitution of X^n, Y^n, Z^n for X, Y, Z assumes a simple form when the line Z is at infinity, and X, Y pass through the two circular points. For, transforming to polar coordinates, the equations of X and Y become

$$\rho (\cos \theta \pm i \sin \theta) = 0;$$

and it is obvious that substituting for these functions their n^{th} powers is equivalent to substituting ρ^n for ρ , and $n\theta$ for θ . This transformation is not rational, but it may conveniently be applied to curves of the form $\rho^m = a^m \cos m\omega$, which are always thus transformed to curves of the same family. For $n=2$ a circle becomes a Cassinian, and for $n=\frac{1}{2}$ a limaçon. Mr. Roberts has also noticed (*Liouville*, XIII. 209) that the angle at which two curves intersect is not altered by this transformation. For the tangent of the angle which the tangent to a curve makes with the radius vector is (Art. 95)

$\frac{\rho d\omega}{d\rho}$, and this is unaltered when we substitute $n d\omega$ for $d\omega$ and $\frac{nd\rho}{\rho}$ for $\frac{d\rho}{\rho}$. Thus the theorems given as examples of inversion lead each to as many theorems as we choose to give different values to n . Theorems also concerning the angles at which curves cut are easily transformed by this method, as, for instance, the theorems that a circle is the locus of intersection of two right lines cutting at a fixed angle which each pass through a fixed point; that a series of concentric circles are cut orthogonally by lines through the common centre, &c.

THE GENERAL THEORY OF RATIONAL TRANSFORMATION.

351. We come now to the general theory of the rational transformation, in which to any system of values of xyz corresponds a single system of values of $x'y'z'$; for example, $x' : y' : z' = U : V : W$, where U, V, W are known functions of x, y, z , which we suppose to be of the n^{th} order; and, reciprocally, to any system of values for $x'y'z'$ corresponds a single system of values $x : y : z = U' : V' : W'$. When such mutual expression is possible, U', V', W' must be also of the n^{th} order in $x'y'z'$. For to the n intersections of an arbitrary line $lx + my + nz$ with any curve $aU + bV + cW$ will correspond, in the other system, the intersections of $lU' + mV' + nW'$ with the line $ax' + by' + cz'$, which must also be in number n .

352. Let us now examine the conditions that such mutual expression may be possible. In general, if we are given the coordinates of a point in one system $x' : y' : z' = a : b : c$, there will correspond in the other system the intersections of the curves $U : V : W = a : b : c$; and these will be n^2 in number if U, V, W are general curves of their order. If, however, U, V, W have p points common to all three, the curves $\frac{U}{a} = \frac{V}{b} = \frac{W}{c}$ will always pass through these points, and there will be only $n^2 - p$ variable points of intersection, which will be the points in the other system corresponding to the given point. Finally, if $p = n^2 - 1$, there is but a single variable point of

intersection; or, in other words, all but one of the intersections of the curves $U : V : W = a : b : c$ being known, the coordinates of the remaining intersection are uniquely determinate, and will thus be rational functions of a, b, c ; that is to say, of x', y', z' , and we have expressions of the form $x : y : z = U' : V' : W'$.

353. Thus, then, one condition for rational transformation is, that the curves U, V, W shall have $n^2 - 1$ common intersections; but there is a further condition. The system of curves $aU + bV + cW$ must be as general as the system of right lines $ax' + by' + cz'$ to which they correspond; that is to say, a curve of the system must not be determinate unless two conditions are given to determine the two expressed constants $a : b : c$. The number of conditions, therefore, which U, V, W can be made to satisfy must be at least two less than the number of conditions necessary to determine a curve of the n^{th} order. For example, if U, V, W be cubics, and if we subject them to the condition of having eight distinct common points, they must also have a ninth (Art. 29); there would be no variable point of intersection, and the construction of Art. 352 would fail. But we can still satisfy the conditions of the problem by supposing the cubics U, V, W to have common one point, which is a node on all, and four ordinary points. These are equivalent to but seven conditions, since to be given a double point is only equivalent to three conditions (Art. 41), and therefore two more conditions are necessary to determine any curve $aU + bV + cW$. But the common points amount to eight intersections, since a point which is a double point on two curves counts for four intersections. And so, in general, we cannot take U, V, W as curves of the n^{th} order, having $n^2 - 1$ distinct common points, because then (n being greater than two) they would have another common point, and no variable point of intersection; but we can satisfy the conditions of the problem by taking for U, V, W curves having common α_1 ordinary points, α_2 double, α_3 triple, &c., in such way that these are equivalent to $n^2 - 1$ intersections, and that the number of conditions implied shall be less by 2 than the number necessary to determine a curve of the n^{th} order. Remembering, then, that to be given a multiple point of the order r is equivalent to $\frac{1}{2}r(r+1)$ conditions, and that such

a point when common to two curves counts as r^2 intersections, we have the two equations

$$\alpha_1 + 4\alpha_2 + 9\alpha_3 + \dots \quad r^2\alpha_r = n^2 - 1 \quad \dots (1),$$

$$\alpha_1 + 3\alpha_2 + 6\alpha_3 + \dots \frac{1}{2}r(r+1)\alpha_r = \frac{1}{2}n(n+3) - 2 \quad \dots (2).$$

Doubling the second equation and subtracting from it the first, we get an equation which may conveniently be substituted for (2)

$$\alpha_1 + 2\alpha_2 + 3\alpha_3 + \dots r\alpha_r = 3(n-1) \dots \dots \dots (3).$$

We have then as many modes of transformation by curves of the n^{th} order as there are solutions of these equations by positive integer values of $\alpha_1, \alpha_2, \&c.$, provided always that the number of higher multiple points which the curves are supposed to possess is subject to the limitations assigned, Art. 43.*

354. The argument of Art. 353, strictly, only shews that in equation (2) the left-hand side cannot be greater than the value there written. But we can also shew that it cannot be less, for add a term $-t$ and subtracting equation (2) from (1) we get

$$\alpha_2 + 3\alpha_3 + \dots \frac{1}{2}r(r-1)\alpha_r = \frac{1}{2}(n-1)(n-2) + t \dots (4).$$

Recollecting that a triple point is equivalent to three double points, and an r -fold multiple point to $\frac{1}{2}r(r-1)$ double points, we see that the left-hand side of the equation represents the number of double points to which all the multiple points of any curve $aU + bV + cW$ are equivalent. And since it was shewn (Art. 42) that this number cannot exceed $\frac{1}{2}(n-1)(n-2)$, we must have $t=0$, then equation (4) asserts that the curves of the system $aU + bV + cW$ have each the maximum number of double points, or, in other words, that they are unicursal. And it is otherwise evident that this must be so, since these curves answer to the right lines of the other system; and not only a right line, but every unicursal curve will be transformed into a unicursal curve; for if the coordinates of a point are rational functions of a parameter, the coordinates of the corresponding

* This theory is due to Cremona, see his memoirs *Sulle trasformazione geometriche delle figure piane*, Mem. di Bologna, t. II. 1863, and t. V. 1865; see also Prof. Cayley's paper, *Proceedings of the London Mathematical Society*, vol. III. 1870, pp. 127-180.

point being rational functions of these, must also be rational functions of the same parameter.

355. We have seen that when n is greater than 2, the equations (1) and (3) cannot be satisfied if the points common to U, V, W are only simple intersections. We shall now shew, in like manner, that if n is greater than 5, there must be a multiple point of order higher than the second; and so on generally. Let r be the highest index; multiply equation (3) by r , and subtract from it equation (1), and we have

$$(r-1)\alpha_1 + 2(r-2)\alpha_2 + 3(r-3)\alpha_3 + \dots + (r-1)\alpha_{r-1} = (n-1)(3r-n-1).$$

Every term on the left-hand side is positive, therefore r cannot be less than $\frac{1}{3}(n+1)$. We may take r equal to this number in the case where $\frac{1}{3}(n+1)$ is an integer, that is to say, if n be of the form $3p-1$, we may take $r=p$; but if so all the numbers $\alpha_1, \alpha_2, \dots, \alpha_{r-1}$ must vanish, and the curves can have no common points but the p -fold points; and we have $p\alpha_p = 3(3p-2)$, which cannot be satisfied by an integer value of α_p if p exceed 3, unless $p=6$. Except, then, when $n=2, 5, 8$, or 17 , r must be greater than $\frac{1}{3}(n+1)$; thus always for n greater than 5 there must be a multiple point of higher than second order.

356. In the same manner is established a theorem from which we shall presently draw an important inference, viz. that if we take the three highest in order of the multiple points, the sum of their orders must exceed n . Let the orders of the three highest be r, s, t , where s is supposed not greater than r and t not greater than s , then transferring the terms contributed by the two former to the opposite sides of equations (1) and (3), these equations become

$$\alpha_1 + 4\alpha_2 + \dots + t^2\alpha_t = n^2 - 1 - r^2 - s^2,$$

$$\alpha_1 + 2\alpha_2 + \dots + t\alpha_t = 3n - 3 - r - s,$$

and, as before, we have a limit to the lowest admissible value of t from the consideration that if we multiply the second equation by t and subtract the first, the remainder is essentially positive. Our business now is to shew that $n-r-s$ is too low a value for t , or that, in this case,

$$n^2 - 1 - r^2 - s^2 > t(3n - 3 - r - s).$$

Substituting $r + s = n - t$, this becomes

$$2rs - 1 + 2nt - t^2 > t(2n - 3 + t).$$

But since, by hypothesis, r and s are not less than t , the least value the first quantity can have is found by putting r and s both $= t$, when the inequality becomes

$$t^2 + 2nt - 1 > t^2 + 2nt - 3t,$$

which is obviously true.

357. Cremona has tabulated as far as $n = 10$ all the admissible solutions of the system of equations we have been considering. Some of his results will be given presently; but enough has been said to shew that we can always take U, V, W functions of the n^{th} order in xyz , such that the equations

$$x' : y' : z' = U : V : W$$

shall represent three curves having common certain fixed points, equivalent to $n^2 - 1$ intersections (which we call the principal points), and one variable point, the coordinates of which expressed in terms of $x'y'z'$ give the converse system of equations

$$x : y : z = U' : V' : W'.$$

We have already seen that U', V', W' are functions of the n^{th} order in $x'y'z'$, and it is plain that these also must represent curves having common a number of fixed points satisfying the conditions (1) and (2) already explained. It does not follow, however, nor is it always true, that the same solution of the system of equations is applicable in both cases; in other words, the system of curves $aU + bV + cW$ which answer to the right lines of one system, and the system of curves $aU' + bV' + cW'$ which answer to the right lines of the other system, have not in general the same distribution of multiple points.

358. We have seen that, in the quadric transformation, to one of the three principal points corresponds in the other figure not a point but a line; and we shall now extend this theorem by shewing that in general to any of the α_r points corresponds a unicursal curve of the r^{th} order. It is evident that the system of equations

$$x' : y' : z' = U : V : W$$

becomes illusory if we seek the point $x'y'z'$ corresponding to any point xyz common to the curves U, V, W . Now, first let this be a point of simple intersection; and, by proceeding to a consecutive point, we have $x'y'z'$ respectively proportional to

$U_1\delta x + U_2\delta y + U_3\delta z, V_1\delta x + V_2\delta y + V_3\delta z, W_1\delta x + W_2\delta y + W_3\delta z$, where $U_1, \&c.$, denote differential coefficients. We have thus a different point $x'y'z'$ corresponding to each element of direction at the assumed point xyz . But if three curves have a common point their Jacobian passes through that point; as is evident by writing the equations $U=0, \&c.$ in the form

$U_1x + U_2y + U_3z = 0, V_1x + V_2y + V_3z = 0, W_1x + W_2y + W_3z = 0$, and eliminating xyz . We thus see that if we eliminate $\delta x, \delta y$ from the values just found for $x'y'z'$, δz will also disappear, and all the points corresponding to xyz will lie on the right line

$$x'(V_1W_2 - V_2W_1) + y'(W_1U_2 - W_2U_1) + z'(U_1V_2 - U_2V_1) = 0.$$

359. We proceed in like manner if the point common to UVW be a multiple point. Let it, for example, be a double point, then the values given, Art. 358, for $x'y'z'$ vanish; but denoting the second differential coefficients as before by $a, b, c, \&c.$, we have $x'y'z'$ respectively proportional to

$$a\delta x^2 + b\delta y^2 + c\delta z^2 + 2f\delta y\delta z + 2g\delta z\delta x + 2h\delta x\delta y : a'\delta x^2 + \&c. : a''\delta x^2 + \&c.$$

But the relation of the point xyz to UVW is such as to allow of the simultaneous elimination from these equations of $\delta x, \delta y, \delta z$. In fact, the above forms in $\delta x, \delta y, \delta z$ are only in appearance ternary, but are really binary. For $ax^2 + by^2 + cz^2 + \&c.$ equated to zero denotes the pair of tangents to the curve U at the double point, and is reducible to the form

$$a(x - mz)^2 + 2h(x - mz)(y - nz) + b(y - nz)^2.$$

There are, therefore, but two quantities $\delta x - m\delta z, \delta y - n\delta z$ to be eliminated between the equations, and it will practically come to the same thing if we write $\delta z = 0$, and eliminate $\delta x, \delta y$. And so for any multiple point we have x', y', z' proportional to

$$(\alpha, \dots \mathfrak{I}\delta x, \delta y)^r; (\alpha', \dots \mathfrak{I}\delta x, \delta y)^r; (\alpha'', \dots \mathfrak{I}\delta x, \delta y)^r;$$

and $\delta x, \delta y$ are eliminated in the manner explained, Art. 44, and x', y', z' being rational functions of a parameter, are the coordinates of a point on a unicursal curve of the r^{th} order.

360. The curves in one system which answer to the principal points in the other may be called the principal curves, and these curves together make up the Jacobian of the system of curves $aU + bV + cW$. For the Jacobian is the locus of the new double point on such of the curves of that system as have a double point in addition to the multiple principal points common to all. But since each of these curves has already the maximum number of double points, it can only acquire a new one by breaking up into inferior curves, and this will happen only when the corresponding right line in the other system passes through one of the principal points. In that case the curve $aU + bV + cW$ breaks up into the fixed r^{ic} curve corresponding to the principal point, together with a residual curve variable with the line through α_r . Now, in general, if we have two unicursal curves, the sum of whose orders r and r' is n , the aggregate multiplicity arising from the singularities of the two curves and their intersections is equivalent to $\frac{1}{2}(r-1)(r-2) + \frac{1}{2}(r'-1)(r'-2) + rr'$, that is, to $\frac{1}{2}(n-1)(n-2) + 1$ double points. Thus we see that in the curve we are considering, the complex curve has besides the principal points one new double point, which will be a point of intersection of the fixed curve answering to α_r , with the residual variable curve; and the locus of such points is therefore the fixed curve. That the sum of the orders of all these principal curves makes up the order of the Jacobian of the system $aU + bV + cW$ is expressed in equation (3), viz.

$$\alpha_1 + 2\alpha_2 + 3\alpha_3 + \dots r\alpha_r = 3(n-1).$$

From the general theory of Jacobians, which will be more fully entered into in the next chapter, it appears that the system of principal curves passes through each of the points α_1 twice, through each point α_2 five times, and through each point α_r $3r-1$ times. There are other theorems which it is sufficient to indicate as to the disposition of the principal curves with respect to the principal points. For instance, take a right line in one system which does not pass through a principal point α_r' , then the corresponding curve $aU + bV + cW$ can have no ordinary point in common with the principal curve α_r , and the intersections of the two curves would be exclusively principal points. In this way we can see that every principal right line

passes through two principal points, the sum of whose orders is n , and every principal conic through five principal points, the sum of whose orders is $2n$.

361. We are now in a position to determine the characteristics of the curve corresponding to a curve of the order k , which we suppose not to pass through any of the principal points. Evidently, if we write U, V, W for x', y', z' in a function of the k^{th} order, we obtain one of the order nk ; and if the curves U, V, W have a point a in common, the line in the other figure corresponding to a will meet the curve S in k points, which will all correspond to a ; this will, therefore, be a k -fold point, and similarly, every one of the principal points α_r will be a rk -fold multiple point. If the original curve have no multiple points, the transformed curve will have no multiple points other than the principal points. Thus it appears that the transformed curve will be of the order nk , the corresponding maximum number of double points being $\frac{1}{2}(nk-1)(nk-2)$; and the principal points will be multiple points, and the number of double points to which they are equivalent will be

$$\frac{1}{2}\alpha_1 k(k-1) + \frac{1}{2}\alpha_2 2k(2k-1) + \dots + \frac{1}{2}\alpha_r rk(rk-1),$$

or $\frac{1}{2}k^2(\alpha_1 + 4\alpha_2 + \dots + r^2\alpha_r) - \frac{1}{2}k(\alpha_1 + 2\alpha_2 + \dots + r\alpha_r),$

or, in virtue of equations (1) and (3),

$$\frac{1}{2}(n^2-1)k^2 - \frac{3}{2}(n-1)k.$$

Substituting, the deficiency of the transformed curve is $\frac{1}{2}(nk-1)(nk-2) - \{\frac{1}{2}(n^2-1)k^2 - \frac{3}{2}(n-1)k\}, = \frac{1}{2}(k-1)(k-2)$, the same as the deficiency of the original curve. If the original curve has multiple points other than the principle points, to these will correspond in the transformed curves multiple points of the same order, and the deficiencies of the two curves remain equal.

If the original curve pass through any of the principal points α_r' , then for each time of passage the corresponding curve α_r is part of the transformed curve, and the degree of the transformed curve proper will be reduced accordingly. There will be also a corresponding reduction in the number of passages of the transformed curve through the principal points through which α_r passes. The effect of this will still be to preserve the equality of the deficiencies of the two curves. Thus, for

example, if the original curve passes through one of the points α_1 , the transformed curve will include as part of itself a right line, and the degree of the residual curve will be reduced from nk to $nk - 1$, and there will be a consequent diminution of $nk - 2$ in the maximum number of double points; so if the right line pass through two points α_s, α_t , the number of passages of the residual curve through these will be each reduced by 1, and the number of equivalent double points will be reduced by $sk - 1$ and $tk - 1$, or by $nk - 2$, since $s + t = n$. It is unnecessary to enter into more detail, because we shall presently arrive at the same results by another method.

362. *Every Cremona-transformation may be reduced to a succession of quadric transformations.* Consider the most general transformation in which to the right lines of one figure answer in the other figure curves of the n^{th} order having in common α_1 ordinary points, α_2 double points, &c. We have seen (Art. 356) that there are three of those points, the sum of whose orders exceeds n . Take these as principal points and effect a quadric transformation, the degree of the transformed curve, being $2n - r - s - t$, is less than n . In like manner, by a new quadric transformation, we can reduce the degree of that curve; and so on until we have at length right lines corresponding to the curves of the n^{th} order. Since it was proved (Art. 346) that the deficiency is not altered by any quadric transformation, the theorem of this article shews that it is not altered by any Cremona-transformation. The following particular example will illustrate the method, and will shew how we can trace the disposition of the principal curves. Consider the transformation in which right lines are transformed into quintics having three ordinary points a_1, a_2, a_3 , three double points b_1, b_2, b_3 , and one triple point c . Take cb_1b_2 as principal points, and by a quadric transformation the quintics become cubics, having b_3' as a double point, and a_1', a_2', a_3', c' as ordinary points. Again, take $a_3'b_3'c'$ as principal points, and apply a new quadric transformation when the cubics become conics passing through a_1'', a_2'', b_3'' , and finally, a new transformation with these for principal points brings them to right lines. In like manner we can see how are transformed the right lines of the first system, or, more

generally, how are transformed curves of the k^{th} order passing a_1 times through the point a_1 , &c. After the first transformation we have

$$\begin{aligned} k' &= 2k - c - b_1 - b_2, \\ c' &= k - b_1 - b_2, \\ b_1' &= k - c - b_2, \quad b_2' = k - c - b_1, \quad b_3' = b_3, \\ a_1' &= a_1, \quad a_2' = a_2, \quad a_3' = a_3. \end{aligned}$$

After the second transformation, in which $a_3' b_3' c'$ are the principal points, we have

$$\begin{aligned} k'' &= 3k - 2c - a_3 - b_1 - b_2 - b_3, \\ c'' &= 2k - c - a_3 - b_1 - b_2 - b_3, \\ b_2'' &= k - c - b_1, \quad b_3'' = k - c - a_3, \quad b_1'' = k - c - b_2, \\ a_3'' &= k - c - b_3, \quad a_1'' = a_1, \quad a_2'' = a_2. \end{aligned}$$

Lastly, after the third transformation, the principal points being $a_1'' a_2'' b_3''$, we have

$$\begin{aligned} k''' &= 5k - 3c - 2b_1 - 2b_2 - 2b_3 - a_1 - a_2 - a_3, \\ c''' &= 2k - c - b_1 - b_2 - b_3 - a_3, \\ a_1''' &= 2k - c - b_1 - b_2 - b_3 - a_2, \quad a_2''' = 2k - c - b_1 - b_2 - b_3 - a_1, \quad a_3''' = k - c - b_3, \\ b_2''' &= k - c - b_1, \quad b_1''' = k - c - b_2, \quad b_3''' = 3k - 2c - b_1 - b_2 - b_3 - a_1 - a_2 - a_3. \end{aligned}$$

And if we put $k=1$, and the other letters = 0, we see that right lines are transformed into quintics having common one triple, three double, and three single points. Again, in order to trace the correspondence of the principal points, we see that in the first transformation to the point c corresponds the line b_1', b_2' ; to this in the second transformation corresponds a conic through $c'' a_3'' b_1'' b_2'' b_3''$; and finally, to this a cubic having b_3''' as a double point, and the remaining six points as ordinary points. The following tables give the effects of the different kinds of Cremona-transformation as far as $n=6$. The values also indicate the curves answering to the principal points. Thus, in Ex. 3, the value $c' = 3k - 2c - \Sigma(a)$ indicates that to c' corresponds a cubic having c as a double point, and passing through the points a .

Ex. 1. (II.) $n = 2, a_1 = 3$.

$$k' = 2k - a_1 - a_2 - a_3, \quad a_1' = k - a_2 - a_3, \quad a_2' = k - a_3 - a_1, \quad a_3' = k - a_1 - a_2,$$

Ex. 2. (III.) $n = 3, \alpha_1 = 4, \alpha_2 = 1.$

$$k' = 3k - 2b - a_1 - a_2 - a_3 - a_4, \quad b' = 2k - b - a_1 - a_2 - a_3 - a_4, \quad a_1' = k - b - a_1, \quad \&c.$$

Ex. 3. (IV. 1) $n = 4, \alpha_1 = 6, \alpha_2 = 0, \alpha_3 = 1.$

$$k' = 4k - 3c - \Sigma(a), \quad c' = 3k - 2c - \Sigma(a), \quad a_1' = k - c - a_1, \quad \&c.$$

Ex. 4. (IV. 2) $n = 4, \alpha_1 = 3, \alpha_2 = 3.$

$$k' = 4k - 2\Sigma(b) - \Sigma(a), \quad b' = 2k - \Sigma(b) - a_2 - a_3, \quad b_2' = \&c., \quad a_1' = k - b_2 - b_3, \quad a_2' = \&c.$$

Ex. 5. (V. 1) $n = 5, \alpha_1 = 8, \alpha_2 = 0, \alpha_3 = 0, \alpha_4 = 1.$

$$k' = 5k - 4d - \Sigma(a), \quad d' = 4k - 3d - \Sigma(a), \quad a_1' = k - d - a_1.$$

Ex. 6. (V. 2) $n = 5, \alpha_1 = 3, \alpha_2 = 3, \alpha_3 = 1.$

$$k' = 5k - c - 2\Sigma(b) - \Sigma(a), \quad c' = 3k - 2c - \Sigma(b) - \Sigma(a), \quad b_1' = 2k - c - a_1 - \Sigma(b), \quad a_1' = k - c - b_1.$$

Ex. 7. (V. 3) $n = 5, \alpha_1 = 0, \alpha_2 = 6.$

$$k' = 5k - 2\Sigma(b), \quad b_1' = 2k - b_2 - b_3 - b_4 - b_5 - b_6, \quad \&c.$$

Ex. 8. (VI. 1) $n = 6, \alpha_1 = 10, \alpha_5 = 1.$

$$k' = 6k - 5e - \Sigma(a), \quad e' = 5k - 4e - \Sigma(a), \quad a_1' = k - e - a_1, \quad \&c.$$

Ex. 9. (VI. 2) $n = 6, \alpha_1 = 1, \alpha_2 = 4, \alpha_3 = 2.$

$$k' = 6k - 3\Sigma(c) - 2\Sigma(b) - a, \quad c_1' = 3k - 2c_1 - c_2 - \Sigma(b) - a,$$

$$b_1' = 2k - \Sigma(c) - b_2 - b_3 - b_4, \quad a' = k - \Sigma(c).$$

Ex. 10. (VI. 3) $n = 6, \alpha_1 = 4, \alpha_2 = 1, \alpha_3 = 3.$

$$k' = 6k - 3\Sigma(c) - 2b - \Sigma(a), \quad d' = 4k - 2\Sigma(c) - b - \Sigma(a),$$

$$b_1' = 2k - \Sigma(c) - b - a_1', \quad b_2' = \&c., \quad b_3' = \&c., \quad b_4' = \&c., \quad a_1' = k - c_2 - c_3, \quad a_2' = \&c., \quad a_3 = \&c.$$

Ex. 11. (VI. 4) $n = 6, \alpha_1 = 3, \alpha_2 = 4, \alpha_3 = 0, \alpha_4 = 1.$

$$k' = 6k - 4d - 2\Sigma(b) - \Sigma(a), \quad c_1' = 3k - 2d - \Sigma(b) - a_2 - a_3, \quad c_2' = \&c., \quad c_3' = \&c.,$$

$$b' = 2k - d - \Sigma(b), \quad a_1' = k - d - b_1, \quad a_2' = \&c., \quad a_3' = \&c., \quad a_4 = \&c.$$

TRANSFORMATION OF A GIVEN CURVE.

363. The conditions assigned in the last section are necessary for the general rational transformation between two planes, so that to any point in either plane shall correspond a unique point in the other. But they are not necessary to rational transformation, if we consider only the transformation of a given curve $S=0$. Let us apply to the curve S a transformation $x' : y' : z' = U : V : W$, where U, V, W are functions of the n^{th} degree in x, y, z , not necessarily satisfying Cremona's conditions; then, obviously, to any point in the first plane will correspond a single point of the second, since x', y', z' are given as rational functions of x, y, z . But according to the preceding theory, if U, V, W have common α_1 ordinary points, α_2 double points, &c., then to any point in the second plane will correspond $n^2 - \alpha_1 - 4\alpha_2 - \&c.$ points in the first plane; and this number, which we shall call θ , will ordinarily be different from

unity. The locus of points in the second plane corresponding to the points of the curve S will be a curve S' corresponding to S , and to any point P of the first curve will correspond a definite point P' of the second. Now, from what we have just said, it appears that to P' will correspond in the first figure, besides the point P , $\theta - 1$ other points; but these points will ordinarily not lie on S , and the curve in the first figure corresponding to S' will consist of S together with a residuary curve, the locus of the $\theta - 1$ points. And if we attend only to the points on the curve S , we see that while to any point P of S corresponds a single point P' on S' , so also to any point P' on S' corresponds a single definite point P on S .

Thus then, though the equations $x' : y' : z' = U : V : W$ do not by themselves suffice to give rational expressions for x, y, z in terms of x', y', z' , it is otherwise when with these we combine the equation $S = 0$. If from all the equations we eliminate xyz , we obtain an equation $S' = 0$, which is the condition for the co-existence of the system of equations. And when this condition is satisfied, it was shewn (*Higher Algebra*, Lesson x.) that we can in general rationally determine the values for x, y, z , which will satisfy all the equations of the system. We see, then, that when a given curve S is transformed by the substitution of $x' : y' : z' = U : V : W$, we can in general obtain a rational converse expression $x : y : z = U' : V' : W'$.

Ex. Suppose that we are given $x' : y' : z' = yz + x^2 : yz + xy : yz + xz$. Here to right lines in the second plane answer conics in the first, having common only two points yx, zx ; and therefore to a point in the second plane will generally answer two points in the first plane. The general expressions for x, y, z in terms of x', y', z' are easily found by observing that $x - y, x - z$ are respectively proportional to $x' - y', x' - z'$; the geometrical meaning of which is, that the points $xyz, x'y'z'$, considered as belonging to the same plane, are collinear with the point 1, 1, 1. In other words, the equations are satisfied by writing $x = x' + \lambda, y = y' + \lambda, z = z' + \lambda$, where λ is determined by the quadratic

$$2\lambda^2 + (x' + y' + z')\lambda + y'z' = 0,$$

and plainly to any system of values for $x'y'z'$ answer two systems of values for xyz . But it is otherwise if we consider the transformation of a given curve. Thus, take a right line in the first plane $ax + \beta y + \gamma z$; then the relation between any point on this line and the corresponding point in the second plane is given by the equations $x = x' + \lambda$, &c., where $(\alpha + \beta + \gamma)\lambda = -(ax' + \beta y' + \gamma z')$.

In like manner, if we have any conic S on the first plane, and if by the substitution $x = x' + \lambda$, &c., S becomes $\lambda^2 + P\lambda + S'$, then the curve corresponding to S is the quartic whose equation is obtained by eliminating between

$$\lambda^2 + P\lambda + S' = 0, \quad 2\lambda^2 + (x' + y' + z')\lambda + y'z' = 0;$$

and the expression for x in terms of x' is obtained by taking for λ the common root of these equations given by the equation $\{2P - (x' + y' + z')\} \lambda + 2S' - y'z' = 0$.

364. The deficiency of a curve is unaltered, not only by Cremona's transformation, as already proved, but by any transformation where to a point on either curve corresponds a single point on the other.* This may be shewn as follows:

In the first place, it is to be observed that in the rational transformation *between two planes*, where to a point A corresponds a single point A' , if any curve pass twice through A the corresponding curve must pass twice through A' , or to a double point on one curve must correspond a double point on the other. But if to A correspond more points than one, $A', B', \&c.$, then if the second curve pass through both A' and B' , the first curve will pass twice through A ; that is to say, a double point on one curve *may* correspond to a double point, but it may also correspond to a pair of distinct points on the other. In like manner, if the points A', B' coincide, we may have a cusp on one curve corresponding either to a cusp or to a pair of coincident points on the other.

Let us now consider two fixed corresponding points A, A' , one on each of two corresponding curves S, S' , whose orders we suppose to be m and m' , and which we suppose to be in the same plane; let us consider also two variable corresponding points M, M' ; and let us examine the degree of the locus of the intersection of the lines $AM, A'M'$. Now take any fixed position of the line AM , since it meets the first curve in $m - 1$ points distinct from A , there are $m - 1$ corresponding positions of the line $A'M'$, and therefore AM meets the locus in $m - 1$ points distinct from A . But if we consider the line AA' , it is easy to see in like manner that it meets the locus in no other points than the point A counted $m' - 1$ times, and A' counted $m - 1$ times. Thus we see that the locus is of the

* This theorem was first derived by Riemann from the theory of Abelian functions; see *Crelle*, LIV. 133. The proof here given is substantially the same as that given by Zeuthen, *Mathematische Annalen*, III. 150; but I am informed by Dr. Fiedler that it had been previously given by Bertini, *Battaglini Giornale*, VII. 105 (1869). See also a direct proof in Clebsch and Gordan's *Theorie der Abelschen Functionen*, p. 54, for the case where the curves in one system answering to right lines in the other have common no multiple points higher than the second.

degree $m + m' - 2$, the points A, A' being multiple points of the orders respectively $m' - 1, m - 1$.

Let us next consider in what cases AM touches the locus. This will be the case when two of the lines $A'M'$ corresponding to AM coincide, without our having at the same time a coincidence between two of the lines AM corresponding to $A'M'$; for in the latter case the intersection of $AM, A'M'$ would be a double point on the locus, and AM would not be an ordinary tangent. Now (1) if AM touch the curve S , AM will evidently also touch the locus. (2) If AM pass through a double point on S , then according as to that double point there corresponds on S' a double point or a pair of distinct points, we have corresponding on the locus a double point or a pair of distinct points, but in neither case is AM an ordinary tangent. (3) If AM pass through a cusp on S , then according as to that cusp corresponds a cusp on S' , or a pair of coincident points, AM passes through a cusp on the locus, or else is an ordinary tangent.

It appears from (1) and (3) that the number of ordinary tangents from A , together with the number of cusps, is the same for the locus and for the curve S . It is by expressing this equality that we obtain the relation connecting the two curves S, S' . It was shewn (Art. 79) that the number of tangents which can be drawn to a curve of the m^{th} degree from a multiple point of the order r is $m^2 - m - r(r + 1)$; or is less than the class of the curve by $2r$. Hence, if N be the class of the locus curve, the number of tangents which can be drawn from A , which is a multiple point of order $m' - 1$, is $N - 2(m' - 1)$; and if we denote the number of cusps on the locus curve by K , and the class of S by n , the equality we desire to express is

$$N - 2(m' - 1) + K = n - 2 + \kappa.$$

In like manner, considering the tangents from A' ,

$$N - 2(m - 1) + K = n' - 2 + \kappa',$$

and we have therefore $n - 2m + \kappa = n' - 2m' + \kappa'$,

or, writing for n its value $m^2 - m - 2\delta - 3\kappa$,

$$\frac{1}{2}(m - 1)(m - 2) - \delta - \kappa = \frac{1}{2}(m' - 1)(m' - 2) - \delta' - \kappa'. \quad \text{Q.E.D.*}$$

* Zeuthen proves in like manner, that if, instead of the correspondence of the curves being rational, a points on S correspond to any point on S' , and a' points on

365. It is proved, as in Art. 361, that if we transform a curve S of the m^{th} order by the transformation $x' : y' : z' = U : V : W$, where U, V, W are functions of the p^{th} order, then since the points where an arbitrary line meets the transformed curve correspond to the points where $\alpha U + \beta V + \gamma W$ meets S , the order of the transformed curve is $mp - \alpha_1 - 2\alpha_2$, &c., where α_1, α_2 , &c. denote the number of single, double, &c. points common to U, V, W , and which also lie on S . Let us now examine how, by this transformation, we can reduce the order of the transformed curve as low as possible. As in Art. 353, we see that U, V, W may be made to satisfy two conditions less than the number sufficient to determine a curve of the p^{th} order, that is to say, $\frac{1}{2}p(p+3) - 2$; and we evidently apply these conditions so as most to reduce the order of the transformed curve, if we make U, V, W pass through as many as possible of the double points of S . Let the deficiency of S be D , and the number of its double points accordingly $\frac{1}{2}(m^2 - 3m) - D + 1$; and let us in the first place take $p = m - 1$, in which case we may make U, V, W pass through $\frac{1}{2}(m^2 + m) - 3$ points. We may, therefore, make the curves pass through all the double points and through $2m + D - 4$ other points on S . Writing, therefore, $\alpha_1 = 2m + D - 4$, $\alpha_2 = \frac{1}{2}(m^2 - 3m) - D + 1$, $p = m - 1$, we find for the order of S' , $mp - \alpha_1 - 2\alpha_2 = D + 2$.

Let us next take $p = m - 2$, which of course implies that m is greater than 2. Proceeding precisely as before, we see that we may take $\alpha_2 = \frac{1}{2}(m^2 - 3m) - D + 1$, $\alpha_1 = m + D - 4$, and that the order of the transformed curve will still be $D + 2$. Once more let us take $p = m - 3$, we may take $\alpha_2 = \frac{1}{2}(m^2 - 3m) - D + 1$, $\alpha_1 = D - 5$, provided always that D is greater than 2; and we now find for the order of the transformed curve $D + 1$. The transformed curve has, as we have proved, the same deficiency as the original, so that our result is, that a curve of order m with deficiency D , or with $\frac{1}{2}(m^2 - 3m) - D + 1$ double points, may be transformed into a curve of order $D + 2$ with deficiency D , that is, with $\frac{1}{2}(D^2 - D)$ double points; or, when D is

S' to any point on S ; and if t and t' denote the number of cases in which two of these α or α' points coincide, then

$$t - t' = 2\alpha'(D - 1) - 2\alpha(D - 1).$$

greater than two, into a curve of order $D + 1$ with $\frac{1}{2}(D^2 - 3D)$ double points.

Thus then, in particular, a curve may be transformed as follows:

if $D = 0$ into a conic,*

$D = 1$,, a cubic,

$D = 2$,, a quartic with one node,

$D = 3$,, a quartic,

$D = 4$,, a quintic with two nodes, &c.,

$D = 5$,, a sextic with five nodes,

$D = 6$,, 7 with 9,

$D = 7$,, 8 with 14 or 6 with 3.

366. The case of unicursal curves need not detain us. Here $D = 0$, and the transformed curve a conic; the coordinates x', y', z' are, as we know, expressible as quadric functions of a parameter θ ; therefore the coordinates x, y, z , which are expressible as rational functions of x', y', z' , can be expressed as rational functions of θ .

Let us then consider the case $D = 1$. Here the transformed curve is a cubic, and it is to be noted that, however the transformation is effected, the resulting cubic will have always the same absolute invariant; that is to say, the anharmonic ratio of the four tangents from any point on the curve will be the same (Art. 229). When $D = 1$, the coordinates of any point on the curve can be expressed as rational functions of a parameter θ , and of $\sqrt{(\Theta)}$ where Θ is a quartic function of θ . It is sufficient to shew this for the case of a cubic, since x, y, z can be expressed as rational functions of x', y', z' ; and for the case of the cubic, it appears at once by taking the cubic to pass through the point xy , and then writing in the equation

* Although by the method just described the case $D = 0$ is only transformed into a conic, yet by the Cremona transformation the conic can be further transformed into a right line.

For some further developments see Jung and Armenante in Battaglini's *Giornale* VII. 235; and Brill and Noether, *Math. Annal.*, VII. 298.

of the curve $y = \theta x$, when the ratios $x : y : z$ are immediately obtained in the form in question. It is, moreover, clear that the values of θ for which $\Theta = 0$ are precisely those answering to the four tangents from xy to the cubic.

We have thus seen that the coordinates of a point on the curve for which $D = 1$ can be expressed as rational functions of θ and $\sqrt{(\Theta)}$; and by a linear transformation of θ (that is to say, replacing θ by a properly determined function $a\theta + b \div c\theta + d$) we can bring $\sqrt{(\Theta)}$ to the form $\sqrt{(1 - \theta^2)(1 - k^2\theta^2)}$. If we write $\theta = \sin am u$, this is $\cos am u \Delta am u$, and we may say that the coordinates of a curve, whose deficiency is 1, can be expressed as elliptic functions of a parameter u .

367. There is a like theory where the deficiency is 2, and where the curve is therefore reducible to a nodal quartic. Taking the node of the quartic for the point xy and writing $y = \theta x$, we can immediately express the ratios $x : y : z$ as rational functions of θ and $\sqrt{(\Theta)}$, where Θ is now a sextic function of θ ; and this is equivalent to saying that the coordinates are expressible as hyper-elliptic functions of the first kind of a parameter u . For higher values of D the coordinates are irrational functions of a parameter, and it is only in special cases that they can be expressed by radicals.

368. Before quitting this part of the subject, another method may be mentioned by which the same problem may be studied. We may start with the equations connecting the coordinates $xyz, x'y'z'$; let these be $A = 0, B = 0, C = 0$, each equation being homogeneous both in xyz and $x'y'z'$; and being in those variables of the orders $a, b, c; a', b', c'$ respectively. If between the three equations we eliminate $x'y'z'$, we obtain an equation $S = 0$ of the order $ab'c' + bc'a' + ca'b'$ in xyz , and if we eliminate xyz , we obtain an equation $S' = 0$ of the order $a'bc + b'ca + c'ab$ in $x'y'z'$. The conditions $S = 0, S' = 0$ must be satisfied in order that the equations $A = 0, B = 0, C = 0$ may co-exist; but for any system of values of xyz satisfying the equation $S = 0$, we can find a corresponding system of values of $x'y'z'$ satisfying equations $A = 0, B = 0, C = 0$, and therefore also $S' = 0$. The number of double points on the curve S may

be investigated by the methods explained in *Higher Algebra*, Lesson XVIII., and the result I have obtained is

$$\begin{aligned} & \frac{1}{2}b'c'(b'c' - 1)a^2 + \frac{1}{2}c'a'(c'a' - 1)b^2 + \frac{1}{2}a'b'(a'b' - 1)c^2 \\ & + \{(a'b' - 1)(c'a' - 1) - \frac{1}{2}(a' - 1)(a' - 2)\}bc \\ & + \{(b'c' - 1)(a'b' - 1) - \frac{1}{2}(b' - 1)(b' - 2)\}ca \\ & + \{(c'a' - 1)(b'c' - 1) - \frac{1}{2}(c' - 1)(c' - 2)\}ab, \end{aligned}$$

and there is of course a similar expression with interchange of accented and unaccented letters for the number of double points on S' . In either case we find the deficiency to be $\frac{1}{2}(\Omega + 2)$, where

$$\begin{aligned} \Omega &= a^2b'c' + b^2c'a' + c^2a'b' + a'^2bc + b'^2ca + c'^2ab \\ &+ 2aa'(bc' + b'c) + 2bb'(ca' + c'a) + 2cc'(ab' + a'b) \\ &- 3(ab'c' + bc'a' + ca'b' + a'bc + b'ca + c'ab); \end{aligned}$$

so that again we have the theorem that the two curves have the same deficiency.

CORRESPONDENCE OF POINTS ON A GIVEN CURVE.

369. What has been said may sufficiently illustrate the theory of rational correspondence; in what follows we consider the general correspondence of two points P, P' on the same curve, such that either determines the other. Suppose that to a given position of P there correspond α' positions of P' , and to a given position of P' , α positions of P , the correspondence is said to be an (α, α') correspondence. When $\alpha = \alpha' = 1$, the correspondence is rational.

As a simple instance of correspondence on a given curve of the m^{th} order, suppose the points P, P' to be collinear with a fixed point O (that is to say, that the line PP' passes through O), then if P be given there are $m - 1$ positions of P' , and if P' be given there are $m - 1$ positions of P ; or this is an $(m - 1, m - 1)$ correspondence. We have already noticed this particular kind of correspondence in the case of the circle (see Art. 347). This correspondence is evidently rational in the case of the conic, or where $m = 2$.

If the point O is on the given curve, then to a given position of either point there correspond $m - 2$ positions of the

other point; or more generally, if O is an α -ple point of the curve, then to a given position of either point there correspond $m - \alpha - 1$ positions of the other point, viz. the correspondence is a $(m - \alpha - 1, m - \alpha - 1)$ correspondence. Observe that we have in this way a $(1, 1)$ correspondence of points on a cubic (by taking O at pleasure on the curve), or on a nodal quartic (by taking O at the node), but that we cannot thus obtain a $(1, 1)$ correspondence of points on a general quartic.

370. In the foregoing instance the correspondence has been a symmetrical one; viz. starting from either point the other is obtained by the same construction, and of course $\alpha = \alpha'$. But as an instance of a non-symmetric correspondence, suppose that P' is given as a tangential of P ; here P being given, P' is any one of the intersections of the tangent at P with the curve (and thus to a given position of P there correspond $m - 2$ positions of P'); but P' being given, P is any one of the points of contact of the tangents from P' to the curve (and thus to a given position of P' there correspond $n - 2$ positions of P , if n be the class of the curve); and we have thus a $(n - 2, m - 2)$ correspondence. It is hardly necessary to remark, that we may have $\alpha = \alpha'$ without the correspondence being symmetrical.

371. In the case of a unicursal curve, to a given point on the curve corresponds a single value of the parameter θ ; and to a given value of θ , a single point on the curve (or extending the notion of correspondence we might say that a point on the curve and the parameter of such point have a $(1, 1)$ correspondence). It at once follows that if the point P has α positions, its parameter θ must be given by an equation of the order α ; whence also, if as above, the points P, P' have an (α, α') correspondence, the relation between their parameters θ, θ' must be given by an equation of the form $(\theta, 1)^\alpha (\theta', 1)^{\alpha'} = 0$, viz. θ being given the equation will be of the order α' in θ' , but θ' being given it will be of the order α in θ .

372. A point may correspond to itself, and it is then said to be a *united* point; thus where the points P, P' are collinear with a fixed point O , it is clear that the point of contact of any

tangent from O to the curve is a united point; and if these are the only united points, their number is $=n$.

The only other points which it might at first sight appear can be united points are the nodes and cusps of the curve; in fact, taking P at a node or a cusp the line OP meets the curve in the point P , in the same point counting as one of the $(m-1)$ intersections, and in $(m-2)$ other points; or, what is the same thing, the line from O to the node or cusp meets the curve in the node or cusp counting twice, and in $(m-2)$ other points. But in the case of the node, the two intersections at the node belong to different branches of the curve, or we may say they are coincident, but non-consecutive points; in the case of the cusp they are consecutive points: the distinction is well seen in the case of a unicursal curve—here for a node we have two distinct values of θ , for each of which the coordinates have the same values; for the cusp these two values of θ have become identical; or, what is the same thing, the line from O to a cusp (although not a proper tangent of the curve) is a tangent in a sense in which the line from O to a node is *not* a tangent to the curve. The conclusion is, that a node is not a united point; in a special sense a cusp is a united point; and we have, besides, the proper united points, which are the points of contact from O to the curve.

Reverting to the unicursal curve and to the equation $(\theta, 1)^\alpha (\theta', 1)^{\alpha'} = 0$, at a united point we have $\theta = \theta'$, and for finding these points we have an equation $(\theta, 1)^{\alpha+\alpha'} = 0$; that is, when the points P, P' have an (α, α') correspondence, the number of united points is $=\alpha + \alpha'$,

Applying the theorem to the case where P, P' are collinear with the fixed point O , the correspondence is $(m-1, m-1)$, or the number of united points should be $=2(m-1)$. The number of points of contact, or proper united points is $=n$, that of the cusps or special united points is $=\kappa$; or we ought to have

$$n + \kappa = 2(m-1),$$

which is in fact the case for a unicursal curve with κ cusps.

In the case where P' is a tangential of P , it has been seen that the correspondence was $(n-2, m-2)$; and the number of united points should be $=m+n-4$. We have here as proper

united points the inflexions, and as special united points the cusps; total number = $\iota + \kappa$; and the theorem thus is $\iota + \kappa = m + n - 4$, or what is the same thing $\iota = 3(m - 2) - 2\kappa$; which is in fact the case for a unicursal curve with κ cusps.

373. Consider the point P as given; the geometrical construction for the determination of P' comes in general to this, that we have depending on P a certain curve Θ which, by its intersections with the given curve, determines the points P' . In some cases P' is any one of the intersections in question; but in others a certain number of them will in general coincide with the given point P , and are to be excluded. Thus, in the case where P, P' are collinear with O , the curve Θ is the line OP meeting the given curve in the point P counting once (to be excluded) and in $(m - 1)$ other points. So when P' is the tangential of P , the curve Θ is the tangent at P meeting the given curve in the point P , counting twice (to be excluded) and in $(m - 2)$ other points.

But further; the curve Θ may meet the given curve in points forming two or more distinct classes, in such wise that only the points of the one class are positions of the point P' . Thus, in the last preceding instance, interchanging the points P, P' , or now considering P' as the point of contact of a tangent from P to the curve, the curve Θ is the system of $n - 2$ tangents from P to the curve; each of these tangents meets the curve in the point P counting once, in the point of contact say P' counting twice, and in $m - 3$ other points say P'' (which are cotangentials of P , that is PP'' touches the curve at a point P' distinct from P or P''). Or, what is the same thing, the curve Θ of the order $n - 2$ cuts the given curve in the point P counting $n - 2$ times, in $n - 2$ points P' counting each twice, and in $(n - 2)(m - 3)$ points P'' counting each once. The correspondence P, P' , as was seen, is $(m - 2, n - 2)$; the correspondence (P, P'') is clearly $(n - 2 \over m - 3, n - 2 \over m - 3)$.

374. The theorem in regard to a unicursal curve suggests the theorem that for a curve in general the number of united points should be $= \alpha + \alpha' +$ multiple of the deficiency, or say $= \alpha + \alpha' + k'.2D$; but admitting that the curve Θ presents itself

in the problem, the last instance shews that there is a necessity for considering the case where the curve Θ has with the given curve distinct classes of intersection. The general theorem is, that if for a given curve of deficiency D , the corresponding points of P are P', P'', \dots , and if P, P' have an (α, α') correspondence, and the number of the united points is $= a : P, P''$ a (β, β') correspondence, and the number of their united points is $b : \&c.$; and if the curve Θ , which, by its intersections with the given curve, determines the points P', P'', \dots , intersects the given curve in the point P counting k times; in each of the points P' counting p times, each of the points P'' counting q times, and so on, then we have

$$p(a - \alpha - \alpha') + q(b - \beta - \beta') + \dots = k \cdot 2D,$$

where of course in each of the different correspondences the special united points (if any) must be taken into account.

Thus, in the instances above considered for a unicursal curve; first, if P, P' are collinear with O , we have

$$n + \kappa = 2(m - 1) + 2D \dots \dots \dots (1).$$

Next, if P' is a tangential of P ,

$$\iota + \kappa = m + n - 4 + 4D \dots \dots \dots (2);$$

and in the case where P is a tangential of P' , and where b, β, β' refer to the correspondence P, P'' cotangentials,

$$b - 2(m - 3)(n - 2) + 2(a - \alpha - \alpha') = (n - 2)2D,$$

where, by the example immediately preceding,

$$a - \alpha - \alpha' = \iota + \kappa - (m + n - 4) = 4D.$$

and therefore $b - 2(m - 3)(n - 2) = (n - 6)2D$.

The proper united points b are here the points of contact of the double tangents, the number of which is 2τ ; but we have also as special united points the cusps each counted $n - 3$ times (*it must be assumed that this is so*), and the result is

$$2\tau = 2(m - 3)(n - 2) + (n - 6)2D - (n - 3)\kappa \dots (3).$$

The several equations (1), (2), (3) giving respectively the class, the number of inflexions and the number of bitangents of a curve of the order m with δ nodes and κ cusps agree with the Plückerian equations; they are most easily verified by means of the expressions given, Art. 83, for the several quantities in terms of m, n , and $\alpha = 3n + \kappa$.

375. If on any curve the points P, P' have a (1, 1) correspondence, the points (P', P'') a (1, 1) correspondence...and so on up to the points $P^{(n-1)}, P^{(n)}$; then it is clear that the points $P, P^{(n)}$ have a (1, 1) correspondence. And, conversely, the points $P, P^{(n)}$ which have a (1, 1) correspondence may be regarded as connected with each other through the series of intermediate points $P', P'' \dots P^{(n-1)}$.

In the case of a unicursal curve, the (1, 1) correspondence of the points P, P' implies a like correspondence of the parameters θ, θ' ; viz. this is of the form $(\theta, 1)(\theta', 1) = 0$, or what is the same thing, $a\theta\theta' + b\theta + c\theta' + d = 0$; that is, the parameters θ, θ' are homographically connected. The transformation depends upon three arbitrary parameters.

Taking the curve to be a conic, then if the points P, P' have a (1, 1) correspondence, it is known that the line PP' envelopes a conic having double contact with the given conic; such enveloped conic, as satisfying the condition of double contact, depends on three parameters. But if taking the points A, B at pleasure, we take on the conic P, Q collinear with A , and P', Q' collinear with B, Q , then the points P, P' will have a (1, 1) correspondence; this apparently depends upon four parameters, and it follows that the points A, B can without loss of generality be subjected to a single condition. Thus let the correspondence P, P' be given by means of the conic enveloped by the line PP' ; if on the chord of contact we take at pleasure the point A , draw PA to meet the conic in Q and QP' to meet the chord in B , then (1, 1) correspondence is also given by means of the points A, B ; but here A may be regarded as a determinate point on the chord of contact (say its intersection with a fixed line), B is then found as above, and we have the correspondence by means of these two points, just as well as if A had been assumed at pleasure on the chord of contact.

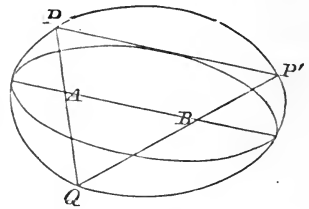

A case really included in the foregoing is when the correspondence of P, P' is such that the line PP' passes through a fixed point C ; viz. the enveloped conic regarded as a line-curve

is here the point C taken twice, regarded as a point-curve it is the pair of tangents from C to the given conic; that is, the chord of contact is the polar of C , and the construction is the same as before, the points A, B, C forming, as it is easy to see, a set of conjugate points in regard to the conic; the original correspondence of P, P' as collinear with the given point C , is here replaced by a correspondence by means of the two points A and B forming with C a system of conjugate points.

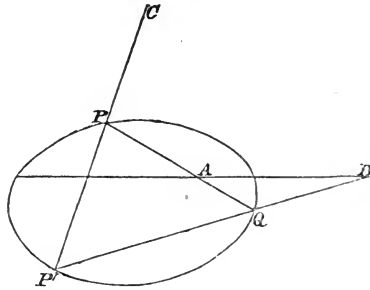

The foregoing properties have reference to the problem of the inscription in a conic of a polygon the sides of which either pass through given points or touch conics having each of them double contact with the given conic.

376. On a cubic curve ($D=1$) we have a $(1, 1)$ correspondence; this depends on a single parameter, but there are two kinds of such correspondence, viz. (1) the points P, P' are collinear with a point A of the cubic. (2) The points P, P' are such that P, Q are collinear with a point A of the cubic and Q, P' collinear with a point B of the cubic; this apparently depends on two parameters, but really on a single one; for taking C a *determinate* point on the cubic, join AC to meet the cubic in O and BO to meet the cubic in D ;

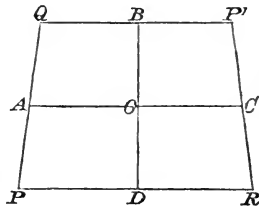

then the same corresponding point P' will be obtained by taking P, R collinear with D , and RP' collinear with C , that is, by means of the single point D . It is, in fact, evident that starting with P and constructing P' as the intersection of the lines QB, RC , then the cubic passing through A, B, C, D, O, P, Q, R will also pass through P' , so that the points A, B and the points D, C lead to the same point P' .

The theorem involved in the foregoing construction may be

stated as follows: If on a cubic the points A, B, C, D are such that the lines AC, BD meet in a point O of the cubic, then we have inscribed in the cubic an infinity of quadrilaterals $PQPR$, the sides of which pass through A, B, C, D respectively; viz. any point P whatever of the cubic may be taken as a vertex of such quadrilateral.

377. More generally imagine inscribed in the cubic an unclosed polygon $PQ\dots X$ of $2n-1$ sides, the sides of which pass through fixed points on the cubic, then the points P, X will have a $(1, 1)$ correspondence of the first kind, that is, the closing side XP will meet the cubic in a fixed point; that is, we have inscribed in the cubic an infinity of $2n$ -gons, the sides of which pass respectively through fixed points of the cubic. And of the fixed points all but one are arbitrary, this one being determined by constructing one such polygon.

378. This theory may be illustrated by the expression of two points in a cubic by means of parameters, Art. 366. A $(1, 1)$ correspondence between two points on a cubic implies a rational expression for the parameters $\sin am u', \cos am u', \Delta am u'$, in terms of $\sin am u, \cos am u, \Delta am u$; and this again implies an equation of one or other of the forms $u + u' = \text{constant}$, $u - u' = \text{constant}$. Now when three points P, P', A , are collinear, we have in general a relation $u + u' + a = \Lambda$ where Λ is a constant depending on the absolute invariant of the cubic. A relation, then, of the form $u + u' = \text{constant}$, implies that P and P' are collinear with a fixed point A . If the relation be of the form $u - u' = \text{constant}$, say $= b - a$, we may write $u + v + a = \Lambda$, $v + b + u' = \Lambda$; and the geometrical meaning is, that P, Q are collinear with a fixed point A and Q, P' with a fixed point B . We may evidently substitute for the points A, B , two others D, C , provided we have $b - a = c - d$, or $a + c = b + d$, that is to say, provided the lines AC, BD intersect on the cubic. We have thus the results already obtained.

379. For a binodal quartic ($D=1$) there is a like theory of the $(1, 1)$ correspondence; for a nodal quartic ($D=2$) there is a

(1, 1) correspondence not depending on any arbitrary parameter, viz. the corresponding points P, P' are collinear with the node.

There is an interesting theory of the (2, 2) correspondence on a unicursal curve, and in particular on a conic. The parameters which determine the position of the two points P, P' are here connected by an equation $(\theta, 1)^2(\theta', 1)^2=0$. As regards the conic we have Poncelet's theorems as to the in-and-circumscribed polygons.

CHAPTER IX.

GENERAL THEORY OF CURVES.

380. In this Chapter we resume the general theory of curves in continuation of Chap. II., and commence with the theory of bitangents of a curve of the n^{th} order postponed from Art. 78. We shall explain two methods by which we can form the equation of a curve whose intersections with a given curve shall determine the points of contact of its bitangents.

The theory of the tangents of a curve was studied (Art. 64) by means of the equation $\Lambda = 0$, or

$$\lambda^n U' + \lambda^{n+1} \mu \Delta U' + \frac{1}{2} \lambda^{n-2} \mu^2 \Delta^2 U' + \&c. = 0,$$

which determines the coordinates of the points in which the line joining two given points meets the curve. We there saw that if the point $x'y'z'$ be on the curve, and xyz anywhere on the tangent, we must have $U' = 0$, $\Delta U' = 0$, and if the tangent meet in three consecutive points we must have besides $\Delta^2 U' = 0$, if in four consecutive points we must have likewise $\Delta^3 U' = 0$, and so on. If the tangent at $x'y'z'$ touch the curve elsewhere, then making $U' = 0$, $\Delta U' = 0$, in the equation $\Lambda = 0$, the reduced equation of the $(n-2)^{\text{th}}$ degree must have equal roots, and therefore, if the discriminant of that equation be Y , the relation $Y = 0$ must be satisfied by the coordinates $x'y'z'$, xyz . In the case of points of inflexion where we have the two conditions $\Delta U' = 0$, $\Delta^2 U' = 0$, the one being of the first degree and the other of the second in xyz , and both satisfied for any point on the tangent, it is evident, as was stated (Art. 74), that $\Delta U' = 0$ is the equation of the tangent, and that $\Delta^2 U' = 0$ must contain $\Delta U' = 0$ as a factor. In like manner, in the case of a bitangent, $Y = 0$ must contain $\Delta U' = 0$ as a factor, and by finding the condition that this shall be the case, we find the condition that $x'y'z'$ shall be a point of contact of a bitangent. The special method used, Art. 74, not being applicable to

the general case, we employ the following method due to Prof. Cayley, and it is convenient to begin with the following lemma.

381. Let the equations of two curves contain the variables xyz in the degrees a, b respectively, and $x'y'z'$ in the degrees a', b' ; and let the ab points of intersection of the two curves all coincide with $x'y'z'$, it is required to find the order of the further condition that must be fulfilled in order that they may have other common points, which can only happen when there is a factor common to U and V . When this is the case any arbitrary line $\alpha x + \beta y + \gamma z = 0$ must be sure to have a point common to U and V ; namely, the point or points where the arbitrary line meets the curve represented by the common factor. It follows that the result of elimination between $U=0$, $V=0$, and the equation of the arbitrary line must, in this case, vanish. This result contains $\alpha\beta\gamma$ in the degree ab , $x'y'z'$ in the degree $ab' + a'b$, and the coefficients of U, V in the degrees b, a respectively. But since the result of elimination is obtained by multiplying together the results of substituting in $\alpha x + \beta y + \gamma z$ the coordinates of each of the intersections of U, V , and since by hypothesis these intersections all coincide with $x'y'z'$, the resultant must be of the form $\Pi (\alpha x' + \beta y' + \gamma z')^{ab}$. The condition $\alpha x' + \beta y' + \gamma z' = 0$ merely indicates that the arbitrary line passes through $x'y'z'$, in which case it passes through a point common to U and V , whether they have a common factor or not. Rejecting this factor, the remaining condition $\Pi = 0$ is the sought condition that U and V may have a common factor, and we see that it does not involve $\alpha\beta\gamma$, that it is of the order $ab' + a'b - ab$ in $x'y'z'$, and of the orders b, a respectively in the coefficients of U and V .

382. When the method just described is applied to the investigation of the points of inflexion, that is, to the determination of the condition that $\Delta U', \Delta^2 U'$ may have a common factor, we have $a=1, a'=n-1, b=2, b'=n-2$, and the formula just obtained gives $3(n-2)$ for the order of Π in $x'y'z'$, which is the order of the Hessian as already found. It appears also that Π is of the second degree in the coefficients of $\Delta U'$, and of the

first in those of $\Delta^2 U'$; and since each of these is of the first degree in the coefficients of the original equation, Π involves these coefficients in the third degree, which also agrees with previous results.

To proceed then to the case of the double tangents, since the equation $\Lambda = 0$ is reduced to the form $\frac{1}{2}\Delta^2 U' \lambda^{n-2} + \dots + U\mu^{n-2} = 0$, a specimen term of its discriminant is $(\Delta^2 U')^{n-3} U^{n-3}$, whence we see that Y is of the order $(n+2)(n-3)$ in xyz , of the order $(n-2)(n-3)$ in $x'y'z'$, and of the order $2(n-3)$ in the coefficients of the original equation. In the next place we can show that all the intersections of Y and $\Delta U'$ coincide with $x'y'z'$; for the equation of the system of $n^2 - n - 2$ tangents through the point $x'y'z'$ found by the method of Art. 78 is of the form $k\Delta U' + Y(\Delta^2 U')^2 = 0$, and this system can evidently be intersected by $\Delta U'$ in no other point than $x'y'z'$; therefore making $\Delta U' = 0$ in the equation last written, we see that $\Delta U'$ can meet neither Y nor $\Delta^2 U'$ in any other point than $x'y'z'$. We may then apply the method of Art. 381, writing $a = 1$, $a' = n - 1$, $b = (n + 2)(n - 3)$, $b' = (n - 2)(n - 3)$, whence $ab' + a'b = (n^2 + 2n - 4)(n - 3)$. We have then for the order of Π in $x'y'z'$, $(n + 3)(n - 2)(n - 3)$. It is of the order $(n + 2)(n - 3)$ in the coefficients of $\Delta U'$, and of the first order in the coefficients of Y , and therefore of the order $(n + 4)(n - 3)$ in the coefficients of the original equation. The bitangential curve $\Pi = 0$ meets the original curve $U = 0$ in $n(n + 3)(n - 2)(n - 3)$ points, and since there are two of those points on each bitangent, the number of bitangents is $\frac{1}{2}n(n - 2)(n^2 - 9)$ as found otherwise, Art. 82.

383. The method of Art. 381 not only enables us to determine the order of the required condition $\Pi = 0$, but by the actual performance of the operations indicated, to find the condition itself. Thus x', y', z' being, as before, the coordinates of the point on the curve, in the case of points of inflexion we have to eliminate between $\alpha x + \beta y + \gamma z = 0$, $\Delta U' = 0$, $\Delta^2 U' = 0$, and the last equations written at length are

$$Lx + My + Nz = 0,$$

$$\alpha x^2 + by^2 + cz^2 + 2fyz + 2gzx + 2hxy = 0.$$

It will be convenient, in order to avoid numerical multipliers, if we suppose the original equation to have been written with binomial coefficients, and the common multipliers to be removed after differentiation, so that L, M, N denote the first differentials of U' divided by n ; $a, b, \&c.$, the second differentials of U' divided by $n(n-1)$; and the ordinary equations of homogeneous functions will be $Lx' + My' + Nz' = U', ax' + hy' + gz' = L, \&c.$

Now the condition that two lines shall intersect in a point on a conic may be written in the form of a determinant

$$\begin{vmatrix} a, & h, & g, & L, & \alpha \\ h, & b, & f, & M, & \beta \\ g, & f, & c, & N, & \gamma \\ L, & M, & N, & & \\ \alpha, & \beta, & \gamma, & & \end{vmatrix} = 0,$$

for it may be verified, that this determinant expanded is the same as the result of substituting in the equation of the conic, the coordinates of the intersection of the two lines, viz. $M\gamma - N\beta, N\alpha - L\gamma, L\beta - M\alpha$. Now, in virtue of the equations of homogeneous functions, the above determinant may be reduced by multiplying successively the first three lines and columns respectively by x', y', z' , and subtracting from the fourth. It then becomes, if we denote $ax' + \beta y' + \gamma z'$ by R ,

$$\begin{vmatrix} a, & h, & g, & 0, & \alpha \\ h, & b, & f, & 0, & \beta \\ g, & f, & c, & 0, & \gamma \\ 0, & 0, & 0, & -U', & -R \\ \alpha, & \beta, & \gamma, & -R, & 0 \end{vmatrix},$$

or
$$-U' \begin{vmatrix} a, & h, & g, & \alpha \\ h, & b, & f, & \beta \\ g, & f, & c, & \gamma \\ \alpha, & \beta, & \gamma, & \end{vmatrix} - R^2 \begin{vmatrix} a, & h, & g \\ h, & b, & f \\ g, & f, & c \end{vmatrix}.$$

After Clebsch we use the abbreviation $\binom{\alpha}{\alpha}$ for the determinant multiplying U' , in which the matrix of the Hessian is bordered vertically and horizontally by α, β, γ . In like manner the de-

terminant with which we started, in which the same matrix is twice bordered, by α, β, γ , and by the differential coefficients of U , would be written $\begin{pmatrix} U, \alpha \\ U, \alpha \end{pmatrix}$; and the equation we have established is

$$\begin{pmatrix} U, \alpha \\ U, \alpha \end{pmatrix} = -U' \begin{pmatrix} \alpha \\ \alpha \end{pmatrix} - R^2 H.$$

When $x'y'z'$ make $U' = 0$, the equation $\begin{pmatrix} U, \alpha \\ U, \alpha \end{pmatrix} = 0$ reduces to $H = 0$, as it ought.

384. In order to proceed by the same method to find the equation of the bitangential curve, we have to find the result of substituting $M\gamma - N\beta, N\alpha - L\gamma, L\beta - M\alpha$ for x, y, z respectively in the discriminant of the equation $\Lambda = 0$ (Art. 380), and our course will be first to find the result of that substitution in the several coefficients of that equation, viz. $\Delta^2 U', \Delta^3 U', \&c.$, or as we shall more briefly write them $\Delta^2, \Delta^3, \&c.$ The result of substitution in Δ^2 has been calculated, (Art. 383), and Hesse has shewn by the following process, that the result of substitution in Δ^k is of the form $P_k U' + Q_k (\alpha x' + \beta y' + \gamma z')^2$, which when $x'y'z'$ is on the curve reduces to $Q_k (\alpha x' + \beta y' + \gamma z')^2$. His method shews that if this be true for two consecutive Δ^{k-1}, Δ^k , it will be true for Δ^{k+1} , and enables us to express P_{k+1}, Q_{k+1} in terms of the corresponding previous coefficients. It will be remembered, that by definition we have $\Delta^{k+1} = \Delta(\Delta^k)$, where Δ denotes the operation $x \frac{d}{dx'} + y \frac{d}{dy'} + z \frac{d}{dz'}$; but in this it was assumed that $xyz, x'y'z'$ are independent quantities. In the case now under consideration, where x is supposed to have the value $M\gamma - N\beta$, and therefore to be implicitly a function of $x'y'z'$, it must therefore be understood, that in the operation Δ the differentiation only affects $x'y'z'$ as far as they appear explicitly, and not as they are implicitly contained in xyz . Let us denote by ∇ the operation $x \frac{d}{dx'} + y \frac{d}{dy'} + z \frac{d}{dz'}$ without this restriction, then according to the general rule for deriving differentials with regard to $x'y'z'$ on the supposition that xyz are variable from the differentials on the supposition that they

are constant, we have in operating on any function S ,

$$\nabla S = \Delta S + \frac{dS}{dx} \nabla x + \frac{dS}{dy} \nabla y + \frac{dS}{dz} \nabla z.$$

385. The next step is to calculate the values of $\nabla x, \nabla y, \nabla z$. The result of operating with ∇ on any function S is easily

seen to be $\begin{vmatrix} S_1, S_2, S_3 \\ L, M, N \\ \alpha, \beta, \gamma \end{vmatrix}$, and therefore when the function is

x or $M\gamma - N\beta$ the result is

$$(n-1) \begin{vmatrix} h\gamma - g\beta, b\gamma - f\beta, f\gamma - c\beta \\ L, M, N \\ \alpha, \beta, \gamma \end{vmatrix},$$

where the coefficient $(n-1)$ arises from the condition we have introduced, according to which the differentials of L , &c. are $(n-1)\alpha$, &c. The determinant just written is then reduced by the following process:

$$\begin{aligned} & \begin{vmatrix} 1, & g, & f, & c \\ 0, & h\gamma - g\beta, & b\gamma - f\beta, & f\gamma - c\beta \\ 0, & L, & M, & N \\ 0, & \alpha, & \beta, & \gamma \end{vmatrix} = \begin{vmatrix} \gamma, & g, & f, & c \\ \beta, & h, & b, & f \\ 0, & L, & M, & N \\ 0, & \alpha, & \beta, & \gamma \end{vmatrix} \\ & = \begin{vmatrix} \gamma, & g, & f, & c \\ \beta, & h, & b, & f \\ -(\beta y' + \gamma z'), & \alpha x', & h x', & g x' \\ 0, & \alpha, & \beta, & \gamma \end{vmatrix} = \begin{vmatrix} R - \alpha x', & -\alpha x', & -h x', & -g x' \\ \beta, & h, & b, & f \\ \gamma, & g, & f, & c \\ 0, & \alpha, & \beta, & \gamma \end{vmatrix} \\ & = R \begin{vmatrix} h, & b, & f \\ g, & f, & c \\ \alpha, & \beta, & \gamma \end{vmatrix} + x' \begin{pmatrix} \alpha \\ \alpha \end{pmatrix}. \end{aligned}$$

If we denote $\begin{pmatrix} \alpha \\ \alpha \end{pmatrix}$ by Σ , and the halves of its several differentials with regard to α, β, γ , by $\Sigma_1, \Sigma_2, \Sigma_3$, these last differ only in sign from the determinants multiplying R in the values of $\nabla x, \nabla y, \nabla z$, and we have

$$\begin{aligned} \nabla(S) = \Delta(S) - (n-1) R \left(\Sigma_1 \frac{dS}{dx} + \Sigma_2 \frac{dS}{dy} + \Sigma_3 \frac{dS}{dz} \right) \\ + (n-1) \begin{pmatrix} \alpha \\ \alpha \end{pmatrix} \left(x' \frac{dS}{dx} + y' \frac{dS}{dy} + z' \frac{dS}{dz} \right). \end{aligned}$$

In particular let $S = \Delta^k(V)$, where V is any function of the order n' in $x'y'z'$, then since $\frac{dS}{dx} = k \frac{d}{dx} \Delta^{k-1}(V)$, we have

$$\begin{aligned} \nabla(\Delta^k V) = & \Delta^{k+1}(V) - k(n-1)R \left(\Sigma_1 \frac{d}{dx'} + \Sigma_2 \frac{d}{dy'} + \Sigma_3 \frac{d}{dz'} \right) \Delta^{k-1}(V) \\ & + k(n-1) \binom{\alpha}{\alpha} \left(x' \frac{d}{dx'} + y' \frac{d}{dy'} + z' \frac{d}{dz'} \right) \Delta^{k-1}V. \end{aligned}$$

Since $\Delta^{k-1}V$ is a homogeneous function in $x'y'z'$ of the degree $n' - k + 1$, the last term reduces to

$$k(n-1)(n'-k+1) \binom{\alpha}{\alpha} \Delta^{k-1}(V).$$

386. It will be convenient to use the abbreviation ψ for the operation $\Sigma_1 \frac{d}{dx'} + \Sigma_2 \frac{d}{dy'} + \Sigma_3 \frac{d}{dz'}$, and it will be observed also that

$$\psi(V) = \begin{vmatrix} a, h, g, V_1 \\ h, b, f, V_2 \\ g, f, c, V_3 \\ \alpha, \beta, \gamma \end{vmatrix} \text{ or } \binom{V}{\alpha}.$$

The result of operating with ψ on x vanishes, as may easily be seen by substituting in the last column of this determinant for $V_1, V_2, V_3, 0$ the values $h\gamma - g\beta, b\gamma - f\beta, f\gamma - c\beta, \beta\gamma - \gamma\beta$, when it at once resolves itself into two, each of which vanishes in consequence of having two columns the same. The result then, of operating, with ψ on any function containing x, y, z , is the same, whether or not these be regarded as constants. The equation of the last article then, as applied to the quantities Δ^k , &c. which we desire to calculate, is

$$\Delta^{k+1} = \nabla(\Delta^k) + k(n-1)R\psi(\Delta^{k-1}) - k(n-1)(n-k+1)\Sigma\Delta^{k-1}.$$

387. From the expression just found, we can shew that if we have $\Delta^{k-1} = P_{k-1}U + Q_{k-1}R^2$, $\Delta^k = P_kU + Q_kR^2$, then Δ^{k+1} must be of like form. For we have only to substitute these values for Δ^{k-1}, Δ^k in the equation of the last article; and we must observe that $\nabla(U)$ and $\nabla(R)$ both vanish, as at once appears by substituting either L, M, N , or α, β, γ for S_1, S_2, S_3 in

$\left[\begin{array}{l} S_1, S_2, S_3 \\ L, M, N \\ \alpha, \beta, \gamma \end{array} \right]$. Hence $\nabla(\Delta^k) = U\nabla(P_k) + R^2\nabla(Q_k)$. We

have, by substituting nL, nM, nN , and α, β, γ respectively for S_1, S_2, S_3 in $\left(\begin{array}{l} S \\ \alpha \end{array} \right)$, $\psi(U) = -nHR, \psi(R) = \left(\begin{array}{l} \alpha \\ \alpha \end{array} \right)$, and therefore

$$\psi \Delta^{k-1} = U\psi(P_{k-1}) + R^2\psi(Q_{k-1}) - nP_{k-1}HR + 2R\Sigma Q_{k-1}.$$

Collecting then the terms in the expression given for Δ^{k+1} (Art. 386), we have $\Delta^{k+1} = UP_{k+1} + R^2Q_{k+1}$, where

$$\begin{aligned} P_{k+1} &= \nabla(P_k) - k(n-1)(n-k+1)\Sigma P_{k-1} + k(n-1)R\psi(P_{k-1}), \\ Q_{k+1} &= \nabla(Q_k) - k(n-1)(n-k-1)\Sigma Q_{k-1} \\ &\quad + k(n-1)R\psi(Q_{k-1}) - n(n-1)kP_{k-1}H. \end{aligned}$$

388. From these formulæ we are able to form a table of the values of P_3, Q_3 , &c. Thus to commence, it is obvious that $P_1=0, Q_1=0$, and (Art. 383) $P_2=-\Sigma, Q_2=-H$. Hence $P_3=-\Delta(\Sigma), Q_3=-\Delta(H)$.

When the curve is a cubic Δ^3 is no other than the cubic function itself, and the value just given for Q_3 may be geometrically interpreted as follows: If any line $\alpha x + \beta y + \gamma z$ meet a cubic, and from each of the points of meeting four tangents be drawn to the curve, the twelve points of contact lie on the quartic

$$\alpha(H_2N - H_3M) + \beta(H_3L - H_1N) + \gamma(H_1M - H_2L) = 0;$$

for this condition must, as we have seen, be fulfilled by any point of the curve whose tangent intersects $\alpha x + \beta y + \gamma z$ on the curve. This result also immediately follows from Art. 183.

Proceeding now to Q_4 , we have (Art. 387)

$$\begin{aligned} Q_4 &= -\nabla(\Delta H) + 3(n-1)(n-4)\Sigma H - 3(n-1)R\psi(H) + 3n(n-1)\Sigma H \\ &= -\nabla(\Delta H) + 6(n-1)(n-2)\Sigma H - 3(n-1)R\psi(H). \end{aligned}$$

But in conformity with the result at the end of Art. 385, writing $k=1$, and denoting by n' the degree of the Hessian, or $3(n-2)$,

$$\nabla(\Delta H) = \Delta^2 H' - (n-1)R\psi(H) + (n-1)n'\Sigma H.$$

Hence $Q_4 = -\Delta^2 H + (n-1)n'\Sigma H - 2(n-1)R\psi(H)$.

389. We have now the materials for forming the equation of the bitangential curve of a quartic. According to the method explained (Art. 384) we are first to form the discriminant of $\Lambda = 0$, or of $\frac{1}{1.2} \Delta^2 \lambda^2 + \frac{1}{1.2.3} \Delta^3 \lambda \mu + \frac{1}{1.2.3.4} \Delta^4 \mu^2$; and then having substituted $M\gamma - N\beta$, &c. for x , &c. we must, by the help of the equation of the curve, remove α , β , γ . By making the substitution before forming the discriminant, the equation becomes

$$\frac{1}{1.2} Q_2 \lambda^2 + \frac{1}{1.2.3} Q_3 \lambda \mu + \frac{1}{1.2.3.4} Q_4 \mu^2 = 0,$$

whose discriminant differs only by a numerical factor from $Q_3^2 - 3Q_2Q_4$, a function still containing α , β , γ in the second degree, and therefore requiring further reduction. For this purpose the following formula is useful.

390. If we border the matrix of the Hessian both horizontally and vertically with three rows and columns, the resulting determinant is clearly the product, with sign changed, of the two determinants added horizontally and vertically. Thus in particular if V , W be functions of the orders n' , n'' we have $-\Delta(V)\Delta(W) =$

$$\begin{vmatrix} a, & h, & g, & \alpha, & V_1, & L \\ h, & b, & f, & \beta, & V_2, & M \\ g, & f, & c, & \gamma, & V_3, & N \\ \alpha, & \beta, & \gamma, & & & \\ W_1, & W_2, & W_3, & & & \\ L, & M, & N & & & \end{vmatrix} = \begin{vmatrix} a, & h, & g, & \alpha, & V_1, & 0 \\ h, & b, & f, & \beta, & V_2, & 0 \\ g, & f, & c, & \gamma, & V_3, & 0 \\ \alpha, & \beta, & \gamma, & 0, & 0, & -R \\ W_1, & W_2, & W_3, & 0, & 0, & -n''W \\ 0, & 0, & 0, & -R, & -n'V, & -U \end{vmatrix}$$

or $\Delta(V)\Delta(W)$

$$= n'n'' VW \begin{pmatrix} \alpha \\ \alpha \end{pmatrix} - n'VR \begin{pmatrix} W \\ \alpha \end{pmatrix} - n''WR \begin{pmatrix} V \\ \alpha \end{pmatrix} + R^2 \begin{pmatrix} V \\ W \end{pmatrix} + U \begin{pmatrix} \alpha V \\ \alpha W \end{pmatrix},$$

and when $x'y'z'$ satisfy the equation $U=0$, the last term vanishes. Thus in particular

$$(\Delta V)^2 = n'^2 V^2 \begin{pmatrix} \alpha \\ \alpha \end{pmatrix} - 2n'VR \begin{pmatrix} V \\ \alpha \end{pmatrix} + R^2 \begin{pmatrix} V \\ V \end{pmatrix},$$

or in the notation we have before used

$$Q_3^2 = (\Delta H)^2 = n'^2 H^2 \Sigma - 2n'HR\psi(H) + R^2 \begin{pmatrix} H \\ H \end{pmatrix},$$

the last term denoting the result of writing in Σ , instead of α, β, γ , the differential coefficients of H .

In precisely the same way we get a formula of reduction for $\Delta^2 V$ by writing in the preceding determinant

$$\frac{d}{dx}, \frac{d}{dy}, \frac{d}{dz} \text{ for } V_1, V_2, V_3 \text{ and for } W_1, W_2, W_3,$$

and supposing the operation to be performed on V . In the reduction, then, we have instead of $n'V$, and of $n''W$,

$$x' \frac{d}{dx'} + y' \frac{d}{dy'} + z' \frac{d}{dz'}$$

and the formula becomes

$$\Delta^2 V = n'(n' - 1) V \left(\frac{\alpha}{\alpha} \right) - 2(n' - 1) R \left(\frac{V}{\alpha} \right) + R^2 \left(\frac{d_x}{d_x} \right) V,$$

where the last symbol denotes the result of substituting in Σ symbols of differentiation instead of α, β, γ , and operating on V .

Introducing the value thus found for $\Delta^2 H$ into the value given for Q_4 (Art. 388), we have

$$Q_4 = -n'(n' - n) \Sigma H + 2(n' - n) R \psi(H) - R^2 \left(\frac{d_x}{d_x} \right) H.$$

Thus, then, since $Q_2 = -H$ we have in general

$$(n' - n) Q_3^2 - n' Q_2 Q_4 = R^2 \left\{ (n' - n) \left(\frac{H}{H} \right) - n' H \left(\frac{d_x}{d_x} \right) H \right\};$$

and in the case of the quartic, for which $n = 4, n' = 6$,

$$Q_3^2 - 3 Q_2 Q_4 = R^2 \left\{ \left(\frac{H}{H} \right) - 3 H \left(\frac{d_x}{d_x} \right) H \right\},$$

and accordingly the equation of the bitangential curve is

$$\left(\frac{H}{H} \right) - 3 H \left(\frac{d_x}{d_x} \right) H = 0;$$

that is to say, if Σ written at full length is

$$A\alpha^2 + B\beta^2 + C\gamma^2 + 2F\beta\gamma + 2G\gamma\alpha + 2H\alpha\beta,$$

this equation is

$$\begin{aligned} & A \frac{dH^2}{dx^2} + B \frac{dH^2}{dy^2} + C \frac{dH^2}{dz^2} + 2F \frac{dH}{dy} \frac{dH}{dz} + 2G \frac{dH}{dz} \frac{dH}{dx} + 2H \frac{dH}{dx} \frac{dH}{dy} \\ & = 3H \left\{ A \frac{d^2 H}{dx^2} + B \frac{d^2 H}{dy^2} + C \frac{d^2 H}{dz^2} + 2F \frac{d^2 H}{dydz} + 2G \frac{d^2 H}{dzdx} + 2H \frac{d^2 H}{dxdy} \right\}, \end{aligned}$$

a curve of the fourteenth order.

391. The equation just obtained may be transformed by the help of the expression given (*Conics*, Art. 381, Ex. 1), for the condition that the polar line of a point, with regard to one conic, may touch another. We there saw that if $ax^2 + \&c.$, $a'x^2 + \&c.$ be the two conics, we have

$$(bc - f^2)(a'x + h'y + g'z)^2 + \&c. = \{a'(bc - f^2) + \&c.\} \{a'x^2 + \&c.\} - \mathbf{F},$$

where \mathbf{F} denotes a conic covariant to the two conics. And, in like manner, that

$$(b'c' - f'^2)(ax + hy + gz)^2 + \&c. = \{a(b'c' - f'^2) + \&c.\} \{ax^2 + \&c.\} - \mathbf{F}.$$

Now if $a, b, c, \&c.$ have the same meaning as before, and if $a', \&c.$ denote the second differential coefficients of the Hessian, then, its degree being n' , $(a'x + h'y + g'z) \&c.$ are $(n' - 1)$ times the first differential coefficients, and $(bc - f^2)(a'x + h'y + g'z)^2 + \&c.$ is $(n' - 1)^2$ times the covariant we have called Θ (Art. 231). We may give the name Θ' to the corresponding covariant in which the differential coefficients of the curve and of the Hessian are interchanged, and whose vanishing expresses the condition that the polar line of a point with respect to the curve should touch the polar conic of the same point with regard to the Hessian. In like manner, $a'(bc - f^2) + \&c.$ is Φ and $a'x^2 + \&c.$ is $n'(n' - 1)H$. We have then the identities

$$(n' - 1)^2 \Theta = n'(n' - 1)H\Phi - \mathbf{F}, \quad \Theta' = U\Phi' - \mathbf{F},$$

$$(n' - 1)^2 \Theta - n'(n' - 1)H\Phi = \Theta' - U\Phi',$$

and in the particular case of the quartic where $n' = 6$,

$$25\Theta - 30H\Phi = \Theta' - U\Phi'.$$

Thus, then, the points of contact of bitangents are the intersections with the curve, not only of $\Theta - 3H\Phi$ as already obtained, but also of $15\Theta - \Theta'$ or of $\Theta' - 45H\Phi$; or, again, bitangential curves might be expressed in terms of the covariant \mathbf{F} .

392. Let us now proceed to the fifth order. We have (Art. 387)

$$Q_5 = \nabla(Q_4) - 4(n-1)(n-5) \Sigma Q_3 + 4(n-1)R\psi(Q_3) - 4n(n-1)HP_3;$$

and using the value of Q_4 last obtained, and employing the abbreviations Θ for $\left(\frac{H}{H}\right)$ and Φ for $\left(\frac{d_x}{d_x}\right) H$, we have

$$\begin{aligned} Q_5 &= -n'(n'-n)H\Delta(\Sigma) - n'(n'-n)\Sigma\Delta(H) + 2(n'-n)R\Delta\psi(H) - R^2\Delta(\Phi) \\ &+ 4n(n-1)H\Delta(\Sigma) + 4(n-1)(n-5)\Sigma\Delta H - 4(n-1)R\psi(\Delta H) \\ &= -2(n^2 - 13n + 18)H\Delta\Sigma - 2(n^2 - 3n + 8)\Sigma\Delta(H) \\ &\quad + 4(n-3)R\Delta(\psi H) - 4(n-1)R\psi(\Delta H) - R^2\Delta(\Phi). \end{aligned}$$

In particular when $n = 5$, we have

$$Q_5 = 44H\Delta(\Sigma) - 36\Sigma\Delta(H) + 8R\Delta(\psi H) - 16R\psi(\Delta H) - R^2\Delta(\Phi).$$

In this case we have also

$$\begin{aligned} Q_4 &= -36\Sigma H + 8R\psi(H) - R^2\Phi, \\ Q_3 &= -\Delta H, \quad Q_2 = -H. \end{aligned}$$

In order to form the bitangential curve of a quintic, the quantity to be calculated is

$$(27 Q_2 Q_5 - 5 Q_3 Q_4)^2 = 5 (4 Q_3^2 - 9 Q_2 Q_4) (5 Q_4^2 - 12 Q_3 Q_5),$$

a quantity containing $\alpha\beta\gamma$ in the sixth order, and which it is necessary, by the help of the equation of the curve, to shew to be divisible by R^6 . Now, in virtue of a formula already obtained, we have

$$4 Q_3^2 - 9 Q_2 Q_4 = R^2 (4\Theta - H\Phi).$$

It is also easy to shew that $27 Q_2 Q_5 - 5 Q_3 Q_4$ and $5 Q_4^2 - 12 Q_3 Q_5$ are each divisible by R ; but I have not been able to carry the reduction further.

We shew elsewhere (*Higher Algebra*, Art. 295) how all these calculations may be made by symbolical methods.

393. Another method* of solving the problem of double tangents is suggested, by what was proved (Arts. 183, 235) that the point where the tangent to a cubic meets it again is determined by the intersection of the tangent with the line $xH_1 + yH_2 + zH_3 = 0$. It occurs to attempt to form in like manner the equation of a curve of the order $n - 2$, which shall pass through the $(n - 2)$ points where the tangent to a curve

* I gave this method in the *Philosophical Magazine*, Oct. 1858, and *Quarterly Journal of Mathematics*, vol. III. p. 317. See also *Memoirs* by Prof. Cayley, *Phil. Trans.* (1859), p. 193, and (1861), p. 357.

of the n^{th} order meets it again. If the equation of this tangential curve were once formed, then, by forming the condition that the given tangent should touch this curve, we should immediately have the equation of the bitangential. Now, what has been proved already as to the order of the bitangential will enable us to see what must be the order of the tangential curve in $x'y'z'$ and in the coefficients. The condition that the line $Lx + My + Nz$ shall touch a curve of the $(n-2)^{\text{th}}$ order is of the order $(n-2)(n-3)$ in L, M, N , and of the order $2(n-3)$ in the coefficients of that curve. Consequently, if the coefficients of the tangential curve contain $x'y'z'$ in the order p , and the coefficients of the original in the order q , the bitangential must be of the order $(n-1)(n-2)(n-3) + 2p(n-3)$ in $x'y'z'$, and of the order $(n-2)(n-3) + 2q(n-3)$ in the coefficients of the original. But actually the bitangential is of the order $(n-2)(n-3)(n+3)$ in $x'y'z'$, and of the order $(n+4)(n-3)$ in the coefficients of the original (Art. 382). It follows then that $p = 2(n-2)$, $q = 3$; that is to say, that the tangential must be of the order $2(n-2)$ in $x'y'z'$, and of the third order in the coefficients of the original. Further, we know that if $x'y'z'$ be on the Hessian, the tangential must pass through $x'y'z'$, and therefore the substitution of $x'y'z'$ for xyz must reduce the tangential to H . This consideration and the known form of the tangential in the case of the cubic suggests that the tangential in general is the $(n-2)^{\text{th}}$ polar of $x'y'z'$ with regard to H or $\Delta^{n-2}H$, for this is a curve of the right order in xyz , in $x'y'z'$, and in the coefficients, and it will pass through $x'y'z'$ when this point is on the Hessian. Accordingly, in the next article we examine whether the curve $\Delta^{n-2}(H)$ does pass through the points where the tangent meets the curve again, and though the answer is found to be in the negative, the process of examination leads to the true form of the tangential.

394. Take then the origin on the curve, and the axis of y as the tangent, and let the equation of the curve be

$$nby + \frac{1}{2}n(n-1)(c_0x^2 + 2c_1xy + c_2y^2) \\ + \frac{1}{2.3}n(n-1)(n-2)(d_0x^3 + 3d_1x^2y + 3d_2xy^2 + d_3y^3) + \&c. = 0.$$

It is to be observed, and the remark will be useful in the sequel, that the several polars of the origin, with regard to the curve, are got by writing $n-1$, $n-2$, &c., for n in this equation. Now, in order that a curve may pass through the tangential points, its equation must be such that when we make $y=0$ it will reduce to

$$\frac{1}{2}n(n-1)c_0 + \frac{1}{2.3}n(n-1)(n-2)d_0x + \&c. = 0.$$

Let us form then the equation of the Hessian, and since we are about to form its polar curves with regard to the origin, and then to make $y=0$, we need only concern ourselves with those terms of the Hessian which do not contain y . The second differential coefficients of the given curve are

$$a = c_0 + (n-2)d_0x + \frac{1}{2}(n-2)(n-3)e_0x^2 + \&c.,$$

$$b = c_2 + (n-2)d_2x + \frac{1}{2}(n-2)(n-3)e_2x^2 + \&c.,$$

$$c = \frac{1}{2}(n-2)(n-3)c_0x^2 + \&c.,$$

$$f = b + (n-2)c_1x + \frac{1}{2}(n-2)(n-3)d_1x^2 + \&c.,$$

$$g = (n-2)c_0x + \frac{1}{2}(n-2)(n-3)d_0x^2 + \&c.,$$

$$h = c_1 + (n-2)d_1x + \frac{1}{2}(n-2)(n-3)e_1x^2 + \&c.$$

The equation then of the Hessian is readily found to be

$$c_0b^2 + (n-2)d_0b^2x + \left\{ \frac{1}{2}(n-2)(n-3)e_0b^2 + (n-1)(n-2)P \right\} x^2 \\ + \left\{ \frac{1}{8}(n-2)(n-3)(n-4)f_0b^2 + (n-1)(n-2)^2 Q \right. \\ \left. + (n-1)(n-2)(n-3)R \right\} x^3 + \&c. = 0,$$

where for brevity we have written

$$2P = c_2c_0^2 - c_0c_1^2 + 2bc_1d_0 - 2bc_0d_1, \quad 2Q = d_0c_1^2 - 2c_0c_1d_1 + c_0^2d_2,$$

$$3R = c_0c_2d_0 - d_0c_1^2 + 2e_0bc_1 - 2c_0be_1,$$

but the actual values of these quantities are not material to our purpose. What is important is to notice that the equation divides itself into groups of terms each having the same function of n as a numerical coefficient, so that if we want to form the equation of the Hessian of the first, second, &c., polar of the given curve with regard to the origin we have only to substitute $n-1$, $n-2$, &c., for n in the above equation.

Now the line polar, with regard to the origin of a curve of the n^{th} degree $u_0 + u_1 + \&c. = 0$ being $nu_0 + u_1 = 0$, the line

polar of the origin, with regard to the Hessian, which is a curve of the order $3(n-2)$ is, from the preceding equation, $3c_0 + d_0x = 0$, together with a term in y irrelevant to the present question; and since this equation does not contain n , we see that the polar of a point on a curve with respect to the Hessian of either the curve itself or of its polar curves all meet the tangent in the same point. In fact, the polar is in every case the same line. When $n=3$, $3c_0 + d_0x$ is the result of making $y=0$ in the equation of the curve; that is to say, the polar with regard to the Hessian is the tangential, as we have seen already.

The equation of the polar conic of the origin with regard to a curve of the n^{th} order is $\frac{1}{2}n(n-1)u_0 + (n-1)u_1 + u_2 = 0$; and therefore the polar conic with regard to the Hessian is

$$\frac{3}{2}(n-2)(3n-7)c_0b^2 + (n-2)(3n-7)d_0b^2x \\ + \left\{ \frac{1}{2}(n-2)(n-3)e_0b^2 + (n-1)(n-2)P \right\} x^2 = 0,$$

and it is evident, on inspection, that in the case of the quartic this polar conic cannot be the tangential, because it contains the group of terms P which do not similarly occur in the equation of the curve. But we can readily form an equation not containing these terms. Let $\Delta^2H=0$ denote the equation we have just obtained, and let Δ^2H_1 denote the polar conic with respect to the Hessian of the first polar of the origin, and as we have already seen, Δ^2H_1 is derived from Δ^2H by writing $n-1$ for n . Then it is easily verified that

$$(n-3)\Delta^2H - (n-1)\Delta^2H_1 = (n-3)b^2\{6c_0 + 4d_0x + e_0x^2\}.$$

But when the given curve is of the fourth degree, the right-hand side is what the equation of the given curve becomes when we make $y=0$. It follows then that $\Delta^2H - 3\Delta^2H_1$ is the required tangential of a quartic.

In precisely the same way the polar cubic of the origin, with regard to the Hessian, is found to be

$$\frac{1}{6}(3n-6)(3n-7)(3n-8)c_0b^2 + \frac{1}{2}(n-2)(3n-7)(3n-8)d_0b^2x \\ + \frac{1}{2}(n-2)(n-3)(3n-8)e_0b^2x^2 + (n-1)(n-2)(3n-8)Px^2 \\ + \frac{1}{6}(n-2)(n-3)(n-4)f_0b^2x^3 + (n-1)(n-2)^2Qx^3 + (n-1)(n-2)(n-3)Rx^3,$$

and $\Delta^3 H_1, \Delta^3 H_2, \&c.$ are found by substituting $(n-1), (n-2), \&c.$ for n . And we can verify that

$$(n-3)(n-4)\Delta^3 H - 2(n-1)(n-4)\Delta^3 H_1 + (n-1)(n-2)\Delta^3 H_2 \\ = 2(n-4)(10c_0 + 10d_0x + 5e_0x^2 + fx^3).$$

And when $n=5$ the right-hand side of the equation is what the original equation becomes when we make in it $y=0$, and therefore it follows, as before, that the tangential is

$$\Delta^3 H - 4\Delta^3 H_1 + 6\Delta^3 H_2 = 0.$$

When $n=6$ the tangential is in like manner

$$\Delta^4 H - 5\Delta^4 H_1 + 10\Delta^4 H_2 = 0.$$

I was hence led, by induction, to the conclusion which Professor Cayley has verified independently, that the tangential is in general

$$\Delta^{n-2} H - (n-1)\Delta^{n-2} H_1 + \frac{1}{2}(n-1)(n-2)\Delta^{n-2} H_2 - \&c. = 0.$$

395. It is easy to establish what has been stated above, that the polar lines of the origin are the same with regard to its Hessian, and to the Hessian of any of the polar curves.

We have $\frac{dH}{dx} = \frac{dH}{da} \frac{da}{dx} + \&c.$, or employing the usual abbreviations A for $bc - f^2$, &c., we have

$$\frac{dH}{dx} = \frac{d}{dx} \left\{ A \frac{d^2}{dx^2} + B \frac{d^2}{dy^2} + C \frac{d^2}{dz^2} \right. \\ \left. + 2F \frac{d^2}{dydz} + 2G \frac{d^2}{dzdx} + 2H \frac{d^2}{dxdy} \right\} U;$$

with similar expressions for the differentials with regard to y and z . It is to be noted that these may be written in the abbreviated form $\frac{dH}{dx} = -\frac{d}{dx} \left(\frac{d_x}{d_x} \right)$. Now the differential coefficients of the first polar $x'U_1 + y'U_2 + z'U_3$ are got from the corresponding coefficients of the original curve by performing on them the operation $x' \frac{d}{dx} + y' \frac{d}{dy} + z' \frac{d}{dz}$, which when we substitute $x'y'z'$ for xyz is equivalent to multiplying each by the factors $n-1, n-2, \&c.$ But the same numerical factor being common to every term in the expression for $H_1,$

it is plain that $xH_1 + yH_2 + zH_3$ represents the same line whether the polar be taken with regard to the Hessian of the original, or to that of its first polar. And the same argument applies to the other polar curves.

Let us proceed to the polar conic. If we differentiate the expressions just given for H , &c., the differential will consist of two groups of terms, viz. the differential on the supposition that A , B , &c. are constant, together with the terms got by differentiating these quantities. If we write, for shortness, ξ , η , ζ to denote the symbols of differentiation with regard to x , y , z , we have

$$\xi^2 H = \xi^2 \{A\xi^2 + B\eta^2 + \&c.\} U + \xi\xi' \{a(\eta\xi' - \eta'\xi)^2 + b(\zeta\xi' - \zeta'\xi)^2 + \&c.\} U,$$

it being understood that the accents in the last group of terms may be dropped after the expansion, the term $\xi\xi' a\eta^2\xi'^2$, for instance, standing for $a \frac{d^2 U}{dx dy^2} \frac{d^2 U}{dx dz^2}$. The last equation may be written in the abbreviated form

$$\xi^2 H = -\xi^2 \begin{pmatrix} \xi \\ \xi \end{pmatrix} + \xi\xi' \begin{pmatrix} \xi\xi' \\ \xi\xi' \end{pmatrix}.$$

Thus then the equation of the polar conic of any point, with regard to the Hessian, may be written $V + W = 0$, where V denotes a group of terms in each of which a fourth differential is multiplied by the product of two second differentials, and W a group in each of which a second differential is multiplied by the product of two third differentials. Now if we take the Hessian of the first polar, then, as has been stated above, the second, third, and fourth differentials become multiplied by $n-2$, $n-3$, $n-4$ respectively, and the result is

$$\Delta^2 H_1 = (n-2)(n-4)V + (n-3)^2 W = 0,$$

which when $n=4$ reduces to the latter group of terms. The equation of the tangential of a quartic is then evidently of the form $V + kW = 0$, and may be transformed accordingly. Thus it may be written in the form

$$\left(x \frac{d}{dx'} + y \frac{d}{dy'} + z \frac{d}{dz'} \right)^2 H' \\ + 3 \left(x \frac{d}{dx'} + y \frac{d}{dy'} + z \frac{d}{dz'} \right) \left(A \frac{d^2}{dx'^2} + \&c. \right) U' = 0.$$

The equation of the bitangential curve is got by expressing the condition that the tangent $Lx + My + Nz$ should touch the conic just written; and it will evidently consist of three groups of terms, since the condition that a line should touch $S + kS'$ is of the form $\Sigma + k\Phi + k'\Sigma' = 0$. What answers here to Σ is the covariant called Θ' ; and I have verified that the other two groups of terms are also expressible in the form $\Theta + kH\Phi$.*

POLES AND POLARS.

396. It will be convenient to collect here some properties of the Jacobian of a system of three curves, stated *Higher Algebra*, Arts. 88 and 176, and elsewhere in this volume. The Jacobian is the locus of points whose polar lines with regard to three curves meet in a point, its equation being

$$J = \begin{vmatrix} u_1 & u_2 & u_3 \\ v_1 & v_2 & v_3 \\ w_1 & w_2 & w_3 \end{vmatrix} = 0.$$

* I attempted in like manner to obtain the bitangential curve of a quintic by writing down for the curve whose equation is given Art. 394, a covariant of the right order, and such that the absolute term vanishes if the axis of x touches the given curve a second time. For instance, if $\psi = 4\theta - 9H\Phi$, then $A \left(\frac{d\psi}{dx}\right)^2 + \&c.$ and $\psi \left(A \frac{d^2\psi}{dx^2} + \&c.\right)$ are covariants of the right order. Although I have not been successful, it may be useful for purposes of reference to give the values I obtained for the covariants in this case. It will be seen that, without loss of generality, we may suppose c_1 and c_2 to vanish. We have then

$$\begin{aligned} H &= b^2c + 3b^2(d_0x + d_1y) + 3(b^2e_0 - 4bcd_1)x^2 + 3(2b^2e_1 - 5bcd_2)xy + 3(b^2e_2 - bcd_3)y^2 \\ &+ (b^2f_0 - 16bce_1 + 18c^2d_2)x^3 + (3b^2f_1 - 39bce_2 - 9bd_0d_2 + 9bd_1^2 + 18c^2d_3)x^2y \\ &+ (-6bcf_1 - 12bd_0e_1 + 12be_0d_1 + 18c^2e_2 + 24cd_0d_2 - 18cd_1^2)x^4 + \&c., \\ \Theta &= 9b^2\{(b^4d_0^2 + 6b^3c^2d_1) + (4b^4d_0e_0 + 12b^3c^2e_1 - 6b^3cd_0d_1 - 57b^2c^3d_2)x \\ &+ (4b^4d_0e_1 + 12b^3c^2e_2 - 28b^3cd_0d_2 + 31b^3cd_1^2 - 39b^2c^3d_3)y \\ &+ (2b^4d_0f_0 + 4b^4e_0^2 + 6b^3c^2f_1 + 6b^3cd_0e_1 - 48b^3cd_1e_0 - 105b^2c^3e_2 - 293b^2c^2d_0d_2 \\ &\quad + 269b^2c^2d_1^2 + 36bc^4d_3)x^2 + \&c.\}, \end{aligned}$$

$$\begin{aligned} \Phi &= 6b[(b^3e_0 + 4b^2cd_1) + x(b^3f_0 - 8b^2ce_1 - 38bc^2d_2) + y\{b^3f_1 - 2b^2ce_2 + 27b^2(d_1^2 - d_0d_2) - 41bc^2d_3\} \\ &+ x^2(-12b^2cf_1 - 12b^2d_0e_1 + 12b^2e_0d_1 + 6bc^2e_2 - 162bcd_0d_2 + 168bcd_1^2 - 6c^3d_3) + \&c.]. \end{aligned}$$

Of the quantities $A, B, \&c.$ the only ones which contain terms independent of x and y are $A = b^2, F = bc$; so that if any quantity ψ of the form $\Theta + kH\Phi$ written at full length be $A + Bx + By + C_0x^2 + \&c.$, then the degree of ψ being 22, the absolute term in the covariant $A \left(\frac{d\psi}{dx}\right)^2 + \&c.$ is $b^2B_0^2 + 41bcAB_1$, and in $A \frac{d^2\psi}{dx^2} + \&c.$ is $2b^2C_0 + 42bcB_1$.

We have seen, Art. 191, that the Jacobian is the locus of the double points of curves of the system

$$\lambda u + \mu v + \nu w = 0.$$

If the three curves have a common point, that point is on the Jacobian. For, from the equations

$$xu_1 + yu_2 + zu_3 = mu, \quad xv_1 + yv_2 + zv_3 = m'v, \quad xw_1 + yw_2 + zw_3 = m''w,$$

(where m, m', m'' are the degrees of the three curves respectively), we have

$$Jx = mu(v_2w_3 - v_3w_2) + m'v(w_2u_3 - w_3u_2) + m''w(u_2v_3 - u_3v_2),$$

which we may write

$$Jx = mA_u + m'B_v + m''C_w,$$

whence evidently J vanishes for any values which make u, v, w to vanish.

If the three curves be of the same degree, this common point is a double point on the Jacobian. For differentiating with respect to x , we have

$$J + x \frac{dJ}{dx} = mu \frac{dA}{dx} + m'v \frac{dB}{dx} + m''w \frac{dC}{dx} + mA_u + m'B_v + m''C_w;$$

but since $Au_1 + Bv_1 + Cw_1 = J$, we see that when $m = m' = m''$, $\frac{dJ}{dx}$ will vanish for any values which make u, v, w and consequently J to vanish. So, again,

$$x \frac{dJ}{dy} = mu \frac{dA}{dy} + m'v \frac{dB}{dy} + m''w \frac{dC}{dy} + mA_{u_2} + m'B_{v_2} + m''C_{w_2},$$

which, since $Au_2 + Bv_2 + Cw_2 = 0$, vanishes for any values that make u, v, w, J to vanish, when $m = m' = m''$. In like manner the other differential coefficient of J vanishes for the same point.

If only two of the curves be of the same degree, the Jacobian touches the third curve at the common point. For the equation written above, when we make $m = m'$, becomes

$$J + x \frac{dJ}{dx} = mu \frac{dA}{dx} + mv \frac{dB}{dx} + m''w \frac{dC}{dx} + mJ + (m'' - m) Cw_1,$$

and for the common point, this reduces to $xJ_1 = (m'' - m) Cw_1$; and we have, in like manner,

$$xJ_2 = (m'' - m) Cw_2, \quad xJ_3 = (m'' - m) Cw_3;$$

so that $xJ_1 + yJ_2 + zJ_3 = 0$, $xw_1 + yw_2 + zw_3 = 0$,

represent the same right line.

If in this case the common point be a double point on w , it will also be a double point on J , having the same tangents as those for the curve w .*

The values just obtained for J_1, J_2, J_3 evidently vanish when w_1, w_2, w_3 vanish. Differentiating again, and omitting the terms which vanish as containing u, v, w, J, J_1 , or w_1, w_2, w_3 , we have

$$x \frac{d^2 J}{dx^2} = m \left(u_1 \frac{dA}{dx} + v_1 \frac{dB}{dx} \right) + (m'' - m) Cw_{11}.$$

But from the values previously found for A and B , we have

$$u_1 \frac{dA}{dx} + v_1 \frac{dB}{dx} = u_1 (v_2 w_{13} - v_3 w_{12}) + v_1 (w_{12} u_3 - w_{13} u_2),$$

and by eliminating xyz from the equations

$$xu_1 + yu_2 + zu_3 = 0, \quad xv_1 + yv_2 + zv_3 = 0, \quad xw_{11} + yw_{12} + zw_{13} = 0,$$

we have

$$u_1 (v_2 w_{13} - v_3 w_{12}) + v_1 (w_{12} u_3 - w_{13} u_2) = -w_{11} (u_2 v_3 - u_3 v_2) = -Cw_{11},$$

or
$$xJ_{11} = (m'' - 2m) Cw_{11},$$

and similarly the other second differential coefficients of J are proportional to those of w ; or the two curves have the same tangents at their common double point.

397. It is proved, as in Art. 190, that there are

$$(m - 1)^2 + (m - 1)(m' - 1) + (m' - 1)^2$$

points, whose polar lines, with respect to two curves u, v , are the same, and through these points must pass the Jacobian of u, v , and any third curve. It was shewn (Art. 97) that the Jacobian intersects u in the points which can be points of contact of u with curves of the system $v + \lambda w$. Hence, it immediately follows that the locus of points, which can be points of contact of curves of the system $u + \lambda u'$ with curves of the system $v + \mu v'$, where u and u' are of the degree m , and v and v' of the degree m' is a curve of the order $2m + 2m' - 3$,

* Clebsch and Gordan, *Abelsche Functionen*, p. 62.

whose equation may be written in either of the equivalent forms:*

$$v' \begin{vmatrix} u_1 & u_2 & u_3 \\ u'_1 & u'_2 & u'_3 \\ v_1 & v_2 & v_3 \end{vmatrix} - v \begin{vmatrix} u_1 & u_2 & u_3 \\ u'_1 & u'_2 & u'_3 \\ v'_1 & v'_2 & v'_3 \end{vmatrix} = 0,$$

$$u' \begin{vmatrix} v_1 & v_2 & v_3 \\ v'_1 & v'_2 & v'_3 \\ u_1 & u_2 & u_3 \end{vmatrix} - u \begin{vmatrix} v_1 & v_2 & v_3 \\ v'_1 & v'_2 & v'_3 \\ u'_1 & u'_2 & u'_3 \end{vmatrix} = 0.$$

Again, it appears from the preceding that the points in which curves of the systems $u + \lambda u'$, $v + \mu v'$, $w + \nu w'$, can all three touch, are among the intersections of two curves of the degrees respectively $2m + 2m' - 3$, $2m + 2m'' - 3$. But among these intersections are included the m^2 points u, u' ; and the $3(m-1)^2$ points common to the Jacobian of all curves of the system $u + \lambda u'$. Deducting these numbers, we obtain for the number of points in which the three curves can touch

$$4(mm' + m'n'' + m''m) - 6(m + m' + m'') + 6.$$

398. We have seen (Art. 97) that the order of the condition of contact of two curves u, v , or, as we shall call it, of their *tact-invariant*, is in the coefficients of v , $m(m + 2m' - 3) - 2\delta - 3\kappa$ or $n + 2m(m' - 1)$; and, in like manner, of the order $n' + 2m'(m - 1)$ in the coefficients of u . The *tact-invariant*, in the case of two conics, was found (*Conics*, Art. 372) by forming the discriminant of $u + \lambda v$, and then the discriminant of this considered as a function of λ . By similar reasoning to that used in the case of conics, it may be shewn that if the same process be employed in the case of two curves of the m^{th} order, the *tact-invariant* is a factor in the result. In fact if A be the *tact-invariant*, $B = 0$ the condition that it may be possible to determine λ so that $u + \lambda v$ may have two double points, and $C = 0$ the condition that it may be possible to determine λ so that $u + \lambda v$ may have a cusp, then the discriminant, with respect to λ , of the discriminant of $u + \lambda v$,

* Steiner has remarked that the number of curves of the system $u + \lambda u'$, which osculate curves of the system $v + \mu v'$ is $3\{(m + m')(m + m' - 6) + 2mm' + 5\}$, *Crelle*, vol. XLVII, p. 6. It will be remembered that we have seen, Art. 102, that the condition for two curves osculating is, in addition to the conditions of ordinary contact, that the ratio of H to L^3 shall be the same for both.

is AB^2C^2 . That B and C are factors appears by taking u as a curve which has either two double points or a cusp. In this case, not only the discriminant of u vanishes, but its differentials, with respect to each of the coefficients of u (*Higher Algebra*, Art. 116); therefore, in the discriminant of $u + \lambda v$, the term not containing λ and the term containing its first power both vanish, or λ^2 is a factor in the discriminant; therefore its discriminant considered as a function of λ vanishes.

Thus, if u and v be cubics, the discriminant of each contains its coefficients in the twelfth degree, and these coefficients enter in the one hundred and thirty-second degree into the discriminant with respect to λ . But the tact-invariant contains the coefficients of each in the degree eighteen; and the invariants which vanish when $u + \lambda v$ can have a cusp, or a pair of double points, contain the coefficients of each curve in the degrees twenty-four and twenty-one respectively. For the degree in the coefficients is the same as the number of curves of the form $u + \lambda v + \mu w$ which have the singularities in question. In the case of the cusp, this number is found by putting the invariants $S=0$, $T=0$; giving thus an equation of the fourth and one of the sixth degree to determine λ , μ , and we have twenty-four solutions. In the case of the two double points, we may suppose u , v , w to have seven points common, and through these points we can have twenty-one systems of a line and a conic. We have then $132 = 18 + 2(21) + 3(24)$.

399. In general the discriminant being of the degree $3(m-1)^2$, the discriminant with respect to λ contains the coefficients of each curve in the degree $3(m-1)^2(3m^2 - 6m + 2)$. Now the tact-invariant contains the coefficients of each in the degree $3m(m-1)$, and from considerations afterwards to be explained, it appears that the order of the condition that $u + \lambda v$ may have a pair of double points, (or, what is the same thing, the number of curves of the system $u + \lambda v + \mu w$, which have two double points), is $\frac{3}{2}(m-1)(3m^3 - 9m^2 - 5m + 22)$, and the corresponding number for the case of the cusp is $12(m-1)(m-2)$; and it may at once be verified that

$$3(m-1)^2(3m^2 - 6m + 2) = 3m(m-1) + 3(m-1)(3m^3 - 9m^2 - 5m + 22) + 36(m-1)(m-2).$$

In like manner, having formed the discriminant of $\lambda u + \mu v + \nu w$, where u, v, w are curves of the same degree, we may form the discriminant of this considered as a function of λ, μ, ν ; and this discriminant will contain as factors the resultant of u, v, w , and the conditions that it may be possible that a curve $\lambda u + \mu v + \nu w$ may have three nodes, or may have a node and cusp, or may have a tacnode; the order of any of these conditions in the coefficients of any of the curves being the same as the number of curves of the form $\lambda u + \mu v + \nu w + t = 0$, which have the singularity in question. When the curves are all conics, the discriminant, considered as a function of λ, μ, ν , of the discriminant of $\lambda u + \mu v + \nu w$, is AB^2 , where A is the resultant of u, v, w , and $B=0$ is the condition that $\lambda u + \mu v + \nu w = 0$ may be capable of representing two coincident right lines, but I am not in possession of the general theory.

400. In connection with this subject it may be observed that, the tact-invariant of a curve and its Hessian being of the order $3(m-2)(5m-9)$ in the coefficients of the former, and of the order $m(7m-15)$ in the coefficients of the latter, is of the order $6(6m^2-17m+9)$ in the coefficients of the original. When $m=3$, this tact-invariant is the sixth power of the discriminant; and assuming, therefore, that the sixth power of the discriminant is always a factor, there remains a factor of the order $6(m-3)(3m-2)$, whose vanishing expresses the condition that the curve has a point of undulation.

Again, take the condition that the curve, its Hessian and bitangential have a common point; this condition being of the orders respectively $3(m-2)^2(m^2-9)$, $m(m-2)(m^2-9)$, $3m(m-2)$ in the coefficients of these curves is of the order $3(m-2)(m-3)(3m^2+8m-6)$ in the coefficients of the original. When $m=4$, this invariant seems only capable of being accounted for as the twelfth power of the discriminant multiplied by the square of the invariant last considered. And assuming that the same factors are to be found in general, there remains an invariant of the order $3(m-4)(3m^3+5m^2-32m+18)$, which will vanish whenever the curve has an inflexional tangent which elsewhere touches the curve.

401. As the Jacobian is the locus of points whose polar lines with respect to three curves meet in a point, so we might consider the locus of the points in which these polar lines meet; or, what is the same thing, the locus of points whose first polars with respect to the three curves have a common point. We shall confine ourselves to the consideration of the case when the three curves are the three first polars of a given curve, in which case the Jacobian is the Hessian of that curve, and the other locus now mentioned is its Steinerian (see Art. 70), the theory now to be explained being the generalization of that given for the cubic* (Art. 175, &c.).

To any point P , then, on the Steinerian corresponds a point Q on the Hessian; the first polar of P has Q for a double point, and the polar conic of Q consists of two right lines intersecting in P . Consider two consecutive points P, P' on the Steinerian; then, as in Art. 178, the intersection of their first polars will be the point Q counted twice, together with the points of contact of the first polar with its envelope. Thus, then, the polar, with regard to the curve, of any point Q on the Hessian, is the tangent to the Steinerian at the corresponding point P . In particular, if Q is a point of inflexion on the curve, its polar will be the tangent at that point; thus we see that the Steinerian is touched by the $3m(m-2)$ stationary tangents of the curve.

402. We have seen, Art. 70, that the orders of the Hessian and Steinerian respectively are $3(m-2)$ and $3(m-2)^2$; the Hessian ordinarily has no double point, and therefore its Plückerian characteristics are

$$\mu = 3(m-2), \quad \delta = 0, \quad \kappa = 0, \quad \nu = 3(m-2)(3m-7),$$

$$\tau = \frac{27}{2}(m-1)(m-2)(m-3)(3m-8), \quad \iota = 9(m-2)(3m-8).$$

Since there is a (1, 1) correspondence between the Hessian and Steinerian, the deficiencies of the two curves will be the

* The principal theorems of this section were given by Steiner in a paper read before the Berlin Academy, 1848, and afterwards reprinted in *Crelle*, 1854, vol. XLVII. The theory, as regards the cubic, was given by me in the former edition of this work (1852) in ignorance of what Steiner had done, with which I only became acquainted through *Crelle*.

same. We have also the class of the Steinerian; for any tangent thereof which passes through a fixed point M , must have its pole lying on the first polar of M , and since it must also lie on the Hessian, it must be one of the $3(m-1)(m-2)$ intersections of the two curves. The characteristics, therefore, of the Steinerian are

$$\begin{aligned}\mu &= 3(m-2)^2, \quad \nu = 3(m-1)(m-2), \\ \delta &= \frac{3}{2}(m-2)(m-3)(3m^2-9m-5), \quad \kappa = 12(m-2)(m-3), \\ \tau &= \frac{3}{2}(m-2)(m-3)(3m^2-3m-8), \quad \iota = 3(m-2)(4m-9).\end{aligned}$$

A point is a double point or cusp on the Steinerian, if it is a point whose first polar has two double points or a cusp. The numbers therefore δ and κ just obtained are the number of first polars of points of the given curve which have the singularities in question (see Art. 399).

403. If the first polars of any two points A, B touch at a point Q , having QP for their tangent, then two of the poles of the line AB coincide with Q ; and the first polar of any point on AB (other than the intersection of AB with PQ) will also touch QP at Q . The first polar of the excepted point or intersection of AB with PQ , will have Q for a double point; Q will be a point on the Hessian, and P the corresponding point on the Steinerian. Thus the Steinerian is the envelope of lines, two of whose poles coincide; and the Hessian is the locus of such coincident poles. Steiner has investigated the envelope of the line PQ , which joins two corresponding points P, Q , or which is the common tangent of two first polars which touch each other. This curve we shall call, as in the case of cubics (Art. 177), the Cayleyan.* It has evidently a (1, 1) correspondence with the Hessian, and with the Steinerian, and has therefore the same deficiency.

In order to determine its class we use the principle established, Art. 372, and *Conics*, Appendix, that if two points on a line (or two lines through a point) have a (m, m') correspondence, there will be $m + m'$ cases of coincidence of these points.

* Professor Cayley himself calls it the Steiner-Hessian.

Consider, then, the lines joining any assumed point M to two corresponding points P, Q . Then, since the Steinerian is a curve of the order $3(m-2)^2$, if the line MP be fixed there will be $3(m-2)^2$ positions of P and as many positions of MQ . In like manner, to any position of MQ correspond $3(m-2)$ positions of P . There are, therefore, $3(m-2)^2 + 3(m-2)$ or $3(m-1)(m-2)$ lines which can be drawn through M containing two corresponding points P, Q , and this is therefore the class of the Cayleyan. It obviously touches the inflexional tangents of the given curve. It has no inflexions, and its characteristics therefore are

$$\begin{aligned} \mu &= 3(m-2)(5m-11), \quad \nu = 3(m-1)(m-2), \\ \delta &= \frac{3}{2}(m-2)(5m-13)(5m^2-19m+16), \quad \kappa = 18(m-2)(2m-5), \\ \tau &= \frac{3}{2}(m-2)^2(m^2-2m-1), \quad \iota = 0. \end{aligned}$$

404. The definitions already given may be further extended, by considering the double points not only on first polars, but on any of the system of polar curves. The locus of a point, such that its θ -polar has a double point, is a curve of the order $3\theta(m-\theta-1)^2$, which is the θ -Steinerian; and the locus of the double point is then a curve of the order $3\theta^2(m-\theta-1)$, which is the θ -Hessian. We know that if the θ -polar of a point P passes through a point Q , then the $(m-\theta)$ polar of Q passes through P ; and it is easy to see also that if the θ -polar of a point P has a double point Q , then the $(m-\theta-1)$ polar of Q has a double point P . Hence the θ -Steinerian is the same curve as the $(m-\theta-1)$ Hessian, and the θ -Hessian the same as the $(m-\theta-1)$ Steinerian. In like manner we might consider the θ -Cayleyan or envelope of the line joining corresponding points on the θ -Steinerian and θ -Hessian, the three curves having the same deficiency. Except in the case of $\theta=1$ these curves have not been much studied.

405. We have studied (Art. 184) the envelope of the polar lines, with regard to a cubic, of the points on a right line, which we have called the polar of that right line. So, in general, if a point P moves along any directing curve S of the order s , the envelope of its θ -polar, with regard to a given

curve U of the order m , will be a curve which may be called the θ -polar of S , with regard to U . We saw (Art. 96) that the envelope of a curve, whose equation contains as parameters the coordinates of a point which moves along a curve S , may be found by considering the parameters as coordinates, and then expressing the condition that the moving curve should touch S . Hence, the θ -polar of S is also the locus of points whose $(m-\theta)$ polars touch S . Using then the expression (Art. 97) for the order of a tact-invariant, we see that the θ -polar of S is a curve of the order $s(s+2\theta-3)(m-\theta)$, this number to be diminished by $2(m-\theta)$ for every double point, and by $3(m-\theta)$ for every cusp on S ; or, if the class of S be s' , then the θ -polar will be of the order

$$(m-\theta)\{s'+2s(\theta-1)\}.$$

It will be of the order $\theta(2s+\theta-3)$ in the coefficients of S . Thus, in particular, if $\theta=1$, the envelope of the first polars of the points of a curve S is the same as the locus of the poles of the tangents of S , its order being $s'(m-1)$. If in this case $s=1$, this order reduces to 0, as it ought, since the envelope then reduces to the $(m-1)^2$ poles of the line S . In general, it is obvious that each double tangent of S will, by its $(m-1)^2$ poles, give rise to $(m-1)^2$ double points on the envelope, and that each stationary tangent of S will give rise to $(m-1)^2$ cusps on the envelope. We have, therefore, for the class of the envelope

$$(m-1)^2 s - (m-1)s' - 2(m-1)^2 \tau - 3(m-1)^2 \iota;$$

or, since $s'^2 - s' - 2\tau - 3\iota = s$, the class of the 1-polar is

$$(m-1)(m-2)s' + (m-1)^2 s.$$

If $\theta=m-1$, the envelope of the polar lines of the points of a curve S , or locus of points whose first polars touch S , is of the order $s(s+2m-5)$ or $s'+2s(m-2)$. And since the number of these polar lines which pass through an arbitrary point M is the same as the number of intersections with S of the first polar of M , the class of the envelope is $(m-1)s$.

In general the number of double points on the θ -polar of S is $(m-\theta)^2$ times the number of $(m-1)$ polars of a point

which touch the curve twice, and the number of cusps is $(m - \theta)^2$ times the number of such polars which osculate the given curve.

406. If the θ -polar of a curve S be a curve R , then the $(m - \theta)$ polar of R must include, as part of itself, the curve S . Thus, for example, if $\theta = m - 1$, R is the envelope of the polar line of a point P which moves on S ; but since the pole of this polar line may not only be the point P , but $(m - 1)^2 - 1$ other points besides, it follows that if we seek the locus of the poles of the tangents of R (or, what is the same thing, the envelope of the first polars of the points of R), we shall get the curve S , together with another curve, which is the locus of points copolar with the points of S ; that is to say, having the same polar lines. In this case, where $\theta = m - 1$, we have seen that the class of R is $s(m - 1)$; therefore, Art. 405, the envelope of the first polars of the points of R is of the order $s(m - 1)^2$; or, in addition to the curve S , there will be a companion curve of the order $sm(m - 2)$. We have seen that every point on the Hessian is a point at which coincide two poles of a tangent to the Steinerian; consequently, the points in which S meets the Hessian will be points on this companion curve, which will, besides, meet S in $\frac{1}{2}s(m - 2)(m - 3)$ pairs of copolar points.

If $\theta = 1$, R is the locus of the poles of the tangents of S , and since a given point has one polar, if we seek the envelope of the polar lines of the points of R , we must fall back on the curve S , and it would appear that there can be no companion curve. It is to be noted, however, that the common tangents of S , and of the Steinerian, form part of the envelope. In fact, we have seen that to each of these common tangents there correspond two coincident points on R , and therefore when we employ the converse process, to these two points answer two coincident lines, every point on either of which has a right to be counted in the envelope. Further, the curve S must be reckoned in that envelope $(m - 1)^2$ times, because to every tangent of S there answer $(m - 1)^2$ poles lying on R , and, therefore, when we take conversely the polars of the points of R , each tangent of S is counted $(m - 1)^2$ times. Now we have

seen that if the order and class of R be r and r' , the order of its $(m-1)$ polar is $r' + 2(m-2)r$, but

$$r' = (m-1)(m-2)s' + (m-1)^2s, \quad r = s'(m-1);$$

hence, the order of the polar is $3(m-1)(m-2)s' + (m-1)^2s$, which agrees with what we have established, since, as the Steinerian is of the class $3(m-1)(m-2)$, the number of its common tangents with S is $3(m-1)(m-2)s'$. There must be a like general theory of the reciprocity when R is the θ -polar of S , and S the $(m-\theta)$ polar of R , but this has not yet been investigated.

OSCULATING CONICS.

407. The form of a curve in the neighbourhood of a point P thereof is defined by the circle of curvature, but it admits of a further definition. In fact, drawing parallel to the tangent at P an infinitesimal chord QR , then if the normal at P meets this at N , the arcs PQ , PR , and the lines NQ , NR , regarded as quantities of the first order, are equal to each other, but they differ by quantities of the second order; in particular, NQ , NR differ by a quantity of the second order; or, what is the same thing, if L be the middle point of QR , then the distance NL is of the second order. But observe that PN is also of the second order; hence the angle LPN , $= \tan^{-1} LN \div PN$ is in general a finite angle; that is, joining P with the middle point of the chord QR (parallel to the tangent at P), we have a line PL inclined at a finite angle to the normal. In the case of the circle, PL coincides with the normal; hence the angle in question is a measure of the deviation from the circular form, or we may call it the "aberrancy," and the line PL the axis of aberrancy.*

In the case of a conic, the axis of aberrancy is the diameter through P , and the aberrancy is the inclination of this diameter to the normal. And for a given curve, drawing any conic having therewith a 4-pointic intersection at P , the curve and

* See Transon, "Recherches sur la courbure des lignes et des surfaces," *Liouv.*, t. vi. (1841); his term 'déviation' is in the text replaced by the more specific one "aberrancy."

conic have the same axis of aberrancy; that is, the centres of all the conics of 4-pointic intersection with the curve at P lie on the axis of aberrancy at this point. Whence also the axis of aberrancy at P and the axis of aberrancy at the consecutive point of the curve, intersect in a point, say the "centre of aberrancy," which is the centre of the conic of 5-pointic intersection with the curve at P ; this conic is completely determined by the conditions that its centre is this point, that it touches the curve at P , and that it has there a curvature equal to that of the curve.

It is easy to show that the aberrancy at the point P is given by the formula

$$\tan \delta = p - \frac{(1+p^2)r}{3q^2},$$

where p, q, r are the first, second, and third differential coefficients of y in regard to x .

408. Observe that the axis of aberrancy is a line having reference to the line infinity, but independent of the circular points at infinity; viz. if instead of these we had any two points I, J , then the line in question is constructed by means of the line IJ without any use of the points I, J themselves; the chord QR is taken so as to pass through the intersection O of the tangent at P with the line IJ , and we have then L the harmonic of O in regard to the points Q, R .

The theorem that the centres of the conics of 4-pointic intersection lie in a line may be presented in a more general form; the conics have, of course, a 4-pointic intersection with each other; or, what is the same thing, they are conics having all of them four common tangents (viz. the tangent at P taken four times); the general theorem is, that for the system of conics touching four given lines, the poles of any line in regard to the several conics of the system lie in a line; a theorem which is better known under the reciprocal form, that for the conics passing through four given points, the polars of any point in regard to the several conics pass all through one and the same point.

In the case where the circular points at infinity are replaced by a conic, there is not any analogous theory of aberrancy.

409. The investigation, Art. 236, of the equation of the conic of 5-pointic contact at any point on a cubic may be extended to curves of any degree. Let S represent the polar conic and T the tangent at the point, then the equation of any conic touching at the same point will be $S - PT = 0$, where P is $lx + my + nz$; l, m, n being still undetermined. Then the equation of the lines joining to the point $x'y'z'$, the intersections of the conic and the curve is obtained by substituting in the equation of each curve $x' + \lambda x$ for x , &c., and eliminating λ between the two equations. The result of the substitution in the first equation is $T + \frac{1}{2}\lambda S + \frac{1}{6}\lambda^2 \Delta^3 + \frac{1}{24}\lambda^3 \Delta^4 + \&c.$; and the result of the substitution in the equation of the conic is $2(n-1)T - P'T + \lambda(S - PT)$; and if this last be written $\theta T + \lambda V$, the result of eliminating λ between the two equations becomes divisible by T , the quotient being

$$V^{n-1} - \frac{1}{2}\theta V^{n-2}S + \frac{1}{6}\theta^2 V^{n-3}T\Delta^3 - \&c. = 0,$$

which represents the $2(n-1)$ lines joining the point $x'y'z'$ to the $2(n-1)$ other points common to the conic and curve. In order that the conic should have a 3-pointic contact with the curve, one of these lines must coincide with T , or the equation just written must be divisible by T ; and since every term, except the two first, is so divisible, this condition is plainly equivalent to $\theta = 2$, which, since $\theta = 2(n-1) - P'$, implies $P' = 2(n-2)$.* Introducing this value of θ , and performing the division by T , the equation reduces to

$$-PV^{n-2} + \frac{2}{3}V^{n-3}\Delta^3 - \frac{1}{3}V^{n-4}T\Delta^4 + \&c. = 0,$$

which represents the $2n-3$ lines joining the point $x'y'z'$ to the other points of intersection of the curve and conic.

The contact will be 4-pointic if this equation be again divisible by T , or if $\frac{2}{3}\Delta^3 - PS$ be divisible by T . The condition that this shall be the case is found, as in Art. 382, by substituting in this quantity the coordinates of an arbitrary point on T , viz. $M\gamma - N\beta$, $N\alpha - L\gamma$, $L\beta - M\alpha$ when it ought identically to vanish, and in this way we find immediately that P' must be of the form $\mu T + \frac{2}{3H} \left(x \frac{dH}{dx} + y \frac{dH}{dy} + z \frac{dH}{dz} \right)$ where μ

* The problem of finding the circle of curvature at any point on a curve is evidently that of describing a 3-pointic conic passing through two fixed points.

is still indeterminate. Thus the chord of intersection with the polar conic of every 4-pointic conic meets the tangent in the fixed point, noticed Art. 394, where the tangent meets both the polar cubic, and also the polar line of $x'y'z'$, with regard to the Hessian either of the curve itself or of any of the polar curves.

Let us denote by Π the line $\frac{1}{H} \left(x \frac{dH}{dx} + y \frac{dH}{dy} + z \frac{dH}{dz} \right)$, and allowing that we have the identical equation $\Delta^3 - \Pi S = JT$, then, introducing the value for P , $\frac{2}{3}\Pi + \mu T$, the equation becomes divisible by T , and gives for the equation of the $2n-4$ lines, joining to $x'y'z'$ the other intersections of the curve and conic

$$\left(\frac{2}{3}J + P^2 - \mu S\right) V^{n-3} - \frac{1}{3}V^{n-4}\Delta^4 + \&c. = 0.$$

The condition for 5-pointic contact is, that this equation should be divisible by T , and we determine the value of μ corresponding to such contact, by substituting in the terms above written $M\gamma - N\beta$, $N\alpha - L\gamma$, $L\beta - M\alpha$ for x, y, z . From the identical equation of Art. 235, we can infer what J is, and I have found that, by the substitution just mentioned, J becomes

$$-3(n-1)(n-2)\Sigma + \frac{2(n-1)}{H}R\psi(H),$$

where Σ , R , and ψH have the same meaning as in Art. 386. The results of substitution

in S , P , and in Δ^4 are Q_2 , $\frac{2}{3H}Q_3$, and Q_4 respectively. Using

then the values of Arts. 390, 391, we have

$$\begin{aligned} \mu H^2 = & \frac{2}{3} \{ 3(n-1)(n-2)\Sigma H - 2(n-1)R\psi(H) \} \\ & - \frac{4}{9} \left\{ 9(n-2)^2 H\Sigma - 6(n-2)R\psi(H) + \frac{1}{H}R^2\Theta \right\} \\ & - \frac{1}{3} \left\{ -6(n-2)(n-3)\Sigma H + 4(n-3)R\psi(H) - \frac{1}{H}R^2\Phi \right\}, \end{aligned}$$

whence reducing, $\mu = -\frac{1}{9H^3}(4\Theta - 3H\Phi)$, and the 5-pointic conic is determined.

410. Prof. Cayley has pursued the enquiry so as to ascertain what condition must be fulfilled by the coordinates $x'y'z'$ in order that the contact may be 6-pointic (see *Phil. Trans.*, 1865, p. 545).

The investigation is too long to give here; his result is that $x'y'z'$ must satisfy the equation

$$(m-2)(12m-27)HJ(U, H, \Phi) - 3(m-1)HJ'(U, H, \Phi) + 40(m-2)^2J(U, H, \Theta) = 0,$$

where by $J(U, H, \Phi)$ is meant the Jacobian of these three functions, and by J' is meant that, in taking the Jacobian, Φ is to be differentiated on the supposition that the second differential coefficients of H , which enter into the expression for Φ , are constant. The equation here written represents a curve of the order $12m-27$ whose intersection with U determines $m(12m-27)$ *sextactic* points.

SYSTEMS OF CURVES.

411. The problem to find how many conics can have a 6-pointic contact with a given curve belongs to the class of questions on which some remarks were made, *Conics*, Appendix on systems of conics satisfying four conditions. We shall here somewhat develop the theory there indicated. De Jonquières, *Liouville*, t. VI. (1861), considered the properties of a series of curves of the m^{th} order satisfying $\frac{1}{2}m(m+3)-1$ conditions, that is to say, one less than the number sufficient to determine the curve, the series being characterized by its index N , where N is the number of curves of the series which can pass through an arbitrary point. Thus, if the equation of the curve algebraically contains a parameter, N will be the degree in which that parameter enters.* Chasles, in papers in the *Comptes Rendus*, 1864—1867, on the number of conics which satisfy four conditions, used, instead of De Jonquières' single index, two characteristics, viz. μ the number of curves of the series which pass through an arbitrary point, and ν the number of them which touch an arbitrary line. This method

* Prof. Cayley has remarked that it is not true conversely that the equation of a curve belonging to a series whose index is N , can be always expressed in this form. For instance, the index will be plainly N if the equation contain linearly the coordinates of a parametric point limited to move on a plane curve of the order N , and unless the curve be unicursal, the equation cannot, without elevation of order, be made an algebraic function of a single parameter. Or, more generally, the equation may contain linearly the coordinates of a point limited to move on a curve in space of k dimensions.

is especially convenient as giving symmetrical results in the case of conics which are curves of the same order and class. A sketch of this method is given in *Conics*, l. c., and we shall here repeat a few of the theorems, stating them for a series of curves of any order.

412. The locus of the poles of a given line, with respect to curves of the series, is a curve of the degree ν . For this is obviously the number of points in which the line itself can meet the locus. The envelope of the polars of a given point, with respect to curves of the system, is, in like manner, a curve of the class μ .

The locus of a point whose polar, with regard to a fixed curve (whose order and class are m' , n'), coincides with its polar, with respect to some curve of the system, is a curve of the order $\nu + \mu(m' - 1)$. For, in order to determine how many points of the locus lie on a given line, consider two points A , A' on that line, such that the polar of A , with regard to the fixed curve, coincides with the polar of A' with regard to some curve of the system, and the problem is to know in how many cases A and A' can coincide. Now, first, if A be fixed, its polar, with respect to the given curve, is also fixed, and the locus of poles of this last line, with respect to curves of the system being by the first theorem of the order ν , we see that to any position of A answer ν positions of A' . Secondly, let A' be fixed, and since its polars, with respect to curves of the system, envelope a curve of the class μ , and since the polars, with respect to the given curve of the points of the given line, envelope a curve of the class $m' - 1$, Art. 405, there are $\mu(m' - 1)$ common tangents to the two envelopes, and therefore as many positions of A answering to A' . The number then of coincidences of the points A and A' is $\nu + \mu(m' - 1)$, or this is the degree of the locus in question. It is obvious that this locus meets the fixed curve in the points where it is touched by curves of the system, and therefore that the number of these curves, which touch the fixed curve, is $m' \{ \nu + \mu(m' - 1) \}$, or is $m'\nu + n'\mu$.

413. In general, the number of curves of the system which satisfy any other condition will be of the form $\mu\alpha + \nu\beta$, and

the numbers α, β may be taken as the characteristics of this condition. If a curve be determined by a sufficient number of conditions of any kind, and if these characteristics be given for each condition, we can determine the number of curves satisfying the prescribed conditions. We exemplify this in the case of conics. The number of conics determined by five points, by four points and a tangent, by three points and two tangents, &c. is

$$1, 2, 4, 4, 2, 1,$$

and, consequently, the characteristics of the systems determined by four points, three points and a tangent, &c. are

$$(1, 2), (2, 4), (4, 4), (4, 2), (2, 1).$$

The number then of conics satisfying the condition whose characteristics are α, β , and also passing through four points, or through three points and touching a line, &c. are

$$\alpha + 2\beta, 2\alpha + 4\beta, 4\alpha + 4\beta, 4\alpha + 2\beta, 2\alpha + \beta.$$

If we call these numbers $\mu''', \nu''', \rho''', \sigma''', \tau'''$ respectively, we see that they are not independent, but we have

$$\nu''' = 2\mu''', \sigma''' = 2\tau''', \rho''' = \frac{2}{3}(\nu''' + \sigma''').$$

The characteristics of the systems formed with the condition α, β together with three points, or together with two points and a line, &c. are plainly

$$(\mu''', \nu'''), (\nu''', \rho'''), (\rho''', \sigma'''), (\sigma''', \tau''').$$

And therefore the number of conics of these systems respectively which satisfy a new condition α', β' is $\mu''' \alpha' + \nu''' \beta', \nu''' \alpha' + \rho''' \beta',$ &c. Or, writing at full length, if we have two conditions whose characteristics are $(\alpha, \beta), (\alpha', \beta')$, and if we denote by $\mu'', \nu'', \rho'', \sigma''$ the number of conics which satisfy these two conditions, and also pass through three points, or pass through two points and touch a line, &c. we have

$$\mu'' = \alpha\alpha' + 2(\beta\alpha' + \alpha\beta') + 4\beta\beta', \quad \nu'' = 2\alpha\alpha' + 4(\beta\alpha' + \alpha\beta') + 4\beta\beta', \\ \rho'' = 4\alpha\alpha' + 4(\beta\alpha' + \alpha\beta') + 2\beta\beta', \quad \sigma'' = 4\alpha\alpha' + 2(\beta\alpha' + \alpha\beta') + \beta\beta',$$

and it is to be noted that these numbers are connected by the identical relation

$$\mu'' - \frac{3}{2}\nu'' + \frac{3}{2}\rho'' - \sigma'' = 0.$$

In like manner the characteristics of the system of conics satisfying the two conditions $(\alpha, \beta), (\alpha', \beta')$, and also passing

through two points, or through a point and touching a line, or touching two lines, are (μ'', ν'') , (ν'', ρ'') , (ρ'', σ'') , and therefore the number of such conics which satisfy a third condition α'', β'' are $\mu''\alpha'' + \nu''\beta''$, &c. Or, writing at full length, if we denote by μ', ν', ρ' the number of conics which satisfy three conditions (α, β) , (α', β') , (α'', β'') , and also pass through two points, or through a point and touch a line, &c. we have

$$\mu' = \alpha\alpha'' + 2\Sigma\alpha\alpha'\beta'' + 4\Sigma\alpha\beta'\beta'' + 4\beta\beta'\beta'',$$

$$\nu' = 2\alpha\alpha'\alpha'' + 4\Sigma\alpha\alpha'\beta'' + 4\Sigma\alpha\beta'\beta'' + 2\beta\beta'\beta'',$$

$$\rho' = 4\alpha\alpha'\alpha'' + 4\Sigma\alpha\alpha'\beta'' + 2\Sigma\alpha\beta'\beta'' + \beta\beta'\beta''.$$

It is evident that the characteristics of the system formed by adding to these three conditions a fourth, α''', β''' , are $\mu'\alpha''' + \nu'\beta'''$, $\nu'\alpha''' + \rho'\beta'''$, or, at full length,

$$\mu = \alpha\alpha'\alpha''\alpha''' + 2\Sigma\alpha\alpha'\alpha''\beta''' + 4\Sigma\alpha\alpha'\beta''\beta''' + 4\Sigma\alpha\beta'\beta''\beta''' + 2\beta\beta'\beta''\beta''',$$

$$\nu = 2\alpha\alpha'\alpha''\alpha''' + 4\Sigma\alpha\alpha'\alpha''\beta''' + 4\Sigma\alpha\alpha'\beta''\beta''' + 2\Sigma\alpha\beta'\beta''\beta''' + \beta\beta'\beta''\beta'''. \quad \text{And so finally, if we add a fifth condition, the number of conics satisfying all five is } \mu\alpha'''' + \nu\beta'''' \text{, or}$$

$$\begin{aligned} \alpha\alpha'\alpha''\alpha'''\alpha'''' + 2\Sigma\alpha\alpha'\alpha''\alpha'''\beta'''' + 4\Sigma\alpha\alpha'\alpha''\beta'''\beta'''' + 4\Sigma\alpha\alpha'\beta''\beta'''\beta'''' \\ + 2\Sigma\alpha\beta'\beta''\beta'''\beta'''' + \beta\beta'\beta''\beta'''\beta'''' . \end{aligned}$$

Thus this formula gives the number of conics which touch five given curves, by writing for α, β , &c. the class and order of each curve. And in like manner we could find the number of curves of any order determined by the condition of touching given curves if we knew the number in each case where the conditions were only those of passing through points or touching lines.

414. In the preceding article, the conditions we considered were each independent of the others, but we may have a condition equivalent to two or more conditions, as for example, the condition that a conic shall touch a given curve twice or oftener, the condition that a curve shall osculate a curve or have with it contact of higher order. A condition equivalent to two may be called two inseparable conditions. It is found that the formulæ obtained in the last article for independent conditions are applicable with the necessary modifications to inseparable conditions. Thus, if we have two

inseparable conditions, the characteristics μ'' , ν'' , ρ'' , σ'' , are the number of conics determined when we combine with the given two-fold condition three points, or two points and a line, &c., and these numbers will be always connected by the relation $\mu'' - \frac{3}{2}\nu'' + \frac{3}{2}\rho'' - \sigma'' = 0$. We proceed precisely as in the last article to find the number of conics determined, when with the two-fold condition are combined any three others. In this way we obtain the following formulæ. If m'' , n'' , r'' , s'' are the characteristics of a second two-fold condition, then the characteristics of the system of conics determined by the pair of two-fold conditions are

$$m''\mu'' - \frac{3}{2}(\mu''n'' + m''\nu'') + (r''\mu'' + \rho''m'') + \frac{7}{4}n''\nu'' - \frac{1}{2}(r''\nu'' + n''\rho''),$$

$$\sigma''s'' - \frac{3}{2}(\sigma''r'' + s''\rho'') + (\nu''s'' + n''\sigma'') + \frac{7}{4}\rho''r'' - \frac{1}{2}(\rho''n'' + r''\nu'').$$

And if μ' , ν' , ρ' be the characteristics of a three-fold condition, the number of conics determined by the two-fold and three-fold condition is

$$\frac{1}{4}\mu'(2\sigma'' - \rho'') + \frac{1}{4}\rho'(2\mu'' - \nu'') + \frac{1}{16}\nu'\{5(\mu'' + \rho'') - 6(\mu'' + \sigma'')\}.$$

415. Returning to the two characteristics μ , ν of a series of curves of the m^{th} order, satisfying one condition less than the number sufficient to determine each curve, we may investigate as follows the relation between these two characteristics. Consider the points A , A' , &c., in which a curve of the series meets a given line; then, since μ curves of the series pass through A , each meeting the line in $m-1$ other points, it is evident that to each point A corresponds $\mu(m-1)$ points A' , and in like manner to each point A' , $\mu(m-1)$ points A . And the number of united points of the correspondence is therefore $2\mu(m-1)$. This number will be ν if the united points can only arise when a curve of the series touches the line AA' , but it may happen that a curve of the series will be a complex containing a portion which counts twice, and such a curve would give rise to united points which must be deducted from $2\mu(m-1)$ in order to give ν the number of proper tangencies. Thus, in the case of conics which we shall specially consider, let λ be the number of conics of the series which reduce to two coincident right lines, and we have $\nu = 2\mu - \lambda$.

416. A conic considered as a curve of the second order may degenerate into a pair of lines, or line-pair; in this case the tangential equation found by the ordinary rule becomes a perfect square; or, geometrically, every line through the common point of the line-pair is to be considered as doubly a tangent to the curve. Similarly, a conic considered as a curve of the second class may degenerate into a pair of points, or point-pair; and every point of the common line of the point-pair may be considered as in a sense doubly belonging to the curve. In the latter case, the point-pair may be considered as the limit of a conic whose transverse axis is fixed, and which flattens by the gradual diminution of its conjugate axis, so as to tend to a terminated right line, the tangents of the conic becoming more nearly lines through two fixed points, viz. the terminating points of the line.

Thus then, if λ be the number of point-pairs in the system, and ϖ the number of line-pairs, we have

$$\mu = 2\nu - \varpi, \quad \nu = 2\mu - \lambda, \quad 3\mu = 2\lambda + \varpi, \quad 3\nu = 2\varpi + \lambda.$$

In Zeuthen's researches, concerning systems of conics, the numbers λ , ϖ are substituted for Chasles' characteristics μ , ν , it being in most cases easier to ascertain the number of conics of a given system which reduce to line-pairs or point-pairs, than the number which pass through an arbitrary point or touch an arbitrary line.

A special case presents itself when the two points of a point-pair coincide, the line of the pair continuing to exist as a definite line; or, the two lines of a line-pair may coincide without their common point ceasing to exist as a definite point. This may be called a line-pair-point.

417. In a system of conics satisfying four conditions of contact, it is comparatively easy to see what are the point-pairs and line-pairs of the system; but in order to find the values of λ and ϖ , each of these pairs has to be counted, not once, but a proper number of times, and it is in the determination of these multiplicities that the difficulty of the problem consists. For this purpose Zeuthen uses the following considerations: Take the elementary system of a conic determined

by four points, then evidently the number of line-pairs is three, and of point-pairs is 0, but since $\mu=1$, $\nu=2$, we have $\lambda=0$, $\varpi=3$; whence it is inferred that a pair of lines joining, two by two, four given points counts once among the number of line-pairs. But take a system of conics determined by three points and a tangent, here we may have three line-pairs, viz. the line joining any two of the points, and the line joining to the third point the intersection of the fixed tangent with the line joining the first two points. There are in this case no point-pairs. We have also $\mu=2$, $\nu=4$, hence $\lambda=0$, $\varpi=6$; and it is inferred that a line-pair counts for two if it consists of the line joining two given points, together with the line joining to a third given point the intersection of the first line with a given line.

Lastly, take the system of conics determined by two points and two tangents, and there can be but a single line-pair, viz. the pair joining the two points to the intersection of the two tangents; but since in this case $\mu=4$, $\nu=4$, $\lambda=\varpi=4$, it is inferred that a line-pair counts for four if it joins to two given points the intersection of two given lines. It is needless to dwell on the reciprocal singularities.

The movement of a conic which touches a given curve may be considered either a rotation round the point of contact or a slipping along the tangent at that point; and hence it is inferred in the case of a conic determined by touching four given curves, that we are to count among the line-pairs, once, (*A'*) a pair consisting of two lines, each being a common tangent to the curves; that we count twice, (*B'*) a pair consisting of a common tangent to two curves, and a tangent drawn to a third curve from a point where this common tangent meets the fourth curve, and that we count four times, (*C'*) a pair consisting of tangents drawn to two curves from the intersection of other two. Reciprocally, we count among the point-pairs once (*A*) a line each of whose determinations is the intersection of two curves, twice (*B*) a tangent to a curve terminated by another curve, and by the intersection of two other curves; and four times (*C*) a double tangent to two curves terminated on two other curves. In these cases for the intersection of two curves, may be substituted the intersection of a curve with

itself or a node, and for a common tangent to two curves may be substituted a double tangent to a single curve.

418. Thus, for example, to find the number of line-pairs in the system of conics which touch four given curves. We have $nn'n''n'''$ line-pairs consisting of one of the nn' common tangents to the first two, combined with one of the $n''n'''$ common tangents to the other two; and, since we can in three ways form two pairs out of the four curves, the number A' is $3nn'n''n'''$. Again, there are $nn'n''m'''$ pairs consisting of a common tangent to the first two curves, and a tangent to the third from one of the points where it meets the fourth; and, since we get the same number if we take a common tangent to the second and third, or to the first and third, we have $B' = 3\Sigma nn'n''m'''$. Lastly, there are plainly $\Sigma nn'n''m'''$ pairs of tangents of the kind C' . We have therefore

$$\varpi = 3nn'n''n''' + 6\Sigma nn'n''m''' + 4\Sigma nn'n''m''',$$

and, in like manner,

$$\lambda = 4\Sigma nn'n''m'' + 6\Sigma nm'm''m''' + 3mm'm''m''',$$

and from these numbers are deduced the same values for μ , and ν , as we have found already.

419. We proceed in the same way if the conditions of the problem are, that the conic shall touch the same curve more than once, or shall have with it contact of higher order. Prof. Cayley uses the following convenient notation. Let (1) denote single contact, (1, 1) single contact with the same curve in two places, (2) contact of the second order or 3-point contact, and so on. Thus the system we have considered of conics having single contact with four curves is denoted by (1), (1), (1), (1). Let us now consider the system (1, 1), (1), (1), that is to say, when the conics have double contact with a single curve and touch two others. Then it is seen, precisely as before, that $A' = \tau n'n'' + nn'.nn''$. We have also

$$B' = \tau(n'm'' + n''m') + nn'(m-2)n'' + nn''(m-2)n' \\ + nn'm''(n-1) + nn''m'(n-1) + n'n''m(n-2),$$

$$C' = \delta n'n'' + mm'(n-2)n'' + mm''(n-2)n' + m'm''\frac{1}{2}n(n-1).$$

Lastly, we must count separately (D') the $\kappa n' n''$ line-pairs, consisting of a pair of tangents drawn from a cusp of the first curve to the other two. Zeuthen shews that these last count each for three, by writing in the formulæ in the first instance an unknown multiplier x , and determining x by an examination of the elementary cases where the second and third curves, reduce to points or lines. Collecting then the numbers $A' + 2B' + 4C'$, and reducing, we find

$$\begin{aligned} \omega &= n' n'' (n^2 + 6mn - 8n - 4m + \tau + 4\delta + 3\kappa) \\ &\quad + 2(m' n'' + m'' n') (n^2 + 2mn - n - 4m + \tau) + 2m' m'' n (n - 1), \end{aligned}$$

and there is a corresponding expression for λ . From these we find expressions for μ , ν , viz.

$$\begin{aligned} \mu &= \mu''' m' m'' + \mu'' (m' n'' + m'' n') + \mu' n' n'', \\ \nu &= \nu''' m' m'' + \nu'' (m' n'' + m'' n') + \nu' n' n'', \end{aligned}$$

where

$$\begin{aligned} \mu' &= 2m(m + n - 3) + \tau, \\ \mu'' = \nu' &= 2m(m + 2n - 5) + 2\tau, \\ \mu''' = \nu'' &= 2n(2m + n - 5) + 2\delta, \\ \nu''' &= 2n(m + n - 3) + \delta. \end{aligned}$$

And these numbers denote the number of conics determined by the conditions of touching one curve twice, together with three points, two points and a tangent, a point and two tangents, and three tangents, respectively.

It is unnecessary to consider separately the case (1, 1), (1, 1), see Art. 413, and the same principles are applicable to the cases (3) (1), (4).

Referring for further details to Zeuthen's memoir, which may be most conveniently consulted, *Nouvelles Annales*, 1866, and to Prof. Cayley's memoirs, *Phil. Trans.*, 1867, we give the following table, in which Prof. Cayley has summed up the simpler results expressed in terms of m , n , and α (see Art. 83).

$$\begin{aligned} (1, 1, 1) \quad \mu' &= \frac{2}{3}m^3 + 2m^2n + mn^2 + \frac{1}{6}n^3 - 2m^2 - 3mn - \frac{1}{2}n^2 \\ &\quad - \frac{2}{3}n - \frac{2}{3}n + \alpha(-3m - \frac{2}{3}n + 13), \\ \nu' &= \frac{1}{3}m^3 + 2m^2n + 2mn^2 + \frac{1}{3}n^3 - m^2 - 4mn - n^2 \\ &\quad - \frac{4}{3}m - \frac{4}{3}n + \alpha(-3m - 3n + 20), \\ \rho' &= \frac{1}{6}m^3 + m^2n + 2mn^2 + \frac{2}{3}n^3 - \frac{1}{2}m^2 - 3mn - 2n^2 \\ &\quad - \frac{2}{3}m - \frac{2}{3}n + \alpha(-\frac{3}{2}m - 3n + 13), \end{aligned}$$

$$\begin{aligned}
 (1, 1, 1, 1) \quad \mu &= \frac{1}{2}m^4 + \frac{2}{3}m^3n + m^2n^2 + \frac{1}{3}mn^3 + \frac{1}{4}n^4 \\
 &\quad - \frac{1}{2}m^3 - 3m^2n - 2mn^2 - \frac{1}{4}n^3 \\
 &\quad - \frac{1}{2}m^2 - 2mn - \frac{2}{3}n^2 + \frac{1}{2}m + \frac{1}{4}n \\
 &\quad + \alpha \left(-\frac{3}{2}m^2 - 3mn - \frac{3}{4}n^2 + \frac{4}{3}m + \frac{5}{4}n - \frac{3}{4} \right) + \frac{3}{8}\alpha^2, \\
 \nu &= \frac{1}{4}m^4 + \frac{1}{3}m^3n + m^2n^2 + \frac{2}{3}mn^3 + \frac{1}{2}n^4 - \frac{1}{4}m^3 - 2m^2n \\
 &\quad - 3mn^2 - \frac{1}{2}n^3 - \frac{2}{3}m^2 - 2mn - \frac{1}{2}n^2 + \frac{4}{3}m \\
 &\quad + \frac{1}{2}n + \alpha \left(-\frac{3}{4}m^2 - 3mn - \frac{3}{2}n^2 + \frac{5}{4}m + \frac{4}{3}n - \frac{3}{4} \right) \\
 &\quad + \frac{9}{8}\alpha^2,
 \end{aligned}$$

$$(2) \quad \mu'' = \alpha, \nu'' = 2\alpha, \rho'' = 2\alpha, \sigma'' = \alpha;$$

$$(2, 1) \quad \mu' = 12m + 12n + \alpha(2m + n - 14),$$

$$\nu' = 24m + 24n + \alpha(2m + 2n - 24),$$

$$\rho' = 12m + 12n + \alpha(m + 2n - 14),$$

$$(2, 1, 1) \quad \mu = 24m^2 + 36mn + 12n^2 - 168m - 168n$$

$$+ \alpha(m^2 + 2mn + \frac{1}{2}n^2 - 25m - \frac{2}{3}n + 138) - \frac{3}{2}\alpha^2,$$

$$\nu = 12m^2 + 36mn + 24n^2 - 168m - 168n$$

$$+ \alpha(\frac{1}{2}m^2 + 2mn + n^2 - \frac{2}{3}m - 25n + 138) - \frac{3}{2}\alpha^2,$$

$$(3, 2) \quad \mu = 27m + 24n - 20\alpha + \frac{1}{2}\alpha^2,$$

$$\nu = 24m + 27n - 20\alpha + \frac{1}{2}\alpha^2,$$

$$(3) \quad \mu' = -4m - 3n + 3\alpha, \nu' = -8m - 8n + 6\alpha,$$

$$\rho' = -3m - 4n + 3\alpha.$$

$$(3, 1) \quad \mu = -8m^2 - 12mn - 3n^2 + 56m + 53n + \alpha(6m + 3n - 39),$$

$$\nu = -3m^2 - 12mn - 8n^2 + 53m + 56n + \alpha(3m + 6n - 39).$$

$$(4) \quad \mu = -10m - 8n + 6\alpha, \nu = -8m - 10n + 6\alpha.$$

420. It still remains to give formulæ for the number of conics satisfying five inseparable conditions, as for example (5) the number of conics having contact of the fifth order with a given curve. These numbers are found from an examination of the case where a curve touched by the conics is a complex of two other curves. Thus the conics having contact of the fifth order with a complex of two curves, are made up of the conics having like contact with the separate curves, and there-

fore the expression for (5) must be such a function of m, n, α , that

$$\phi(m+m', n+n', \alpha+\alpha') = \phi(m, n, \alpha) + \phi(m', n', \alpha'),$$

whence (5) is plainly of the form $am+bn+c\alpha$. From symmetry we must have $a=b$, and knowing the number of sextactic conics when $m=3$, we determine a and c , and find (5) = $-15m - 15n + 9\alpha$.

So, in like manner, the conics (4, 1) are made up of the conics having this contact with each of the separate curves, and of the conics having the contact 4 with one curve and the contact 1 with the other. The number of these last conics is found by the formulæ of the last article, so that we have $\phi(m+m', n+n', \alpha+\alpha') - \phi(m, n, \alpha) - \phi(m', n', \alpha')$ a known function of m, n, α . By the process here indicated, Prof. Cayley establishes the table:

$$\begin{aligned} (4, 1) &= -8m^2 - 20mn - 8n^2 + 10\alpha(m+n) + 6\alpha(m+n-11), \\ (3, 2) &= 120(m+n) + \alpha(-4m-4n-78) + 3\alpha^2, \\ (3, 2, 1) &= -\frac{3}{2}m^3 - 10m^2n - 10mn^2 - \frac{3}{2}n^3 + \frac{1}{2}9m^2 \\ &\quad + 116mn + \frac{1}{2}9n^2 - 434m - 434n \\ &\quad + \alpha(\frac{3}{2}m^2 + 6mn + \frac{3}{2}n^2 - \frac{6}{2}m - \frac{6}{2}n + 291) - \frac{3}{2}\alpha^2, \\ (2, 2, 1) &= 24m^2 + 54mn + 24n^2 - 468(m+n) \\ &\quad + \alpha(-8m-8n+327) + \alpha^2(\frac{1}{2}m + \frac{1}{2}n - 12), \\ (2, 1, 1, 1) &= 6m^3 + 30m^2n + 30mn^2 + 6n^3 - 17n(m+n)^2 + 1320(m+n) \\ &\quad + \alpha(\frac{1}{6}m^3 + m^2n + mn^2 + \frac{1}{6}n^3 - \frac{1}{2}m^2 - 26mn - \frac{1}{2}n^2 \\ &\quad + \frac{3}{5}m + \frac{3}{5}n - 960) + \alpha^2(-\frac{3}{2}m - \frac{3}{2}n + 28), \\ (1, 1, 1, 1, 1) &= \frac{1}{120}(m^5 + n^5) + \frac{1}{12}mn(m^3 + n^3) + \frac{1}{3}m^2n^2(m+n) \\ &\quad - \frac{1}{12}(m^4 + n^4) - \frac{5}{6}mn(m^2 + n^2) - 2m^2n^2 \\ &\quad - \frac{1}{15}(m^3 + n^3) - \frac{2}{12}mn(m+n) + \frac{1}{12}(m^2 + n^2) \\ &\quad + \frac{5}{3}mn - \frac{3}{5}(m+n) + \alpha(-\frac{1}{4}m^3 - \frac{3}{2}m^2n - \frac{3}{2}mn^2 \\ &\quad - \frac{1}{4}n^3 + \frac{2}{4}m^2 + 23mn + \frac{2}{4}n^2 - \frac{3}{4}m - \frac{3}{4}n + 486) \\ &\quad + \alpha^2\{\frac{9}{8}(m+n) - 15\}. \end{aligned}$$

Zeuthen and Cayley have also investigated formulæ for the cases where the conditions include contact with a curve at a given point; and Cayley's memoir contains investigations of

a formula of De Jonquière's, giving the number of curves of the order r having with a given curve of the order m , t contacts of the order a , b , c , &c., and besides passing through p points on the curve. But the subject is too extensive to be here further treated of.

NOTE BY PROFESSOR CAYLEY ON ART. 416.

Some remarks may be added as to the analytical theory of the degenerate forms of curves. As regards conics, a line-pair can be represented in point-coordinates by an equation of the form $xy=0$; and reciprocally a point-pair can be represented in line-coordinates by an equation $\xi\eta=0$, but we have to consider how the point-pair can be represented in point-coordinates: an equation $x^2=0$ is no adequate representation of the point-pair, but merely represents (as a two-fold or twice repeated line) the line joining the two points of the point-pair, all traces of the points themselves being lost in this representation: and it is to be noticed, that the conic, or two-fold line $x^2=0$, or say $(\alpha x + \beta y + \gamma z)^2=0$ is a conic which, analytically, and (in an improper sense) geometrically, satisfies the condition of touching *any line whatever*; whereas the only proper tangents of a point-pair are the lines which pass through one or other of the two points of the point-pair.

The solution arises out of the notion of a point-pair, considered as the limit of a conic, or say as an indefinitely flat conic; we have to consider conics certain of the coefficients whereof are infinitesimals, and which when the infinitesimal coefficients actually vanish reduce themselves to two-fold lines; and it is, moreover, necessary to consider the evanescent coefficients as infinitesimals of different orders. Thus consider the conics which pass through two given points, and touch two given lines (four conditions); take $y=0$, $z=0$ for the given lines, $x=0$ for the line joining the given points, and $(x=0, y-\alpha z=0)$, $(x=0, y-\beta z=0)$ for the given points; the equation of a conic satisfying the required conditions and containing one arbitrary parameter θ , is

$$x^2 + 2\theta xy + 2\theta \sqrt{\alpha\beta} xz + \theta^2 (y - \alpha z)(y - \beta z) = 0;$$

or, what is the same thing,

$$\{x + \theta y + \theta \sqrt{\alpha\beta} z\}^2 - \theta^2 (\alpha + \beta) yz = 0;$$

and this equation, considering therein θ as an infinitesimal, say of the first order, represents the flat conic or point-pair composed of the two given points. Comparing with the general equation

$$(a, b, c, f, g, h) \chi(x, y, z)^2 = 0,$$

we have

$a = 1$, $b = \theta^2$, $c = \theta^2 \alpha\beta$, $f = -\frac{1}{2}\theta^2 (\alpha + \beta)$, $g = \theta \sqrt{\alpha\beta}$, $h = \theta$, viz. a being taken to be finite, we have g and h infinitesimals of the first order; b, c, f infinitesimals of the second order; and the four ratios $\sqrt{b} : \sqrt{c} : \sqrt{f} : g : h$ are so determined as to satisfy the prescribed conditions.

Observe that the flat conic, considered as a conic passing through the two given points and touching the two given lines, is represented by a *determinate* equation, viz. considering the condition imposed upon θ ($\theta =$ infinitesimal) as a determination of θ , the equation is a completely determinate one; but considering the flat conic merely as a conic passing through the two given points, the equation would contain two arbitrary parameters, determinable if the flat conic was subjected to the condition of touching two given lines, or to any other two conditions.

Generally we may consider the equation of a curve of the order n ; such equation containing certain infinitesimal coefficients, and when these vanish, reducing itself to a composite equation $P^a Q^b \dots = 0$; the equation in its original form represents a curve which may be called the penultimate curve. Consider the tangents from an arbitrary point to the penultimate curve; when this breaks up, the system of tangents reduces itself to (1) the tangents from the fixed point to the several component curves $P=0$, $Q=0$, &c. respectively; (2) the lines through the singular points of these same curves respectively; (3) the lines through the points of intersection $P=0$, $Q=0$, &c. of each two of the component curves; these points, each reckoned a proper number of times, are called "fixed summits;" (4) the lines from the fixed point to certain determinate points called "free summits" on the several component curves $P=0$, $Q=0$, &c. respectively. We have thus a degenerate form

of the n -thic curve, which may be regarded as consisting of the component curves, each its proper number of times, and of the foregoing points called summits, and is consequently only inadequately represented by the ultimate equation $P^\alpha Q^\beta \dots = 0$; the number and distribution of the summits is not arbitrary, but is regulated by laws arising from the consideration of the penultimate curve, and there are of course for any given value of n various forms of degenerate curve, according to the different ultimate forms $P^\alpha Q^\beta \dots = 0$, and to the number and distribution of the summits on the different component curves. The case of a quartic curve having the ultimate form $x^2 y^2 = 0$ has been considered by Cayley, *Comptes Rendus*, t. LXXIV., p. 708 (March, 1872), who states his conclusion as follows: "there exists a quartic curve the penultimate of $x^2 y^2 = 0$, with nine free summits, three of them on one of the lines (say the line $y = 0$), and which are three of the intersections of the quartic by this line (the fourth intersection being indefinitely near to the point $x = 0, y = 0$), six situate at pleasure on the other line $x = 0$; and three fixed summits at the intersection of the two lines." Other forms have been considered by Dr. Zeuthen, *Comptes Rendus*, t. LXXV. pp. 703 and 950 (September and October, 1872), and some other forms by Zeuthen; the whole question of the degenerate forms of curves is one well deserving further investigation.

The question of the number of cubic curves satisfying given elementary conditions (depending as it does on the consideration of the degenerate forms of these curves) has been solved by Maillard and Zeuthen; that of the number of quartic curves has been solved by Dr. Zeuthen.

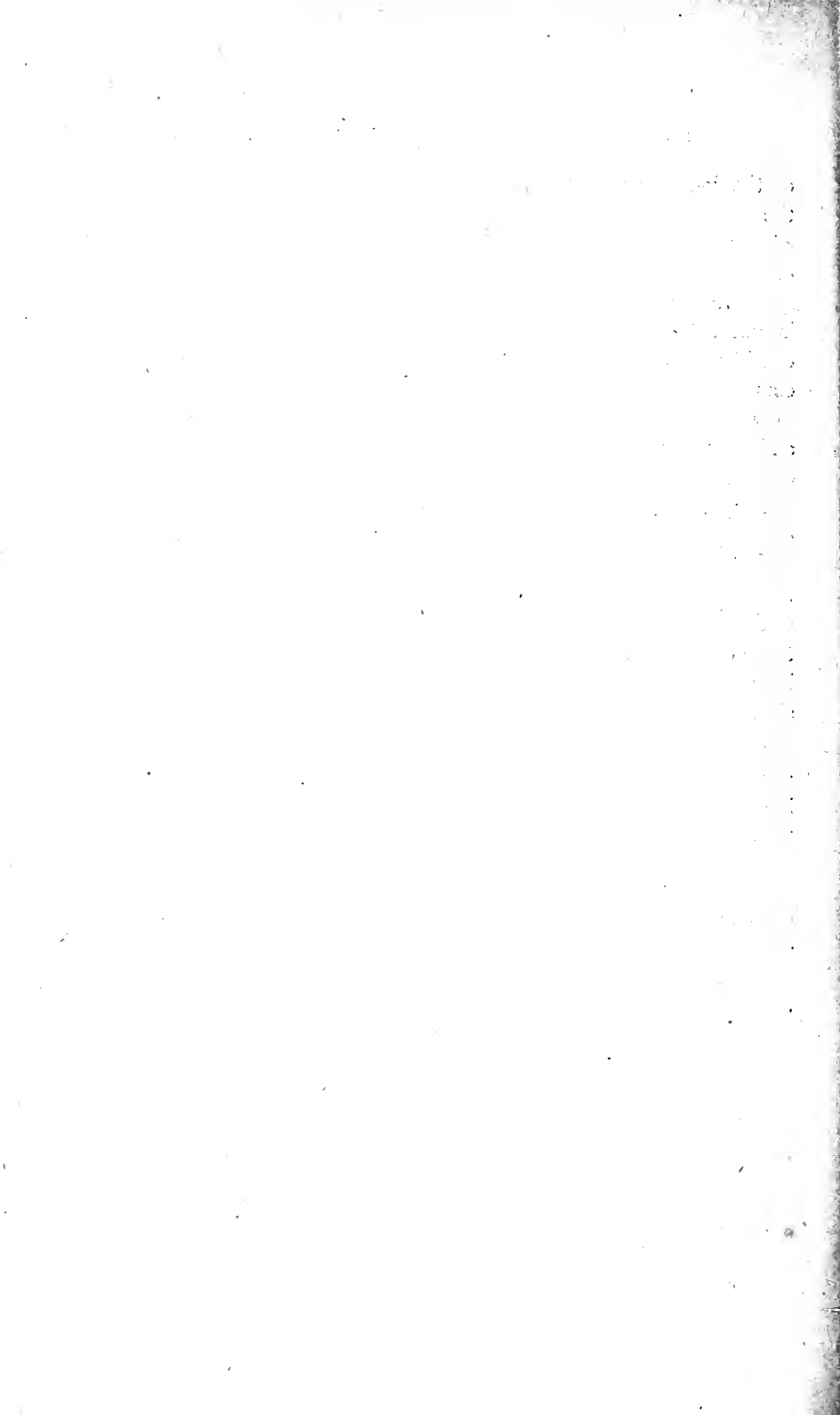

NOTES.

Art. 58, p. 48. On the equivalence of higher singularities of curves to ordinary singularities, see Professor H. J. S. Smith, "On the higher singularities of plane curves, *Proceedings London Math. Soc.* VI. 153; Zeuthen, *Math. Ann.*, X, 212.

Art. 151, p. 132. In connection with this theory see Cremona (*Novelles Annales*, 1864, p. 23); also Schröter "on a mode of generating cubics"; *Math. Ann.* V, 50, Durège "on a cubic considered as the locus of the foci of a system of conics," *Math. Ann.* V, 83; and Clebsch "on two methods of generating cubics," *Math. Ann.* V, 422. Grassmann (*Crelle*, LII. 254) has generated a cubic as the locus of a point such that the lines joining it to three fixed points meet three fixed lines in points which lie on a right line.

Art. 161, p. 139. Investigations of a nature kindred to those of Sylvester on residuation were made about the same time by Brill and Noether, *Göttinger Nachr.*, 1873, p. 116. An abstract is given by Fiedler in the notes to his translation of this work.

p. 185. Add to the note "See also a dissertation by Rosenow Breslau, 1873."

Art. 220, p. 191. The form in which S is written by Aronhold is as follows:

$$\begin{aligned}
 -S = & (b_1c_1 - m^2)^2 + (c_1a - a_3^2)(bc_2 - b_3^2) + (ab_1 - a_2^2)(b_3c - c_2^2) \\
 & + (a_3a_2 - ma)(bc - b_3c_2) + (a_2m - a_3b_1)(b_3c_1 + cb_1 - 2c_2m) \\
 & + (ma_3 - a_2c_1)(b_1c_2 + c_1b - 2mb_3).
 \end{aligned}$$

p. 212. Add to the note, "In the paper last mentioned Gundelfinger writes down the 34 forms which constitute the system of concomitants to a ternary cubic, in conformity with Gordan's theory, *Math. Ann.* I. 90. See also Gundelfinger's paper *Math. Ann.*, VIII. 136. On the subject of cubic curves Clebsch ought also to be consulted, *Vorlesungen über Geometrie*, p. 497."

ON THE BITANGENTS OF A QUARTIC, BY PROFESSOR CAYLEY.

THE equations of the 28 bitangents of a quartic curve were obtained in a very elegant form by Riemann in the paper "Zur Theorie der Abelschen Functionen für den Fall $p = 3$," Werke, Leipzig, 1876, pp. 456—472; and see also Weber's "Theorie der Abelschen Functionen vom Geschlecht 3," Berlin, 1876. Riemann connects the several bitangents with the characteristics of the 28 odd functions, thus obtaining for them an algorithm which it is worth while to explain, but they will be given also with the algorithm employed p. 231 *et seq.* of the present work, which is in fact the more simple one. The characteristic of a triple θ -function is a symbol of the form

$$\begin{array}{c}
 \alpha \beta \gamma, \\
 \alpha' \beta' \gamma',
 \end{array}$$

where each of the letters is = 0 or 1; there are thus in all 64 such symbols, but they are considered as odd or even according as the sum $\alpha\alpha' + \beta\beta' + \gamma\gamma'$ is odd or even;

and the numbers of the odd and even characteristics are 28 and 36 respectively; and, as already mentioned, the 28 odd characteristics correspond to the 28 bitangents respectively.

We have x, y, z trilinear coordinates, $\alpha, \beta, \gamma, \alpha', \beta', \gamma'$ constants chosen at pleasure, and then $\alpha'', \beta'', \gamma''$ determinate constants, such that the equations

$$\begin{aligned}x + y + z + \xi + \eta + \zeta &= 0, \\ \alpha x + \beta y + \gamma z + \frac{\xi}{\alpha} + \frac{\eta}{\beta} + \frac{\zeta}{\gamma} &= 0, \\ \alpha' x + \beta' y + \gamma' z + \frac{\xi}{\alpha'} + \frac{\eta}{\beta'} + \frac{\zeta}{\gamma'} &= 0, \\ \alpha'' x + \beta'' y + \gamma'' z + \frac{\xi}{\alpha''} + \frac{\eta}{\beta''} + \frac{\zeta}{\gamma''} &= 0,\end{aligned}$$

are equivalent to three independent equations; this being so, they determine ξ, η, ζ each of them as a linear function of (x, y, z) ; and the equations of the bitangents of the curve $\mathcal{J}(x\xi) + \mathcal{J}(y\eta) + \mathcal{J}(z\zeta) = 0$ (see Weber, p. 100) are

18	$\begin{matrix} 111 \\ 111 \end{matrix}$	$x = 0,$
28	$\begin{matrix} 001 \\ 011 \end{matrix}$	$y = 0,$
38	$\begin{matrix} 011 \\ 001 \end{matrix}$	$z = 0,$
23	$\begin{matrix} 010 \\ 010 \end{matrix}$	$\xi = 0,$
13	$\begin{matrix} 100 \\ 110 \end{matrix}$	$\eta = 0,$
12	$\begin{matrix} 110 \\ 100 \end{matrix}$	$\zeta = 0,$
48	$\begin{matrix} 101 \\ 100 \end{matrix}$	$x + y + z = 0,$
14	$\begin{matrix} 010 \\ 011 \end{matrix}$	$\xi + y + z = 0,$
58	$\begin{matrix} 100 \\ 101 \end{matrix}$	$\alpha x + \beta y + \gamma z = 0,$
15	$\begin{matrix} 011 \\ 010 \end{matrix}$	$\frac{\xi}{\alpha} + \beta y + \gamma z = 0,$
68	$\begin{matrix} 110 \\ 010 \end{matrix}$	$\alpha' x + \beta' y + \gamma' z = 0,$
16	$\begin{matrix} 001 \\ 101 \end{matrix}$	$\frac{\xi}{\alpha'} + \beta' y + \gamma' z = 0,$
78	$\begin{matrix} 010 \\ 110 \end{matrix}$	$\alpha'' x + \beta'' y + \gamma'' z = 0,$
17	$\begin{matrix} 101 \\ 001 \end{matrix}$	$\frac{\xi}{\alpha''} + \beta'' y + \gamma'' z = 0,$
24	$\begin{matrix} 100 \\ 111 \end{matrix}$	$x + \eta + z = 0,$
34	$\begin{matrix} 110 \\ 101 \end{matrix}$	$x + y + \zeta = 0,$

26	101 110	$ax + \frac{\eta}{\beta} + \gamma z = 0,$
35	111 100	$ax + \beta y + \frac{\zeta}{\gamma} = 0,$
26	111 001	$\alpha'x + \frac{\eta}{\beta'} + \gamma'z = 0,$
36	101 011	$\alpha'x + \beta'y + \frac{\zeta'}{\gamma} = 0,$
27	011 101	$\alpha''x + \frac{\eta}{\beta''} + \gamma''z = 0,$
37	001 111	$\alpha''x + \beta''y + \frac{\zeta''}{\gamma} = 0,$
67	100 100	$\frac{x}{1-\beta\gamma} + \frac{y}{1-\gamma\alpha} + \frac{z}{1-\alpha\beta} = 0,$
57	110 011	$\frac{x}{1-\beta'\gamma'} + \frac{y}{1-\gamma'\alpha'} + \frac{z}{1-\alpha'\beta'} = 0,$
56	010 111	$\frac{x}{1-\beta''\gamma''} + \frac{y}{1-\gamma''\alpha''} + \frac{z}{1-\alpha''\beta''} = 0,$
45	001 001	$\frac{\xi}{\alpha(1-\beta\gamma)} + \frac{\eta}{\beta(1-\gamma\alpha)} + \frac{\zeta}{\gamma(1-\alpha\beta)} = 0,$
46	011 110	$\frac{\xi}{\alpha'(1-\beta'\gamma')} + \frac{\eta}{\beta'(1-\gamma'\alpha')} + \frac{\zeta}{\gamma'(1-\alpha'\beta')} = 0,$
47	111 010	$\frac{\xi}{\alpha''(1-\beta''\gamma'')} + \frac{\eta}{\beta''(1-\gamma''\alpha'')} + \frac{\zeta}{\gamma''(1-\alpha''\beta'')} = 0.$

The whole number of ways in which the equation of the curve can be expressed in a form such as $\mathcal{J}(x\xi) + \mathcal{J}(y\eta) + \mathcal{J}(z\zeta) = 0$ is 1260; viz. the three pairs of bitangents entering into the equation of the curve are of one of the types

12.34, 13.24, 14.23	⊠	No. is 70
12.34, 13.24, 56.78	□	„ 630
13.23, 14.24, 15.25	◇	„ 560
		1260

and it may be remarked that selecting at pleasure any two pairs out of a system of three pairs the type is always □ or |||, viz. (see p. 233) the four bitangents are such that their points of contact are situate on a conic.

Art. 269, p. 241. In saying that the case of quartics with a single node had received no attention I overlooked Brioschi's paper, *Math. Ann.* iv. 95, followed by Cremona, p. 99, and Brill, *Math. Ann.* vi. 66 and *Crelle*, vol. 65.

Art. 276, p. 246. The method here employed had been indicated by Burnside, *Educational Times* reprint vii. 70.

Art. 287, p. 257. On this subject see a paper by Mr. Malet, *Trans. Royal Irish Academy*, xxvi. 431 (1878).

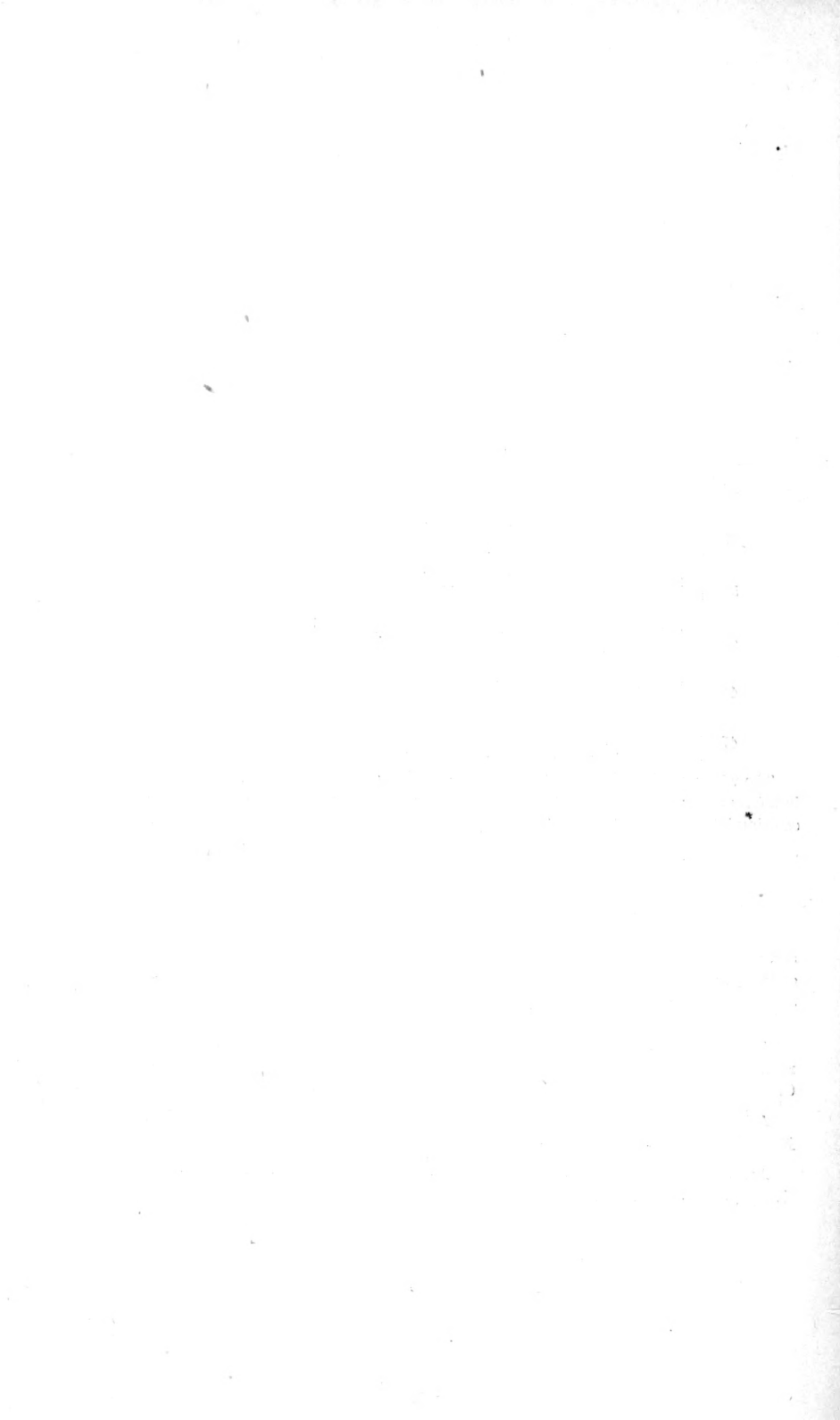

INDEX.

- Aberrancy of curvature, 97, 368.
Absolute invariant of a cubic, 144, 165.
Acnode, 25, 129.
 of cubic constructed when stationary tangents are given, 184.
Angle made by tangents with axis, 36.
 with radius vector, 80.
 sum of, given which tangents from a point make with fixed line, 123.
 between focal radii and tangent, 125.
Angle at which curves cut, unaltered by certain transformations, 314.
Anharmonic, theorems of conics, their analogues in cubics, 140.
 ratio constant of pencil of tangents from point on cubic, 144.
 this ratio expressed in terms of fundamental invariants, 199.
 ratio unaltered by linear transformation, 296.
 ratios equal of tangents from two nodes of quartic, 241.
Antipoints, 122.
Arc of evolute, length of, 88.
Archimedes, spiral of, 291.
Aronhold's invariants of cubics, 191.
 discussion of bitangents of quartics, 238.
Asymptotes, their equation how found, 40.
 how cut by any transversal, 113.
 of cubic, 170.
Atkins on caustics, 101.
Bernoulli, on lemniscate, catenary and logarithmic spiral, 44, 289, 293.
Bertini on rational transformation, 326.
Bicircular quartics, 126, 142, 241.
Bifid substitution, 232.
Bifocnodes, 217.
Bipartite cubics, 168.
Bitangents, general theory of, 342, &c.
 of quartics, 111, 220, 223.
Bitangential curve, of quartic, 223, 349, 357.
Brill, on transformation of curves, 329.
 on residuation, 387, 389.
Brioschi, on nodal quartics, 389.
Canonical form, of equation of cubic, 188, 196.
 general equation of cubic how reduced to, 198.
Cardioide, 44, 252, 282.
Carnot, theorem of transversals, 109.
Cartesians, 101, 104, 126, 241, 244, 250.
Cartesian coordinates, how related to trilinear, 6.
Casey, on bicircular quartics, 241.
Cassini's ovals, 44, 126.
Catenary, 287.
Caustics, 98, &c.
 of parabola, 107.
Cayley on intersections of two curves, 21, 22.
 on equivalence of higher singularities to a union of simpler, 48.
 modification of Plücker's equations, 66.
 on envelope of equation containing independent parameters, 74.
 on quasi-evolutes, 92.
 on characteristics of parallel curves, 102.
 on problem of negative pedals, 107.
 on foci, 120.
 on involution, and classification of cubics, 162, 179.
 his notation for equation of cubic, 189.
 algorithm for bitangents of quartics, 230, 232.
 on tangents from nodes of binodal quartic, 241.
 on cartesians, 251.
 on logarithmic curve, 287.
 on skew reciprocals, 304.
 on transformation of curves, 316.
 solution of problem of bitangents, 341, 351, 355.
 on sextactic points, 371.
 on systems of curves, 372, 379.
 on degenerate forms of curves, 383.
 note on bitangents of quartic, 387.
Cayleyan of cubic, different definitions of, 151.
 its equation, 190.
 in point coordinates, 203.
 of a system of conics, 225.
 of a curve in general, 364.
Centres, 115.
Central cubics, 164.
Centre of mean distances, 112.
 of contacts of parallel tangents, 119.

- Characteristics of reciprocal, 65.
 of evolute, 94.
 of parallel, 102.
 of inverse curve and pedals, 106.
 of system of conics, 372.
- Chasles on contact of parallel tangents, 119.
 on projection of cubics into central cubics, 164.
 on Cartesians, 241, 250.
 on systems of curves, 372.
- Circular points at infinity, 1, 83, 90, 119, 124.
 their coordinates, 7.
 normal at, 94.
 circular cubic, 126, 142, 248.
- Circular coordinates, 7.
- Cissoid, 84, 182.
- Class of a curve how connected with its order, 54.
- Clebsch, on unicursal cubics, 188.
 on canonical form of a quartic, 265.
 on Jacobians, 359.
 on generation of cubics, 387.
 on symbolical notation, 343.
- Clifford, on Miquel's theorem, 128.
- Conchoid of Nicomedes, 44.
- Condition that curve should have a double point, 55.
 a cusp, 58.
 a point of undulation, 362.
 that two curves should touch, 80.
 that four consecutive points on curve should lie in a circle, 97.
 that cubic should be sum of three cubics, 197.
 should represent three lines, 197.
 a conic and a line, 210.
 that quartic should be sum of five fourth powers, 265.
- Contact of conics with cubics, 135, 207.
 with curves in general, 368.
- Contravariants of cubic, 190, 204.
 of quartic, 264, 271, 273.
- Coresiduals, 134.
- Correspondence of two points on a cubic, 132.
 on Hessian, 149.
 general theory of, 255, 324, 331.
- Cotes, theorem of harmonic means, 115.
- Covariants of cubics, 189, 200.
 of quartics, 264, 269, 273.
- Cramer on intersections of two curves, 22.
 on points of visible inflexion, 37.
 on tracing of curves, 43.
- Cremona, on Cayleyans, 151.
 on transformation of curves, 316.
 on nodal quartics, 3.
- Critic centres of system of cubics, 160, 174, 178.
 of cubic and Hessian, 200.
- Crunodes, 24, 129.
- Curvature, centre and radius of, 84, 86.
 of roulettes, 284.
 aberrancy of, 368.
- Cusps, 25, 48, 58.
 curvature at, 87.
- Cuspidal cubics, 180.
- Cycloid, 275.
- Dandelin on caustics, 99.
- Deficiency of a curve defined, 30.
 same for curve and its reciprocal, 66.
 or for any curve connected with it by linear correspondence, 97.
 unaltered by Cremona transformation, 321.
 or any rational transformation, 326, 331.
- Degenerate forms of curves, 377, 383.
- De Jonquières on systems of curves, 372, 383.
- De Morgan on Newton's process for finding figure of curve at multiple point, 46.
- Des Cartes (see Cartesians), on the cycloid, 278.
 on the logarithmic spiral, 293.
- Descriptive properties, 1, 82.
- Diameters, 112.
- Diocles, the cissoid, 182.
- Discriminant of a curve defined, 55.
 of a cubic expressed in terms of fundamental invariants, 159, 196, 199, 210.
 expressed as a determinant, 211.
 of discriminant, 360.
- Divergent parabolas, 164, 166, 173, 176.
- Double points, their species, 24.
 equivalent to how many conditions, 28.
 limit to their number, 28.
- Duality, geometrical, 12.
- Durege, on cubic considered as locus of foci, 387.
- Envelopes, general theory of, 67.
 of line whose equation is algebraic function of parameter, 70.
 of line whose intercept between two lines is constant, 102, (see also 69, 84), 283.
 of line joining feet of perpendiculars from point on circle on sides of inscribed triangle, 283.
 of line joining corresponding points on cubic, 133.
- Equitangential curve, 290.
- Epicycloids, 278.
- Euler, on intersections of two curves, 22.
 on epicycloids, 279.
 on logarithmic curve, 286.
- Evectants of invariants S and T , 191, 194.
- Evolutes of conics, 41, 83.
 of curves generally, 82.
 tangential equation of, 89.
 characteristics of, 94.
 confocal with curve, 124.
- Flecnodes, 217.
- Foci, general theory of, 119.
 locus of foci under certain conditions, 127.
 of circular cubic lie on circles, 248.
 of bicircular quartic, 242.
- Galileo, on the cycloid, 277.
 on the catenary, 289.
- Geiser, on bitangents of quartics, 231.
- Gergonne, on intersections of two curves, 22.
- Gordan, on number of concomitants to a cubic, 387.

- Grassman, on generation of cubics, 387.
- Gregory, on tracing of curves, 43.
on logarithmic curve, 287.
- Groups, of cubics, Plücker's, 178.
- Guldensinger, on concomitants of cubics, 387.
- Haase, on unicursal cubics, 185.
- Harmonic mean of radii, 115.
pencil by chords of cubic, 133.
polar of point of inflexion of cubic, 146, 203.
- Hart, construction for ninth point common to all cubics passing through eight, 140.
theorem that foci of a circular cubic lie on circles, 145.
proof of Hesse's theorem on inflexions of cubics, 148.
on foci of bicircular quartic, 242.
theorem that confocals cut at right angles, 248.
on logarithmic curve, 287.
- Hesse, his theorem that inflexions of cubic are also inflexions of Hessian, 148.
algorithm for bitangents of a quartic, 230, 234.
reduction of bitangential of quartic, 344.
- Hessian, defined, 57.
passes through points of inflexion, 59, 87.
of cubic, its equation, 190.
of quartic, 223.
of Hessian of cubic, 196.
of UV , 212.
- Homographic, tangents from nodes of a binodal quartic are, 241.
transformation, 295.
- Huyghens, on evolutes, 88.
on the cycloid, 278.
- Hyperbolas, cubical, 170, &c.
- Hyperbolism of any curve, 178.
- Hyperelliptic integrals, 330.
- Identical equation for cubic, 205.
- Igel, on unicursal cubics, 185.
- Independent parameters, envelopewith, 74.
- Infinity, pole of, 117.
normal at, 94.
satellite of, 131.
polar conic of, with respect to cubic, 158.
- Inflexion, points of, 33.
tangent at it double, 34.
curve there crosses tangent, 35.
number of, 59.
three inflexions of cubics lie on a right line, 110, 131.
inverse of this theorem, 312.
real for acnodal cubics, imaginary for crunodal, 184.
of quartics, how many real, 221.
- Inflexional tangents of cubic touch Hessian, 152.
equation of system of, 203.
- Ingram, on inversion, 312.
- Interscendental curves, 275.
- Intersections of curves, 16.
- Inversion, 106.
characteristics of inverse curves, 106.
of parabola, 183.
applied to obtain focal properties, 252.
in wider sense of word, 254.
a case of quadric transformation, 310.
applications of the method, 311.
- Involute of circle, 290.
- Jacobî, on intersection of two curves, 22.
- Jacobian of three curves, 150.
of a system of conics, 225.
common point of three curves of same degree is double point on, 160, 358.
properties of, 357.
- Joachimsthal, his method of determining point where line meets curve, 49.
- Jungius, on catenary, 289.
- Keratoid cusps, 48.
- Kirkman, on Pascal's hexagon, 19.
- Leibnitz, on interscendental curves, 275.
- Lemniscate, 44.
- Limaçon, 44, 99, 252, 282.
- Line coordinates, 9.
- Linear transformation, 295.
- Lituus, 292.
- Locus, of common vertex of two triangles, whose bases are given, and vertical angles have given difference, 142.
of point whence tangents to a curve have given invariant relation, 79.
whence tangents make with fixed line angles whose sum is given, 123.
of nodes of all nodal cubics through seven fixed points, 160.
- Logarithmic curve, 286.
spiral, 292.
- Lüroth, on special class of quartics, 265.
- MacLaurin's, general theorem on curves, 117.
theory of correspondence of points on a cubic, 133.
on harmonic polars of inflexions of cubic, 146.
- Magnus, on reduction of homographic transformation to projection, 299.
- Maillard, on number of cubics satisfying elementary conditions, 385.
- Mersenne, on cycloid, 277.
- Metrical theorems defined, 1, 108.
- Miquel's theorem, 128.
- Multiple points, equivalent to how many nodes, 28.
how related to polar curves, 52.
how affect points of inflexion, 60.
number of tangents from, 63.
- Multiple tangents, 32, 52.
- Newton's process for finding figure of curve at multiple point, 46.
theorem of ratio of rectangles, 108.
on diameters, 112.

- Newton, on intercept between curve and asymptotes, 113.
 theorem that a cubic may be projected into one of the five parabolas, 164.
 classification of cubics, 176.
 description of cissoid by continuous motion, 183.
- Newton's rectification of epicycloids, 284.
- Nicomedes, conchoid of, 44.
- Node cusps, 214.
- Normal, 89.
 of point at infinity, 94
- Number of terms in general equation, 15.
 of conditions which determine a curve, 15.
 of tangents to a curve from a given point, 54.
 of conics which touch five given curves, 375.
 satisfying any five conditions of contact, 382.
- Oscnodes, 216.
- Osculating conics, 368, &c.
- Oval, no real tangents can be drawn to cubic from, 167.
 a quartic may have four, 219.
- Parabola, cubical and semicubical, 83, 176.
 divergent of the third degree, 164.
- Parallel curve to a conic, equation of, 70.
 tangential equation of, 103.
 characteristics in general, 102.
- Parallel tangents, have fixed point as centre of mean distance of their contacts, 119.
- Parametric expression of point on unicursal cubic, 185.
 on cubic in general, 329, 338.
 on unicursal quartic, 260.
 on nodal quartic, 330.
- Partitivity of cubics, 168.
 of quartics, 219.
 limit in general, 220.
- Pascal, theorem of hexagon derived from theory of cubics, 19.
 limaçon, 44, 99.
 on cycloid, 278.
- Pedal, of a curve, 99, 105.
 negative, 105, 106.
- Perpendicularity, extension of relation, 82, 93.
- Pippian of cubic, 151.
- Plücker, on intersection of curves, 22.
 on degree of reciprocal, 54.
 his equations connecting reciprocal singularities, 65.
 on theorem of transversals, 110.
 on foci, 119.
 classification of cubics, 161, 178.
 on forms of quartics, 219.
 on bitangents of quartics, 227.
- Poles and polars,
 general theory of, 49, 115, 357, &c.
 in case of cubics, 142.
 polar of point with regard to triangle, 4, 143.
- Poles and polars,
 of infinity with regard to a curve of the n^{th} class, 119.
 first polar contains points of contact of tangents, 53.
 polar conic of line with regard to cubic, 156.
- Polar coordinates, problems discussed in, 23, 79, 88, 108, 112, 116.
- Polygons, problem of inscription of, in conics, 253, 337.
 in cubics, 181, 338.
 in quartics, 253.
- Poncelet, on number of tangents to a curve from any point, 54.
 on inscription of polygons in curves, 253, 339.
- Projection, of cubics, 164, 169.
 a homographic transformation, 298.
- Pursuit, curves of, 290.
- Quadrangle formed by contacts of tangents from point on cubic, 132, 206.
- Quasi evolutes and quasi normals, 90, 182.
- Quetelet, on caustics, 99.
- Ramphoid cusps, 48, 214.
- Rational expression for coordinates of point on unicursal curve, 30, 185, 260.
 transformation, 308.
- Reciprocal of a curve, its degree, 54.
 characteristics of, 65.
 method of finding equation of, 67, 76.
 of a cubic, 76, 158, 193.
 of a quartic, 78, 223.
 in polar coordinates, 79.
 skew reciprocals, 306.
- Residuation, Sylvester's theory of, 134.
 for cuspidal cubics, 180.
- Riemann, on constancy of deficiency, 326.
 on bitangents to a quartic, 387.
- Roberts, on problem of parallels and negative pedals, 105.
 on transformation of curves, 313.
- Roberval, on the cycloid, 278.
- Roemer, on epicycloids, 284.
- Roulettes, 284,
- Satellite of a line with respect to a cubic, 130,
 of line infinity, 131,
 envelope of, 162,
 used in classification, 161, 178,
- Schröter, on generation of cubics, 387.
- Sextactic points on cubics, 135.
 on curves in general, 371.
- Signs of coordinates, how determined, 3.
- Singularities, higher equivalent to a union of simpler, 49.
 which to be counted ordinary, 64.
- Sinusoid, 285.
- Skew reciprocals, 306.
- Smith, on singularities of curves, 387.
- Spinodes, 25.
- Spirals, 291.
- Stationary points, 25.
 tangents, 33.
 of cubic touch Hessian, 153.

- Stationary tangents, equation of system, 203.
- Steiner, on hexagon, 19.
 on inscription of polygons in quartics, 253.
 on bitangents of quartics, 234.
 on curve enveloping line joining feet of three perpendiculars, 288.
 on circles osculating conic and passing through given point, 312.
 on systems of curves, 360.
- Steinerian defined, 57.
 identical with Hessian in case of cubic, 150.
 its properties, 363.
- Steiner-Hessian, 364.
- Stubbs, on inversion, 312.
- Sylvester's theory of residuation, 134.
- Symbolical form of equation of reciprocal, 77.
 of locus of points, whence tangents satisfy invariant relation, 79.
- Systems of curves, 372.
- Syntractrix, 289.
- Tacnode, 214.
 cusp, 214.
- Tact-invariant of two curves, 80, 360.
- Tangent, at origin, equation of, 23.
 from any point, points of contact, how determined, 53.
 how specially related in case of cubic, 132.
 equation of system, 61, 78.
 from a multiple point, 63.
 locus of point if sum of angles made with by a fixed line be constant, 123.
 if tangents fulfil invariant relation, 79.
- Tangential coordinates, 9.
 particular cases of, 10.
 equation of evolutes, 89.
 of a point with respect to a cubic, 130, 180, 206.
- Tangential,
 its coordinates, how found, 156.
 points of a curve, how related, 38.
 curve, mode of finding its equation, 352.
- Tracing of curves, 40.
- Tractrix, 289.
- Transformation of curves, 294.
- Transon, aberrancy of curvature, 368.
- Tricuspidal quartics, 258.
- Trident, 176.
- Trinodal quartic, properties of, 254.
 tangents at or from nodes touch conic, 256.
- Triple points, their species, 27.
- Tschirnhausen on caustics, 93.
- Twinpair sheet of cones, 165.
- Undulation, point of, 37.
 in case of quartics, 218.
 general condition for, 362.
- Unicursal curve, defined, 31, 69, 107.
 cubics, 168, 179.
 quartics, 254.
 correspondence of points on, 332.
- Unipartite cubics, 168.
- United points of correspondence, 332.
- Vincent, on logarithmic curve, 286.
- Walker on invariants of quartics, 274.
- Waring on number of tangents to a curve from any point, 54.
- Wallace on catenary, 288.
- Weber, on Abelian functions, 387.
- Wren on cycloid, 278.
- Zeuthen, proof that deficiency is unaltered by rational transformation, 326.
 on bitangents to a quartic, 220.
 on systems of curves, 377, 385.
 on singularities of curves, 387.

THE END.

BY THE SAME AUTHOR.

A TREATISE ON CONIC SECTIONS.

Sixth Edition.

London: LONGMANS, GREEN, AND CO.

A TREATISE ON THE GEOMETRY OF
THREE DIMENSIONS.

Third Edition.

Dublin: HODGES, FOSTER, AND FIGGIS.

LESSONS INTRODUCTORY TO THE
MODERN HIGHER ALGEBRA.

Third Edition.

Dublin: HODGES, FOSTER, AND FIGGIS.

114



**PLEASE DO NOT REMOVE
CARDS OR SLIPS FROM THIS POCKET**

UNIVERSITY OF TORONTO LIBRARY

P&A Sci.

