



3 1761 04732749 9

Digitized by the Internet Archive
in 2007 with funding from
Microsoft Corporation





**THEORY AND CALCULATION
OF
ALTERNATING-CURRENT PHENOMENA**



McGraw-Hill Book Co. Inc.

PUBLISHERS OF BOOKS FOR

Coal Age ▽ Electric Railway Journal
Electrical World ▽ Engineering News-Record
American Machinist ▽ The Contractor
Engineering & Mining Journal ▽ Power
Metallurgical & Chemical Engineering
Electrical Merchandising

THEORY AND CALCULATION
OF
ALTERNATING CURRENT
PHENOMENA

BY
CHARLES PROTEUS STEINMETZ, A.M., PH.D.

FIFTH EDITION
THOROUGHLY REVISED AND ENTIRELY RESET
SECOND IMPRESSION

172/92
20/6/22

McGRAW-HILL BOOK COMPANY, INC.
239 WEST 39TH STREET. NEW YORK

LONDON: HILL PUBLISHING CO., LTD.
6 & 8 BOUVERIE ST., E. C.

1916

9 0
9 3 0

COPYRIGHT, 1916, BY THE
MCGRAW-HILL BOOK COMPANY, INC.

COPYRIGHT, 1908, BY THE
MCGRAW PUBLISHING COMPANY

COPYRIGHT, 1900, BY
ELECTRICAL WORLD AND ENGINEER (INCORPORATED)

Dedicated

TO THE

MEMORY OF MY FATHER

CARL HEINRICH STEINMETZ

PREFACE TO FIFTH EDITION

When the first edition of "Alternating-Current Phenomena" appeared nearly twenty years ago, it was a small volume of 424 pages. From this, it grew to a volume of 746 pages in the fourth edition, which appeared eight years ago. Since that time, the advance of electrical engineering has been more rapid than ever before, and any attempt to treat adequately in one volume all the new material developed in the last eight years, and the material which during this time has become of such importance as to require more extensive consideration, thus became out of the question. It was found necessary, therefore, to divide the work into three volumes. In the following, under the old title "Theory and Calculation of Alternating-Current Phenomena," is included only the discussion of the most common and general phenomena and apparatus, old and new, revised and expanded so as to bring it up to our present knowledge. All the material, some partly old, but mostly new, which could not find place in the present volume, has been presented in two supplementary volumes, under the titles "Theory and Calculation of Electric Circuits," and "Theory and Calculation of Electrical Apparatus."

In the study of electrical engineering theory, it is recommended to read first Part I of "Theoretical Elements of Electrical Engineering," and then the first three sections of "Alternating Current Phenomena," but to parallel the reading with that of the chapters of "Engineering Mathematics," which deal with the mathematics involved. Then Sections IV to VII of "Alternating-Current Phenomena" should be studied simultaneously with the corresponding discussion of the apparatus in the Part II of "Theoretical Elements." Following this should be taken up the study of "Theory and Calculation of Electric Circuits," "Theory and Calculation of Electrical Apparatus," and the first three sections of "Transient Phenomena," and, finally, the study of "Electric Discharges, Waves and Impulses" and of the fourth section of "Transient Phenomena."

In the present edition of "Alternating-Current Phenomena," the crank diagram of vector representation, and the symbolic method based on it, which denotes the inductive reactance by

$Z = r + jx$, have been adopted in conformity with the decision of the International Electrical Congress of Turin, but the time diagram or polar coördinate system has been explained and discussed in Chapter VII, since the crank diagram is somewhat inferior to the polar diagram, as it is limited to sine waves, and the time diagram will thus remain in use when dealing with general waves and their graphic reduction.

SCHENECTADY, N. Y.,
May, 1916.

CHARLES P. STEINMETZ.

PREFACE TO FIRST EDITION

THE following volume is intended as an exposition of the methods which I have found useful in the theoretical investigation and calculation of the manifold phenomena taking place in alternating-current circuits, and of their application to alternating-current apparatus.

While the book is not intended as first instruction for a beginner, but presupposes some knowledge of electrical engineering, I have endeavored to make it as elementary as possible, and have therefore used only common algebra and trigonometry, practically excluding calculus, except in §§**144** to **151** and Appendix II; and even §§**144** to **151** have been paralleled by the elementary approximation of the same phenomenon in §§**140** to **143**.

All the methods used in the book have been introduced and explicitly discussed, with examples of their application, the first part of the book being devoted to this. In the investigation of alternating-current phenomena and apparatus, one method only has usually been employed, though the other available methods are sufficiently explained to show their application.

A considerable part of the book is necessarily devoted to the application of complex imaginary quantities, as the method which I found most useful in dealing with alternating-current phenomena; and in this regard the book may be considered as an expansion and extension of my paper on the application of complex imaginary quantities to electrical engineering, read before the International Electrical Congress at Chicago, 1893. The complex imaginary quantity is gradually introduced, with full explanations, the algebraic operations with complex quantities being discussed in Appendix I, so as not to require from the reader any previous knowledge of the algebra of the complex imaginary plane.

While those phenomena which are characteristic of polyphase systems, as the resultant action of the phases, the effects of unbalancing, the transformation of polyphase systems, etc., have been discussed separately in the last chapters, many of the investigations in the previous parts of the book apply to polyphase systems as well as single-phase circuits, as the chapters on induction motors, generators, synchronous motors, etc.

A part of the book is original investigation, either published here for the first time, or collected from previous publications and more fully explained. Other parts have been published before by other investigators, either in the same, or more frequently in a different form.

I have, however, omitted altogether literary references, for the reason that incomplete references would be worse than none, while complete references would entail the expenditure of much more time than is at my disposal, without offering sufficient compensation; since I believe that the reader who wants information on some phenomenon or apparatus is more interested in the information than in knowing who first investigated the phenomenon.

Special attention has been given to supply a complete and extensive index for easy reference, and to render the book as free from errors as possible. Nevertheless, it probably contains some errors, typographical and otherwise; and I will be obliged to any reader who on discovering an error or an apparent error will notify me.

I take pleasure here in expressing my thanks to Messrs. W. D. WEAVER, A. E. KENNELLY, and TOWNSEND WOLCOTT, for the interest they have taken in the book while in the course of publication, as well as for the valuable assistance given by them in correcting and standardizing the notation to conform to the international system, and numerous valuable suggestions regarding desirable improvements.

Thanks are due to the publishers, who have spared no effort or expense to make the book as creditable as possible mechanically.

CHARLES PROTEUS STEINMETZ.

January, 1897.

CONTENTS

SECTION I

METHODS AND CONSTANTS

CHAPTER I. INTRODUCTION.

	PAGE
1. Fundamental laws of continuous-current circuits.	1
2. Impedance, reactance, effective resistance.	2
3. Electromagnetism as source of reactance.	2
4. Capacity as source of reactance.	4
5. Joule's law and power equation of alternating circuit.	5
6. Fundamental wave and higher harmonics, alternating waves with and without even harmonics.	5
7. Alternating waves as sine waves.	8
8. Experimental determination and calculation of reactances.	8

CHAPTER II. INSTANTANEOUS VALUES AND INTEGRAL VALUES.

9. Integral values of wave.	11
10. Ratio of mean to maximum to effective value of wave.	13
11. General alternating-current wave.	14
12. Measurement of values.	15

CHAPTER III. LAW OF ELECTROMAGNETIC INDUCTION.

13. Induced e.m.f. mean value.	16
14. Induced e.m.f. effective value.	17
15. Inductance and reactance.	17

CHAPTER IV. VECTOR REPRESENTATION.

16. Crank diagram of sine wave.	19
17. Representation of lag and lead.	20
18. Parallelogram of sine waves, Kirchhoff's laws, and energy equation.	21
19. Non-inductive circuit fed over inductive line, example.	22
20. Counter e.m.f. and component of impressed e.m.f.	23
21. Example, continued.	24
22. Inductive circuit and circuit with leading current fed over in- ductive line. Alternating-current generator.	25
23. Vector diagram of alternating-current transformer, example.	26
24. Continued.	28

CHAPTER V. SYMBOLIC METHOD.

25. Disadvantage of graphic method for numerical calculation.	30
26. Trigonometric calculation.	31

	PAGE
27. Rectangular components of vectors.	31
28. Introduction of j as distinguishing index.	32
29. Rotation of vector by 180° and 90° . $j = \sqrt{-1}$.	32
30. Combination of sine waves in symbolic expression.	33
31. Resistance, reactance, impedance, in symbolic expression.	34
32. Capacity reactance in symbolic representation.	35
33. Kirchhoff's laws in symbolic representation.	36
34. Circuit supplied over inductive line, example.	37
35. Products and ratios of complex quantities.	37
CHAPTER VI. TOPOGRAPHIC METHOD.	
36. Ambiguity of vectors.	39
37. Instance of a three-phase system.	39
38. Three-phase generator on balanced load.	41
39. Cable with distributed capacity and resistance.	42
40. Transmission line with inductance, capacity, resistance, and leakage.	43
41. Line characteristic at 90° lag.	45
CHAPTER VII. POLAR COORDINATES AND POLAR DIAGRAM.	
42. Polar Coordinates	46
43. Sine wave, vector representation or time diagram.	46
44. Parallelogram of sine waves, Kirchhoff's Laws and power equation.	48
45. Comparison of time diagram and crank diagram.	49
46. Comparison of corresponding symbolic methods.	51
47. Disadvantage of crank diagram. General wave and its equivalent sine wave in time diagram.	52
SECTION II	
CIRCUITS	
CHAPTER VIII. ADMITTANCE, CONDUCTANCE, SUSCEPTANCE.	
48. Combination of resistances and conductances in series and in parallel.	54
49. Combination of impedances. Admittance, conductance, susceptance.	55
50. Relation between impedance, resistance, reactance, and admittance, conductance, susceptance.	56
51. Dependence of admittance, conductance, susceptance, upon resistance and reactance. Combination of impedances and admittances.	57
52. Measurements of admittance and impedance.	59

CHAPTER IX. CIRCUITS CONTAINING RESISTANCE, INDUCTANCE, AND CAPACITY.

	PAGE
53. Introduction.	60
54. Resistance in series with circuit.	60
55. Reactance in series with circuit.	63
56. Discussion of examples.	65
57. Reactance in series with circuit.	67
58. Impedance in series with circuit.	69
59. Continued.	70
60. Example.	70
61. Compensation for lagging currents by shunted condensance.	72
62. Complete balance by variation of shunted condensance.	73
63. Partial balance by constant shunted condensance.	75
64. Constant potential—constant-current transformation.	76

CHAPTER X. RESISTANCE AND REACTANCE OF TRANSMISSION LINES.

65. Introduction.	78
66. Non-inductive receiver circuit supplied over inductive line.	79
67. Example.	81
68. Maximum power supplied over inductive line.	82
69. Dependence of output upon the susceptance of the receiver circuit.	82
70. Dependence of output upon the conductance of the receiver circuit.	84
71. Summary.	85
72. Example.	86
73. Condition of maximum efficiency.	88
74. Control of receiver voltage by shunted susceptance.	89
75. Compensation for line drop by shunted susceptance.	90
76. Maximum output and discussion.	91
77. Example.	92
78. Maximum rise of potential in receiver circuit.	94
79. Summary and examples.	96

CHAPTER XI. PHASE CONTROL.

80. Effect of the current phase in series reactance, on the voltage.	97
81. Production of reactive currents by variation of field of synchronous machines.	98
82. Fundamental equations of phase control.	99
83. Phase control for unity power-factor supply.	100
84. Phase control for constant receiver-voltage.	102
85. Relations between supply voltage, no-load current, full-load current and maximum output current.	104
86. Phase control by series field of converter.	105
87. Multiple-phase control for constant voltage.	107
88. Adjustment of converter field for phase control.	109

SECTION III

POWER AND EFFECTIVE CONSTANTS

CHAPTER XII. EFFECTIVE RESISTANCE AND REACTANCE.

	PAGE
89. Effective resistance, reactance, conductance, and susceptance.	111
90. Sources of energy losses in alternating-current circuits.	112
91. Magnetic hysteresis.	113
92. Hysteretic cycles and corresponding current waves.	114
93. Wave-shape distortion not due to hysteresis.	117
94. Action of air-gap and of induced current on hysteretic distortion.	119
95. Equivalent sine wave and wattless higher harmonics.	120
96. True and apparent magnetic characteristic.	121
97. Angle of hysteretic advance of phase.	122
98. Loss of energy by molecular magnetic friction.	123
99. Effective conductance, due to magnetic hysteresis.	126
100. Absolute admittance of iron-clad circuits and angle of hysteretic advance.	129
101. Magnetic circuit containing air-gap.	131
102. Electric constants of circuit containing iron.	132
103. Conclusion.	133
104. Effective conductance of eddy currents.	135

CHAPTER XIII. FOUCAULT OR EDDY CURRENTS.

105. Advance angle of eddy currents.	136
106. Loss of power by eddy currents, and coefficient of eddy currents.	137
107. Laminated iron.	138
108. Iron wire.	140
109. Comparison of sheet iron and iron wire.	141
110. Demagnetizing or screening effect of eddy currents.	142
111. Continued.	143
112. Large eddy currents.	144
113. Eddy currents in conductor and unequal current distribution.	144
114. Continued.	145
115. Mutual inductance.	147

CHAPTER XIV. DIELECTRIC LOSSES.

116. Dielectric hysteresis.	150
117. Leakage. Dynamic current and displacement current. Power factor.	151
118. Effect of frequency. Heterogeneous dielectric.	153
119. Power factor and stress in compound dielectric.	154
120. Variation of power factor with frequency.	156
121. Dielectric circuit and dynamic circuit. Admittance and impedance. Admittivity.	158
122. Study of dielectric field.	160
123. Corona. Dielectric strength and gradient.	161

CONTENTS

xv

	PAGE
124. Corona and disruption. Numerical instance.	161
125. Energy distance, disruptive gradient and visual corona gradient.	164
126. Law of corona on parallel conductors.	165
CHAPTER XV. DISTRIBUTED CAPACITY, INDUCTANCE, RESISTANCE, AND LEAKAGE.	
127. Energy components and wattless components.	168
128. Distributed capacity.	168
129. Magnitude of charging current of transmission lines.	170
130. Line capacity represented by one condenser shunted across middle of line.	171
131. Distributed capacity, inductance, conductance and resistance.	172
132. Constants of transmission line.	174
133. Oscillating functions of distance. Approximate calculation.	175
134. Equations of transmission line.	177
CHAPTER XVI. POWER, AND DOUBLE-FREQUENCY QUANTITIES IN GENERAL.	
135. Double frequency of power.	179
136. Symbolic representation of power.	180
137. Extra-algebraic features thereof.	182
138. Polar coordinates.	183
139. Combination of powers.	184
140. Torque as double-frequency product.	185
SECTION IV	
INDUCTION APPARATUS	
CHAPTER XVII. THE ALTERNATING-CURRENT TRANSFORMER.	
141. General.	187
142. Mutual inductance and self-inductance of transformer.	187
143. Magnetic circuit of transformer.	188
144. Continued.	189
145. Polar diagram of transformer.	190
146. Example.	192
147. Diagram for varying load.	196
148. Example.	197
149. Symbolic method, equations.	197
150. Continued.	199
151. Apparent impedance of transformer. Transformer equivalent to divided circuit.	201
152. Continued.	202
153. Experimental determination of transformer constants.	205
154. Calculation of transformer constants.	207

CHAPTER XVIII. POLYPHASE INDUCTION MOTOR.

	PAGE
155. Slip and secondary frequency.	208
156. Equations of induction motor.	209
157. Magnetic flux, admittance, and impedance.	210
158. E.m.f.	212
159. Graphic representation.	214
160. Continued.	215
161. Torque and power.	216
162. Power of induction motors.	217
163. Maximum torque.	219
164. Continued.	221
165. Maximum power.	222
166. Starting torque.	223
167. Equations of torque.	227
168. Synchronism.	229
169. Near synchronism.	229
170. Numerical example of induction motor.	230
171. Calculation of induction-motor curves.	232
172. Numerical example.	235

CHAPTER XIX. INDUCTION GENERATOR.

173. Induction generator.	237
174. Power-factor of induction generator.	237
175. Constant speed induction generator.	239
176. Induction generator and synchronous motor.	242

CHAPTER XX. SINGLE-PHASE INDUCTION MOTOR.

177. Single-phase induction motor.	245
178. Starting devices of single-phase motor.	246
179. Polyphase motor on single-phase circuit.	247
180. Condenser in tertiary circuit.	249
181. Speed curves with condenser.	250
182. Monoeyelic starting device.	253
183. Resistance-reactance starter.	256
184. Discussion.	257

SECTION V

SYNCHRONOUS MACHINES

CHAPTER XXI. ALTERNATE-CURRENT GENERATOR.

185. Magnetic reaction of lag and lead.	259
186. Self-inductance and synchronous reactance.	261
187. Equations of alternator.	263
188. Numerical instance, field characteristic.	264
189. Dependence of terminal voltage on phase relation.	266
190. Constant potential regulation.	267
191. Constant current regulation, maximum output.	270

	PAGE
CHAPTER XXII. ARMATURE REACTIONS OF ALTERNATORS.	
192. Similarity and difference between armature reaction and self-induction.	272
193. Graphic representation of armature reaction and self-induction.	273
194. Symbolic representation.	274
195. Discussion: synchronous reactance and normal induced e.m.f.	276
196. Variability, and quadrature components in space, of armature reaction and self-induction.	278
197. Graphic representation of variable armature reaction and self-induction.	279
198. Symbolic representation.	281
199. Continued.	284
200. Regulation curve of alternator.	287
201. Example.	288
202. Discussion.	290
CHAPTER XXIII. SYNCHRONIZING ALTERNATORS.	
203. Introduction.	292
204. Rigid mechanical connection.	292
205. Uniformity of speed.	292
206. Synchronizing.	293
207. Running in synchronism.	293
208. Series operation of alternators.	294
209. Equations of synchronous-running alternators, synchronizing power.	294
210. Special case of equal alternators at equal excitation.	297
211. Numerical example.	300
CHAPTER XXIV. SYNCHRONOUS MOTOR.	
212. Graphic method.	301
213. Continued.	302
214. Example.	303
215. Constant impressed e.m.f. and constant current.	306
216. Constant impressed and counter e.m.f.	307
217. Constant impressed e.m.f. and maximum efficiency.	310
218. Constant impressed e.m.f. and constant output.	311
219. Analytical method. Fundamental equations and power characteristic.	315
220. Maximum output.	318
221. No load.	319
222. Minimum current.	321
223. Maximum displacement of phase.	323
224. Constant counter e.m.f.	323
225. Numerical example.	324
226. Discussion of results.	326
227. Phase characteristics of synchronous motor.	328

	PAGE
228. Example.	331
229. Load curves of synchronous motor.	334
230. Variable armature reaction and self-induction.	338
231. Synchronous condenser.	339

SECTION VI

GENERAL WAVES

CHAPTER XXV. DISTORTION OF WAVE-SHAPE, AND ITS CAUSES.

232. Equivalent sine wave.	341
233. Cause of distortion.	341
234. Lack of uniformity and pulsation of magnetic field.	342
235. Continued.	345
236. Pulsation of reactance.	348
237. Pulsation of reactance in reaction machine.	348
238. General discussion.	350
239. Pulsation of resistance, arc.	350
240. Example.	351
241. Distortion of wave-shape by arc.	353
242. Discussion.	353
243. Calculation of example.	354
244. Separation of overtones from distorted wave.	357
245. Resolution of exciting-current wave of transformer.	360
246. Distortion of e.m.f. wave with sine wave of current, in iron-clad circuit.	361
247. Existence and absence of third harmonic in three-phase system.	363
248. Suppression of third harmonics in transformers on three-phase system.	364
249. Wave-shape distortion in Y-connected transformers.	365
250. Disappearance of distortion by delta connection, etc.	367

CHAPTER XXVI. EFFECTS OF HIGHER HARMONICS.

251. Distortion of wave-shape by triple and quintuple harmonics. Some characteristic wave-shapes.	369
252. Effect of self-induction and capacity on higher harmonics.	372
253. Resonance due to higher harmonics in transmission lines.	373
254. Power of complex harmonic waves.	375
255. Three-phase generator.	375
256. Decrease of hysteresis by distortion of wave-shape.	377
257. Increase of hysteresis by distortion of wave-shape.	377
258. Eddy currents and effect of distorted waves on insulation.	377

CHAPTER XXVII. SYMBOLIC REPRESENTATION OF GENERAL ALTERNATING WAVE.

259. Symbolic representation.	379
260. Effective values.	381

	PAGE
261. Power, torque, etc. Circuit-factor.	381
262. Resistance, inductance, and capacity in series.	384
263. Apparent capacity of condenser.	386
264. Synchronous motor.	389
265. Induction motor.	392

SECTION VII

POLYPHASE SYSTEMS

CHAPTER XXVIII. GENERAL POLYPHASE SYSTEMS.

266. Definition of systems, symmetrical and unsymmetrical systems.	396
267. Flow of energy. Balanced and unbalanced systems. Independent and interlinked systems. Star connection and ring connection.	396
268. Classification of polyphase systems.	398

CHAPTER XXIX. SYMMETRICAL POLYPHASE SYSTEMS.

269. General equations of symmetrical systems.	399
270. Particular systems.	400
271. Resultant m.m.f. of symmetrical system.	401
272. Particular systems.	403

CHAPTER XXX. BALANCED AND UNBALANCED POLYPHASE SYSTEMS.

273. Flow of energy in single-phase system.	405
274. Flow of energy in polyphase systems, balance factor of system.	406
275. Balance factor.	406
276. Three-phase system, quarter-phase system.	407
277. Inverted three-phase system.	408
278. Diagrams of flow of energy.	408
279. Monocyclic and polycyclic systems.	409
280. Power characteristic of alternating-current system.	409
281. The same in rectangular coordinates.	409
282. Main power axes of alternating-current system.	414

CHAPTER XXXI. INTERLINKED POLYPHASE SYSTEMS.

283. Interlinked and independent systems.	415
284. Star connection and ring connection. Y-connection and delta connection.	415
285. Continued.	417
286. Star potential and ring potential. Star current and ring current. Y-potential and Y-current, delta potential and delta current.	417
287. Equations of interlinked polyphase systems.	417
288. Continued.	419

CHAPTER XXXII. TRANSFORMATION OF POLYPHASE SYSTEMS.		PAGE
289.	Constancy of balance factor.	422
290.	Equations of transformation of polyphase systems.	422
291.	Three-phase quarter-phase transformation.	423
292.	Some of the more common polyphase transformations.	425
293.	Transformation with change of balance factor.	430
CHAPTER XXXIII. COPPER EFFICIENCY OF SYSTEMS.		
294.	General discussion.	431
295.	Comparison on the basis of equality of minimum difference of potential.	433
296.	Comparison on the basis of equality of maximum difference of potential between conductors.	437
297.	Continued.	439
298.	Comparison on the basis of equality of maximum difference of potential between conductors and ground.	440
CHAPTER XXXIV. METERING OF POLYPHASE CIRCUIT.		
299.	General equations.	442
300.	Continued.	443
301.	Three-phase metering.	445
302.	Discussion.	446
CHAPTER XXXV. BALANCED SYMMETRICAL POLYPHASE SYSTEMS.		
303.	Resolution of polyphase system into constituent single-phase systems.	448
304.	Instance of calculation of transmission line.	449
305.	Resultant effects of all phases.	452
306.	Three-phase and single-phase admittance.	454
307.	Three-phase and single-phase impedance.	456
CHAPTER XXXVI. THREE-PHASE SYSTEMS.		
308.	General equations.	457
309.	Special cases: balanced system, one branch loaded, two branches loaded.	460
CHAPTER XXXVII. QUARTER-PHASE SYSTEM.		
310.	General equations.	462
311.	Special cases: balanced system, one branch loaded.	463
APPENDIX. ALGEBRA OF COMPLEX IMAGINARY QUANTITIES		
312.	Introduction.	466
313.	Numeration, addition, multiplication, involution.	466

CONTENTS

xxi

	PAGE
314. Subtraction, negative number.	467
315. Division, fraction.	468
316. Evolution and logarithmation.	468
317. Imaginary unit, complex imaginary number.	468
318. Review.	469
319. Algebraic operations with complex quantities.	470
320. Continued.	471
321. Roots of the unit.	472
322. Rotation.	472
323. Complex imaginary plane.	472

INDEX.	475
--------	-----

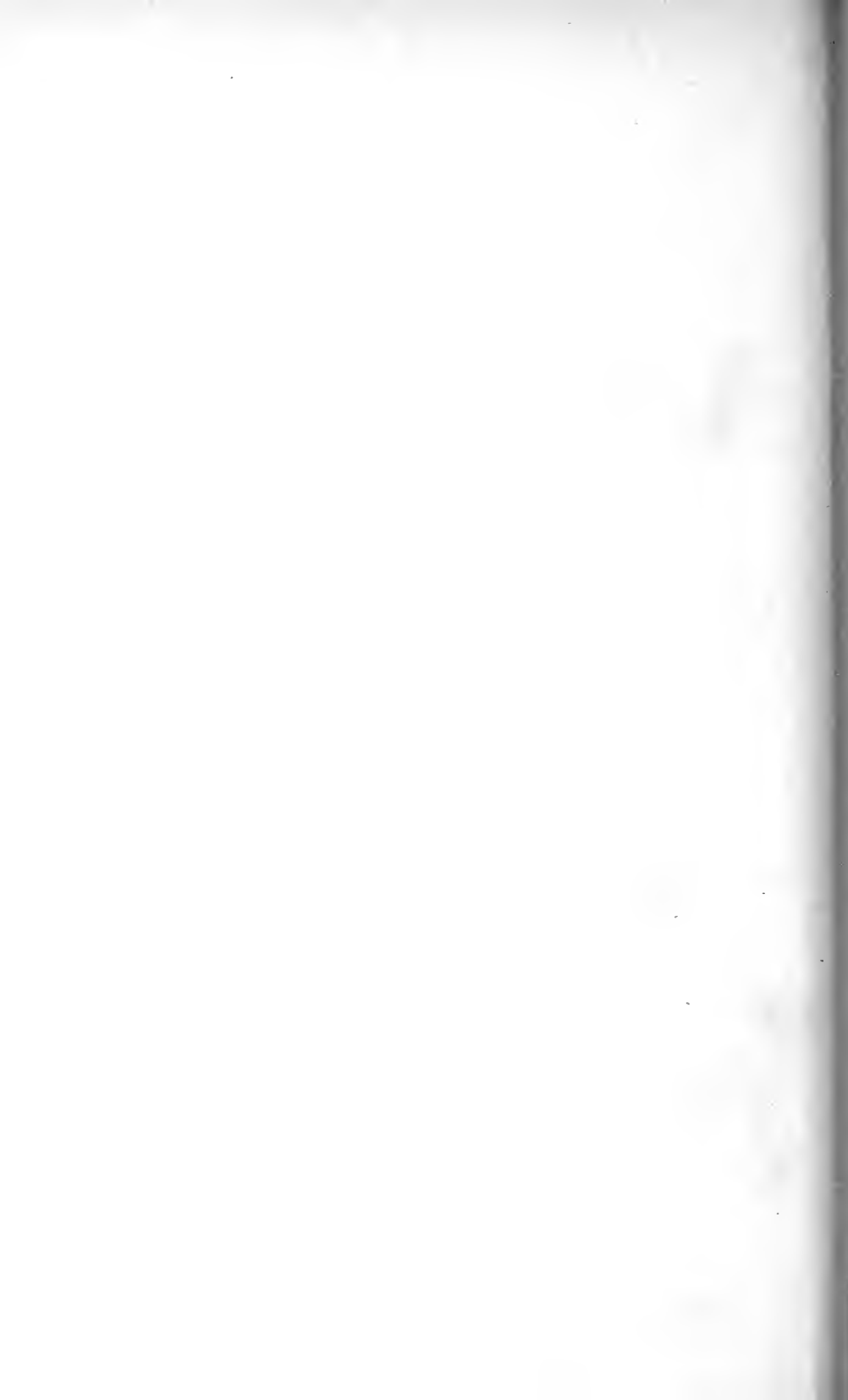

SECTION I

METHODS AND CONSTANTS

CHAPTER I

INTRODUCTION

1. In the practical applications of electrical energy, we meet with two different classes of phenomena, due respectively to the continuous current and to the alternating current.

The continuous-current phenomena have been brought within the realm of exact analytical calculation by a few fundamental laws:

1. Ohm's law: $i = \frac{e}{r}$, where r , the resistance, is a constant of the circuit.

2. Joule's law: $P = i^2r$, where P is the power, or the rate at which energy is expended by the current, i , in the resistance, r .

3. The power equation: $P_0 = ei$, where P_0 is the power expended in the circuit of e.m.f., e , and current, i .

4. Kirchhoff's laws:

(a) The sum of all the e.m.fs. in a closed circuit = 0, if the e.m.f. consumed by the resistance, ir , is also considered as a counter e.m.f., and all the e.m.fs. are taken in their proper direction.

(b) The sum of all the currents directed toward a distributing point = 0.

In alternating-current circuits, that is, in circuits in which the currents rapidly and periodically change their direction, these laws cease to hold. Energy is expended, not only in the conductor through its ohmic resistance, but also outside of it; energy is stored up and returned, so that large currents may exist simultaneously with high e.m.fs., without representing any considerable amount of expended energy, but merely a surging to and fro of energy; the ohmic resistance ceases to be the deter-

mining factor of current value; currents may divide into components, each of which is larger than the undivided current, etc.

2. In place of the above-mentioned fundamental laws of continuous currents, we find in alternating-current circuits the following:

Ohm's law assumes the form $i = \frac{e}{z}$, where z , the apparent resistance, or *impedance*, is no longer a constant of the circuit, but depends upon the frequency of the currents; and in circuits containing iron, etc., also upon the e.m.f.

Impedance, z , is, in the system of absolute units, of the same dimension as resistance (that is, of the dimension lt^{-1} = velocity), and is expressed in ohms.

It consists of two components, the resistance, r , and the reactance, x , or

$$z = \sqrt{r^2 + x^2}.$$

The resistance, r , in circuits where energy is expended only in heating the conductor, is the same as the ohmic resistance of continuous-current circuits. In circuits, however, where energy is also expended outside of the conductor by magnetic hysteresis, mutual inductance, dielectric hysteresis, etc., r is larger than the true ohmic resistance of the conductor, since it refers to the total expenditure of energy. It may be called then the *effective resistance*. It may no longer be a constant of the circuit.

The reactance, x , does not represent the expenditure of energy as does the effective resistance, r ; but merely the surging to and fro of energy. It is not a constant of the circuit, but depends upon the frequency, and frequently, as in circuits containing iron, or in electrolytic conductors, upon the e.m.f. also. Hence while the effective resistance, r , refers to the power or active component of e.m.f., or the e.m.f. in phase with the current, the reactance, x , refers to the wattless or reactive component of e.m.f., or the e.m.f. in quadrature with the current.

3. The principal sources of reactance are electromagnetism and capacity.

Electromagnetism

An electric current, i , in a circuit produces a magnetic flux surrounding the conductor in lines of magnetic force (or more correctly, lines of magnetic induction), of closed, circular, or other form, which alternate with the alternations of the current,

and thereby generate an e.m.f. in the conductor. Since the magnetic flux is in phase with the current, and the generated e.m.f. 90° , or a quarter period, behind the flux, this *e.m.f. of self-induction* lags 90° , or a quarter period, behind the current; that is, is in quadrature therewith, and therefore wattless.

If now Φ = the magnetic flux produced by, and interlinked with, the current, i (where those lines of magnetic force which are interlinked n -fold, or pass around n turns of the conductor, are counted n times), the ratio, $\frac{\Phi}{i}$, is denoted by L , and called the *inductance* of the circuit. It is numerically equal, in absolute units, to the interlinkages of the circuit with the magnetic flux produced by unit current, and is, in the system of absolute units, of the dimension of length. Instead of the inductance, L , sometimes its ratio with the ohmic resistance, r , is used, and is called the *time-constant* of the circuit,

$$T = \frac{L}{r}.$$

If a conductor surrounds with n turns a magnetic circuit of reluctance, \mathcal{R} , the current, i , in the conductor represents the m.m.f. of ni ampere-turns, and hence produces a magnetic flux of $\frac{ni}{\mathcal{R}}$ lines of magnetic force, surrounding each n turns of the conductor, and thereby giving $\Phi = \frac{n^2i}{\mathcal{R}}$ interlinkages between the magnetic and electric circuits. Hence the inductance is

$$L = \frac{\Phi}{i} = \frac{n^2}{\mathcal{R}}.$$

The fundamental law of electromagnetic induction is, that the e.m.f. generated in a conductor by a magnetic field is proportional to the rate of cutting of the conductor through the magnetic field.

Hence, if i is the current and L is the inductance of a circuit, the magnetic flux interlinked with a circuit of current, i , is Li , and $4fLi$ is consequently the average rate of cutting; that is, the number of lines of force cut by the conductor per second, where f = frequency, or number of complete periods (double reversals) of the current per second, i = maximum value of current.

Since the maximum rate of cutting bears to the average rate the same ratio as the quadrant to the radius of a circle (a sinu-

soidal variation supposed), that is, the ratio $\frac{\pi}{2} \div 1$, the maximum rate of cutting is $2\pi f$, and, consequently, the maximum value of e.m.f. generated in a circuit of maximum current value, i , and inductance, L , is

$$e = 2\pi fLi.$$

Since the maximum values of sine waves are proportional (by factor $\sqrt{2}$) to the effective values (square root of mean squares), if i = effective value of alternating current, $e = 2\pi fLi$ is the effective value of e.m.f. of self-induction, and the ratio, $\frac{e}{i} = 2\pi fL$, is the *inductive reactance*,

$$x_m = 2\pi fL.$$

Thus, if r = resistance, x_m = reactance, z = impedance,

the e.m.f. consumed by resistance is $e_1 = ir$;

the e.m.f. consumed by reactance is $e_2 = ix_m$;

and, since both e.m.f.s. are in quadrature to each other, the total e.m.f. is

$$e = \sqrt{e_1^2 + e_2^2} = i\sqrt{r^2 + x_m^2} = iz;$$

that is, the impedance, z , takes in alternating-current circuits the place of the resistance, r , in continuous-current circuits.

Capacity

4. If upon a condenser of capacity C an e.m.f., e , is impressed, the condenser receives the electrostatic charge, Ce .

If the e.m.f., e , alternates with the frequency, f , the average rate of charge and discharge is $4f$, and $2\pi f$ the maximum rate of charge and discharge, sinusoidal waves supposed; hence, $i = 2\pi fCe$, the current to the condenser, which is in quadrature to the e.m.f. and leading.

It is then

$$x_c = \frac{e}{i} = \frac{1}{2\pi fC},$$

the "*condensive reactance*."

Polarization in electrolytic conductors acts to a certain extent like capacity.

The condensive reactance is inversely proportional to the frequency and represents the leading out-of-phase wave; the inductive reactance is directly proportional to the frequency, and represents the lagging out-of-phase wave. Hence both are

of opposite sign with regard to each other, and the total reactance of the circuit is their difference, $x = x_m - x_c$.

The total resistance of a circuit is equal to the sum of all the resistances connected in series; the total reactance of a circuit is equal to the algebraic sum of all the reactances connected in series; the total impedance of a circuit, however, is not equal to the sum of all the individual impedances, but in general less, and is the resultant of the total resistance and the total reactance. Hence it is not permissible directly to add impedances, as it is with resistances or reactances.

A further discussion of these quantities will be found in the later chapters.

5. In Joule's law, $P = i^2r$, r is not the true ohmic resistance, but the "effective resistance;" that is, the ratio of the power component of e.m.f. to the current. Since in alternating-current circuits, in addition to the energy expended in the ohmic resistance of the conductor, energy is expended, partly outside, partly inside of the conductor, by magnetic hysteresis, mutual induction, dielectric hysteresis, etc., the effective resistance, r , is in general larger than the true resistance of the conductor, sometimes many time larger, as in transformers at open secondary circuit, and is no longer a constant of the circuit. It is more fully discussed in Chapter VIII.

In alternating-current circuits the power equation contains a third term, which, in sine waves, is the cosine of the angle of the difference of phase between e.m.f. and current:

$$P_0 = ci \cos \theta.$$

Consequently, even if e and i are both large, P_0 may be very small, if $\cos \theta$ is small, that is, θ near 90° .

Kirchhoff's laws become meaningless in their original form, since these laws consider the e.m.fs. and currents as directional quantities, counted positive in the one, negative in the opposite direction, while the alternating current has no definite direction of its own.

6. The alternating waves may have widely different shapes; some of the more frequent ones are shown in a later chapter.

The simplest form, however, is the sine wave, shown in Fig. 1, or, at least, a wave very near sine shape, which may be represented analytically by

$$i = I \sin \frac{2\pi}{t_0} (t - t_1) = I \sin 2\pi f(t - t_1),$$

where I is the maximum value of the wave, or its *amplitude*; t_0 is the time of one complete cyclic repetition, or the *period* of the wave, or $f = \frac{1}{t_0}$ is the *frequency* or number of complete periods per second; and t_1 is the time, where the wave is zero, or the *epoch* of the wave, generally called the *phase*.¹

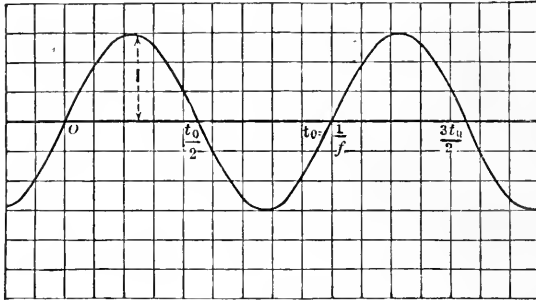

FIG. 1.—Sine wave.

Obviously, “phase” or “epoch” attains a practical meaning only when several waves of different phases are considered, as “difference of phase.” When dealing with one wave only, we may count the time from the moment when the wave is zero, or from the moment of its maximum, representing it respectively by

$$i = I \sin 2 \pi f t,$$

and

$$i = I \cos 2 \pi f t.$$

Since it is a univalent function of time, that is, can at a given instant have one value only, by Fourier’s theorem, any alternating wave, no matter what its shape may be, can be represented by a series of sine functions of different frequencies and different phases, in the form

$$i = I_1 \sin 2 \pi f(t - t_1) + I_2 \sin 4 \pi f(t - t_2) \\ + I_3 \sin 6 \pi f(t - t_3) + \dots$$

where I_1, I_2, I_3, \dots are the maximum values of the different components of the wave, t_1, t_2, t_3, \dots the times, where the respective components pass the zero value.

¹ “Epoch” is the time where a periodic function reaches a certain value, for instance, zero; and “phase” is the angular position, with respect to a datum position, of a periodic function at a given time. Both are in alternate-current phenomena only different ways of expressing the same thing.

The first term, $I_1 \sin 2\pi f(t - t_1)$, is called the *fundamental wave*, or the *first harmonic*; the further terms are called the *higher harmonics*, or "overtones," in analogy to the overtones of sound waves. $I_n \sin 2n\pi f(t - t_n)$ is the n^{th} harmonic.

By resolving the sine functions of the time differences, $t - t_1$, $t - t_2$. . . , we reduce the general expression of the wave to the form:

$$i = A_1 \sin 2\pi ft + A_2 \sin 4\pi ft + A_3 \sin 6\pi ft + \dots \\ + B_1 \cos 2\pi ft + B_2 \cos 4\pi ft + B_3 \cos 6\pi ft + \dots$$

The two half-waves of each period, the *positive wave* and the *negative wave* (counting in a definite direction in the circuit), are usually identical, because, for reasons inherent in their construction, practically all alternating-current machines generate e.m.fs. in which the negative half-wave is identical with the positive. Hence the even higher harmonics, which cause a difference in the shape of the two half-waves, disappear, and only the odd harmonics exist, except in very special cases.

Hence the general alternating-current wave is expressed by:

$$i = I_1 \sin 2\pi f(t - t_1) + I_3 \sin 6\pi f(t - t_3) \\ + I_5 \sin 10\pi f(t - t_5) + \dots$$

or,

$$i = A_1 \sin 2\pi ft + A_3 \sin 6\pi ft + A_5 \sin 10\pi ft + \dots \\ + B_1 \cos 2\pi ft + B_3 \cos 6\pi ft + B_5 \cos 10\pi ft + \dots$$



FIG. 2.—Wave without even harmonics.

Such a wave is shown in Fig. 2, while Fig. 3 shows a wave whose half-waves are different. Figs. 2 and 3 represent the secondary currents of a Ruhmkorff coil, whose secondary coil is closed by a high external resistance; Fig. 3 is the coil operated in the usual way, by make and break of the primary battery

current; Fig. 2 is the coil fed with reversed currents by a commutator from a battery.

7. Inductive reactance, or electromagnetic momentum, which is always present in alternating-current circuits—to a large extent in generators, transformers, etc.—tends to suppress the higher harmonics of a complex harmonic wave more than the

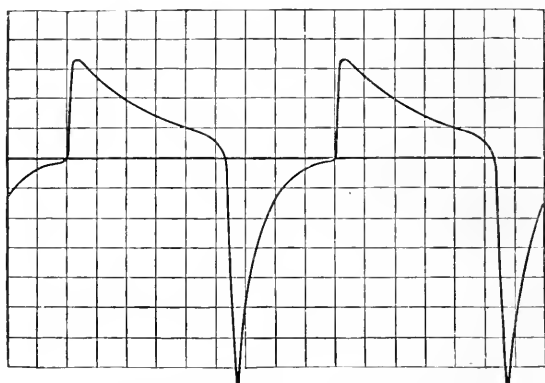

FIG. 3.—Wave with even harmonics.

fundamental harmonic, since the inductive reactance is proportional to the frequency, and is thus greater with the higher harmonics, and thereby causes a general tendency toward simple sine shape, which has the effect that, in general, the alternating currents in our light and power circuits are sufficiently near sine waves to make the assumption of sine shape permissible.

Hence, in the calculation of alternating-current phenomena, we can safely assume the alternating wave as a sine wave, without making any serious error; and it will be sufficient to keep the distortion from sine shape in mind as a possible disturbing factor, which, however, is in practice generally negligible—except in the case of low-resistance circuits containing large inductive reactance and large condensive reactance in series with each other, so as to produce resonance effects of these higher harmonics, and also under certain conditions of long-distance power transmission and high-potential distribution.

8. Experimentally, the impedance, effective resistance, inductance, capacity, etc., of a circuit or a part of a circuit are conveniently determined by impressing a sine wave of alternating e.m.f. upon the circuit and measuring with alternating-current

ammeter, voltmeter and wattmeter the current, i , in the circuit, the potential difference, e , across the circuit, and the power, p , consumed in the circuit.

Then,

$$\text{The impedance, } z = \frac{e}{i};$$

$$\text{The phase angle, } \cos \theta = \frac{p}{ei};$$

$$\text{The effective resistance, } r = \frac{P}{i^2}.$$

From these equations,

$$\text{The reactance, } x = \sqrt{z^2 - r^2}.$$

If the reactance is inductive, the inductance is

$$L = \frac{x}{2\pi f}.$$

If the reactance is condensive, the capacity or its equivalent is

$$C = \frac{1}{2\pi f x}.$$

wherein f = the frequency of the impressed e.m.f. If the reactance is the resultant of inductive and condensive reactances connected in series, it is

$$x = 2\pi fL - \frac{1}{2\pi fC};$$

L and C can be found by measuring the reactance at two different frequencies, f_1 and f_2 , as follows;

$$x_1 = 2\pi f_1L - \frac{1}{2\pi f_1C},$$

$$x_2 = 2\pi f_2L - \frac{1}{2\pi f_2C},$$

then,

$$L = \frac{x_1f_1 - x_2f_2}{2\pi(f_1^2 - f_2^2)},$$

and

$$C = \frac{f_1^2 - f_2^2}{2\pi f_1 f_2 (x_1 f_2 - x_2 f_1)}.$$

A moderate deviation of the wave of alternating impressed e.m.f. from sine shape does not cause any serious error as long as the circuit contains no capacity.

In the presence of capacity, however, even a very slight distortion of wave shape may cause an error of some hundred per cent.

To measure capacity and condensive reactance by ordinary alternating currents it is, therefore, advisable to insert in series with the condensive reactance a non-inductive resistance or inductive reactance which is larger than the condensive reactance, or to use a source of alternating current, in which the higher harmonics are suppressed, as the *T*-connection of Constant Potential—Constant-current Transformation, paragraph 64.

In iron-clad inductive reactances, or reactances containing iron in the magnetic circuit, the reactance varies with the magnetic induction in the iron, and thereby with the current and the impressed e.m.f. Therefore the impressed e.m.f. or the magnetic induction must be given, to which the ohmic reactance refers, or preferably a curve is plotted from test (or calculation), giving the ohmic reactance, or, as usually done, the impressed e.m.f. as function of the current. Such a curve is called an *excitation curve* or *impedance curve*, and has the general character of the magnetic characteristic. The same also applies to electrolytic reactances, etc.

The calculation of an inductive reactance is accomplished by calculating the magnetic circuit, that is, determining the ampere-turns, m.m.f. required to send the magnetic flux through the magnetic reluctance. In the air part of the magnetic circuit, unit permeability (or, referred to ampere-turns as m.m.f., reluctance $\frac{10}{4\pi}$) is used; for the iron part, the ampere-turns are taken from the curve of the magnetic characteristic, as discussed in the following.

CHAPTER II

INSTANTANEOUS VALUES AND INTEGRAL VALUES

9. In a periodically varying function, as an alternating current, we have to distinguish between the *instantaneous value*, which varies constantly as function of the time, and the *integral value*, which characterizes the wave as a whole.

As such integral value, almost exclusively the *effective value* is used, that is, the square root of the mean square; and wherever the intensity of an electric wave is mentioned without further reference, the effective value is understood.

The *maximum value* of the wave is of practical interest only in few cases, and may, besides, be different for the two half-waves, as in Fig. 3.

As *arithmetic mean*, or *average value*, of a wave as in Figs. 4 and 5, the arithmetical average of all the instantaneous values during one complete period is understood.

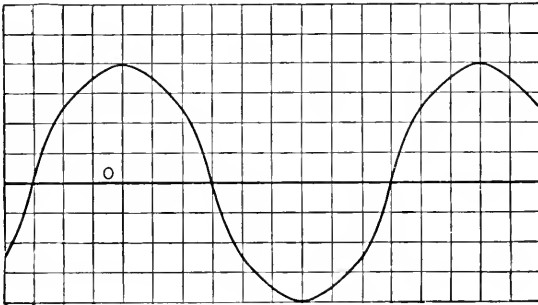

FIG. 4.—Alternating wave.

This arithmetic mean is either $= 0$, as in Fig. 4, or it differs from 0, as in Fig. 5. In the first case, the wave is called an *alternating wave*, in the latter a *pulsating wave*.

Thus, an alternating wave is a wave whose positive values give the same sum total as the negative values; that is, whose two half-waves have in rectangular coördinates the same area, as shown in Fig. 4.

A pulsating wave is a wave in which one of the half-waves preponderates, as in Fig. 5.

By electromagnetic induction, pulsating waves are produced only by commutating and unipolar machines (or by the superposition of alternating upon direct currents, etc.).

All inductive apparatus without commutation give exclusively alternating waves, because, no matter what conditions may exist in the circuit, any line of magnetic force which during a complete period is cut by the circuit, and thereby generates an e.m.f., must during the same period be cut again in the opposite direction, and thereby generate the same total amount of e.m.f. (Obviously, this does not apply to circuits consisting of different

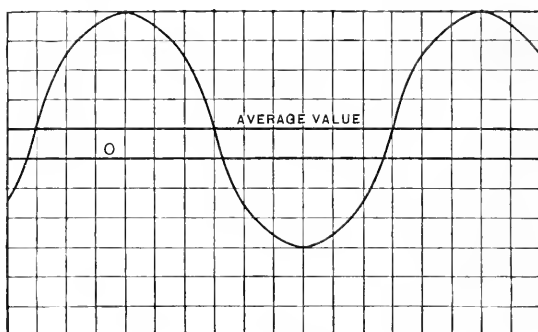

FIG. 5.—Pulsating wave.

parts movable with regard to each other, as in unipolar machines.) A direct-current machine without commutator or collector rings, or a coil-wound unipolar machine, thus is an impossibility.

Pulsating currents, and therefore pulsating potential differences across parts of a circuit can, however, be produced from an alternating induced e.m.f. by the use of asymmetrical circuits, as arcs, some electrochemical cells, as the aluminum-carbon cell, etc. Most of the alternating-current rectifiers are based on the use of such asymmetrical circuits.

In the following we shall almost exclusively consider the alternating wave, that is, the wave whose true arithmetic mean value = 0.

Frequently, by mean value of an alternating wave, the average of one half-wave only is denoted, or rather the average of all instantaneous values without regard to their sign. This *mean value* of one half-wave is of importance mainly in the rectifica-

tion of alternating e.m.fs., since it determines the unidirectional value derived therefrom.

10. In a sine wave, the relation of the mean to the maximum value is found in the following way:

Let, in Fig. 6, AOB represent a quadrant of a circle with radius 1.

Then, while the angle θ traverses the arc $\frac{\pi}{2}$ from A to B , the sine varies from 0 to $OB = 1$. Hence the average variation of the sine bears to that of the corresponding arc the ratio $1 \div \frac{\pi}{2}$, or $\frac{2}{\pi} \div 1$. The maximum variation of the sine takes place about its zero value, where the sine is equal to the arc. Hence the maximum variation of the sine is equal to the variation of the

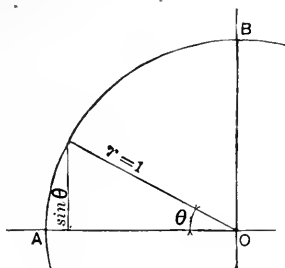

FIG. 6.

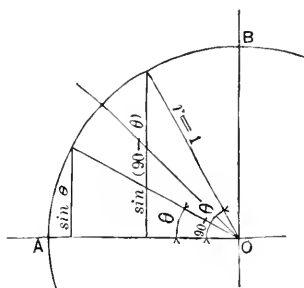

FIG. 7.

corresponding arc, and consequently the maximum variation of the sine bears to its average variation the same ratio as the average variation of the arc to that of the sine, that is, $1 \div \frac{2}{\pi}$, and since the variations of a sine function are sinusoidal also, we have Mean value of sine wave \div maximum value = $\frac{2}{\pi} \div 1 = 0.63663$.

The quantities, "current," "e.m.f.," "magnetism," etc., are in reality mathematical fictions only, as the components of the entities, "energy," "power," etc.; that is, they have no independent existence, but appear only as squares or products.

Consequently, the only integral value of an alternating wave which is of practical importance, as directly connected with the mechanical system of units, is that value which represents the same power or effect as the periodical wave. This is called the *effective*

value. Its square is equal to the mean square of the periodic function, that is:

The effective value of an alternating wave, or the value representing the same effect as the periodically varying wave, is the square root of the mean square.

In a sine wave, its relation to the maximum value is found in the following way:

Let, in Fig. 7, AOB represent a quadrant of a circle with radius 1.

Then, since the sines of any angle, θ , and its complementary angle, $90^\circ - \theta$, fulfill the condition,

$$\sin^2 \theta + \sin^2 (90 - \theta) = 1,$$

the sines in the quadrant, AOB , can be grouped into pairs, so that the sum of the squares of any pair = 1; or, in other words, the mean square of the sine = $\frac{1}{2}$, and the square root of the mean square, or the effective value of the sine, = $\frac{1}{\sqrt{2}}$. That is:

The effective value of a sine function bears to its maximum value the ratio,

$$\frac{1}{\sqrt{2}} \div 1 = 0.70711.$$

Hence, we have for the sine wave the following relations:

Max.	Eff.	Arith. mean	
		Half period	Whole period
1	$\frac{1}{\sqrt{2}}$	$\frac{2}{\pi}$	0
1.0	0.7071	0.63663	0
1.4142	1.0	0.90034	0
1.5708	1.1107	1.0	0

11. Coming now to the general alternating wave,

$$i = A_1 \sin 2\pi ft + A_2 \sin 4\pi ft + A_3 \sin 6\pi ft + \dots$$

$$+ B_1 \cos 2\pi ft + B_2 \cos 4\pi ft + B_3 \cos 6\pi ft + \dots,$$

we find, by squaring this expression and cancelling all the products which give 0 as mean square, the *effective value*

$$I = \sqrt{\frac{1}{2}(A_1^2 + A_2^2 + A_3^2 + \dots + B_1^2 + B_2^2 + B_3^2 \dots)}.$$

The *mean value* does not give a simple expression, and is of no general interest.

12. All alternating-current instruments, as ammeter, voltmeter, etc., measure and indicate the *effective value*. The maximum value and the mean value can be derived from the curve of instantaneous values, as determined by wave-meter or oscillograph.

Measurement of the alternating wave after rectification by a unidirectional conductor, as an arc, gives the *mean* value with direct-current instruments, that is, instruments employing a permanent magnetic field, and the *effective value* with alternating-current instruments.

Voltage determination by spark-gap, that is, by the striking distance, gives a value approaching the *maximum*; especially with spheres as electrodes of a diameter larger than the spark-gap.

CHAPTER III

LAW OF ELECTROMAGNETIC INDUCTION

13. If an electric conductor moves relatively to a magnetic field, an e.m.f. is generated in the conductor which is proportional to the intensity of the magnetic field, to the length of the conductor, and to the speed of its motion perpendicular to the magnetic field and the direction of the conductor; or, in other words, proportional to the number of lines of magnetic force cut per second by the conductor.

As a practical unit of e.m.f., the *volt* is defined by the e.m.f. generated in a conductor, which cuts $10^8 = 100,000,000$ lines of magnetic flux per second.

If the conductor is closed upon itself, the e.m.f. produces a current.

A closed conductor may be called a turn or a convolution. In such a turn, the number of lines of magnetic force cut per second is the increase or decrease of the number of lines inclosed by the turn, or n times as large with n turns.

Hence the e.m.f. in volts generated in n turns, or convolutions, is n times the increase or decrease, per second, of the flux inclosed by the turns, times 10^{-8} .

If the change of the flux inclosed by the turn, or by n turns, does not take place uniformly, the product of the number of turns times change of flux per second gives the average e.m.f.

If the magnetic flux, Φ , alternates relatively to a number of turns, n —that is, when the turns either revolve through the flux or the flux passes in and out of the turns—the total flux is cut four times during each complete period or cycle, twice passing into, and twice out of, the turns.

Hence, if $f =$ number of complete cycles per second, or the frequency of the flux, Φ , the average e.m.f. generated in n turns is

$$E_{avg.} = 4 n \Phi f 10^{-8} \text{ volts.}$$

This is the fundamental equation of electrical engineering, and applies to continuous-current, as well as to alternating-current, apparatus.

14. In continuous-current machines and in many alternators, the turns revolve through a constant magnetic field; in other alternators and in induction motors, the magnetic field revolves; in transformers, the field alternates with respect to the stationary turns; in other apparatus, alternation and rotation occur simultaneously, as in alternating-current commutator motors.

Thus, in the continuous-current machine, if n = number of turns in series from brush to brush, Φ = flux inclosed per turn, and f = frequency, the e.m.f. generated in the machine is $E = 4 n \Phi f 10^{-8}$ volts, independent of the number of poles, of series or multiple connection of the armature, whether of the ring, drum, or other type.

In an alternator or transformer, if n is the number of turns in series, Φ the maximum flux inclosed per turn, and f the frequency, this formula gives

$$E_{avg.} = 4 n \Phi f 10^{-8} \text{ volts.}$$

Since the maximum e.m.f. is given by

$$E_{max.} = \frac{\pi}{2} E_{avg.},$$

we have

$$E_{max.} = 2 \pi n \Phi f 10^{-8} \text{ volts.}$$

And since the effective e.m.f. is given by

$$E_{eff.} = \frac{E_{max.}}{\sqrt{2}}$$

we have

$$\begin{aligned} E_{eff.} &= \sqrt{2} \pi n \Phi f 10^{-8} \\ &= 4.44 n f \Phi 10^{-8} \text{ volts,} \end{aligned}$$

which is the fundamental formula of alternating-current induction by sine waves.

15. If, in a circuit of n turns, the magnetic flux, Φ , inclosed by the circuit is produced by the current in the circuit, the ratio,

$$\frac{\text{flux} \times \text{number of turns} \times 10^{-8}}{\text{current}},$$

is called the inductance, L , of the circuit, in henrys.

The product of the number of turns, n , into the maximum flux, Φ , produced by a current of I amperes effective, or $I\sqrt{2}$ amperes maximum, is therefore

$$n\Phi = LI\sqrt{2} 10^8;$$

and consequently the effective e.m.f. of self-induction is

$$\begin{aligned} E &= \sqrt{2} \pi n \Phi f 10^{-8} \\ &= 2 \pi f L I \text{ volts.} \end{aligned}$$

The product, $x = 2 \pi f L$, is of the dimension of resistance, and is called the *inductive reactance* of the circuit; and the e.m.f. of self-induction of the circuit, or the reactance voltage, is

$$E = Ix,$$

and lags 90° behind the current, since the current is in phase with the magnetic flux produced by the current, and the e.m.f. lags 90° behind the magnetic flux. The e.m.f. lags 90° behind the magnetic flux, as it is proportional to the rate of change in flux; thus it is zero when the magnetism does not change, at its maximum value, and a maximum when the flux changes quickest, which is where it passes through zero.

CHAPTER IV

VECTOR REPRESENTATION

16. While alternating waves can be, and frequently are, represented graphically in rectangular coördinates, with the time as abscissæ, and the instantaneous values of the wave as ordinates, the best insight with regard to the mutual relation of different alternating waves is given by their representation as vectors, in the so-called *crank diagram*. A vector, equal in length to the maximum value of the alternating wave, revolves at uniform speed so as to make a complete revolution per period, and the projections of this revolving vector on the horizontal then denote the instantaneous values of the wave.

Obviously, by this diagram only sine waves can be represented or, in general, waves which are so near sine shape that they can be represented by a sine.

Let, for instance, \overline{OI} represent in length the maximum value I of a sine wave of current. Assuming then a vector, \overline{OI} , to revolve, left handed or in counter-clockwise direction, so that it makes a complete revolution during each cycle or period t_0 . If then at a certain moment of time, this vector stands in position $\overline{OI_1}$ (Fig. 8), the projection, $\overline{OA_1}$, of $\overline{OI_1}$ on the horizontal line \overline{OA} represents the instantaneous value of the current at this moment. At a later moment, \overline{OI} has moved farther, to $\overline{OI_2}$, and the projection, $\overline{OA_2}$, of $\overline{OI_2}$ on \overline{OA} is the instantaneous value at this later moment. The diagram so shows the instantaneous condition of the sine wave: each sine wave reaches its maximum at the moment of time where its revolving vector passes the horizontal, and reaches zero at the moment where its revolving vector passes the vertical.

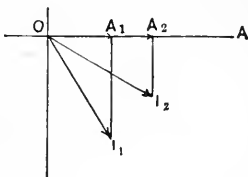

FIG. 8.

If now the time, t , and thus the angle, $\vartheta = IOA = 2\pi \frac{t}{t_0}$ (where $t_0 =$ time of one complete cycle or period), is counted from the moment of time where the revolving vector \overline{OI} in Fig. 8 stands in position $\overline{OI_1}$, then this sine wave would be represented by

$$i = I \cos (\vartheta - \vartheta_1),$$

where $\vartheta_1 = I_1OA$ may be called the *phase* of the wave, and $I = \overline{OI_1}$ the *amplitude* or *intensity*.

At the time, $\vartheta = \vartheta_1$, that is, the angle, ϑ_1 , after the moment of time represented by position $\overline{OI_1}$, $i = I$, and \overline{OI} passes through the horizontal \overline{OA} , that is, has its maximum value. The phase ϑ_1 thus is the angle representing the time, t_1 , at which the wave reaches its maximum value.

If the time, t , and thus the angle, ϑ , are counted from the moment at which the revolving vector reaches position $\overline{OI_2}$, the equation of the wave would be

$$i = I \cos (\vartheta - \vartheta_2),$$

and $\vartheta_2 = I_2OA$ is the phase.

17. When dealing with one wave only, it obviously is immaterial from which moment of time as zero value the time and thus the angle, ϑ , is counted. That is, the phase ϑ_1 or ϑ_2 may be chosen anything desired. As soon, however, as several alternating waves enter the diagram, it is obvious that for all the waves of the same diagram the time must be counted from the same moment, and by choosing the phase angle of one of the waves, that of the others is determined.

Thus, let $I =$ the maximum value of a current, lagging behind the maximum value of voltage E by time t_1 ,

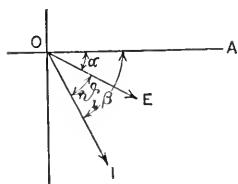

FIG. 9.

that is, angle of phase difference $\vartheta_1 = 2\pi \frac{t_1}{t_0}$. The phase of the voltage, E , then may be chosen as α , and the voltage represented, in Fig. 9, by vector $\overline{OE} = E$ at phase angle $EOA = \alpha$. As the current lags by phase difference ϑ_1 , the phase of the current then must be $\beta = \alpha + \vartheta_1$, and the current is represented, in Fig. 9, by vector $\overline{OI} = I$, under phase angle $\beta = IOA$.

The equations of voltage and current then are:

$$\begin{aligned} e &= E \cos (\vartheta - \alpha) \\ i &= I \cos (\vartheta - \beta) \\ &= I \cos (\vartheta - \alpha - \vartheta_1). \end{aligned}$$

The voltage $\overline{OE} = E$, as the first vector, may be plotted in any desired direction, for instance, under angle $-\alpha' = EOA$ in Fig. 10. The current then would be represented by $\overline{OI} = I$, under

phase angle $-\beta' = -(\alpha' - \vartheta_1) = IOA$, and the equations of voltage and current would be:

$$\begin{aligned} e &= E \cos(\vartheta + \alpha') \\ i &= I \cos(\vartheta + \beta') \\ &= I \cos(\vartheta + \alpha' - \vartheta_1). \end{aligned}$$

Or, the current $\overline{OI} = I$ may be chosen as the first vector, in Fig. 9, under phase angle $\beta = IOA$, and the voltage then would have the phase angle $\alpha = \beta - \vartheta_1$, and be represented by vector $\overline{OE} = E$, and the equations would be:

$$\begin{aligned} i &= I \cos(\vartheta - \beta) \\ e &= E \cos(\vartheta - \alpha) \\ &= E \cos(\vartheta - \beta + \vartheta_1). \end{aligned}$$

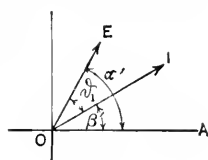

FIG. 10.

In this vector representation, a current *lagging* behind its voltage makes a *greater* angle with the horizontal, \overline{OA} , that is, the current vector, \overline{OI} , lags behind the voltage vector, \overline{OE} , in the direction of rotation, thus passes the zero line, \overline{OA} , of maximum value, at a later time.

Inversely, a leading current passes the zero line \overline{OA} earlier, that is, is ahead in the direction of rotation.

Instead of the maximum value of the rotating vector, the effective value is commonly used, especially where the instantaneous values are not required, but the diagram intended to represent the relations of the different alternating waves to each other. With the length of the rotating vector equal to the effective value of the alternating wave, the maximum value obviously is $\sqrt{2}$ times the length of the vector, and the instantaneous values are $\sqrt{2}$ times the projections of the vectors on the horizontal.

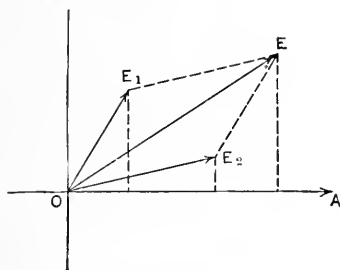

FIG. 11.

18. To combine different sine waves, their graphical representations as vectors, are combined by the parallelogram law.

If, for instance, two sine waves, \overline{OE}_1 , and \overline{OE}_2 (Fig. 11), are superposed—as, for instance, two e.m.f.s. acting in the same circuit—their resultant wave is represented by \overline{OE} , the diagonal of a parallelogram with \overline{OE}_1 and \overline{OE}_2 as sides. As the projection of

the diagonal of a parallelogram equals the sum of the projections of the sides, during the rotation of the parallelogram OE_1EE_2 , the projection of \overline{OE} on the horizontal \overline{OA} , that is, the instantaneous value of the wave represented by vector \overline{OE} , is equal to the sum of the projection of the two sides $\overline{OE_1}$ and $\overline{OE_2}$, that is, the sum of the instantaneous values of the component vectors $\overline{OE_1}$ and $\overline{OE_2}$.

From the foregoing considerations we have the conclusions:

The sine wave is represented graphically in the crank diagram, by a vector, which by its length, \overline{OE} , denotes the intensity, and by its amplitude, AOE , the phase, of the sine wave.

Sine waves are combined or resolved graphically, in vector representation, by the law of the parallelogram or the polygon of sine waves.

Kirchhoff's laws now assume, for alternating sine waves, the form:

(a) The resultant of all the e.m.fs. in a closed circuit, as found by the parallelogram of sine waves, is zero if the counter e.m.fs. of resistance and of reactance are included.

(b) The resultant of all the currents toward a distributing point, as found by the parallelogram of sine waves, is zero.

The power equation expressed graphically is as follows:

The power of an alternating-current circuit is represented in vector representation by the product of the current, I , into the projection of the e.m.f., E , upon the current, or by the e.m.f., E , into the projection of the current, I , upon the e.m.f., or by $IE \cos \theta$, where $\theta =$ angle of phase displacement.

19. Suppose, as an example, that in a line having the resistance, r , and the reactance, $x = 2\pi fL$ —where $f =$ frequency and $L =$ inductance—there exists a current of I amp., the line being connected to a non-inductive circuit operating at a voltage of E volts. What will be the voltage required at the generator end of the line?

In the vector diagram, Fig. 12, let the phase of the current be assumed as the initial or zero line, \overline{OI} . Since the receiving circuit is non-inductive, the current is in phase with its voltage. Hence the voltage, E , at the end of the line, impressed upon the receiving circuit, is represented by a vector, \overline{OE} . To overcome

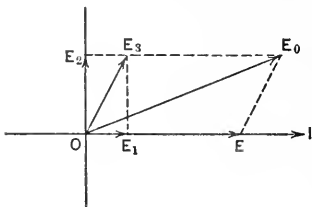

FIG. 12.

the resistance, r , of the line, a voltage, Ir , is required in phase with the current, represented by \overline{OE}_1 in the diagram. The inductive reactance of the line generates an e.m.f. which is proportional to the current, I , and the reactance, x , and lags a quarter of a period, or 90° , behind the current. To overcome this counter e.m.f. of inductive reactance, a voltage of the value Ix is required, in phase 90° ahead of the current, hence represented by vector \overline{OE}_2 . Thus resistance consumes voltage in phase, and reactance voltage 90° ahead of the current. The voltage of the generator, E_0 , has to give the three voltages E , E_1 , E_2 , hence it is determined as their resultant. Combining by the parallelogram law, \overline{OE}_1 and \overline{OE}_2 , give \overline{OE}_3 , the voltage required to overcome the impedance of the line, and similarly \overline{OE}_3 and \overline{OE} give \overline{OE}_0 , the voltage required at the generator side of the line, to yield the voltage, E , at the receiving end of the line. Algebraically, we get from Fig. 12

$$E_0 = \sqrt{(E + Ir)^2 + (Ix)^2}$$

or

$$E = \sqrt{E_0^2 - (Ix)^2} - Ir.$$

In this example we have considered the voltage consumed by the resistance (in phase with the current) and the voltage consumed by the reactance (90° ahead of the current) as parts, or components, of the impressed voltage, E_0 , and have derived E_0 by combining Er , E_x , and E .

20. We may, however, introduce the effect of the inductive reactance directly as an e.m.f., E'_2 , the counter e.m.f. of inductive reactance = Ix , and lagging 90° behind the current; and the e.m.f. consumed by the resistance as a counter e.m.f., $E'_1 = Ir$, in opposition to the current, as is done in Fig. 13; and combine the three voltages E_0 , E'_1 , E'_2 , to form a resultant voltage E , which is left at the end of the line. E'_1 and E'_2 combine to form E'_3 , the counter e.m.f. of impedance; and since E'_3 and E_0 must combine to form E , E_0 is found as the side of a parallelogram, $OE_0EE'_3$, whose other side, \overline{OE}'_3 , and diagonal \overline{OE} , are given.

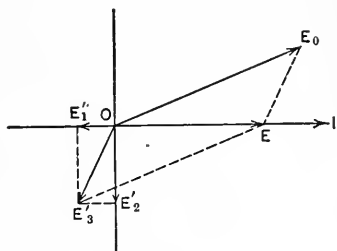

FIG. 13.

Or we may say (Fig. 14), that to overcome the counter e.m.f.

of impedance, $\overline{OE'_3}$, of the line, the component, $\overline{OE_3}$, of the impressed voltage is required which, with the other component, \overline{OE} , must give the impressed voltage, $\overline{OE_0}$.

As shown, we can represent the voltages produced in a circuit in two ways—either as counter e.m.fs., which combine with the impressed voltage, or as parts, or components, of the impressed voltage, in the latter case being of opposite phase. According to the nature of the problem, either the one or the other way may be preferable.

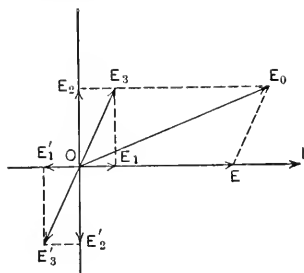

FIG. 14.

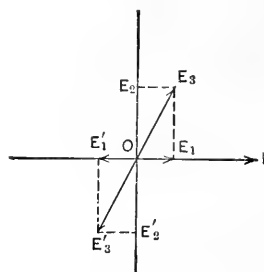

FIG. 15.

As an example, the voltage consumed by the resistance is Ir , and in phase with the current; the counter e.m.f. of resistance is in opposition to the current. The voltage consumed by the reactance is Ix , and 90° ahead of the current, while the counter e.m.f. of reactance is 90° behind the current; so that, if, in Fig. 15, \overline{OI} is the current.

$\overline{OE_1}$ = voltage consumed by resistance,

$\overline{OE'_1}$ = counter e.m.f. of resistance,

$\overline{OE_3}$ = voltage consumed by inductive reactance,

$\overline{OE'_2}$ = counter e.m.f. of inductive reactance,

$\overline{OE_3}$ = voltage consumed by impedance,

$\overline{OE'_3}$ = counter e.m.f. of impedance.

Obviously, these counter e.m.fs. are different from, for instance, the counter e.m.f. of a synchronous motor, in so far as they have no independent existence, but exist only through, and as long as the current exists. In this respect they are analogous to the opposing force of friction in mechanics.

21. Coming back to the equation found for the voltage at the generator end of the line,

$$E_0 = \sqrt{(E + Ir)^2 + (Ix)^2}$$

we find, as the drop of potential in the line,

$$e = E_0 - E = \sqrt{(E + Ir)^2 + (Ix)^2} - E.$$

This is different from, and less than, the e.m.f. of impedance,

$$E_3 = Iz = I\sqrt{r^2 + x^2}.$$

Hence it is wrong to calculate the drop of potential in a circuit by multiplying the current by the impedance; and the drop of potential in the line depends, with a given current fed over the line into a non-inductive circuit, not only upon the constants of the line, r and x , but also upon the voltage, E , at the end of line, as can readily be seen from the diagrams.

22. If the receiver circuit is inductive, that is, if the current, I , lags behind the voltage, E , by an angle, θ , and we choose again as the zero line, the current \overline{OI} (Fig. 16), the voltage, \overline{OE} , is ahead of

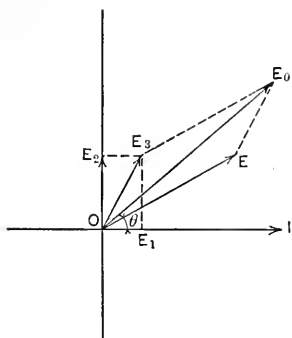

FIG. 16.

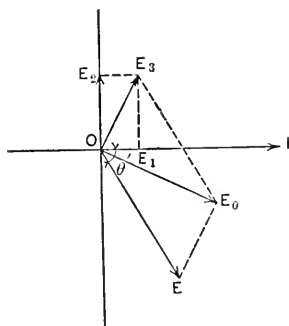

FIG. 17.

the current by the angle, θ . The voltage consumed by the resistance, Ir , is in phase with the current, and represented by $\overline{OE_1}$ the voltage consumed by the reactance, Ix , is 90° ahead of the current, and represented by $\overline{OE_2}$. Combining \overline{OE} , $\overline{OE_1}$, and $\overline{OE_2}$, we get $\overline{OE_0}$, the voltage required at the generator end of the line. Comparing Fig. 16 with Fig. 12, we see that in the former $\overline{OE_0}$ is larger; or conversely, if E_0 is the same, E will be less with an inductive load. In other words, the drop of potential in an inductive line is greater if the receiving circuit is inductive than if it is non-inductive. From Fig. 16,

$$E_0 = \sqrt{(E \cos \theta + Ir)^2 + (E \sin \theta + Ix)^2}.$$

If, however, the current in the receiving circuit is leading, as

is the case when feeding condensers or synchronous motors whose counter e.m.f. is larger than the impressed voltage, then the voltage will be represented, in Fig. 17, by a vector, \overline{OE} , lagging behind the current, \overline{OI} , by the angle of lead, θ' ; and in this case we get, by combining \overline{OE} with \overline{OE}_1 , in phase with the current, and \overline{OE}_2 , 90° ahead of the current, the generator voltage, \overline{OE}_0 , which in this case is not only less than in Fig. 16 and in Fig. 12, but may be even less than E ; that is, the voltage rises in the line. In other words, in a circuit with leading current, the inductive reactance of the line raises the voltage, so that the drop of voltage is less than with a non-inductive load, or may even be negative, and the voltage at the generator lower than at the other end of the line.

These diagrams, Figs. 12 to 17, can be considered vector diagrams of an alternating-current generator of a generated e.m.f., E_0 , a resistance voltage, $E_1 = Ir$, a reactance voltage, $E_2 = Ix$, and a difference of potential, E , at the alternator terminals; and we see, in this case, that with the same generated e.m.f., with an inductive load the potential difference at the alternator terminals will be lower than with a non-inductive load, and that with a non-inductive load it will be lower than when feeding into a circuit with leading current, as for instance, a synchronous motor circuit under the circumstances stated above.

23. As a further example, we may consider the diagram of an alternating-current transformer, feeding through its secondary circuit an inductive load.

For simplicity, we may neglect here the magnetic hysteresis, the effect of which will be fully treated in a separate chapter on this subject.

Let the time be counted from the moment when the magnetic flux is zero and rising. The magnetic flux then passes its maximum at the time $\vartheta = 90^\circ$, and the phase of the magnetic flux thus is $\vartheta = 90^\circ$, the flux thus represented by the vector $\overline{O\Phi}$ in Fig. 18, vertically downward. The e.m.f. generated by this magnetic flux in the secondary circuit, E_1 , lags 90° behind the flux; thus its vector, \overline{OE}_1 , passes the zero line, \overline{OA} 90° , later than the magnetic flux vector, or at the time $\vartheta = 180^\circ$; that is, the e.m.f. generated in the secondary by the magnetic flux, \overline{OE}_1 , has the phase $\vartheta = 180^\circ$. The secondary current, I_1 , lags behind the e.m.f., E_1 , by an angle, θ_1 , which is determined by the resistance and inductive reactance of the secondary circuit; that is, by the

load in the secondary circuit, and is represented in the diagram by the vector, $\overline{OF_1}$, of phase $180 + \theta_1$.

Instead of the secondary current, I_1 , we plot, however, the secondary m.m.f., $F_1 = n_1 I_1$, where n_1 is the number of secondary turns, and F_1 is given in ampere-turns. This makes us independent of the ratio of transformation.

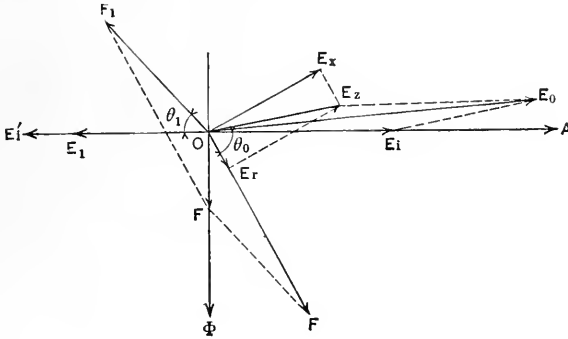

FIG. 18.

From the secondary e.m.f., E_1 , we get the flux, Φ , required to induce this e.m.f., from the equation

$$E_1 = \sqrt{2} \pi n_1 f \Phi 10^{-8};$$

where

E_1 = secondary e.m.f., in effective volts,

f = frequency, in cycles per second,

n_1 = number of secondary turns,

Φ = maximum value of magnetic flux, in lines of magnetic force.

The derivation of this equation has been given in a preceding chapter.

This magnetic flux, Φ , is represented by a vector, $\overline{O\Phi}$, 90° in phase, and to produce it a m.m.f., F , is required, which is determined by the magnetic characteristic of the iron and the section and length of the magnetic circuit of the transformer; this m.m.f. is in phase with the flux, Φ , and is represented by the vector, \overline{OF} , in effective ampere-turns.

The effect of hysteresis, neglected at present, is to shift \overline{OF} ahead of $\overline{O\Phi}$, by an angle, α , the angle of hysteretic lead. (See Chapter on Hysteresis.)

This m.m.f., F , is the resultant of the secondary m.m.f., F_1 ,

and the primary m.m.f., F_0 ; or graphically, \overline{OF} is the diagonal of a parallelogram with $\overline{OF_1}$ and $\overline{OF_0}$ as sides. $\overline{OF_1}$ and \overline{OF} being known, we find $\overline{OF_0}$, the primary ampere-turns, and therefrom and the number of primary turns, n_0 , the primary current, $I_0 = \frac{F_0}{n_0}$, which corresponds to the secondary, I_1 .

To overcome the resistance, r_0 , of the primary coil, a voltage, $E_r = I_0 r_0$, is required, in phase with the current, I_0 , and represented by the vector, $\overline{OE_r}$.

To overcome the reactance, $x_0 = 2\pi fL_0$, of the primary coil, a voltage, $E_x = I_0 x_0$, is required, 90° ahead of the current, I_0 , and represented by vector, $\overline{OE_x}$.

The resultant magnetic flux, Φ , which generates in the secondary coil the e.m.f., E_1 , generates in the primary coil an e.m.f. proportional to E_1 by the ratio of turns $\frac{n_0}{n_1}$ and in phase with E_1 , or,

$$E'_i = \frac{n_0}{n_1} E_1,$$

which is represented by the vector, $\overline{OE'_i}$. To overcome this counter e.m.f., E'_i , a primary voltage, E_i , is required, equal but in phase opposition to E'_i , and represented by the vector, $\overline{OE_i}$.

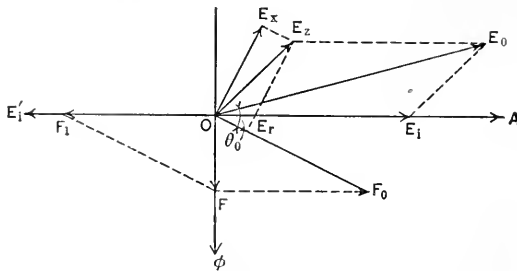

FIG. 19.

The primary impressed e.m.f., E_0 , must thus consist of the three components $\overline{OE_i}$, $\overline{OE_r}$, and $\overline{OE_x}$, and is, therefore, their resultant $\overline{OE_0}$, while the difference of phase in the primary circuit is found to be

$$\theta_0 = E_0 OF_0.$$

24. Thus, in Figs. 18 to 20, the diagram of a transformer is drawn for the same secondary e.m.f., E_1 , secondary current, I_1 , and therefore secondary m.m.f., F_1 , but with different conditions of secondary phase displacement:

In Fig. 18 the secondary current, I_1 , lags 60° behind the secondary e.m.f., E_1 .

In Fig. 19, the secondary current, I_1 , is in phase with the secondary e.m.f., E_1 .

In Fig. 20 the secondary current, I_1 , leads by 60° the secondary e.m.f., E_1 .

These diagrams show that lag of the current in the secondary circuit increases and lead decreases the primary current and primary impressed e.m.f. required to produce in the secondary circuit the same e.m.f. and current; or conversely, at a given primary impressed e.m.f., E_0 , the secondary e.m.f., E_1 , will be smaller with an inductive, and larger with a condensive (leading current), load than with a non-inductive load.

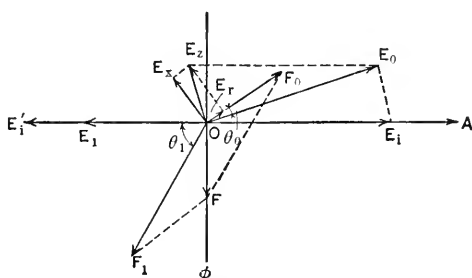

FIG. 20.

At the same time we see that a difference of phase existing in the secondary circuit of a transformer reappears in the primary circuit, somewhat decreased, if the current is leading, and slightly increased if lagging in phase. Later we shall see that hysteresis reduces the displacement in the primary circuit, so that, with an excessive lag in the secondary circuit, the lag in the primary circuit may be less than in the secondary.

A conclusion from the foregoing is that the transformer is not suitable for producing currents of displaced phase, since primary and secondary current are, except at very light loads, very nearly in phase, or rather in opposition, to each other.

CHAPTER V

SYMBOLIC METHOD

25. The graphical method of representing alternating-current phenomena affords the best means for deriving a clear insight into the mutual relation of the different alternating sine waves entering into the problem. For numerical calculation, however, the graphical method is generally not well suited, owing to the widely different magnitudes of the alternating sine waves represented in the same diagram, which make an exact diagrammatic determination impossible. For instance, in the transformer diagrams (*cf.* Figs. 18-20), the different magnitudes have numerical values in practice somewhat like the following: $E_1 = 100$ volts, and $I_1 = 75$ amp. For a non-inductive secondary load, as of incandescent lamps, the only reactance of the secondary circuit thus is that of the secondary coil, or $x_1 = 0.08$ ohms, giving a lag of $\theta_1 = 3.6^\circ$. We have also,

$$\begin{aligned} n_1 &= 30 \text{ turns.} \\ n_0 &= 300 \text{ turns.} \\ F_1 &= 2250 \text{ ampere-turns.} \\ F &= 100 \text{ ampere-turns.} \\ E_r &= 10 \text{ volts.} \\ E_x &= 60 \text{ volts.} \\ E_i &= 1000 \text{ volts.} \end{aligned}$$

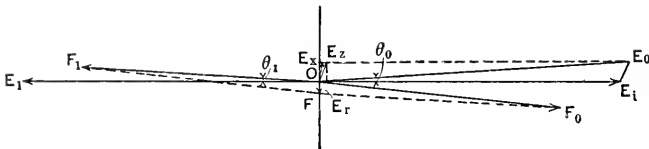

FIG. 21.—Vector diagram of transformer.

The corresponding diagram is shown in Fig. 21. Obviously, no exact numerical values can be taken from a parallelogram as flat as OF_1FF_0 , and from the combination of vectors of the relative magnitudes 1 : 6 : 100.

Hence the importance of the graphical method consists not

so much in its usefulness for practical calculation as to aid in the simple understanding of the phenomena involved.

26. Sometimes we can calculate the numerical values trigonometrically by means of the diagram. Usually, however, this becomes too complicated, as will be seen by trying to calculate, from the above transformer diagram, the ratio of transformation. The primary m.m.f. is given by the equation

$$F_0 = \sqrt{F^2 + F_1^2 + 2FF_1 \sin \theta_1},$$

an expression not well suited as a starting-point for further calculation.

A method is therefore desirable which combines the exactness of analytical calculation with the clearness of the graphical representation.

27. We have seen that the alternating sine wave is represented in intensity, as well as phase, by a vector, \overline{OI} , which is determined analytically by two numerical quantities—the length, \overline{OI} , or intensity; and the amplitude, \overline{AOI} , or phase, θ , of the wave, I .

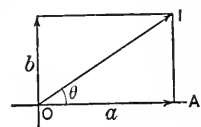

FIG. 22.

Instead of denoting the vector which represents the sine wave in the polar diagram by the polar coordinates, I and θ , we can represent it by its rectangular coordinates, a and b (Fig. 22), where

$a = I \cos \theta$ is the horizontal component,

$b = I \sin \theta$ is the vertical component of the sine wave.

This representation of the sine wave by its rectangular components is very convenient, in so far as it avoids the use of trigonometric functions in the combination or solution of sine waves.

Since the rectangular components, a and b , are the horizontal and the vertical projections of the vector representing the sine wave, and the projection of the diagonal of a parallelogram is equal to the sum of the projections of its sides, the combination of sine waves by the parallelogram law is reduced to the addition, or subtraction, of their rectangular components. That is:

Sine waves are combined, or resolved, by adding, or subtracting, their rectangular components.

For instance, if a and b are the rectangular components of a sine wave, I , and a' and b' the components of another sine wave,

I' (Fig. 23), their resultant sine wave, I_0 , has the rectangular components $a_0 = (a + a')$, and $b_0 = (b + b')$.

To get from the rectangular components, a and b , of a sine wave its intensity, i , and phase, θ , we may combine a and b by the parallelogram, and derive

$$i = \sqrt{a^2 + b^2};$$

$$\tan \theta = \frac{b}{a}.$$

Hence we can analytically operate with sine waves, as with forces in mechanics, by resolving them into their rectangular components.

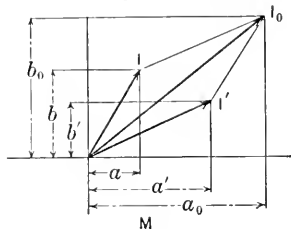

FIG. 23.

28. To distinguish, however, the horizontal and the vertical components of sine waves, so as not to be confused in lengthier calculation, we may mark, for instance, the vertical components by a distinguishing index, or the addition of an otherwise meaningless symbol, as the letter j , and

thus represent the sine wave by the expression

$$I = a + jb,$$

which now has the meaning that a is the horizontal and b the vertical component of the sine wave I , and that both components are to be combined in the resultant wave of intensity,

$$i = \sqrt{a^2 + b^2},$$

and of phase, $\tan \theta = \frac{b}{a}$.

Similarly, $a - jb$ means a sine wave with a as horizontal, and $-b$ as vertical, components, etc.

Obviously, the plus sign in the symbol, $a + jb$, does not imply simple addition, since it connects heterogeneous quantities—horizontal and vertical components—but implies combination by the parallelogram law.

For the present, j is nothing but a distinguishing index, and otherwise free for definition except that it is not an ordinary number.

29. A wave of equal intensity, and differing in phase from the wave, $a + jb$, by 180° , or one-half period, is represented in

polar coordinates by a vector of opposite direction, and denoted by the symbolic expression, $-a - jb$. Or,

Multiplying the symbolic expression, $a + jb$, of a sine wave by -1 means reversing the wave, or rotating it through 180° , or one-half period.

A wave of equal intensity, but leading $a + jb$ by 90° , or one-quarter period, has (Fig. 24) the horizontal component, $-b$, and the vertical component, a , and is represented symbolically by the expression, $ja - b$.

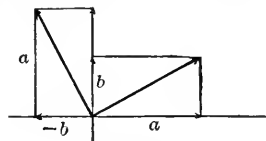

FIG. 24.

Multiplying, however, $a + jb$ by j , we get

$$ja + j^2b;$$

therefore, if we define the heretofore meaningless symbol, j , by the condition,

$$j^2 = -1,$$

we have

$$j(a + jb) = ja - b;$$

hence,

Multiplying the symbolic expression, $a + jb$, of a sine wave by j means rotating the wave through 90° , or one-quarter period; that is, leading the wave by one-quarter period.

Similarly—

Multiplying by $-j$ means lagging the wave by one-quarter period.

Since

$$j^2 = -1,$$

it is

$$j = \sqrt{-1};$$

and

j is the imaginary unit, and the sine wave is represented by a complex imaginary quantity or general number, $a + jb$.

As the imaginary unit, j , has no numerical meaning in the system of ordinary numbers, this definition of $j = \sqrt{-1}$ does not contradict its original introduction as a distinguishing index. For the Algebra of Complex Quantities see Appendix I. For a more complete discussion thereof see "Engineering Mathematics."

30. In the vector diagram, the sine wave is represented in intensity as well as phase by one complex quantity,

$$a + jb,$$

where a is the horizontal and b the vertical component of the wave; the intensity is given by

$$i = \sqrt{a^2 + b^2},$$

the phase by

$$\tan \theta = \frac{b}{a}$$

and

$$\begin{aligned} a &= i \cos \theta, \\ b &= i \sin \theta; \end{aligned}$$

hence the wave, $a + jb$, can also be expressed by

$$i(\cos \theta + j \sin \theta),$$

or, by substituting for $\cos \theta$ and $\sin \theta$ their exponential expressions, we obtain

$$i e^{j\theta}.$$

Since we have seen that sine waves may be combined or resolved by adding or subtracting their rectangular components, consequently,

Sine waves may be combined or resolved by adding or subtracting their complex algebraic expressions.

For instance, the sine waves,

$$a + jb$$

and

$$a' + jb',$$

combined give the sine wave,

$$I = (a + a') + j(b + b').$$

It will thus be seen that the combination of sine waves is reduced to the elementary algebra of complex quantities.

31. If $I = i + ji'$ is a sine wave of alternating current, and r is the resistance, the voltage consumed by the resistance is in phase with the current, and equal to the product of the current and resistance. Or

$$rI = ri + jri'.$$

If L is the inductance, and $x = 2\pi fL$ the inductive reactance, the e.m.f. produced by the reactance, or the counter e.m.f.

¹ In this representation of the sine wave by the exponential expression of the complex quantity, the angle θ necessarily must be expressed in *radians*, and not in degrees, that is, with one complete revolution or cycle as 2π , or with $\frac{180}{\pi} = 57.3^\circ$ as unit.

of self-induction, is the product of the current and reactance, and lags in phase 90° behind the current; it is, therefore, represented by the expression

$$-jxI = -jxi + xi'.$$

The voltage required to overcome the reactance is consequently 90° ahead of the current (or, as usually expressed, the current lags 90° behind the e.m.f.), and represented by the expression

$$jxI = jxi - xi'.$$

Hence, the voltage required to overcome the resistance, r , and the reactance, x , is

$$(r + jx)I;$$

that is,

$Z = r + jx$ is the expression of the impedance of the circuit in complex quantities.

Hence, if $I = i + ji'$ is the current, the voltage required to overcome the impedance, $Z = r + jx$, is

$$\begin{aligned} E &= ZI = (r + jx)(i + ji') \\ &= (ri + j^2xi') + j(ri' + xi); \end{aligned}$$

hence, since $j^2 = -1$

$$E = (ri - xi') + j(ri' + xi);$$

or, if $E = e + je'$ is the impressed voltage and $Z = r + jx$ the impedance, the current through the circuit is

$$I = \frac{\dot{E}}{\dot{Z}} = \frac{e + je'}{r + jx};$$

or, multiplying numerator and denominator by $(r - jx)$ to eliminate the imaginary from the denominator, we have

$$I = \frac{(e + je')(r - jx)}{r^2 + x^2} = \frac{er + e'x}{r^2 + x^2} + j \frac{e'r - ex}{r^2 + x^2};$$

or, if $E = e + je'$ is the impressed voltage and $I = i + ji'$ the current in the circuit, its impedance is

$$Z = \frac{\dot{E}}{\dot{I}} = \frac{e + je'}{i + ji'} = \frac{(e + je')(i - ji')}{i^2 + i'^2} = \frac{ei + e'i'}{i^2 + i'^2} + j \frac{e'i - ei'}{i^2 + i'^2}.$$

32. If C is the capacity of a condenser in series in a circuit in which exists a current $I = i + ji'$, the voltage impressed upon

the terminals of the condenser is $E = \frac{\dot{I}}{2\pi fC}$, 90° behind the cur-

rent; and may be represented by $-\frac{j\dot{I}}{2\pi fC}$ or $-jx_1I$, where $x_1 = \frac{1}{2\pi fC}$ is the *condensive reactance* or *condensance* of the condenser.

Condensive reactance is of opposite sign to inductive reactance; both may be combined in the name reactance.

We therefore have the conclusion that

If r = resistance and L = inductance,

thus $x = 2\pi fL$ = inductive reactance.

If C = capacity, $x_1 = \frac{1}{2\pi fC}$ = condensive reactance,

$Z = r + j(x - x_1)$ is the impedance of the circuit.

Ohm's law is then re-established as follows:

$$\dot{E} = Z\dot{I}, \quad \dot{I} = \frac{\dot{E}}{Z}, \quad Z = \frac{\dot{E}}{\dot{I}}.$$

The more general form gives not only the intensity of the wave but also its phase, as expressed in complex quantities.

33. Since the combination of sine waves takes place by the addition of their symbolic expressions, Kirchoff's laws are now re-established in their original form:

(a) The sum of all the e.m.fs. acting in a closed circuit equals zero, if they are expressed by complex quantities, and if the resistance and reactance e.m.fs. are also considered as counter e.m.fs.

(b) The sum of all the currents directed toward a distributing point is zero, if the currents are expressed as complex quantities.

If a complex quantity equals zero, the real part as well as the imaginary part must be zero individually; thus, if

$$a + jb = 0, \quad a = 0, \quad b = 0.$$

Resolving the e.m.fs. and currents in the expression of Kirchoff's law, we find:

(a) The sum of the components, in any direction, of all the e.m.fs. in a closed circuit equals zero, if the resistance and reactance are represented as counter e.m.fs.

(b) The sum of the components, in any direction, of all the currents at a distributing point equals zero.

Joule's law and the power equation do not give a simple expression in complex quantities, since the effect or power is

a quantity of double the frequency of the current or e.m.f. wave, and therefore requires for its representation as a vector a transition from single to double frequency, as will be shown in Chapter XVI.

In what follows, complex vector quantities will always be denoted by dotted capitals when not written out in full; absolute quantities and real quantities by undotted letters.

34. Referring to the example given in the fourth chapter, of a circuit supplied with a voltage, E , and a current, I , over an inductive line, we can now represent the impedance of the line by $Z = r + jx$, where r = resistance, x = reactance of the line, and have thus as the voltage at the beginning of the line, or at the generator, the expression

$$\dot{E}_0 = \dot{E} + Z\dot{I}.$$

Assuming now again the current as the zero line, that is, $I = i$, we have in general

$$\dot{E}_0 = \dot{E} + ir + jix;$$

hence, with non-inductive load, or $\dot{E} = e$,

$$\dot{E}_0 = (e + ir) + jix,$$

$$\text{or } e_0 = \sqrt{(e + ir)^2 + (ix)^2}, \quad \tan \theta_0 = \frac{ix}{e + ir}.$$

In a circuit with lagging current, that is, with leading e.m.f., $\dot{E} = e + je'$, and

$$\begin{aligned} \dot{E}_0 &= e + je' + (r + jx)i \\ &= (e + ir) + j(e' + ix), \end{aligned}$$

$$\text{or } e_0 = \sqrt{(e + ir)^2 + (e' + ix)^2}, \quad \tan \theta_0 = \frac{e' + ix}{e + ir}.$$

In a circuit with leading current, that is, with lagging e.m.f., $\dot{E} = e - je'$, and

$$\begin{aligned} \dot{E}_0 &= (e - je') + (r + jx)i \\ &= (e + ir) - j(e' - ix), \end{aligned}$$

$$\text{or } e_0 = \sqrt{(e + ir)^2 + (e' - ix)^2}, \quad \tan \theta_0 = -\frac{e' - ix}{e + ir},$$

values which easily permit calculation.

35. When transferring from complex quantities to absolute values, it must be kept in mind that:

The absolute value of a product or a ratio of complex quantities is the product or ratio of their absolute values.

The phase angle of a product or a ratio of complex quantities is the sum or difference of their phase angles.

That is, if

$$A = a' + ja'' = a(\cos \alpha + j \sin \alpha)$$

$$B = b' + jb'' = b(\cos \beta + j \sin \beta)$$

$$C = c' + jc'' = c(\cos \gamma + j \sin \gamma)$$

the absolute value of $\frac{AB}{C}$ is given by $\frac{ab}{c}$, and its phase angle by $\alpha + \beta - \gamma$, that is, it is

$$\frac{AB}{C} = \frac{ab}{c}[\cos(\alpha + \beta - \gamma) + j \sin(\alpha + \beta - \gamma)],$$

where

$$a = \sqrt{a'^2 + a''^2}$$

$$b = \sqrt{b'^2 + b''^2}$$

$$c = \sqrt{c'^2 + c''^2}$$

are the absolute values of A , B and C .

This rule frequently simplifies greatly the derivation of the absolute value and phase angle, from a complicated complex expression.

CHAPTER VI

TOPOGRAPHIC METHOD

36. In the representation of alternating sine waves by vectors, a certain ambiguity exists, in so far as one and the same quantity—voltage, for instance—can be represented by two vectors of opposite direction, according as to whether the e.m.f. is considered as a part of the impressed voltage or as a counter e.m.f. This is analogous to the distinction between action and reaction in mechanics.

Further, it is obvious that if in the circuit of a generator, G (Fig. 25), the current in the direction from terminal A over resistance R to terminal B is represented by a vector, \overline{OI} (Fig. 26), or by $\dot{I} = i + ji'$, the same current can be considered as being

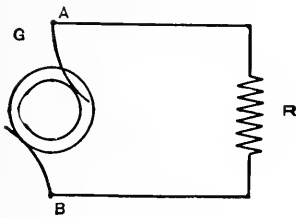

FIG. 25.

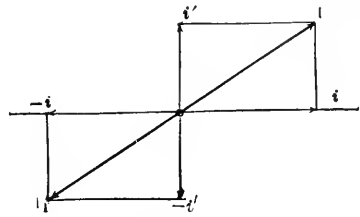

FIG. 26.

in the opposite direction, from terminal B to terminal A in opposite phase, and therefore represented by a vector, $\overline{OI_1}$ (Fig. 26), or by $\dot{I}_1 = -i - ji'$.

Or, if the difference of potential from terminal B to terminal A is denoted by the $\dot{E} = e + je'$, the difference of potential from A to B is $E_1 = -e - je'$.

Hence, in dealing with alternating-current sine waves it is necessary to consider them in their proper direction with regard to the circuit. Especially in more complicated circuits, as interlinked polyphase systems, careful attention has to be paid to this point.

37. Let, for instance, in Fig. 27, an interlinked three-phase system be represented diagrammatically as consisting of three

voltages, of equal intensity, differing in phase by one-third of a period. Let the voltages in the direction from the common connection, O , of the three branch circuits to the terminals, A_1 , A_2 , A_3 , be represented by E_1 , E_2 , E_3 . Then the difference of potential from A_2 to A_1 is $E_2 - E_1$, since the two voltages, E_1 and E_2 , are connected in circuit between the terminals, A_1 and A_2 , in the direction A_1-O-A_2 ; that is, the one, E_2 , in the direction, OA_2 , from the common connection to terminal, the other, E_1 , in the opposite direction, A_1O , from the terminal to common connection, and represented by $-E_1$. Conversely, the difference of potential from A_1 to A_2 is $E_1 - E_2$.

It is then convenient to go still a step farther, and drop the vector line altogether in the diagrammatic representation; that is, denote the sine wave by a point only, the end of the corresponding vector.

Looking at this from a different point of view, it means that we choose one point of the system—for instance, the common

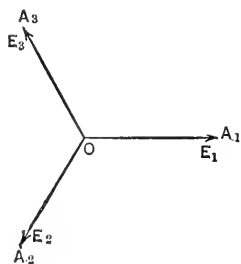

FIG. 27.

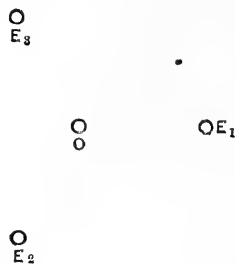

FIG. 28.

connection, or neutral O —as a zero point, or point of zero potential, and represent the potentials of all the other points of the circuit by points in the diagram, such that their distances from the zero point give the intensity, their amplitude the phase of the difference of potential of the respective point with regard to the zero point; and their distance and amplitude with regard to other points of the diagram, their difference of potential from these points in intensity and phase.

Thus, for example, in an interlinked three-phase system with three voltages of equal intensity, and differing in phase by one-third of a period, we may choose the common connection of the star-connected generator as the zero point, and represent, in Fig. 28, one of the voltages, or the potential at one of the three-

phase terminals, by point E_1 . The potentials at the two other terminals will then be given by the points E_2 and E_3 , which have the same distance from O as E_1 , and are equidistant from E_1 and from each other.

The difference of potential between any pair of terminals, for instance, E_1 and E_2 , is then the distance $\overline{E_2E_1}$, or $\overline{E_1E_2}$, according to the direction considered.

38. If now the three branches, $\overline{OE_1}$, $\overline{OE_2}$ and $\overline{OE_3}$, of the three-phase system are loaded equally by three currents equal in intensity and in difference of phase against their voltages,

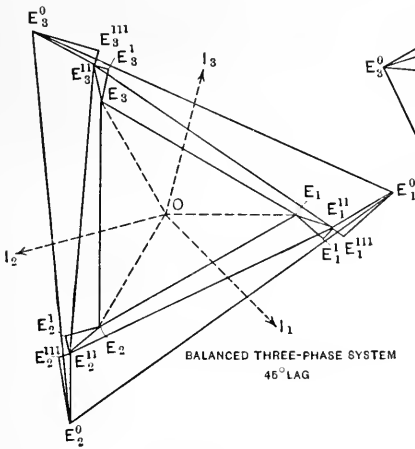

FIG. 29.

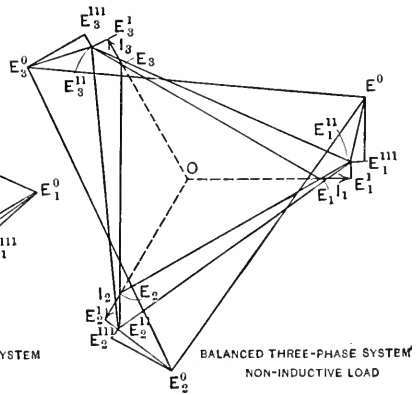

FIG. 30.

these currents are represented in Fig. 29 by the vectors $\overline{OI_1} = \overline{OI_2} = \overline{OI_3} = I$, lagging behind the voltages by angles $E_1OI_1 = E_2OI_2 = E_3OI_3 = \theta$.

Let the three-phase circuit be supplied over a line of impedance, $Z_1 = r_1 + jx_1$, from a generator of internal impedance, $Z_0 = r_0 + jx_0$.

In phase $\overline{OE_1}$ the voltage consumed by resistance r_1 is represented by the distance, $\overline{E_1E_1^1} = Ir_1$, in phase, that is, parallel with current $\overline{OI_1}$. The voltage consumed by reactance x_1 is represented by $\overline{E_1^1E_1^{11}} = Ix_1$, 90° ahead of current $\overline{OI_1}$. The same applies to the other two phases, and it thus follows that to produce the voltage triangle, $E_1E_2E_3$, at the terminals of the consumer's circuit, the voltage triangle, $E_1^{11}E_2^{11}E_3^{11}$, is required at the generator terminals.

Repeating the same operation for the internal impedance of the generator, we get $\overline{E^{11}E^{111}} = Ir_0$, and parallel to $\overline{OI_1}$, $\overline{E^{111}E^0} = Ix_0$, and 90° ahead of $\overline{OI_1}$, and thus as triangle of (nominal) generated e.m.fs. of the generator, $E_1^0 E_2^0 E_3^0$.

In Fig. 29 the diagram is shown for 45° lag, in Fig. 30 for non-inductive load, and in Fig. 31 for 45° lead of the currents with regard to their voltages.

As seen, the generated e.m.f. and thus the generator excitation with lagging current must be higher, and with leading current lower, than at non-inductive load, or conversely with the same generator excitation, that is, the same internal generator e.m.f.

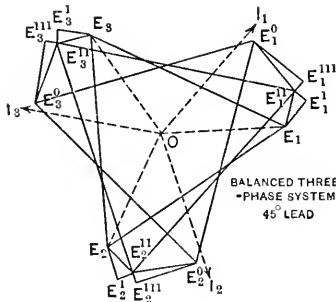

FIG. 31.

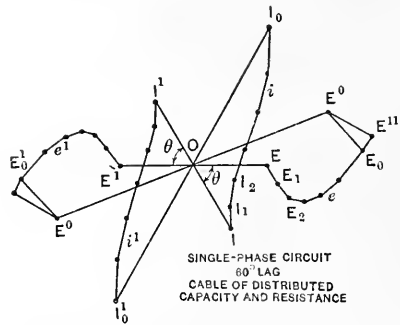

FIG. 32.

triangle, $E_1^0 E_2^0 E_3^0$, the voltages at the receiver's circuit, E_1, E_2, E_3 , fall off more with lagging, and less with leading current, than with non-inductive load.

39. As a further example may be considered the case of a single-phase alternating-current circuit supplied over a cable containing resistance and distributed capacity.

Let, in Fig. 32, the potential midway between the two terminals be assumed as zero point 0. The two terminal voltages at the receiver circuit are then represented by the points E and E^1 , equidistant from 0 and opposite each other, and the two currents at the terminals are represented by the points I and I^1 , equidistant from 0 and opposite each other, and under angle θ with E and E^1 respectively.

Considering first an element of the line or cable next to the receiver circuit. In this voltage, $\overline{EE_1}$, is consumed by the resistance of the line element, in phase with the current, \overline{OI} , and proportional thereto, and a current, $\overline{II_1}$, consumed by the

capacity, as charging current of the line element, 90° ahead in phase of the voltage, \overline{OE} , and proportional thereto, so that at the generator end of this cable element current and voltage are $\overline{OI_1}$ and $\overline{OE_1}$ respectively.

Passing now to the next cable element we have again a voltage, $\overline{E_1E_2}$, proportional to and in phase with the current, $\overline{OI_1}$, and a current, $\overline{I_1I_2}$, proportional to and 90° ahead of the voltage, $\overline{OE_1}$, and thus passing from element to element along the cable to the generator, we get curves of voltages, e and e^1 , and curves of currents, i and i^1 , which can be called the topographical circuit characteristics, and which correspond to each other, point for point, until the generator terminal voltages, $\overline{OE_0}$ and $\overline{OE_0^1}$, and the generator currents, $\overline{OI_0}$ and $\overline{OI_0^1}$, are reached.

Again, adding $\overline{E_0E_0^1} = I_0r_0$ and parallel to $\overline{OI_1}$ and $\overline{E_0^1E_0} = I_0x_0$ and 90° ahead of $\overline{OI_0}$, gives the (nominal) generated e.m.f. of the generator $\overline{OE_0}$, where $Z_0 = r_0 + jx_0 =$ internal impedance of the generator.

In Fig. 32 is shown the circuit characteristics for 60° lag of a cable containing only resistance and capacity.

Obviously by graphical construction the circuit characteristics appear more or less as broken lines, due to the necessity of using finite line elements, while in reality they are smooth curves when calculated by the differential method, as explained in Section III of "Theory and Calculation of Transient Electric Phenomena and Oscillations."

40. As further example may be considered a three-phase circuit supplied over a long-distance transmission line of distributed capacity, self-induction, resistance, and leakage.

Let, in Fig. 33, $\overline{OE_1}$, $\overline{OE_2}$, $\overline{OE_3} =$ three-phase voltages at receiver circuit, equidistant from each other and $= E$.

Let $\overline{OI_1}$, $\overline{OI_2}$, $\overline{OI_3} =$ three-phase currents in the receiver circuit equidistant from each other and $= I$, and making with E the phase angle, θ .

Considering again as in §3 the transmission line, element by element, we have in every element a voltage, $\overline{E_1E_1^1}$, consumed by the resistance in phase with the current, $\overline{OI_1}$, and proportional thereto, and a voltage, $\overline{E_1^1}$, $\overline{E_1^{11}}$, consumed by the reactance of the line element, 90° ahead of the current, $\overline{OI_1}$, and proportional thereto.

In the same line element we have a current, $\overline{I_1I_1^1}$, in phase with the voltage, $\overline{OE_1}$, and proportional thereto, representing

as e_1 and i_1 . As seen, passing from the receiving end toward the generator end of the line, potential and current alternately rise and fall, while their phase angle changes periodically between lag and lead.

41. More markedly this is shown in Fig. 34, the topographic circuit characteristic of one of the lines with 90° lag in the receiver circuit. Corresponding points of the two characteristics, e and i , are marked by corresponding figures 0 to 16, representing equidistant points of the line. The values of voltage, current and

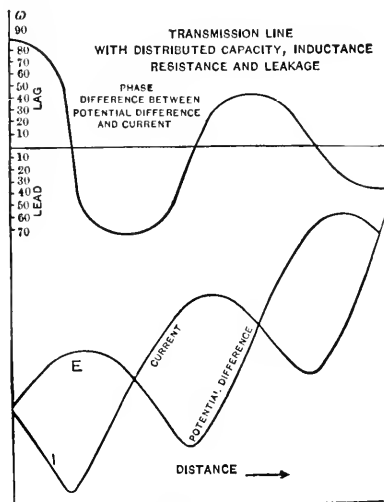

FIG. 35.

their difference of phase are plotted in Fig. 35 in rectangular coördinates with the distance as abscissas, counting from the receiving circuit toward the generator. As seen from Fig. 35, voltage and current periodically but alternately rise and fall, a maximum of one approximately coinciding with a minimum of the other, and with a point of zero phase displacement. The phase angle between current and e.m.f. changes from 90° lag to 72° lead, 44° lag, 34° lead, etc., gradually decreasing in the amplitude of its variation.

CHAPTER VII

POLAR COÖRDINATES AND POLAR DIAGRAMS

42. The graphic representation of alternating waves in rectangular coördinates, with the time as abscissæ and the instantaneous values as ordinates, gives a picture of their wave structure, as shown in Figs. 1 to 5. It does not, however, show their periodic character as well as the representation in polar coördinates, with the time as the angle or the amplitude—one complete period being represented by one revolution—and the instantaneous values as radius vectors; the polar coördinate system, in which the independent variable, the angle, is periodic, obviously lends itself better to the representation of periodic functions, as alternating waves.

Thus the two waves of Figs. 2 and 3 are represented in polar coördinates in Figs. 36 and 37 as closed characteristic curves, which, by their intersection with the radius vector, give the instantaneous value of the wave, corresponding to the time represented by the amplitude or angle of the radius vector.

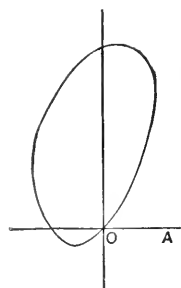

FIG. 36.

These instantaneous values are positive if in the direction of the radius vector, and negative if in opposition. Hence the two half-waves in Fig. 2 are represented by the same polar characteristic curve, which is traversed by the point of intersection of the radius vector twice per period—once in the direction of the vector,

giving the positive half-wave, and once in opposition to the vector, giving the negative half-wave. In Figs. 3 and 37 where the two half-waves are different, they give different polar characteristics.

43. The sine wave, Fig. 1, is represented in polar coördinates by one circle, as shown in Fig. 38. The diameter of the characteristic curve of the sine wave, $I = \overline{OC}$, represents the intensity of the wave; and the amplitude of the diameter \overline{OC} , $\sphericalangle \theta_0 = AOC$, is the phase of the wave, which, therefore, is represented analytically by the function

$$i = I \cos (\theta - \theta_0),$$

where $\theta = 2\pi \frac{t}{t_0}$ is the instantaneous value of the amplitude corresponding to the instantaneous value, i , of the wave.

The instantaneous values are cut out on the movable radius vector by its intersection with the characteristic circle. Thus, for instance, at the amplitude, $AOB_1 = \theta_1 = 2\pi \frac{t_1}{t_0}$ (Fig. 38), the instantaneous value is OB' ; at the amplitude, $AOB_2 = \theta_2 = 2\pi \frac{t_2}{t_0}$, the instantaneous value is $\overline{OB''}$, and negative, since in opposition to the radius vector, OB_2 .

The angle, θ , so represents the time, and increasing time is represented by an increase of angle θ in counter-clockwise rota-

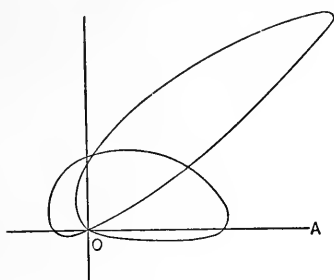

FIG. 37.

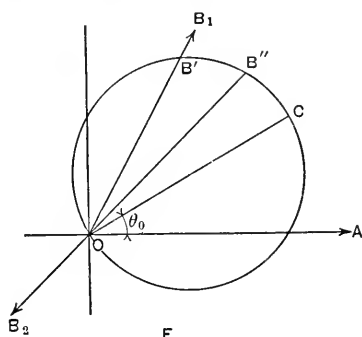

FIG. 38.

tion. That is, the positive direction, or increase of time, is chosen as counter-clockwise rotation, in conformity with general custom.

The characteristic circle of the alternating sine wave is determined by the length of its diameter—the intensity of the wave; and by the amplitude of the diameter—the phase of the wave.

Hence wherever the integral value of the wave is considered alone, and not the instantaneous values, the characteristic circle may be omitted altogether, and the wave represented in intensity and in phase by the diameter of the characteristic circle.

Thus, in polar coördinates, the alternating wave may be represented in intensity and phase by the length and direction of a vector, \overline{OC} , Fig. 38, and its analytical expression would then be $c = \overline{OC} \cos(\theta - \theta_0)$.

This leads to a second vector representation of alternating

waves, differing from the crank diagram discussed in Chapter IV. It may be called the time diagram or polar diagram, and is used to a considerable extent in the literature, thus must be familiar to the engineer, though in the following we shall in graphic representation and in the symbolic representation based thereon, use the crank diagram of Chapters IV and V.

In the time diagram as well as in the crank diagram, instead of the maximum value of the wave, the effective value, or square root of mean square, may be used as the vector, which is more convenient; and the maximum value is then $\sqrt{2}$ times the vector \overline{OC} , so that the instantaneous values, when taken from the diagram, have to be increased by the factor $\sqrt{2}$.

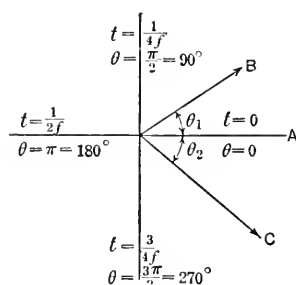

FIG. 39.

Thus, the wave,

$$b = B \cos 2\pi f(t - t_1) \\ = B \cos (\theta - \theta_1),$$

is, in Fig. 39, represented by

$$\text{vector } \overline{OB} = \frac{B}{\sqrt{2}}$$

of phase

$$AOB = \theta_1;$$

and the wave,

$$c = C \cos 2\pi f(t + t_2) \\ = C \cos (\theta + \theta_2)$$

is, in Fig. 39, represented by

$$\text{vector } \overline{OC} = \frac{C}{\sqrt{2}}$$

of phase

$$AOC = -\theta_2.$$

The former is said to lag by angle θ_1 , the latter to lead by angle θ_2 , with regard to the zero position.

The wave b lags by angle $(\theta_1 + \theta_2)$ behind wave c , or c leads b by angle $(\theta_1 + \theta_2)$.

44. To combine different sine waves, their graphical representations, or vectors, are combined by the parallelogram law.

From the foregoing considerations we have the conclusions:

The sine wave is represented graphically in polar coordinates by a vector, which by its length \overline{OC} , denotes the intensity, and by its amplitude, AOC , the phase, of the sine wave.

Sine waves are combined or resolved graphically, in polar coordinates, by the law of the parallelogram or the polygon of sine waves. (Fig. 40.)

Kirchhoff's laws now assume, for alternating sine waves, the form:

(a) The resultant of all the e.m.f.s. in a closed circuit, as found by the parallelogram of sine waves, is zero if the counter e.m.f.s. of resistance and of reactance are included.

(b) The resultant of all the currents toward a distributing point, as found by the parallelogram of sine waves, is zero.

The power equation expressed graphically is as follows:

The power of an alternating-current circuit is represented in polar coördinates by the product of the current, I , into the projection of the e.m.f., E , upon the current, or by the e.m.f., E , into the projection of the current, I , upon the e.m.f., or by $IE \cos \theta$, where $\theta =$ angle of time-phase displacement.

45. The instances represented by the vector representation of the crank diagram in Chapter IV as Figs. 16, 17, 18, 19, 20,

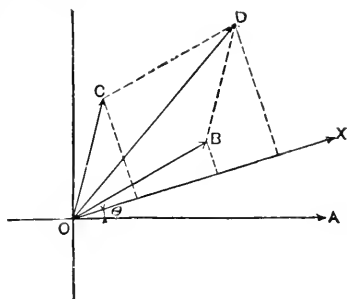

FIG. 40.

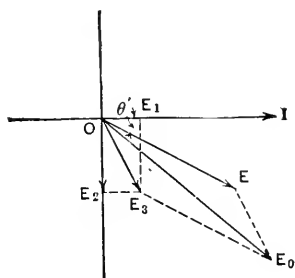

FIG. 41.

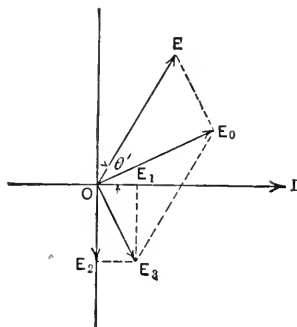

FIG. 42.

then appear in the vector representation of the time diagram or polar coordinate diagram, in the form of Figs. 41, 42, 43, 44, 45.

These figures are the reverse, or mirror image of each other. That is, the crank diagrams, turned around the horizontal (or any other axis), so as they would be seen in a mirror, are the time diagrams, and inversely.

The polar diagram, Fig. 46, of a current:

$$i = I \cos(\vartheta - \beta)$$

represented by vector \overline{OI} ,

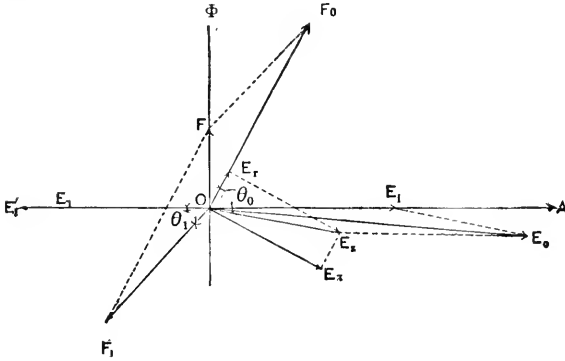

FIG. 43.

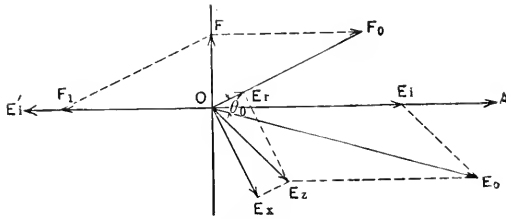

FIG. 44.

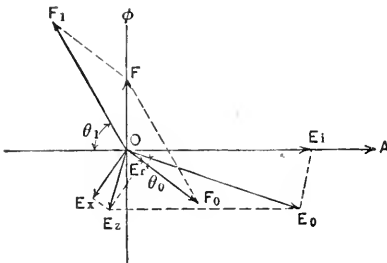

FIG. 45.

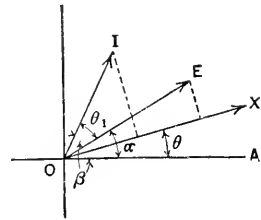

FIG. 46.

lagging behind the voltage:

$$e = E \cos(\vartheta - \alpha)$$

represented by vector \overline{OE} ,

by angle

$$\theta_1 = \beta - \alpha$$

then means:

The voltage e reaches its maximum at the time t_1 , which is represented by angle $\alpha = 2\pi\frac{t_1}{t_0}$, where $t_0 =$ period, and the current, i , reaches its maximum at the time t_2 , which is represented by angle $\beta = 2\pi\frac{t_2}{t_0}$, and since $\beta > \alpha$, the current reaches its maximum at a later time than the voltage, that is, lags behind the voltage, and the lag of the current behind the voltage is the difference between the times of their maxima, β and α , in angular measure, that is, is

$$\theta_1 = \beta - \alpha = 2\pi\frac{t_2 - t_1}{t_0}.$$

At any moment of time t , represented by angle $\theta = 2\pi\frac{t}{t_0}$, the instantaneous values of current and voltage, i and e , are the projections of \overline{OI} and \overline{OE} on the time radius OX drawn under angle $AOX = \theta$.

The crank diagram corresponding to the time diagram Fig. 46 is shown in Fig. 47. It means: The vectors \overline{OI} and \overline{OE} , representing the current and the voltage respectively, rotate synchronously, and by their projections on the horizontal \overline{OA} represent the instantaneous values of current and voltage. Angle $\overline{IOA} = \beta$ being larger than angle $\overline{EOA} = \alpha$, the current vector \overline{OI} passes its maximum, in position OA , later than the voltage vector \overline{OE} , that is, the current lags behind the voltage, by the difference of time corresponding to the passage of the current and voltage vectors through their maxima, in the direction OA , that is, by the time angle $\theta_1 = \beta - \alpha$.

A polar diagram, Fig. 46, with the current, \overline{OI} , lagging behind the voltage, \overline{OE} , by the angle, θ_1 , thus considered as crank diagram would represent the current leading the voltage by the angle, θ_1 , and a crank diagram, Fig. 47, with the current lagging behind the voltage by the angle, θ_1 , would as polar diagram represent a current leading the voltage by the angle, θ_1 .

46. The main difference in appearance between the crank diagram and the polar diagram therefore is that, with the same direction of rotation, lag in the one diagram is represented in the same manner as lead in the other diagram, and inversely. Or, a representation by the crank diagram looks like a representation by the polar diagram, with reversed direction of rotation, and *vice versa*. Or, the one diagram is the image of the other and can

be transformed into it by reversing right and left, or top and bottom. So the crank diagram, Fig. 47, is the image of the polar diagram, Fig. 46.

In symbolic representation, based upon the crank diagram, the impedance was denoted by

$$Z = r + jx,$$

where x = inductive reactance.

In the polar diagram, the impedance thus is denoted by:

$$Z = r - jx$$

since the latter is the mirror image of the crank diagram, that is, differs from it symbolically by the interchange of $+j$ and $-j$.

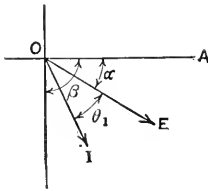

FIG. 47.

A treatise written in the symbolic representation by the polar diagram, thus can be translated to the representation by the crank diagram, and inversely, by simply reversing the signs of all imaginary quantities, that is, considering the signs of all terms with j changed.

A graphical representation in the polar diagram can be considered as a graphic representation in the crank diagram, with clockwise or right-handed rotation, and inversely.

Thus, for the engineer familiar with one representation only, but less familiar with the other, the most convenient way when meeting with a treatise in the, to him, unfamiliar representation is to consider all the diagrams as clockwise and all the signs of j reversed.

In conformity with the recommendation of the Turin Congress—however ill considered this may appear to many engineers—in the following the crank diagram will be used, and wherever conditions require the time diagram, the latter be translated to the crank diagram. It is not possible to entirely avoid the time diagram, since the crank diagram is more limited in its application.

47. The crank diagram offers the disadvantage, that it can be applied to sine waves only, while the polar diagram permits the construction of the curve of waves of any shapes, as those in Figs. 36 and 37.

In most cases, this objection is not serious, and in the diagrammatic and symbolic representation, the alternating quantities can be assumed as sine waves, that is, the general wave represented by the equivalent sine wave, that is, the sine wave of the same effective value as the general wave.

The transformation of the general wave into the equivalent sine wave, however, has to be carried out algebraically in the crank diagram, while the polar diagram permits a graphical transformation of the general wave into the equivalent sine wave.

Let Fig. 48 represent a general alternating wave. An element B_1OB_2 of this wave then has the area

$$dA = \frac{r^2 d\theta}{2},$$

and the total area of the polar curve is

$$A = \int_0^{2\pi} \frac{r^2}{2} d\theta.$$

The effective value of the wave is

$$\begin{aligned} R &= \sqrt{\text{mean square}} \\ &= \sqrt{\frac{1}{2\pi} \int_0^{2\pi} r^2 d\theta}; \end{aligned}$$

hence,

$$R^2 \pi = \frac{1}{2} \int_0^{2\pi} r^2 d\theta = A.$$

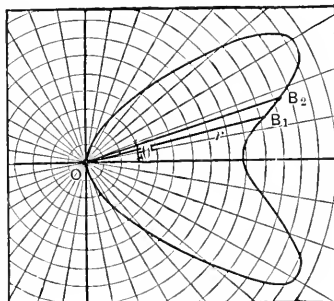

FIG. 48.

The area of the polar curve of the general periodic wave, as measured by planimeter, therefore equals the area of a circle with the effective value of the wave as radius.

The effective value of the equivalent sine wave therefore is the radius of a circle having the same area as the general wave, in polar coördinates:

$$R = \sqrt{\frac{A}{\pi}}$$

The diameter of the general polar circle, therefore, is

$$R\sqrt{2} = \sqrt{\frac{2A}{\pi}}.$$

And the phase of the equivalent sine wave, or the direction of the diameter of its polar circle, is the vector bisecting the area of the general wave, in polar coordinates.

The transformation of the general alternating wave into the equivalent sine wave, therefore, is carried out by measuring the area of the general wave in polar coördinates, and drawing the sine wave circle of half this area.

SECTION II

CIRCUITS

CHAPTER VIII

ADMITTANCE, CONDUCTANCE, SUSCEPTANCE

48. If in a continuous-current circuit, a number of resistances, r_1, r_2, r_3, \dots , are connected in series, their joint resistance, R , is the sum of the individual resistances, $R = r_1 + r_2 + r_3 + \dots$.

If, however, a number of resistances are connected in multiple or in parallel, their joint resistance, R , cannot be expressed in a simple form, but is represented by the expression

$$R = \frac{1}{\frac{1}{r_1} + \frac{1}{r_2} + \frac{1}{r_3} + \dots}$$

Hence, in the latter case it is preferable to introduce, instead of the term *resistance*, its reciprocal, or inverse value, the term *conductance*, $g = \frac{1}{r}$. If, then, a number of conductances,

g_1, g_2, g_3, \dots are connected in parallel, their joint conductance is the sum of the individual conductances, or $G = g_1 + g_2 + g_3 + \dots$. When using the term conductance, the joint conductance of a number of series-connected conductances becomes similarly a complicated expression

$$G = \frac{1}{\frac{1}{g_1} + \frac{1}{g_2} + \frac{1}{g_3} + \dots}$$

Hence the term *resistance* is preferable in case of series connection, and the use of the reciprocal term *conductance* in parallel connections; therefore,

The joint resistance of a number of series-connected resistances is equal to the sum of the individual resistances; the joint conductance of a number of parallel-connected conductances is equal to the sum of the individual conductances.

49. In alternating-current circuits, instead of the term *resistance* we have the term *impedance*, $Z = r + jx$, with its two components, the *resistance*, r , and the *reactance*, x , in the formula of Ohm's law, $E = IZ$. The resistance, r , gives the component of e.m.f. in phase with the current, or the power component of the e.m.f., Ir ; the reactance, x , gives the component of the e.m.f. in quadrature with the current, or the wattless component of e.m.f., Ix ; both combined give the total e.m.f.,

$$Iz = I\sqrt{r^2 + x^2}.$$

Since e.m.fs. are combined by adding their complex expressions, we have:

The joint impedance of a number of series-connected impedances is the sum of the individual impedances, when expressed in complex quantities.

In graphical representation impedances have not to be added, but are combined in their proper phase by the law of parallelogram in the same manner as the e.m.fs. corresponding to them.

The term impedance becomes inconvenient, however, when dealing with parallel-connected circuits; or, in other words, when several currents are produced by the same e.m.f., such as in cases where Ohm's law is expressed in the form,

$$I = \frac{E}{Z}.$$

It is preferable, then, to introduce the reciprocal of impedance, which may be called the *admittance* of the circuit, or

$$Y = \frac{1}{Z}.$$

As the reciprocal of the complex quantity, $Z = r + jx$, the admittance is a complex quantity also, or $Y = g - jb$; it consists of the component, g , which represents the coefficient of current in phase with the e.m.f., or the power or active component, gE , of the current, in the equation of Ohm's law,

$$I = YE = (g - jb)E,$$

and the component, b , which represents the coefficient of current in quadrature with the e.m.f., or wattless or reactive component, bE , of the current.

g is called the *conductance*, and b the *susceptance*, of the circuit. Hence the conductance, g , is the power component, and

the susceptance, b , the wattless component, of the admittance, $Y = g - jb$, while the numerical value of admittance is

$$y = \sqrt{g^2 + b^2};$$

the resistance, r , is the power component, and the reactance, x , the wattless component, of the impedance, $Z = r + jx$, the numerical value of impedance being

$$z = \sqrt{r^2 + x^2}.$$

50. As shown, the term *admittance* implies resolving the current into two components, in phase and in quadrature with the e.m.f., or the power or active component and the wattless or reactive component; while the term *impedance* implies resolving the e.m.f. into two components, in phase and in quadrature with the current, or the power component and the wattless or reactive component.

It must be understood, however, that the conductance is not the reciprocal of the resistance, but depends upon the reactance as well as upon the resistance. Only when the reactance $x = 0$, or in continuous-current circuits, is the conductance the reciprocal of resistance.

Again, only in circuits with zero resistance ($r = 0$) is the susceptance the reciprocal of reactance; otherwise, the susceptance depends upon reactance and upon resistance.

The conductance is zero for two values of the resistance:

1. If $r = \infty$, or $x = \infty$, since in this case there is no current, and either component of the current = 0.

2. If $r = 0$, since in this case the current in the circuit is in quadrature with the e.m.f., and thus has no power component.

Similarly, the susceptance, b , is zero for two values of the reactance:

1. If $x = \infty$, or $r = \infty$.

2. If $x = 0$.

From the definition of admittance, $Y = g - jb$, as the reciprocal of the impedance, $Z = r + jx$, we have

$$Y = \frac{1}{Z}, \text{ or } g - jb = \frac{1}{r + jx};$$

or, multiplying numerator and denominator on the right side by $(r - jx)$,

$$g - jb = \frac{r - jx}{(r + jx)(r - jx)};$$

hence, since

$$(r + jx)(r - jx) = r^2 + x^2 = z^2,$$

$$g - jb = \frac{r}{r^2 + x^2} - j \frac{x}{r^2 + x^2} = \frac{r}{z^2} - j \frac{x}{z^2}$$

or

$$g = \frac{r}{r^2 + x^2} = \frac{r}{z^2},$$

$$b = \frac{x}{r^2 + x^2} = \frac{x}{z^2};$$

and conversely

$$r = \frac{g}{g^2 + b^2} = \frac{g}{y^2},$$

$$x = \frac{b}{g^2 + b^2} = \frac{b}{y^2}.$$

By these equations, the conductance and susceptance can be calculated from resistance and reactance, and conversely.

Multiplying the equations for g and r , we get

$$gr = \frac{rg}{z^2 y^2};$$

hence, $z^2 y^2 = (r^2 + x^2)(g^2 + b^2) = 1;$

and

$$z = \frac{1}{y} = \frac{1}{\sqrt{g^2 + b^2}}, \quad \left. \begin{array}{l} \text{the absolute value} \\ \text{of impedance;} \end{array} \right\}$$

$$y = \frac{1}{z} = \frac{1}{\sqrt{r^2 + x^2}}, \quad \left. \begin{array}{l} \text{the absolute value} \\ \text{of admittance.} \end{array} \right\}$$

51. If, in a circuit, the reactance, x , is constant, and the resistance, r , is varied from $r = 0$ to $r = \infty$, the susceptance, b , decreases from $b = \frac{1}{x}$ at $r = 0$, to $b = 0$ at $r = \infty$; while the conductance, $g = 0$ at $r = 0$, increases, reaches a maximum for $r = x$, where $g = \frac{1}{2r}$, is equal to the susceptance or $g = b$, and then decreases again, reaching $g = 0$ at $r = \infty$.

In Fig. 49, for constant reactance $x = 0.5$ ohm, the variation of the conductance, g , and of the susceptance, b , are shown as functions of the varying resistance, r . As shown, the absolute value of admittance, susceptance, and conductance are plotted in full lines, and in dotted line the absolute value of impedance,

$$z = \sqrt{r^2 + x^2} = \frac{1}{y}.$$

Obviously, if the resistance, r , is constant, and the reactance, x , is varied, the values of conductance and susceptance are merely exchanged, the conductance decreasing steadily from $g = \frac{1}{r}$ to 0, and the susceptance passing from 0 at $x = 0$ to the maximum, $b = \frac{1}{2r} = g = \frac{1}{2x}$ at $x = r$, and to $b = 0$ at $x = \infty$.

The resistance, r , and the reactance, x , vary as functions of the conductance, g , and the susceptance, b , in the same manner as g and b vary as functions of r and x .

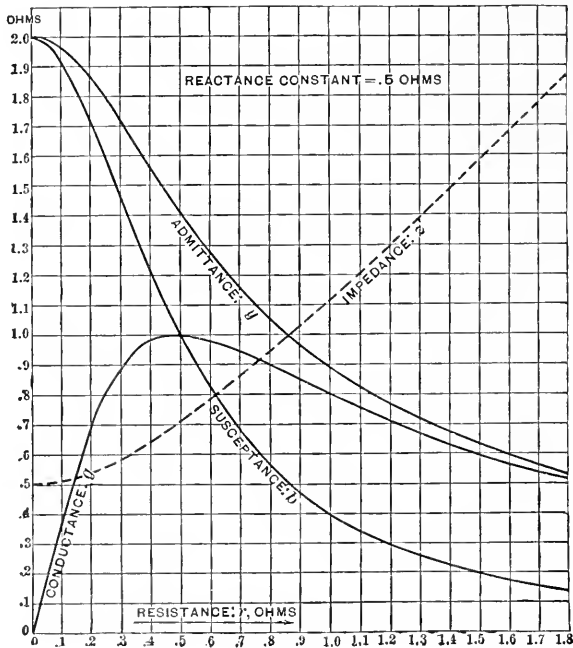

FIG. 49.

The sign in the complex expression of admittance is always opposite to that of impedance; this is obvious, since if the current lags behind the e.m.f., the e.m.f. leads the current, and conversely.

We can thus express Ohm's law in the two forms,

$$\begin{aligned} E &= IZ, \\ I &= EY, \end{aligned}$$

and therefore,

The joint impedance of a number of series-connected impedances is equal to the sum of the individual impedances; the joint admittance of a number of parallel-connected admittances is equal to the sum of the individual admittances, if expressed in complex quantities. In diagrammatic representation, combination by the parallelogram law takes the place of addition of the complex quantities.

52. Experimentally, impedances and admittances are most conveniently determined by establishing an alternating current in the circuit, and measuring by voltmeter, ammeter and wattmeter, the volts, e , the amperes, i , and the watts, p .

It is then,

$$\text{Impedance: } z = \frac{e}{i}.$$

$$\text{Resistance (effective): } r = \frac{p}{i^2}.$$

$$\text{Reactance: } x = \sqrt{z^2 - r^2}.$$

$$\text{Admittance: } y = \frac{i}{e}.$$

$$\text{Conductance: } g = \frac{p}{e^2}.$$

$$\text{Susceptance: } b = \sqrt{y^2 - g^2}.$$

Regarding their calculation, see "Theoretical Elements of Electrical Engineering."

CHAPTER IX

CIRCUITS CONTAINING RESISTANCE, INDUCTIVE REACTANCE, AND CONDENSIVE REACTANCE

53. Having, in the foregoing, re-established Ohm's law and Kirchoff's laws as being also the fundamental laws of alternating-current circuits, when expressed in their complex form,

$$\dot{E} = Z\dot{I}, \quad \text{or, } \dot{I} = Y\dot{E},$$

and

$$\begin{aligned} \Sigma \dot{E} &= 0 \text{ in a closed circuit,} \\ \Sigma \dot{I} &= 0 \text{ at a distributing point,} \end{aligned}$$

where \dot{E} , \dot{I} , Z , Y , are the expressions of e.m.f., current, impedance, and admittance in complex quantities—these values representing not only the intensity, but also the phase, of the alternating wave—we can now—by application of these laws, and in the same manner as with continuous-current circuits, keeping in mind, however, that \dot{E} , \dot{I} , Z , Y , are complex quantities—calculate alternating-current circuits and networks of circuits containing resistance, inductive reactance, and condensive reactance in any combination, without meeting with greater difficulties than when dealing with continuous-current circuits.

It is obviously not possible to discuss with any completeness all the infinite varieties of combinations of resistance, inductive reactance, and condensive reactance which can be imagined, and which may exist, in a system of network of circuits; therefore only some of the more common or more interesting combinations will here be considered.

1. Resistance in Series with a Circuit

54. In a constant-potential system with impressed e.m.f.,

$$E_0 = e_0 + je'_0, \quad E_0 = \sqrt{e_0^2 + e_0'^2},$$

let the receiving circuit of impedance,

$$Z = r + jx, \quad z = \sqrt{r^2 + x^2},$$

be connected in series with a resistance, r_0 .

The total impedance of the circuit is then

$$Z + r_0 = r + r_0 + jx;$$

hence the current is

$$I = \frac{\dot{E}_0}{Z + r_0} = \frac{\dot{E}_0}{r + r_0 + jx} = \frac{E_0(r + r_0 - jx)}{(r + r_0)^2 + x^2};$$

and the e.m.f. of the receiving circuit becomes

$$\begin{aligned} E = IZ &= \frac{\dot{E}_0(r + jx)}{r + r_0 + jx} = \frac{\dot{E}_0\{r(r + r_0) + x^2 + jr_0x\}}{(r + r_0)^2 + x^2} \\ &= \frac{\dot{E}_0\{z^2 + 2rr_0 + r_0^2\}}{z^2 + 2rr_0 + r_0^2}; \end{aligned}$$

or, in absolute values we have the following:

Impressed e.m.f.,

$$E_0 = \sqrt{e_0^2 + e_0'^2};$$

current,

$$I = \frac{E_0}{\sqrt{(r + r_0)^2 + x^2}} = \frac{E_0}{\sqrt{z^2 + 2rr_0 + r_0^2}};$$

e.m.f. at terminals of receiver circuit,

$$E = E_0 \sqrt{\frac{r^2 + x^2}{(r + r_0)^2 + x^2}} = \frac{E_0 z}{\sqrt{z^2 + 2rr_0 + r_0^2}};$$

difference of phase in receiver circuit, $\tan \theta = \frac{x}{r}$;

difference of phase in supply circuit, $\tan \theta_0 = \frac{x}{r + r_0}$

since in general,

$$\tan(\text{phase}) = \frac{\text{imaginary component}}{\text{real component}}.$$

(a) If x is negligible with respect to r , as in a non-inductive receiving circuit,

$$I = \frac{E_0}{r + r_0}, \quad E = E_0 \frac{r}{r + r_0},$$

and the current and e.m.f. at receiver terminals decrease steadily with increasing r_0 .

(b) If r is negligible compared with x , as in a wattless receiver circuit,

$$I = \frac{E_0}{\sqrt{r_0^2 + x^2}}, \quad E = E_0 \frac{x}{\sqrt{r_0^2 + x^2}};$$

or, for small values of r_0 ,

$$I = \frac{E_0}{x}, \quad E = E_0;$$

that is, the current and e.m.f. at receiver terminals remain approximately constant for small values of r_0 , and then decrease with increasing rapidity.

In the general equations, x appears in the expressions for I and E only as x^2 , so that I and E assume the same value when x is negative as when x is positive; or, in other words, series resistance acts upon a circuit with leading current, or in a condenser circuit, in the same way as upon a circuit with lagging current, or an inductive circuit.

For a given impedance, z , of the receiver circuit, the current, I , and e.m.f., E , are smaller the larger the value of r ; that is, the less the difference of phase in the receiver circuit.

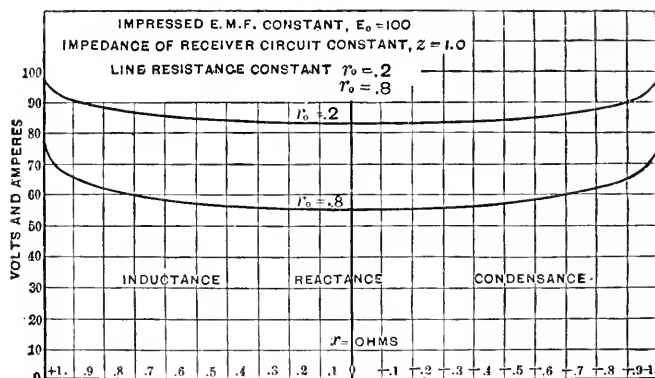

FIG. 50.—Variation of voltage at constant series resistance with phase relation of receiver circuit.

As an instance, in Fig. 50 is shown the e.m.f., E , at the receiver circuit, for $E_0 = \text{const.} = 100$ volts, $z = 1$ ohm; hence $I = E$, and

$$\begin{aligned} (a) \quad r_0 &= 0.2 \text{ ohm} && \text{(Curve I)} \\ (b) \quad r_0 &= 0.8 \text{ ohm} && \text{(Curve II)} \end{aligned}$$

with values of reactance, $x = \sqrt{z^2 - r^2}$, for abscissæ, from $x = +1.0$ to $x = -1.0$ ohm.

As shown, I and E are smallest for $x = 0$, $r = 1.0$, or for the non-inductive receiver circuit, and largest for $x = \pm 1.0$, $r = 0$, or for the wattless circuit, in which latter a series resistance causes but a very small drop of potential.

Hence the control of a circuit by series resistance depends upon the difference of phase in the circuit.

For $r_0 = 0.8$ and $x = 0$, $x = +0.8$, $x = -0.8$, the vector diagrams are shown in Figs. 51 to 53.

In these Figs. $\overline{OE_0}$ is the supply voltage, $\overline{OE_3}$ the voltage consumed by the line resistance, and \overline{OE} the receiver voltage, with its two components, $\overline{OE_1}$ in phase and $\overline{OE_2}$ in quadrature with the current.

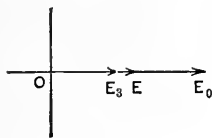

FIG. 51.

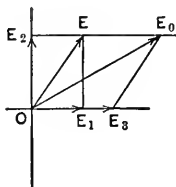

FIG. 52.

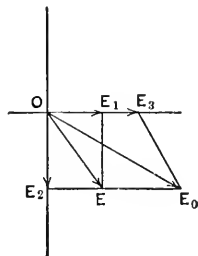

FIG. 53.

2. Reactance in Series with a Circuit

52. In a constant potential system of impressed e.m.f.,

$$E_0 = e_0 + je'_0, \quad E_0 = \sqrt{e_0^2 + e_0'^2}$$

let a reactance, x_0 , be connected in series in a receiver circuit of impedance,

$$Z = r + jx, \quad z = \sqrt{r^2 + x^2}.$$

Then, the total impedance of the circuit is

$$Z + jx_0 = r + j(x + x_0),$$

and the current is

$$I = \frac{\dot{E}_0}{Z + jx_0} = \frac{\dot{E}_0}{r + j(x + x_0)},$$

while the difference of potential at the receiver terminals is

$$\dot{E} = \dot{I}Z = \dot{E}_0 \frac{r + jx}{r + j(x + x_0)}.$$

Or, in absolute quantities,

current,

$$I = \frac{E_0}{\sqrt{r^2 + (x + x_0)^2}} = \frac{E_0}{\sqrt{z^2 + 2xx_0 + x_0^2}};$$

e.m.f. at receiver terminals,

$$E = E_0 \sqrt{\frac{r^2 + x^2}{r^2 + (x + x_0)^2}} = \frac{E_0 z}{\sqrt{r^2 + 2xx_0 + x_0^2}};$$

difference of phase in receiver circuit,

$$\tan \theta = \frac{x}{r};$$

difference of phase in supply circuit,

$$\tan \theta_0 = \frac{x + x_0}{r}.$$

(a) If x is small compared with r , that is, if the receiver circuit is non-inductive, I and E change very little for small values of x_0 ; but if x is large, that is, if the receiver circuit is of large reactance, I and E change considerably with a change of x_0 .

(b) If x is negative, that is, if the receiver circuit contains condensers, synchronous motors, or other apparatus which produce leading currents, below a certain value of x_0 the denominator in the expression of E becomes $< z$, or $E > E_0$; that is, the reactance, x_0 , raises the voltage.

(c) $E = E_0$, or the insertion of a series reactance, x_0 , does not affect the potential difference at the receiver terminals, if

$$\sqrt{z^2 + 2x x_0 + x_0^2} = z;$$

or,

$$x_0 = -2x.$$

That is, if the reactance which is connected in series in the circuit is of opposite sign, but twice as large as the reactance of the receiver circuit, the voltage is not affected, but $E = E_0$, $I = \frac{E_0}{z}$. If $x_0 < -2x$, it raises, if $x_0 > -2x$, it lowers, the voltage.

We see, then, that a reactance inserted in series in an alternating-current circuit will always lower the voltage at the receiver terminals, when of the same sign as the reactance of the receiver circuit; when of opposite sign, it will lower the voltage if larger, raise the voltage if less, than twice the numerical value of the reactance of the receiver circuit.

(d) If $x = 0$, that is, if the receiver circuit is non-inductive, the e.m.f. at receiver terminals is

$$\begin{aligned} E &= \frac{E_0 r}{\sqrt{r^2 + x_0^2}} = \frac{E_0}{\sqrt{1 + \left(\frac{x_0}{r}\right)^2}} \\ &= E_0 \left\{ 1 - \frac{1}{2} \left(\frac{x_0}{r}\right)^2 + \frac{3}{8} \left(\frac{x_0}{r}\right)^4 - + \dots \right\} \end{aligned}$$

$\left(\frac{1}{\sqrt{1+x}} = (1+x)^{-1/2} \right.$ expanded by the binomial theorem

$$\left. (1+x)^n = 1 + nx + \frac{n(n-1)}{1.2} x^2 + \dots \right).$$

Therefore, if x_0 is small compared with r ,

$$E = E_0 \left(1 - \frac{1}{2} \left(\frac{x_0}{r} \right)^2 \right),$$

$$\frac{E_0 - E}{E_0} = \frac{1}{2} \left(\frac{x_0}{r} \right)^2.$$

That is, the percentage drop of potential by the insertion of reactance in series in a non-inductive circuit is, for small values of reactance, independent of the sign, but proportional to the square of the reactance, or the same whether it be inductive reactance or condensive reactance.

56. As an example, in Fig. 54 the changes of current, I , and of e.m.f. at receiver terminals, E , at constant impressed e.m.f.,

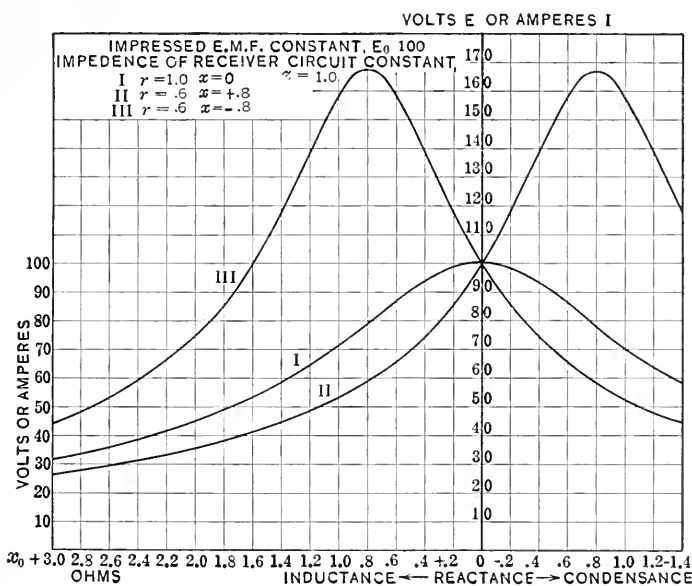

FIG. 54.

E_0 , are shown for various conditions of a receiver circuit and amounts of reactance inserted in series.

Fig. 54 gives for various values of reactance, x_0 (if positive, inductive; if negative, condensive), the e.m.f.s., E , at receiver terminals, for constant impressed e.m.f., $E_0 = 100$ volts, and the following conditions of receiver circuit:

- $z = 1.0, r = 1.0, x = 0$ (Curve I)
- $z = 1.0, r = 0.6, x = 0.8$ (Curve II)
- $z = 1.0, r = 0.6, x = -0.8$ (Curve III).

As seen, curve I is symmetrical, and with increasing x_0 the voltage E remains first almost constant, and then drops off with increasing rapidity.

In the inductive circuit series inductive reactance, or in a condenser circuit series condensive reactance, causes the voltage to drop off very much faster than in a non-inductive circuit.

Series inductive reactance in a condenser circuit, and series condensive reactance in an inductive circuit, cause a rise of potential. This rise is a maximum for $x_0 = \pm 0.8$, or $x_0 = -x$ (the condition of resonance), and the e.m.f. reaches the value $E = 167$ volts, or $E = E_0 \frac{z}{r}$. This rise of potential by series reactance continues up to $x_0 = \pm 1.6$, or, $x_0 = -2x$, where $E = 100$ volts again; and for $x_0 > 1.6$ the voltage drops again.

At $x_0 = \pm 0.8$, $x = \mp 0.8$, the total impedance of the circuit is $r - j(x + x_0) = r = 0.6$, $x + x_0 = 0$, and $\tan \theta_0 = 0$; that

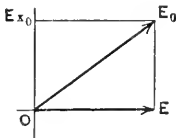

FIG. 55.

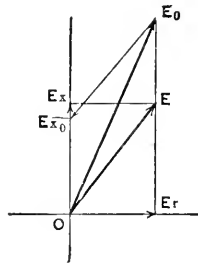

FIG. 56.

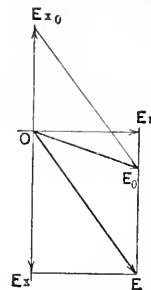

FIG. 57.

is, the current and e.m.f. in the supply circuit are in phase with each other, or the circuit is in *electrical resonance*.

Since a synchronous motor in the condition of efficient working acts as a condensive reactance, we get the remarkable result that, in synchronous motor circuits, choking coils, or reactive coils, can be used for raising the voltage.

In Figs. 55 to 57, the vector diagrams are shown for the conditions

$$\begin{array}{lll}
 E_0 = 100, x_0 = 0.6, x = 0 & (\text{Fig. 48}) & E = 85.7 \\
 & x = + 0.8 & (\text{Fig. 49}) & E = 65.7 \\
 & x = - 0.8 & (\text{Fig. 50}) & E = 158.1.
 \end{array}$$

57. In Fig. 58 the dependence of the potential, E , upon the difference of phase, θ , in the receiver circuit is shown for the constant impressed e.m.f., $E_0 = 100$; for the constant receiver impedance, $z = 1.0$ (but of various phase differences θ), and for various series reactances, as follows:

$x_0 = 0.2$	(Curve I)
$x_0 = 0.6$	(Curve II)
$x_0 = 0.8$	(Curve III)
$x_0 = 1.0$	(Curve IV)
$x_0 = 1.6$	(Curve V)
$x_0 = 3.2$	(Curve VI).

Since $z = 1.0$, the current, I , in all these diagrams has the same value as E .

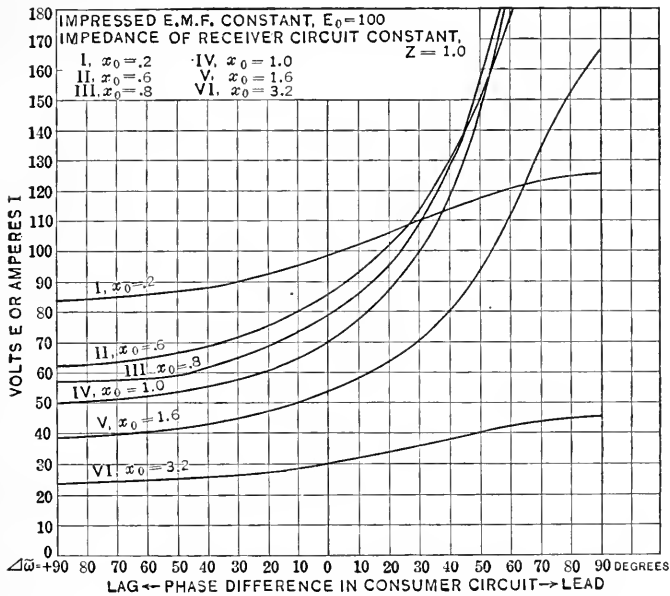

FIG. 58.

In Figs. 59 and 60, the same curves are plotted as in Fig. 58, but in Fig. 59 with the reactance, x , of the receiver circuit as abscissas; and in Fig. 60 with the resistance, r , of the receiver circuit as abscissas.

As shown, the receiver voltage, E , is always lowest when x_0 and x are of the same sign, and highest when they are of opposite sign.

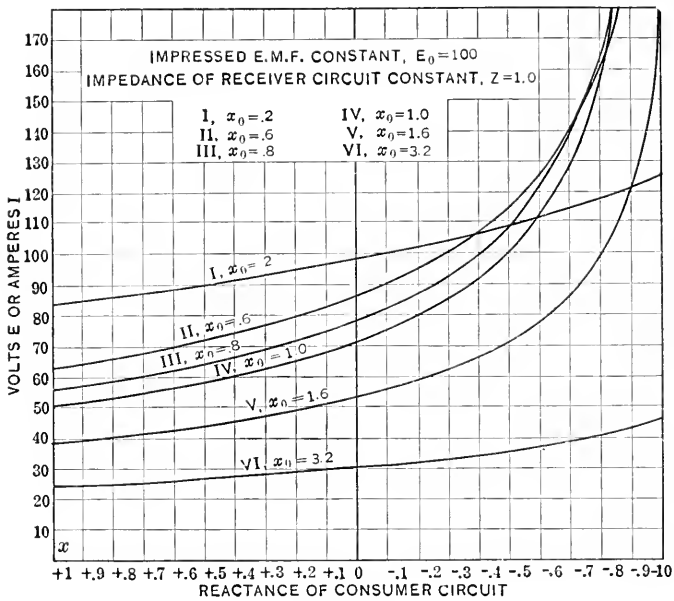

FIG. 59.

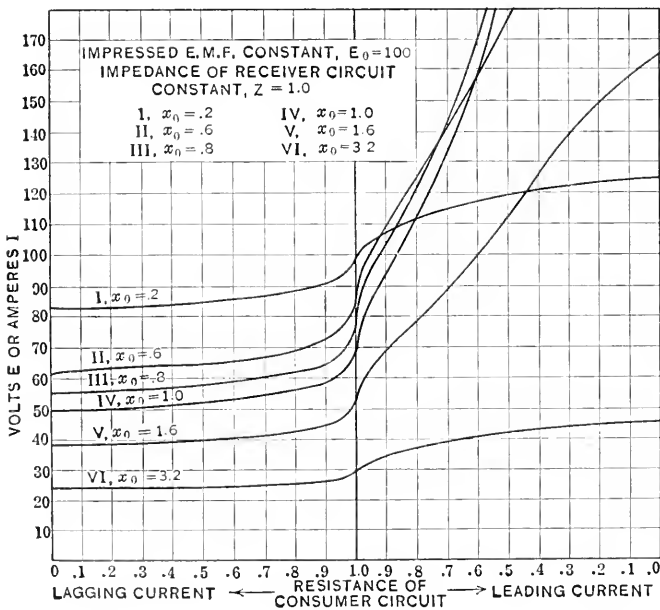

FIG. 60.

The rise of voltage due to the balance of x_0 and x is a maximum for $x_0 = +1.0$, $x = -1.0$, and $r = 0$, where $E = \infty$; that is, absolute resonance takes place. Obviously, this condition cannot be completely reached in practice.

It is interesting to note, from Fig. 60, that the largest part of the drop of potential due to inductive reactance, and rise to condensive reactance—or conversely—takes place between $r = 1.0$ and $r = 0.9$; or, in other words, a circuit having a power-factor $\cos \theta = 0.9$ gives a drop several times larger than a non-inductive circuit, and hence must be considered as an inductive circuit.

3. Impedance in Series with a Circuit

58. By the use of reactance for controlling electric circuits, a certain amount of resistance is also introduced, due to the ohmic resistance of the conductor and the hysteretic loss, which, as will be seen hereafter, can be represented as an effective resistance.

Hence the impedance of a reactive coil (choking coil) may be written thus:

$$Z_0 = r_0 + jx_0, \quad z_0 = \sqrt{r_0^2 + x_0^2},$$

where r_0 is in general small compared with x_0 .

From this, if the impressed e.m.f. is

$$E_0 = e_0 + j e'_0, \quad E_0 = \sqrt{e_0^2 + e_0'^2},$$

and the impedance of the consumer circuit is

$$Z = r + jx, \quad z = \sqrt{r^2 + x^2},$$

we get the current

$$I = \frac{\dot{E}_0}{Z + Z_0} = \frac{\dot{E}_0}{(r + r_0) + j(x + x_0)}$$

and the e.m.f. at receiver terminals,

$$E = E_0 \frac{Z}{Z + Z_0} = E_0 \frac{r + jx}{(r + r_0) + j(x + x_0)}.$$

Or, in absolute quantities, the current is,

$$I = \frac{E_0}{\sqrt{(r + r_0)^2 + (x + x_0)^2}} = \frac{E_0}{\sqrt{z^2 + z_0^2 + 2(rr_0 + xx_0)}},$$

the e.m.f. at receiver terminals is

$$E = \frac{E_0 z}{\sqrt{(r + r_0)^2 + (x + x_0)^2}} = \frac{E_0 z}{\sqrt{z^2 + z_0^2 + 2(rr_0 + xx_0)}};$$

the difference of phase in receiver circuit is

$$\tan \theta = \frac{x}{r};$$

and the difference of phase in the supply circuit is

$$\tan \theta = \frac{x + x_0}{r + r_0}.$$

59. In this case, the maximum drop of potential will not take place for either $x = 0$, as for resistance in series, or for $r = 0$, as for reactance in series, but at an intermediate point. The drop of voltage is a maximum; that is, E is a minimum if the denominator of E is a maximum; or, since z, z_0, r_0, x_0 are constant, if $rr_0 + xx_0$ is a maximum, that is, since $x = \sqrt{z^2 - r^2}$, if $rr_0 + x_0\sqrt{z^2 - r^2}$ is a maximum. A function, $f = rr_0 + x_0\sqrt{z^2 - r^2}$, is a maximum when its differential coefficient equals zero. For, plotting f as curve with values of r as abscissas, at the point where f is a maximum or a minimum, this curve is for a short distance horizontal, hence the tangens-function of its tangent equals zero. The tangens-function of the tangent of a curve, however, is the ratio of the change of ordinates to the change of abscissas, or is the differential coefficient of the function represented by the curve.

Thus we have

$$f = rr_0 + x_0\sqrt{z^2 - r^2}$$

is a maximum or minimum, if

$$\frac{df}{dr} = 0$$

Differentiating, we get

$$r_0 + \frac{1}{2} \frac{x_0}{\sqrt{z^2 - r^2}} (-2r) = 0;$$

or, expanded,

$$r_0\sqrt{z^2 - r^2} - x_0r = r_0x - x_0r = 0,$$

or,

$$r \div x = r_0 \div x_0.$$

That is, the drop of potential is a maximum, if the reactance factor, $\frac{x}{r}$, of the receiver circuit equals the reactance factor, $\frac{x_0}{r_0}$, of the series impedance.

60. As an example, Fig. 61 shows the e.m.f., E , at the receiver terminals, at a constant impressed e.m.f., $E_0 = 100$, a constant

impedance of the receiver circuit, $z = 1.0$, and constant series impedances,

$$Z_0 = 0.3 + j 0.4 \quad (\text{Curve I})$$

$$Z_0 = 1.2 + j 1.6 \quad (\text{Curve II})$$

as functions of the reactance, x , of the receiver circuit.

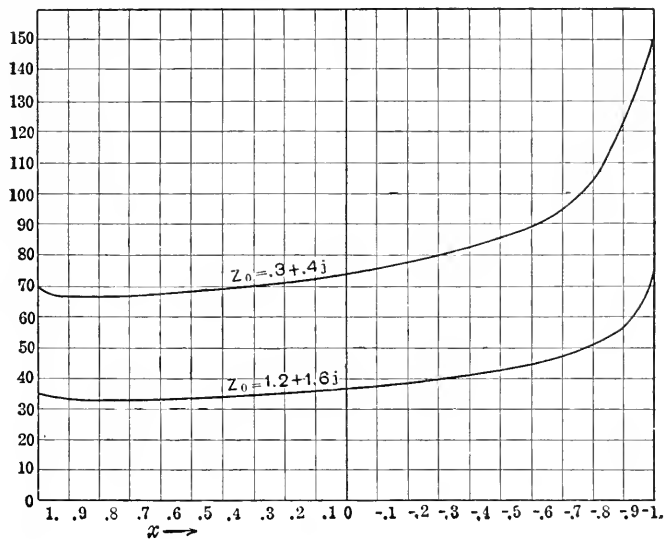

FIG. 61.

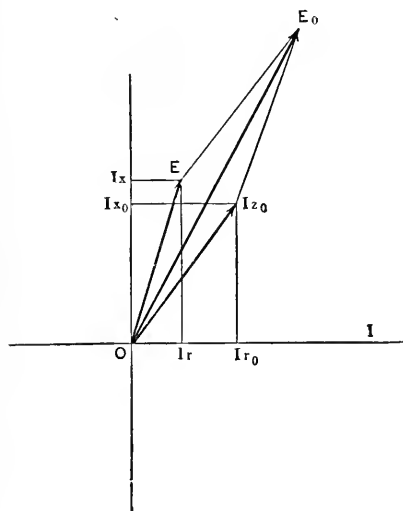

FIG. 62.

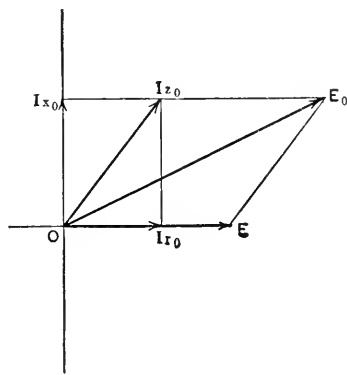

FIG. 63.

Figs. 62 to 64, give the vector diagram for $E_0 = 100$, $x = 0.95$, $x = 0$, $x = -0.95$, and $Z_0 = 0.3 + 0.4j$.

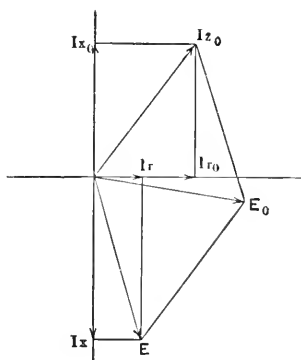

FIG. 64.

4. Compensation for Lagging Currents by Shunted Condensive Reactance

61. We have seen in the preceding paragraphs, that in a constant potential alternating-current system, the voltage at the terminals of a receiver circuit can be varied by the use of a variable reactance in series with the circuit, without loss of energy except the unavoidable loss due to the resistance and hysteresis of the reactance; and that, if the series reactance is very large compared with the resistance of the receiver circuit, the current in the receiver circuit becomes more or less independent of the resistance—that is, of the power consumed in the receiver circuit, which in this case approaches the conditions of a constant alternating-current circuit, whose current is

$$I = \frac{E_0}{\sqrt{r^2 + x_0^2}}, \text{ or, approximately, } I = \frac{E_0}{x_0}.$$

This potential control, however, causes the current taken from the mains to lag greatly behind the e.m.f., and thereby requires a much larger current than corresponds to the power consumed in the receiver circuit.

Since a condenser draws from the mains a current in leading phase, a condenser shunted across such a circuit carrying current in lagging phase compensates for the lag, the leading and the lagging current combining to form a resultant current more

or less in phase with the e.m.f., and therefore proportional to the power expended.

In a circuit shown diagrammatically in Fig. 65, let the non-inductive receiver circuit of resistance, r , be connected in series with the inductive reactance, x_0 , and the whole shunted by a condenser C of condensive reactance, x_c , entailing but a negligible loss of power.

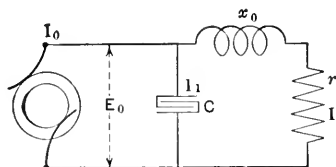

FIG. 65.

Then, if $E_0 =$ impressed e.m.f.,
the current in receiver circuit is

$$I = \frac{\dot{E}_0}{r + jx_0}, \quad I = \frac{E_0}{\sqrt{r^2 + x_0^2}};$$

the current in condenser circuit is

$$I_1 = -\frac{E_0}{jx_c}, \quad I_1 = \frac{E_0}{x_c};$$

and the total current is

$$\begin{aligned} I_0 &= I + I_1 = E_0 \left\{ \frac{1}{r + jx_0} - \frac{1}{jx_c} \right\} \\ &= E_0 \left\{ \frac{r}{r^2 + x_0^2} - j \left(\frac{x_0}{r^2 + x_0^2} - \frac{1}{x_c} \right) \right\}, \end{aligned}$$

or, in absolute terms,

$$I_0 = E_0 \sqrt{\left(\frac{r}{r^2 + x_0^2} \right)^2 + \left(\frac{x_0}{r^2 + x_0^2} - \frac{1}{x_c} \right)^2};$$

while the e.m.f. at receiver terminals is

$$E = I r = E_0 \frac{r}{r + jx_0}, \quad E = \frac{E_0 r}{\sqrt{r^2 + x_0^2}}.$$

62. The main current, I_0 , is in phase with the impressed e.m.f., E_0 , or the lagging current is completely balanced, or supplied by, the condensive reactance, if the imaginary term in the expression of I_0 disappears; that is, if

$$\frac{x_0}{r^2 + x_0^2} - \frac{1}{x_c} = 0.$$

This gives, expanded,

$$x_c = \frac{r^2 + x_0^2}{x_0}.$$

Hence the capacity required to compensate for the lagging current produced by the insertion of inductive reactance in series with a non-inductive circuit depends upon the resistance and the inductive reactance of the circuit. x_0 being constant, with increasing resistance, r , the condensive reactance has to be increased, or the capacity decreased, to keep the balance.

Substituting

$$x_c = \frac{r^2 + x_0^2}{x_0},$$

we get, as the equations of the inductive circuit balanced by condensive reactance,

$$\begin{aligned} I &= \frac{\dot{E}_0}{r + jx_0} = \frac{\dot{E}_0(r - jx_0)}{r^2 + x_0^2}, & I &= \frac{E_0}{\sqrt{r^2 + x_0^2}}; \\ I_1 &= \frac{j\dot{E}_0x_0}{r^2 + x_0^2}, & I_1 &= \frac{E_0x_0}{r^2 + x_0^2}; \\ I_0 &= \frac{\dot{E}_0r}{r^2 + x_0^2}, & I_0 &= \frac{E_0r}{r^2 + x_0^2}; \\ E &= \frac{\dot{E}_0r}{r + jx_0}, & E &= \frac{E_0r}{\sqrt{r^2 + x_0^2}}; \end{aligned}$$

and for the power expended in the receiver circuit,

$$I^2r = \frac{E_0^2r}{r^2 + x_0^2} = I_0E_0;$$

that is, the main current is proportional to the expenditure of power.

For $r = 0$, we have $x_c = x_0$, as the condition of balance.

Complete balance of the lagging component of current by shunted capacity thus requires that the condensive reactance x_c be varied with the resistance, r ; that is, with the varying load on the receiver circuit.

In Fig. 66 are shown, for a constant impressed e.m.f., $E_0 = 1000$ volts, and a constant series reactance, $x_0 = 100$ ohms, values for the balanced circuit of

- current in receiver circuit (Curve I),
- current in condenser circuit (Curve II),
- current in main circuit (Curve III),
- e.m.f. at receiver terminals (Curve IV),

with the values the resistance, r , of the receiver circuit as abscissas.

63. If, however, the condensive reactance is left unchanged, $x_c = x_0$ at the no-load value, the circuit is balanced for $r = 0$, but will be overbalanced for $r > 0$, and the main current will become leading.

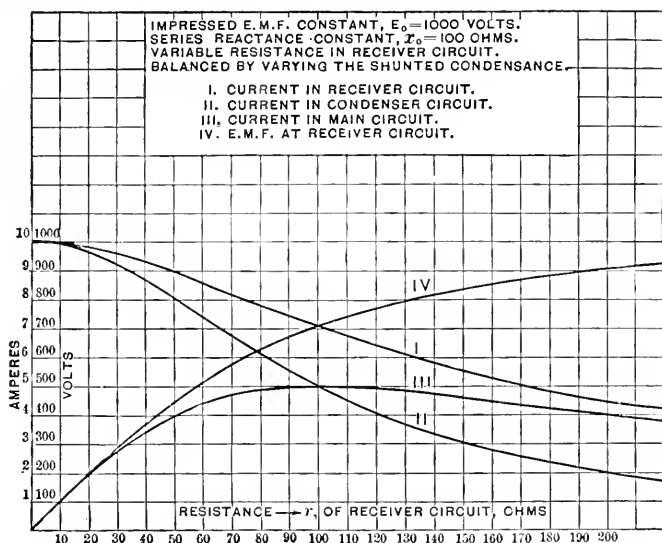

FIG. 66.—Compensation of lagging currents in receiving circuit by variable shunted condensation.

We get in this case,

$$x_c = x_0;$$

$$\begin{aligned} \dot{I} &= \frac{\dot{E}_0}{r + jx_0}, & I &= \frac{E_0}{\sqrt{r^2 + x_0^2}}; \\ \dot{I}_1 &= \frac{j\dot{E}_0}{x_0}, & I_1 &= \frac{E_0}{x_0}; \\ \dot{I}_0 &= \dot{I} + \dot{I}_1 = \frac{\dot{E}_0 r}{x_0(x_0 - jr)}, & I_0 &= \frac{E_0 r}{x_0 \sqrt{r^2 + x_0^2}}; \\ \dot{E} &= \dot{I} r = \frac{\dot{E}_0 r}{r + jx_0}, & E &= \frac{E_0 r}{\sqrt{r^2 + x_0^2}}. \end{aligned}$$

The difference of phase in the main circuit is

$$\tan \theta_0 = -\frac{r}{x_0},$$

which is $= 0$, when $r = 0$ or at no-load, and increases with increasing resistance, as the lead of the current. At the same time, the current in the receiver circuit, I , is approximately constant for small values of r , and then gradually decreases.

In Fig. 67 are shown the values of I , I_1 , I_0 , E , in Curves I, II, III, IV, similarly as in Fig. 60, for $E_0 = 1000$ volts, $x_c = x_0 = 100$ ohms, and r as abscissas.

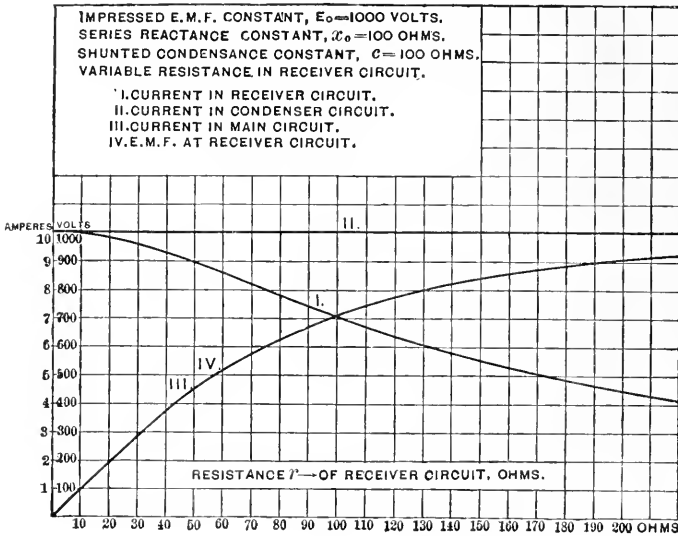

FIG. 67.

5. Constant Potential—Constant-current Transformation

64. In a constant potential circuit containing a large and constant reactance, x_0 , and a varying resistance, r , the current is approximately constant, and only gradually drops off with increasing resistance, r —that is, with increasing load—but the current lags greatly behind the voltage. This lagging current in the receiver circuit can be supplied by a shunted condensation. Leaving, however, the condensation constant, $x_c = x_0$, so as to balance the lagging current at no-load, that is, at $r = 0$, it will overbalance with increasing load, that is, with increasing r , and thus the main current will become leading, while the receiver current decreases if the impressed voltage, E_0 , is kept constant. Hence, to keep the current in the receiver circuit entirely constant, the impressed voltage, E_0 , has to be increased with in-

creasing resistance, r ; that is, with increasing lead of the main current. Since, as explained before, in a circuit with leading current, a series inductive reactance raises the potential, to maintain the current in the receiver circuit constant under all loads, an inductive reactance, x_2 , inserted in the main circuit, as shown in the diagram, Fig. 68, can be used for raising the voltage, E_0 , with increasing load, and by properly choosing the inductive and the condensive reactances, practically constant current at varying load can be produced from constant voltage supply, and inversely.

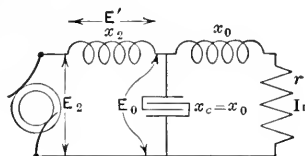

FIG. 68

The generation of alternating-current electric power almost always takes place at constant potential. For some purposes, however, as for operating series arc circuits, and to a limited extent also for electric furnaces, a constant, or approximately constant, alternating current is required.

Such constant alternating currents can be produced from constant potential circuits by means of inductive reactances, or combinations of inductive and condensive reactances; and the investigation of different methods of producing constant alternating current from constant alternating potential, or inversely, constitutes a good illustration of the application of the terms "impedance," "reactance," etc., and offers a large number of problems or examples for the application of the method of complex quantities. A number of such are given in "Theory and Calculation of Electric Circuits."

CHAPTER X

RESISTANCE AND REACTANCE OF TRANSMISSION LINES

65. In alternating-current circuits, voltage is consumed in the feeders of distributing networks, and in the lines of long-distance transmissions, not only by the resistance, but also by the reactance, of the line. The voltage consumed by the resistance is in phase, while the voltage consumed by the reactance is in quadrature, with the current. Hence their influence upon the voltage at the receiver circuit depends upon the difference of phase between the current and the voltage in that circuit. As discussed before, the drop of potential due to the resistance is a maximum when the receiver current is in phase, a minimum when it is in quadrature, with the voltage. The change of voltage due to line reactance is small if the current is in phase with the voltage, while a drop of potential is produced with a lagging, and a rise of potential with a leading, current in the receiver circuit.

Thus the change of voltage due to a line of given resistance and reactance depends upon the phase difference in the receiver circuit, and can be varied and controlled by varying this phase difference; that is, by varying the admittance, $Y = g - jb$, of the receiver circuit.

The conductance, g , of the receiver circuit depends upon the consumption of power—that is, upon the load on the circuit—and thus cannot be varied for the purpose of regulation. Its susceptance, b , however, can be changed by shunting the circuit with a reactance, and will be increased by a shunted inductive reactance, and decreased by a shunted condensive reactance. Hence, for the purpose of investigation, the receiver circuit can be assumed to consist of two branches, a conductance, g ,—the non-inductive part of the circuit—shunted by a susceptance, b , which can be varied without expenditure of energy. The two components of current can thus be considered separately, the energy component as deter-

mined by the load on the circuit, and the wattless component, which can be varied for the purpose of regulation.

Obviously, in the same way, the voltage at the receiver circuit may be considered as consisting of two components, the power component, in phase with the current, and the wattless component, in quadrature with the current. This will correspond to the case of a reactance connected in series to the non-inductive part of the circuit. Since the effect of either resolution into components is the same so far as the line is concerned, we need not make any assumption as to whether the wattless part of the receiver circuit is in shunt, or in series, to the power part.

Let

$Z_0 = r_0 + jx_0$ = impedance of the line;

$$z_0 = \sqrt{r_0^2 + x_0^2};$$

$Y = g - jb$ = admittance of receiver circuit;

$$y = \sqrt{g^2 + b^2};$$

$E_0 = e_0 + je'_0$ = impressed voltage at generator end of line;

$$E_0 = \sqrt{e_0^2 + e_0'^2};$$

$E = e + je'$ = voltage at receiver end of line;

$$E = \sqrt{e^2 + e'^2};$$

$I_0 = i_0 + ji'_0$ = current in the line;

$$I_0 = \sqrt{i_0^2 + i_0'^2}.$$

The simplest condition is the non-inductive circuit.

1. Non-inductive Receiver Circuit Supplied over an Inductive Line

66. In this case, the admittance of the receiver circuit is $Y = g$, since $b = 0$.

We have then

current,

$$I_0 = E_0 g;$$

impressed voltage:

$$E_0 = E + Z_0 I_0 = E(1 + Z_0 g).$$

Hence—voltage at receiver circuit,

$$E = \frac{\dot{E}_0}{1 + Z_0 g} = \frac{\dot{E}_0}{1 + gr_0 + jgx_0};$$

current,

$$I_0 = \frac{\dot{E}_0 g}{1 + Z_0 g} = \frac{\dot{E}_0 g}{1 + gr_0 + jgx_0}.$$

Hence, in absolute values—voltage at receiver circuit,

$$\dot{E} = \frac{\dot{E}_0}{\sqrt{(1 + gr_0)^2 + g^2x_0^2}};$$

current,

$$I_0 = \frac{\dot{E}_0g}{\sqrt{(1 + gr_0)^2 + g^2x_0^2}}.$$

The ratio of e.m.fs. at receiver circuit and at generator, or supply circuit, is

$$\alpha = \frac{E}{E_0} = \frac{1}{\sqrt{(1 + gr_0)^2 + g^2x_0^2}};$$

and the power delivered in the non-inductive receiver circuit, or output,

$$P = I_0E = \frac{E_0^2g}{(1 + gr_0)^2 + g^2x_0^2}.$$

As a function of g , and with a given E_0 , r_0 , and x_0 , this power is a maximum, if

$$\frac{dP}{dg} = 0;$$

that is,

$$-1 + g^2r_0^2 + g^2x_0^2 = 0;$$

hence,

conductance of receiver circuit for maximum output,

$$g_m = \frac{1}{\sqrt{r_0^2 + x_0^2}} = \frac{1}{z_0}.$$

Resistance of receiver circuit, $r_m = \frac{1}{g_m} = z_0$;

and, substituting this in P ,

$$\text{Maximum output, } P_m = \frac{E_0^2}{2(r_0 + z_0)} = \frac{E_0^2}{2\{r_0 + \sqrt{r_0^2 + x_0^2}\}};$$

and ratio of e.m.f. at receiver and at generator end of line,

$$\alpha_m = \frac{E}{E_0} = \frac{1}{\sqrt{2\left(1 + \frac{r_0}{z_0}\right)}};$$

efficiency,

$$\frac{r_m}{r_m + r_0} = \frac{z_0}{r_0 + z_0}.$$

That is:

The output which can be transmitted over an inductive line of resistance, r_0 , and reactance, x_0 —that is, of impedance, z_0 —into a

non-inductive receiver circuit, is a maximum if the resistance of the receiver circuit equals the impedance of the line, $r = z_0$, and is

$$P_m = \frac{E_0^2}{2(r_0 + z_0)}$$

The output is transmitted at the efficiency of

$$\frac{z_0}{r_0 + z_0},$$

and with a ratio of e.m.fs. of

$$\alpha_m = \frac{1}{\sqrt{2\left(1 + \frac{r_0}{z_0}\right)}}$$

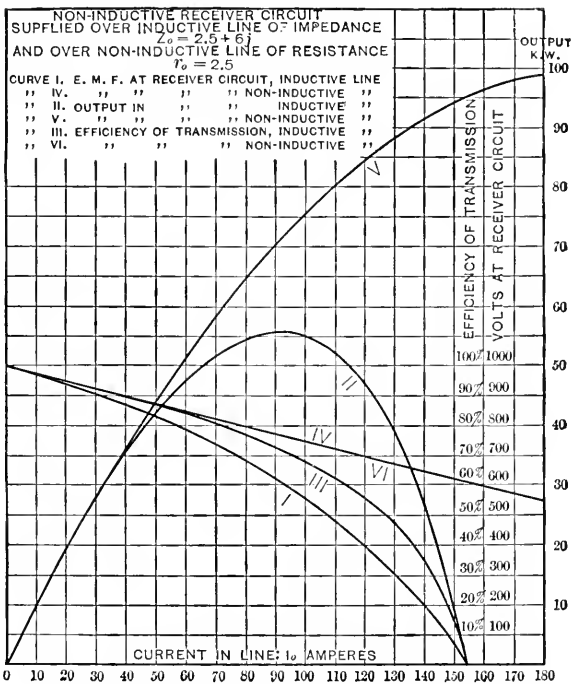

FIG. 69.—Non-inductive receiver-circuit supplied over inductive line.

67. We see from this that the maximum output which can be delivered over an inductive line is less than the output delivered over a non-inductive line of the same resistance—that is, which can be delivered by continuous currents with the same generator potential.

In Fig. 69 are shown, for the constants,

$E_0 = 1000$ volts, $Z_0 = 2.5 + 6j$; that is, $r_0 = 2.5$ ohms, $x_0 = 6$ ohms, $z_0 = 6.5$ ohms, with the current I_0 as abscissas, the values.

e.m.f. at receiver circuit, E ,	(Curve I);
output of transmission, P ,	(Curve II);
efficiency of transmission,	(Curve III).

The same quantities for a non-inductive line of resistance, $r_0 = 2.5$ ohms, $x_0 = 0$, are shown in Curves IV, V, and VI.

2. Maximum Power Supplied over an Inductive Line

68. If the receiver circuit contains the susceptance, b , in addition to the conductance, g , its admittance can be written thus:

$$Y = g - jb, \quad y = \sqrt{g^2 + b^2}.$$

Then, current, $I_0 = EY$;

Impressed voltage, $E_0 = E + I_0 Z_0 = E(1 + YZ_0)$.

Hence, voltage at receiver terminals,

$$E = \frac{\dot{E}_0}{1 + YZ_0} = \frac{\dot{E}_0}{(1 + r_{0g} + x_0b) + j(x_{0g} - r_0b)};$$

current,

$$I_0 = \frac{\dot{E}_0 Y}{1 + YZ_0} = \frac{\dot{E}_0(g - jb)}{(1 + r_{0g} + x_0b) + j(x_{0g} - r_0b)};$$

or, in absolute values, voltage at receiver circuit,

$$E = \frac{E_0}{\sqrt{(1 + r_{0g} + x_0b)^2 + (x_{0g} - r_0b)^2}};$$

current,

$$I_0 = E_0 \sqrt{\frac{g^2 + b^2}{(1 + r_{0g} + x_0b)^2 + (x_{0g} - r_0b)^2}};$$

ratio of e.m.fs. at receiver circuit and at generator circuit,

$$\alpha = \frac{E}{E_0} = \frac{1}{\sqrt{(1 + r_{0g} + x_0b)^2 + (x_{0g} - r_0b)^2}};$$

and the output in the receiver circuit is

$$P = E^2 g = E_0^2 \alpha^2 g.$$

69. (a) *Dependence of the output upon the susceptance of the receiver circuit.*

At a given conductance, g , of the receiver circuit, its output, $P = E_0^2 \alpha^2 g$, is a maximum if α^2 is a maximum; that is, when

$$f = \frac{1}{\alpha^2} = (1 + r_{0g} + x_0b)^2 + (x_{0g} - r_0b)^2$$

is a minimum.

The condition necessary is

$$\frac{df}{db} = 0,$$

or, expanding,

$$x_0(1 + r_0g + x_0b) - r_0(x_0g - r_0b) = 0.$$

Hence

Susceptance of receiver circuit,

$$b = -\frac{x_0^2}{r_0^2 + x_0^2} = -\frac{x_0}{z_0^2} = -b_0;$$

or

$$b + b_0 = 0,$$

that is, if the sum of the susceptances of line and of receiver circuit equals zero.

Substituting this value, we get

ratio of e.m.fs. at maximum output,

$$\alpha_1 = \frac{E}{E_0} = \frac{1}{z_0(g + g_0)};$$

maximum output,

$$P_1 = \frac{E_0^2g}{z_0^2(g + g_0)^2};$$

current,

$$\begin{aligned} I_0 &= \frac{\dot{E}_0 Y}{1 + Z_0 Y} = \frac{\dot{E}_0(g + jb_0)}{1 + (r_0 + jx_0)(g + jb_0)} \\ &= \frac{\dot{E}_0(g + jb_0)}{(1 + r_0g - x_0b_0) - j(r_0b_0 + x_0g)}; \\ I_0 &= E_0 \sqrt{\frac{g^2 + b_0^2}{(1 + r_0g - x_0b_0)^2 + (r_0b_0 + x_0g)^2}}; \end{aligned}$$

and, since,

$$b_0 = \frac{x_0}{r_0^2 + x_0^2}, \quad g_0 = \frac{r_0}{r_0^2 + x_0^2},$$

it is,

$$\begin{aligned} (1 + r_0g - x_0b_0)^2 + (r_0b_0 + x_0g)^2 &= \left(r_0g + 1 - \frac{x_0^2}{r_0^2 + b^2}\right)^2 \\ &\quad + \left(\frac{r_0x_0}{r_0^2 + x_0^2} + x_0g\right)^2 \\ &= \left(r_0g + \frac{r_0^2}{r_0^2 + x_0^2}\right)^2 + \left(x_0g + \frac{r_0x_0}{r_0^2 + x_0^2}\right)^2 \\ &= r_0^2(g + g_0)^2 + x_0^2(g + g_0)^2 \\ &= z_0^2(g + g_0)^2, \end{aligned}$$

Thus, it is, current,

$$I_0 = \frac{E_0 \sqrt{g^2 + b_0^2}}{z_0(g + g_0)};$$

phase difference in receiver circuit,

$$\tan \theta = \frac{b}{g} = -\frac{b_0}{g};$$

phase difference in generator circuit,

$$\tan \theta_0 = \frac{x + x_0}{r + r_0} = \frac{b_0(y^2 - y_0^2)}{g_0y^2 + gy_0^2}.$$

70. (b) *Dependence of the output upon the conductance of the receiver circuit.*

At a given susceptance, b , of the receiver circuit, its output, $P = E_0^2 \alpha^2 g$, is a maximum if

$$\frac{dP}{dg} = 0, \quad \text{or} \quad \frac{d}{dg} \left(\frac{1}{P} \right) = 0,$$

or

$$\frac{d}{dg} \left(\frac{1}{\alpha^2 g} \right) = \frac{d}{dg} \left(\frac{(1 + r_0g + x_0b)^2 + (x_0g - r_0b)^2}{g} \right) = 0;$$

that is, expanding,

$$(1 + r_0g + x_0b)^2 + (x_0g - r_0b)^2 - 2g(r_0 + r_0^2g + x_0^2g) = 0;$$

or, expanding,

$$(b + b_0)^2 = g^2 - g_0^2; \quad g = \sqrt{g_0^2 + (b + b_0)^2}.$$

Substituting this value in the equation for α , §68, we get—ratio of e.m.fs.,

$$\begin{aligned} \alpha_2 &= \frac{1}{z_0 \sqrt{2\{g_0^2 + (b + b_0)^2 + g_0\sqrt{g_0^2 + (b + b_0)^2}\}}} \\ &= \frac{1}{z_0 \sqrt{2} g(g + g_0)} = \frac{y_0}{\sqrt{2} g(g + g_0)}; \end{aligned}$$

power,

$$\begin{aligned} P_2 &= \frac{E_0^2 y_0^2}{2(g + g_0)} = \frac{E_0^2 y_0^2}{2^2\{g_0 + \sqrt{g_0^2 + (b + b_0)^2}\}} \\ &= \frac{E_0^2}{2 \left\{ r_0 + \sqrt{r_0^2 + \left(x_0 + x \frac{z_0^2}{z^2} \right)^2} \right\}}. \end{aligned}$$

As a function of the susceptance, b , this power becomes a maximum for $\frac{dP_2}{db} = 0$, that is, according to §69 if

$$b = -b_0.$$

Substituting this value, we get

$$\begin{aligned} b &= -b_0, \quad g = g_0, \quad y = y_0, \quad \text{hence:} \quad Y = g - jb = g_0 + jb_0; \\ x &= -x_0, \quad r = r_0, \quad z = z_0, \quad Z = r + jx = r_0 - jx_0; \end{aligned}$$

substituting this value, we get—

$$\text{ratio of e.m.f.s.,} \quad \alpha_m = \frac{y_0}{2g_0} = \frac{z_0}{2r_0};$$

$$\text{power,} \quad P_m = \frac{E_0^2}{4r_0};$$

that is, the same as with a continuous-current circuit; or, in other words, the inductive reactance of the line and of the receiver circuit can be perfectly balanced in its effect upon the output.

71. As a summary, we thus have:

The output delivered over an inductive line of impedance, $Z_0 = r_0 + jx_0$, into a non-inductive receiver circuit, is a maximum for the resistance, $r = z_0$, or conductance, $g = y_0$, of the receiver circuit, and this maximum is

$$P = \frac{E_0^2}{2(r_0 + z_0)},$$

at the ratio of voltages,

$$\alpha = \frac{1}{\sqrt{2\left(1 + \frac{r_0}{z_0}\right)}}.$$

With a receiver circuit of constant susceptance, b , the output, as a function of the conductance, g , is a maximum for the conductance,

$$g = \sqrt{g_0^2 + (b + b_0)^2},$$

and is

$$P = \frac{E_0^2 y_0^2}{2(g + g_0)},$$

at the ratio of voltages,

$$\alpha = \frac{y_0}{\sqrt{2g(g + g_0)}}.$$

With a receiver circuit of constant conductance, g , the output, as a function of the susceptance, b , is a maximum for the susceptance $b = -b_0$, and is

$$P = \frac{E_0^2 g}{z_0^2 (g + g_0)^2},$$

at the ratio of voltages,

$$\alpha = \frac{1}{z_0 (g + g_0)}.$$

The maximum output which can be delivered over an inductive line, as a function of the admittance or impedance of the receiver circuit, takes place when $Z = r_0 - jx_0$, or $Y = g_0 + jb_0$; that is, when the resistance or conductance of receiver circuit and line are equal, the reactance or susceptance of the receiver circuit and line are equal but of opposite sign, and is $P = \frac{E_0^2}{4r_0}$, or independent of the reactances, but equal to the output of a

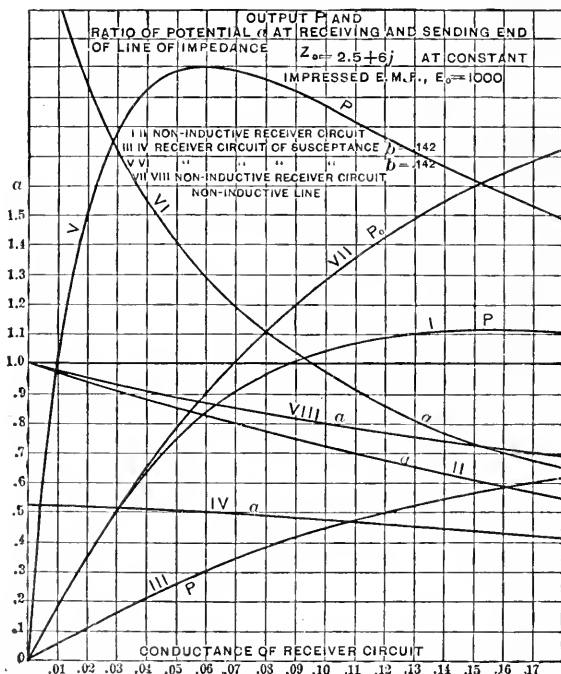

FIG. 70.—Variation of the potential in line at different loads.

continuous-current circuit of equal line resistance. The ratio of voltages is, in this case, $\alpha = \frac{z_0}{2r_0}$, while in a continuous-current circuit it is equal to 0.5. The efficiency is equal to 50 per cent.

72. As an example, in Fig. 70 are shown for the constants

$$E_0 = 1000 \text{ volts, and } Z_0 = 2.5 + 6j; \text{ that is, for} \\ r_0 = 2.5 \text{ ohms, } x_0 = 6 \text{ ohms, } z_0 = 6.5 \text{ ohms,}$$

and with the variable conductances as abscissas, the values of the output, in Curve I, Curve III, and Curve V; ratio of voltages, in Curve II, Curve IV, and Curve VI; Curves I and II refer to a non-inductive receiver circuit; Curves III and IV refer to a receiver circuit of constant susceptance $b = 0.142$

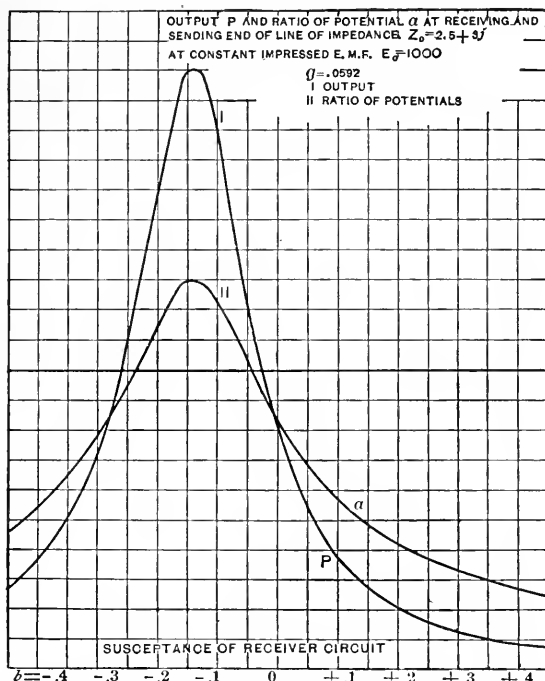

FIG. 71.—Variation of the potential in line at various loads.

Curves V and VI refer to a receiver circuit of constant susceptance $b = -0.142$
 Curves VII and VIII refer to a non-inductive receiver circuit and non-inductive line.

In Fig. 71 the output is shown as Curve I, and the ratio of voltages as Curve II, for the same line constants, for a constant conductance, $g = 0.0592$ ohm, and for variable susceptances, b , of the receiver circuit.

3. Maximum Efficiency

73. The output for a given conductance, g , of a receiver circuit is a maximum if $b = -b_0$. This, however, is generally not the condition of maximum efficiency.

The loss of power in the line is constant if the current is constant; the output of the generator for a given current and given generator voltage is a maximum if the current is in phase with the voltage at the generator terminals. Hence the condition of maximum output at given loss, or of maximum efficiency is

$$\tan \theta_0 = 0.$$

The current is

$$I_0 = \frac{\dot{E}_0}{Z + Z_0} = \frac{\dot{E}_0}{(r + r_0) + j(x + x_0)};$$

The current, I_0 , is in phase with the e.m.f., E_0 , if its quadrature component—that is, the imaginary term—disappears, or

$$x + x_0 = 0.$$

This, therefore, is the condition of maximum efficiency,

$$x = -x_0.$$

Hence, the condition of maximum efficiency is that the reactance of the receiver circuit shall be equal, but of opposite sign, to the reactance of the line.

Substituting $x = -x_0$, we have:

ratio of e.m.fs.,

$$\alpha = \frac{E}{E_0} = \frac{z}{(r + r_0)} = \frac{\sqrt{r^2 + x_0^2}}{(r + r_0)};$$

power,

$$P = E_0^2 g \alpha^2 = \frac{E_0^2 r}{(r + r_0)^2},$$

and depending upon the resistance only, and not upon the reactance.

This power is a maximum if $g = g_0$, as shown before; hence, substituting $g = g_0$, $r = r_0$,

maximum power at maximum efficiency, $P_m = \frac{E_0^2}{4r_0}$,

at a ratio of potentials, $\alpha_m = \frac{z_0}{2r_0}$,

or the same result as in §70.

In Fig. 72 are shown, for the constants,
 $E_0 = 100$ volts,
 $Z_0 = 2.5 + 6j$; $r_0 = 2.5$ ohms, $x_0 = 6$ ohms, $z_0 = 6.5$ ohms,
 and with the variable conductances, g , of the receiver circuit
 as abscissas, the

- Output at maximum efficiency, (Curve I);
 Volts at receiving end of line, (Curve II);
 Efficiency = $\frac{r}{r + r_0}$, (Curve III).

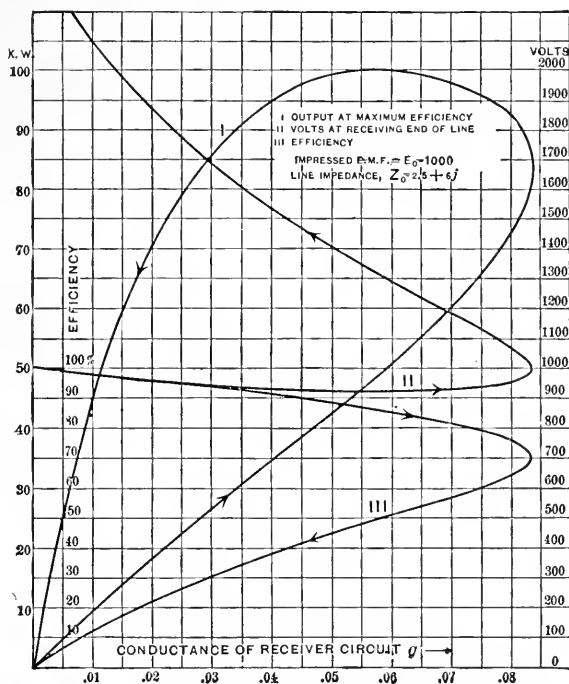

FIG. 72.—Load characteristics of transmission lines.

4. Control of Receiver Voltage by Shunted Susceptance

74. By varying the susceptance of the receiver circuit, the voltage at the receiver terminals is varied greatly. Therefore, since the susceptance of the receiver circuit can be varied at will, it is possible, at a constant generator voltage, to adjust the receiver susceptance so as to keep the voltage constant at the receiver end of the line, or to vary it in any desired manner, and independently of the generator voltage, within certain limits.

The ratio of voltages is

$$\alpha = \frac{E}{E_0} = \frac{1}{\sqrt{(1 + r_0g + x_0b)^2 + (x_0g - r_0b)^2}}$$

If at constant generator voltage E_0 the receiver voltage E shall be constant,

$$\alpha = \text{constant};$$

hence,

$$(1 + r_0g + x_0b)^2 + (x_0g - r_0b)^2 = \frac{1}{\alpha^2};$$

or, expanding,

$$b = -b_0 + \sqrt{\left(\frac{y_0}{\alpha}\right)^2 - (g + g_0)^2},$$

which is the value of the susceptance, b , as a function of the receiver conductance—that is, of the load—which is required to yield constant voltage, αE_0 , at the receiver circuit.

For increasing g , that is, for increasing load, a point is reached where, in the expression

$$b = -b_0 + \sqrt{\left(\frac{y_0}{\alpha}\right)^2 - (g + g_0)^2},$$

the term under the root becomes negative, and b thus imaginary, and it thus becomes impossible to maintain a constant voltage, αE_0 . Therefore the maximum output which can be transmitted at voltage, αE_0 , is given by the expression

$$\sqrt{\left(\frac{y_0}{\alpha}\right)^2 - (g + g_0)^2} = 0;$$

hence the susceptance of receiver circuit is $b = -b_0$, and the conductance of receiver circuit is $g = -g_0 + \frac{y_0}{\alpha}$,

$$P = E_0^2 g \alpha^2 = \alpha^2 E_0^2 \left(\frac{y_0}{\alpha} - g_0 \right), \text{ the output.}$$

75. If $\alpha = 1$, that is, if the voltage at the receiver circuit equals the generator voltage,

$$g = y_0 - g_0; P = E_0^2 (y_0 - g_0).$$

If $\alpha = 1$, when $g = 0$, $b = 0$
when $g > 0$, $b < 0$;

if $\alpha > 1$, when $g = 0$, or $g > 0$, $b < 0$,
that is, condensive reactance;

if $\alpha < 1$, when $g = 0$, $b > 0$,

$$\text{when } g = -g_0 + \sqrt{\left(\frac{y_0}{\alpha}\right)^2 - b_0^2}, \quad b = 0;$$

$$\text{when } g > -g_0 + \sqrt{\left(\frac{y_0}{\alpha}\right)^2 - b_0^2}, \quad b < 0,$$

or, in other words, if $\alpha < 1$, the phase difference in the main line must change from lag to lead with increasing load.

76. The value of α giving the maximum possible output in a receiver circuit is determined by $\frac{dP}{d\alpha} = 0$;

$$\text{expanding} \quad 2\alpha\left(\frac{y_0}{\alpha} - g_0\right) - \frac{\alpha^2 y_0^2}{\alpha^2} = 0;$$

$$\text{hence} \quad y_0 = 2\alpha g_0,$$

$$\text{and} \quad \alpha = \frac{y_0}{2g_0} = \frac{1}{2\sqrt{g_0 r_0}} = \frac{z_0}{2r_0};$$

the maximum output is determined by

$$g = -g_0 + \frac{y_0}{\alpha} = g_0;$$

$$\text{and is,} \quad P = \frac{E_0^2}{4r_0}.$$

$$\text{From} \quad \alpha = \frac{y_0}{2g_0} = \frac{z_0}{2r_0},$$

the line reactance, x_0 , can be found, which delivers a maximum output into the receiver circuit at the ratio of voltages, α , as

$$\begin{aligned} z_0 &= 2r_0\alpha, \\ x_0 &= r_0\sqrt{4\alpha^2 - 1}; \end{aligned}$$

for $\alpha = 1$,

$$\begin{aligned} z_0 &= 2r_0; \\ x_0 &= r_0\sqrt{3}. \end{aligned}$$

If, therefore, the line impedance equals 2α times the line resistance, the maximum output, $P = \frac{E_0^2}{4r_0}$, is transmitted into the receiver circuit at the ratio of voltages, α .

If $z_0 = 2r_0$, or $x_0 = r_0\sqrt{3}$, the maximum output, $P = \frac{E_0^2}{4r_0}$, can be supplied to the receiver circuit, without change of voltage at the receiver terminals.

Obviously, in an analogous manner, the law of variation of the susceptance of the receiver circuit can be found which is required to increase the receiver voltage proportionally to

the load; or, still more generally, to cause any desired variation of the voltage at the receiver circuit independently of any variation of the generator voltage, as, for instance, to keep the voltage of a receiver circuit constant, even if the generator voltage fluctuates widely.

77. In Figs. 73, 74, and 75 are shown, with the output, $P = E_0^2 g \alpha^2$, as abscissas, and a constant impressed voltage,

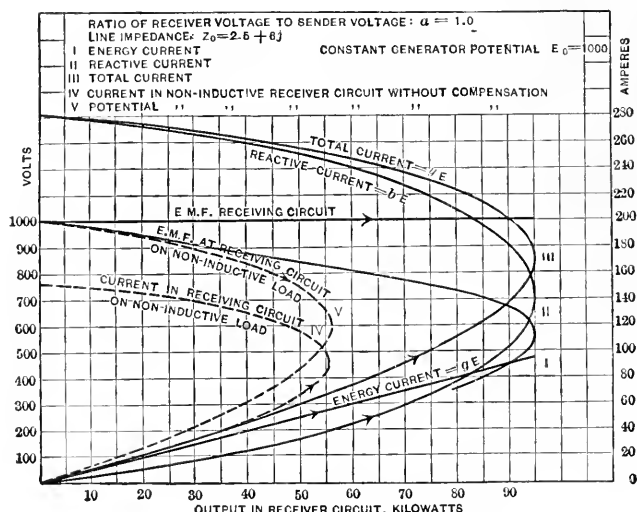

FIG. 73.—Variation of voltage of transmission lines.

$E_0 = 1000$ volts, and a constant line impedance, $Z_0 = 2.5 + 6j$, or $r_0 = 2.5$ ohms, $x_0 = 6$ ohms, $z = 6.5$ ohms, the following values:

power component of current, gE , (Curve I);
 reactive, or wattless component of current, bE , (Curve II);
 total current, yE , (Curve III),
 and power factor at generator for the following conditions:

$\alpha = 1.0$ (Fig. 73); $\alpha = 0.7$ (Fig. 74); $\alpha = 1.3$ (Fig. 75).

For the non-inductive receiver circuit (in dotted lines), the curve of e.m.f., E , and of the current, $I = gE$, are added in the three diagrams for comparison, as Curves IV and V.

As shown, the output can be increased greatly, and the voltage at the same time maintained constant, by the judicious

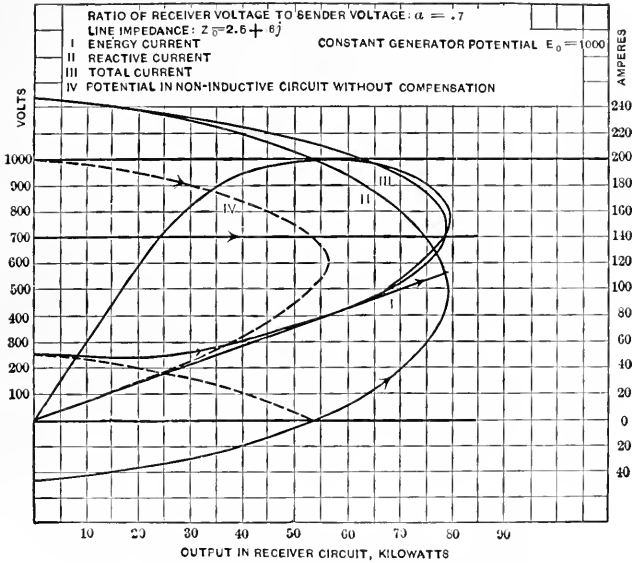

Fig. 74.—Variation of voltage of transmission lines.

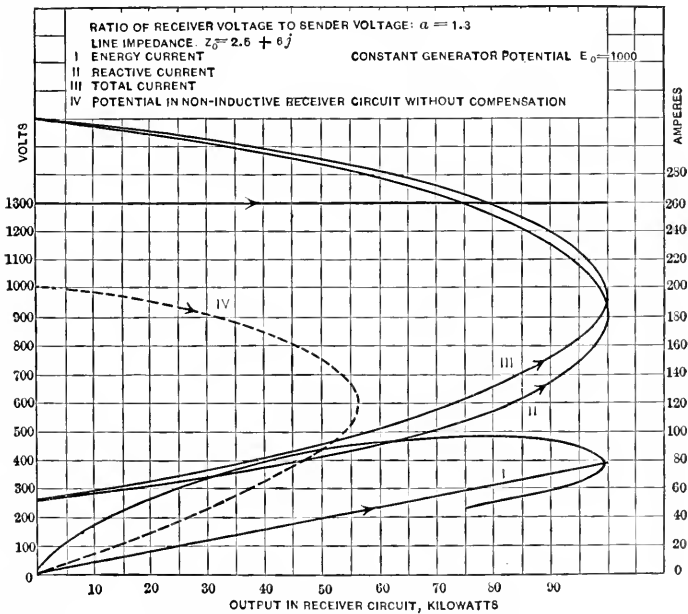

Fig. 75.—Variation of voltage of transmission lines.

use of shunted reactance, so that a much larger output can be transmitted over the line with no drop, or even with a rise, of voltage. Shunted susceptance, therefore, is extensively used for voltage control of transmission lines, by means of synchronous condensers, or by synchronous converters with compound field winding.

5. Maximum Rise of Voltage at Receiver Circuit

78. Since, under certain circumstances, the voltage at the receiver circuit may be higher than at the generator, it is of interest to determine what is the maximum value of voltage, E , that can be produced at the receiver circuit with a given generator voltage, E_0 .

The condition is that

$$\alpha = \text{maximum or } \frac{1}{\alpha^2} = \text{minimum};$$

that is,

$$\frac{d\left(\frac{1}{\alpha^2}\right)}{dg} = 0, \quad \frac{d\left(\frac{1}{\alpha^2}\right)}{db} = 0;$$

substituting,

$$\frac{1}{\alpha^2} = (1 + r_0g + x_0b)^2 + (x_0g - r_0b)^2,$$

and expanding, we get,

$$\frac{d\left(\frac{1}{\alpha^2}\right)}{dg} = 0; \quad g = -\frac{r_0}{z_0^2}$$

—a value which is impossible, since neither r_0 nor g can be negative. The next possible value is $g = 0$ —a wattless circuit.

Substituting this value, we get,

$$\frac{1}{\alpha^2} = (1 + x_0b)^2 + r_0^2b^2;$$

and by substituting, in

$$\frac{d\left(\frac{1}{\alpha^2}\right)}{db} = 0, \quad b = -\frac{x_0}{z_0^2} = -b_0,$$

$$b + b_0 = 0;$$

that is, the sum of the susceptances = 0, or the inductive susceptance of the line is balanced by the capacity susceptance of the load.

Substituting

$$b = -b_0,$$

we have

$$\alpha = \frac{1}{\sqrt{r_0 g_0}} = \frac{z_0}{r_0} = \frac{y_0}{g_0}.$$

The current in this case is

$$I = \alpha b E_0 = \frac{x_0 E_0}{z_0 r_0},$$

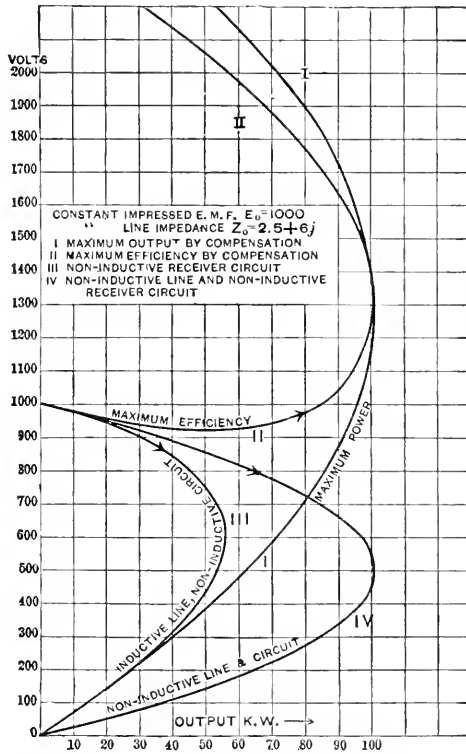

FIG. 76.—Efficiency and output of transmission lines.

or somewhat less than the current at complete resonance, that is, when the line inductive reactance, x_0 , is balanced by the capacity reactance, x , of the load, $x = -x_0$; in which latter case the current is

$$I' = \frac{E_0}{r_0},$$

assuming wattless receiver circuit, and is in phase with the voltage, E_0 .

79. As summary to this chapter, in Fig. 76 are plotted, for a constant generator e.m.f., $E_0 = 1000$ volts, and a line impedance, $Z_0 = 2.5 + 6j$, or $r_0 = 2.5$ ohms, $x_0 = 6$ ohms, $z_0 = 6.5$ ohms, and with the receiver output as abscissas and the receiver voltages as ordinates, curves representing

the condition of maximum output, (Curve I);

the condition of maximum efficiency, (Curve II);

the condition $b = 0$, or a non-inductive receiver circuit, (Curve III);

the condition $b = 0$, $b_0 = 0$, or a non-inductive line and non-inductive receiver circuit.

In conclusion, it may be remarked here that of the sources of susceptance, or reactance,

a choking coil or reactive coil corresponds to an inductive reactance;

a condenser corresponds to a condensive reactance;

a polarization cell corresponds to a condensive reactance;

a synchronous machine (motor, generator or converter) corresponds to an inductive or a condensive reactance at will;

an induction motor or generator corresponds to an inductive reactance.

The reactive coil and the polarization cell are specially suited for series reactance, and the condenser and synchronous machine for shunted susceptance.

CHAPTER XI

PHASE CONTROL

80. At constant voltage, e_0 , impressed upon a circuit, as a transmission line, resistance, r , inserted in series with the receiving circuit, causes the voltage, e , at the receiver circuit to decrease with increasing current, I , through the resistance. The decrease of the voltage, e , is greatest if the current, I , is in phase with the voltage, e —less if the current is not in phase. Inductive reactance in series with the receiving circuit, e , at constant impressed e.m.f., e_0 , causes the voltage, e , to drop less with a unity power-factor current, I , but far more with a lagging current, and causes the voltage, e , to rise with a leading current.

While series resistance always causes a drop of voltage, series inductive reactance, x , may cause a drop of voltage or a rise of voltage, depending on whether the current is lagging or leading. If the supply line contains resistance, r , as well as reactance, x , and the phase of the current, I , can be varied at will, by producing in the receiver circuit lagging or leading currents, the change of voltage, e , with a change of load in the circuit can be controlled. For instance, by changing the current from lagging at no-load to lead at heavy load the reactance, x , can be made to lower the voltage at light load and raise it at overload, and so make up for the increasing drop of voltage with increasing load, caused by the resistance, r , that is, to maintain constant voltage, or even a voltage, e , which rises with the load on the receiving circuit, at constant voltage, e_0 , at the generator side of the line. Or the wattless component of the current can be varied so as to maintain unity power-factor at the generator end of the line, e_0 , etc.

This method of controlling a circuit supplied over an inductive line, by varying the phase relation of the current in the circuit, has been called "phase control," and is used to a great extent, especially in the transmission of three-phase power for conversion to direct current by synchronous converters for

railroading, and in the voltage control at the receiving end of very long high voltage transmission lines.

It requires a receiving circuit in which, independent of the load, a lagging or leading component of current can be produced at will. Such is the case in synchronous motors or converters: in a synchronous motor a lagging current can be produced by decreasing, a leading current by increasing, the field excitation.

81. If in a direct-current motor, at constant impressed voltage, the field excitation and therefore the field magnetism is decreased, the motor speed increases, as the armature has to revolve faster to consume the impressed e.m.f., and if the field excitation is increased, the motor slows down. A synchronous motor, however, cannot vary in speed, since it must keep in step with the impressed frequency, and if, therefore, at constant impressed voltage the field excitation is decreased below that which gives a field magnetism, that at the synchronous speed consumes the impressed voltage, the field magnetism still must remain the same, and the armature current thus changes in phase in such a manner as to magnetize the field and make up for the deficiency in the field excitation. That is, the armature current becomes lagging. Inversely, if the field excitation of the synchronous motor is increased, the magnetic flux still must remain the same as to correspond to the impressed voltage at synchronous speed, and the armature current so becomes demagnetizing—that is, leading.

By varying the field excitation of a synchronous motor or converter, quadrature components of current can be produced at will, proportional to the variation of the field excitation from the value that gives a magnetic flux, which at synchronous speed just consumes the impressed voltage (after allowing for the impedance of the motor).

Phase control of transmission lines is especially suited for circuits supplying synchronous motors or converters; since such machines, in addition to their mechanical or electrical load, can with a moderate increase of capacity carry or produce considerable values of wattless current. For instance, a quadrature component of current equal to 50 per cent. of the power component of current consumed by a synchronous motor would increase the total current only to $\sqrt{1 + 0.5^2} = 1.118$, or 11.8 per cent., while a quadrature component of current equal to 30 per cent. of the power component of the current would give an

increase of 4.4 per cent. only, that is, could be carried by the motor armature without any appreciable increase of the motor heating.

Phase control depends upon the inductive reactance of the line or circuit between generating and receiving voltage, e_0 and e , and where the inductive reactance of the transmission line is not sufficient, additional reactance may be inserted in the form of reactive coils or high internal reactance transformers. This is usually the case in railway transmissions to synchronous converters. Phase control is extensively used for voltage control in railway power transmission by compounded synchronous converters. It is also used to a considerable extent in very long distance transmission, for controlling the voltage and the power-factor; in a distribution system for controlling the power-factor of the system.

While, therefore, the resistance, r , of the line is fixed, as it would not be economical to increase it, the reactance, x , can be increased beyond that given by line and transformer, by the insertion of reactive coils, and therefore can be adjusted so as to give best results in phase control, which are usually obtained when the quadrature component of the current is a minimum.

82. Let, then,

e = voltage at receiving circuit, chosen as zero vector.

$I = i - ji'$ = current in receiving circuit, comprising a power component, i , which depends upon the load in the receiving circuit, and a quadrature component, i' , which can be varied to suit the requirements of regulation, and is considered positive when lagging, negative when leading.

$E_0 = e'_0 - je''_0$ = voltage impressed upon the system at the generator end, or supply voltage, and the absolute value is

$$e_0 = \sqrt{e'_0{}^2 + e''_0{}^2}.$$

$Z = r + jx$ = impedance of the circuit between voltage e and voltage e_0 , and the absolute value is $z = \sqrt{r^2 + x^2}$.

If e = terminal voltage of receiving station, e_0 = terminal voltage of generating station, Z = impedance of transmission line; if e = nominal induced e.m.f. of receiving synchronous machine, that is, voltage corresponding to its field excitation, and e_0 = nominal induced e.m.f. of generator, Z also includes the synchronous impedance of both machines, and of step-up and step-down transformers, where used,

It is

$$E_0 = e + ZI,$$

or,

$$E_0 = (e + ri + xi') - j(ri' - xi), \quad (1)$$

and in absolute value we have

$$e_0^2 = (e + ri + xi')^2 + (ri' - xi)^2. \quad (2)$$

This is the fundamental equation of phase control, giving the relation of the two voltages, e and e_0 , with the two components of current, i and i' , and the circuit constants r and x .

From equation (2), follows:

$$e = \sqrt{e_0^2 - (ri' - xi)^2} - (ri + xi'), \quad (3)$$

expressing the receiver voltage, e , as a function of e_0 and I .

And:

$$i' = \pm \sqrt{\frac{e_0^2}{z^2} - \left(\frac{er}{z^2} + i\right)^2} - \frac{ex}{z^2}. \quad (4)$$

Denoting

$$\tan \theta = \frac{x}{r}, \quad (5)$$

where θ is the phase angle of the line impedance, we have

$$r = z \cos \theta \text{ and } x = z \sin \theta \quad (6)$$

and

$$i' = \pm \sqrt{\frac{e_0^2}{z^2} - \left(\frac{e \cos \theta}{z} + i\right)^2} - \frac{e \sin \theta}{z}, \quad (7)$$

gives the reactive component of the current, i' , required by the power component of the current, i , at the voltages, e and e_0 .

83. The phase angle of the impressed e.m.f., E_0 , is, from (1),

$$\tan \theta_0 = \frac{ri' - xi}{e + ri + xi'}, \quad (8)$$

the phase angle of the current

$$\tan \theta_1 = \frac{i'}{i}, \quad (9)$$

hence, to bring the current, I , into phase with the impressed e.m.f., E_0 , or produce unity power-factor at the generator terminal, e_0 , it must be

$$\theta_0 = \theta_1;$$

hence,

$$\frac{ri' - xi'}{e + ri + xi'} = \frac{i'}{i},$$

and herefrom follows:

$$i' = \frac{\pm \sqrt{e^2 - 4x^2i^2} - e}{2x}, \tag{10}$$

hence always negative, or leading, but $i' = 0$ for $i = 0$, or at no-load.

From equation (10) follows that i' becomes imaginary, if the term under the square root, $(e^2 - 4x^2i^2)$, becomes negative, that is, if

$$i > \frac{e}{2x},$$

that is, the maximum load, or power component of current, at which unity power-factor can still be maintained at the supply voltage, e_0 , is given by

$$i_m = \frac{e}{2x}, \tag{11}$$

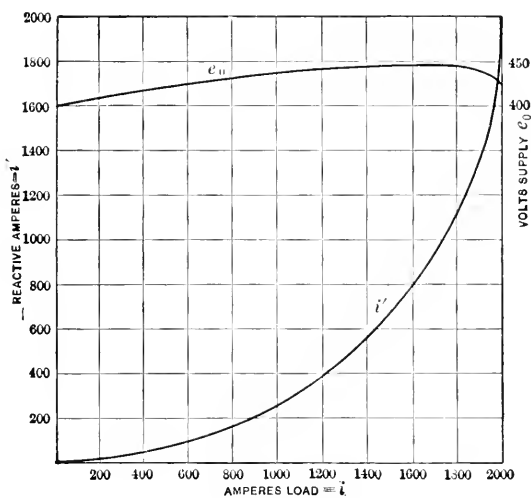

FIG. 77.

and the leading quadrature component of current required to compensate for the line reactance x at maximum current, i_m , is from equation (10),

$$i_m' = \frac{e}{2x}, \tag{12}$$

that is, in this case of the maximum load which can be delivered at e , with unity power-factor at e_0 , the total current, I , leads the receiver voltage, e , by 45° .

Substituting the value, i' , of equation (10), which compensates for the line reactance, x , and so gives unity power-factor at e_0 , into equation (2), gives as required supply voltage e_0 .

$$e_0 = \frac{e^2 z^2}{2 x^2} + \frac{(x - r) (e - 2 i x) \sqrt{e^2 - 4 i^2 x^2}}{2 x} \tag{13}$$

As illustration are shown, in Fig. 77, with the load current, i , as abscissas, the values of leading quadrature component of current, i' , and of generator voltage, e_0 , for the constants $e = 400$ volts; $r = 0.05$ ohm, and $x = 0.10$ ohm.

84. More frequently than for controlling the power-factor, phase control is used for controlling the voltage, that is, to maintain the receiver voltage, e , constant, or raise it with increasing load, i , at constant generator voltage, e_0 .

In this case, equation (4) gives the quadrature component of current, i' , required by current, i , at constant receiver voltage, e , and constant generator voltage, e_0 .

Since the equation (4) of i' contains a square root, the maximum value of i , that is, the maximum load which can be carried at constant voltage, e and e_0 , is given by equating the term under the square root to zero

$$\frac{e_0^2}{z^2} - \left(\frac{er}{z^2} + i \right)^2 = 0;$$

as

$$i_m = \frac{e_0 z - er}{z^2} = \frac{e_0 - e \cos \theta}{z} \tag{14}$$

and the corresponding quadrature component of current, by (4), is

$$i'_m = - \frac{ex}{z^2} = - \frac{e \sin \theta}{z} \tag{15}$$

that is, leading.

From equation (14) follows as the impedance, z , which, at constant line-resistance, r , gives the maximum value of i_m

$$\frac{di_m}{dz} = 0;$$

hence,

$$z_m = 2 r \frac{e}{e_0} \tag{16}$$

and for this value of impedance, z_m , substituting in (14) and (15)

$$i_{mm} = \frac{e_0^2}{4r}, \quad \text{and} \quad i'_{mm} = \frac{e_0^2}{4r} \tag{17}$$

The maximum load, i , which can be delivered at constant voltage, e , therefore depends upon the line impedance, and the voltages, e and e_0 .

Since e_0 and e are not very different from each other, the ratio $\frac{e}{e_0}$ in equation (16) is approximately unity, and the impedance, z , which permits maximum load to be transmitted, is approximately twice the line resistance, r , or rather slightly less.

$$z \leq 2r,$$

gives

$$x \leq r\sqrt{3}.$$

A relatively low line-reactance, x , so gives maximum output. In practice, a far higher reactance, x , is used, since it gives sufficient output and a lesser quadrature component of current.

By substituting $i = 0$ in equation (4), the value of the quadrature component of current at no-load is found as

$$\left. \begin{aligned} i'_0 &= \frac{\sqrt{e_0^2 z^2 - e^2 r^2 - ex}}{z^2} \\ &= \frac{\sqrt{e_0^2 - e^2 \cos^2 \theta - e \sin \theta}}{z} \end{aligned} \right\} \quad (18)$$

This can be written in the form

$$i'_0 = \frac{\sqrt{(e_0^2 - e^2) + e^2 \sin^2 \theta - e \sin \theta}}{z},$$

and then shows that for $e = e_0$, $i'_0 = 0$, or no quadrature component of current exists at no-load; for $e > e_0$, $i'_0 < 0$ or negative, that is, the quadrature component of current is already leading at no-load. For: $e < e_0$, $i'_0 > 0$ or lagging, that is, the quadrature component of current i'_0 is lagging at no-load, becomes zero at some load, and leading at still higher loads.

The latter arrangement, $e < e_0$, is generally used, as the quadrature component of current passes through zero at some intermediate load, and so is less over the range of required load than it would be if i'_0 were 0 or negative.

From (18) follows that the larger z , and at constant resistance r , also x , the smaller the quadrature component of current. That is, increase of the line reactance, x , reduces the quadrature current at no-load, i'_0 , and in the same way at load, that is, improves the power-factor of the circuit, and so is desirable, and the insertion of reactive coils in the line for this reason customary.

Increase of reactance, however, reduces the maximum output i_m , and too large a reactance is for this reason objectionable.

Let

$$i = i_1$$

be the load at which the quadrature component of current vanishes, $i' = 0$, that is, the receiver circuit has unity power-factor.

Substituting $i = i_1$, $i' = 0$ into equation (2) gives

$$e_0^2 = (e + ri_1)^2 + x^2i_1^2 \quad (19)$$

and, substituting (19) in (4), (18), (14), gives reactive component of current

$$i' = \sqrt{\frac{e^2 \sin^2 \theta}{z^2} + \frac{2e \cos \theta}{z}(i_1 - i) + (i_1^2 - i^2)} - \frac{e \sin \theta}{z}, \quad (20)$$

and at no-load

$$i'_0 = \sqrt{\frac{e^2 \sin^2 \theta}{z^2} + \frac{2ei_1 \cos \theta}{z} + i_1^2} - \frac{e \sin \theta}{z}, \quad (21)$$

Maximum output current

$$i_m = \sqrt{\frac{e^2}{z^2} + \frac{2ei_1 \cos \theta}{z} + i_1^2} - \frac{e \cos \theta}{z}. \quad (22)$$

85. Of importance in phase control for constant voltage, e , at constant e_0 , are the three currents

i_1 , the power component of current at which the quadrature component of current vanishes: $i' = 0$.

i_m , the maximum load which can be transmitted at constant voltage, e .

i'_0 , the reactive component of current at no-load.

The equation of phase control, (2), however, contains only two quantities which can be chosen: The reactance, x , which can be increased by inserting reactive coils, and the generator voltage, e_0 , which can be made anything desired, even with an existing generating station, since between e and e_0 practically always transformers are interposed, and their ratio can be chosen so as to correspond to any desired generator voltage, e_0 , as they usually are supplied with several voltage steps.

Of the three quantities, i_1 , i_m and i'_0 , only two can be chosen, and the constants, x and e_0 , derived therefrom. The third current then also follows, and if the value found for it does not suit the requirements of the problem, other values have to be tried. For instance, choosing i_1 as corresponding to three-fourths

load, and i'_0 fairly small, gives very good power-factors over the whole range of load, but a relatively low value of i_m , and where very great overload capacities are required, i_m may not be sufficient, and i_1 may have to be chosen corresponding to full-load and a higher value of i'_0 permitted, that is, some sacrifice made in the power-factor, in favor of overload capacity.

So, for instance, the values may be chosen

$$i_1, \text{ corresponding to full-load,}$$

and required that i'_0 does not exceed half of full-load current;

$$i'_0 < 0.5i_1,$$

and that the synchronous converter or motor can carry at least 100 per cent. overload, that is,

$$i_m > 2 i_1.$$

We then can put, $i_m = 2 i_1 c$ and $i'_0 = \frac{0.5i_1}{c}$, (23)

and substitute (23) in (19), (22) and determine x , e_o , c .

86. The variation of the reactive current, i' with the load, i , equation (4), is brought about by varying the field excitation of the receiving synchronous machine. Where the load on the synchronous machine is direct-current output, as in a motor generator and especially a converter, the most convenient way of varying the field excitation with the load is automatically, by a series field-coil traversed by the direct-current output. The field windings of converters intended for phase control—as for the supply of power to electric railways, from substations fed by a high-potential alternating-current transmission line—are compound-wound, and the shunt field is adjusted for under-excitation, so as to produce at no-load the lagging current, i'_0 , and the series field adjusted so as to make the reactive component of current, i' , disappear at the desired load, i_1 .

In this case, however, the variation of the field excitation by the series field is directly proportional to the load, as is also the variation of i' , that is, it varies from $i' = i'_0$ for $i = 0$, to $i' = 0$ for $i = i_1$, and can be expressed by the equation

$$\left. \begin{aligned} i' &= i'_0 \left(1 - \frac{i}{i_1} \right) \\ &= q(i_1 - i) \end{aligned} \right\} \quad (24)$$

where

$$q = \frac{i'_0}{i_1} \quad (25)$$

is the ratio of (reactive) no-load current, i'_0 , to (effective) non-inductive load current, i_1 .

To maintain constant voltage, e , at constant, e_0 , the required variation of i' is not quite linear, and with a linear variation of i' , as given by a compound field-winding on the synchronous machine, the receiver-voltage, e , at constant impressed voltage does not remain perfectly constant, but when adjusted for the same value at no-load and at full-load, e is slightly high at intermediate loads, low at higher loads. It is, however, sufficiently constant for all practical purposes.

Choosing then the full-load current, i_1 , and the no-load current, $i'_0 = qi_1$, and let the reactive component of current, i' , by a compound field-winding vary as a linear function of the load, i :

$$i' = q(i_1 - i).$$

Then, substituting i_1 and $i'_0 = qi_1$ in the equations (2) for phase control:

$$\begin{aligned} \text{No-load:} \quad & i = 0, \quad i' = qi_1; \\ & e_0^2 = (e + qxi_1)^2 + qri_1^2. \end{aligned} \quad (26)$$

$$\begin{aligned} \text{Full load:} \quad & i_1 = i_1, \quad i' = 0; \\ & e_0^2 = (e + ri_1)^2 + xi_1^2. \end{aligned} \quad (27)$$

From these equations (26) and (27) then calculate the required reactance, x , and the generator voltage, e_0 , as:

$$x = \frac{\frac{qe}{i_1} \pm \sqrt{\frac{e^2}{i_1^2}(1+q^2) - \left[\frac{e}{i_1} + r(1-q^2)\right]^2}}{1-q^2}, \quad (28)$$

and from (27) or (26) the voltage, e_0 .

The terminal voltage at the receiving circuit then is, by equation (3):

$$e = \sqrt{e_0^2 - [qri_1 - (qr+x)i]^2} - ((r-qx)i + qxi_1). \quad (29)$$

As an example is shown, in Fig. 78, the curve of receiving voltage, e , with the load, i , as abscissas, for the values:

$$\begin{aligned} e &= 400 \text{ volts at no-load and at full-load,} \\ i_1 &= 500 \text{ amp. at full-load, power component of current,} \\ i'_0 &= 200 \text{ amp., lagging reactive or quadrature component} \\ &\quad \text{of current at no-load,} \end{aligned}$$

hence $q = 0.4$,

$$i' = 200 - 0.4i,$$

and $r = 0.05 \text{ ohm.}$

From equation (28) then follows:

$$x = 0.381 \pm 0.165 \text{ ohm.}$$

Choosing the lower value:

$$x = 0.216 \text{ ohm.}$$

gives, from equation (27):

$$e_0 = 443.4 \text{ volts;}$$

hence

$$e = \sqrt{196,420 + 5.76 i - 0.0576 i^2} - (43.2 - 0.0264 i).$$

For comparison is shown, in Fig. 78, the receiving voltage, e' , at the same supply voltage, $e_0 = 443.4$ volts, but without phase control, that is, with a non-inductive receiver-circuit.

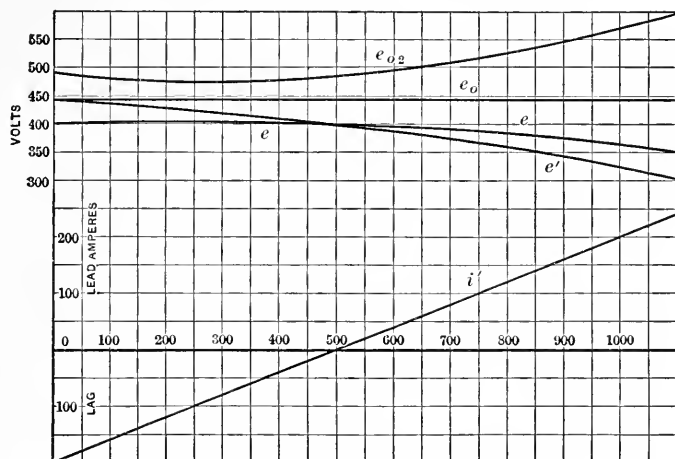

FIG. 78.

87. Equation (28) shows that there are two values of x : x_1 and x_2 ; and corresponding thereto two values of e_0 : e_{01} and e_{02} , which as constant-supply voltage give the same receiver-voltage, e , at no-load and at full-load, and so approximately constant receiver-voltage throughout.

One of the two reactances, x_2 , is much larger than the other, x_1 , and the corresponding voltage, e_{02} , accordingly larger than e_{01} .

In addition to the terminal voltage, e , at the receiver-circuit, there are therefore two further points of constant voltage in the system: e_{01} , distant from e by the resistance, r , and reactance, x_1 , and e_{02} , distant from e_{01} by the reactance $x_0 = x_2 - x_1$.

That is, by the proper choice of the reactances, x_1 and x_0 , three points of the system can be maintained automatically at approximately constant voltage, by phase control: e , e_{01} and e_{02} .

Such *multiple-phase control* can advantageously be employed by using:

e as the terminal voltage of the receiving circuit,

e_{01} as the generator terminal voltage e_0 , and

e_{02} as the nominal induced e.m.f. of the generator, that is, the voltage corresponding to the field-excitation. Constancy of e_{02} accordingly means constant field-excitation.

That is, with constant field-excitation of the generator, the voltage remains approximately constant, by multiple-phase control, at the generator busbars as well as at the terminals of the receiving circuit, at the end of the transmission line of resistance, r .

In this case:

x_1 = reactance of transmission line plus reactive coils inserted in the line (usually at the receiving station).

$x_0 = x_2 - x_1$ = synchronous reactance of the generator plus reactive coils inserted between generator and generator busbars, where necessary.

Since the generator also contains a small resistance, r_0 , the two values of reactance, x_1 and $x_2 = x_1 + x_0$, are given by the equation (28) as:

$$x_1 = \frac{\frac{qe}{i_1} - \sqrt{\frac{e^2}{i_1^2}(1+q^2) - \left[\frac{e}{i_1} + r(1-q^2)\right]^2}}{1-q^2},$$

and

$$x_2 = \frac{\frac{qe}{i_1} + \sqrt{\frac{e^2}{i_1^2}(1+q^2) - \left[\frac{e}{i_1} + (r+r_0)(1-q^2)\right]^2}}{1-q^2}$$

Assuming in above example:

$$r_0 = 0.01 \text{ ohm}$$

gives

$$x_2 = 0.440 \text{ ohm};$$

hence,

$$x_0 = 0.224 \text{ ohm.}$$

The curve of nominal generated e.m.f., e_{02} , of the generator is shown in Fig. 78 as e_{02} .

That is, at constant field-excitation, corresponding to a nominal generated e.m.f.,

$$e_{02} = 488.2 \text{ volts.}$$

The generator of synchronous impedance,

$$Z_0 = r_0 + jx_0 = 0.01 + 0.224 j \text{ ohms,}$$

maintains approximately constant voltage at its own terminals, or at the generator busbars,

$$e_0 = 443.4 \text{ volts,}$$

and at the same time maintains constant voltage,

$$e = 400 \text{ volts,}$$

at the end of a transmission line of impedance,

$$Z = r + jx_1 = 0.06 + 0.216 j \text{ ohms,}$$

if by phase control in the receiving circuit, by compounded converter, the reactive or quadrature component of current, i' , is varied with the load or power component of current, i , and proportional thereto, that is:

$$\begin{aligned} i' &= q(i_1 - i) \\ &= 200 - 0.4 i. \end{aligned}$$

88. To adjust a circuit experimentally for phase control for constant voltage, by overcompounded synchronous converter: at constant-supply voltage and no-load on the converter—with the transmission line with its transformers, reactances, etc., or an impedance equal thereto, in the circuit between converter and supply voltage—the shunt field of the converter is adjusted by the field rheostat so as to give the desired direct-current voltage at the converter brushes. Then load is put on the converter, and, without changing the supply voltage or the adjustment of the shunt field, the rheostat or shunt across the series field of the converter is adjusted so as to give the desired direct-current voltage.

If the supply voltage can be varied, as is usually provided for by different voltage taps on the transformer, then, before adjusting the converter fields as described above, first the proper supply voltage is found. This is done by loading the converter with the current, at which unity power-factor at the converter is

desired—for instant full-load—and then varying the converter shunt field so as to get minimum alternating-current input, and varying the supply voltage so as to get—at minimum alternating-current input—the desired direct-current voltage. Where the supply voltage can only be varied in definite steps: at some voltage step, the converter field—at the desired non-inductive load—is adjusted for minimum alternating-current input; if then the direct-current voltage is too low, the transformer connections are changed to the next higher supply voltage step; if the direct-current voltage is too high, the change is made to the next lower supply voltage step, until that supply voltage step is found, which, at the adjustment of the converter field for minimum alternating-current input, brings the direct-current voltage nearest to that desired. Then for this supply voltage step, the converter field circuits are adjusted for phase control, as above described.

SECTION III

POWER AND EFFECTIVE CONSTANTS

CHAPTER XII

EFFECTIVE RESISTANCE AND REACTANCE

89. The resistance of an electric circuit is determined:

1. By direct comparison with a known resistance (Wheatstone bridge method, etc.).

This method gives what may be called the true ohmic resistance of the circuit.

2. By the ratio:

$$\frac{\text{Volts consumed in circuit}}{\text{Amperes in circuit}}$$

In an alternating-current circuit, this method gives, not the resistance of the circuit, but the impedance,

$$z = \sqrt{r^2 + x^2}.$$

3. By the ratio:

$$r = \frac{\text{Power consumed}}{(\text{Current})^2},$$

where, however, the "power" does not include the work done by the circuit, and the counter e.m.f.s. representing it, as, for instance, in the case of the counter e.m.f. of a motor.

In alternating-current circuits, this value of resistance is the power coefficient of the e.m.f.,

$$r = \frac{\text{Power component of e.m.f.}}{\text{Total current}}$$

It is called the *effective resistance* of the circuit, since it represents the effect, or power, expended by the circuit. The power coefficient of current,

$$g = \frac{\text{Power component of current}}{\text{Total e.m.f.}},$$

is called the *effective conductance* of the circuit.

In the same way, the value,

$$x = \frac{\text{Wattless component of e.m.f.}}{\text{Total current}},$$

is the *effective reactance*, and

$$b = \frac{\text{Wattless component of current}}{\text{Total e.m.f.}},$$

is the *effective susceptance* of the circuit.

While the true ohmic resistance represents the expenditure of power as heat inside of the electric conductor by a current of uniform density, the effective resistance represents the total expenditure of power.

Since in an alternating-current circuit, in general power is expended not only in the conductor, but also outside of it, through hysteresis, secondary currents, etc., the effective resistance frequently differs from the true ohmic resistance in such way as to represent a larger expenditure of power.

In dealing with alternating-current circuits, it is necessary, therefore, to substitute everywhere the values "effective resistance," "effective reactance," "effective conductance," and "effective susceptance," to make the calculation applicable to general alternating-current circuits, such as inductive reactances containing iron, etc.

While the true ohmic resistance is a constant of the circuit, depending only upon the temperature, but not upon the e.m.f., etc., the effective resistance and effective reactance are, in general, not constants, but depend upon the e.m.f., current, etc. This dependence is the cause of most of the difficulties met in dealing analytically with alternating-current circuits containing iron.

90. The foremost sources of energy loss in alternating-current circuits, outside of the true ohmic resistance loss, are as follows:

1. Molecular friction, as,
 - (a) Magnetic hysteresis;
 - (b) Dielectric hysteresis.
2. Primary electric currents, as,
 - (a) Leakage or escape of current through the insulation, brush discharge, corona.
 - (b) Eddy currents in the conductor or unequal current distribution.

3. Secondary or induced currents, as,
 - (a) Eddy or Foucault currents in surrounding magnetic materials;
 - (b) Eddy or Foucault currents in surrounding conducting materials;
 - (c) Secondary currents of mutual inductance in neighboring circuits.
4. Induced electric charges, electrostatic induction or influence.

While all these losses can be included in the terms effective resistance, etc., the magnetic hysteresis and the eddy currents are the most frequent and important sources of energy loss.

Magnetic Hysteresis

91. In an alternating-current circuit surrounded by iron or other magnetic material, energy is expended outside of the conductor in the iron, by a kind of molecular friction, which, when the energy is supplied electrically, appears as magnetic hysteresis, and is caused by the cyclic reversals of magnetic flux in the iron in the alternating magnetic field.

To examine this phenomenon, first a circuit may be considered, of very high inductive reactance, but negligible true ohmic resistance; that is, a circuit entirely surrounded by iron, as, for instance, the primary circuit of an alternating-current transformer with open secondary circuit.

The wave of current produces in the iron an alternating magnetic flux which generates in the electric circuit an e.m.f.—the counter e.m.f. of self-induction. If the ohmic resistance is negligible, that is, practically no e.m.f. consumed by the resistance, all the impressed e.m.f. must be consumed by the counter e.m.f. of self-induction, that is, the counter e.m.f. equals the impressed e.m.f.; hence, if the impressed e.m.f. is a sine wave, the counter e.m.f., and, therefore, the magnetic flux which generates the counter e.m.f., must follow a sine wave also. The alternating wave of current is not a sine wave in this case, but is distorted by hysteresis. It is possible, however, to plot the current wave in this case from the hysteretic cycle of magnetic flux.

From the number of turns, n , of the electric circuit, the effective counter e.m.f., E , and the frequency, f , of the current, the maximum magnetic flux, Φ , is found by the formula:

$$E = \sqrt{2} \pi n f \Phi 10^{-8};$$

hence,

$$\Phi = \frac{E 10^8}{\sqrt{2 \pi n j}}$$

A maximum flux, Φ , and magnetic cross-section, A , give the maximum magnetic induction, $B = \frac{\Phi}{A}$.

If the magnetic induction varies periodically between $+B$ and $-B$, the magnetizing force varies between the corresponding values $+f$ and $-f$, and describes a looped curve, the cycle of hysteresis.

If the ordinates are given in lines of magnetic force, the abscissas in tens of ampere-turns, then the area of the loop equals the energy consumed by hysteresis in ergs per cycle.

From the hysteretic loop the instantaneous value of magnetizing force is found, corresponding to an instantaneous value of magnetic flux, that is, of generated e.m.f.; and from the magnetizing force, f , in ampere-turns per units length of magnetic circuit, the length, l , of the magnetic circuit, and the number of turns, n , of the electric circuit, are found the instantaneous values of current, i , corresponding to a magnetizing force, f , that is, magnetic induction, B , and thus generated e.m.f., e , as:

$$i = \frac{fl}{n}$$

92. In Fig. 79, four magnetic cycles are plotted, with maximum values of magnetic induction, $B = 2,000, 6,000, 10,000,$ and $16,000$, and corresponding maximum magnetizing forces, $f = 1.8, 2.8, 4.3, 20.0$. They show the well-known hysteretic loop, which becomes pointed when magnetic saturation is approached.

These magnetic cycles correspond to sheet iron or sheet steel, of a hysteretic coefficient, $\eta = 0.0033$, and are given with ampere-turns per centimeter as abscissas, and kilolines of magnetic force as ordinates.

In Figs. 80 and 81, the curve of magnetic induction as derived from the generated e.m.f. is a sine wave. For the different values of magnetic induction of this sine curve, the corresponding values of magnetizing force f , hence of current, are taken from Fig. 79, and plotted, giving thus the exciting current required to produce the sine wave of magnetism; that is, the wave of current which a sine wave of impressed e.m.f. will establish in the circuit.

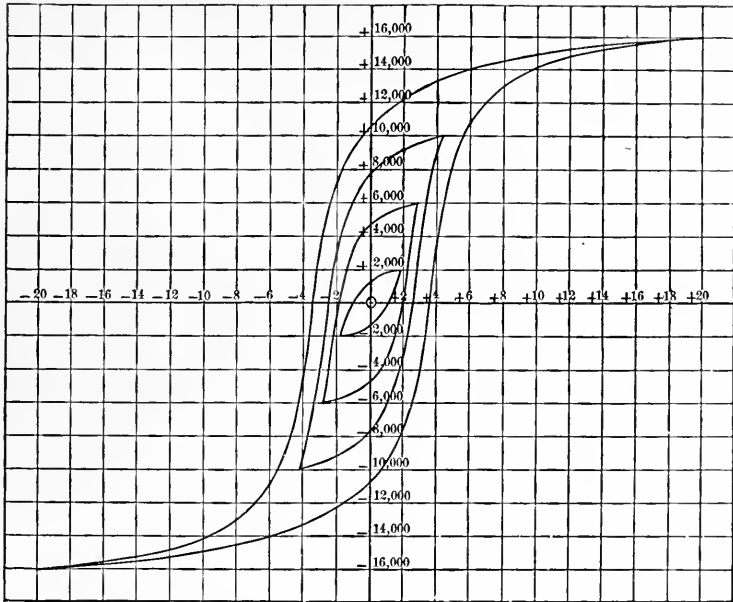

FIG. 79.—Hysteretic cycle of sheet iron.

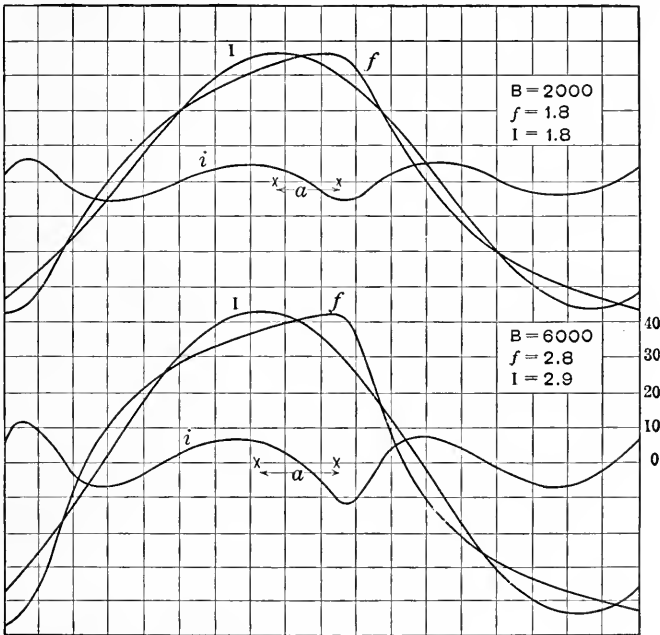

FIG. 80.

As shown in Figs. 80 and 81, these waves of alternating current are not sine waves, but are distorted by the super-position of higher harmonics, and are complex harmonic waves. They reach their maximum value at the same time with the maximum of magnetism, that is, 90° ahead of the maximum generated e.m.f., and hence about 90° behind the maximum impressed e.m.f., but pass the zero line considerably ahead of the zero value of magnetism of 42° , 52° , 50° and 41° , respectively.

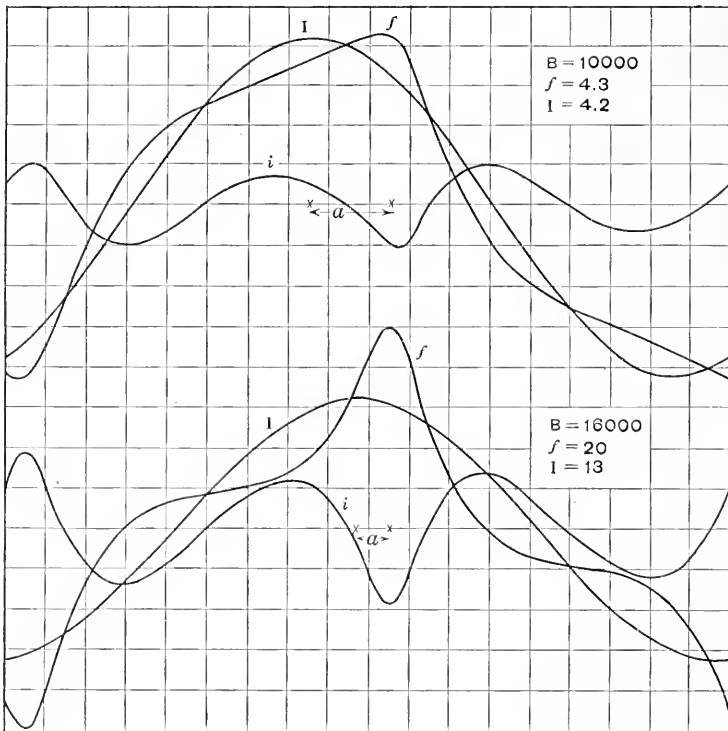

FIG. 81.

The general character of these current waves is, that the maximum point of the wave coincides in time with the maximum point of the sine wave of magnetism; but the current wave is bulged out greatly at the rising, and hollowed in at the decreasing, side. With increasing magnetization, the maximum of the current wave becomes more pointed, as shown by the curves of Fig. 81, for $B = 10,000$; and at still higher saturation a peak is

formed at the maximum point, as in the curve for $B = 16,000$. This is the case when the curve of magnetization reaches within the range of magnetic saturation, since in the proximity of saturation the current near the maximum point of magnetization has to rise abnormally to cause even a small increase of magnetization. The four curves, Figs. 80 and 81 are not drawn to the same scale. The maximum values of magnetizing force, corresponding to the maximum values of magnetic induction, $B = 2,000, 6,000, 10,000,$ and $16,000$ lines of force per square centimeter, are $f = 1.8, 2.8, 4.3,$ and 20.0 ampere-turns per centimeter. In the different diagrams these are represented in the ratio of 8:6:4:1, in order to bring the current curves to approximately the same height. The magnetizing force, in c.g.s. units, is

$$H = 4\pi f/10 = 1.257f.$$

93. The distortion of the current waves, f , in Figs. 80 and 81, is almost entirely due to the magnetizing current, and is caused by the disproportionality between magnetic induction, B , and magnetizing force, f , as exhibited by the magnetic characteristic or saturation curve, and is very little due to hysteresis.

Resolving these curves, f , of Figs. 80 and 81 into two components, one in phase with the magnetic induction, B , or symmetrical thereto, hence in quadrature with the induced e.m.f., and therefore wattless: the magnetizing current, i_m ; and the other, in time quadrature with the magnetic induction, B , hence in phase, or symmetrical, with the generated e.m.f., that is, representing power: the hysteresis power-current, i_h . Then we see that the hysteresis power-current, i_h , is practically a sine wave, while the magnetizing current, i_m , differs considerably from a sine wave, and tends toward peakedness—the more the higher the magnetic induction, B , that is, the more magnetic saturation is approached, so that for $B = 16,000$ a very high peak is shown, and the wave of magnetizing current, i_m , does not resemble a sine wave at all, but at the maximum value is nearly four times higher than a sine wave of the same instantaneous values near zero induction would have.

These curves of hysteresis power-current, i_h , and magnetizing current, i_m , derived by resolving the distorted current curves, f , of Figs. 80 and 81, are plotted in Fig. 82, the last one, corresponding to $B = 16,000$, with one-quarter the ordinates of the first three.

As curves, symmetrical with regard to the maximum value of $B - i_m -$, and to the zero value of $B - i_h -$, these curves are constructed thus:

Let

$$b = B \sin \phi = \text{sine wave of magnetic induction,}$$

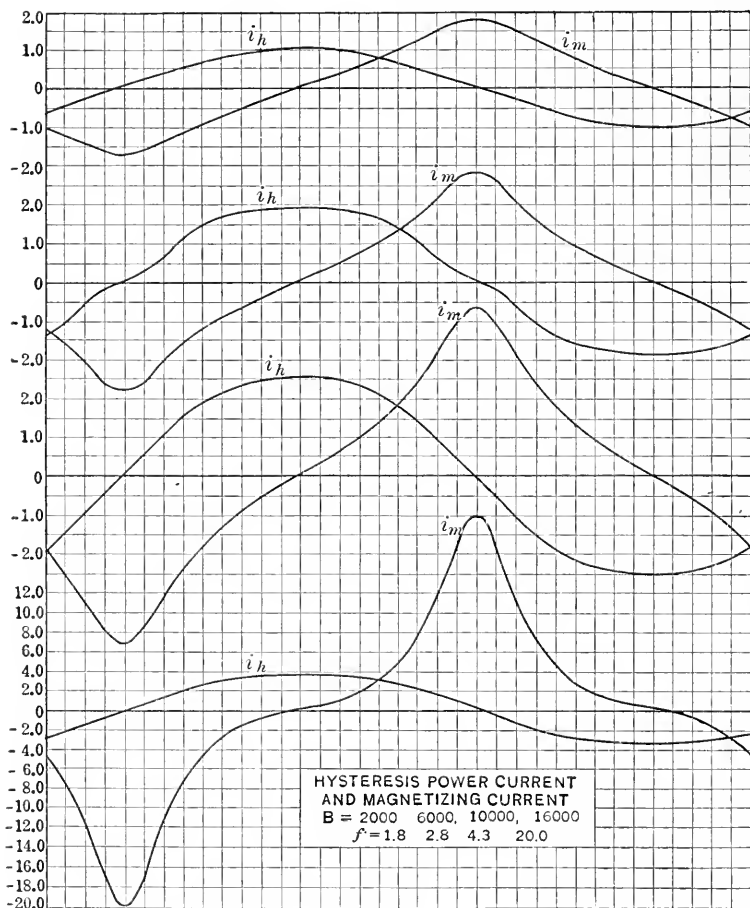

FIG. 82.

then

$$i_m = \frac{1}{2}(f_\phi + f_{180-\phi}),$$

$$i_h = \frac{1}{2}(f_\phi + f_{-\phi}).$$

That is, i_m is the average value of f for an angle ϕ , and its supplementary angle $180 - \phi$, i_h the average value of f for an angle ϕ and its negative angle $-\phi$.

94. The distortion of the wave of magnetizing current is as large as shown here only in an iron-closed magnetic circuit expending power by hysteresis only, as in an ironclad transformer on open secondary circuit. As soon as the circuit expends power in any other way, as in resistance or by mutual

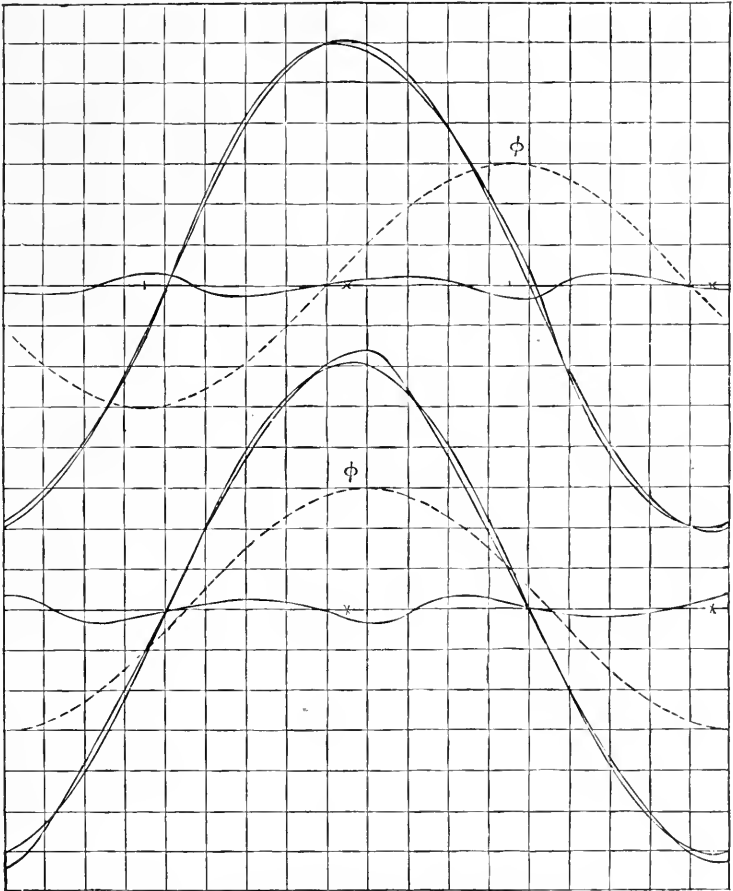

FIG. 83.—Distortion of current wave by hysteresis.

inductance, or if an air-gap is introduced in the magnetic circuit, the distortion of the current wave rapidly decreases and practically disappears, and the current becomes more sinusoidal. That is, while the distorting component remains the same, the sinusoidal component of the current greatly increases, and ob-

seures the distortion. For example, in Fig. 83, two waves are shown corresponding in magnetization to the last curve of Fig. 80, as the one most distorted. The first curve in Fig. 83 is the current wave of a transformer at 0.1 load. At higher loads the distortion is correspondingly still less, except where the magnetic flux of self-induction, that is, flux passing between primary and secondary and increasing in proportion to the load, is so large as to reach saturation, in which case a distortion appears again and increases with increasing load. The second curve of Fig. 83 is the exciting current of a magnetic circuit containing an air-gap whose length equals $\frac{1}{400}$ the length of the magnetic circuit. These two curves are drawn to one-third the size of the curve in Fig. 80. As shown, both curves are practically sine waves. The sine curves of magnetic flux are shown dotted as ϕ .

95. The distorted wave of current can be resolved into two components: *A true sine wave of equal effective intensity and equal power to the distorted wave*, called the *equivalent sine wave*, and a *wattless higher harmonic*, consisting chiefly of a term of triple frequency.

In Figs. 80, 81 and 83 are shown, as I , the equivalent sine waves, and as i , the difference between the equivalent sine wave and the real distorted wave, which consists of wattless complex higher harmonics. The equivalent sine wave of m.m.f. or of current, in Figs. 80 and 81, leads the magnetism in time phase by 34° , 44° , 38° , and 15.5° , respectively. In Fig. 83 the equivalent sine wave almost coincides with the distorted curve, and leads the magnetism by only 9 degrees.

It is interesting to note that even in the greatly distorted curves of Figs. 80 and 81 the maximum value of the equivalent sine wave is nearly the same as the maximum value of the original distorted wave of m.m.f., so long as magnetic saturation is not approached, being 1.8, 2.9, and 4.2, respectively, against 1.8, 2.8, and 4.3, the maximum values of the distorted curve. Since, by the definition, the effective value of the equivalent sine wave is the same as that of the distorted wave, it follows that this distorted wave of exciting current shares with the sine wave the feature, that the maximum value and the effective value have the ratio of $\sqrt{2} \div 1$. Hence, below saturation, the maximum value of the distorted curve can be calculated from the effective value—which is given by the reading of an electro-

dynamometer—by using the same ratio that applies to a true sine wave, and the magnetic characteristic can thus be determined by means of alternating currents, with sufficient exactness, by the electro-dynamometer method, in the range below saturation, that is, by alternating-current voltmeter and ammeter.

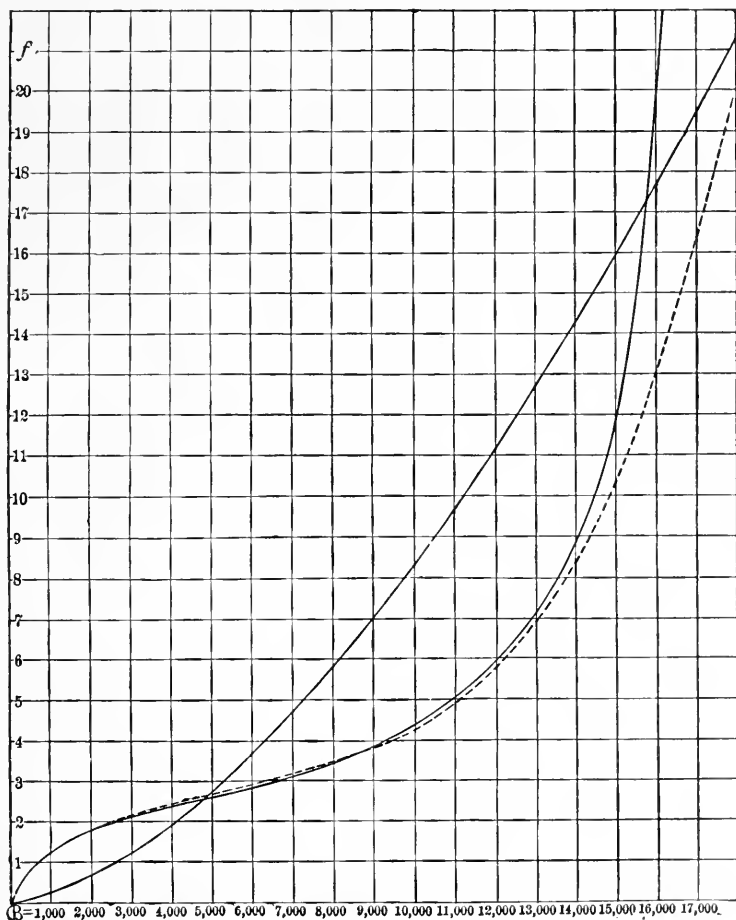

FIG. 84.—Magnetization and hysteresis curve.

96. In Fig. 84 is shown the true magnetic characteristic of a sample of average sheet iron, as found by the method of slow reversals with the magnetometer; for comparison there is shown in dotted lines the same characteristic, as determined with alternating currents by the electro-dynamometer, with ampere-

turns per centimeter as ordinates and magnetic inductions as abscissas. As represented, the two curves practically coincide up to a value of $B = 13,000$; that is, up to fairly high inductions. For higher saturations, the curves rapidly diverge, and the electro-dynamometer curve shows comparatively small magnetizing forces producing apparently very high magnetizations.

The same Fig. 84 gives the curve of hysteretic loss, in ergs per cubic centimeter and cycle, as ordinates, and magnetic inductions as abscissas.

The electro-dynamometer method of determining the magnetic characteristic is preferable for use with alternating-current apparatus, since it is not affected by the phenomenon of magnetic "creeping," which, especially at low densities, may in the magnetometer tests bring the magnetism very much higher, or the magnetizing force lower, than found in practice in alternating-current apparatus.

So far as current strength and power consumption are concerned, the distorted wave can be replaced by the equivalent sine wave and the higher harmonics neglected.

All the measurements of alternating currents, with the single exception of instantaneous readings, yield the equivalent sine wave only, since all measuring instruments give either the mean square of the current wave or the mean product of instantaneous values of current and e.m.f., which, by definition, are the same in the equivalent sine wave as in the distorted wave.

Hence, in most practical applications it is permissible to neglect the higher harmonics altogether, and replace the distorted wave by its equivalent sine wave, keeping in mind, however, the existence of a higher harmonic as a possible disturbing factor which may become noticeable in those cases where the frequency of the higher harmonic is near the frequency of resonance of the circuit, that is, in circuits containing condensive as well as inductive reactance, or in those circuits in which the higher harmonic of current is suppressed, and thereby the voltage is distorted, as discussed in Chapter XXV.

97. The equivalent sine wave of exciting current leads the sine wave of magnetism by an angle α , which is called the *angle of hysteretic advance of phase*. Hence the current lags behind the e.m.f. by the time angle $(90^\circ - \alpha)$, and the power is, therefore,

$$P = IE \cos (90^\circ - \alpha) = IE \sin \alpha.$$

Thus the exciting current, I , consists of a power component, $I \sin \alpha$, called the *hysteretic or magnetic power current*, and a wattless component, $I \cos \alpha$, which is called the *magnetizing current*. Or, conversely, the e.m.f. consists of a power component, $E \sin \alpha$, the *hysteretic power component*, and a wattless component, $E \cos \alpha$, the e.m.f. consumed by *self-induction*.

Denoting the absolute value of the impedance of the circuit, $\frac{E}{I}$, by z —where z is determined by the magnetic characteristic of the iron and the shape of the magnetic and electric circuits—the impedance is represented, in phase and intensity, by the symbolic expression,

$$Z = r + jx = z \sin \alpha + jz \cos \alpha;$$

and the admittance by,

$$Y = g - jb = \frac{1}{z} \sin \alpha - j\frac{1}{z} \cos \alpha = y \sin \alpha - jy \cos \alpha.$$

The quantities z , r , x , and y , g , b are, however, not constants as in the case of the circuit without iron, but depend upon the intensity of magnetization, B —that is, upon the e.m.f. This dependence complicates the investigation of circuits containing iron.

In a circuit entirely inclosed by iron, α is quite considerable, ranging from 30° to 50° for values below saturation. Hence, even with negligible true ohmic resistance, no great lag can be produced in ironclad alternating-current circuits.

98. The loss of energy by hysteresis due to molecular magnetic friction is, with sufficient exactness, proportional to the 1.6th power of magnetic induction, B . Hence it can be expressed by the formula:

$$W_H = \eta B^{1.6}$$

where—

W_H = loss of energy per cycle, in ergs or (c.g.s.) units ($= 10^{-7}$ joules) per cubic centimeter,

B = maximum magnetic induction, in lines of force per sq. cm., and η = the *coefficient of hysteresis*.

This I found to vary in iron from 0.001 to 0.0055. As a safe mean, 0.0033 can be accepted for common annealed sheet iron or sheet steel, 0.002 for silicon steel and 0.0010 to 0.0015 for specially selected low hysteresis steel. In gray cast iron, η averages

0.013; it varies from 0.0032 to 0.028 in cast steel, according to the chemical or physical constitution; and reaches values as high as 0.08 in hardened steel (tungsten and manganese steel). Soft nickel and cobalt have about the same coefficient of hysteresis as gray cast iron; in magnetite I found $\eta = 0.023$.

In the curves of Figs. 79 to 84, $\eta = 0.0033$.

At the frequency, f , the loss of power in the volume, V , is, by this formula,

$$\begin{aligned} P &= \eta f V B^{1.6} 10^{-7} \text{ watts} \\ &= \eta f V \left(\frac{\Phi}{A} \right)^{1.6} 10^{-7} \text{ watts,} \end{aligned}$$

where A is the cross-section of the total magnetic flux, Φ .

The maximum magnetic flux, Φ , depends upon the counter e.m.f. of self-induction,

$$\begin{aligned} E &= \sqrt{2} \pi f n \Phi 10^{-8}, \\ \text{or} \quad \Phi &= \frac{E 10^8}{2 \pi f n}, \end{aligned}$$

where n = number of turns of the electric circuit, f = frequency.

Substituting this in the value of the power, P , and canceling, we get,

$$P = \eta \frac{E^{1.6}}{f^{0.6}} \frac{V 10^{5.8}}{2^{0.8} \pi^{1.6} A^{1.6} n^{1.6}} = 58 \eta \frac{E^{1.6}}{f^{0.6}} \frac{V 10^3}{A^{1.6} n^{1.6}};$$

or

$$P = \frac{K E^{1.6}}{f^{0.6}}, \text{ where } K = \eta \frac{V 10^{5.8}}{2^{0.8} \pi^{1.6} A^{1.6} n^{1.6}} = 58 \eta \frac{V 10^3}{A^{1.6} n^{1.6}};$$

or, substituting $\eta = 0.0033$, we have $K = 191.4 \frac{V}{A^{1.6} n^{1.6}}$;

or, substituting $V = Al$, where l = length of magnetic circuit,

$$K = \frac{2^{0.8} \eta l 10^{5.8}}{\pi^{1.6} A^{0.6} n^{1.6}} = \frac{58 \eta l 10^3}{A^{0.6} n^{1.6}} = 191.4 \frac{l}{A^{0.6} n^{1.6}};$$

and

$$P = \frac{58 \eta E^{1.6} l 10^3}{f^{0.6} A^{0.6} n^{1.6}} = \frac{191.4 E^{1.6} l}{f^{0.6} A^{0.6} n^{1.6}}.$$

In Figs. 85, 86, and 87 is shown a curve of hysteretic loss, with the loss of power as ordinates, and

in curve 85, with the e.m.f., E , as abscissas,

$$\text{for } l = 6, A = 20, f = 100, \text{ and } n = 100;$$

in curve 86, with the number of turns as abscissas, for

$$l = 6, A = 20, f = 100, \text{ and } E = 100;$$

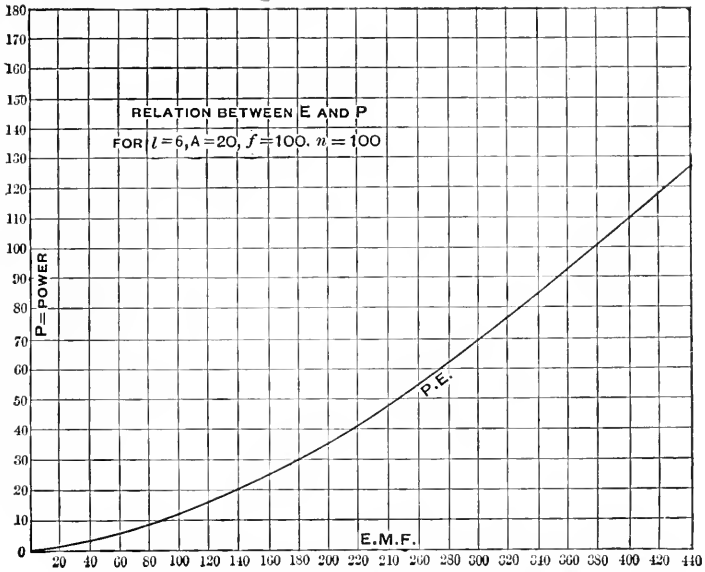

FIG. 85.—Hysteresis loss as function of E.M.F.

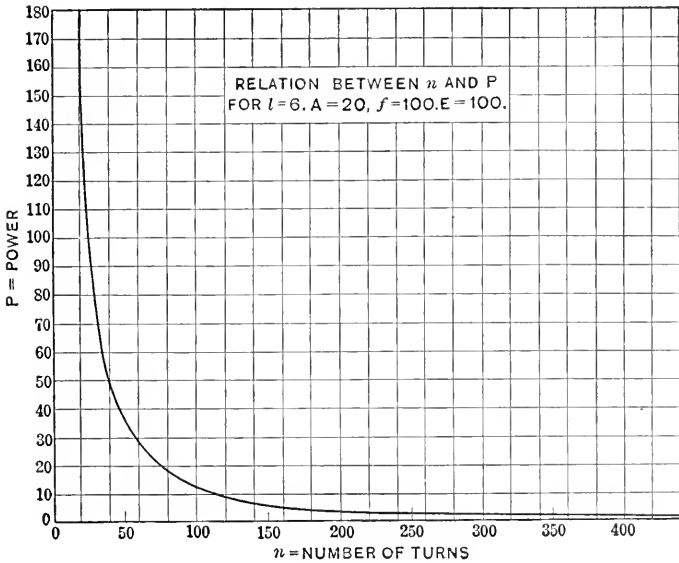

FIG. 86.

in curve 87, with the frequency, f , or the cross-section, A , as abscissas, for $l = 6$, $n = 100$, and $E = 100$.

As shown, the hysteretic loss is proportional to the 1.6th power of the e.m.f., inversely proportional to the 1.6th power of the number of turns, and inversely proportional to the 0.6th power of the frequency and of the cross-section.

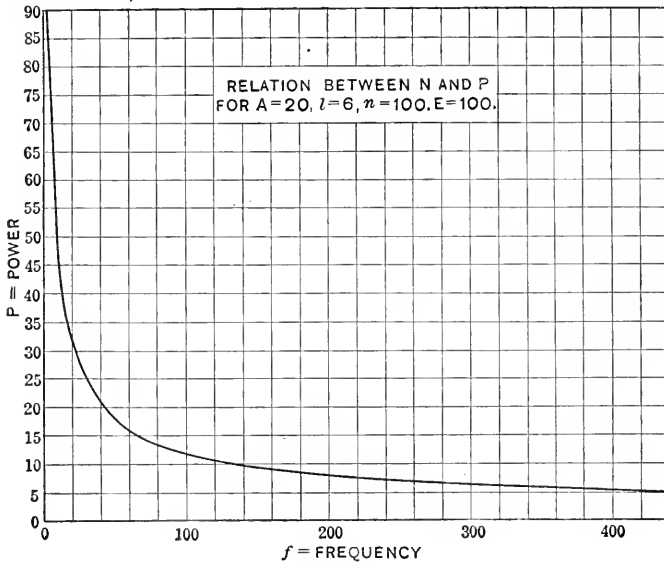

FIG. 87.

99. If g = effective conductance, the power component of a current is $I = Eg$, and the power consumed in a conductance, g , is $P = IE = E^2g$.

Since, however,

$$P = K \frac{E^{1.6}}{f^{0.6}}, \text{ we have } K \frac{E^{1.6}}{f^{0.6}} = E^2g;$$

it is:

$$g = \frac{K}{f^{0.6}E^{0.4}} = \frac{58 \eta l 10^3}{E^{0.4}f^{0.6}A^{0.6}n^{1.6}} = 191.4 \frac{l}{E^{0.4}f^{0.6}A^{0.6}n^{1.6}}.$$

From this we have the following deduction:

The effective conductance due to magnetic hysteresis is proportional to the coefficient of hysteresis, η , and to the length of the magnetic circuit, l , and inversely proportional to the 0.4th power of the e.m.f., to the 0.6th power of the frequency, f , and of the cross-section

of the magnetic circuit, A , and to the 1.6th power of the number of turns, n .

Hence, the effective hysteretic conductance increases with decreasing e.m.f., and decreases with increasing e.m.f.; it varies, however, much slower than the e.m.f., so that, if the hysteretic conductance represents only a part of the total power consumption, it can, within a limited range of variation—as, for instance, in constant-potential transformers—be assumed as constant without serious error.

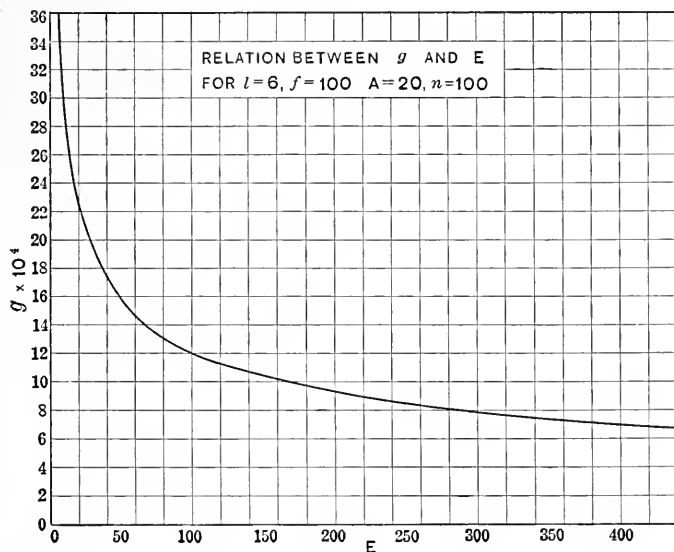

FIG. 88.

In Figs. 88, 89, and 90, the hysteretic conductance, g , is plotted, for $l = 6$, $E = 100$, $f = 100$, $A = 20$ and $n = 100$, respectively, with the conductance, g , as ordinates, and with

E as abscissas in Curve 88.
 f as abscissas in Curve 89.
 n as abscissas in Curve 90.

As shown, a variation in the e.m.f. of 50 per cent. causes a variation in g of only 14 per cent., while a variation in f or A by 50 per cent. causes a variation in g of 21 per cent.

If \mathcal{R} = magnetic reluctance of a circuit, F_A = maximum

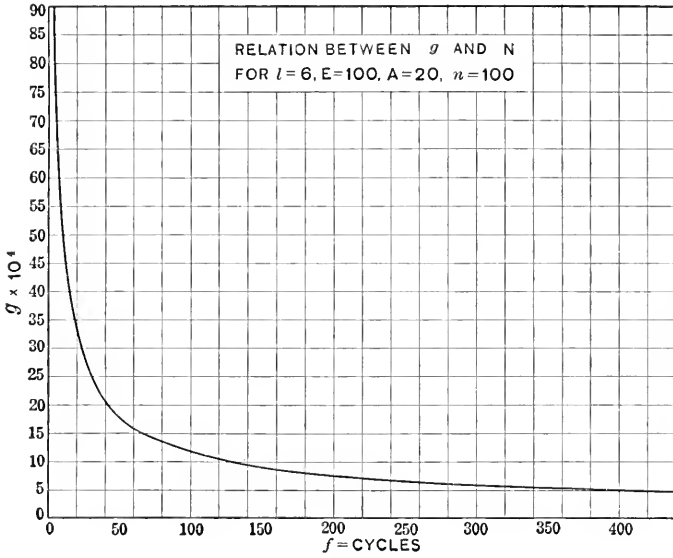

FIG. 89.

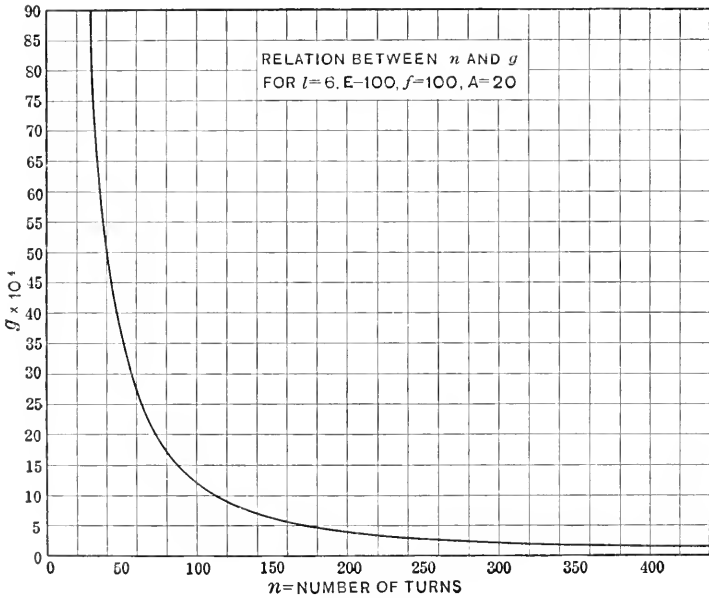

FIG. 90.

m.m.f., I = effective current, since $I\sqrt{2}$ = maximum current, the magnetic flux,

$$\Phi = \frac{F_A}{\mathcal{R}} = \frac{nI\sqrt{2}}{\mathcal{R}}.$$

Substituting this in the equation of the counter e.m.f. of self-induction,

$$E = \sqrt{2} \pi f n \Phi 10^{-8},$$

we have

$$E = \frac{2 \pi n^2 f I 10^{-8}}{\mathcal{R}};$$

hence, the absolute admittance of the circuit is

$$y = \sqrt{g^2 + b^2} = \frac{I}{E} = \frac{\mathcal{R} 10^8}{2 \pi n^2 f} = \frac{a\mathcal{R}}{f},$$

where

$$a = \frac{10^8}{2 \pi n^2}, \text{ a constant.}$$

Therefore, the absolute admittance, y , of a circuit of negligible resistance is proportional to the magnetic reluctance, \mathcal{R} , and inversely proportional to the frequency, f , and to the square of the number of turns, n .

100. In a circuit containing iron, the reluctance, \mathcal{R} , varies with the magnetization; that is, with the e.m.f. Hence the admittance of such a circuit is not a constant, but is also variable.

In an ironclad electric circuit—that is, a circuit whose magnetic field exists entirely within iron, such as the magnetic circuit of a well-designed alternating-current transformer— \mathcal{R} is the reluctance of the iron circuit. Hence, if μ = permeability since

$$\mathcal{R} = \frac{F_A}{\Phi},$$

and

$$F_A = IF = \frac{10}{4 \pi} l H = \text{m.m.f.},$$

$$\Phi = A\mathcal{R} = \mu A H = \text{magnetic flux},$$

and

$$\mathcal{R} = \frac{10 l}{4 \pi \mu A};$$

substituting this value in the equation of the admittance,

$$y = \frac{\mathcal{R} 10^8}{2 \pi n^2 f},$$

we have

$$y = \frac{l 10^9}{8 \pi^2 n^2 \mu A f} = \frac{c}{f \mu},$$

where

$$c = \frac{l 10^9}{8 \pi^2 n^2 A} = \frac{127 l 10^5}{n^2 A}.$$

Therefore, in an ironclad circuit, the absolute admittance, y , is inversely proportional to the frequency, f , to the permeability, μ , to the cross-section, A , and to the square of the number of turns, n ; and directly proportional to the length of the magnetic circuit, l .

The conductance is

$$g = \frac{K}{f^{0.6} E^{0.4}};$$

and the admittance,

$$y = \frac{c}{f \mu};$$

hence, the angle of hysteretic advance is

$$\sin \alpha = \frac{g}{y} = \frac{K \mu f^4}{c E^{0.4}};$$

or, substituting for A and c (§119),

$$\begin{aligned} \sin \alpha &= \mu \frac{f^{0.4}}{E^{0.4}} \frac{\eta l 10^{5.8}}{2^{0.8} \pi^{1.6} A^{0.6} n^{1.6}} \frac{8 \pi^2 n^2 A}{l 10^9} \\ &= \frac{\mu \eta f^{0.4} n^{0.4} A^{0.4} \pi^{0.4} 2^{2.2}}{E^{0.4} 10^{3.2}}; \end{aligned}$$

or, substituting

$$E = 2^{0.5} \pi f n A \mathfrak{B} 10^{-8},$$

we have

$$\sin \alpha = \frac{4 \mu \eta}{\mathfrak{B}^{0.4}},$$

which is independent of frequency, number of turns, and shape and size of the magnetic and electric circuit.

Therefore, in an ironclad inductance, the angle of hysteretic advance, α , depends upon the magnetic constants, permeability and coefficient of hysteresis, and upon the maximum magnetic induction, but is entirely independent of the frequency, of the shape and other conditions of the magnetic and electric circuit; and, therefore, all ironclad magnetic circuits constructed of the same quality of iron and using the same magnetic density, give the same angle of hysteretic advance, and the same power factor of their electric energizing circuit.

The angle of hysteretic advance, α , in a closed circuit transformer and the no-load power factor, depend upon the quality of the iron, and upon the magnetic density only.

The sine of the angle of hysteretic advance equals 4 times the product of the permeability and coefficient of hysteresis, divided by the 0.4th power of the magnetic density.

101. If the magnetic circuit is not entirely ironclad, and the magnetic structure contains air-gaps, the total reluctance is the sum of the iron reluctance and of the air reluctance, or

$$\mathcal{R} = \mathcal{R}_i + \mathcal{R}_a;$$

hence the admittance is

$$y = \sqrt{g^2 + b^2} = \frac{a}{f}(\mathcal{R}_i + \mathcal{R}_a).$$

Therefore, in a circuit containing iron, the admittance is the sum of the admittance due to the iron part of the circuit, $y_i = \frac{a\mathcal{R}_i}{f}$, and of the admittance due to the air part of the circuit, $y_a = \frac{a\mathcal{R}_a}{f}$, if the iron and the air are in series in the magnetic circuit.

The conductance, g , represents the loss of power in the iron, and, since air has no magnetic hysteresis, is not changed by the introduction of an air-gap. Hence the angle of hysteretic advance of phase is

$$\sin \alpha' = \frac{g}{y} = \frac{g}{y_i + y_a} = \frac{g}{y_i} \frac{\mathcal{R}_i}{\mathcal{R}_i + \mathcal{R}_a},$$

and a maximum, $\frac{g}{y_i}$, for the ironclad circuit, but decreases with increasing width of the air-gap. The introduction of the air-gap of reluctance, \mathcal{R}_a , decreases $\sin \alpha$ in the ratio,

$$\frac{\mathcal{R}_i}{\mathcal{R}_i + \mathcal{R}_a}.$$

In the range of practical application, from $B = 2,000$ to $B = 14,000$, the permeability of iron usually exceeds 1,000, while $\sin \alpha$ in an ironclad circuit varies in this range from 0.51 to 0.69. In air, $\mu = 1$.

If, consequently, 1 per cent. of the length of the iron consists of an air-gap, the total reluctance only varies by a few per cent., that is, remains practically constant; while the angle of hysteretic advance varies from $\sin \alpha = 0.035$ to $\sin \alpha = 0.064$. Thus g is negligible compared with b , and b is practically equal to y .

Therefore, in an electric circuit containing iron, but forming an open magnetic circuit whose air-gap is not less than $\frac{1}{400}$ the length of the iron, the susceptance is practically constant and equal to the admittance, so long as saturation is not yet approached, or,

$$b = \frac{\mathcal{R}_a}{f}, \text{ or: } x = \frac{f}{\mathcal{R}_a}.$$

The angle of hysteretic advance is small, and the hysteretic conductance is

$$g = \frac{K}{E^{0.4} f^{0.6}}.$$

The current wave is practically a sine wave.

As an example, in Fig. 83, Curve II, the current curve of a circuit is shown, containing an air-gap of only $\frac{1}{400}$ of the length of the iron, giving a current wave much resembling the sine shape, with an hysteretic advance of 9° .

102. To determine the electric constants of a circuit containing iron, we shall proceed in the following way:

Let

$$E = \text{counter e.m.f. of self-induction}$$

then from the equation,

$$E = \sqrt{2} \pi n f \Phi 10^{-8},$$

where f = frequency, n = number of turns, we get the magnetism, Φ , and by means of the magnetic cross-section, A , the maximum magnetic induction: $B = \frac{\Phi}{A}$.

From B , we get, by means of the magnetic characteristic of the iron, the magnetizing force, = f ampere-turns per centimeter length where

$$f = \frac{10}{4\pi} H$$

if H = magnetizing force in c.g.s. units.

Hence,

if l_i = length of iron circuit, $F_i = l_i f$ = ampere-turns required in the iron;

if l_a = length of air circuit, $F_a = \frac{10 l_a B}{4 \pi}$ = ampere-turns required in the air;

hence, $F = F_i + F_a =$ total ampere-turns, maximum value, and $\frac{F}{\sqrt{2}} =$ effective value. The exciting current is

$$I = \frac{F}{n\sqrt{2}},$$

and the absolute admittance,

$$y = \sqrt{g^2 + b^2} = \frac{I}{E}.$$

If F_i is not negligible as compared with F_a , this admittance, y , is variable with the e.m.f., E .

If $V =$ volume of iron, $\eta =$ coefficient of hysteresis, the loss of power by hysteresis due to molecular magnetic friction is

$$P = \eta f V B^{1.6};$$

hence the hysteretic conductance is $g = \frac{P}{E^2}$, and variable with the e.m.f., E .

The angle of hysteretic advance is

$$\sin \alpha = \frac{g}{y};$$

the susceptance,

$$b = \sqrt{y^2 - g^2};$$

the effective resistance,

$$r = \frac{g}{y^2};$$

and the reactance,

$$x = \frac{b}{y^2}.$$

103. As conclusions, we derive from this chapter the following:

1. In an alternating-current circuit surrounded by iron, the current produced by a sine wave of e.m.f. is not a true sine wave, but is distorted by hysteresis, and inversely, a sine wave of current requires waves of magnetism and e.m.f. differing from sine shape.

2. This distortion is excessive only with a closed magnetic circuit transferring no energy into a secondary circuit by mutual inductance.

3. The distorted wave of current can be replaced by the equivalent sine wave—that is, a sine wave of equal effective intensity and equal power—and the superposed higher harmonic, con-

sisting mainly of a term of triple frequency, may be neglected except in resonating circuits.

4. Below saturation, the distorted curve of current and its equivalent sine wave have approximately the same maximum value.

5. The angle of hysteretic advance—that is, the phase difference between the magnetic flux and equivalent sine wave of m.m.f.—is a maximum for the closed magnetic circuit, and depends there only upon the magnetic constants of the iron, upon the permeability, μ , the coefficient of hysteresis, η , and the maximum magnetic induction, as shown in the equation,

$$\sin \alpha = \frac{4 \mu \eta}{B^{0.4}}.$$

6. The effect of hysteresis can be represented by an admittance $Y = g - jb$, or an impedance, $Z = r + jx$.

7. The hysteretic admittance, or impedance, varies with the magnetic induction; that is, with the e.m.f., etc.

8. The hysteretic conductance, g , is proportional to the coefficient of hysteresis, η , and to the length of the magnetic circuit, l , inversely proportional to the 0.4th power of the e.m.f. E , to the 0.6th power of frequency, f , and of the cross-section of the magnetic circuit, A , and to the 1.6th power of the number of turns of the electric circuit, n , as expressed in the equation,

$$g = \frac{58 \eta l 10^3}{E^{0.4} f^{0.6} A^{0.6} n^{1.6}}.$$

9. The absolute value of hysteretic admittance,

$$y = \sqrt{g^2 + b^2},$$

is proportional to the magnetic reluctance: $\mathcal{R} = \mathcal{R}_i + \mathcal{R}_a$, and inversely proportional to the frequency, f , and to the square of the number of turns, n , as expressed in the equation,

$$y = \frac{(\mathcal{R}_i + \mathcal{R}_a) 10^5}{2 \pi f n^2}.$$

10. In an ironclad circuit, the absolute value of admittance is proportional to the length of the magnetic circuit, and inversely proportional to cross-section, A , frequency, f , permeability, μ and square of the number of turns, n , or

$$y_i = \frac{127 l 10^5}{n^2 A f \mu}.$$

11. In an open magnetic circuit, the conductance, g , is the same as in a closed magnetic circuit of the same iron part.

12. In an open magnetic circuit, the admittance, y , is practically constant, if the length of the air-gap is at least $\frac{1}{100}$ of the length of the magnetic circuit, and saturation be not approached.

13. In a closed magnetic circuit, conductance, susceptance, and admittance can be assumed as constant through a limited range only.

14. From the shape and the dimensions of the circuits, and the magnetic constants of the iron, all the electric constants, g , b , y ; r , x , z , can be calculated.

104. The preceding applies to the alternating magnetic circuit, that is, circuit in which the magnetic induction varies between equal but opposite limits: $B_1 = +B_0$ and $B_2 = -B_0$.

In a pulsating magnetic circuit, in which the induction B varies between two values B_1 and B_2 , which are not equal numerically, and which may be of the same sign or of opposite sign, that is in which the hysteresis cycle is unsymmetrical, the law of the 1.6th power still applies, and the loss of energy per cycle is proportional to the 1.6th power of the amplitude of the magnetic variation:

$$W_H = \eta \left(\frac{B_1 - B_2}{2} \right)^{1.6}$$

but the hysteresis coefficient η is not the same as for alternating magnetic circuits, but increases with increasing average value $\frac{B_1 + B_2}{2}$ of the magnetic induction.

Such unsymmetrical magnetic cycles occur in some types of induction alternators,¹ in which the magnetic induction does not reverse, but pulsates between a high and a low value in the same direction.

Unsymmetrical magnetic cycles occasionally occur—and give trouble—in transformers by the entrance of a stray direct current (railway return) over the ground connection, or when an unsuitable transformer connection is used on a synchronous converter feeding a three-wire system.

Very unsymmetrical cycles may give very much higher losses than symmetrical cycles of the same amplitude.

For more complete discussion of unsymmetrical cycles see "Theory and Calculation of Electric Circuits."

¹ See "Theory and Calculation of Electric Apparatus."

CHAPTER XIII

FOUCAULT OR EDDY CURRENTS

105. While magnetic hysteresis due to molecular friction is a magnetic phenomenon, eddy currents are rather an electrical phenomenon. When iron passes through a magnetic field, a loss of energy is caused by hysteresis, which loss, however, does not react magnetically upon the field. When cutting an electric conductor, the magnetic field produces a current therein. The m.m.f. of this current reacts upon and affects the magnetic field, more or less; consequently, an alternating magnetic field cannot penetrate deeply into a solid conductor, but a kind of screening effect is produced, which makes solid masses of iron unsuitable for alternating fields, and necessitates the use of laminated iron or iron wire as the carrier of magnetic flux.

Eddy currents are true electric currents, though existing in minute circuits; and they follow all the laws of electric circuits.

Their e.m.f. is proportional to the intensity of magnetization, B , and to the frequency, f .

Eddy currents are thus proportional to the magnetization, B , the frequency, f , and to the electric conductivity, λ , of the iron; hence, can be expressed by

$$i = b\lambda Bf.$$

The power consumed by eddy currents is proportional to their square, and inversely proportional to the electric conductivity, and can be expressed by

$$P = b^2\lambda B^2f^2;$$

or, since Bf is proportional to the generated e.m.f., E , in the equation

$$E = \sqrt{2} \pi A n f B 10^{-8},$$

it follows that, *The loss of power by eddy currents is proportional to the square of the e.m.f., and proportional to the electric conductivity of the iron; or,*

$$P = aE^2\lambda.$$

Hence, that component of the effective conductance which is due to eddy currents is

$$g = \frac{P}{E^2} = a\lambda;$$

that is, *The equivalent conductance due to eddy currents in the iron is a constant of the magnetic circuit; it is independent of e.m.f., frequency, etc., but proportional to the electric conductivity of the iron, λ .*

Eddy currents, like magnetic hysteresis, cause an advance of phase of the current by an *angle of advance*, β ; but unlike hysteresis, eddy currents in general do not distort the current wave.

The angle of advance of phase due to eddy currents is

$$\sin \beta = \frac{g}{y},$$

where y = absolute admittance of the circuit, g = eddy current conductance.

While the equivalent conductance, g , due to eddy currents, is a constant of the circuit, and independent of e.m.f., frequency, etc., the loss of power by eddy currents is proportional to the square of the e.m.f. of self-induction, and therefore proportional to the square of the frequency and to the square of the magnetization.

Only the power component, gE , of eddy currents, is of interest, since the wattless component is identical with the wattless component of hysteresis, discussed in the preceding chapter.

106. To calculate the loss of power by eddy currents,

- Let V = volume of iron;
 B = maximum magnetic induction;
 f = frequency;
 λ = electric conductivity of iron;
 ϵ = coefficient of eddy currents.

The loss of energy per cubic centimeter, in ergs per cycle, is

$$w = \epsilon\lambda f B^2;$$

hence, the total loss of power by eddy currents is

$$P = \epsilon\lambda V f^2 B^2 \cdot 10^{-7} \text{ watts,}$$

and the equivalent conductance due to eddy currents is

$$g = \frac{P}{E^2} = \frac{10 \epsilon\lambda l}{2 \pi^2 A n^2} = \frac{0.507 \epsilon\lambda l}{A n^2},$$

where

- l = length of magnetic circuit,
 A = section of magnetic circuit,
 n = number of turns of electric circuit.

The coefficient of eddy currents, ϵ , depends merely upon the shape of the constituent parts of the magnetic circuit; that is, whether of iron plates or wire, and the thickness of plates or the diameter of wire, etc.

The two most important cases are:

- (a) Laminated iron.
 (b) Iron wire.

107. (a) *Laminated Iron.*

Let, in Fig. 91,

- d = thickness of the iron plates;
 B = maximum magnetic induction;
 f = frequency;
 λ = electric conductivity of the iron.

Then, if u is the distance of a zone, du , from the center of the sheet, the conductance of a zone of thickness, du , and of one centimeter length and width is λdu ; and the magnetic flux cut by this zone is Bu . Hence, the e.m.f. induced in this zone is

$$\delta E = \sqrt{2} \pi f B u, \text{ in c.g.s. units.}$$

This e.m.f. produces the current, $dI = \delta E \lambda du = \sqrt{2} \pi f B \lambda u du$, in c.g.s. units, provided the thickness of the plate is negligible as compared with the length, in order that the current may be assumed as parallel to the sheet, and in opposite directions on opposite sides of the sheet.

The power consumed by the current in this zone, du , is

$$dP = \delta E dI = 2 \pi^2 f^2 B^2 \lambda u^2 du,$$

in c.g.s. units or ergs per second, and, consequently, the total power consumed in one square centimeter of the sheet of thickness, d , is

$$\begin{aligned} \delta P &= \int_{-\frac{d}{2}}^{+\frac{d}{2}} dP = 2 \pi^2 f^2 B^2 \lambda \int_{-\frac{d}{2}}^{+\frac{d}{2}} u^2 du \\ &= \frac{\pi^2 f^2 B^2 \lambda d^3}{6}, \text{ in c.g.s. units;} \end{aligned}$$

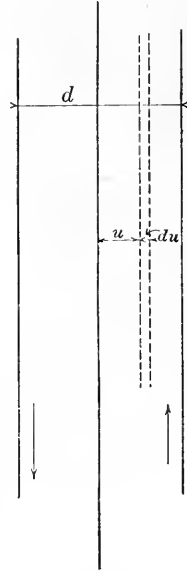

FIG. 91.

the power consumed per cubic centimeter of iron is, therefore,

$$p = \frac{\delta P}{d} = \frac{\pi^2 f^2 B^2 \lambda d}{6}, \text{ in c.g.s. units or erg-seconds,}$$

and the energy consumed per cycle and per cubic centimeter of iron is

$$w = \frac{p}{f} = \frac{\pi^2 \lambda d^2 f B^2}{6} \text{ ergs.}$$

The coefficient of eddy currents for laminated iron is, therefore,

$$\epsilon = \frac{\pi^2 d^2}{6} = 1.645 d^2,$$

where λ is expressed in c.g.s. units. Hence, if λ is expressed in practical units or 10^{-9} c.g.s. units,

$$\epsilon = \frac{\pi^2 d^2 10^{-9}}{6} = 1.645 d^2 10^{-9}.$$

Substituting for the conductivity of sheet iron the approximate value.

$$\lambda = 10^5,^1$$

we get as the coefficient of eddy currents for laminated iron,

$$\epsilon = \frac{\pi^2}{6} d^2 10^{-9} = 1.645 d^2 10^{-9};$$

loss of energy per cubic centimeter and cycle,

$$\begin{aligned} W &= \epsilon \lambda f B^2 = \frac{\pi^2}{6} d^2 \lambda f B^2 10^{-9} = 1.645 d^2 \lambda f B^2 10^{-9} \text{ ergs} \\ &= 1.645 d^2 f B^2 10^{-4} \text{ ergs;} \end{aligned}$$

or, $W = \epsilon \lambda f B^2 10^{-7} = 1.645 d^2 f B^2 10^{-11}$ joules.

The loss of power per cubic centimeter at frequency, f , is

$$p = fW = \epsilon \lambda f^2 B^2 10^{-7} = 1.645 d^2 f^2 B^2 10^{-11} \text{ watts;}$$

the total loss of power in volume, V , is

$$P = Vp = 1.645 V d^2 f^2 B^2 10^{-11} \text{ watts.}$$

As an example,

$$\begin{aligned} d &= 1 \text{ mm.} = 0.1 \text{ cm.}; f = 100; B = 5,000; V = 1,000 \text{ c.c.}; \\ \epsilon &= 1.645 \times 10^{-11}; \\ W &= 4,110 \text{ ergs} \\ &= 0.000411 \text{ joules;} \\ p &= 0.0411 \text{ watts;} \\ P &= 41.4 \text{ watts.} \end{aligned}$$

¹ In some of the modern silicon steels used for transformer iron, λ reaches values as low as 2×10^4 , and even lower; and the eddy current losses are reduced in the same proportion (1915).

108. (b) *Iron Wire.*

Let, in Fig. 92, d = diameter of a piece of iron wire; then if u is the radius of a circular zone of thickness, du , and one centimeter in length, the conductance of this zone is $\frac{\lambda du}{2\pi u}$, and the magnetic flux inclosed by the zone is $Bu^2\pi$.

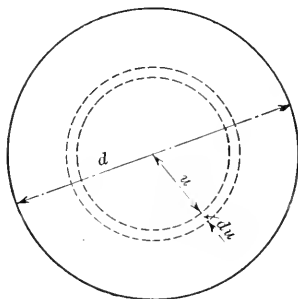

FIG. 92.

Hence, the e.m.f. generated in this zone is

$$\delta E = \sqrt{2}\pi^2 f B u^2 \text{ in c.g.s. units,}$$

and the current produced thereby is

$$\begin{aligned} dI &= \frac{\lambda du}{2\pi u} \times \sqrt{2}\pi^2 f B u^2 \\ &= \frac{\sqrt{2}\pi}{2} \lambda f B u \, du, \text{ in c.g.s. units.} \end{aligned}$$

The power consumed in this zone is, therefore,

$$dP = \delta E dI = \pi^3 \lambda f^2 B^2 u^3 du, \text{ in c.g.s. units;}$$

consequently, the total power consumed in one centimeter length of wire is

$$\begin{aligned} \delta P &= \int_0^{\frac{d}{2}} dW = \pi^3 \lambda f^2 B^2 \int_0^{\frac{d}{2}} u^3 du \\ &= \frac{\pi^3}{64} \lambda f^2 B^2 d^4, \text{ in c.g.s. units.} \end{aligned}$$

Since the volume of one centimeter length of wire is

$$v = \frac{d^2\pi}{4},$$

the power consumed in one cubic centimeter of iron is

$$p = \frac{\delta P}{v} = \frac{\pi^2}{16} \lambda f^2 B^2 d^2, \text{ in c.g.s. units or erg-seconds,}$$

and the energy consumed per cycle and cubic centimeter of iron is

$$W = \frac{p}{f} = \frac{\pi^2}{16} \lambda f B^2 d^2 \text{ ergs.}$$

Therefore, the coefficient of eddy currents for iron wire is

$$\epsilon = \frac{\pi^2}{16} d^2 = 0.617 d^2;$$

or, if λ is expressed in practical units, or 10^{-9} c.g.s. units,

$$\epsilon = \frac{\pi^2}{16} d^2 10^{-9} = 0.617 d^2 10^{-9}.$$

Substituting

$$\lambda = 10^5,$$

we get as the coefficient of eddy currents for iron wire,

$$\epsilon = \frac{\pi^2}{16} d^2 10^{-9} = 0.617 d^2 10^{-9}.$$

The loss of energy per cubic centimeter of iron, and per cycle, becomes

$$\begin{aligned} W &= \epsilon \lambda f B^2 = \frac{\pi^2}{16} d^2 \lambda f B^2 10^{-9} = 0.617 d^2 \lambda f B^2 10^{-9} \\ &= 0.617 d^2 f B^2 10^{-4} \text{ ergs,} \\ &= \epsilon \lambda f B^2 10^{-7} = 0.617 d^2 f B^2 10^{-11} \text{ joules;} \end{aligned}$$

loss of power per cubic centimeter at frequency, f ,

$$p = fW = \epsilon \lambda N^2 B^2 10^{-7} = 0.617 d^2 N^2 B^2 10^{-11} \text{ watts;}$$

total loss of power in volume, V ,

$$P = Vp = 0.617 V d^2 f^2 B^2 10^{-11} \text{ watts.}$$

As an example,

$d = 1 \text{ mm.,} = 0.1 \text{ cm.}; f = 100; B^2 = 5,000; V = 1,000 \text{ cu. cm.}$

Then,

$$\begin{aligned} \epsilon &= 0.617 \times 10^{-11}, \\ W &= 1,540 \text{ ergs} = 0.000154 \text{ joules,} \\ p &= 0.0154 \text{ watts,} \\ P &= 1.54 \text{ watts,} \end{aligned}$$

hence very much less than in sheet iron of equal thickness.

109. Comparison of sheet iron and iron wire.

If

$d_1 =$ thickness of lamination of sheet iron, and
 $d_2 =$ diameter of iron wire,

the eddy current coefficient of sheet iron being

$$\epsilon_1 = \frac{\pi^2}{6} d_1^2 10^{-9},$$

and the eddy current coefficient of iron wire

$$\epsilon_2 = \frac{\pi^2}{16} d_2^2 10^{-9},$$

the loss of power is equal in both—other things being equal—if $\epsilon_1 = \epsilon_2$; that is, if

$$d_2^2 = \frac{8}{3} d_1^2, \text{ or } d_2 = 1.63.d_1.$$

It follows that the diameter of iron wire can be 1.63 times or, roughly, $1\frac{2}{3}$ as large as the thickness of laminated iron, to give the same loss of power through eddy currents, as shown in Fig. 93.

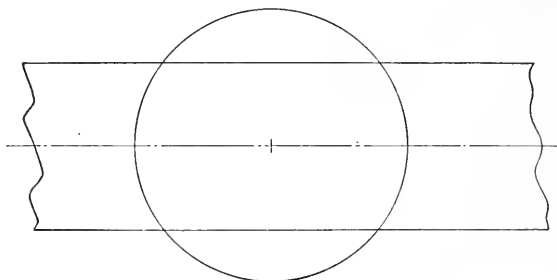

FIG. 93.

110. Demagnetizing, or screening effect of eddy currents.

The formulas derived for the coefficient of eddy currents in laminated iron and in iron wire hold only when the eddy currents are small enough to neglect their magnetizing force. Otherwise the phenomenon becomes more complicated; the magnetic flux in the interior of the lamina, or the wire, is not in phase with the flux at the surface, but lags behind it. The magnetic flux at the surface is due to the impressed m.m.f., while the flux in the interior is due to the resultant of the impressed m.m.f. and to the m.m.f. of eddy currents; since the eddy currents lag 90 degrees behind the flux producing them, their resultant with the impressed m.m.f., and therefore the magnetism in the interior, is made lagging. Thus, progressing from the surface toward the interior, the magnetic flux gradually lags more and more in phase, and at the same time decreases in intensity. While the complete analytical solution of this phenomenon is beyond the

scope of this book, a determination of the magnitude of this demagnetization, or screening effect, sufficient to determine whether it is negligible, or whether the subdivision of the iron has to be increased to make it negligible, can be made by calculating the maximum magnetizing effect, which cannot be exceeded by the eddys.

Assuming the magnetic density as uniform over the whole cross-section, and therefore all the eddy currents in phase with each other, their total m.m.f. represents the maximum possible value, since by the phase difference and the lesser magnetic density in the center the resultant m.m.f. is reduced.

In laminated iron of thickness d , the current in a zone of thickness du , at distance u from center of sheet, is

$$\begin{aligned} dI &= \sqrt{2} \pi f B \lambda u \, du \text{ units (c.g.s.)} \\ &= \sqrt{2} \pi f B \lambda u \, du \, 10^{-8} \text{ amp.;} \end{aligned}$$

hence the total current in the sheet is

$$\begin{aligned} I &= \int_0^{\frac{d}{2}} dI = \sqrt{2} \pi f B \lambda \, 10^{-8} \int_0^{\frac{d}{2}} u \, du \\ &= \frac{\sqrt{2} \pi}{8} f B \lambda d^2 \, 10^{-8} \text{ amp.} \end{aligned}$$

Hence, the maximum possible demagnetizing ampere-turns, acting upon the center of the lamina, are

$$\begin{aligned} I &= \frac{\sqrt{2} \pi}{8} f B \lambda d^2 \, 10^{-8} = 0.555 f B \lambda d^2 \, 10^{-8}, \\ &= 0.555 f B \lambda d^2 \, 10^{-8} \text{ ampere-turns per cm.} \end{aligned}$$

Example: $d = 0.1$ cm., $f = 100$, $B = 5000$, $\lambda = 10^5$,
or $I = 2.775$ ampere-turns per cm.

111. In iron wire of diameter d , the current in a tubular zone of du thickness and u radius is

$$dI = \frac{\sqrt{2}}{2} \pi f B \lambda u \, du \, 10^{-8} \text{ amp.;}$$

hence, the total current is

$$\begin{aligned} I &= \int_0^{\frac{d}{2}} dI = \frac{\sqrt{2}}{2} \pi f B \lambda \, 10^{-8} \int_0^{\frac{d}{2}} u \, dx \\ &= \frac{\sqrt{2}}{16} \pi f B \lambda d^2 \, 10^{-8} \text{ amp.} \end{aligned}$$

Hence, the maximum possible demagnetizing ampere-turns, acting upon the center of the wire, are

$$\begin{aligned} I &= \frac{\sqrt{2}\pi}{16} fB\lambda d^2 10^{-8} = 0.2775 fB\lambda d^2 10^{-8} \\ &= 0.2775 fB\lambda d^2 10^{-8} \text{ ampere-turns per cm.} \end{aligned}$$

For example, if $d = 0.1$ cm., $f = 100$, $B = 5000$, $\lambda = 10^5$, then $I = 1.338$ ampere-turns per cm.; that is, half as much as in a lamina of the thickness d .

For a more complete investigation of the screening effect of eddy currents in laminated iron, see Section III of "Theory and Calculation of Transient Electric Phenomena and Oscillations."

112. Besides the eddy, or Foucault, currents proper, which exist as parasitic currents in the interior of the iron lamina or wire, under certain circumstances eddy currents also exist in larger orbits from lamina to lamina through the whole magnetic structure. Obviously a calculation of these eddy currents is possible only in a particular structure. They are mostly surface currents, due to short circuits existing between the laminae at the surface of the magnetic structure.

Furthermore, eddy currents are produced outside of the magnetic iron circuit proper, by the magnetic stray field cutting electric conductors in the neighborhood, especially when drawn toward them by iron masses behind, in electric conductors passing through the iron of an alternating field, etc. All these phenomena can be calculated only in particular cases, and are of less interest, since they can and should be avoided.

The power consumed by such large eddy currents frequently increases more than proportional to the square of the voltage, when approaching magnetic saturation, by the magnetic stray field reaching unlaminated conductors, and so, while negligible at normal voltage, this power may become large at over-normal voltage.

Eddy Currents in Conductor, and Unequal Current Distribution

113. If the electric conductor has a considerable size, the alternating magnetic field, in cutting the conductor, may set up differences of potential between the different parts thereof, thus giving rise to local or eddy currents in the copper. This phenomenon can obviously be studied only with reference to a

particular case, where the shape of the conductor and the distribution of the magnetic field are known.

Only in the case where the magnetic field is produced by the current in the conductor can a general solution be given. The alternating current in the conductor produces a magnetic field, not only outside of the conductor, but inside of it also; and the lines of magnetic force which close themselves inside of the conductor generate e.m.fs. in their interior only. Thus the counter e.m.f. of self-induction is largest at the axis of the conductor, and least at its surface; consequently, the current density at the surface will be larger than at the axis, or, in extreme cases, the current may not penetrate at all to the center, or a reversed current may exist there. Hence it follows that only the exterior part of the conductor may be used for the conduction of electricity, thereby causing an increase of the ohmic resistance due to unequal current distribution.

The general discussion of this problem, as applicable to the distribution of alternating current in very large conductors, as the iron rails of the return circuit of alternating-current railways, is given in Section III of "Theory and Calculation of Transient Electric Phenomena and Oscillations."

In practice, this phenomenon is observed mainly with very high frequency currents, as lightning discharges, wireless telegraph and lightning arrester circuits; in power-distribution circuits it has to be avoided by either keeping the frequency sufficiently low or having a shape of conductor such that unequal current-distribution does not take place, as by using a tubular or a flat conductor, or several conductors in parallel.

114. It will, therefore, here be sufficient to determine the largest size of round conductor, or the highest frequency, where this phenomenon is still negligible.

In the interior of the conductor, the current density is not only less than at the surface, but the current lags in phase behind the current at the surface, due to the increased effect of self-induction. This time-lag of the current causes the magnetic fluxes in the conductor to be out of phase with each other, making their resultant less than their sum, while the lesser current density in the center reduces the total flux inside of the conductor. Thus, by assuming, as a basis for calculation, a uniform current density and no difference of phase between the currents in the different layers of the conductor, the unequal distribution is found larger

than it is in reality. Hence this assumption brings us on the safe side, and at the same time greatly simplifies the calculation; however, it is permissible only where the current density is still fairly uniform.

Let Fig. 94 represent a cross-section of a conductor of radius, R , and a uniform current density,

$$i = \frac{I}{R^2 \pi},$$

where I = total current in conductor.

The magnetic reluctance of a tubular zone of unit length and thickness du , of radius u , is

$$\mathfrak{R}_u = \frac{2 u \pi}{du}.$$

The current inclosed by this zone is $I_u = iu^2\pi$, and therefore, the m.m.f. acting upon this zone is

$$F_u = 0.4 \pi I_u = 0.4 \pi^2 i u^2,$$

and the magnetic flux in this zone is

$$d\Phi = \frac{F_u}{\mathfrak{R}_u} = 0.2 \pi i u du.$$

Hence, the total magnetic flux inside the conductor is

$$\Phi = \int_0^R d\Phi = \frac{2 \pi i}{10} \int_0^R u du = \frac{\pi i R^2}{10} = \frac{I}{10}.$$

From this we get, as the excess of counter e.m.f. at the axis of the conductor over that at the surface,

$$\begin{aligned} \Delta E &= \sqrt{2} \pi f \Phi 10^{-8} = \sqrt{2} \pi f I 10^{-9}, \text{ per unit length,} \\ &= \sqrt{2} \pi^2 f i R^2 10^{-9}; \end{aligned}$$

and the reactivity, or specific reactance at the center of the conductor, becomes $k = \frac{\Delta E}{i} = \sqrt{2} \pi^2 f R^2 10^{-9}$.

Let ρ = resistivity, or specific resistance, of the material of the conductor.

We have then,

$$\frac{k}{\rho} = \frac{\sqrt{2} \pi^2 f R^2 10^{-9}}{\rho};$$

and

$$\frac{\rho}{\sqrt{k^2 + \rho^2}},$$

the ratio of current densities at center and at periphery.

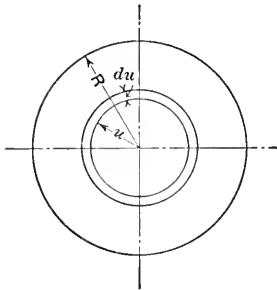

FIG. 94.

For example, if, in copper, $\rho = 1.7 \times 10^{-6}$, and the percentage decrease of current density at center shall not exceed 5 per cent., that is,

$$\rho \div \sqrt{k^2 + \rho^2} = 0.95 \div 1,$$

we have

$$k = 0.51 \times 10^{-6};$$

hence

$$0.51 \times 10^{-6} = \sqrt{2} \pi^2 f R^2 10^{-9},$$

or

$$f R^2 = 36.3;$$

hence, when

$f =$	125	100	60	25
$R =$	0.541	0.605	0.781	1.21 cm.
$D = 2R =$	1.08	1.21	1.56	2.42 cm.

Hence, even at a frequency of 125 cycles, the effect of unequal current distribution is still negligible at one centimeter diameter of the conductor. Conductors of this size are, however, excluded from use at this frequency by the external self-induction, which is several times larger than the resistance. We thus see that unequal current distribution is usually negligible in practice.

The above calculation was made under the assumption that the conductor consists of unmagnetic material. If this is not the case, but the conductor of iron of permeability

μ , then $d\Phi = \frac{\mu F_u}{R_u}$; and thus ultimately, $k = \sqrt{2} \pi^2 f \mu R^2 10^{-9}$, and $\frac{k}{\rho} = \sqrt{2} \pi^2 \frac{f \mu R^2 10^{-9}}{\rho}$. Thus, for instance, for iron wire at $\rho = 10 \times 10^{-6}$, $\mu = 500$, it is, permitting 5 per cent. difference between center and outside of wire, $k = 3.2 \times 10^{-6}$, and $f R^2 = 0.46$;

hence, when

$f =$	125	100	60	25
$R =$	0.061	0.068	0.088	0.136 cm.;

thus the effect is noticeable even with relatively small iron wire.

Mutual Induction

115. When an alternating magnetic field of force includes a secondary electric conductor, it generates therein an e.m.f. which produces a current, and thereby consumes energy if the circuit of the secondary conductor is closed.

Particular cases of such secondary currents are the eddy or Foucault currents previously discussed.

Another important case is the generation of secondary e.m.f.s. in neighboring circuits; that is, the interference of circuits running parallel with each other.

In general, it is preferable to consider this phenomenon of mutual induction as not merely producing a power component and a wattless component of e.m.f. in the primary conductor, but to consider explicitly both the secondary and the primary circuit, as will be done in the chapter on the alternating-current transformer.

Only in cases where the energy transferred into the secondary circuit constitutes a small part of the total primary energy, as in the discussion of the disturbance caused by one circuit upon a parallel circuit, may the effect on the primary circuit be considered analogously as in the chapter on eddy currents by the introduction of a power component, representing the loss of power, and a wattless component, representing the decrease of self-induction.

Let

$x = 2\pi fL$ = reactance of main circuit; that is, L = total number of interlinkages with the main conductor, of the lines of magnetic force produced by unit current in that conductor;

$x_1 = 2\pi fL_1$ = reactance of secondary circuit; that is, L_1 = total number of interlinkages with the secondary conductor, of the lines of magnetic force produced by unit current in that conductor;

$x_m = 2\pi fL_m$ = mutual inductive reactance of the circuits; that is, L_m = total number of interlinkages with the secondary conductor, of the lines of magnetic force produced by unit current in the main conductor, or total number of interlinkages with the main conductor of the lines of magnetic force produced by unit current in the secondary conductor.

Obviously: $x_m^2 \geq x x_1$.¹

¹ As self-inductance L , L_1 , the total flux surrounding the conductor is here meant. Usually in the discussion of inductive apparatus, especially of transformers, as the self-inductance of circuit is denoted that part of the magnetic flux which surrounds one circuit but not the other circuit; and as mutual inductance flux which passes between both circuits. Hence, the total self-inductance, L , is in this case equal to the sum of the self-inductance, L_1 , and mutual inductance, L_m .

The object of this distinction is to separate the wattless part, L_1 , of the

Let r_1 = resistance of secondary circuit. Then the impedance of secondary circuit is

$$Z_1 = r_1 + jx_1, \quad z_1 = \sqrt{r_1^2 + x_1^2};$$

e.m.f. generated in the secondary circuit, $E_1 = -jx_m I$, where I = primary current. Hence, the secondary current is

$$I_1 = \frac{E_1}{z_1} = \frac{-jx_m}{r_1 + jx_1} I;$$

and the e.m.f. generated in the primary circuit by the secondary current, E , is

$$E = -jx_m I_1 = \frac{-x_m^2}{r_1 + jx_1} I;$$

or, expanded,

$$E = \left\{ \frac{-x_m^2 r_1}{r_1^2 + x_1^2} + \frac{jx_m^2 x_1}{r_1^2 + x_1^2} \right\} I.$$

Hence, the e.m.f. consumed thereby,

$$E' = \left\{ \frac{x_m^2 r_1}{r_1^2 + x_1^2} - \frac{jx_m^2 x_1}{r_1^2 + x_1^2} \right\} I = (r + jx)I.$$

$$r = \frac{x_m^2 r_1}{r_1^2 + x_1^2} = \text{effective resistance of mutual inductance};$$

$$x = \frac{-x_m^2 x_1}{r_1^2 + x_1^2} = \text{effective reactance of mutual inductance}.$$

The susceptance of mutual inductance is negative, or of opposite sign from the reactance of self-inductance. Or,

Mutual inductance consumes energy and decreases the self-inductance.

For the calculation of the mutual inductance between circuits L_m , see "Theoretical Elements of Electrical Engineering," 4th Ed.

total self-inductance, L , from that part, L_m , which represents the transfer of e.m.f. into the secondary circuit, since the action of these two components is essentially different.

Thus, in alternating-current transformers it is customary—and will be done later in this book—to denote as the self-inductance, L , of each circuit only that part of the magnetic flux produced by the circuit which passes between both circuits, and thus acts in "choking" only, but not in transforming; while the flux surrounding both circuits is called the mutual inductance, or useful magnetic flux.

With this denotation, in transformers the mutual inductance, L_m , is usually very much greater than the self-inductance, L' , and L_1' , while, if the self-inductance, L and L_1 , represent the total flux, their product is larger than the square of the mutual inductance, L_m ; or

$$LL_1 \geq L_m^2; \quad (L' + L_m)(L_1' + L_m) \geq L_m^2.$$

CHAPTER XIV

DIELECTRIC LOSSES

Dielectric Hysteresis

116. Just as magnetic hysteresis and eddy currents give a power component in the inductive reactance, as "effective resistance," so the energy losses in the dielectric lead to a power component in the condensive reactance, which may be represented by an "effective resistance of dielectric losses" or an "effective conductance of dielectric losses."

In the alternating magnetic field, power is consumed by magnetic hysteresis. This is proportional to the frequency, and to the 1.6th power of the magnetic density, and is considerable, amounting in a closed magnetic circuit to 40 to 60 per cent. of the total volt-amperes.

In the dielectric field, the energy losses usually are very much smaller, rarely amounting to more than a few per cent., though they may at high temperature in cables rise as high as 40 to 60 per cent. The foremost such losses are: leakage, that is, i^2r loss of the current passing by conduction (as "dynamic current") through the resistance of the dielectric; corona, that is, losses due to a partial or local breakdown of the electrostatic field, and dielectric hysteresis or phenomena of similar nature.

It is doubtful whether a true dielectric hysteresis, that is, a molecular dielectric friction, exists. A dielectric loss, proportional to the frequency and to the 1.6th power of the dielectric field:

$$P = nfD^{1.6}$$

has been observed in rotating dielectric fields, but is so small, that it usually is overshadowed by the other losses.

In alternating dielectric fields in solid materials, such as in condensers, coil insulation, etc., a loss is commonly observed which gives an approximately constant power-factor of the electric energizing circuit, over a wide range of voltage and of frequency, from less than a fraction of 1 per cent. up to a few per cent.

Constancy of the power-factor with the frequency, means that the loss is proportional to the frequency, as the current i , and thus the volt-ampere input, ei , are proportional to the frequency. Constancy of the power-factor with the voltage, means that the loss is proportional to the square of the voltage, as the current i is proportional to the voltage, and the volt-ampere input ei thus proportional to the square of the voltage. This loss thus would be approximated by the expression:

$$P = \eta f D^2$$

and thus seems to be akin to magnetic hysteresis, except that at least a part of this dielectric loss is possibly consumed in chemical and mechanical disintegration of the insulating material, while the magnetic hysteresis loss is entirely converted to heat.

Leakage

117. The eddy current losses in the magnetic field are the i^2r loss of the currents flowing in the magnetic material, and as such are proportional to the square of the frequency and of the magnetic density:

$$P = \epsilon \gamma f^2 B^2$$

where γ = conductivity of the magnetic material.

This expression obviously holds only as long as the m.m.f. of the eddy currents is not sufficient to appreciably affect the magnetic flux distribution.

As corresponding hereto in the dielectric field may be considered the conduction loss through the resistance of the dielectric.

In a homogeneous dielectric of electric conductivity γ (usually very low) and specific capacity or permittivity k , if:

l = thickness of the dielectric,

A = area or cross-section,

e = impressed alternating-current voltage, effective value,
the dielectric capacity of the material is:

$$C = \frac{kA}{l}$$

and the capacity susceptance:

$$b = 2\pi fC = \frac{2\pi f k A}{l}$$

hence the current passing through the dielectric as capacity current or "displacement current," is:

$$i_0 = eb = 2\pi f C e = \frac{2\pi f k A}{l} e$$

The conductance of the dielectric is:

$$g = \frac{\gamma A}{l}$$

hence, the current, conducted through the dielectric, or leakage current:

$$i_1 = eg = \frac{\gamma A}{l} e$$

thus, the total current:

$$I = i_0 + ji_1 = \frac{eA}{l} \{\gamma + 2\pi f k j\}$$

here the j denotes, that the current component i_1 is in quadrature ahead of the voltage e .

The absolute value of the current thus is:

$$i = \sqrt{i_0^2 + i_1^2} = \frac{eA}{l} \sqrt{\gamma^2 + (2\pi f k)^2}$$

and the power consumption:

$$P = ei_1 = \frac{e^2 \gamma A}{l}$$

or, since the dielectric density D is proportional to the voltage gradient $\frac{e}{l}$ and the permittivity:

$$D = \frac{ek}{4\pi v^2 l}$$

(where $v = 3 \times 10^{10}$ = velocity of light, see "Theoretical Elements of Electrical Engineering.")

Thus:

$$P = \frac{(4\pi v^2)^2 \gamma V D^2}{k^2}$$

where

$$V = Al = \text{volume}$$

The power-factor then is:

$$p = \frac{P}{ei} = \frac{\gamma}{\sqrt{\gamma^2 + (2\pi f k)^2}}$$

Or, if, as usually the case, the conductivity γ is small compared with the susceptibility $2\pi fk$:

$$p = \frac{\gamma}{2\pi fk}$$

that is, the power-factor is inverse proportional to the frequency.

The observation of leakage losses and leakage resistance thus is best made at low frequencies or at direct-current voltage.

While, however, in magnetic materials the conductivity γ is fairly constant, varying only with the temperature, like that of all metals, the very low conductivity of the dielectric is often not even approximately constant, but may vary with the temperature, the voltage, etc., sometimes by many thousand per cent.

118. While in a homogeneous dielectric field, the leakage current power losses are independent of the frequency and herein differ from the magnetic eddy current losses, which latter are proportional to the square of the frequency, in non-homogeneous dielectric fields, leakage current losses may depend on the frequency.

As an instance, let us consider a dielectric consisting of two layers of different constants, for instance, a layer of mica and a layer of varnished cloth, such as is sometimes used in high-voltage armature insulation.

Let γ_1 = electric conductivity,
 k_1 = permittivity or specific capacity,
 l_1 = thickness and,
 A_1 = area or section

of the first layer of the dielectric, and

$$\gamma_2, k_2, l_2, A_2$$

the corresponding values of the second layer.

It is then:

$$\left. \begin{aligned} g &= \frac{\gamma A}{l} = \text{electric conductance} \\ C &= \frac{kA}{l} = \text{electrostatic capacity of the layer} \\ &\quad \text{of dielectric, hence:} \\ b &= 2\pi fC = \frac{2\pi fkA}{l} = \text{capacity susceptance, and} \end{aligned} \right\} \quad (1)$$

$$\left. \begin{aligned}
 Y &= g + jb = \text{admittance, thus:} \\
 Z &= \frac{1}{Y} = r - jx = \text{impedance, where:} \\
 r &= \frac{g}{y^2} = \text{vector resistance (not ohmic resistance,} \\
 &\quad \text{but energy component of impedance,} \\
 &\quad \text{see paragraph 89.)} \\
 x &= \frac{b}{y^2} = \text{vector reactance, and} \\
 y &= \sqrt{g^2 + b^2} = \text{absolute admittance,} \\
 (z &= \sqrt{r^2 + x^2} = \text{absolute impedance.)}
 \end{aligned} \right\} \quad (2)$$

If then, E_1 = potential drop across the first, E_2 = potential drop across the second layer of dielectric,

$$E = E_1 + E_2 = \text{voltage impressed upon the dielectric.} \quad (3)$$

The current i , which traverses the dielectric, partly by conduction through its resistance, partly by capacity as displacement current, then is the same in both layers, as they are in series in the dielectric field, and it is:

$$\left. \begin{aligned}
 E_1 &= i(r_1 - jx_1) \\
 E_2 &= i(r_2 - jx_2)
 \end{aligned} \right\} \quad (4)$$

and, by (3):

$$E = i \{ (r_1 + r_2) - j(x_1 + x_2) \} \quad (6)$$

or, absolute:

$$e = i\sqrt{(r_1 + r_2)^2 + (x_1 + x_2)^2} \quad (6)$$

Thus, the current:

$$i = \frac{e}{\sqrt{(r_1 + r_2)^2 + (x_1 + x_2)^2}} \quad (7)$$

the apparent power, or volt-ampere input:

$$Q = ei = \frac{e^2}{\sqrt{(r_1 + r_2)^2 + (x_1 + x_2)^2}} \quad (8)$$

the power consumed in the dielectric is:

$$\begin{aligned}
 P &= i^2(r_1 + r_2) \\
 &= \frac{e^2(r_1 + r_2)}{(r_1 + r_2)^2 + (x_1 + x_2)^2}
 \end{aligned} \quad (9)$$

and the power-factor:

$$P = \frac{P}{Q} = \frac{r_1 + r_2}{\sqrt{(r_1 + r_2)^2 + (x_1 + x_2)^2}} \quad (10)$$

119. Let us consider some special cases:

(a) If the conductivity, γ_1 and γ_2 , of the two layers of dielectric

is so small that the conduction current, ge , is negligible compared with the capacity current, $2\pi fCe$.

In this case, r_1 and r_2 are negligible compared with x_1 and x_2 , and it is:

$$\left. \begin{aligned} i &= \frac{e}{x_1 + x_2} \\ P &= \frac{e^2(r_1 + r_2)}{(x_1 + x_2)^2} \\ p &= \frac{r_1 + r_2}{x_1 + x_2} \end{aligned} \right\} \quad (11)$$

Substituting now for the impedance quantities $Z = r - jx$, which have no direct physical meaning in the dielectric field, the admittance quantities $Y = g + jb$, which have the physical meaning that g is the effective ohmic conductance, b the capacity susceptance, it is:

g negligible compared with b and y , and $b = y$.

Thus, by (2):

$$i = \frac{eb_1b_2}{b_1 + b_2} = \frac{2\pi fC_1C_2e}{C_1 + C_2} \quad (12)$$

hence proportional to the frequency f :

$$P = \frac{e^2(g_1b_2^2 + g_2b_1^2)}{(b_1 + b_2)^2} = \frac{e^2(g_1C_2^2 + g_2C_1^2)}{(C_1 + C_2)^2} \quad (13)$$

hence, the loss of power by current leakage in the dielectric in this case is independent of the frequency.

$$p = \frac{g_1 \frac{b_2}{b_1} + g_2 \frac{b_1}{b_2}}{b_1 + b_2} = \frac{g_1 \frac{C_2}{C_1} + g_2 \frac{C_1}{C_2}}{2\pi f(C_1 + C_2)} \quad (14)$$

hence, in this case the power-factor is inverse proportional to the frequency.

(b) If in both layers the leakage current is large compared with the capacity current, that is, $2\pi fCe$ negligible compared with ge .

In this case, x_1 and x_2 are negligible compared with r_1 and r_2 , and:

$$\left. \begin{aligned} i &= \frac{e}{r_1 + r_2} \\ Q &= \frac{e^2}{r_1 + r_2} \\ P &= \frac{e^2}{r_1 + r_2} \\ p &= 1 \end{aligned} \right\} \quad (15)$$

and as in this case r_1 and r_2 are the effective ohmic resistance of the dielectric, all the quantities are independent of the frequency; that is, the case is one of simple conduction.

120 (c) If in the first layer the leakage is negligible compared with the capacity current, but is not negligible in the second layer. That is, in a two-layer insulation, one layer leaks badly.

Assuming for simplicity that the two layers have the same capacity, $C = C_1 = C_2$. If the two capacities are unequal, the treatment is analogous, but merely the equations somewhat more complicated.

Let the conductance of the second layer = g , the capacity susceptance $2\pi fC = b$.

It is then:

r_1 negligible compared with the other quantities.

$$\left. \begin{aligned} r_2 &= \frac{g}{g^2 + b^2} \\ x_1 &= \frac{1}{b} \\ x_2 &= \frac{b}{g^2 + b^2} \end{aligned} \right\} \quad (16)$$

Substituting these values in equations (7) (8) (9) (10) gives:

$$i = \frac{e(g^2 + b^2)}{g \sqrt{1 + \left(\frac{g}{b} + \frac{2b}{g}\right)^2}} = \frac{e(g^2 + (2\pi fC)^2)}{g \sqrt{1 + \left(\frac{g}{2\pi fC} + \frac{4\pi fC}{g}\right)^2}} \quad (17)$$

$$P = \frac{e^2(g^2 + b^2)}{g \left\{ 1 + \left(\frac{g}{b} + \frac{2b}{g}\right) \right\}} = \frac{e^2(g^2 + (2\pi fC)^2)}{g \left\{ 1 + \left(\frac{g}{2\pi fC} + \frac{4\pi fC}{g}\right)^2 \right\}} \quad (18)$$

$$p = \frac{1}{\sqrt{1 + \left(\frac{g}{b} + 2\frac{b}{g}\right)^2}} = \frac{1}{\sqrt{1 + \left(\frac{g}{2\pi fC} + \frac{4\pi fC}{g}\right)^2}} \quad (19)$$

As seen, in this case current, power loss and power-factor depend on the frequency, but in a more complex manner.

With changing values of the conductance from low values, where g is negligible compared with the other terms, but the other terms negligible compared with $\frac{1}{g}$, up to high conductivity, where $\frac{1}{g}$ is negligible, but the terms with g predominate, the *current* changes from:

low g :

$$i = \pi f C e,$$

proportional to the frequency, to:

high g :

$$i = 2 \pi f C e.$$

Again proportional to the frequency, but twice as large, and at intermediate values of g , the current changes more rapidly than proportional to the frequency. The *loss of power* changes from:

low g :

$$P = \frac{g e}{4},$$

or independent of the frequency, to:

high g :

$$P = \frac{(2 \pi f C)^2 e}{g},$$

or proportional to the square of the frequency. The *power-factor* changes from:

low g :

$$p = \frac{g}{4 \pi f C},$$

or inverse proportional to the frequency, to:

high g :

$$p = \frac{2 \pi f C}{g},$$

or proportional to the frequency.

And over a considerable range of intermediate values of conductance, g , the power-factor, therefore, remains approximately constant; or, inversely, with changing frequency and constant g and b , the power-factor changes from proportionality with the frequency at low frequencies, up to inverse proportionality at high frequencies, and thereby passes through a maximum.

The value of g , for which the power-factor in equation (19) is a maximum, is found by differentiating: $\frac{dp}{dg} = 0$, as:

$$g = 2\sqrt{2} \pi f C \quad (20)$$

and this maximum power-factor is $p_0 = \frac{1}{2}$.

For $C_2 > C_1$, higher, for $C_2 < C_1$, lower values of power-factor maximum result, where C_2 is the leaky dielectric.

As illustration, Fig. 95 gives the values of power-factor, p , from equation (19), as function of $\frac{g}{b} = \frac{g}{2\pi fC} = \frac{g}{2\pi fk}$ as abscissæ.

A dielectric circuit, in which the power-factor decreases with increasing frequency, for instance, is that of the capacity of the transmission line; a dielectric circuit, in which the power-factor increases with the frequency, is that of the aluminum-cell lightning arrester.

121. As seen, in the dielectric circuit, that is, in insulators in which the current is essentially a displacement current, the

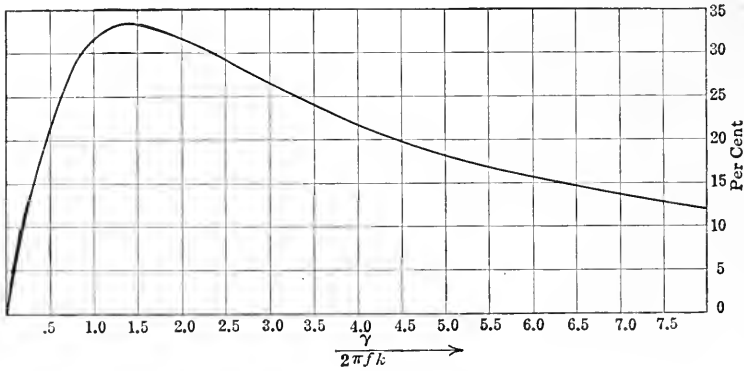

FIG. 95.

relations between voltage, current, power, phase angle and power-factor can be represented by the same symbolic equations as the relations between voltage, current, power and power-factor in metallic conductors, in which the current flow is dynamic, by the introduction of the effective admittance of the dielectric circuit, or part of circuit:

$$Y = g + jb,$$

where g is the effective conductance of the dielectric circuit, or the energy component of the admittance, representing the energy consumption by leakage, dielectric hysteresis, corona, etc., and $b = 2\pi fC$ is the capacity susceptance. Instead of the admittance Y , its reciprocal, the impedance $Z = r - jx$, may be used.

The main differences between the dielectric and the electrodynamic circuit are:

In the dielectric circuit, the susceptance, b , is positive, the reactance, x , negative; the current normally leads the voltage,

that is, capacity effects predominate and inductive effects are usually absent.

In the dynamic circuit, the reactance, x , usually is positive, the susceptance, b , negative; the current usually lags, that is, inductive effects predominate and capacity effects are usually absent.

In the dielectric circuit, the admittance terms, $Y = g + jb$, have a physical meaning as the effective conductance and the capacity susceptance, $2\pi fC$, but the impedance terms, $Z = r - jx$, are only derived quantities, without direct physical meaning: the vector resistance, r , is not the effective ohmic resistance of the dielectric, $\frac{1}{g}$, but is also depending on the capacity, $r = \frac{g}{g^2 + b^2}$, and the vector reactance, x , is not the condensive reactance, $\frac{1}{b} = \frac{1}{2\pi fC}$, but also depends on the conductance, $x = \frac{b}{g^2 + b^2}$.

In the dynamic circuit, the impedance terms, $Z = r + jx$, have a direct physical meaning, as effective ohmic resistance, r , and as self-inductive reactance, $2\pi fL$, while the admittance terms, $Y = g - jb$, are derived quantities, and the vector conductance, g , is not the reciprocal of the resistance, r , the vector susceptance, b , not the reciprocal of the reactance, x , as discussed in preceding chapters.

Physically, the most prominent difference between the dielectric circuit and the dynamic circuit is that for the displacement current of the dielectric circuit, that is, for the electrostatic flux, all space is conducting, while for the dynamic current, most materials are practically non-conductors, and the dynamic circuit thus is sharply defined in the extent of the flow of the current, while the dielectric circuit is not. The dielectric circuit thus is similar to the magnetic circuit; for the magnetic circuit all space is conducting also, that is, can carry magnetic flux. An un-insulated submarine electric circuit would be more nearly similar, in the distribution of current flow, to the dielectric and the magnetic circuit.

In the electric circuit, the conductor through which the current flows is generally sharply defined and of a uniform section, which is small compared with the length, and the conductor thus can be approximated as a linear conductor, that is, the current distribution throughout the conductor section assumed as uniform. With the dielectric and the magnetic circuit this is

rarely the case, and such circuits thus have to be investigated from place to place across the section of the current flow. This brings in the consideration of dielectric current density or dielectric flux density, and corresponding thereto magnetic flux density, as commonly used terms, while dynamic current density, that is, current per unit section of conductor, is far less frequently considered.

Thus, in the dielectric circuit, instead of admittance $Y = g + jb$, commonly the admittance per unit section and unit length of the dielectric circuit, or the *admittivity*, $v = \gamma - j\beta$, has to be considered, where γ = conductivity of the dielectric (or effective conductivity, including all other energy losses), and $\beta = 2\pi fk$ = susceptivity, where k = permittivity or specific capacity of the material.

We then have:

$$\left. \begin{aligned} \dot{I} &= \int (\gamma + 2\pi f k j) \frac{d\dot{E}}{dl} dA \\ \dot{E} &= \int \frac{\gamma - 2\pi f k j}{\gamma^2 + (2\pi f k)^2} \frac{d\dot{I}}{dA} dl \end{aligned} \right\} \quad (20)$$

122. With the extended industrial use of very high voltage, the explicit study of the dielectric field has become of importance, and it is not safe merely to consider the thickness of the insulation in relation to the voltage impressed upon it.

In an ununiform electric conductor, the relation of the voltage to the length of the conductor does not determine whether the conductor is safe or whether locally, due to small cross-section or high resistivity, unsafe current densities may cause destructive heating, but the adaptability of the conductor to the current carried by it must be considered throughout its entire length. So in the dielectric field, the thickness of the dielectric may be such that the voltage impressed upon it may give a very safe average voltage gradient or average dielectric flux density, and the dielectric nevertheless may break down, due to local concentration of the dielectric flux density in the insulating material. Thus, for instance, in the dielectric field between parallel conductors, at a voltage far below that which would jump from conductor to conductor, locally at the conductor surface the concentration of electrostatic stress exceeds the dielectric strength of air, and causes it to break down as corona. In solid dielectrics, under similar conditions, the breakdown due to local over-stress

often may change the flux distribution so as to gradually extend throughout the entire dielectric, until puncture results.

Corona

123.—In the magnetic field, with increasing magnetizing force, f , or magnetic field intensity, H , the magnetic flux density, B , increases, but for high field intensities the flux density ceases to be even approximately proportional to the field intensity, and finally, at very high field intensities, H , the “metallic magnetic induction,” $B_0 = B - H$, reaches a finite limiting value, which with iron is not far from $B_0 = 20,000$, the so-called “saturation value.”

In the dielectric field, with increasing voltage gradient, g , or dielectric field intensity, K , the dielectric flux density, D , increases proportional thereto, until a finite limiting field intensity, K_0 , or voltage gradient, g_0 , is reached, beyond which the dielectric cannot be stressed, but breaks down and becomes dynamically conducting, that is, punctures, and thereby short-circuits the dielectric field.

The voltage gradient, g_0 , at which disruption of the dielectric occurs is called the “disruptive strength” or “dielectric strength” of the dielectric. With air at atmospheric pressure and temperature, it is $g_0 = 30$ kv. per centimeter. Thus under alternating electric stress, air punctures at 21 kv. effective per centimeter $\left(\frac{30}{\sqrt{2}}\right)$. The dielectric strength of air is over a very wide range proportional to the air density, and thus proportional to the barometric pressure and inverse proportional to the absolute temperature. Air is one of the weakest dielectrics, and liquids and still more solids show far higher values of dielectric strength, up to and beyond a million volts per centimeter.

124. If then in a uniform dielectric field, such as that between parallel plates A and B as shown in Fig. 96, the voltage is gradually increased, as soon as the voltage maximum reaches a gradient of $g_0 = 30$ kv. in the gap between the metal plates, the air in this gap ceases to sustain the voltage, a spark passes, usually followed by the arc, and the potential difference across this gap drops from $g_0 l$ —where l is the distance between the metal plates A and B —to practically nothing, and the electric circuit thereby ceases to include a dielectric field.

Assuming now that the gap between the metal plates does not contain a homogeneous dielectric, but one consisting of several layers of different dielectric strength and different permittivity. For instance, we put two glass plates, *a* and *b*, of thickness l_0 into the gap, as shown in Fig. 97, thereby leaving an air space, *c*, of $l - 2l_0$. The dielectric flux density in the field is still uniform

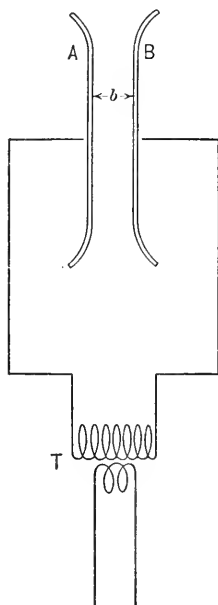

FIG. 96.

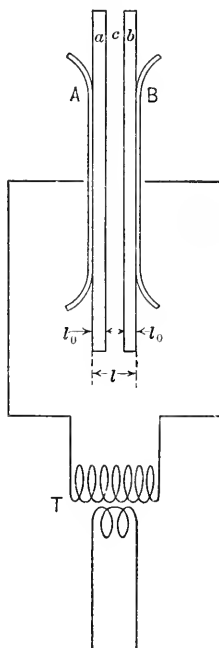

FIG. 97.

throughout the field section, but the voltage gradient in the different layers, *a*, *b* and *c*, is not the same, is not the average gradient, $g = \frac{e}{l}$, of the gap, but is inverse proportional to the permittivities:

$$g_0 \div g_1 = \frac{1}{k_0} \div \frac{1}{k_1}$$

where k_0 is the permittivity of the layers, *a* and *b*, k_1 the permittivity of the layer *c* ($=1$, if this layer is air). The potential drop across *a* and *b* thus is $l_0 g_0$, across *c* is $(l - 2l_0)g_1$, and the total voltage thus:

$$e = 2l_0 g_0 + (l - 2l_0)g_1,$$

or, substituting $g_0 = \frac{g_1 k_1}{k_0}$ gives:

$$e = g_1 \left\{ 2l_0 \left(\frac{k_1}{k_0} - 1 \right) + l \right\}$$

hence:

$$g_1 = \frac{e}{2l_0 \left(\frac{k_1}{k_0} - 1 \right) + l} = \frac{ek_0}{2l_0(k_1 - k_0) + lk_0}$$

and

$$g_0 = \frac{e \frac{k_1}{k_0}}{2l_0 \left(\frac{k_1}{k_0} - 1 \right) + l} = \frac{ek_1}{2l_0(k_1 - k_0) + lk_0}$$

Depending on the values of k_1 and k_0 , either g_0 or g_1 may be higher than the average gradient

$$g = \frac{e}{l}$$

To illustrate on a numerical instance:

Let the distance between the metal plates A and B be $l = 1$ cm. With nothing but air at atmospheric pressure and temperature between the plates, the gap would break down by a spark discharge, and short-circuit the circuit of Fig. 96; at $e = 30$ kv. maximum, and at $e = 25$ kv., no discharge would occur.

Assuming now two glass plates, a and b , each of 0.3 cm. thickness and permittivity $k_0 = 4$, were inserted, leaving an air-gap of 0.4 cm. of permittivity $k_1 = 1$. At $e = 25$ kv. the gradients thus would be, by above equation:

In the glass plates:

$$g_1 = 8.4 \text{ kv. per cm.}$$

In the air-gap:

$$g_0 = 35.7 \text{ kv. per cm.}$$

The air would thus be stressed beyond its dielectric strength, and would break down by spark discharge. This would drop the gradient in the air down to practically $g'_0 = 0$, and the gradient in the glass plates thus would become:

$$g'_1 = \frac{25}{0.6} = 41.7 \text{ kv. per cm.}$$

Thus the insertion of the glass plates would cause the air-gap to break down. The dynamic current which flows through the air-gap in this case would not be the short-circuit current of the

electric circuit, as would be the case in the absence of the glass plates but it would merely be the capacity current of the glass plates; and it would not be followed by the arc, but passes as a uniform bluish glow discharge, or as pink streamers—corona.

125. If the dielectric field is not uniform, but varying in density as, for instance, the field between two spheres or the field between two parallel wires, then with increasing voltage the breakdown gradient will not be reached simultaneously throughout the entire field, as in a uniform field, but it is first reached in the denser portion of the field—at the surface of the spheres or parallel wires, where the lines of dielectric force converge. Thus the dielectric will first break down at the denser portion of the field, and short-circuit these portions by the flow of dynamic current. This, however, changes the voltage gradient in the rest of the field, and may raise it so as to break down the entire field, or it may not do so.

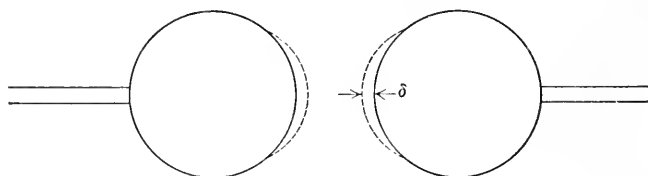

FIG. 98.



FIG. 99.

For instance, in the dielectric field between two spheres at distance l from each other, as shown in Figs. 98 and 99, with increasing potential difference, e , finally the breakdown gradient of the air, $g_0 = 30 \text{ kv.} = \text{cm.}$, is reached at the surface of the spheres, and up to a certain distance δ beyond it, and in this space δ the air breaks down, becomes conducting, and the space up to the distance δ is filled with corona. As the result, the conducting terminals of the dielectric field are not the original spheres, but the entire space filled by the corona, that is, the terminals are increased in size, and the convergency of the dielectric flux lines, that is, the voltage gradient at the effective terminals, is reduced. At the same time the gap between the effective terminals is reduced by 2δ , and the average voltage gradient thereby increased.

If the latter effect is greater—as is the case with large spheres at short distance from each other—the air becomes over-stressed at the edge δ of the corona formed by the original field, the corona spreads farther, and so on, until the entire field breaks down, that is, no stable corona forms, but immediate disruptive discharge. Inversely, with small spheres at considerable distance from each other, the formation of corona very soon increases the size of the effective terminals so as to bring the voltage gradient at the edge of the corona down to the disruptive gradient, g_0 , and the corona spreads no farther. In this case then, with increasing voltage, at a certain voltage, e_0 , corona begins to form at the terminals, first as bluish glow, then as violet streamers, which spread farther and farther with increasing voltage, until finally the disruptive spark passes between the terminals. In this case, corona precedes the disruptive discharge.

Experience shows that the voltage, e_v , at which corona begins at the surface is not the voltage at which the breakdown gradient of air, $g_0 = 30$, is reached at the sphere surface, but e_v is the voltage at which the breakdown gradient, g_0 , has extended up to a certain small but definite distance the “energy distance” from the spheres. That is, dielectric breakdown of the air requires a finite volume of over-stressed air, that is, a finite amount of dielectric energy. As the result, when corona begins, the gradient at the terminal surface, g_v , is higher than the breakdown gradient, g_0 , the more so the more the flux lines converge, that is, the smaller the spheres (or parallel wires) are.

126. With the development of high-voltage transmission at 100 kv. and over, the electrical industry has entered the range of voltage, where corona appears on parallel wires of sizes such as are industrially used. Such corona consumes power, and thereby introduces an energy component into the expression of the line capacity, a corona conductance.

The power consumption by the corona is approximately proportional to the frequency, its power factor therefore independent of the frequency.

The power consumption by the corona is proportional to the square of the excess voltage over that voltage, e_0 , which brings the dielectric field at the conductor surface up to the breakdown gradient, g_0 .

However, corona does not yet appear at the voltage, e_0 , which produces the breakdown gradient, g_0 , at the conductor surface,

but at the higher voltage, e_v , which has extended the breakdown gradient by the energy distance from the conductor surface. Then the corona power begins with a finite value, and in the range between e_0 and e_v it is indefinite, depending on the surface condition of the conductor.

The equations of the power consumption by corona in parallel conductors are:

$$P = a(f + c)(e - e_0)^2$$

where:

P = power loss in kilowatts per kilometer length of single-line conductor;

e = effective value of the voltage between the line conductor and neutral in kilovolts;¹

f = frequency;

$c = 25$;

and a is given by the equation:

$$a = \frac{A}{\delta} \sqrt{\frac{r}{s}}$$

where:

r = radius of conductor in centimeters;

s = distance between conductor and return conductor in centimeters;

δ = density of the air, referred to 25°C. and 76 cm. barometer;

$A = 241$;

and:

e_0 = effective disruptive critical voltage to neutral, given in kilovolts by the equation (natural logarithm)

$$e_0 = m_0 g_0 \delta r \log \frac{s}{r}$$

where:

$g_0 = 21.1$ kv. per centimeter effective = breakdown gradient of air;

m_0 = surface constant of the conductor.

It is:

$m_0 = 1$ for perfectly smooth polished wire;

$m_0 = 0.98$ to 0.93 for roughened or weathered wire;

¹ = $\frac{1}{2}$ the voltage between the conductors in a single-phase circuit, $1/\sqrt{3}$ times the voltage between the conductors in a three-phase circuit.

decreasing to:

$m_0 = 0.87$ to 0.83 for 7-strand cable (r being the outer radius of the cable).¹

Materially higher losses occur in snow storms and rain.

For further discussion of the dielectric field and the power losses in it, see F. W. Peek's "Dielectric Phenomena in High-voltage Engineering."

¹ "Dielectric Phenomena in High-voltage Engineering," by F. W. Peek, Jr., page 200.

CHAPTER XV

DISTRIBUTED CAPACITY, INDUCTANCE, RESISTANCE, AND LEAKAGE

127. In the foregoing, the phenomena causing loss of energy in an alternating-current circuit have been discussed; and it has been shown that the mutual relation between current and e.m.f. can be expressed by two of the four constants:

power component of e.m.f., in phase with current, and = current \times effective resistance, or r ;

reactive component of e.m.f., in quadrature with current, and = current \times effective reactance, or x ;

power component of current, in phase with e.m.f., and = e.m.f. \times effective conductance, or g ;

reactive component of current, in quadrature with e.m.f., and = e.m.f. \times effective susceptance, or b .

In many cases the exact calculation of the quantities, r , x , g , b , is not possible in the present state of the art.

In general, r , x , g , b , are not constants of the circuit, but depend—besides upon the frequency—more or less upon e.m.f., current, etc. Thus, in each particular case it becomes necessary to discuss the variation of r , x , g , b , or to determine whether, and through what range, they can be assumed as constant.

In what follows, the quantities r , x , g , b , will always be considered as the coefficients of the power and reactive components of current and e.m.f.—that is, as the *effective* quantities—so that the results are directly applicable to the general electric circuit containing iron and dielectric losses.

Introducing now, in Chapters VIII, to XI, instead of “ohmic resistance,” the term “effective resistance,” etc., as discussed in the preceding chapter, the results apply also—within the range discussed in the preceding chapter—to circuits containing iron and other materials producing energy losses outside of the electric conductor.

128. As far as capacity has been considered in the foregoing chapters, the assumption has been made that the condenser or

other source of negative reactance is shunted across the circuit at a definite point. In many cases, however, the condensive reactance is distributed over the whole length of the conductor, so that the circuit can be considered as shunted by an infinite number of infinitely small condensers infinitely near together, as diagrammatically shown in Fig. 100.

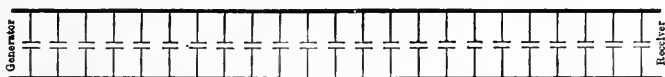

FIG. 100.

In this case the intensity as well as phase of the current, and consequently of the counter e.m.f. of inductive reactance and resistance, vary from point to point; and it is no longer possible to treat the circuit in the usual manner by the vector diagram.

This phenomenon is especially noticeable in long-distance lines, in underground cables, and to a certain degree in the high-potential coils of alternating-current transformers for very high voltage and also in high frequency circuits. It has the effect that not only the e.m.fs., but also the currents, at the beginning, end, and different points of the conductor, are different in intensity and in phase.

Where the capacity effect of the line is small, it may with sufficient approximation be represented by one condenser of the same capacity as the line, shunted across the line at its middle. Frequently it makes no difference either, whether this condenser is considered as connected across the line at the generator end, or at the receiver end, or at the middle.

A better approximation is to consider the line as shunted at the generator and at the motor end, by two condensers of one-sixth the line capacity each, and in the middle by a condenser of two-thirds the line capacity. This approximation, based on Simpson's rule, assumes the variation of the electric quantities in the line as parabolic. If, however, the capacity of the line is considerable, and the condenser current is of the same magnitude as the main current, such an approximation is not permissible, but each line element has to be considered as an infinitely small condenser, and the differential equations based thereon integrated. Or the phenomena occurring in the circuit can be investigated graphically by the method given in Chapter VI, §39, by dividing the circuit into a sufficiently large number of sections or line

elements, and then passing from line element to line element, to construct the topographic circuit characteristics.

129. It is thus desirable to first investigate the limits of applicability of the approximate representation of the line by one or by three condensers.

Assuming, for instance, that the line conductors are of 1 cm. diameter, and at a distance from each other of 50 cm., and that the length of transmission is 50 km., we get the capacity of the transmission line from the formula—

$$C = 1.11 \times 10^{-6} kl \div 4 \log_e 2 \frac{d}{\delta} \text{ microfarads,}$$

where

k = dielectric constant of the surrounding medium = 1 in air;

l = length of conductor = 5×10^6 cm.;

d = distance of conductors from each other = 50 cm.;

δ = diameter of conductor = 1 cm.

Hence $C = 0.3$ microfarad,

the condensive reactance is $x = \frac{10^6}{2\pi fC}$ ohms,

where f = frequency; hence at $f = 60$ cycles,

$$x = 8,900 \text{ ohms;}$$

and the charging current of the line, at $E = 20,000$ volts, becomes,

$$i_0 = \frac{E}{x} = 2.25 \text{ amp.}$$

The resistance of 100 km. of wire of 1 cm. diameter is 22 ohms; therefore, at 10 per cent. = 2,000 volts loss in the line, the main current transmitted over the line is

$$I = \frac{2,000}{22} = 91 \text{ amp.}$$

representing about 1,800 kw.

In this case, the condenser current thus amounts to less than 2.5 per cent., and hence can still be represented by the approximation of one condenser shunted across the line.

If the length of transmission is 150 km., and the voltage, 30,000,

condensive reactance at 60 cycles,	$x = 2,970$ ohms;
charging current,	$i_0 = 10.1$ amp.;
line resistance,	$r = 66$ ohms;
main current at 10 per cent. loss,	$I = 45.5$ amp.

The condenser current is thus about 22 per cent. of the main current, and the approximate calculation of the effect of line capacity still fairly accurate.

At 300 km. length of transmission it will, at 10 per cent. loss and with the same size of conductor, rise to nearly 90 per cent. of the main current, thus making a more explicit investigation of the phenomena in the line necessary.

In many cases of practical engineering, however, the capacity effect is small enough to be represented by the approximation of one; or, three condensers shunted across the line.

130. (A) *Line capacity represented by one condenser shunted across middle of line.*

Let

$Y = g - jb =$ admittance of receiving circuit;

$Z = r + jx =$ impedance of line;

$b_c =$ condenser susceptance of line.

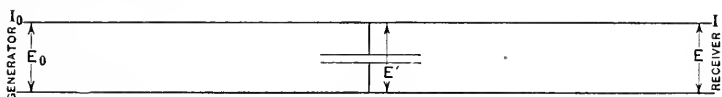

FIG. 101.

Denoting in Fig. 101.

the e.m.f., and current in receiving circuit by $E, I,$

the e.m.f. at middle of line by $E',$

the e.m.f., and current at generator by $E_0, I_0;$

we have,

$$\begin{aligned} I &= E (g - jb); \\ E' &= E + \frac{r + jx}{2} I \\ &= E \left\{ 1 + \frac{(r + jx)(g - jb)}{2} \right\}; \\ I_0 &= I + jb_c E' \\ &= E \left\{ g - jb + jb_c \left[1 + \frac{(r + jx)(g - jb)}{2} \right] \right\}; \\ E_0 &= E' + \frac{r + jx}{2} I_0 \\ &= E \left\{ 1 + \frac{(r + jx)(g - jb)}{2} + \frac{(r + jx)(g - jb)}{2} \right. \\ &\quad \left. + \frac{jb_c(r + jx)}{2} + jb_c \frac{(r + jx)^2 (g - jb)}{4} \right\}; \end{aligned}$$

or, expanding,

$$\begin{aligned} I_0 &= E \left[\left\{ g + \frac{b_c}{2}(rb - xg) \right\} - j \left[(b - b_c) - \frac{b_c}{2}(rg + xb) \right] \right]; \\ E_0 &= E \left\{ 1 + (r + jx)(g - jb) + \frac{j b_c}{2}(r + jx) \right. \\ &\quad \left. \left[1 + \frac{(r + jx)(g - jb)}{2} \right] \right\} \\ &= E \left\{ 1 + (r + jx) \left(g - jb + \frac{j b_c}{2} \right) + \frac{j b_c}{4}(r + jx)^2(g - jb) \right\}. \end{aligned}$$

131. *Distributed condensive reactance, inductive reactance, leakage, and resistance.*

In some cases, especially in very long circuits, as in lines conveying alternating-power currents at high potential over extremely long distances by overhead conductors or underground cables, or with very feeble currents at extremely high frequency, such as telephone currents, the consideration of the *line resistance*—which consumes e.m.f.s. in phase with the current—and of the *line reactance*—which consumes e.m.f.s. in quadrature with the current—is not sufficient for the explanation of the phenomena taking place in the line, but several other factors have to be taken into account.

In long lines, especially at high potentials, the *electrostatic capacity* of the line is sufficient to consume noticeable currents. The charging current of the line condenser is proportional to the difference of potential, and is one-fourth period ahead of the e.m.f. Hence, it will either increase or decrease the main current, according to the relative phase of the main current and the e.m.f.

As a consequence, the current changes in intensity as well as in phase, in the line from point to point; and the e.m.f. consumed by the resistance and inductive reactance therefore also changes in phase and intensity from point to point, being dependent upon the current.

Since no insulator has an infinite resistance, and as at high potentials not only leakage, but even direct *escape of electricity* into the air, takes place by corona, we have to recognize the existence of a current approximately proportional and in phase with the e.m.f. of the line. This current represents consumption of power, and is, therefore, analogous to the e.m.f. consumed by resistance, while the condenser current and the e.m.f. of self-induction are wattless or reactive.

Furthermore, the alternating current in the line produces in all neighboring conductors secondary currents, which react upon the primary current, and thereby introduce e.m.fs. of *mutual inductance* into the primary circuit. Mutual inductance is neither in phase nor in quadrature with the current, and can therefore be resolved into a *power component* of mutual inductance in phase with the current, which acts as an increase of resistance, and into a *reactive component* in quadrature with the current, which decreases the self-inductance.

This mutual inductance is not always negligible, as, for instance, its disturbing influence in telephone circuits shows.

The alternating voltage of the line induces, by *electrostatic influence*, electric charges in neighboring conductors outside of the circuit, which retain corresponding opposite charges on the line wires. This electrostatic influence requires a current proportional to the e.m.f. and consisting of a *power component*, in phase with the e.m.f., and a *reactive component*, in quadrature thereto.

The alternating electromagnetic field of force set up by the line current produces in some materials a loss of energy by magnetic hysteresis, or an expenditure of e.m.f. in phase with the current, which acts as an increase of resistance. This electromagnetic hysteretic loss may take place in the conductor proper if iron wires are used, and will then be very serious at high frequencies, such as those of telephone currents.

The effect of *eddy currents* has already been referred to under "mutual inductive reactance," of which it is a power component.

The alternating electrostatic field of force expends energy in dielectrics by *corona* and *dielectric hysteresis*. In concentric cables, where the electrostatic gradient in the dielectric is comparatively large, the dielectric losses may at high potentials consume appreciable amounts of energy. The dielectric loss appears in the circuit as consumption of a current, whose component in phase with the e.m.f. is the *dielectric power current*, which may be considered as the power component of the capacity current.

Besides this, there is the increase of ohmic resistance due to *unequal distribution of current*, which, however, is usually not large enough to be noticeable.

Furthermore, the electric field of the conductor progresses with a finite velocity, the velocity of light, hence lags behind

the flow of power in the conductor, and so also introduces power components, depending on current as well as on potential difference.

132. This gives, as the most general case, and per unit length of line:

e.m.fs. consumed in phase with the current, I , and $= rI$, representing consumption of power, and due to:

Resistance, and its increase by unequal current distribution; to the power component of *mutual inductive reactance* or to *induced currents*; to the power component of *self-inductive reactance* or to *electromagnetic hysteresis*, and to *radiation*.

e.m.fs. consumed in quadrature with the current, I , and $= xI$, wattless, and due to:

Self-inductance, and *mutual inductance*.

Currents consumed in phase with the e.m.f., E , and $= g E$, representing consumption of power, and due to:

Leakage through the insulating material, including silent discharge and *corona*; power component of *electrostatic influence*; power component of *capacity* or *dielectric hysteresis*, and to *radiation*.

Currents consumed in quadrature to the e.m.f., E , and $= bE$, being wattless, and due to:

Capacity and *electrostatic influence*.

Hence we get four constants:

- Effective resistance, r ,
- Effective reactance, x ,
- Effective conductance, g ,
- Effective susceptance, $-b$,

per unit length of line, which represents the coefficients, per unit length of line, of

- e.m.f. consumed in phase with current;
- e.m.f. consumed in quadrature with current;
- current consumed in phase with e.m.f.;
- current consumed in quadrature with e.m.f.;

or,

$$Z = r + jx,$$

$$Y = g + jb,$$

and, absolute,

$$z = \sqrt{r^2 + x^2},$$

$$y = \sqrt{g^2 + b^2}.$$

The complete investigation of a circuit or line containing distributed capacity, inductive reactance, resistance, etc., leads to functions which are products of exponential and of trigonometric functions. That is, the current and potential difference along the line, l , are given by expressions of the form:

$$e^{\pm al}(A \cos \beta l + B \sin \beta l).$$

Such functions of the distance, l , or position on the line, while alternating in time, differ from the true alternating waves in that the intensities of successive half-waves progressively increase or decrease with the distance. Such functions are called oscillating waves, and, as such, are beyond the scope of this book, but are more fully treated in "Theory and Calculation of Transient Electric Phenomena and Oscillations," Section III. There also will be found the discussion of the phenomena of distributed capacity in high-potential transformer windings, the effect of the finite velocity of propagation of the electric field, etc.

For most purposes, however, in calculating long-distance transmission lines and other circuits of distributed constants, the following approximate solutions of the general differential equation of the circuit offers sufficient exactness.

133. The impedance of an element, dl , of the line is:

$$Zdl$$

and the voltage, dE , consumed by the current, I , in this line element dl :

$$dE = ZI dl$$

The admittance of the line element, dl , is:

$$Ydl$$

hence the current, dI , consumed by the voltage, dE , of this line element dl :

$$dI = YE dl$$

This gives the two equations of the transmission line:

$$\frac{d\dot{E}}{dl} = Z\dot{I}$$

$$\frac{d\dot{I}}{dl} = Y\dot{E}$$

Differentiating the first equation, and substituting therein the second, gives:

$$\frac{d^2\dot{E}}{dl^2} = ZY\dot{E}. \quad (1)$$

and from the first equation follows:

$$I = \frac{1}{Z} \frac{dE}{dl} \tag{2}$$

Equation (1) is integrated by:

$$E = A e^{Bl} \tag{3}$$

and, substituting (3) in (1), gives:

$$B^2 = ZY$$

hence:

$$B = +\sqrt{ZY} \text{ and } -\sqrt{ZY}$$

There exist thus two values of B , which make (3) a solution of (1), and the most general solution, therefore, is:

$$E = A_1 e^{+\sqrt{ZY}l} + A_2 e^{-\sqrt{ZY}l} \tag{4}$$

Substituting (4) in (2) gives:

$$I = \sqrt{\frac{Y}{Z}} \left\{ A_1 e^{+\sqrt{ZY}l} - A_2 e^{-\sqrt{ZY}l} \right\} \tag{5}$$

where l is counted from some point of the line as starting point, for instance, from the step-down end as $l = 0$.

If then:

E_0 = voltage at step-down end of the line,

I_0 = current at step-down end,

it is, for: $l = 0$;

$$E_0 = A_1 + A_2$$

$$I_0 = \sqrt{\frac{Y}{Z}} \left\{ A_1 - A_2 \right\}$$

hence:

$$\left. \begin{aligned} A_1 &= \frac{1}{2} \left\{ E_0 + \sqrt{\frac{Z}{Y}} I_0 \right\} \\ A_2 &= \frac{1}{2} \left\{ E_0 - \sqrt{\frac{Z}{Y}} I_0 \right\} \end{aligned} \right\} \tag{6}$$

and, substituting (6) into (5):

$$\left. \begin{aligned} E &= E_0 \frac{e^{+\sqrt{ZY}l} + e^{-\sqrt{ZY}l}}{2} + \sqrt{\frac{Z}{Y}} I_0 \frac{e^{+\sqrt{ZY}l} - e^{-\sqrt{ZY}l}}{2} \\ I &= I_0 \frac{e^{+\sqrt{ZY}l} + e^{-\sqrt{ZY}l}}{2} + \sqrt{\frac{Y}{Z}} E_0 \frac{e^{+\sqrt{ZY}l} - e^{-\sqrt{ZY}l}}{2} \end{aligned} \right\} \tag{7}$$

Substituting in (7) for the exponential function the infinite series:

$$\epsilon^{\pm \sqrt{ZY}l} = 1 \pm \sqrt{ZY}l + \frac{ZYL^2}{\underline{2}} \pm \frac{ZY\sqrt{ZY}l^3}{\underline{3}} + \frac{Z^2Y^2l^4}{\underline{4}} + \dots$$

gives:

$$\begin{aligned} E_1 &= E_0 \left\{ 1 + \frac{ZYL^2}{2} + \dots \right\} + ZlI_0 \left\{ 1 + \frac{ZYL^2}{6} + \dots \right\} \\ I_1 &= I_0 \left\{ 1 + \frac{ZYL^2}{2} + \dots \right\} + YlE_0 \left\{ 1 + \frac{ZYL^2}{6} + \dots \right\} \end{aligned} \quad (8)$$

134. If then: $l = l_0$ is the total length of line, and

$Z_0 = l_0Z =$ total line impedance,

$Y_0 = l_0Y =$ total line admittance,

the equations of voltage E_1 and current I_1 at the end l_0 of the line are given by substituting $l = l_0$ into equations (8), as:

$$\begin{aligned} E_1 &= E_0 \left\{ 1 + \frac{Z_0Y_0}{2} + \dots \right\} + Z_0I_0 \left\{ 1 + \frac{Z_0Y_0}{6} + \dots \right\} \\ I_1 &= I_0 \left\{ 1 + \frac{Z_0Y_0}{2} + \dots \right\} + Y_0E_0 \left\{ 1 + \frac{Z_0Y_0}{6} + \dots \right\} \end{aligned} \quad (9)$$

Since Z_0 is the line impedance, and thus Z_0I_0 the impedance voltage, $\frac{Z_0I_0}{E_0}$ is the impedance voltage, as fraction of the total voltage. Since Y_0 is the line admittance, Y_0E_0 is the charging current, and $\frac{Y_0E_0}{I_0}$ the charging current as fraction of the total current. The product of these two fractions is:

$$\frac{Z_0I_0}{E_0} \times \frac{Y_0E_0}{I_0} = Z_0Y_0.$$

Z_0Y_0 thus is the product of impedance voltage and charging current of the line, expressed as fraction of total voltage and total current, respectively, hence is a small quantity, and its higher powers can therefore almost always be neglected even in very long transmission lines, and the equation (9) approximated to:

$$\begin{aligned} E_1 &= E_0 \left\{ 1 + \frac{Z_0Y_0}{2} \right\} + Z_0I_0 \left\{ 1 + \frac{Z_0Y_0}{6} \right\} \\ I_1 &= I_0 \left\{ 1 + \frac{Z_0Y_0}{2} \right\} + Y_0E_0 \left\{ 1 + \frac{Z_0Y_0}{6} \right\} \end{aligned} \quad (10)$$

These equations are simpler than those often given by representing the line capacity by a condenser shunted across the middle of the line, and are far more exact. They give the generator voltage and current, E_1 respectively I_1 , by the step-down voltage and current, E_0 and I_0 respectively.

Inversely, if E_0 and I_0 are chosen as the values at the generator end, the values at the step-down end are given by substituting $l = -l_0$ in equations (8), as:

$$\left. \begin{aligned} E_1 &= E_0 \left\{ 1 + \frac{Z_0 Y_0}{2} \right\} - Z_0 I_0 \left\{ 1 + \frac{Z_0 Y_0}{6} \right\} \\ I_1 &= I_0 \left\{ 1 + \frac{Z_0 Y_0}{2} \right\} - Y_0 E_0 \left\{ 1 + \frac{Z_0 Y_0}{6} \right\} \end{aligned} \right\} \quad (11)$$

Neglecting the line conductance: $g_0 = 0$, gives:

$$Y_0 = +jb_0$$

and:

$$Z_0 = r_0 + jx_0$$

hence, substituted in equations (10) and (11), and expanded, gives

$$\left. \begin{aligned} E_1 &= E_0 \left\{ 1 - \frac{b_0 x_0}{2} + j \frac{b_0 r_0}{2} \right\} \pm I_0 (r_0 + jx_0) \left\{ 1 - \frac{b_0 x_0}{6} + j \frac{b_0 r_0}{6} \right\} \\ I_1 &= I_0 \left\{ 1 - \frac{b_0 x_0}{2} + j \frac{b_0 r_0}{2} \right\} \pm jb_0 E_0 \left\{ 1 - \frac{b_0 x_0}{6} + j \frac{b_0 r_0}{6} \right\} \end{aligned} \right\} \quad (12)$$

where the upper sign holds, if E_0, I_0 are at the step-down end, E_1, I_1 at the generator end of the line, and the lower sign holds, if E_0, I_0 are at the generator end, E_1, I_1 at the step-down end of the line.

As seen, the equations (12) are just as simple as those of a circuit containing the resistance, inductance and capacity localized, and are amply exact for practically all cases. Where a still closer approximation should be required, the next term of equations (8) and (9) may be included.

In many cases, the $\frac{Z_0 Y_0}{6}$ term in (10) and (11) may also be dropped, giving the still simpler equation:

$$\left. \begin{aligned} E_1 &= E_0 \left\{ 1 + \frac{Z_0 Y_0}{2} \right\} \pm Z_0 I_0 \\ I_1 &= I_0 \left\{ 1 + \frac{Z_0 Y_0}{2} \right\} \pm Y_0 E_0 \end{aligned} \right\} \quad (13)$$

CHAPTER XVI

POWER, AND DOUBLE-FREQUENCY QUANTITIES IN GENERAL

135. Graphically, alternating currents and voltages are represented by vectors, of which the length represents the intensity, the direction the phase of the alternating wave. The vectors generally issue from the center of coördinates.

In the topographical method, however, which is more convenient for complex networks, as interlinked polyphase circuits, the alternating wave is represented by the straight line between two points, these points representing the absolute values of potential (with regard to any reference point chosen as coördinate center), and their connection the difference of potential in phase and intensity.

Algebraically these vectors are represented by complex quantities. The impedance, admittance, etc., of the circuit is a complex quantity also, in symbolic denotation.

Thus current, voltage, impedance, and admittance are related by multiplication and division of complex quantities in the same way as current, voltage, resistance, and conductance are related by Ohm's law in direct-current circuits.

In direct-current circuits, power is the product of current into voltage. In alternating-current circuits, if

$$\begin{aligned} E &= e^1 + je^{11}, \\ I &= i^1 + ji^{11}, \end{aligned}$$

the product,

$$P_0 = EI = (e^1 i^1 - e^{11} i^{11}) + j(e^{11} i^1 + e^1 i^{11}),$$

is not the power; that is, multiplication and division, which are correct in the inter-relation of current, voltage, impedance, do not give a correct result in the inter-relation of voltage, current, power. The reason is, that E and I are vectors of the same frequency, and Z a constant numerical factor or "operator," which thus does not change the frequency.

The power, P , however, is of double frequency compared with E and I , that is, makes a complete wave for every half wave of E or I , and thus cannot be represented by a vector in the same diagram with E and I .

$P_0 = EI$ is a quantity of the same frequency with E and I , and thus cannot represent the power.

136. Since the power is a quantity of double frequency of E and I , and thus a phase angle, θ , in E and I corresponds to a phase angle, 2θ , in the power, it is of interest to investigate the product, EI , formed by doubling the phase angle.

Algebraically it is,

$$\begin{aligned} P &= EI = (e^1 + je^{11})(i^1 + ji^{11}) \\ &= (e^1i^1 + j^2e^{11}i^{11}) + (ie^{11}i^1 + e^1ji^{11}). \end{aligned}$$

Since $j^2 = -1$, that is, 180° rotation for E and I , for the double-frequency vector, P , $j^2 = +1$, or 360° rotation, and

$$\begin{aligned} j \times 1 &= j, \\ 1 \times j &= -j. \end{aligned}$$

That is, multiplication with j reverses the sign, since it denotes a rotation by 180° for the power, corresponding to a rotation of 90° for E and I .

Hence, substituting these values, we have

$$P = [EI] = (e^1i^1 + e^{11}i^{11}) + j(e^{11}i^1 - e^1i^{11}).$$

The symbol $[EI]$ here denotes the transfer from the frequency of E and I to the double frequency of P .

The product, $P = [EI]$, consists of two components: the real component,

$$P^1 = [EI]^1 = (e^1i^1 + e^{11}i^{11});$$

and the imaginary component,

$$jP^j = j[EI]^j = j(e^{11}i^1 - e^1i^{11}).$$

The component,

$$P^1 = [EI]^1 = (e^1i^1 + e^{11}i^{11}),$$

is the true or "effective" power of the circuit, $= EI \cos (EI)$.

The component,

$$P^j = [EI]^j = (e^{11}i^1 - e^1i^{11}),$$

is what may be called the "reactive power," or the wattless or quadrature volt-amperes of the circuit, $= EI \sin (EI)$.

The real component will be distinguished by the index 1; the imaginary or reactive component by the index, j .

By introducing this symbolism, the power of an alternating circuit can be represented in the same way as in the direct-current circuit, as the symbolic product of current and voltage.

Just as the symbolic expression of current and voltage as complex quantity does not only give the mere intensity, but also the phase,

$$\begin{aligned} E &= e^1 + je^{11} \\ E &= \sqrt{e^{1^2} + e^{11^2}} \\ \tan \theta &= \frac{e^{11}}{e^1}, \end{aligned}$$

so the double-frequency vector product $P = [EI]$ denotes more than the mere power, by giving with its two components, $P^1 = [EI]^1$ and $P^j = [EI]^j$, the true power volt-ampere, or "effective power," and the wattless volt-amperes, or "reactive power."

If

$$\begin{aligned} E &= e^1 + je^{11}, \\ I &= i^1 + ji^{11}, \end{aligned}$$

then

$$\begin{aligned} E &= \sqrt{e^{1^2} + e^{11^2}}, \\ I &= \sqrt{i^{1^2} + i^{11^2}}, \end{aligned}$$

and

$$\begin{aligned} P^1 &= [EI]^1 = (e^1 i^1 + e^{11} i^{11}), \\ P^j &= [EI]^j = (e^{11} i^1 - e^1 i^{11}), \end{aligned}$$

or

$$\begin{aligned} P^1{}^2 + P^j{}^2 &= e^{1^2} i^{1^2} + e^{11^2} i^{11^2} + e^{11^2} i^{1^2} + e^{1^2} i^{11^2} \\ &= (e^{1^2} + e^{11^2})(i^{1^2} + i^{11^2}) = (EI)^2 = P_a{}^2 \end{aligned}$$

where P_a = total volt-amperes of circuit. That is,

The effective power, P^1 , and the reactive power, P^j , are the two rectangular components of the total apparent power, P_a , of the circuit.

Consequently,

In symbolic representation as double-frequency vector products, powers can be combined and resolved by the parallelogram of vectors just as currents and voltages in graphical or symbolic representation.

The graphical methods of treatment of alternating-current phenomena are here extended to include double-frequency quantities, as power, torque, etc.

$$p = \frac{P^1}{P_a} = \cos \theta = \text{power-factor.}$$

$$q = \frac{P^j}{P_a} = \sin \theta = \text{induction factor}$$

of the circuit, and the general expression of power is

$$P = P_a (p + jq) = P_a (\cos \theta + j \sin \theta).$$

137. The introduction of the double-frequency vector product, $P = [EI]$, brings us outside of the limits of algebra, however, and the commutative principle of algebra, $a \times b = b \times a$, does not apply any more, but we have

$$[EI] \text{ unlike } [IE]$$

since

$$[EI] = [EI]^1 + j[EI]^j$$

$$[IE] = [IE]^1 + j[IE]^j = [EI]^1 - j[EI]^j,$$

we have

$$[EI]^1 = [IE]^1$$

$$[EI]^j = -[IE]^j$$

that is, the imaginary component reverses its sign by the interchange of factors.

The physical meaning is, that if the reactive power, $[EI]^j$, is lagging with regard to E , it is leading with regard to I .

The reactive component of power is absent, or the total apparent power is effective power, if

$$[EI]^j = (e^{11}i^1 - e^{11}i^{11}) = 0;$$

that is,

$$\frac{e^{11}}{e^1} = \frac{i^{11}}{i^1}$$

or,

$$\tan (E) = \tan (I);$$

that is, E and I are in phase or in opposition.

The effective power is absent, or the total apparent power reactive, if

$$[EI]^1 = (e^{11}i^1 + e^{11}i^{11}) = 0;$$

that is,

$$\frac{e^{11}}{e^1} = -\frac{i^1}{i^{11}}$$

or,

$$\tan \dot{E} = -\cot \dot{I};$$

that is, \dot{E} and \dot{I} are in quadrature.

The reactive component of power is lagging (with regard to \dot{E} or leading with regard to \dot{I}) if

$$[\dot{E}\dot{I}]^j > 0,$$

and leading if

$$[\dot{E}\dot{I}]^j < 0.$$

The effective power is negative, that is, power returns, if

$$[\dot{E}\dot{I}]^1 < 0.$$

We have,

$$\begin{aligned} [\dot{E}, -\dot{I}] &= [-\dot{E}, \dot{I}] = -[\dot{E}\dot{I}] \\ [-\dot{E}, -\dot{I}] &= +[\dot{E}\dot{I}] \end{aligned}$$

that is, when representing the power of a circuit or a part of a circuit, current and voltage must be considered in their proper *relative* phases, but their phase relation with the remaining part of the circuit is immaterial.

We have further,

$$\begin{aligned} [\dot{E}, j\dot{I}] &= -j[\dot{E}, \dot{I}] = [\dot{E}, \dot{I}]^j - j[\dot{E}, \dot{I}]^1 \\ [j\dot{E}, \dot{I}] &= j[\dot{E}, \dot{I}] = -[\dot{E}, \dot{I}]^j + j[\dot{E}, \dot{I}]^1 \\ [j\dot{E}, j\dot{I}] &= [\dot{E}, \dot{I}] = [\dot{E}\dot{I}]^1 + j[\dot{E}, \dot{I}]^j \end{aligned}$$

138. Expressing voltage and current in polar coördinates;

$$\dot{E} = e^1 + je^{11} = e(\cos \alpha + j \sin \alpha)$$

$$\dot{I} = i^1 + ji^{11} = i(\cos \beta + j \sin \beta)$$

gives the vector power:

$$\dot{P} = ei \{(\cos \alpha \cos \beta + j^2 \sin \alpha \sin \beta) + (j \sin \alpha \cos \beta + \cos \alpha j \sin \beta)\}$$

and since, by the change to double frequency:

$$+ j^2 = + 1$$

$$+ aj = -ja$$

it is:

$$\dot{P} = ei \{(\cos \alpha \cos \beta + \sin \alpha \sin \beta) + j(\sin \alpha \sin \beta - \cos \alpha \cos \beta)\}$$

$$\dot{P} = ei \{\cos(\alpha - \beta) + j \sin(\alpha - \beta)\}$$

and:

the effective power:

$$P^1 = ei \cos (\alpha - \beta)$$

the reactive power:

$$P^j = ei \sin (\alpha - \beta)$$

We thus must note the distinction:

$$\begin{aligned} E = ZI &= (r + jx) (i^1 + ji^{11}) = zi (\cos \gamma + j \sin \gamma) (\cos \beta + j \sin \beta) \\ &= (ri^1 - xi^{11}) + j (ri^{11} + xi^1) = zi \{ \cos (\gamma + \beta) + j \sin (\gamma + \beta) \} \end{aligned}$$

and:

$$\begin{aligned} P &= [E, I] = [E, I]^1 + j[E, I]^j \\ &= [(e^1 + je^{11}), (i^1 + ji^{11})] = ei [(\cos \alpha + j \sin \alpha), (\cos \beta + j \sin \beta)] \\ &= (e^1i^1 + e^{11}i^{11}) + j (e^{11}i^1 - e^1i^{11}) = ei \{ \cos (\alpha - \beta) + \\ & \hspace{15em} j \sin (\alpha - \beta) \} \end{aligned}$$

139. If $P_1 = [E_1I_1]$, $P_2 = [E_2I_2]$. . . $P_n = [E_nI_n]$

are the symbolic expressions of the power of the different parts of a circuit or network of circuits, the total power of the whole circuit or network of circuits is

$$\begin{aligned} P &= P_1 + P_2 + \dots + P_n, \\ P^1 &= P_1^1 + P_2^1 + \dots + P_n^1, \\ P^j &= P_2^j + P_2^j \dots + P_n^j. \end{aligned}$$

In other words, the total power in symbolic expression (effective as well as reactive) of a circuit or system is the sum of the powers of its individual components in symbolic expression.

The first equation is obviously directly a result from the law of conservation of energy.

One result derived herefrom is, for instance:

If in a generator supplying power to a system the current is out of phase with the e.m.f. so as to give the reactive power P^j , the current can be brought into phase with the generator e.m.f. or the load on the generator made non-inductive by inserting anywhere in the circuit an apparatus producing the reactive power— P^j ; that is, compensation for wattless currents in a system takes place regardless of the location of the compensating device.

Obviously, wattless currents exist between the compensating device and the source of wattless currents to be compensated for, and for this reason it may be advisable to bring the compensator as near as possible to the circuit to be compensated.

140. Like power, torque in alternating apparatus is a double-frequency vector product also, of magnetism and m.m.f. or current, and thus can be treated in the same way.

In an induction motor, for instance, the torque is the product of the magnetic flux in one direction into the component of secondary current in phase with the magnetic flux in time, but in quadrature position therewith in space, times the number of turns of this current, or since the generated e.m.f. is in quadrature and proportional to the magnetic flux and the number of turns, the torque of the induction motor is the product of the generated e.m.f. into the component of secondary current in quadrature therewith in time and space, or the product of the secondary current into the component of generated e.m.f. in quadrature therewith in time and space.

Thus, if

$E^1 = e^1 + je^{11} =$ generated e.m.f. in one direction in space,

$I_2 = i^1 + ji^{11} =$ secondary current in the quadrature direction in space,

the torque is

$$D = [EI]^j = e^{11}i^1 - e^1i^{11}.$$

By this equation the torque is given in watts, the meaning being that $D = [EI]^j$ is the power which would be exerted by the torque at synchronous speed, or the torque in synchronous watts.

The torque proper is then

$$D_0 = \frac{D}{2\pi fp},$$

where

$p =$ number of pairs of poles of the motor.

$f =$ frequency.

In the polyphase induction motor, if $I_2 = i^1 + ji^{11}$ is the secondary current in quadrature position, in space, to e.m.f. E_1 , the current in the same direction in space as E_1 is $I_1 = jI_2 = -i^{11} + ji^1$; thus the torque can also be expressed as

$$D = [E_1 I_1]^1 = e^{11}i^1 - e^1i^{11}.$$

It is interesting to note that the expression of torque,

$$D = [EI]^j,$$

and the expression of power,

$$P = [EI]^1,$$

are the same in character, but the former is the imaginary, the latter the real component. Mathematically, torque, in synchronous watts, can so be considered as imaginary power, and inversely. Physically, "imaginary" means quadrature component; torque is defined as force times leverage, that is, force times length in quadrature position with force; while energy is defined as force times length in the direction of the force. Expressing quadrature position by "imaginary," thus gives torque of the dimension of imaginary energy; and "synchronous watts," which is torque times frequency, or torque divided by time, thus becomes of the dimension of imaginary power. Thus, in its complex imaginary form, the vector product of force and length contains two quadrature components, of which the one is energy, the other is torque:

$$F = [f, l] = [f, l]^1 + j[f, l]^j$$

and

$$[f, l]^1 = \text{energy}$$

$$[f, l]^j = \text{torque.}$$

SECTION IV

INDUCTION APPARATUS

CHAPTER XVII

THE ALTERNATING-CURRENT TRANSFORMER

141. The simplest alternating-current apparatus is the transformer. It consists of a magnetic circuit interlinked with two electric circuits, a primary and a secondary. The primary circuit is excited by an impressed e.m.f., while in the secondary circuit an e.m.f. is generated. Thus, in the primary circuit power is consumed, and in the secondary a corresponding amount of power is produced.

Since the same magnetic circuit is interlinked with both electric circuits, the e.m.f. generated per turn must be the same in the secondary as in the primary circuit; hence, the primary generated e.m.f. being approximately equal to the impressed e.m.f., the e.m.fs. at primary and at secondary terminals have approximately the ratio of their respective turns. Since the power produced in the secondary is approximately the same as that consumed in the primary, the primary and secondary currents are approximately in inverse ratio to the turns.

142. Besides the magnetic flux interlinked with both electric circuits—which flux, in a closed magnetic circuit transformer, has a circuit of low reluctance—a magnetic cross-flux passes between the primary and secondary coils, surrounding one coil only, without being interlinked with the other. This magnetic cross-flux is proportional to the current in the electric circuit, or rather, the ampere-turns or m.m.f., and so increases with the increasing load on the transformer, and constitutes what is called the self-inductive or leakage reactance of the transformer; while the flux surrounding both coils may be considered as mutual inductive reactance. This cross-flux of self-induction does not generate e.m.f. in the secondary circuit,

and is thus, in general, objectionable, by causing a drop of voltage and a decrease of output. It is this cross-flux, however, or flux of self-inductive reactance, which is utilized in special transformers, to secure automatic regulation, for constant power, or for constant current, and in this case is exaggerated by separating primary and secondary coils. In the constant potential transformer, however, the primary and secondary coils are brought as near together as possible, or even interspersed, to reduce the cross-flux.

There is, however, a limit, to which it is safe to reduce the cross-flux, as at short-circuit at the secondary terminals, it is the e.m.f. of self-induction of this cross-flux which limits the current, and with very low self-induction, these currents may become destructive by their mechanical forces. Therefore experience shows that in large power transformers it is not safe to go below 4 to 6 per cent. cross-flux.

As will be seen, by the self-inductive reactance of a circuit, not the total flux produced by, and interlinked with, the circuit is understood, but only that (usually small) part of the flux which surrounds one circuit without interlinking with the other circuit.

143. The alternating magnetic flux of the magnetic circuit surrounding both electric circuits is produced by the combined magnetizing action of the primary and of the secondary current.

This magnetic flux is determined by the e.m.f. of the transformer, by the number of turns, and by the frequency.

If

$$\begin{aligned}\Phi &= \text{maximum magnetic flux,} \\ f &= \text{frequency,} \\ n &= \text{number of turns of the coil,}\end{aligned}$$

the e.m.f. generated in this coil is

$$E = \sqrt{2}\pi fn\Phi 10^{-8} = 4.44 fn\Phi 10^{-8} \text{ volts;}$$

hence, if the e.m.f., frequency, and number of turns are determined, the maximum magnetic flux is

$$\Phi = \frac{E 10^8}{\sqrt{2}\pi fn}.$$

To produce the magnetism, Φ , of the transformer, a m.m.f. of F ampere-turns is required, which is determined by the shape and the magnetic characteristic of the iron, in the manner discussed in Chapter XII.

144. Consider as instance, a closed magnetic circuit transformer. The maximum magnetic induction is $B = \frac{\Phi}{A}$, where A = the cross-section of magnetic circuit.

To induce a magnetic density, B , a magnetizing force of f ampere-turns maximum is required, or $\frac{f}{\sqrt{2}}$ ampere-turns effective, per unit length of the magnetic circuit; hence, for the total magnetic circuit, of length, l ,

$$F = \frac{lf}{\sqrt{2}} \text{ ampere-turns;}$$

or

$$I = \frac{F}{n} = \frac{lf}{n\sqrt{2}} \text{ amp. eff.}$$

where n = number of turns.

At no-load, or open secondary circuit, this m.m.f., F , is furnished by the *exciting current*, I_{00} , improperly called the *leakage current*, of the transformer; that is, that small amount of primary current which passes through the transformer at open secondary circuit.

In a transformer with open magnetic circuit, such as the "hedgehog" transformer, the m.m.f., F , is the sum of the m.m.f. consumed in the iron and in the air part of the magnetic circuit (see Chapter XII).

The power component of the exciting current represents the power consumed by hysteresis and eddy currents and the small ohmic loss.

The exciting current is not a sine wave, but is, at least in the closed magnetic circuit transformer, greatly distorted by hysteresis, though less so in the open magnetic circuit transformer. It can, however, be represented by an equivalent sine wave, I_{00} , of equal intensity and equal power with the distorted wave, and a wattless higher harmonic, mainly of triple frequency.

Since the higher harmonic is small compared with the total exciting current, and the exciting current is only a small part of the total primary current, the higher harmonic can, for most practical cases, be neglected, and the exciting current represented by the equivalent sine wave.

This equivalent sine wave, I_{00} , leads the wave of magnetism, Φ , by an angle, α , the angle of hysteretic advance of phase, and

consists of two components—the hysteretic power current in quadrature with the magnetic flux, and therefore in phase with the generated e.m.f. = $I_{00} \sin \alpha$; and the magnetizing current, in phase with the magnetic flux, and therefore in quadrature with the generated e.m.f., and so wattless, = $I_{00} \cos \alpha$.

The exciting current, I_{00} , is determined from the shape and magnetic characteristic of the iron, and the number of turns; the hysteretic power current is

$$I_{00} \sin \alpha = \frac{\text{power consumed in the iron}}{\text{generated e.m.f.}}$$

145. Graphically, the polar diagram of m.m.f.s., of a transformer is constructed thus:

Let, in Fig. 102, $\overline{O\Phi}$ = the magnetic flux in intensity and phase (for convenience, as intensities, the effective values are

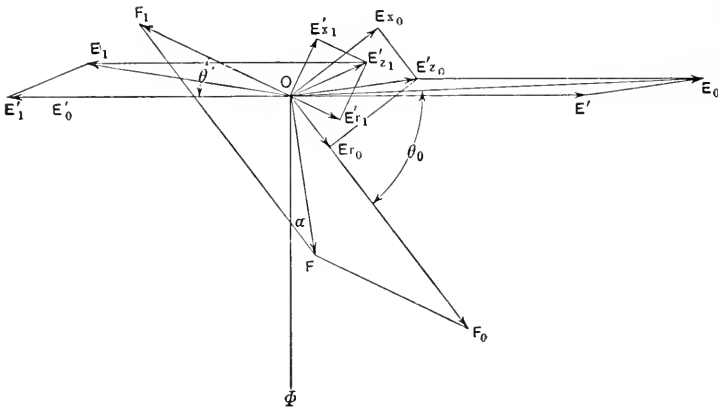

FIG. 102.

used throughout), assuming its phase as the downwards vertical; that is, counting the time from the moment where the rising magnetism passes its zero value.

Then the resultant m.m.f. is represented by the vector, \overline{OF} , leading $\overline{O\Phi}$ by the angle, $\angle FO\Phi = \alpha$.

The generated e.m.f.s. have the phase 180° , that is, are plotted toward the left, and represented by the vectors, $\overline{OE'_0}$ and $\overline{OE'_1}$.

If, now, θ' = angle of lag in the secondary circuit, due to the total (internal and external) secondary reactance, the secondary current, I_1 , and hence the secondary m.m.f., $F_1 = n_1 I_1$ lag behind E'_1 by an angle θ' , and have the phase, $180^\circ + \theta'$, repre-

sented by the vector \overline{OF}_1 . Constructing a parallelogram of m.m.fs., with \overline{OF} as the diagonal and \overline{OF}_1 as one side, the other side or \overline{OF}_0 is the primary m.m.f., in intensity and phase, and hence, dividing by the number of primary turns, n_0 , the primary current is $I_0 = \frac{F_0}{n_0}$.

To complete the diagram of e.m.fs., we have now,

In the primary circuit:

e.m.f. consumed by resistance is $I_0 r_0$, in phase with I_0 , and represented by the vector, \overline{OE}_{r_0} ;

e.m.f. consumed by reactance is $I_0 x_0$, 90° ahead of I_0 , and represented by the vector, \overline{OE}_{x_0} ;

e.m.f. consumed by induced e.m.f. is E' , equal and opposite to E'_0 , and represented by the vector, \overline{OE}' .

Hence, the total primary impressed e.m.f. by combination of \overline{OE}_{r_0} , \overline{OE}_{x_0} , and \overline{OE}' by means of the parallelogram of e.m.fs. is

$$E_0 = \overline{OE}_0,$$

and the difference of phase between the primary impressed e.m.f. and the primary current is

$$\theta_0 = E_0 OF_0.$$

In the secondary circuit:

Counter e.m.f. of resistance is $I_1 r_1$ in opposition with I_1 , and represented by the vector, \overline{OE}'_{r_1} ;

Counter e.m.f. of reactance is $I_1 x_1$, 90° behind I_1 , and represented by the vector, \overline{OE}'_{x_1} .

Generated e.m.fs., E'_1 , represented by the vector, \overline{OE}'_1 .

Hence, the secondary terminal voltage, by combination of \overline{OE}'_{r_1} , \overline{OE}'_{x_1} and \overline{OE}'_1 by means of the parallelogram of e.m.fs. is

$$E_1 = \overline{OE}_1,$$

and the difference of phase between the secondary terminal voltage and the secondary current is

$$\theta_1' = E_1 OF_1.$$

As seen, in the primary circuit the "components of impressed e.m.f. required to overcome the counter e.m.fs." were used for convenience, and in the secondary circuit the "counter e.m.fs."

146. In the construction of the transformer diagram, it is usually preferable not to plot the secondary quantities, current and e.m.f., direct, but to reduce them to correspondence with the primary circuit by multiplying by the ratio of turns, $\alpha = \frac{n_0}{n_1}$, for the reason that frequently primary and secondary e.m.fs., etc., are of such different magnitude as not to be easily represented on the same scale; or the primary circuit may be reduced to the secondary in the same way. In either case, the vectors representing the two generated e.m.fs. coincide, or $\overline{OE'_1} = \overline{OE'_0}$.

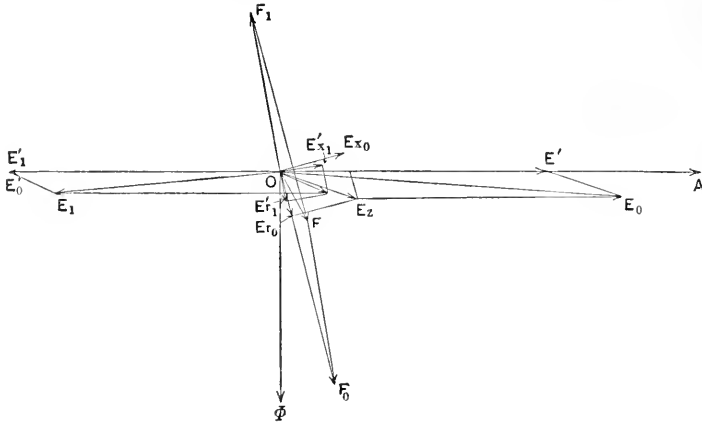

FIG. 103.

Figs. 103 to 109 give the polar diagram of a transformer having the constants, reduced to the secondary circuit:

- | | |
|---------------------|-----------------------|
| $r_0 = 0.2$ ohm, | $b_0 = 0.173$ mhos, |
| $x_0 = 0.33$ ohm, | $E'_1 = 100$ volts, |
| $r_1 = 0.167$ ohm, | $I_1 = 60$ amp., |
| $x_1 = 0.25$ ohm, | $\alpha = 30^\circ$. |
| $g_0 = 0.100$ mhos, | |

For the conditions of secondary circuit:

$\theta'_1 = 80^\circ$ lag	in Fig. 103	$\theta'_1 = 20^\circ$ lead	in Fig. 107
50° lag	“ 104	50° lead	“ 108
20° lag	“ 105	80° lead	“ 109
0, or in phase,	“ 106		

As shown, with a change of θ'_1 the other quantities, E_0 , I_1 , I_0 , etc., change in intensity and direction. The loci described

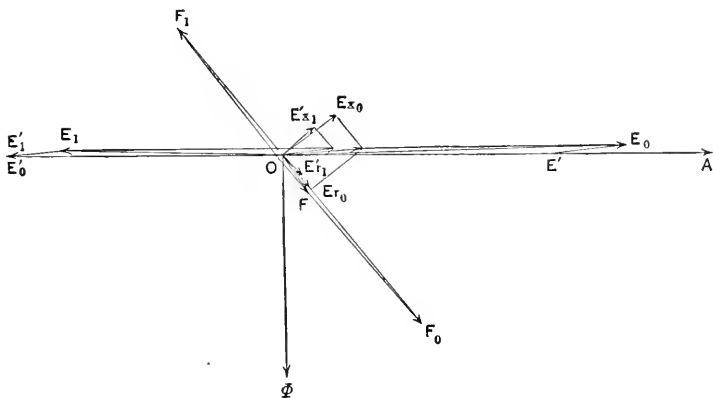

FIG. 104.

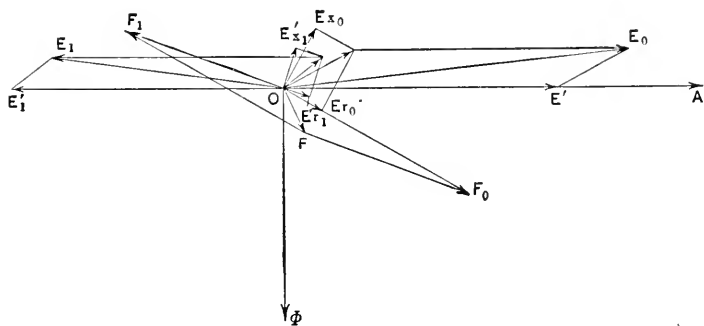

FIG. 105.

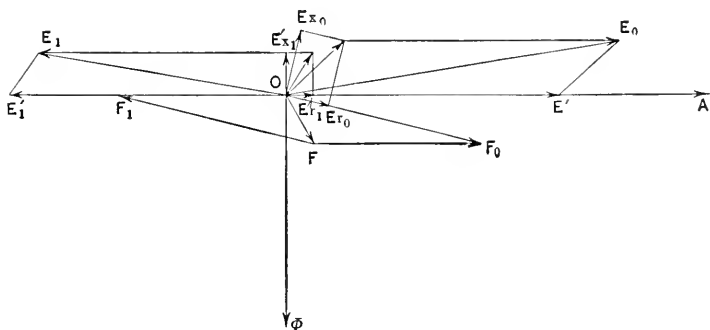

FIG. 106.

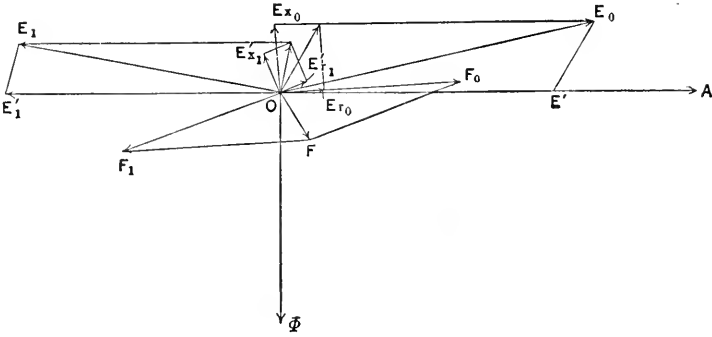

FIG. 107.

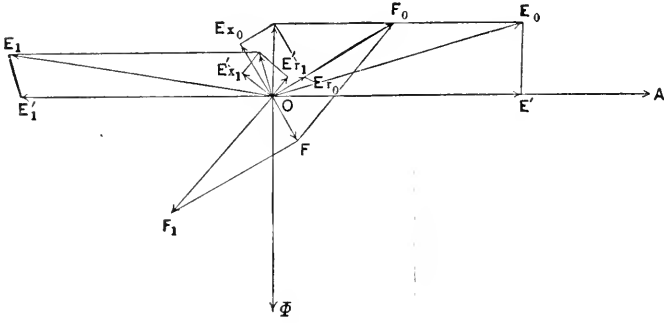

FIG. 108.

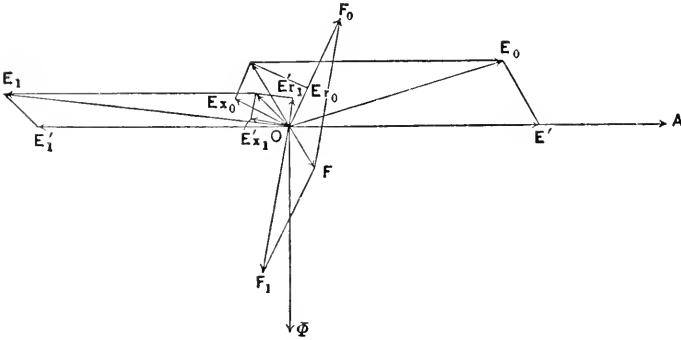

FIG. 109.

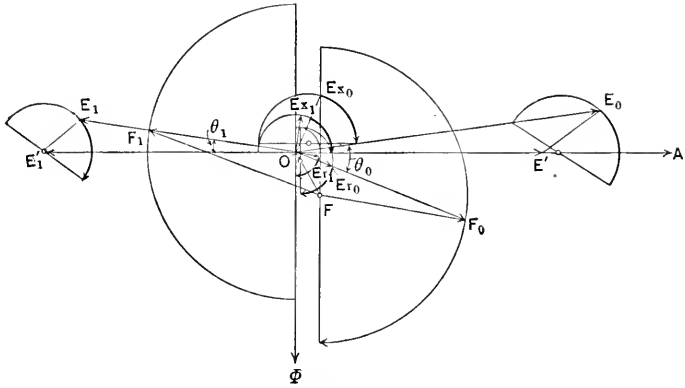

FIG. 110.

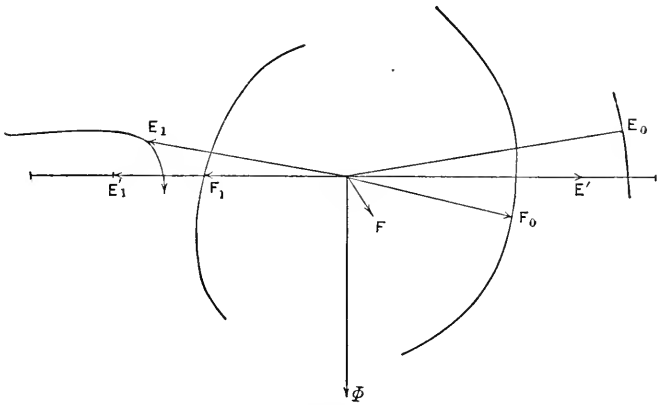

FIG. 111.

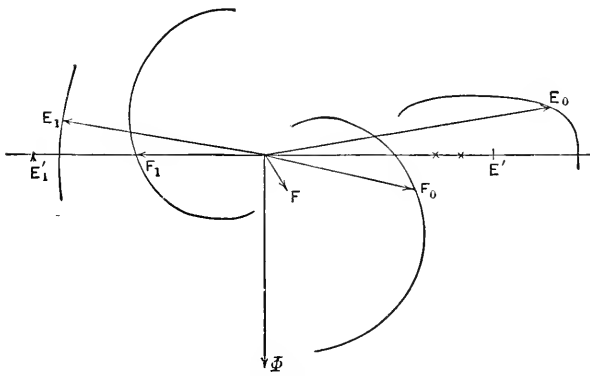

FIG. 112.

by them are circles, and are shown in Fig. 110, with the point corresponding to non-inductive load marked. The part of the locus corresponding to a lagging secondary current is shown in thick full lines, and the part corresponding to leading current in thin full lines.

147. This diagram represents the condition of constant secondary generated e.m.f., E'_1 , that is, corresponding to a constant maximum magnetic flux.

By changing all the quantities proportionally from the diagram of Fig. 110, the diagrams for the constant primary im-

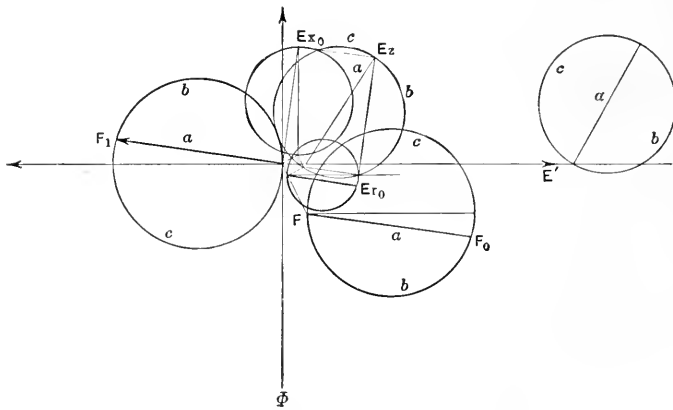

FIG. 113.

pressed e.m.f. (Fig. 111), and for constant secondary terminal voltage (Fig. 112), are derived. In these cases, the locus gives curves of higher order.

Fig. 113 gives the locus of the various quantities when the load is changed from full-load, $I_1 = 60$ amp. in a non-inductive secondary external circuit, to no-load or open-circuit:

(a) By increase of secondary current; (b) by increase of secondary inductive resistance; (c) by increase of secondary condensive reactance.

As shown in (a), the locus of the secondary terminal voltage, E_1 , and thus of E_0 , etc., are straight lines; and in (b) and (c), parts of one and the same circle; (a) is shown in full lines, (b) in heavy full lines, and (c) in light full lines. This diagram corresponds to constant maximum magnetic flux; that is, to constant secondary generated e.m.f. The diagrams representing constant

primary impressed e.m.f. and constant secondary terminal voltage can be derived from the above by proportionality.

148. It must be understood, however, that for the purpose of making the diagrams plainer, by bringing the different values to somewhat nearer the same magnitude, the constants chosen for these diagrams represent not the magnitudes found in actual transformers, but refer to greatly exaggerated internal losses.

In practice, about the following magnitudes would be found:

$$\begin{array}{ll} r_0 = 0.01 & \text{ohm;} \\ x_0 = 0.033 & \text{ohm;} \\ r_1 = 0.00008 & \text{ohm;} \end{array} \qquad \begin{array}{ll} x_1 = 0.00025 & \text{ohm;} \\ g_0 = 0.001 & \text{mho;} \\ b_0 = 0.00173 & \text{mho;} \end{array}$$

that is, about one-tenth as large as assumed. Thus the changes of the values of E_0 , E_1 , etc., under the different conditions will be very much smaller.

Symbolic Method

149. In symbolic representation by complex quantities the transformer problem appears as follows:

The exciting current, I_{00} , of the transformer depends upon the primary e.m.f., which dependence can be represented by an admittance, the "primary admittance," $Y_0 = g_0 - jb_0$, of the transformer.

The resistance and reactance of the primary and the secondary circuit are represented in the impedance by

$$Z_0 = r_0 + jx_0, \quad \text{and} \quad Z_1 = r_1 + jx_1.$$

Within the limited range of variation of the magnetic density in a constant-potential transformer, admittance and impedance can usually, and with sufficient exactness, be considered as constant.

Let

n_0 = number of primary turns in series;

n_1 = number of secondary turns in series;

$a = \frac{n_0}{n_1}$ = ratio of turns;

$Y_0 = g_0 - jb_0$ = primary admittance

$$= \frac{\text{Exciting current}}{\text{Primary induced e.m.f.}}$$

$$\begin{aligned}
 Z_0 &= r_0 + jx_0 = \text{primary impedance} \\
 &= \frac{\text{e.m.f. consumed in primary coil by resistance and reactance}}{\text{Primary current}}; \\
 Z_1 &= r_1 + jx_1 = \text{secondary impedance} \\
 &= \frac{\text{e.m.f. consumed in secondary coil by resistance and reactance}}{\text{Secondary current}};
 \end{aligned}$$

where the reactances, x_0 and x_1 , refer to the true self-induction only, or to the cross-flux passing between primary and secondary coils; that is, interlinked with one coil only.

Let also

$$\begin{aligned}
 Y &= g - jb = \text{total admittance of secondary circuit, including the internal impedance;} \\
 E_0 &= \text{primary impressed e.m.f.;} \\
 E' &= \text{e.m.f. consumed by primary counter e.m.f.;} \\
 E'_1 &= \text{secondary terminal voltage;} \\
 E'_1 &= \text{secondary generated e.m.f.;} \\
 I_0 &= \text{primary current, total;} \\
 I_{00} &= \text{primary exciting current;} \\
 I_1 &= \text{secondary current.}
 \end{aligned}$$

Since the primary counter e.m.f., E'_0 , and the secondary generated e.m.f., E'_1 , are proportional by the ratio of turns, a ,

$$\begin{aligned}
 E'_0 &= + aE'_1. \\
 E'_0 &= - E'.
 \end{aligned} \tag{1}$$

The secondary current is

$$I_1 = YE'_1. \tag{2}$$

consisting of a power component, gE'_1 , and a reactive component, bE'_1 .

To this secondary current corresponds the component of primary current.

$$I'_0 = \frac{-YE'_1}{a} = \frac{YE'_1}{a^2}. \tag{3}$$

The primary exciting current is

$$I_{00} = Y_0E'. \tag{4}$$

Hence, the total primary current is

$$\begin{aligned} I_0 &= I'_0 + I_{00} \\ &= \frac{YE'}{a^2} + Y_0E', \end{aligned} \tag{5}$$

or,

$$\begin{aligned} I_0 &= \frac{\dot{E}'_1}{a^2} \{Y + a^2Y_0\} \\ &= -\frac{\dot{E}'_1}{a^2} \{Y + a^2Y_0\}. \end{aligned} \tag{6}$$

The e.m.f. consumed in the secondary coil by the internal impedance is Z_1I_1 .

The e.m.f. generated in the secondary coil by the magnetic flux is E'_1 .

Therefore, the secondary terminal voltage is

$$E_1 = E'_1 - Z_1I_1;$$

or, substituting (2), we have

$$E_1 = E'_1 \{1 - Z_1Y\}. \tag{7}$$

The e.m.f. consumed in the primary coil by the internal impedance is Z_0I_0 .

The e.m.f. consumed in the primary coil by the counter e.m.f. is E' .

Therefore, the primary impressed e.m.f. is

$$E_0 = E' + Z_0I_0,$$

or, substituting (6),

$$\begin{aligned} E_0 &= E' \left\{ 1 + Z_0Y_0 + \frac{Z_0Y}{a^2} \right\} \\ &= -aE'_1 \left\{ 1 + Z_0Y_0 + \frac{Z_0Y}{a^2} \right\}. \end{aligned} \tag{8}$$

150. We thus have,

primary e.m.f., $E_0 = -aE'_1 \left\{ 1 + Z_0Y_0 + \frac{Z_0Y}{a^2} \right\},$ (8)

secondary e.m.f., $E_1 = E'_1 \{1 - Z_1Y\},$ (7)

primary current, $I_0 = -\frac{E'_1}{a} \{Y + a^2Y_0\},$ (6)

secondary current, $I_1 = YE_1^1$, (2)

as functions of the secondary generated e.m.f., E_1' , as parameter.

From the above we derive

Ratio of transformation of e.m.fs.:

$$\frac{\dot{E}_0}{\dot{E}_1} = -a \frac{1 + Z_0Y_0 + \frac{Z_0Y}{a^2}}{1 - Z_1Y} \tag{9}$$

Ratio of transformations of currents:

$$\frac{\dot{I}_0}{\dot{I}_1} = -\frac{1}{a} \left\{ 1 + a^2 \frac{Y_0}{Y} \right\} \tag{10}$$

From this we get, at constant primary impressed e.m.f.,

$$E_0 = \text{constant};$$

secondary generated e.m.f.,

$$E_1' = -\frac{\dot{E}_0}{a} \frac{1}{1 + Z_0Y_0 + \frac{Z_0Y}{a^2}};$$

e.m.f. generated per turn,

$$\delta E = -\frac{\dot{E}_0}{n_0} \frac{1}{1 + Z_0Y_0 + \frac{Z_0Y}{a^2}};$$

secondary terminal voltage,

$$E_1 = -\frac{\dot{E}_0}{a} \frac{1 - Z_1Y}{1 + Z_0Y_0 + \frac{Z_0Y}{a^2}};$$

primary current,

$$I_0 = \frac{\dot{E}_0}{a^2} \frac{Y + a^2Y_0}{1 + Z_0Y_0 + \frac{Z_0Y}{a^2}} = E_0 \frac{\frac{Y}{a^2} + Y_0}{1 + Z_0Y_0 + \frac{Z_0Y}{a^2}};$$

secondary current,

$$I_1 = -\frac{\dot{E}_0}{a} \frac{Y}{1 + Z_0Y_0 + \frac{Z_0Y}{a^2}}.$$

At constant secondary terminal voltage,

$$E_1 = \text{const.};$$

(11)

secondary generated e.m.f.,

$$\dot{E}'_1 = \frac{\dot{E}_1}{1 - Z_1 Y};$$

e.m.f. generated per turn,

$$\delta \dot{E} = \frac{\dot{E}'_1}{n_1} \frac{1}{1 - Z_1 Y};$$

primary impressed e.m.f.,

$$\dot{E}_0 = -a \dot{E}'_1 \frac{1 + Z_0 Y_0 + \frac{Z_0 Y}{a^2}}{1 - Z_1 Y}; \quad (12)$$

primary current,

$$\dot{I}_0 = -\frac{\dot{E}'_1}{a} \frac{Y + a^2 Y_0}{1 - Z_1 Y};$$

secondary current,

$$\dot{I}_1 = \dot{E}'_1 \frac{Y}{1 - Z_1 Y}.$$

151. Some interesting conclusions can be drawn from these equations.

The apparent impedance of the total transformer is

$$\begin{aligned} Z_t &= \frac{\dot{E}_0}{\dot{I}_0} = a^2 \frac{1 + Z_0 Y_0 + \frac{Z_0 Y}{a^2}}{Y + a^2 Y_0} \\ &= \frac{1 + Z_0 \left(Y_0 + \frac{Y}{a^2} \right)}{Y_0 + \frac{Y}{a^2}}; \end{aligned} \quad (13)$$

$$Z_t = \frac{1}{Y_0 + \frac{Y}{a^2}} + Z_0. \quad (14)$$

Substituting now, $\frac{Y}{a^2} = Y'$, the total secondary admittance, reduced to the primary circuit by the ratio of turns, it is

$$Z_t = \frac{1}{Y_0 + Y'} + Z_0. \quad (15)$$

$Y_0 + Y'$ is the total admittance of a divided circuit with the exciting current of admittance, Y_0 , and the secondary current of admittance, Y' (reduced to primary), as branches. Thus,

$$\frac{1}{Y_0 + Y'} = Z'_0 \quad (16)$$

is the impedance of this divided circuit, and

$$Z_t = Z'_0 + Z_0. \tag{17}$$

That is,

The alternate-current transformer, of primary admittance Y_0 , total secondary admittance Y , and primary impedance Z_0 , is equivalent to, and can be replaced by, a divided circuit with the branches of admittance Y_0 , the exciting current, and admittance $Y' = \frac{Y}{a^2}$, the secondary current, fed over mains of the impedance Z_0 , the internal primary impedance.

This is shown diagrammatically in Fig. 114.

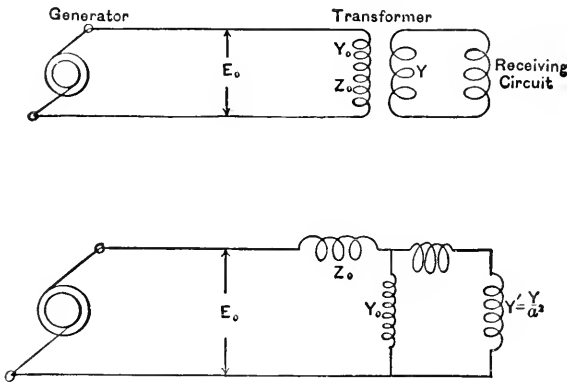

FIG. 114.

152. Separating now the internal secondary impedance from the external secondary impedance, or the impedance of the consumer circuit, it is

$$\frac{1}{Y} = Z_1 + Z; \tag{18}$$

where Z = external secondary impedance,

$$Z = \frac{\dot{E}_1}{I_1}. \tag{19}$$

Reduced to primary circuit, it is

$$\begin{aligned} \frac{1}{Y'} &= \frac{a^2}{Y} = a^2 Z_1 + a^2 Z \\ &= Z'_1 + Z'. \end{aligned} \tag{20}$$

That is,

An alternate-current transformer, of primary admittance Y_0 , primary impedance Z_0 , secondary impedance Z_1 , and ratio of turns a , can, when the secondary circuit is closed by an impedance, Z (the impedance of the receiver circuit), be replaced, and is equivalent to a circuit of impedance, $Z' = a^2Z$, fed over mains of the impedance, $Z_0 + Z'_1$, where $Z'_1 = a^2Z_1$, shunted by a circuit of admittance, Y_0 , which latter circuit branches off at the points, a , b , between the impedances, Z_0 and Z'_1 .

This is represented diagrammatically in Fig. 115.

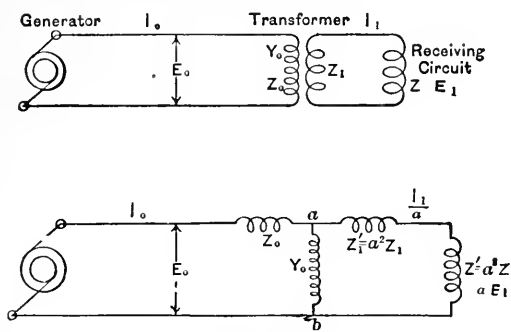

FIG. 115.

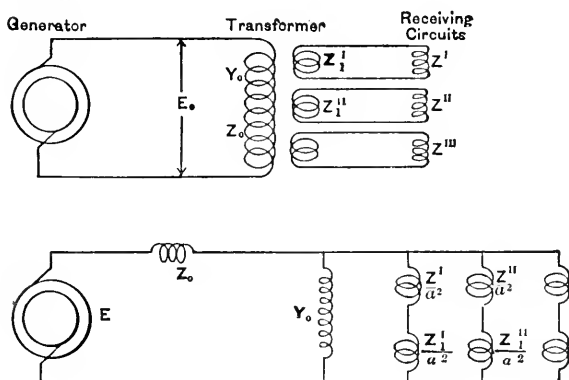

FIG. 116.

It is obvious, therefore, that if the transformer contains several independent secondary circuits, they are to be considered as branched off at the points a , b , in diagram, Fig. 115, as shown in diagram, Fig. 116.

It therefore follows:

An alternate-current transformer, of s secondary coils, of the

internal impedances, $Z_1^I, Z_1^{II}, \dots, Z_1^s$, closed by external secondary circuits of the impedances, Z^I, Z^{II}, \dots, Z^s , is equivalent to a divided circuit of $s + 1$ branches, one branch of admittance, Y_0 , the exciting current, the other branches of the impedances, $Z_1^I + Z^I, Z_1^{II} + Z^{II}, \dots, Z_1^s + Z^s$, the latter impedances being reduced to the primary circuit by the ratio of turns, and the whole divided circuit being fed by the primary impressed e.m.f., E_0 , over mains of the impedance, Z_0 .

Consequently, transformation of a circuit merely changes all the quantities proportionally, introduces in the mains the impedance, $Z_0 + Z'_1$, and a branch circuit between Z_0 and Z'_1 , of admittance Y_0 .

Thus, double transformation will be represented by diagram, Fig. 117.

With this the discussion of the alternate-current transformer ends, by becoming identical with that of a divided circuit containing resistances and reactances.

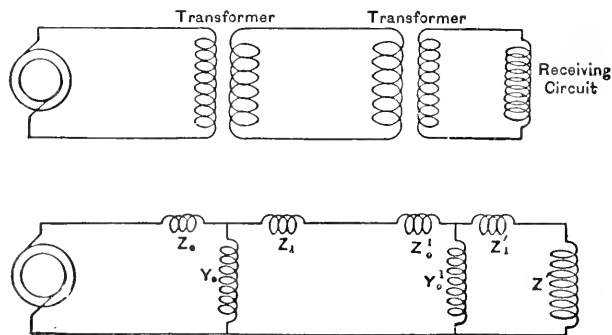

FIG. 117.

Such circuits have been discussed in detail in Chapter IX, and the results derived there are now directly applicable to the transformer, giving the variation and the control of secondary terminal voltage, resonance phenomena, etc.

Thus, for instance, if $Z'_1 = Z_0$, and the transformer contains an additional secondary coil, constantly closed by a condensive reactance of such size that this auxiliary circuit, together with the exciting circuit, gives the reactance, $-x_0$, with a non-inductive secondary circuit, $Z_1 = r_1$, we get the condition of transformation from constant primary potential to constant secondary current, and inversely.

153. As seen, the alternating-current transformer is characterized by the constants:

$$\begin{aligned} \text{Ratio of turns:} & \quad a = \frac{n_0}{n_1}. \\ \text{Exciting admittance:} & \quad Y_0 = g_0 - jb_0. \\ \text{Self-inductive impedances:} & \quad Z_0 = r_0 + jx_0. \\ & \quad Z_1 = r_1 + jx_1. \end{aligned}$$

Since the effect of the secondary impedance is essentially the same as that of the primary impedance (the only difference being, that no voltage is consumed by the exciting current in the secondary impedance, but voltage is consumed in the primary impedance, though very small in a constant-potential transformer), the individual values of the two impedances, Z_0 and Z_1 , are of less importance than the resultant or total impedance of the transformer, that is, the sum of the primary impedance plus the secondary impedance reduced to the primary circuit:

$$Z' = Z_0 + \alpha^2 Z_1,$$

and the transformer accordingly is characterized by the two constants:

$$\begin{aligned} \text{Exciting admittance,} & \quad Y_0 = g_0 - jb_0. \\ \text{Total self-inductive impedance,} & \quad Z' = r' + jx'. \end{aligned}$$

Especially in constant-potential transformers with closed magnetic circuit—as usually built—the combination of both impedances into one, Z' , is permissible as well within the errors of observation.

Experimentally, the exciting admittance, $Y_0 = g_0 - jb_0$, and the total self-inductive impedance, $Z' = r' + jx'$, are determined by operating the transformer at its normal frequency:

1. With open secondary circuit, and measuring volts e_0 , amperes i_0 , and watts w_0 , input—excitation test.

2. With the secondary short-circuited, and measuring volts e_1 , amperes i_1 , and watts p_1 , input. (In this case, usually a far lower impressed voltage is required—impedance test.)

It is then:

$$\left. \begin{aligned} y_0 &= \frac{i_0}{e_0}, \\ g_0 &= \frac{p_0}{e_0^2}, \\ b_0 &= \sqrt{y_0^2 + g_0^2}. \end{aligned} \right\} \begin{aligned} z' &= \frac{e_1}{i_1}, \\ r' &= \frac{p_1}{i_1^2}, \\ x' &= \sqrt{z'^2 - r'^2}. \end{aligned}$$

If a separation of the total impedance Z' into the primary impedance and the secondary impedance is desired, as a rule the secondary reactance reduced to the primary can be assumed as equal to the primary reactance:

$$a^2x_1 = x_0,$$

except if from the construction of the transformer it can be seen that one of the circuits has far more reactance than the other, and then judgment or approximate calculation must guide in the division of the total reactance between the two circuits.

If the total effective resistance, r' , as derived by wattmeter, equals the sum of the ohmic resistances of primary and of secondary reduced to the primary:

$$r' = r_0 + a^2r_1,$$

the ohmic resistances, r_0 and r_1 , as measured by Wheatstone bridge or by direct current, are used.

If the effective resistance is greater than the resultant of the ohmic resistances:

$$r' > r_0 + a^2r_1,$$

the difference:

$$r'' = r' - (r_0 + a^2r_1)$$

may be divided between the two circuits in proportion to the ohmic resistances, that is, the effective resistance distributed between the two circuits in the proportion of their ohmic resistances, so giving the effective resistances of the two circuits, r'_0 and r'_1 , by:

$$r'_0 \div r'_1 = r_0 \div r_1;$$

or, if from the construction of the transformer as the use of large solid conductors, it can be seen that the one circuit is entirely or mainly the seat of the power loss by hysteresis, eddies, etc., which is represented by the additional effective resistance, r'' , this resistance, r'' , is entirely or mainly assigned to this circuit.

In general, it therefore may be assumed:

$$\left. \begin{aligned} x_0 &= \frac{x'}{2}, \\ x_1 &= \frac{x'}{2a^2} \end{aligned} \right\} \left. \begin{aligned} r'_0 &= r_0 \frac{r'}{r_0 + a^2r_1}, \\ r'_1 &= r_1 \frac{r'}{r_0 + a^2r_1}. \end{aligned} \right\}$$

Usually, the excitation test is made on the low-voltage coil, the impedance test on the high-voltage coil, and then reduced to the same coil as primary. Hereby the currents and voltages are more nearly of the same magnitude in both tests.

154. In the calculation of the transformer:

The exciting admittance, Y_0 , is derived by calculating the total exciting current from the ampere-turns excitation, the magnetic characteristic of the iron and the dimensions of the main magnetic circuit, that is the magnetic circuit interlinked with primary and secondary coils. The conductance, g_0 , is derived from the hysteresis loss in the iron, as given by magnetic density, hysteresis coefficient and dimensions of magnetic circuit, allowance being made for eddy currents in the iron.

The ohmic resistances, r_0 and r_1 , are found from the dimensions of the electric circuit, and, where required, allowance made for the additional effective resistance, r'' .

The reactances, x_0 and x_1 , are calculated by calculating the leakage flux, that is the magnetic flux produced by the total primary respectively secondary ampere-turns, and passing between primary and secondary coils, and within the primary respectively secondary coil, in a magnetic circuit consisting largely of air. In this case, the iron part of the magnetic leakage circuit can as a rule be neglected.

CHAPTER XVIII

POLYPHASE INDUCTION MOTORS

155. The induction motor consists of a magnetic circuit interlinked with two electric circuits or sets of circuits, the primary and the secondary. It therefore is electromagnetically the same structure as the transformer. The difference is, that in the transformer secondary and primary are stationary, and the electromagnetic induction between the circuits utilized to transmit electric power to the secondary, while in the induction motor the secondary is movable with regards to the primary, and the mechanical forces between the primary, and secondary utilized to produce motion. In the general alternating-current transformer or frequency converter we shall find an apparatus transmitting electric as well as mechanical energy, and comprising both, induction motor and transformer, as the two limiting cases. In the induction motor, only the mechanical force between primary and secondary is used, but not the transfer of electrical energy, and thus the secondary circuits are closed upon themselves. Hence the induction motor consists of a magnetic circuit interlinked with two electric circuits or sets of circuits, the primary and the secondary circuit, which are movable with regard to each other. In general a number of primary and a number of secondary circuits are used, angularly displaced around the periphery of the motor, and containing e.m.fs. displaced in phase by the same angle. This multi-circuit arrangement has the object always to retain secondary circuits in inductive relation to primary circuits and *vice versa*, in spite of their relative motion.

The result of the relative motion between primary and secondary is, that the e.m.fs. generated in the secondary or the motor armature are not of the same frequency as the e.m.fs. impressed upon the primary, but of a frequency which is the difference between the impressed frequency and the frequency of rotation, or equal to the "slip," that is, the difference between synchronism and speed (in cycles).

Hence, if

$$\begin{aligned} f &= \text{frequency of main or primary e.m.f.,} \\ s &= \text{slip as fraction of synchronous speed,} \\ sf &= \text{frequency of armature or secondary e.m.f.,} \end{aligned}$$

and $(1 - s)f = \text{frequency of rotation of armature.}$

In its reaction upon the primary circuit, however, the armature current is of the same frequency as the primary current, since it is carried around mechanically, with a frequency equal to the difference between its own frequency and that of the primary. Or rather, since the reaction of the secondary on the primary must be of primary frequency—whatever the speed of rotation—the secondary frequency is always such as to give at the existing speed of rotation a reaction of primary frequency.

156. Let the primary system consist of p_0 equal circuits, displaced angularly in space by $\frac{1}{p_0}$ of a period, that is, $\frac{1}{p_0}$ of the width of two poles, and excited by p_0 e.m.fs. displaced in phase by $\frac{1}{p_0}$ of a period; that is, in other words, let the field circuits consist of a symmetrical p_0 -phase system. Analogously, let the armature or secondary circuits consist of a symmetrical p_1 -phase system.

Let

$$\begin{aligned} n_0 &= \text{number of primary turns per circuit or phase;} \\ n_1 &= \text{number of secondary turns per circuit or phase;} \end{aligned}$$

$$a = \frac{n_0}{n_1}$$

$$b = \frac{p_0}{p_1}$$

Since the number of secondary circuits and number of turns of the secondary circuits, in the induction motor—as in the stationary transformer—is entirely unessential, it is preferable to reduce all secondary quantities to the primary system, by the ratio of transformation, a ; thus

if $E'_1 = \text{secondary e.m.f. per circuit,}$

$$E_1 = aE'_1 = \text{secondary e.m.f. per circuit reduced to primary system;}$$

if I'_1 = secondary current per circuit,

$$I_1 = \frac{I'_1}{ab} = \text{secondary current per circuit reduced to primary system};$$

if r'_1 = secondary resistance per circuit,

$$r_1 = a^2 b r'_1 = \text{secondary resistance per circuit reduced to primary system};$$

if x'_1 = secondary reactance per circuit,

$$x_1 = a^2 b x'_1 = \text{secondary reactance per circuit reduced to primary system};$$

if z'_1 = secondary impedance per circuit,

$$z_1 = a^2 b z'_1 = \text{secondary impedance per circuit reduced to primary system};$$

that is, the number of secondary circuits and of turns per secondary circuit is assumed the same as in the primary system.

In the following discussion, as secondary quantities, the values reduced to the primary system shall be exclusively used, so that, to derive the true secondary values, these quantities have to be reduced backward again by the factor

$$a^2 b = \frac{n_0^2 p_0}{n_1^2 p_1}$$

157. Let

Φ = total maximum flux of the magnetic field per motor pole.

We then have

$$E = \sqrt{2} \pi n_0 f \Phi 10^{-8} = \text{effective e.m.f. generated by the magnetic field per primary circuit.}$$

Counting the time from the moment where the rising magnetic flux of mutual induction, Φ (flux interlinked with both electric circuits, primary and secondary), passes through zero, in complex quantities, the magnetic flux is denoted by

$$\dot{\Phi} = -j\Phi,$$

and the primary generated e.m.f.,

$$E = -e;$$

where

$$e = \sqrt{2} \pi n f \Phi 10^{-8} \text{ may be considered as the "active e.m.f. of the motor," or "counter e.m.f."}$$

Since the secondary frequency is sf , the secondary induced e.m.f. (reduced to primary system) is $E_1 = -se$.

Let

I_0 = exciting current, or current through the motor, per primary circuit, when doing no work (at synchronism),

and

$Y = g - jb$ = primary exciting admittance per circuit = $\frac{I_0}{e}$.

We thus have,

ge = magnetic power current, ge^2 = loss of power by hysteresis (and eddy currents) per primary coil.

Hence

p_0ge^2 = total loss of power by hysteresis and eddies, as calculated according to Chapter XII.

be = magnetizing current, and

n_0be = effective m.m.f. per primary circuit;

hence

$\frac{p_0}{2}n_0be$ = total effective m.m.f.,

and

$\frac{p_0}{\sqrt{2}}n_0be$ = total maximum m.m.f., as resultant of the m.m.fs. of the p_0 -phases, combined by the parallelogram of m.m.fs.¹

If \mathcal{R} = reluctance of magnetic circuit per pole, as discussed in Chapter XII, it is

$$\frac{p_0}{\sqrt{2}}n_0be = \mathcal{R}\Phi.$$

Thus, from the hysteretic loss, and the reluctance, the constants, g and b and thus the admittance, Y , are derived.

Let r_0 = resistance per primary circuit;

x_0 = reactance per primary circuit;

thus,

$Z_0 = r_0 + jx_0$ = impedance per primary circuit;

r_1 = resistance per secondary circuit reduced to primary system;

x_1 = reactance per secondary circuit reduced to primary system, at full frequency f ;

¹ Complete discussion hereof, see Chapter XXXIII.

hence,

$sx_1 =$ reactance per secondary circuit at slip s ,

and

$Z_1 = r_1 + jsx_1 =$ secondary internal impedance.

158. We now have,

Primary generated e.m.f.,

$$E = -e.$$

Secondary generated e.m.f.,

$$E_1 = -se.$$

Hence,

Secondary current,

$$I_1 = \frac{E_1}{Z_1} = -\frac{se}{r_1 + jsx_1}.$$

Component of primary current, corresponding thereto, or primary load current,

$$I' = -I_1 = \frac{se}{r_1 + jsx_1};$$

Primary exciting current,

$$I_0 = eY = e(g - jb); \text{ hence,}$$

Total primary current,

$$\begin{aligned} I &= I' + I_0 \\ &= e \left\{ \frac{s}{r_1 + jsx_1} + (g - jb) \right\}; \end{aligned}$$

e.m.f. consumed by primary impedance,

$$\begin{aligned} E_z &= Z_0 I \\ &= e(r_0 + jx_0) \left\{ \frac{s}{r_1 + jsx_1} + (g - jb) \right\}; \end{aligned}$$

e.m.f. required to overcome the primary generated e.m.f.,

$$-E = e;$$

hence,

Primary terminal voltage,

$$\begin{aligned} E_0 &= e + E_z \\ &= e \left\{ 1 + \frac{s(r_0 + jx_0)}{r_1 + jsx_1} + (r_0 + jx_0)(g - jb) \right\}. \end{aligned}$$

We get thus, in an induction motor, at slip s and active e.m.f. e .

Primary terminal voltage,

$$E_0 = e \left\{ 1 + \frac{s(r_0 + jx_0)}{r_1 + jsx_1} + (r_0 + jx_0)(g - jb) \right\};$$

Primary current,

$$I = e \left\{ \frac{s}{r_1 + jsx_1} + (g - jb) \right\};$$

or, in complex expression,

Primary terminal voltage,

$$E_0 = e \left\{ 1 + s \frac{Z_0}{Z_1} + Z_0 Y \right\};$$

Primary current,

$$I = e \left\{ \frac{s}{Z_1} + Y \right\}.$$

To eliminate e , we divide, and get,

Primary current, at slip s , and impressed e.m.f., E_0 ;

$$I = \frac{s + Z_1 Y}{Z_1 + sZ_0 + Z_0 Z_1 Y} E_0;$$

or,

$$I = \frac{s + (r_1 + jsx_1)(g - jb)}{(r_1 + jsx_1) + s(r_0 + jx_0) + (r_0 + jx_0)(r_1 + jsx_1)(g - jb)} E_0.$$

Neglecting, in the denominator, the small quantity $Z_0 Z_1 Y$, it is

$$\begin{aligned} I &= \frac{s + Z_1 Y}{Z_1 + sZ_0} E_0 \\ &= \frac{s + (r_1 + jsx_1)(g - jb)}{(r_1 + jsx_1) + s(r_0 + jx_0)} E_0 \\ &= \frac{(s + r_1 g + sx_1 b) - j(r_1 b - sx_1 g)}{(r_1 + sr_0) + js(x_1 + x_0)} E_0, \end{aligned}$$

or, expanded,

$$I = \frac{[(sr_1 + s^2 r_0) + r_1^2 g + sr_1(r_0 g - x_0 b) + s^2 x_1(x_0 g + x_1 g + r_0 b) - j\{s^2(x_0 + x_1) + r_1^2 b + sr_1(x_0 g + r_0 b) + s^2 x_1(x_0 b + x_1 b - r_0 g)\}]}{(r_1 + sr_0)^2 + s^2(x_1 + x_0)^2} E_0.$$

Hence, displacement of phase between current and e.m.f.,

$$\tan \theta_0 = \frac{s^2(x_0 + x_1) + r_1^2 b + sr_1(x_0 g + r_0 b) + s^2 x_1(x_0 b + x_1 b - r_0 g)}{(sr_1 + s^2 r_0) + r_1^2 g + sr_1(r_0 g - x_0 b) + s^2 x_1(x_0 g + x_1 b - r_0 b)}.$$

Neglecting the exciting current, I_0 , altogether, that is, setting $Y = 0$,

We have

$$\begin{aligned} I &= s E_0 \frac{(r_1 + sr_0) - js(x_0 + x_1)}{(r_1 + sr_0)^2 + s^2(x_0 + x_1)^2} \\ &= \frac{E_s}{(r_1 + sr_0) + js(x_0 + x_1)}; \\ \tan \theta_0 &= \frac{s(x_0 + x_1)}{r_1 + sr_0}. \end{aligned}$$

159. In graphic representation, the induction motor diagram appears as follows:—

Denoting the magnetism by the vertical vector $\overline{O\Phi}$ in Fig. 118, the m.m.f. in ampere-turns per circuit is represented by vector \overline{OF} , leading the magnetism, $\overline{O\Phi}$, by the angle of hysteretic advance α . The e.m.f. generated in the secondary is proportional to the slip s , and represented by $\overline{OE_1}$ at the amplitude of 180° . Dividing $\overline{OE_1}$ by a in the proportion of $r_1 \div sx_1$, and connecting a with the middle, b , of the lower arc of the circle, $\overline{OE_1}$, this line intersects the upper arc of the circle at the point, $\overline{I_1r_1}$. Thus, $\overline{OI_1r_1}$ is the e.m.f. consumed by the secondary resistance, and $\overline{OI_1x_1}$ equal and parallel to $\overline{E_1I_1r_1}$ is the e.m.f. consumed by the secondary reactance. The angle, $E_1OI_1r_1 = \theta_1$, is the angle of secondary lag.

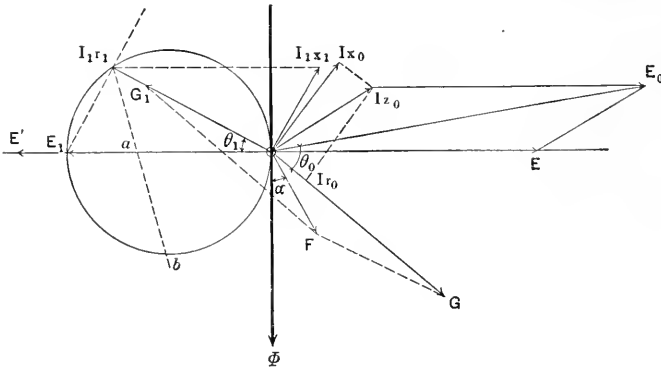

FIG. 118.

The secondary m.m.f., $\overline{OG_1}$, is in the direction of the vector, $\overline{OI_1r_1}$. Completing the parallelogram of m.m.fs. with \overline{OF} as diagonal and $\overline{OG_1}$, as one side, gives the primary m.m.f., \overline{OG} , as other side. The primary current and the e.m.f. consumed by the primary resistance, represented by $\overline{OI_1r_0}$, is in line with \overline{OG} , the e.m.f. consumed by the primary reactance 90° ahead of \overline{OG} , and represented by $\overline{OI_1x_0}$, and their resultant, $\overline{OI_2_0}$, is the e.m.f. consumed by the primary impedance. The e.m.f. generated in the primary circuit is $\overline{OE'}$, and the e.m.f. required to overcome this counter e.m.f. is \overline{OE} equal and opposite to $\overline{OE'}$. Combining \overline{OE} with $\overline{OI_2_0}$ gives the primary terminal voltage represented by vector $\overline{OE_0}$, and the angle of primary lag, $E_0OG = \theta_0$.

160. Thus far the diagram is essentially the same as the diagram of the stationary alternating-current transformer. Regarding dependence upon the slip of the motor, the locus of the different quantities for different values of the slip, s , is determined thus,

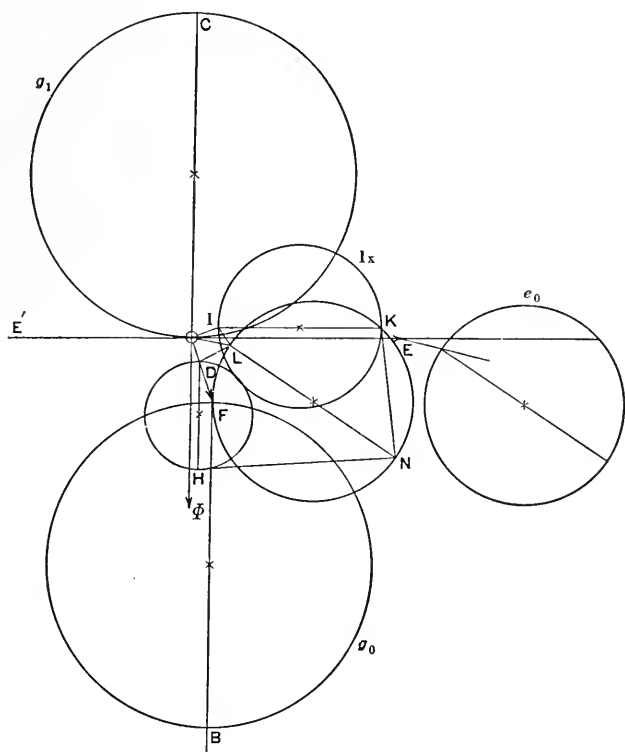

FIG. 119.

Let

$$E_1 = sE'.$$

Assume in opposition to $\overline{O\Phi}$, a point, A , such that

$$OA \div I_1 r_1 = E_1 \div I_1 s x_1, \text{ then}$$

$$OA = \frac{I_1 r_1 \times E_1}{I_1 s x_1} = \frac{I_1 r_1 \times s E'}{I_1 s x_1} = \frac{r_1}{x_1} E' = \text{constant.}$$

That is, $I_1 r_1$ lies on a half-circle with $OA = \frac{r_1}{x_1} E'$ as diameter.

That means G_1 lies on a half-circle, g_1 , in Fig. 119 with \overline{OC} as diameter. In consequence hereof, G_0 lies on half-circle g_0 with \overline{FB} equal and parallel to \overline{OC} as diameter.

Thus Ir_0 lies on a half-circle with \overline{DH} as diameter, which circle is perspective to the circle, \overline{FB} , and Ix_0 lies on a half-circle with \overline{IK} as diameter, and Iz_0 on a half-circle with \overline{LN} as diameter, which circle is derived by the combination of the circles, Ir_0 and Ix_0 .

The primary terminal voltage, E_0 , lies thus on a half-circle, e_0 , equal to the half-circle, Iz_0 , and having to point E the same relative position as the half-circle, Iz_0 , has to point O .

This diagram corresponds to constant intensity of the maximum magnetism, $\overline{O\Phi}$. If the primary impressed voltage, E_0 , is kept constant, the circle, e_0 , of the primary impressed voltage changes to an arc with O as center, and all the corresponding points of the other circles have to be reduced in accordance herewith, thus giving as locus of the other quantities curves of higher order which most conveniently are constructed point for point by reduction from the circle of the loci in Fig. 119.

Torque and Power

161. The torque developed per pole by an electric motor equals the product of effective magnetism, $\frac{\Phi}{\sqrt{2}}$, times effective armature m.m.f., $\frac{F}{\sqrt{2}}$, times the sine of the angle between both,

$$D' = \frac{\Phi F}{2} \sin(\Phi F).$$

If n_1 = number of turns, I_1 = current, per circuit, with p_1 armature circuits, the total maximum current polarization, or m.m.f. of the armature, is

$$F_1 = \frac{p_1 n_1 I_1}{\sqrt{2}}.$$

Hence the torque per pole,

$$D' = \frac{p_1 n_1 \Phi I_1}{2 \sqrt{2}} \sin(\Phi I_1).$$

If q = the number of poles of the motor, the total torque of the motor is,

$$D = \frac{q p_1 n_1 \Phi I_1}{2 \sqrt{2}} \sin(\Phi I_1).$$

The secondary induced e.m.f., E_1 , lags 90° behind the inducing magnetism, hence reaches a maximum displaced in space by 90° from the position of maximum magnetization. Thus, if the secondary current, I_1 , lags behind its emf., E_1 , by angle, θ_1 , the space displacement between armature current and field magnetism is

$$\angle (I_1\Phi) = 90^\circ + \theta_1,$$

hence

$$\sin (\Phi I_1) = \cos \theta_1.$$

We have, however,

$$\cos \theta_1 = \frac{r_1}{\sqrt{r_1^2 + s^2 x_1^2}},$$

$$I_1 = \frac{es 10^{-1}}{\sqrt{r_1^2 + s^2 x_1^2}}$$

$$e = \sqrt{2} \pi n_1 \Phi f 10^{-8},$$

thus,

$$n_1 \Phi = \frac{e 10^8}{\sqrt{2} \pi f};$$

substituting these values in the equation of the torque, it is

$$D = \frac{qp_1 s r_1 e^2 10^7}{4 \pi f (r_1^2 + s^2 x_1^2)};$$

or, in practical (c.g.s.) units,

$$D = \frac{qp_1 s r_1 e^2}{4 \pi f (r_1^2 + s^2 x_1^2)},$$

is the torque of the induction motor.

At the slip, s , the frequency, f , and the number of poles, q , the linear speed at unit radius is

$$v = \frac{4 \pi f}{q} (1 - s);$$

hence the output of the motor,

$$P = Dv,$$

or, substituted,

$$P = \frac{p_1 r_1 e^2 s (1 - s)}{r_1^2 + s^2 x_1^2},$$

is the power of the induction motor.

162. We can arrive at the same results in a different way:

By the counter e.m.f., e , of the primary circuit with current $I = I_0 + I_1$ the power is consumed, $eI = eI_0 + eI_1$. The power, eI_0 , is that consumed by the primary hysteresis and eddys.

The power, eI_1 , disappears in the primary circuit by being transmitted to the secondary system.

Thus the total power impressed upon the secondary system, per circuit, is

$$P_1 = eI_1.$$

Of this power a part, E_1I_1 , is consumed in the secondary circuit by resistance. The remainder,

$$P' = I_1 (e - E_1),$$

disappears as electrical power altogether; hence, by the law of conservation of energy, must reappear as some other form of energy, in this case as mechanical power, or as the output of the motor (including friction).

Thus the mechanical output per motor circuit is

$$P' = I_1 (e - E_1).$$

Substituting,

$$\begin{aligned} E_1 &= se; \\ I_1 &= \frac{se}{r_1 + jsx_1}; \end{aligned}$$

it is

$$\begin{aligned} P' &= \frac{e^2s(1-s)}{r_1 + jsx_1} \\ &= \frac{e^2s(1-s)(r_1 - jsx_1)}{r_1^2 + s^2x_1^2}; \end{aligned}$$

hence, since the imaginary part has no meaning as power,

$$P' = \frac{r_1e^2s(1-s)}{r_1^2 + s^2x_1^2},$$

and the total power of the motor,

$$P = \frac{p_1r_1e^2s(1-s)}{r_1^2 + s^2x_1^2}.$$

At the linear speed,

$$v = \frac{4\pi f}{q}(1-s)$$

at unit radius the torque is

$$D = \frac{qp_1r_1e^2s}{4\pi f(r_1^2 + s^2x_1^2)}.$$

In the foregoing, we found

$$E_0 = e \left\{ 1 + s \frac{Z_0}{Z_1} + Z_0Y \right\},$$

or, approximately,

$$E_0 = e \left\{ 1 + s \frac{Z_0}{Z_1} \right\};$$

or,

$$e = \frac{E_0 Z_1}{s Z_0 + Z_1};$$

expanded,

$$e = E_0 \frac{r_1 + jsx_1}{(r_1 + sr_0) + js(x_1 + x_0)};$$

or, eliminating imaginary quantities,

$$e = E_0 \sqrt{\frac{r_1^2 + s^2 x_1^2}{(r_1 + sr_0)^2 + s^2 (x_1 + x_0)^2}}.$$

Substituting this value in the equations of torque and of power, they become,

$$D = \frac{qp_1 r_1 E_0^2 s}{4 \pi f \{ (r_1 + sr_0)^2 + s^2 (x_1 + x_0)^2 \}};$$

power,

$$P = \frac{p_1 r_1 E_0^2 s (1 - s)}{(r_1 + sr_0)^2 + s^2 (x_1 + x_0)^2}.$$

Maximum Torque

163. The torque of the induction motor is a maximum for that value of slip, s , where

$$\frac{dD}{ds} = 0,$$

or, since

$$D = \frac{qp_1 r_1 E_0^2 s}{4 \pi f \{ (r_1 + sr_0)^2 + s^2 (x_1 + x_0)^2 \}},$$

for,

$$\frac{d}{ds} \left\{ \frac{(r_1 + sr_0)^2 + s^2 (x_1 + x_0)^2}{s} \right\} = 0;$$

expanded, this gives,

$$- \frac{r_1^2}{s^2} + r_0^2 + (x_1 + x_0)^2 = 0,$$

or,

$$s_t = \frac{r_1}{\sqrt{r_0^2 + (x_1 + x_0)^2}}.$$

Substituting this in the equation of torque, we get the value of maximum torque,

$$D_t = \frac{qp_1 E_0^2}{8\pi f \{r_0 + \sqrt{r_0^2 + (x_1 + x_0)^2}\}},$$

that is, independent of the secondary resistance, r_1 .

The power corresponding hereto is, by substitution of s_t in P ,

$$P_t = \frac{p_1 E_0^2 \{\sqrt{r_0^2 + (x_1 + x_0)^2} - r_1\}}{2\sqrt{r_0^2 + (x_1 + x_0)^2} \{\sqrt{r_0^2 + (x_1 + x_0)^2} + r_0\}}.$$

This power is not the maximum output of the motor, but is less than the maximum output. The maximum output is found at a lesser slip, or higher speed, while at the maximum torque point the output is already on the decrease, due to the decrease of speed.

With increasing slip, or decreasing speed, the torque of the induction motor increases; or inversely, with increasing load, the speed of the motor decreases, and thereby the torque increases, so as to carry the load down to the slip, s_t , corresponding to the maximum torque. At this point of load and slip the torque begins to decrease again; that is, as soon as with increasing load, and thus increasing slip, the motor passes the maximum torque point, s_t , it "falls out of step," and comes to a standstill.

Inversely, the torque of the motor, when starting from rest, increases with increasing speed, until the maximum torque point is reached. From there toward synchronism the torque decreases again.

In consequence hereof, the part of the torque-speed curve below the maximum torque point is in general unstable, and can be observed only by loading the motor with an apparatus whose counter-torque increases with the speed faster than the torque of the induction motor.

In general, the maximum torque point, s_t , is between synchronism and standstill, rather nearer to synchronism. Only in motors of very large armature resistance, that is, low efficiency, $s_t > 1$, that is, the maximum torque, occurs below standstill, and the torque constantly increases from synchronism down to standstill.

It is evident that the position of the maximum torque point, s_t , can be varied by varying the resistance of the secondary

circuit, or the motor armature. Since the slip of the maximum torque point, s_t , is directly proportional to the armature resistance, r_1 , it follows that very constant speed and high efficiency brings the maximum torque point near synchronism, and gives small starting torque, while good starting torque means a maximum torque point at low speed; that is, a motor with poor speed regulation and low efficiency.

Thus, to combine high efficiency and close speed regulation with large starting torque, the armature resistance has to be varied during the operation of the motor, and the motor started with high armature resistance, and with increasing speed this armature resistance cut out as far as possible.

164. If

$$s_t = 1,$$

$$r_1 = \sqrt{r_0^2 + (x_1 + x_0)^2}.$$

In this case the motor starts with maximum torque, and when overloaded does not drop out of step, but gradually slows down more and more, until it comes to rest.

If

$$s_t > 1,$$

then

$$r_1 > \sqrt{r_0^2 + (x_1 + x_0)^2}.$$

In this case, the maximum torque point is reached only by driving the motor backward, as counter-torque.

As seen above, the maximum torque, D_t , is entirely independent of the armature resistance, and likewise is the current corresponding thereto, independent of the armature resistance. Only the speed of the motor depends upon the armature resistance.

Hence the insertion of resistance into the motor armature does not change the maximum torque, and the current corresponding thereto, but merely lowers the speed at which the maximum torque is reached.

The effect of resistance inserted into the induction motor is merely to consume the e.m.f., which otherwise would find its mechanical equivalent in an increased speed, analogous to resistance in the armature circuit of a continuous-current shunt motor.

Further discussion on the effect of armature resistance is found under "Starting Torque."

Maximum Power

165. The power of an induction motor is a maximum for that slip, s_p , where

$$\frac{dP}{ds} = 0;$$

or, since

$$P = \frac{p_1 r_1 E_0^2 s(1-s)}{(r_1 + sr_0)^2 + s^2(x_1 + x_0)^2},$$

$$\frac{d}{ds} \left\{ \frac{(r_1 + sr_0)^2 + s^2(x_1 + x_0)^2}{s(1-s)} \right\} = 0;$$

expanded, this gives

$$s_p = \frac{r_1}{r_1 + \sqrt{(r_1 + r_0)^2 + (x_1 + x_0)^2}};$$

substituted in P , we get the maximum power,

$$P_p = \frac{p_1 E_0^2}{2 \{ (r_1 + r_0) + \sqrt{(r_1 + r_0)^2 + (x_1 + x_0)^2} \}}.$$

This result has a simple physical meaning: $(r_1 + r_0) = r$ is the total resistance of the motor, primary plus secondary (the latter reduced to the primary). $(x_1 + x_0)$ is the total reactance, and thus $\sqrt{(r_1 + r_0)^2 + (x_1 + x_0)^2} = z$ is the total impedance of the motor. Hence

$$P_p = \frac{p_1 E_0^2}{2 \{ r + z \}},$$

is the maximum output of the induction motor, at the slip,

$$s_p = \frac{r_1}{r_1 + z}.$$

The same value has been derived in Chapter X, as the maximum power which can be transmitted into a non-inductive receiver circuit over a line of resistance, r , and impedance, z , or as the maximum output of a generator, or of a stationary transformer. Hence:

The maximum output of an induction motor is expressed by the same formula as the maximum output of a generator, or of a stationary transformer, or the maximum output which can be transmitted over an inductive line into a non-inductive receiver circuit.

The torque corresponding to the maximum output, P_p , is

$$D_p = \frac{qp_1 E_0^2 (r_1 + z)}{8 \pi f z (r + z)}.$$

This is not the maximum torque; but the maximum torque, D_t , takes place at a lower speed, that is, greater slip,

$$s_t = \frac{r_1}{\sqrt{r_0^2 + (x_1 + x_0)^2}},$$

since

$$\frac{r_1}{\sqrt{r_0^2 + (x_1 + x_0)^2}} > \frac{r_1}{r_1 + \sqrt{(r_1 + r_0)^2 + (x_1 + x_0)^2}};$$

that is,

$$s_t > s_p.$$

It is obvious from these equations, that, to reach as large an output as possible, r and z should be as small as possible; that is, the resistances, $r_1 + r_0$, and the impedances, z , and thus the reactances, $x_1 + x_0$, should be small. Since $r_1 + r_0$ is usually small compared with $x_1 + x_0$ it follows, that the problem of induction motor design consists in constructing the motor so as to give the minimum possible reactances, $x_1 + x_0$.

Starting Torque

166. In the moment of starting an induction motor, the slip is

$$s = 1;$$

hence, starting current,

$$I = \frac{1 + (r_1 + jx_1)(g - jb)}{(r_1 + jx_1) + (r_0 + jx_0) + (r_1 + jx_1) + (r_0 + jx_0)(g - jb)} E_0;$$

or, expanded, with the rejection of the last term in the denominator, as insignificant,

$$I = \frac{[(r_1 + r_0) + g(r_1[r_1 + r_0] + x_1[x_1 + x_0]) + b(r_0x_1 - x_0r_1)] - j[(x_1 + x_0) + b(r_1[r_1 + r_0] + x_1[x_1 + x_0]) - g(r_0x_1 - x_0r_1)]}{(r_1 + r_0)^2 + (x_1 + x_0)^2} E_0;$$

and, displacement of phase, or angle of lag,

$$\tan \theta_0 = \frac{(x_1 + x_0) + b(r_1[r_1 + r_0] + x_1[x_1 + x_0]) - g(r_0x_1 - x_0r_1)}{(r_1 + r_0) + g(r_1[r_1 + r_0] + x_1[x_1 + x_0]) + b(r_0x_1 - x_0r_1)}.$$

Neglecting the exciting current, $g = 0 = b$, these equations assume the form,

$$I = \frac{(r_1 + r_0) - j(x_1 + x_0)}{(r_1 + r_0)^2 + (x_1 + x_0)^2} E_0 = \frac{E_0}{(r_1 + r_0) + j(x_1 + x_0)},$$

or, eliminating imaginary quantities,

$$I = \frac{E_0}{\sqrt{(r_1 + r_0)^2 + (x_1 + x_0)^2}} = \frac{E_0}{z},$$

and

$$\tan \theta_0 = \frac{x_1 + x_0}{r_1 + r_0}.$$

That means, that in starting the induction motor without additional resistance in the armature circuit—in which case $x_1 + x_0$ is large compared with $r_1 + r_0$, and the total impedance, z , small—the motor takes excessive and greatly lagging currents.

The starting torque is

$$\begin{aligned} D_0 &= \frac{qp_1 r_1 E_0^2}{4\pi f \{(r_1 + r_0)^2 + (x_1 + x_0)^2\}} \\ &= \frac{qp_1 E_0^2 r_1}{4\pi f z^2}. \end{aligned}$$

That is, the starting torque is proportional to the armature resistance, and inversely proportional to the square of the total impedance of the motor.

It is obvious thus, that, to secure large starting torque, the impedance should be as small, and the armature resistance as large, as possible. The former condition is the condition of large maximum output and good efficiency and speed regulation; the latter condition, however, means inefficiency and poor regulation, and thus cannot properly be fulfilled by the internal resistance of the motor, but only by an additional resistance which is short-circuited while the motor is in operation.

Since, necessarily,

$$r_1 < z,$$

we have,

$$D_0 < \frac{qp_1 E_0^2}{4\pi f z};$$

and since the starting current is, approximately

$$I = \frac{E_0}{z},$$

we have,

$$D_0 < \frac{qp_1}{4\pi f} E_0 I.$$

$$D_{00} = \frac{qp_1}{4\pi f} E_0 I$$

would be the theoretical torque developed at 100 per cent. efficiency and power-factor, by e.m.f. E_0 , and current I , at synchronous speed.

Thus,

$$D_0 < D_{00},$$

and the ratio between the starting torque, D_0 , and the theoretical maximum torque, D_{00} , gives a means to judge the perfection of a motor regarding its starting torque.

This ratio, $\frac{D_0}{D_{00}}$, exceeds 0.9 in the best motors.

Substituting $I = \frac{E_0}{z}$ in the equation of starting torque, it assumes the form,

$$D_0 = \frac{qp_1}{4\pi f} I^2 r_1.$$

Since $\frac{4\pi f}{q} =$ synchronous speed, it is:

The starting torque of the induction motor is equal to the resistance loss in the motor armature, divided by the synchronous speed.

The armature resistance which gives maximum starting torque is

$$\frac{dD_0}{dr_1} = 0$$

or since,

$$D_0 = \frac{qp_1 E_0^2}{4\pi f} \frac{r_1}{(r_1 + r_0)^2 + (x_1 + x_0)^2}$$

$$\frac{d}{dr_1} \left\{ \frac{(r_1 + r_0)^2 + (x_1 + x_0)^2}{r_1} \right\} = 0;$$

expanded, this gives,

$$r_1 = \sqrt{r_0^2 + (x_1 + x_0)^2},$$

the same value as derived in the paragraph on "maximum torque."

Thus, adding to the internal armature resistance, r'_1 , in starting the additional resistance,

$$r''_1 = \sqrt{r_0^2 + (x_1 + x_0)^2} - r'_1,$$

makes the motor start with maximum torque, while with increasing speed the torque constantly decreases, and reaches zero at synchronism. Under these conditions, the induction motor behaves similarly to the continuous-current series motor, varying in speed with the load, the difference being, however, that the induction motor approaches a definite speed at no-load, while with the series motor the speed indefinitely increases with decreasing load.

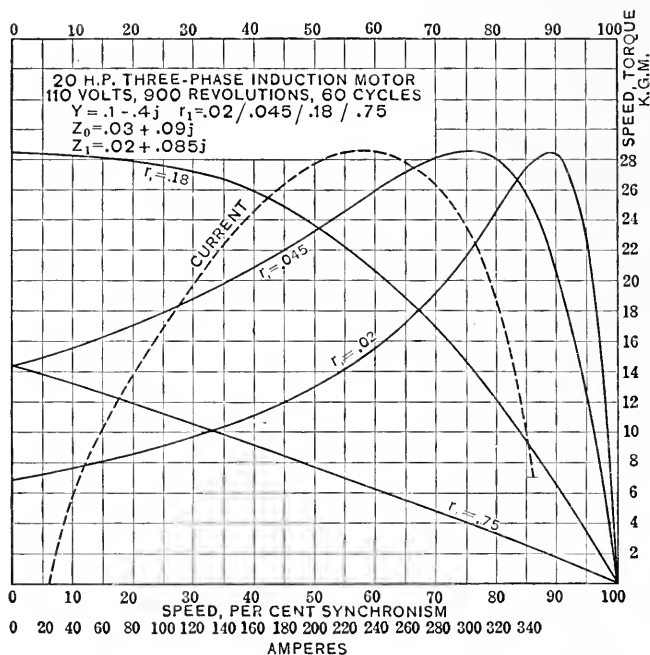

FIG. 120.

The additional armature resistance, r''_1 , required to give a certain starting torque, is found from the equation of starting torque:

Denoting the internal armature resistance by r'_1 , the total armature resistance is $r_1 = r'_1 + r''_1$,

and thus,

$$D_0 = \frac{qp_1 E_0^2}{4 \pi f} \frac{r'_1 + r''_1}{(r'_1 + r''_1 + r_0)^2 + (x_1 + x_0)^2};$$

hence,

$$r''_1 = -r'_1 - r_0 + \frac{qp_1 E_0^2}{8 \pi f D_0} \pm \sqrt{\left(\frac{qp_1 E_0^2}{8 \pi f D_0}\right)^2 - \frac{qp_1 E_0^2 r_0}{4 \pi f D_0} - (x_1 + x_0)^2 f.}$$

This gives two values, one above, the other below, the maximum torque point.

Choosing the positive sign of the root, we get a larger armature resistance, a small current in starting, but the torque constantly decreases with the speed.

Choosing the negative sign, we get a smaller resistance, a large starting current, and with increasing speed the torque first increases, reaches a maximum, and then decreases again toward synchronism.

These two points correspond to the two points of the speed-torque curve of the induction motor, in Fig. 120, giving the desired torque, D_0 .

The smaller value of r''_1 gives fairly good speed regulation, and thus in small motors, where the comparatively large starting current is no objection, the permanent armature resistance may be chosen to represent this value.

The larger value of r''_1 allows to start with minimum current, but requires cutting out of the resistance after the start, to secure speed regulation and efficiency.

167. Approximately, the *torque* of the induction motor at any slip, s :

$$D = \frac{qp_1r_1E_0^2s}{4\pi f\{(r_1 + sr_0)^2 + s^2(x_1 + x_0)^2\}},$$

can be expressed in a simple and so convenient form as function of the *maximum torque*:

$$D_t = \frac{qp_1E_0^2}{8\pi f\{r_0 + \sqrt{r_0^2 + (x_1 + x_0)^2}\}},$$

or of the *starting torque*: $s = 1$:

$$D_0 = \frac{qp_1r_1E_0^2}{4\pi f\{(r_1 + r_0)^2 + (x_1 + x_0)^2\}}.$$

Dividing D by D_t we have

$$D = \frac{2r_1s\{r_0 + \sqrt{r_0^2 + (x_1 + x_0)^2}\}}{(r_1 + sr_0)^2 + s^2(x_1 + x_0)^2} D_t.$$

Since r_0 , the primary resistance, is small compared with

$$x = x_1 + x_0,$$

the total self-inductive reactance of the motor, it can be neglected under the square root, and the equation so gives:

$$D = \frac{2 r_1 s (r_0 + x)}{(r_1 + sr_0)^2 + s^2 x^2} D_t,$$

or, still more approximately:

$$D = \frac{2 sr_1 x}{r_1^2 + s^2 x^2} D_t,$$

and the starting torque, for: $s = 1$:

$$D_0 = \frac{2 r_1 x}{r_1^2 + x^2} D_t,$$

hence, dividing,

$$D = \frac{s (r_1^2 + x^2)}{r_1^2 + s^2 x^2} D_0,$$

or, if r_1 is small compared with x , that is, in a motor of low-resistance armature:

$$D = \frac{s x^2}{r_1^2 + s^2 x^2} D_0,$$

From the equation:

$$D = \frac{2 sr_1 x}{r_1^2 + s^2 x^2} D_t.$$

it follows that for small values of s , or near synchronism:

$$D = \frac{2 sx}{r_1} D_t.$$

by neglecting $s^2 x^2$ compared with r_1^2 :

For low values of speed, or high values of s , it follows, by neglecting r_1^2 compared with $s^2 x^2$:

$$D = \frac{2 r_1}{sx} D_t,$$

that is, approximately, near synchronism, the torque is directly proportional to the slip, and inversely proportional to the armature resistance, that is, proportional to the ratio

$\frac{\text{slip}}{\text{armature resistance}}$; near standstill, the torque is inversely proportional to the slip, but directly proportional to the armature resistance, and so is increased by increasing the armature resistance in a motor of low-armature resistance.

Synchronism

168. At synchronism, $s = 0$, we have,

$$I_s = E_0 (g - jb);$$

or,

$$I_s = E_0 \sqrt{g^2 + b^2};$$

$$P = 0, D = 0;$$

that is, power and torque are zero. Hence, the induction motor can never reach complete synchronism, but must slip sufficiently to give the torque consumed by friction.

Running near Synchronism

169. When running near synchronism, at a slip, s , above the maximum output point, where s is small, from 0.01 to 0.05 at full-load, the equations can be simplified by neglecting terms with s , as of higher order.

We then have, current,

$$I = \frac{s + r_1 (g - jb)}{r_1} E_0;$$

or, eliminating imaginary quantities,

$$I = \sqrt{\left(\frac{s}{r_1} + g\right)^2 + b^2} E_0;$$

angle of lag,

$$\tan \theta_0 = \frac{s^2 (x_1 + x_0) + r_1^2 b}{sr_1 + r_1^2 g} = \frac{s^2 \frac{x_1 + x_0}{r_1} + r_1 b}{s + r_1 g};$$

$$P = \frac{p_1 E_0^2 s}{r_1};$$

$$D = \frac{qp_1 E_0^2 s}{4\pi f r_1};$$

or, inversely,

$$s = \frac{r_1 P}{p_1 E_0^2};$$

$$s = \frac{4\pi f r_1 D}{qp_1 E_0^2},$$

that is,

Near synchronism, the slip, s , of an induction motor, or its drop

in speed, is proportional to the armature resistance, r_1 , and to the power, P , or torque, D .

EXAMPLE

170. As an example are shown, in Fig. 120, characteristic curves of a 20-hp. three-phase induction motor, of 900 revolutions synchronous speed, 8 poles, frequency of 60 cycles.

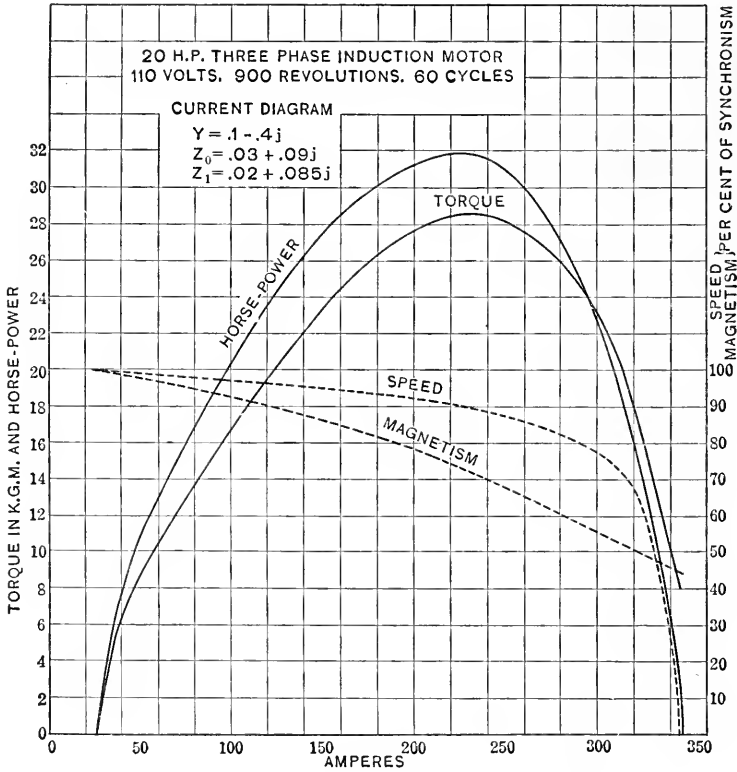

FIG. 121.

The impressed e.m.f. is 110 volts between lines, and the motor star connected, hence the e.m.f. impressed per circuit:

$$\frac{110}{\sqrt{3}} = 63.5; \text{ or } E_0 = 63.5.$$

The constants of the motor are:

Primary admittance, $Y = 0.1 - 0.4j$.
 Primary impedance, $Z = 0.03 + 0.09j$.
 Secondary impedance, $Z_1 = 0.02 + 0.085j$.

In Fig. 120 is shown, with the speed in per cent. of synchronism, as abscissas, the torque in kilogram-meters as ordinates in drawn lines, for the values of armature resistance:

$r_1 = 0.02$: short-circuit of armature, full speed.

$r_1 = 0.045$: 0.025 ohms additional resistance.

$r_1 = 0.18$: 0.16 ohms additional, maximum starting torque.

$r_1 = 0.75$: 0.73 ohms additional, same starting torque as

$r_1 = 0.045$.

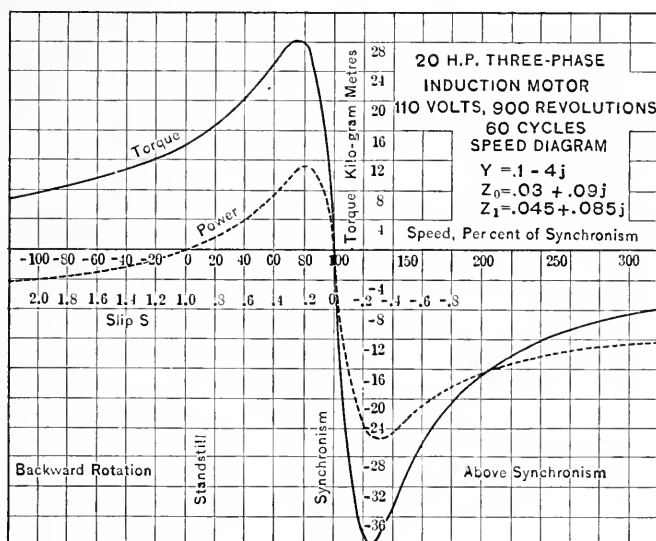

FIG. 122.

On the same figure is shown the current per line, in dotted lines, with the verticals or torque as abscissas, and the horizontals or amperes as ordinates. To the same current always corresponds the same torque, no matter what the speed may be.

On Fig. 121 is shown, with the current input per line as abscissas, the torque in kilogram-meters and the output in horse-power as ordinates in drawn lines, and the speed and the magnetism, in per cent. of their synchronous values, as ordinates in dotted lines, for the armature resistance, $r_1 = 0.02$, or short-circuit.

In Fig. 122 is shown, with the speed, in per cent. of synchronism, as abscissas, the torque in drawn line, and the output in dotted line, for the value of armature resistance $r_1 = 0.045$, for the whole range of speed from 120 per cent. backward speed to 200 per cent. beyond synchronism, showing the two maxima, the motor maximum at $s = 0.25$, and the generator maximum at $s = -0.25$.

171. As seen in the preceding, the induction motor is characterized by the three complex imaginary constants,

$Y_0 = g_0 - jb_0$, the primary exciting admittance,

$Z_0 = r_0 + jx_0$, the primary self-inductive impedance, and

$Z_1 = r_1 + jx_1$, the secondary self-inductive impedance,

reduced to the primary by the ratio of secondary to primary turns.

From these constants and the impressed e.m.f., e_0 , the motor can be calculated as follows:

Let,

e = counter e.m.f. of motor, that is, e.m.f. generated in the primary by the mutual magnetic flux.

At the slip, s , the e.m.f. generated in the secondary circuit is se .

Thus the secondary current,

$$I_1 = \frac{se}{r_1 + jsx_1} = e(a_1 - ja_2),$$

where

$$a_1 = \frac{sr_1}{r_1^2 + s^2x_1^2} \text{ and } a_2 = \frac{s^2x_1}{r_1^2 + s^2x_1^2}.$$

The primary exciting current is,

$$I_{00} = eY_0 = e(g_0 - jb_0);$$

thus, the total primary current,

$$I_0 = I_1 + I_{00} = e(b_1 - jb_2),$$

where,

$$b_1 = a_1 + g_0, \text{ and } b_2 = a_2 + b_0.$$

The e.m.f. consumed by the primary impedance is,

$$E^1 = I_0Z_0 = e(r_0 + jx_0)(b_1 - jb_2);$$

the primary counter e.m.f. is e , thus the primary impressed e.m.f.,

$$\dot{E}_0 = e + \dot{E}^1 = e(c_1 - jc_2),$$

where,

$$c_1 = 1 + r_0b_1 + x_0b_2 \text{ and } c_2 = r_0b_2 - x_0b_1,$$

or, the absolute value is,

$$e_0 = e \sqrt{c_1^2 + c_2^2},$$

hence,

$$e = \frac{e_0}{\sqrt{c_1^2 + c_2^2}}.$$

Substituting this value gives,

Secondary current,

$$\dot{I}_1 = e_0 \frac{a_1 - ja^2}{\sqrt{c_1^2 + c_2^2}}, \quad I_1 = e_0 \sqrt{\frac{a_1^2 + a_2^2}{c_1^2 + c_2^2}};$$

Primary current,

$$\dot{I}_0 = e_0 \frac{b_1 - jb_2}{\sqrt{c_1^2 + c_2^2}}, \quad I_0 = e_0 \sqrt{\frac{b_1^2 + b_2^2}{c_1^2 + c_2^2}};$$

Impressed e.m.f.,

$$\dot{E}_0 = e_0 \frac{c_1 - jc_2}{\sqrt{c_1^2 + c_2^2}}.$$

Thus torque, in synchronous watts (that is, the watts output which the torque would produce at synchronous speed),

$$\begin{aligned} D &= [eI_1]^1 \\ &= \frac{e_0^2 a_1}{c_1^2 + c_2^2}, \end{aligned}$$

hence, the torque in absolute units,

$$D_0 = \frac{D}{2\pi f} = \frac{e_0^2 a_1}{(c_1^2 + c_2^2) 2\pi f},$$

where f = frequency.

The power output is torque times speed, thus:

$$P_1 = D(1 - s) = \frac{e_0^2 a_1 (1 - s)}{c_1^2 + c_2^2}.$$

The power input is,

$$\begin{aligned} P_0 &= [\dot{E}_0 \dot{I}_0] = [\dot{E}_0 \dot{I}_0]^1 - j[\dot{E}_0 \dot{I}_0]^j = P_0^1 + jP_0^j \\ &= \frac{e_0^2 (b_1 c_1 + b_2 c_2)}{c_1^2 + c_2^2} - j \frac{e_0^2 (b_2 c_1 - b_1 c_2)}{c_1^2 + c_2^2}. \end{aligned}$$

The volt-ampere input,

$$P_{a_0} = e_0 I_0 = \frac{e_0^2 \sqrt{b_1^2 + b_2^2}}{\sqrt{c_1^2 + c_2^2}}$$

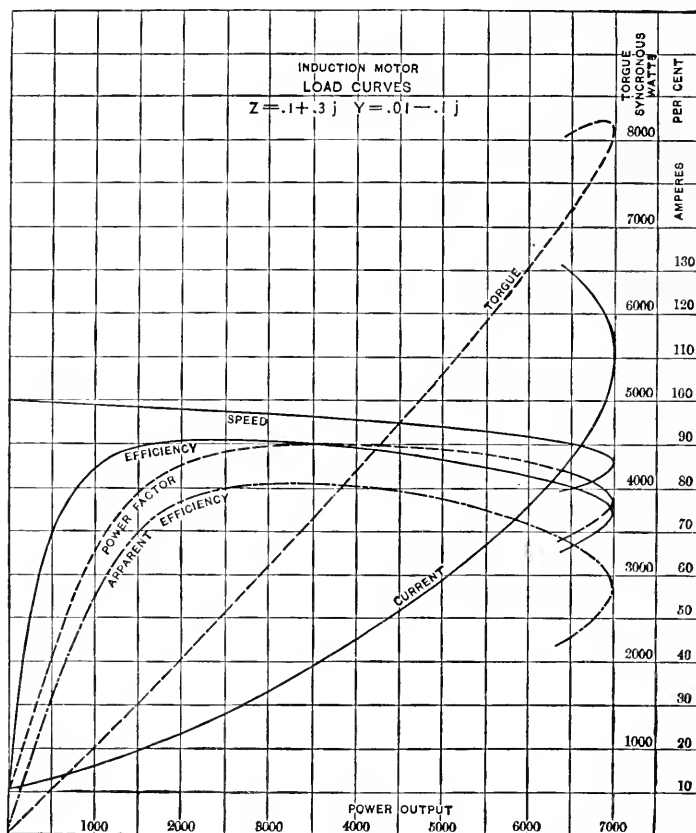

FIG. 123.

hence, the efficiency is,

$$\frac{P_1}{P_0^1} = \frac{a_1(1-s)}{b_1c_1 + b_2c_2}$$

the power-factor,

$$\frac{P_0^1}{P_{a_0}} = \frac{b_1c_1 + b_2c_2}{\sqrt{(b_1^2 + b_2^2)(c_1^2 + c_2^2)}}$$

the apparent efficiency,

$$\frac{P_1}{P_{a_0}} = \frac{a_1(1-s)}{\sqrt{(b_1^2 + b_2^2)(c_1^2 + c_2^2)}};$$

the torque efficiency,¹

$$\frac{D}{P_0^1} = \frac{a_1}{b_1c_1 + b_2c_2},$$

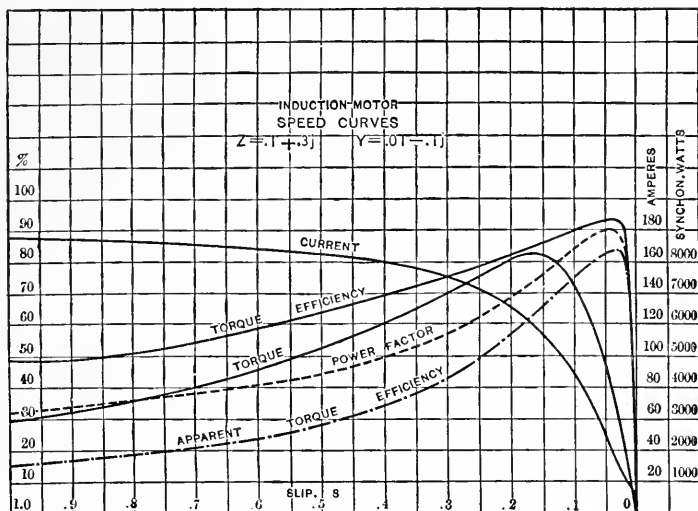

FIG. 124.

and the apparent torque efficiency,²

$$\frac{D}{P_{a_0}} = \frac{a_1}{\sqrt{(b_1^2 + b_2^2)(c_1^2 + c_2^2)}}.$$

172. Most instructive in showing the behavior of an induction motor are the load curves and the speed curves.

The load curves are curves giving, with the power output as abscissas, the current input, speed, torque, power-factor, efficiency, and apparent efficiency, as ordinates.

The speed curves give, with the speed as abscissas, the torque,

¹ That is the ratio of actual torque to torque which would be produced, if there were no losses of energy in the motor, at the same power input.

² That is the ratio of actual torque to torque which would be produced if there were neither losses of energy nor phase displacement in the motor, at the same volt-ampere input.

current input, power-factor, torque efficiency, and apparent torque efficiency, as ordinates.

The load curves characterize the motor especially at its normal running speeds near synchronism, while the speed curves characterize it over the whole range of speed.

In Fig. 123 are shown the load curves, and in Fig. 124 the speed curves of a motor having the constants: $Y_0 = 0.01 - 0.1j$; $Z_0 = 0.1 + 0.3j$; and $Z_1 = 0.1 + 0.3j$.

CHAPTER XIX

INDUCTION GENERATORS

173. In the foregoing, the range of speed from $s = 1$, standstill, to $s = 0$, synchronism, has been discussed. In this range the motor does mechanical work.

It consumes mechanical power, that is, acts as generator or as brake outside of this range.

For $s > 1$, backward driving, P_1 becomes negative, representing consumption of power, while D remains positive; hence, since the direction of rotation has changed, represents consumption of power also. All this power is consumed in the motor, which thus acts as brake.

For $s < 0$, or negative, P_1 and D become negative, and the machine becomes an electric generator, converting mechanical into electric energy.

The calculation of the induction generator at constant frequency, that is, at a speed increasing with the load by the negative slip, s_1 , is the same as that of the induction motor except that s_1 has negative values, and the load curves for the machine shown as motor in Fig. 122, are shown in Fig. 125 for negative slip s_1 as induction generator.

Again, a maximum torque point and a maximum output point are found, and the torque and power increase from zero at synchronism up to a maximum point, and then decrease again, while the current constantly increases.

174. The induction generator differs essentially from the ordinary synchronous alternator in so far as the induction generator has a definite power-factor, while the synchronous alternator has not. That is, in the synchronous alternator the phase relation between current and terminal voltage entirely depends upon the condition of the external circuit. The induction generator, however, can operate only if the phase relation of current and e.m.f., that is, the power-factor required by the external circuit, exactly coincides with the internal power-factor of the induction generator. This requires that

the power-factor either of the external circuit or of the induction generator varies with the voltage, so as to permit the generator and the external circuit to adjust themselves to equality of power-factor.

Beyond magnetic saturation the power-factor decreases; that is, the lead of current increases in the induction machine. Thus, when connected to an external circuit of constant power-factor the induction generator will either not generate at all, if its power-factor is lower than that of the external circuit, or, if its power-factor is higher than that of the external circuit, the

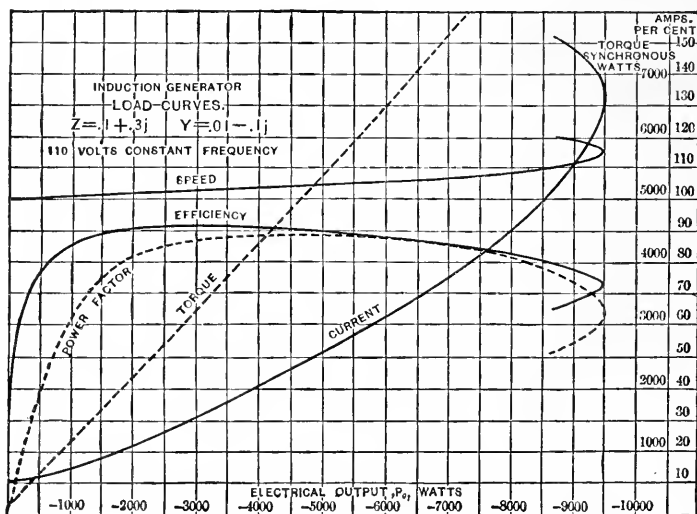

FIG. 125.

voltage will rise until by magnetic saturation in the induction generator its power-factor has fallen to equality with that of the external circuit. This, however, requires magnetic saturation in the induction generator, in some part of the magnetic circuit, as for instance in the armature teeth.

To operate below saturation—that is, at constant internal power-factor—the induction generator requires an external circuit with leading current, whose power-factor varies with the voltage, as a circuit containing synchronous motors or synchronous converters. In such a circuit, the voltage of the induction generator remains just as much below the counter e.m.f. of the synchronous motor as is necessary to give the

required leading exciting current of the induction generator, and the synchronous motor can thus to a certain extent be called the exciter of the induction generator.

When operating self-exciting, that is, shunt-wound, converters from the induction generator, below saturation of both the converter and the induction generator, the conditions are unstable also, and the voltage of one of the two machines must rise beyond saturation of its magnetic field.

When operating in parallel with synchronous alternating current generators, the induction generator obviously takes its leading exciting current from the synchronous alternator, which thus carries a lagging wattless current.

175. To generate constant frequency, the speed of the induction generator must increase with the load. Inversely, when driven at constant speed, with increasing load on the induction generator, the frequency of the current generated thereby decreases. Thus, when calculating the characteristic curves of the constant-speed induction generator, due regard has to be taken of the decrease of frequency with increase of load, or what may be called the slip of frequency, s .

Let, in an induction generator,

$$Y_0 = g_0 - jb_0 = \text{primary exciting admittance,}$$

$$Z_0 = r_0 + jx_0 = \text{primary self-inductive impedance,}$$

$$Z_1 = r_1 + jx_1 = \text{secondary self-inductive impedance,}$$

reduced to primary, all these quantities being reduced to the frequency of synchronism with the speed of the machine, f .

Let e = generated em.f., reduced to full frequency.

s = slip of frequency, thus: $(1 - s)f$ = frequency generated by machine.

We then have

the secondary generated e.m.f.,

se :

thus, the secondary current,

$$I_1 = \frac{se}{r_1 + jsx_1} = e(a_1 - ja_2),$$

where,

$$a_1 = \frac{sr_1}{r_1^2 + s^2x_1^2} \text{ and } a_2 = \frac{s^2x_1}{r_1^2 + s^2x_1^2};$$

the primary exciting current,

$$I_{00} = EY_0 = e(g_0 - jb_0),$$

thus, the total primary current,

$$I_0 = I_1 + I_{00} = e(b_1 - jb_2),$$

where,

$$b_1 = a_1 + g_0 \text{ and } b_2 = a_2 + b_0;$$

the primary impedance voltage,

$$E^1 = I_0 (r_0 + j[1 - s] x_0);$$

the primary generated e.m.f. is,

$$e(1 - s).$$

Thus, primary terminal voltage,

$$E_0 = e(1 - s) - I_0(r_0 + j[1 - s]x_0) = e(c_1 - jc_2),$$

where,

$$c_1 = 1 - s - r_0b_1 - (1 - s)x_0b_2 \text{ and } c_2 = (1 - s)x_0b_1 - r_0b_2,$$

hence, the absolute value is,

$$e_0 = e\sqrt{c_1^2 + c_2^2},$$

and,

$$e = \frac{e_0}{\sqrt{c_1^2 + c_2^2}}.$$

Thus,

the secondary current,

$$I_1 = \frac{e_0 (a_1 - ja_2)}{\sqrt{c_1^2 - c_2^2}}, \quad I_1 = e_0 \sqrt{\frac{a_1^2 + a_2^2}{c_1^2 + c_2^2}};$$

the primary current,

$$I_0 = \frac{e_0 (b_1 - jb_2)}{\sqrt{c_1^2 + c_2^2}}, \quad I_0 = e_0 \sqrt{\frac{b_1^2 + b_2^2}{c_1^2 + c_2^2}};$$

the primary terminal voltage,

$$E_0 = \frac{e_0 (c_1 - jc_2)}{\sqrt{c_1^2 + c_2^2}};$$

the torque and mechanical power input,

$$D = P_1 = [eI_1]^1 = \frac{e_0^2 a_1}{c_1^2 + c_2^2};$$

the electrical output,

$$\begin{aligned} P_0 &= P_0^1 - jP_0^j = [E_0 I_0] = [E_0 I_0]^1 - j[E_0 I_0]^j \\ &= \frac{c_0^2}{c_1^2 + c_2^2} \left\{ (b_1 c_1 + b_2 c_2) - j(b_2 c_1 - b_1 c_2) \right\}; \end{aligned}$$

the volt-ampere output,

$$\begin{aligned} P_{a_0} &= c_0 I_0 \\ &= c_0^2 \frac{\sqrt{b_1^2 + b_2^2}}{c_1^2 + c_2^2}; \end{aligned}$$

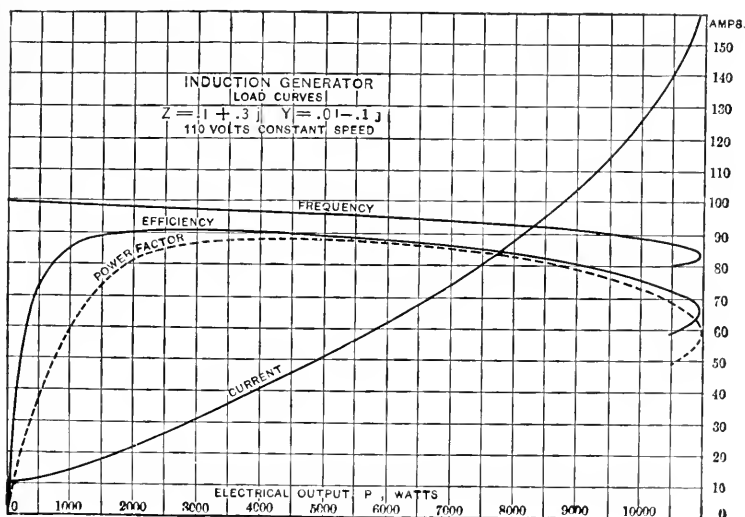

FIG. 126.

the efficiency,

$$\frac{P_0^1}{P_1} = \frac{b_1 c_1 + b_2 c_2}{a_1};$$

the power-factor,

$$\cos \theta = \frac{P_0^1}{P_{a_0}} = \frac{b_1 c_1 + b_2 c_2}{\sqrt{(b_1^2 + b_2^2)(c_1^2 + c_2^2)}},$$

or,

$$\tan \theta = \frac{P_0^j}{P_0^1} = \frac{b_2 c_1 - b_1 c_2}{b_1 c_1 + b_2 c_2}.$$

In Fig. 126 is plotted the load characteristic of a constant-speed induction generator, at constant terminal voltage $c_0 = 110$,

and the constants: $Y_0 = 0.01 - 0.1j$; $Z_0 = 0.1 + 0.3j$, and $Z_1 = 0.1 + 0.3j$.

176. As an example may be considered a power transmission from an induction generator of constants Y_0 , Z_0 , Z_1 , over a line of impedance, $Z = r + jx$, into a synchronous motor of synchronous impedance, $Z_2 = r_2 + jx_2$, operating at constant-field excitation.

Let e_0 = counter e.m.f. or nominal generated e.m.f. of synchronous motor at full frequency; that is, frequency of synchronism with the speed of the induction generator. By the preceding paragraph the primary current of the induction generator was,

$$I_0 = e(b_1 - jb_2);$$

the primary terminal voltage,

$$E_0 = e(c_1 - jc_2);$$

thus, terminal voltage at synchronous motor terminals,

$$\begin{aligned} E'_0 &= E_0 - I_0(r + j[1 - s]x) \\ &= e(d_1 - jd_2), \end{aligned}$$

where,

$$d_1 = c_1 - rb_1 - (1 - s)xb_2 \text{ and } d_2 = c_2 + (1 - s)xb_1 - rb_2;$$

the counter e.m.f. of the synchronous motor,

$$\begin{aligned} E_2 &= E'_0 - I_0(r_2 + j[1 - s]x_2) \\ &= e(k_1 - jk_2); \end{aligned}$$

where,

$$k_1 = d_1 - r_2b_1 - (1 - s)x_2b_2 \text{ and } k_2 = d_2 + (1 - s)x_2b_1 - r_2b_2,$$

or the absolute value

$$E_2 = e\sqrt{k_1^2 + k_2^2},$$

since, however,

$$E_2 = e_0(1 - s),$$

we have,

$$e = \frac{e_0(1 - s)}{\sqrt{k_1^2 + k_2^2}}.$$

Thus, the current,

$$I_0 = \frac{e_0(1 - s)(b_1 - jb_2)}{\sqrt{k_1^2 + k_2^2}};$$

the terminal voltage at induction generator,

$$E_0 = \frac{e_0(1-s)(c_1 - jc_2)}{\sqrt{k_1^2 + k_2^2}}$$

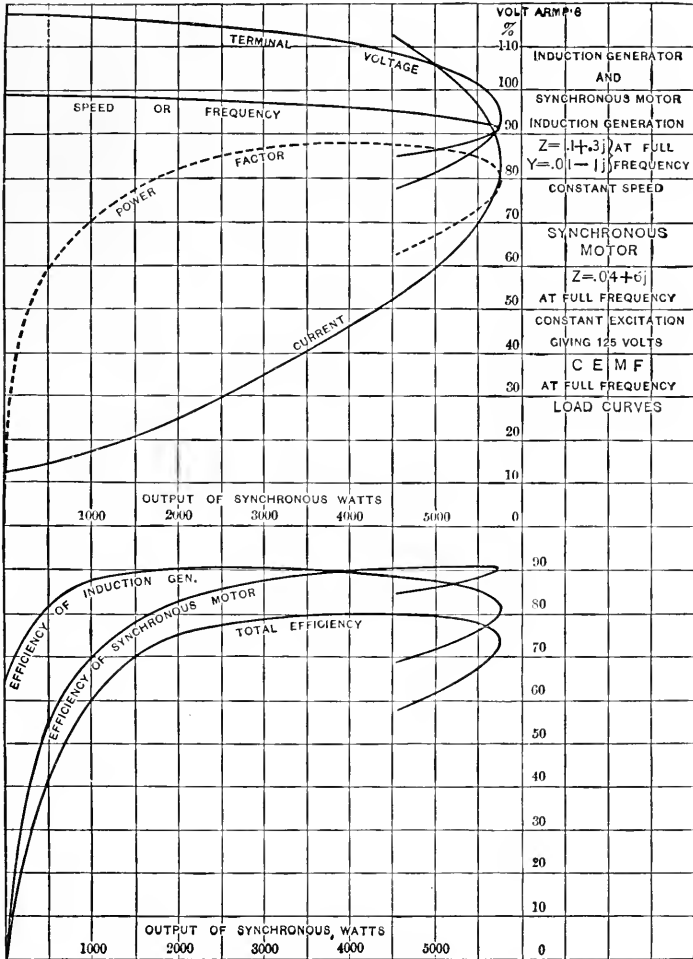

FIG. 127.

and the terminal voltage at the synchronous motor,

$$E_0' = \frac{e_0(1-s)(d_1 - jd_2)}{\sqrt{k_1^2 + k_2^2}}$$

herefrom in the usual way the efficiencies, power-factor, etc., are derived.

When operated from an induction generator, a synchronous motor gives a load characteristic very similar to that of an induction motor operated from a synchronous generator, but in the former case the current is leading, in the latter lagging.

In either case, the speed gradually falls off with increasing load (in the synchronous motor, due to the falling off of the frequency of the induction generator), up to a maximum output point, where the motor drops out of step and comes to standstill.

Such a load characteristic of the induction generator in Fig. 126, feeding a synchronous motor of counter e.m.f. $e_0 = 125$ volts (at full frequency) and synchronous impedance $Z_2 = 0.04 + 6j$, over a line of negligible impedance is shown in Fig. 127.

CHAPTER XX

SINGLE-PHASE INDUCTION MOTORS

177. The magnetic circuit of the induction motor at or near synchronism consists of two magnetic fluxes superimposed upon each other in quadrature, in time, and in position. In the polyphase motor these fluxes are produced by e.m.fs. displaced in phase. In the monocyclic motor one of the fluxes is due to the primary power circuit, the other to the primary exciting circuit. In the single-phase motor the one flux is produced by the primary circuit, the other by the currents produced in the secondary or armature, which are carried into quadrature position by the rotation of the armature. In consequence thereof, while in all these motors the magnetic distribution is the same at or near synchronism, and can be represented by a rotating field of uniform intensity and uniform velocity, it remains such in polyphase and monocyclic motors; but in the single-phase motor, with increasing slip—that is, decreasing speed—the quadrature field decreases, since the secondary armature currents are not carried to complete quadrature position; and thus only a component is available for producing the quadrature flux. Hence, approximately, the quadrature flux of a single-phase motor can be considered as proportional to its speed; that is, it is zero at standstill.

Since the torque of the motor is proportional to the product of secondary current times magnetic flux in quadrature, it follows that the torque of the single-phase motor is equal to that of the same motor under the same condition of operation on a polyphase circuit, multiplied with the speed; hence equal to zero at standstill.

Thus, while single-phase induction motors are quite satisfactory at or near synchronism, their torque decreases proportionally with the speed, and becomes zero at standstill. That is, they are not self-starting, but some starting device has to be used.

Such a starting device may either be mechanical or electrical. All the electrical starting devices essentially consist in impress-

ing upon the motor at standstill a magnetic quadrature flux. This may be produced either by some outside e.m.f., as in the monocyclic starting device, or by displacing the circuits of two or more primary coils from each other, either by mutual induction between the coils—that is, by using one as secondary to the other—or by impedances of different inductance factors connected with the different primary coils.

178. The starting devices of the single-phase induction motor by producing a quadrature magnetic flux can be subdivided into three classes:

1. **Phase-Splitting Devices.** Two or more primary circuits are used, displaced in position from each other, and either in series or in shunt with each other, or in any other way related, as by transformation. The impedances of these circuits are made different from each other as much as possible to produce a phase displacement between them. This can be done either by inserting external impedances in the circuits, as a condenser and a reactive coil, or by making the internal impedances of the motor circuits different, as by making one coil of high and the other of low resistance.

2. **Inductive Devices.** The different primary circuits of the motor are inductively related to each other in such a way as to produce a phase displacement between them. The inductive relation can be outside of the motor or inside, by having the one coil submitted to the inductive action of the other; and in this latter case the current in the secondary coil may be made leading, accelerating coil, or lagging, shading coil.

3. **Monocyclic Devices.** External to the motor an essentially wattless e.m.f. is produced in quadrature with the main e.m.f. and impressed upon the motor, either directly or after combination with the single-phase main e.m.f. Such wattless quadrature e.m.f. can be produced by the common connection of two impedances of different power-factor, as an inductive reactance and a resistance, or an inductive and a condensive reactance connected in series across the mains.

The investigation of these starting-devices offers a very instructive application of the symbolic method of investigation of alternating-current phenomena, and a study thereof is thus recommended to the reader.¹

¹ See paper on the Single-phase Induction Motor, A. I. E. E. Transactions, 1898.

179. Occasionally, no special motors are built for single-phase operation, but polyphase motors used in single-phase circuits, since for starting the polyphase primary winding is required, the single primary-coil motor obviously not allowing the application of phase-displacing devices for producing the starting quadrature flux.

Since at or near synchronism, at the same impressed e.m.f.—that is, the same magnetic density—the total volt-amperes excitation of the single-phase induction motor must be the same as of the same motor on polyphase circuit, it follows that by operating a quarter-phase motor from single-phase circuit on one primary coil, its primary exciting admittance is doubled. Operating a three-phase motor single-phase on one circuit its primary exciting admittance is trebled. The self-inductive primary impedance is the same single-phase as polyphase, but the secondary impedance reduced to the primary is lowered, since in single-phase operation all secondary circuits correspond to the one primary circuit used. Thus the secondary impedance in a quarter-phase motor running single-phase is reduced to one-half, in a three-phase motor running single-phase reduced to one-third. In consequence thereof the slip of speed in a single-phase induction motor is usually less than in a polyphase motor; but the exciting current is considerably greater, and thus the power-factor and the efficiency are lower.

The preceding considerations obviously apply only when running so near synchronism that the magnetic field of the single-phase motor can be assumed as uniform, that is, the cross-magnetizing flux produced by the armature as equal to the main magnetic flux.

When investigating the action of the single-phase motor at lower speeds and at standstill, the falling off of the magnetic quadrature flux produced by the armature current, the change of secondary impedance, and where a starting device is used the effect of the magnetic field produced by the starting device, have to be considered.

The exciting current of the single-phase motor consists of the primary exciting current or current producing the main magnetic flux, and represented by a constant admittance, Y_0^1 , the primary exciting admittance of the motor, and the secondary exciting current, that is, that component of primary current corresponding to the secondary current which gives the excita-

tion for the quadrature magnetic flux. This latter magnetic flux is equal to the main magnetic flux, Φ_0 , at synchronism, and falls off with decreasing speed to zero at standstill, if no starting device is used, or to $\Phi_1 = \Phi_0 t$ at standstill if by a starting device a quadrature magnetic flux is impressed upon the motor, and at standstill $t =$ ratio of quadrature or starting magnetic flux to main magnetic flux.

Thus the secondary exciting current can be represented by an admittance, Y_1^1 , which changes from equality with the primary exciting admittance, Y_0^1 at synchronism to $Y_1^1 = 0$, respectively to $Y_1^1 = tY_0^1$ at standstill. Assuming thus that the starting device is such that its action is not impaired by the change of speed, at slip s the secondary exciting admittance can be represented by:

$$Y_1^1 = [1 - (1 - t) s] Y_0^1.$$

The secondary impedance of the motor at synchronism is the joint impedance of all the secondary circuits, since all secondary circuits correspond to the same primary circuit, hence $= \frac{Z_1}{3}$ with a three-phase secondary, and $= \frac{Z_1}{2}$ with a two-phase secondary with impedance Z_1 per circuit.

At standstill, however, the secondary circuits correspond to the primary circuit only with their projection in the direction of the primary flux, and thus as resultant only one-half of the secondary circuits are effective, so that the secondary impedance at standstill is equal to $\frac{2Z_1}{3}$ with a three-phase, and equal to Z_1 with a two-phase, secondary. Thus the effective secondary impedance of the single-phase motor changes with the speed and can at the slip s be represented by $Z_1^1 = \frac{(1+s)Z_1}{3}$ in a three-phase secondary, and $Z_1^1 = \frac{(1+s)Z_1}{2}$ in a two-phase secondary, with the impedance Z_1 per secondary circuit.

In the single-phase motor without starting device, due to the falling off of the quadrature flux, the torque at slip s is:

$$D = a_1 e^2 (1 - s).$$

(a and e see paragraph 171.)

In a single-phase motor with a starting device which at

standstill produces a ratio of magnetic fluxes t , the torque at standstill is

$$D_0 = tD_1,$$

where $D_1 = a_1e^2 =$ total torque of the same motor on polyphase circuit.

Thus denoting the value $\frac{D_0}{D_1} = v$, the single-phase motor torque at standstill is:

$$D_0 = vD_1 = a_1e^2v,$$

and the single-phase motor torque at slip s is:

$$D = a_1e^2[1 - (1 - v)s].$$

180. In the single-phase motor considerably more advantage is gained by compensating for the wattless magnetizing component of current by capacity than in the polyphase motor, where this wattless component of the current is relatively small. The use of shunted capacity, however, has the disadvantage of requiring a wave of impressed e.m.f. very close to sine shape, since even with a moderate variation from sine shape the wattless charging current of the condenser of higher frequency may lower the power-factor more than the compensation for the wattless component of the fundamental wave raises it, as will be seen in the chapter on General Alternating-current Waves.

Thus the most satisfactory application of the condenser in the single-phase motor is not in shunt to the primary circuit, but in a tertiary circuit; that is, in a circuit stationary with regard to the primary impressed circuit but submitted to inductive action by the revolving secondary circuit.

In this case the condenser is supplied with an e.m.f. transformed twice, from primary to secondary and from secondary to tertiary, through multitooth structures in a uniformly revolving field, and thus a very close approximation to sine wave produced at the condenser, irrespective of the wave-shape of primary impressed e.m.f.

With the condenser connected into a tertiary circuit of a single-phase induction motor, the wattless magnetizing current of the motor is supplied by the condenser in a separate circuit, and the primary coil carries the power current only, and thus the efficiency of the motor is essentially increased.

The tertiary circuit may be at right angles to the primary, or under any other angle. Usually it is applied on an angle of 45° to 60° , so as to secure a mutual induction between tertiary and primary for starting, which produces in starting in the condenser a leading current, and gives the quadrature magnetic flux required.

181. The most convenient way to secure this arrangement is the use of a three-phase motor which with two of its terminals, 1-2, is connected to the single-phase mains, and with terminals 1 and 3 to a condenser.

Let $Y_0 = g_0 - jb_0 =$ primary exciting admittance of the motor per delta circuit.

$Z_0 = r_0 + jx_0 =$ primary self-inductive impedance per delta circuit.

$Z_1 = r_1 + jx_1 =$ secondary self-inductive impedance per delta circuit reduced to primary.

Let

$Y_3 = g_3 + jb_3 =$ admittance of the condenser connected between terminals 1 and 3.

If then, as single-phase motor,

$t =$ ratio of auxiliary quadrature flux to main flux in starting,

$h =$ ratio of e.m.f. generated in condenser circuit to e.m.f. generated in main circuit in starting,

$v = \frac{\text{starting torque}}{a_1 e^2 \text{ in starting}}$

Operating single-phase

$Y_0^1 = 1.5 Y_0 = 1.5(g_0 - jb_0) =$ primary exciting admittance;

$Y_1^1 = 1.5 Y_0 [1 - (1 - t) s]$
 $= 1.5 (g_0 - jb_0) [1 - (1 - t) s] =$ secondary exciting admittance at slip s ;

$Z_0^1 = \frac{2 Z_0}{3} = \frac{2(r_0 + jx_0)}{3} =$ primary self-inductive impedance;

$Z_1^1 = \frac{(1 + s)}{3} Z_1 = \frac{(1 + s)}{3} (r_1 + jsx_1) =$ secondary self-inductive impedance;

$Z_2^1 = \frac{2 Z_0}{3} = \frac{2(r_0 + jx_0)}{3} =$ tertiary self-inductive impedance of motor.

Thus,

$$Y_4 = \frac{1}{Z_2^1 + \frac{1}{Y_3}} = \text{total admittance of tertiary circuit.}$$

Since the e.m.f. generated in the tertiary circuit decreases from e at synchronism to he at standstill, the effective tertiary admittance or admittance reduced to a generated e.m.f., e , is at slip s ,

$$Y_4^1 = [1 - (1 - h)s]Y_4.$$

Let then,

$$\begin{aligned} e &= \text{counter e.m.f. of primary circuit,} \\ s &= \text{slip.} \end{aligned}$$

We have,

the secondary load current,

$$I_1 = \frac{se}{Z_1^1} = \frac{3se}{(1+s)(r_1 + jsx_1)} = e(a_1 - ja_2);$$

the secondary exciting current,

$$I_1^1 = eY_1^1 = 1.5eY_0[1 - (1-t)s];$$

the secondary condenser current;

$$I_4 = eY_4^1 = eY_4[1 - (1-h)s];$$

thus, the total secondary current,

$$I^1 = I_1 + I_1^1 + I_4;$$

the primary exciting current,

$$I_0^1 = eY_0^1 = 1.5eY_0,$$

thus, the total primary current,

$$I_0 = I^1 + I_0^1 = I_1 + I_4 + I_1^1 + I_0^1 = e(b_1 - jb_2);$$

the primary impressed e.m.f.,

$$E_0 = e + Z_0^1 I_0 = e(c_1 - jc_2);$$

thus, the main counter e.m.f.,

$$e = \frac{E_0}{c_1 - jc_2},$$

or,

$$E = \frac{e_0}{c_1 - jc_2},$$

and the absolute value,

$$e = \frac{e_0}{\sqrt{c_1^2 + c_2^2}},$$

hence, the primary current,

$$I_0 = \frac{e_0(b_1 - jb_2)}{c_1 - jc_2},$$

or,

$$I_0 = e_0 \sqrt{\frac{b_1^2 + b_2^2}{c_1^2 + c_2^2}}.$$

The volt-ampere input,

$$P_{a_0} = e_0 I_0;$$

the power input,

$$P_0 = [I_0 e_0]^2 = e_0^2 \frac{b_1 c_1 + b_2 c_2}{c_1^2 + c_2^2};$$

the torque at slip s ,

$$D = D^1 [1 - (1 - v) s] = \frac{e_0^2 a_1}{c_1^2 + c_2^2} [1 - (1 - v) s],$$

and the power output,

$$\begin{aligned} P &= D (1 - s) \\ &= \frac{e_0^2 a_1}{c_1^2 + c_2^2} (1 - s) [1 - (1 - v) s], \end{aligned}$$

and herefrom in the usual manner may be derived the efficiency, apparent efficiency, torque efficiency, apparent torque efficiency, and power-factor.

The derivation of the constants, t , h , v , which have to be determined before calculating the motor, is as follows:

Let e_0 = single-phase impressed e.m.f.,

Y = total stationary admittance of motor per delta circuit,

E_3 = e.m.f. at condenser terminals in starting.

In the circuit between the single-phase mains from terminal 1 over terminal 3 to 2, the admittances, $Y + Y_3$, and Y , are connected in series, and have the respective e.m.fs., E_3 and $e_0 - E_3$. It is thus,

$$Y + Y_3 \div Y = e_0 - E_3 \div E_3,$$

since with the same current in both circuits, the impressed e.m.fs. are inversely proportional to the respective admittances.

Thus,

$$E_3 = \frac{e_0 Y}{2 Y + Y_3} = e_0 (h_1 - j h_2),$$

and the quadrature e.m.f. is

$$e_0 h_2,$$

hence,

$$E_3 = c_0 \sqrt{h_1^2 + h_2^2},$$

and

$$h = \sqrt{h_1^2 + h_2^2}.$$

Since in the three-phase e.m.f. triangle, the altitude corresponding to the quadrature magnetic flux $= \frac{c_0}{2\sqrt{3}}$, and the quadrature and main fluxes are equal, in the single-phase motor the ratio of quadrature to main flux is

$$t = \frac{2h_2}{\sqrt{3}} = 1.155 h_2.$$

From t , v is derived as shown in the preceding.

182. The most frequently used starting device of single-phase induction motors (with the exception of fan motors, in which the

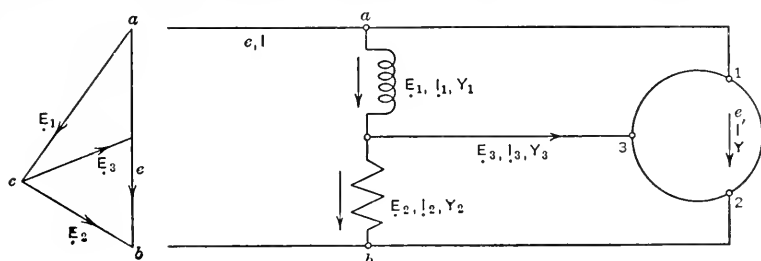

FIG. 128.

shading coil is commonly used) is the mono-cyclic starting device. It consists in producing externally to the motor a system of polyphase e.m.f.s. with single-phase flow of energy, and impressing it upon the motor, which is wound as polyphase, usually three-phase motor.

Such a polyphase system of e.m.f.s. with single-phase flow of energy has been called a mono-cyclic system. It essentially consists, or can be resolved into, a main or energy e.m.f., in phase with the flow of energy, and an auxiliary or wattless e.m.f. in quadrature thereto.

If across the single-phase mains of voltage, e , two impedances of different inductance factors, of the respective admittances, Y_1 and Y_2 , are connected, the voltages, E_1 and E_2 of these im-

pedances are displaced from each other, thus forming with the main voltage, e , a voltage triangle, or a more or less distorted three-phase system, as shown in Fig. 128.

Connecting now a three-phase induction motor with two of its terminals, 1 and 2, to the single-phase mains a , and b , and with its third terminal 3 to the common connection, c , of the two impedances, a quadrature flux is produced in this motor, by the traverse voltage, E_3 , of the monocyclic triangle, Fig. 128.

It is then:

$$\dot{E}_1 + \dot{E}_2 = e \quad (1)$$

$$\dot{E}_2 - \dot{E}_1 = \dot{E}_3 \quad (2)$$

hence:

$$\left. \begin{aligned} \dot{E}_1 &= \frac{e}{2} - \dot{E}_3 \\ \dot{E}_2 &= \frac{e}{2} + \dot{E}_3 \end{aligned} \right\} \quad (3)$$

Let now, in Fig. 128.

Y = effective admittance of motor between terminals 1 and 2 at standstill.

Y_3 = effective admittance of motor for the quadrature flux, from terminal 3 to middle between 1 and 2.

As the voltage of this latter admittance is $\frac{e}{2}\sqrt{3}$, the altitude of the three-phase motor triangle, and as the magnetic flux is the same in all directions, in the polyphase motor, and the effective admittances are proportional to the square of the voltage, it is:

$$\begin{aligned} Y_3 \div Y &= e^2 \div \left(\frac{e}{2}\sqrt{3}\right)^2 \\ &= 1 \div \frac{3}{4} \end{aligned}$$

hence:

$$Y_3 = \frac{4}{3}Y$$

Denoting the currents and voltages in the direction as shown by the arrows in Fig. 128, it is:

$$\dot{I}_3 = \dot{I}_1 - \dot{I}_2 \quad (4)$$

and:

$$\dot{I}_3 = Y_3 \dot{E}_3 = \frac{4}{3} Y \dot{E}_3 \quad (5)$$

$$\left. \begin{aligned} \dot{I}_1 &= Y_1 \dot{E}_1 = Y_1 \left(\frac{e}{2} - \dot{E}_3 \right) \\ \dot{I}_2 &= Y_2 \dot{E}_2 = Y_2 \left(\frac{e}{2} + \dot{E}_3 \right) \end{aligned} \right\} \quad (6)$$

(By equation (3)) substituting (5) and (6) into (4), gives, after transposing:

$$\dot{E}_3 = \frac{e}{2} \frac{Y_1 - Y_2}{Y_1 + Y_2 + \frac{4}{3} Y} \quad (7)$$

Substituting (7) into (3), (5), (6) then gives the voltages and currents:

$$\dot{E}_1, \dot{E}_2, \dot{I}_3, \dot{I}_1, \dot{I}_2$$

The current traversing the motor from terminal 1 to terminal 2 is

$$\dot{I}' = eY \quad (8)$$

and upon this superimpose the return of the current \dot{I}_3 , so that current

$$\dot{I}'_2 = eY + \frac{1}{2} \dot{I}_3 \quad (9)$$

leaves terminal 2, and current

$$\dot{I}'_1 = eY - \frac{1}{2} \dot{I}_3 \quad (10)$$

enters terminal 1.

The total current taken by the motor and starting device from the single-phase mains then is:

$$\left. \begin{aligned} \dot{I} &= \dot{I}_1 + \dot{I}'_1 \\ &= \dot{I}_2 + \dot{I}'_2 \end{aligned} \right\} \quad (11)$$

and herefrom follows the volt-ampere input:

$$Q = eI \quad (12)$$

while on polyphase supply, the volt-ampere input is:

$$Q_0 = 2eI' = 2e^2Y \quad (13)$$

thus the ratio of volt-ampere inputs is:

$$q = \frac{Q}{Q_0} = \frac{I}{2eY} \quad (14)$$

The ratio of the starting torque of the motor with the monocyclic starting device, to that of the same motor on three-phase

supply, is the ratio of the quadrature fluxes, which is proportional to the quadrature voltages:

$$t = \frac{E_3^j}{\frac{e}{2}\sqrt{3}} = \left/ \frac{Y_1 - Y_2}{\sqrt{3} \left\{ Y_1 + Y_2 + \frac{4}{3} Y \right\}} \right/ ^j \quad (15)$$

where the index, j , denotes, that only the quadrature term of the expression is effective in producing torque.

The ratio of the apparent starting torque efficiencies thus is:

$$s = \frac{t}{q} \quad (16)$$

183. Usually a resistance and a reactance are used as the two impedances of the monocyclic starting device, as the cheapest, though the triangle produced thereby has a low altitude, E_2 , and starting torque and torque efficiency thus are comparatively low.

Let as illustration, in the three-phase motor, Figs. 122 and 123, a resistance-reactance starting device be used of the values: $r = 1$ ohm, and $x = 1$ ohm hence:

$$Y_1 = \frac{1}{r} = 1$$

$$Y_2 = -\frac{j}{x} = -j$$

In this motor, at standstill, it is, per delta circuit:

(a) Without starting resistance:	(b) With secondary resistance increased ten fold:
----------------------------------	---

Voltage:	e = 110 volts	
Current:	i = 176 amp.	8.97 amp.
Torque:	D = 2.93 syn. kw.	7.38 syn. kw.
Power-factor:	p = 0.313	0.835

Hence the current,

vectorially:	I = 55 - 167 j	75 - 49 j
--------------	----------------	-----------

and the admittance, per motor

circuit:	Y' = 0.5 - 1.52 j	0.68 - 0.45 j
----------	-------------------	---------------

Hence, the effective admittance, between two motor terminals 1 and 2:

$$Y = 1.5 Y' = 0.75 - 2.28 j \quad 1.02 - 0.67 j$$

Herefrom follows:

Quadrature voltage:	E ₃ = - 5.5 + 16.3 j	2.7 + 25.5 j
---------------------	---------------------------------	--------------

Relative starting torque:	$t = 0.172$	0.268
Starting torque:	$3 tD = 1.52$ syn. kw.	6.73 syn. kw.

As seen, with starting resistance in the secondary circuit, a fairly good starting torque is given by this device; but with short-circuited armature, the starting torque is low.

184. The greater the difference in the inductance factors of the two impedances in the starting device, the higher values of quadrature voltage, E_3 , and thus of starting torque are available.

The combination of inductance and capacity thus gives the highest torque, and by such combination, true three-phase relation can be secured, that is, the conditions brought about:

$$E_1 = E_2 = e$$

The starting by condenser in the tertiary circuit, of a three-phase motor, can be considered as a special case of the monocyclic starting device, for $Y_1 = O$ and $Y_2 =$ capacity susceptance.

A further extension of the monocyclic starting device is, to use another induction motor, which is running at speed, to supply the quadrature voltage, E_3 .

Thus, if a number of single-phase induction motors are operated near each other, as in the same factory, etc., they can all be made self-starting—except the first one—by connecting their third terminals together. That is, connecting a number of three-phase induction motors, with two of their terminals, 1, 2 to single-phase mains a, b , and connecting all their third terminals, 3, with each other by an interconnecting main, c , then, as soon as one of the motors is running, all the others can be started by drawing quadrature voltage and current from the one which is running.

This is a convenient means of operating single-phase induction motors self-starting without separate starting devices. It has the further advantage, that an overloaded motor begins to draw current over the interconnecting circuit, c , from the other motors, as phase converters, and the maximum output of the individual motors thereby is increased far beyond that of the motor as single-phase motor, near to that as three-phase motor.

As single-phase motors, especially with armature resistance, when once started and when not loaded, speed up from low speed

to full speed, the first motor in such monocyclic interconnecting system can be started by hand, after taking its load off.

For further discussion on the theory and calculation of the single-phase induction motor, see American Institute Electrical Engineers Transactions, January, 1898 and 1900.

SECTION V

SYNCHRONOUS MACHINES

CHAPTER XXI

ALTERNATING-CURRENT GENERATOR

185. In the alternating-current generator, e.m.f. is generated in the armature conductors by their relative motion through a constant or approximately constant magnetic field.

When yielding current, two distinctly different m.m.fs. are acting upon the alternator armature—the m.m.f. of the field due to the field-exciting spools, and the m.m.f. of the armature current. The former is constant, or approximately so, while the latter is alternating, and in synchronous motion relatively to the former; hence fixed in space relative to the field m.m.f., or uni-

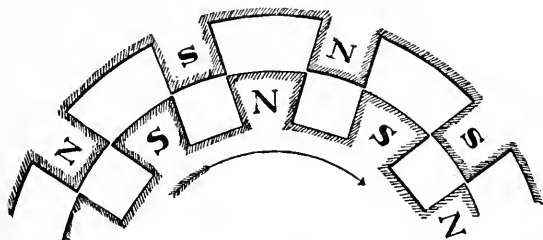

FIG. 129.

directional, but pulsating in a single-phase alternator. In the polyphase alternator, when evenly loaded or balanced, the resultant m.m.f. of the armature current is more or less constant.

The e.m.f. generated in the armature is due to the magnetic flux passing through and interlinked with the armature conductors. This flux is produced by the resultant of both m.m.fs., that of the field, and that of the armature.

On open-circuit, the m.m.f. of the armature is zero, and the e.m.f. of the armature is due to the m.m.f. of the field-coils only. In this case the e.m.f. is, in general, a maximum at the moment when the armature coil faces the position midway between adjacent field-coils, as shown in Fig. 129, and thus incloses

no magnetism. The e.m.f. wave in this case is, in general, symmetrical.

An exception to this statement may take place only in those types of alternators where the magnetic reluctance of the armature is different in different directions; thereby, during the synchronous rotation of the armature, a pulsation of the magnetic flux passing through it is produced. This pulsation of the magnetic flux generates e.m.f. in the field-spools, and thereby makes the field current pulsating also. Thus, we have, in this case, even on open-circuit, no rotation through a constant magnetic field, but rotation through a pulsating field, which makes the e.m.f. wave unsymmetrical, and shifts the maximum point from its theoretical position midway between the field-poles. In general this secondary reaction can be neglected, and the field m.m.f. be assumed as constant.

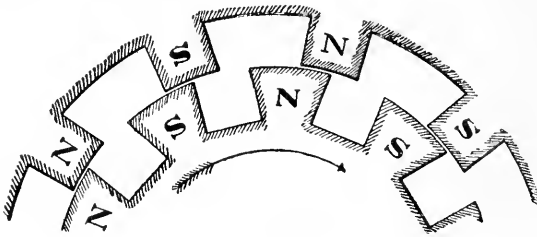

FIG. 130.

The relative position of the armature m.m.f. with respect to the field m.m.f. depends upon the phase relation existing in the electric circuit. Thus, if there is no displacement of phase between current and e.m.f., the current reaches its maximum at the same moment as the e.m.f. or, in the position of the armature shown in Fig. 129, midway between the field-poles. In this case the armature current tends neither to magnetize nor demagnetize the field, but merely distorts it; that is, demagnetizes the trailing pole corner, *a*, and magnetizes the leading pole corner, *b*. A change of the total flux, and thereby of the resultant e.m.f., will take place in this case only when the magnetic densities are so near to saturation that the rise of density at the leading pole corner will be less than the decrease of density at the trailing pole corner. Since the internal self-inductive reactance of the alternator itself causes a certain lag of the current behind the generated e.m.f., this condition of no displacement can exist only in a circuit with external negative reactance, as capacity, etc.

If the armature current lags, it reaches the maximum later than the e.m.f.; that is, in a position where the armature-coil partly faces the field-pole which it approaches, as shown in diagram in Fig. 130. Since the armature current is in opposite direction to the current in the following field-pole (in a generator), the armature in this case will tend to demagnetize the field.

If, however, the armature current leads—that is, reaches its maximum while the armature-coil still partly faces the field-pole which it leaves, as shown in diagram, Fig. 131—it tends to magnetize this field-pole, since the armature current is in the same direction as the exciting current of the preceding field spools.

Thus, with a leading current, the armature reaction of the alternator strengthens the field, and thereby, at constant field excitation, increases the voltage; with lagging current it weakens

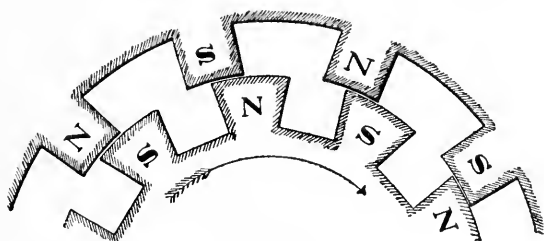

FIG. 131.

the field, and thereby decreases the voltage in a generator. Obviously, the opposite holds for a synchronous motor, in which the armature current is in the opposite direction; and thus a lagging current tends to magnetize, a leading current to demagnetize, the field.

186. The e.m.f. generated in the armature by the resultant magnetic flux, produced by the resultant m.m.f. of the field and of the armature, is not the terminal voltage of the machine; the terminal voltage is the resultant of this generated e.m.f. and the e.m.f. of self-inductive reactance and the e.m.f. representing the power loss by resistance in the alternator armature. That is, in other words, the armature current not only opposes or assists the field m.m.f. in creating the resultant magnetic flux, but sends a second magnetic flux in a local circuit through the armature, which flux does not pass through the field-spools, and is called the magnetic flux of armature self-inductive reactance.

Thus we have to distinguish in an alternator between armature reaction, or the magnetizing action of the armature upon the field, and armature self-inductive reactance, or the e.m.f. generated in the armature conductors by the current therein. This e.m.f. of self-inductive reactance is (if the magnetic reluctance, and consequently the reactance, of the armature circuit is assumed as constant) in quadrature behind the armature current, and will thus combine with the generated e.m.f. in the proper phase relation. Obviously the e.m.f. of self-inductive reactance and the generated e.m.f. do not in reality combine, but their respective magnetic fluxes combine in the armature-core, where they pass through the same structure. These component e.m.f.s. are therefore mathematical fictions, but their resultant is real. This means that, if the armature current lags, the e.m.f. of self-inductive reactance will be more than 90° behind the generated e.m.f., and therefore in partial opposition, and will tend to reduce the terminal voltage. On the other hand, if the armature current leads, the e.m.f. of self-inductive reactance will be less than 90° behind the generated e.m.f., or in partial conjunction therewith, and increase the terminal voltage. This means that the e.m.f. of self-inductive reactance increases the terminal voltage with a leading, and decreases it with a lagging current, or, in other words, acts in the same manner as the armature reaction. For this reason both actions can be combined in one, and represented by what is called the *synchronous reactance* of the alternator. In the following, we shall represent the total reaction of the armature of the alternator by the one term, *synchronous reactance*. While this is not exact, as stated above, since the reactance should be resolved into the magnetic reaction due to the magnetizing action of the armature current, and the electric reaction due to the self-induction of the armature current, it is in general sufficiently near for practical purposes, and well suited to explain the phenomena taking place under the various conditions of load. This synchronous reactance, x , is occasionally not constant, but is pulsating, owing to the synchronously varying reluctance of the armature magnetic circuit, and the field magnetic circuit; it may, however, be considered in what follows as constant; that is, the e.m.f.s. generated thereby may be represented by their equivalent sine waves. A specific discussion of the distortions of the wave shape due to the pulsation of the synchronous reactance is found in Chapter XXVI. The synchron-

ous reactance, x , is not a true reactance in the ordinary sense of the word, but an *equivalent* or *effective* reactance. Sometimes the total effects taking place in the alternator armature are represented by a magnetic reaction, neglecting the self-inductive reactance altogether, or rather replacing it by an increase of the armature reaction or armature m.m.f. to such a value as to include the self-inductive reactance. This assumption is often made in the preliminary designs of alternators. Further discussion of the relation of armature reaction and self-induction see "Theory and Calculation of Electrical Circuits" under "Reactance and Apparatus."

187. Let E_0 = generated e.m.f. of the alternator, or the e.m.f. generated in the armature-coils by their rotation through the constant magnetic field produced by the current in the field-spools, or the open-circuit voltage, more properly called the "nominal generated e.m.f.," since in reality it does not exist as before stated.

Then

$$E_0 = \sqrt{2} \pi n f \Phi 10^{-8};$$

where

n = total number of turns in series on the armature,

f = frequency,

Φ = total magnetic flux per field-pole.

Let

x_0 = synchronous reactance,

r_0 = internal resistance of the alternator;

then

$Z_0 = r_0 + jx_0$ = internal impedance.

If the circuit of the alternator is closed by the external impedance,

$$Z = r + jx,$$

the current

$$I = \frac{E_0}{Z_0 + Z} = \frac{E_0}{(r_0 + r) + j(x_0 + x)},$$

or,

$$I = \frac{E_0}{\sqrt{(r_0 + r)^2 + (x_0 + x)^2}};$$

and, the terminal voltage,

$$E = IZ = E_0 - IZ_0 = \frac{E_0(r + jx)}{(r_0 + r) + j(x_0 + x)},$$

or,

$$E = \frac{E_0 \sqrt{r^2 + x^2}}{\sqrt{(r_0 + r)^2 + (x_0 + x)^2}}$$

$$= E_0 \frac{1}{\sqrt{1 + 2 \frac{r_0 r + x_0 x}{r^2 + x^2} + \frac{r_0^2 + x_0^2}{r^2 + x^2}}};$$

or, expanded in a series,

$$E = E_0 \left\{ 1 - \frac{r_0 r + x_0 x}{r^2 + x^2} + \frac{(x x_0 + r r_0)^2 + 4(x r_0 - r x_0)^2}{8(r^2 + x^2)^2} \pm \dots \right\}.$$

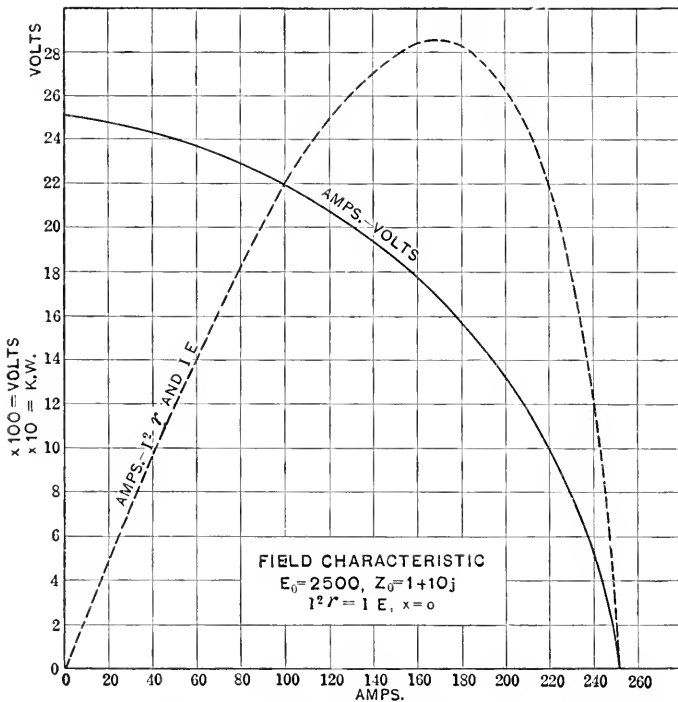

FIG. 132.—Field characteristic of alternator on non-inductive load.

As shown, the terminal voltage varies with the conditions of the external circuit.

188. As an example are shown in Figs. 132–137, at constant generated e.m.f.,

$$E_0 = 2500;$$

and the values of the internal impedance,

$$Z_0 = r_0 + jx_0 = 1 + 10j,$$

with the current, I , as abscissas, the terminal voltages, E , as ordinates in full line, and the kilowatts output, $= I^2r$, in dotted lines, the kilovolt-amperes output, $= IE$, in dash-dotted lines, for the following conditions of external circuit:

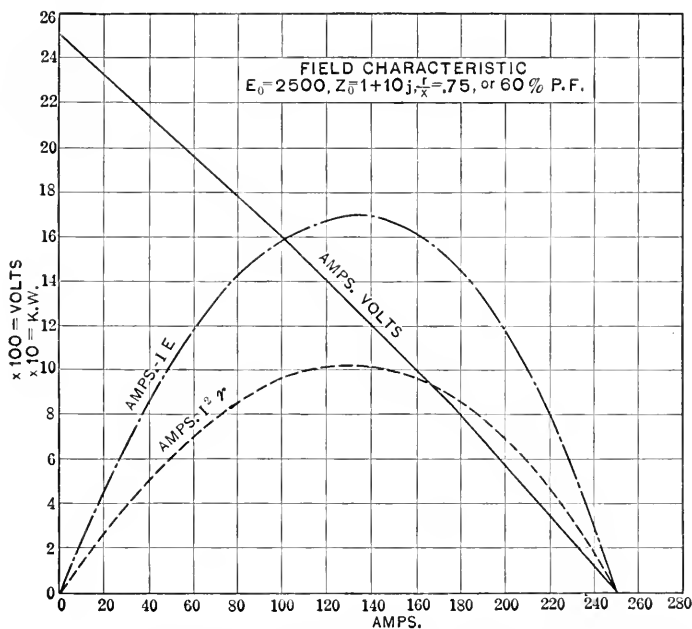

FIG. 133.—Field characteristic of alternator at 60 per cent. power-factor on inductive load.

In Fig. 132, non-inductive external circuit, $x = 0$.

In Fig. 133, inductive external circuit, of the condition, $\frac{r}{x} = + 0.75$, or a power-factor, 0.6.

In Fig. 134, inductive external circuit, of the condition, $r = 0$, or a power-factor, 0.

In Fig. 135, external circuit with leading current, of the condition, $x = - 0.75$, or a power-factor, 0.6.

In Fig. 136, external circuit with leading current, of the condition, $r = 0$, or a power-factor, 0.

In Fig. 137, all the volt-ampere curves are shown together as

complete ellipses, giving also the negative or synchronous motor part of the curves.

Such a curve is called a *field characteristic*.

As shown, the e.m.f. curve at non-inductive load is nearly horizontal at open-circuit, nearly vertical at short-circuit, and is similar to an arc of an ellipse.

With reactive load the curves are more nearly straight lines.

The voltage drops on inductive load and rises on capacity load.

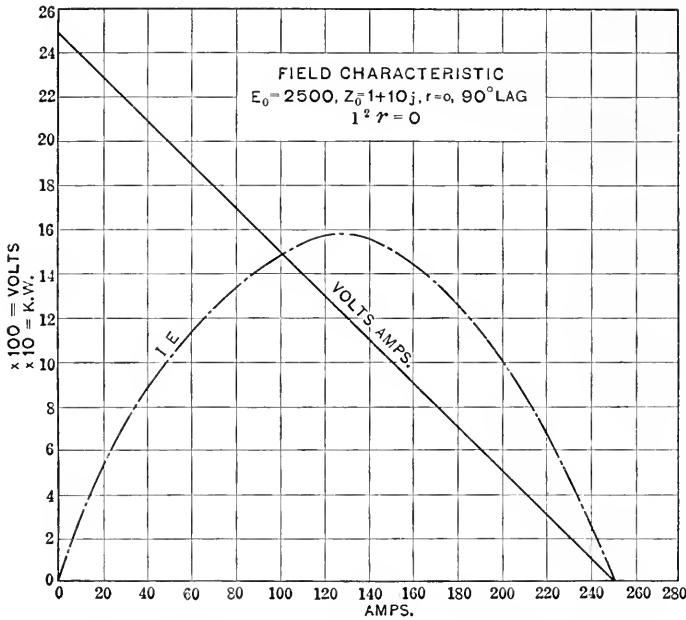

Fig. 134.—Field characteristic of alternator on wattless inductive load.

The output increases from zero at open-circuit to a maximum, and then decreases again to zero at short-circuit.

189. The dependence of the terminal voltage, E , upon the phase relation of the external circuit is shown in Fig. 138, which gives, at impressed e.m.f., $E_0 = 2500$ volts, and the currents, $I = 50, 100, 150, 200, 250$ amp., the terminal voltages, E , as ordinates, with the inductance factor of the external circuit

$$\frac{x}{\sqrt{r^2 + x^2}}, \text{ as abscissas.}$$

190. If the internal impedance is negligible compared with the external impedance, then, approximately,

$$E = \frac{E_0 \sqrt{r^2 + x^2}}{\sqrt{(r_0 + r)^2 + (x_0 + x)^2}} = E_0;$$

that is, an alternator with small internal resistance and synchronous reactance tends to regulate for constant-terminal voltage.

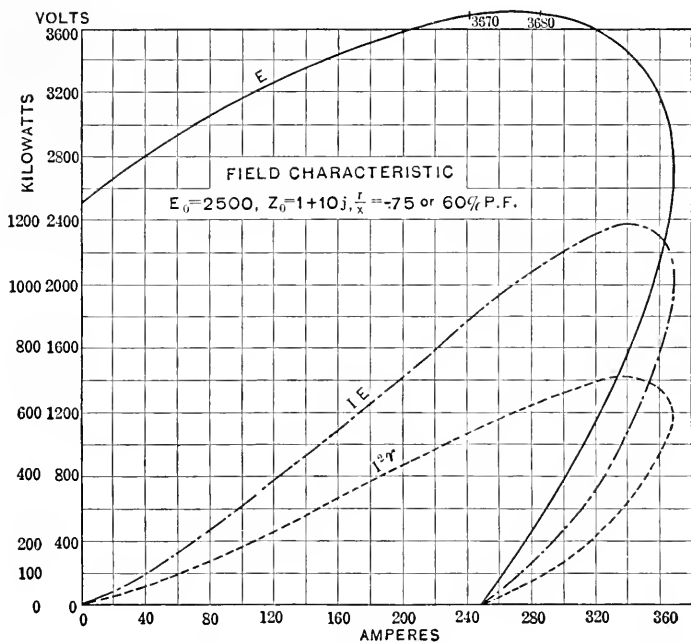

FIG. 135.—Field characteristic of alternator at 60 per cent. power-factor on condenser load.

Every alternator does this near open-circuit, especially on non-inductive load.

Even if the synchronous reactance, x_0 , is not quite negligible, this regulation takes place, to a certain extent, on non-inductive circuit, since for $x = 0$,

$$E = \frac{E_0}{\sqrt{1 + 2 \frac{r_0}{r} + \frac{z_0^2}{r^2}}}$$

and thus the expression of the terminal voltage, E , contains

the synchronous reactance, x_0 , only as a term of second order in the denominator.

On inductive circuit, however, x_0 appears in the denominator

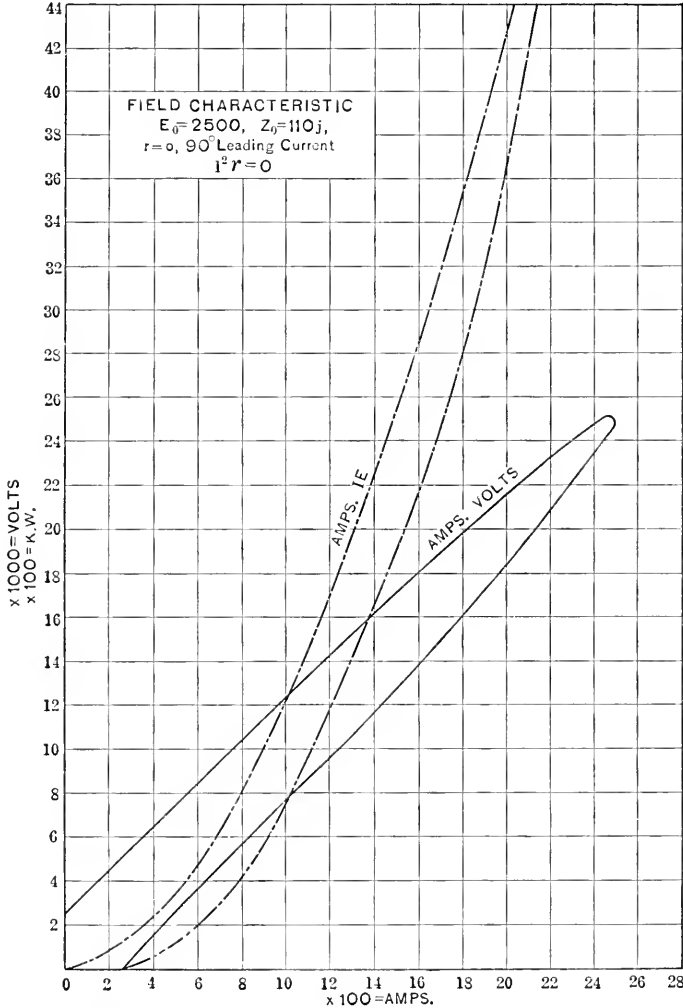

FIG. 136.—Field characteristic of alternator on wattless condenser load.

as a term of first order, and therefore constant-potential regulation does not take place as well.

With a non-inductive external circuit, if the synchronous

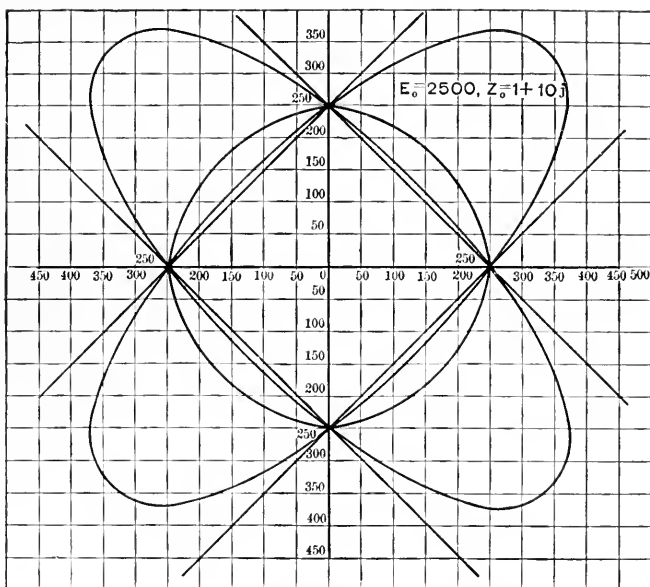

FIG. 137.—Field characteristic of alternator.

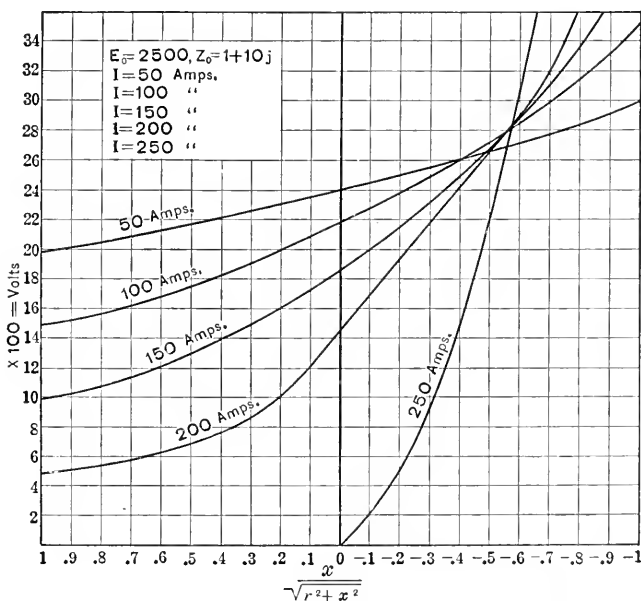

FIG. 138.—Regulation of alternator on various loads.

reactance, x_0 , of the alternator is very large compared with the external resistance, r ,
current

$$I = \frac{E_0}{x_0} \frac{1}{\sqrt{1 + \left(\frac{r_0 + r}{x_0}\right)^2}} = \frac{E_0}{x_0},$$

approximately, or constant; or, if the external circuit contains the reactance, x ,

$$I = \frac{E_0}{x_0 + x} \frac{1}{\sqrt{1 + \left(\frac{r_0 + r}{x_0 + x}\right)^2}} = \frac{E_0}{x_0 + x},$$

approximately, or constant.

In this case, the terminal voltage of a non-inductive circuit is

$$E = \frac{E_0}{x_0} r,$$

approximately proportional to the external resistance. In an inductive circuit,

$$E = \frac{E_0}{x_0 + x} \sqrt{r^2 + x^2},$$

approximately proportional to the external impedance.

191. That is, on a non-inductive external circuit, an alternator with very low synchronous reactance regulates for constant-terminal voltage, as a constant-potential machine, an alternator with a very high synchronous reactance regulates for a terminal voltage proportional to the external resistance as a constant-current machine.

Thus, every alternator acts as a constant-potential machine near open-circuit, and as a constant-current machine near short-circuit. Between these conditions, there is a range where the alternator regulates approximately as a constant-power machine, that is, current and e.m.f. vary in inverse proportion, as between 130 and 200 amp. in Fig. 132.

The modern alternators are generally more or less machines of the first class; the old alternators, as built by Jablockhoff, Gramme, etc., were machines of the second class, used for arc lighting, where constant-current regulation is an advantage.

Very high-power steam-turbine alternators are now again built with fairly high reactance, for reasons of safety.

Obviously, large external reactances cause the same regula-

tion for constant current independently of the resistance, r , as a large internal reactance, x_0 .

On non-inductive circuit, if

$$I = \frac{E_0}{\sqrt{(r + r_0)^2 + x_0^2}},$$

and

$$E = \frac{E_0 r}{\sqrt{(r + r_0)^2 + x_0^2}},$$

the output is

$$P = IE = \frac{E_0^2 r}{(r + r_0)^2 + x_0^2};$$

and

$$\frac{dP}{dr} = \frac{x_0^2 - r^2 + r_0^2}{\{(r + r_0)^2 + x_0^2\}^2} E_0^2;$$

Hence, if

$$x_0 = \sqrt{r^2 - r_0^2},$$

or

$$r = \sqrt{r_0^2 + x_0^2} = z_0;$$

$$\frac{dP}{dr} = 0.$$

the power is a maximum, and

$$P = \frac{E_0^2}{2 \{z_0 + r_0\}}.$$

$$E = \frac{E_0}{\sqrt{2 \left\{ 1 + \frac{r_0}{z_0} \right\}}}.$$

and

$$I = \frac{E_0}{\sqrt{2 z_0 \{z_0 + r_0\}}}.$$

Therefore, with an external resistance equal to the internal impedance, or, $r = z_0 = \sqrt{r_0^2 + x_0^2}$, the output of an alternator is a maximum, and near this point it regulates for constant output; that is, an increase of current causes a proportional decrease of terminal voltage, and inversely.

The field characteristic of the alternator shows this effect plainly.

CHAPTER XXII

ARMATURE REACTIONS OF ALTERNATORS

192. The change of the terminal voltage of an alternating current generator, resulting from a change of load at constant field excitation, is due to the combined effect of armature reaction and armature self-induction. The counter m.m.f. of the armature current, or armature reaction, combines with the impressed m.m.f. or field excitation to the resultant m.m.f., which produces the resultant magnetic field in the field poles and generates in the armature an e.m.f. called the "virtual generated e.m.f.," since it has no actual existence, but is merely a mathematical fiction. The counter e.m.f. of self-induction of the armature current, that is, e.m.f. generated by the armature current by a local magnetic flux, combines with the virtual generated e.m.f. to the actual generated e.m.f. of the armature, which corresponds to the magnetic flux in the armature core. This combined with the e.m.f. consumed by the armature resistance gives the terminal voltage.

In most cases the effect of armature reaction and of self-induction are the same in character, and so both effects usually are contracted in one constant; for purposes of design, frequently the self-induction is represented by an increase of the armature reaction, that is, an effective armature reaction used which combines the effect of the true armature reaction and the armature self-induction. That is, instead of the counter e.m.f. of self-induction, a counter m.m.f. is used, which would produce the magnetic flux which would generate the e.m.f. of self-induction. For theoretical investigations usually the armature reaction is represented by an effective self-induction, that is, instead of the counter m.m.f. of the armature reaction, the e.m.f. considered, which would be generated by the magnetic flux, which the armature reaction would produce. That is, both effects are combined in an effective reactance, the "synchronous reactance."

While armature reaction and self-inductance are similar in

effect, in some cases they differ in their action; the e.m.f. of self-inductance is instantaneous, that is, appears and disappears with the current to which it is due. The effect of the armature reaction, however, requires time; the change of the magnetic field resulting from the combination of the counter m.m.f. of armature reaction with the impressed m.m.f. of field excitation occurs gradually, since the magnetic field flux interlinks with the field winding, and any sudden change of the field generates an e.m.f. in the field circuit, which temporarily increases or decreases the field current, and so retards the change of the field flux. So, for instance, a sudden increase of load results in a simultaneous increase of the counter e.m.f. of self-induction and counter m.m.f. of armature reaction. With the armature reaction demagnetizing the field, the field flux begins to decrease, and thus generates an e.m.f. in the field-exciting circuit, which increases the field current and retards the decrease of field flux, so that the field flux adjusts itself only gradually to the change of circuit conditions, at a rate of speed depending upon the constants of the field-exciting circuit, etc.

The extreme case hereof takes place when suddenly short-circuiting an alternator; at the first moment the short-circuit current is limited only by the self-inductance, and the magnetic field still has full strength, the field-exciting current has greatly increased by the e.m.f. generated in the field circuit by the armature reaction. Gradually the field-exciting current and therewith the field magnetism die down to the values corresponding to the short-circuit condition. Thus the momentary short-circuit current of an alternator is far greater than the permanent short-circuit current; many times in a machine of low self-induction and high armature reaction, as a low-frequency, high-speed alternator of large capacity; relatively little in a machine of low armature reaction and high self-induction, as a high-frequency unitooth alternator.

193. Graphically, the internal reactions of the alternating-current generator can be represented as follows:

Let the impressed m.m.f., or field excitation, F_0 , be represented by the vector \overline{OF}_0 , in Fig. 139, chosen for convenience as vertical axis. Let the armature current, I , be represented by vector \overline{OI} . This current, I , gives armature reaction $F_1 = nI$, where n = number of effective turns of the armature, and is represented by the vector, \overline{OF}_1 , with the two quadrature components,

$\overline{OF''_1}$, in line with the field m.m.f., $\overline{OF'_0}$ —and usually opposite thereto—and $\overline{OF''}$, in quadrature with $\overline{OF'_0}$.

$\overline{OF'_0}$ combined with $\overline{OF_1}$ gives the resultant m.m.f., \overline{OF} , with the quadrature components, $\overline{OF'} = \overline{OF'_0} - \overline{OF''_1}$, and $\overline{OF''}$.

The m.m.f., \overline{OF} , produces a magnetic flux, $\overline{O\Phi}$, and this generates an e.m.f., $\overline{OE_2}$, in the armature circuit, 90° behind \overline{OF} in phase, the virtual generated e.m.f.

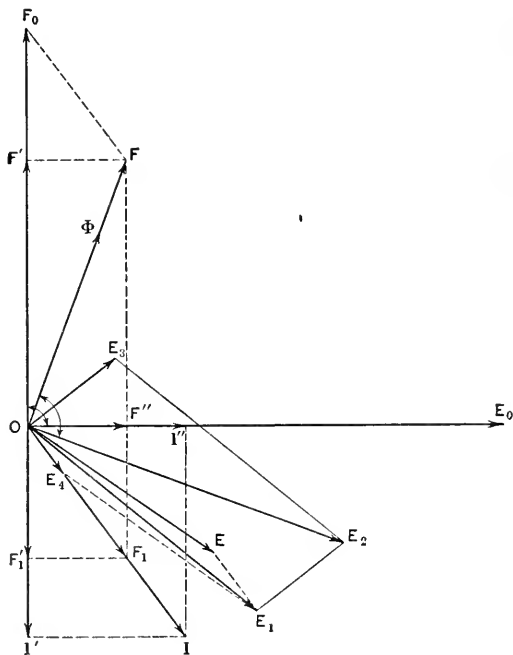

FIG. 139.

The armature self-induction consumes an e.m.f., $\overline{OE_3}$, 90° ahead of the current, thus, subtracted vectorially from $\overline{OE_2}$, gives the actual generated e.m.f., $\overline{OE_1}$.

The armature resistance, r , consumes an e.m.f., $\overline{OE_4}$, in phase with the current, which subtracts vectorially from the actual generated e.m.f., and thus gives the terminal voltage, \overline{OE} .

194. Analytically, these reactions are best calculated by the symbolic method.

Let the impressed m.m.f., or field-excitation, F_0 , be chosen as the imaginary axis, hence represented by

$$F_0 = +jf_0 \tag{1}$$

Let

$$I = i_1 - ji_2 = \text{armature current.} \tag{2}$$

The m.m.f. of the armature then is

$$F_1 = nI = n(i_1 - ji_2) \tag{3}$$

where

$$n = \text{number of effective armature turns,}$$

and the resultant m.m.f. then is

$$F = F_0 + F_1 = j(f_0 - ni_2) + ni_1. \tag{4}$$

If, then,

\mathcal{O} = magnetic permeance of the structure, that is, magnetic flux divided by the ampere-turns m.m.f. producing it,

$$\mathcal{O} = \frac{\Phi}{F}, \text{ or, } \Phi = \mathcal{O}F = j\mathcal{O}(f_0 - ni_2) + \mathcal{O}ni_1. \tag{5}$$

The e.m.f. generated by the magnetic flux Φ in the armature is

$$e_2 = 2\pi fn\Phi 10^{-8}, \tag{6}$$

where f = frequency.

Denoting $2\pi fn 10^{-8}$ by a we have, $\tag{7}$

$$e_2 = a\Phi \tag{8}$$

and since the generated e.m.f. is 90° behind the generating flux, in symbolic expression,

$$E_2 = -ja\Phi; \tag{9}$$

hence, substituting (5) in (9),

$$E_2 = a\mathcal{O}(f_0 - ni_2) - ja\mathcal{O}ni_1, \tag{10}$$

the *virtual generated e.m.f.*

The e.m.f. consumed by the self-inductive reactance of the armature circuit is,

$$E_3 = jxI = jxi_1 + xi_2; \tag{11}$$

and therefore, the *actual generated e.m.f.*

$$\begin{aligned} E_1 &= E_2 - E_3 \\ &= \{a\mathcal{O}f_0 - (a\mathcal{O}n + x)i_2\} - ji_1(a\mathcal{O}n + x). \end{aligned} \tag{12}$$

The e.m.f. consumed by the armature resistance, r , is

$$E_4 = rI = ri_1 - jri_2;$$

hence, the *terminal voltage*,

$$\begin{aligned} E &= E_1 - E_4 \\ &= \{a\phi f_0 - (a\phi n + x)i_2 - ri_1\} - j\{i_1(a\phi n + x) - ri_2\}. \end{aligned} \quad (14)$$

195. It is

$f_0 =$ field m.m.f.; hence

$\Phi_0 = \phi f_0 =$ magnetic flux, which would be produced by the field excitation, f_0 , if the magnetic permeance at this m.m.f., f_0 , were the same, ϕ , as at the m.m.f., F —that is, if the magnetic characteristic would not bend between f_0 and F , due to magnetic saturation, or in other words, when neglecting saturation, and therefore $e_0 = a\phi f_0$ (15) = e.m.f. generated in the armature by the field excitation, when neglecting magnetic saturation, or assuming a straight line saturation curve.

e_0 is called the “*nominal generated e.m.f.* of the machine.”

$ni =$ armature m.m.f.; therefore,

$\phi ni =$ magnetic flux produced thereby, and,

$a\phi ni =$ e.m.f. generated in the armature by the magnetic flux of armature reaction, hence,

$$a\phi n = x_1$$

= effective reactance, representing the armature reaction,

and $x_0 = a\phi n + x$ (16)

= synchronous reactance, that is, the effective reactance representing the combined effect of armature self-induction and armature reaction.

Substituting (15) and (16) in (14) gives,

$$E = (e_0 - x_0i_2 - ri_1) - j(x_0i_1 - ri_2) \quad (17)$$

It follows herefrom:

In an alternating-current generator, the combined effect of armature reaction and self-induction can be represented by an effective reactance, the *synchronous reactance*, x_0 , which consists of the two components:

$$x_0 = x + x_1 \quad (18)$$

where,

$x =$ true self-inductive reactance of the armature circuit.

$x_1 = a\phi n =$ effective reactance of armature reaction, (19)

and the *nominal generated e.m.f.*,

$$e_0 = a\mathcal{P}f_0; \tag{15}$$

where,

$$\begin{aligned} n &= \text{number of armature turns, effective,} \\ f_0 &= \text{field excitation, in ampere-turns,} \\ a &= 2\pi fn10^{-8}. \end{aligned} \tag{7}$$

\mathcal{P} = magnetic permeance of the field structure at a magnetic flux in the field-poles corresponding to the virtual generated e.m.f., E_2 .

The introduction of the term “synchronous reactance,” x_0 , and “nominal generated e.m.f.,” e_0 , is hereby justified, when dealing with the permanent condition of the electric circuit. The case of the transient phenomena of momentary short-circuit currents, etc., is discussed in a chapter on “Transient Phenomena and Oscillations,” section I.

It must be understood that the “nominal generated e.m.f.,” e_0 , in an actual machine, in which the magnetic characteristic bends due to the approach to magnetic saturation, is not the voltage generated by the field excitation f_0 at open-circuit, but is the voltage which would be generated, if at excitation, f_0 , the magnetic permeance, $\mathcal{P} = \frac{\Phi}{F}$ were the same as at the actual flux existing in the machine—that is, if the magnetic characteristic would continue in a straight line passing through the origin when prolonged.

The equation (17) may also be written

$$E = e_0 - Z_0I; \tag{20}$$

where,

$Z_0 = r + jx_0$ = synchronous impedance of the alternator.

$$I = i_1 - ji_2,$$

or, more generally

$$E = E_0 - Z_0I, \tag{22}$$

and so is the equation of a circuit, supplied by the e.m.f., E_0 , with the current, I , over the impedance, Z_0 , as has been discussed in the chapter on resistance, inductive reactance and condensive reactance.

An alternator so is equivalent to an e.m.f., E_0 , the nominal generated e.m.f., supplying current over an impedance, Z_0 , the synchronous impedance.

196. In theoretical investigations of alternators, the synchronous reactance, x_0 , is usually assumed as constant, and has been assumed so in the preceding.

In reality, however, this is not exactly, and frequently not even approximately correct, but the synchronous reactance is different in different positions of the armature with regard to the field. Since the relative position of the armature to the field varies with the armature current, and with the phase angle of the armature current, the regulation curve of the alternator, and other characteristic curves, when calculated under the assumption of constant synchronous reactance, may differ considerably from the observed curves, in machines in which the synchronous reactance varies with the position of the armature.

The two components of the synchronous reactance are the self-inductive reactance, and the effective reactance of armature reaction. The self-inductive reactance represents the e.m.f. generated in the armature by the local field produced in the armature by the armature current. The magnetic reluctance of the self-inductive field of the armature coil, however, is, in general, different when this coil stands in front of a field-pole, and when it stands midway between two field-poles, and the self-inductive reactance so periodically varies, between two extreme values, representing respectively the positions of the armature coils in front of, and midway between the field-poles, that is, pulsates with double frequency, between a value, x' , corresponding to the position in front, and a value, x'' , corresponding to a position midway between the field-poles. Depending upon the structure of the machine, as the angle of the pole arc, that is, the angle covered by the pole face, either x' or x'' may be the larger one.

The effective reactance of armature reaction, x_1 , corresponds to the magnetic flux, which the armature would produce in the field-circuit. With the armature coil facing the field-pole, that is, in a nearly closed magnetic field-current, x_1 , therefore is usually far greater than with the armature coil facing midway between the field-poles, in a more or less open magnetic circuit. Hence, x_1 , also varies between two extreme values, x_1' and x_1'' , corresponding respectively to the position in line with, and in

quadrature with, the field-poles. In this case, usually x_1' is larger than x_1'' .

Since $x_1 = a\phi n$, where ϕ = magnetic permeance, ϕ varies between ϕ' , corresponding to the position of the armature coil opposite the field-poles, and ϕ'' , corresponding to the position of the armature coil midway between the field-poles. Usually ϕ' is far larger.

This means that the two components of the resultant m.m.f. F : F_1' , in line with, and F'' in quadrature with, the field-poles, act upon magnetic circuits of very different permeance, ϕ' and ϕ'' , and the components of magnetic flux, due to F' and F'' respectively, are

$$\begin{aligned}\Phi' &= \phi'F' \\ \Phi'' &= \phi''F''.\end{aligned}$$

The two components of magnetic flux, Φ' and Φ'' , therefore are in general, not proportional to their respective m.m.f.s. F' and F'' , and the resultant flux, Φ , accordingly is not in line with the resultant m.m.f., F , but differs therefrom in direction, being usually nearer to the center line of the field-poles. That is, the resultant magnetic flux, Φ , is more nearly in line with the impressed m.m.f. of field excitation, F_0 , than the resultant m.m.f., F , is—or in other words—the magnetic flux is shifted by the armature reaction less than the resultant m.m.f. is shifted.

197. To consider, in the investigation of the armature reactions of an alternator, the difference of the magnetic reluctance of the structure in the different directions with regard to the field, that is, the effect of the polar construction of the field, or the use of definite polar projections in the magnetic field, the reactions of the machine must be resolved into two components, one in line and the other in quadrature with the center line of the field-poles, or the direction of the impressed m.m.f. or field-excitation, F_0 .

Denoting then the components in line with the field-poles or parallel with the field-excitation, F_0 , by *prime*, as I' , F' , etc., and the components facing midway between the field-poles, or in quadrature position with the field-excitation, F_0 , by *second*, as I'' , F'' , the diagram of the alternator reactions is modified from that given in Fig. 139.

Choosing again, in Fig. 140, the impressed m.m.f. or field-excitation, F_0 , as vertical vector \overline{OF}_0 , the current, \overline{OI} , consists

of the component, $\overline{OI'}$, in line with F_0 , or vertical, and $\overline{OI''}$ in quadrature with F_0 , or horizontal. The armature reaction, $\overline{OF_1}$, gives the components, $\overline{OF_1'}$ and $\overline{OF_1''}$, and the resultant m.m.f. therefore consists of two components, $\overline{OF''} = \overline{OF_0} - \overline{OF_1'}$, and $\overline{OF_1''} = \overline{OF_1''}$.

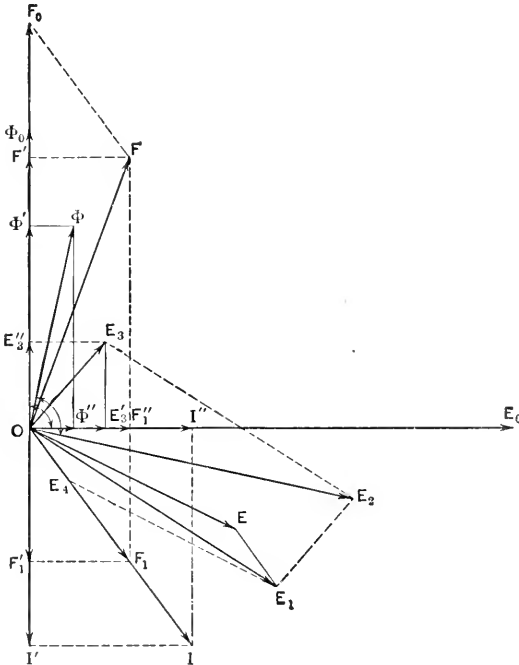

FIG. 140.

Let now

$$\mathcal{P}' = \text{permeance of the field magnetic circuit}; \tag{23}$$

$$\mathcal{P}'' = \text{permeance of the magnetic circuit through the armature in quadrature position to the field-poles}; \tag{24}$$

the components of the resultant magnetic flux are,

$$\Phi' = \mathcal{P}'F', \text{ represented by } \overline{O\Phi'}; \text{ and } \Phi'' = \mathcal{P}''F'', \text{ represented by } \overline{O\Phi''},$$

and the resultant magnetic flux, by combination of $\overline{O\Phi'}$ and $\overline{O\Phi''}$, is $\overline{O\Phi}$, and is not in line with \overline{OF} , but differs therefrom, being usually nearer to $\overline{OF_0}$.

The virtual generated e.m.f. is

$$E_2 = a\Phi,$$

and represented by \overline{OE}_2 , 90° behind $O\Phi$.

Let now

x' = self-inductive reactance of the armature when facing the field-poles, and thus corresponding to the component, I' , of the current, (25)

and

x'' = self-inductive reactance of the armature when facing midway between the field-poles, and thus corresponding to the component, I'' , of the current. (26)

Then

$E'_3 = x'I' =$ e.m.f. consumed by the self-induction of the current component, I' ,

and

$E''_3 = x''I'' =$ e.m.f. consumed by the self-induction of the current component, I'' .

E'_3 is represented by vector \overline{OE}'_3 , 90° ahead of \overline{OI}' , and E''_3 is represented by vector \overline{OE}''_3 , 90° ahead of \overline{OI}'' . The resultant e.m.f. of self-induction then is given by the combination of \overline{OE}'_3 and \overline{OE}''_3 , as \overline{OE}_3 . It is not 90° ahead of \overline{OI} , but either more or less. In the former case, the self-induction consumes power, in the latter case, it produces power. That is, in such an armature revolving in the structure of non-uniform reluctance, the e.m.f. of self-induction is not wattless, but may represent consumption, or production of power, as "reaction machine." (See "Calculation of Electrical Apparatus.")

Subtracting vectorially \overline{OE}_3 from the virtual generated e.m.f. \overline{OE}_2 , gives the actual generated e.m.f., \overline{OE}_1 , and subtracting therefrom the e.m.f. consumed by the armature resistance, \overline{OE}_4 , in phase with the current, \overline{OI} , gives the terminal voltage, \overline{OE} .

198. Here the diagram has been constructed graphically, by starting with the field-excitation, F_0 , the armature current, I , and the phase angle between the armature current, I , and the field-excitation, F_0 —that is, the angle between the position in which the armature current reaches its maximum, and the direction of the field-poles. This angle, however, is unknown. Usually the terminal voltage, \overline{OE} , the current, \overline{OI} , and the angle,

EOI , between current and terminal voltage are given. From these latter quantities, however, the diagram cannot be constructed, since the position of the field-excitation, F_0 , and so the directions, in which the electric quantities have to be resolved into components, are still unknown, when starting the construction of the diagram.

That is, as usually, the graphical representation affords an

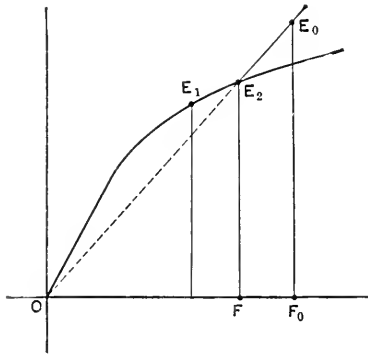

FIG. 141.

insight into the inner relations of the phenomena, but not a method for their numerical calculations, and for the latter purpose, the symbolic method is required.

Let

E_0 = nominal generated e.m.f., or e.m.f. corresponding to the field-excitation, F_0 , on a straight line continuation of the magnetic characteristic from the actual value of the field onward

—as shown by Fig. 141.

The impressed m.m.f., or field excitation, is then given by

$$jF_0. \tag{27}$$

Let

$$I = I' + I'' = \text{armature current}, \tag{28}$$

where the component, I' , is in line, the component, I'' , in quadrature with: jF_0 .

If n = number of effective armature turns, the m.m.f. of the armature current, I , or the armature reaction, then is

$$F_1 = nI, \tag{29}$$

with its components, in phase and in quadrature with the field;

$$\left. \begin{aligned} F_1' &= nI', \\ F_1'' &= nI''; \end{aligned} \right\} \tag{30}$$

and the components of the resultant m.m.f. then are

$$\left. \begin{aligned} F' &= jF_0 + nI', \\ F'' &= nI''; \end{aligned} \right\} \tag{31}$$

and the resultant

$$F = jF_0 + nI' + nI'' \quad (32)$$

The components of the magnetic flux, in line and in quadrature with jF_0 , then are

$$\begin{aligned} \Phi' &= \mathcal{O}'F' \\ &= \mathcal{O}'(jF_0 + nI'); \end{aligned} \quad (33)$$

$$\begin{aligned} \Phi'' &= \mathcal{O}''F'' \\ &= \mathcal{O}''nI''; \end{aligned} \quad (34)$$

hence, the resultant magnetic flux

$$\begin{aligned} \Phi &= \Phi' + \Phi'' \\ &= \mathcal{O}'(jF_0 + nI') + \mathcal{O}''nI'' \end{aligned} \quad (35)$$

The e.m.f. generated by this magnetic flux, Φ , or the virtual generated e.m.f. is

$$\begin{aligned} E_2 &= -ja\Phi \\ &= -a\mathcal{O}'(F_0 + jnI') + -ja\mathcal{O}''nI''. \end{aligned} \quad (36)$$

The e.m.f. consumed by the self-inductive reactance, x' , of the current component, I' , is,

$$E'_3 = jx'I', \quad (37)$$

the e.m.f. consumed by the self-inductive reactance, x'' , of the current component, I'' , is

$$E''_3 = jx''I'', \quad (38)$$

and the total e.m.f. consumed by self-induction thus is

$$E_3 = j(x'I' + x''I''); \quad (39)$$

hence, the actual generated e.m.f.

$$\begin{aligned} E_1 &= E_2 - E_3 \\ &= a\mathcal{O}'F_0 - jI'(a\mathcal{O}'n + x') - jI''(a\mathcal{O}''n + x''). \end{aligned} \quad (40)$$

The e.m.f. consumed by the resistance, r , is

$$\begin{aligned} E_4 &= rI \\ &= rI' + rI''; \end{aligned} \quad (41)$$

hence, the terminal voltage of the machine is

$$\begin{aligned} E &= E_1 - E_4 \\ &= a\mathcal{O}'F_0 - I' \{r + j(a\mathcal{O}'n + x')\} - I'' \{r + j(a\mathcal{O}''n + x'')\}. \end{aligned} \quad (42)$$

In this equation of the terminal voltage,

$$\left. \begin{aligned} x'_0 &= a\mathcal{O}'n + x', \\ x''_0 &= a\mathcal{O}''n + x'', \end{aligned} \right\} \quad (43)$$

are effective reactances, corresponding to the two quadrature positions; that is

x'_0 = synchronous reactance corresponding to the position of the armature circuit parallel to the field circuit; (44a)

x''_0 = synchronous reactance corresponding to the position of the armature circuit in quadrature with the field circuit; (44b)

$a\mathcal{O}'F_0$ is the e.m.f. which would be generated by the field excitation, F_0 , with the permeance, \mathcal{O}' , in the direction in which the field excitation, F_0 , acts, that is

$$E_0 = a\mathcal{O}'F_0 = \textit{nominal generated e.m.f.} \quad (45)$$

and it is: *terminal voltage*,

$$E = E_0 - I'(r + jx'_0) - I''(r + jx''_0). \quad (46)$$

That is, even with an heteroform structure, as a machine with definite polar projections, the armature reaction and armature self-induction can be combined by the introduction of the terms "nominal generated e.m.f." and "synchronous reactance," as defined above, except that in this case the synchronous reactance, x_0 , has two different values, x'_0 and x''_0 , corresponding respectively to the two main axes of the magnetic structure, in line and in quadrature with the field-poles.

199. In the equation (46), E , E_0 , I' and I'' are complex quantities, and

I'' is in phase with E_0 ,

I' is in quadrature behind E_0 , and so behind I'' ;

hence, I' can be represented by

$$I' = -jtI'', \quad (47)$$

where $t =$ ratio of numerical values of I'' and I' , that is

$$t = \frac{I''}{I'} = \tan \theta \tag{48}$$

and

$\theta =$ angle of lag of current, I , behind nominal generated e.m.f., E_0 . Then

$$I = I' + I'' = I'(1 - jt), \tag{49}$$

or

$$I'' = \frac{\dot{I}}{1 - jt} \text{ and } I' = \frac{j\dot{I}}{1 + jt}. \tag{50}$$

Substituting these values (50) in equation (46) gives

$$E = E_0 - \frac{\dot{I}}{1 - jt} \{ (r + jr''_0) - jt(r + jx'_0) \}. \tag{51}$$

In this equation, E_0 leads I by angle θ .

Hence, choosing the current, I , as zero vector,

$$I = i, \tag{52}$$

the e.m.f., E_0 , which leads i by angle, θ , can be represented by

$$E_0 = e_0(\cos \theta + j \sin \theta), \tag{53}$$

or, since by equation (48),

$$\sin \theta = \frac{t}{\sqrt{1 + t^2}} \text{ and } \cos \theta = \frac{1}{\sqrt{1 + t^2}}, \tag{54}$$

$$E_0 = \frac{e_0}{\sqrt{1 + t^2}} (1 + jt) \frac{e_0 \sqrt{1 + t^2}}{1 - jt}. \tag{55}$$

Substituting (52) and (55) in equation (51), gives

$$E = \frac{e_0 \sqrt{1 + t^2} - i \{ (r + jx''_0) - jt(r + jx'_0) \}}{1 - jt}. \tag{56}$$

Let

$$E = e_1 + je_2, \tag{57}$$

where

$$\frac{e_2}{e_1} = \tan \theta', \tag{58}$$

and

$$\theta' = \text{angle of lag of current, } i, \text{ behind terminal voltage, } E, \tag{59}$$

substituting (57) in (56) and transposing,

$$e_0 \sqrt{1+t^2} - (e_1 + je_2)(1-jt) - i \{ (r+jx''_0) - jt(r+jx'_0) \} = 0, \quad (60)$$

or, expanded,

$$\{ e_0 \sqrt{1+t^2} - e_1 - te_2 - i(r+tx'_0) \} + j \{ te_1 - e_2 + i(tr-x''_0) \} = 0. \quad (61)$$

As the left side is a complex quantity, and equals zero, the real part as well as the imaginary part must be zero, and equation (61) so resolves into the two equations

$$e_0 \sqrt{1+t^2} - e_1 - te_2 - i(r+tx'_0) = 0, \quad (62)$$

$$te_1 - e_2 + i(tr-x''_0) = 0. \quad (63)$$

From equation (63) follows

$$t = \frac{e_2 + x''_0 i}{e_1 + r i}. \quad (64)$$

Substituting (64) in (62), and expanding, gives

$$e_0 = \frac{(e_1 + r i)^2 + (e_2 + x''_0 i)(e_2 + x''_0 i)}{\sqrt{(e_1 + r i)^2 + (e_2 + x''_0 i)^2}} \quad (65)$$

That is, if

$$\left. \begin{aligned} x'_0 &= \text{synchronous reactance in the direction of the field-} \\ &\quad \text{excitation,} \\ x''_0 &= \text{synchronous reactance in quadrature with the} \\ &\quad \text{field excitation,} \\ r &= \text{armature resistance,} \end{aligned} \right\} \quad (66)$$

$$\left. \begin{aligned} i &= \text{armature current,} \\ E &= e_1 + je_2 = e(\cos \theta' + j \sin \theta') = \text{terminal voltage,} \\ &\quad \text{that is,} \\ \tan \theta' &= \frac{e_2}{e_1} = \text{angle of lag of current } i \text{ behind terminal} \\ &\quad \text{voltage, } e, \end{aligned} \right\} \quad (67)$$

the nominal generated e.m.f. of the machine is

$$\begin{aligned} e_0 &= \frac{(e_1 + r i)^2 + (e_2 + x''_0 i)(e_2 + x''_0 i)}{\sqrt{(e_1 + r i)^2 + (e_2 + x''_0 i)^2}} \\ &= \frac{(e \cos \theta' + r i)^2 + (e \sin \theta' + x''_0 i)(e \sin \theta' + x''_0 i)}{\sqrt{(e \cos \theta' + r i)^2 + (e \sin \theta' + x''_0 i)^2}} \end{aligned} \quad (68)$$

and the field excitation, f_0 , required to give terminal voltage, e , at current, i , and angle of lag, θ' , is, therefore

$$f_0 = \frac{e_0}{a\phi'n} = \frac{e_0 10^8}{2\pi f n^2 \phi'} \quad (69)$$

and the position angle, θ , between the field-excitation, f_0 , and the armature current, i , that is, between the direction of the field-poles and the direction in which the armature current reaches its maximum, is

$$\tan \theta = t = \frac{e_2 + x''_0 i}{e_1 + ri} = \frac{e \sin \theta' + x''_0 i}{e \cos \theta' + ri} \quad (70)$$

200. At non-inductive load,

$$e_1 = e \text{ and } e_2 = 0 \quad (71)$$

from (68),

$$e_0 = \frac{(e + ri)^2 + x_0' x''_0 i^2}{\sqrt{(e + ri)^2 + x''_0 i^2}} \quad (72)$$

If

$$x'_0 = x''_0 = x_0, \quad (73)$$

that is, the synchronous reactance of the machine is constant in all positions of the armature, or in other words, the magnetic permeance, ϕ , and the self-inductive reactance, x , do not vary with the position of the armature in the field, equation (68) assumes the form

$$e_0 = \sqrt{(e_1 + ri)^2 + (e_2 + x_0 i)^2}, \quad (74)$$

and this is the absolute value of the equation (22)

$$E_0 = E + Z_0 I, \quad (22)$$

derived in §195 for the case of uniform synchronous impedance.

Substituting in (22),

$$I = i, \text{ and } E = e_1 + j e_2,$$

and expanding, gives

$$\begin{aligned} E_0 &= (e_1 + j e_2) + i(r + j x_0) \\ &= (e_1 + ri) + j(e_2 + x_0 i); \end{aligned}$$

thus, the absolute value,

$$e_0^2 = (e_1 + ri)^2 + (e_2 + x_0 i)^2. \quad (74)$$

201. At short-circuit, and approximately, near short-circuit,

$$e_1 = 0 \text{ and } e_2 = 0, \tag{75}$$

equation (68) assumes the form

$$e_0 = \frac{r^2 + x'_0 x''_0}{\sqrt{r^2 + x_0''^2}} i_0, \tag{76}$$

or the short-circuit current,

$$i_0 = \frac{e_0 \sqrt{r^2 + x_0''^2}}{r^2 + x'_0 x''_0}. \tag{77}$$

Since x'_0 and x''_0 usually are large, compared with r , r can be neglected in equation (77), and (77) so assumes the form

$$i_0 = \frac{e_0}{x'_0}, \tag{78}$$

that is, the short-circuit current of an alternator,

$$i_0 = \frac{e_0}{x'_0},$$

depends only upon the synchronous reactance of the armature in the direction of the field-excitation, x'_0 , but not upon the synchronous reactance of the armature in quadrature position to the field-excitation, x''_0 .

Near open-circuit, that is, in the range where the machine regulates approximately for constant potential, and ix_0 and especially ir are small compared with e , we have, for non-inductive load, from equation (72),

$$\begin{aligned} e_0 &= \frac{(e + ri)^2 + x'_0 x''_0 i^2}{\sqrt{(e + ri)^2 + x_0''^2 i^2}} \\ &= (e + ri) \frac{1 + \frac{x'_0 x''_0 i^2}{(e + ri)^2}}{\sqrt{1 + \frac{x_0''^2 i^2}{(e + ri)^2}}}, \end{aligned}$$

or, approximately,

$$e_0 = (e + ri) \left(1 + \frac{x'_0 x''_0 i^2}{e^2} \right) \left(1 + \left(\frac{x'_0 i}{e} \right)^2 \right)^{-\frac{1}{2}};$$

hence, expanded by the binomial series,

$$e_0 = (e + ri) \left(1 + \frac{x'_0 x''_0 i^2}{e^2} \right) \left(1 - \frac{1}{2} \left(\frac{x'_0 i}{e} \right)^2 - + \dots \right),$$

and, dropping terms of higher order,

$$e_0 = e + ri + \frac{x'_0 x''_0 i^2}{e} - \frac{x''_0{}^2 i^2}{2e},$$

or,

$$e_0 = e + ri + \frac{x'_0(2x'_0 - x''_0)}{2} \frac{i^2}{e} \quad (79)$$

For $x'_0 = x''_0 = x_0$, this equation (79) assumes the usual form,

$$e_0 = e + ri + \frac{x_0^2}{2} \frac{i^2}{e}. \quad (80)$$

In the range near open-circuit, for non-inductive load, the regulation of the machine accordingly depends not upon the synchronous reactance, x'_0 , nor upon x''_0 , but upon the equivalent synchronous reactance,

$$x'''_0 = \sqrt{x''_0(2x'_0 - x''_0)}. \quad (81)$$

That is, in an alternator with non-uniform synchronous reactance, the short-circuit current and the regulation of the machine near short-circuit, depend upon the value of the synchronous reactance, corresponding to the position of the armature coils parallel, or coaxial with the field-poles, x'_0 , while the regulation of the machine for non-inductive load, in the range where the machine tends to regulate for approximately constant potential, that is, near open-circuit, depends upon the value of the synchronous reactance, $x'''_0 = \sqrt{x''_0(2x'_0 - x''_0)}$, where x'_0 and x''_0 are the two quadrature components of the synchronous reactance.

That is, the regulation of such an alternator of variable synchronous reactance cannot be calculated from open-circuit test and short-circuit test, or from the magnetic characteristic of the machine at open-circuit, or nominal generated e.m.f., and the synchronous reactance, as given by the machine at short-circuit.

For instance, if

$$x'_0 = 10 \text{ and } x''_0 = 4,$$

the effective synchronous reactance near short-circuit,

$$x'_0 = 10;$$

and the effective synchronous reactance near open-circuit,

$$x'''_0 = 8.$$

The regulation for non-inductive load thus is better than corresponds to the short-circuit impedance.

From equation (68), by solving for the terminal voltage, e , the variation of the terminal voltage, e , with change of load, i , at constant field-excitation, f_0 , and so constant nominal generated e.m.f., e_0 , that is, the regulation curve of the machine, is calculated.

For instance, for non-inductive load, or $\theta' = 0$, equation (68), solved for e , gives

$$e = \sqrt{\frac{e_0^2}{2} - x'_0 x''_0 i^2 + e_0 \sqrt{\frac{e_0^2}{4} + x_0''^2 i^2 (x''_0 - x'_1)^2 - ri}} \quad (82)$$

202. As illustrations are shown, in Fig. 142, the regulation curves, with the terminal voltage, e , as ordinates, and the current, i , as abscissas, at constant field-excitation, that is, constant nominal generated e.m.f., e_0 , for the constants

$$\begin{aligned} e_0 &= 2500 \text{ volts;} & x'_0 &= 10 \text{ ohms;} \\ r &= 1 \text{ ohm;} & x''_0 &= 4 \text{ ohms;} \\ \text{for non-inductive load} & & E = e, & \quad (\text{Curve I.}) \end{aligned}$$

and for inductive load of 60 per cent. power-factor, $E = e(0.6 + 0.8j)$. (Curve II.)

For comparison are plotted in the same figure, in dotted lines, the regulation curves for constant synchronous reactance

$$x_0 = 10 \text{ ohms,}$$

that is, for the same open-circuit voltage and same short-circuit current.

As seen from Fig. 142, the difference between the two regulation curves, for variable and for constant synchronous reactance, is quite considerable at non-inductive load, but practically negligible at highly inductive load. This is to be expected, since at inductive load the armature current reaches its maximum nearly in opposition to the field-poles, and in this direction the synchronous reactance is the same, x'_0 , as at short-circuit.

In the preceding discussion of the alternator with variable synchronous reactance, e.m.f. and current are assumed as sine waves. The periodic variation of reactance produces, however, a distortion of wave-shape, consisting mainly of a third harmonic which superimposes on the fundamental, as discussed in Chapter XXV. The preceding, therefore, applies to the equivalent

sine wave, which represents approximately the actual distorted wave.

As the intensity, and the phase difference between the third harmonic and the fundamental changes with the load, in such

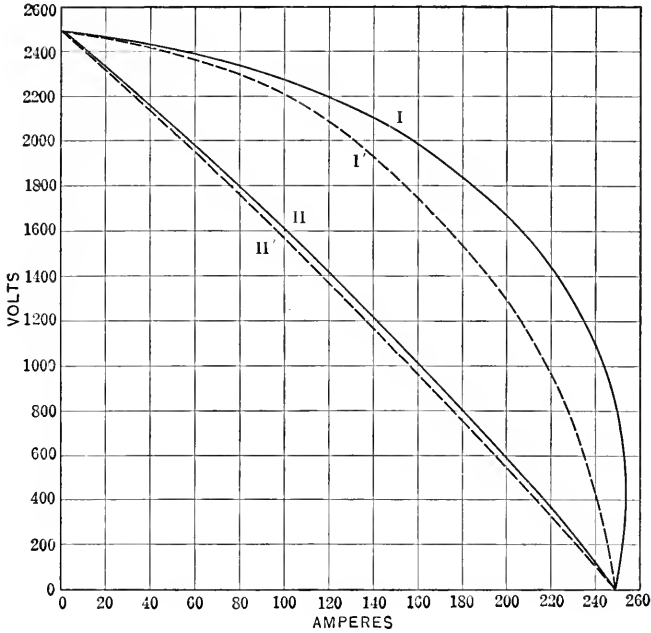

FIG. 142.

an alternator of pulsating synchronous reactance, the wave-shape of the machine changes more or less with the load and the character of the load.

CHAPTER XXIII

SYNCHRONIZING ALTERNATORS

203. All alternators, when brought to synchronism with each other, operate in parallel more or less satisfactorily. This is due to the reversibility of the alternating-current machine; that is, its ability to operate as synchronous motor. In consequence thereof, if the driving power of one of several parallel-operating generators is withdrawn, this generator will keep revolving in synchronism as a synchronous motor; and the power with which it tends to remain in synchronism is the maximum power which it can furnish as synchronous motor under the conditions of running.

204. The principal and foremost condition of parallel operation of alternators is equality of frequency; that is, the transmission of power from the prime movers to the alternators must be such as to allow them to run at the same frequency without slippage or excessive strains on the belts or transmission devices.

Rigid mechanical connection of the alternators cannot be considered as synchronizing, since it allows no flexibility or phase adjustment between the alternators, but makes them essentially one machine. If connected in parallel, a difference in the field-excitation, and thus the generated e.m.f. of the machines, may cause large cross-current, since it cannot be taken care of by phase adjustment of the machines.

Thus rigid mechanical connection is not desirable for parallel operation of alternators.

205. The second important condition of parallel operation is uniformity of speed; that is, constancy of frequency. If, for instance, two alternators are driven by independent single-cylinder engines, and the cranks of the engines happen to be crossed, the one engine will pull, while the other is near the dead-point, and conversely. Consequently, alternately the one alternator will tend to speed up and the other slow down, then the other speed up and the first slow down. This effect, if not taken care of by fly-wheel capacity, causes a "hunting" or surging

action; that is, a fluctuation of the voltage with the period of the engine revolution, due to the alternating transfer of the load from one engine to the other, which may even become so excessive as to throw the machines out of step, especially when by an approximate coincidence of the period of engine impulses (or a multiple thereof), with the natural period of oscillation of the revolving structure, the effect is made cumulative. This difficulty as a rule does not exist with turbine or water-wheel driving, but is specially severe with gas-engine drive, and special precautions are then often taken, by the use of a short-circuited squirrel cage winding in the field pole faces.

206. In synchronizing alternators, we have to distinguish the phenomena taking place when throwing the machines in parallel or out of parallel, and the phenomena when running in synchronism.

When connecting alternators in parallel, they are first brought approximately to the same frequency and same voltage; and then, at the moment of approximate equality of phase, as shown by a phase-lamp or other device, they are thrown in parallel.

Equality of voltage is less important with moderate size alternators than equality of frequency, and perfect equality of phase is usually of importance only in avoiding an instantaneous flickering of the light of lamps connected to the system. When two alternators are thrown together, currents exist between the machines, which accelerate the one and retard the other machine until equal frequency and proper phase relation are reached.

With modern ironclad alternators, this interchange of mechanical power is usually, even without very careful adjustment before synchronizing, sufficiently limited not to endanger the machines mechanically, since the cross-currents, and thus the interchange of power, are limited by self-induction and armature reaction.

In machines of very low armature-reaction, that is, machines of "very good constant-potential regulation," much greater care has to be exerted in the adjustment to equality of frequency, voltage, and phase, or the interchange of current may become so large as to destroy the machine by the mechanical shock; and sometimes the machines are so sensitive in this respect that it is difficult to operate them in parallel. The same applies in getting out of step.

207. When running in synchronism, nearly all types of machines will operate satisfactorily; a medium amount of armature

reaction is preferable, however, such as is given by modern alternators—not too high to reduce the synchronizing power too much, nor too low to make the machine unsafe in case of accident, such as falling out of step, etc.

If the armature reaction is very low, an accident—such as a short-circuit, falling out of step, opening of the field circuit, etc.—may destroy the machine. If the armature reaction is very high, the driving power has to be adjusted very carefully to constancy, since the synchronizing power of the alternators is too weak to hold them in step and carry them over irregularities of the driving-power.

208. Series operation of alternators is possible only by rigid mechanical connection, or by some means whereby the machines, with regard to their synchronizing power, act essentially in par-

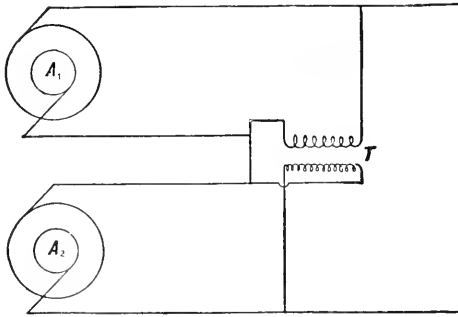

FIG. 143.

allel; as, for instance, by the arrangement shown in Fig. 143, where the two alternators, A_1 , A_2 , are connected in series, but interlinked by the two coils of a transformer, T , of which the one is connected across the terminals of one alternator and the other across the terminals of the other alternator in such a way that, when operating in series, the coils of the transformer will be without current. In this case, by interchange of power through the transformers, the series connection will be maintained stable.

209. In two parallel operating alternators, as shown in Fig. 144, let the voltage at the common busbars be assumed as zero line, or real axis of coördinates of the complex representation; and let

e = difference of potential at the common busbars of the two alternators;

$Z = r + jx =$ impedance of the external circuit;
 $Y = g - jb =$ admittance of the external circuit;

hence, the current in the external circuit is

$$I = \frac{e}{r + jx} = e(g - jb).$$

Let

$E_1 = e_1 + je'_1 = a_1(\cos \theta_1 + j \sin \theta_1) =$ generated e.m.f. of first machine;

$E_2 = e_2 + je'_2 = a_2(\cos \theta_2 + j \sin \theta_2) =$ generated e.m.f. of second machine;

$I_1 = i_1 - ji'_1 =$ current of the first machine;

$I_2 = i_2 - ji'_2 =$ current of the second machine;

$Z_1 = r_1 + jx_1 =$ internal impedance, and $Y_1 = g_1 - jb_1 =$ internal admittance of the first machine;

$Z_2 = r_2 + jx_2 =$ internal impedance, and $Y_2 = g_2 - jb_2 =$ internal admittance of the second machine.

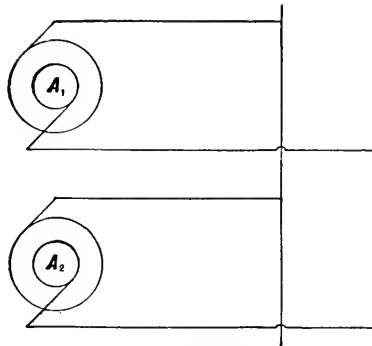

FIG. 144.

Then,

$$e_1^2 + e'_1{}^2 = a_1^2;$$

$$e_2^2 + e'_2{}^2 = a_2^2;$$

$E_1 = e + I_1Z_1$, or $e_1 + je'_1 = (e + i_1r_1 + i'_1x_1) + j(i_1x_1 - i'_1r_1)$;

$E_2 = e + I_2Z_2$, or $e_2 + je'_2 = (e + i_2r_2 + i'_2x_2) + j(i_2x_2 - i'_2r_2)$;

$I = I_1 + I_2$, or $eg - jeb = (i_1 + i_2) - j(i'_1 + i'_2)$.

This gives the equations:

$$e_1 = e + i_1r_1 + i'_1x_1;$$

$$e_2 = e + i_2r_2 + i'_2x_2;$$

$$\begin{aligned}
 e'_1 &= i_1 x_1 - i'_1 r_1; \\
 e'_2 &= i_2 x_2 - i'_2 r_2; \\
 eg &= i_1 + i_2; \\
 eb &= i'_1 + i'_2; \\
 e_1^2 + e_1'^2 &= a_1^2; \\
 e_2^2 + e_2'^2 &= a_2^2;
 \end{aligned}$$

or eight equations with nine variables, $e_1, e'_1, e_2, e'_2, i_1, i'_1, i_2, i'_2, e$.

Combining these equations by twos,

$$\begin{aligned}
 e_1 r_1 + e'_1 x_1 &= e r_1 + i_1 z_1^2; \\
 e_2 r_2 + e'_2 x_2 &= e r_2 + i_2 z_2^2;
 \end{aligned}$$

substituting in

$$i_1 + i_2 = eg,$$

we have

$$e_1 g_1 + e'_1 b_1 + e_2 g_2 + e'_2 b_2 = e(g_1 + g_2 + g);$$

and analogously,

$$e_1 b_1 - e'_1 g_1 + e_2 b_2 - e'_2 g_2 = e(b_1 + b_2 + b);$$

dividing,

$$\frac{g + g_1 + g_2}{b + b_1 + b_2} = \frac{e_1 g_1 + e_2 g_2 + e'_1 b_1 + e'_2 b_2}{e_1 b_1 + e_2 b_2 - e'_1 g_1 - e'_2 g_2}$$

substituting

$$\begin{aligned}
 g &= y \cos \alpha & e_1 &= a_1 \cos \theta_1 & e_2 &= a_2 \cos \theta_2 \\
 b &= y \sin \alpha & e'_1 &= a_1 \sin \theta_1 & e'_2 &= a_2 \sin \theta_2
 \end{aligned}$$

gives

$$\frac{g + g_1 + g_2}{b + b_1 + b_2} = \frac{a_1 y_1 \cos(\alpha_1 - \theta_1) + a_2 y_2 \cos(\alpha_2 - \theta_2)}{a_1 y_1 \sin(\alpha_1 - \theta_1) + a_2 y_2 \sin(\alpha_2 - \theta_2)}$$

as the equation between the phase displacement angles, θ_1 and θ_2 , in parallel operation.

The power supplied to the external circuit is,

$$p = e^2 g,$$

of which that supplied by the first machine is,

$$p_1 = e i_1;$$

by the second machine,

$$p_2 = e i_2.$$

The total electrical power of both machines is,

$$P = P_1 + P_2,$$

of which that of the first machine is,

$$P_1 = e_1 i_1 - e'_1 i'_1;$$

and that of the second machine,

$$P_2 = e_2 i_2 - e'_2 i'_2.$$

The difference of output of the two machines is,

$$\Delta P = P_1 - P_2 = e (i_1 - i_2);$$

denoting

$$\frac{\theta_1 + \theta_2}{2} = \epsilon \frac{\theta_1 - \theta_2}{2} = \delta.$$

$\frac{\Delta P}{\Delta \delta}$ may be called the synchronizing power of the machines, or the power which is transferred from one machine to the other by a change of the relative phase angle.

210. SPECIAL CASE.—*Two equal alternators of equal excitation.*

$$\begin{aligned} a_1 &= a_2 = a, \\ Z_1 &= Z_2 = Z_0. \end{aligned}$$

Substituting this in the eight initial equations, these assume the form,

$$\begin{aligned} e_1 &= e + i_1 r_0 + i'_1 x_0, \\ e_2 &= e + i_2 r_0 + i'_2 x_0, \\ e'_1 &= i_1 x_0 - i'_1 r'_0, \\ e'_2 &= i_2 x_0 - i'_2 r_0, \\ eg &= i_1 + i_2, \\ eb &= i'_1 + i'_2, \\ e_1^2 + e_1'^2 &= e_2^2 + e_2'^2 = a^2. \end{aligned}$$

Combining these equations by twos,

$$\begin{aligned} e_1 + e_2 &= 2e + e(r_0g + x_0b), \\ e'_1 + e'_2 &= e(x_0g - r_0b); \end{aligned}$$

substituting

$$\begin{aligned} e_1 &= a \cos \theta_1, \\ e'_1 &= a \sin \theta_1, \\ e_2 &= a \cos \theta_2, \\ e'_2 &= a \sin \theta_2, \end{aligned}$$

we have

$$\begin{aligned} a (\cos \theta_1 + \cos \theta_2) &= e (2 + r_0g + x_0b), \\ a (\sin \theta_1 + \sin \theta_2) &= e (x_0g - r_0b); \end{aligned}$$

expanding and substituting

$$\epsilon = \frac{\theta_1 + \theta_2}{2},$$

$$\delta = \frac{\theta_1 - \theta_2}{2};$$

gives

$$a \cos \epsilon \cos \delta = e \left(1 + \frac{r_0 g + x_0 b}{2} \right),$$

$$a \sin \epsilon \cos \delta = e \frac{x_0 g - r_0 b}{2};$$

hence

$$\tan \epsilon = \frac{x_0 g - r_0 b}{2 + r_0 g + x_0 b} = \text{constant}.$$

That is,

$$\theta_1 + \theta_2 = \text{constant};$$

and

$$\cos \delta = \frac{e}{a} \sqrt{\left(1 + \frac{r_0 g + x_0 b}{2} \right)^2 + \left(\frac{x_0 g - r_0 b}{2} \right)^2};$$

or,

$$e = \frac{a \cos \delta}{\sqrt{\left(1 + \frac{r_0 g + x_0 b}{2} \right)^2 + \left(\frac{x_0 g - r_0 b}{2} \right)^2}};$$

at no-phase displacement between the alternators, or,

$$\delta = \frac{\theta_1 - \theta_2}{2} = 0,$$

we have

$$e = \frac{a}{\sqrt{\left(1 + \frac{r_0 g + x_0 b}{2} \right)^2 + \left(\frac{x_0 g - r_0 b}{2} \right)^2}}.$$

From the eight initial equations we get, by combination,

$$e_1 r_0 + e'_1 x_0 = e_0 r_0 + i_1 (r_0^2 + x_0^2),$$

$$e_2 r_0 + e'_2 x_0 = e_0 r_0 + i_2 (r_0^2 + x_0^2);$$

subtracted and expanded,

$$i_1 - i_2 = \frac{r_0 (e_1 - e_2) + x_0 (e'_1 - e'_2)}{z_0^2};$$

or, since

$$e_1 - e_2 = a (\cos \theta_1 - \cos \theta_2) = -2 a \sin \epsilon \sin \delta,$$

$$e'_1 - e'_2 = a (\sin \theta_1 - \sin \theta_2) = 2 a \cos \epsilon \sin \delta,$$

we have

$$\begin{aligned} i_1 - i_2 &= \frac{2a \sin \delta}{z_0^2} \{x_0 \cos \epsilon - r_0 \sin \epsilon\} \\ &= 2ay_0 \sin \delta \sin (\alpha - \epsilon), \end{aligned}$$

where

$$\tan \alpha = \frac{x_0}{r_0}.$$

The difference of output of the two alternators is

$$\Delta P = P_1 - P_2 = e (i_1 - i_2);$$

hence, substituting,

$$\Delta P = \frac{2ae \sin \delta}{z_0^2} \{x_0 \cos \epsilon - r_0 \sin \epsilon\};$$

substituting,

$$\begin{aligned} e &= \frac{a \cos \delta}{\sqrt{\left(1 + \frac{r_0g + x_0b}{2}\right)^2 + \left(\frac{x_0g - r_0b}{2}\right)^2}}, \\ \sin \epsilon &= \frac{\frac{x_0g - r_0b}{2}}{\sqrt{\left(1 + \frac{r_0g + x_0b}{2}\right)^2 + \left(\frac{x_0g - r_0b}{2}\right)^2}}, \\ \cos \epsilon &= \frac{1 + \frac{r_0g + x_0b}{2}}{\sqrt{\left(1 + \frac{r_0g + x_0b}{2}\right)^2 + \left(\frac{x_0g - r_0b}{2}\right)^2}}, \end{aligned}$$

we have,

$$\Delta P = \frac{2a^2 \sin \delta \cos \delta \left\{ x_0 \left(1 + \frac{r_0g + x_0b}{2}\right) - r_0 \left(\frac{x_0g - r_0b}{2}\right) \right\}}{z_0^2 \left\{ \left(1 + \frac{r_0g + x_0b}{2}\right)^2 + \left(\frac{x_0g - r_0b}{2}\right)^2 \right\}};$$

expanding,

$$\Delta P = \frac{a^2 \sin 2\delta \left\{ x_0 + \frac{bz_0^2}{2} \right\}}{z_0^2 \left\{ 1 + r_0g + x_0b + \frac{1}{4}z_0^2y^2 \right\}};$$

or

$$\Delta P = \frac{a^2 \sin 2\delta \left\{ b_0 + \frac{b}{2} \right\} y_0^2}{y_0^2 + gy_0 + bb_0 + \frac{1}{4}y^2};$$

$$\frac{\Delta P}{\Delta \delta} = \frac{2a^2 \cos 2\delta \left\{ b_0 + \frac{b}{2} \right\} y_0^2}{y_0^2 + gy_0 + bb_0 + \frac{1}{4}y^2}.$$

Hence, the transfer of power between the alternators, ΔP , is a maximum, if $\delta = 45^\circ$; or $\theta_1 - \theta_2 = 90^\circ$; that is, when the alternators are in quadrature.

The synchronizing power, $\frac{\Delta P}{\Delta \delta}$, is a maximum if $\delta = 0$; that is, the alternators are in phase with each other.

211. As an instance, curves may be plotted for,

$$a = 2500,$$

$$Z_0 = r_0 + jx_0 = 1 + 10j; \text{ or } Y_0 = g_0 - jb_0 = 0.01 - 0.1j,$$

with the angle, $\delta = \frac{\theta_1 - \theta_2}{2}$, as abscissas, giving

the value of terminal voltage, e ;

the value of current in the external circuit, $i = ey$;

the value of interchange of current between the alternators $i_1 - i_2$;

the value of interchange of power between the alternators, $\Delta P = P_1 - P_2$;

the value of synchronizing power, $\frac{\Delta P}{\Delta \delta}$.

For the condition of external circuit,

$g = 0,$	$b = 0,$	$y = 0,$
0.05,	0,	0.05,
0.08,	0,	0.08,
0.03,	+ 0.04,	0.05,
0.03,	- 0.04,	0.05.

CHAPTER XXIV

SYNCHRONOUS MOTOR

212. In the chapter on synchronizing alternators we have seen that when an alternator running in synchronism is connected with a system of given voltage, the work done by the alternator can be either positive or negative. In the latter case the alternator consumes electrical, and consequently produces mechanical, power; that is, runs as a synchronous motor, so that the investigation of the synchronous motor is already contained essentially in the equations of parallel-running alternators.

Since in the foregoing we have made use mostly of the symbolic method, we may in the following, as an example of the graphical method, treat the action of the synchronous motor graphically.

Let an alternator of the e.m.f., E_1 , be connected as synchronous motor with a supply circuit of e.m.f., E_0 , by a circuit of the impedance, Z .

If E_0 is the e.m.f. impressed upon the motor terminals, Z is the impedance of the motor of generated e.m.f., E_1 . If E_0 is the e.m.f. at the generator terminals, Z is the impedance of motor and line, including transformers and other intermediate apparatus. If E_0 is the generated e.m.f. of the generator, Z is the sum of the impedances of motor, line, and generator, and thus we have the problem, generator of generated e.m.f., E_0 , and motor of generated e.m.f., E_1 ; or, more general, two alternators of generated e.m.f.s., E_0, E_1 , connected together into a circuit of total impedance, Z .

Since in this case several e.m.f.s. are acting in circuit with the same current, it is convenient to use the current, I , as zero line \overline{OI} of the polar diagram. (Fig. 145.)

If $I = i =$ current, and $Z =$ impedance, $r =$ effective resistance, $x =$ effective reactance, and $z = \sqrt{r^2 + x^2} =$ absolute value of impedance, then the e.m.f. consumed by the resistance is $E_{11} = ri$, and is in phase with the current; hence represented by vector \overline{OE}_{11} ; and the e.m.f. consumed by the reactance is $E_2 = xi$, and 90° ahead of the current; hence the e.m.f. consumed

by the impedance is $E = \sqrt{(E_{11})^2 + (E_2)^2}$, or $= i \sqrt{r^2 + x^2} = iz$, and ahead of the current by the angle δ , where $\tan \delta = \frac{x}{r}$.

We have now acting in circuit the e.m.fs., E, E_1, E_0 ; or E_1 and E are components of E_0 , that is, E_0 is the diagonal of a parallelogram, with E_1 and E as sides.

Since the e.m.fs. E_1, E_0, E , are represented in the diagram, Fig. 145, by the vectors $\overline{OE_1}, \overline{OE_0}, \overline{OE}$, to get the parallelogram of E_0, E_1, E , we draw arcs of circles around O with E_0 , and around E with E_1 . Their point of intersection gives the impressed e.m.f., $\overline{OE_0} = E_0$, and completing the parallelogram, $OE E_0 E_1$, we get, $\overline{OE_1} = E_1$, the generated e.m.f. of the motor.

$\angle IOE_0$ is the difference of phase between current and impressed e.m.f., or generated e.m.f. of the generator.

$\angle IOE_1$ is the difference of phase between current and generated e.m.f. of the motor.

And the power is the current, i , times the projection of the e.m.f. upon the current, or the zero line, \overline{OI} .

Hence, dropping perpendiculars, $\overline{E_0 E_0^1}$ and $\overline{E_1 E_1^1}$, from E_0 and E_1 upon \overline{OI} , it is—

$P_0 = i \times \overline{OE_0^1}$ = power supplied by generator e.m.f. of generator;

$P_1 = i \times \overline{OE_1^1}$ = electric power transformed into mechanical power by the motor;

$P = i \times \overline{OE_{11}}$ = power consumed in the circuit by effective resistance.

Obviously $P_0 = P_1 + P$.

Since the circles drawn with E_0 and E_1 around O and E , respectively, intersect twice, two diagrams exist. In general, in one of these diagrams shown in Fig. 145 in full lines, current and e.m.f. are in the same direction, representing mechanical work done by the machine as motor. In the other, shown in dotted lines, current and e.m.f. are in opposite direction, representing mechanical work consumed by the machine as generator.

Under certain conditions, however, E_0 is in the same, E_1 in opposite direction, with the current; that is, both machines are generators.

213. It is seen that in these diagrams the e.m.fs. are considered from the point of view of the motor; that is, work done as synchronous motor is considered as positive, work done as generator

is negative. In the chapter on synchronizing generators we took the opposite view, from the generator side.

In a single unit-power transmission, that is, one generator supplying one synchronous motor over a line, the e.m.f. consumed by the impedance, $E = \overline{OE}$, Figs. 146 to 148, consists three components; the e.m.f., $\overline{OE_2^1} = E_2$, consumed by the impedance of the motor, the e.m.f., $\overline{E_2^1 E_3^1} = E_3$ consumed by the impedance of the line, and the e.m.f., $\overline{E_3^1 E} = E_4$, consumed by

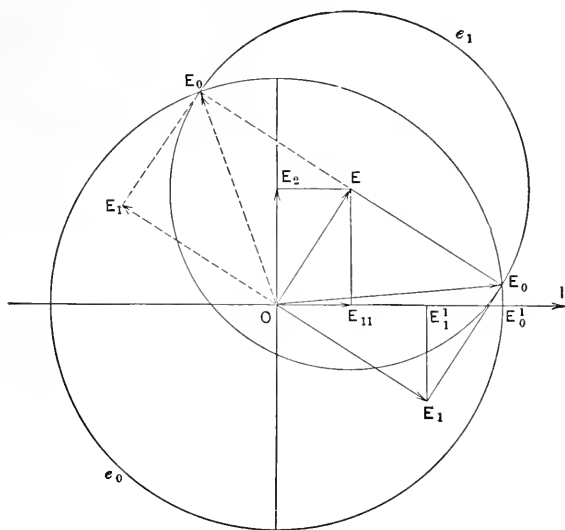

FIG. 145.

the impedance of the generator. Hence, dividing the opposite side of the parallelogram, $\overline{E_1 E_0}$, in the same way, we have: $\overline{OE_1} = E_1 =$ generated e.m.f. of the motor, $\overline{OE_2} = E_2 =$ e.m.f. at motor terminals or at end of line, $\overline{OE_3} = E_3 =$ e.m.f. at generator terminals, or at beginning of line. $\overline{OE_0} = E_0 =$ generated e.m.f. of generator.

The phase relation of the current with the e.m.f.s., E_1, E_0 , depends upon the current strength and the e.m.f.s., E_1 and E_0 .

214. Figs. 146 to 148 show several such diagrams for different values of E_1 , but the same value of I and E_0 . The motor diagram being given in drawn line, the generator diagram in dotted line.

As seen, for small values of E_1 the potential drops in the alternator and in the line. For the value of $E_1 = E_0$ the potential rises in the generator, drops in the line, and rises again in the

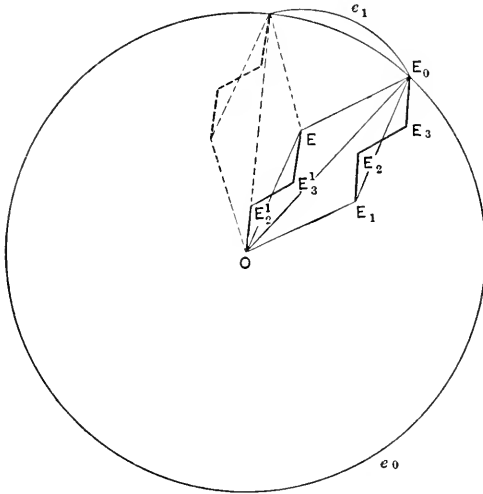

FIG. 146.

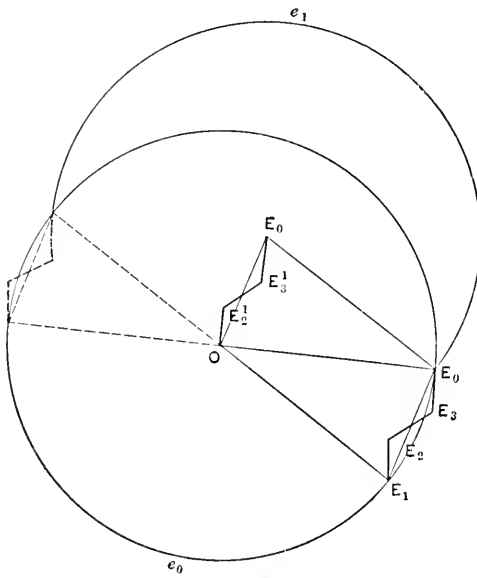

FIG. 147.

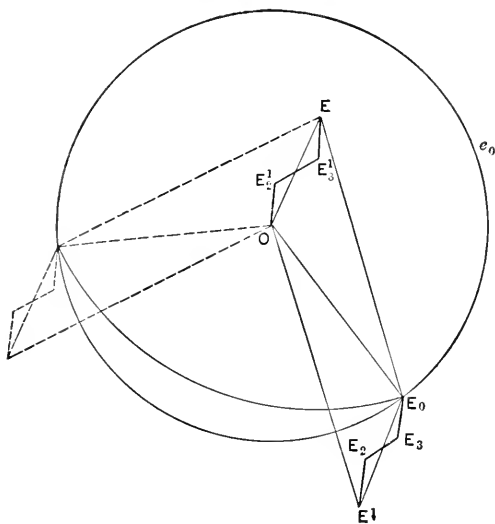

FIG. 148.

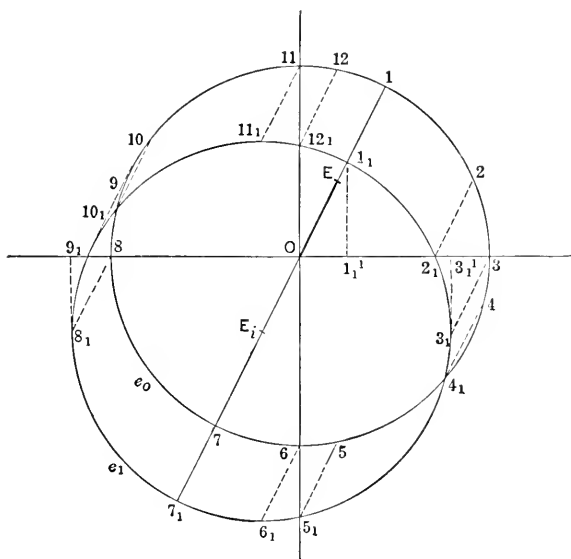

FIG. 149.

motor. For larger values of E_1 , the potential rises in the alternator as well as in the line, so that the highest potential is the generated e.m.f. of the motor, the lowest potential the generated e.m.f. of the generator.

It is of interest now to investigate how the values of these quantities change with a change of the constants.

215. A. *Constant impressed e.m.f., E_0 , constant-current strength $I = i$, variable motor excitation, E_1 .* (Fig. 149.)

If the current is constant, $= i$; \overline{OE} , the e.m.f. consumed by the impedance, and therefore point, E , are constant. Since the intensity, but not the phase of E_0 is constant, E_0 lies on a circle e_0 with E_0 as radius. From the parallelogram, OEE_0E_1 follows, since $\overline{E_1E_0}$ parallel and $= \overline{OE}$, that E_1 lies on a circle, e_1 , congruent to the circle, e_0 , but with Ei , the image of E , as center; $\overline{OE_i} = \overline{OE}$.

We can construct now the variation of the diagram with the variation of E_1 ; in the parallelogram, OEE_0E_1 , O , and E are fixed, and E_0 and E_1 move on the circles, e_0 and e_1 , so that $\overline{E_0E_1}$ is parallel to \overline{OE} .

The smallest value of E_1 consistent with current strength, I , is $\overline{01_1} = E_1$, $\overline{01} = E_0$. In this case the power of the motor is $01_1^1 \times I$, hence already considerable. Increasing E_1 to $\overline{02_1}$, $\overline{03_1}$, etc., the impressed e.m.f.s. move to $\overline{02}$, $\overline{03}$, etc., the power is $I \times \overline{02_1^1}$, $I \times \overline{03_1^1}$, etc., increases first, reaches the maximum at the point 3_1 , 3 , the most extreme point at the right, with the impressed e.m.f. in phase with the current, and then decreases again, while the generated e.m.f. of the motor, E_1 , increases and becomes $= E_0$ at 4_1 , 4 . At 5_1 , 5 , the power becomes zero, and further on negative; that is, the motor has changed to a generator, and produces electrical energy, while the impressed e.m.f., e_0 , still furnishes electrical energy—that is, both machines as generators feed into the line, until at 6_1 , 6 , the power of the impressed e.m.f., E_0 , becomes zero, and further on energy begins to flow back; that is, the motor is changed to a generator and the generator to a motor, and we are on the generator side of the diagram. At 7_1 , 7 , the maximum value of E_1 , consistent with the current, I , has been reached, and passing still further the e.m.f., E_1 decreases again, while the power still increases up to the maximum at 8_1 , 8 , and then decreases again, but still E_1 remaining generator, E_0 motor, until at 11_1 , 11 , the power of E_0 becomes zero; that is, E_0 changes again to a generator, and both machines are generators,

up to 12_1 , 12, where the power of E_1 is zero, E_1 , changes from generator to motor, and we come again to the motor side of the diagram, and the power of the motor increases while E_1 still decreases, until 1_1 , 1, is reached.

Hence, there are two regions, for very large E_1 from 5 to 6 and for very small E_1 from 11 to 12, where both machines are generators; otherwise the one is generator, the other motor.

For small values of E_1 the current is lagging, begins, however, at 2 to lead the generated e.m.f. of the motor, E_1 , at 3 the generated e.m.f. of the generator, E_0 .

It is of interest to note that at the smallest possible value of E_1 , 1_1 , the power is already considerable. Hence, the motor can run under these conditions only at a certain load. If this load is thrown off, the motor cannot run with the same current, but the current must increase. We have here the curious condition that loading the motor reduces, unloading increases, the current within the range between 1 and 12.

The condition of maximum output is 3, current in phase with impressed e.m.f. Since at constant current the loss is constant, this is at the same time the condition of maximum efficiency; no displacement of phase of the impressed e.m.f., or self-induction of the circuit compensated by the effect of the lead of the motor current. This condition of maximum efficiency of a circuit we have found already in Chapter XI.

216. B. E_0 and E_1 constant, I variable.

Obviously E_0 lies again on the circle c_0 with E_0 as radius and O as center.

E lies on a straight line, e , passing through the origin.

Since in the parallelogram, OEE_0E_1 , $\overline{EE_0} = E_1$, we derive E_0 by laying a line, $\overline{EE_0} = E_1$, from any point, E , in the circle, c_0 , and complete the parallelogram.

All these lines, $\overline{EE_0}$, envelop a certain curve, e_1 , which can be considered as the characteristic curve of this problem, just as circle, e_1 , in the former problem.

These curves are drawn in Figs. 150, 151, 152, for the three cases: 1st, $E_1 = E_0$; 2d, $E_1 < E_0$; 3d, $E_1 > E_0$.

In the first case, $E_1 = E_0$ (Fig. 150), we see that at very small current, that is very small \overline{OE} , the current, I , leads the impressed e.m.f., E_0 , by an angle, $E_1OI = \theta_0$. This lead decreases with increasing current, becomes zero, and afterward for larger current, the current lags. Taking now any pair of corresponding

points, E, E_0 , and producing $\overline{EE_0}$ until it intersects e_i , in E_i , we have $\angle E_iOE = 90^\circ, \overline{E_1} = \overline{E_0}$, thus: $\overline{OE_1} = \overline{EE_0} = \overline{OE_0} = \overline{E_0E_i}$;

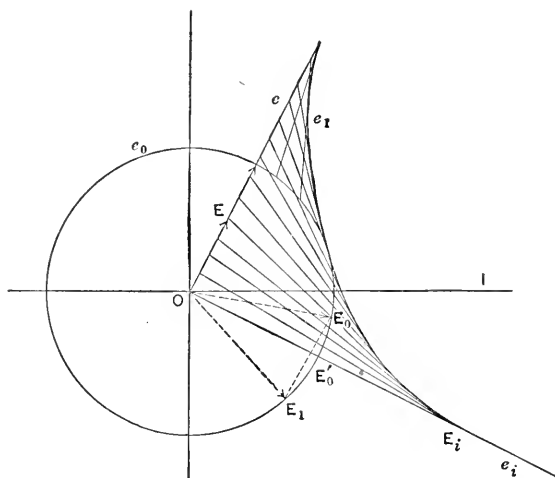

FIG. 150.

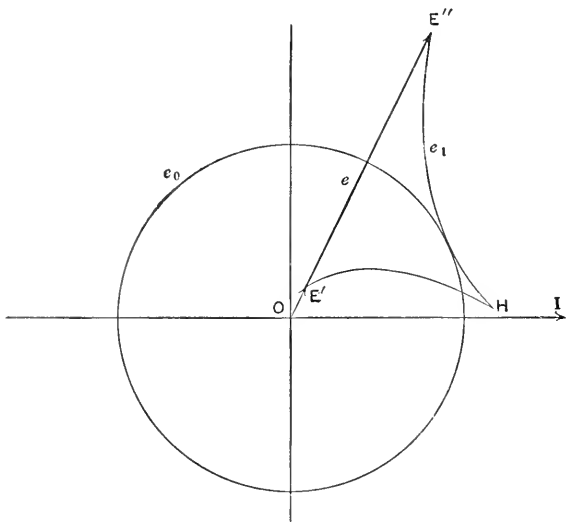

FIG. 151.

that is, $\overline{EE_i} = 2 E_0$. That means the characteristic curve, e_1 , is the envelope of lines $\overline{EE_i}$, of constant lengths, $2 E_0$, sliding between the legs of the right angle, E_iOE ; hence, it is the sextic hypocy-

cloid osculating circle, e_0 , which has the general equation, with e, e_i as axes of coördinates,

$$\sqrt[3]{x^2} + \sqrt[3]{y^2} = \sqrt[3]{4E_0^2}.$$

In the next case, $E_1 < E_0$ (Fig. 151), we see first, that the current can never become zero like in the first case, $E_1 = E_0$, but has a minimum value corresponding to the minimum value of $\overline{OE'}$: $I'_1 = \frac{E_0 - E_1}{z}$, and a maximum value: $I''_1 = \frac{E_0 - E_1}{z}$.

Furthermore, the current may never lead the impressed e.m.f., E_0 , but always lags. The minimum lag is at the point, H . The locus, e_1 , as envelope of the lines, $\overline{EE_0}$, is a finite sextic curve, shown in Fig. 151.

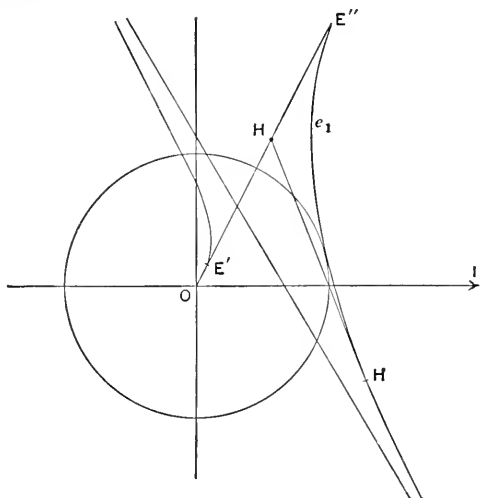

FIG. 152.

If $E_1 < E_0$, at small $E_0 - E_1$, H can be below the zero line, and a range of leading current exists between two ranges of lagging currents.

In the case, $E_1 > E_0$ (Fig. 152), the current cannot equal zero either, but begins at a finite value, I'_1 , corresponding to the minimum value of \overline{OE} , $I'_1 = \frac{E_1 - E_0}{z}$. At this value, however, the alternator, E_1 , is still generator and changes to a motor, its power passing through zero, at the point corresponding to the vertical tangent, upon e_1 , with a very large lead of the impressed e.m.f. against the current. At H the lead changes to lag.

The minimum and maximum values of current in the three conditions are given by:

<i>Minimum</i>	<i>Maximum</i>
1st. $I = 0,$	$I = \frac{2E_0}{z}.$
2d. $I = \frac{E_0 - E_1}{z},$	$I = \frac{E_0 + E_1}{z}.$
3d. $I = \frac{E_1 - E_0}{z},$	$I = \frac{E_0 + E_1}{z}.$

Since the current in the line at $E_1 = 0$, that is, when the motor stands still, is $I_0 = \frac{E_0}{z}$, we see that in such a synchronous motor-plant, when running at synchronism, the current can rise far beyond the value it has at standstill of the motor, to twice this value at 1, somewhat less at 2, but more at 3.

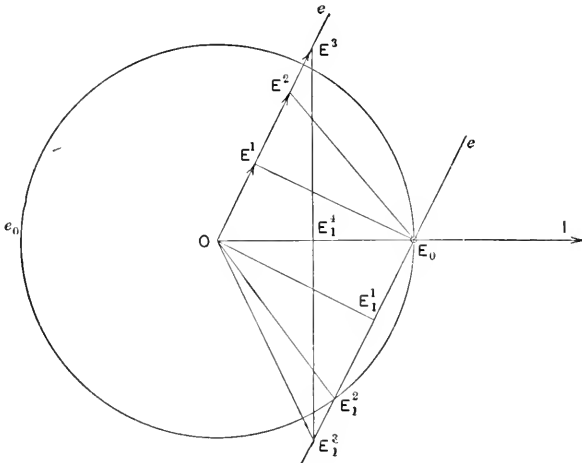

FIG. 153.

217. C. $E_0 = \text{constant}$, E_1 varied so that the efficiency is a maximum for all currents. (Fig. 153.)

Since we have seen that the output at a given current strength, that is, a given loss, is a maximum, and therefore the efficiency a maximum, when the current is in phase with the generated e.m.f., E_0 , of the generator, we have as the locus of E_0 the point, E_0 (Fig. 153), and when E with increasing current varies on e , E_1 must vary on the straight line, e_1 , parallel to e .

Hence, at no-load or zero current, $E_1 = E_0$, decreases with increasing load, reaches a minimum at $\overline{OE_1^1}$ perpendicular to e_1 , and then increases again, reaches once more $E_1 = E_0$ at E_1^2 , and then increases beyond E_0 . The current is always ahead of the generated e.m.f., E_1 , of the motor, and by its lead compensates for the self-induction of the system, making the total circuit non-inductive.

The power is a maximum at E_1^3 , where $\overline{OE_1^4} = \overline{E_1^4 E_0} = 0.5 \times \overline{OE_0}$, and is then $= I \times \frac{E_0}{2}$. Since $\overline{OE_1^4} = Ir = \frac{E_0}{2}$, $I = \frac{E_0}{2r}$ and $P = \frac{E_0^2}{4r}$, hence = the maximum power which, over a non-inductive line of resistance r can be transmitted, at 50 per cent. efficiency, into a non-inductive circuit.

In this case,

$$E_1^3 = \frac{z}{r} \times \frac{E_0}{2} = \frac{E_0}{2} \sqrt{1 + \left(\frac{x}{r}\right)^2}.$$

In general, it is, taken from the diagram, at the condition of maximum efficiency,

$$E_1 = \sqrt{(E_0 - Ir)^2 + I^2 x^2}.$$

Comparing these results with those in Chapter XI on Inductive and Condensive Reactance, we see that the condition of maximum efficiency of the synchronous motor system is the same as in a system containing resistance and condensive reactance, fed over an inductive line, the lead of the current against the generated e.m.f., E_1 , here acting in the same way as the condenser capacity in Chapter XI.

218. D. $E_0 = \text{constant}; P_1 = \text{constant}.$

If the power of a synchronous motor remains constant, we have (Fig. 154) $I \times \overline{OE_1^1} = \text{constant}$, or, since $\overline{OE_1^1} = Ir$, $I = \frac{\overline{OE_1^1}}{r}$ and $\overline{OE_1^1} \times \overline{OE_1^1} = \overline{OE_1^1} \times \overline{E_1^1 E_0^1} = \text{constant}.$

Hence we get the diagram for any value of the current, I , at constant power, P_1 , by making $\overline{OE_1^1} = Ir$, $\overline{E_1^1 E_0^1} = \frac{P_1}{I}$ erecting in E_0^1 a perpendicular, which gives two points of intersection with circle, e_0 , E_0 , one leading, the other lagging. Hence, at a given impressed e.m.f., E_0 , the same power, P_1 , can be transmitted by the same current, I , with two different generated e.m.fs., E_1 , of the motor; one, $\overline{OE_1} = \overline{EE_0}$ small, corresponding

to a lagging current; and the other, $\overline{OE_1} = \overline{EE_0}$ large, corresponding to a leading current. The former is shown in dotted lines, the latter in full lines, in the diagram, Fig. 154.

Hence a synchronous motor can work with a given output, at the same current with two different counter e.m.fs., E_1 . In one of the cases the current is leading, in the other lagging.

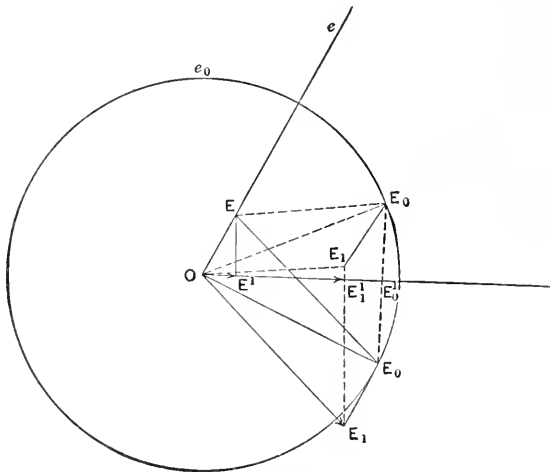

Fig. 154.

In Figs. 155 to 158 are shown diagrams, giving the points

E_0 = impressed e.m.f., assumed as constant = 1000 volts,

E = e.m.f. consumed by impedance,

E^1 = e.m.f. consumed by resistance (not numbered).

The counter e.m.f. of the motor, E_1 , is $\overline{OE_1}$, equal and parallel $\overline{EE_0}$, but not shown in the diagrams, to avoid complication.

The four diagrams correspond to the values of power, or motor output,

$P = 1,000,$	$6,000,$	$9,000,$	$12,000$ watts, and give:	
$P = 1,000$	$46 < E_1 < 2,200,$	$1 < I < 49$		Fig. 155.
$P = 6,000$	$340 < E_1 < 1,920,$	$7 < I < 43$		Fig. 156.
$P = 9,000$	$540 < E_1 < 1,750,$	$11.8 < I < 38.2$		Fig. 157.
$P = 12,000$	$920 < E_1 < 1,320,$	$20 < I < 30$		Fig. 158.

As seen, the permissible value of counter e.m.f., E_1 , and of current, I , becomes narrower with increasing output.

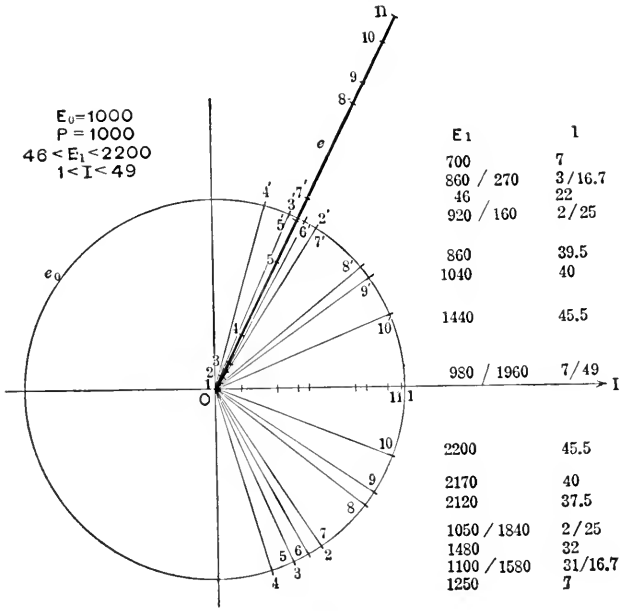

FIG. 155.

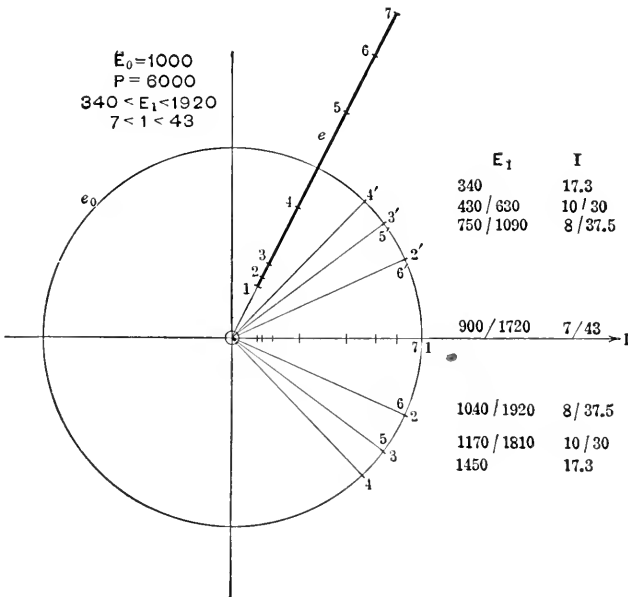

FIG. 156.

In the diagrams, different points of E_0 are marked with 1, 2, 3 . . . , when corresponding to leading current, with 2', 3', . . . , when corresponding to lagging current.

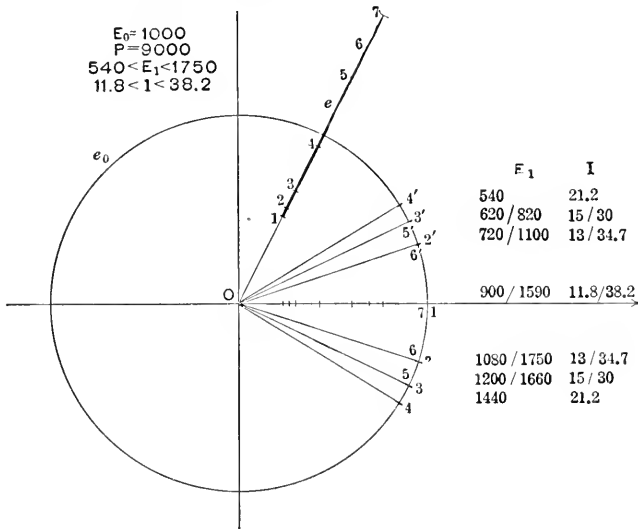

FIG. 157.

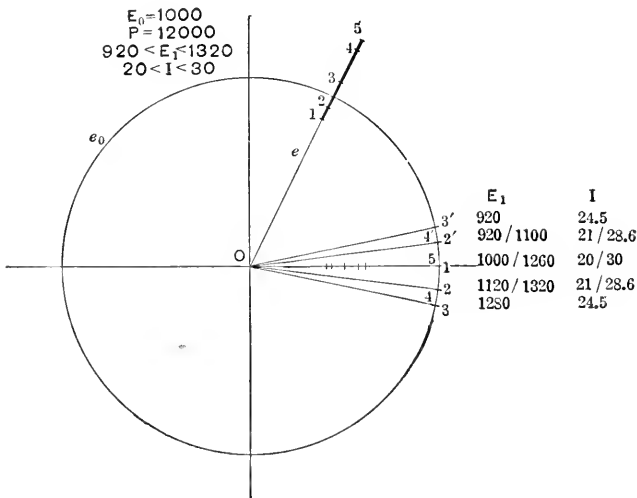

FIG. 158.

The values of counter e.m.f., E_1 , and of current, I , are noted on the diagrams, opposite to the corresponding points, E_0 .

In this condition it is interesting to plot the current as function of the generated e.m.f., E_1 , of the motor, for constant power, P_1 . Such curves are given in Fig. 162 and explained in the following on page 430.

219. While the graphic method is very convenient to get a clear insight into the interdependence of the different quantities, for numerical calculation it is preferable to express the diagrams analytically.

For this purpose,

Let $z = \sqrt{r^2 + x^2}$ = impedance of the circuit of (equivalent) resistance, r , and (equivalent) reactance, $x = 2 \pi fL$, containing the impressed e.m.f., e_0 and the counter e.m.f., e_1 , of the synchronous motor¹; that is, the e.m.f. generated in the motor armature by its rotation through the (resultant) magnetic field.

Let i = current in the circuit (effective values).

The mechanical power delivered by the synchronous motor (including friction and core loss) is the electric power consumed by the counter e.m.f., e_1 ; hence

$$p = ie_1 \cos (i, e_1); \tag{1}$$

thus,

$$\left. \begin{aligned} \cos (i, e_1) &= \frac{p}{ie_1}, \\ \sin (i, e_1) &= \sqrt{1 - \left(\frac{p}{ie_1}\right)^2}. \end{aligned} \right\} \tag{2}$$

The displacement of phase between current i , and e.m.f. $e = zi$ consumed by the impedance, z , is

$$\left. \begin{aligned} \cos (i, e) &= \frac{r}{z} \\ \sin (i, e) &= \frac{x}{z} \end{aligned} \right\} \tag{3}$$

Since the three e.m.fs. acting in the closed circuit,

- e_0 = e.m.f. of generator,
- e_1 = counter e.m.f. of synchronous motor,
- $e = zi$ = e.m.f. consumed by impedance,

¹ If e_0 = e.m.f. at motor terminals, z = internal impedance of the motor; if e_0 = terminal voltage of the generator, z = total impedance of line and motor; if e_0 = e.m.f. of generator, that is, e.m.f. generated in generator armature by its rotation through the magnetic field, z includes the generator impedance also.

form a triangle, that is, e_1 and e are components of e_0 , it is (Figs. 159 and 160),

$$e_0^2 = e_1^2 + e^2 + 2 ee_1 \cos (e_1, e), \tag{4}$$

hence, $\cos (e_1, e) = \frac{e_0^2 - e_1^2 - e^2}{2 e_1 e} = \frac{e_0^2 - e_1^2 - z^2 i^2}{2 z i e_1}, \tag{5}$

since, however, by diagram,

$$\begin{aligned} \cos (e_1, e) &= \cos (i, e - i, e_1) \\ &= \cos (i, e) \cos (i, e_1) + \sin (i, e) \sin (i, e_1) \end{aligned} \tag{6}$$

substitution of (2), (3) and (5) in (6) gives, after some transposition,

$$e_0^2 - e_1^2 - z^2 i^2 - 2 r p = 2 x \sqrt{i^2 e_1^2 - p^2}, \tag{7}$$

the *fundamental equation of the synchronous motor*, relating impressed e.m.f., e_0 ; counter e.m.f., e_1 ; current, i ; power, p , and resistance, r ; reactance, x ; impedance, z .

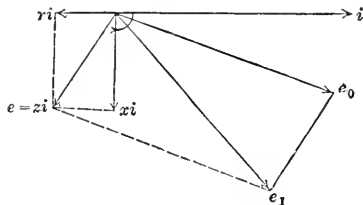

FIG. 159.

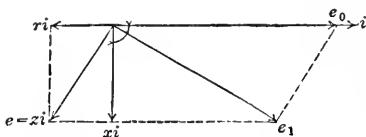

FIG. 160.

This equation shows that, at given impressed e.m.f., e_0 , and given, impedance, $z = \sqrt{r^2 + x^2}$, three variables are left, e_1, i, p , of which two are independent. Hence, at given e_0 and z , the current, i , is not determined by the load, p , only, but also by the excitation, and thus the same current, i , can represent widely different loads, p , according to the excitation; and with the same load, the current, i , can be varied in a wide range, by varying the field-excitation, e_1 .

The meaning of equation (7) is made more perspicuous by some transformations, which separate e_1 and i , as function of p and of an angular parameter, ϕ .

Substituting in (7) the new coördinates;

$$\left. \begin{aligned} \alpha &= \frac{e_1^2 + z^2 i^2}{\sqrt{2}}, \\ \beta &= \frac{e_1^2 - z^2 i^2}{\sqrt{2}}, \end{aligned} \right\} \text{ or, } \left\{ \begin{aligned} e_1^2 &= \frac{\alpha + \beta}{\sqrt{2}}, \\ z^2 i^2 &= \frac{\alpha - \beta}{\sqrt{2}}, \end{aligned} \right\} \tag{8}$$

we get
$$e_0^2 - \alpha\sqrt{2} - 2rp = 2\frac{x}{z}\sqrt{\frac{\alpha^2 - \beta^2}{2} - z^3p^2}; \tag{9}$$

substituting again,
$$\left. \begin{aligned} e_0^2 &= a \\ 2zp &= b \\ r &= \epsilon z, \\ x &= z\sqrt{1 - \epsilon^2} \\ 2rp &= \epsilon b, \end{aligned} \right\} \tag{10}$$

hence,
$$a - \alpha\sqrt{2} - \epsilon b = \sqrt{(1 - \epsilon^2)(2\alpha^2 - 2\beta^2 - b^2)}; \tag{11}$$

and, squared,
$$\epsilon^2\alpha^2 + (1 - \epsilon^2)\beta^2 - \alpha\sqrt{2}(a - \epsilon b) + \frac{b^2(1 - \epsilon^2)}{2} + \frac{(a - \epsilon b)^2}{2} = 0; \tag{12}$$

substituting
$$\left. \begin{aligned} \epsilon\alpha - \frac{(a - \epsilon b)\sqrt{2}}{2\epsilon} &= v, \\ \beta\sqrt{1 - \epsilon^2} &= w, \end{aligned} \right\} \tag{13}$$

gives, after some transposition,
$$v^2 + w^2 = \frac{(1 - \epsilon^2)}{2\epsilon^2} a(a - 2\epsilon b), \tag{14}$$

hence, if
$$R = \sqrt{\frac{(1 - \epsilon^2)(a - 2\epsilon b)a}{2\epsilon^2}}, \tag{15}$$

it is
$$v^2 + w^2 = R^2 \tag{16}$$

the equation of a circle with radius, R .

Substituting now backward, we get, with some transpositions,

$$\{r^2(e_1^2 + z^2i^2) - z^2(e_0^2 - 2rp)\}^2 + \{rx(e_1^2 + z^2i^2)\}^2 = x^2z^2e_0^2(e_0^2 - 4rp) \tag{17}$$

the *fundamental equation of the synchronous motor* in a modified form.

The separation of e_1 and i can be effected by the introduction of a parameter, ϕ , by the equations

$$\left. \begin{aligned} r^2(e_1^2 + z^2i^2) - z^2(e_0^2 - 2rp) &= xze_0\sqrt{e_0^2 - 4rp} \cos \phi \\ rx(e_1^2 - z^2i^2) &= xze_0\sqrt{e_0^2 - 4rp} \sin \phi \end{aligned} \right\} \tag{18}$$

These equations (18), transposed, give

$$e_1 = \sqrt{\frac{1}{2} \left\{ \frac{z^2}{r^2}(e_0^2 - 2rp) + \frac{ze_0}{r} \left(\frac{x}{r} \cos \phi + \sin \phi \right) \sqrt{e_0^2 - 4rp} \right\}}$$

$$= \frac{e_0 z}{r} \sqrt{\frac{1}{2} \left\{ \left(1 - \frac{2rp}{e_0^2} \right) + \frac{x}{z} \cos \phi + \frac{r}{z} \sin \phi \right\} \sqrt{1 - \frac{4rp}{e_0^2}}}; \quad (19)$$

$$i = \sqrt{\frac{1}{2} \left\{ \left(\frac{1}{r^2} (e_0^2 - 2rp) + \frac{e_0}{rz} \left(\frac{x}{r} \cos \phi - \sin \phi \right) \sqrt{e_0^2 - 4rp} \right) \right\}}$$

$$= \frac{e_0}{r} \sqrt{\frac{1}{2} \left\{ \left(1 - \frac{2rp}{e_0^2} \right) + \left(\frac{x}{z} \cos \phi - \frac{r}{z} \sin \phi \right) \sqrt{1 - \frac{4rp}{e_0^2}} \right\}}. \quad (20)$$

The parameter, ϕ , has no direct physical meaning, apparently.

These equations (19) and (20), by giving the values of e_1 and i as functions of p and the parameter, ϕ , enable us to construct the *power characteristics of the synchronous motor*, as the curves relating e_1 and i , for a given power, p , by attributing to ϕ all different values.

Since the variables, v and w , in the equation of the circle (16) are quadratic functions of e_1 and i , the *power characteristics of the synchronous motor are quartic curves*.

They represent the action of the synchronous motor under all conditions of load and excitation, as an element of power transmission even including the line, etc.

Before discussing further these power characteristics, some special conditions may be considered.

220. A. Maximum Output.

Since the expression of e_1 and i [equations (19) and (20)] contain the square root, $\sqrt{e_0^2 - 4rp}$, it is obvious that the maximum value of p corresponds to the moment where this square root disappears by passing from real to imaginary; that is,

$$e_0^2 - 4rp = 0,$$

$$\text{or,} \quad p = \frac{e_0^2}{4r}. \quad (21)$$

This is the same value which represents the maximum power transmissible by c.m.f., e_0 , over a non-inductive line of resistance, r ; or, more generally, the maximum power which can be transmitted over a line of impedance,

$$z = \sqrt{r^2 + x^2},$$

into any circuit, shunted by a condenser of suitable capacity.

Substituting (21) in (19) and (20), we get,

$$\left. \begin{aligned} e_1 &= \frac{z}{2r} e_0, \\ i &= \frac{e_0}{2r}, \end{aligned} \right\} \quad (22)$$

and the displacement of phase in the synchronous motor,

$$\cos (e_1, i) = \frac{p}{ie_1} = \frac{r}{z};$$

hence,

$$\tan (e_1, i) = -\frac{x}{r}, \tag{23}$$

that is, the angle of internal displacement in the synchronous motor is equal, but opposite to, the angle of displacement of line impedance,

$$\begin{aligned} (e_1, i) &= - (e, i), \\ &= - (z, r), \end{aligned} \tag{24}$$

and consequently,

$$(e_0, i) = 0; \tag{25}$$

that is, the current, i , is in phase with the impressed e.m.f., e_0 .

If $z < 2r$, $e_1 < e_0$; that is, motor e.m.f. < generator e.m.f.

If $z = 2r$, $e_1 = e_0$; that is, motor e.m.f. = generator e.m.f.

If $z > 2r$, $e_1 > e_0$; that is, motor e.m.f. > generator e.m.f.

In either case, the current in the synchronous motor is leading.

221. B. Running Light, $p = 0$.

When running light, or for $p = 0$, we get, by substituting in (19) and (20),

$$\begin{aligned} e_1 &= \frac{e_0 z}{r} \sqrt{\frac{1}{2} \left\{ 1 + \frac{x}{z} \cos \phi + \frac{r}{z} \sin \phi, \right\}} \\ i &= \frac{e_0}{z} \sqrt{\frac{1}{2} \left\{ 1 + \frac{x}{z} \cos \phi - \frac{r}{z} \sin \phi. \right\}} \end{aligned} \tag{26}$$

Obviously this condition cannot well be fulfilled, since p must at least equal the power consumed by friction, etc.; and thus the true no-load curve merely approaches the curve $p = 0$, being, however, rounded off, where curve (26) gives sharp corners.

Substituting $p = 0$ into equation (7) gives, after squaring and transposing,

$$e_1^4 + e_0^4 + z^4 i^4 - 2 e_1^2 e_0^2 - 2 z^2 i^2 e_0^2 + 2 z^2 i^2 e_1^2 - 4 x^2 i^2 e_1^2 = 0. \tag{27}$$

This quartic equation can be resolved into the product of two quadratic equations,

$$\begin{aligned} e_1^2 + z^2 i^2 - e_0^2 + 2 x i e_1 &= 0. \\ e_1^2 + z^2 i^2 - e_0^2 - 2 x i e_1 &= 0. \end{aligned} \tag{28}$$

which are the equations of two ellipses, the one the image of the other, both inclined with their axes.

The minimum value of counter e.m.f., e_1 , is $e_1 = 0$ at $i = \frac{e_0}{z}$ (29)

The minimum value of current, i , is $i = 0$ at $e_1 = e_0$. (30)

The maximum value of e.m.f., e_1 , is given from equation (28)

$$f = e_1^2 + z^2 i^2 - e_0^2 \pm 2 x i e_1 = 0;$$

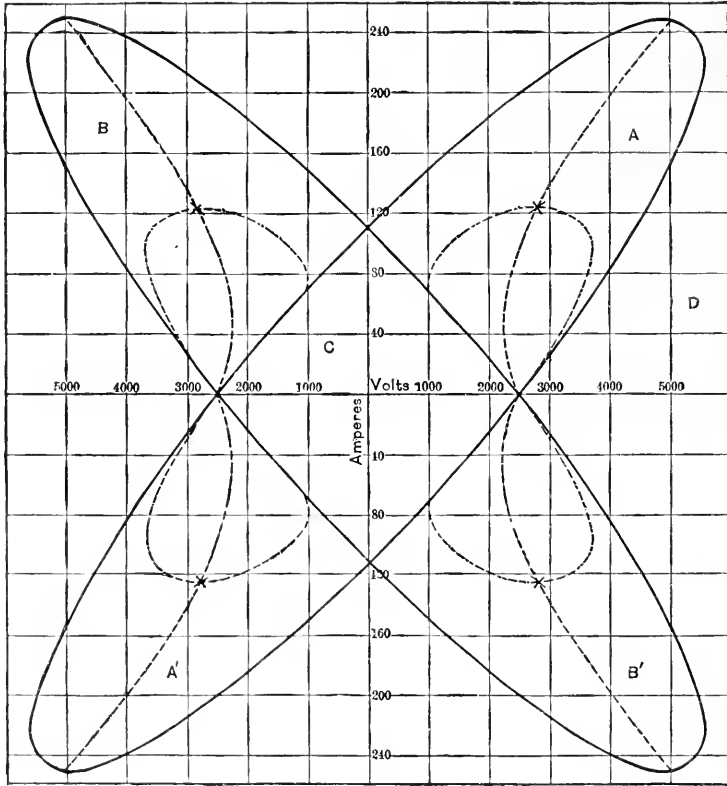

FIG. 161.

by the condition,

$$\frac{de_1}{di} = - \frac{df/di}{df/de_1} = 0, \text{ as } z^2 i \mp x e_1 = 0,$$

hence,

$$i = e_0 \frac{x}{r z^2}, e_1 = \pm e_0 \frac{z}{r}. \tag{31}$$

The maximum value of current, i , is given from equation (28) by

$$\frac{di}{de_1} = 0,$$

as

$$i = \frac{e_0}{r} e_1 = \mp e_0 \frac{x}{r}. \tag{32}$$

If, as abscissas, e_1 , and as ordinates, zi , are chosen, the axes of these ellipses pass through the points of maximum power given by equation (22).

It is obvious thus, that in the V-shaped curves of synchronous motors running light, the two sides of the curves are not straight lines, as sometimes assumed, but arcs of ellipses, the one of concave, the other of convex, curvature.

These two ellipses are shown in Fig. 161, and divide the whole space into six parts—the two parts, A and A' , whose areas contain the quartic curves (19) (20) of the synchronous motor, the two parts, B and B' , whose areas contain the quartic curves of the generator, the interior space, C , and exterior space, D , whose points do not represent any actual condition of the alternator circuit, but make e_1 and i imaginary. Some of the quartic curves, however, may overlap into space, C .

A and A' and the same B and B' are identical conditions of the alternator circuit, differing merely by a simultaneous reversal of current and e.m.f., that is differing by the time of a half-period.

Each of the spaces A and B contains one point of equation (22), representing the condition of maximum output as generator, viz., synchronous motor.

222. C. Minimum Current at Given Power.

The condition of minimum current, i , at given power, p , is determined by the absence of a phase displacement at the impressed e.m.f., e_0 ,

$$(e_0, i) = 0.$$

This gives from diagram Fig. 160,

$$e_1^2 = e_0^2 + i^2 z^2 - 2 i e_0 r, \tag{33}$$

or, transposed,

$$e_1 = \sqrt{(e_0 - ir)^2 + i^2 z^2}. \tag{34}$$

This quadratic curve passes through the point of zero current and zero power,

$$i = 0, \quad e_1 = e_0,$$

through the point of maximum power (22),

$$i = \frac{e_0}{2r}, \quad e_1 = \frac{e_0 z}{2r},$$

and through the point of maximum current and zero power,

$$i = \frac{e_0}{r}, \quad e_1 = \frac{e_0 x}{r}, \quad (35)$$

and divides each of the quartic curves or power characteristics into two sections, one with leading, the other with lagging, current, which sections are separated by the two points of equation (34), the one corresponding to minimum, the other to maximum, current.

It is interesting to note that at the latter point the current can be many times larger than the current which would pass through the motor while at rest, which latter current is,

$$i = \frac{e_0}{z}, \quad (36)$$

while at no-load the current can reach the maximum value,

$$i = \frac{e_0}{r}, \quad (35)$$

the same value as would exist in a non-inductive circuit of the same resistance.

The minimum value at counter e.m.f., e_1 , at which coincidence of phase, $(e_0, i) = 0$, can still be reached is determined from equation (34) by,

$$\frac{de_1}{di} = 0,$$

as

$$i = e_0 \frac{r}{z^2}, \quad e_1 = e_0 \frac{x}{z}. \quad (37)$$

The curve of no-displacement, or of minimum current, is shown in Figs. 161 and 162 in dotted lines.¹

¹ It is interesting to note that the equation (34) is similar to the value $e_1 = \sqrt{(e_0 - ir)^2 - i^2 x^2}$, which represents the output transmitted over an inductive line of impedance, $z = \sqrt{r^2 + x^2}$, into a non-inductive circuit.

Equation (34) is identical with the equation giving the maximum voltage, e_1 , at current, i , which can be produced by shunting the receiving circuit with a condenser; that is, the condition of "complete resonance" of the line, $z = \sqrt{r^2 + x^2}$, with current, i . Hence, referring to equation (35), $e_1 = e_0 \frac{x}{r}$ is the maximum resonance voltage of the line reached when closed by a condenser of reactance, $-x$.

223. D. *Maximum Displacement of Phase.*

$$(e_0, i) = \text{maximum.}$$

At a given power, p , the input is,

$$p_0 = p + i^2r = e_0i \cos (e_0, i); \tag{38}$$

hence,

$$\cos (e_0, i) = \frac{p + i^2r}{e_0i}. \tag{39}$$

At a given power, p , this value, as function of the current, i , is a maximum when

$$\frac{d}{di} \left(\frac{p + i^2r}{e_0i} \right) = 0;$$

this gives,

$$p = i^2r, \tag{40}$$

or,

$$i = \sqrt{\frac{p}{r}}. \tag{41}$$

That is, the displacement of phase, lead or lag is a maximum when the power of the motor equals the power consumed by the resistance; that is, at the electrical efficiency of 50 per cent.

Substituting (40) in equation (7) gives, after squaring and transposing, the quartic equation of maximum displacement,

$$(e_0^2 - e_1^2)^2 + i^4z^2(z^2 + 8r^2) + 2i^2e_1^2(4r^2 - z^2) - 2i^2e_0^2(z^2 + 3r^2) = 0. \tag{42}$$

The curve of maximum displacement is shown in dash-dotted lines in Figs. 161 and 162. It passes through the point of zero current—as singular or nodal point—and through the point of maximum power, where the maximum displacement is zero, and it intersects the curve of zero displacement.

224. E. *Constant Counter e.m.f.*

At constant counter e.m.f., $e_1 = \text{constant}$.

If

$$e_1 < e_0 \frac{e_0x}{z}$$

the current at no-load is not a minimum, and is lagging. With increasing load the lag decreases, reaches a minimum, and then increases again, until the motor falls out of step, without ever coming into coincidence of phase.

If

$$\frac{e_0x}{z} < e_1 < e_0,$$

the current is lagging at no-load. With increasing load the lag decreases, the current comes into coincidence of phase with e_0 , then becomes leading, reaches a maximum lead; then the lead decreases again, the current comes again into coincidence of phase, and becomes lagging, until the motor falls out of step.

If $e_0 < e_1$, the current is leading at no-load, and the lead first increases, reaches a maximum, then decreases; and whether the current ever comes into coincidence of phase and then becomes lagging, or whether the motor falls out of step while the current is still leading, depends whether the counter e.m.f. at the point of maximum output is $> e_0$ or $< e_0$.

225. F. Numerical Example.

Figs. 161 and 162 show the characteristics of a 100-kw. motor supplied from a 2500-volt generator over a distance of 5 miles, the line consisting of two wires, No. 2 B. & S., 18 in. apart.

In this case we have:

$$\left. \begin{aligned} e_0 &= 2500 \text{ volts constant at generator terminals;} \\ r &= 10 \text{ ohms, including line and motor;} \\ x &= 20 \text{ ohms, including line and motor;} \end{aligned} \right\} \quad (43)$$

hence $z = 22.36$ ohms.

Substituting these values, we get:

$$2500^2 - e_1^2 - 500 i^2 - 20 p = 40 \sqrt{i^2 e_1^2 - p^2} \quad (7)$$

$$\{e_1^2 + 500 i^2 - 31.25 \times 10^6 + 100 p\}^2 + \{2 e_1^2 - 1000 i^2\}^2 = 7.8125 \times 10^{14} - 5 \times 10^9 p. \quad (17)$$

$$e_1 = 5590 \times \quad (19)$$

$$i = 250 \times \frac{\sqrt{\frac{1}{2}\{(1 - 3.2 \times 10^{-6} p) + (0.894 \cos \phi + 0.447 \sin \phi)\}}}{\sqrt{1 - 6.4 \times 10^{-6} p}}. \quad (20)$$

$$\sqrt{\frac{1}{2}\{(1 - 3.2 \times 10^{-6} p) + (0.894 \cos \phi - 0.447 \sin \phi)\}} \sqrt{16.4 \times 10^{-6} p}.$$

Maximum output,

$$p = 156.25 \text{ kw.} \quad (21)$$

$$\text{at } \left. \begin{aligned} e_1 &= 2795 \text{ volts} \\ i &= 125 \text{ amp.} \end{aligned} \right\} \quad (22)$$

Running light,

$$\left. \begin{aligned} e_1^2 + 500 i^2 - 6.25 \times 10^4 \mp 40 i e_1 &= 0 \\ e_1 &= 20 i \pm \sqrt{6.25 \times 10^4 - 100 i^2} \end{aligned} \right\} \quad (28)$$

At the minimum value of counter e.m.f., $e_1 = 0$ is $i = 112$ (29)

At the minimum value of current, $i = 0$ is $e_1 = 2500$ (30)

At the maximum value of counter e.m.f., $e_1 = 5590$ is $i = 223.5$ (31)

At the maximum value of current, $i = 250$ is $e_1 = 5000$. (32)

Curve of zero displacement of phase,

$$e_1 = 10 \sqrt{(250 - i)^2 + 4 i^2} \quad (34)$$

$$= 10 \sqrt{6.25 \times 10^4 - 500 i + 5 i^2}.$$

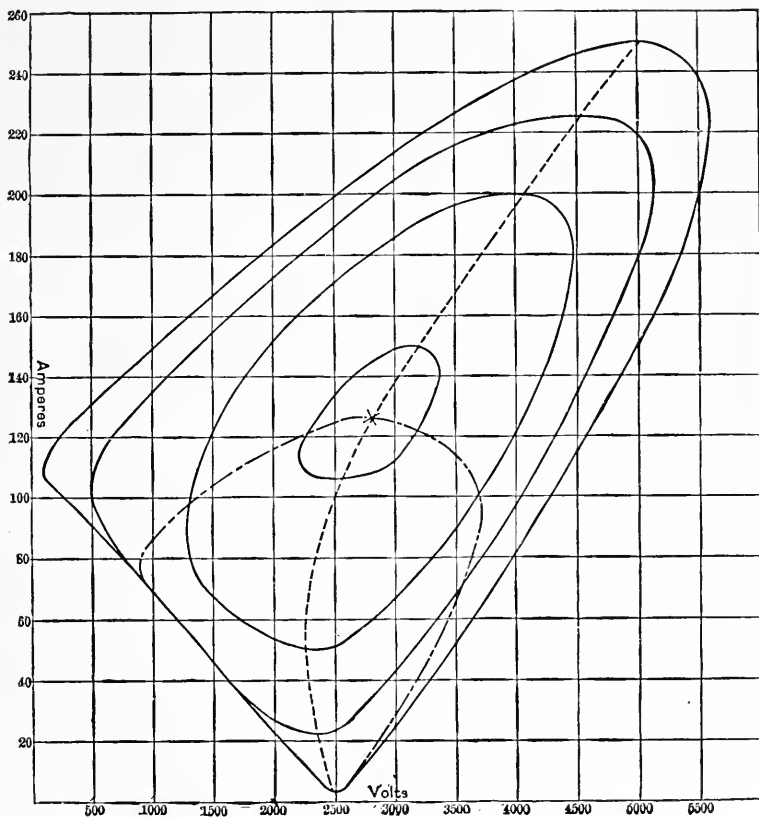

FIG. 162.

Minimum counter e.m.f. point of this curve,

$$i = 50, \quad e_1 = 2240. \quad (35)$$

Curve of maximum displacement of phase,

$$p = 10 i^2 \quad (40)$$

$$(6.25 \times 10^6 - e_1^2)^2 + 0.65 \times 10^6 i^4 - 10^{10} i^2 = 0 \quad (42)$$

Fig. 161 gives the two ellipses of zero power in full lines, with the curves of zero displacement in dotted, the curves of maximum displacement in dash-dotted lines, and the points of maximum power as crosses.

Fig. 162 gives the motor-power characteristics for $p = 10$ kw.; $p = 50$ kw.; $p = 100$ kw.; $p = 150$ kw., and $p = 156.25$ kw., together with the curves of zero displacement and of maximum displacement.

226. G. Discussion of Results.

The characteristic curves of the synchronous motor, as shown in Fig. 162, have been observed frequently, with their essential features, the V-shaped curve of no-load, with the point rounded off and the two legs slightly curved, the one concave, the other

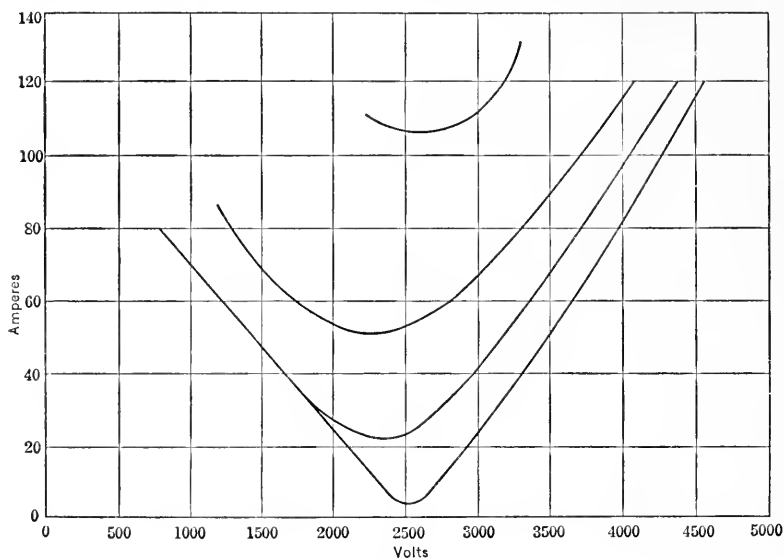

FIG. 163.

convex; the increased rounding off and contraction of the curves with increasing load; and the gradual shifting of the point of minimum current with increasing load, first toward lower, then toward higher, values of counter e.m.f., e_1 .

The upper parts of the curves, however, I have never been able to observe completely and consider it as probable that they correspond to a condition of synchronous motor running, which is unstable. The experimental observations usually

extend about over that part of the curves of Fig. 162 which is reproduced in Fig. 163, and in trying to extend the curves further to either side, the motor is thrown out of synchronism.

It must be understood, however, that these power characteristics of the synchronous motor in Fig. 162 can be considered as approximations only, since a number of assumptions are made which are not, or only partly, fulfilled in practice. The foremost of these are:

1. It is assumed that e_1 can be varied unrestrictedly, while in reality the possible increase of e_1 is limited by magnetic saturation. Thus in Fig. 162, at an impressed e.m.f., $e_0 = 2500$ volts, e_1 rises up to 5590 volts, which may or may not be beyond that which can be produced by the motor, but certainly is beyond that which can be constantly given by the motor.

2. The reactance, x , is assumed as constant. While the reactance of the line is practically constant, that of the motor is not, but varies more or less with the saturation, decreasing for higher values. This decrease of x increases the current, i , corresponding to higher values of e_1 , and thereby bends the curves upward at a lower value of e_1 than represented in Fig. 162.

It must be understood that the motor reactance is not a simple quantity, but represents the combined effect of self-induction, that is, the e.m.f. generated in the armature conductor by the current therein and armature reaction, or the variation of the counter e.m.f. of the motor by the change of the resultant field, due to the superposition of the m.m.f. of the armature current upon the field-excitation; that is, it is the "synchronous reactance."

3. Furthermore, this synchronous reactance usually is not a constant quantity even at constant induced e.m.f., but varies with the position of the armature with regard to the field; that is, varies with the current and its phase angle, as discussed in the chapter on the armature reactions of alternators. While in most cases the synchronous reactance can be assumed as constant, with sufficient approximation, sometimes a more complete investigation is necessary, consisting in a resolution of the synchronous impedance in two components, in phase and in quadrature respectively with the field-poles.

Especially is this the case at low power-factors. So by gradually decreasing the excitation and thereby the e.m.f., e , the curves may, especially at light load, occasionally be extended

below zero, into negative values of e , or onto the part of the curve, B , in Fig. 161, while the power still remains constant and positive, as synchronous motor. In other words, the motor keeps in step even if the field-excitation is reversed; the lagging component of the armature reaction magnetizes the field, in opposition to the demagnetizing action of the reversed field excitation.

4. These curves in Fig. 162 represent the conditions of constant electric power of the motor, thus including the mechanical and the magnetic friction (core loss). While the mechanical friction can be considered as approximately constant, the magnetic friction is not, but increases with the magnetic induction; that is, with e_1 , and the same holds for the power consumed for field excitation.

Hence the useful mechanical output of the motor will on the same curve, $p = \text{const.}$, be larger at points of lower counter e.m.f., e_1 , than at points of higher e_1 ; and if the curves are plotted for constant useful mechanical output, the whole system of curves will be shifted somewhat toward lower values of e_1 ; hence the points of maximum output of the motor correspond to a lower e.m.f. also.

It is obvious that the true mechanical power characteristics of the synchronous motor can be determined only in the case of the particular conditions of the installation under consideration.

227. H. *Phase Characteristics of the Synchronous Motor.*

While an induction motor at constant impressed voltage is fully determined as regards to current, power-factor, efficiency, etc., by one independent variable, the load or output; in the synchronous motor two independent variables exist, load and field-excitation. That is, at constant impressed voltage the current, power-factor, etc., of a synchronous motor can at the same power output be varied over a wide range by varying the field-excitation, that is, the counter e.m.f. or "nominal generated e.m.f." Hence the synchronous motor can be utilized to fulfill two independent functions: to carry a certain load and to produce a certain wattless current, lagging by under-excitation, leading by over-excitation. Synchronous motors are, therefore, to a considerable extent used to control the phase relation and thereby the voltage, in addition to producing mechanical power.

The same applies to synchronous converters.

With given impressed e.m.f., field-excitation or nominal gener-

ated e.m.f. corresponding thereto, and load, determine all the quantities of the synchronous motor, as current, power-factor, etc. Thus if in diagram Fig. 164, $\overline{OE} = e =$ e.m.f. consumed by the counter e.m.f. or nominal generated e.m.f. of the synchronous motor, and if $P_0 =$ output of motor (exclusive of friction and core loss and, if the exciter is driven by the motor, power consumed by the exciter), $i_1 = \frac{P_0}{e} =$ power component of current, represented by $\overline{OI_1}$, and the current vector therefore must terminate on a line, i , perpendicular to $\overline{OI_1}$. If, then, $r =$ resistance and $x =$ reactance of the circuit between counter e.m.f., e , and im-

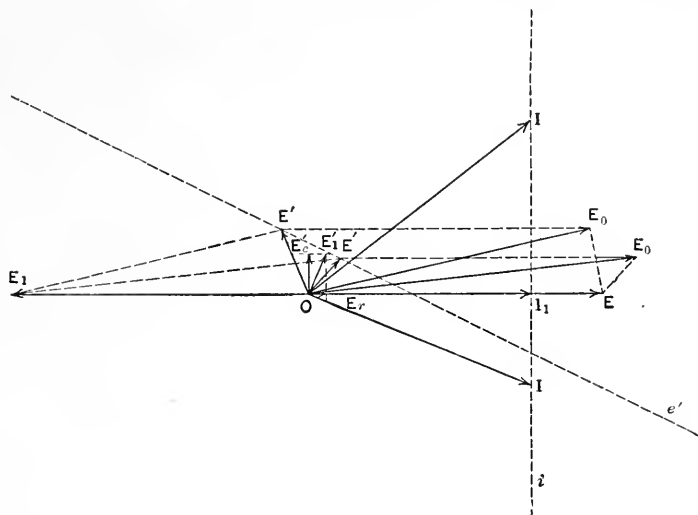

FIG. 164.

pressed e.m.f., e_0 , $\overline{OE_r} = i_1 r =$ e.m.f. consumed by resistance, $\overline{OE_x} = i_1 x =$ e.m.f. consumed by reactance of the power component of the current, i_1 , hence $\overline{OE'_1} =$ e.m.f. consumed by impedance of the power component of the current, i_1 , and the impedance voltage of the total current lies on the perpendicular e' on $\overline{OE'_1}$. Producing $\overline{OE_1} = \overline{OE}$, and drawing an arc with the impressed e.m.f., e_0 , as radius and E_1 as center, the point of intersection with e' gives the impedance voltage, $\overline{OE'}$, and corresponding thereto the current $\overline{OI} = i$; and completing the parallelogram, OEE_0E' , gives the impressed e.m.f., $\overline{OE_0}$.

Hence, by impressed e.m.f., e_0 , counter e.m.f., e , and load, P_0 , the vector diagram is determined, and thereby the vectors, $OI =$

current, $\overline{OE_0}$ = impressed e.m.f., \overline{OE} = counter e.m.f., and their phase relation.

Or, in symbolic representation, let

$$E_0 = e'_0 - je''_0 = \text{impressed e.m.f.};$$

$$e_0 = \sqrt{e_0'^2 + e_0''^2}; \tag{1}$$

$$E = e' - je'' = \text{e.m.f. consumed by counter e.m.f.};$$

$$e = \sqrt{e'^2 + e''^2}; \tag{2}$$

$I = i$ = current, assumed as zero vector;

$Z = r + jx$ = impedance of circuit between e_0 and e .

Z is the synchronous impedance of the motor, if e_0 is its terminal voltage. It is the impedance of transmission line with transformers and motor, if e_0 is terminal voltage of generator, and Z is synchronous impedance of motor and generator, plus impedance of line and transformers, if e_0 is the nominal generated e.m.f. of the generator (corresponding to its field-excitation).

It is, then,

$$E_0 = E + iZ, \tag{3}$$

or,

$$e'_0 - je''_0 = e' - je'' + ir + jix, \tag{4}$$

and, resolved,

$$\begin{cases} e'_0 = e' + ir; & (5) \\ e''_0 = e'' - ix. & (6) \end{cases}$$

The power output of the motor (inclusive of friction and core loss, and if the exciter is driven by the motor, power consumed by exciter) is current times power component of generated e.m.f., or

$$P_0 = e'i. \tag{7}$$

Hence, the calculation of the motor, of supply voltage e_0 from power output, P_0 , occurs by the equations:

Chosen: i = current.

$$\left. \begin{aligned} (7) \quad e' &= \frac{P_0}{i}, \\ (5) \quad e'_0 &= e' + ir, \\ (1) \quad e''_0 &= \pm \sqrt{e_0^2 - e_0'^2}, \\ (6) \quad e'' &= e''_0 + ix \\ (2) \quad e &= \sqrt{e'^2 + e''^2}. \end{aligned} \right\} \tag{8}$$

That is, at given power, P_0 , to every value of current, i , correspond two values of the counter e.m.f., e (and hence the field-excitation).

Solving equations (8) for i and P_0 , that is, eliminating e' , e'_0 , e''_0 , e'' , gives as the nominal generated e.m.f.,

$$e = \sqrt{e_0^2 - r^2i^2 + x^2i^2 - 2rP_0 \pm 2xi \sqrt{e_0^2 - \left(\frac{P_0}{i} + ri\right)^2}}, \quad (9)$$

and the power-factor of the motor is,

$$\cos \theta = \frac{e'}{e} = \frac{P_0}{ei}, \quad (10)$$

The power-factor of the supply is

$$\cos \theta_0 = \frac{e'_0}{e_0} = \frac{\frac{P_0}{i} + ir}{e_0} = \frac{P_0 + ri^2}{e_0i}. \quad (11)$$

From equation (9), by solving for i , i can now be expressed as function of P_0 and e , that is, of power output and field-excitation.

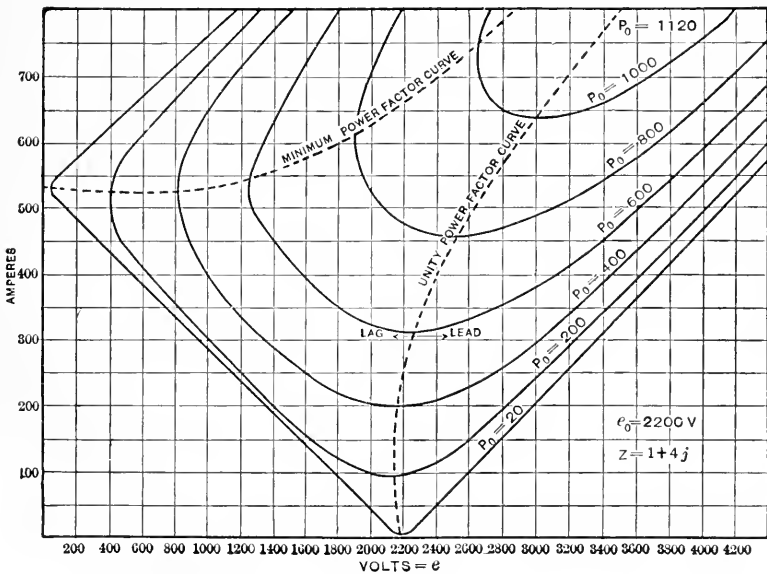

FIG. 165.

248. As illustrations are plotted, in Fig. 165, curves giving the current, i , as function of the counter or nominal generated e.m.f., e , at constant power, P_0 . Such curves as discussed before in Figs. 161, 162, 163, are called "phase characteristics of the synchronous motor."

They are given for the values

$$\begin{aligned} e_0 &= 2200 \text{ volts,} \\ Z &= 1 + 4j \text{ ohms,} \end{aligned}$$

and

$$P_0 = 20, 200, 400, 600, 800, 1000 \text{ kw. output.}$$

The five equations of the synchronous motor,

$$\begin{aligned} (1) \quad e_0^2 &= e_0'^2 + e_0''^2, \\ (2) \quad e^2 &= e'^2 + e''^2, \\ (7) \quad P_0 &= e'i, \\ (5) \quad e'_0 &= e' + ir, \\ (6) \quad e''_0 &= e'' - ix, \end{aligned}$$

determine the five quantities, e'_0 , e''_0 , e' , e'' , e , as functions of P_0 and i .

The condition of zero phase displacement, or unity power-factor at the impressed e.m.f., e_0 , is

$$e''_0 = 0;$$

hence

$$e'_0 = e_0,$$

and

$$(6) \quad e'' = ix,$$

$$(5) \quad e' = e_0 - ir;$$

hence,

$$e^2 = (e_0 - ir)^2 + i^2x^2, \quad (12)$$

a quadratic equation, the hyperbola of unity power-factor, shown as dotted line in Fig. 165.

In this case, the power is found by substituting $e' = e_0 - ir$ in $P_0 = e'i$, as

$$P_0 = e_0i - i^2r, \quad (13)$$

or

$$i = \frac{e_0}{2r} \left\{ 1 \pm \sqrt{1 - \frac{4rP_0}{e_0^2}} \right\}. \quad (14)$$

The maximum output of the synchronous motor follows herefrom, by the condition,

$$\sqrt{1 - \frac{4rP_0}{e_0^2}} = 0$$

as

$$P_m = \frac{e_0^2}{4r} \quad (15)$$

in above example

$$P_m = 1210 \text{ kw. at } i = 1100 \text{ amp.}$$

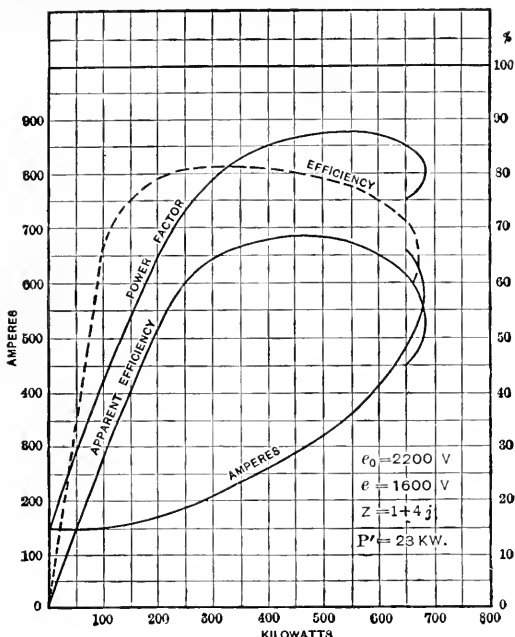

FIG. 166.

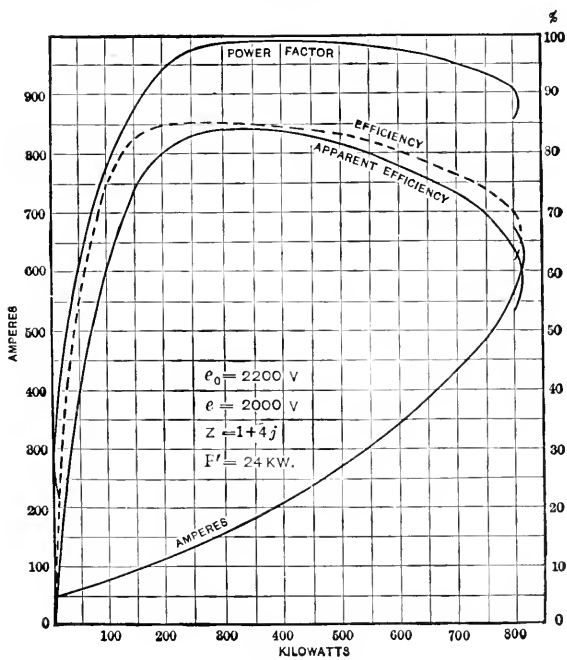

FIG. 167.

The curve of unity power-factor (12) divides the synchronous motor-phase characteristics into two sections, one, for lower e , with lagging, the other with leading current.

The study of these "phase characteristics," Fig. 165, gives the best insight into the behavior of the synchronous motor under conditions of steady operation.

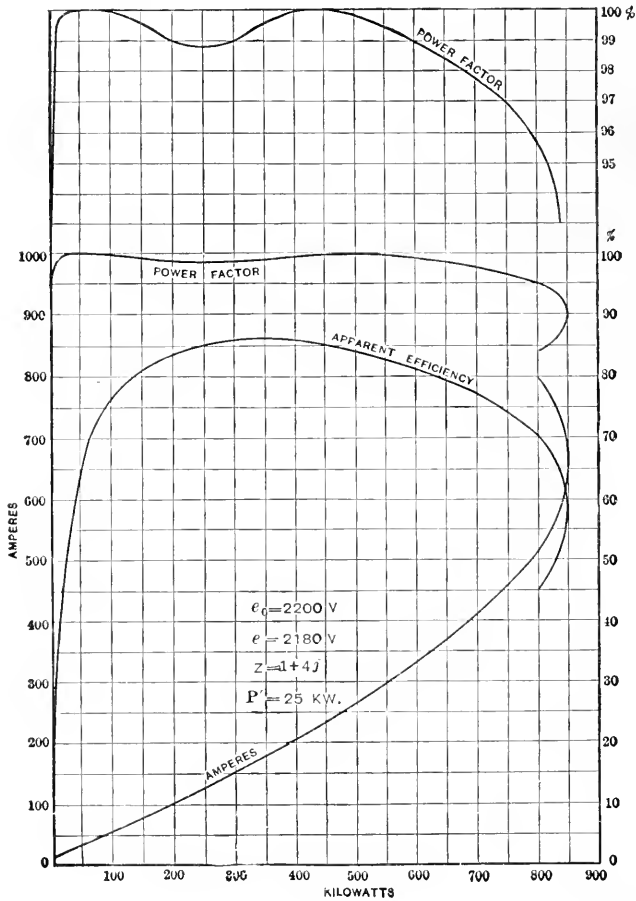

FIG. 168.

229. I. Load Curves of Synchronous Motor.

Of special interest are the "load curves" of the synchronous motor, or curves giving, at constant excitation, $e = \text{constant}$, the current, power-factor, efficiency and apparent efficiency as

function of the load or output $P = P_0 - (\text{friction} + \text{core loss} + \text{excitation})$. Such load curves are represented in Figs. 166 to 170, for $e = 1600, 2000, 2180, 2400, 2800$ volts. They can be derived from Fig. 165 as the intersection of the curves $P_0 = \text{constant}$ with the vertical lines $e = \text{constant}$.

Hence, while an induction motor has one load curve only, a synchronous motor has an infinite series of load curves, depending upon the value of e .

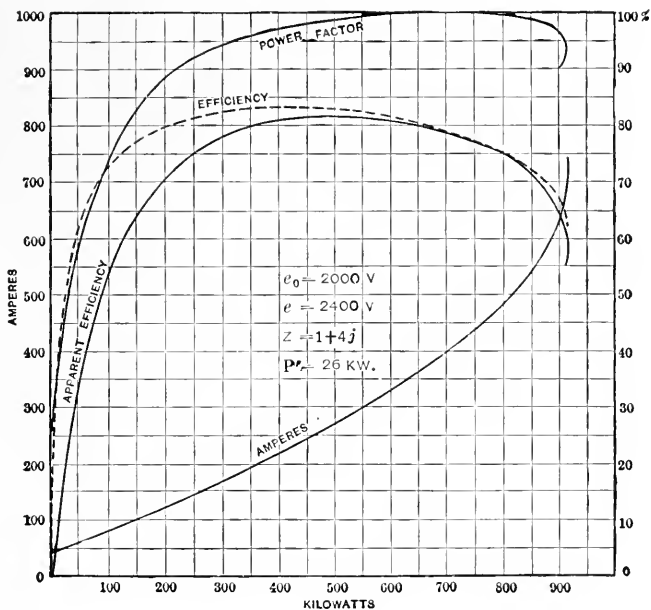

FIG. 169.

For low values of e ($e = 1600$, under excitation, Fig. 166), the load curves are similar to those of an induction motor. The current is lagging, the power-factor rises from a low initial value to a maximum, and then falls again. With increasing excitation ($e = 2000$, Fig. 167) the power-factor curve rises to values beyond those available in induction motors, approaches and ultimately touches unity, and with still higher excitation ($e = 2180$, Fig. 168) two points of unity power-factor exist, at $P = 20$ and $P = 450$ kw. output, which are separated by a range with leading current, while at very low and very high load the current is lagging. The first point of unity power-factor

moves toward $P = 0$, and then disappears, that is, the current becomes leading already at no-load, and the second point of unity power-factor moves with increasing excitation toward higher loads, from $P = 450$ kw. at $e = 2180$ in Fig. 168, to $P = 700$ kw. at $e = 2400$, Fig. 169, and $P = 900$ kw. at $e = 2800$, Fig. 170, while the power-factor and thereby the apparent efficiency decrease at light loads. The maximum output increases with the increase of excitation and almost proportionally thereto.

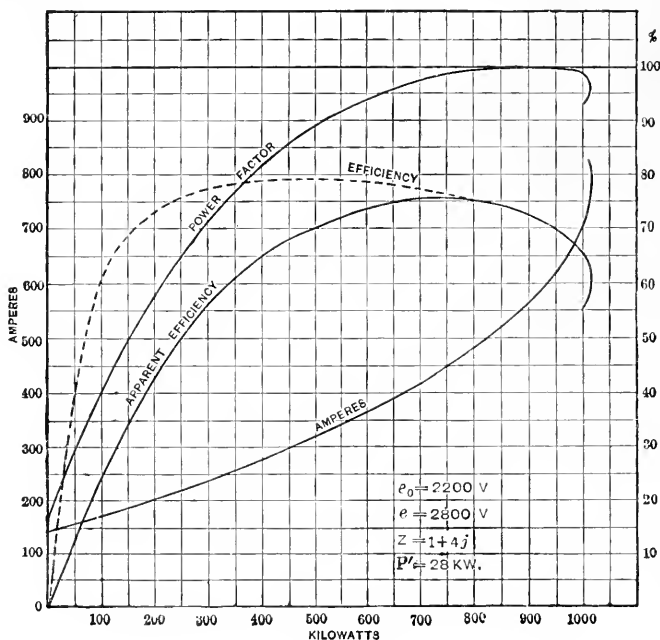

FIG. 170.

It is interesting that at $e = 2180$, the power-factor is practically unity over the whole range of load up to near the maximum output. It is shown once more in Fig. 168 with increased scale of the ordinates. A synchronous motor at constant excitation can, therefore, give practically unity power-factor for all loads.

The resistance, $r = 1$ ohm, is assumed so as to represent a synchronous motor inclusive of transmission line, with about 9 per cent. loss of energy in the line at 400 kw. output.

The friction and core loss are assumed as 20 kw., the excitation as 4 kw. at $e = 2000$.

Considering the intersections of a horizontal line with the constant power curves of Fig. 165, gives the characteristic curves of the synchronous motor when operating on constant current. Such curves are shown for $i = 300$ in Fig. 171. They illustrate

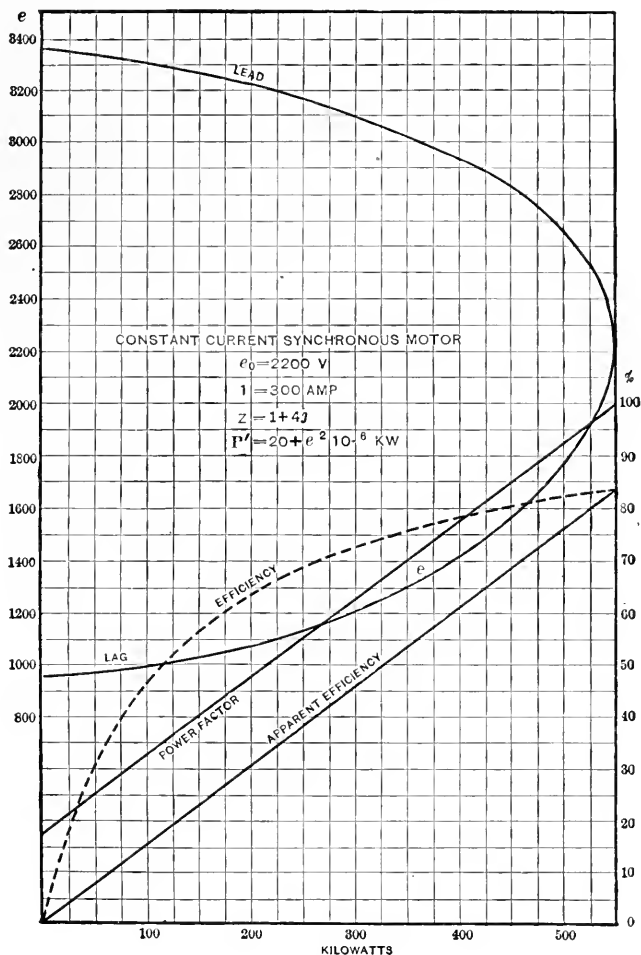

FIG. 171.

that at the same impressed voltage, with the same current input the power output of the synchronous motor can vary over a wide range, and also that for each value of power output two points exist, one with lagging, the other with leading current.

As regards phase characteristics and load characteristics, the same applies to the synchronous converter as to the synchronous motor, except that in the former the continuous current output affords a means of automatically varying the excitation with the load.

230. The investigation of a variation of the armature reaction and the self-induction, that is, of the synchronous reactance, with the position of the armature in the magnetic field, and so the intensity and phase of the current in its effect on the characteristic curves of the synchronous motor, can be carried out in the same manner as done for the alternating-current generator in Chapter XX.

In the graphical and the symbolic investigations in Chapter XX, the current, $I = i_1 - j i_2$, has been considered as the output current, and chosen of such phase as to differ less than 90° from the terminal voltage, $E = e_1 + j e_2$, so representing power output.

Choosing then the current vector, \overline{OI} , in opposite direction from that chosen in Figs. 139 and 140, and then constructing the diagram in the same manner as done in Chapter XX, brings the output current, \overline{OI} , more than 90° displaced from the terminal voltage, \overline{OE} . Then the current consumes power, that is, the machine is a synchronous motor. The graphical representation in Chapter XX so applies equally well to alternating-current generator as to synchronous motor, and the former corresponds to the case $\angle EOI < 90^\circ$, the latter to the case: $\angle EOI > 90^\circ$.

In the same manner, in the symbolic representation of Chapter XX, choosing the current as $I = -i_1 + j i_2$, or, in the final equation, where the current has been assumed as zero vector, $I = -i$, that is, reversing all the signs of the current, gives the equations of the synchronous motor.

Choosing the same denotations as in Chapter XX, and substituting $-i$ for $+i$ in equation (64) so gives the general equation of the synchronous motor,

$$e_0 = \frac{(e_1 - ri)^2 + (e_2 - x'_{0i})(e_2 - x''_{0i})}{\sqrt{(e_1 - ri)^2 + x'_{0i}{}^2}}$$

and for non-inductive load,

$$e_0 = \frac{(e - ri)^2 + x'_0 x''_0 i^2}{\sqrt{(e - ri)^2 + x_0''^2 i^2}}$$

Or, by choosing \overline{OI} in the graphic, and $\dot{I} = \dot{I}' + \dot{I}''$ in the symbolic method, as the input current, the diagram can be constructed by combining the vectors in their proper directions, that is, where they are added in Chapter XX, they are now subtracted, and inversely. For instance,

$$\dot{E}_1 = \dot{E}_2 + \dot{E}_3, \quad \dot{E} = \dot{E}_1 + \dot{E}_4, \text{ etc.}$$

The reversal of the sign of the current in the above equations, compared with the equations of Chapter XX, shows that in the synchronous motor, the effect of lag and of lead of the input current are the opposite of the effect of lag and lead of the output current in the generator, as discussed before.

It also follows herefrom, that the representation of the internal reactions of the synchronous motor by an effective reactance, the "synchronous reactance," is theoretically justified; but that, like in the alternating-current generator, this reactance may have to be resolved in two components, x'_0 and x'' , parallel and at right angles respectively to the field-poles.

231. The phase characteristics, Fig. 165, and more particularly the no-load curve, is of special importance in the so-called *synchronous condenser*, that is, a synchronous machine running idle and producing lagging or leading current at will.

As at constant impressed voltage, the reactive current taken by the synchronous machine depends upon, and varies with the field-excitation, synchronous motors offer a convenient means for producing reactive currents of varying amounts.

As lagging reactive currents can more conveniently be produced by stationary reactors, synchronous machines are mainly used for producing leading currents, or producing reactive currents varying between lag and lead. Therefore, the name "synchronous condenser" for such machines.

Their foremost use is:

1. For power-factor correction in systems of low power-factor, such as systems containing many induction motors or other reactive devices. In this case, the synchronous condenser is connected in shunt to the circuit as close to the source of the reactive lagging currents as feasible.

2. For voltage control of long-distance transmission lines. In very long lines, especially at 60 cycles, the inherent voltage regulation at the receiving end of the line becomes very poor, and then a synchronous condenser is made to "float" on the

receiving circuit, controlled by a voltage regulator so that its reactive current varies from lag at no-load on the line, to lead at heavy load, and thereby maintains the line voltage constant.

In synchronous condensers, low armature reaction is an advantage, as requiring less field regulation.

As synchronous condensers must run at high leading currents, and this is the condition where the tendency to surging is greatest, synchronous condensers are usually supplied with anti-hunting devices. For this purpose, generally a squirrel-cage winding in the field-poles is used. Such a winding is desirable also to improve the self-starting character of the machine.

Very large synchronous condensers are in successful operation on transmission lines of such length, that without the synchronous condenser, operation of the circuits would be entirely impossible.

SECTION VI

GENERAL WAVES

CHAPTER XXV

DISTORTION OF WAVE-SHAPE AND ITS CAUSES

232. In the preceding chapters we have considered the alternating currents and alternating e.m.fs. as sine waves or as replaced by their equivalent sine waves.

While this is sufficiently exact in most cases, under certain circumstances the deviation of the wave from sine shape becomes of importance, and with certain distortions it may not be possible to replace the distorted wave by an equivalent sine wave, since the angle of phase displacement of the equivalent sine wave becomes indefinite. Thus it becomes desirable to investigate the distortion of the wave, its causes and its effects.

Since, as stated before, any alternating wave can be represented by a series of sine functions of odd orders, the investigation of distortion of wave-shape resolves itself in the investigation of the higher harmonics of the alternating wave.

In general we have to distinguish between higher harmonics of e.m.f. and higher harmonics of current. Both depend upon each other in so far as with a sine wave of impressed e.m.f. a distorting effect will cause distortion of the current wave, while with a sine wave of current passing through the circuit, a distorting effect will cause higher harmonics of e.m.f.

233. In a conductor revolving with uniform velocity through a uniform and constant magnetic field, a sine wave of e.m.f. is generated. In a circuit with constant resistance and constant reactance, this sine wave of e.m.f. produces a sine wave of current. Thus distortion of the wave-shape or higher harmonics may be due to lack of uniformity of the velocity of the revolving conductor; lack of uniformity or pulsation of the magnetic field; pulsation of the resistance or pulsation of the reactance.

The first two cases, lack of uniformity of the rotation or of the magnetic field, cause higher harmonics of e.m.f. at open circuit. The last, pulsation of resistance and reactance, causes higher harmonics only when there is current in the circuit, that is, under load.

Lack of uniformity of the rotation is hardly ever of practical interest as a cause of distortion, since in alternators, due to mechanical momentum, the speed is always very nearly uniform during the period. A periodic pulsation of speed may occur in low speed singlephase machines.

Thus as causes of higher harmonics remain:

1st. Lack of uniformity and pulsation of the magnetic field, causing a distortion of the generated e.m.f. at open circuit as well as under load.

2d. Pulsation of the reactance, causing higher harmonics under load.

3d. Pulsation of the resistance, causing higher harmonics under load also.

Taking up the different causes of higher harmonics, we have:

Lack of Uniformity and Pulsation of the Magnetic Field.

234. Since most of the alternating-current generators contain definite and sharply defined field-poles covering in different types different proportions of the pitch, in general the magnetic flux interlinked with the armature coil will not vary as a sine wave, of the form

$$\Phi \cos \beta,$$

but as a complex harmonic function, depending on the shape and the pitch of the field-poles and the arrangement of the armature conductors. In this case the magnetic flux issuing from the field-pole of the alternator can be represented by the general equation,

$$\begin{aligned} \Phi = & A_0 + A_1 \cos \beta + A_2 \cos 2\beta + A_3 \cos 3\beta + \dots \\ & + B_1 \sin \beta + B_2 \sin 2\beta + B_3 \sin 3\beta + \dots \end{aligned}$$

If the reluctance of the armature is uniform in all directions, so that the distribution of the magnetic flux at the field-pole face does not change by the rotation of the armature, the rate of cutting magnetic flux by an armature conductor is Φ , and the e.m.f. generated in the conductor thus equal thereto in wave-shape. As a rule $A_0, A_2, A_4 \dots B_2, B_4$ equal zero; that is, successive field-poles are equal in strength and distribu-

tion of magnetism, but of opposite polarity. In some types of machines, however, especially inductor alternators, this is not the case.

The e.m.f. generated in a full-pitch armature turn—that is, armature conductor and return conductor distant from former by the pitch of the armature pole (corresponding to the distance from field-pole center to pole center)—is

$$\begin{aligned} \delta e &= \Phi_0 - \Phi_{180} \\ &= 2 \left\{ A_1 \cos \beta + A_3 \cos 3 \beta + A_5 \cos 5 \beta + \dots \right. \\ &\quad \left. + B_1 \sin \beta + B_3 \sin 3 \beta + B_5 \sin 5 \beta + \dots \right\} \end{aligned}$$

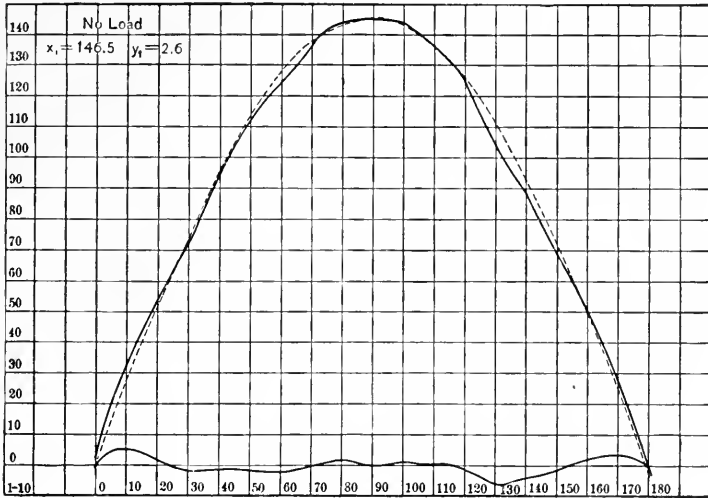

FIG. 172.

Even with an unsymmetrical distribution of the magnetic flux in the air-gap, the e.m.f. wave generated in a full-pitch armature coil is symmetrical, the positive and negative half-waves equal, and correspond to the mean flux distribution of adjacent poles. With fractional pitch-windings—that is, windings whose turns cover less than the armature pole-pitch—the generated e.m.f. can be unsymmetrical with unsymmetrical magnetic field, but as a rule is symmetrical also. In unitooth alternators the total generated e.m.f. has the same shape as that generated in a single turn.

With the conductors more or less distributed over the surface of the armature, the total generated e.m.f. is the resultant of

several e.m.f.s. of different phases, and is thus more uniformly varying; that is, more sinusoidal, approaching sine shape to within 3 per cent. or less, as for instance the curves Fig. 172 and Fig. 173 show, which represent the no-load and full-load wave of e.m.f. of a three-phase multitooth alternator. The principal term of these harmonics is the third harmonic, which consequently appears more or less in all alternator waves. As a rule these harmonics can be considered together with the harmonics due to the varying reluctance of the magnetic circuit.

In iron-clad alternators with few slots and teeth per pole, the passage of slots across the field-poles causes a pulsation of the

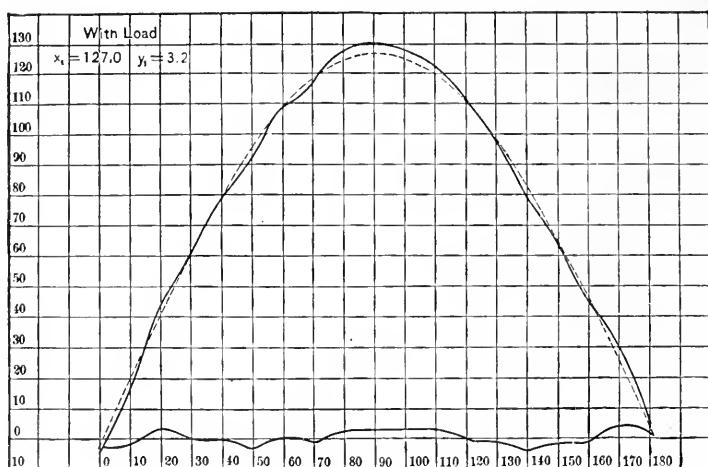

FIG. 173.

magnetic reluctance, or its reciprocal, the magnetic reactance of the circuit. In consequence thereof the magnetism per field-pole, or at least that part of the magnetism passing through the armature, will pulsate with a frequency 2γ , if γ = number of slots per pole.

Thus, in a machine with one slot per pole the instantaneous magnetic flux interlinked with the armature conductors can be expressed by the equation

$$\phi = \Phi \cos \beta \{ 1 + \epsilon \cos [2\beta - \theta] \}$$

where

Φ = average magnetic flux,

ϵ = amplitude of pulsation,

and

θ = phase of pulsation.

In a machine with γ slots per pole, the instantaneous flux interlinked with the armature conductors will be

$$\phi = \Phi \cos \beta \{ 1 + \epsilon \cos [2 \gamma \beta - \theta] \},$$

if the assumption is made that the pulsation of the magnetic flux follows a simple sine law, as first approximation.

In general the instantaneous magnetic flux interlinked with the armature conductors will be

$$\phi = \Phi \cos \beta \{ 1 + \epsilon_1 \cos (2 \beta - \theta_1) + \epsilon_2 \cos (4 \beta - \theta_2) + \dots \},$$

where the term ϵ_γ is predominating, if $\gamma =$ number of armature slots per pole. This general equation includes also the effect of lack of uniformity of the magnetic flux.

In case of a pulsation of the magnetic flux with the frequency, 2γ , due to an existence of γ slots per pole in the armature, the instantaneous value of magnetism interlinked with the armature coil is

$$\phi = \Phi \cos \beta \{ 1 + \epsilon \cos [2 \gamma \beta - \theta] \}.$$

Hence the e.m.f. generated thereby,

$$\begin{aligned} e &= -n \frac{d\phi}{dt} \\ &= -\sqrt{2} \pi f \Phi \frac{d}{d\beta} \{ \cos \beta (1 + \epsilon \cos [2 \gamma \beta - \theta]) \}. \end{aligned}$$

And, expanded,

$$\begin{aligned} e &= \sqrt{2} \pi f n \Phi \left\{ \sin \beta + \epsilon \frac{2\gamma - 1}{2} \sin [(2\gamma - 1)\beta - \theta] \right. \\ &\quad \left. + \epsilon \frac{2\gamma + 1}{2} \sin [(2\gamma + 1)\beta - \theta] \right\}. \end{aligned}$$

Hence, the pulsation of the magnetic flux with the frequency, 2γ , as due to the existence of γ slots per pole, introduces two harmonics, of the orders $(2 \gamma - 1)$ and $(2 \gamma + 1)$.

235. If $\gamma = 1$ it is

$$e = \sqrt{2} \pi f n \Phi \left\{ \sin \beta + \frac{\epsilon}{2} \sin (\beta - \theta) + \frac{3\epsilon}{2} \sin (3 \beta - \theta) \right\};$$

that is, in a unitooth single-phaser a pronounced triple harmonic may be expected, but no pronounced higher harmonics.

Fig. 174 shows the wave of e.m.f. of the main coil of a monocyclic alternator at no load, represented by,

$$e = E \left\{ \sin \beta - 0.242 \sin (3 \beta - 6.3) - 0.046 \sin (5 \beta - 2.6) \right. \\ \left. + 0.068 \sin (7 \beta - 3.3) - 0.027 \sin (9 \beta - 10.0) - 0.018 \right. \\ \left. \sin (11 \beta - 6.6) + 0.029 \sin (13 \beta - 8.2) \right\};$$

hence giving a pronounced triple harmonic only, as expected.

If $\gamma = 2$, it is,

$$e = \sqrt{2} \pi f n \Phi \left\{ \sin \beta + \frac{3 \epsilon}{2} \sin (3 \beta - \theta) + \frac{5 \epsilon}{2} \sin (5 \beta - \theta) \right\},$$

the no-load wave of a unitooth quarter-phase machine, having pronounced triple and quintuple harmonics.

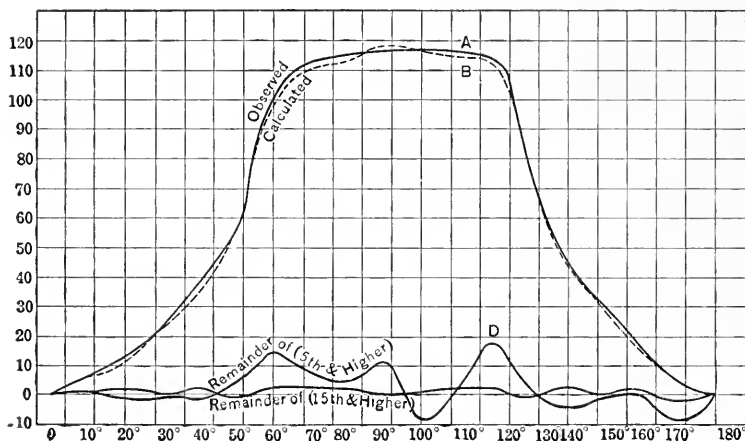

FIG. 174.—No-load of e.m.f. of unitooth monocyclic alternator.

If $\gamma = 3$, it is,

$$e = \sqrt{2} \pi f n \Phi \left\{ \sin \beta + \frac{5 \epsilon}{2} \sin (5 \beta - \theta) + \frac{7 \epsilon}{2} \sin (7 \beta - \theta) \right\}.$$

That is, in a unitooth three-phaser, a pronounced quintuple and septuple harmonic may be expected, but no pronounced triple harmonic.

Fig. 175 shows the wave of e.m.f. of a unitooth three-phaser at no-load, represented by

$$e = E \left\{ \sin \beta - 0.12 \sin (3 \beta - 2.3) - 0.23 \sin (5 \beta - 1.5) \right. \\ \left. + 0.134 \sin (7 \beta - 6.2) - 0.002 \sin (9 \beta + 27.7) - 0.046 \right. \\ \left. \sin (11 \beta - 5.5) + 0.031 \sin (13 \beta - 61.5) \right\}.$$

Thus giving a pronounced quintuple and septuple and a

lesser triple harmonic, probably due to the deviation of the field from uniformity, as explained above, and deviation of the pulsation of reluctance from sine-shape. In some especially favorable cases, harmonics as high as the 35th and 37th have been observed, caused by pulsation of the reluctance, and even still higher harmonics.

In general, if the pulsation of the magnetic reactance is denoted by the general expression

$$1 + \sum_1^{\infty} \gamma \epsilon_{\gamma} r \cos (2 \gamma \beta - \theta_{\gamma}),$$

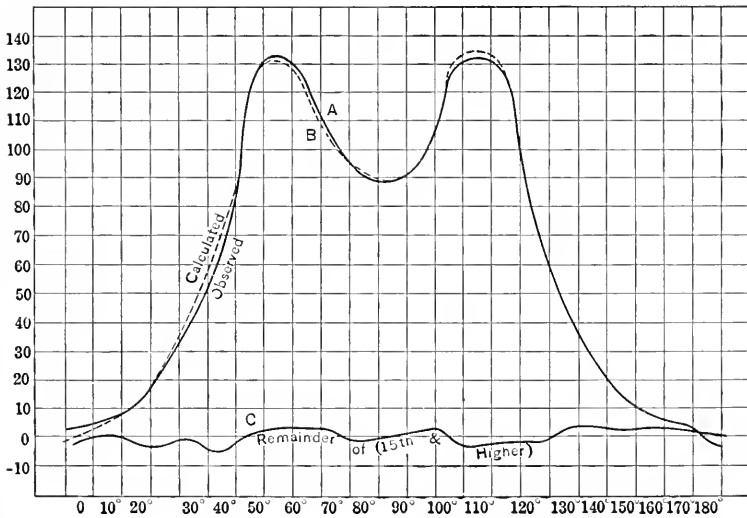

FIG. 175.—No-load wave of e.m.f. of unitooth three-phase alternator.

the instantaneous magnetic flux is

$$\begin{aligned} \phi &= \Phi \cos \beta \left\{ 1 + \sum_1^{\infty} \gamma \epsilon_{\gamma} \cos (2 \gamma \beta - \theta_{\gamma}) \right\} \\ &= \Phi \left\{ \cos \beta + \frac{\epsilon_1}{2} \cos (\beta - \theta_1) + \sum_1^{\infty} \left[\frac{\epsilon_{\gamma}}{2} \cos [(2 \gamma + 1) \beta - \theta_{\gamma}] + \frac{\epsilon_{\gamma+1}}{2} \cos [(2 \gamma + 1) \beta - \theta_{\gamma+1}] \right] \right\}; \end{aligned}$$

hence, the e.m.f.,

$$e = \sqrt{2} \pi f n \Phi \left\{ \sin \beta + \frac{\epsilon_1}{2} \sin (\beta - \theta_1) + \sum_1^{\infty} \frac{2 \gamma + 1}{2} \left[\epsilon_{\gamma} \sin [(2 \gamma + 1) \beta - \theta_{\gamma}] + \epsilon_{\gamma+1} \sin [(2 \gamma + 1) \beta - \theta_{\gamma+1}] \right] \right\}.$$

With the general adoption of distributed fractional pitch armature windings, such pronounced wave shape distortions as shown by the unitooth alternators shown as illustrations, have become infrequent.

Pulsation of Reactance

236. The main causes of a pulsation of reactance are magnetic saturation and hysteresis, and synchronous motion. Since in an iron-clad magnetic circuit the magnetism is not proportional to the m.m.f., the wave of magnetism and thus the wave of e.m.f. will differ from the wave of current. As far as this distortion is due to the variation of permeability, the distortion is symmetrical and the wave of generated e.m.f. represents no power. The distortion caused by hysteresis, or the lag of the magnetism behind the m.m.f., causes an unsymmetrical distortion of the wave which makes the wave of generated e.m.f. differ by more than 90° from the current wave and thereby represents power—the power consumed by hysteresis.

In practice both effects are always superimposed; that is, in a ferric inductive reactance, a distortion of wave-shape takes place due to the lack of proportionality between magnetism and m.m.f. as expressed by the variation in the hysteretic cycle.

This pulsation of reactance gives rise to a distortion consisting mainly of a triple harmonic. Such current waves distorted by hysteresis, with a sine wave of impressed e.m.f., are shown in Figs. 80 and 81, Chapter XII, on Hysteresis. Inversely, if the current is a sine wave, the magnetism and the e.m.f. will differ from sine-shape.

For further discussion of this distortion of wave-shape by hysteresis, Chapter XII may be consulted.

237. Distortion of wave-shape takes place also by the pulsation of reactance due to synchronous rotation, as discussed in the chapter on Reaction Machines, in "Theory and Calculation of Electrical Apparatus."

With a sine wave of e.m.f., distorted current waves result.

Inversely, if a sine wave of current,

$$i = I \cos \beta,$$

exists through a circuit of synchronously varying reactance, as for instance, the armature of a unitooth alternator or synchronous motor—or, more general, an alternator whose arma-

ture reluctance is different in different positions with regard to the field-poles—and the reactance is expressed by

$$X = x \{1 + \epsilon \cos (2 \beta - \theta)\};$$

or, more general,

$$X = x \left\{ 1 + \sum_1^{\infty} \epsilon_{\gamma} \cos (2 \gamma \beta - \theta_{\gamma}) \right\};$$

the wave of magnetism is

$$\begin{aligned} \phi &= \frac{X}{2 \pi f n} \cos \beta = \frac{x}{2 \pi f n} \left\{ \cos \beta + \sum_1^{\infty} \epsilon_{\gamma} \cos \beta \cos (2 \gamma \beta - \theta_{\gamma}) \right\} \\ &= \frac{x}{2 \pi f n} \left\{ \cos \beta + \frac{\epsilon_1}{2} \cos (\beta - \theta_1) + \sum_1^{\infty} \left[\frac{\epsilon_{\gamma}}{2} \cos [(2 \gamma + 1) \right. \right. \\ &\quad \left. \left. \beta - \theta_{\gamma}] + \frac{\epsilon_{2 \gamma + 1}}{2} \cos [(2 \gamma + 1) \beta - \theta_{\gamma + 1}] \right] \right\}; \end{aligned}$$

hence the wave of generated e.m.f.,

$$\begin{aligned} e &= -n \frac{d\phi}{dt} = -2 \pi f n \frac{d\phi}{d\beta} \\ &= x \left\{ \sin \beta + \frac{\epsilon_1}{2} \sin (\beta - \theta_1) + \sum_1^{\infty} \frac{2 \gamma + 1}{2} [\epsilon_{\gamma} \sin [(2 \gamma + 1) \right. \\ &\quad \left. \beta - \theta_{\gamma}] + \epsilon_{2 \gamma + 1} \sin [(2 \gamma + 1) \beta - \theta_{\gamma + 1}]] \right\}; \end{aligned}$$

that is, the pulsation of reactance of frequency, 2γ , introduces two higher harmonics of the order $(2 \gamma - 1)$ and $(2 \gamma + 1)$.

If

$$X = x \{1 + \epsilon \cos (2 \beta - \theta)\},$$

it is

$$\begin{aligned} \phi &= \frac{x}{2 \pi f n} \left\{ \cos \beta + \frac{\epsilon}{2} \cos (\beta - \theta) + \frac{\epsilon}{2} \cos (3 \beta - \theta) \right\}; \\ e &= x \left\{ \sin \beta + \frac{\epsilon}{2} \sin (\beta - \theta) + \frac{3 \epsilon}{2} \sin (3 \beta - \theta) \right\}. \end{aligned}$$

Since the pulsation of reactance due to magnetic saturation and hysteresis is essentially of the frequency, $2 f$ —that is, describes a complete cycle for each half-wave of current—this shows why the distortion of wave-shape by hysteresis consists essentially of a triple harmonic.

The phase displacement between e and i , and thus the power consumed or produced in the electric circuit, depends upon the angle, θ , as discussed before.

238. In case of a distortion of the wave-shape by reactance, the distorted waves can be replaced by their equivalent sine waves, and the investigation with sufficient exactness for most cases be carried out under the assumption of sine waves, as done in the preceding chapters.

Similar phenomena take place in circuits containing polarization cells, leaky condensers, or other apparatus representing a synchronously varying negative reactance. Possibly dielectric hysteresis in condensers causes a distortion similar to that due to magnetic hysteresis.

Inversely, at very high voltages, where corona appears on the conductors, with a sine wave of impressed voltage, a distortion of the capacity current wave occurs, which is largely effective, but partly reactive due to the increase of capacity under corona.

Pulsation of Resistance

239. To a certain extent the investigation of the effect of synchronous pulsation of the resistance coincides with that of reactance; since a pulsation of reactance, when unsymmetrical with regard to the current wave, introduces a power component which can be represented by an "effective resistance."

Inversely, an unsymmetrical pulsation of the ohmic resistance introduces a wattless component, to be denoted by "effective reactance."

A typical case of a synchronously pulsating resistance is represented in the alternating arc.

The apparent resistance of an arc depends upon the current through the arc; that is, the apparent resistance of the arc = $\frac{\text{potential difference between electrodes}}{\text{current}}$ is high for small currents, low for large currents. Thus in an alternating arc the apparent resistance will vary during every half-wave of current between a maximum value at zero current and a minimum value at maximum current, thereby describing a complete cycle per half-wave of current.

Let the effective value of current through the arc be represented by I .

Then the instantaneous value of current, assuming the current wave as sine wave, is represented by

$$i = I \sqrt{2} \sin \beta;$$

and the apparent resistance of the arc, in first approximation, by

$$R = r(1 + \epsilon \cos 2\beta);$$

thus the potential difference at the arc is

$$\begin{aligned} e &= iR = I\sqrt{2}r \sin \beta (1 + \epsilon \cos 2\beta) \\ &= rI\sqrt{2} \left\{ \left(1 - \frac{\epsilon}{2}\right) \sin \beta + \frac{\epsilon}{2} \sin 3\beta \right\}. \end{aligned}$$

Hence the effective value of potential difference,

$$\begin{aligned} E &= rI \sqrt{\left(1 - \frac{\epsilon}{2}\right)^2 + \frac{\epsilon^2}{4}} \\ &= rI \sqrt{1 - \epsilon + \frac{\epsilon^2}{2}}, \end{aligned}$$

and the apparent resistance of the arc,

$$r_0 = \frac{E}{I} = r \sqrt{1 - \epsilon + \frac{\epsilon^2}{2}}.$$

The instantaneous power consumed in the arc is

$$ie = 2rI^2 \left\{ \left(1 - \frac{\epsilon}{2}\right) \sin^2 \beta + \frac{\epsilon}{2} \sin \beta \sin 3\beta \right\}.$$

Hence the effective power,

$$P = rI^2 \left(1 - \frac{\epsilon}{2}\right).$$

The apparent power, or volt-amperes consumed by the arc,

$$IE = rI^2 \sqrt{1 - \epsilon + \frac{\epsilon^2}{2}}.$$

Thus the power-factor of the arc,

$$p = \frac{P}{IE} = \frac{1 - \frac{\epsilon}{2}}{\sqrt{1 - \epsilon + \frac{\epsilon^2}{2}}}$$

that is, less than unity.

240. We find here a case of a circuit in which the power-factor—that is, the ratio of watts to volt-amperes—differs from unity without any displacement of phase; that is, while current and e.m.f. are in phase with each other, but are distorted, the alternating wave cannot be replaced by an equivalent sine wave,

since the assumption of equivalent sine wave would introduce a phase displacement,

$$\cos \theta = p$$

of an angle, θ , whose sign is indefinite.

As an example are shown, in Fig. 176, for the constants, $I = 12$, $r = 3$, $\epsilon = 0.9$, the resistance,

$$R = 3 (1 + 0.9 \cos 2 \beta);$$

the current,

$$i = 17 \sin \beta;$$

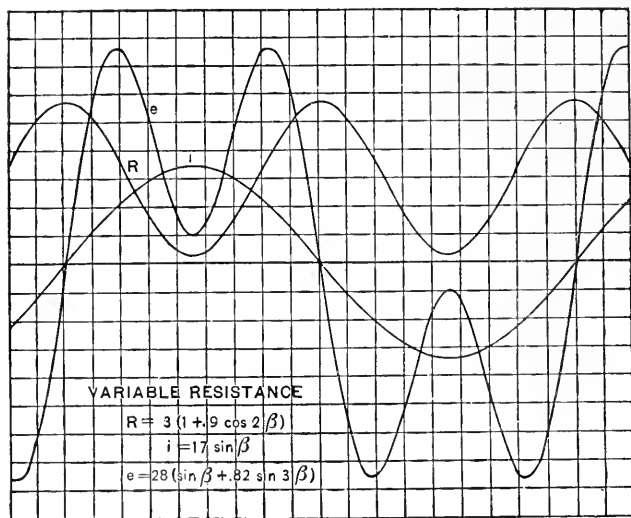

FIG. 176.—Periodically varying resistance.

the potential difference,

$$e = 28 (\sin \beta + 0.82 \sin 3 \beta).$$

In this case the effective e.m.f. is

$$E = 25.5;$$

the apparent resistance,

$$r_0 = 2.13;$$

the power,

$$P = 244;$$

the apparent power,

$$EI = 307;$$

the power-factor,

$$p = 0.796.$$

As seen, with a sine wave of current the e.m.f. wave in an alternating arc will become double-peaked, and rise very abruptly near the zero values of current. Inversely, with a sine wave of e.m.f. the current wave in an alternating arc will become peaked, and very flat near the zero values of e.m.f.

241. In reality the distortion is of more complex nature, since the pulsation of resistance in the arc does not follow a simple sine law of double frequency, but varies much more abruptly near the zero value of current, making thereby the variation of e.m.f. near the zero value of current much more abruptly, or, inversely, the variation of current more flat.

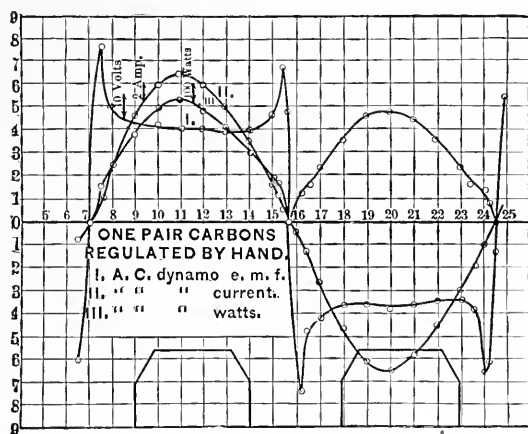

FIG. 177.—Electric arc.

A typical wave of potential difference, with an approximate sine wave of current through the arc, is given in Fig. 177.¹

242. The value of ϵ , the amplitude of the resistance pulsation, largely depends upon the nature of the electrodes and the steadiness of the arc, and with soft carbons and a steady arc is small, and the power-factor, p , of the arc near unity. With hard carbons and an unsteady arc, ϵ rises greatly, higher harmonics appear in the pulsation of resistance, and the power-factor, p , falls, being in extreme cases even as low as 0.6. Especially is this the case with metal arcs.

This double-peaked appearance of the voltage wave, as shown by Figs. 176 and 177, is characteristic of the arc to such an extent

¹From American Institute of Electrical Engineers, Transactions, 1890, p. 376. Tobey and Walbridge, on the Stanley Alternate Arc Dynamo.

that when in the investigation of an electric circuit by oscillograph such a wave-shape is found, the existence of an arc or arcing ground somewhere in the circuit may usually be suspected. This is of importance as in high-voltage systems arcs are liable to cause dangerous voltages.

The pulsation of the resistance in an arc, as shown in Fig. 177 for hard carbons, is usually very far from sinusoidal, as assumed in Fig. 176. It is due to the feature of the arc that the voltage consumed in the arc flame decreases with increase of current—approximately inversely proportional to the square root of the current—and so is lowest at maximum current.

Approximately, the volt-ampere characteristic of the arc can be represented by,

$$e = e_0 + \frac{c}{\sqrt{i}}, \quad (1)$$

where e_0 is a constant of the electrode material (mainly), c a constant depending also upon the electrode material and on the arc length, and approximately proportional thereto.

This equation would give $e = \infty$, for $i = 0$. This obviously is not feasible. However, besides the arc conduction as given by above equation—which depends upon mechanical motion of the vapor stream—a slight conduction also takes place through the residual vapor between the electrodes, as a path of high resistance, r , and near zero current, where the voltage is not sufficient to maintain an arc, this latter conduction carries the current.

The characteristic of the alternating-current arc therefore consists of the combination of two curves: the arc characteristic, (1), and the resistance characteristic,

$$e = ri. \quad (2)$$

The phenomenon then follows that curve which gives the lowest voltage; that is, for high values of current, is represented by equation (1), for low values of current, by equation (2).

243. As an example are shown in Fig. 178 the calculated curves of an alternating arc between hard carbons (or carbides), for the constants,

$$\begin{aligned} e_0 &= 30 \text{ volts,} \\ c &= 40, \\ r &= 70 \text{ ohms.} \end{aligned}$$

The curve I represents the arc conduction, following equation (1),

$$e = 30 + \frac{40}{\sqrt{i}},$$

and the curve II represents the conduction through the (stationary) residual vapor, by equation (2), near the zero points, *A* and *D*, of the current,

$$e = 70 i.$$

As seen, from *A* to *B* the voltage varies approximately proportionally with the current. At *B* the arc starts, and the vol-

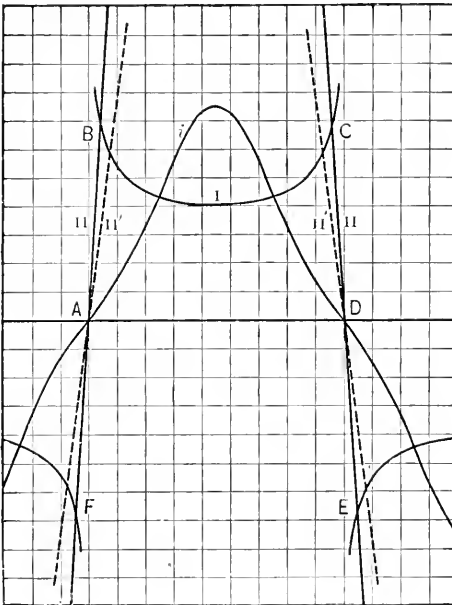

FIG. 178.

tage drops with the further increase of current, and then rises again with the decreasing current, until at *C*, the intersection point between curves I and II, the arc extinguishes and the voltage follows curve II, until at *E* the arc starts again. The two sharp peaks of the curve thus represent respectively the starting and the extinction of the arc.

Since the high values of voltage near zero current lower and the low values of voltage near maximum current raise the value of

the current, the current wave does not remain a sine wave, if the arc voltage is an appreciable part of the total voltage, but the current wave becomes peaked, with flat zero, as expressed approximately by a third harmonic in phase with the fundamental. The current wave in Fig. 178 so has been assumed as

$$i = 13 \cos \phi + 2 \cos 3 \phi.$$

From Fig. 178 follows:

effective value of current, 9.30 amp.,
effective value of voltage, 47.2 volts;

hence, volt-amperes consumed by the arc, 439 volt-amp.; and, by averaging the products of the instantaneous values of volts and amperes,

power consumed in the arc, 388 watts;

hence,

power-factor, 77 per cent.

If the resistance, r , of the residual arc-vapor is lower, as by the use of softer carbons, for instance, given by

$$r = 30 \text{ ohms,}$$

as shown by the dotted curve, Π' , in Fig. 178, the voltage peaks are greatly cut down, giving a lesser wave-shape distortion, and so,

effective value of voltage, 43.1 volts,
volt-amperes in arc, 395 volt-amp.,
watts in arc, 335 watts,

hence,

power-factor, 85 per cent.

Comparing Fig. 178 with 177 shows that 178 fairly well approximates 177, except that in Fig. 177 the second peak is lower than the first. This is due to the lower resistance, r , of the residual vapor immediately after the passage of the arc than before the starting of the arc. Fig. 177 also shows a decrease of resistance, r , immediately before starting, or after extinction of the arc, which may be represented by some expression like

$$r = r_0 i^{-b},$$

where

$$b < 1,$$

but which has not been considered in Fig. 178.

The softer the carbons, the more is the latter effect appreciable and the peaks rounded off, thus causing the curve to approach the appearance of Fig. 176, while with metal arcs, where r is very high, the peaks, especially the first, become very sharp and high, frequently reaching values of several thousand volts.

Further discussion on the effect of the arc see "Theory and Calculation of Electric Circuits."

244. One of the most important sources of wave-shape distortion is the presence of iron in a magnetic circuit. The magnetic induction in iron, and therewith the magnetic flux, is not proportional to the magnetizing force or the exciting current, but the magnetic induction and the magnetizing force are related to each other by the hysteresis cycle of the iron, as discussed in Chapter XII. In an iron-clad magnetic circuit, the magnetic

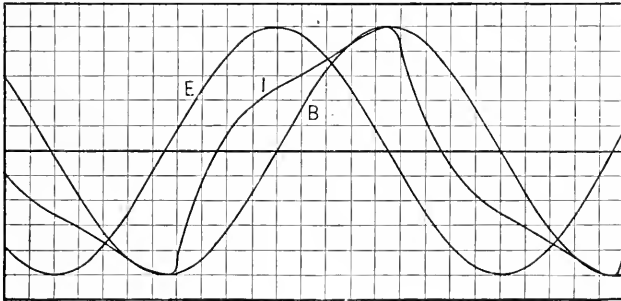

FIG. 179.

flux and the current, therefore, cannot both be sine waves; if the magnetic flux and therefore the generated e.m.f. are sine waves, the current differs from sine wave-shape, while if a sine wave of current is sent through the circuit, the magnetic flux and the generated e.m.f. cannot be sine waves.

A. Sine Wave of Voltage

Let a sine wave of e.m.f. be impressed upon an iron-clad reactance coil, or a primary coil of a transformer with open secondary circuit. Neglecting the ohmic resistance of the circuit, that is, assuming the generated e.m.f. as equal or practically equal to the impressed e.m.f., the voltage consumed by the generated e.m.f. and therewith the magnetic flux are sine waves, as represented by E and B in Fig. 179. The cur-

rent which produces this magnetic flux, B , and so the voltage, E , then is derived point by point from B , by the hysteresis cycle of the iron. With the hysteresis cycle given in Fig. 180, the current then has the wave-shape given as I in Fig. 179, that is, greatly differs from a sine wave. This distortion of the current wave is mainly due to the bend of the magnetic characteristic, that is, the magnetic saturation, and not to the energy loss or the area of the curve. This is seen by resolving the current wave, I , into two components: an energy component, i' , in phase with

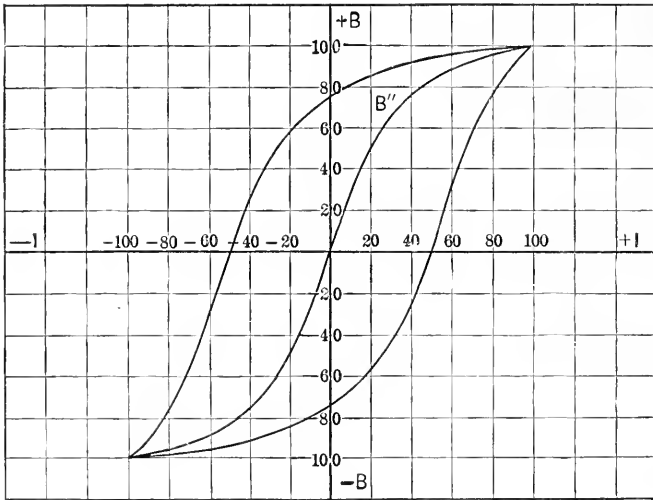

FIG. 180.

the e.m.f., $e = E \sin \phi$, and a wattless component, i'' , in quadrature with E , and in phase with B . These components are calculated as

$$i' = \frac{1}{2} \{i_\phi + i_{\pi-\phi}\},$$

and

$$i'' = \frac{1}{2} \{i_\phi - i_{\pi-\phi}\},$$

where i_ϕ and $i_{\pi-\phi}$ are the instantaneous values of the current, I , at the angles ϕ and $\pi - \phi$, respectively.

These components, the *hysteresis power current*, i' , and the reactive *magnetizing current*, i'' , are plotted in Fig. 181 and show that i' is nearly a sine wave, while i'' is greatly distorted and peaked.

The total current, I , derived by the hysteresis cycle, Fig. 180, from the magnetic flux,

$$B = B_0 \cos \phi,$$

can be resolved into an infinite series of harmonic waves, that is, a trigonometric or Fourier series of the form:

$$i = a_1 \cos \phi + a_3 \cos 3 \phi + a_5 \cos 5 \phi + \dots + a_n \cos n\phi + \dots + b_1 \sin \phi + b_3 \sin 3 \phi + b_5 \sin 5 \phi + \dots + b_n \sin n\phi + \dots$$

or of the form:

$$i = c_1 \cos (\phi - \theta_1) + c_3 \cos (3 \phi - \theta_3) + c_5 \cos (5 \phi - \theta_5) + \dots + c_n \cos (n\phi - \theta_n) + \dots$$

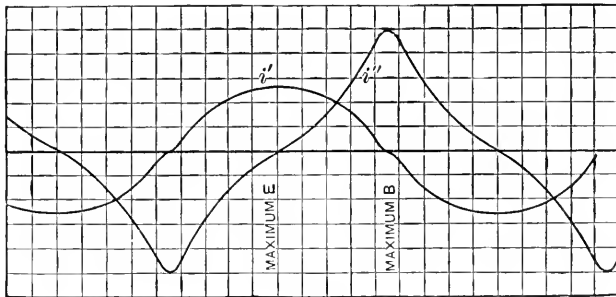

FIG. 181.

where

$$c_n = \sqrt{a_n^2 + b_n^2},$$

$$\tan \theta_n = \frac{b_n}{a_n}.$$

The coefficients a_n and b_n are determined by the definite integrals:¹

$$a_n = \frac{2}{\pi} \int_0^\pi i \cos n\phi d\phi = 2 \times \text{avg} (i \cos n\phi)_0^\pi,$$

$$b_n = \frac{2}{\pi} \int_0^\pi i \sin n\phi d\phi = 2 \times \text{avg} (i \sin n\phi)_0^\pi;$$

that is, by multiplying the instantaneous values of i , as given numerically, by $\cos n\phi$ and $\sin n\phi$, respectively, and then averaging.

¹See "Engineering Mathematics."

Just as in most investigations dealing with alternating currents, not the fundamental sine wave, but the fundamental sine wave together with all its higher harmonics, that is, the total wave, is of importance; so also when dealing with the higher harmonics, frequently not the individual higher harmonic sine wave is of importance, but the higher harmonic together with all of its higher harmonics. For instance, when dealing with the disturbances caused by the third harmonic in a three-phase system, the third harmonic together with all its higher harmonics or overtones, as the ninth, fifteenth, twenty-first, etc., comes in consideration, that is, all the components which repeat after one-third cycle. The higher harmonic then appears as a distorted wave, including its higher harmonics.

To determine, from the instantaneous values of a distorted wave, the instantaneous values of its n th harmonic distorted wave, that is, the n th harmonic together with its overtones, of order $3n, 5n, 7n$, etc., the average is taken of n instantaneous values of the total wave (or any component thereof, which includes the n th harmonic), differing from each other in phase by $\frac{1}{n}$ period. That is, it is

$$i_n = \sum_0^{n-1} \kappa i_{\phi + \frac{2\kappa\pi}{n}}$$

This method is based on the relations:

$$\sum_0^{n-1} \kappa \cos \left(m\phi + \frac{2\kappa\pi}{n} \right) = n \cos m\phi,$$

$$\sum_0^{n-1} \kappa \sin \left(m\phi + \frac{2\kappa\pi}{n} \right) = n \sin m\phi,$$

if $m = n$ or if m is a multiple of n ; otherwise these sums = 0, where m and n are integer numbers.

245. In this manner the wave of exciting current, I , of Fig. 179 is resolved, in Fig. 182, into the fundamental sine wave, i_1 , and the higher harmonics, i_3, i_5, i_7 , which are general waves, that is, include their higher harmonics.

Analytically, it can be represented by

$$i = 8.857 \cos (\phi + 37.6^\circ) + 1.898 \cos 3 (\phi + 4.1^\circ) \\ + 0.585 \cos 5 (\phi - 1.7^\circ) + 0.319 \cos 7 (\phi - 3.2^\circ) \\ + 0.158 \cos 9 (\phi - 2.5^\circ) + \dots$$

where $B = 10,000 \cos \phi$ is the wave of magnetic induction.

The equivalent sine wave of above current wave is

$$i_0 = 9.104 \cos (\phi - 36.3^\circ).$$

In this case of the distortion of a current wave by an iron-clad reactance coil or transformer, with a sine wave of impressed e.m.f., it is, from the above equation of the current wave,

Effective value of the total current	6.423
Effective value of its fundamental sine wave	6.27
Effective value of the sum of all its higher harmonics	1.43.

That is, the effective value of all the harmonics is 22.3 per cent. of the effective value of the total current.

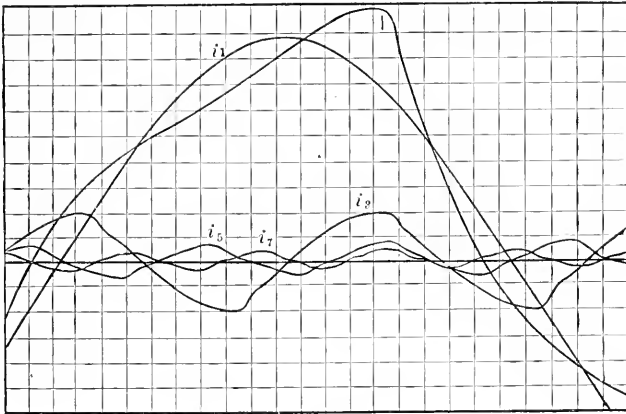

FIG. 182.

B. Sine Wave of Current

246. If a sine wave of current exists through an iron-clad magnetic circuit, as, for instance, an iron-clad reactance coil or transformer connected in series to a circuit traversed by a sine wave, the potential difference at the terminals of the reactance cannot be a sine wave, but contains higher harmonics.

From the sine wave of current

$$i = I \cos \phi,$$

follows by the hysteresis cycle, Fig. 180, the wave of magnetism. This is not a sine wave, but hollowed out on the rising, humped on the decreasing side, that is, has a distortion about opposite

from that of the current wave in Fig. 179; the wave of magnetism has the maximum at the same angle, ϕ , as the current, but passes the zero much later than the current.

From the wave of magnetism follows the wave of generated e.m.f., and so (approximately, that is, neglecting resistance) of terminal voltage, e , at the reactance, since e is proportional to $\frac{dB}{d\phi}$. It is plotted as E in Fig. 183, and resolved into its harmonics in the same manner as the current wave in A .

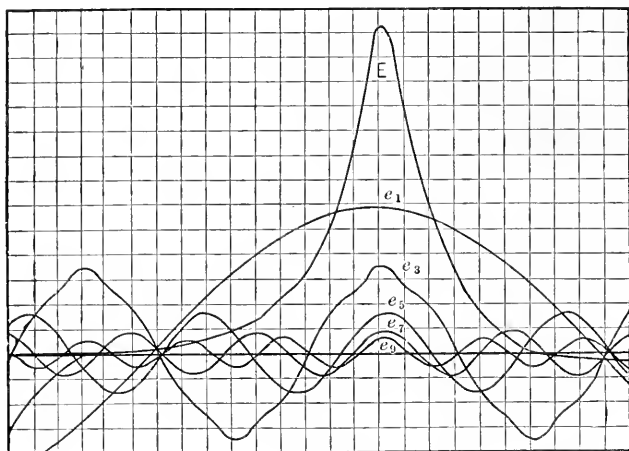

FIG. 183.

As seen, with a sine wave of current traversing an iron-clad reactance, the e.m.f. wave is very greatly distorted, and the maximum value of the distorted e.m.f. wave is more than twice the maximum of its fundamental sine wave.

Denoting the current wave by,

$$i = 10 \sin (\phi + 30^\circ),$$

the e.m.f. wave in Fig. 183 is represented by

$$\begin{aligned} e = & 11.67 \cos (\phi + 2.5^\circ) + 6.64 \cos 3 (\phi - 1.13^\circ) \\ & + 3.24 \cos 5 (\phi - 2.4^\circ) + 1.8 \cos 7 (\phi - 1.53^\circ) + \\ & 1.16 \cos 9 (\phi - 0.5^\circ) + 0.80 \cos 11 (\phi - 2^\circ) \\ & + 0.53 \cos 13 (\phi - 2^\circ) + 0.19 \cos 15 (\phi - 1^\circ) + \dots \end{aligned}$$

that is, all the harmonics are nearly in phase with each other, so accounting for the very steep peak. It is

Effective value of total wave	9.91
Effective value of its fundamental sine wave . . .	8.25
Effective value of the sum of all its higher harmonics	5.48

that is, the effective value of all the higher harmonics is 55.3 per cent. of the effective value of the total wave.

The impedance of this iron-clad reactance, with a sine wave current of 7.07 effective, so is

$$z = \frac{9.91}{7.07} = 1.40,$$

while the same reactance, with a sine wave e.m.f. of 7.07 effective, in *A*, gives the impedance,

$$z = \frac{7.07}{6.42} = 1.10.$$

The conclusion is that an iron-clad magnetic circuit is not suitable for a reactor, since even below saturation (as above assumed) it produces very great wave-shape distortion.

As discussed before, the insertion of even a small air-gap into the magnetic circuit makes the current wave nearly coincide in phase and in shape with the wave of magnetism.

C. Three-phase Circuits

247. The wave-shape distortion in an iron-clad magnetic circuit has an important bearing on transformer connections in three-phase circuits.

The e.m.fs. and the currents in a three-phase system are displaced from each other in phase by one-third of a period or 120°. Their third harmonics, therefore, differ by $3 \times 120^\circ$, or a complete period, that is, are in phase with each other. That is, whatever third harmonics of e.m.f. and of current may exist in a three-phase system must be in phase with each other in all three phases, or, in other words, for the third harmonics the three-phase system is single-phase.

The sum of the three e.m.fs. between the lines of a three-phase system (Δ voltages) is zero. Since their third harmonic would be in phase with each other, and so add up, it follows:

The voltages between the lines of a three-phase system, or Δ voltages, cannot contain any third harmonic or its overtones (ninth, fifteenth, twenty-first, etc., harmonics).

Since in a three-wire, three-phase system the sum of the three

currents in the line is zero, but their third harmonics would be in phase with each other, and their sum, therefore, not zero, it follows:

The currents in the lines of a three-wire, three-phase system, or Y currents, cannot contain any third harmonic.

Third harmonics, however, can exist in the Y voltage or voltage between line and neutral of the system, and since the third harmonics are in phase with each other, in this case, a potential difference of triple frequency exists between the neutral of the system and all three phases as the other terminal, that is, the whole system pulsates against the neutral at triple frequency.

Third harmonics can also exist in the currents between the lines, or Δ currents. Since the two currents from one line to the other two lines are displaced 60° from each other, their third harmonics are in opposition and, therefore, neutralize. That is, the third harmonics in the Δ currents of a three-phase system do not exist in the Y currents in the lines, but exist only in a local closed circuit.

Third harmonics can exist in the line currents in a four-wire, three-phase system, as a system with grounded neutral. In this case the third harmonics of currents in the lines return jointly over the fourth or neutral wire, and even with balanced load on the three phases, the neutral wire carries a current which is of triple frequency.

248. With a sine wave of impressed e.m.f. the current in an iron-clad circuit, as the exciting current of a transformer, must contain a strong third harmonic, otherwise the e.m.f. cannot be a sine wave. Since in the lines of a three-phase system the third harmonics of current cannot exist, interesting wave-shape distortions thus result in transformers, when connected to a three-phase system in such a manner that the third harmonic of the exciting current would have to enter the line as Y current, and so is suppressed.

For instance, connecting three iron-clad reactors, as the primary coils of three transformers—with their secondaries open-circuited—in star or Y connection into a three-phase system, with a sine wave of e.m.f., e , impressed upon the lines. Normally, the voltage of each transformer should be a sine wave also, and equal $\frac{e}{\sqrt{3}}$. This, however, would require that the current taken by the transformer as exciting current contains a

third harmonic. As such a third harmonic cannot exist in a three-phase circuit, the wave of magnetism cannot be a sine wave, but must contain a third harmonic, about opposite to that which was suppressed in the exciting current. The e.m.f. generated by this magnetism, and therewith the potential difference at the transformer or Y voltage, therefore, must also contain a third harmonic, and its overtones, three times as great as that of the magnetism, due to the triple frequency.

With three transformers connected in Y into a three-phase system with open secondary circuit, we have, then, with a sine wave of e.m.f. impressed between the three-phase lines, the conditions:

The voltage at the transformers, or Y voltage, cannot be a sine wave, but must contain a third harmonic and its overtones, but can contain no other harmonics, since the other harmonics, as the fifth, seventh, etc., would not eliminate by combining two Y voltages to the Δ voltage or line voltage, and the latter was assumed as sine wave.

The exciting current in the transformers cannot contain any third harmonic or its overtones, but can contain all other harmonics.

The magnetic flux is not a sine wave, but contains a third harmonic and its overtones, corresponding to those of the Y voltage, but contains no other harmonics, and is related to the exciting current by the hysteresis cycle.

Herefrom then the wave-shapes of currents, magnetism and voltage can be constructed. Obviously, since the relation between current and magnetism is merely empirical, given by the hysteresis cycle, this cannot be done analytically, but only by the calculation or construction of the instantaneous values of the curves.

249. For the hysteresis cycle in Fig. 180, and for a system of transformers connected in Y, with open secondary circuit, into a three-phase system with a sine wave of e.m.f. between the lines, the curves of exciting current, magnetic flux and voltage per transformer, or between lines and neutral, are constructed in Fig. 184.

i is the exciting current of the transformer, and contains all the harmonics, except the third and its multiples. It is given by the equation:

$$i = 8.28 \sin(\phi + 30.8^\circ) - 0.71 \sin(5\phi - 17.2^\circ) + \dots$$

B is the magnetic flux density in the transformer. It contains only the third harmonic and its multiples, but no other harmonics, and is given by the equation:

$$B = 10.0 \sin \phi + 1.38 \sin (3 \phi - 9.2^\circ) + 0.045 \sin 9 \phi + \dots$$

e is the potential difference of the transformer terminals, or voltage between the three-phase lines and the transformer neutral. It contains the third harmonic and its multiples, but no other harmonics, and is given by the equation:

$$e = 10.0 \cos \phi + 4.14 \cos (3 \phi - 9.2^\circ) + 0.405 \cos 9 \phi + \dots$$

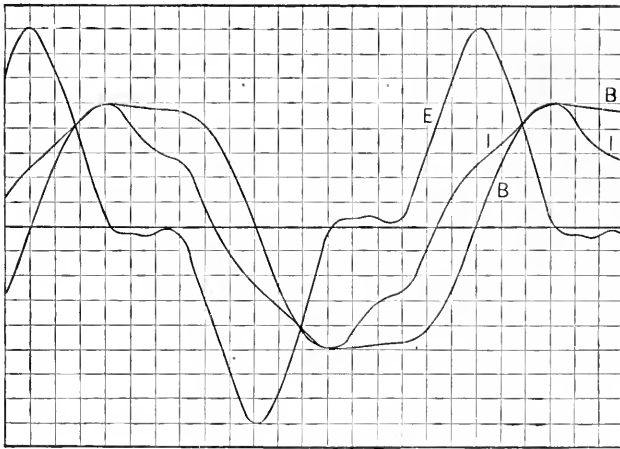

FIG. 184.

The effective value of the voltage is $0.625 e$, and the maximum value is $1.175 E$, where $E =$ supply voltage or Δ voltage.

While with a sine wave the effective value would be

$$\frac{E}{\sqrt{3}} = 0.577 E,$$

and the maximum value

$$\frac{E \sqrt{2}}{\sqrt{3}} = 0.815 E,$$

that is, by the suppression of the third harmonic of exciting current in the three-phase system, the effective value of the voltage per transformer, or voltage between three-phase lines and neutral (or ground, if the neutral is grounded) has been increased by

8.5 per cent., the maximum value by 44.6 per cent., and the voltage wave has become very peaked, by a pronounced third harmonic of an effective value of $0.24 E$ —that is, 38.5 per cent. of the effective value of the total wave.

The very high peak of e.m.f. produced by this wave-shape distortion is liable to be dangerous in high-potential, three-phase systems by increasing the strain on the insulation between lines and ground, and leading to resonance phenomena with the third harmonic.

The maximum value of the distorted wave of magnetism is 8.89, while with a sine wave it would be 10.0, that is, the maximum of the wave of magnetism has been reduced by 11.1 per cent., and the core loss of the transformer so by about 17 per cent.

250. Assuming now that in such transformers, connected with their primaries in Y into a three-phase circuit, the secondaries are connected in Δ . The third harmonics of e.m.f., generated in the three transformer secondaries, then are in series in short-circuit, thus produce a local current in the secondary transformer triangle. This current is of triple frequency, and hence supplies the third harmonic of exciting current, which was suppressed in the primary, and thereby eliminates the third harmonic of magnetism and of e.m.f., which results from the suppression of the third harmonic of exciting current, and so limits itself. That is, connecting the transformer secondaries in Δ , the wave-shape distortion disappears, and voltage and magnetism are again sine waves, and the exciting current is that corresponding to a sine wave of magnetism, except that it is divided between primary and secondary; the third harmonic of the exciting current does not exist in the primary, but is produced by induction in the secondary circuit. Obviously, in this case the magnetic flux and the voltage are not perfect sine waves, but contain a slight third harmonic, which produces in the secondary the triple-frequency exciting current.

If the primary neutral of the transformers is connected to a fourth wire, in a four-wire, three-phase system or three-phase system with grounded neutral, and this fourth wire leads back to the generator neutral, or a neutral of a transformer in which the triple-frequency current can exist, that is, in which the secondary is connected in Δ , the wave-shape distortion also disappears.

It follows herefrom that in the three-phase system attention must be paid to provide a path for the third harmonic of the transformer exciting current, either directly or inductively, otherwise a serious distortion of the e.m.f. wave of the transformers occurs. (See "Theoretical Elements of Electrical Engineering," Chapter X.)

CHAPTER XXVI

EFFECTS OF HIGHER HARMONICS

251. To elucidate the variation in the shape of alternating waves caused by various harmonics, in Figs. 185 and 186 are shown the wave-forms produced by the superposition of the

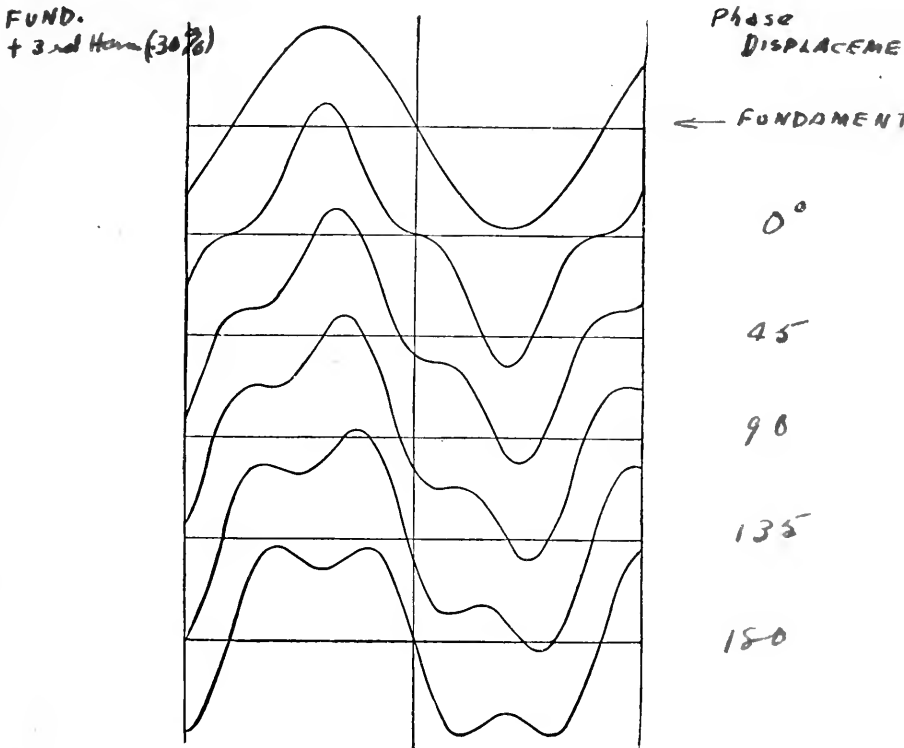

FIG. 185.

triple and the quintuple harmonic upon the fundamental sine wave.

In Fig. 185 is shown the fundamental sine wave and the complex waves produced by the superposition of a triple harmonic of 30 per cent. the amplitude of the fundamental, under the rela-

tive phase displacements of 0° , 45° , 90° , 135° , and 180° , represented by the equations:

$$\begin{aligned} &\sin \beta \\ &\sin \beta - 0.3 \sin 3\beta \\ &\sin \beta - 0.3 \sin (3\beta - 45^\circ) \\ &\sin \beta - 0.3 \sin (3\beta - 90^\circ) \\ &\sin \beta - 0.3 \sin (3\beta - 135^\circ) \\ &\sin \beta - 0.3 \sin (3\beta - 180^\circ). \end{aligned}$$

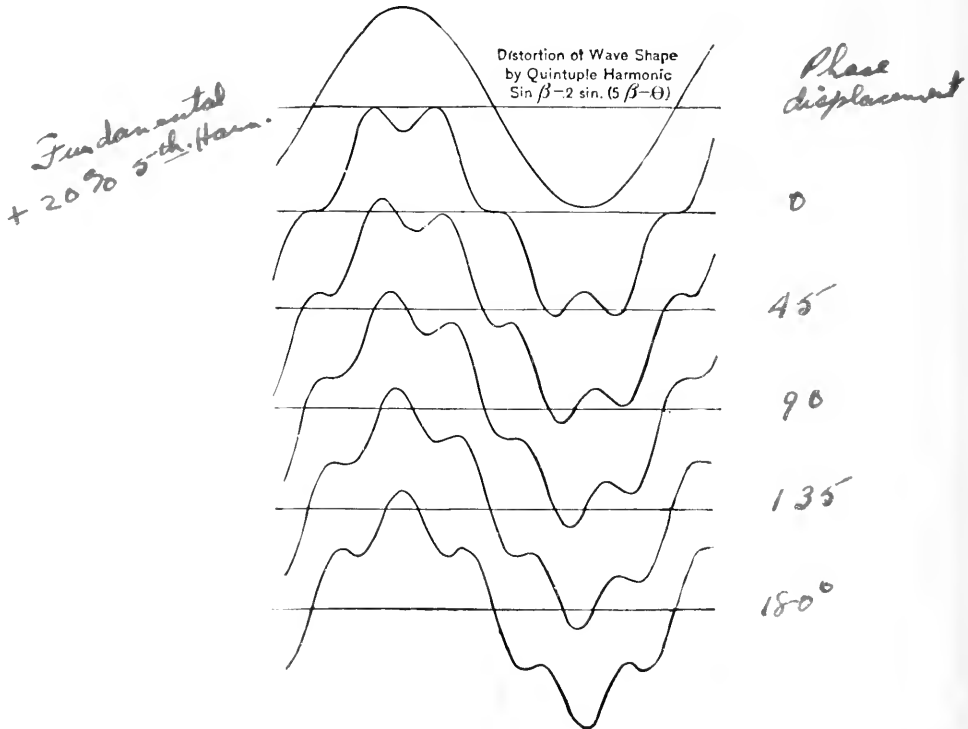

FIG. 186.

As seen, the effect of the triple harmonic is, in the first figure, to flatten the zero values and point the maximum values of the wave, giving what is called a peaked wave. With increasing phase displacement of the triple harmonic, the flat zero rises and gradually changes to a second peak, giving ultimately a flat-top or even double-peaked wave with sharp zero. The intermediate positions represent what is called a saw-tooth wave.

In Fig. 186 are shown the fundamental sine wave and the

complex waves produced by superposition of a quintuple harmonic of 20 per cent. the amplitude of the fundamental, under the relative phase displacement of 0° , 45° , 90° , 135° , 180° , represented by the equations:

$$\begin{aligned} & \sin \beta \\ & \sin \beta - 0.2 \sin 5 \beta \\ & \sin \beta - 0.2 \sin (5 \beta - 45^\circ) \\ & \sin \beta - 0.2 \sin (5 \beta - 90^\circ) \\ & \sin \beta - 0.2 \sin (5 \beta - 135^\circ) \\ & \sin \beta - 0.2 \sin (5 \beta - 180^\circ). \end{aligned}$$

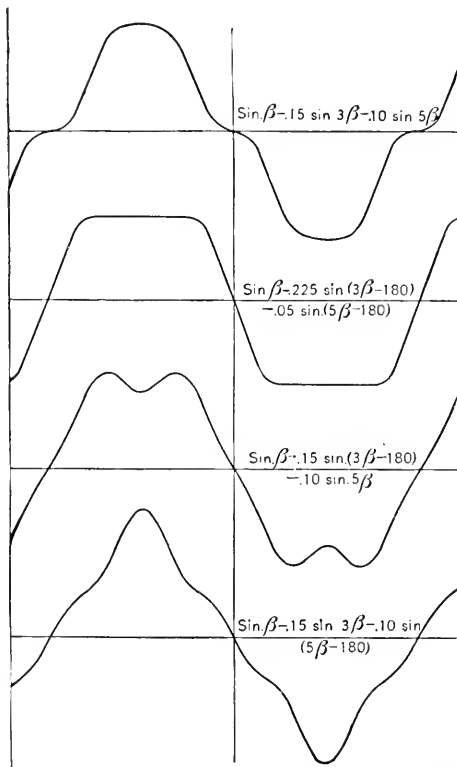

FIG. 187.—Some characteristic wave-shapes.

The quintuple harmonic causes a flat-topped or even double-peaked wave with flat zero. With increasing phase displacement the wave becomes of the type called saw-tooth wave also. The flat zero rises and becomes a third peak, while of the two former

peaks, one rises, the other decreases, and the wave gradually changes to a triple-peaked wave with one main peak, and a sharp zero.

As seen, with the triple harmonic, flat top or double peak coincides with sharp zero, while the quintuple harmonic flat top or double peak coincides with flat zero.

Sharp peak coincides with flat zero in the triple, with sharp zero in the quintuple harmonic. With the triple harmonic, the saw-tooth shape appearing in case of a phase difference between fundamental and harmonic is single, while with the quintuple harmonic it is double.

Thus in general, from simple inspection of the wave-shape, the existence of these first harmonics can be discovered. Some characteristic shapes are shown in Fig. 187.

Flat top with flat zero,

$$\sin \beta - 0.15 \sin 3 \beta - 0.10 \sin 5 \beta.$$

Flat top with sharp zero,

$$\sin \beta - 0.225 \sin (3 \beta - 180^\circ) - 0.05 \sin (5 \beta - 180^\circ).$$

Double peak, with sharp zero,

$$\sin \beta - 0.15 \sin (3 \beta - 180^\circ) - 0.10 \sin 5 \beta.$$

Sharp peak with sharp zero,

$$\sin \beta - 0.15 \sin 3 \beta - 0.10 \sin (5 \beta - 180^\circ).$$

For further discussion of wave-shape distortion by harmonics see "Engineering Mathematics."

252. Since the distortion of the wave-shape consists in the superposition of higher harmonics, that is, waves of higher frequency, the phenomena taking place in a circuit supplied by such a wave will be the combined effect of the different waves.

Thus in a non-inductive circuit the current and the potential difference across the different parts of the circuit are of the same shape as the impressed e.m.f. If inductive reactance is inserted in series with a non-inductive circuit, the self-inductive reactance consumes more e.m.f. of the higher harmonics, since the reactance is proportional to the frequency, and thus the current and the e.m.f. in the non-inductive part of the circuit show the higher harmonics in a reduced amplitude. That is, self-inductive reactance in series with a non-inductive circuit reduces the higher harmonics or smooths out the wave to a closer resemblance to sine-shape. Inversely, capacity in series to a non-inductive circuit consumes less e.m.f. at higher than at lower frequency, and thus makes the higher harmonics of current and of potential

difference in the non-inductive part of the circuit more pronounced—intensifies the harmonics.

Self-induction and capacity in series may cause an increase of voltage due to complete or partial resonance with higher harmonics, and a discrepancy between volt-amperes and watts, without corresponding phase displacement, as will be shown hereafter.

253. In long-distance transmission over lines of noticeable inductive and condensive reactance, rise of voltage due to resonance may occur with higher harmonics, as waves of higher frequency, while the fundamental wave is usually of too low a frequency to cause resonance.

An approximate estimate of the possible rise by resonance with various harmonics can be obtained by the investigation of a numerical example. Let in a long-distance line, fed by step-up transformers at 60 cycles,

The resistance drop in the transformers at full-load = 1 per cent.
The reactance voltage in the transformers at full-load = 5 per cent. with the fundamental wave.

The resistance drop in the line at full-load = 10 per cent.

The reactance voltage in the line at full-load = 20 per cent. with the fundamental wave.

The capacity or charging current of the line = 20 per cent. of the full-load current, I , at the frequency of the fundamental.

The line capacity may approximately be represented by a condenser shunted across the middle of the line. The e.m.f. at the generator terminals, E , is assumed as maintained constant.

The e.m.f. consumed by the resistance of the circuit from generator terminals to condenser is

$$Ir = 0.06 E,$$

or,

$$r = 0.06 \frac{E}{I}.$$

The reactance e.m.f. between generator terminals and condenser is, for the fundamental frequency,

$$Ix = 0.15 E,$$

or,

$$x = 0.15 \frac{E}{I};$$

thus the reactance corresponding to the frequency $(2k - 1)f$ of the higher harmonic is

$$x(2k - 1) = 0.15(2k - 1) \frac{E}{I}$$

The capacity current at fundamental frequency is,

$$i = 0.2 I;$$

hence, at the frequency $(2k - 1)f$,

$$i = 0.2(2k - 1) e' \frac{I}{E},$$

if

e' = e.m.f. of the $(2k - 1)$ th harmonic at the condenser,

e = e.m.f. of the $(2k - 1)$ th harmonic at the generator terminals.

The e.m.f. at the condenser is

$$e' = \sqrt{e^2 - i^2 r^2} + ix(2k - 1);$$

hence, substituted,

$$a = \frac{e'}{e} = \frac{1}{\sqrt{1 - 0.059856(2k - 1)^2 + 0.0009(2k - 1)^4}},$$

the rise of voltage by inductive and condensive reactance.

Substituting,

	$k =$	1	2	3	4	5	6
or,	$2k - 1 =$	1	3	5	7	9	11
and	$a =$	1.03	1.36	3.76	2.18	0.70	0.38

That is, the fundamental will be increased at open circuit by 3 per cent., the triple harmonic by 36 per cent., the quintuple harmonic by 276 per cent., the septuple harmonic by 118 per cent., while the still higher harmonics are reduced.

The maximum possible rise will take place for

$$\frac{da}{d(2k - 1)} = 0, \text{ or, } 2k - 1 = 5.77;$$

that is, at a frequency $f = 346$, and $a = 14.4$.

That is, complete resonance will appear at a frequency between quintuple and septuple harmonic, and would raise the voltage at this particular frequency 14.4-fold.

If the voltage shall not exceed the impressed voltage by more than 100 per cent., even at coincidence of the maximum of the harmonic with the maximum of the fundamental,

the triple harmonic must be less than 70 per cent. of the fundamental,

the quintuple harmonic must be less than 26.5 per cent. of the fundamental,

the septuple harmonic must be less than 46 per cent. of the fundamental.

The voltage will not exceed twice the normal, even at a frequency of complete resonance with the higher harmonic, if none of the higher harmonics amounts to more than 7 per cent. of the fundamental. Herefrom it follows that the danger of resonance in high-potential lines is frequently overestimated, since the conditions assumed in this example are rather more severe than found in lines of moderate length, the capacity current of such line very seldom reaching 20 per cent. of the main current.

254. The power developed by a complex harmonic wave in a non-inductive circuit is the sum of the powers of the individual harmonics. Thus if upon a sine wave of alternating e.m.f. higher harmonic waves are superposed, the effective e.m.f. and the power produced by this wave in a given circuit or with a given effective current are increased. In consequence hereof alternators and synchronous motors of iron-clad unitooth construction—that is, machines giving waves with pronounced higher harmonics—may give with the same number of turns on the armature, and the same magnetic flux per field-pole at the same frequency, a higher output than machines built to produce sine waves.

255. This explains an apparent paradox:

If in the three-phase star-connected generator with the magnetic field constructed as shown diagrammatically in Fig. 188 the magnetic flux per pole = Φ , the number of turns in series per circuit = n , the frequency = f , the e.m.f. between any two collector rings is

$$E = \sqrt{2} \pi f 2 n \Phi 10^{-8},$$

since $2n$ armature turns simultaneously interlink with the magnetic flux, Φ .

The e.m.f. per armature circuit is

$$e = \sqrt{2} \pi f n \Phi 10^{-8};$$

hence the e.m.f. between collector rings, as resultant of two e.m.fs., e , displaced by 60° from each other, is

$$E = e \sqrt{3} = \sqrt{2} \pi f \sqrt{3} n \Phi 10^{-8},$$

while the same e.m.f. was found from the number of turns, the magnetic flux, and the frequency by direct calculation to be equal to $2e$; that is, the two values found for the same e.m.f. have the proportion $\sqrt{3}:2 = 1:1.154$.

This discrepancy is due to the existence of more pronounced higher harmonics in the wave e than in the wave $E = e \times \sqrt{3}$, which have been neglected in the formula

$$e = \sqrt{2} \pi f n \Phi 10^{-8}.$$

Hence it follows that, while the e.m.f. between two collector rings in the machine shown diagrammatically in Fig. 188 is only

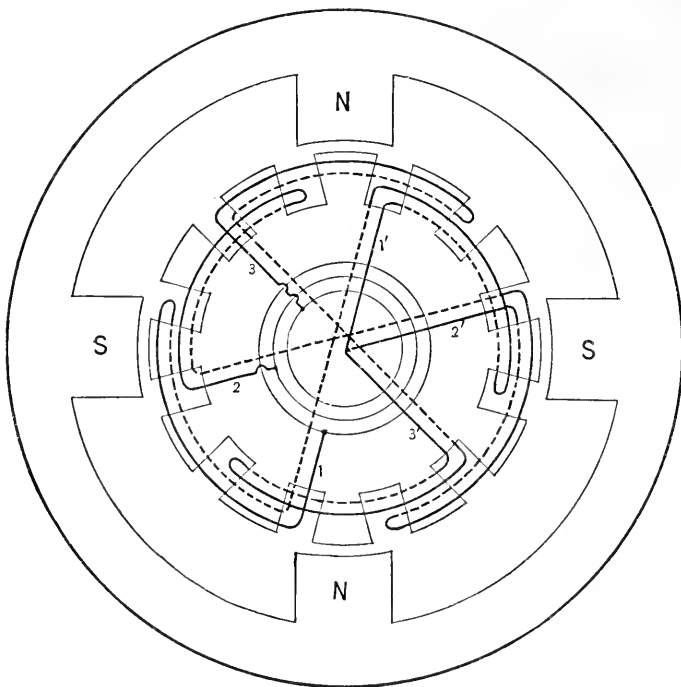

FIG. 188.—Three-phase star-connected alternator.

$e \times \sqrt{3}$, by massing the same number of turns in one slot instead of in two slots, we get the e.m.f. $2e$, or 15.4 per cent. higher e.m.f., that is, larger output.

It follows herefrom that the distorted e.m.f. wave of a unitooth alternator is produced by lesser magnetic flux per pole—that is, in general, at a lesser hysteric loss in the armature or at higher

efficiency—than the same effective e.m.f. would be produced with the same number of armature turns if the magnetic disposition were such as to produce a sine wave.

256. Inversely, if such a distorted wave of e.m.f. is impressed upon a magnetic circuit, as, for instance, a transformer, the wave of magnetism in the primary will repeat in shape the wave of magnetism interlinked with the armature coils of the alternator, and consequently with a lesser maximum magnetic flux the same effective counter e.m.f. will be produced, that is, the same power converted in the transformer. Since the hysteretic loss in the transformer depends upon the maximum value of magnetism, it follows that the hysteretic loss in a transformer is less with a distorted wave of a unitooth alternator than with a sine wave.

257. From another side the same problem can be approached: If upon a transformer a sine wave of e.m.f. is impressed, the wave of magnetism will be a sine wave also. If now upon the sine wave of e.m.f. higher harmonics, as sine waves of triple, quintuple, etc., frequency are superposed in such a way that the corresponding higher harmonic sine waves of magnetism do not increase the maximum value of magnetism, or even lower it by a coincidence of their negative maxima with the positive maximum of the fundamental, in this case all the power represented by these higher harmonics of e.m.f. will be transformed without an increase of the hysteretic loss, or even with a decreased hysteretic loss.

Obviously, if the maximum of the higher harmonic wave of magnetism coincides with the maximum of the fundamental, and thereby makes the wave of magnetism more pointed, the hysteretic loss will be increased more than in proportion to the increased power transformed, *i.e.*, the efficiency of the transformer will be lowered.

That is, some distorted waves of e.m.f. are transformed at a lesser, some at a larger, hysteretic loss than the sine wave, if the same effective e.m.f. is impressed upon the transformer.

The unitooth alternator wave and the first wave in Fig. 226 belong to the former class; the waves derived from continuous-current machines, tapped at two equidistant points of the armature, frequently, to the latter class.

258. Regarding the loss of energy by Foucault or eddy currents, this loss is not affected by distortion of wave-shape, since the

e.m.f. of eddy currents, like the generated e.m.f., is proportional to the secondary e.m.f.; and thus at constant impressed primary e.m.f. the power consumed by eddy currents bears a constant relation to the output of the secondary circuit, as obvious, since the division of power between the two secondary circuits—the eddy-current circuit and the useful or consumer circuit—is unaffected by wave-shape or intensity of magnetism.

In high-potential lines, distorted waves whose maxima are very high above the effective values, as peaked waves, are objectionable by increasing the strain on the insulation. The striking-distance of an alternating voltage depends upon the maximum value, except at extremely high frequencies, such as oscillating discharges. In the latter, the very short duration of the voltage peak may reduce the disruptive strength, as dielectric disruption requires energy, that is, not only voltage, but time also.

CHAPTER XXVII

SYMBOLIC REPRESENTATION OF GENERAL ALTERNATING WAVES

259. The vector representation,

$$A = a^1 + ja^{11} = a (\cos \theta + j \sin \theta)$$

of the alternating wave,

$$A = a_0 \cos (\phi - \theta)$$

applies to the sine wave only.

The general alternating wave, however, contains an infinite series of terms, of odd frequencies,

$A = A_1 \cos (\phi - \theta_1) + A_3 \cos (3\phi - \theta_3) + A_5 \cos (5\phi - \theta_5) +$
thus cannot be directly represented by one complex vector quantity.

The replacement of the general wave by its equivalent sine wave, as before discussed, that is, a sine wave of equal effective intensity and equal power, while sufficiently accurate in many cases, completely fails in other cases, especially in circuits containing capacity, or in circuits containing periodically (and in synchronism with the wave) varying resistance or reactance (as alternating arcs, reaction machines, synchronous induction motors, oversaturated magnetic circuits, etc.).

Since, however, the individual harmonics of the general alternating wave are independent of each other, that is, all products of different harmonics vanish, each term can be represented by a complex symbol, and the equations of the general wave then are the resultants of those of the individual harmonics.

This can be represented symbolically by combining in one formula symbolic representations of different frequencies, thus,

$$A = \sum_1^{\infty} 2n-1 (a_n^1 + j_n a_n^{11}),^1$$

¹The index $2n - 1$ in the Σ sign denotes that only the odd values of n are considered. If the wave contained even harmonics, the even values of n would also be considered, and the index in the Σ sign would be n .

where

$$j_n = \sqrt{-1},$$

and the index of the j_n merely denotes that the j 's of different indices, n , while algebraically identical, physically represent different frequencies, and thus cannot be combined.

The general wave of e.m.f. is thus represented by

$$E = \sum_1^{\infty} 2^{n-1} (e_n^1 + j_n e_n^{11}),$$

the general wave of current by

$$I = \sum_1^{\infty} 2^{n-1} (i_n^1 + j_n i_n^{11}).$$

If

$$Z_1 = r + j (x_m + x_0 + x_c)$$

is the impedance of the fundamental harmonic, where

x_m is that part of the reactance which is proportional to the frequency (inductance, etc.).

x_0 is that part of the reactance which is independent of the frequency (mutual inductance, synchronous motion, etc.).

x_c is that part of the reactance which is inversely proportional to the frequency (capacity, etc.).

The impedance for the n th harmonic is

$$Z = r + j_n \left(n x_m + x_0 + \frac{x_c}{n} \right).$$

This term can be considered as the general symbolic expression of the impedance of a circuit of general wave-shape.

Ohm's law, in symbolic expression, assumes for the general alternating wave the form

$$I = \frac{\dot{E}}{Z} \text{ or, } \sum_1^{\infty} 2^{n-1} (i_n^1 + j_n i_n^{11}) = \sum_1^{\infty} 2^{n-1} \frac{e_n^1 + j_n e_n^{11}}{r + j_n \left(n x_m + x_0 + \frac{x_c}{n} \right)};$$

$$E = IZ \text{ or, } \sum_1^{\infty} 2^{n-1} (e_n^1 + j_n e_n^{11}) = \sum_1^{\infty} 2^{n-1} \left[r + j_n \left(n x_m + x_0 + \frac{x_c}{n} \right) \right] (i_n^1 + j_n i_n^{11});$$

$$Z = \frac{\dot{E}}{I} \text{ or } Z_n = r + j_n \left(n x_m + x_0 + \frac{x_c}{n} \right) = \frac{e_n^1 + j_n e_n^{11}}{i_n^1 + j_n i_n^{11}}.$$

The symbols of multiplication and division of the terms, E , I , Z ,

thus represent, not algebraic operation, but multiplication and division of corresponding terms of E, I, Z , that is, terms of the same index, n , or, in algebraic multiplication and division of the series, E, I , all compound terms, that is, terms containing two different n 's, vanish.

260. The effective value of the general wave,

$a = A_1 \cos(\phi - \theta_1) + A_3 \cos(3\phi - \theta_3) + A_5 \cos(5\phi - \theta_5) + \dots$
is the square root of the sum of mean squares of individual harmonics,

$$A = \sqrt{\frac{1}{2}\{A_1^2 + A_3^2 + A_5^2 + \dots\}}.$$

Since, as discussed above, the compound terms of two different indices, n , vanish, the absolute value of the general alternating wave,

$$A = \sum_1^{\infty} 2^{n-1} \frac{a_n^1 + j_n a_n^{11}}{b_n^1 + j_n b_n^{11}},$$

is thus,

$$A = \sqrt{\sum_1^{\infty} 2^{n-1} \frac{a_n^1{}^2 + a_n^{11}{}^2}{b_n^1{}^2 + b_n^{11}{}^2}},$$

which offers an easy means of reduction from symbolic to absolute values.

Thus, the absolute value of the e.m.f.,

$$E = \sum_1^{\infty} 2^{n-1} (e_n^1 + j_n e_n^{11}),$$

is

$$E = \sqrt{\sum_1^{\infty} 2^{n-1} (e_n^1{}^2 + e_n^{11}{}^2)},$$

the absolute value of the current,

$$I = \sum_1^{\infty} 2^{n-1} (i_n^1 + j_n i_n^{11}),$$

is

$$I = \sqrt{\sum_1^{\infty} 2^{n-1} (i_n^1{}^2 + i_n^{11}{}^2)}.$$

261. The double frequency power (torque, etc.) equation of the general alternating wave has the same symbolic expression as with the sine wave,

$$\begin{aligned}
 P &= [EI] \\
 &= P^1 + jP^i \\
 &= [EI]^1 + j[EI]^j \\
 &= \sum_1^{\infty} 2^{n-1} (e_n^1 i_n^1 + e_n^{11} i_n^{11}) + \sum_1^{\infty} 2^{n-1} j_n (e_n^{11} i_n^1 - e_n^1 i_n^{11}),
 \end{aligned}$$

where

$$\begin{aligned}
 P^1 &= [EI]^1 = \sum_1^{\infty} 2^{n-1} (e_n^1 i_n^1 + e_n^{11} i_n^{11}), \\
 P^j &= [EI]^j = \sum_1^{\infty} 2^{n-1} \frac{j_n}{j} (e_n^{11} i_n^1 - e_n^1 i_n^{11}).
 \end{aligned}$$

The j_n enters under the summation sign of the reactive or "wattless power," P^j , so that the wattless powers of the different harmonics cannot be algebraically added.

Thus,

The total "true power" of a general alternating-current circuit is the algebraic sum of the powers of the individual harmonics.

The total "reactive power" of a general alternating-current circuit is not the algebraic, but the absolute sum of the wattless powers of the individual harmonics.

Thus, regarding the reactive power as a whole, in the general alternating circuit no distinction can be made between lead and lag, since some harmonics may be leading, others lagging.

The apparent power, or total volt-amperes, of the circuit is

$$P_a = EI = \sqrt{\sum_1^{\infty} 2^{n-1} (e_n^1)^2 + e_n^{11}{}^2} \sum_1^{\infty} 2^{n-1} (i_n^1)^2 + i_n^{11}{}^2}.$$

The power-factor of the circuit is,

$$p = \frac{P^1}{P_a} = \frac{\sum_1^{\infty} 2^{n-1} (e_n^1 i_n^1 + e_n^{11} i_n^{11})}{\sqrt{\sum_1^{\infty} 2^{n-1} (e_n^1)^2 + e_n^{11}{}^2} \sum_1^{\infty} 2^{n-1} (i_n^1)^2 + i_n^{11}{}^2}}.$$

The term "inductance factor," however, has no meaning any more, since the reactive powers of the different harmonics are not directly comparable.

The quantity

$$q_0 = \sqrt{1 - p^2}$$

has no physical significance, and is not $\frac{\text{reactive power}}{\text{total apparent power}}$.

The term

$$\begin{aligned} \frac{P^i}{EI} &= \sum_1^{\infty} 2^{n-1} \frac{j_n}{j} \frac{e_n^{11} i_n^{11} - e_n^{11} i_n^{11}}{EI} \\ &= \sum_1^{\infty} 2^{n-1} \frac{j_n}{j} q_n, \end{aligned}$$

where

$$q_n = \frac{e_n^{11} i_n^{11} - e_n^{11} i_n^{11}}{EI},$$

consists of a series of inductance factors, q_n , of the individual harmonics.

As a rule, if $q^2 = \sum_1^{\infty} 2^{n-1} q_n^2,$

$$p^2 + q^2 < 1,$$

for the general alternating wave, that is, q differs from

$$q_0 = \sqrt{1 - p^2}.$$

The complex quantity,

$$\begin{aligned} V &= \frac{P}{P_a} = \frac{[\dot{E}I]}{EI} = \frac{[\dot{E}I]^1 + j[\dot{E}I]^j}{EI} \\ &= \frac{\sum_1^{\infty} 2^{n-1} (e_n^{11} i_n^{11} + e_n^{11} i_n^{11}) + \sum_1^{\infty} 2^{n-1} j_n (e_n^{11} i_n^{11} - e_n^{11} i_n^{11})}{\sqrt{\sum_1^{\infty} 2^{n-1} (e_n^{12} + e_n^{11^2}) \sum_1^{\infty} 2^{n-1} (i_n^{12} + i_n^{11^2})}} \\ &= p + \sum_1^{\infty} 2^{n-1} j_n q_n, \end{aligned}$$

takes in the circuit of the general alternating wave the same position as power-factor and inductance factor with the sine wave.

$$V = \frac{\dot{P}}{P_a} \text{ may be called the "circuit-factor."}$$

It consists of a real term, p , the power-factor, and a series of imaginary terms, $j_n q_n$, the inductance factors of the individual harmonics.

The absolute value of the circuit-factor,

$$v = \sqrt{p^2 + \sum_1^{\infty} 2^{n-1} q_n^2},$$

as a rule, is < 1 .

262. Some applications of this symbolism will explain its mechanism and its usefulness more fully.

First Example.—Let the e.m.f.,

$$E = \sum_1^5 2^{n-1} (e_n^1 + j_n e_n^{11}),$$

be impressed upon a circuit of the impedance,

$$Z = r + j_n \left(nx_m - \frac{x_c}{n} \right) = 10 + j_n \left(10n - \frac{30}{n} \right)$$

that is, containing resistance, r , inductive reactance x_m and condensive reactance x_c in series.

Let

$$e_1^1 = 720$$

$$e_1^{11} = -540$$

$$e_3^1 = 283$$

$$e_3^{11} = 283$$

$$e_5^1 = -104$$

$$e_5^{11} = -138$$

or,

$$e_1 = 900$$

$$\tan \theta_1 = 0.75$$

$$e_3 = 400$$

$$\tan \theta_3 = -1.0$$

$$e_5 = 173$$

$$\tan \theta_5 = -1.33$$

It is thus in symbolic expression,

$$Z_1 = 10 - 80 j_1$$

$$z_1 = 80.6$$

$$Z_3 = 10$$

$$z_3 = 10.0$$

$$Z_5 = 10 + 32 j_5$$

$$z_5 = 33.5,$$

and e.m.f.,

$$E = (720 - 540 j_1) + (283 + 283 j_3) + (-104 - 138 j_5),$$

or, absolute,

$$E = 1000,$$

and current,

$$\begin{aligned} I = \frac{\dot{E}}{Z} &= \frac{720 - 540 j_1}{10 - 80 j_1} + \frac{283 + 283 j_3}{10} + \frac{-104 - 138 j_5}{10 + 32 j_5} \\ &= (7.76 + 8.04 j_1) + (28.3 + 28.3 j_3) + (-4.86 + 1.73 j_5) \end{aligned}$$

or, absolute,

$$I = 41.85,$$

of which is of fundamental frequency,

$$I_1 = 11.15$$

of triple frequency,

$$I_3 = 40$$

of quintuple frequency,

$$I_5 = 5.17.$$

The total apparent power of the circuit is

$$P_a = EI = 41,850.$$

The true power of the circuit is,

$$\begin{aligned} P^1 &= [EI]^1 = 1240 + 16,000 + 270, \\ &= 17,510, \end{aligned}$$

the reactive power,

$$jP^j = j[EI]^j = -10,000 j_1 + 850 j_5;$$

thus, the total power,

$$P = 17,510 - 10,000 j_1 + 850 j_5.$$

That is, the reactive power of the first harmonic is leading, that of the third harmonic zero, and that of the fifth harmonic lagging.

$$17,510 = I^2 r, \text{ as obvious.}$$

The circuit-factor is,

$$\begin{aligned} V &= \frac{\dot{P}}{P_a} = \frac{[\dot{E}I]}{EI} \\ &= 0.418 - 0.239 j_1 + 0.0203 j_5, \end{aligned}$$

or, absolute,

$$\begin{aligned} v &= \sqrt{0.418^2 + 0.239^2 + 0.0203^2}. \\ &= 0.482. \end{aligned}$$

The power-factor is

$$p = 0.418.$$

The inductance factor of the first harmonic is $q_1 = -0.239$, that of the third harmonic $q_3 = 0$, and of the fifth harmonic $q_5 = +0.0203$.

Considering the waves as replaced by their equivalent sine waves, from the sine wave formula,

$$p^2 + q_0^2 = 1,$$

the inductance factor would be,

$$q_0 = 0.914,$$

and the phase angle,

$$\tan \theta = \frac{q_0}{p} = \frac{0.914}{0.418} = 2.8, \quad \theta = 65.4^\circ,$$

giving apparently a very great phase displacement, while in reality, of the 41.85 amp. total current, 40 amp. (the current of the third harmonic) are in phase with their e.m.f.

We thus have here a case of a circuit with complex harmonic waves which cannot be represented by their equivalent sine waves. The relative magnitudes of the different harmonics in the wave of current and of e.m.f. differ essentially, and the circuit has simultaneously a very low power-factor and a very low inductance factor; that is, a low power-factor exists without corresponding phase displacement, the circuit-factor being less than one-half.

Such circuits, for instance, are those including alternating arcs, reaction machines, synchronous induction motors, reactances with over-saturated magnetic circuit, high potential lines in which the maximum difference of potential exceeds the corona voltage, polarization cells and in general electrolytic conductors above the dissociation voltage of the electrolyte, etc. Such circuits cannot correctly, and in many cases not even approximately, be treated by the theory of the equivalent sine waves, but require the symbolism of the complex harmonic wave.

263. Second Example.—A condenser of capacity, $C_0 = 20$ mf. is connected into the circuit of a 60-cycle alternator giving a wave of the form,

$$e = E(\cos \phi - 0.10 \cos 3 \phi - 0.08 \cos 5 \phi + 0.06 \cos 7 \phi),$$

or, in symbolic expression,

$$E = e(1_1 - 0.10_3 - 0.08_5 + 0.06_7).$$

The synchronous impedance of the alternator is

$$Z_0 = r_0 + j_n n x_0 = 0.3 + 5 n j_n.$$

What is the apparent capacity, C , of the condenser (as calculated from its terminal volts and amperes) when connected directly with the alternator terminals, and when connected thereto through various amounts of resistance and inductive reactance?

The condensive reactance of the condenser is

$$x_c = \frac{10^6}{2 \pi f C_0} = 132 \text{ ohms,}$$

or, in symbolic expression,

$$- j_n \frac{x_c}{n} = - \frac{132}{n} j_n.$$

Let $Z_1 = r + j_n n x =$ impedance inserted in series with the condenser.

The total impedance of the circuit is then

$$Z = Z_0 + Z_1 - j_n \frac{x_c}{n} = (0.3 + r) + j_n \left[(5 + x) n - \frac{132}{n} \right].$$

The current in the circuit is

$$I = \frac{\dot{E}}{Z} = e \left[\frac{1}{(0.3 + r) + j(x - 127)} - \frac{0.1}{(0.3 + r) + j_3(3x - 29)} - \frac{0.08}{(0.3 + r) + j_5(5x - 1.4)} + \frac{0.06}{(0.3 + r) - j_7(7x + 16.1)} \right],$$

and the e.m.f. at the condenser terminals,

$$E_1 = -j_n \frac{x_c \dot{I}}{n} = -e \left[\frac{132 j_1}{(0.3 + r) + j_1(x - 127)} - \frac{4.4 j_3}{(0.3 + r) + j_3(3x - 29)} - \frac{2.11 j_5}{(0.3 + r) + j_5(5x - 1.4)} + \frac{1.13 j_7}{(0.3 + r) + j_7(7x + 16.1)} \right];$$

thus the apparent condensive reactance of the condenser is

$$x_1 = \frac{E_1}{I},$$

and the apparent capacity,

$$C = \frac{10^6}{2 \pi f x_1}.$$

(a) $x = 0$: Resistance, r , in series with the condenser. Reduced to absolute values it is

$$\frac{1}{x_1^2} = \frac{1}{(0.3+r)+16129} + \frac{0.01}{(0.3+r)^2+841} + \frac{0.0064}{(0.3+r)^2+1.96} + \frac{0.0036}{(0.3+r)^2+259} \\ \frac{1}{(0.3+r)^2+16129} + \frac{19.4}{(0.3+r)^2+841} + \frac{4.45}{(0.3+r)^2+1.96} + \frac{1.28}{(0.3+r)^2+259}$$

(b) $r = 0$: Inductive reactance, x , in series with the condenser. Reduced to absolute values it is

$$\frac{1}{x_1^2} = \frac{1}{0.09+(x-127)^2} + \frac{0.01}{0.09+(3x-29)^2} + \frac{0.0064}{0.09+(5x-1.4)^2} + \frac{0.0036}{0.09+(7x+16.1)^2} \\ \frac{19.4}{0.09+(x-127)^2} + \frac{4.45}{0.09+(3x-29)^2} + \frac{1.28}{0.09+(5x-1.4)^2} + \frac{1.28}{0.09+(7x+16.1)^2}$$

From $\frac{1}{x_1^2}$ are derived the values of apparent capacity,

$$C = \frac{10^6}{2\pi f x_1}$$

and plotted in Fig. 189 for values of r and x respectively varying from 0 to 22 ohms.

As seen, with neither additional resistance nor reactance in series to the condenser, the apparent capacity with this generator wave is 84 mf., or 4.2 times the true capacity, and gradually decreases with increasing series resistance, to $C = 27$ mf. = 1.35 times the true capacity at $r = 13.2$ ohms, or one-tenth the true capacity reactance. With $r = 132$ ohms, or with an additional resistance equal to the condensive reactance, $C = 20.2$ mf. or only

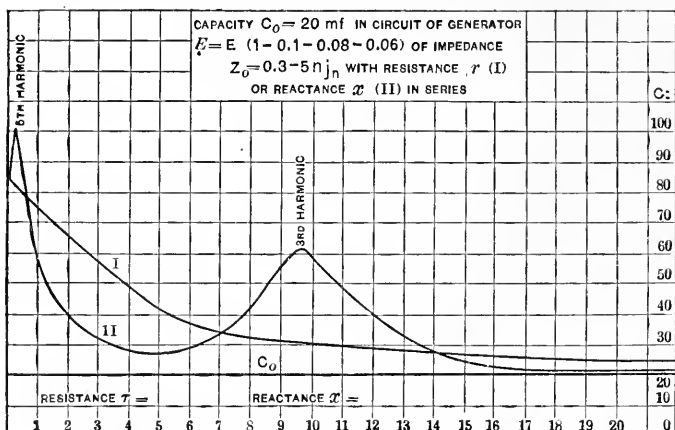

FIG. 189.

one per cent. in excess of the true capacity, C_0 , and at $r = \infty$, $C = 20$ mf. or the true capacity.

With reactance, x , but no additional resistance, r , in series, the apparent capacity, C , rises from 4.2 times the true capacity at $x = 0$, to a maximum of 5.03 times the true capacity, or $C = 100.6$ mf. at $x = 0.28$, the condition of resonance of the fifth harmonic, then decreases to a minimum of 27 mf., or 35 per cent. in excess of the true capacity, rises again to 60.2 mf., or 3.01 times the true capacity at $x = 9.67$, the condition of resonance with the third harmonic, and finally decreases, reaching 20 mf., or the true capacity at $x = 132$, or an inductive reactance equal to the condensive reactance.

It thus follows that the true capacity of a condenser cannot even approximately be determined by measuring volts and amperes if there are any higher harmonics present in the generator wave, except by inserting a very large resistance or reactance in series to the condenser.

264. Third Example.—An alternating-current generator of the wave,

$$E_0 = 2000 [1_1 + 0.12_3 - 0.23_5 - 0.13_7],$$

and of synchronous impedance,

$$Z_0 = 0.3 + 5 nj_n,$$

feeds over a line of impedance,

$$Z_1 = 2 + 4 nj_n,$$

a synchronous motor of the wave,

$$E_1 = 2250 [(\cos \theta - j_1 \sin \theta) + 0.24 (\cos 3 \theta - j_3 \sin 3 \theta)],$$

and of synchronous impedance,

$$Z_2 = 0.3 + 6 nj_n.$$

The total impedance of the system is then,

$$Z = Z_0 + Z_1 + Z_2 = 2.6 + 15 nj_n,$$

thus the current,

$$\begin{aligned} I &= \frac{\dot{E}_0 - \dot{E}_1}{Z} \\ &= \frac{2000 - 2250 \cos \theta + 2250 j_1 \sin \theta}{2.6 + 15 j_1} + \frac{240 - 540 \cos 3 \theta + 540 j_3 \sin 3 \theta}{2.6 - 45 j_3} \\ &\quad - \frac{460}{2.6 + 75 j_5} - \frac{260}{2.6 + 105 j_7} \\ &= (a_1^1 - j_1 a_1^{11}) + (a_3^1 - j_3 a_3^{11}) + (a_5^1 - j_5 a_5^{11}) + (a_7^1 - j_7 a_7^{11}); \end{aligned}$$

where

$$\begin{aligned} a_1^1 &= 22.5 - 25.2 \cos \theta + 146 \sin \theta, \\ a_3^1 &= 0.306 - 0.69 \cos 3 \theta + 11.9 \sin 3 \theta, \\ a_5^1 &= 0.213, \\ a_7^1 &= -0.061, \\ a_1^{11} &= 130 - 146 \cos \theta - 25.2 \sin \theta, \\ a_3^{11} &= 5.3 - 11.9 \cos 3 \theta - 0.69 \sin 3 \theta, \\ a_5^{11} &= -6.12, \\ a_7^{11} &= -2.48, \end{aligned}$$

or, absolute,

first harmonic,

$$a_1 = \sqrt{a_1^{12} + a_1^{112}},$$

third harmonic,

$$a_3 = \sqrt{a_3^{12} + a_3^{112}},$$

fifth harmonic,

$$a_5 = 6.12,$$

seventh harmonic,

$$a_7 = 2.48,$$

$$I = \sqrt{a_1^2 + a_3^2 + a_5^2 + a_7^2};$$

while the total current of higher harmonics is

$$I_0 = \sqrt{a_3^2 + a_5^2 + a_7^2}.$$

The true input of the synchronous motor is

$$P^1 = [E_1 I]^1$$

$$\begin{aligned} &= (2250 a_1^1 \cos \theta + 2250 a_1^{11} \sin \theta) + (540 a_1^1 \cos 3 \theta + 540 a_3^{11} \sin 3 \theta) \\ &= P_1^1 + P_3^1 \end{aligned}$$

$$P_1^1 = 2250 (a_1^1 \cos \theta + a_1^{11} \sin \theta),$$

is the power of the fundamental wave,

$$P_3^1 = 540 (a_3^1 \cos 3 \theta + a_3^{11} \sin 3 \theta),$$

the power of the third harmonic.

The fifth and seventh harmonics do not give any power, since they are not contained in the synchronous motor wave. Substituting now different numerical values for θ , the phase angle between generator e.m.f. and synchronous motor counter e.m.f., corresponding values of the currents, I , I_0 , and the powers, P^1 , P_1^1 , P_3^1 , are derived. These are plotted in Fig. 190 with the total current, I , as abscissas. To each value of the total current, I , correspond two values of the total power, P^1 , a positive value plotted as Curve I—synchronous motor—and a negative value plotted as Curve II—alternating-current generator—. Curve III gives the total current of higher frequency, I_0 , Curve IV the difference between the total current and the current of fundamental frequency, $I - I_1$, in percentage of the total current, I , and V the power of the third harmonic, P_3^1 , in percentage of the total power, P^1 .

Curves III, IV, and V correspond to the positive or synchronous motor part of the power curve, P^1 . As seen, the increase of

current due to the higher harmonics is small, and entirely disappears at about 180 amp. The power of the third harmonic is positive, that is, adds to the power of the synchronous motor

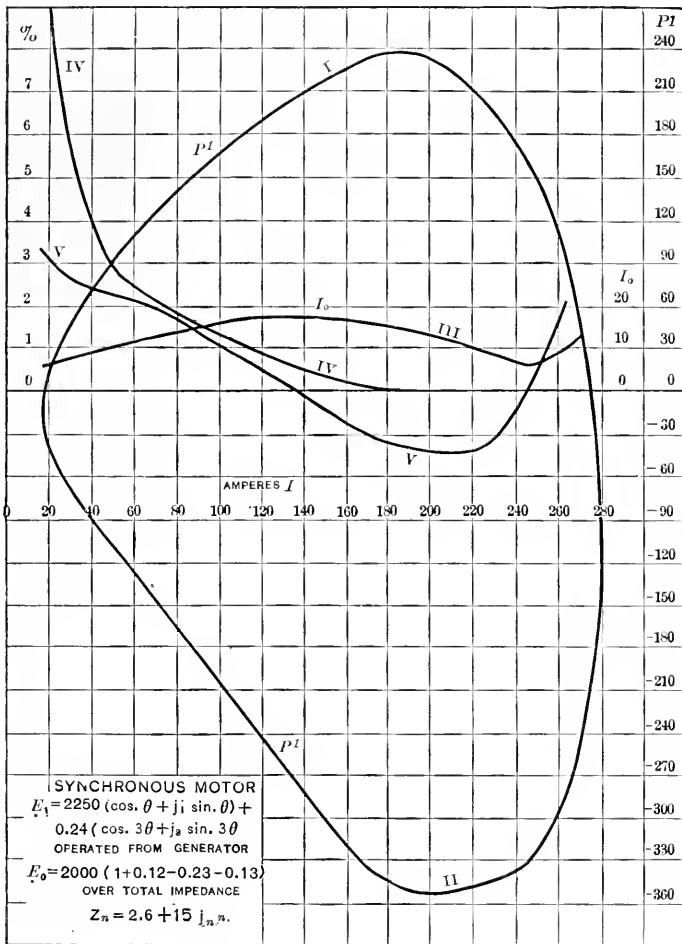

FIG. 190.—Synchronous motor.

up to about 140 amp. or near the maximum output of the motor, and then becomes negative.

It follows herefrom that higher harmonics in the e.m.f. waves of generators and synchronous motors do not represent a mere waste of current, but may contribute more or less to the output of

the motor. Thus at 75 amp. total current, the percentage of increase of power due to the higher harmonic is equal to the increase of current, or in other words the higher harmonics of current do work with the same efficiency as the fundamental wave.

265. Fourth Example.—In a small three-phase induction motor, the constants per delta circuit are

$$\begin{aligned} \text{primary admittance} \quad Y &= 0.002 - 0.03 j, \\ \text{self-inductive impedance} \quad Z_0 = Z_1 &= 0.6 + 2.4 j, \end{aligned}$$

and a sine wave of e.m.f., $e_0 = 110$ volts, is impressed upon the motor.

The power output, P , current input, I_s , and power-factor, p , as function of the slip, s , are given in the first columns of the following table, calculated in the manner as described in the chapter on Induction Motors.

To improve the power-factor of the motor and bring it to unity at an output of 500 watts, a condenser capacity is required giving 4.28 amp. leading current at 110 volts, that is, neglecting the power loss in the condenser, capacity susceptance

$$\frac{4.28}{110} = 0.039.$$

In this case, let $I_s =$ current input into the motor per delta circuit at slip s , as given in the following table.

The total current supplied by the circuit with a sine wave of impressed e.m.f. is

$$I' = I_s + 4.28 j,$$

and herefrom the power-factor = $\frac{\text{power current}}{\text{total current}}$, given in the second columns of the table.

If the impressed e.m.f. is not a sine wave but a wave of the shape,

$$E_0 = e_0(1_1 + 0.12_3 - 0.23_5 - 0.134_7),$$

to give the same output, the fundamental wave must be the same: $e_0 = 110$ volts, when assuming the higher harmonics in the motor as wattless, that is,

$$E_0 = 110_1 + 13.2_3 - 25.3_5 - 14.7_7 = e_0 + E_0^1,$$

where $E_0^1 = 13.2_3 - 25.3_5 - 14.7_7$

= component of impressed e.m.f. of higher frequency.

The effective value is

$$E_0 = 114.5 \text{ volts.}$$

The condenser admittance for the general alternating wave is

$$Y_c = 0.039 nj_n.$$

Since the frequency of rotation of the motor is small compared with the frequency of the higher harmonics, as total impedance of the motor for these higher harmonics can be assumed the stationary impedance, and by neglecting the resistance we have

$$Z^1 = nj_n(x_0 + x_1) = 4.8 nj_n$$

The exciting admittance of the motor, for these higher harmonics, is, by neglecting the conductance,

$$Y^1 = -\frac{bj_n}{n} = -\frac{0.03j_n}{n},$$

and the higher harmonics of counter e.m.f.,

$$E^1 = \frac{E_0^1}{2}.$$

Thus we have,

current input in the condenser,

$$I_c = E_0 Y_c = + 4.28 j_1 + 1.54 j_3 - 4.93 j_5 - 4.02 j_7;$$

high-frequency component of motor-impedance current,

$$\frac{\dot{E}_0^1}{Z^1} = - 0.92 j_3 + 1.06 j_5 + 0.44 j_7;$$

high-frequency component of motor-exciting current,

$$E^1 Y^1 = \frac{\dot{E}_0^1 Y^1}{2} = - 0.07 j_3 + 0.08 j_5 + 0.03 j_7;$$

thus, total high-frequency component of motor current,

$$I_0^1 = \frac{\dot{E}_0^1}{Z^1} + E^1 Y^1 = - 0.99 j_3 + 1.14 j_5 + 0.47 j_7,$$

and total current, without condenser,

$$I_0 = I_s + I_0^1 = I_s - 0.99 j_3 + 1.14 j_5 + 0.47 j_7,$$

with condenser,

$$I = I_s + I_0^1 - I_c = I_s + 4.28 j_1 + 0.55 j_3 - 3.79 j_5 + 3.55 j_7;$$

and herefrom the power-factor.

In the following table and in Fig. 191 are given the values of current and power-factor:

- I. With sine wave of e.m.f., of 110 volts, and no condenser.
- II. With sine wave of e.m.f., of 110 volts, and with condenser.
- III. With distorted wave of e.m.f., of 114.5 volts, and no condenser.
- IV. With distorted wave of e.m.f., of 114.5 volts, and with condenser.

TABLE

s	P	I.		II.		III.		IV.			
		I_s	p	I'	p	I_0	p	I	p		
0.0	0	0.24+	3.10 j	3.1	7.8	1.2	20.0	3.5	6.6	5.2	4.4
0.01	160	1.73+	3.16 j	3.6	48.0	2.1	84.0	3.9	43.0	5.5	31.0
0.02	320	3.32+	3.47 j	4.8	69.0	3.4	97.2	5.1	64.0	6.1	54.0
0.035	500	5.16+	4.28 j	6.7	77.0	5.2	100.0	6.9	72.5	7.2	68.0
0.05	660	6.95+	5.4 j	8.8	79.0	7.0	98.7	8.9	76.0	8.6	77.0
0.07	810	8.77+	7.3 j	11.4	77.0	9.3	94.5	11.5	73.5	10.6	80.0
0.10	885	10.1 +	9.85 j	14.1	71.5	11.5	87.0	14.2	68.0	12.6	77.0
0.13	900	10.45+	11.45 j	15.5	67.5	12.7	82.0	15.6	64.5	13.7	73.0
0.15	890	10.75+	12.9 j	16.8	64.0	13.8	78.0	16.9	61.0	14.7	70.0

The curves II and IV with condenser are plotted in dotted lines in Fig. 191. As seen, even with such a distorted wave the current input and power-factor of the motor are not much changed if no condenser is used. When using a condenser in shunt to the motor, however, with such a wave of impressed e.m.f. the increase of the total current, due to higher-frequency currents in the condenser, is greater than the decrease, due to the compensation of lagging currents, and the power-factor is actually lowered by the condenser, over the total range of load up to overload, and especially at light load.

Where a compensator or transformer is used for feeding the condenser, due to the internal self-inductance of the compensator, the higher harmonics of current are still more accentuated, that is, the power-factor still more lowered.

In the preceding the energy loss in the condenser and compensator and that due to the higher harmonics of current in the motor

has been neglected. The effect of this energy loss is a slight decrease of efficiency and corresponding increase of power-factor. The power produced by the higher harmonics has also been neglected; it may be positive or negative, according to the index

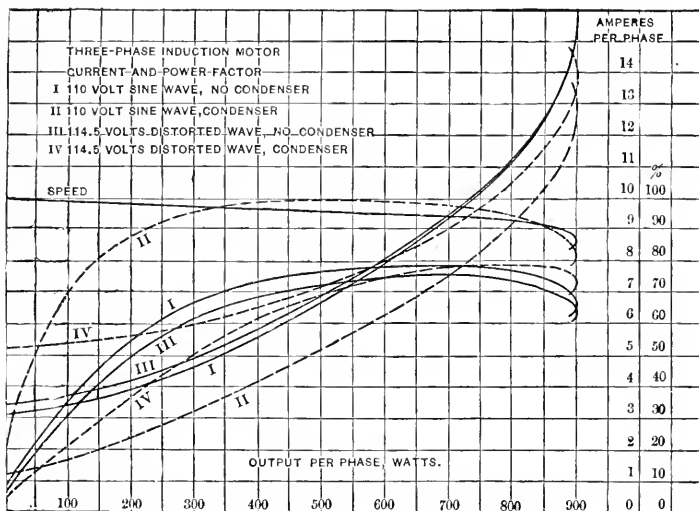

FIG. 191.

of the harmonic, and the winding of the motor primary. Thus, for instance, the effect of the triple harmonic is negative in the quarter-phase motor, zero in the three-phase motor, etc.; altogether, however, the effect of these harmonics is usually small.

SECTION VII

POLYPHASE SYSTEMS

CHAPTER XXVIII

GENERAL POLYPHASE SYSTEMS

266. A polyphase system is an alternating-current system in which several e.m.fs. of the same frequency, but displaced in phase from each other, produce several currents of equal frequency, but displaced phases.

Thus any polyphase system can be considered as consisting of a number of single circuits, or branches of the polyphase system, which may be more or less interlinked with each other.

In general the investigation of a polyphase system is carried out by treating the single-phase branch circuits independently.

Thus all the discussions on generators, synchronous motors, induction motors, etc., in the preceding chapters, apply to single-phase systems as well as polyphase systems, in the latter case the total power being the sum of the powers of the individual or branch circuits.

If the polyphase system consists of n equal e.m.fs. displaced from each other by $\frac{1}{n}$ of a period, the system is called a *symmetrical system*, otherwise an *unsymmetrical system*.

Thus the three-phase system, consisting of three equal e.m.fs. displaced by one-third of a period, is a symmetrical system. The quarter-phase system, consisting of two equal e.m.fs. displaced by 90° , or one-quarter of a period, is an unsymmetrical system.

267. The power in a single-phase system is pulsating; that is, the watt curve of the circuit is a sine wave of double frequency, alternating between a maximum value and zero, or a negative maximum value. In a polyphase system the watt curves of the different branches of the system are pulsating also. Their sum, however, or the total power of the system, may be either con-

stant or pulsating. In the first case, the system is called a *balanced system*, in the latter case an *unbalanced system*.

The three-phase system and the quarter-phase system, with equal load on the different branches, are balanced systems; with unequal distribution of load between the individual branches both systems become unbalanced systems.

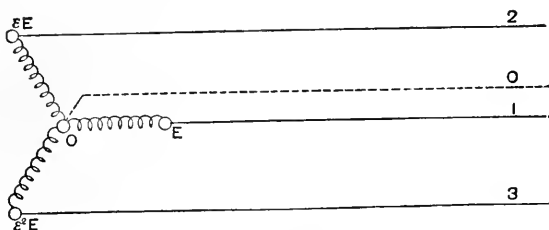

FIG. 192.

The different branches of a polyphase system may be either independent from each other, that is, without any electrical interconnection, or they may be interlinked with each other. In the first case the polyphase system is called an *independent system*, in the latter case an *interlinked system*.

The three-phase system with star-connected or ring-connected generator, as shown diagrammatically in Figs. 192 and 193, is an interlinked system.

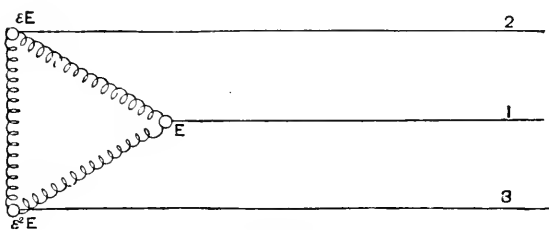

FIG. 193.

The four-phase system as derived by connecting four equidistant points of a continuous-current armature with four collector rings, as shown diagrammatically in Fig. 194, is an interlinked system also. The four-wire, quarter-phase system produced by a generator with two independent armature coils, or by two single-phase generators rigidly connected with each other in quadrature, is an independent system. As interlinked system, it is shown in Fig. 195, as star-connected, four-phase system.

268. Thus, polyphase systems can be subdivided into:
 Symmetrical systems and unsymmetrical systems.
 Balanced systems and unbalanced systems.
 Interlinked systems and independent systems.

The only polyphase systems which have found practical application are:

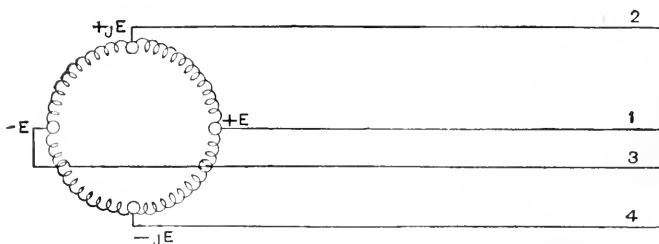

FIG. 194.

The three-phase system, consisting of three e.m.fs. displaced by one-third of a period, is used exclusively as interlinked system.

The quarter-phase system, consisting of two e.m.fs. in quadrature, and used with four wires, or with three wires, which may be either an interlinked system or an independent system.

The six-phase system, consisting of two three-phase systems in opposition to each other, and derived by transformation from

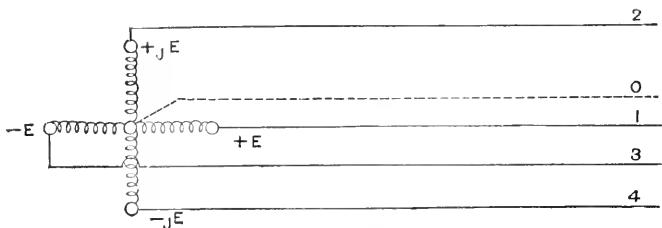

FIG. 195.

a three-phase system, in the alternating supply circuit of large synchronous converters.

The inverted three-phase system, consisting of two e.m.fs. displaced from each other by 60° , and derived from two phases of a three-phase system by transformation with two transformers, of which the secondary of one is reversed with regard to its primary (thus changing the phase difference from 120° to $180^\circ - 120^\circ = 60^\circ$) finds a limited application in low-tension distribution.

CHAPTER XXIX

SYMMETRICAL POLYPHASE SYSTEMS

269. If all the e.m.fs. of a polyphase system are equal in intensity and differ from each other by the same angle of difference of phase, the system is called a symmetrical polyphase system.

Hence, a symmetrical n -phase system is a system of n e.m.fs. of equal intensity, differing from each other in phase by $\frac{1}{n}$ of a period:

$$\begin{aligned} e_1 &= E \sin \beta; \\ e_2 &= E \sin \left(\beta - \frac{2\pi}{n} \right); \\ e_3 &= E \sin \left(\beta - \frac{4\pi}{n} \right); \\ &\vdots \\ e_n &= E \sin \left(\beta - \frac{2(n-1)\pi}{n} \right). \end{aligned}$$

The next e.m.f. is, again,

$$e_1 = E \sin (\beta - 2\pi) = E \sin \beta.$$

In the vector diagram the n e.m.fs. of the symmetrical n -phase system are represented by n equal vectors, following each other under equal angles.

Since in symbolic writing rotation by $\frac{1}{n}$ of a period, or angle $\frac{2\pi}{n}$, is represented by multiplication with

$$\cos \frac{2\pi}{n} + j \sin \frac{2\pi}{n} = \epsilon,$$

the e.m.fs. of the symmetrical polyphase system are

$$E \left(\cos \frac{2\pi}{n} + j \sin \frac{2\pi}{n} \right) = E\epsilon;$$

$$\begin{aligned} E \left(\cos \frac{4\pi}{n} + j \sin \frac{4\pi}{n} \right) &= E\epsilon^2; \\ E \left(\cos \frac{2(n-1)\pi}{n} + j \sin \frac{2(n-1)\pi}{n} \right) &= E\epsilon^{n-1}. \end{aligned}$$

The next e.m.f. is again,

$$E(\cos 2\pi + j \sin 2\pi) = E\epsilon^n = E.$$

Hence, it is

$$\epsilon = \cos \frac{2\pi}{n} + j \sin \frac{2\pi}{n} = \sqrt[n]{1}.$$

Or in other words:

In a symmetrical n -phase system any e.m.f. of the system is expressed by

$$\epsilon^i E;$$

where

$$\epsilon = \sqrt[n]{1}.$$

270. Substituting now for n different values, we get the different symmetrical polyphase systems, represented by

$$\epsilon^i E,$$

where

$$\epsilon = \sqrt[n]{1} = \cos \frac{2\pi}{n} + j \sin \frac{2\pi}{n}.$$

$$1. \quad n = 1, \quad \epsilon = 1, \quad \epsilon^i E = E,$$

the ordinary single-phase system.

$$2. \quad n = 2, \quad \epsilon = -1, \quad \epsilon^i E = E \text{ and } -E.$$

Since $-E$ is the return of E , $n = 2$ gives again the single-phase system.

$$\begin{aligned} 3. \quad n = 3, \quad \epsilon &= \cos \frac{2\pi}{3} + j \sin \frac{2\pi}{3} = \frac{-1 + j\sqrt{3}}{2} \\ \epsilon^2 &= \frac{-1 - j\sqrt{3}}{2}. \end{aligned}$$

The three e.m.fs. of the three-phase system are

$$\epsilon^i E = E, \quad \frac{-1 + j\sqrt{3}}{2} E, \quad \frac{-1 - j\sqrt{3}}{2} E.$$

Consequently the three-phase system is the lowest symmetrical polyphase system.

4. $n = 4, \epsilon = \cos \frac{2\pi}{4} + j \sin \frac{2\pi}{4} = j, \epsilon^2 = -1, \epsilon^3 = -j.$

The four e.m.fs. of the four-phase system are,

$$\epsilon^i E = E, \quad jE, \quad -E, \quad -jE.$$

They are in pairs opposite to each other,

$$E \text{ and } -E; \quad jE \text{ and } -jE.$$

Hence can be produced by two coils in quadrature with each other, analogous as the two-phase system, or ordinary alternating current system, can be produced by one coil.

Thus the symmetrical quarter-phase system is a four-phase system.

Higher systems than the quarter-phase or four-phase system have not been very extensively used, and are thus of less practical interest. A symmetrical six-phase system, derived by transformation from a three-phase system, has found application in synchronous converters, as offering a higher output from these machines, and a symmetrical eight-phase system proposed for the same purpose.

271. A characteristic feature of the symmetrical n -phase system is that under certain conditions it can produce a rotating m.m.f. of constant intensity.

If n equal magnetizing coils act upon a point under equal angular displacements in space, and are excited by the n e.m.fs. of a symmetrical n -phase system, a m.m.f. of constant intensity is produced at this point, whose direction revolves synchronously with uniform velocity.

Let

- n' = number of turns of each magnetizing coil.
- E = effective value of impressed e.m.f.
- I = effective value of current.

Hence,

$$F = n'I = \text{effective m.m.f. of one of the magnetizing coils.}$$

Then the instantaneous value of the m.m.f. of the coil acting in the direction, $\frac{2\pi i}{n}$, is

$$\begin{aligned} f_i &= F \sqrt{2} \sin \left(\beta - \frac{2\pi i}{n} \right) \\ &= n'I \sqrt{2} \sin \left(\beta - \frac{2\pi i}{n} \right). \end{aligned}$$

The two rectangular space components of this m.m.f. are

$$\begin{aligned} f_i' &= f_i \cos \frac{2\pi i}{n} \\ &= n'I \sqrt{2} \cos \frac{2\pi i}{n} \sin \left(\beta - \frac{2\pi i}{n} \right). \end{aligned}$$

and

$$\begin{aligned} f_i'' &= f_i \sin \frac{2\pi i}{n} \\ &= n'I \sqrt{2} \sin \frac{2\pi i}{n} \sin \left(\beta - \frac{2\pi i}{n} \right). \end{aligned}$$

Hence the m.m.f. of this coil can be expressed by the symbolic formula

$$f_i = n'I \sqrt{2} \sin \left(\beta - \frac{2\pi i}{n} \right) \left(\cos \frac{2\pi i}{n} + j \sin \frac{2\pi i}{n} \right).$$

Thus the total or resultant m.m.f. of the n coils displaced under the n equal angles is

$$f = \sum_1^n f_i = n'I \sqrt{2} \sum_1^n \sin \left(\beta - \frac{2\pi i}{n} \right) \left(\cos \frac{2\pi i}{n} + j \sin \frac{2\pi i}{n} \right).$$

or, expanded,

$$\begin{aligned} f &= n'I \sqrt{2} \left\{ \sin \beta \sum_1^n \left(\cos^2 \frac{2\pi i}{n} + j \sin \frac{2\pi i}{n} \cos \frac{2\pi i}{n} \right) \right. \\ &\quad \left. - \cos \beta \sum_1^n \left(\sin \frac{2\pi i}{n} \cos \frac{2\pi i}{n} + j \sin^2 \frac{2\pi i}{n} \right) \right\}. \end{aligned}$$

It is, however,

$$\begin{aligned} \cos^2 \frac{2\pi i}{n} + j \sin \frac{2\pi i}{n} \cos \frac{2\pi i}{n} &= \frac{1}{2} \left(1 + \cos \frac{4\pi i}{n} + j \sin \frac{4\pi i}{n} \right) \\ &= \frac{1}{2} (1 + \epsilon^{2i}), \end{aligned}$$

$$\begin{aligned} \sin \frac{2\pi i}{n} \cos \frac{2\pi i}{n} + j \sin^2 \frac{2\pi i}{n} &= \frac{j}{2} \left(1 - \cos \frac{4\pi i}{n} - j \sin \frac{4\pi i}{n} \right) \\ &= \frac{j}{2} (1 - \epsilon^{2i}); \end{aligned}$$

and, since

$$\sum_1^n \epsilon^{2i} = 0, \quad \sum_1^n \epsilon^{-2i} = 0,$$

it is,

$$f = \frac{nn'I \sqrt{2}}{2} (\sin \beta - j \cos \beta);$$

or,

$$\begin{aligned}
 f &= \frac{nn'I}{\sqrt{2}} (\sin \beta - j \cos \beta) \\
 &= \frac{nF}{\sqrt{2}} (\sin \beta - j \cos \beta);
 \end{aligned}$$

the symbolic expression of the m.m.f. produced by the n circuits of the symmetrical n -phase system, when exciting n equal magnetizing coils displaced in space under equal angles.

The absolute value of this m.m.f. is

$$F_0 = \frac{nn'I}{\sqrt{2}} = \frac{nF}{\sqrt{2}} = \frac{nF_{max}}{2}.$$

Hence constant and equal $\frac{n}{\sqrt{2}}$ times the effective m.m.f. of each coil or $\frac{n}{2}$ times the maximum m.m.f. of each coil.

The phase of the resultant m.m.f. at the time represented by the angle β is

$$\tan \theta = -\cot \beta; \text{ hence } \theta = -\beta \frac{\pi}{2}.$$

That is, the m.m.f. produced by a symmetrical n -phase system revolves with constant intensity,

$$F_0 = \frac{nF}{\sqrt{2}},$$

and constant speed, in synchronism with the frequency of the system; and, if the reluctance of the magnetic circuit is constant, the magnetism revolves with constant intensity and constant speed also, at the point acted upon symmetrically by the n m.m.fs. of the n -phase system.

This is a characteristic feature of the symmetrical polyphase system.

272. In the three-phase system, $n = 3$, $F_0 = 1.5 F_{max}$, where F_{max} is the maximum m.m.f. of each of the magnetizing coils.

In a symmetrical quarter-phase system, $n = 4$, $F_0 = 2 F_{max}$, where F_{max} is the maximum m.m.f. of each of the four magnetizing coils, or, if only two coils are used, since the four-phase m.m.fs. are opposite in phase by two, $F_0 = F_{max}$, where F_{max} is the maximum m.m.f. of each of the two magnetizing coils of the quarter-phase system.

While the quarter-phase system, consisting of two e.m.fs. displaced by one-quarter of a period, is by its nature an unsymmetrical system, it shares a number of features—as, for instance, the ability of producing a constant-resultant m.m.f.—with the symmetrical system, and may be considered as one-half of a symmetrical four-phase system.

Such systems, consisting of one-half of a symmetrical system, are called *hemisymmetrical systems*.

CHAPTER XXX

BALANCED AND UNBALANCED POLYPHASE SYSTEMS

273. If an alternating e.m.f.,

$$e = E\sqrt{2} \sin \beta,$$

produces a current,

$$i = I\sqrt{2} \sin (\beta - \theta),$$

where θ is the angle of lag, the power is

$$\begin{aligned} p &= ei = 2 EI \sin \beta \sin (\beta - \theta) \\ &= EI (\cos \theta - \cos (2\beta - \theta)), \end{aligned}$$

and the average value of power,

$$P = EI \cos \theta.$$

Substituting this, the instantaneous value of power is found as

$$p = P \left(1 - \frac{\cos (2\beta - \theta)}{\cos \theta} \right).$$

Hence the power, or the flow of energy, in an ordinary single-phase, alternating-current circuit is fluctuating, and varies with twice the frequency of e.m.f. and current, unlike the power of a continuous-current circuit, which is constant,

$$p = ei.$$

If the angle of lag, $\theta = 0$, it is,

$$p = P(1 - \cos 2\beta);$$

hence the flow of energy varies between zero and $2P$, where P is the average flow of energy or the effective power of the circuit.

If the current lags or leads the e.m.f. by angle θ , the power varies between

$$P \left(1 - \frac{1}{\cos \theta} \right) \text{ and } P \left(1 + \frac{1}{\cos \theta} \right),$$

that is, becomes negative for a certain part of each half-wave. That is, for a time during each half-wave, energy flows back into

the generator, while during the other part of the half-wave the generator sends out energy, and the difference between both is the effective power of the circuit.

If $\theta = 90^\circ$, it is

$$p = -EI \sin 2\beta;$$

that is, the effective power $P = 0$, and the energy flows to and fro between generator and receiving circuit.

Under any circumstances, however, the flow of energy in the single-phase system is fluctuating, at least between zero and a maximum value, frequently even reversing.

274. If in a polyphase system

$$\begin{aligned} e_1, e_2, e_3, \dots &= \text{instantaneous values of e.m.f.;} \\ i_1, i_2, i_3, \dots &= \text{instantaneous values of current produced thereby,} \end{aligned}$$

the total power in the system is

$$p = e_1 i_1 + e_2 i_2 + e_3 i_3 + \dots$$

The average power is

$$P = E_1 I_1 \cos \theta_1 + E_2 I_2 \cos \theta_2 + \dots$$

The polyphase system is called a balanced system, if the flow of energy

$$p = e_1 i_1 + e_2 i_2 + e_3 i_3 + \dots$$

is constant, and it is called an unbalanced system if the flow of energy varies periodically, as in the single-phase system; and the ratio of the minimum value to the maximum value of power is called the *balance-factor of the system*.

Hence in a single-phase system on non-inductive circuit, that is, at no-phase displacement, the balance-factor is zero; and it is negative in a single-phase system with lagging or leading current, and becomes equal to -1 if the phase displacement is 90° —that is, the circuit is wattless.

275. Obviously, in a polyphase system the balance of the system is a function of the distribution of load between the different branch circuits.

A balanced system in particular is called a polyphase system, whose flow of energy is constant, if all the circuits are loaded equally with a load of the same character, that is, the same phase displacement.

276. All the symmetrical systems from the three-phase system upward are balanced systems. Many unsymmetrical systems are balanced systems also.

1. Three-phase system:

Let

$$\begin{aligned} e_1 &= E \sqrt{2} \sin \beta, & \text{and } i_1 &= I \sqrt{2} \sin (\beta - \theta), \\ e_2 &= E \sqrt{2} \sin (\beta - 120), & i_2 &= I \sqrt{2} \sin (\beta - \theta - 120), \\ e_3 &= E \sqrt{2} \sin (\beta - 240), & i_3 &= I \sqrt{2} \sin (\beta - \theta - 240), \end{aligned}$$

be the e.m.f.s. of a three-phase system and the currents produced thereby.

Then the total power is

$$\begin{aligned} p &= 2 EI \{ \sin \beta \sin (\beta - \theta) + \sin (\beta - 120) \sin (\beta - \theta - 120) \\ &+ \sin (\beta - 240) \sin (\beta - \theta - 240) \} \\ &= 3 EI \cos \theta = P, \text{ or constant.} \end{aligned}$$

Hence the symmetrical three-phase system is a balanced system.

2. Quarter-phase system:

$$\begin{aligned} \text{Let } e_1 &= E \sqrt{2} \sin \beta, & i_1 &= I \sqrt{2} \sin (\beta - \theta), \\ e_2 &= E \sqrt{2} \cos \beta, & i_2 &= I \sqrt{2} \cos (\beta - \theta) \end{aligned}$$

be the e.m.f.s. of the quarter-phase system, and the currents produced thereby.

This is an unsymmetrical system, but the instantaneous value of power is

$$\begin{aligned} p &= 2 EI \{ \sin \beta \sin (\beta - \theta) + \cos \beta \cos (\beta - \theta) \} \\ &= 2 EI \cos \theta = P, \text{ or constant.} \end{aligned}$$

Hence the quarter-phase system is an unsymmetrical balanced system.

3. The symmetrical n -phase system, with equal load and equal phase-displacement in all n branches, is a balanced system. For, let

$$e_i = E \sqrt{2} \sin \left(\beta - \frac{2\pi i}{n} \right) = \text{e.m.f.};$$

$$i_i = I \sqrt{2} \sin \left(\beta - \theta - \frac{2\pi i}{n} \right) = \text{current};$$

the instantaneous value of power is

$$\begin{aligned} p &= \sum_1^n e_i i_i \\ &= 2 EI \sum_1^n i \sin\left(\beta - \frac{2\pi i}{n}\right) \sin\left(\beta - \theta - \frac{2\pi i}{n}\right) \\ &= EI \left\{ \sum_1^n i \cos \theta - \sum_1^n i \cos\left(2\beta - \theta - \frac{4\pi i}{n}\right) \right\}; \end{aligned}$$

or $p = nEI \cos \theta = P$, or constant.

277. An unbalanced polyphase system is the so-called inverted three-phase system, derived from two branches of a three-phase system by transformation by means of two transformers, whose secondaries are connected in opposite direction with respect to their primaries. Such a system takes an intermediate position between the Edison three-wire system and the three-phase system. It shares with the latter the polyphase feature, and with the Edison three-wire system the feature that the potential difference between the outside wires is higher than between middle wire and outside wire.

By such a pair of transformers the two primary e.m.fs. of 120° displacement of phase are transformed into two secondary e.m.fs., differing from each other by 60° . Thus in the secondary circuit the difference of potential between the outside wires is $\sqrt{3}$ times the difference of potential between middle wire and outside wire. At equal load on the two branches, the three currents are equal, and differ from each other by 120° , that is, have the same relative proportion as in a three-phase system. If the load on one branch is maintained constant, while the load of the other branch is reduced from equality with that in the first branch down to zero, the current in the middle wire first decreases, reaches a minimum value of $\frac{\sqrt{3}}{2} = 0.866$ of its original value, and then increases again, reaching at no-load the same value as at full-load.

The balance factor of the inverted three-phase system on non-inductive load is 0.333.

278. In Figs. 196 to 203 are shown the e.m.fs., as e and currents as i in full lines, and the power as p in dotted lines, for balance-factor, 0; balance-factor, -0.333 ; balance-factor, $+1$; balance-factor, $+1$; balance-factor, $+1$; balance-factor, $+1$; balance-factor, $+0.333$, and balance-factor, 0.

279. The flow of energy in an alternating-current system is a most important and characteristic feature of the system, and by its nature the systems may be classified into:

Monocyclic systems, or systems with a balance-factor zero or negative.

Polycyclic systems, with a positive balance-factor.

Balance-factor -1 corresponds to a wattless single-phase circuit, balance-factor zero to a non-inductive single-phase circuit, balance-factor $+1$ to a balanced polyphase system.

280. In polar coördinates the flow of energy of an alternating current system is represented by using the instantaneous value of power as radius vector, with the angle, β , corresponding to the time as amplitude, one complete period being represented by one revolution.

In this way the power of an alternating-current system is represented by a closed symmetrical curve, having the zero point as quadruple point. In the monocyclic systems the zero point is quadruple nodal point; in the polycyclic systems quadruple isolated point.

Thus these curves are sextics.

Since the flow of energy in any single-phase branch of the alternating-current system can be represented by a sine wave of double frequency,

$$p = P \left(1 + \frac{\sin (2\beta - \theta)}{\cos \theta} \right),$$

the total flow of energy of the system as derived by the addition of the powers of the branch circuits can be represented in the form

$$p = P(1 + \epsilon \sin (2\beta - \theta_0)).$$

This is a wave of double frequency also, with ϵ as amplitude of fluctuation of power.

This is the equation of the power characteristics of the system in polar coördinates.

287. To derive the equation in rectangular coördinates we introduce a substitution which revolves the system of coördinates by an angle, $\frac{\theta_0}{2}$, so as to make the symmetry axes of the power characteristic the coördinate axes.

$$p = \sqrt{x^2 + y^2},$$

$$\tan \left(\beta - \frac{\theta_0}{2} \right) = \frac{y}{x};$$

hence,

$$\sin (2\beta - \theta_0) = 2 \sin \left(\beta - \frac{\theta_0}{2} \right) \cos \left(\beta - \frac{\theta_0}{2} \right) = \frac{2xy}{x^2 + y^2},$$

substituted,

$$\sqrt{x^2 + y^2} = P \left\{ 1 + \frac{2\epsilon xy}{x^2 + y^2} \right\},$$

or, expanded,

$$(x^2 + y^2)^3 - P^2(x^2 + y^2 + 2\epsilon xy)^2 = 0,$$

the sextic equation of the power characteristic.

Introducing

$$a = (1 + \epsilon) P = \text{maximum value of power,}$$

$$b = (1 - \epsilon) P = \text{minimum value of power;}$$

we have

$$P = \frac{a + b}{2},$$

$$\epsilon = \frac{a - b}{a + b};$$

hence, substituted, and expanded,

$$(x^2 + y^2)^3 - \frac{1}{4} \{a(x + y)^2 + b(x - y)^2\}^2 = 0,$$

the equation of the power characteristic, with the *main power axes*, a and b , and the balance-factor, $\frac{b}{a}$.

It is thus:

Single-phase. non-inductive circuit, $p = P(1 + \sin 2\theta)$, $b = 0$,
 $a = 2P$,

$$(x^2 + y^2)^3 - P^2(x + y)^4 = 0, \quad \frac{b}{a} = 0.$$

Single-phase circuit, 60° lag: $p = P(1 + 2\sin 2\theta)$, $b = -P$,
 $a = +3P$,

$$(x^2 + y^2)^3 - P^2(x^2 + y^2 + 4xy)^2 = 0, \quad \frac{b}{a} = -\frac{1}{3}.$$

Single-phase circuit, 90° lag: $p = EI \sin 2\theta$,

$$b = -EI, \quad a = +EI,$$

$$(x^2 + y^2)^3 - 4(EI)^2 x^2 y^2, \quad \frac{b}{a} = -1.$$

Three-phase non-inductive circuit, $p = P$, $b = 1$, $a = 1$,

$$x^2 + y^2 - P^2 = 0, \text{ circle. } \frac{b}{a} = +1.$$

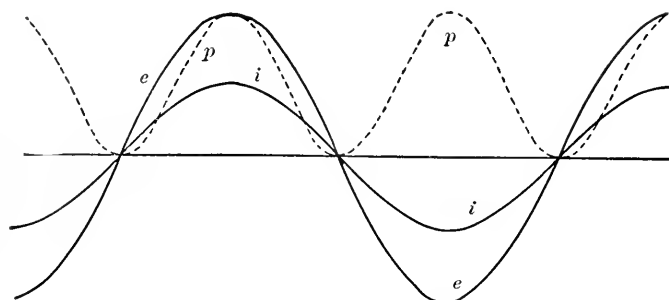

FIG. 196.—Single-phase, non-inductive circuit.

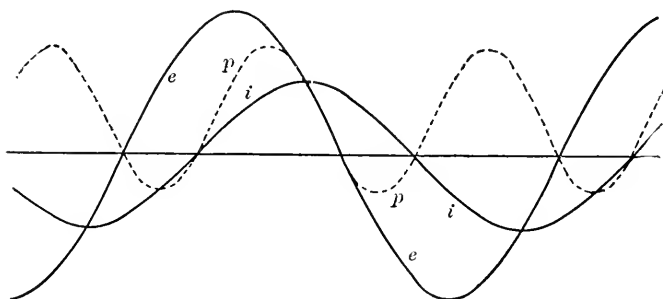

FIG. 197.—Single-phase, 60° lag.

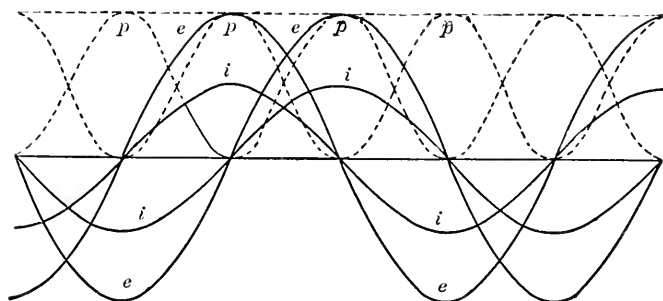

FIG. 198.—Quarter-phase, non-inductive circuit.

Three-phase circuit, 60° lag, $p = P$, $b = 1$, $a = 1$,

$$x^2 + y^2 - P^2 = 0, \text{ circle. } \frac{b}{a} = +1.$$

Quarter-phase non-inductive circuit, $p = P$, $b = 1$, $a = 1$,

$$x^2 + y^2 - P^2 = 0, \text{ circle. } \frac{b}{a} = +1.$$

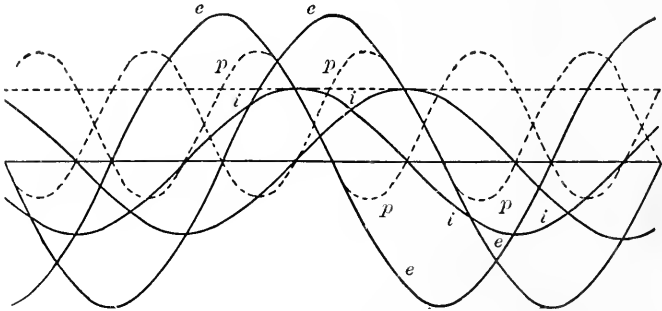

FIG. 199.—Quarter-phase, 60° lag.

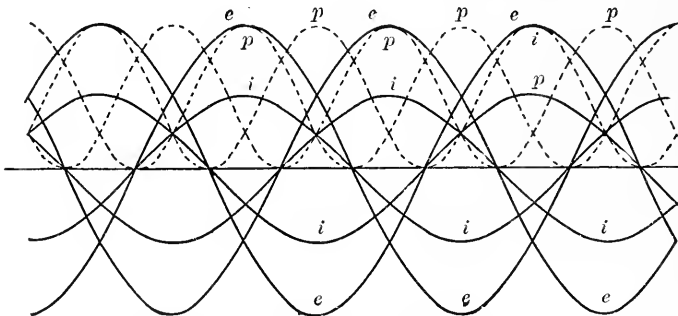

FIG. 200.—Three-phase, non-inductive circuit.

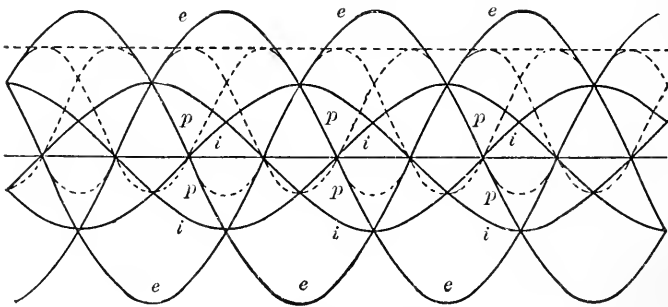

FIG. 201.—Three-phase, 60° lag.

Quarter-phase circuit, 60° lag, $p = P$, $b = 1$, $a = 1$,

$$x^2 + y^2 - P^2 = 0, \text{ circle. } \frac{b}{a} = +1.$$

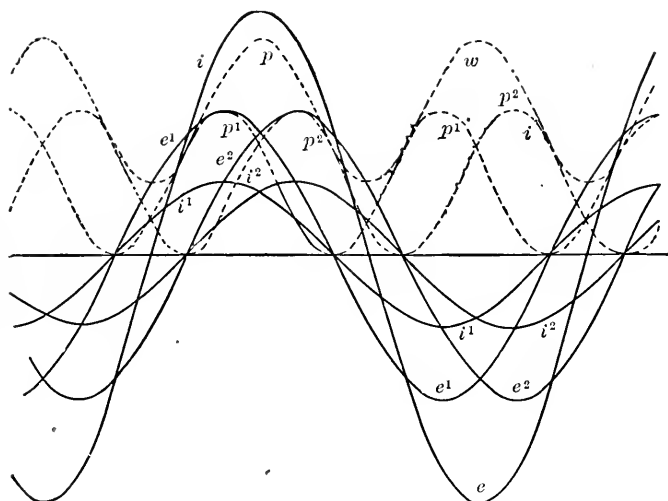

FIG. 202.—Inverted three-phase, non-inductive circuit.

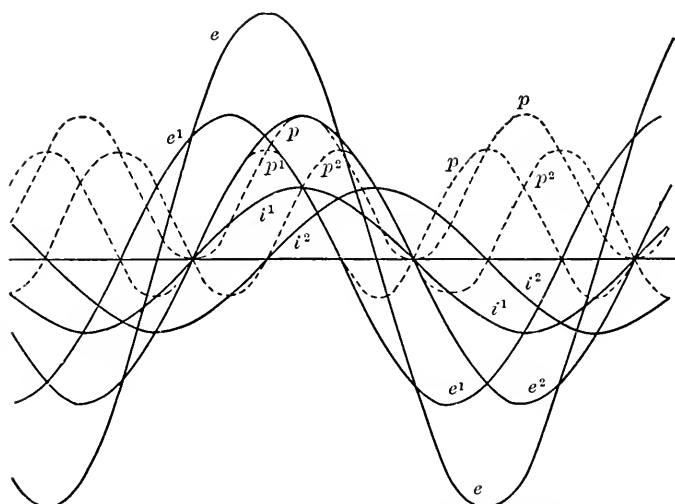

FIG. 203.—Inverted three-phase, 60° lag.

Inverted three-phase non-inductive circuit,

$$p = P \left(1 + \frac{\sin 2\theta}{2} \right), \quad b = \frac{1}{2}P, \quad a = \frac{3}{2}P,$$

$$(x^2 + y)^3 - P^2(x^2 + y^2 + xy)^2 = 0. \quad \frac{b}{a} = +\frac{1}{3}.$$

Inverted three-phase circuit 60° lag, $p = P(1 + \sin 2\theta)$, $b = 0$,
 $a = 2P$,

$$(x^2 + y^2)^3 - P^2(x + y)^4 = 0. \quad \frac{b}{a} = 0.$$

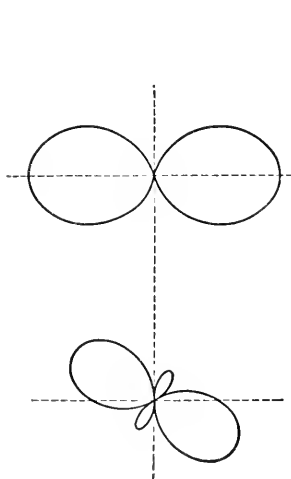

FIGS. 204 AND 205.—Power characteristic of single-phase system, at 0° and 60° lag.

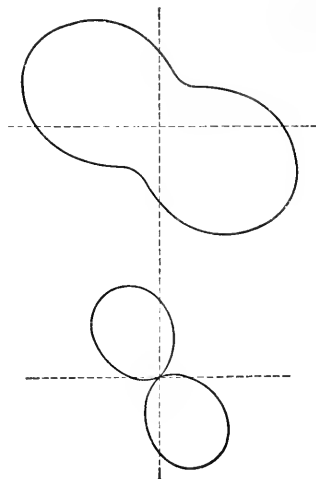

FIGS. 206 AND 207.—Power characteristic of inverted three-phase system, at 0° and 60° lag.

a and b are called the main power axes of the alternating-current system, and the ratio, $\frac{b}{a}$, is the balance-factor of the system.

282. As seen, the flow of energy of an alternating-current system is completely characterized by its two main power axes, a and b .

The power characteristics in polar coördinates, corresponding to the Figs. 196, 197, 202 and 203 are shown in Figs. 204, 205, 206 and 207.

The balanced quarter-phase and three-phase systems give as polar characteristics concentric circles.

CHAPTER XXXI

INTERLINKED POLYPHASE SYSTEMS

283. In a polyphase system the different circuits of displaced phases, which constitute the system, may either be entirely separate and without electrical connection with each other, or they may be connected with each other electrically, so that a part of the electrical conductors are in common to the different phases, and in this case the system is called an interlinked polyphase system.

Thus, for instance, the quarter-phase system will be called an independent system if the two e.m.fs. in quadrature with each other are produced by two entirely separate coils of the same, or different, but rigidly connected, armatures, and are connected to four wires which energize independent circuits in motors or other receiving devices. If the quarter-phase system is derived by connecting four equidistant points of a closed-circuit drum or ring-wound armature to the four collector rings, the system is an interlinked quarter-phase system.

Similarly in a three-phase system. Since each of the three currents which differ from each other by one-third of a period is equal to the resultant of the other two currents, it can be considered as the return circuit of the other two currents, and an interlinked three-phase system thus consists of three wires conveying currents differing by one-third of a period from each other, so that each of the three currents is a common return of the other two, and inversely.

284. In an interlinked polyphase system two ways exist of connecting apparatus into the system.

1. The *star connection*, represented diagrammatically in Fig. 208. In this connection the n circuits, excited by currents differing from each other by $\frac{1}{n}$ of a period, are connected with their one end together into a neutral point or common connection, which may either be grounded, or connected with other corresponding neutral points, or insulated.

In a three-phase system this connection is usually called a Y connection, from a similarity of its diagrammatical representation with the letter Y, as shown in Fig. 197.

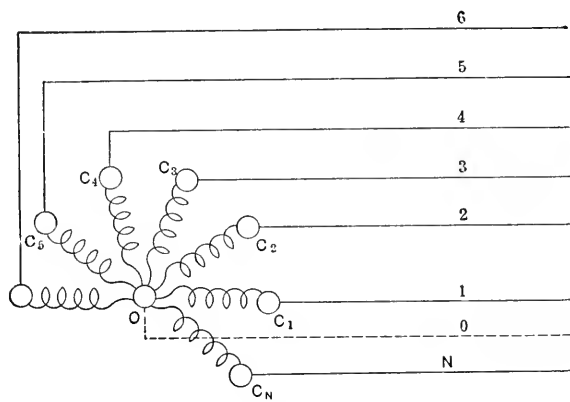

FIG. 208.

2. The *ring connection*, represented diagrammatically in Fig. 209, where the n circuits of the apparatus are connected with each other in closed circuit, and the corners or points of connection of adjacent circuits connected to the n lines of the polyphase

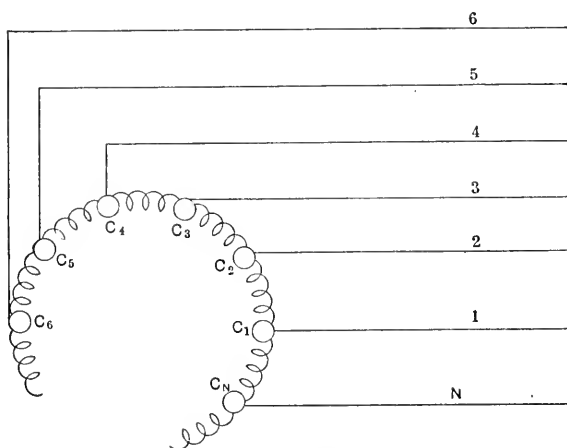

FIG. 209.

system. In a three-phase system this connection is called the delta (Δ) connection, from the similarity of its diagrammatic representation with the Greek letter delta, as shown in Fig. 193.

In consequence hereof we distinguish between star-connected and ring-connected generators, motors, etc., or in three-phase systems Y-connected and Δ -connected apparatus.

285. Obviously, the polyphase system as a whole does not differ, whether star connection or ring connection is used in the generators or other apparatus; and the transmission line of a symmetrical n -phase system always consists of n wires carrying currents of equal strength, when balanced, differing from each other in phase by $\frac{1}{n}$ of a period. Since the line wires radiate from the n terminals of the generator, the lines can be considered as being in star connection.

The circuits of all the apparatus, generators, motors, etc., can either be connected in star connection, that is, between one line and a neutral point, or in ring connection, that is, between two adjacent lines.

In general some of the apparatus will be arranged in star connection, some in ring connection, as the occasion may require.

286. In the same way as we speak of star connection and ring connection of the circuits of the apparatus, the terms star voltage and ring voltage, star current and ring current, etc., are used, whereby as star voltage or in a three-phase circuit Y voltage, the potential difference between one of the lines and the neutral point, that is, a point having the same difference of potential against all the lines, is understood; that is, the voltage as measured by a voltmeter connected into star or Y connection. By ring or delta voltage is understood the difference of potential between adjacent lines, as measured by a voltmeter connected between adjacent lines, in ring or delta connection.

In the same way the star or Y current is the current in a circuit from one line to a neutral point; the ring or delta current, the current in a circuit from one line to the next line.

The current in the transmission line is always the star or Y current, and the potential difference between the line wires, the ring or delta voltage.

Since the star voltage and the ring voltage differ from each other, apparatus requiring different voltages can be connected into the same polyphase mains, by using either star or ring connection.

287. If in a generator with star-connected circuits, the e.m.f. per circuit = E , and the common connection or neutral point

is denoted by zero, the voltages of the n terminals are

$$E, \epsilon E, \epsilon^2 E \dots \dots \epsilon^{n-1} E;$$

or in general, $\epsilon^i E$,

at the i^{th} terminal, where,

$$i = 0, 1, 2 \dots \dots n - 1, \quad \epsilon = \cos \frac{2\pi}{n} + j \sin \frac{2\pi}{n} = \sqrt[n]{1}.$$

Hence the e.m.f. in the circuit from the i^{th} to the k^{th} terminal is

$$E_{ki} = \epsilon^k E - \epsilon^i E = (\epsilon^k - \epsilon^i) E.$$

The e.m.f. between adjacent terminals i and $i + 1$ is

$$(\epsilon^{i+1} - \epsilon^i) E = \epsilon^i (\epsilon - 1) E.$$

In a generator with ring-connected circuits, the e.m.f. per circuit

$$\epsilon^i E,$$

is the ring e.m.f., and takes the place of

$$\epsilon^i (\epsilon - 1) E;$$

while the e.m.f. between terminal and neutral point, or the star e.m.f., is

$$\frac{\epsilon^i}{\epsilon - 1} E.$$

Hence in a star-connected generator with the e.m.f. E per circuit, it is:

star e.m.f., $\epsilon^i E$,

ring e.m.f., $\epsilon^i (\epsilon - 1) E$,

e.m.f. between terminal i and terminal k , $(\epsilon^k - \epsilon^i) E$.

In a ring-connected generator with the e.m.f., E , per circuit, it is

star e.m.f., $\frac{\epsilon^i}{\epsilon - 1} E$,

ring e.m.f., $\epsilon^i E$,

e.m.f. between terminals i and k , $\frac{\epsilon^k - \epsilon^i}{\epsilon - 1} E$.

In a star-connected apparatus, the e.m.f. and the current per

circuit have to be the star e.m.f. and the star current. In a ring-connected apparatus the e.m.f. and current per circuit have to be the ring e.m.f. and ring current.

In the generator of a symmetrical polyphase system, if $\epsilon^i E$ are the e.m.fs. between the n terminals and the neutral point, or star e.m.fs.

I_i = the currents issuing from terminals i over a line of the impedance, Z_i (including generator impedance in star connection), we have

voltage at end of line i ,

$$\epsilon^i E - Z_i I_i,$$

and difference of potential between terminals k and i

$$(\epsilon^k - \epsilon^i) E - (Z_k I_k - Z_i I_i),$$

where I_i is the star current of the system, Z_i the star impedance.

The ring voltage at the end of the line between terminals i and k is E_{ik} , and

$$E_{ik} = - E_{ki}.$$

If now I_{ik} denotes the current from terminal i to terminal k , and Z_{ik} impedance of the circuit between terminal i and terminal k , where

$$\begin{aligned} I_{ik} &= - I_{ki}, \\ Z_{ik} &= Z_{ki}, \\ E_{ik} &= Z_{ik} I_{ik}. \end{aligned}$$

we have

If I_{i0} denotes the current in the circuit from terminal i to a ground or neutral point, and Z_{i0} is the impedance of this circuit between terminal i and neutral point, it is

$$E_{i0} = \epsilon^i E - Z_i I_i = Z_{i0} I_{i0}.$$

288. We have thus, by Ohm's law and Kirchoff's law:

If $\epsilon^i E$ is the e.m.f. per circuit of the generator, between the terminal, i , and the neutral point of the generator, or the star e.m.f.

I_i = the current at the terminal, i , of the generator, or the star current.

Z_i = the impedance of the line connected to a terminal, i , of the generator, including generator impedance.

E_i = the e.m.f. at the end of line connected to a terminal, i , of the generator.

E_{ik} = the difference of potential between the ends of the lines, i and k .

I_{ik} = the current from line i to line k .

Z_{ik} = the impedance of the circuit between lines i and k .

I_{io}, I_{ioo} = the current from line i to neutral points 0, 00,

Z_{io}, Z_{ioo} = the impedance of the circuits between line i and neutral points 0, 00,

Then:

1. $E_{ik} = -E_{ki}, I_{ik} = -I_{ki}, Z_{ik} = Z_{ki}, I_{io} = -I_{oi},$
 $Z_{io} = Z_{oi},$ etc.
2. $E_i = \epsilon^i E - Z_i I_i.$
3. $E_i = Z_{io} I_{io} = Z_{ioo} I_{ioo} =$
4. $E_{ik} = E_k - E_i = (\epsilon^k - \epsilon^i) E - (Z_k I_k - Z_i I_i).$
5. $E_{ik} = Z_{ik} I_{ik}.$
6. $I_i = \sum_0^n I_{ik}.$

7. If the neutral point of the generator does not exist, as in ring connection, or is insulated from the other neutral points:

$$\sum_1^n I_i = 0$$

$$\sum_1^n I_{io} = 0;$$

$$\sum_1^n I_{ioo} = 0, \text{ etc}$$

Where 0, 00, etc., are the different neutral points which are insulated from each other.

If the neutral point of the generator and all the other neutral points are grounded or connected with each other, we have,

$$\sum_1^n I_i = \sum_1^n (I_{io} + I_{ioo} +)$$

$$= \sum_1^n I_{io} + \sum_1^n I_{ioo} +$$

If the neutral point of the generator or other neutral points are grounded, the system is called a grounded system. If the neutral points are not grounded, the system is an insulated polyphase system, and an insulated polyphase system with equalizing return, if all the neutral points are connected with each other.

8. The power of the polyphase system is

$$P = \sum_1^n \epsilon^i E I_{ii} \cos \theta_i \text{ at the generator,}$$

$$P = \sum_0^n \sum_i^n E_{ik} I_{ik} \cos \theta_{ik} \text{ in the receiving circuits.}$$

CHAPTER XXXII

TRANSFORMATION OF POLYPHASE SYSTEMS

289. In transforming one polyphase system into another polyphase system, it is obvious that the primary system must have the same flow of energy as the secondary system, neglecting losses in transformation, and that consequently a balanced system will be transformed again into a balanced system, and an unbalanced system into an unbalanced system of the same balance-factor, since the transformer is not able to store energy, and thereby to change the nature of the flow of energy. The energy stored as magnetism amounts in a well-designed transformer only to a very small percentage of the total energy. This shows the futility of producing symmetrical balanced polyphase systems by transformation from the unbalanced single-phase system without additional apparatus able to store energy efficiently, as revolving machinery, etc.

Since any e.m.f. can be resolved into, or produced by, two components of given directions, the e.m.f. of any polyphase system can be resolved into components or produced from components of two given directions. This enables the transformation of any polyphase system into any other polyphase system of the same balance-factor by two transformers only.

290. Let $E_1, E_2, E_3 \dots$ be the e.m.fs. of the primary system which shall be transformed into

$E'_1, E'_2, E'_3 \dots$ the e.m.fs. of the secondary system.

Choosing two magnetic fluxes, $\bar{\Phi}$ and $\bar{\bar{\Phi}}$, of different phases, as magnetic circuits of the two transformers, which generate the e.m.fs., \bar{e} and $\bar{\bar{e}}$, per turn, by the law of parallelogram the e.m.fs., E_1, E_2, \dots can be resolved into two components, \bar{E}_1 and $\bar{\bar{E}}_1, \bar{E}_2$ and $\bar{\bar{E}}_2, \dots$ of the phases, \bar{e} and $\bar{\bar{e}}$.

Then

$\bar{E}_1, \bar{E}_2, \dots$ are the counter e.m.fs. which have to be generated in the primary circuits of the first transformer;

$\bar{\bar{E}}_1, \bar{\bar{E}}_2, \dots$ the counter e.m.fs. which have to be generated in the primary circuits of the second transformer.

Hence

$\frac{\overline{E}_1}{e}, \frac{\overline{E}_2}{e} \dots$ are the numbers of turns of the primary coils of the first transformer.

Analogously

$\frac{\overline{\overline{E}}_1}{\overline{e}}, \frac{\overline{\overline{E}}_2}{\overline{e}} \dots$ are the numbers of turns of the primary coils in the second transformer.

In the same manner as the e.m.fs. of the primary system have been resolved into components in phase with \overline{e} and $\overline{\overline{e}}$, the e.m.fs. of the secondary system, E'_1, E'_2, \dots are produced from components, \overline{E}'_1 , and $\overline{\overline{E}}'_1, \overline{E}'_2$, and $\overline{\overline{E}}'_2 \dots$ in phase with \overline{e} and $\overline{\overline{e}}$, and give as numbers of secondary turns—

$$\frac{\overline{E}'_1}{e}, \frac{\overline{E}'_2}{e} \dots \text{ in the first transformer;}$$

$$\frac{\overline{\overline{E}}'_1}{\overline{e}}, \frac{\overline{\overline{E}}'_2}{\overline{e}} \dots \text{ in the second transformer.}$$

That means each of the two transformers, m and $\overline{\overline{m}}$, contains in general primary turns of each of the primary phases, and secondary turns of each of the secondary phases. Loading now the secondary polyphase system in any desired manner, corresponding to the secondary currents, primary currents will exist in such a manner that the total flow of energy in the primary polyphase system is the same as the total flow of energy in the secondary system, plus the loss of power in the transformers.

291. As an instance may be considered the transformation of the symmetrical balanced three-phase system,

$$E \sin \beta, \quad E \sin (\beta - 120), \quad E \sin (\beta - 240),$$

into an unsymmetrical balanced quarter-phase system,

$$E' \sin \beta, \quad E' \sin (\beta - 90).$$

Let the magnetic flux of the two transformers be chosen in quadrature

$$\Phi \cos \beta \text{ and } \Phi \cos (\beta - 90).$$

Then the e.m.fs. generated per turn in the transformers are

$$e \sin \beta \text{ and } e \sin (\beta - 90);$$

hence, in the primary circuit the first phase, $E \sin \beta$, will give, in the first transformer, $\frac{E}{e}$ primary turns; in the second transformer, 0 primary turns.

The second phase, $E \sin (\beta - 120)$, will give, in the first transformer, $\frac{-E}{2e}$ primary turns; in the second transformer, $\frac{E \times \sqrt{3}}{2e}$ primary turns.

The third phase, $E \sin (\beta - 240)$, will give, in the first transformer, $\frac{-E}{2e}$ primary turns; in the second transformer, $\frac{-E \times \sqrt{3}}{2e}$ primary turns.

In the secondary circuit the first phase, $E' \sin \beta$, will give in the first transformer: $\frac{E'}{e}$ secondary turns; in the second transformer: 0 secondary turns.

The second phase: $E' \sin (\beta - 90)$ will give in the first transformer: 0 secondary turns; in the second transformer, $\frac{E'}{e}$ secondary turns.

Or, if

$$E = 5000, E' = 100, e = 10.$$

	PRIMARY			SECONDARY	
	1st.	2d.	3d.	1st.	2d.
First transformer	+500	-250	-250	10	0
Second transformer	0	+433	-433	0	10 turns.

Using autotransformer connection in the three-phase primaries of the first transformer, that is, using as coils of the second and the third phase the two halves of the coil of the first phase, this gives the well known T-connection of three-phase-quarter-phase transformation.

That means:

Any balanced polyphase system can be transformed by two transformers only, without storage of energy, into any other balanced polyphase system.

Or more generally stated:

Any polyphase system can be transformed by two transformers only, without storage of energy, into any other polyphase system of the same balance factor.

292. Some of the more common methods of transformation between polyphase systems are:

1. The *delta-Y connection* of transformers between three-phase systems, shown in Fig. 210. One side of the transformers is connected in delta, the other in Y. This arrangement becomes necessary for feeding four-wire three-phase secondary distributions. The Y connection of the secondary allows the bringing out of a neutral wire, while the delta connection of the primary maintains the balance, in regard to the voltage between the phases at unequal distribution of load.

The delta-Y connection of step-up transformers is frequently used in long-distance transmissions, to allow grounding of the high-potential neutral. Under certain conditions—which therefore have to be guarded against—it is liable to induce excessive voltages by resonance with the line capacity.

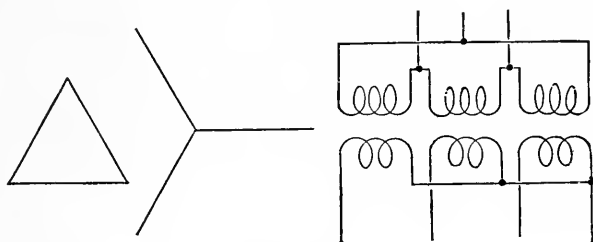

FIG. 210.

The reverse thereof, or the *Y-delta connection*, is undesirable on unbalanced load, since it gives what has been called a “floating neutral;” the three primary Y voltages do not remain even approximately constant, at unequal distribution of load on the secondary delta, but the primary voltage corresponding to the heavier loaded secondary, and, therefore, also the corresponding secondary voltage, collapses. Thereby the common connection of the primary shifts toward one corner of the e.m.f. triangle, away from the center of the triangle, and may even fall outside of the triangle. As result thereof the secondary triangle becomes very greatly distorted even at moderate inequality of load, and the system thus loses all ability to maintain constant voltage at unequal distribution of load, that is, becomes inoperative. In high-potential systems in this case excessive voltages may be induced by resonance with the line capacity.

For instance, if only one phase of the secondary triangle is

loaded, the other two unloaded, the primary current of the loaded phase must return over the other two transformers, which, at open secondaries, act as very high reactances, thus limiting the current and consuming practically all the voltage, and the loaded primary, and thus its secondary, receive practically no voltage.

Y-delta connection is satisfactory if the secondary load is balanced, as induction—or synchronous motors, or if the primary neutral is connected with the generator neutral or the secondary neutral of step-up transformers in which the primaries are connected in delta, and the unbalanced current can return over the neutral. If with Y-delta connection, in addition to an unbalanced load, the secondary carries polyphase motors, the motors take different currents in the different phases, so that the total current is approximately the same in all three phases. That is, the motors act as phase converters, and so partially restore the balance of the system.

2. The *delta-delta connection* of transformers between three-phase systems, in which primaries as well as secondaries are connected in the same manner as the primaries in Fig. 210.

Since in this system each phase is transformed by a separate transformer, the voltages of the system remain balanced even at unbalanced load, within the limits of voltage variation due to the internal self-inductive impedance (or short-circuit impedance) of the transformers—which is small, while the exciting impedance (or open-circuit impedance) of the transformers, which causes the unbalancing in the Y-delta connection above discussed is enormous.

3. *Y-Y connection* of transformers between three-phase systems. Primaries and secondaries connected as the secondaries in Fig. 210.

In this case, if the neutral is not fixed by connection with a fixed neutral, either directly or by grounding it, the neutral also is floating, and so abnormal voltages may be produced between the lines and the neutral, without appearing in the voltages between the lines, and may lead to disruptive effects, or to overheating of the transformers, so that this connection is not an entirely safe one.

Where in transformer connections in polyphase systems, a neutral or common connection of the transformers exists, care must, therefore, be taken to have this neutral a fixed voltage

point, irrespective of the variation of the load or its distribution, which may occur; otherwise harmful phenomena may result from a "floating" or "unstable" neutral.

In connections (2) and (3), the secondary-e.m.f. triangle is in phase with the primary-e.m.f. triangle, while in (1) it is displaced therefrom by 30° . Therefore, even if the voltages are equal, connection (1) cannot be operated in parallel with (2) or (3), but (2)

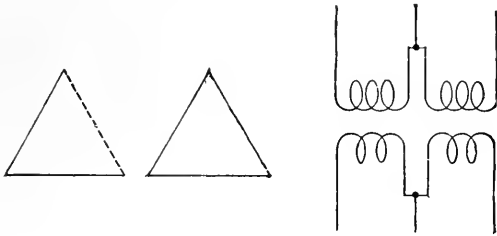

FIG. 211.

and (3) can be operated in parallel with each other, and with the connections (4) and (5), provided that the voltages are correct.

4. The *V connection* or *open delta connection* of transformers between three-phase systems, consists in using two sides of the triangle only, as shown in Fig. 211. This arrangement has the disadvantage of transforming one phase by two transformers in series, hence is less efficient, and is liable to unbalance the system

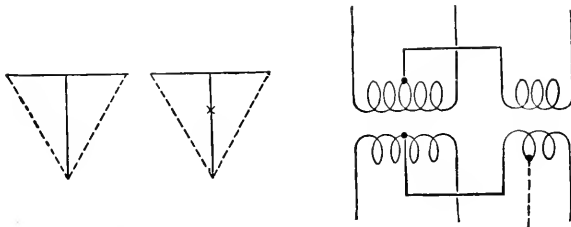

FIG. 212.

by the internal impedance of the transformers. It is convenient for small powers at moderate voltage, since it requires only two transformers, but is dangerous in high potential circuits, being liable to produce destructive voltages by its electrostatic unbalancing.

5. The *main and teaser*, or *T connection* of transformers between three-phase systems, is shown in Fig. 212. One of the

two transformers is wound for $\frac{\sqrt{3}}{2}$ times the voltage of the other (the altitude of the equilateral triangle), and connected with one of its ends to the center of the other transformer. From the point one-third inside of the teaser transformer, a neutral wire can be brought out in this connection.

6. The *monocyclic connection*, transforming between three-

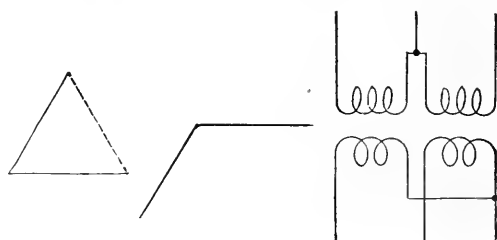

FIG. 213.

phase and inverted three-phase or polyphase monocyclic, by two transformers, the secondary of one being reversed regarding its primary, as shown in Fig. 213.

7. The *L connection* for transformation between quarter-phase and three-phase as described in the example, §291.

8. The *T connection* of transformation between quarter-phase and three-phase, as shown in Fig. 214. The quarter-phase sides

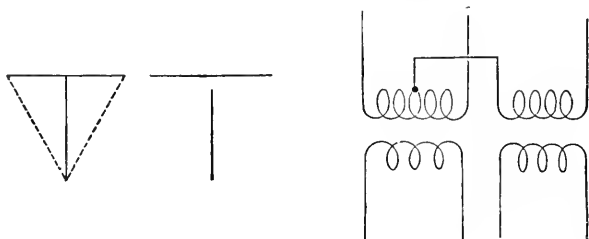

FIG. 214.

of the transformers contain two equal and independent (or inter-linked) coils, the three-phase sides two coils with the ratio of turns, $1 \div \frac{\sqrt{3}}{2}$, connected in *T*.

9. The *double delta connection* of transformation from three-phase to six-phase, shown in Fig. 215. Three transformers, with two secondary coils each, are used, one set of secondary coils connected in delta, the other set in delta also, but with reversed

terminals, so as to give a reversed e.m.f. triangle. These e.m.fs. thus give topographically a six-cornered star.

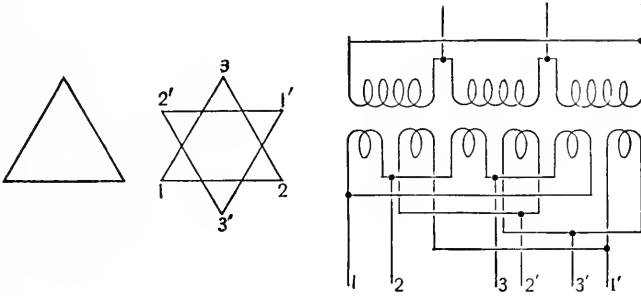

FIG. 215.

10. The *double Y connection* or *diametrical connection* of transformation from three-phase to six-phase, shown in Fig. 216. It

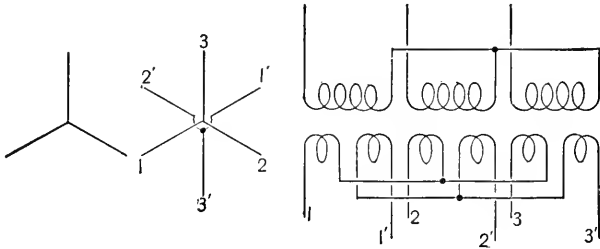

FIG. 216.

is analogous to (7), the delta connection merely being replaced by the Y connection. The neutrals of the two Y's may be connected together and to an external neutral if desired.

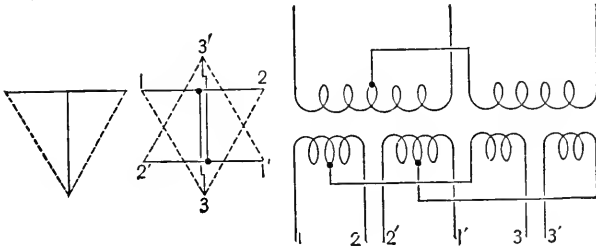

FIG. 217.

The primaries in 9 and 10 may be connected either delta or Y, and in the latter case a floating neutral must be guarded against.

11. The *double T connection* of transformation from three-phase to six-phase, shown in Fig. 216. Two transformers are used with two secondary coils which are T-connected, but one with reversed terminals. This method also allows a secondary neutral to be brought out.

293. Transformation with a change of the balance-factor of the system is possible only by means of apparatus able to store energy, since the difference of energy between primary and secondary circuit has to be stored at the time when the secondary power is below the primary, and returned during the time when the primary power is below the secondary. The most efficient storing device of electric energy is mechanical momentum in revolving machinery. It has, however, the disadvantage of requiring attendance; fairly efficient also are condensive and inductive reactances, but, as a rule, they have the disadvantage of not giving constant potential.

CHAPTER XXXIII

EFFICIENCY OF SYSTEMS

294. In electric power transmission and distribution, wherever the place of consumption of the electric energy is distant from the place of production, the conductors which carry the current are a sufficiently large item to require consideration, when deciding which system and what potential is to be used.

In general, in transmitting a given amount of power at a given loss over a given distance, other things being equal, the amount of copper required in the conductors is inversely proportional to the square of the potential used. Since the total power transmitted is proportional to the product of current and e.m.f., at a given power, the current will vary inversely proportionally to the e.m.f., and therefore, since the loss is proportional to the product of current-square and resistance, to give the same loss the resistance must vary inversely proportional to the square of the current, that is, proportional to the square of the e.m.f.; and since the amount of copper is inversely proportional to the resistance, other things being equal, the amount of copper varies inversely proportional to the square of the e.m.f. used.

This holds for any system.

Therefore to compare the different systems, as two-wire single-phase, single-phase three-wire, three-phase and quarter-phase, equality of the potential must be assumed.

Some systems, however, as, for instance, the Edison three-wire system, or the inverted three-phase system, have different potentials in the different circuits constituting the system, and thus the comparison can be made either—

1st. On the basis of the maximum potential difference between any two conductors of the system; or

2nd. On the basis of the maximum potential difference between any conductor of the system and the ground; or

3rd. On the basis of the minimum potential difference in the system, or the potential difference per circuit or phase of the system.

In low-potential circuits, as secondary networks, where the potential is not limited by the insulation strain, but by the potential of the apparatus connected into the system, as incandescent lamps, the proper basis of comparison is equality of the potential per branch of the system, or per phase.

On the other hand, in long-distance transmissions where the potential is not restricted by any consideration of apparatus suitable for a certain maximum potential only, but where the limitation of potential depends upon the problem of insulating the conductors against disruptive discharge, the proper comparison is on the basis of equality of the maximum difference of potential; that is, equal maximum dielectric strain on the insulation.

In this case, the comparison voltage may be either the potential difference between any two conductors of the system, or it may be the potential difference between any conductor of the system and the ground, depending on the character of the circuit.

The dielectric stress is from conductor to conductor, or between any two conductors, in a system which is insulated from the ground, as is mostly the case in medium voltage overhead transmissions, and frequently in underground cables.

In an ungrounded cable system, in which all the conductors are enclosed in the same cable, the insulation stress is mainly from conductor to conductor, and this therefore is the basis of comparison. But even in an underground cable system with grounded neutral, as very commonly used, a direct path exists from conductor to conductor inside of the cables, for a disruptive voltage, and the comparison of systems, therefore, has to be made, in this case, on the basis of maximum potential difference between conductors as well as between conductor and ground.

In an ungrounded overhead system, the disruptive stress is from conductor to ground and back from ground to conductor. If the system is of considerable extent—as is the case where high voltages of serious disruptive strength have to be considered—the neutral of the system is maintained at approximate ground potential by the capacity of the system, and the normal voltage stress from conductor to ground therefore is that from conductor to neutral, that is, the same as in a system with grounded neutral, and the basis of comparison then is the voltage from line to ground, and not between lines. Since, however, one conductor

of the system may temporarily ground, if it is required to maintain operation even with one conductor of the system grounded, the voltage between conductors must be the basis of comparison, since with one conductor grounded, the disruptive stress between the other conductors and ground is the potential difference between the conductors of the system.

In an overhead system with grounded neutral, frequently used for transmission systems of very high voltage, or in general in a grounded system, the disruptive stress is that due to the potential difference between conductor and ground or neutral, and this then is the basis of comparison.

In moderate-potential power circuits, in considering the danger to life from live wires entering buildings or otherwise accessible, the comparison on the basis of maximum potential also appears appropriate.

Thus the comparison of different systems of long-distance transmission at high potential or power distribution for motors is to be made on the basis of equality of the maximum difference of potential existing in the system; the comparison of low-potential distribution circuits for lighting on the basis of equality of the minimum difference of potential between any pair of wires connected to the receiving apparatus.

295. 1st. *Comparison on the basis of equality of the minimum difference of potential, in low-potential lighting circuits:*

In the single-phase, alternating-current circuit, if $e = \text{e.m.f.}$, $i = \text{current}$, $r = \text{resistance per line}$, the total power is $= ei$, the loss of power, $2 i^2 r$.

Using, however, a three-wire system: the potential between outside wires and neutral being given equal to e , the potential between the outside wires is equal to $2e$, that is, the distribution takes place at twice the potential, or only one-fourth the copper is needed to transmit the same power at the same loss, if, as it is theoretically possible, the neutral wire has no cross-section. If, however, the neutral wire is made of the same cross-section as each of the outside wires, three-eighths as much copper as in the two-wire system is needed; if the neutral wire is one-half the cross-section of each of the outside wires, five-sixteenths as much copper is needed. Obviously, a single-phase, five-wire system will be a system of distribution at the potential, $4e$, and therefore require only one-sixteenth of the copper of the single-phase system in the outside wires; and if each of the three neutral

wires is of one-half the cross-section of the outside wires, seven-sixty-fourths or 10.93 per cent. of the copper.

Coming now to the three-phase system with the potential, e , between the lines as delta potential, if i = the current per line or Y current, the current from line to line or delta current = $\frac{i_1}{\sqrt{3}}$; and since three branches are used, the total power is $\frac{3ei_1}{\sqrt{3}} = ei_1\sqrt{3}$.

Hence if the same power has to be transmitted by the three-phase system as with the single-phase system, the three-phase line current must be $i_1 = \frac{i}{\sqrt{3}}$; where i = single-phase current, r = single-phase resistance per line, at equal power and loss: hence if r_1 = resistance of each of the three wires, the loss per wire is $i_1^2r_1 = \frac{i^2r_1}{3}$, and the total loss is i^2r_1 , while in the single-phase system it is $2i^2r$. Hence, to get the same loss, it must be: $r_1 = 2r$, that is, each of the three three-phase lines has twice the resistance—that is, half the copper of each of the two single-phase lines; or in other words, the three-phase system requires three-fourths as much copper as the single-phase system of the same potential.

Introducing, however, a fourth or neutral wire into the three-phase system, and connecting the lamps between the neutral wire and the three outside wires—that is, in Y connection—the potential between the outside wires or delta potential will be = $e \times \sqrt{3}$, since the Y potential = e , and the potential of the system is raised thereby from e to $e\sqrt{3}$; that is, only one-third as much copper is required in the outside wires as before—that is one-fourth as much copper as in the single-phase two-wire system. Making the neutral of the same cross-section as the outside wires, requires one-third more copper, or $\frac{1}{3} = 33.3$ per cent. of the copper of the single-phase system; making the neutral of half cross-section, requires one-sixth more, or $\frac{1}{6} = 16.7$ per cent. of the copper of the single-phase system. The system, however, now is a four-wire system.

The independent quarter-phase system with four wires is identical in efficiency to the two-wire, single-phase system, since it is nothing but two independent single-phase systems in quadrature.

The four-wire, quarter-phase system can be used as two inde-

pendent Edison three-wire systems also, deriving therefrom the same saving by doubling the potential between the outside wires, and has in this case the advantage, that by interlinkage, the same neutral wire can be used for both phases, and thus one of the neutral wires saved.

In this case the quarter-phase system with common neutral of full cross-section requires $\frac{5}{16}$ or 31.25 per cent., the quarter-phase system with common neutral of one-half cross-section requires $\frac{9}{2}$ or 28.125 per cent. of the copper of the two-wire, single-phase system.

In this case, however, the system is a five-wire system, and as such far inferior in copper efficiency to the five-wire, single-phase system.

Coming now to the quarter-phase system with common return and potential e per branch, denoting the current in the outside wires by i_2 , the current in the central wire is $i_2\sqrt{2}$; and if the same current density is chosen for all three wires, as the condition of maximum efficiency, and the resistance of each outside wire denoted by r_2 , the resistance of the central wire = $\frac{r^2}{\sqrt{2}}$, and the

loss of power per outside wire is $i_2^2 r_2$, in the central wire $\frac{2 i_2^2 r^2}{\sqrt{2}} = i_2^2 r_2 \sqrt{2}$; hence the total loss of power is $2 i_2^2 r_2 + i_2^2 r_2 \sqrt{2} = i_2^2 r_2 (2 + \sqrt{2})$. The power transmitted per branch is $i_2 e$, hence the total power, $2 i_2 e$. To transmit the same power as by a single-phase system of power, ei , it must be $i_2 = \frac{i}{2}$; hence the loss, $\frac{i^2 r_2 (2 + \sqrt{2})}{4}$. Since this loss shall be the same as the loss,

$2 i^2 r$, in the single-phase system, it must be $2 r = \frac{(2 + \sqrt{2})}{4} r_2$, or $r_2 = \frac{8r}{2 + \sqrt{2}}$. Therefore each of the outside wires must be $\frac{2 + \sqrt{2}}{8}$ times as large as each single-phase wire, the central

wire $\sqrt{2}$ times larger; hence the copper required for the quarter-phase system with common return bears to the copper required for the single-phase system the relation,

$$\frac{2(2 + \sqrt{2})}{8} + \frac{(2 + \sqrt{2})\sqrt{2}}{8} \div 2, \text{ or, } \frac{3 + 2\sqrt{2}}{8} \div 1, = 72.9$$

per cent. of the copper of the single-phase system.

Hence the quarter-phase system with common return saves 2 per cent. more copper than the three-phase system, but is inferior to the single-phase three-wire system.

The inverted three-phase system, consisting of two e.m.fs. e at 60° displacement, and three equal currents i_3 in the three lines of equal resistance r_3 , gives the output $2ei_3$, that is, compared with the single-phase system, $i_3 = \frac{i}{2}$. The loss in the three lines is $3i_3^2r_3 = \frac{3}{4}i^2r_3$. Hence, to give the same loss, $2i^2r$, as the single-phase system, it must be $r_3 = \frac{8}{3}r$, that is, each of the three wires must have three-eighths of the copper cross-section of the wire in the two-wire single-phase system; or in other words, the inverted three-phase system requires nine-sixteenths of the copper of the two-wire single-phase system.

Thus if a given power has to be transmitted at a given loss, and a given *minimum* potential, as for instance 110 volts for lighting, the amount of copper necessary is:

2 WIRES:	Single-phase system,	100.0
3 WIRES:	Edison three-wire single-phase system, neutral full section,	37.5
	Edison three-wire single-phase system, neutral half-section,	31.25
	Inverted three-phase system,	56.25
	Quarter-phase system with common return,	72.9
	Three-phase system,	75.0
4 WIRES:	Three-phase, with neutral-wire full sec- tion,	33.3
	Three-phase, with neutral-wire half- section,	29.17
	Independent quarter-phase system,	100.0
5 WIRES:	Edison five-wire, single-phase system, full neutral,	15.625
	Edison five-wire, single-phase system, half-neutral,	10.93
	Four-wire, quarter-phase, with com- mon-neutral full section,	31.25
	Four-wire, quarter-phase, with com- mon-neutral half-section,	28.125

We see herefrom, that in distribution for lighting—that is, with the same minimum potential, and with the same number

of wires—the single-phase system is superior to any polyphase system.

The continuous-current system is equivalent in this comparison to the single-phase alternating-current system of the same effective potential, since the comparison is made on the basis of effective potential, and the power depends upon the effective potential also.

296. *Comparison on the Basis of Equality of the Maximum Difference of Potential between any two Conductors of the System, in Long-distance Transmission, Power Distribution, etc.*

Wherever the potential is so high as to bring the question of the strain on the insulation into consideration, or in other cases, to approach the danger limit to life, the proper comparison of different systems is on the basis of equality of maximum potential in the system.

Hence in this case, since the maximum potential is fixed, nothing is gained by three- or five-wire, Edison systems. Thus, such systems do not come into consideration.

The comparison of the three-phase system with the single-phase system remains the same, since the three-phase system has the same maximum as minimum potential; that is:

The three-phase system requires three-fourths of the copper of the single-phase system to transmit the same power at the same loss over the same distance.

The four-wire, quarter-phase system requires the same amount of copper as the single-phase system, since it consists of two single-phase systems.

In a quarter-phase system with common return, the potential between the outside wires is $\sqrt{2}$ times the potential per branch, hence to get the same maximum strain on the insulation—that is, the same potential, e , between the outside wires as in the single-phase system—the potential per branch will be $\frac{e}{\sqrt{2}}$, hence the

current $i_4 = \frac{i}{\sqrt{2}}$, if i equals the current of the single-phase system of equal power, and $i_4\sqrt{2} = i$ will be the current in the central wire.

Hence, if $r_4 =$ resistance per outside wire, $\frac{r_4}{\sqrt{2}} =$ resistance of central wire, and the total loss in the system is

$$2 i_4^2 r_4 + \frac{i_4^2 2 r^4}{\sqrt{2}} = i_4^2 r_4 (2 + \sqrt{2}) = i^2 r_4 \frac{(2 + \sqrt{2})}{2}.$$

Since in the single-phase system, the loss = $2 i^2 r$, it is

$$r_4 = \frac{4r}{2 + \sqrt{2}}$$

That is, each of the outside wires has to contain $\frac{2 + \sqrt{2}}{4}$ times as much copper as each of the single-phase wires. The central wires have to contain $\frac{2 + \sqrt{2}}{4} \sqrt{2}$ times as much copper; hence the total system contains $\frac{2(2 + \sqrt{2})}{4} + \frac{2 + \sqrt{2}}{4} \sqrt{2}$ times as much copper as each of the single-phase wires; that is, $\frac{3 + 2\sqrt{2}}{4}$ times the copper of the single-phase system.

Or, in other words,

A quarter-phase system with common return requires $\frac{3 + 2\sqrt{2}}{4}$ = 1.457 times as much copper as a single-phase system of the same maximum potential, same power, and same loss.

Since the comparison is made on the basis of equal maximum potential, and the maximum potential of an alternating system is $\sqrt{2}$ times that of a continuous-current circuit of equal effective potential, the alternating circuit of effective potential, e , compares with the continuous-current circuit of potential $e \sqrt{2}$, which latter requires only half the copper of the alternating system.

This comparison of the alternating with the continuous-current system is not proper, however, since the continuous-current voltage may introduce, besides the electrostatic strain, an electrolytic strain on the dielectric which does not exist in the alternating system, and thus may make the action of the continuous-current voltage on the insulation more severe than that of an equal alternating voltage. Besides, self-induction having no effect on a steady current, continuous-current circuits as a rule have a self-induction far in excess of any alternating circuit. During changes of current, as make and break, and changes of load, especially rapid changes, there may consequently be generated in these circuits e.m.fs. far exceeding their normal potentials. Inversely, however, with alternating voltages, dielectric hysteresis, etc., may cause heating and thereby lower the disruptive strength. At the voltages which came under consideration, the continuous current is usually excluded to begin with.

Thus we get:

If a given power is to be transmitted at a given loss, and a given *maximum* difference of potential in the system, that is, with the same strain on the insulation, the amount of copper required is:

2 WIRES: Single-phase system,	100.0
[Continuous-current system,	50.0]
3 WIRES: Three-phase system,	75.0
Quarter-phase system, with common return,	145.7
4 WIRES: Independent Quarter-phase system,	100.0

Hence the quarter-phase system with common return is practically excluded from long-distance transmission.

297. In a different way the same comparative results between single-phase, three-phase, and quarter-phase systems can be derived by resolving the systems into their single-phase branches.

The three-phase system of e.m.f., e , between the lines can be considered as consisting of three single-phase circuits of e.m.f., $\frac{e}{\sqrt{3}}$, and no return; the single-phase system of e.m.f., e , between lines as consisting of two single-phase circuits of e.m.f., $\frac{e}{2}$, and no return. Thus, the relative amount of copper in the two systems being inversely proportional to the square of e.m.f., bears the relation $\left(\frac{\sqrt{3}}{e}\right)^2 : \left(\frac{2}{e}\right)^2 = 3 : 4$; that is, the three-phase system requires 75 per cent. of the copper of the single-phase system.

The quarter-phase system with four equal wires requires the same copper as the single-phase system, since it consists of two single-phase circuits. Replacing two of the four quarter-phase wires by one wire of the same cross-section as each of the wires replaced thereby, the current in this wire is $\sqrt{2}$ times as large as in the other wires, hence, the loss is twice as large—that is, the same as in the two wires replaced by this common wire, or the total loss is not changed—while 25 per cent. of the copper is saved, and the system requires only 75 per cent. of the copper of the single-phase system, but produces $\sqrt{2}$ times as high a poten-

tial between the outside wires. Hence, to give the same maximum potential, the e.m.fs. of the system have to be reduced by $\sqrt{2}$, that is, the amount of copper doubled, and thus the quarter-phase system with common return of the same cross-section as the outside wires requires 150 per cent. of the copper of the single-phase system. In this case, however, the current density in the middle wire is higher, thus the copper not used most economically, and transferring a part of the copper from the outside wires to the middle wire, to bring all three wires to the same current density, reduces the loss, and thereby reduces the amount of copper at a given loss, to 145.7 per cent. of that of a single-phase system.

298. *Comparison on the basis of equality of the maximum difference of potential between any conductor of the system and the ground, in long-distance, three-phase transmissions with grounded neutral, single-phase systems with ground return, etc.*

A system may be grounded by grounding its neutral point, for the purpose of maintaining constant-potential difference between the conductors and ground, without carrying any current through the ground, or the ground may be used as return conductor. In either case the system can be considered as consisting of and resolved into as many single-phase systems with ground return, as there are overhead conductors, and with zero resistance in the ground.

It immediately follows herefrom, that the copper efficiency of such a system is the same as that of a single-phase system with ground return, of the same voltage as exists between conductor and ground of the system under consideration. If then all the overhead conductors have the same potential difference against ground, as is the case in a three-phase or quarter-phase system with grounded neutral, a single-phase system with grounded neutral, or quarter-phase system with common ground return of both phases, the copper efficiency is the same. That is:

All grounded systems, whether with grounded neutral or with ground return, have the same copper efficiency, provided that all the overhead conductors have the same potential difference against ground.

Hence:

The three-phase system with grounded neutral has no superiority over the single-phase or the quarter-phase system with grounded neutral, in copper efficiency. The advantage of the three-phase system—which causes its practically universal use—

over the single-phase system is the greater usefulness of polyphase power, the advantage over the quarter-phase system is the use of three conductors, against four with the quarter-phasesystem.

No saving in copper results from the use of the ground (of zero resistance) as return circuit, but a single-phase or quarter-phase system with ground return, at equal dielectric strain on the insulation, requires the same amount of copper as a system with grounded neutral, but has a greater self-induction, due to the greater distance between conductor and return conductor or ground, and has the objection of establishing current through the ground and so disturbing neighboring circuits, by electromagnetic and electrostatic induction.

The apparent saving in copper, in the single-phase system, by replacing one of the conductors by the ground as return, therefore is a fallacy. By doing so, the potential difference of the other conductors against ground becomes twice what it would be with two conductors and grounded neutral, and at the same potential difference between conductors. That is, the single-phase system with ground return requires the same insulation as a single-phase system with grounded neutral, of twice the voltage, and then requires the same copper. A saving results only in the number of insulators required, etc. Only where the amount of power is so small that mechanical strength, and not power loss, determines the size of the conductor, a saving results by replacing one of the conductors by the ground.

The high-tension, direct-current system, whether insulated, or with grounded neutral, or with ground return, appears equal in copper efficiency to a single-phase system of the same character (insulated, or with grounded neutral, or with ground return) and of the same effective voltage, that is, with a sine wave of a maximum voltage $\sqrt{2}$ times that of the direct current. Due to the different character of unidirectional electric stress of the direct-current system, from the alternating stress, a general comparison of the system by a numerical factor appears hardly feasible. It is, however, claimed that usually the insulation stress with perfectly uniform continuous voltage is less than that of an alternating voltage of the same maximum value, so that continuous-current high-voltage transmission would offer advantages, if it were not for the difficulty of generating and utilizing very high continuous voltages, which with alternating voltages is overcome by the interposition of the stationary transformer.

CHAPTER XXXIV

METERING OF POLYPHASE CIRCUIT

299. The power of a polyphase system or circuit is the sum of the powers of all the individual branch circuits, and the sum of the wattmeter readings of all the branch circuits thus gives the total power.

Let, then, in a general polyphase system, $e_1, e_2, e_3 \dots e_n =$ potentials at the n terminals or supply wires of the n -phase system.

These may be represented topographically by points in a plane, as shown in Fig. 218.

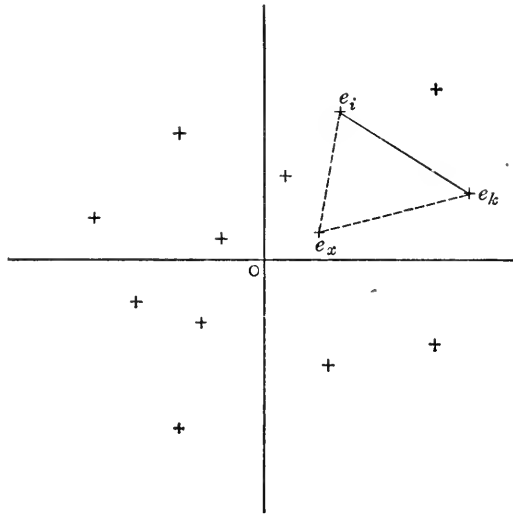

FIG. 218.

The voltage between any two terminals e_i and e_k then is:

$$e_{ik} = e_i - e_k \quad (1)$$

And this voltage, in any circuit connected between these two terminals, produces a current, i_{ik} , as the current, which flows from e_i to e_k through this circuit.

As there are $\frac{n(n-1)}{2}$ pairs of terminals e_i and e_k , there are existing in a general n -phase system $\frac{n(n-1)}{2}$ different phases, and there may thus be $\frac{n(n-1)}{2}$ different circuits, or rather sets

of circuits—since a number of circuits may and usually are connected between the n terminals.

Consider one of these numerous circuits of the general n -phase system, that of the current i_{ik} passing from e_i to e_k . The power of this circuit is:

$$P_{ik} = [e_i - e_k, i_{ik}] \tag{2}$$

where the brackets denote the effective power, as discussed in Chapter XVI.

Choosing any point e_x , which may be one of the terminals, or the neutral point of the system, if such exists, or any other point. Then the voltage $e_i - e_k$ can be resolved by the parallelogram (Fig. 218) into the voltages: $e_i - e_x$ and $e_x - e_k$, that is:

$$e_i - e_k = e_i - e_x + e_x - e_k \tag{3}$$

hence, substituted into (2):

$$\begin{aligned} P_{ik} &= [(e_i - e_x) + (e_x - e_k), i_{ik}] \\ &= [e_i - e_x, i_{ik}] + [e_x - e_k, i_{ik}] \end{aligned} \tag{4}$$

It is, however:

$$[e_x - e_k, i_{ik}] = [e_k - e_x, i_{ki}] \tag{5}$$

where i_{ki} is the current flowing from e_k to e_i , that is, the same current as i_{ik} , only considered in the reverse direction.

Thus it is, substituting (5) into (4):

$$P_{ik} = [e_i - e_x, i_{ik}] + [e_k - e_x, i_{ki}] \tag{6}$$

That is, the power of any branch circuit between two terminals, e_i and e_k , is the product of the powers giving by the two potential differences $e_i - e_x$ and $e_k - e_x$, of any arbitrarily chosen point e_x , with the current flowing into this branch circuit from the two terminals, e_i and e_k , that is, i_{ik} and i_{ki} , respectively.

300. The total power of the n -phase system, as the sum of the powers of all the branch circuits, then is:

$$\begin{aligned} P &= \sum_1^n i \sum_1^n k P_{ik} \\ &= \sum_1^n i \sum_1^n k [e_i - e_x, i_{ik}] \end{aligned} \tag{7}$$

where the double summation sign indicates that the summation is to be carried out for all values of k , from 1 to n , and for all values of i , from 1 to n .

As the term $e_i - e_z$ in (7) does not contain the index k , it is the same for all values of k , thus can be taken out from the second summation sign, that is:

$$P = \sum_1^n [e_i - e_z, \sum_1^n i_{ik}] \quad (8)$$

However:

$\sum_1^n i_{ik}$ is the sum of all the currents, flowing from the terminal e_i to all the other terminals e_k ($k = 1, 2 \dots n$), that is, it is the total current issuing from the terminal e_i , or:

$$i_i = \sum_1^n i_{ik} \quad (9)$$

and, substituting this in 9, gives as the total power of the n -phase system:

$$P = \sum_1^n [e_i - e_z, i_i] \quad (10)$$

That is:

"The total power of a general n -phase system, is the sum of the n powers, given by the n currents i_i , which issue from the n terminals e_i , with the n potential differences of these terminals e_i against any arbitrarily chosen point e_z ."

"The total power of the system, no matter how many branch circuits it contains, thus is measured by n wattmeters."

Choosing as the point, e_z one of the n -phase circuit terminals, that is one of the phase potentials (for instance, the neutral potential of the system, where such exists), as e_n , the number of terms in (10) reduces by one:

$$P = \sum_1^{n-1} [e_i - e_n, i_i] \quad (11)$$

That is:

"The total power of a general n -phase system is measured by $n - 1$ wattmeters, connected between one terminal e_n and the $n - 1$ other terminals e_i ."

Thus for instance, a five-wire, four-phase system (Fig. 195), in which $\frac{5 \times 4}{2} = 10$ different sets of circuits are possible, is metered by $5 - 1 = 4$ meters.

A four-wire, three-phase system is metered by 3 meters.

A three-wire, three-phase system is metered by 2 meters.

301. In a three-phase system with ungrounded neutral, that is, a three-wire, three-phase system, the common method of measuring the total power thus is, by (11), as shown in Fig. 219.

Often the two meters of Fig. 219 are arranged in one structure.

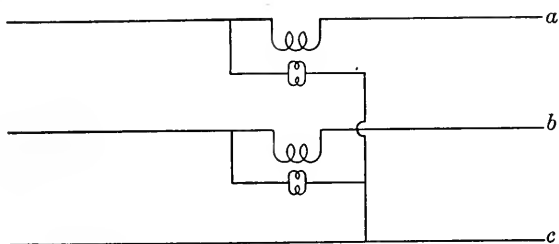

FIG. 219.

Thus, if Fig. 220 denotes a general three-wire, three-phase system, with the voltages and currents in the three phases:

$$\dot{E}_1, \dot{E}_2, \dot{E}_3 \text{ and } \dot{I}_1, \dot{I}_2, \dot{I}_3$$

counting voltages and currents in the direction indicated by the arrows in Fig. 220.

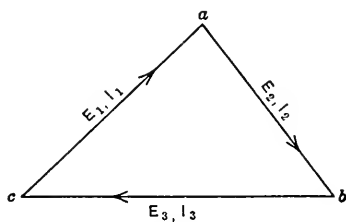

FIG. 220.

The voltages may be unequal in sizes and under unequal angles, by a distortion of the three-phase triangle, but it must be:

$$\dot{E}_1 + \dot{E}_2 + \dot{E}_3 = 0 \tag{12}$$

in a closed triangle.

Connecting then the current coils of the two wattmeters into the lines *a* and *b*, and the voltage coils between *a* respectively *b*, and *c*, the two wattmeter readings are:

$$\text{and: } \left. \begin{aligned} [-\dot{E}_1, \dot{I}_2 - \dot{I}_1] &= [\dot{E}_1, \dot{I}_1] - [\dot{E}_1, \dot{I}_2] \\ [\dot{E}_3, \dot{I}_3 - \dot{I}_2] &= [\dot{E}_3, \dot{I}_3] - [\dot{E}_3, \dot{I}_2] \end{aligned} \right\} \tag{13}$$

and their sum is:

$$P = \left. \begin{aligned} & [E_1, I_1] - [E_1, I_2] - [E_3, I_2] + [E_3, I_3] \\ & = [E_1, I_1] - [E_1 + E_3, I_2] + [E_3, I_3] \end{aligned} \right\} \quad (14)$$

and since by (12):

$$E_1 + E_3 = -E_2,$$

it is:

$$P = [E_1, I_1] + [E_2, I_2] + [E_3, I_3]$$

that is, the total power of the three-phase system is the sum of the individual powers of the three branch circuits.

302. In the standard polyphase wattmeter connection of the three-wire, three-phase system, Fig. 219, the voltage coils are out of phase with the current coils at non-inductive load, the one lagging, the other leading by 30° . Therefore, even in a balanced

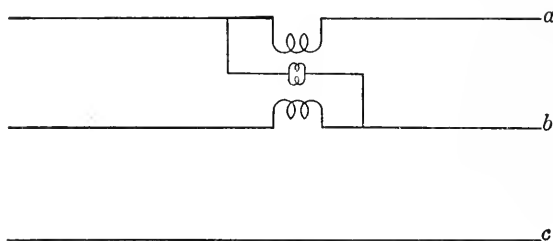

FIG. 221.

system, if the current lags, the two wattmeter coils do not read alike, as the voltmeter coil in the one lags by the angle of lag of the current plus 30° , and in the other by the angle of lag minus 30° . At 60° angle of lag, the voltage coil of the former lags $60 + 30 = 90^\circ$, and the reading becomes zero, and at more than 60° lag, the one meter reads negative, but the algebraic sum of the two meter readings still remains the total power of the circuit, the one meter reading more than the total power, while the other meter reads negative.

In a balanced, or nearly balanced three-wire, three-phase system, instead of connecting the potential coils from *a* and *b* to *c*, Figs. 219 and 220, they are often connected from *a* to *b*. This interchanges the lagging and the leading coil, but on balanced loads leaves the same total. In this case, one voltage coil only may be used, acted upon by two current coils. That is, a single-phase wattmeter is constructed, similar to the Edison three-wire

meter, with one current coil in the one, the other current coil in the other line, and the voltage coil connected between these two lines, as shown in Fig. 221.

If there is considerable unbalancing, this latter connection gives considerable error, and the double meter has to be used.

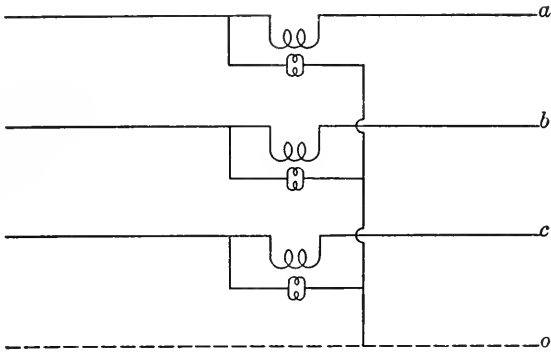

FIG. 222.

In a four-wire, three-phase system, the connection of the two meters obviously becomes wrong, if current flows in the neutral, and three meters must be used.

Most conveniently these are arranged with the three current coils in the three lines, and the voltage coils between these lines and the neutral, as shown in Fig. 222.

CHAPTER XXXV

BALANCED SYMMETRICAL POLYPHASE SYSTEMS

303. In most applications of polyphase systems the system is a balanced symmetrical system, or as nearly balanced as possible. That is, it consists of n equal e.m.fs. displaced in phase from each other by $\frac{1}{n}$ period, and producing equal currents of equal phase displacement against their e.m.fs. In such systems, each e.m.f. and its current can be considered separately as constituting a single-phase system, that is, the polyphase system can be resolved into n equal single-phase systems, each of which consists of one conductor of the polyphase system, with zero impedance as return circuit. Hereby the investigation of the polyphase system resolves itself into that of its constituent single-phase system.

So, for instance, the polyphase system shown in Fig. 208, at balanced load, can be considered as consisting of the equal single-phase systems: 0 - 1; 0 - 2; 0 - 3; . . . 0 - n , each of which consists of one conductor, 1, 2, 3, . . . n , and the return conductor, 0. Since the sum of all the currents equals 0, there is no current in conductor 0, that is, no voltage is consumed in this conductor; this is equivalent to assuming this conductor as of zero impedance. This common return conductor, 0, since it carries no current, can be omitted, as is usually the case. With star connection of an apparatus into a polyphase system, as in Fig. 200, the impedance of the equivalent single-phase system is the impedance of one conductor or circuit; if, however, the apparatus is ring connected, as shown diagrammatically in Fig. 201, the impedance of the ring-connected part of the circuit has to be reduced to star connection, in the usual manner of reducing a circuit to another circuit of different voltage, by the ratio

$$c = \frac{\text{ring voltage}}{\text{star voltage}},$$

or, as these voltages are usually called in a three-phase system,

$$c = \frac{\text{delta voltage}}{\text{Y voltage}}.$$

That is, all ring voltages are divided, all ring currents multiplied with c ; all ring impedances are divided, all ring admittances multiplied with the square of the ratio, c^2 .

For instance, if in a three-phase induction motor with delta-connected circuits, the impedance of each circuit is

$$Z = r + jx,$$

and the voltage impressed upon the circuit terminals E , and the motor is supplied over a line of impedance, per line wire,

$$Z_0 = r_0 + jx_0,$$

the motor impedance, reduced to star connection, or Y impedance, is

$$Z' = r \frac{r + jx}{c^2} = \frac{1}{3} (r + jx),$$

and the impressed voltage, reduced to Y circuit,

$$E' = \frac{E}{\sqrt{3}},$$

and the total impedance of the equivalent single-phase circuit is therefore

$$Z_0 + Z' = (r_0 + jx_0) + \frac{1}{3} (r + jx).$$

Inversely, however, where this appears more convenient, all quantities may be reduced to ring or delta connection, or one of the ring connections considered as equivalent single-phase circuit, of impedance

$$Z + c^2 Z_0 = (r + jx) + 3(r_0 + jx_0).$$

Since the line impedances, line currents and the voltages consumed in the lines of a polyphase system are star, or (in a three-phase system) Y quantities, it usually is more convenient to reduce all quantities to Y connection, and use one of the Y -circuits as the equivalent single-phase circuit.

304. As an example may be considered the calculation of a long-distance transmission line, delivering 10,000 kw., three-phase power at 60 cycles, 80,000 volts and 90 per cent. power-factor at 100 miles from the generating station, with approximately 10 per cent. loss of power in the transmission line, and with the line conductors arranged in a triangle 6 ft. distant from each other.

10,000 kw. total power delivered gives 3,333 kw. per line or single-phase branch (*Y* power).

3,333 kw. at 90 per cent. power-factor gives 3,700 kv.-amp.

80,000 volts between the lines gives $80,000 \div \sqrt{3} = 46,100$ volts from line to neutral, or per single-phase circuit.

3,700 kv.-amp. per circuit, at 46,100 volts, gives 80 amp. per line.

10 per cent. loss gives 333 kw. loss per line, and at 80 amp., this gives a resistance per line,

$$333,000 \div 80^2 = 52 \text{ ohms,}$$

or, 0.52 ohms per mile.

The nearest standard size of wire is No. 0 B. & S., which has a resistance of 0.52 ohms, and a weight of 1680 lb. per mile.

Choosing this size of wire so requires for the 300 miles of line conductor, $300 \times 1680 = 500,000$ lb. of copper.

At 0.52 ohms per mile, the resistance per transmission line or circuit of 100 miles length is,

$$r = 52 \text{ ohms.}$$

The inductance of wire No. 0, with $d = 0.325$ in. diameter, and 6 ft. = 72 in. distance from the return conductor, is calculated from the formula of line inductance¹ as, 2.3 mil-henrys per mile; hence, per circuit,

$$L = 0.23 \text{ henry,}$$

and herefrom the reactance,

$$\begin{aligned} x &= 2 \pi f L \\ &= 88 \text{ ohms.} \end{aligned}$$

The capacity of the transmission line may be calculated directly, or more conveniently it may be derived from the inductance. If C is the capacity of the circuit, of which the inductance is L , then

$$f_1 = \frac{1}{4 \sqrt{LC}}$$

is the fundamental frequency of oscillation, or natural period, that is, the frequency which makes the length, l , of the line a quarter-wave length.

Since the velocity of propagation of the electric field is the ve-

¹“Theoretical Elements of Electrical Engineering.”

locity of light, v , with a wave-length, $4l$, the number of waves per second, or frequency of oscillation of the line, is

$$f_1 = \frac{v}{4l}$$

and herefrom then follows:

$$\frac{v}{l} = \frac{1}{\sqrt{LC}}$$

hence, for

$$\begin{aligned} l &= 100 \text{ miles,} \\ v &= 186,000 \text{ miles per second,} \\ L &= 0.23 \text{ henry,} \\ C &= 1.26 \text{ mf.} \end{aligned}$$

and the capacity susceptance,

$$b = 2 \pi f C = 475 \times 10^{-6}.$$

Representing, as approximation, the line capacity by a condenser shunted across the middle of the line

We have, impedance of half the line,

$$Z = \frac{r}{2} + j \frac{x}{2} = 26 + 44 j \text{ ohms.}$$

Choosing the voltage at the receiving end as zero vector,

$$e = 46,100 \text{ volts,}$$

at 90 per cent. power-factor and therefore 43.6 per cent. inductance factor, the current is represented by

$$I = 80 (0.9 - 0.436 j) = 72 - 35 j.$$

¹Or, if μ = permeability, κ = dielectric constant of the medium surrounding the conductor, it is

$$f_1 = \frac{v}{4l \sqrt{\mu\kappa}}$$

hence,

$$\frac{v}{l} = \sqrt{\frac{\mu\kappa}{LC}}$$

or,

$$C = \frac{\left(\frac{l}{v}\right)^2}{L};$$

This gives:

Voltage at receiver circuit, $e = 46,100$ volts;

current in receiver circuit, $I = 72 - 35 j$ amp.;

impedance voltage of half the line, $ZI = 3410 + 2260 j$ volts.

Hence, the condenser voltage, $E_1 = e + ZI = 49,510 + 2260 j$ volts;

and the condenser current, $+jbE_1 = -1.1 + 23.8 j$ amp.;

hence, the total, or generator current, $I_0 = I + jbE_1 = 70.9 - 11.2 j$ amp.

The impedance voltage of the other half of the line, $ZI_0 = 2330 - 2830 j$ volts;

hence, the generator voltage, $E_0 = E_1 + ZI_0 = 51,840 + 5090 j$ volts;

and the phase angle of the generator current,

$$\tan \theta_1 = \frac{11.2}{70.9} = 0.158; \theta_1 = 9.0^\circ$$

The phase angle of the generator voltage,

$$\tan \theta_2 = -\frac{5090}{51,840} = -0.098; \theta_2 = -5.6^\circ;$$

the lag of the generator current, $\theta_0 = \theta_1 - \theta_2 = 14.6^\circ$;

hence the power-factor at the generator, $\cos \theta_0 = 96.7$ per cent.

And the power output, $3 [I, e]^1 = 10,000$ kw.;

the power input, $3 [I_0, E_0]^1 = 11,190$ kw.;

the efficiency = 89.35 per cent.;

the volt-ampere output, $3 ie = 11,110$ kv.-amp.;

the volt-ampere input, $3 i_0 e_0 = 11,220$ kv.-amp.;

ratio: = 99.02 per cent.

And the absolute values are:

receiver current, $i = 80$ amp.;

receiver voltage, $e = 46,100 \times \sqrt{3} = 80,000$ volts;

generator current, $i_0 = 71.8$ amp.;

generator voltage, $e_0 = 52,100 \times \sqrt{3} = 90,000$ volts;

voltage drop in line, = 11.1 per cent.

305. Balanced polyphase systems thus can be calculated as single-phase systems, and this has been done in many preceding chapters, as in those on the induction machines, synchronous machines, etc., that is, apparatus which is usually operated on polyphase circuits.

Only in dealing with those phenomena which are resultants of all the phases of the polyphase system, in the resolution of the polyphase system into its constituent single-phase systems the effective value of the constant has to be used, which corresponds to the resultant effect. This, for instance, is the case in calculating the magnetic field of the induction machine—which is energized by the combination of all phases—or the armature reaction of synchronous machines, etc.

For instance, in the induction machine, from the generated e.m.f., e —in Chapter XVIII—the magnetic flux of the machine is calculated, and from the magnetic flux and the dimensions of the magnetic circuit: length and section of air-gap, and length and section of the iron part, follows the ampere-turns excitation, that is, the ampere turns, F_0 , required to produce the magnetic flux.

The resultant m.m.f. of m equal magnetizing coils displaced in position by $\frac{1}{m}$ cycle, energized by m equal currents of an m -phase system, is given by §271 as

$$F_0 = \frac{nmI}{\sqrt{2}}$$

where

- I = current per phase, or per magnetizing coil,
- n = number of turns per coil,
- m = number of phases.

The exciting current per phase required to produce the resulting m.m.f., F_0 , therefore, is

$$I = \frac{F_0 \sqrt{2}}{nm};$$

hence, for a three-phase system,

$$I = \frac{F_0 \sqrt{2}}{3n},$$

and for a quarter-phase system, with two coils in quadrature,

$$I = \frac{F_0}{n \sqrt{2}}.$$

In the investigation of the armature reaction of synchronous machines, Chapter XXII, the armature reaction of an m -phase machine is, by §271,

$$F = \frac{n_0 m I}{\sqrt{2}};$$

where

- m = number of phases,
 n_0 = number of turns per phase, effective, that is, allowing for the spread of turns over an arc of the periphery in machines of distributed winding,
 I = current per phase,

and when, in Chapter XX, the armature reaction is given by nI , the number of effective turns, n , is, accordingly, for a polyphase alternator,

$$n = \frac{m}{\sqrt{2}} n_0;$$

hence, in a three-phase machine,

$$n = \frac{3n_0}{\sqrt{2}} = 1.5 n_0 \sqrt{2};$$

in a quadrature-phase machine,

$$n = n_0 \sqrt{2}.$$

306. When replacing a balanced symmetrical polyphase system by its constituent single-phase systems, it must be considered, that the constants of the constituent single-phase circuit may not be the same which this circuit would have as independent single-phase circuit.

If the branches of the polyphase circuit, which constitute the equivalent single-phase circuits, are electrically or magnetically interlinked, the constants, as admittance, impedance, etc., of the equivalent single-phase circuit often are different from those of the same circuit on single-phase supply, and the polyphase values then must be used in the equivalent single-phase circuits which replace the polyphase system.

This is the case in induction machines, in the armatures of synchronous machines, etc., where the phases are in mutual induction with each other.

Let, in a star or Y-connected three-phase induction motor:

$$Y = g - jb$$

be the exciting admittance and e the impressed voltage per three-phase Y circuit or constituent single-phase circuit.

The exciting current per circuit then is:

$$I = eY$$

or, absolute:

$$i = ey$$

if n = number of turns per circuit,

$f = ni$ = effective value of the m.m.f. per phase, and

$F = 1.5 \times \sqrt{2} ni$ = resultant m.m.f. of all three phases.

F then produces in the magnetic circuit the flux Φ , which consumes the impressed voltage e .

Assuming now, that instead of impressing three three-phase voltage e on the three constituent single-phase circuits of the motor, we impress only a single-phase voltage e on one of the three circuits.

The current in this circuit then must produce the same flux Φ , and have the same maximum m.m.f. F , as was given by the resultant of all three phases.

With n turns, that means, the current i_1 under the single-phase e.m.f. e is given by:

$$F = \sqrt{2} ni_1$$

and since we had, under the same voltage e and flux Φ , three-phase:

$$F = 1.5 \sqrt{2} ni$$

it follows:

$$i_1 = 1.5 i$$

That is, with a single-phase voltage, e , the current, i_1 , and thus the admittance, Y_1 , of the circuit, is 1.5 times the current, i , and thus the admittance, Y , which is produced in the same circuit by the three-phase voltage:

$$Y_1 = 1.5 Y$$

or:

$$Y = \frac{2}{3} Y_1$$

That is:

If we measure the admittance of one of the motor circuits by single-phase supply voltage, this is not the admittance of this circuit as constituent single-phase circuit of the three-phase motor, but

The admittance of the constituent or equivalent single-phase

circuit of a three-phase induction motor is two-thirds of the admittance of this same circuit as independent single-phase circuit.

We can look at this in a different way:

As the three-phase circuits combine to a resultant which is 1.5 times the m.m.f. of each circuit, each circuit requires only two-thirds of the m.m.f., and thus two-thirds of the exciting admittance, as equivalent single-phase circuit of a three-phase motor, which it would require, if as independent single-phase circuit it had to produce the entire m.m.f.

307. The same applies to the self-inductive reactance: as the self-inductive or leakage flux, which consumes the reactance voltage, is produced by the resultant of the currents of all three phases, and this resultant is 1.5 times the maximum of one phase, each phase produces only two-thirds, that is, the impedance current of each phase of the motor on three-phase voltage supply is only two-thirds that of the same circuit at the same voltage of single-phase supply, and the impedance thus is $\frac{3}{2} = 1.5$ times.

That is:

The effective admittance of the equivalent or constituent single-phase circuit of a three-phase induction machine is two-thirds of the admittance, and the effective impedance is 1.5 times the impedance of this circuit as independent single-phase circuit.

The same applies to synchronous machines:

The three-phase synchronous reactance per armature circuit, that is, the synchronous reactance of this armature circuit as equivalent single-phase circuit of the three-phase system, is 1.5 times the single-phase synchronous reactance of the same armature circuit, that is, synchronous reactance of this circuit as single-phase machine.

In dealing with the constituent single-phase circuits of a three-phase system, the proper "three-phase" values of the constants of the equivalent circuit must be used.

CHAPTER XXXVI

THREE-PHASE SYSTEM

308. With equal load of the same phase displacement in all three branches, the symmetrical three-phase system offers no special features over those of three equally loaded single-phase systems, and can be treated as such; since the mutual reactions between the three phases balance at equal distribution of load, that is, since each phase is acted upon by the preceding phase in an equal but opposite manner as by the following phase.

With unequal distribution of load between the different branches, the voltages and phase differences become more or less unequal. These unbalancing effects are obviously maximum if some of the phases are fully loaded, others unloaded.

Let E = e.m.f. between branches 1 and 2 of a three-phaser.
Then

$$\epsilon E = \text{e.m.f. between 2 and 3,}$$

$$\epsilon^2 E = \text{e.m.f. between 3 and 1;}$$

where
$$\epsilon = \sqrt[3]{1} = \frac{-1 + j\sqrt{3}}{2}.$$

Let

Z_1, Z_2, Z_3 = impedances of the lines issuing from generator terminals 1, 2, 3,

and Y_1, Y_2, Y_3 = admittances of the consumer circuits connected between lines 2 and 3, 3 and 1, 1 and 2.

If then,

I_1, I_2, I_3 , are the currents issuing from the generator terminals into the lines, it is,

$$I_1 + I_2 + I_3 = 0. \tag{1}$$

If, I'_1, I'_2, I'_3 = currents through the admittances, Y_1, Y_2, Y_3 , from 2 to 3, 3 to 1, 1 to 2, it is,

$$\left. \begin{aligned} I_1 &= I'_3 - I'_2, \text{ or, } I_1 + I'_2 - I'_3 = 0 \\ I_2 &= I'_1 - I'_3, \text{ or, } I_2 + I'_3 - I'_1 = 0 \\ I_3 &= I'_2 - I'_1, \text{ or, } I_3 + I'_1 - I'_2 = 0 \end{aligned} \right\} \tag{2}$$

These three equations (2) added, give (1) as dependent equation.

At the ends of the lines 1, 2, 3, it is:

$$\left. \begin{aligned} \dot{E}'_1 &= \dot{E}_1 - Z_2 \dot{I}_2 + Z_3 \dot{I}_3 \\ \dot{E}'_2 &= \dot{E}_2 - Z_3 \dot{I}_3 + Z_1 \dot{I}_1 \\ \dot{E}'_3 &= \dot{E}_3 - Z_1 \dot{I}_1 + Z_2 \dot{I}_2 \end{aligned} \right\} \quad (3)$$

the differences of potential, and:

$$\left. \begin{aligned} \dot{I}'_1 &= \dot{E}'_1 Y_1 \\ \dot{I}'_2 &= \dot{E}'_2 Y_2 \\ \dot{I}'_3 &= \dot{E}'_3 Y_3 \end{aligned} \right\} \quad (4)$$

the currents in the receiver circuits.

These nine equations (2), (3), (4), determine the nine quantities: $\dot{I}_1, \dot{I}_2, \dot{I}_3, \dot{I}'_1, \dot{I}'_2, \dot{I}'_3, \dot{E}'_1, \dot{E}'_2, \dot{E}'_3$.

Equations (4) substituted in (2) give:

$$\left. \begin{aligned} \dot{I}_1 &= \dot{E}'_3 Y_3 - \dot{E}'_2 Y_2 \\ \dot{I}_2 &= \dot{E}'_1 Y_1 - \dot{E}'_3 Y_3 \\ \dot{I}_3 &= \dot{E}'_2 Y_2 - \dot{E}'_1 Y_1 \end{aligned} \right\} \quad (5)$$

These equations (5) substituted in (3), and transposed, give:

since $\left. \begin{aligned} \dot{E}_1 &= \epsilon \dot{E} \\ \dot{E}_2 &= \epsilon^2 \dot{E} \\ \dot{E}_3 &= \dot{E} \end{aligned} \right\}$ as e.m.fs. at the generator terminals.

$$\left. \begin{aligned} \epsilon \dot{E} - \dot{E}'_1(1 + Y_1 Z_2 + Y_1 Z_3) + \dot{E}'_2 Y_2 Z_3 + \dot{E}'_3 Y_3 Z_2 &= 0 \\ \epsilon^2 \dot{E} - \dot{E}'_2(1 + Y_2 Z_3 + Y_2 Z_1) + \dot{E}'_3 Y_3 Z_1 + \dot{E}'_1 Y_1 Z_3 &= 0 \\ \dot{E} - \dot{E}'_3(1 + Y_3 Z_1 + Y_3 Z_2) + \dot{E}'_1 Y_1 Z_2 + \dot{E}'_2 Y_2 Z_1 &= 0 \end{aligned} \right\} \quad (6)$$

as three linear equations with the three quantities, $\dot{E}'_1, \dot{E}'_2, \dot{E}'_3$.

Substituting the abbreviations:

$$\left. \begin{aligned}
 K &= \begin{bmatrix} -(1 + Y_1Z_2 + Y_1Z_3), & Y_2Z_3, & Y_3Z_2 \\ Y_1Z_3, & -(1 + Y_2Z_3 + Y_2Z_1), & Y_3Z_1 \\ Y_1Z_2, & Y_2Z_1, & -(1 + Y_3Z_1 + Y_3Z_2) \end{bmatrix} \\
 K_1 &= \begin{bmatrix} \epsilon, & Y_2Z_3, & Y_3Z_2 \\ \epsilon^2, & -(1 + Y_2Z_3 + Y_2Z_1), & Y_3Z_1 \\ 1, & Y_2Z_1, & -(1 + Y_3Z_1 + Y_3Z_2) \end{bmatrix} \\
 K_2 &= \begin{bmatrix} -(1 + Y_1Z_2 + Y_1Z_3), & \epsilon, & Y_3Z_2 \\ Y_1Z_3, & \epsilon^2, & Y_3Z_1 \\ Y_1Z_2, & 1, & -(1 + Y_3Z_1 + Y_3Z_2) \end{bmatrix} \\
 K_3 &= \begin{bmatrix} -(1 + Y_1Z_2 + Y_1Z_3), & Y_2Z_3, & \epsilon \\ Y_1Z_3, & -(1 + Y_2Z_3 + Y_2Z_1), & \epsilon^2 \\ Y_1Z_2, & Y_2Z_1, & 1 \end{bmatrix}
 \end{aligned} \right\} (7)$$

we have:

$$\left. \begin{aligned}
 \dot{E}'_1 &= \frac{EK_1}{K} \\
 \dot{E}'_2 &= \frac{EK_2}{K} \\
 \dot{E}'_3 &= \frac{EK_3}{K}
 \end{aligned} \right\} (8)$$

$$\left. \begin{aligned}
 \dot{I}'_1 &= \frac{Y_1EK_1}{K} \\
 \dot{I}'_2 &= \frac{Y_2EK_2}{K} \\
 \dot{I}'_3 &= \frac{Y_3EK_3}{K}
 \end{aligned} \right\} (9)$$

$$\left. \begin{aligned}
 \dot{I}_1 &= \frac{Y_3K_3 - Y_2K_2\dot{E}}{K} \\
 \dot{I}_2 &= \frac{Y_1K_1 - Y_3K_3\dot{E}}{K} \\
 \dot{I}_3 &= \frac{Y_2K_2 - Y_1K_1\dot{E}}{K}
 \end{aligned} \right\} (10)$$

hence,

$$\left. \begin{aligned}
 \dot{E}'_1 + \dot{E}'_2 + \dot{E}'_3 &= 0 \\
 \dot{I}_1 + \dot{I}_2 + \dot{I}_3 &= 0
 \end{aligned} \right\} (11)$$

309. SPECIAL CASES.

A. Balanced System

$$Y_1 = Y_2 = Y_3 = Y$$

$$Z_1 = Z_2 = Z_3 = Z.$$

Substituting this in (6), and transposing:

$$\left. \begin{aligned} \dot{E}_1 &= \epsilon \dot{E} \\ \dot{E}_2 &= \epsilon^2 \dot{E} \\ \dot{E}_3 &= \dot{E} \end{aligned} \right\} \left. \begin{aligned} \dot{E}'_1 &= \frac{\epsilon \dot{E}}{1 + 3 YZ} \\ \dot{E}'_2 &= \frac{\epsilon^2 \dot{E}}{1 + 3 YZ} \\ \dot{E}'_3 &= \frac{\dot{E}}{1 + 3 YZ} \end{aligned} \right\} \quad (12)$$

$$\left. \begin{aligned} \dot{I}'_1 &= \frac{\epsilon \dot{E} Y}{1 + 3 YZ} \\ \dot{I}'_2 &= \frac{\epsilon^2 \dot{E} Y}{1 + 3 YZ} \\ \dot{I}'_3 &= \frac{\dot{E} Y}{1 + 3 YZ} \end{aligned} \right\} \left. \begin{aligned} \dot{I}_1 &= \frac{\epsilon^2 (\epsilon - 1) \dot{E} Y}{1 + 3 YZ} \\ \dot{I}_2 &= \frac{(\epsilon - 1) \dot{E} Y}{1 + 3 YZ} \\ \dot{I}_3 &= \frac{\epsilon (\epsilon - 1) \dot{E} Y}{1 + 3 YZ} \end{aligned} \right\}$$

The equations of the symmetrical balanced three-phase system.

B. One Circuit Loaded, Two Unloaded

$$Y_1 = Y_2 = 0, Y_3 = Y,$$

$$Z_1 = Z_2 = Z_3 = Z.$$

Substituted in equations (6):

$$\left. \begin{aligned} \epsilon \dot{E} - \dot{E}'_1 + \dot{E}'_3 YZ &= 0 \\ \epsilon^2 \dot{E} - \dot{E}'_2 + \dot{E}'_3 YZ &= 0 \end{aligned} \right\} \text{unloaded branches.}$$

$$\dot{E} - \dot{E}'_3 (1 + 2 YZ) = 0, \text{ loaded branch.}$$

hence:

$$\left. \begin{aligned} \dot{E}'_1 &= \frac{\dot{E} \{ \epsilon + (1 + 2 \epsilon) YZ \}}{1 + 2 YZ} \\ \dot{E}'_2 &= \frac{\dot{E} \{ \epsilon^2 + (1 + 2 \epsilon^2) YZ \}}{1 + 2 YZ} \\ \dot{E}'_3 &= \frac{\dot{E}}{1 + 2 YZ} \end{aligned} \right\} \left. \begin{array}{l} \text{unloaded;} \\ \text{loaded;} \end{array} \right\} \begin{array}{l} \text{all three} \\ \text{e.m.fs.} \\ \text{unequal, and} \\ \text{of unequal} \\ \text{phase angles.} \end{array} \quad (13)$$

$$\left. \begin{aligned} I'_1 &= I'_2 = 0 \\ I'_3 &= \frac{EY}{1 + 2YZ} \end{aligned} \right\} \quad (13)$$

$$\left. \begin{aligned} I_1 &= \frac{EY}{1 + 2YZ} \\ I_2 &= -\frac{EY}{1 + 2YZ} \\ I_3 &= 0 \end{aligned} \right\} \quad (13)$$

C. Two Circuits Loaded, One Unloaded

$$\begin{aligned} Y_1 &= Y_2 = Y, \quad Y_3 = 0, \\ Z_1 &= Z_2 = Z_3 = Z. \end{aligned}$$

Substituting this in equations (6), it is

$$\left. \begin{aligned} \epsilon E - E'_1(1 + 2YZ) + E'_2YZ &= 0 \\ \epsilon^2 E - E'_2(1 + 2YZ) + E'_1YZ &= 0 \\ E - E'_3 + (E'_1 + E'_2)YZ &= 0 \end{aligned} \right\} \begin{array}{l} \text{loaded branches.} \\ \text{unloaded branch.} \end{array}$$

or, since

$$\begin{aligned} (E'_1 + E'_2) &= -E'_3; \\ E - E'_3 - E'_3YZ &= 0, \\ E'_3 &= \frac{E}{1 + YZ}; \end{aligned}$$

thus,

$$\left. \begin{aligned} E'_1 &= \frac{E\epsilon \{1 + (2 + \epsilon)YZ\}}{1 + 4YZ + 3Y^2Z^2} \\ E'_2 &= \frac{E\epsilon^2 \{1 + (2 + \epsilon^1)YZ\}}{1 + 4YZ + 3Y^2Z^2} \\ E'_3 &= \frac{E}{1 + YZ} \end{aligned} \right\} \begin{array}{l} \text{loaded branches.} \\ \text{unloaded branch.} \end{array} \quad (14)$$

As seen, with unsymmetrical distribution of load, all three branches become more or less unequal, and the phase displacement between them unequal also.

CHAPTER XXXVII

QUARTER-PHASE SYSTEM

310. In a three-wire quarter-phase system, or quarter-phase system with common return-wire of both phases, let the two outside terminals and wires be denoted by 1 and 2, the middle wire or common return by 0.

It is then,

$\dot{E}_1 = E = \text{e.m.f. between 0 and 1 in the generator.}$

$\dot{E}_2 = jE = \text{e.m.f. between 0 and 2 in the generator.}$

Let \dot{I}_1 and $\dot{I}_2 = \text{currents in 1 and in 2,}$

$\dot{I}_0 = \text{current in 0,}$

Z_1 and $Z_2 = \text{impedances of lines 1 and 2,}$

$Z_0 = \text{impedance of line 0,}$

Y_1 and $Y_2 = \text{admittances of circuits 0 to 1, and 0 to 2,}$

\dot{I}'_1 and $\dot{I}'_2 = \text{currents in circuits 0 to 1, and 0 to 2,}$

\dot{E}'_1 and $\dot{E}'_2 = \text{potential differences at circuit 0 to 1, and 0 to 2.}$

it is then,

$$\left. \begin{aligned} \dot{I}_1 + \dot{I}_2 + \dot{I}_0 &= 0, \\ \dot{I}_0 &= -(\dot{I}_1 + \dot{I}_2); \end{aligned} \right\} \quad (1)$$

or,

that is, \dot{I}_0 is common return of \dot{I}_1 and \dot{I}_2 .

Further, we have:

$$\left. \begin{aligned} \dot{E}'_1 &= E - \dot{I}_1 Z_1 + \dot{I}_0 Z_0 = E - \dot{I}_1 (Z_1 + Z_0) - \dot{I}_2 Z_0 \\ \dot{E}'_2 &= jE - \dot{I}_2 Z_0 + \dot{I}_0 Z_0 = jE - \dot{I}_2 (Z_2 + Z_0) - \dot{I}_1 Z_1 \end{aligned} \right\} \quad (2)$$

and

$$\left. \begin{aligned} \dot{I}_1 &= Y_1 \dot{E}'_1 \\ \dot{I}_2 &= Y_2 \dot{E}'_2 \\ \dot{I}_0 &= -(Y_1 \dot{E}'_1 + Y_2 \dot{E}'_2) \end{aligned} \right\} \quad (3)$$

Substituting (3) in (2), and expanding,

$$\left. \begin{aligned} \dot{E}'_1 &= E \frac{1 + Y_2 Z_2 + Y_2 Z_0 (1 - j)}{(1 + Y_1 Z_0 + Y_1 Z_1) (1 + Y_2 Z_0 + Y_2 Z_2) - Y_1 Y_2 Z_0^2} \\ \dot{E}'_2 &= jE \frac{1 + Y_1 Z_1 + Y_1 Z_0 (1 + j)}{(1 + Y_1 Z_0 + Y_1 Z_1) (1 + Y_2 Z_0 + Y_2 Z_2) - Y_1 Y_2 Z_0^2} \end{aligned} \right\} \quad (4)$$

Hence, the two e.m.fs. at the end of the line are unequal in magnitude, and not in quadrature any more.

311. SPECIAL CASES:

A. Balanced System

$$Z_1 = Z_2 = Z$$

$$Z_0 = \frac{Z}{\sqrt{2}};$$

$$Y_1 = Y_2 = Y.$$

Substituting these values in (4), gives:

$$\left. \begin{aligned} E'_1 &= E \frac{1 + \frac{1 + \sqrt{2} - j}{\sqrt{2}} YZ}{1 + \sqrt{2} (1 + \sqrt{2}) YZ + (1 + \sqrt{2}) Y^2 Z^2} \\ &= E \frac{1 + (1.707 + 0.707 j) YZ}{1 + 3.414 YZ + 2.414 Y^2 Z^2} \\ E'_2 &= jE \frac{1 + \frac{1 + \sqrt{2} + j}{\sqrt{2}} YZ}{1 + \sqrt{2} (1 + \sqrt{2}) YZ + (1 + \sqrt{2}) Y^2 Z^2} \\ &= jE \frac{1 + (1.707 + 0.707 j) YZ}{1 + 3.414 YZ + 2.414 Y^2 Z^2} \end{aligned} \right\} (5)$$

Hence, the balanced quarter-phase system with common return is unbalanced with regard to voltage and phase relation, or in other words, even if in a quarter-phase system with common return both branches or phases are loaded equally, with a load of the same phase displacement, nevertheless the system becomes unbalanced, and the two e.m.fs. at the end of the line are neither equal in magnitude, nor in quadrature with each other.

B. One Branch Loaded, One Unloaded

$$Z_1 = Z_2 = Z,$$

$$Z_0 = \frac{Z}{\sqrt{2}}.$$

(a) $Y_1 = 0, Y_2 = Y,$

(b) $Y_1 = Y, Y_2 = 0.$

Substituting these values in (4), gives:

$$\begin{aligned}
 (a) \quad E'_1 &= E \frac{1 + YZ \frac{1 + \sqrt{2} - j}{\sqrt{2}}}{1 + YZ \frac{1 + \sqrt{2}}{\sqrt{2}}} \\
 &= E \left\{ 1 - \frac{j}{1 + \sqrt{2} + \frac{\sqrt{2}}{YZ}} \right\} \\
 &= E \left\{ 1 - \frac{j}{2.414 + \frac{1.414}{YZ}} \right\}
 \end{aligned} \tag{6}$$

$$\begin{aligned}
 E'_2 &= jE \frac{1}{1 + YZ \frac{1 + \sqrt{2}}{\sqrt{2}}} \\
 &= jE \frac{1}{1 + 1.707 YZ}
 \end{aligned}$$

$$\begin{aligned}
 (b) \quad E'_1 &= E \frac{1}{1 + YZ \frac{1 + \sqrt{2}}{\sqrt{2}}} \\
 &= E \frac{1}{1 + 1.707 YZ} \\
 E'_2 &= jE \frac{1 + YZ \frac{1 + \sqrt{2} + j}{\sqrt{2}}}{1 + YZ \frac{1 + \sqrt{2}}{\sqrt{2}}} \\
 &= jE \left\{ 1 + \frac{j}{1 + \sqrt{2} + \frac{\sqrt{2}}{YZ}} \right\} \\
 &= jE \left\{ 1 + \frac{j}{2.414 + \frac{1.414}{YZ}} \right\}
 \end{aligned} \tag{7}$$

These two e.m.fs. are unequal, and not in quadrature with each other.

But the values in case (a) are different from the values in case (b).

That means:

The two phases of a three-wire, quarter-phase system are

unsymmetrical, and the leading phase, 1, reacts upon the lagging phase, 2, in a different manner than 2 reacts upon 1.

It is thus undesirable to use a three-wire, quarter-phase system, except in cases where the line impedances, Z , are negligible.

In all other cases, the four-wire, quarter-phase system is preferable, which essentially consists of two independent single-phase circuits, and is treated as such.

Obviously, even in such an independent quarter-phase system, at unequal distribution of load, unbalancing effects may take place.

If one of the branches or phases is loaded differently from the other, the drop of voltage and the shift of the phase will be different from that in the other branch; and thus the e.m.fs. at the end of the lines will be neither equal in magnitude, nor in quadrature with each other.

With both branches, however, loaded equally, the system remains balanced in voltage and phase, just like the three-phase system under the same conditions.

Thus the four-wire, quarter-phase system and the three-phase system are balanced with regard to voltage and phase at equal distribution of load, but are liable to become unbalanced at unequal distribution of load; the three-wire, quarter-phase system is unbalanced in voltage and phase, even at equal distribution of load.

APPENDIX

ALGEBRA OF COMPLEX IMAGINARY QUANTITIES

(“See Engineering Mathematics”)

INTRODUCTION

312. The system of numbers, of which the science of algebra treats, finds its ultimate origin in experience. Directly derived from experience, however, are only the absolute integral numbers; fractions, for instance, are not directly derived from experience, but are abstractions expressing relations between different classes of quantities. Thus, for instance, if a quantity is divided in two parts, from one quantity two quantities are derived, and denoting these latter as halves expresses a relation, namely, that two of the new kinds of quantities are derived from, or can be combined to one of the old quantities.

313. Directly derived from experience is the *operation of counting* or of *numeration*,

$$a, a + 1, a + 2, a + 3 \dots$$

Counting by a given number of integers,

$$a + \underbrace{1 + 1 + 1 \dots + 1}_{b \text{ integers}} = c,$$

introduces the operation of *addition*, as multiple counting,

$$a + b = c.$$

It is

$$a + b = b + a;$$

that is, the terms of addition, or addenda, are interchangeable.

Multiple addition of the same terms,

$$\underbrace{a + a + a + \dots + a}_{b \text{ equal numbers}} = c,$$

introduces the operation of *multiplication*,

$$a \times b = c.$$

It is

$$a \times b = b \times a,$$

that is, the terms of multiplication, or factors, are interchangeable.

Multiple multiplication of the same factors,

$$\underbrace{a \times a \times a \times \dots \times a}_{b \text{ equal numbers}} = c$$

introduces the operation of *involution*,

$$a^b = c.$$

Since

$$a^b \text{ is not equal to } b^a,$$

the terms of involution are not interchangeable.

314. The reverse operation of addition introduces the operation of *subtraction*.

If

$$a + b = c,$$

it is

$$c - b = a.$$

This operation cannot be carried out in the system of absolute numbers, if

$$b > c.$$

Thus, to make it possible to carry out the operation of subtraction under any circumstances, the system of absolute numbers has to be expanded by the introduction of the *negative number*,

$$-a = (-1) \times a,$$

where

$$(-1) \text{ is the } \textit{negative unit}.$$

Thereby the system of numbers is subdivided in the positive and negative numbers, and the operation of subtraction possible for all values of subtrahend and minuend. From the definition of addition as multiple numeration, and subtraction as its inverse operation, it follows:

$$c - (-b) = c + b,$$

thus:

$$(-1) \times (-1) = 1;$$

that is, the negative unit is defined by $(-1)^2 = 1$.

315. The reverse operation of multiplication introduces the operation of *division*.

If

$$a \times b = c,$$

it is

$$\frac{c}{b} = a.$$

In the system of integral numbers this operation can only be carried out if b is a factor of c .

To make it possible to carry out the operation of division under any circumstances, the system of integral numbers has to be expanded by the introduction of the *fraction*,

$$\frac{c}{b} = c \times \left(\frac{1}{b}\right),$$

where $\frac{1}{b}$ is the integer fraction, and is defined by

$$\left(\frac{1}{b}\right) \times b = 1.$$

316. The reverse operation of involution introduces two new operations, since in the involution,

$$a^b = c,$$

the quantities a and b are not reversible.

Thus

$$\begin{aligned} \sqrt[b]{c} &= a, \text{ the } \textit{evolution}, \\ \log_a c &= b, \text{ the } \textit{logarithmation}. \end{aligned}$$

The operation of evolution of terms, c , which are not complete powers, makes a further expansion of the system of numbers necessary, by the introduction of the *irrational number* (endless decimal fraction), as for instance,

$$\sqrt{2} = 1.414213. . .$$

317. The operation of evolution of negative quantities, c , with even exponents, b , as for instance,

$$\sqrt[2]{-a},$$

makes a further expansion of the system of numbers necessary, by the introduction of the *imaginary unit*

$$\sqrt{-1}$$

Thus

$$\sqrt[2]{-a} = \sqrt[2]{-1} \times \sqrt[2]{a},$$

where:

$$\sqrt{-1} \text{ is denoted by } j.$$

Thus, the imaginary unit, j , is defined by

$$j^2 = -1.$$

By addition and subtraction of real and imaginary units, compound numbers are derived of the form,

$$a + jb,$$

which are denoted as *complex imaginary numbers*, or *general numbers*.

No further system of numbers is introduced by the operation of evolution.

The operation of logarithmation introduces the irrational and imaginary and complex imaginary numbers also, but no further system of numbers.

318. Thus, starting from the absolute integral numbers of experience, by the two conditions:

1st. Possibility of carrying out the algebraic operations and their reverse operations under all conditions,

2d. Permanence of the laws of calculation,
the expansion of the system of numbers has become necessary, into

positive and negative numbers,

integral numbers and fractions,

rational and irrational numbers,

real and imaginary numbers and complex imaginary numbers.

Therewith closes the field of algebra, and all the algebraic operations and their reverse operations can be carried out irrespective of the values of terms entering the operation.

Thus within the range of algebra no further extension of the system of numbers is necessary or possible, and the most general number is

$$a + jb,$$

where a and b can be integers or fractions, positive or negative, rational or irrational.

Any attempt to extend the system of numbers beyond the complex quantity, leads to numbers, in which the factors of a product are not interchangeable, in which one factor of a product

may be zero without the product being zero, etc., and which thus cannot be treated by the usual methods of algebra, that is, are extra-algebraic numbers. Such for instance are the double frequency vector products of Chapter XV.

ALGEBRAIC OPERATIONS WITH GENERAL NUMBERS

319. *Definition of imaginary unit:*

$$j^2 = -1.$$

Complex imaginary number:

$$A = a + jb.$$

Substituting:

$$a = r \cos \beta,$$

$$b = r \sin \beta,$$

it is

$$A = r(\cos \beta + j \sin \beta),$$

where

$$r = \sqrt{a^2 + b^2},$$

$$\tan \beta = \frac{b}{a},$$

r = vector,

β = amplitude of general number, A .

Substituting:

$$\cos \beta = \frac{e^{j\beta} + e^{-j\beta}}{2},$$

$$\sin \beta = \frac{e^{j\beta} - e^{-j\beta}}{2j},$$

it is

$$A = re^{j\beta},$$

where $\epsilon = \lim_{n \rightarrow \infty} \left(1 + \frac{1}{n}\right)^n = \sum_0^{\infty} \frac{1}{1 \times 2 \times 3 \times \dots \times k}$,

is the basis of the natural logarithms.

Conjugate numbers are called:

$$a + jb = r(\cos \beta + j \sin \beta) = re^{j\beta},$$

and $a - jb = r(\cos [-\beta] + j \sin [-\beta]) = r(\cos \beta - j \sin \beta) = re^{-j\beta}$,

it is

$$(a + jb)(a - jb) = a^2 + b^2 = r^2.$$

Associate numbers are called:

$$a + jb = r (\cos \beta + j \sin \beta) = r\epsilon^{j\beta},$$

and

$$b + ja = r \left(\cos \left[\frac{\pi}{2} - \beta \right] + j \sin \left[\frac{\pi}{2} - \beta \right] \right) = r\epsilon^{j\left(\frac{\pi}{2} - \beta\right)},$$

it is

$$(a + jb)(b + ja) = j(a^2 + b^2) = jr^2.$$

If

$$a + jb = a' + jb',$$

it is

$$\begin{aligned} a &= a', \\ b &= b'. \end{aligned}$$

If

$$a + jb = 0;$$

it is

$$\begin{aligned} a &= 0, \\ b &= 0. \end{aligned}$$

320. Addition and Subtraction:

$$(a + jb) \pm (a' + jb') = (a + a') + j(b + b').$$

Multiplication:

$$(a + jb)(a' + jb') = (aa' - bb') + j(ab' + ba');$$

or $r (\cos \beta + j \sin \beta) \times r' (\cos \beta' + j \sin \beta') = rr' (\cos [\beta + \beta'] + j \sin [\beta + \beta']);$

or $re^{j\beta} \times r'e^{j\beta'} = rr'e^{j(\beta + \beta')}$

Division:

Expansion of complex imaginary fraction, for rationalization of denominator or numerator, by multiplication with the conjugate quantity:

$$\begin{aligned} \frac{a + jb}{a' + jb'} &= \frac{(a + jb)(a' - jb')}{(a' + jb')(a' - jb')} = \frac{(aa' + bb') + j(ba' - ab')}{a'^2 + b'^2} \\ &= \frac{(a + jb)(a - jb)}{(a' + jb')(a - jb)} = \frac{a^2 + b^2}{(aa' + bb') + j(ab' - ba')}; \end{aligned}$$

or,

$$\frac{r (\cos \beta + j \sin \beta)}{r' (\cos \beta' + j \sin \beta')} = \frac{r}{r'} (\cos [\beta - \beta'] + j \sin [\beta - \beta']);$$

or,

$$\frac{re^{j\beta}}{r'e^{j\beta'}} = \frac{r}{r'} e^{j(\beta - \beta')}$$

involution:

$$(a + jb)^n = \{r(\cos \beta + j \sin \beta)\}^n = \{re^{j\beta}\}^n \\ = r^n(\cos n\beta + j \sin n\beta) = r^n e^{jn\beta};$$

evolution:

$$\sqrt[n]{a + jb} = \sqrt[n]{r(\cos \beta + j \sin \beta)} = \sqrt[n]{re^{j\beta}} \\ = \sqrt[n]{r} \left(\cos \frac{\beta}{n} + j \sin \frac{\beta}{n} \right) = \sqrt[n]{r} e^{j\frac{\beta}{n}}.$$

321. Roots of the Unit:

$$\sqrt[2]{1} = +1, -1;$$

$$\sqrt[3]{1} = +1, \frac{-1 + j\sqrt{3}}{2}, \frac{-1 - j\sqrt{3}}{2};$$

$$\sqrt[4]{1} = +1, -1, +j, -j;$$

$$\sqrt[6]{1} = +1, \frac{+1 + j\sqrt{3}}{2}, \frac{-1 + j\sqrt{3}}{2}, -1, \frac{-1 - j\sqrt{3}}{2}, \frac{+1 - j\sqrt{3}}{2};$$

$$\sqrt[8]{1} = +1, -1, +j, -j, \frac{+1 + j}{\sqrt{2}}, \frac{+1 - j}{\sqrt{2}}, \frac{-1 + j}{\sqrt{2}}, \frac{-1 - j}{\sqrt{2}};$$

$$\sqrt[n]{1} = \cos \frac{2\pi k}{n} + j \sin \frac{2\pi k}{n} = e^{\frac{2\pi jk}{n}}, k = 0, 1, 2 \dots n - 1.$$

322. Rotation:

In the complex imaginary plane, multiplication with

$$\sqrt[n]{1} = \cos \frac{2\pi}{n} + j \sin \frac{2\pi}{n} = e^{\frac{2\pi j}{n}}$$

means rotation, in positive direction, by $\frac{1}{n}$ of a revolution,

multiplication with (-1) means reversal, or rotation by 180° ,

multiplication with $(+j)$ means positive rotation by 90° ,

multiplication with $(-j)$ means negative rotation by 90° .

323. Complex Imaginary Plane:

While the positive and negative numbers can be represented by the points of a line, the complex imaginary numbers or general numbers are represented by the points of a plane, with the horizontal axis, $A'OA$, as real axis, the vertical axis, $B'OB$, as imaginary axis. Thus all

the positive real numbers are represented by the points of half-axis \overline{OA} toward the right;

the negative real numbers are represented by the points of half-axis $\overline{OA'}$ toward the left;

- the positive imaginary numbers are represented by the points of half-axis \overline{OB} upward;
- the negative imaginary numbers are represented by the points of half-axis $\overline{OB'}$ downward;
- the complex imaginary or general numbers are represented by the points outside of the coordinate axes.



INDEX

- Absolute values of complex quantities, 37
- Actual generated e.m.f., alternator, 272
- Admittance, 55
of dielectric, 154
due to eddy currents, 137
to hysteresis, 129
- Admittivity of dielectric circuit, 160
- Air-gap in magnetic circuit, 119, 132
- Ambiguity of vectors, 39
- Amplitude, 6, 20
- Apparent capacity of distorted wave, 386
efficiency of induction motor, 234
impedance of transformer, 201
torque efficiency of induction motor, 234
- Arc causing harmonics, 353
as pulsating resistance, 352
volt-ampere characteristic, 354
wave construction, 355
- Armature reaction of alternator, 260, 272
- Average value of wave, 11
- Balanced polyphase system, 397
- Balance factor of polyphase system, 406
- Brush discharge, 112
- Cable, topographical characteristic, 42
- Capacity, 4, 9
of line, 174
- Choking coil, 96
- Circuit characteristic of line and cable, 44
dielectric and dynamic, 159
factor of general wave, 383
- Coefficient of eddy currents, 138
of hysteresis, 123
- Combination of sine waves, 31
- Compensation for lagging currents by condensance, 72
- Condensance in symbolic expression, 36
- Condenser as reactance and susceptance, 96
with distorted wave, 384
motor on distorted wave, 392
motor, single-phase induction, 249, 257
synchronous, 339
- Conductance of circuit with inductive line, 84
direct current, 55
due to eddy currents, 137
effective, 111
due to hysteresis, 126
parallel and series connection, 54
- Conductivity, dielectric, 153
of dielectric circuit, 160
- Constant current from constant potential, 76
synchronous motor, 337
potential constant current transformation, 76
- Consumed voltage, by resistance, reactance, impedance, 23
- Control of voltage by shunted susceptance, 89
- Corona, 112, 161
of line, 174
- Counter e.m.f. of impedance, reactance, resistance, self-induction, 23
of synchronous motor, 24, 315
- Crank diagram, 19
and polar diagram, comparison, 51
- Critical voltage of corona, 166
- Cross currents in alternators, 293
- Cross flux, magnetic of transformer, 187
- Cycle, magnetic or hysteresis, 114

- Delta connection of three-phase system, 416
 current in three-phase system, 417
 delta transformation, 425
 Y transformation, 425
 voltage in three-phase system, 417
- Demagnetizing effect of eddy currents, 142
- Diametrical connection of transformers, six-phase, 429
- Dielectric circuit, 159
 density, 152
 field, 150
 hysteresis, 112, 150
 strength, 151
- Direct-current system, efficiency, 441
- Displacement current, 152
- Disruptive gradient, 165
- Distortion by magnetic field, resistance and reactance pulsation, 342
 of magnetizing current, 117
 of wave, *see* Harmonics
 by hysteresis, 116
- Distributed capacity, 168
- Double delta connections of transformers to six-phase, 428
 frequency power and torque with distorted wave, 381
 quantities, 180
 peak wave, 370
 T connections of transformers to six-phase, 430
 Y connection of transformers to six-phase, 429
- Drop of voltage in line, 25
- Dynamic circuit, 159
- Eddy currents, 112
 admittance, 137
 coefficient, 138
 conductance, 137
 in conductor, 144
 loss with distorted wave, 377
 of power, 136
- Effective circuit constants, 168
- Effective circuit conductance, 111
 power, 180
 reactance, 112
 resistance, 2, 5, 9, 111
 susceptance, 112
 value of wave, 11
 in polar diagram, 53
- Efficiency of circuit with inductive line, 88, 95
 induction motor, 234
- Electrostatic, *see* Dielectric
- E. m. f. of self-induction, 123
- Energy distance of dielectric field, 165
 flow in polyphase system, 406
 and torque as component of double frequency vector, 186
- Epoch, 6
- Equivalent circuit of transformer, 202
 sine wave in polar diagram, 53
 single-phase circuit of polyphase system, 448
- Excitation of induction generator, 238
- Exciter of induction generator, 238
- Exciting admittance of induction motor, 211
 current of induction motor, 211
 single-phase induction motor, 247
 transformer, 189
- Field characteristic of alternator, 265
- Fifth harmonic, 370
- Five-wire system, efficiency, 466
- Flat top wave, 370
 zero wave, 370
- Foucault currents, 113
- Four-phase system, 397
 wire systems, efficiency, 466
- Frequency, 6
- General wave, symbolism, 379
- Generator, induction, 237
- Harmonics, 7
 caused by arc, 353

Inductive reactance 100
 Inductance 100
 Inductance of coil 100
 Inductance of solenoid 100
 Inductance of transformer 100
 Inductance of wire 100
 Inductive circuit 100
 Inductive circuit, starting current 100
 Inductive circuit, maximum power 100
 Inductive reactance, maximum 100
 Inductive reactance, minimum 100
 Inductive reactance, from line 100
 Inductance, maximum value 100
 Inductance of wire 100
 Interlinked, polyphase system, 307

Inductive reactance 100
 Inductance 100
 Inductance of coil 100
 Inductance of solenoid 100
 Inductance of transformer 100
 Inductance of wire 100
 Inductive circuit 100
 Inductive circuit, starting current 100
 Inductive circuit, maximum power 100
 Inductive reactance, maximum 100
 Inductive reactance, minimum 100
 Inductive reactance, from line 100
 Inductance, maximum value 100
 Inductance of wire 100
 Interlinked, polyphase system, 307
 Magnetic cycle 114
 hysteresis 112
 Magnetizing current 117
 Maximum output of inductive line 83
 non-inductive circuit and inductive line 81

- Delta connection of three-phase system, 416
 current in three-phase system, 417
 delta transformation, 425
 Y transformation, 425
 voltage in three-phase system, 417
- Demagnetizing effect of eddy currents, 142
- Diametrical connection of transformers, six-phase, 429
- Dielectric circuit, 159
 density, 152
 field, 150
 hysteresis, 112, 150
 strength, 161
- Direct-current system, efficiency, 441
- Displacement current, 152
- Disruptive gradient, 165
- Distortion by magnetic field, resistance and reactance pulsation, 342
 of magnetizing current, 117
 of wave, *see* Harmonics
 by hysteresis, 116
- Distributed capacity, 168
- Double delta connections of transformers to six-phase, 428
 frequency power and torque with distorted wave, 381
 quantities, 180
 peak wave, 370
 T connections of transformers to six-phase, 430
 Y connection of transformers to six-phase, 429
- Drop of voltage in line, 25
- Dynamic circuit, 159
- Eddy currents, 112
 admittance, 137
 coefficient, 138
 conductance, 137
 in conductor, 144
 loss with distorted wave, 377
 of power, 136
- Effective circuit constants, 168
- Effective circuit conductance, 111
 power, 180
 reactance, 112
 resistance, 2, 5, 9, 111
 susceptance, 112
 value of wave, 11
 in polar diagram, 53
- Efficiency of circuit with inductive line, 88, 95
 induction motor, 234
- Electrostatic, *see* Dielectric
- E.m.f. of self-induction, 123
- Energy distance of dielectric field, 165
 flow in polyphase system, 406
 and torque as component of double frequency vector, 186
- Epoch, 6
- Equivalent circuit of transformer, 202
 sine wave in polar diagram, 53
 single-phase circuit of polyphase system, 448
- Excitation of induction generator, 238
- Exciter of induction generator, 238
- Exciting admittance of induction motor, 211
 current of induction motor, 211
 single-phase induction motor, 247
 transformer, 189
- Field characteristic of alternator, 265
- Fifth harmonic, 370
- Five-wire system, efficiency, 466
- Flat top wave, 370
 zero wave, 370
- Foucault currents, 113
- Four-phase system, 397
 wire systems, efficiency, 466
- Frequency, 6
- General wave, symbolism, 379
- Generator, induction, 237
- Harmonics, 7
 caused by arc, 353

- Harmonics of current, 341
 by hysteresis, 116, 358
 by three-phase transformer, 363
 of voltage, 341
 Hedgehog transformer, 189
 Hemisymmetrical polyphase system, 404
 Higher harmonics, *see* Harmonics
 Hysteresis, admittance, 129
 advance of phase, 122, 130
 coefficient, 123
 conductance, 126
 cycle, 115
 unsymmetrical, 135
 dielectric, 150
 dielectric and magnetic, 112
 in line, 174
 loss, 122
 with distorted wave, 377
 power current, 117
 voltage, 123
 Imaginary power, 186
 Impedance, 2, 9
 apparent, of transformer, 201
 of induction motor, 211
 in series with circuit, 69
 series and parallel connections, 55, 59
 in symbolic expression, 35
 synchronous, of alternator, 277
 Independent polyphase system, 397
 Inductance, 3, 9
 factor of general wave, 382
 Induction generator, 237
 machine as inductive reactance, 96
 motor, 208
 on distorted wave, 392
 Inductive devices, starting single-phase induction motor, 246
 line, maximum power, 82
 Inductor alternator, unsymmetrical magnetic cycle, 135
 Influence, electrostatic, from line, 174
 Instantaneous value, 11
 Intensity of wave, 20
 Interlinked polyphase system, 397
 Inverted three-phase system, 398, 408, 413
 efficiency, 466
 Ironclad circuit, 119, 131
 wave shape distortion, 358, 361
 Iron wire and eddy currents, 140
 unequal current distribution, 147
j as distinguishing index, 32
 as imaginary unit, 33
 Joule's law, 1, 5
 Kirchhoff's laws, direct current, 1
 in crank diagram, 22, 60
 in polar diagram, 49
 in symbolic expression, 34
 Lag in alternator, demagnetizing, 260
 of current, 21
 in synchronous motor, magnetizing, 261
 Laminated iron and eddy currents, 138
 Lead in alternator, magnetizing, 260
 of current, 21
 by synchronous condenser, 339
 in synchronous motor, demagnetizing, 261
 Leakage, 112, 151
 currents through dielectric, 152
 in transformer, 189
 of line, 174
 reactance of transformer, 187
 Line capacity, 169
 phase control, 99
 power factor control, 99
 topographic characteristic, 43
 Load curves of synchronous motor, 333
 Magnetic cycle, 114
 hysteresis, 112
 Magnetizing current, 117
 Maximum output of inductive line, 83
 non-inductive circuit and inductive line, 81

- Maximum power of induction motor, 222
 torque of induction motor, 219
 Mean value of wave, 12
 Metering of polyphase systems, 442
 M.m.f., rotating, of polyphase system, 401
 Molecular friction, 112
 Mono-cyclic connection of transformers, 428
 devices, starting single-phase induction motor, 246
 system, 409
 Multiple phase control, 108
 Mutual inductance, 174
 induction, 147
 inductive reactance of line, 174

 Neutral voltage of three-phase transformer, 367
 Nominal generated e.m.f. of alternator, 263, 276, 282
 Non-inductive circuit and inductive line, 79, 81

 Ohm's law, 1
 Open delta transformation, 427
 Oscillating waves, 175
 Output, *see* Power
 of circuit with inductive line, 82, 95
 in phase control, 104

 Parallel connection of admittances, 59
 of resistances and conductances, 54
 operation of alternators, 292
 Parallelogram of sine waves, 22
 in polar diagram, 48
 Peaked waves, 370
 Peaks of voltage by wave distortion, 360, 367
 Permittivity, 152
 of dielectric circuit, 160
 Phase, 6, 20
 advance angle by hysteresis, 122, 130
 Phase characteristic of synchronous motor, 328
 control, 97
 multiple, 108
 difference in transformer, 29
 splitting devices starting single-phase induction motor, 246
 Polar coördinates of alternating waves, 46
 and crank diagram, comparison, 51
 Polarization, 4
 cell as condensive reactance, 96
 Polycyclic systems, 409
 Polygone of sine waves, 22
 in polar diagram, 48
 Polyphase and constituent single-phase circuit, 448
 Power, *see* Output
 characteristics of polyphase systems, 409
 components of current and voltage, 168
 consumption by corona, 165
 as double frequency vector, 180
 factor of arc, 356
 correction by synchronous condenser, 339
 of dielectric circuit, 152
 of general wave, 382
 of induction motor, 234
 phase control, 99
 of general wave, 381
 of induction motor, 216, 222
 loss in dielectric, 157
 of sine wave, 22
 vector denotation, 179
 of wave in polar diagram, 49
 Primary admittance of transformer, 197
 impedance of transformer, 198
 Pulsating magnetic circuit, 135
 wave, 11
 Pulsation of magnetic circuit, reactance and resistance, 342

 Quadrature components of alternator armature reaction and reactance, 282

- Quadrature flux of single-phase induction motor, 245
 Quarter-phase system, 398
 efficiency, 466
 three-phase transformation, 423
 Quintuple harmonic, *see* Fifth harmonic

 Radiation from line, 174
 Ratio of transformer, 197
 Reactance, 2, 9
 effective, 112
 in phase control, 103
 in series with circuit, 63
 in symbolic expression, 35
 synchronous, of alternator, 277
 Reactive component of current and voltage, 168
 power, 180
 with general wave, 382
 Rectangular components, 31
 Reduction of polyphase system to single-phase circuit, 448
 Regulation of circuit with inductive line, 82, 86
 curve of alternator, 290
 Resistance, effective, 2, 5, 9, 111
 of line, 174
 parallel and series connection, 54
 in series with circuit, 60
 in starting induction motor, 224
 in symbolic expression, 35
 Resolution of sine waves, 31
 Resonance of condenser with distorted wave, 387
 by harmonics, 373
 Ring connection of polyphase system, 416
 current in polyphase system, 417
 voltage in polyphase system, 417
 Rise of voltage of circuit by shunted susceptance, 94
 Rotating field of symmetrical polyphase system, 401
 Ruhmkorff coil, 7

 Saturation, magnetic, induction generator, 238
 Saw-tooth wave, 370
 Screening effect of eddy currents, 142
 Secondary impedance of transformer, 198
 Self-excitation of induction generator, 238
 Self-inductance, 174
 Self-inductive reactance of alternator, 261
 of transformer, 187
 voltage, 123
 Series connection of impedances, 55, 59
 of resistances and conductances, 54
 impedance in circuit, 69
 operation of alternators, 294
 reactance in circuit, 63
 resistance in circuit, 60
 Sharp zero wave, 370
 Short circuit of alternator, 273, 288
 Shunted condensance and lagging current, 72
 Silent discharge from line, 174
 Single-phase cable, topographical characteristic, 42
 circuit equivalent to polyphase system, 448
 efficiency, 466
 induction motor, 245
 system, 398
 Slip of induction motor, 208
 Spheres, dielectric field, 164
 Stability of induction motor, 238
 Star connection of polyphase system, 415
 current in polyphase system, 417
 voltage in polyphase system, 417
 Starting devices of single-phase induction motor, 245
 torque of induction motor, 223
 single-phase induction motor, 252
 Susceptance, 55
 of circuit with inductive line, 82

- Susceptance, effective, 112
 Susceptivity, dielectric, 153, 160
 Symbolic expression of power, 181
 Symmetrical polyphase system, 396
 Synchronizing power of alternators, 294
 Synchronous condenser, 339
 converter for phase control, 98
 impedance of alternator, 277
 machine as shunted susceptance, 96
 motor, fundamental equation, 316
 for phase control, 98
 supplied by distorted wave, 389
 reactance of alternator, 262, 272
 watts as torque, 233
 T connection of transformers, 427
 Terminal voltage of alternator, 263
 Tertiary circuit with condenser, single-phase induction motor, 249
 Third harmonic, 369
 in three-phase system, 364
 Three-phase line, topographic characteristic, 43
 quarter-phase transformation, 423
 system, 397
 efficiency, 466
 voltage drop, 41
 transformer, wave distortion, 363
 Three-wire single-phase system, efficiency, 466
 Time constant, 3
 and crank diagram, comparison, 51
 diagram of alternating wave, 48
 Topographic characteristic of cable and line, 42
 Torque as double frequency vector, 185
 efficiency of induction motor, 234
 Torque of induction motor, 216, 219, 223
 single-phase induction motor, 248, 252
 Transformation by two transformers, of polyphase systems, 422
 Transformer, 187
 diagram, 26, 30
 equivalent circuit, 202
 Transmission line, *see* Line
 Treble peak wave, 370
 Triple harmonic, *see* Third harmonic
 True power of generator wave, symbolic, 382
 Unbalanced polyphase system, 397
 quarter-phase system, 463
 three-phase system, 461
 Unequal current distribution in conductor, 144
 Unsymmetrical hysteresis cycle, 135
 polyphase system, 396
 V connection of transformers on three-phase system, 427
 Vector power, 179
 Virtual generated e.m.f. of alternator, 272
 Voltage of circuit with inductive line, 82, 86
 control by shunted susceptance, 89
 by synchronous condenser, 339
 peaks by wave distortion, 360, 367
 phase control, 99
 Y connection of three-phase system, 416
 current in three-phase system, 417
 Delta transformation, 426
 voltage in three-phase system, 417
 Y transformation, 426

✓

~~Electric Engineering~~. 172192 June 31, 1923

Author Steinmetz, Charles Proteus

Title Theory and calculation of alternating current phenomena.

DATE _____

NAME OF BORROWER _____

University of Toronto

**REMOVE
THE
CARD
FROM
THIS
POCKET**

Acme Library Card Pocket
LOWE-MARTIN CO. LIMITED



