

Directions for Using the Attachments for the Wheeler & Wilson No. 9 Family Sewing Machine.

Binder, Ruffler,

Tuck Marker and
Adjustable Hemmer
and Feller,

which is
adjustable for different
widths of Hem or Fell.

Manufactured by the
Wheeler & Wilson Mfg. Co.
Factory and Head Office,
Bridgeport, Connecticut, U. S. A.

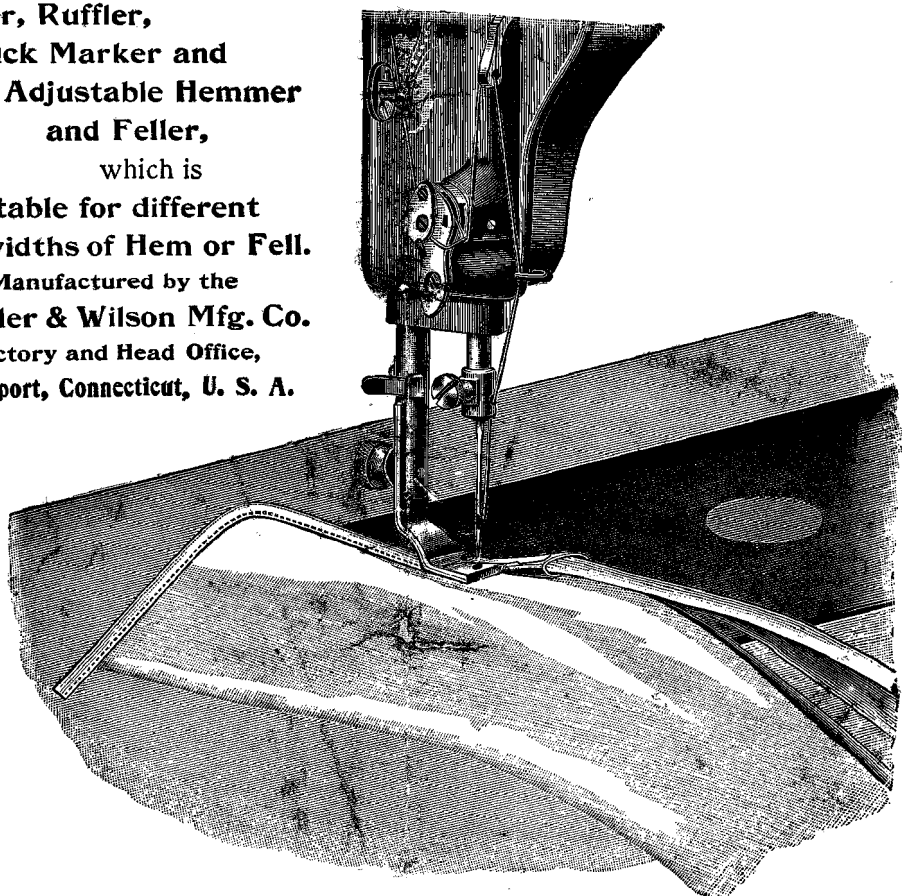

The Binder. Insert the binder in place of the presser-foot.

If bias binding is to be used it must be cut $\frac{7}{8}$ of an inch wide.

Insert the binding through the scroll and pass the edge of the material to be bound between the folded edges of the binding.

If the needle does not stitch the proper distance from the edge of the binding, **loosen the presser-foot thumb-screw** and move the foot to the right or left and re-tighten the screw.

To use the binding for trimming, insert the binding as usual, but let the cloth pass beneath the presser-foot so as to stitch the binding at any distance from the edge, or where you desire to lay the trimming. Lace edging or other trimming may be passed through the folds of the binding at the same time and both be stitched upon the garment. The quilting gauge may be used to lay the rows of trimming equal distances apart.

To use the binder for dress braid, pass the braid through the slot on the back side of the scroll and proceed as usual.

The Wheeler & Wilson Ruffler for the No. 9 Family Sewing Machine.

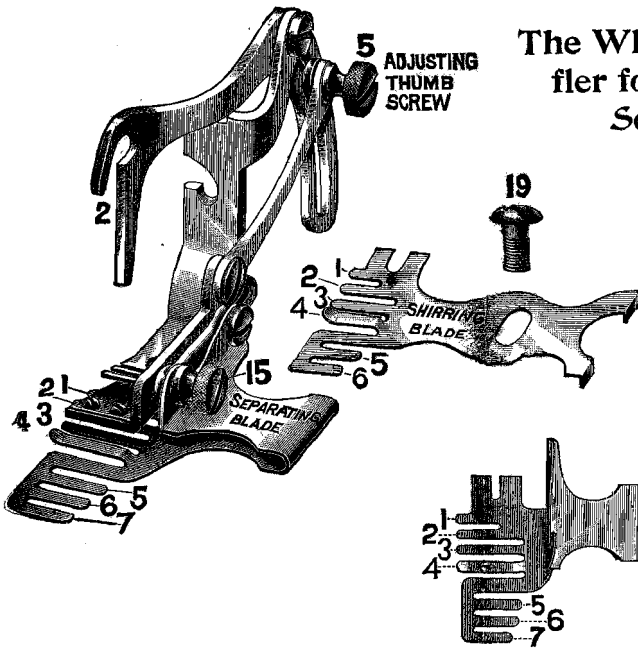

Oil the Ruffler

At all of its joints and friction points, and the long prong where it comes in contact with the needle clamp.

Separating Blade

Removed from the Ruffler with the guide fingers numbered as referred to in directions.

The ruffler is easily attached

removed, if the directions are

To Attach the Ruffler.

Remove the presser foot from the machine. Raise the needle to its highest point. Take the ruffler in the right hand by the adjusting thumb-screw, pass it under the arm of the machine, and pass the forked end of the lever, between the presser-bar and the needle bar and over the neck of the needle set screw, and swing the upright part of the ruffler to the left into the slot in the presser-bar. Let down the lifter. See that the

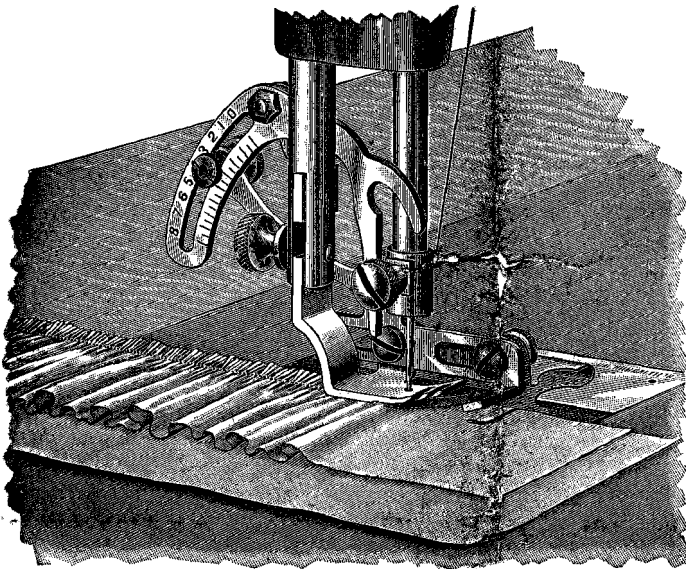

The Ruffler Ruffling, as described in Fig. B.

needle will pass down through the center of the needle hole in the foot as shown in this cut, then tighten the presser-bar screw firmly with the screw driver,

To Remove the Ruffler.

Stop the machine with the needle down through the foot, raise the presser lifter, loosen the thumb-screw, push the ruffler downward to the right and it will fall out; raise the needle to remove it.

In Operating the Ruffler,

Either the separating or the shirring blade should always be used to prevent the feed points from damaging the ruffling blade. Both blades cannot be used at the same time.

The Separating Blade

Can be removed by loosening the thumb-nut (15) at the front of the ruffler and drawing the blade forward.

The Shirring Blade,

Is attached to the bed of the machine by the screw (19) which has a low, flat head that allows cloth to pass over it freely.

In Edge Stitching,

If the needle does not enter the goods at the desired point, loosen the presser bar thumb-screw and move the ruffler a little to the right or left as may be necessary and re-tighten the screw.

The Fullness of the Ruffle

May be increased by moving the adjusting thumb-screw (5) downward on the graduating scale, or by setting the stitch regulator of the machine for a shorter stitch. It may be decreased by the opposite movements.

It is often necessary

To tighten the upper tension when the ruffler is used in order to draw up the thread and make a good stitch.

Directions

For placing the cloth in the guides of the ruffler for doing different kinds of work.

A.

To Place the Cloth to Make a Plain Ruffle.

Pass the strip of cloth which is to form the ruffle under finger No. 4, over the others and back under the ruffling blade, which is the blade having the sharp points, and operate the machine. If a strip of paper is guided between the feed points and the ruffler, it will prevent damage to both by rubbing together and a more regular ruffle can be produced. The paper is easily torn off after stitching it on.

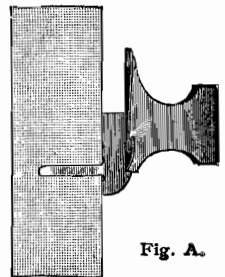

Fig. A.

B.**To Place a Band to which a Ruffle Is to be Stitched.**

Pass the band over finger No. 3 and under the others, then place the strip of cloth which is to form the ruffle as shown in Fig. A. This operation is illustrated in the cut showing "The Ruffler Ruffling."

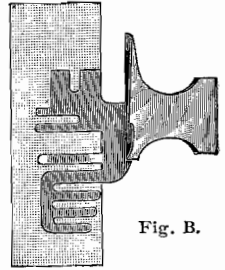

Fig. B.

C.**To Place the Upper Band when a Ruffle is to be Stitched Between two Bands that are Blind Stitched.**

Pass this upper band under the foot and over the blade having the sharp points. The lower band is to be placed as in Fig. B. and the strip of cloth to form the ruffle is to be placed as in Fig. A.

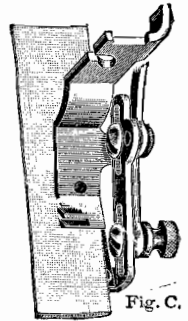

Fig. C.

D.**To Place the Cloth to Form a Narrow Ruffle when the Band is to be Edge Stitched to it.**

The strip of cloth to form the ruffle is to be passed through the ruffler as shown, under finger No. 5 and over the others and under the blade having the sharp points.

N. B. To edge stitch a wide ruffle remove the separating blade and attach the shirring blade, guide the cloth for the ruffle under finger No. 5 of the shirring blade.

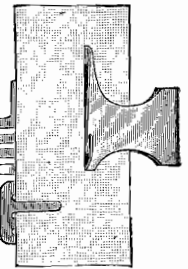

Fig. D.

E.**To Place the Upper Band in the Ruffler when it is to be Edge Stitched to the Ruffle.**

Fold under $\frac{1}{4}$ inch of the edge of the band, pass the folded edge into the guide slot in the foot which is nearest to the needle and back under the foot; also pass in the strips to be ruffled as shown in Fig. D.

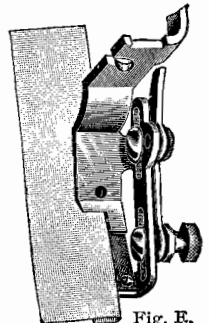

Fig. E.

F.

To Place Piping in the Ruffler to be Stitched Between the Band and the Ruffle.

Fold double a $\frac{1}{2}$ inch strip and pass the folded edge into that guide slot in the foot which is second from the needle and out under the band. Place the strip to be ruffled as in Fig. D. and the band as in Fig. E.

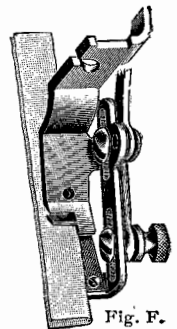

Fig. F.

G.

To Place the Lower Band which is to be Edge Stitched to a Ruffle.

Fold over $\frac{1}{4}$ inch of the band, pass the folded edge over guide finger No. 2 under all the others and have guide finger No. 7 within the fold. Place the strip to be ruffled as in Fig. D. and the upper band as in Fig. E. using piping as in Fig. F., if wanted, producing a ruffle between two edge stitched bands.

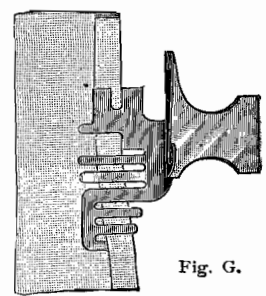

Fig. G.

H.

To Place the Lower Band when it is to be Blind-Stitched and the Upper Band is to be Edge-Stitched.

Place the strip to be ruffled as shown in Fig. D., the upper band as in Fig. E., and pass the lower band over guide finger No. 7 and under all of the others.

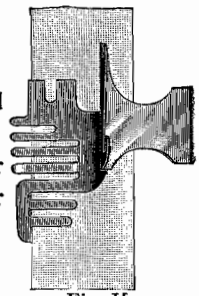

Fig. H.

I.

To Place the Cloth to make Narrow Plaits.

Take an inch strip of Lonsdale cambic and fold it double. Pass the folded edge under guide finger No. 4, over the others and move the adjusting thumb screw down to the lowest position; place the band as in Fig. 2. for edge stitching. Scallops are made by guiding the cambic from right to left alternately.

For Full Ruffles or Small Plaits.

Set the stitch regulating knob so that figure 2 shows at the washer.

Some thicknesses of cloth will work well with a shorter stitch, and some require that the separating blade be moved and set out, leaving a larger opening between the foot of the ruffler and the blade.

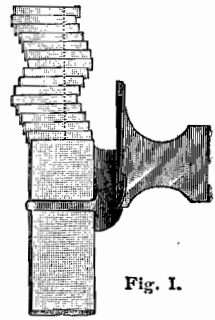

Fig. I.

J.

To Place a Tape in Order to Shirr or Ruffle to it.

Remove the separating blade, attach the shirring blade with the flat-headed screw (19) which allows cloth to pass over it, then pass the tape under guide fingers Nos. 7, 4, 2 and 1 and over the others; crease the cloth to be shirred every three inches or the distance apart that shirrs are wanted, and guide the crease to the needle.

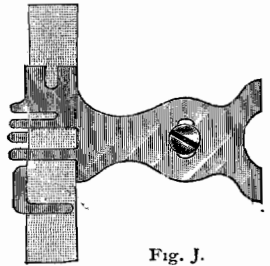

Fig. J.

K.

To Ruffle with a Heading.

Fold the cloth to be ruffled down one inch and guide it into the ruffler between the blades one-half inch from the folded edge. A skirt or waist can be placed under the ruffler and the heading stitched to it.

L.

To sew a Ruffle with a Finished Heading to a Single Band.

Used for silk curtains, lace work and common cloth. Fold $\frac{1}{8}$ of an inch of the band down. Place the band, with the folded edge on the feed, over finger No. 3 and under all others, as shown in Fig. B. Fold $\frac{1}{8}$ of an inch of the ruffle down. Place the ruffle with the folded edge next to the band, under finger No. 4 and over the others, passing it out between the blades, as shown in Fig. A. After ruffling fold back the seam and stitch the folded edge of the ruffle down to the band.

The Tuck Marker.

Fasten the tuck marker to the machine by inserting the foot (1) into the presser bar in place of the regular presser foot, let down the lifter and see that the needle passes down through the middle of the needle hole in the presser foot. Then fasten the thumb screw in the presser bar firmly with the screw driver. Each

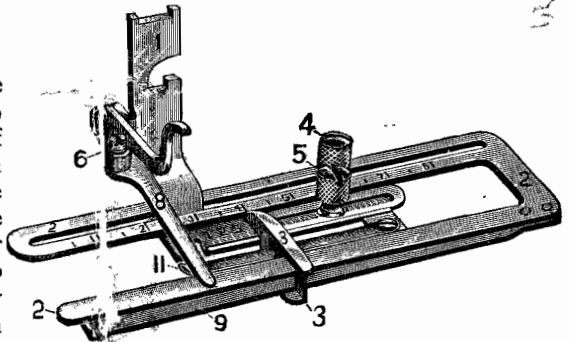
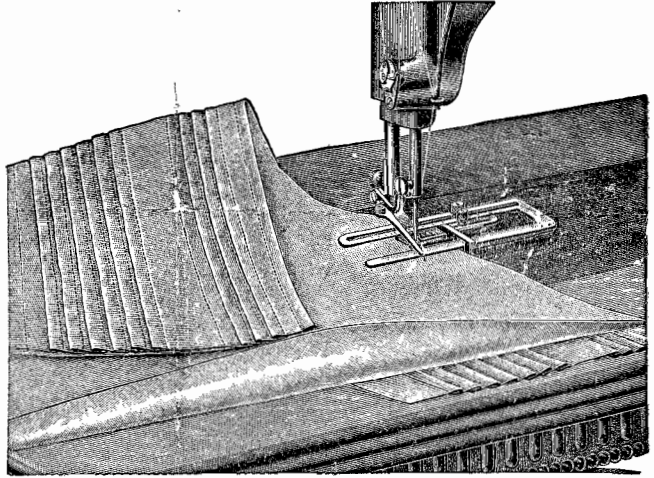

figure on the presser foot scale represents just how many eighths of an inch it is from the needle. The guide (3) can be fastened with thumb screw 5 in line with any one of them and so limit the width of the tuck, or the distance from the edge of the fabric that stitching can be done. The figures on the frame scale (2) represent the distance from the needle to the left, that the marker can be set to make marks or creases for the next tuck, and is secured by thumb screw (4). Ordinarily, when a figure on the frame scale is set in line with the same figure on the foot scale and guide (3) is secured in line with them, the tuck will be as many eighths of an inch wide as the figure on the foot scale represents and the mark or crease for the next tuck will be the distance from the needle which will leave that space between the tucks most frequently desired for the size of the tuck being made. EXAMPLE: Secure the guide (3) in line with figure (2) of the foot scale; and bring figure (2) of the frame scale in line with the guide and figure. This combination will produce a $\frac{1}{4}$ inch tuck and a mark or crease for the next

tuck at the space most frequently used for this sized tuck. If more space is wanted between the tucks, move the frame to the left until $2\frac{1}{2}$ or 3 on the frame scale is in line with the guide. If less space is desired, move the frame to the right and the mark will be made nearer to the needle. If a tuck $\frac{3}{8}$ of an inch wide is wanted, set the guide (3) in line with figure (3) on the foot scale and bring figure (3) on the frame scale in line with them.

To Tuck.

Have the guide (3) set for the desired width of tuck, and the frame (2) set for the proper space between the tucks. Fold the cloth for the first tuck by hand. Place the folded edge under the front of the frame (2) and over the marker (9), under the spring (11), up to the guide (3), back under the presser foot and needle, and let down the presser lifter. In sewing keep the folded edge to the right against the guide (3). For following tucks, fold the goods at the marks or creases made by the tuck marker and repeat the operation. If the mark or crease is not distinct, more pressure can be made (on the marking frame) by turning down (to the right) screw No. 6, or if too heavy for some fabrics it can be decreased by turning it up (to the left).



The Adjustable Hemmer and Feller.

To Hem.

Put the hemmer in the place of the presser foot and have the two threads passed back under the hemmer ready to sew. For an inch or more, fold over $\frac{1}{8}$ of an inch of the edge of the cloth, pass this edge partly under the hemmer and bring it up under the guard into the scroll, up to the indicator as shown in this cut, in order that the stitches will commence at the end of the hem. For a wide hem, if the material is very soft, pass it through the hemmer some distance and draw it back to the proper position. Let down the presser foot and proceed as in ordinary sewing, guiding

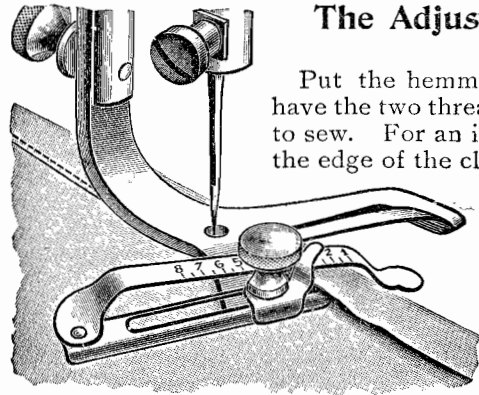

the cloth so that its edge will keep up to the indicator.

To Adjust

For different widths of hem or fell, loosen the thumb-screw and move the guide to the right or left to give the desired width and re-tighten the screw.

When the Presser Bar

Thumb-screw is loose the hemmer can be moved to the right or to the left so that the needle will stitch the proper distance from the edge of the hem or fell.

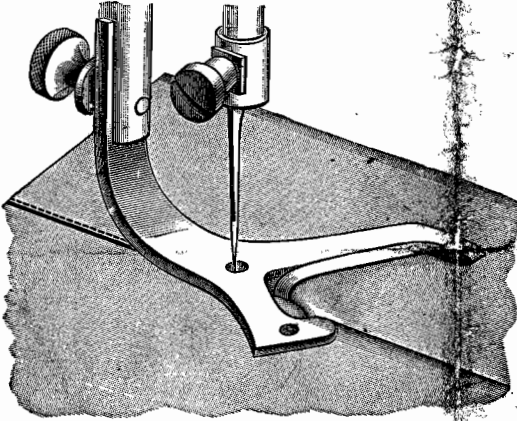

For an extra wide hem remove the thumb-screw and indicator, fold over the cloth for the desired width of hem—turn under the edge for a start and sew as shown in this cut.

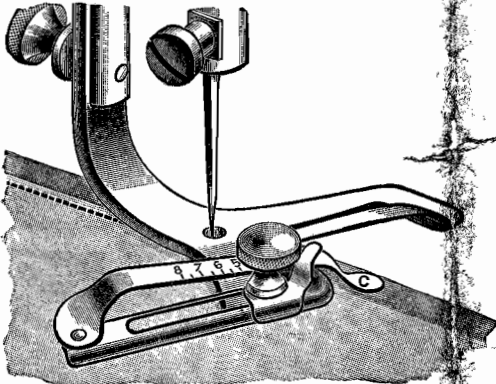

To Fell.

Sew the two pieces of cloth together with the edge of the lower piece even with the outer edge of the guide C., and with the upper piece so placed that the seam will be about $\frac{1}{8}$ inch from its edge, as shown in this cut.

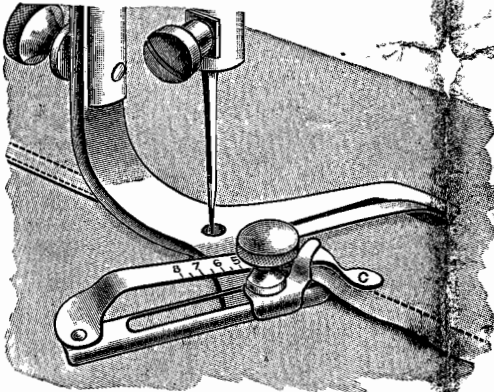

Then spread out the cloth and hem down the wide edge over the narrow one, guide the stitched seam under the inside corner of the guide C. as shown in this cut.

(Thick goods require a wider seam than thin, as more room is needed for the cloth to turn in.)