

# THE WORLDWIDE TV-FM DX ASSOCIATION

Serving the UHF-VHF Enthusiast

THE VHF-UHF DIGEST IS THE OFFICIAL PUBLICATION OF THE WORLDWIDE TV-FM DX ASSOCIATION DEDICATED TO THE OBSERVATION AND STUDY OF THE PROPAGATION OF LONG DISTANCE TELEVISION AND FM BROADCASTING SIGNALS AT VHF AND UHF. WTFDA IS GOVERNED BY A BOARD OF DIRECTORS: TOM BRYANT, GREG CONIGLIO, BRUCE HALL, DAVE JANOWIAK AND MIKE BUGAJ.



Editor and publisher: **Mike Bugaj**

Treasurer: **Dave Janowiak** Webmaster: **Tim McVey**

Editorial Staff: **Steven Wiseblood, Victor Frank, George W. Jensen, Jeff Kruszka, Keith McGinnis, Fred Nordquist, Matt Sittel, Doug Smith, Thomas J. Yingling, Jr. and John Zondlo,**

Our website: [www.anarc.org/wtfda](http://www.anarc.org/wtfda)

ANARC Rep: **Jim Thomas**, Back Issues: **Dave Nieman**

ELECTRONIC EDITION for **DECEMBER 2003**



Finally! For those of you online with an email address, we now offer a quick, convenient and secure way to join or renew your membership in the WTFDA from our page at:

<http://fmdx.usclargo.com/join.html>

Dues are \$25 if paid to our Paypal account. But of course you can always renew by check or money order for the usual price of just \$24. Either way, it's still a bargain!

## The WTFDA TV STATION GUIDE

It's the most comprehensive listing of North American Television stations in print! Just \$23 US will get you one. Mail your check or money order today. Make it payable to Dave Janowiak and mail it to John Ebeling, 9209 Vincent Avenue S., Bloomington, MN 55431-2157. Get your WTFDA TV Station Guide **now** before it goes out of print!

**\*\*ONLY TWELVE LEFT!\*\***



## CONTENTS

|  |    |
|--|----|
| Page Two                               | 2  |
| Mailbox                                | 3  |
| TV News...Doug Smith                   | 5  |
| ATSC Primer Part III...Doug Smith      | 12 |
| Western TV DX...Victor Frank           | 12 |
| Photo News...Jeff Kruszka              | 16 |
| Vacation or DxPedition?? ...Bill Smith | 18 |
| Northern FM DX...Keith McGinnis        | 19 |
| FM News...Steve Wiseblood              | 31 |
| CCI Solutions...Bob Cooper             | 33 |
| Southern FM News...John Zondlo         | 39 |
| Cuban Television...Jesús Perez         | 41 |
| Satellite News...George Jensen         | 42 |

It's the Holiday 2003 issue of the VUD! In this issue we have a short article about DXing (or trying to do some DXing) on Cape Cod brought to you by member Bill Smith.

Bob Cooper wraps up part two of his technical paper on minimizing CCI. This part tells you how to stack antennas.

Doug Smith continues with part three of his ATSC-101 course on digital television.

Oh yes, and if you EVER wanted a calendar with pictures of antenna towers, do we have a calendar for you just in time for 2004!

Happy holiday reading!

## FM ATLAS #19

Bruce Elving's newest listing of FM Stations is just \$23.00. Send your check or money order to FM Atlas, PO Box 336, Esko, MN 55733-9413 and keep it next to your radio or in the glove box of your car!

## Sportsradio!

Jim Thomas tells you who's on what station and when...basketball, football, baseball, hockey, racing...just about everything! Send your check for \$12.00 to WTFDA, PO Box 501, Somersville, CT 06072 (checks payable to Dave Janowiak).

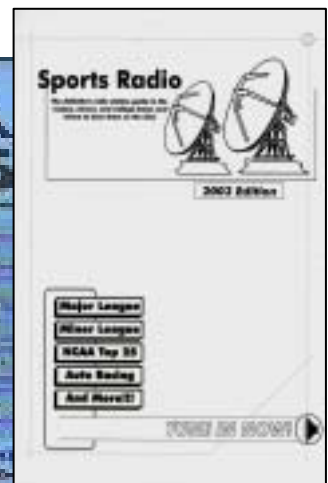
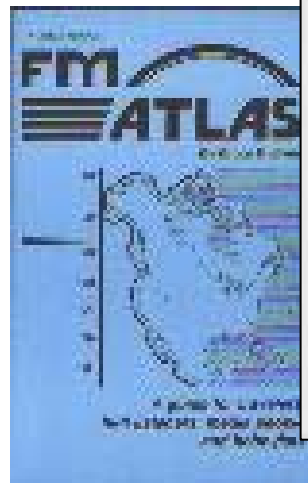



# The Mailbox

P.O. Box 501, Somersville, CT USA 06072  
MIKE BUGAJ MBUGAJ@SNET.NET

---

## DECEMBER 2003

First of all, we wish all of you a very happy and joyous holiday season. We wouldn't want it any other way. And may the year 2004 be good to you all!



Well, what's going on with our sun, eh? The poor thing has been throwing fits lately with sunspots and flares and CMEs being ejected toward our planet. Now we read that the earth's magnetic field is supposedly in the first stages of a polarity shift. Does this mean more Es, less Es or should we just wait for that ship to land on the Washington Monument mall with Klatuu aboard.

Seriously though, the end of October saw some *serious* aurora on FM radio along with *visible* aurora through much of northern North America. One strange occurrence was possible F2 on channel A2 one afternoon by Steven Wiseblood and Danny Oglethorpe. The possibilities were narrowed down to KHON 2 in Honolulu, although no definite ID was possible. But conditions like these just show that strange receptions are possible even in the off-season. And with our sun still acting strangely, more unusual happenings are bound to occur.

## MEMBERS AND MORE

Dues received this month from **Jim Renfrew(NY)**, **Jeff Kitsko(PA)**, **John Jefferson(WA)**, **John Adams(OR)**, **Chester Jaffee(CA)**, **George Hamer(NY)**, **George Greene(OH)**. Just a short list this time as opposed to the long lists in the summer, but the quality of these folks more than offsets the quantity on this list. Thank you all for writing one more check!

Here's one interesting letter received from **Steve McGreevy** in Keeler, CA. Try to find Keeler on a map. I dare you. Steve writes: "It's great to at long last be a member of WTFDA! I wonder why I didn't join the past two decades, as I began FM sporadic-E-skip DXing the summer of 1982. Shel Remington, KH6SR, then living in Fairfax, Calif. played me tapes of his FM dx going back several years and I was astounded! I caught my first

opening on a G.E. Super Radio with a cheap twin-lead folded dipole laying on my bed - catching an opening to Albuquerque, NM late May 1982, and I was hooked. Seeing CCI bars on TV's channel 2-6 and weird ghosting images behind the strong locals in the S.F. Bay Area was also thrilling, and then also began an era of TV dxing, although I generally partake in casual TV dxing to this day while waiting for the MUF to hit FM or just after an opening died away on FM - FM Es is my first love, and I've had the opportunities to DX FM Es in some far-flung areas, such as southern Georgia in the spring and summer of 1990 - hearing Maine all the way to Colorado and lots of Mexican DX as far as Veracruz - an exciting place too for tropo! Tropo is fabulous in Hawaii even though it would take a two-hop opening for any Dx from the mainland to occur, but I did get a chance upon several long stays and a short residency in '86 that tropo between the Islands abounds - Kauai FM signals being surprisingly at times 300 miles away in on the Kona Coast of the Big Island of Hawaii.

In July 1997, I moved to the Owens Valley of eastern California, and now live in the tiny hamlet of Keeler - a town of about 50 people on the eastern edge of dry Owens Lake - the famed lake that Los Angeles drained dry. The FM dial could be considered "empty" by some standards - indeed only two strong signals are on the band here from two 10 watt or less translators 6 miles distant on a mountain top and the rest of the semi-local stations being shadowed by mountains to all 'round. But, while there is almost a total lack of tropo, the main dxing fun besides VERY evident Es openings are aero-scatter and meteor scatter, and finally but a big part - mountain or Knife-edge scatter - the high peaks of the Sierra Nevada Mtns. loom 20 - 30 miles distant, and I am amazed to find hundreds of "hot spots" in the local area favoring one transmitter site or another up and down the Central Valley on the other side of the mountains - sometimes the stations in Modesto are like having local translators. Airplanes skip in Bay area,, Sacramento, down to Tijuana BCN and Las Vegas stations regularly, and meteor showers are a joy - especially the wild Leonids of 2001 - I think I caught 4 station id's on 102.1 that special

night.

E-skip openings are pure fun here, and this past summer was pretty good considering I was away on family visitation and camping trips for three weeks in June and July - I think the opening all across Mexico on July 9th was the most fun. Two years ago - the summer of 2001, it seemed north-east Texas came in time and time again - including one day while I was driving in company Jeep Cherokee on Owens Lake that had a pretty sensitive Christler radio- Dallas Ft. Worth and the entire region of east Texas were in so strongly and steadily that I called my boss on the VHF radio and told him to put his radio on 97.9 Dallas with rock music that he'd like - he totally enjoyed the DX reception, and noticed how jammed up the otherwise generally empty FM dial was. I know of other friends in rural California who have noticed August to be a "bad-reception" time for them to hear 90.9 Klmth Falls 120 miles away because of bursts of other signals - I explained to them what meteors do...

Also in the summer of 2001, while returning from Saskatchewan and Alberta where I recorded natural VLF radio signals deep in the Canadian Boreal Forest (see: [www.spaceweathersounds.com](http://www.spaceweathersounds.com)) in a practically empty-dial location, never hearing e-skip, then on July 10th, while driving through Teton National Park, I'd flicked on the FM radio and surfed the dial, wondering why every madly picket-fencing station seemed to have another with it - and what is SPANISH doing on the FM dial in Wyoming? I pulled over to a picnic area out of the trees and recorded a fine opening from Tijuana to San Luis Obispo, Calif. - I think the first time I'd noticed an opening while driving - oh, wait - friend Gail West and I tuned in 94.1 WOW in Omaha while driving a remote eastern Oregon desert highway in mid-August 1990, and I'd forgotten e-skip can happen later than July... including October (like in '93).

So it is a really fun hobby and amateur science project, and I'm right now, though rather late, my logs from this past summer's Es openings and will e-mail them to the respective column editors, so other members will be able to compare my Es receptions to their own opening patterns." (Nice letter Steve. I think we all at one time or another have wanted to live in a remote area like Keeler, just for the DXing -mike)

### **F2 TO HAWAII, OR ???**

First, **Mike Cherry** posted this on the WTFDA list on October 30th: "There was a VERY rare out-of-season Es2 opening to Hawaii from 0230UTC/1830PST to 0312UTC/1912PDT on 6 meters & I re-logged KHON "Fox 2" Honolulu @ 0300UTC. This is the first time in 35 years of TV DXing that I've

seen Ch 2 Honolulu outside of the summer Es season. Meanwhile, strong Au on 6 meters to usual eastern B.C., Alberta, eastern Wash. & Montana w/ un-ID Au on clear ch 3 with TV VHF antenna pointed northeast." This note prompted **Steve Wiseblood** to post: "Based on what DXers saw yesterday, and the strong reception of HAWAII on 6-meters by HAMS throughout the SOUTH-EASTERN U.S. as well as Danny's (Shreveport) log of the "PEOPLE's COURT" at 1715 CST on Channel-2. I reviewed my notes, and on Chanel-2 at 1715 CST I did see large letters on the screen followed by several sets of smaller letters (perhaps on how to apply to be on the show).

I am sure now, that the large letters that I saw did, in fact, say "PEOPLE's COURT". Apparently because of the smearing and multiple phasing caused by the F2 reception, I thought that I had seen something in Spanish or Portuguese, but the letters were too smeared to actually read. I thought that the format looked somewhat like a tele-novela. The format of the show I saw did, in fact, fit that of PEOPLE's COURT.

Although only TENTATIVE, looks like Danny and I were both receiving Chanel-2 in HAWAII by F2 between 1700-1730 CST yesterday."

**Dan Oglethorpe** responded: "The only station that I can find (so far) on channel 2 in the U.S. that airs "The People's Court" at 1700 \*CT\* is KHON-2 Honolulu. (This is from zap2it; KHON's website is being renovated.) That would be 1 PM there. That would also be about 4,000 miles! I'll watch the other tape and continue to investigate this situation over the weekend. If anybody has any information or suggestions, I would appreciate hearing from them."

So, who knows? Whatever it was, it sure made for an exciting end of October.

### **A NOTE FROM HAVANA**

A short note from **Jesús Perez**: "I have even received the October issue the other day, so thank you very much, yes I realized on how early it arrived. I have enjoyed VERY MUCH reading the Gordon Simkim's article: MY FIRST TV-DX. I liked it so much. I also recall my first DX's on TV when I was a kid, and it was also channels 2 from New York City and Baltimore as E-Skip. My first tropo experiences were Channel 7 and 10 Miami, and Ch-11 Fort Myers and my father built and put up our first antenna which was one double yagi calculated for chs-7 to 13. I have always enjoyed this hobby."

Well, that makes two of us, or better yet, about 280 of us. See you all next month. Have a great New Year! -Mike

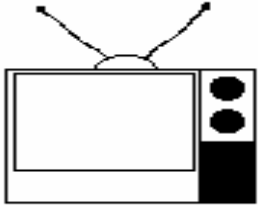

# TV NEWS

**Doug Smith W9WI**  
**1385 Old Clarksville Pike**  
**Pleasant View, TN 37146-8098**  
**w9wi@w9wi.com**

## December 2003

### Abbreviations:

|            |  |            |   |
|------------|--|------------|---|
| <b>#</b>   | License to cover (for changes or new station)      | <b>PC</b>  | channel allotments<br>Power (and/or tower height) change on the air |
| <b>AF</b>  | Applied For (a new station)                        | <b>PG</b>  | Power change granted  |
| <b>aux</b> | Auxiliary (backup) transmitter                     | <b>PR</b>  | Power change requested  |
| <b>CC</b>  | Call Change  | <b>QC</b>  | Channel ("frequency"?) change on the air                            |
| <b>CL</b>  | City-of-license change                             | <b>QG</b>  | Channel change granted  |
| <b>DE</b>  | Station deleted                                    | <b>QR</b>  | Channel change requested  |
| <b>FC</b>  | Programming ("format") change                      | <b>RA</b>  | Returned to the air   |
| <b>FTP</b> | Failure to Prosecute (an application)              | <b>ROA</b> | Request of applicant  |
| <b>GA</b>  | Granted Amendment (to table of channel allotments) | <b>SI</b>  | Off the air ("silent"?)   |
| <b>LC</b>  | License to Cover                                   | <b>STA</b> | Special Temporary Authorization                                     |
| <b>NO</b>  | Not on the air                                     | <b>XC</b>  | Transmitter site change on the air                                  |
| <b>NS</b>  | New station granted permit                         | <b>XG</b>  | Transmitter site change granted                                     |
| <b>NW</b>  | New station on the air                             | <b>XR</b>  | Transmitter site change requested                                   |
| <b>PA</b>  | Proposed Amendment (to table of                    |            |   |

### News:



#### USA:

##### Alaska:

Anchorage 41K41DP PG>34.5kw, 61-20-11/149-30-48; already on

**Fairbanks 26KTVF-DT NW 12kw/-11m**

Homer 9K09XO NW 3kw, 59-27-17/151-40-18 (KYES-5 UPN)

Ketchikan 41K41IE NS 150kw, 55-20-22/131-38-12

Kodiak 17K17GQ NS 10.3kw, 57-47-03/152-23-57

##### Alabama:

**Anniston 9WJSU-DT PA from ch. 58**

Berry 51WSFG-LP QR from ch. 63, 19.4kw

**Montgomery 14WAIQ-DT PR>425kw dismissed**

Montgomery 61WFRZ-CA CC from W61DH

##### Arizona:

Camp Verde 47K47IK QC from K11MI, 80w

Flagstaff 48K48GI QC from ch. 26, 1.44kw

Flagstaff 50K50HU QC from K64BI, 1.04kw

Globe 57K57BO FC; sold to KTVK-3

**Green Valley 46KUIV-TV CC from KXGR**

Klagetoh 43K43GQ QC from K68BL, 220w

Lake Havasu C. 10KBBA-LP CC from K10OS

Peach Spring 28NEW-LP AF dismissed

Phoenix 19KPHE-LP NW 13.8kw, 33-19-58/112-03-53; "Bohemian Music Videos"

Phoenix 27KAZT-CA PR>34kw, 33-20-02/112-03-41; already granted & on the air

Phoenix 43K43GV QC from ch. 31; 13kw; DTV? // KPHE-LP 19

**Phoenix 45KUTP AF 2473kw/502m (aux)**

Prescott 35K35HA NS 3.9kw, 34-29-25/112-32-00 (TBN)

Prescott 53NEW-LP AF dismissed

Quartzsite 20NEW-LP AF dismissed

Quartzsite 42NEW-LP AF dismissed

Tecna 56NEW-LP AF dismissed

**Tucson 23KVOA-DT PR>650kw/1122m**

Tusayan 33NEW-LP AF dismissed

Williams 43K43IE QC from K25DP, 1.62kw

Williams 53K53GM QC from K60ED, 1kw, 35-12-01/112-12-15

**Arkansas:**

**El Dorado 43KEJB NW 5000kw/530m, 33-04-41/92-13-41 (UPN)**

**Hot Springs 20960520KE NS 5000kw/345m, 34-33-56/93-05-03 (2nd Baptist Church)**

Searcy 43K12MY QR from ch. 12, 150kw, 35-22-53/91-31-30; CL from Batesville; QR to ch. 54, 1kw

Sheridan 47KWBF-LP QC from ch. 5, 104.6kw, 34-30-27/92-32-48

**California:**

Bakersfield 11K14IK QC from ch. 14, 3kw, 35-26-17/118-44-22; CL from Delano

**Bakersfield 25KGET-DT NW 135kw/405m**

Barstow 28K28IE AF dismissed but reinstated & granted, 30kw, 34-50-59/117-03-04

Barstow 29NEW-LP AF dismissed  
Big Bear Lake 6K06MU PC>1kw, 34-14-24/116-54-47

Calexico 18K36FO QR from ch. 36 dismissed

Chico 57NEW-LP AF 5kw, 39-43-15/122-20-24 dismissed but reinstated

Cloverdale 36KTVJ-LP PR>50kw, 38-30-31/122-39-41; already granted; CC from K36GG

Coalinga 42K42DT PG>150kw, 36-22-08/120-38-34

**Corona 39KVEA-DT NW 54kw/912m, 34-12-48/118-03-41**

**Fort Bragg 8KUNO-TV CC from KFWU**  
**Fresno 34KGPE-DT NW 185kw/577m**  
Fresno 46K56DZ QR from ch. 56, 10kw  
Lancaster 50KTRO-LP PC>26kw, 34-32-50/118-12-57

**Los Angeles 11KTTV NS 156kw/921m, 34-13-27/118-03-45 (aux)**

**Monterey 32KION-DT NW 46kw/758m**  
Porterville 31KKAK-LP QC from ch. 20, 38.2kw

Redding 2K56ID QR from ch. 56, 410w, 40-39-19/122-31-22

Redding 29K29FZ NS 160w, 40-39-15/122-31-12

Redding 56K56ID NS 630w, 40-31-10/122-41-30 -- see ch. 2

**Sacramento 3KCRA-TV PR>600m, drop DA**  
Sacramento 45K45HC QR from K69FB, 150kw, 38-15-54/121-29-24; already granted

**Salinas 13KCBA-DT NW 19.75kw/720m**  
**San Mateo 43KCSM-DT NW 536kw/428m, 37-45-19/122-27-06**

Santa Clara 22KAXT-CA PC>56kw  
Santa Rosa 25K30DO QC from ch. 30  
**Santa Rosa 54KFTY-DT NW 30kw/928m**  
S. Lake Tahoe 12K12PP NW 50w, 39-04-57/120-10-28 (KRXI-11 Fox)

**Vallejo 40NEW AF dismissed**  
**Vallejo 66KFSF XC 37-45-19/122-27-16**

**Colorado:**  
Basalt 36K36GX NS 2.104kw, 39-21-10/107-06-06

Carbondale 38K38FO XR 39-25-21/107-22-31

Cortez 46K64FF QR from ch. 64, 1.64kw, 37-21-54/108-08-51; CL from Towaoc

**Denver 16KUSA-DT PG>1000kw/318m, 39-43-51/105-13-54**

**Denver 17KMGH-DT PG>1000kw/295m, 39-43-51/105-13-54**

**Denver 19KTVD-DT PG>1000kw/295m, 39-43-51/105-13-54**

**Denver 35KCNC-DT PG>1000kw/373m, 39-43-51/105-13-54**

Denver 66K66FB PC>47.3kw  
Fort Collins 39K35EQ QR from ch. 56; CL from Estes Park

Pinewood 44K08IV QC from ch. 8, 700w, 39-45-54/105-32-32

Vail 45NEW-LP AF dismissed

Yuma 42K42GI NS 2.685kw, 40-08-35/102-48-51

**Connecticut:**  
**Hartford 45WEDH-DT QR from ch. 32, 465kw/517m, 41-42-13/72-49-57**

**Norwich 32WEDN-DT QR from ch. 45, 500w/192m**

**District of Columbia:**  
**Washington 20WDCA NS 957kw/207m, 38-57-22/77-04-59 (aux)**

Washington 23WKRP-LP PC<2.2kw, 38-56-09/77-04-26

Washington 47WMDO-CAQC from ch. 48, 10kw

**Florida:**  
**Cocoa 52WTGL-TV PG 2500kw/514m, 28-35-12/81-04-58**

**Jacksonville 19WTEV-DT NW 1000kw/291m, 30-16-51/81-34-12**

**Jacksonville 32WAWS-DT NW 1000kw/291m, 30-16-51/81-34-12**

Jupiter 53WWJV-LP CC from W53BS  
Lake City 15W66CQ QR from ch. 66, 150kw, 30-12-49/82-39-01

**Leesburg 45WLCB-TV PG>5000kw/472m, 28-35-12/81-04-58**

Marathon 24WVFW-LP CC from W24CA  
**Miami 26WPXM-DT NW 200kw/282m, 25-59-09/80-11-37**

Naples 43WWDT-CAPG>144kw, 26-30-18/81-51-14

Rock Harbor 30W64AN QR from ch. 64 dismissed

Tallahassee 45WVUP-CA PG>150kw, 30-34-27/84-12-09

West Gate 16W67AP QC from ch. 67, 115kw, 25-59-35/80-10-26; CL from Rock Harbor

**W.Palm Beach 55WPTV-DT NW 900kw/387m**

**Georgia:**  
Augusta 49WBPI-LP XR 33-30-53/81-56-23 (correction to previous app which specified 91-56-23 in Arkansas)

**Perry 32WPGA-DT NW 18kw/185m**  
**Thomasville 46WCTV-DT PG<265m, 30-34-27/84-12-09**

**Hawaii:**  
**Waimanalo 56KMGT NW 83.2kw/632m, 21-19-49/157-45-24**

**Idaho:**  
Arco 39NEW-LP AF dismissed  
Arco 48NEW-LP AF dismissed  
Driggs 42NEW-LP AF dismissed  
Driggs 44NEW-LP AF dismissed  
Idaho Falls 52NEW-LP AF dismissed  
Idaho Falls 52K52IT AF 25kw, 43-29-30/112-02-53 dismissed, reinstated & granted

**Pocatello 38NEW-DT PA by KFXP-31**  
Pocatello 45NEW-LP AF dismissed



Preston 44K44HA NS 1.8kw, 41-53-00/  
112-04-42; already on  
Preston 48K48IJ NS 1.8kw, 41-53-00/  
112-04-42; already on  
Sandpoint 16K16EN QC from K64BD  
**Twin Falls 22KIPT-DT NW 50kw/182m**  
Twin Falls 38KTFT-LP PR>150kw  
Twin Falls 58KTID-LP PC<15kw

**Illinois:**

Chicago 23WFBT-CA PG>51kw  
**Jacksonville 15WSEC-DT NW 75kw/295m,**  
**39-36-09/90-02-47**  
**Macomb 21WMEC-DT NW 75kw/131m,**  
**40-23-54/90-43-55**  
**Moline 38WQAD-DT NW 1000kw/334m**  
Quincy 38W38DM PR>49.9kw, 39-48-10/  
91-15-49  
Rochelle 55W55DF PG>85kw, 41-52-33/  
88-45-16

**Indiana:**

**Bloomington 48WTTV-DT PA from ch. 53**  
**Fort Wayne 24WPTA-DT NW 335kw/224m**  
**Indianapolis 45WXIN-DT PC>700kw**  
**Muncie 52WIPB-DT PR>140kw/246m,**  
**40-05-37/85-23-32**  
**Terre Haute 38WBAK-TV XC 39-13-55/87-23-41**

**Iowa:**

**Des Moines 43960508KE NS 5000kw/525m,**  
**41-47-47/93-36-39**  
**(IPBB // KDIN)**  
**Des Moines 56960117KE PR<589m**  
Ottumwa 21K21EM PR>150kw  
Ottumwa 53K53FC PG>150kw, QG from  
minus offset to zero  
Ottumwa 65K65GA PG>150kw  
Spencer 65KIAT-LP CC from K65HI  
Storm Lake 53KMWT-LP CC from K53HW  
**Waterloo 22KWWF NW 500kw/28m,**  
**42-29-51/92-20-07;**  
**PG>3000kw/198m,**  
**42-24-53/92-00-34**

**Kansas:**

Hays 27NEW-LP AF dismissed  
**Hutchinson 29KPTS-DT LC DISMISSED**  
**Pittsburg 14KFJX NW 5000kw/163m,**  
**37-13-15/94-42-22**  
**(Fox)**

**Louisiana:**

**Baton Rouge 34WVLA-DT NW 1kw/31m,**  
**30-22-40/91-05-49**  
**Baton Rouge 45WGMB-DTNW 1000kw/424m**  
**Lafayette 16KADN-DT NW 1kw/67m,**  
**30-13-18/92-03-50**  
**Lafayette 28KATC-DT NW 10.8kw/41m,**  
**30-13-25/92-03-20**  
**New Orleans 15WGNO-DTNW 870kw/309m**  
**New Orleans 40WNOL-DT NW 500kw/312m,**  
**29-58-57/89-56-58**

**Maine:**

Biddeford 26WMEA-TV PG<133kw/231m  
**Presque Isle 16WAGM-DTNW 3kw/333m**

**Maryland:**

Annapolis 22WMPT PC>273m, DA  
**Annapolis 42WMPT-DT NW 150kw/289m**  
**Baltimore 29WMPB-DT NW 14kw/309m,**  
**39-26-50/76-46-48**  
**Hagerstown 44WWPB-DTNW 209kw/359m**

Pocomoke 17NEW-LP AF dismissed  
City  
Salisbury 32NEW-LP AF dismissed  
**Salisbury 56WCPB-DT NW 130kw/157m**  
Salisbury 61W61DS PG>150kw, 38-39-48/  
75-50-09;  
XR 38-26-02/76-27-00

**Massachusetts:**

**Boston 43WGBX-DT NW 500kw/391m**  
Boston 67WTMU-LP PG<24.5kw  
**Norwell 52WWDP-DTNW 337kw/216m,**  
**42-00-45/71-05-39**  
**Vineyard Haven 58WDPX PC>1665kw/153m**

**Michigan:**

**Battle Creek 20WOTV-DT NW 270kw/311m**  
**Bay City 46960710KZ QR from ch. 61,**  
**281m, 43-26-07/84-26-**  
**12**  
**Kalamazoo 5WGVK-DT PR<2.5kw, DA**  
Lansing 27W69BJ QC from ch. 69, 8.5kw,  
42-43-16/84-33-01  
**Lansing 53WLAJ PC<1410kw**  
Pinconning 44W44BO NW 250w, 43-50-46/  
84-05-32  
**Sault Ste. Marie 9WGTQ-DT PR<24kw/288m**  
Traverse City 12WLLZ-LP NW 70w, 44-45-22/  
85-40-42  
Traverse City 54W54CR PC>30.45kw

**Minnesota:**

Alexandria 18K18DG FC to KARE (11 NBC)  
Alexandria 21K21GN Off?  
Alexandria 36K36AA Off?  
Alexandria 44K44GH Off?  
Alexandria 55K55ID FC to Great American  
Country  
Alexandria 60K60EJ FC to Good Life TV  
Alexandria 62K62AU Hallmark Channel  
**Bemidji 18KAWE-DT NW 80kw/303m**  
Brainerd 48K48IF QC from K28DF,  
1.14kw  
**Crookston 16KCGE-DT NW 105kw/220m,**  
**47-58-38/96-36-18**  
**(KBME-3 PBS)**  
Duluth 50NEW-LP AF dismissed  
Duluth 51W51DN NS 7kw,  
46-47-20/92-07-28  
Frost 23K23FY NW 1.35kw, 43-35-09/  
93-55-46  
Frost 23K23FY PG<1.35kw  
**St. Cloud 40KPXM-DT NW 1000kw/430m**  
St. James 49K49HE PR>650w;  
NW, 44-06-28/94-35-  
55  
Virginia 47K47IR NW 15.6kw, 47-29-18/  
92-31-12 (KQDS-21)  
Walker 65K65DT FC to KMSP-9 (Fox)

**Mississippi:**

**Biloxi 16WMAH-DT NW 150kw/477m,**  
**30-45-18/88-56-44**  
**Biloxi 19WMAH-TV PG<1593kw/476m,**  
**30-45-18/88-56-44**  
Bruce 65NEW-LP AF dismissed  
**Clarksdale 21960919KK NS 759kw/94m, 34-**  
**09-22/90-37-52 (MS**  
**ETV)**  
Greenwood 33NEW-LP AF dismissed

Jackson 10WBMS-CA PC>3kw, QC from + offset to zero

**Tupelo Vicksburg** 49NEW PA from ch. 35  
35WUFX NW 5000kw/253m, 32-19-35/90-37-03; Fox for Jackson

**Missouri:**

Columbia 42K38DA NS 1kw, 39-04-25/92-15-05

**Kansas City** 41KSHB-TV PC<306m, 38-58-42/94-32-02

**Kansas City** 42KSHB-DT NW 450kw/276m, 38-58-42/94-32-02

St. Louis 33K18BT QC from ch. 18, 10kw

**Montana:**

Big Arm 3K03DJ PR>150w  
Bozeman 34K34FI FC? sold to KECI-13  
**Butte** 24KBTZ NW 330kw/570m, 46-00-24/112-26-30

Deer Lodge 22NEW-LP AF dismissed  
Elmo 39K11RX QR from ch. 11, 250w  
Finley Point 30K06MQ QR from ch. 6, 250w  
Great Falls 28NEW-LP AF dismissed  
Great Falls 34NEW-LP AF dismissed  
Kalispell 42KTMF-LP QG from ch. 59  
Lewistown 8NEW-LP AF dismissed  
Polson 34K10LP QR from ch. 10, 250w  
Poplar 57K57JG NS 910w, 48-17-28/105-15-09

White Sulphur Springs 7K07NU PR>60w, 46-27-44/110-51-22 dismissed but reinstated

Whitehall 40K40HL AF 374w, 45-55-15/112-01-15 dismissed but reinstated & granted

**Nebraska:**

Blair 24K68AV QR from ch. 68  
Decatur 34K66AR QR from ch. 66  
**McCook** 12KSNK-DT NW 13.6kw/177m  
McCook 38KPCI-LP CC from K38HI  
Neligh 50K65AT QR from ch. 65, 1.1kw  
Niobrara 14K69BM QR from ch. 69  
**Norfolk** 16KXNE-DT NW 200kw/253m  
Norfolk 57KPTP-LP CC from K57IY  
**Scottsbluff** 16KTUW NS 2559kw, 41-50-23/103-49-35

**Scottsbluff** 4KDUH-TV PC<446m, 41-50-28/103-04-27

Wauneta 20K69BN QR from ch. 69

**Nevada:**

Deeth 41K41DL PC>920w  
Ely 16NEW-LP AF dismissed  
Ely 18NEW-LP AF dismissed  
Golconda 26K26GG QC from K67FU  
Golconda 31K31FU QC from K59DS  
Golconda 33K33GB QC from ch. 64, 1.7kw  
Hawthorne 33K33GZ NW 890w, 38-27-37/118-45-39

Las Vegas 17KEEN-LP FC; sold to religious organization

Mina-Luning 18K18GG NW 470w, 38-23-40/118-03-00

Quinn River 40K40FV QC from K69BJ, 760w  
**Reno** 9KOLO-DT NW 15.6kw/893m  
Stateline 59K59GM PC>8kw  
Valmy 27K27GG QC fm. K69CC, 1.13kw

Valmy 29K29EV QC from K65BL, 1.13kw

Valmy 34K34FP QC fm. K63BH, 1.13kw

Walker Lake 6K06NQ NW 400w, 38-36-27/118-34-28

Winnemucca 21K21FO QC from K55CX, 1.49kw

Winnemucca 23K23FR QC from K57CO, 1.49kw

**New Hampshire:**

**Concord** 33WPXG-DT NW 100kw/344m

**New Jersey:**

Cherry Hill 42NEW-LP Application for review of dismissal of AF denied.

**New Mexico:**

Albuquerque 36KTVS-LP QC from ch. 59, 30kw  
Artesia 34K34HG NS 15kw, 32-49-47/104-24-20

Aztec 44K61BO QC from ch. 61, 1.12kw, 36-48-38/107-53-52; CL from Bayfield, CO

Carlsbad 12KPAG-LP CC from K12PK  
Carlsbad 36K36GD NW 10kw, 32-24-16/104-11-13; TBN

Colfax 30K57AB QC from ch. 57, 12.7kw

Cuba 34K34HF NS 2.23kw, 36-00-48/106-50-38 (KNME-5 PBS)

Lordsburg 40K40HJ NS 279w, 32-19-40/108-43-36 (KASA-2 Fox)

Tres Piedras 28K53BA QC from ch. 53, 990w

**New York:**

Brooklyn 3W38CL PR<750w, 40-44-46/73-58-52; CL from Bronx

**Garden City** 22WLIW-DT NW 92kw/111m  
**Kingston** 48WRNN-DT NW 750kw/378m, 41-29-18/73-56-56

**North Pole** 14WPTZ-DT PG>650kw/842m, DA  
Philadelphia 54NEW-LP AF dismissed  
**Poughkeepsie** 27WTBY-DT NW 800kw/358m, 41-29-20/73-56-53

**North Carolina:**

Asheville 64WAEN-LP XC 35-27-40/82-21-27  
Smithfield 34WARZ-LP PR>70kw  
Tryon 19W24BA QC from ch. 24, 1.23kw

**Wilmington** 3WWAY PC<565m  
**Wilmington** 46WWAY-DT NW 800kw/590m

**North Dakota:**

Devils Lake 33K30FU QC from ch. 23, 13.2kw

**Fargo** 44KVLV-DT PA from ch. 58  
Minot 21K21GQ NW, 10kw, 48-09-48/101-17-55; Church Channel

**Minot** 40KSRE-DT NW 146kw/249m, 48-03-02/101-23-25

**Minot** 45XMC-DT NW, 50kw/249m

**Ohio:**

**Alliance** 46WNEO-DT NW 400kw/223m

**Cleveland** **34WQHS-DT NW 525kw/334m, 41-22-58/81-42-07**  
 Defiance 26WDFM-LP QC from ch. 19, 7.5kw  
 Kirtland 38W51BI QR from ch. 51, 18.8kw  
 Lima 16WLMO-LP QR from ch. 65, 15kw dismissed, Canadian objection

**Toledo** **17WTOL-DT NW 735kw/263m**  
 Toledo 22W22CO QR from ch. 68, 1kw, 41-39-22/83-26-41 dismissed, Canadian objection

**Toledo** **29WGTE-DT NW 49.5kw/313m**

**Oklahoma:**  
 Lawton 30K30HP NS 10.91kw, 34-35-31/98-32-56  
 Lawton 38K38GL QC from ch. 15, 53kw  
 Lawton 64K64GJ NS 21.83kw, 34-35-31/98-32-56  
 Oklahoma City 19KUOT-CA CC from KKCC-LP

**Oregon:**  
**Coos Bay** **22KMTZ-DT NW 10kw/179m**  
**Medford** **38KDRV-DT NW 38.9kw/819m**  
 Newberg 51KOXO-CA PC<118kw, 45-29-24/122-41-53

**Portland** **6KOIN PR<491m**  
 Redmond 25K25GA NW 11.8kw, 44-26-07/120-57-10; HSN

**Salem** **33KWBP-DT NW 750kw/523m, 45-30-58/122-43-58**  
 Terrebonne 48K48BL FC; country videos  
 Warm Springs 28NEW-LP AF dismissed

**Pennsylvania**  
 :  
**Harrisburg** **10WHTM-DT PG 16.2kw/311m**  
**Jeannette** **19WNPA PC>340m, 40-10-52/79-07-46**  
**Johnstown** **34WJAC-DT NW 250kw/383m**

**Rhode Island:**  
**Block Island** **17WPXQ-DT PR 1000kw/228m, 41-29-41/71-47-06**

**South Carolina:**  
 Charleston 20W21BX QR from ch. 21, 18.7kw  
 Myrtle Beach 41W49AN QR from ch. 49, 50kw, 33-35-28/79-02-55

**Spartanburg** **53WSPA-DT PC>875kw/657m**  
**Sumter** **27WRJA-TV PR<647kw**  
**Sumter** **28WRJA-DT PR>98.4kw/364m; already granted**

**South Dakota:**  
 Pierre 27K27HJ NW 11.6kw, 44-18-42/100-21-09 (KDLV-5 NBC)  
 Rapid City 27KWBH-LP CC from KZWB-LP  
**Sioux Falls** **36KWSD CC from KAUN**  
 Sioux Falls 42KAUN-LP CC from KXWB-LP  
**Vermillion** **34KUSD-DT granted DA**

**Tennessee:**  
 Acton 66W66CG PG>150kw  
 Jackson 38W38BY PG>150kw  
 Jackson 52W52CZ PG>150kw  
 Jackson 54W54BU PG>150kw  
 Jackson 64W64BZ PG>150kw

**Knoxville** **7NEW-DT PA**  
**Lebanon** **44WJFB-DT NW 10.65kw/161m**  
 Lenoir City 24WDTT-LP QG from ch. 38, 7.51kw, 35-59-44/83-57-23

**Memphis** **10WKNO PC<324m**  
 Memphis 19WJRJ-LP PR>55kw, 35-08-41/90-02-57  
 Union City 26WUWT-CA PR>150kw

**Texas:**  
 Abilene 60NEW-LP AF dismissed  
**Alvin** **36KFTH-DT NW 135kw/579m, 29-34-15/95-30-37**

**Austin** **42KEYE-TV PC>5000kw/380m, 30-19-19/97-48-12**

**Baytown** **41KAZH-DT NW 125kw/553m, 29-34-15/95-30-37**

**Beaumont** **50KBMT-DT NW 10.5kw/33m, 30-04-24/94-08-01**  
 Beaumont 53K53II NS 100kw, 30-10-17/94-12-57

**Belton** **38KNCT-DT NW 200kw/393m, 30-59-08/97-37-51**  
 Big Spring 44NEW-LP AF dismissed  
 Big Springs 21NEW-LP AF dismissed  
 Big Wells 35NEW-LP AF dismissed  
 Big Wells 36NEW-LP AF dismissed  
 Big Wells 40NEW-LP AF dismissed  
 Big Wells 42NEW-LP AF dismissed  
 Big Wells 44NEW-LP AF dismissed  
 Big Wells 51NEW-LP AF dismissed

**Conroe** **49KPXB PR>589m, 29-34-15/95-30-37**  
 Corpus Christi 61KCCZ-LP CC from K61HH  
 Crockett 65K65HK NS 150kw, 31-14-39/95-19-53

**Dallas** **14KERA-DT NW 475kw/500m**  
**Decatur** **29KMPX PG>5000kw/544m, 32-35-19/96-58-05; FC to Spanish indep. organization**

**Denton** **2KDTN**

**Fort Worth** **47KUVN-CA QC from ch. 31, 16.2kw**  
 Gainesville 69KBFW-LP CC from K69IL  
**Houston** **26KRIV AF 224kw/526m, 29-34-34/95-30-36 (aux)**

**Houston** **31KHOU-DT NW 759kw/551m**  
 Houston 43KHLM-LP PC>80.1kw, 29-48-18/95-12-18; FC to Bohemian Music Videos

**Katy** **52KNWS-DT NW 12.5kw/308m**  
 Kerrville 15KVHC-LP PG<7.71kw  
**Longview** **38KCEB GA from ch. 54**  
 Midland 21K21GU NS 10kw, 31-57-48/102-02-17  
 Midland 34K34HH NS 50kw, 32-08-47/102-04-23

**Odessa** **4K04PU NS 900w, 31-55-06/102-22-06**

**Odessa** **9KWES-TV PR>391m, 31-59-17/102-52-41; drop DA**

**Odessa** **38KOCV-DT NW 500kw/80m**  
 Odessa 46K46HN NS 50kw, 31-53-28/102-15-45

**Pecos** **54NEW-LP AF dismissed**  
**Ranger** **44NEW-LP AF dismissed**  
**San Angelo** **3KSAN-TV CC from KACB-TV**  
 San Angelo 49K49HS NS 30kw, 31-35-21/100-31-00; one competing app dismissed



**San Antonio 23KHCE PC>2032kw/327m, 29-17-24/98-15-20**  
San Antonio 14K57GO PC>53.1kw, 29-26-29/98-30-22  
Sweetwater 27NEW-LP AF dismissed  
Sweetwater 41NEW-LP AF dismissed

**Utah:**  
Antimony 42K42FB QC from K54CO, 720w, 38-10-57/112-02-25  
Antimony 44K44GA QC from K56AZ, 720w, 38-10-57/112-02-25  
Beaver 24K24FE QC from K69EW, 960w, 38-31-05/113-17-03  
Blanding 43K43IN NS 300w, 37-50-22/109-27-41  
Bloomington 22KUWB-LP QC from ch. 65, 790w  
Brian Head 43K43IO NS 75w, 37-41-25/112-49-45  
Cedar City 2K02NU PC>1.78kw  
Cedar City 39K39FQ QC from K22EK  
Cedar City 41K41GE QC from K24DC  
Delta 41K41GH QC from K40DR, 2.63kw  
Delta 43K43GN QC from K66EH, 2.6kw  
Fish Lake 13K13YL NS 4w, 38-31-13/111-43-29  
Garfield Co. 16K16EQ QC from K59AK, 1.38kw  
Garfield Co. 18K18FT QC from K61AH, 1.36kw  
Garfield Co. 20K20GE QC from K63AG, 1.36kw  
Garfield Co. 22K22FT QC from K65AL, 1.3kw  
Garfield Co. 24K24FD QC from K25OC, 1.3kw  
Garfield Co. 26K26GD QC from K27CE, 1.36kw  
Garfield Co. 28K28GM QC from K67BT, 1.38kw, 38-32-10/112-04-19 (old ch. 67 coords 112-41-19 probably a typo)  
Garfield Co. 30K30GA QC from K23EJ  
Laketown 48K48GV QC from K38AL, 1.2kw  
Laketown 50K50GA QC from K36DZ, 1.2kw  
Logan 41K41GQ QC from K53AP, 2.6kw  
Logan 43K43GR QC from K55BM, 2.8kw  
Logan 47K47HW QC from K59BC, 2.8kw  
Marysvale 46K46FX QC from K32AL, 570w  
Marysvale 48K48GS QC from K30CW, 570w  
Milford 20K20GH QC from K63BY, 960w, 38-31-05/113-17-03  
Mount Pleasant 46K46HO NS 1.8kw, 39-32-21/111-23-17  
Mount Pleasant 48K48IL NS 1.8kw, 39-32-21/111-23-17  
New Harmony 49K49GA QC from K52DW  
New Harmony 51K51GI QC from K54DS  
Park City 57K57JB NW 730w, 40-51-15/111-28-51  
Randolph 26K26GH QC from K47AI, 1.2kw  
Randolph 34K34FR QC from K49AP, 1.2kw

Randolph 36K36FS QC from K51AP, 1.2kw  
Randolph 40K40FY QC from K53AX, 1.2kw  
Randolph Co. 35K35GI QC from K66FC, 840w  
Rockville 40K40FU QC from K60BI, 3.54kw  
Salina 15K15FF QC from K64BC, 160w  
Salina 17K17FC QC from K68DI, 160w  
Salina 23K23FK QC from K60FD, 160w  
**Salt Lake City 40KTVX-DT NW 476kw/1256m, 40-39-33/112-12-07**  
Salt Lake City 66K66FN PR>38kw, 40-39-35/112-12-02; already granted  
St. George 67K67HK NW 1.3kw, 37-03-50/113-34-23  
Toquerville 23K23FQ QC from K66BP, 2.57kw  
Virgin 25K25HB QC from K62BR, 540w

**Virginia:**  
Charlottesville 50W50CM QG from ch. 19; already on  
**Richmond 23WCVE-TV PC 2300kw/346m**  
Tazewell 21W21CG NS 1kw, 37-11-27/81-31-49

**Vermont:**  
Windsor 22W22CS PR>2.6kw; PC<130w

**Washington:**  
Ellensburg 49KWWA-LP PC<8kw  
Yakima 27KAZW-LP QG from ch. 14, 44kw, 46-31-57/120-30-37  
Yakima 41KCYU-LP PG>25.4kw, 46-31-57/120-30-37

**West Virginia:**  
Huntington 45WBWV-LP PR<20.8kw  
Weirton 18W18DD QG from W57BH, 150kw  
**Weston 6WDTV-DT QG from ch. 58, 10kw/248m**

**Wisconsin:**  
Ashland 31K31HF NS 7.6kw, 46-41-30/90-59-27 (WDIO-10 ABC)  
**Kenosha 40WPXE-DT PG 830kw/358m**  
**Madison 20WHA-DT NW 124kw/408m (aux)**  
**Wausau 24WHRM-DT NW 90kw/387m**

**Wyoming:**  
**Casper 15KGWC-DT PR<11.5kw/572m, 42-44-37/106-18-31**  
Casper 33K33GI FC, sold to TBN  
Cheyenne 13K08NK QR from ch. 8, 41-07-01/104-40-07

**U.S. Possessions:**  
  
**American Samoa:**  
Pago Pago 11K11UU NW 3kw, 14-21-14/170-44-18  
Pago Pago 30K30HO NS 2kw, 14-16-12/170-41-10 (TBN)  
Pago Pago 32K32GL NS 2kw, 14-16-12/170-41-10 (TBN)

|           |         |                                      |
|-----------|---------|--------------------------------------|
| Pago Pago | 34K34HI | NS 2kw, 14-16-12/<br>170-41-10 (TBN) |
| Pago Pago | 36K36GY | NS 2kw, 14-16-12/<br>170-41-10 (TBN) |
| Pago Pago | 38K38HX | NS 2kw, 14-16-12/<br>170-41-10 (TBN) |



**Guam:**  
**Tamuning**      **14KTGM**      **PG 6.8kw/74m,**  
**13-29-15/144-49-05**



**Puerto Rico:**  
**Ponce**            **7WSTE**            **PR<100kw/64m,**  
**18-02-52/66-39-16**

**Notes:**

Thanks to Jeff Kruszka, Dave Williams, Mike Bugaj, Kevin Redding, and Fred McCormack for information appearing elsewhere in this column.

Nothing happened in Canada this month. The CRTC did propose a must-carry regimen for digital TV on Canadian cable systems. Cable systems in the U.S. must carry either a qualified station's digital signal or its analog signal. Under the CRTC proposal, Canadian cable systems will be required to carry both on any "priority" signal.

Remember that WSTE-7 in Puerto Rico recently applied for a special "multiple main transmitters" license. They proposed to operate full-power transmitters on channel 7 in three locations on the island, each location shielded from the others by Puerto Rico's mountainous terrain.

My educated guess is that the WSTE application above is for just one of these transmitters. In other words, it doesn't reflect the major decrease in overall coverage that the numbers suggest.

Yes, TBN won five new permits in American Samoa. My educated guess is they won't build all five. However...

Note the new "Church Channel" station in Minot, North Dakota. This new network is operated by TBN. Their website indicates the network carries church services. This is the third network operated by TBN, the other two being their main network most DXers are familiar with, and a Spanish-language service. It's interesting to note there is no station on the "regular" TBN network in Minot. (I wonder if K21GQ's carriage of the Church Channel is a mistake – if the satellite receiver is on the wrong channel?)

The new stations in Des Moines, Hot Springs, and Clarksdale are the first to be awarded under the new policy for resolving mutually-exclusive non-commercial applications. Applicants receive points for being an established local organization; for diversity of ownership (not owning any other stations); for operating a state-wide network; and for offering better coverage. (higher power/antenna)

(the whole process has been appealed to the D.C. Circuit Court by the American Family Association – presumably this appeal has to do with the process' application to radio applications but the results will be binding on TV as well.)

A special public notice was released on October 23<sup>rd</sup> detailing the progress of the DTV conversion. As of the beginning of October, 563 DTV stations are on the air with full licensed facilities and 695 with special temporary authority. This adds up to 1,258 stations or roughly 75% of all TV stations.

141 stations have sought a third six-month extension of their DTV construction permits. Of these, 104 provided evidence of good reason for delays, and were granted extensions. Another 30 are "satellite" high-power relay facilities. The Commission is considering excusing these stations from gradual transition to digital and allowing them to instantly switch from analog to digital at the 2006 deadline.

Some of the reasons given for granting extensions included the 9/11 attacks; transmitter manufacturers filing for bankruptcy; and two typhoons (KUAM-DT, Guam) The Commission itself is at fault for delays at fifty stations. Twenty are awaiting action on applications to change their DTV channel assignment; 21 more are waiting for action on other modification requests or have received approval too late to complete construction by November 1<sup>st</sup>. KXGR-DT and WBAK-DT are awaiting action on applications to transfer their licenses to new owners.

Twenty-two stations convinced the Commission they can't afford to complete DTV construction on time. It may not surprise one to learn KYUS-DT Miles City, Montana (widely regarded as the smallest full-license station in the USA) is one of them.

Seven stations' extension requests were denied. (WSJU, WDWL, WVUE, KMVU, WKBW, WICZ, and WJAR) These stations are officially admonished and required to

(Continued on page 15)

# ATSC Primer Part III

Doug Smith

## PSIP

We've already discussed two types of PES data packets: video, and audio. We've also already discussed the fact that you can transmit more than one TV program on a single ATSC DTV station at the same time. This means there must be at least two video streams, and at least two audio streams. How does your TV set know which one to display?

That, among many other things, is the purpose of the Program and System Information Protocol, or *PSIP*, packets. The PSIP describes eight different *tables*, of which five are necessary for reception of an ATSC signal. Those tables are:

- ⓈSTT – System Time Table
- ⓈMGT – Master Guide Table
- ⓈVCT – Virtual Channel Table
- ⓈRRT – Ratings Region Table
- ⓈEIT – Event Information Table
- Ⓢ#ETT – Extended Text Table
- Ⓢ#DCCT – Directed Channel Change Table
- Ⓢ#DCCST – Directed Channel Change Selection Code Table

# these tables are optional.

*STT* – the system time table is simple. It contains the transmitter's opinion of the correct time, sent once every second.

*MGT* - this table tells the ATSC receiver where to look for the other tables.

*VCT* – this table tells the receiver where to look for the audio and video streams associated with a given program. It also tells the receiver what to call that program. Some of the fields in the VCT include the:

- Ⓢ*Major channel number* – generally same as the station's analog channel, this is displayed to the user.
- Ⓢ*Minor channel number* – this distinguishes between different programs on the same ATSC station. Zero is reserved for the station's analog signal. Generally, 1 is used for the first digital program, and additional minor channel numbers counting up from there.
- Ⓢ*Transport Stream Identification* - this tells the receivers which audio and video streams go with a given major and minor channel number.
- Ⓢ*Short Name* – this is the name of the program, something like “KXYZ-HD”. It's the “text ID” commonly mentioned in the *VUD*.

*RRT* – The RRT is the implementation of the “V-chip” for digital TV. It defines which program acceptability ratings are possible for a given region or country. The actual rating is in the EIT and/or PMT.

*EIT* – At least four EITs are (theoretically) required. (EIT-0, EIT-1, EIT-2, EIT-3) Additional EITs through EIT-127 are permitted, and 24 recommended<sup>1</sup>. Each EIT is the guide to 3 hours worth of programming. With a maximum of 128 EITs, 16 days of program guide material can be transmitted. If a station has more than one virtual channel, it may have more than one EIT with the same number. One EIT-0 may apply to WTVF-HD, virtual channel 5-1, while another EIT-0 would apply to WTVF-5+, virtual channel 5-2.

The Extended Text Table (ETT) allows the transmission of more descriptive information about virtual channels or program events. I've never seen it used. Likewise for the DCCT and associated DCCST. These tables are intended to allow the station to cause your receiver to change channels on cue – for example, to carry a special regional commercial, or local weather.

ATSC recommends minimum repetition rates for these tables. The most frequent is the MGT, which is to be transmitted every 150 milliseconds. The VCT is to be sent every 400ms. (this means the “text ID” is sent 2½ times a second, far more frequently than any other identifying information in the DTV signal.) As mentioned above, the STT clock information is to be sent every second. The frequency of the EITs depends on which EIT: EIT-0 is sent twice a second; EIT-1 every three seconds; and EITs 2 and 3 every minute. There appears to be no standard for EITs 4-127.

All of these tables are assembled into 188-byte packets. They are then *multiplexed* with video and other data, and sent to the 8VSB modulator for transmission. More on all of that later... (I'll bet this paragraph was familiar... again...)

---

<sup>1</sup>I have never seen a station with more than four EITs. I have also never seen a station put anything in their EITs except “Regular Schedule”. Two Nashville stations have no EITs, but seem to decode just fine.

# WESTERN TV DX

**VICTOR FRANK**  
**12450 SKYLINE BLVD.**  
**WOODSIDE, CA 94062-4554**  
**Victor.frank@sri.com**

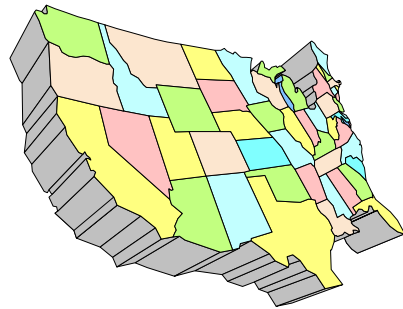

**Dennis Park Smith**, 3605 San Remo Drive, Santa Barbara, CA 93105-2523 (805)687-7803

This report is for October 2003. The southern-California coastal tropo continued to exist, as it has been, in its "summer" pattern, and continued through Oct. 25, averaging fair to good during that time, with quite a high inversion layer boundary with its associated stable and quiet conditions, and on Oct. 26 approaching very good because the boundary was lower. There was no tropo Oct. 27-28, and this was when our southern-California fires flared up with windy conditions. The tropo returned with a low boundary (very good) on Oct. 29, but then disappeared with changing cooler weather and eventual rain (the start of the "winter" pattern) on Oct. 31 (rain went on further south into fire areas somewhat, on Nov. 1).

### Wasco Report

I was in Wasco on Oct. 15-17, and observed another new regular on the air: K11VA 11 Bakersfield (Telemundo, Spanish), very good, at 45 miles. Very weak occasional offset CCI may have been from KNTV 11 San Jose at 175 miles. Also noted under new KFAZ-CA 8 Visalia (Azteca America, Spanish) at approx. 50 miles was weak but consistent offset CCI, which may have been K08MM Bakersfield (new tentative).

Best of DX to All. Dennis

**William Eckberg**, 1032 Sterling Rd., Dixon, IL 61021-9355

### October 2003 CDT

|       |      |                   |    |                 |      |
|-------|------|-------------------|----|-----------------|------|
| 10 tr | 0005 | <u>W46DM</u>      | 46 | IL Arbury Hills | 64   |
| 19 tr | 0430 | <u>WOCK-CA 13</u> |    | IL Chicago      | 88   |
| 24 tr | 0545 | WCFT              | 33 | AL              | 593  |
|       | 0605 | WAFF              | 48 | AL              | 503  |
|       | 0620 | WIAT              | 42 | AL              | 582  |
|       | 0640 | WFIQ              | 36 | AL              | 483  |
|       | 0700 | WTTO              | 21 | AL              | 582  |
|       | 0850 | WJSU              | 40 | AL              | 585  |
|       | 0855 | WTJP              | 60 | AL              | 551  |
|       | 0935 | WHNT              | 19 | AL              | 503  |
|       | 1020 | WZDX              | 54 | AL              | 503  |
|       | 1030 | WUXP              | 30 | TN              | 408  |
| 25 Es | 2215 | KMID              | 2  | TX              | 967  |
|       | 2240 | XEFB              | 2  | NL              | 1162 |

Late AM on October 24 I saw 600 mile tropo to Alabama. Birmingham-42 and Anniston-40 were snowfree late. Local enhancement was below average, creating ideal conditions. It was strictly a super Alabama opening with a poor Nashville-30.

I'm convinced tropo went down to Montgomery and Selma. These stations escaped identification. A stationary front went across northern LA, southern MS, AL, and GA. A cold front was in western IA.

I saw C/B and ID from Arbury Hills-46 on one night only. The town has 1,300 population and is east of Batavia.

I saw my first hi-VHF LP tropo on ch. 13. I also saw Es on Oct. 25 to the SW and on Oct. 29 to PQ at 2100 CST. No ID on the latter.

**Eric Bueneman (N0UIH)**, 631 Coachway Lane, Hazelwood, MO 63042-1347  
**E-mail:** N0UIHEric@aol.com **Web site:** <http://www.qsl.net/n0uih/>

**Equipment:** Alaron 12-inch black and white TV, Samsung 19-inch color TV, Radio Shack VU-210XR with RS Archerotor at 35 feet (10.6 meters) above ground level

*All times CDT, all distances in miles/kilometers*

### August 19, 2003 (trop)

- 0248 WXYZ 7 MI Detroit 460/740
- 0252 WDRB 41 KY Louisville 250/402
- 0254 WLKY 32 KY Louisville 250/402
- 0255 WFYI 20 IN Indianapolis 240/386
- 0303 WBKI 34 KY Campbellsville 290/467
- 0323 WTTK 29 IN Kokomo "Indiana's WB 4" 255/410
- 0324 WANE 15 IN Fort Wayne 320/515
- 0327 WSBT 22 IN South Bend 300/483
- 0330 WISE 33 IN Fort Wayne (ex-WKJG) 320/515
- 0332 WSJV 28 IN Elkhart 305/491
- 0338 WNDY 23 IN Marion "UPN Indiana" 285/459
- 0353 WCLJ 42 IN Bloomington 210/338

### August 20, 2003 (trop)

- 0345 WOTV 41 MI Battle Creek 365/587
- 0350 WCPX 38 IL Chicago 255/410
- 0352 WNDU 16 IN South Bend 300/483
- 0353 WLS 7 IL Chicago "ABC 7" 255/410
- 0357 WDRB 41 KY Louisville 250/402
- 0359 WFYI 20 IN Indianapolis 240/386
- 0402 WHIO 7 OH Dayton 340/547
- 0405 WLFI 18 IN Lafayette (thru K18BT) 225/362

### August 21, 2003 (trop)

- 0234 KOLR 10 MO Springfield 190/306
- 0236 KMBC 9 MO Kansas City 225/362

0241 KSPR 33 MO Springfield "Springfield 33"  
190/306

0242 KOZK 21 MO Springfield 190/306

0243 KYTV 3 MO Springfield 190/306

0246 KCWE 29 MO Kansas City 225/362

#### **August 24, 2003 (trop)**

2230 WRTV 6 IN Indianapolis "RTV 6" 240/386

2231 Indianapolis 8, 13, 20, 40 (Grade B), 59  
(Grade A) 240/386

2232 WSNS 44 IL Chicago 255/410

2245 WSJV 28 IN Elkhart 305/491

2247 WHIO 7 OH Dayton 340/547

2248 WISE 33 IN Fort Wayne 320/515

2249 WWHO 53 OH Chillicothe "UPN Columbus"

2249 WWHO 53 OH Chillicothe "UPN Columbus"  
400/644

2253 WANE 15 IN Fort Wayne 320/515

2258 WKPC 15 KY Louisville (KET-1) 250/402

2300 WKPI 22 KY Pikeville (KET-1) 435/700

2307 WKON 52 KY Owenton (KET-1) 305/491

2312 WBXX 20 TN Crossville (under WFYI)  
355/571

2315 WCVN 54 KY Covington (KET-1) 325/523

2319 WSTR 64 OH Cincinnati "WB 64" 320/515

2322 WYMT 57 KY Hazard 410/660

2341 WKGB 53 KY Bowling Green (KET-1)

220/354

2346 WKZT 23 KY Elizabethtown (KET-1) 265/426

2352 WKPD 29 KY Paducah (KET-1) 155/249

2353 WKMU 21 KY Murray (KET-1) 190/306

#### **August 25, 2003 (trop)**

0000 WXIX 19 KY Newport 325/523

0018 WRGT 45 OH Dayton "Fox 45" 340/547

0019 WKEF 22 OH Dayton "NBC 22" 340/547

0030 WTTE 28 OH Columbus "Fox 28" 405/652

0045 WIPB 49 IN Muncie 255/410

0055 WNWO 24 OH Toledo (under KNLC) 415/668

0100 KMCI 38 KS Lawrence "38 The Spot"  
255/410

0105 Springfield, MO 3, 10, 21, 33 190/306

0110 WKMJ 68 KY Louisville (KET-2) 250/402

0742 WCET 48 OH Cincinnati 320/515

2219 WDKA 49 KY Paducah "WB 49" (K49FC  
nulled) 155/249

2241 WKMR 38 KY Morehead (KET-1) 380/612

2242 WKLE 46 KY Lexington (KET-1) (through  
WRBU) 330/531

2246 WUPX 67 KY Morehead 380/612

2247 WLFJ 68 VA Grundy (WKMJ nulled) 460/740

2250 K45CA 45 MO Cape Girardeau (WTCT-27)  
115/184

2256 WBKI-CA 28 KY Louisville 250/402

2300 WLEX 18 KY Lexington (K18BT nulled)  
330/531

2301 WKYT 27 KY Lexington 330/531

2302 WHAS 11 KY Louisville (KPLR nulled)  
250/402

2324 WAVE 3 KY Louisville (through WSIL)  
250/402

2335 WIPX 63 IN Bloomington 210/338

#### **August 26, 2003 (trop)**

0029 W29CS 29 IN Shelburn (3ABN) 160/258

0114 WTWO 2 IN Terre Haute (KTVI nulled)  
170/274

0211 WIPB 49 IN Muncie 255/410

0301 WPXK 54 TN Jellico (ID w/WPXK-DT 23)  
375/604

0308 WBXX 20 TN Crossville 355/571

0405 WNPX 28 TN Cookeville 325/523

0406 WBNA 21 KY Louisville 250/402

#### **September 15, 2003 (trop)**

0805 Cincinnati, OH 48, 64 320/515

0806 Louisville, KY 32, 41 250/402

#### **September 17, 2003 (trop)**

0730 Peoria, IL 25, 47, 59 140/225

#### **October 20, 2003 (trop)**

0734 Chicago, IL 32, 38 255/410

0725 Urbana, IL 12, 27 155/249

0736 Champaign, IL 3, 15 150/240

0737 WVUT 22 IN Vincennes 135/217

0740 WAZE 19 KY Madisonville 190/306

The trop opening of August 19 was mostly an Indiana and Kentucky opening; WXYZ 7 was noted carrying a commercial for a car dealer's post-blackout sale. Detroit was hit hard by the blackout in the northeastern United States a week earlier. Did note a call letter change for WISE 33 (last logged as WKJG). August 20 brought in WOTV 41 as the only Michigan station that morning; it was a Chicago-Louisville opening. The opening on August 21 was an all-Missouri opening.

The VHF and UHF bands were wide open between August 24 and 26. Chicago was noted on 44, along with several Indiana and Ohio stations before 2300 on the 24th. After 2300, the action moved into Kentucky; noting WKPI 22 for another KET-1 station in the logbook. After midnight on the 25th, it was mostly Indiana, Kentucky and Ohio in; the only station noted from west of Missouri was KMCI 38. Springfield was the only other MO market in besides St. Louis and Cape Girardeau. It's not common to note two stations in at once on UHF Channel 68 (unless you live in Nashville or Lexington), but it happened in St. Louis! WKMJ was in with KET-2 programming (it's KET-2's only analog affiliate, as far as I know); separate program from KET-1 on WKPC 15. The other station in was my first trop catch from Virginia; WLFJ Grundy with Christian programming. Also pulled in WUPX 67, albeit with a weaker signal than WKMR 38. Finally pulled in long sought-after WAVE 3 with Jay Leno through WSIL for station #450 from this QTH. WHAS 11 was also noted with Nightline through KPLR. Toward the end of the opening in the wee hours of August 26, I noted WTWO 2 tearing up KTVI. Some tropes were also noted on September 15 with Cincinnati and Louisville in, and two mornings later with Peoria in on 47 (through WRBU-DT) and 59 (noted with a fair signal). Minor trop also made it in on October 20, with Chicago (with the exception of WSNS 44) and Champaign/Urbana making it in, along with WAZE 19 and WVUT 22.

As of September 1, 2003, 450 stations have been logged at this QTH.

73, Eric (N0UIH)



Kevin Redding, Mesa Arizona

The url for the new Channel 19 in Mesa, AZ is:

http://www.bohemiaafterdark.com.

Jeff Kruszka, 5024 S. Braxton Ave., Baton Rouge, LA 70817

September 2003 CT

|       |      |                           |     |                    |
|-------|------|---------------------------|-----|--------------------|
| 5 tr  | 1817 | KLRT                      | 16  | AR                 |
|       |      | KTHV                      | 11  | AR                 |
| 9 tr  | 0659 | KALB-DT                   | 35  | LA                 |
|       |      | LA station #100           | 95  |                    |
| 15 GW | 2056 | WGNO-DT                   | 15  | LA                 |
| 20 tr | 1014 | KTBS-DTt                  | 28  | LA sync lock to NW |
| 29 tr | 2254 | WUFX                      | 35  | MS "Fox 35,"       |
|       |      | per tip from Chris Carter | 120 |                    |

|       |      |                  |    |                                |
|-------|------|------------------|----|--------------------------------|
| 9 GW  | 1737 | WGMB-DT          | 45 | LA                             |
| 16 GW | 2129 | WNOL-DT          | 40 | LA                             |
| 22 tr | 0644 | KEYE             | 42 | TX                             |
|       |      | KATC-DT          | 28 | LA                             |
|       | 0650 | KAZH-DT          | 41 | TX                             |
|       | 0704 | KXLN-DTt         | 46 | TX sync lock to W.             |
| 23 tr | 0654 | WAWD             | 58 | FL                             |
|       | 2217 | <del>XO5AB</del> | 7  | TA                             |
|       | 2311 | 805d             |    | sync lock to E. on ch. 24 & 29 |
| 24 tr | 0700 | WFSU             | 11 | FL                             |
| 25 Es | 2125 | unids 3-5        |    |                                |
|       |      | 75               |    |                                |

See Matt Sittel's website for PSIP information on the DTV's. That's a great database he's establishing; I hope more of us will contribute.

October 2003

## TV NEWS CONTINUES FROM PAGE 11

submit additional reports on their progress.

Kevin says the KPHE-LP (ch. 19, Phoenix) ID also specifies "DT 43". Presumably this means



K43GV is operating as a DTV station, simulcasting analog KPHE? This would make it the second regularly-licensed digital LPTV I'm aware of. KPHE is carrying "Bohemian Music Videos"; their website says KHLM-LP in Houston is to soon begin carrying the same network. Maybe there will be a digital LPTV in Houston too? (there's no mention of DT 43 in Phoenix on the website)

Fred has noticed there's a long delay in the audio between the TBN in Minneapolis

(K58BS) and the one in Rochester. (K56HW) It's "like a whole word". Apparently some TBNs are fed via a different satellite feed than others?

Fred also provided the programming information that appears above for the Alexandria, MN translators. He notes that he's listed K62AU as the Hallmark Channel before, while I was still listing it as Odyssey, and wonders if they might be the same thing? It seems Odyssey changed its name (three years ago!) and I managed to miss the change. K62AU is the only over-the-air station carrying this network, so I'm not too embarrassed over it<grin>!

Tropo's been rather flat around here. My best success in November was on a car radio in Iowa when I caught three Des Moines FM stations off the air due to high winds! Here's hoping things are better where you are.

## VACATION OR DXPEDITION CONTINUES FROM PAGE 18

to visit the Marconi site as soon as the car returns. Car returns. Wife wants to shop in Provincetown. I postpone the Marconi until the morning. Shopping is uneventful. Evening is spent sitting out on the veranda and utilizing the heated pool.

Monday – Sept 15<sup>th</sup> – I arrive at the Marconi site where the trans-Atlantic transmissions took place. Setting up, I log a new Cape Cod Station WDVN 93.5 in Harwichport and then I log the only DX of the trip...WMSJ 89.3, Freeport, ME, shades of Marconi! Nothing else of consequence heard.

After a bicycle excursion through the Cape Cod National Seashore Park, we decide to head home. At 2:30pm we head down Route 6, over the Sagamore Bridge and up 495

towards home. I listen a bit to WBOT 97.7 in Brockton before tuning to the oldies station, 101.5, WWBB in Providence. Wife re-re-claims the radio as we exit 495. She tunes to 96.1 WSRS in Worcester, MA which accompanies us through Bellingham, Mendon, Uxbridge and back into Douglas.

The house is still standing and the kids are hungry. Vacation (DXpedition?) is over.





December 2003

It's time to see some stuff yours truly picked up this summer, as well as some "alternate shots" from the Super tropo event back in May:



Unid 4 Cuba  
? mi Es seen 7/4/03  
@1252 CT  
*"logo LR says "TV Noticias"  
with a half globe"*



Unid 5 Cuba  
? mi Es seen 7/4/03  
@1245 CT  
*"the standard TP we're all  
used to seeing"*



KCTV-5 Kansas City, MO  
625 mi Es seen 7/9/03  
@2235 CT



KDBC-4 El Paso, TX  
910 mi Es seen 6/13/03  
@1844 CT



XHGV-4 Las Lajas, VE  
850 mi Es seen 7/2/03  
@1753 CT  
*"RTV (Radiotelevisión de  
Veracruz) logo lower right"*





WCSC-5 Charleston, SC  
680 mi Es seen 6/24/03  
@1658 CT



KHWB-DT-38 Houston, TX  
255 mi Tr seen 8/5/03  
@2204 CT

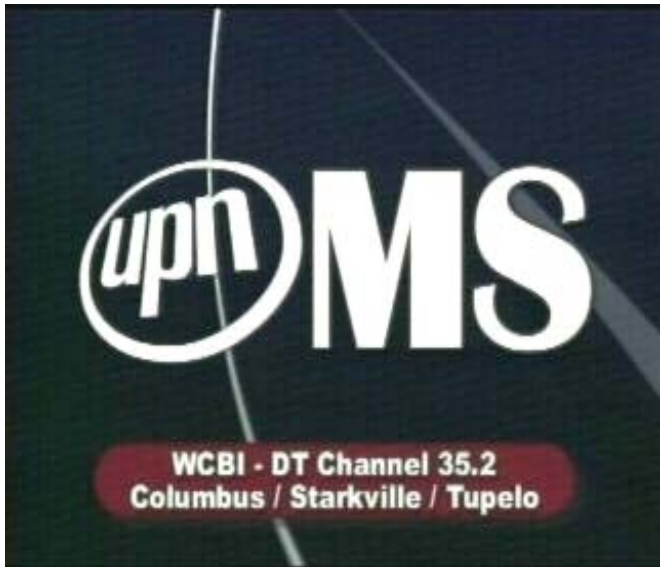

WCBI-DT-35 Columbus, MS  
425 mi Tr seen 8/14/03  
@0700 CT  
*"Notice the '35.2' indicating program 2"*



WUNC-DT-59 Chapel Hill, NC  
795 mi Tr seen 5/11/03  
@2126 CT  
*"program 4, UNC-KD (kids channel)"*



WRJM-67 Troy, AL  
320 mi Tr seen 5/11/03  
@2141 CT



WCBI-DT-35 Columbus, MS  
seen 5/11/03 @0136 CT  
*"Program 3"*

# VACATION OR DXPEDITION?

## Sometimes It's Hard to Tell

BILL SMITH, WA1NYV

For the first time in twenty years, our annual mini-September vacation to Provincetown on the top of Cape Cod would be taken without the benefit of children. This would mean that I could possibly do some FM DXing as I used to do in those dimly remembered pre-married times. My wife assured me that this was to be a “restful” vacation – no whale watches, sunset cruises or shopping expeditions. I could even be in charge of the car radio.

Pre-vacation (DXpedition?) plans commenced. The main FM receiver at home is an ancient Hallicrafters SX-62A which is not exactly portable, weighing about 40 pounds. However, my parents had a Radio Shack Patrolman SW60, which although not exactly “state-of-the-art”, was battery powerable, had provisions for headphones and also tuned various other frequencies. I also borrowed a pair of binoculars, avoiding the adage “neither a borrower or lender be.” An order was placed for the 19<sup>th</sup> edition of the FM Atlas. It arrived promptly. I advised my wife that a 2:30pm departure of Friday, Sept 12, would allow us to avoid the infamous Cape Cod traffic.

Thursday, Sept 11, I am packed and ready. My wife assures me everything will be a “go” at 2:30 the following day.

Friday, Sept 12, 2:30pm. My wife has yet to begin packing. Several testy moments follow. Departure reset for 4:30. We depart Douglas, MA at 4pm. Wife tells me “We are leaving one half hour early.” It is a beautiful late summer day. I turn on the car radio to sounds of WBRU 95.5, remnants of the kids...heavy metal from Providence, RI (20 miles south). I retune from bottom up, for bandscan, and get WGAO 88.3 Franklin, MA. We head east on Route 16 through Uxbridge and Mendon, then to Route 140 into Bellingham and then Franklin.

At Franklin, we take I-495 south, a straight 40 mile shot to the Cape Cod Canal. At this point, wife reclaims the radio and I miss trying for several low power stations en route. She tunes WPRO 92.3 in Providence; WPLM 99.1 Plymouth, MA and finally settles on WCTK 98.1 New Bedford, MA which is twenty miles down the road and has the benefit of being both country and western.

Five pm - traffic jam – I- 495 drops a line just past route 24, an infamous MA bottleneck. We crawl along. Wife announces she is going to take a nap. I reclaim the radio and get “the Wave” 101.1, WTWV in Mashpee on the other side of the canal. I find out it's just a 20 minute slowdown and that

the Bourne and Sagamore rotaries are “slightly” clogged.

Finally, I-495 adds two lanes and I zip into Bourne. I drive parallel to the Cape Cod Canal before hitting a 10 minute snag at the Sagamore rotary. A rotary is a traffic device that occurs when engineers can think of nothing else to do. It is a phenomenon which occurs often in Massachusetts.

I cross the canal via the Sagamore Bridge. Wife still sleeping. I tune to WPXC “Pixie 103” (102.9) in Hyannis and then to WQRC 99.9 in Barnstable. Route 6 turns into 2 lanes for 13 miles and then into a rotary. I get Chatham at 107.5. Wife awakens and announces she is near starvation. We sup at Arnold's Clam Bar, “best clams on Cape Cod.”

After a brief stop at the Wellfleet Country Store, we arrive at the Tides Motel in Provincetown. Our rooms are about 100 feet from Cape Cod Bay with a view of Provincetown Harbor and the Pilgrim Monument. Radio-wise, there is a large dune to the south, but it's a clear shot in all other directions with nothing between me and Europe to the northeast. WOMR 92.1 Provincetown is overwhelming on several locations on the dial. Only thing unusual is the presence of two Coast Guard cutters anchored offshore to get out of the way of Hurricane Isabel.

Saturday morning – Sept. 13<sup>th</sup>. Today is beautiful. No sign of a hurricane although one of the cutters has left. We journey a few miles to the Cape Race to check the surf on the ocean side. Nothing unusual and Cape Race Lighthouse gleams in the sunlight.

We decide to go into Provincetown for lunch at the Lobster Pot. After lunch, wife returns to the motel. I grab the radio and walk out on the breakwater and past Wood End Lighthouse built in 1822. Nothing between me and Europe. All the Boston stations are loud. I log WXTK 95.1 West Yarmouth, WCIB 101.9 Falmouth “Cool Classics”, WKPE 104.7 Orleans, WOCN 102.9 S. Yarmouth, WCOD 106.1 Hyannis – all of these on Cape Cod. Best logging is WRZE “the Rose”, 96.3 on Nantucket Island.

I hike back and take wife to supper at Montagnos, and Italian eatery with good Veal Parmigan. Evening is spent watching the surf and engaging in activities totally unrelated to DXing.

Sunday – Sept 14<sup>th</sup> – Morning is spent sunbathing and wading at the motel. Wife leaves to have lunch and visit relatives. I watch the Patriots game and make decision

(Continued on page 15 )



# Northern FM DX

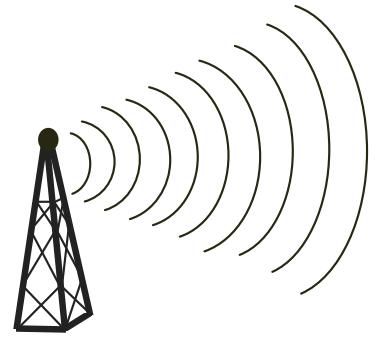

**Keith McGinnis**  
**387 Shirley Street, Winthrop, MA 02152**  
**longwave@attbi.com 617-846-5760**

For Dxers in the following states: **CT IA ID IL IN MA ME MI MN MT ND NE NH NJ NY OH OR PA RI SD VT WA WI WY** and all of **Canada**. Please submit by the 10<sup>th</sup> of each month. If possible please submit in the formats shown Below.

**EDITORS NOTE: PLEASE NOTE THAT ANY TYPEWRITTEN OR HANDWRITTEN REPORTS MIGHT BE DELAYED TILL A LATER ISSUE AS TIME PERMITS. ALSO PLEASE KEEP REPORTS AS RECENT AS POSSIBLE (THE LAST 3 MONTHS SHOULD WORK FINE). THANK YOU.**

**Frank W. Merrill Box 669 Macomb IL 61455**

**Equipment: McIntosh MR-78 and Tandberg 3001-A**

*Antennas: For all 2003 E skip a CM Probe 9 at 8 feet and for all 2003 Tropo one or two CM Probe 9's at 45 feet (when using both antennas a Bolin Phase Box was also used).*

*Mileage is last number.*

May 13 Es

1447 noted MUF to at least 102.9 with Monterrey NL 1161

May 14

1142 Z??? 100.3 "Drive around the streets of Nassau

May 25 Es

|      |             |       |                 |    |  |     |
|------|-------------|-------|-----------------|----|--|-----|
| 1513 | <u>WMGM</u> | 103.7 | Atlantic City   | NJ | Steel Pier and Woodbine Ads  | 864 |
| 1524 | <u>WGCO</u> | 98.3  | Midway          | GA | 761  |     |
| 1531 | <u>WACL</u> | 98.5  | Elkton          | VA | Harrisonburg Ad  | 657 |
| 1537 | <u>WXVA</u> | 98.3  | Charlestown     | WV | local promo "Extra Country 98-3"   | 684 |
| 1541 | <u>WJXN</u> | 105.9 | Lewes           | DE | "97.5 and 105.9 Cat Country"   | 835 |
| 1544 | <u>WFXH</u> | 106.1 | Hilton Head     | SC | 793  |     |
| 1547 | <u>WRCQ</u> | 103.5 | Dunn            | NC | Steve Jones Chevy ad plus a promo for summer school at UNC Pembroke (with CCI from WGMS) | 747 |
| 1549 | <u>WZXS</u> | 103.9 | Topsail Beach   | NC | 826  |     |
| 1558 | <u>WQMG</u> | 97.1  | Greensboro      | NC | 664  |     |
| 1602 | <u>WWVV</u> | 97.5  | Charlottesville | VA | Legal ID   | 673 |
| 1611 | <u>WRDU</u> | 106.1 | Wilson          | NC | 673  |     |
| 1616 | <u>WNCT</u> | 107.9 | Greenville      | NC | 796  |     |
| 1620 | <u>WCCA</u> | 106.3 | Shallotte       | NC | "some folks like to call us Bubba...Classic Country 106.3 WCCA"                          | 811 |
| 1621 | <u>WSFL</u> | 106.5 | New Bern        | NC | 830  |     |
| 1625 | <u>WRSF</u> | 105.7 | Columbia        | NC | "Dixie 105.7" jingle   | 843 |
| 1630 | <u>WBRW</u> | 105.3 | Blacksburg      | VA | New River Nissan in Christianburg ad   | 595 |
| 1632 | <u>WSVY</u> | 105.3 | Norfolk         | VA | 822  |     |
| 1633 | <u>Unid</u> | 106.3 |                 |    | on top of local w/ relig teaching  |     |
| 1635 | <u>WTTX</u> | 107.1 | Appomattox      | VA | State Police PSA into bluegrass got phone confirmation                                   | 671 |
| 1651 | <u>WAFX</u> | 106.9 | Suffolk         | VA | Virginia Beach Izuzu   | 800 |
| 1654 | <u>WJJZ</u> | 106.1 | Philadelphia    | PA | "WJJZ 106.1" Jingle  | 821 |
| 1658 | <u>WARM</u> | 103.3 | York            | PA | 736  |     |
| 1700 | <u>WBLS</u> | 107.5 | New York        | NY | 874  |     |
| 1701 | <u>WBYN</u> | 107.5 | Boyertown       | PA | Legal ID (included several cities)   | 791 |
| 1702 | <u>WEBE</u> | 107.9 | Westport        | CT | 906  |     |
| 1702 | <u>WPRB</u> | 103.3 | Princeton       | NJ | 842  |     |
| 1711 | <u>WXKS</u> | 107.9 | Medford         | MA | 1022   |     |
| 1714 | <u>WMRV</u> | 105.7 | Endicott        | NY | "The Southern Tier's #1 Hit Music x Station...Star 105.7"                                | 768 |

|      |             |       |              |    |   |
|------|-------------|-------|--------------|----|---|
| 1715 | <u>WPZX</u> | 105.9 | Pocono Pines | PA | Scranton Ad "Rock 107..NE PA's all time favorite.." 790 |
| 1728 | <u>Z???</u> | 96.1  | Freeport     | BH | Prgmng in Creole with EE ad for "Internatl Bazaar" 1370 |

May 27 GW

|      |                |      |        |    |                                  |
|------|----------------|------|--------|----|----------------------------------|
| 0851 | <u>KCSW-lp</u> | 97.1 | Canton | MO | "KCSW, Culver-Stockton Radio" 51 |
|------|----------------|------|--------|----|----------------------------------|

May 30 Es

|      |              |       |                 |    |   |
|------|--------------|-------|-----------------|----|---|
| 0001 | WUSF         | 89.7  | Tampa           | FL | with local xltr off 983   |
| 0018 | WRLR         | 100.1 | Port Charlotte  | FL | with another local off the air 1053   |
| 0021 | WCKT         | 107.1 | Lehigh Acres    | FL | "Cat Country 107.1" 1089  |
| 0027 | WDRR         | 98.5  | San Carlos Park | FL | Ft Myers Ad 1110  |
| 0033 | WBZE         | 98.9  | Tallahassee     | FL | 781   |
| 0049 | WSJJ         | 94.1  | Lakeland        | FL | 991   |
| 0101 | WWRZ         | 98.3  | Fort Meade      | FL | rosefm.com 1045   |
| 0520 | WGBH         | 89.7  | Boston          | MA | 1024  |
| 0523 | WHJY         | 94.1  | Providence      | RI | 1006  |
| 0525 | WPLM         | 99.1  | Plymouth        | MA | 1044  |
| 0527 | CIOO         | 100.1 | Halifax         | NS | "C100" plus Halifax mentions 1408   |
| 0531 | <u>WWFX</u>  | 100.1 | Southbridge     | MA | "Chris Engle", "Fox Morning News",<br>"Worcester's Rock Station"...also got phone<br>confirmation 974 |
| 0600 | <u>WHOU</u>  | 100.1 | Houlton         | ME | "100.1 Houlton-Woodstock" as CIOO faded   |
| 0608 | <u>CBAL</u>  | 98.3  | Mocton          | NB | CBC Stereo FF Atlantic feed 1359  |
| 0632 | <u>CBAL1</u> | 101.9 | Neguac          | NB | Same as 98.3 1359   |
| 0636 | CKRO         | 97.1  | Pokemouche      | NB | FF ...mentions of Caraquet 1375   |

May 30 Tr

|      |             |       |           |    |                                      |
|------|-------------|-------|-----------|----|--------------------------------------|
| 0600 | WGLC        | 100.1 | Mendota   | IL | Legal ID                             |
| 0701 | <u>WKNB</u> | 102.9 | Earlville | IL | Legal ID (multi cities included) 120 |

June 2 Tr

|      |             |      |           |    |  |
|------|-------------|------|-----------|----|--|
| 1300 | <u>WRLJ</u> | 88.3 | Whitehall | IL | No legal ID but did give WLUJ (88.1) in the x<br>TOH ID 85 |
|------|-------------|------|-----------|----|--|

June 4 Es

0955 noted MUF to 93.1 to Mexico

June 6 Es

|                   |             |       |                                      |    |  |
|-------------------|-------------|-------|--------------------------------------|----|--|
| 1025              | XHRYS       | 90.1  | Reynosa                              | TA | Estero Hits 1084                         |
| 1035              | XHAAA       | 93.1  | Reynosa                              | TA | 1081                                     |
| 1930-2020.1.1.1.1 |             |       | South Florida to the top of the band |    |  |
| 1952              | Unid        | 95.1  |                                      |    | weak Latino/Carib music no talk..pirate? |
| 1955              | WKZM(t)     | 104.3 | Sarasota                             | FL | religion (tentative)                     |
| 2010              | <u>WTLQ</u> | 97.7  | Punta Rassa                          | FL | "la Latina Tropical" 1088                |

June 6 Tr

|      |      |      |           |    |   |
|------|------|------|-----------|----|---|
| 1058 | WRLJ | 88.3 | Whitehall | IL | Finally a full legal ID including xltrs |
| 1101 | KTTK | 90.7 | Lebanon   | MO | "All God's music is on Powre 90.7" 219  |

June 9 Es

|      |              |       |                |    |                                      |
|------|--------------|-------|----------------|----|--------------------------------------|
| 1906 | <u>KUAZ</u>  | 89.1  | Tucson         | AZ | Tuscon wx 1265                       |
| 1909 | Unid         | 97.7  |                |    | bank ad, country music               |
| 1911 | <u>KLPX</u>  | 96.1  | Tucson         | AZ | ad for Aerosmith tix...klpx.com 1265 |
| 1919 | Unid         | 96.5  |                |    | ss ...briefly                        |
| 1927 | XHPX         | 98.3  | Cd Juarez      | CI | "Exa FM" 1197                        |
| 1930 | <u>XHECS</u> | 97.3  | Neuvo Sacrmnto | CI | Legal ID...slogan 1240               |
| 2001 | <u>XHCTC</u> | 99.9  | Cd Cuauhtemoc  | CI | Legal ID                             |
| 2003 | <u>KFMA</u>  | 101.3 | Green Valley   | AZ | "101.3 KFMA" 1291                    |
| 2032 | <u>XHSAP</u> | 98.5  | Agua Prieta    | SO | ad with local mentions 1230          |
| 2059 | XET          | 94.1  | Monterrey      | NL | 1161                                 |
| 2111 | XHPE         | 97.1  | Torreon        | CU | 1270                                 |
| 2148 | Unid         | 106.1 |                |    | probable Mexican                     |

June 9 Tr

|      |             |      |             |    |                       |
|------|-------------|------|-------------|----|-----------------------|
| 1926 | <u>KCHI</u> | 98.5 | Chillicothe | MO | kchi.com ex 103.9 159 |
|------|-------------|------|-------------|----|-----------------------|

June 10 Es

|      |      |      |          |    |                                       |
|------|------|------|----------|----|---------------------------------------|
| 1155 | WEAS | 93.1 | Savannah | GA | 788                                   |
| 1900 | Unid | 94.7 |          |    | FF ...this was the MUF in the evening |

June 11 Es

|      |       |      |               |    |                 |
|------|-------|------|---------------|----|-----------------|
| 0832 | XHSOC | 89.7 | Saltillo      | CU | partial ID 1199 |
| 0843 | XHEC  | 91.9 | Sabinas       | CU | 1056            |
| 0852 | XHCTO | 93.1 | Gomez Palacio | DU | 1280            |

June 12 Es

|      |         |      |               |    |      |
|------|---------|------|---------------|----|------|
| 1314 | WJIS    | 88.1 | Bradenton     | FL | 1009 |
| 2037 | KQOL    | 93.1 | Las Vegas     | NV | 1359 |
| 2048 | KHYZ(t) | 99.7 | Mountain Pass | CA | 1395 |

June 14 Es

|      |       |      |         |    |                    |
|------|-------|------|---------|----|--------------------|
| 1957 | XHAAA | 93.1 | Reynosa | TA | Sole fm noted 1084 |
|------|-------|------|---------|----|--------------------|

June 16 Tr

|      |        |       |        |    |                             |
|------|--------|-------|--------|----|-----------------------------|
| 0629 | W278AE | 103.5 | Peoria | IL | with WGLT break..weather 59 |
|------|--------|-------|--------|----|-----------------------------|

June 19 Es

|      |       |      |                    |    |  |
|------|-------|------|--------------------|----|--|
| 2009 | CJKR  | 97.5 | Winnipeg           | MB | "Winnipeg's Power.....Power 97"                                      |
| 2015 | KRWG  | 90.7 | Las Cruces         | NM | 1041   |
| 2029 | CFRY  | 93.1 | Portage la Prairie | MB | "You've been listening to Focus on the Family on CFRY" 736           |
| 2038 | WDAY  | 93.7 | Fargo              | ND | Y94 Traffic ...Saturn of Fargo (Prior Tr) 539                        |
| 2100 | KMPR  | 88.9 | Minot              | ND | Legal ID for station of NDPR 752                                     |
| 2102 | CBWV  | 97.9 | Brandon            | MB | Mono CBC news then SW MB weather 791                                 |
| 2108 | KCAD  | 99.1 | Dickinson          | ND | "Rough Rider Country" "KCAD 99.1" 751                                |
| 2112 | CKSB1 | 88.9 | Regina             | SK | CBC FF in stereo 966   |
| 2124 | KZIN  | 96.7 | Shelby             | MT | jewelry store ad..best selection in North Central Montana "K96" 1183 |

June 20 Es

|      |      |       |             |    |                            |
|------|------|-------|-------------|----|----------------------------|
| 1030 | WFCC | 107.5 | Chatham     | MA | Presumed                   |
| 1033 | WAAF | 107.3 | Worcester   | MA | "WAAF" when I tuned in 986 |
| 1037 | WROR | 105.7 | Framingham  | MA | "105.7 WRO....." 1006      |
| 1050 | WTSA | 96.7  | Brattleboro | VT | 949                        |
| 1054 | WTRY | 98.3  | Rotterdam   | NY | 892                        |
| 1057 | WOKQ | 97.5  | Dover       | NH | 1034                       |

June 21 Tr

|      |      |       |              |    |                               |
|------|------|-------|--------------|----|-------------------------------|
| 0200 | WDLJ | 97.5  | Bresse       | IL | Legal ID with WBBA phased 150 |
| 1850 | KLDE | 103.5 | Poplar Bluff | MO | Legal ID 256                  |
| 2226 | WYMX | 99.1  | Greenwood    | MS | 484                           |

June 22 Tr

|      |      |      |          |    |   |
|------|------|------|----------|----|---|
| 0004 | KSMD | 99.1 | Pangburn | AR | "Smooth jazz favorites ..Diamond 99.1" with KFUE phased 375 |
|------|------|------|----------|----|---|

June 22 Es

|      |         |       |              |    |   |
|------|---------|-------|--------------|----|---|
| 1417 | KAZF    | 91.9  | Hebbronville | TX | talk about relig events in area 1020  |
| 1429 | KROM    | 92.9  | San Antonio  | TX | "estero Latino 92.9" 879  |
| 1438 | KXTN    | 107.5 | San Antonio  | TX | 879   |
| 1500 | KQQT    | 106.3 | Gonzales     | TX | Legal ID for this and KQJZ  |
| 1502 | XHCER   | 100.7 | Cerralvo     | NL | Multiple station ID 1118  |
| 1507 | XHCHL   | 99.1  | China        | NL | gave XECT calls 1130  |
| 1512 | KGSR    | 107.1 | Bastrop      | TX | Legal ID 806  |
| 1515 | KBAW    | 93.5  | Zapata       | TX | Nueva Laredo Phone number 1050  |
| 1517 | KODA    | 99.1  | Houston      | TX | sunny99.com 784   |
| 1519 | KMJQ    | 102.1 | Houston      | TX | 784   |
| 1520 | KPAC    | 88.3  | San Antonio  | TX | "..PAC 88.3" at tune in 879   |
| 1526 | Unid    | 91.7  |              |    | 2 <sup>nd</sup> SS fighting Monterrey's 91X                                     |
| 1537 | KQUR    | 94.9  | Laredo       | TX | 1027  |
| 1543 | KHOY    | 88.1  | Laredo       | TX | 1027  |
| 1549 | XHCAO   | 89.1  | Reynosa      | TX | local ads 1084  |
| 1601 | KPUS(t) | 104.5 | Gregory      | TX | NASCAR with local sponsors but still could be another Texan Es just about gone. |

June 24 Tr



|      |         |      |                 |    |   |
|------|---------|------|-----------------|----|---|
| 0244 | WKSF    | 99.9 | Asheville       | NC | ashevillehelpwanted.com "99 Kiss Country"   |
| 0247 | WGWG(t) | 88.3 | Boiling Springs | NC | tentative....smooth jazz and then faded out |
| 0251 | WNCW    | 88.7 | Spindale        | NC | 592   |
| 0258 | WGGC    | 95.1 | Bowling Green   | KY | 350   |

June 24 Es

|      |              |       |         |    |   |
|------|--------------|-------|---------|----|---|
| 1116 | <u>Cuba</u>  | 93.3  | CUBA    |    | Slogan may be "La Voz de Continental" or may just be a program name |
| 1140 | <u>Cuba</u>  | 98.3  | Havana  | CU | La Habana. This one is listed! Similar history on 93.3 at 1128 1292 |
| 1202 | <u>XHCUN</u> | 105.9 | Cancun  | QR | "XHCUN Radio Popular..la voz de Caribe x Mexicano" 1355             |
| 1203 | <u>XHNUC</u> | 105.1 | Cancun  | QR | Cancun ad 1355  |
| 1219 | <u>XGCAQ</u> | 92.3  | Cancun  | QR | ad for Internet Cancun 1355   |
| 1222 | <u>XHYI</u>  | 93.1  | Cancun  | QR | Mix 9.1 also heard same ad that was heard x on 105.9 and 105.1 1355 |
| 1228 | <u>XHCCQ</u> | 91.5  | Cancun  | QR | Cancun ad legal ID heard at 1404 1355                               |
| 1317 | <u>XHQOO</u> | 90.7  | Cancun  | QR | talk about Cancun and "Radio Pirata" slogan                         |
| 1324 | <u>XHCBJ</u> | 106.7 | Cancun  | QR | more Cancun ads "106.7" jingle 1355                                 |
| 1332 | <u>XHGL</u>  | 97.7  | Merida  | YU | 1348  |
| 1335 | <u>XHCAN</u> | 107.5 | Cancun  | QR |   |
| 1350 | Unid         | 100.5 |         |    | Very weak SS tentative XHRTO  |
| 1435 | <u>XHVG</u>  | 94.5  | Merida  | YU | Merida mentions..pre election coverage 1348                         |
| 1440 | <u>XHRB</u>  | 89.9  | Cozumel | QR | more election info...local ad 1400                                  |

June 25 Tr

|      |             |       |                                 |    |  |
|------|-------------|-------|---------------------------------|----|--|
| 0102 | <u>WFCB</u> | 93.3  | Chillicothe<br>Chillicothe" 415 | OH | with WPBG phased "New Mix 93.3 WFCB                    |
| 0259 | <u>WTUE</u> | 104.7 | Dayton                          | OH | with local WLMD off 343                                |
| 0423 | <u>WWWW</u> | 102.9 | Ann Arbor                       | MI | 381  |
| 1100 | <u>KULH</u> | 105.9 | Wheeling                        | MO | "The Wave KULH..Wheeling, Breckenridge, Rockville" 152 |

June 25 Es

|      |              |       |               |    |                              |
|------|--------------|-------|---------------|----|------------------------------|
| 0924 | <u>XHAAA</u> | 93.1  | Reynosa       | TA | 1084                         |
| 1003 | <u>KRFM</u>  | 96.5  | Show Low      | AZ | 1147                         |
| 1006 | <u>KWKM</u>  | 95.7  | Saint John    | AZ | Power 95.7 kwkm.com 1105     |
| 1020 | <u>KAUM</u>  | 107.1 | Colorado City | TX | kvmckaum.com KAUM jingle 794 |
| 1037 | <u>KZII</u>  | 102.5 | Lubbock       | TX | 1070                         |

June 26 Es

|      |             |       |                |    |  |
|------|-------------|-------|----------------|----|--|
| 1130 | <u>KDCD</u> | 92.9  | San Angelo     | TX | "947-KDCD for Las Vegas trip" 827  |
| 1136 | <u>KACT</u> | 105.5 | Andrews        | TX | "the heart of the Country..KACT" 868                                     |
| 1145 | Unid        | 96.5  |                |    | "393-2163 event center concert (suspect Sterling City TX)                |
| 1148 | <u>KCSW</u> | 96.5  | Rock Springs   | WY | 970  |
| 1222 | <u>KSEL</u> | 95.3  | Portales       | NM | "Here's the K-Sel wx forecast" 820                                       |
| 1230 | <u>KRZA</u> | 88.7  | Alamosa        | CO | Alamosa live music association 842                                       |
| 1232 | <u>KWES</u> | 93.5  | Ruidoso        | NM | 964  |
| 1233 | <u>KEND</u> | 106.5 | Roswell        | NM | 908  |
| 1241 | <u>KBKL</u> | 107.9 | Grand Junction | CO | local ads "Cool 107.9" 954   |
| 1243 | <u>KZKS</u> | 105.3 | Rifle          | CO | Rifle mentions & ads "Kicks Country 105.3"                               |
| 1252 | <u>KATP</u> | 101.9 | Amarillo       | TX | 712  |
| 1257 | <u>KUPI</u> | 99.1  | Idaho Falls    | ID | 1118   |
| 1342 | <u>KWRR</u> | 89.5  | Ethete         | WY | 950  |
| 1349 | <u>KADQ</u> | 94.3  | Rexburg        | ID | 1107   |
| 1350 | <u>KGTM</u> | 98.1  | Rexburg        | ID | Pocatello, Idaho Falls and Rexburg ads "Good times music KGTM 98.1" 1107 |
| 1359 | <u>KBYI</u> | 100.5 | Rexburg        | ID | 1107   |
| 1406 | <u>KUER</u> | 90.1  | Salt Lake City | UT | 1113   |
| 1408 | <u>KKLX</u> | 96.1  | Worland        | WY | 918  |

June 27 Es

|      |             |      |        |    |     |
|------|-------------|------|--------|----|-----|
| 1128 | <u>KKMJ</u> | 95.5 | Austin | TX | 809 |
|------|-------------|------|--------|----|-----|

July 3 Es

|      |             |       |            |    |  |
|------|-------------|-------|------------|----|--|
| 0859 | <u>WGOR</u> | 93.9  | Martinez   | GA | "WGOR...Martinez-Augusta....Good Time Oldies 93.9" 677                       |
| 0919 | <u>WAIA</u> | 107.1 | Melbourne  | FL | 1029   |
| 0932 | <u>WWRZ</u> | 98.3  | Fort Meade | FL | 1045   |
| 0935 | Unid        | 102.3 |            |    | "The all new Blazin 102.3...102 Blazin days of summer" Ad for Proctor Accura |
| 0950 | <u>WBAM</u> | 98.9  | Montgomery | AL | Montgomery Ad...former TR catch 608  |

|                   |         |       |                            |    |   |      |
|-------------------|---------|-------|----------------------------|----|---|------|
| 0957              | Unid    | 104.3 |                            |    | "Jim Lawson show tomorrow at 6"   |      |
| 1011              | WHTQ    | 96.5  | Orlando                    | FL | "96.5 WHTQ"   | 978  |
| 1016              | WLTS    | 105.3 | Kenner                     | LA | Kirschman's Nissan...NO mention (how far did this move? Is it considered new from 725 |      |
| 1021              | KFTE    | 96.5  | Slidell?)<br>Breaux Bridge | LA | "Planet Radio 96.5"   | 707  |
| <u>July 4 Tr</u>  |         |       |                            |    |   |      |
| 0501              | KZPL    | 97.3  | Lee's Summit               | MO | "KZPL Lee's Summit....The Planet's Best Music 97.3"                                   | 224  |
| 0511              | KRLI    | 103.9 | Malta Bend                 | MO | KRLI Community Calendar   | 167  |
| 0527              | KPOW    | 97.7  | La Monte                   | MO | "100,000 watts of Power 97"   |      |
| <u>July 9 Es</u>  |         |       |                            |    |   |      |
| 2131              | WFCT    | 105.5 | Apalachicola               | FL | Port St Joe ad..."Coast weather"  | 807  |
| 2139              | WKXK    | 96.7  | Pine Hill                  | AL | Montgomery ad   | 608  |
| 2159              | WMAU    | 88.9  | Bude                       | MS | Legal ID  | 621  |
| <u>July 12 Es</u> |         |       |                            |    |   |      |
| 1023              | KWNM    | 105.5 | Hurley                     | NM | SW NM wx "from the KWNM news and x information center"                                | 1105 |
| 1030              | XHNGS   | 96.7  | Nogales                    | SO | Nogales AZ ad "En la FM Globo"  | 1298 |
| 1031              | XHEM    | 103.5 | Cd Juarez                  | CI | 1070  |      |
| 1044              | KFMM    | 99.1  | Thatcher                   | AZ | 1182  |      |
|                   | KWFM    | 97.1  | Green Valley               | AZ | This 330 watter in well nothing on 96.1   |      |
| 1058              | Unid    | 96.9  |                            |    | brief strong Mexican (nothing near see 1123)  |      |
| 1110              | XHNRI   | 93.7  | Merida                     | YU | 1348  |      |
| 1123              | XHCPH   | 96.9  | Hidalgo del Parral         | CI | Parral ads  | 1275 |
| 1136              | XHHPR   | 101.7 | Hidalgo del Parral         | CI | "Radio Parral" jingle   | 1275 |
| 1140              | XHHAC   | 90.9  | Chihuahua                  | CI | 1199  |      |
| 1150              | XHONG   | 100.9 | Ojinaga                    | CI | local mentions  | 1060 |
| 1157              | XHCRCG  | 102.9 | Cd Camargo                 | CI | "Super FM" slogan..Camargo mentions   | 1084 |
| 1216              | XHHIH   | 102.5 | Ojinaga                    | CI | Local ad  |      |
| 1222              | KFZX    | 102.1 | Gardendale                 | TX | "102.1 FZX"   | 1060 |
| 1230              | XHCHA   | 104.5 | Chihuahua                  | TX | 1199  |      |
| 1239              | XHECS   | 97.3  | Nuevo Sacramento           | CI | 1197  |      |
| 1738              | WSYR    | 94.7  | Gifford                    | FL | 1059  |      |
| 1906              | KQOL    | 93.1  | Las Vegas                  | NV | 1359  |      |
| 1916              | KQMR    | 99.3  | Indian Springs             | NV | "Amor 99.3" Mexican Lite Rock format  | 1378 |
| 1923              | KXTE    | 107.5 | Pahrump                    | NV | 1404  |      |
| <u>July 15 Tr</u> |         |       |                            |    |   |      |
| 0729              | KJCK    | 97.5  | Junction City              | KS | Junction City ad  | 342  |
| 0740              | KLNE    | 88.7  | Lexington                  | NE | 477   |      |
| 0754              | KKTR    | 89.7  | Kirksville                 | MO | w / W209AL phased   | 102  |
| 0820              | KJHK    | 90.7  | Lawrence                   | KS | w / KHGN phased ...calls  | 263  |
| 0906              | KACZ    | 96.3  | Riley                      | KS | w / KRNQ phased ...Legal ID   | 350  |
| 0925              | KKQY    | 101.9 | Hill City                  | KS | First Natl Bank of Brighton   | 492  |
| <u>July 16 Tr</u> |         |       |                            |    |   |      |
| 1601              | KJYL    | 100.7 | Eagle Grove                | IA | w / KKRQ phased "we are Kinship Christian Radio" then Legal ID                        | 227  |
| 1644              | WJMC    | 96.1  | Rice Lake                  | WI | 353   |      |
| 1650              | WXYM    | 96.1  | Tomah                      | WI | w / KMXG phased on this and above catch   |      |
| 1708              | KRDS    | 95.5  | New Prague                 | MN | 318   |      |
| 1732              | KJCY    | 95.5  | St. Ansgar                 | IA | local wx including Mason City mention   | 245  |
| 1815              | KIHK    | 106.9 | Rock Valley                | IA | 316   |      |
| 1852              | WYTE    | 96.7  | Whiting                    | WI | 284   |      |
| 1900              | WMMA    | 93.9  | Nekosa                     | WI | w / KIAI phased ...Legal ID   | 270  |
| 2026              | KIOW    | 107.3 | Forest City                | IA | w / KGRS phased   | 248  |
| 2100              | WFMP    | 107.1 | Coon Rapids                | MN | Legal ID  | 350  |
| 2200              | KQQL    | 107.9 | Anoka                      | MN | over KFMW with no phasing   | 355  |
| 2228              | KGGN    | 101.5 | Ortonville                 | MN | 446   |      |
| 2250              | KARL    | 105.1 | Tracy                      | MN | w / KCCQ phased   | 364  |
| 2300              | KRRW    | 101.5 | St James                   | MN | w / KCSI phased "Country 101.5 is KRRW St James 11:00"                                | 317  |
| 2356              | WDRK    | 99.1  | Cornell                    | WI | w / KAUS phased "WDRK Cronell-Eau Claire"   | 325  |
| <u>July 19 Tr</u> |         |       |                            |    |   |      |
| 0116              | KRPR    | 89.9  | Rochester                  | MN | "a service of Rochester Public Radio"   | 264  |
| 0115              | KPSD(t) | 97.1  | Faith                      | SD | never in at ID time   | 658  |

|      |             |       |                |    |   |
|------|-------------|-------|----------------|----|---|
| 0126 | <u>KOLY</u> | 99.5  | Mobridge       | SD | w / KKMA phased ...local ads "Star 99 wx"   |
| 0206 | <u>KZNG</u> | 99.1  | Huron          | SD | "we-fest Tickets" "Kissin Country Forecast"                                       |
| 0300 | <u>KINI</u> | 96.1  | Crookston      | NE | Religion 586  |
| 0638 | <u>KGIM</u> | 103.7 | Redfield       | SD | very strong 503   |
| 0644 | <u>KEXL</u> | 106.7 | Norfolk        | NE | 367   |
| 0713 | <u>KNBZ</u> | 97.7  | Redfield       | SD | w / WMOI phased "the station for today's<br>best hits Z97..KNBZ FM" 503           |
| 0716 | <u>KMLO</u> | 100.7 | Lowry          | SD | w / KKRZ phased Slogan 573  |
| 0844 | <u>WIBW</u> | 94.5  | Topeka         | KS | w / KRXL phased...local ads ...slogan   |
| 1301 | <u>KQLS</u> | 100.3 | Colby          | KS | Legal ID...they are Q100 no LS Radio 555  |
| 1311 | <u>KHOK</u> | 100.7 | Hoisington     | KS | w / KMZU phased "Eagle Country 101 and<br>local weather and ads 453               |
| 1334 | <u>KRGY</u> | 97.3  | Aurora         | NE | 385   |
| 1335 | <u>KDGS</u> | 93.9  | Andover        | KS | w / WCEZ phased...Power 93.9 395  |
| 1339 | <u>KBGL</u> | 106.9 | Larned         | KS | Alltel (Great Bend, Hayes) 477  |
| 1400 | <u>KPRD</u> | 88.9  | Hays           | KS | w / KRNW phased .."thank you for your x<br>support of KPRD"473                    |
| 1433 | <u>KINZ</u> | 95.3  | Humboldt       | KS | w / KOKX phased "KINZ"318   |
| 1503 | <u>KIWR</u> | 89.7  | Council Bluffs | IA | through local 278   |
| 1600 | <u>KRNW</u> | 88.9  | Chillicothe    | MO | 159   |
| 2054 | <u>KQNS</u> | 95.5  | Lindsbourg     | KS | Salina and other local ads TOH ID 395   |
| 2120 | <u>KZBZ</u> | 104.9 | Salina         | KS | Salina ads ..."The Buzz 104.9" 386  |
| 2300 | <u>KCVW</u> | 94.3  | Kingman        | KS | w / WRMS phased..Legal ID Witchita wx 444   |
| 2327 | <u>KQMA</u> | 92.5  | Phillipsburg   | KS | w / WKXQ phased "92.5 KKAN-KQMA you're<br>listening to keeping the 70s alive" 460 |
| 2359 | <u>KAKA</u> | 88.5  | Salina         | KS | w / WGCA phased ...Legal ID ..weak 386  |

July 19 Es

|      |             |       |               |    |      |
|------|-------------|-------|---------------|----|------|
| 1347 | <u>WXTK</u> | 95.1  | West Yarmouth | MA | 1067 |
| 1347 | <u>WFCC</u> | 107.5 | Chatham       | MA | 1082 |

July 20 Tr

|      |             |      |              |    |   |
|------|-------------|------|--------------|----|---|
| 0111 | <u>KANR</u> | 92.7 | Belle Plaine | KS | "this is Jesse James and you're listening to<br>the Deadhead Rockout" confirmed by<br>phone 413 |
|------|-------------|------|--------------|----|---|

July 25 Es

|      |              |       |                  |    |   |
|------|--------------|-------|------------------|----|---|
| 1734 | <u>CBKS</u>  | 105.5 | Saskatoon        | SK | classical...presumed 1110   |
| 1735 | <u>KZZY</u>  | 103.5 | Devils Lake      | ND | "keep it right here for the best..on Double Z<br>Country 662                      |
| 1742 | <u>KYYX</u>  | 97.1  | Minot            | ND | "...on 97 Kicks FM" 752   |
| 1748 | <u>KLCE</u>  | 97.3  | Blackfoot        | ID | 1132  |
| 1753 | <u>KGTM</u>  | 98.1  | Rexburg          | ID | 1107  |
| 1800 | <u>CHSK</u>  | 95.7  | Swift Current    | SK | "this is CBC Radio 2 in Saskatoon at 96.9 in<br>Regina, 105.5 in Saskatoon" 1075  |
| 1912 | <u>CHHK</u>  | 93.3  | Taber            | AB | "Classic Rock 93.3 The Hawk" 1250   |
| 2016 | <u>CKUA3</u> | 97.3  | Medicine Hat     | AB | 1177  |
|      | <u>CBRM</u>  | 98.3  | Medicine Hat     | AB | presumed  |
| 2037 | <u>CJCQ</u>  | 97.9  | North Battleford | SK | 1194  |
| 2100 | <u>KLMP</u>  | 97.9  | Rapid City       | SD | Black Hills, Rapid City mentions "KLMP The<br>Light" into Focus on the Family 690 |
| 2106 | <u>KLGT</u>  | 92.9  | Buffalo          | WY | 861   |
| 2116 | <u>KZZS</u>  | 98.3  | Story            | WY | "98.3 The Peak" confirmed by phone 878  |
| 2117 | <u>WRTO</u>  | 98.3  | Goulds           | FL | 1189  |
| 2131 | <u>KMMS</u>  | 95.1  | Bozeman          | MT | 1090  |
| 2149 | <u>Unid</u>  | 95.5  |                  |    | Colorado Rockies baseball   |

July 28 Es

|      |              |       |           |    |                              |
|------|--------------|-------|-----------|----|------------------------------|
| 0950 | <u>Unid</u>  | 95.7  |           |    | MUF at the time...faded fast |
| 1000 | <u>XHRYS</u> | 90.1  | Reynosa   | TA | Legal ID 1084                |
| 1103 | <u>XHPAG</u> | 105.3 | Monterrey | NL | Legal ID 1161                |

August 1 Es

|      |              |      |                  |    |  |
|------|--------------|------|------------------|----|--|
| 1132 | <u>XHITE</u> | 94.9 | Monterrey        | NL | Caribbean music prgrm...matches website<br>other Monterrey's to 103.7 1161 |
| 1150 | <u>KZSP</u>  | 95.3 | South Padre Isld | TX | 1067   |
| 1150 | <u>KKPS</u>  | 99.5 | Brownsville      | TX | 1080   |

August 5 Es

|      |              |       |             |    |      |
|------|--------------|-------|-------------|----|------|
| 1941 | <u>XHAAA</u> | 93.1  | Reynosa     | TA | 1084 |
| 1945 | <u>KTEX</u>  | 100.3 | Brownsville | TX | 1080 |

August 20 Tr

|      |      |       |                 |    |  |
|------|------|-------|-----------------|----|--|
| 0208 | CJQM | 104.3 | Sault Ste Marie | ON | "Soo Weather" 526                          |
| 0251 | WBDK | 96.7  | Algoma          | WI | "50 years of favorites WBDK" 330           |
| 0300 | WVXA | 96.7  | Rogers City     | MI | Legal ID 488                               |
| 0353 | WHAK | 99.9  | Rogers City     | MI | w / WIXO phased multi station Legal ID 488 |
| 0440 | WCCW | 107.5 | Traverse City   | MI | w / WGCI phased local mentions & ads 394   |

August 21 Tr

|      |      |       |               |    |  |
|------|------|-------|---------------|----|--|
| 1930 |      |       |               |    | Lexington NE 88.7 and 93.1                   |
| 2056 | KXNP | 103.5 | North Platte  | NE | 530  |
| 2200 | KAMI | 104.5 | Cozad         | NE | Legal ID 489                                 |
| 2205 | KBBN | 98.3  | Broken Bow    | NE | w / KRKQ phased local weather Legal ID 473   |
| 2251 | KNCY | 103.1 | Nebraska City | NE | "you won't find a better radio station KNCY" |

August 22 Tr

|      |      |       |              |    |  |
|------|------|-------|--------------|----|--|
| 0034 | KMCX | 106.5 | Ogallala     | NE | "KMCX" inserted in C&W format prev Es                              |
| 0043 | KJJC | 107.1 | Osceola      | IA | New format   |
| 0113 | KNDY | 95.5  | Marysville   | KS | w / WGLO phased KNDY between songs                                 |
| 0312 | WDAF | 106.5 | Liberty      | MO | New Format   |
| 0353 | KKYY | 101.3 | Whiting      | IA | Y-101.3 local mentions 345   |
| 2059 | KJIA | 88.9  | Spirit Lake  | IA | 3 Station Legal ID 307   |
| 2130 | KOKS | 89.5  | Poplar Bluff | MO | Legal ID (antenna toward Ft Dodge) 256                             |
| 2144 | KXOQ | 104.3 | Kennett      | MO | Promo for Cardinal BB on 97.5 then promo for "104.3 The Quake" 293 |

August 24 Tr

|      |      |       |                |    |  |
|------|------|-------|----------------|----|--|
| 0059 | KRBI | 105.5 | St Peter       | MN | w / KILJ phased Legal ID 313           |
| 0101 | KIOW | 107.3 | Forest City    | IA | w / KGRS phased Legal ID 248           |
| 0200 | KQPR | 96.1  | Albert Lea     | MN | w / KMXG phased Legal ID 261           |
| 0315 | WJMC | 96.1  | Rice Lake      | WI | w / KMXG phased                        |
| 1633 | WTGR | 97.5  | Union City     | OH | w / WHMS Strong! 310                   |
| 1651 | WDFM | 98.1  | Defiance       | OH | on top without any phasing 334         |
| 2104 | WIOK | 107.5 | Falmouth       | KY | Legal ID 359                           |
| 2158 | WYSO | 91.3  | Yellow Springs | OH | w / WILM phased Legal ID..wyso.org 361 |

August 26 Tr

|      |      |       |                |    |   |
|------|------|-------|----------------|----|---|
| 0003 | WGFX | 104.5 | Gallatin       | TN | w / WFMB phased 361                       |
| 0049 | WRQQ | 97.1  | Goodlettsville | TN | w / KFTK phased "Nashville's New Star 97" |
| 0118 | WBDC | 100.9 | Huntingburg    | TN | w / WZUS phased 248                       |
| 0450 | WGUC | 90.9  | Cincinnati     | OH | w / WILL 2 Program promos and Legal ID    |
| 0505 | WDGG | 93.7  | Ashland        | KY | last heard as WRVC in the 80s 450         |
| 0508 | WGGC | 95.1  | Glasgow        | KY | w / WDZQ phased                           |
| 0533 | WRVY | 101.5 | Gallipolis     | OH | local mentions "101.5 The River" 464      |
| 0600 | WXCH | 103.1 | Versailles     | IN | Legal ID for this and WSCH 303            |

**Bob Seybold 1865 W. Main Rd Silver Creek, NY 14136**

June 10 Es between 1000-1230

|      |       |              |    |
|------|-------|--------------|----|
| WFIT | 89.5  | Orlando      | FL |
| WMCU | 89.7  | Miami        | FL |
| WLPT | 88.3  | Jessup       | GA |
| WMGB | 95.1  | Montezuma    | GA |
| WUWF | 88.1  | Pensacola    | FL |
| KXKZ | 107.5 | Ruston       | LA |
| WAVV | 101.1 | Marco Island | FL |

June 20 Es

|      |      |           |    |
|------|------|-----------|----|
| KRNA | 94.1 | Iowa City | IA |
| CHIQ | 94.3 | Winnipeg  | MB |

July 19 Es

25 stations from GA, FL, MS and AL but many were difficult to ID

|      |       |            |    |
|------|-------|------------|----|
| WBAM | 98.9  | Montgomery | AL |
| WACR | 103.9 | Columbus   | MS |
| WLZA | 96.1  | Europa     | MS |
| WYOY | 101.7 | Gluckstadt | MS |

July 21 Es

Canadians to the Northwest

July 30 Es

|      |      |            |    |
|------|------|------------|----|
| WLRH | 89.3 | Huntsville | AL |
| WUAL | 91.5 | Tuscaloosa | AL |
| WNLE | 91.7 | Fernandina | FL |
| WSJT | 94.1 | Lakeland   | FL |

August 21 Tr

To the NW...Ottawa, Montreal, Plattsburg and Watertown

August 24 Tr

To the WNW...Chicago, South Bend, Milwaukee, Grand Rapids and Indianapolis

September 7 Tr

To the WSW....TN, KY and southern OH

November 4 – 6 Tr

Great Tr opening starting in MN to WI and MI ....ending on east coast.

|      |       |              |    |
|------|-------|--------------|----|
| KESD | 88.3  | Brookings    | SD |
| WYZY | 106.3 | Saranac Lake | NY |
| WZMX | 93.7  | Hartford     | CT |
| WVPS | 107.9 | Burlington   | VT |
| WPNE | 89.3  | Green Bay    | WI |

**Steve Solomon Yarmouthport, MA mail@stevemcvie.com**

*Equipment: Yamaha T-85 & Kenwood KR-6400 modified, APS-13 at 28*

July 19 Es

|                              |      |       |    |                  |
|------------------------------|------|-------|----|------------------|
| 1215                         | WKSJ | 94.9  | AL |                  |
| 1220                         | WZYP | 104.3 | AL |                  |
| 1225                         | WQLD | 104.3 | AL |                  |
| 1250                         | WXRR | 104.5 | MS | ROCK 104         |
| 1255                         | WSLY | 104.9 | AL | Sly              |
| 1302                         | WMAX | 105.3 | GA |                  |
| 1303                         | WBPT | 106.9 | AL |                  |
| 1320                         | WQLT | 107.3 | AL | Q107-Paul Harvey |
| 1345                         | KLAL | 107.7 | AR | 1280             |
| 1345                         | WMGI | 100.7 | IN | Mix-FM           |
| 1350                         | KMZU | 100.7 | MO |                  |
| 1355                         | KLAZ | 105.9 | AR |                  |
| 1356                         | KKRQ | 100.7 | IA | Fox              |
| 1409                         | KBCN | 104.3 | AR | 1310             |
| 1418                         | KKDY | 102.5 | MO |                  |
| 1420                         | KTXR | 101.3 | MO |                  |
| 1440                         | KGGO | 94.9  | IA |                  |
| 1457                         | KNIM | 97.1  | MO |                  |
| 1200-1440 rolled unattended: |      |       |    |                  |
|                              | KFIN | 107.9 | AR | K-Fine           |
|                              | WCVQ | 107.9 | KY |                  |
|                              | WFCA | 107.9 | MS |                  |
|                              | KEZK | 102.5 | MO |                  |
|                              | KIXQ | 102.5 | MO | Kix 102.5        |
|                              | KSTZ | 102.5 | IA | Star 102.5       |
|                              | WEZB | 97.1  | LA |                  |
|                              | WOKK | 97.1  | MS |                  |

July 20 Es

|     |      |      |    |
|-----|------|------|----|
| 945 | WTYX | 94.7 | MS |
| 949 | WKOR | 94.9 | MS |

July 21 Tr

|      |      |       |    |
|------|------|-------|----|
| 0635 | WGNV | 103.1 | NY |
| 1900 | CBAF | 102.3 | NB |

|      |      |      |    |            |
|------|------|------|----|------------|
| 1910 | WKSQ | 94.5 | ME | over local |
|------|------|------|----|------------|

July 21 Es

|      |      |       |    |                       |
|------|------|-------|----|-----------------------|
| 2100 | KUND | 89.3  | ND | 1379                  |
| 2105 | unid | 92.7  |    | classical             |
| 2106 | CHMT | 93.1  | ON | 715                   |
| 2106 | CHIQ | 94.3  | MB | 1407                  |
| 2109 | unid | 97.1  |    | FF                    |
| 2112 | unid | 98.3  |    | CLASSICAL             |
| 2114 | unid | 98.7  |    | mono talk             |
| 2117 | unid | 89.9  |    | mono talk             |
| 2130 | CFNO | 93.1  | ON |                       |
| 2132 | unid | 89.3  |    | FF                    |
| 2138 | unid | 100.9 |    | mono-talk             |
| 2140 | KYYX | 97.1  | ND | 1576 ads-local #s     |
| 2141 | KYCK | 97.1  | MN | Kick                  |
| 2200 | CKLF | 94.7  | MB | 1530 Star             |
| 2200 | KSRQ | 90.1  | MN | 1350                  |
| 2210 | CJSD | 94.3  | ON | 1150 matched internet |
| 2213 | unid | 88.3  |    | talk-mono             |
| 2220 | KZZY | 103.5 | ND | 1464                  |

July 23 Es

|      |      |       |    |               |
|------|------|-------|----|---------------|
| 1043 | KKLV | 94.7  | AR |               |
| 1044 | WHRK | 97.1  | TN |               |
| 1050 | WSIE | 88.7  | IL |               |
| 1100 | WNKJ | 89.3  | KY |               |
| 1101 | WMKR | 94.3  | IL |               |
| 1102 | unid | 94.9  |    | K-Love        |
| 1105 | KKAC | 104.3 | MO |               |
| 1106 | unid | 104.9 |    | Fox Country   |
| 1109 | WYFX | 106.7 | IL | "RDS ""Fox""" |
| 1112 | WDEK | 92.5  | IL | SS            |
| 1114 | WKIO | 92.5  | IL | Oldies 92-5   |
| 1115 | KZLE | 93.1  | AR | Max-FM        |
| 1124 | WLIE | 94.3  | IL | //94.7        |
| 1124 | WLLE | 94.7  | KY |               |
| 1125 | KDAB | 94.9  | AR | 95 The Max    |
| 1127 | KICK | 97.9  | MO | Kick-FM       |
| 1129 | unid | 100.5 |    | WYNT          |
| 1130 | KDEZ | 100.5 | AR | Z100 Rocks    |
| 1140 | WAAG | 94.9  | IL |               |
| 1204 | WXRT | 93.1  | IL |               |
| 1227 | KIAI | 93.9  | IA |               |
| 1237 | WOLX | 94.9  | WI |               |

August 2 Es

|      |      |      |    |  |
|------|------|------|----|--|
| 1000 | WDJR | 96.9 | AL |  |
|------|------|------|----|--|

August 20 Tr

|      |      |       |    |     |
|------|------|-------|----|-----|
| 2330 | CFCA | 105.3 | ON | 530 |
|------|------|-------|----|-----|

August 21 Tr

|      |       |       |    |                        |
|------|-------|-------|----|------------------------|
| 0721 | CFMX  | 103.1 | ON | 470                    |
| 0722 | CJMX  | 105.3 | ON | 630 EZ Rock            |
| 0808 | WOMC  | 104.3 | MI | 660                    |
| 0820 | WWFY  | 100.9 | VT | 250                    |
| 0830 | WMUZ  | 103.5 | MI | 660                    |
| 0832 | CIMX  | 88.7  | ON | 650 89X                |
| 0836 | WKRK  | 97.1  | MI | 660 Stern              |
| 0846 | CICX  | 105.9 | ON | 500 Now & then         |
| 1903 | CKBY  | 105.3 | ON | 360 Y105               |
| 1912 | CIDC  | 103.5 | ON | 480 Z103.5             |
| 1913 | CFMX  | 103.1 | ON | 410 very strong!       |
| 1937 | WCVR  | 102.1 | VT | 200 Champ              |
| 1937 | CIME2 | 101.3 | PQ | 480 FF A/C             |
| 1954 | CJMJ  | 100.3 | ON | 360 Magic 100          |
| 2008 | CJEZ  | 97.3  | ON | 480 Delilah-over local |
| 2025 | CHAY  | 93.1  | ON | 510 Chay               |
| 2037 | CKQB  | 106.9 | ON | 360 The Bear           |
| 2040 | WYRK  | 106.5 | NY | 450                    |
| 2042 | CICX  | 105.9 | ON | 500 Lite FM            |
| 2048 | CHUM  | 104.5 | ON | 480 over local!!!!!!   |



|      |      |       |    |     |              |
|------|------|-------|----|-----|--------------|
| 2105 | CFNY | 102.1 | ON | 480 | The Edge     |
| 2114 | CKKL | 93.9  | ON | 360 | Bob          |
| 2117 | CHEY | 94.7  | PQ | 350 | FF           |
| 2126 | CIMF | 94.9  | ON | 360 | FF           |
| 2131 | CHVR | 96.7  | ON | 450 | Star Country |
| 2135 | CHLX | 97.1  | PQ | 370 | FF           |
| 2146 | WBFO | 88.7  | NY | 450 |              |
| 2151 | WNSA | 107.7 | NY | 430 |              |
| 2200 | WVPR | 89.5  | VT | 150 |              |

September 13 Tr

|      |       |       |    |      |    |
|------|-------|-------|----|------|----|
| 0930 | CJLM  | 103.5 | PQ | 350  | FF |
| 0950 | WDME  | 103.1 | ME |      |    |
| 0954 | CITE1 | 102.7 | PQ | FF   |    |
| 1047 | CIOK  | 100.5 | NB | K100 |    |
| 1048 | CBAF5 | 92.3  | NS | FF   |    |

September 18 Tr

|      |      |       |    |          |  |
|------|------|-------|----|----------|--|
| 2207 | WVAY | 100.7 | VT | The Fox' |  |
|------|------|-------|----|----------|--|

**Bob Smolarek - 31 Mark Drive - High Bridge NJ 08829**

*McIntosh MR 78 Channel Master Stereo Probe 9 Conrad RDS manager*

June 20 Es

|      |      |      |        |    |           |
|------|------|------|--------|----|-----------|
| 2040 | WWSA | 89.9 | Brule  | WI | classical |
| 2042 | WSCD | 92.9 | Duluth | MN | classical |

July 3 Es

|      |      |      |                        |                 |                      |
|------|------|------|------------------------|-----------------|----------------------|
| 2018 | KTFW | 92.1 | Glen Rose              | TX              | minor league BB game |
| 2020 | KVRE | 92.9 | Hot Springs Village AR | adult standards |                      |
| 2025 | KDOK | 92.1 | Tyler                  | TX              |                      |
| 2032 | KLRK | 92.9 | Marlin                 | TX              | RDS log as LITEROCK  |

July 7 Es

|      |      |      |            |    |                      |
|------|------|------|------------|----|----------------------|
| 2000 | KUHF | 88.7 | Houston    | TX |                      |
| 2008 | KHST | 92.1 | Lamar      | MO | classical            |
| 2037 | KLRK | 92.9 | Marlin     | TX | RDS log as LITEROCK  |
| 2039 | KKBQ | 92.9 | Rockdale   | TX | syndicated Leah show |
| 2056 | KQID | 93.1 | Alexandria | LA |                      |

July 9 Es

|      |      |      |               |    |                              |
|------|------|------|---------------|----|------------------------------|
| 2131 | KANS | 92.9 | Osage City    | KS | RDS log as KS RADIO          |
| 2152 | KNIN | 92.9 | Wichita Falls | TX | CHR                          |
| 2154 | KLTY | 94.9 | Arlington     | TX | contemporary Christian music |
| 2156 | KMGZ | 95.3 | Lawton        | OK | CHR                          |
| 2200 | KOLI | 94.9 | Electra       | TX |                              |
| 2207 | KNID | 99.7 | Alva          | OK |                              |
| 2211 | KFXI | 92.1 | Marlow        | OK | Foxy 92                      |

July 19 Es

|      |      |       |                  |    |                    |
|------|------|-------|------------------|----|--------------------|
| 1128 | WJXR | 92.1  | Macclenny        | FL |                    |
| 1129 | WQHL | 98.1  | Live Oak         | FL | country            |
| 1132 | WIKX | 92.9  | Charlotte Harbor | FL |                    |
| 1133 | WMFQ | 92.9  | Ocala            | FL |                    |
| 1139 | WLPT | 88.3  | Jessup           | GA | "RDS log, PI=734D" |
| 1141 | WNFB | 94.3  | Lake City        | FL | Mix 94.3           |
| 1143 | WXCW | 95.3  | Homosassa Sprg   | FL |                    |
| 1146 | WXTB | 97.9  | Clearwater       | FL | rock               |
| 1147 | WMCD | 100.1 | Statesboro       | GA |                    |
| 1148 | WWUF | 97.7  | Waycross         | GA | Big Wolf           |
| 1150 | WYZK | 96.7  | Valdosta         | GA |                    |
| 1151 | WSKY | 97.3  | Micanopy         | FL | news/talk          |
| 1151 | WHHZ | 100.5 | Newberry         | FL | The Buzz           |
| 1155 | WRBQ | 104.7 | Tampa            | FL | oldies             |
| 1156 | WIFO | 105.5 | Jessup           | GA | Big Dog Country    |
| 1200 | WXMK | 105.9 | Dock Junction    | GA | Magic 105.9        |
| 1200 | WOCY | 106.5 | Carrabelle       | FL | Oyster Country     |
| 1202 | WOKA | 106.7 | Douglas          | GA | Dixie Country      |

|      |      |       |                        |                 |                             |
|------|------|-------|------------------------|-----------------|-----------------------------|
| 1208 | WBGA | 107.7 | Darien                 | GA              | The Beach                   |
| 1211 | WTUF | 106.3 | Boston                 | GA              |                             |
| 1213 | WLOW | 107.9 | Hilton Head Island SC  | adult standards |                             |
| 1221 | WVKX | 103.7 | Irwinton               | GA              |                             |
| 1224 | WWLD | 102.3 | Cairo                  | GA              | Blazin' 102.3               |
| 1228 | WFSY | 98.5  | Panama City            | FL              | RDS log as Sunny            |
| 1230 | WFXF | 97.3  | Bainbridge             | GA              | RDS log as Real Rock        |
| 1230 | WDJR | 96.9  | Enterprise             | AL              | RDS log as CNTRY969         |
| 1234 | WRJM | 93.7  | Geneva                 | AL              | last heard in 1986 on 93.5! |
| 1236 | WIOL | 92.7  | Eufaula                | AL              | The River                   |
| 1238 | WKSM | 99.5  | Fort Walton Beach FL   | rock            |                             |
| 1240 | WOOF | 99.7  | Dothan                 | AL              |                             |
| 1245 | WAVH | 106.5 | Daphne                 | AL              | oldies                      |
| 1248 | WHTA | 107.9 | Hampton                | GA              | urban                       |
| 1253 | WKGQ | 107.3 | Columbus               | GA              |                             |
| 1255 | KBZE | 105.9 | Berwick                | LA              | urban                       |
| 1259 | WRAX | 107.7 | Birmingham             | AL              | The X                       |
| 1300 | WLMG | 101.9 | New Orleans            | LA              | Magic                       |
| 1302 | WJDQ | 101.3 | Meridian               | MS              | Q 101                       |
| 1306 | WBEI | 101.7 | Reform                 | AL              | The New B 101.7             |
| 1311 | KNEK | 104.7 | Washington             | LA              | adult R&B                   |
| 1312 | WSTZ | 106.7 | Vicksburg              | MS              | classic rock                |
| 1318 | WFCA | 107.9 | Ackerman               | MS              |                             |
| 1330 | WTCD | 96.9  | Indianola              | MS              | talk                        |
| 1335 | WOXD | 95.5  | Oxford                 | MS              |                             |
| 1338 | KPCH | 97.7  | Dubach                 | LA              | RDS log as KPCH-FM          |
| 1340 | WJMI | 99.7  | Jackson                | MS              | Jams                        |
| 1341 | WBLE | 100.5 | Batesville             | MS              |                             |
| 1342 | KQEW | 102.3 | Fordyce                | AR              | KQ 102.3                    |
| 1346 | KCXY | 95.3  | East Camden            | AR              | RDS log as KCXY-Y95         |
| 1349 | KMSX | 94.9  | Maumelle               | AR              | RDS log as MIX949           |
| 1350 | KVRE | 92.9  | Hot Springs Village AR | adult standards |                             |
| 1353 | KURB | 98.5  | Little Rock            | AR              | Hot AC                      |
| 1357 | WGKY | 95.9  | Wickliffe              | KY              | reading obituaries          |
| 1400 | KTTG | 96.3  | Mena                   | AR              | sports                      |
| 1401 | KKBD | 95.9  | Sallisaw               | OK              | The Big Dog                 |
| 1405 | KKEG | 92.1  | Fayetteville           | AR              | The Zone                    |
| 1422 | KTJJ | 98.5  | Farmington             | MO              | J-98 Kickin' Country        |
| 1423 | KJMK | 93.9  | Webb City              | MO              | AC                          |
| 1424 | KSD  | 93.7  | St. Louis              | MO              | The Bull                    |
| 1425 | KLOZ | 92.7  | Eldon                  | MO              |                             |
| 1425 | WNNS | 98.7  | Springfield            | IL              |                             |
| 1426 | KCMQ | 96.7  | Columbia               | MO              | RDS log                     |
| 1432 | KCHI | 98.5  | Chillicothe            | MO              |                             |
| 1433 | KPOW | 97.7  | La Monte               | MO              |                             |
| 1434 | KTGL | 92.9  | Beatrice               | NE              | The Eagle                   |

July 23 Es

|      |      |      |             |    |                  |
|------|------|------|-------------|----|------------------|
| 2020 | WWSA | 89.9 | Brule       | WI | classical        |
| 2027 | WSCD | 92.9 | Duluth      | MN | classical        |
| 2100 | WPGP | 88.3 | Tafton      | PA | religious        |
| 2122 | KDJS | 95.3 | Willmar     | MN | "RDS, P.I.=18E8" |
| 2143 | KQDS | 94.9 | Duluth      | MN |                  |
| 2158 | KMXK | 94.9 | Cold Spring | MN | Mix 94.9         |

September 6 Tr

|      |      |       |                |    |  |
|------|------|-------|----------------|----|--|
| 2225 | WHBR | 103.1 | Parkersburg    | WV |  |
| 2327 | WJAN | 100.9 | McConnelsville | OH |  |

September 7 Tr

|      |      |       |            |    |                        |
|------|------|-------|------------|----|------------------------|
| 1838 | WRFX | 99.7  | Kannapolis | NC | Carolina Panther's PBP |
| 1840 | WLNK | 107.9 | Charlotte  | NC | The Link               |
| 1925 | WWRT | 104.9 | Strasburg  | VA |                        |
| 2104 | WKEE | 100.5 | Huntington | WV |                        |
| 2235 | WSSL | 100.5 | Gray Court | SC | Foxworthy Countdown    |

**Jason Koralja Surf City, NJ**

*Sony ICF-SW7600GR w/ built in whip antenna*

November 3 Tr

|      |      |           |    |       |
|------|------|-----------|----|-------|
| WERQ | 92.3 | Baltimore | MD | 135mi |
|------|------|-----------|----|-------|

|      |       |            |    |   |
|------|-------|------------|----|---|
| WPOC | 93.1  | Baltimore  | MD | 140mi                                   |
| WKYS | 93.9  | Washington | DC | 163mi (over normal reception of W230AA) |
| WRDX | 94.7  | Dover      | DE | 81mi (usually get WFME)                 |
| WRBS | 95.1  | Baltimore  | MD | 136mi (over local 50,000 watt WAYV!)    |
| WKDB | 95.3  | Laurel     | DE | 113mi                                   |
| WVKL | 95.7  | Norfolk    | VA | 233mi                                   |
| WFLB | 96.5  | Laurinburg | NC | 431mi                                   |
| WWDC | 101.1 | Washington | DC | 161mi (over normal reception of WBEB)   |
| WXPZ | 101.3 | Milford    | DE | 90mi                                    |

November 18 Tr

|      |      |             |    |        |
|------|------|-------------|----|--------|
| WMJC | 94.3 | Smithtown   | NY | 91mi   |
| WDAC | 94.5 | Lancaster   | PA | 111mi  |
| WVKL | 95.7 | Norfolk     | VA | 233mi  |
| WCTK | 98.1 | New Bedford | MA | 218 mi |



**“TOWER SITE 2004 CALENDAR” GOES ON SALE**  
*Third Edition Follows Two Consecutive Sold Out Editions*

**CONTACT:** Scott Fybush, 585-442-5411 (scott@fybush.com)

ROCHESTER, N.Y. – Fans of radio and television transmitter sites will once again have something to hang on their walls in 2004, thanks to the creator of “Tower Site of the Week” ([www.fybush.com/featuredsite.html](http://www.fybush.com/featuredsite.html)) and “NorthEast Radio Watch” ([www.fybush.com/nerw.html](http://www.fybush.com/nerw.html)).

Now in its third year, the full-color monthly calendar has become a tradition for many radio engineers and a curiosity for those who think all radio towers look alike.

Even after more than tripling the press run from the inaugural 2002 edition, the 2003 edition sold out within months.

“Fans of broadcast towers have never had a calendar like this,” Fybush said. “There’s an untapped market out there that was just waiting for it, apparently.”

Like the 2002 and 2003 editions, each month of the 2004 calendar will feature an 8”x11” color photograph of a broadcast transmitter site, taken by Fybush during his travels around the U.S., Canada and beyond. Sites to be pictured on the 2004 calendar include:

- WCBS/WFAN, New York, the only tower in America that radiates 100,000 watts on AM, not to mention both the Yankees and the Mets
- CKLW, Windsor, Ontario, the legendary top-40 station of the Midwest in the 60s and 70s
- KHJ, Los Angeles, the iconic Southern California top-40 AM outlet
- WTEM (formerly WRC), Washington D.C.
- Cedar Hill, Texas, home to Dallas-Fort Worth’s FM and TV signals and one of the biggest tower clusters in America
- WBT, Charlotte, N.C., the only site in the world with three diamond-shaped Blaw-Knox guyed radio towers
- A tribute to the broadcast facilities destroyed in a fire on Mount Washington, N.H. in early 2003

In addition to tower photos, the calendar’s monthly pages include significant dates in radio and television history as well as civil and religious holidays and major industry trade shows and events.

The high-quality, professionally printed calendar will ship in early December, but orders are being taken immediately.

Like the 2003 edition, the 2004 calendars cost \$16 each, postpaid (\$17.28 including sales tax for New York State residents), and can be purchased by check (payable to “Scott Fybush”) or money order to 92 Bonnie Brae Avenue, Rochester NY 14618. Orders can also be placed with major credit cards at [www.fybush.com](http://www.fybush.com).

“It’s been exciting to travel around the country and see the calendar hanging in radio stations from coast to coast,” says Fybush, who also edits the radio directory site [10000watts.com](http://10000watts.com) and is a regular contributor to the trade publication *Radio World*.

**EDITORS:** High-resolution digital images of calendar pages and photos are available on request.

# FM NEWS

Steven C. Wiseblood  
28 LBJ Blvd.  
Brownsville, TX 78521  
stevenwisebl@hotmail.com

## **ABBREVIATIONS:**

AFA: American Family Association  
CC: call letter change  
CL: city of license change  
CX: a construction permit has been cancelled  
C1, C2, etc.: a change in status to that FM license class  
DA: directional antenna  
DE: station has been deleted  
FC: format change  
GA: granted amendment to the table of FM allocations  
GE: granted extension of construction permit  
GX: granted replacement of expired permit  
LC: license to cover filed (ready to come on the air)  
MC: multiple-city ID  
NC: no change yet on a reported change or permit  
ND: non directional antenna

NO: not on the air  
NS: new station granted  
NW: new station signs on  
OSA: one step application granted for change  
PA: proposed amendment change to FM allocation table  
PC: power change on the air (> = increase, < = decrease)  
PG: power change granted (> = increase, < = decrease)  
QC: frequency changed occurred  
QG: frequency change granted  
RA: silent stations returns to the air  
RE: station requests an extension on permit  
RX: station requests replacement of expired permit  
SC: slogan change or update  
SI: station is silent  
XA: dismissed amendment to FM allocations  
XC: transmitter site change occurred  
XG: transmitter site change granted



## **ALABAMA:**

Selma: WBFZ 105.3 ,FC "hip-hop", SC "Z-105.3", RA

## **ARKANSAS:**

Prairie Grove: KYNF 94.9, CC (ex KFBV) .

## **CALIFORNIA:**

Escondido: KFSD 92.1, FC to country, //KSON-FM 97.3  
Grass Valley: KCEE 103.3 NW (Sacramento)  
Placerville: KZSA 92.1 FC to country, RA (Sacramento)  
Rosedale: KOGR 88.9 NW  
San Jacinto: KWRP 96.1. FC to rhythmic top-40, SC as "Wild 96, (San Bernardino/Riverside)  
Williams: KARA 99.1, NW, "Air 1", Christian rock  
Yermo: KRSX 105.3, CC (ex KJAT), FC to oldies, SC as "Cruisin' 105.3" (Barstow)

## **COLORADO:**

Carbondale: KNTE 88.9, NW  
Dolores: KKDC 93.3, NW

## **FLORIDA:**

Clearwater: WBTP 95.7, CC (ex WSSR), FC to R&B,  
SC to "The Beat" (Tampa-St. Petersburg)

## **GEORGIA:**

Hinesville: WSSJ 92.3, CC (ex WSKX)

## **ILLINOIS:**

Arlington Heights: WCLR 88.3, "Air 1", Christian rock, NW  
Clinton: WHOW 95.9, country, RA



## **INDIANA:**

Fort Wayne: WYLT 103.9, hot AC, SC as "My 103.9."

Roanoke: WCKZ 94.1, FC to classic rock, SC as "Z-94.1 (Fort Wayne)

Shelbyville: WENS 97.1, hot AC, SC as "Real 97.1."(Indianapolis)



## **IOWA:**

Ankeny: KDRB 106.3, CC (ex KVJZ), FC to R&B, SC as "The Beat" (Des Moines)  
Boone: KRKQ 98.3, FC to talk, (Des Moines)  
Hosts include Sean Hannity & Michael Savage

## **KENTUCKY:**

Glasgow: WLYE 94.1 CC (ex WGBV)  
SC as "Willie 94.1"

## **LOUISIANA:**

Erath: KRKA 107.9, FC to R&B, SC as "Hot 107.9" (Lafayette)  
Jonesville: KTGTV 105.1, CC (ex KTYX ), FC to R&B, SC as "105.1 the Groove" (Natchez MS)  
Laplace : WCKW 92.3, FC to AC, SC as "Lite"  
Morgan City : KBZZ 96.7, FC to AC, SC to "Soft Rock 96.7"  
Tallulah: KBYO 104.5, FC to classic rock.

## **MASSACHUSETTS:**

Athol: WAHL 99.9, FC to classic rock, SC as "The Eagle"  
Lowell : WUML 91.5, CC (ex WJUL)

## **MISSOURI:**

Ash Grove: KSGF 104.1, (ex KZRQ)  
Cuba: KNLQ 91.9 , NW  
Mount Vernon:KZRQ 106.7, CC (ex KHTO), FC to rock

## **MONTANA:**

Big Sky: KBFN 104.5 MT changes calls to KBZM.

## **NEVADA:**

Las Vegas : KNPR 88.9, QG (ex 89.5),  
FC to news and talk  
Las Vegas: KCNV 89.7, Classical music, LC

## **NEW JERSEY:**

Wildwood Crest: WDTN 93.1, CC (ex WBNJ) ,  
// WTTN 96.1 Margate City NJ, SC as "**Touch**" .

## **NEW MEXICO:**

Pecos: KLBU 102.9, CC (ex KENC)



## **NEW YORK:**

Monticello: WJUX 99.7, FC to religion,  
// WRDR 89.7 Freehold Township NJ

## **NORTH CAROLINA:**

Bayboro: WRUP 97.9, country oldies,  
"**97.9 the Bear**", NW

## **OHIO:**

Bellevue: WOHF 92.1, CC (ex WNRR)  
Dayton: WUDR 98.1, NW

## **OKLAHOMA:**

Enid: KQBL 96.9, FC to classic hits,  
SC to "**Bob**"  
Seminole: KXTH 89.1, CC (ex KZXV),  
FC to contemporary Christian

## **OREGON:**

Cottage Grove: KEUG 105.5,  
SC to "**World Class Rock, G-105.5**" (Eugene)

## **PENNSYLVANIA:**

Philadelphia: WPTP 96.5, FC to R&B,  
SC to "**Wild 96.5**"  
Wyomissing: WYTL 91.7, NW

## **SOUTH CAROLINA:**

Orangeburg : WQKI 102.9, CC (ex WIGL), FC  
R&B ,  
SC as "**Quickie**"  
St. Matthews: WIGL 93.9, CC (ex WQKI), FC to  
AC,  
SC as "**Mix 93.9**"

## **TENNESSEE:**

Clarksville: WAYQ 88.3, FC to contemporary  
Christian,  
SC as "**The Way**"  
Crossville: WXVL 99.3, FC to AC  
Tullahoma: WHRP 93.3, CC (ex WUSX), FC to  
R&B,  
SC as "**Power**" (Huntsville AL)



## **TEXAS:**

Flower Mound: KTYS 96.7, CC (ex KMEO),  
FC to country, SC as "**The Twister**" (Dallas/Fort  
Worth)  
Jefferson: KHCJ 91.9, religion (Longview), NW  
Pittsburg: KKXI 91.7, LC  
San Antonio: KTFM 102.7, FC to active rock,  
SC as "**102.7 K-Rock**"  
Terrell Hills: KELZ 106.7, CC (ex KCJZ),  
FC to top 40, SC as "**Z-106-7**" (San Antonio)

## **UTAH:**

Oakley: KEGA 101.5, country, "**Eagle 101.5**",  
NW (Salt Lake City)



## **VERMONT:**

Killington : WEBK 105.3, FC to modern AC,  
SC as "**The Peak**"

## **VIRGINIA:**

Crozet: WSUH 102.3, CC (ex WFFX),  
SC to "**Super Hits**" (Charlottesville)

## **WEST VIRGINIA:**

South Charleston : WMXE 100.9, CC (ex WJYP),  
FC to hot AC, SC as "**Mix 100.9**"



## **WISCONSIN:**

Denmark: WPCK 104.9, "Kicks 104.9." (Green Bay),  
NW  
Goodman: WMVM 91.3, religious, RA,  
// WRVM 102.7 Suring WI  
Marathon: WKQH 104.9, FC to active rock,  
SC as "**Rock 104.9**" (Wausau)  
Tomah: WTMB 94.5, CC (ex WBOG),  
FC to country, SC as "**B-94-5**"



## **MANITOBA**

Winnipeg: CJWV 107.9 LC.

## **ONTARIO:**

Kitchener: CKBT 91.5, R&B/top 40, "**91.5 the Beat**"



JOHN EBELING'S SP9 - DX LODGE AT ALBORN, MN



# Co-Channel Interference Solution-Part II of II

BOB COOPER

## ANTENNA PATTERN

Remember our mythical modeling antenna, the isotropic source./point? And the more practical reference antenna, the resonant dipole? The dipole obtains its 'gain' over the isotropic point source by eliminating the isotropic's "radiates equally all directions", replacing that with "radiates equally well in directions perpendicular to its element". Think of an isotropic point as a three dimensional pool of water with a pebble dropped into the water. The splash goes up and down, left and right; in fact it goes outward away from the point of pebble impact equally in all directions; similar to a sky rocket exploding high in the air. Now think of the dipole as a two-dimensional antenna. You drop it onto a pool of water, flat side down, and small ripples /waves radiate outward from the point where the dipole strikes the water but primarily perpendicular to the axis of the dipole metal element; there is almost no ripple nor wave created by the end tips of the dipole. The dipole has gain over an isotropic point source because it eliminates any radiation from the ends of the antenna, redirecting the radiation pattern in two directions; each perpendicular to the plane of the element. Now add a new element to the antenna, parallel to the dipole and slightly longer (physically) than the dipole. This longer element acts as a reflector to block antenna gain (sensitivity) in the direction/plane of the dipole + reflector. With a reflector in place, the dipole now receives 'equally well in one direction'; squirting away from the dipole in the direction not blocked by the reflector.

Next add one or more elements away from the dipole/reflector, each shorter than the dipole and progressively shorter the further they are placed from the dipole. 'These are called directors and the combination of a reflector and (multiple) directors cause the signal beam to become thinner and thinner; more directive, more focused in the desired (front) direction. As the antenna designer adds more elements (assuming they have been added with some knowledge of where they go and how they interact with one another), the pattern of the antenna becomes more sensitive to signals arriving from the frontal (favored) direction and more importantly, less responsive to signals arriving from the sides or perhaps the rear of the antenna. ALAS - this additional forward gain comes with a price. Think of a latex balloon filled with water to the point of being over filled. Take the balloon in your hand and squeeze the latex; the water shifts inside the balloon and moves to a portion where your hand is not exerting pressure. This portion of the balloon grows larger while the portion you are squeezing becomes smaller. The increase in balloon size in one direction is like your antenna as you add additional directors(elements). Each newly placed director reduces the gain to the rear and sides, while increasing the gain towards the 'front'. With proper skills the antenna designer can maximize the forward gain and cause the directional antenna to have less and less 'response' to the sides and rear. This is the basis for controlling CCI; 'shaping' the antenna pattern so as to reduce to a minimum the antenna's ability in the direction of the UT while maximizing its gain towards the desired station; at the front of the antenna.

And the 'price'? Each director element increases the physical size of the antenna and can reduce the bandwidth of the antenna (remember our TV channels are 7 MHz broad at VHF 8 at UHF). It is possible to add too many directors and defeat the entire purpose of the antenna system!

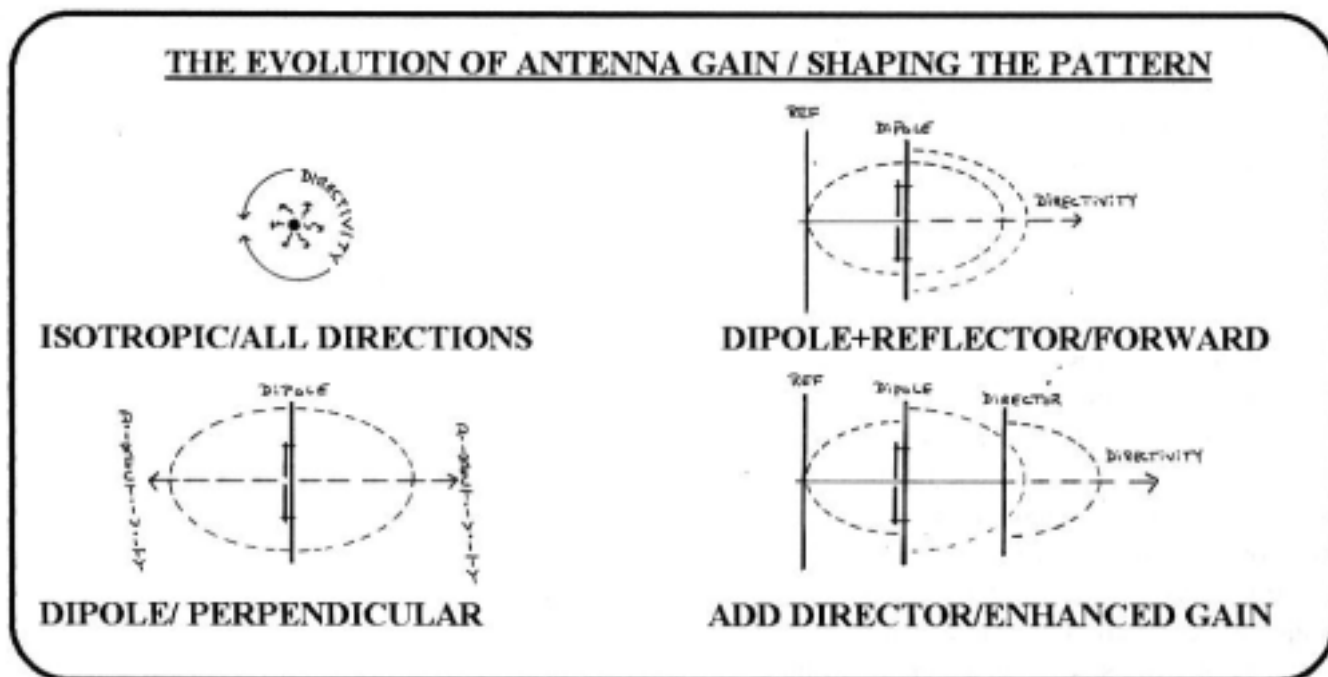

## STACKING ANTENNAS /MORE GAIN

If the antenna designer can add too many gain-enhancing director elements and overshoot his performance target (see Tech Bulletin 9302), but you need additional gain for a system, how is it done? The answer is stacking or, as it is also known, phasing two or more antennas together. The concept of stacking/phasing antennas together into a single antenna array is basic to antennas. If a single antenna of certain physical size and characteristics will create 10 dB of gain in the favored (front) direction, a second antenna electrically phased to the first will produce almost (but not quite) twice as much received signal voltage. In theory, you will gain 3 dB more with a second antenna but in practice some of that gain is lost in the phasing system (see Tech Bulletin 9302 for a discussion of how this works). The rules for 'stacking' gain follows:

- 1) Both antennas must be identical in physical shape and size;
- 2) The 'distance' from the transmitter to each antenna must be as close to identical as possible;
- 3) The antennas must be electrically connected together in such a manner that the signal voltage from one adds to the signal voltage picked up by the second antenna (that's where 3dB comes from; a doubling of the signal voltage as presented to the transmission line going to the TV set).

NOW - let's consider a unique situation where the two antennas are not the same physical distance from the transmitter. If you erect a metal pipe vertically and place one antenna at the top of the pipe, and the second antenna down say 1 free-space wavelength below the top antenna, because the pipe support is common to both and is straight up and down. The two identical antennas will have their respective directors, dipole elements and reflectors dead-in-line with one another if viewed from below (or above). This is a common way to stack two antennas for the additional (2.53.0 db stacking gain. And, both antennas are the same distance from the transmitter. To connect the two antennas together (i.e.. to phase as in adding the output voltage of one antenna to the output voltage of the other antenna), we can use parallel rods of tubing or wire (called stacking lines/phasing bars), or, we can use two identical lengths of the same coaxial cable (called phasing lines connecting each antenna into a two-way signal splitter (using the splitter as a signal combiner). We'll elect to use two identical lengths of foam type RG-6U here. If the antennas are 300 ohm, we install a 300 ohm / 75 ohm outdoor matching transformer at the antenna connection point for both antennas. Then we cut two identical lengths of RG-6U long enough in each case to reach from the 75 ohm output of the matching transformer to the two-way splitter/combiner which is attached to the antenna mast precisely half way between the two antennas. With weatherproof F fittings on both ends of the cable, we now have the two antennas electrically connected together through the combiner. Each antenna captures signal sending it through the matching transformer to the two-way combiner (understand that an outdoor two-way splitter connected up backwards, becomes a two-way combiner in this application), and then the combiner outputs the two signals in phase with one another through its one remaining (output in this case) port. The performance of the antenna system could be as shown at the top of page 11.

Now the CCI challenge. We wish to deepen the antenna system rejection for a CCI UT arriving from approximately the rear of the antenna. The antennas alone offer but 20 dB of front-to-back ratio; i.e., signals arriving at the dipole element from the rear of the antenna are attenuated by only 20 dB reference the same signal coming to the antenna from the front. Phase is the answer.

Remember that when we stack two identical antennas great care is taken to insure the signal captured by the dipole on one antenna gets to the combiner in phase with the signal captured by the second antenna. This means the desired transmitter signal from the front of the antenna array, and, whether we like it or not, also the undesired transmitter signal approaching from the rear of the antenna. Suppose we installed the two antennas in such a way the undesired transmitter signal arrives at the combiner box out of phase with itself? What then? The two antennas cancel one another; the undesired signal is simply phase-cancelled at the antennas! Here is how that is done.

- 1) The top antenna is mounted in the standard way.
- 2) The bottom antenna has new holes drilled in the boom so the boom to mast clamp sits in a position that causes the bottom antenna to mount on the mast 1.14 wavelength behind the top antenna. If we connect the two antennas together using identical lengths of RG-6/U, the desired signal and the undesired signal will arrive at the combiner 90 degrees (one-quarter of a phase cycle; there being 360 degrees in a complete phase cycle) out of phase with each other. And now we are approaching a solution.

4) The phasing lines are now length-adjusted. Rather than making both lines exactly the same length, we cut the two lines so that one is electrically 1/4th wavelength longer than the other. in the accompanying diagram (page 11) we show this as 'X' 'X' and 'X± 1/4 wave'.

5) The longer line goes from the top (normally mounted) antenna to the combiner. The shorter line goes from the bottom antenna (which is physically 1/4 wavelength behind the top



**COMPARATIVE PERFORMANCE / SINGLE vs. TWO-STACK YAGI ARRAY**

| Array       | Gain     | Beamwidth/Hor. | Beamwidth/Vert. | Front-to-Back |
|-------------|----------|----------------|-----------------|---------------|
| 10 el. Yagi | 10 dBd   | 65 degrees     | 60 degrees      | 20 dB         |
| 10 el. X 2  | 12.5 dBd | 65 degrees     | 40 degrees      | 20 dB         |

antenna) to the combiner. Think about it. A signal from the front of the antenna array goes into the top antenna 1/4th wavelength (90 degrees) before it goes into the bottom antenna. Then the signal from the top antenna goes through a length of coaxial cable that is an additional 1/4 wavelength (90 degrees) longer (electrically) before it gets to the combiner. By being 1/4th wavelength in front, it is out of phase by 90 degrees with the bottom antenna. But, by going through an additional 1/4th wavelength of RG-6/U, it arrives at the combiner phase adjusted with the DT signal coming from the bottom antenna (i.e., 90 degrees faster at the top antenna, 90 degrees slower at the top antenna + coax; net result 0 degrees change). The two antennas still add signal together because they are still in phase for a forward direction signal.

And the rear arriving signal? It arrives at the bottom antenna first because the bottom antenna is 1/4th wavelength closer to the signal source. 90 degrees in time later it arrives at the top antenna where it must go through an additional 1/4 wavelength (i.e., 90 degrees in phase) delay on the way to the combiner. Now the top antenna UT is 180 degrees out of phase with the bottom antenna UT and the two signals cancel; electrically, cleanly. This technique works very nicely with the following caveats:

- 1) The UT signal should fall someplace between 165 and 195 compass degrees of the DT (i.e., point your antenna at the DT and call this 0 degrees. Now use a compass and map to determine whether the UT will approach the antenna array at an angle [reference the DT] of between 165 and 195 degrees; essentially off the back of the antenna. If it will, this will work for you, eliminating the CCI source by as much as 20[+] dB.)
- 2) You can also use this technique for eliminating a non-desired adjacent channel signal (say you want a channel 7 signal and there is a stronger channel 6 [and/or 8] signal off the back side of the antenna); with a 3 dB penalty for off-channel use. Arrange the antennas exactly as you would for same-channel configuration, except as follows:
  - a) Offset-mount the bottom antenna by 1/4 wavelength on the adjacent (non-desired) channel (not the desired channel), and,
  - b) Cut the cable length 1/4 wavelength longer on the non-desired channel, not the desired

**STACKING YAGIS FOR REJECTION OF REAR-DIRECTION CO-CHANNEL**



Non-desired signal is placed 180 degrees out-of-phase by bottom antenna offset and delay in 1/4th wave of coaxial cable

channel.

A signal from the front of the antenna array goes into the top antenna 1/4th wavelength (90 degrees) before it goes into the bottom antenna. Then the signal from the top antenna goes through a length of coaxial cable that is an additional 1/4 wavelength (90 degrees) longer (electrically) before it gets to the combiner. By being 1/4th wavelength in front, it is out of phase by 90 degrees with the bottom antenna. But, by going through an additional 1/4th wavelength of RG-6/U, it arrives at the combiner phase adjusted with the DT signal coming from the bottom antenna (i.e., 90 degrees faster at the top antenna, 90 degrees slower at the top antenna + coax net result 0 degrees change). The two antennas still add signal together because they are still in phase for a forward direction signal.

And the rear arriving signal? It arrives at the bottom antenna first because the bottom antenna is 1/4th wavelength closer to the signal source. 90 degrees in time later it arrives at the top antenna where it must go through an additional 1/4 wavelength (i.e., 90 degrees in phase) delay on the way to the combiner. Now the top antenna UT is 180 degrees out of phase with the bottom antenna UT and the two signals cancel; electrically, cleanly. This technique works very nicely with

the following caveats:

1) The UF signal should fall someplace between 165 and 195 compass degrees of the DT (i.e., point your antenna at the DT and call this 0 degrees. Now use a compass and map to determine whether the UT will approach the antenna array at an angle [reference the DT] of between 165 and 195 degrees; essentially off the back of the antenna. If it will, this will work for you, eliminating the CCI source by as much as 20[+] dB.)

2) You can also use this technique for eliminating a non-desired adjacent channel signal (say you want a channel 7 signal and there is a stronger channel 6 [and/or 8] signal off the back side of the antenna); with a 3 dB penalty for off-channel use. Arrange the antennas exactly as you would for same-channel configuration, except as follows:

a) Offset-mount the bottom antenna by 1/4 wavelength on the adjacent (non-desired) channel\_ (not the desired channel), and,

b) Cut the cable length 1/4 wavelength longer than the non-desired channel, not the desired channel.

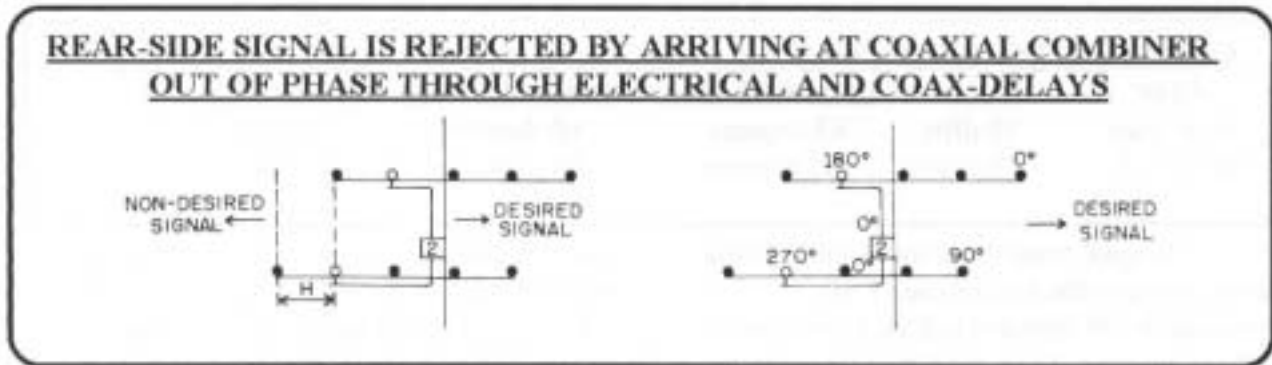

### NON-REAR OF ANTENNA / PHASING

Of course not all UT signals arrive at the receiving site from the rear (i.e., +/- 15 degrees of straight off the back of the boom). The solution for such angles of arrival is still phasing but the technique is different. The antennas are not stacked one above the other (i.e., vertically) since it would be difficult to achieve any type of phase difference in this configuration. Rather, the identical-in-design antennas are placed side-by-side in a horizontal stacking format. If you followed the rear L<sup>1</sup>T phase cancellation, you'll have no difficulty with the horizontal two-stack. The key is to find a horizontal distance, along a common antenna mounting boom (a piece of horizontal pipe mounted against a tower face; or, a flat roof line where you can mount antennas in a horizontal line at will), where the distance equals 180 degrees of phase cancellation for the UT source. The magic distance in free space is 1/2 wavelength. adjusted to the actual difference in angle-of-arrival between the two signals. We call this distance 'H' (see diagram page 13). Here's how it is calculated:

1) Use a map and determine the beam heading from your receive site to the desired transmitter. Let's say it is + 10 degrees with 0 degrees true-north.

2) Now calculate the beam heading to the undesired transmitter. In this example it is 35 degrees true.

3) The difference between the two is 35 minus 10 or 25 degrees of angle.

4) Go to Graph 1 here which reveals a 25 degree angle difference requires a horizontal spacing between the two identical antennas of 1.22 wavelengths.

5) Now, in our example the channel of interest is 4 where one wavelength in free space (see Table 1) equals 1.717 metres (65.7"). The two identical antennas would then be mounted on a horizontal cross-arm, both pointing directly at the DT. spaced apart 1.717 metres times 1.22 (distance; Graph 1) or 2.095 metres boom centre to boom centre (distance H). The antennas would be phased with two identical lengths of RG-6/U to a two-way outdoor weather protected hybrid combiner (splitter used backwards).

NOTE: With this technique, no difference should exist in the lengths of coaxial cable connecting each individual antenna to the combiner. What does change with each channel change or each angular difference change is the spacing (distance H) between the two antennas. Also observe in Graph 1 that as the spacing between antennas reduces down to 0.75 wavelength, the Graph jumps to a greater physical spacing of nearly 2.25 wavelengths to insure adequate physical separation (i.e., so two antennas do not touch each other).

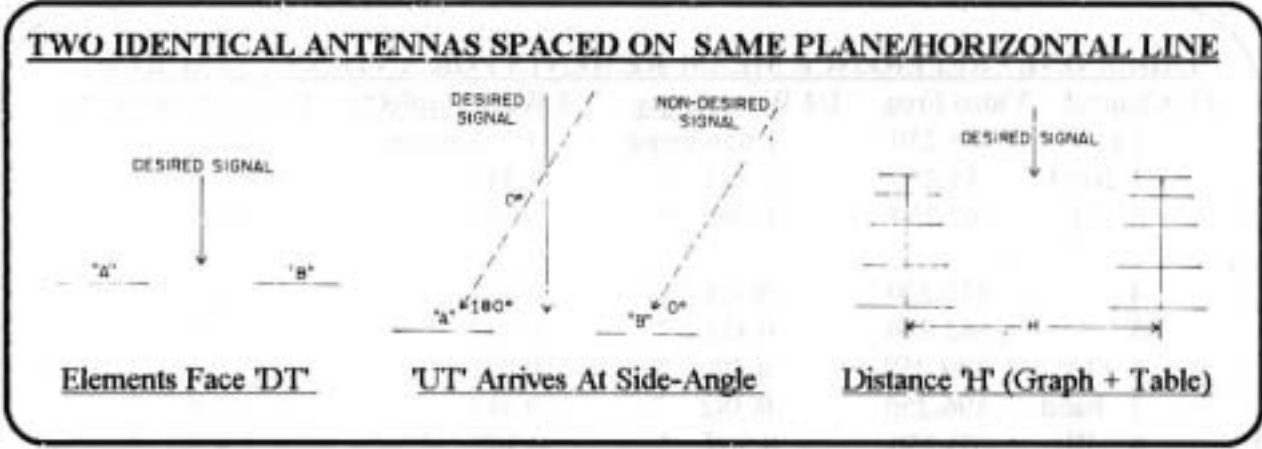

**CHALLENGES**

When your antenna receive site requires more forward gain than can be provided with two (identical) antennas (stacked), you are headed for four or even eight antennas in a more complex array. It is not uncommon in North America and Europe to stack four identical antennas horizontally; that is, all in a line on perhaps quite long boom. This is a perfectly adequate approach for increasing forward gain but not when you are also attempting to eliminate or reduce a co-channel signal source with precise horizontal (antenna boom-to-boom) spacing. Because any individual yagi (or log) antenna exhibits a complicated antenna pattern (i.e., small lobes of

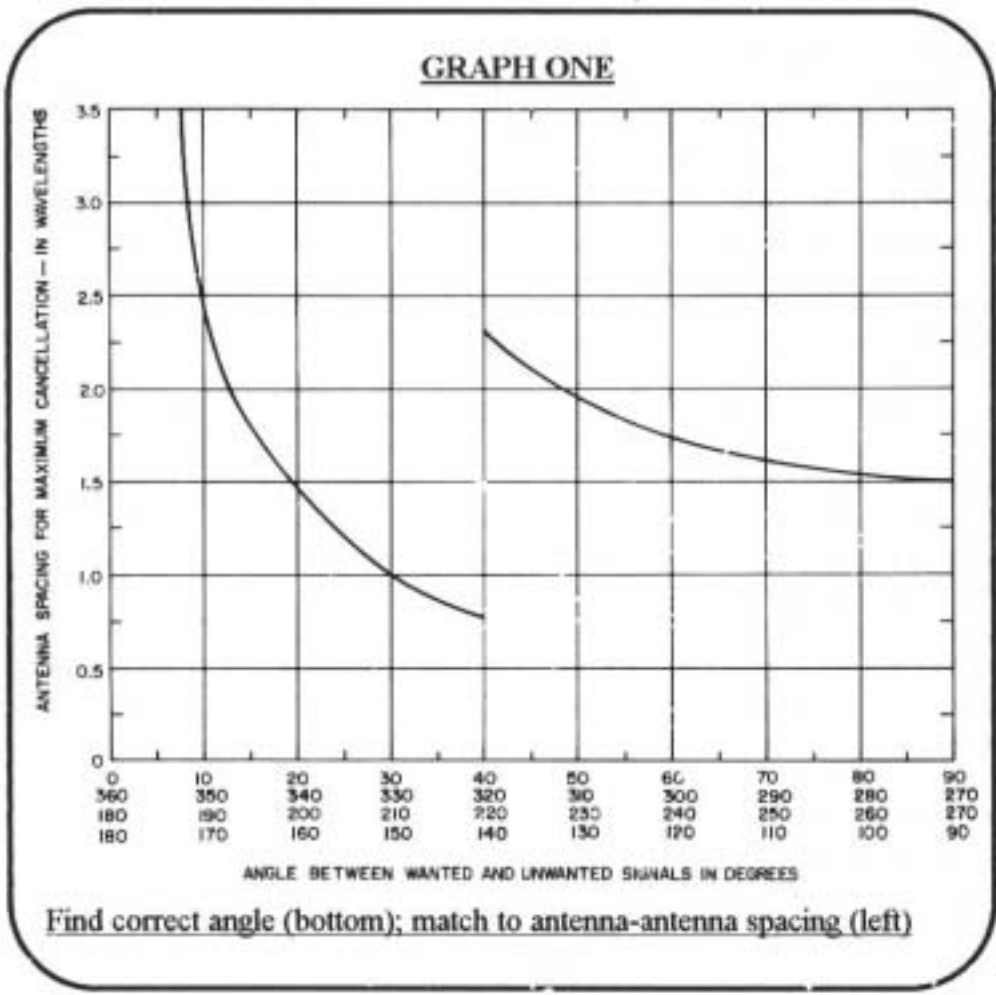

signal response that 'squirt' out of the antenna at unpredictable angles), when four or more antennas end up in a horizontal line, these essentially unpredictable minor lobes often end up 'combining' towards a co-channel source; in spite of your efforts to select a precision spacing between antennas to create a null. If you find yourself in a CCI situation that requires more gain than two yagis will provide, consider upgrading to larger yagis. Where five elements (reflector, dipole and three directors) may produce as much as 7 dB of gain (reference a dipole), a properly designed ten element will usually produce 10 dB of gain. That says a pair of well designed ten elements

can offer the same gain as 5-element yagis in a phased array. And should you still be short of gain, the co-channel problem must be tackled with a so-called 'box' or 'H Frame' array slack as shown on page 15. Four antennas are stacked. two side by side and two more above the first two. For H i antennas, contact us.

Note: You cannot combine antennas in this array using a single four-way combiner a trio of 2 way combiners with all RG-6/U lines of the same length must be used. The vertical (up/down) stacking distance should be no less than .75 wavelength in free space for antennas of up to 5 elements; 1 wavelength in free space. or the length of the boom (whichever is greater) for antennas of more than 5 elements. Selecting and stacking multiple yagi or log arrays for maximum gain, as well as matching them with appropriate masthead amplifiers is carefully studied in Tech Bulletin 9302.

**GAIN NUMBERS**

**TABLE ONE / REFERENCE MEASUREMENTS FOR ANTENNA STACKING**

| TV Channel | Video Freq. | 1/4 Wave/Space | 1/4 Wave/Cable(*) | 1 Wave/Space (**) |
|------------|-------------|----------------|-------------------|-------------------|
| 1 [TV      | 45.250      | 1.656 metre    | 1.358 metre       | 6.624 metre       |
| 2 band     | 55.250      | 1.357 "        | 1.112 "           | 5.428 "           |
| 3 I]       | 62.250      | 1.204 "        | 0.987 "           | 4.816 "           |
| 4          | 175.250     | 0.428 "        | 0.351 "           | 1.717 "           |
| 5          | 182.250     | 0.411 "        | 0.337 "           | 1.644 "           |
| 6 [TV      | 189.250     | 0.396 "        | 0.325 "           | 1.584 "           |
| 7 band     | 196.250     | 0.382 "        | 0.313 "           | 1.528 "           |
| 8 III]     | 203.250     | 0.369 "        | 0.302 "           | 1.476 "           |
| 9          | 210.250     | 0.357 "        | 0.292 "           | 1.428 "           |
| 10         | 217.250     | 0.345 "        | 0.283 "           | 1.380 "           |
| 11         | 224.250     | 0.334 "        | 0.274 "           | 1.336 "           |
| 27         | 519.250     | 0.144 "        | 0.116 "           | 0.576 "           |
| 45         | 679.250     | 0.110 "        | 0.091 "           | 0.440 "           |
| 62         | 799.250     | 0.094 "        | 0.077 "           | 0.376 "           |

\*/ 1/4 wavelength in cable calculated for 0.82 velocity of propagation factor (cable) such as 7 Foam Series or 11 Foam Series by Paramedrop.

\*\*/ 1 wavelength in space utilized when calculating H or horizontal spacing between antennas for CCI nulling; per dimension H (diagram, page 13). Multiply 1 wavelength in space distance (this table) times the antenna spacing for maximum nulling number from Graph 1 to determine physical distance of H.

Let's summarize the dual-challenge problems of a typical fringe area receiving site with co-channel interference.

First - the site suffers from low signal levels arriving from the desired transmitter (DT). Minus co-channel as a degradation factor we should have no less than 250 microvolts (uV) or -12 dBmV to produce a TASO Passable Grade picture (28 dB signal

noise to noise ratio; see Tech Bulletin 9302.) Second with co-channel interference, the additional degradation can reduce the apparent TASO grade picture by some amount. The degree of degradation depends upon (a) the signal ratio between the DT and the UT when the antenna is pointed at the DT, and, (b) the frequency difference (i.e., tone) of the offset. Keep in mind that with a constant ratio in amplitude (signal levels) between DT and UT, the degradation of the co-channel can be reduced or increased as much as 24 dB simply by tweeking on the transmitter oscillator to move the offset frequency by as little as 260 hertz (!). if you suspect the offset could be improved, talk with your regional RFS office.

The low signal level from the DT can be enhanced by increasing the capture area of the receiving antenna; two properly designed 5 element yagis, for example, produce 2.5 dB more signal than a single yagi. Or, a properly designed ten element yagi can produce from 2 to 3.0 dB more gain than a single five element yagi. There is a caveat; properly designed. Merely adding more (director) elements is no guarantee the larger antenna will outperform (or even perform as well as) a smaller antenna. Your success as an installer depends upon the quality of the antennas you select.

The low signal level can also be enhanced with a masthead amplifier. To be effective, the masthead unit should have a noise figure that is appreciably better than the noise figure of the TV set tuner; and, no less than 20 dB of gain (see Tech Bulletin 9302).

Unfortunately, a masthead amplifier and/or a larger capture area antenna will increase the amplitude (level) of the UT co-channel source as well as the desired transmitter unless the antenna is configured to reduce (phase out) the UT source.

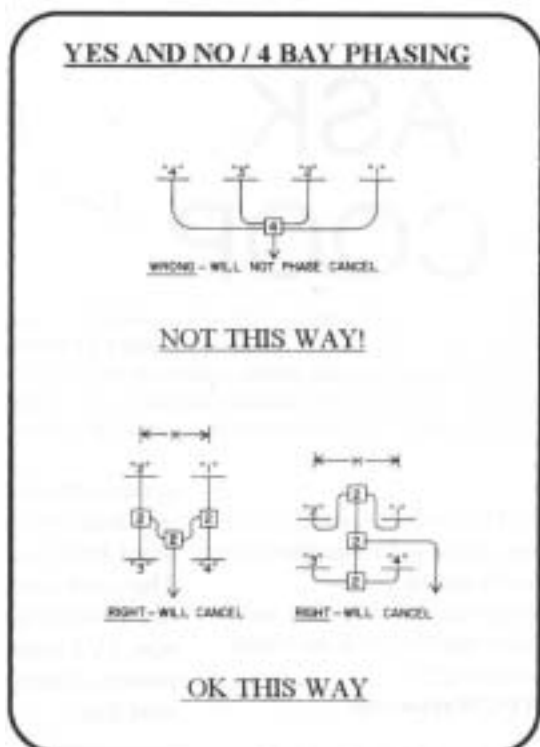

# SOUTHERN FM DX



John Zondlo  
4009 Driftwood Circle  
Yukon, OK 73099  
sfm@fmdxweb.com  
Deadline: 15th

For DXers in AL, AZ, AR, CA, CO, DE, DC, FL, GA, HI, KS, KY, LA, MD, MS, MO, NV,  
NM, NC, OK, SC, TN, TX, UT, VA, WV, Cuba & Mexico

December 2003

**Eric Bueneman – N0UIH – 631 Coachway Lane – Hazelwood, MO 63042-1347 – N0UIHEric@aol.com - <http://www.qsl.net/n0uih>**

Realistic STA-90 AM/FM/FM stereo receiver for FM DX, Radio Shack PRO-79 handheld scanner for NOAA weather radio DX, Radio Shack VU-210XR with Radio Shack Archerotor at 35' (10.6m) AGL, all times CDT, all distances in miles/kilometers, all NOAA frequencies start with 162

## 6/24 Tr

0109 KIH43.475 KY Louisville, EDT TC, forecast for north central KY and south central IN, cx for Louisville 250/402

## 7/19 Tr

0822 KXI71 .525 SD Brookings, wx forecast/conditions for the Brookings area  
505/813  
0917 WXK62 .475 IA Sioux City, legal ID, wx forecast for NW IA, SW MN & SE SD  
0925 KXI50 .500 MN Russell, wx forecast for SW MN 480/772  
0933 KZZ38 .500 MO Trenton, wx forecast for NW MO and southern IA 195/314  
1755 WXK91 .475 KS Topeka, conditions for Topeka, forecast for KS/MO/NE 285/459  
2038 KIH61 .400 NE Omaha, CDT TC, legal ID, forecast for NE/IA, severe wx outlook 335/539  
2227 KZZ52 .525 IA Hancock, legal ID, wx forecast for IA/NE 320/515  
2230 WWH30 .500 OK Grove, legal ID, wx forecast for NE OK/NW AR 285/459  
2241 KGG98 .425 KS Halls Summit, legal ID, severe wx outlook for northern KS, local conditions 290/467  
2354 WNG534 .500 KS Belvidere, legal ID, cx for Medicine Lodge and Great Bend, wx for south central KS 485/781  
2357 WXL71 .525 KS Abilene, legal ID, wx cx for Salina 370/595  
2359 WXK93 .475 KS Dodge City, legal ID, wx cx for central KS 530/853

## 7/20 Tr

0005 WXK95 .400 KS Chanute, wx summary, forecast and cx for SE KS 290/467  
0223 WWF76 .475 MO Summersville, legal ID, summary for south central MO 130/209  
0225 WXL46 .400 MO Springfield, SW MO forecast, cx for Springfield 190/306

## 8/24 Tr

0255 KWRT 93.1 MO Booneville, "Casino 93," adult standards, legal ID, AP nx 125/201  
0307 KSRC 102.1 MO Kansas City, "Star 102," AC, \$ 225/362  
0315 KZZ39 .500 MO Clinton, wx forecast for Sedalia/Whiteman AFB 185/298  
2310 WWG72 .500 IN Georgia, forecast for IN/SE IL, //WXM78 Bloomington 205/330  
2338 WKRQ 101.9 OH Cincinnati, "Q-102," CHR 320/515  
2344 WXJ91 .525 KY Madisonville, wx cx for western KY 190/306

## 8/25 TR

0024 WNOU 93.1 IN Indianapolis, "Radio Now 93.1," rap mx (x-WNAP) 240/386  
0026 unID 92.9 ?? ??, noted with ESPN and ABC promos, talk on the NFL from ESPN





**8/26 Tr**

|      |              |      |    |  |
|------|--------------|------|----|--|
| 0102 | <u>KXI47</u> | .525 | IL | Paris, forecast and cx for Paris, Charleston and Mattoon 145/233                         |
| 0106 | WXJ76        | .550 | IL | Champaign, forecast for east central IL, Champaign-Urbana cx, local KDO89 nulled 150/240 |
| 0122 | <u>WRAN</u>  | 98.3 | IL | Tower Hill, calls, o 85/137  |
| 0327 | <u>WWG83</u> | .425 | IN | Edwardsport, legal ID and wx forecast 170/274  |
| 0336 | WKDQ         | 99.5 | KY | Henderson, promo, calls, k 170/274   |

This logbook includes NOAA weather radio logs that were sent to Matt Sittel, but never saw print. The events of August 24-26 were mainly TV events, but did manage to catch WNOU 93.1 for a call letter change. The conditions were good enough to allow me to null the local NOAA weather radio station (KDO89 St. Louis MO) on 162.550 MHz to pull in Champaign with a clear signal. The only time I caught WXJ76 was through the local. Also noted KWRT 93.1 is no longer simulcasting the AM on 1370 kHz. Finally heard one of my closest unheards in WRAN 98.3; I only live about 50 miles from KDJR 100.1 and haven't hear the station at this location due to locals on 99.9 and 100.3. Makes me want to have my next receiver modified with the proper filters for adjacent channel DX! 73, Eric (NOUIH)

---

**Doug Smith – W9WI – 1385 Old Clarksville Pike - Pleasant View, TN  
37146-8098 - w9wi@w9wi.com - www.w9wi.com**

**9/7 Tr**

|      |             |       |    |  |
|------|-------------|-------|----|--|
| 1834 | WFBQ        | 94.7  | IN | Indianapolis, "Q95 weather" 246            |
| 1928 | WILL        | 90.9  | IL | Urbana, legal ID 265                       |
| 1930 | <u>WTCJ</u> | 105.7 | IN | Tell City, "Owensboro's Party Station" 107 |

**9/8 Tr**

|      |             |       |    |   |
|------|-------------|-------|----|---|
| 0650 | WMOJ        | 94.9  | OH | Fairfield, "Mojo" 238                   |
| 0705 | <u>WCBK</u> | 102.3 | IN | Martinsville, local news and sports 212 |
| 0710 | <u>WTTS</u> | 92.3  | IN | Bloomington, "92-3 WTTS" 213            |

**11/9 Gw**

|      |               |      |    |  |
|------|---------------|------|----|--|
| 1954 | <u>W214BQ</u> | 90.7 | TN | Brentwood, mention of KAWZ and IDs for translators in AK, TX and CA 28 |
|------|---------------|------|----|--|



**John 3:16 "For God so loved the world that he gave his one and only Son, that whoever believes in him shall not perish but have eternal life.**

*Merry Christmas from the Zondlo family  
John, Carol, Christy & Joel*

# CUBAN TELEVISION

ALL OFF-AIR PHOTOS SUPPLIED BY JESÚS PEREZ, HAVANA, CUBA



CHTV ( Local ) Havana City Chs 2 & 10



PERLAVISION ( Local ) Cienfuegos City Ch-5



TV YUMURI ( Local ) Matanzas City Ch-13



TVA Ciego de Avila City

## December 2003 Meteor Scatter Projections

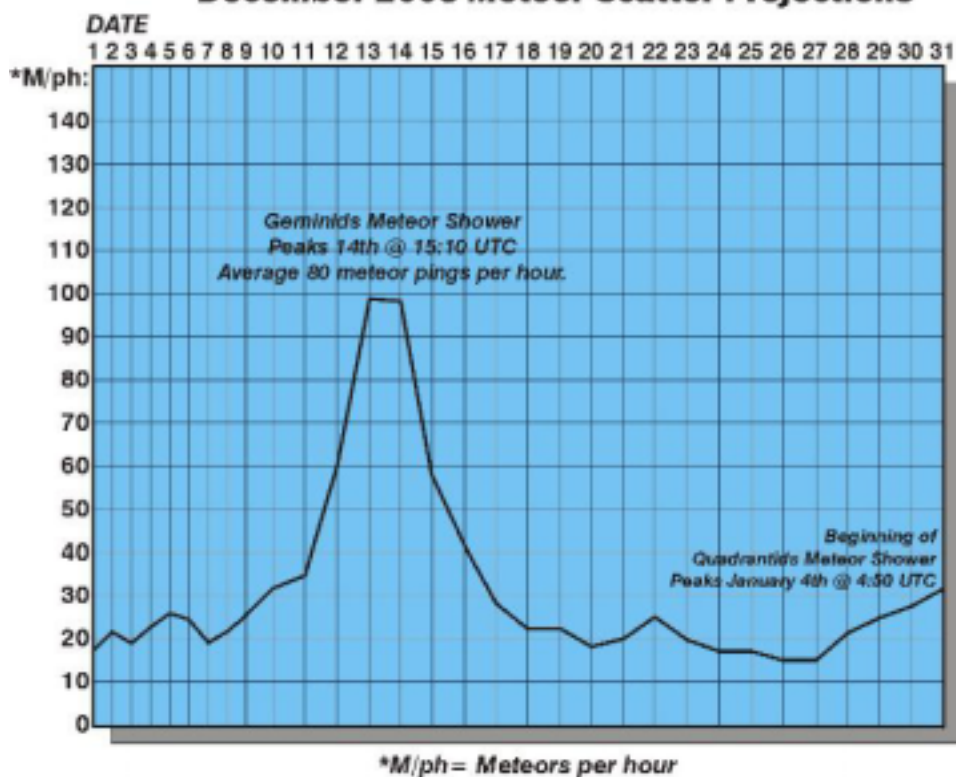

## METEOR SHOWER GUIDE FOR DECEMBER 2003 (chart courtesy of Jim Thomas)

All we need to say about the December chart is this: The Geminids The Geminids peak on the 13-14 of the month. THIS IS A SATURDAY-SUNDAY peak!

After a short lull, things begin to pick up right after Christmas





# ***SATELLITE NEWS***

**GEORGE W. JENSEN**

**4604 ANTANNA AVE, Baltimore, MD 21206-4220**

**SCISATMAN@AOL.COM**

---

Another slow month with more deletes than new services. - Here are the deletes:-  
**Satcom/AMC4** - transponder 20 - Sundance Channel VC2 now only on Digicipher (4DTV)  
**Satcom C3** - Lifetime West VC2 - gone to ????

**Galaxy 10** - ESPNNews VC2 now on 4DTV only - (see later) On the Ku side - MPEG2 - TARBS International Channels several unused except for color bars channels are no longer operating with minor changes to others.

More details in a later column on this  
On **AMC1** a possible error on my part - XPDR 6 is WNBC

**Telstar 5** Ku Band International clusters continue to change almost daily, this

also will be looked at in a later column.

**Galaxy 11** - delete the following - 400 - NBA Television, 601 Bloomberg

**AMC 3** - ADD - 640 - Georgia Public Television here from the failed T4. Lastly - TheDMX channels on **PanAmSat 9** continue to be in a state of flux, Most are various forms of US pop music. 835 is unique in that it all Tango.

That's all for this month. May you all have a Merry Christmas, Happy 2004 New Year and Kwanza and Happy Chanukah. Have some great DX and see you in 30. 73"s.

*George*

---

## **This Month's Cover**

A WONDERLAND OF DX GOODIES



This month belongs to Rich Wertman (Lockport, NY). The picture on the left is a 72 foot Triax tower with a VHF Ringer Ranger, a UHF ringo and ten element GMRS beam, a 7 foot dish with an AC-4990 pre-amp, and a HD73 rotor about one-fourth of the way up. On the garage is a CM Stereo Probe-9 on a ten foot tripod. There's also a Phase2 DirecTV dish.

On the front cover you will find on the top shelf moving from left to right: CB and VHF Walkie-Talkies, a Yamaha T-1020 tuner, Standard GX-3000 GMRS radio, a Radio Shack pro-2004 scanner, a RS TRC-458 11-meter radio, a 13" Zenith monitor. On the center shelf, moving left to right: CM rotor controller, Pioneer TX-6500 tuner, HD-73 rotor controller, MFJ antenna tuner, GE extension speaker, Uniden HR-2510 10 meter set, Kenwood TMV-7A dual band radio, HD-73 rotor controller. On the bottom shelf: Technics SA-310 receiver, Yeasu FT-890 HF, RS rotor controller, RS DX-302 shortwave radio, CM 9512 rotor controller, 13" 1984 Zenith TV, Sony beta VCR and a homebrew PC.

## SIGN UP/Renewal form

Name \_\_\_\_\_

Address \_\_\_\_\_ Apt # \_\_\_\_\_

City \_\_\_\_\_ State/Prov \_\_\_\_\_ Zip \_\_\_\_\_

Country \_\_\_\_\_ Interests: TV ( ) FM ( ) 30-50( ) Weather( )

email address \_\_\_\_\_

Sign me up/renew me for: 1 year ( ) 2 years ( ) More ( )

Yearly dues \$24 to US addresses, \$26 to Canada and Mexico  
\$38 to the rest of the world (payable in U.S. Funds)

**Mail your dues to: WTFDA, P.O. Box 501, Somersville, CT USA 06072**

**Make your checks/money orders payable to: DAVE JANOWIAK**

**And *thanks* for your support of the WTFDA!**

Return this form with your dues or make a copy of it and return that.

### WTFDA BOARD OF DIRECTORS

|   |  |
|---|--|
| Mike Bugaj, use the WTFDA Mailing address listed below            | mbugaj@snet.net  |
| Tom Bryant, 849 Todd Preis Dr., Nashville, TN 37221-2607          | tjbdx@comcast.net  |
| Greg Coniglio, 11825 Genesee St., Alden, NY 14004                 | <a href="mailto:wqrc@rochester.rr.com">wqrc@rochester.rr.com</a> |
| Bruce Hall, 5 Stirton Ave., Brantford, ON N3T 1E2                 | dbruceaa@hotmail.com   |
| Dave Janowiak, 5023 S. 65 <sup>th</sup> St., Greenfield, WI 53220 | tvdxr@hotmail.com  |

\*

### THE MAILBOX and all general club correspondence:

Mike Bugaj at WTFDA, PO Box 501, Somersville, CT 06072 mbugaj@snet.net

### SATELLITE NEWS

George Jensen, 4604 Antana Ave., Baltimore, MD 20206-4220 scisatman@aol.com

### TV NEWS

Doug Smith, 1385 Old Clarksville Pike, Pleasant View, TN 37146-8098 w9wi@w9wi.com

### FM NEWS

Steven Wiseblood, 28 LBJ Blvd., Brownville, TX 78521 stevenwisebl@hotmail.com

### PHOTO NEWS

Jeff Kruszka, 5024 S. Braxton Ave., Baton Rouge, LA 70817 jkruszka@bellsouth.net

### EASTERN TV DX

Matt Sittel, 15013 Eureux Circle, Bellevue, NE 68123 mcsittel@cox.net

### WESTERN TV DX

Victor Frank, 12450 Skyline Blvd., Woodside, CA 94062-4554 victor.frank@sri.com

### SOUTHERN FM

John Zondlo, 4009 Driftwood Cir., Yukon, OK 73099 sfm@fmdxweb.com

### NORTHERN FM

Keith McGinnis, 387 Shirley Street, Winthrop, MA 02152 longwave@comcast.net

### VERIFICATIONS AND QSL SIGNERS

Tom Yingling, 221 Pinewood Road, Baltimore, MD 21222-2345 ka3tcc@erols.com

### TV and FM STATISTICS

Fred Nordquist, 7945 Boxford Road, Clay, NY 13041 nordquis@twcnny.rr.com

**BACK ISSUES** Dave Nieman, PO Box 17, Clarence, NY 14031-0017 nieman@localnet.com

*We have a large selection available for \$1.00 each. Email or write Dave for availability.*

**WEBSITE** Tim McVey Webmaster <http://www.anarc.org/wtfda/> tkmcvey@erols.com

**Please Remember to make your renewal checks payable to Dave Janowiak  
Checks made payable to WTFDA may be returned and your renewal may be delayed.**