

SERVICE MANUAL

T-500 SERIES

T-524

T-582

T-546

T-595

NOTE: For all other T-Series
service information, refer
to H000-000431

CAUTION

SEE SAFETY NOTICE ON
INSIDE COVER SHEET

H000-001270



HAMMOND ORGAN COMPANY

A DIVISION OF MARMON COMPANY

A MEMBER OF THE MARMON GROUP OF COMPANIES

4200 W. Diversey Avenue

Chicago, Illinois 60639

[312] 283-2000

SECTION I

HOW THE ORGAN OPERATES

1-1 GENERAL - The Hammond T-500 Organ is completely self-contained, requiring no external tone cabinet. The organ is equipped with two manuals, or keyboards, of 44 keys each, a 13-note pedal keyboard, and an expression (swell) pedal for controlling output volume. Seventeen adjustable tonebars and six preset tabs enable selection of tone colors. An automatic programable rhythm unit with auto chording feature is the

distinguishing function of this organ from previous T-Series organs. The remaining musical variations are controlled by tablets and knobs provided. A switch (See figure 1-1.) controls power to all motor and electronic circuits in the organ. A pilot light indicates when the instrument is powered.

1-2 TONE SOURCE - All tones of the organ originate as electrical

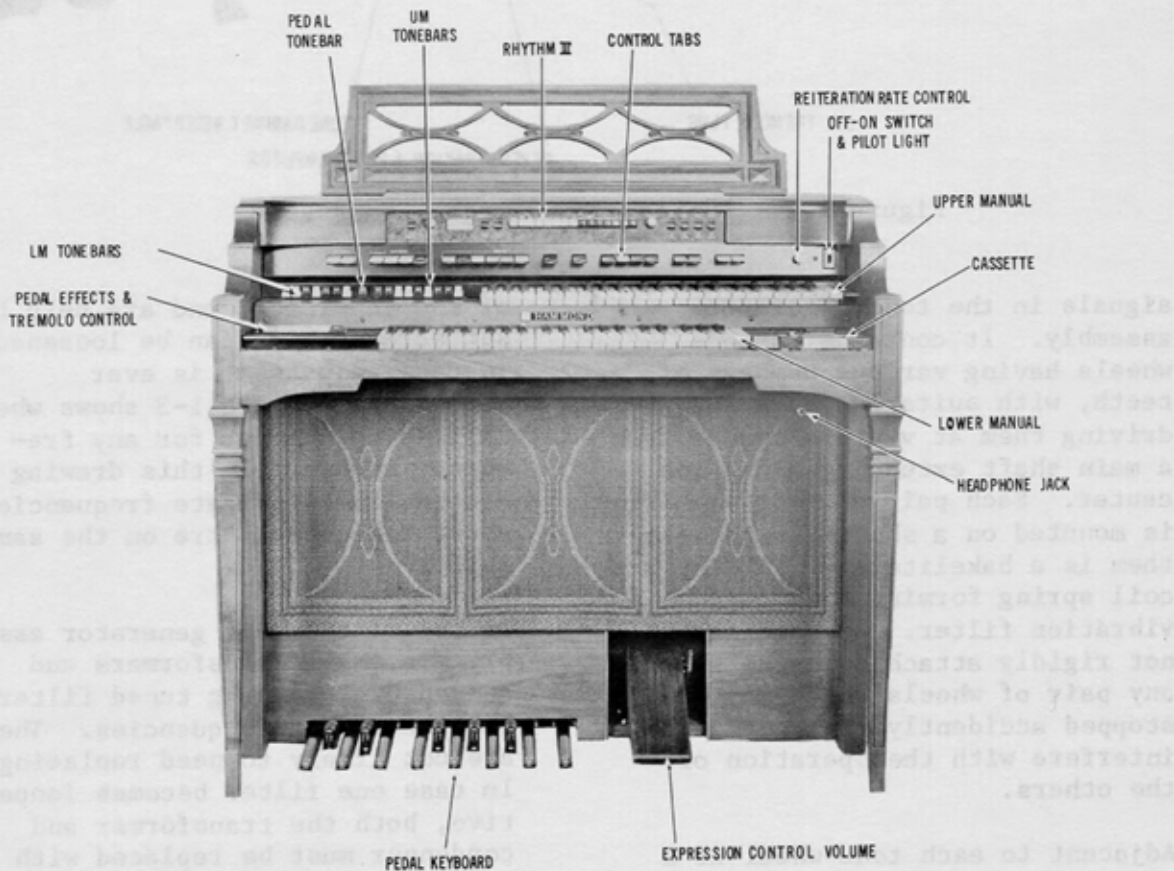

Figure 1-1. Typical T-500 Organ Front View

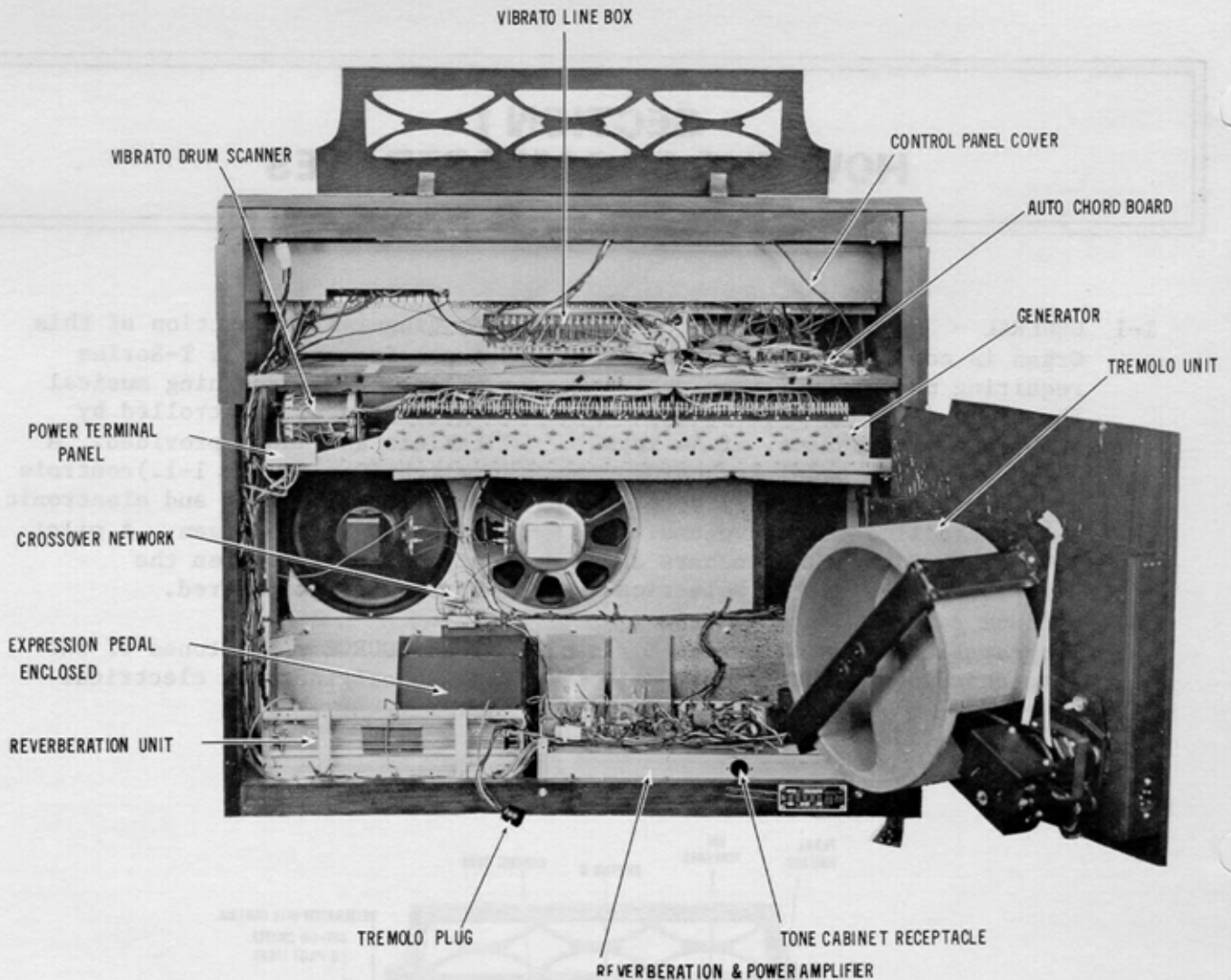

Figure 1-2. Typical T-500 Organ, Rear View

signals in the tone generator assembly. It contains 74 tone wheels having various numbers of teeth, with suitable gears for driving them at various speeds from a main shaft extending along the center. Each pair of tone wheels is mounted on a shaft and between them is a bakelite gear held by a coil spring forming a mechanical vibration filter. As the gear is not rigidly attached to the shaft, any pair of wheels which may be stopped accidentally will not interfere with the operation of the others.

Adjacent to each tone wheel is a magnetized rod with a pick-up coil wound on it. These magnets extend through the front and back

of the generator, and are held by set screws which can be loosened in case adjustment is ever necessary. Figure 1-3 shows where to find the magnet for any frequency number. In this drawing the dotted lines indicate frequencies whose tone wheels are on the same shaft.

On top of the tone generator assembly are small transformers and condensers, forming tuned filters for the higher frequencies. They are not likely to need replacing. In case one filter becomes inoperative, both the transformer and condenser must be replaced with a matched set from the factory. Figure 1-4 shows the location of these filters.

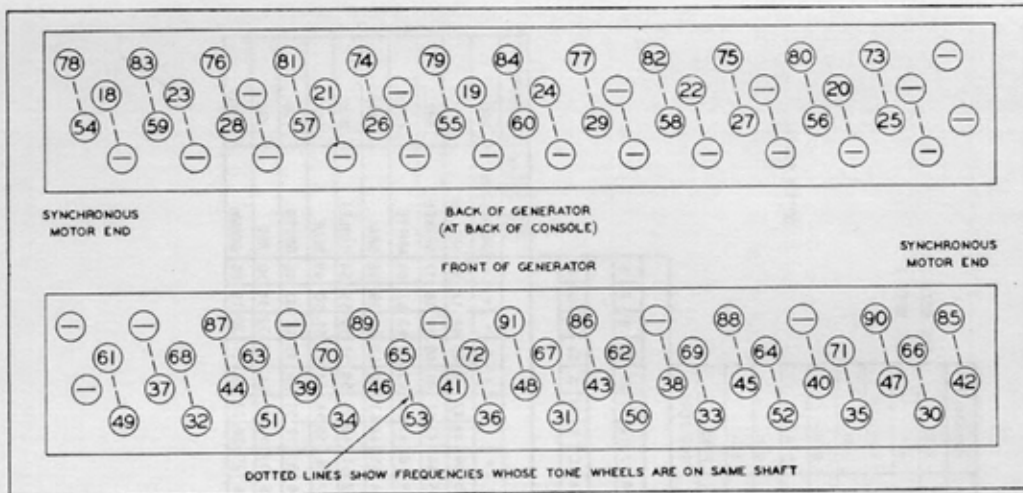

Figure 1-3. Magnet Location on Tone Generator

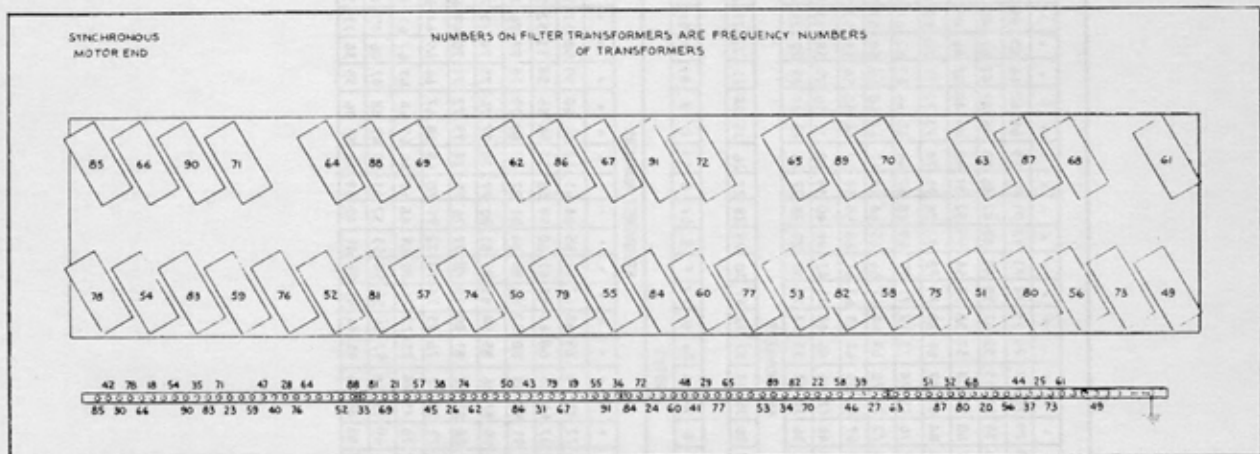

Figure 1-4. Filter Location and Frequency Termination on Generator Cover

The output frequencies of the tone generator are numbered, for convenience, in order of increasing frequency. The lowest, number 18, is about 87 Hz, and the highest, number 91, is about 6000 Hz.

The output terminals of the generator consist of solder lugs mounted on the back edge of the generator. Figure 1-4 shows the terminations by frequency number.

1-3 PEDAL TONES - The fundamental pedal tones are derived from generator frequencies nos. 25 through 37 by means of dividers mounted on the Pedal Divider board, 124-000178. The derived

frequencies are nos. 1 through 13 for the 16' pitch and 13 through 25 for the 8' pitch.

1-4 MANUALS - Musical frequencies from the tone generator go through the manual cable to terminal strips on the two manuals and from them to the key contact springs.

Each of the two manuals has 44 playing keys, or approximately 3 1/2 octaves. The two manuals do not cover exactly the same pitch range, but they are arranged so that the keys of like pitch are in line. Middle "C" is the first C on the upper manual and the key

in line with it on the lower manual.

Under each key are a number of contact springs (for the fundamental and harmonics of that key) which touch an equal number of bus bars when the key is pressed. (Some keys at the right end of each manual have fewer springs, as noted in Figure 1-5) All contact springs and bus bars have precious metal contact surfaces to avoid corrosion, and the manuals are sealed to exclude dust so far as possible.

In case a contact becomes dirty in spite of these precautions, a bus bar shifter is provided in each manual to slide the bus bars endwise and thus provide a fresh contact surface.

The busbar shifting mechanism for the lower manual will be found by looking on the underside left-hand end of the manual. A black wood end block will be observed. One-half inch from the front of this block is a drilled hole. Within this drilling is a

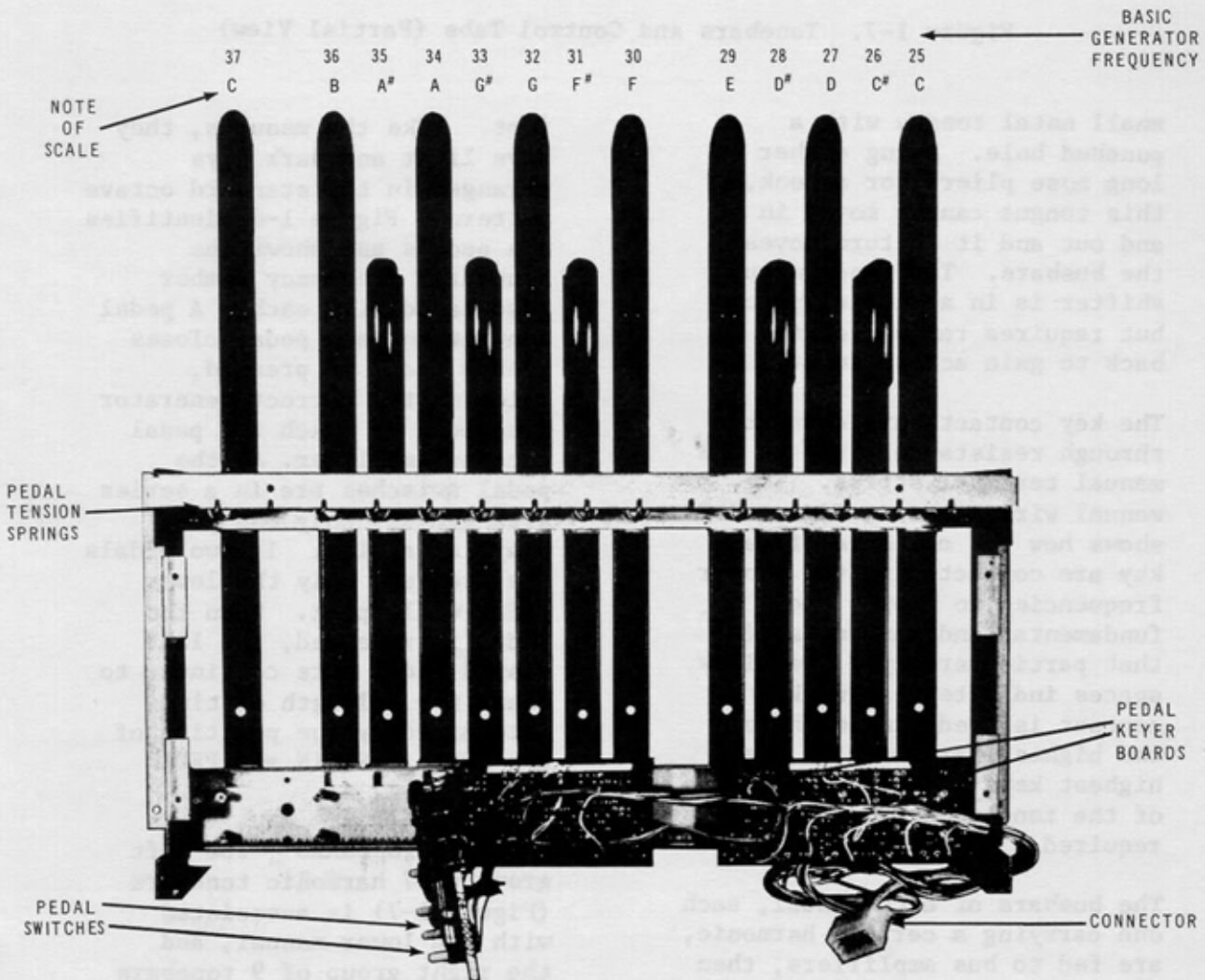

Figure 1-6. Pedal Keyboard



Figure 1-7. Tonebars and Control Tabs (Partial View)

small metal tongue with a punched hole. Using either long nose pliers, or a hook, this tongue can be moved in and out and it in turn moves the busbars. The upper manual shifter is in a similar place but requires removal of the back to gain access to it.

The key contacts are connected through resistance wires to the manual terminal strips. The manual wiring chart, Figure 1-5 shows how the contacts of each key are connected to the proper frequencies to supply the fundamental and harmonics of that particular key. The blank spaces indicate that no key contact is used, inasmuch as the highest harmonics of the highest keys are above the range of the tone generator and are not required.

The busbars of each manual, each one carrying a certain harmonic, are fed to bus amplifiers, then to the harmonic tonebars for that manual.

foot. Like the manuals, they have light and dark keys arranged in the standard octave pattern. Figure 1-6 identifies the pedals and shows the generator frequency number associated with each. A pedal contact on each pedal closes when a pedal is pressed, allowing the correct generator frequency to reach the pedal tonebar amplifier. As the pedal switches are in a series arrangement, only one pedal plays at a time. If two pedals are pressed, only the lower pedal will speak. When the pedal is released, the last played pedal note continues to sound for a length of time, determined by the position of the PEDAL SUSTAIN and PEDAL LEGATO tabs.

1-6 HARMONIC TONEBARS - The left group of 7 harmonic tonebars (Figure 1-7) is associated with the lower manual, and the right group of 9 tonebars controls the upper manual. By sliding these tonebars in and out, the organist is able to mix the fundamental and harmonics (or overtones) in

1-5 PEDAL KEYBOARD - The 13 playing pedals are operated by the left

various proportions. The distance a bar is pulled out determines the strength of the corresponding harmonic; and if a tonebar is set all the way in, the harmonic it represents is not present in the mixture. Neither manual will play unless at least one of its tonebars is pulled out part of the way, with the TONEBARS tab pressed, or a preset tab is pressed.

The tonebars slide over 9 busbars, representing intensity levels, and each tonebar has two contacts connected together by a 5600 ohm resistor. As the tonebar moves, at least one of the contacts is touching some busbar at all times, and therefore there is no "dead spot" in the tonebar motion. The 5600 ohm resistor avoids an actual short circuit between adjacent busbars.

These busbars extend the length of the tonebar assembly but are split in the middle to form two groups of 9 (see Figure 5-1.) Those in the left group, under the lower manual tonebars are connected to the base of the transistor Q-851. Those on the right group, under the upper manual tonebars, are connected to the base of transistor Q-854 through the upper manual TONEBAR & PERCUSSION tablet.

1-7 PEDAL TONEBAR - The center tonebar adjust the volume of the pedals by sliding over 9 busbars mechanically segregated from the upper and lower manual busbars. The output from this busbar is fed in parallel with the signal from the lower manual to the base of transistor Q-851.

1-8 EXPRESSION PEDAL - The "expression" pedal, sometimes called "swell" pedal (Figure 1-1), is operated by the player's right foot and varies the volume of both manuals and pedals together.

When the pedal is tilted back (closed) by pushing on the player's heel, the music is softest, and when pushed forward (opened) by the player's toe, the music is loudest.

1-9 CONTROL TABS - There are 28 tabs on the T-500 series instrument, each providing some change in the instrument's operation.

To have the instrument sound after turning it on, tabs such as THEATER BRASS and ENSEMBLE will place the upper and lower manuals in operation. A tab is in use when in the down position. Functions of the various tabs from left to right, as they appear on the instrument, are given in the following paragraphs.

1-10 PRESET TABS - Two preset tabs are provided for the lower manual; namely, TONEBARS and ENSEMBLE. Four preset tabs are provided for the upper manual; namely, TONEBARS and PERCUSSION, STRINGS 8', FULL TIBIAS 16', THEATER BRASS 16'.

1-11 PERCUSSION CONTROL TABS - There are 7 tabs which control percussion. These operate in either the up or down position of the upper manual TONEBARS & PERCUSSION tab. When the TONEBARS & PERCUSSION tab is up, percussion only is played on the upper manual; when the tab is down, tonebar effects and percussion are played simultaneously. For tonebar

effects alone on the upper manual, the seven percussion tabs must be in up position, and the TONEBARS & PERCUSSION tab must be down.

1-12 VIBRATO TABS - The T-Series instruments are equipped with four Vibrato tabs to vary the Vibrato effect. An additional tab (VIBRATO ON) to the left of the vibrato group permits the vibrato effect to be introduced immediately.

Various vibrato effects are available by use of the tabs. Vibrato Celeste III is achieved by depressing both VIBRATO CELESTE I AND II tabs.

1-13 REVERBERATION - Three degrees of reverberation are obtained by the use of either or both tabs labeled REVERB I and REVERB II. These tabs, in addition to turning this feature on, govern the loudness or amount of reverberation.

1-14 VOLUME SOFT, BRILLIANCE TAB, AND REITERATION RATE CONTROL
The VOLUME SOFT tab controls the overall volume of the organ and is useful when playing might disturb others.

The BRILLIANCE tab in the up position bypasses a portion of the higher frequencies to ground, making the organ sound deeper.

The REITERATION RATE control, as the name implies, adjusts the rate or speed of reiteration when used in conjunction with the percussion tabs and reiterate tab.

1-15 PEDAL ROCKER TABS, LOWER LEFT END BLOCK - Upon playing the

bass pedals, a normal decay and attack are heard when the pedal tonebar is pulled out. Either 16' or 8' pitch is available by means of the PEDAL 8'/16' tablet.

Use of the PEDAL LEGATO tablet provides a very slow pedal decay which many beginners find useful, as the pedal last played sounds until the next one is played. PEDAL SUSTAIN causes the pedal tone to decay slowly. PEDAL MUTE gives added deep tone to the pedals when desired. Further information concerning electrical function is given in paragraph 2-5.

1-16 TREMOLO ROCKER TABS, lower LEFT END BLOCK The TREMOLO ON/OFF tab connects the organ signal to the Tremolo speakers when "on". The TREMOLO SLOW/FAST tab controls the speed of the Tremolo, which runs whenever the organ is "on".

1-17 AUTO CHORD BOARD (124-000179)
The Auto Chord Board contains the gating circuits for lower manual and Hi/Low Bass of the pedals. This board is not independent functioning as it needs keying or gating pulses from the Rhythm III unit. The different auto chord modes are selected by the Rhythm III switching circuitry.

If the Auto Chord Board is removed the pedal and lower manual voicing is silenced.

1-18 CASSETTE 121-000139 & 121-000165
This unit is 1/2 track monaural cassette transport deck. It features controlled electronic speed regulation and automatic level control

minizing distorted recordings. A microphone is included.

The operational features are as follows:

- A. Keyboard type transport control for Stop, Rewind, Fast Forward & Play/Record functions.
- B. Thumb wheel type playback level adjustment. (Non-functional in record mode)
- C. Electromechanical accidental erasure-prevention system keyed with Record/Play controls and rear knock-out tabs on cassette cartridge.
- D. External access jack for Microphone. The microphone has a motor start-stop switch and when plugged in, disconnects the "Aux." input.
- E. Lid loading cassette.
- F. Thumb wheel type speed control adjustment with red mark on knob denoting center position. This red mark allows rapid return to standard cassette speed.
- G. In the record mode of operation, output signal must be disconnected from output terminal.

1-19 RHYTHM III - The inbuilt automatic Rhythm III is contained in one assembly 125-000082. This rhythm unit is a step-up version of Rhythm 11-A containing such features as Auto-Accompaniment output signals, Touch-Start, Foot Switch Preset capability, and four play-a-long voices. All player-operated controls are mounted on the Inbuilt Rhythm Unit. The following describes the function of the controls.

- A. PROGRAMMED PUSH BUTTONS. There are 15 interlocking push buttons mounted on the control panel to select different rhythm

patterns. Two or more rhythm patterns may be played simultaneously if desired, including 3/4 and 4/4 time rhythm patterns.

- B. SILENT/SOUND - The Silent/Sound tablet is used to silence the audio output for the automatic rhythm voices (but not the follow-the-player voices) and reset the timing generator when it is moved to the Sound position.
- C. CONTINUOUS/TOUCH START - The Continuous/Touch Start switch allows the player to start the rhythm unit from either the lower manuals or pedals by first placing this tablet in the Touch Start position, second, move the Silent/Sound rocker switch to its Sound position, and then depress either a lower manual or pedal key.
- D. FOOT SWITCH RESET - The Foot Switch Reset tablet allows the player to either just silence the audio output (including the follow-the-player voices) when the foot switch is depressed or, when the Foot Switch reset position, to also reset the generator when the foot switch is released.
- E. AUTO ACCOMPANIMENT - The Auto Accompaniment switch when placed in the "on" position, provides gating signals for the lower manual and for high and low pedal gates. If the Foot Switch Reset is in the "off" position, the foot switch does not

affect Auto Accompaniment. If the Foot Switch Reset is in the "on" position, the foot switch silences the lower manual and pedals, because the pulsing tracks are not available to operate the 3 gates. Turning "on" the Auto Accompaniment switch disables the Pedal Sustain Tab and the Pedal 16'/8' Tab.

- F. TEMPO LAMP - The Tempo Lamp blinks beats (4 beats per measure) when the rhythm unit is silent and blinks measures when the rhythm unit is "on". If the Foot Switch Reset is in the "off" position, the foot switch does not affect the blinking lamp. If the Foot Switch Reset is in the "on" position the foot switch operation causes the lamp to blink at the beat rate.
- G. TEMPO CONTROL - The tempo knob controls the rate of the rhythm unit from 48 to 300 beats per minute. The tempo knob also has a Lamp Off position to turn off the Tempo Lamp when the rhythm unit is not in use.
- H. VOLUME CONTROL - The Volume Control is a dual control which varies the output level of both the high frequency and the low frequency output channels simultaneously.
- I. BASS DRUM & CYMBAL - The Bass Drum and Cymbal tablets allow the player to activate these voices by depressing a pedal key on the organ. These voices are controlled by the volume and can be silenced by the expression pedal kick switch.

SAFETY NOTICE

Great care has been taken in the design and manufacture of this product to assure that no shock hazard exists on any exposed metal parts. Internal service operations can expose the technician to hazardous line voltages and accidentally cause these voltages to appear on exposed metal parts during repair or reassembly of product components. To prevent this, work on these products should only be performed by those who are thoroughly familiar with the precautions necessary when working on this type of equipment.

To protect the user, it is required that all enclosure parts and safety interlocks be restored to their original condition and the following tests be performed before returning the product to the owner after any service operation.

Plug the AC line cord directly into a line voltage AC receptacle (do not use an isolation transformer for this test) and turn the product on. Connect the network (as shown below) in series with all exposed metal parts and a known earth ground such as a water pipe or conduit. Use an AC VOM of 5,000 ohms per volt or higher sensitivity to measure the voltage drop across the network. Move the network connection to each exposed metal part (metal chassis and control shafts, escutcheon, etc.) and measure the voltage drop across the network. Reverse the line plug and repeat the measurements. Any reading of 4 volts RMS or more is excessive and indicates a potential shock hazard which must be corrected before returning the product to the user.

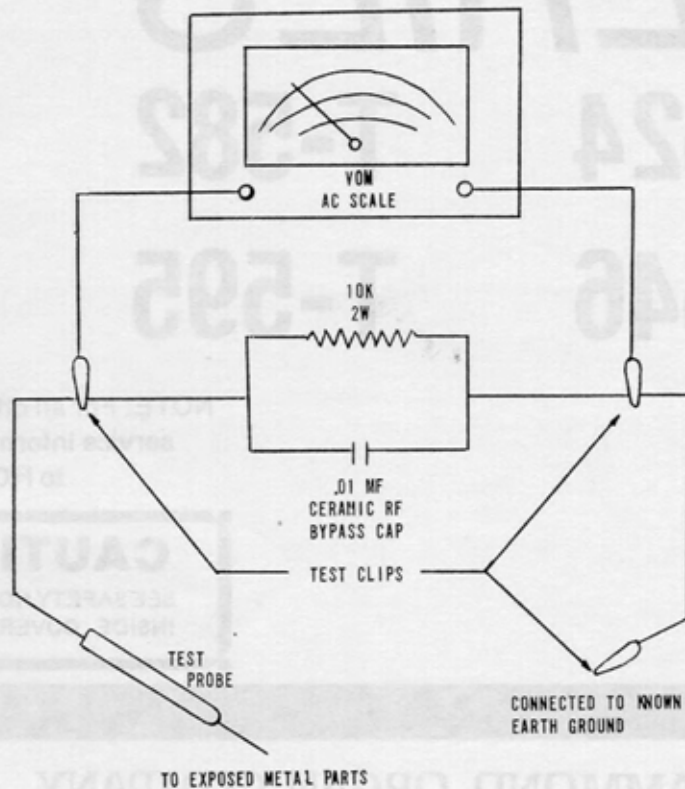

SECTION II THEORY OF OPERATION

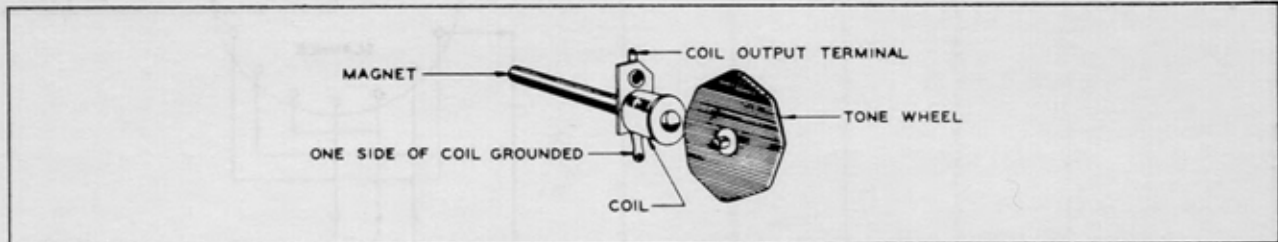

Figure 2-1. Typical Tone Generator

2-1 GENERAL - Theory of the Tone Generator, Vibrato system, and individual circuits are discussed in this section.

2-2 TONE GENERATOR - Electrical impulses of various frequencies are produced in the "tone generator assembly" which contains a number of "tone wheels" driven at predetermined speeds by a motor and gear arrangement. Each tone wheel is a steel disc similar to a gear with high and low spots, or teeth, on its edge. (See Figure 2-1). As the wheel rotates, these teeth pass near a permanent magnet, and the resulting variations in the magnetic field induce a voltage in a coil wound on the magnet. This small voltage, when suitably filtered, produces one note of the musical scale, its pitch or frequency depending on the number of teeth passing the magnet each second.

2-3 VIBRATO SYSTEM - The Hammond Organ vibrato equipment (see Fundamental Diagram of Vibrato System, Figure 2-2) varies the frequency of all tones (excepting

the pedal and percussive tones) by continuously shifting their phase. It includes a phase shift network or electrical time delay line, composed of a number of low pass filter sections, and a capacity type pickup or scanner, which is motor driven so that it scans back and forth along the line.

Electrical waves fed into the line are shifted in phase by each line section (the amount per section being proportional to frequency), so that at any tap of the line, the phase is retarded relative to the previous tap.

The scanning pickup traveling along the line will thus encounter waves increasingly retarded in phase at each successive tap. As a shift in phase is equivalent to an instantaneous change in frequency, the continuous change in phase becomes a continuous frequency variation. Since the scanner sweeps from start to end of the line and then back, it alternately raises and lowers

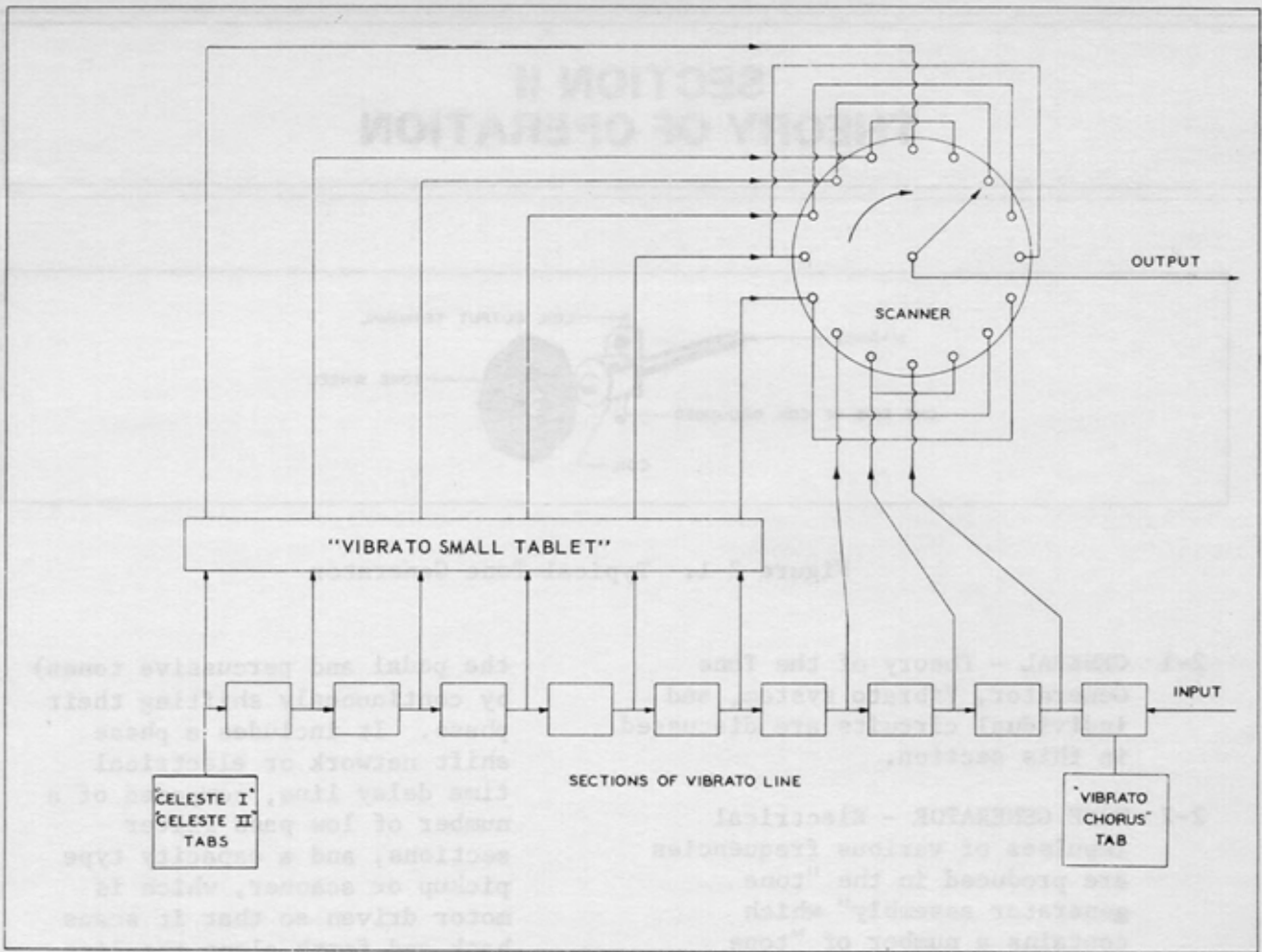

Figure 2-2. Fundamental Diagram of Vibrato System

the output frequency, the average remaining equal to the input frequency.

The exact amount of frequency shift depends not only on the amount of phase shift in the line but also on the scanning

rate. This rate, however, is constant because the scanner is driven by the synchronous running motor of the organ.

The "Vibrato Small" tab varies the amount of frequency shift by causing one half of the line to

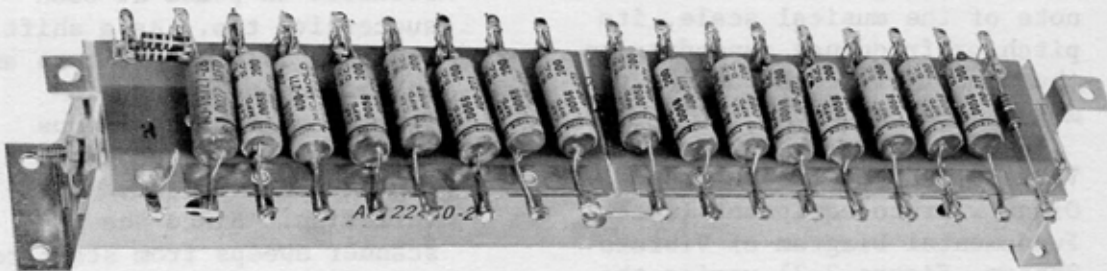

Figure 2-3. Vibrato Line Box

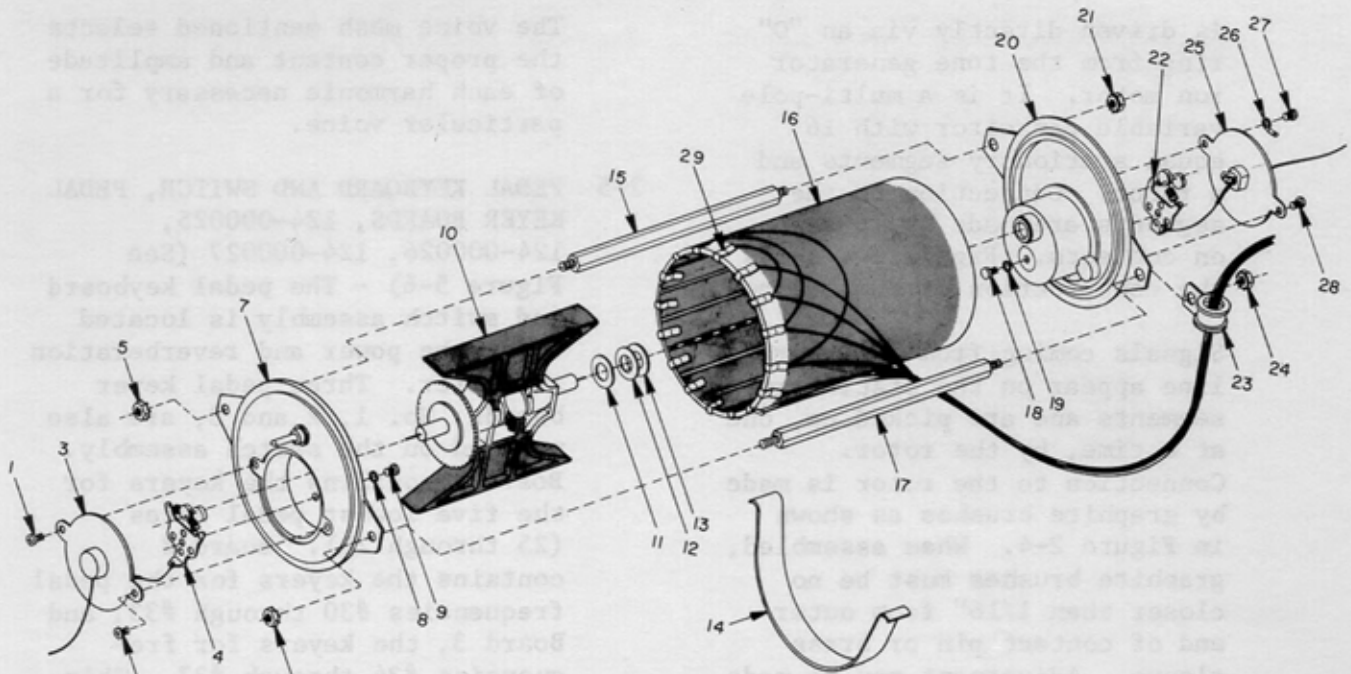

Figure 2-4. Typical Drum Scanner

be scanned, in contrast to the entire line when in the up position.

A vibrato chorus effect, similar to the effect of two or three slightly out-of-tune frequencies mixed together, is obtained when the vibrato output signal is mixed with a portion of signal without vibrato. This is accomplished by the "Vibrato Chorus" tab, which causes only part of the incoming signal to appear across the vibrato line and the rest across a resistor in series with the line. As the vibrato effect is applied to the part of the signal appearing across the line but not to the part appearing across the resistor, the combination produces a chorus effect.

A celeste effect is obtainable by the use of "Vibrato Celeste I"

and "Vibrato Celeste II" tabs. These can be used independently or together. Use of these tabs introduces a resistor network at the far end of the vibrato line, changing the termination impedance. This causes a reflective signal to appear in the line, which is picked up by the scanner.

Figure 2-2 shows only the "vibrato" channel of the amplifier. All tones sent through this channel have the vibrato effect. When vibrato is not desired, the "Vibrato On" tab in the up position feeds the signal through the "non-vibrato" channel.

Figure 2-3 shows the vibrato line box. It is mounted on the rear of the upper manual.

The scanner is mounted on the left end of the generator and

is driven directly via an "0" ring from the tone generator run motor. It is a multi-pole variable capacitor with 16 equal stationary segments and a rotor. Connection to the segments are made by 16 snap-on contacts. Figure 2-4 shows the construction of the scanner.

Signals coming from the vibrato line appear on the stationary segments and are picked up, one at a time, by the rotor. Connection to the rotor is made by graphite brushes as shown in Figure 2-4. When assembled, graphite brushes must be no closer than 1/16" from outer end of contact pin or brass sleeve. Adjustment may be made, if necessary, by bending legs of the brush lug. Brushes should not contact each other in operation.

- 2-4 MANUAL BUS BAR AMPLIFIERS, 124-000015 & 124-000016 (See figures 5-3 & 5-4)
- The busbar amplifiers for both manuals are located to the rear of the control panel. The lower manual board contains one amplifier for each of the seven harmonic bus bars. The outputs of these amplifiers are routed to the tonebars and voice mesh. The upper manual board contains one amplifier for each of the nine harmonics. Amplified signals are fed to the tonebars and three preset voice meshes. All the amplifiers have a response curve designed to decrease the amount of key transient. A typical bus amplifier receives its input signal from the busbar. The signal is amplified and sent to the proper tonebar and/or voice mesh.

The voice mesh mentioned selects the proper content and amplitude of each harmonic necessary for a particular voice.

- 2-5 PEDAL KEYBOARD AND SWITCH, PEDAL KEYS, 124-000025, 124-000026, 124-000027 (See Figure 5-6) - The pedal keyboard and switch assembly is located under the power and reverberation amplifier. Three pedal key boards, No. 1, 2 and 3, are also mounted on the switch assembly. Board 1 contains the keys for the five lowest pedal notes (25 through 29). Board 2 contains the keys for the pedal frequencies #30 through #33, and Board 3, the keys for frequencies #34 through #37. This provides one key for each pedal note.

All pedal keys operate in the same manner. Following is a typical function, involving the lowest pedal (C). Switch S-751 is closed, placing +15V on C-751. This voltage forward biases Q-753 through resistors R-756 and R-757. This allows the generator signal, present at pin 6 to pass to the emitter. All emitters are common on the boards and provide the input signal to the high pass active filter network located on pedal key board #3. Board #1 also contains an erase circuit and buffer stage, working in conjunction with all pedals. When any pedal is pressed, a negative pulse is coupled across C-750 to the base of Q-750. This negative pulse reverse biases Q-750, causing a positive pulse to appear at the collector. The positive pulse passes through D-750 and forward biases Q-751, resulting in a negative going

pulse to ground at the base of Q-752 and the cathodes of pedal diodes D-751 through D-763. This is the erase pulse and turns off any pedal keyer which does not have its associated pedal pressed. The buffer stage Q-752 transfers the positive DC signal from the keyer and the erase pulse to other organ functions at pin 8.

- 2-6 PEDAL DIVIDER & FILTER BOARD ASSEMBLY, 124-000178 (See Figure 5-7) - The Pedal Divider and Filter Board Assembly is located on the power and reverberation amplifier chassis. It provides amplification, shaping and division by four bistable frequency dividers.

The amplifier and shaping circuit receives its input signals from the pedal keyer circuitry. The signal is amplified by Q-701, Q-702 and Q-703. Shaping is accomplished by Q-704 and Q-705, which furnishes a +12V square wave at the input frequency to the first divider bi-stable. Q-706 and Q-707 make up the first bi-stable or flip-flop configuration. The input signal is divided by 2 and appears at the collector of Q-707. This signal will become the 8' component of the pedal signal when called for by the positive DC signal from the Auto Chord board. The DC signal forward biases D-702 which allows the signal to pass to output pin #12. The signal at the collector of Q-707 also becomes the input to the second bistable.

Q-708 and Q-709 make up the second divider. The signal is again divided by 2, and will appear at the collector of Q-709. This signal will

become the 16' component when called for by the positive DC signal from the Auto Chord board. The DC signal forward biases D-701 which allows the signal to pass to output pin #11.

- 2-7 RECOVERY AND NON-VIBRATO BOARD, 124-000014 (See Figure 5-4) - The recovery and non-vibrato board is located on the control panel and consists of two recovery amplifiers. One recovery amplifier handles the signals from the pedal tonebar, lower manual tonebars and presets. The other handles the signals from the upper manual tonebars, and presets. The board also contains the non-vibrato amplifier and intermediate amplifier (with click filter) which drives the main amplifier.

The recovery amplifier receives its signal from input pins 6 or 8. The signal is amplified by Q-851 or Q-852, and the outputs appear at pins 5 and 7. These outputs are tied together and sent to the "Vibrato On" tablet located on the control panel, where the "Vibrato or Non-Vibrato" mode will be determined.

With the "Vibrato On" switch in the Off position the pedal and both manual signals appear at pin 4. The signal is amplified by Q-853 and sent to the intermediate amplifier and click filter.

The intermediate ampli-

fier receives its signal from pin 9 in the vibrato mode or from R-860 in the non-vibrato mode. It is amplified by Q-854. The remainder of the circuitry acts as a click filter with the output appearing at pin 3.

The output of the entire board is controlled by potentiometer R-870 that also serves as "system" volume adjustment.

- 2-8 VIBRATO BOARD ASSEMBLY, 124-000018 (See Figure 5-6) - The vibrato board assembly is also located on the control panel. It controls the vibrato drive and vibrato recovery amplifiers.

The vibrato drive amplifier receives its signal at pin 1 from the "Vibrato On" switch. This signal is amplified by a low noise transistor Q-801, followed by further amplification by Q-802, and Q-803 (the latter an emitter follower). Final amplification is by Q-804 and transformer T-801. Output to the phase shift is from pin 4.

The vibrato recovery circuit receives its input signal at pin 3 from the vibrato scanner.

The emitter follows Q-805, Q-806 and Q-807, present a high reactive impedance to the scanner with the output appearing on pin 7.

- 2-9 SWELL PEDAL CIRCUITRY - The main organ signal input to the Power Amplifier board (124-000017) is at pin 8. Pin 10 of the board is connected to the LDR located on the Swell Pedal assembly (123-000004). The LDR provides a variable resistance to ground to vary the amplitude of the input signal.

- 2-10 POWER AND REVERBERATION AMPLIFIER ASSEMBLY - The power and reverberation amplifier assembly is mounted on the pedal keyboard and switch assembly. It contains the power supplies, the swell pedal circuitry, the main amplifier, the reverberation drive and recovery, and the previously mentioned pedal divider and filter board assembly.

MAIN AMPLIFIER, 124-000176 (See Figure 5-8) - The resulting signal at C-601 is amplified by Q-601 passed to the base of Q-602. The signal is then amplified by Q-602 and transferred to the primary of T-601 through the Darlington configuration emitter follower Q-603 and Q-604. Q-605 and Q-606 is an "AB" type amplifier and the output to the speakers appears on pin 19.

REVERBERATION DRIVE The reverberation drive gets its

signal from the emitter of Q-601. The signal is amplified by Q-607 and Q-608 and transferred to the primary of T-602. Q-609 and Q-610 is an "AB" type amplifier and the output appears at pin 28.

REVERBERATION RECOVERY. The output from the reverberation unit appears on pin 4. The signal is amplified by Q-611 and Q-612 and appears at pin 6. The reverberation signal then goes through the reverberation tab circuitry and appears as an input at pin 12.

- 2-11 POWER SUPPLY CIRCUIT - Power supply components are located in the power supply chassis assembly (127-000176 thru -000178). All necessary DC supply voltages for the rhythm unit are supplied by this chassis. The voltages are +15V DC, +18V DC, +23V DC, +25V DC and -25V DC. 120V AC 50/60 Hz is supplied to the power transformer from an external source. The secondary AC voltage is 27V RMS.

D601 & D602 rectify the secondary voltage C615 filters it and -25V DC appear at the output of this circuit.

D603 & D604 rectify the secondary voltage C616, R644 filter +25V DC. 15V zener D608, R645, & C117 regulate and filter the +15V DC supply.

D605 & D606 rectify the secondary voltage and the combination of C618, L601, C619A, R643, and C619B filter the supply voltages of +25V DC, +23V DC, and +18V DC.

2-12 PHONE JACK - T-500 organs are equipped with an earphone jack which will give pleasing results. Use headsets such as Clark 200, Koss SP-3XC, or Sharp HA-10. When earphones are plugged in speakers are disconnected for listening privacy. Tremolo effects are not heard in earphones.

2-13 SPECIAL POWER SOURCES - T-500 organs are made to operate on the voltage and frequency specified on the nameplate. They are available for 117V/60 cycle - 117V/50 cycle - 234V/50 cycle and 234V/60 cycle. If the unit is moved to an area having voltages or frequencies other than those specified on the nameplate, consult your local dealer concerning changes required for conversion.

2-14 PERCUSSION BOARD ASSEMBLY (124-000170) - The following inter-related circuits are located on this board (See Figure 5-10):

1. 1 1/4 Harmonic Generator
2. Normal Percussion Keying
3. Reiteration Keying and Triggering
4. Main and Alternate Channel Gates

A. 1 1/4 HARMONIC GENERATOR
The output of this circuit is used only as part of the chimes voice.

The circuit receives its input at pin 11 from the

upper manual 5th harmonic buss amplifier. The signal is amplified by Q514, Q515 and Q516. The resultant square wave output provides the input to IC501. IC501 is a *J-K Flip Flop integrated circuit. The collector supply voltage for the IC and Q516 is a result of the action of D12, a 5 volt Zener diode.

The output from IC501, pin 8 is coupled to a waveshaping network and to the output pin 14.

*J-K Flip Flop - IC 510 is a single package two stage bi-stable divider. Failure of one stage requires the replacment of the IC package. Several pins of the IC package are not used in this circuit application.

B. NORMAL PERCUSSION KEYING -

In the normal percussion mode, when a key is depressed on the upper manual, 220K ohms of resistance are connected between pin 15 and ground. As a result, the positive voltage at pin 15 is reduced. This negative change is differentiated by C517 and applied to the base of Q512 (normally on). The resulting positive pulse at Q512 collector is coupled to Q513, turning it on. The negative change, at the collector of Q513, is coupled by C510, forward biasing D509 and D510. C511 is also charged. Since the pulse used to charge C511 is momentary, C511 begins to discharge immediately.

With the Guitar and Chimes switch in the off position, pin 10 is grounded. The discharge path of C511 is split. One path is through D510, R537, and the combination of Q510 and Q511. The other is through D511 and R546 to ground. This provides for the short decay time. When either the Chimes or Guitar switch is depressed, the ground is removed from pin 10 and the second discharge path is opened. The result is a longer decay time.

The entire action will be rekeyed when an additional key is depressed. The voltage at the input will drop in increments with each key depressed and result in an output pulse fed to Q510 and Q511. This type of keying is referred to as Legato type percussion.

C. REITERATION KEYING AND TRIGGERING - When the reiteration tab is depressed, the percussion keying busbar in the upper manual is connected to pin 2. With normal percussion, it was connected to pin 15.

When an upper manual key is depressed, a 220K resistor connects pin 2 to ground. This causes the base of transistor Q501 (normally off) to drop from +23 volts to approximately +22.5 volts which causes it to conduct. The collector of Q501 rises to +23 volts. The +23 volts is routed to pin 4, which is connected to the reiter-

ation rate control on the control panel, and also to the top of R506.

From Pin 4, through to the wiper of the reiteration control, which is connected to pin 18, the voltage is fed to R508 and R509. The varying voltage applied to pin 18 causes the astable multivibrator (Q506 and Q507) to vary in frequency.

The positive 23 volts applied to R506 causes D502 to be forward biased. This action brings the junction of R506 and D502 to a positive 15 volt level. This 15 volts causes D503 to be forward biased and subsequently becomes the supply voltage.

The outputs are taken alternately from the bases of the multivibrator transistors. The negative pulses drive the main and alternate gate circuits.

- D. MAIN AND ALTERNATE CHANNEL GATES - The main channel gate circuit consists of transistors Q508, Q509, Q510, Q511.

As Q506 and Q507 (Multivibrator transistors) conduct alternately, pulses from the base of Q507 are supplied to the emitter of Q511, the gating transistor, and Q510, a grounded base amplifier. The AC signal on the base of Q511 is insufficient for Q511 to conduct. The pulses from

the base of Q507 supply sufficient bias to cause conduction of Q511.

Through Q511, two signal paths exist, one for the gating signal and one for the music signal. The usable portion of the music signal passes through the base collector junction of Q511, through R556 (Main Null Control), to the base of Q509. The music signal is amplified by Q509 and controlled as to amount of output by the setting of R557 (Percussion Level Control).

The gating signal, as was mentioned previously, is applied to the emitters of Q510 and Q511. The signal which goes through Q511 appears at the collector with the music signal and is applied to the base of Q509. The gating signal also appears at the collector of Q510 and is directly coupled to the base of Q508. From the emitter of Q508, the signal is coupled to the emitter of Q509. The signal from the emitter of Q509 appears at the collector out of phase with the signal impressed on its base. As a result, the two gating signals are out of phase and cancellation takes place. The Main Null Control (R556) is to affect maximum cancellation of the gating pulses.

The operation of the alternate channel gate is identical as that described for the main channel.

Of special note is that R557 (Percussion Level Control) is the common collector load for both Q502 and Q509. As a result, the gain of both gates is controlled by R557.

E. PERCUSSION SETUP PROCEDURE
Equipment Needed:

1. Tektronics Oscilloscope 503 or equivalent.

Depress the "REITERATE" tab and set Reiterate Rate control at approximately mid position.

Depress and hold key #25. Rotate the Percussion control R557 full counter clockwise (up). Refer to Figure 5-10 for following setup procedure.

Connect the oscilloscope to the junction of C503 and R527 on Percussion Board. Set the oscilloscope sensitivity to 10 mv/cm and rotate the Alternate Null R519 and Main Null R556 controls until the pulses on the oscilloscope are adjusted to minimum amplitude. Observe Figure 2-5 for proper waveshape.

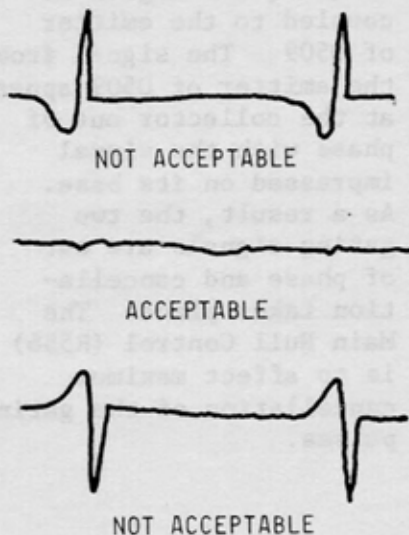

Figure 2-5
Percussion Null Adjustment

PERCUSSION AND REITERATION GAIN
Depress "CELESTA" tab, depress "REITERATE" tab and place control in approximate mid position. Connect the oscilloscope to the speaker terminal and adjust vertical sensitivity to 1.0 V/cm. Depress and hold upper manual key #25.

Adjust the Percussion Level control (R557) until the percussion output is 10.5V \pm .3V Peak to Peak.

Return all tabs to their "off" position. Depress CHIMES or GUITAR tab. Depress Key #25. And hold. Decay time should be approximately three seconds. All other percussion voices should have a decay time of approximately one-half to one second.

REITERATE RATE ADJUSTMENT
Depress CELESTA and REITERATE tabs. Adjust the Reiterate Rate control to maximum (full clockwise). Hold down upper manual key #25 and measure the duration of one complete percussion wave form on oscilloscope. It should be between 45 and 65 milliseconds (Figure 2-6). Reset the oscilloscope.

Horizontal Sweep .1 sec/cm. Adjust the Reiteration Rate control to minimum (full counter-clockwise). Hold down upper manual key #25 and measure the duration of one complete percussion waveform on the oscilloscope. It should be between .10 and .45 seconds. Turn off REITERATION tab.

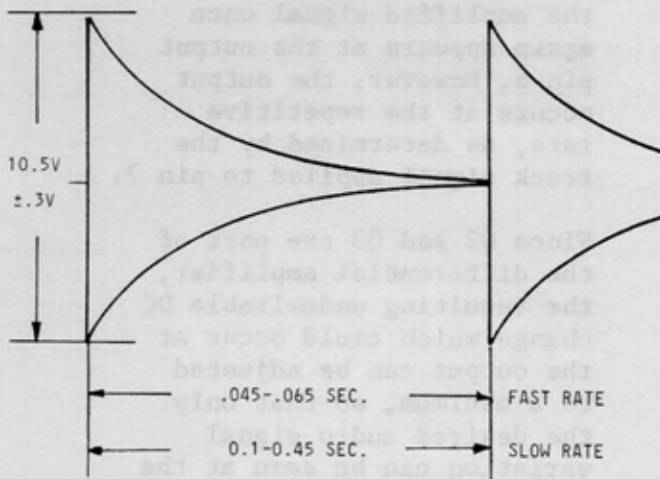

Figure 2-6
Percussion Decay Adjustment

PERCUSSION PRESET VOICES

To check voicing of percussion, it is necessary to match the upper manual percussion voice with a lower manual Tonebar registration by playing a chord in short staccato fashion on the upper manual, and then playing the same chord, in the same staccato manner, on the lower manual. Note that the output for percussion voices on the upper manual will be slightly higher than the corresponding Tonebar registration output of the lower manual.

Tonebars that are registered will be set at position #8.

Clear all tonebar registrations and depress "CELESTA" and "TONEBARS" (lower) tabs.

VOICE	TONEBARS						
	1	2	3	4	5	6	7
CELESTE	0	8	0	0	0	0	0
CHIMES *	0	8	8	8	0	0	0
GUITAR	8	8	8	8	0	0	0
MARIMBA	8	0	0	8	0	0	0
XYLOPHONE	0	8	0	0	0	8	0
BANJO	0	8	8	8	8	8	0

*NOTE

There will be a mismatch in chimes. The 1 1/4 harmonic present in the upper manual chimes voice is not available in the lower manual Tonebar registration. By disconnecting the orange lead at pin #14 (1 1/4 harmonic output) on the Percussion Board (124-000170), a perfect match should be obtained.

2-15 AUTO CHORD BOARD (124-000179)

A. 1. Non-Autochord Manual Mode

The lower manual input signals are connected to pin 4, through C2 to base of common emitter Q1. For a 5mv input signal, approximately 15mv appear on the collector Q1. This signal is fed through C3 to the base of transistor Q5, which is part of the gate and differential amplifier circuit consisting of Q2.

2. Non-Automatic Accompaniment Mode

In the non-automatic accompaniment mode, pin 11 is grounded by a switch contact in the Rhythm III unit. This causes the collector of Q10 to switch from 0V to approximately -19VDC. This DC level is connected through R37, D2, R15, R14 to the emitters of gates Q4 and Q5.

The emitters of Q4 and Q5 are now at -.5VDC due to the emitter base junction and Q4 and Q5 are turned on. The signal on the base of Q5 is amplified by Q5 and fed through R11 to the base of Q3. The signal on the emitter of Q3 is connected through R18, R6 to the emitter of Q2. Q2 amplifies the signal to approximately 200 mv P-P on the collector of Q2. This is fed through part of level control R5, through C4 and R12, and to the lower manual preamp

in the organ. Lower manual level is adjusted by R5.

B. Automatic Accompaniment Mode

In the automatic accompaniment mode, pin 11 is not connected to ground in the Rhythm III unit. The appropriate track, differentiated output is connected to pin 7 of the Autochord PWB. This is approximately 1 ms wide -5V P-P spike, which is connected through R24 to the base of Q7.

When the player depresses a lower manual key, pin 9 becomes connected to ground through a 220K resistor. The -20VDC at pin 9 rises approximately 2V. This changes the bias of Q8 and its collector switches from 0V to -20VDC. The -20VDC is connected through R23 to the collector of Q7, which allows the repetitive spike on the base of Q7 to appear on its emitter. Q7 acts as an emitter follower each time a key is depressed. The negative spike is fed through R21, D3 to the base of pulse amplifier Q6. The positive going spike at the collector of Q6 is fed through C6, integrated by R15 and C5 and the resulting negative pulse is fed through R14 to the emitters of gates Q4 and Q5. Since the input signal from the manual is at the base of Q5 (as described in non-automatic accompaniment mode),

the amplified signal once again appears at the output pin 6, however, the output occurs at the repetitive rate, as determined by the track signal applied to pin 7.

Since Q2 and Q3 are part of the differential amplifier, the resulting undesirable DC change which could occur at the output can be adjusted to a minimum, so that only the desired audio signal variation can be seen at the output collector of Q2. Also, each time a key is depressed the resulting DC level change at pin 9 is fed through C10 to the base of Q9, which is a pulse amplifier. The resulting -20VDC pulse on the collector of Q8 is fed through pin 10 and is used by the Rhythm III unit for the touch response mode and for legato keying from the manual of the Brush and Snare Drum voices.

C. 1. Non-Auto Accompaniment Pedal Mode

In the non-auto accompaniment pedal mode of operation, pin 15 is not grounded by Rhythm III; and when a pedal is played, approximately +9V is applied to pin 19, through D10, R49 and to base of Q16. Q16 is turned off and its collector switches to approximately -15V. This signal is fed through R46 to base of Q15 and turns off Q15. Q15 is used as a noise gate, and when it turns off it allows any signal which appears on its collector to

be coupled through C15 to the base of pedal preamplifier Q20.

When a pedal is depressed, the 8' and 16' signals are applied through diodes to pins 21 and 18. The +9V is also connected through R50, D13 to the base of Q19. This positive voltage turns on Q19, and its emitter rises to approximately +8VDC. This DC level is fed through R59, and it provides forward bias for the diode from the pedal 8' divider; and the 8' pedal signal is fed through R60 and C15 to the base of Q20. It should be remembered that Q15 noise gate was also turned "off" by the +9VDC, which thus allows the 8' signal to appear at the base of Q20.

Q20 is a common emitter amplifier, and its collector output is connected back to the pedal pre-amplifier in the organ.

Operation of the 16' pedal circuit is identical to the above stated description, except Q14 must be turned "on" by bias on diode D7. This is accomplished by the 16/8 switch in the organ as it connects pins 15 and 14 together.

2. Automatic Accompaniment Pedal Mode

In the automatic accompaniment pedal mode, the 8' and 16' signals are connected once again to pins 21 and 18, but pin 15 is grounded by a switch contact in Rhythm III. This removes the bias from diodes D7 and D13 but allows the noise gate transistor Q15 to function as previously described. In this mode a differentiated track (depending on which pattern is being played) is connected to pin

20, through R52 and to the base of switch transistor Q17.

This produces a +15VDC pulse on the collector of Q17, which occurs at the rate of input track pulse. The pulse is DC coupled by R55 to the base of Q18. This switches Q18 on-off at the input track rate, and the resulting 0 to 15 volt positive pulse is fed through C13, D12 and R58 to the base of Q19. Q19 turns "on" and "off" at the input track rate and this biases the diode in the pedal circuit and allows the 8' signal to appear at the base of amplifier Q20. C13 and R57 determine the "on" time period.

The operation of the 16' pedal circuit is identical to that described above except that Q12, Q13, and Q14 are used.

Each time a pedal is depressed the resulting -20V pulse on collector Q16 is also connected through R51 to the Rhythm III unit. This is used in the Touch mode of operation and used for pedal keying of Cymbal and Bass Drum Voices.

The collector of Q11 is connected to the sustain circuit of the console. When operating Rhythm III in the Auto Accompaniment Mode, Q11 is turned "on" and removes the 15 volts from the sustaining circuit. This disables the Pedal Sustain rocker switch.

2-16 CASSETTE 121-000139 & 121-000165

Performance Specifications (Electrical)

- A. Record/Play Response:
With 70 m v applied to "Aux. Input", record 50 Hz followed by 6K Hz using Philips TC-R

cassette and using a 100 ohms load resistor at playback output, with volume level set for 1.0 volt, the 50 Hz and the 6K Hz output shall be within -6 db using 1K Hz as a reference.

- B. ALC Dynamic Range Output and Harmonic Distortion:
1. With 40 mv at 1 K Hz applied to "Aux. Input" and using Philips TC-R or equivalent cassette and using 100 ohms load resistor at playback output, record for approximately 1 minute. Adjust playback level for 1.0 volt; the total harmonic distortion shall not exceed 5%.
 2. With 1.2 volts at 1 K Hz applied to "Aux. Input" and using Philips TC-R or equivalent cassette and using 100 ohms load resistor at playback output, record for approximately 1 minute. Adjust playback level for 1.0 volt; the total harmonic distortion shall not exceed 5%.

- C. Signal to Noise Ratio and Minimum Output Level: Apply 215 m v at 1K Hz to "Aux. Input" and connect 100 ohms load resistor to playback output. Using Philips TC-R or equivalent cassette, record for approximately 1 minute. Adjust level control during playback for 1.0 volt rms. Output level must drop a minimum of 40 db at end of recording.

- D. Power Supply: Use -6VDC supply \pm 10%

Play	150 ma	
Record	175 ma	Nominal
Fast Forward	175 ma	
Rewind	200 ma	

- E. Noise and Hum: Noise and Hum output shall be less than .06V on playback with volume at maximum with cassette cartridge in play mode with tape stopped.
- F. Erase Head Efficiency: Minimum of -55 db erasure of 400 Hz saturated recording with 60 ma of erase head current.
- G. Speed Control Range: With speed control mid position (red mark on knob) the tape speed of standard cartridge Philips TCFL3 or equivalent shall be 1-7/8 ips \pm 3%. With speed control in maximum counter-clockwise position, the tape speed shall be -10 \pm 3%. With speed control in maximum clockwise position, the tape speed shall be +10 \pm 3%. Slowly turning the speed control through the entire range shall provide a smooth change in speed.

2-17 RHYTHM III - Theory of Operation

- A. MASTER OSCILLATOR - The master oscillator is a relaxation oscillator controlled by a programmable unijunction transistor (PUT). The rate is controlled by varying the charging current for C1 through the control panel mounted potentiometer. The output of the oscillator drives a buffer transistor, which in turn drives the first stage of a five-stage counter.

- B. COUNTER - The five stage counter is made up of 3 dual J-K, DTL flip-flops. One-half of IC 3 is used to provide pulses (at a beat rate) to the lamp one-shot

only when stages 2 through 5 of the counter are reset by Q3 and Q6. The five-stage counter normally counts to 32 before restarting. When either the Waltz or the Slow Rock rhythm patterns are called for, the output of the fourth divider is fed back to the third divider through Q6. This feedback pulse will cause the counter to restart after a count of 24. The output of the fourth divider is also used to trigger a one-shot through R21 and C34, which drives the tempo lamp at a measure rate.

- C. TOUCH START CONTROL - The Touch Start circuit is a set-reset bistable comprised of transistors Q8 and Q9 and resistors R64 through R71. The output of transistor Q8 provides signals for voice gates on the Voicing Board (124-000180) and also for generator gating circuits controlled by transistors Q7 and Q10.

When a positive input pulse is applied to J1-2 (reset input), transistor Q8 provides a ground signal that turns off the voice gating circuits (J1-3), and is inverted by transistor Q7. Transistor Q7 provides a positive signal to transistors Q3 and Q6 which reset counter stage 2 through 6 and enable the beat rate divider (Pin 9 of IC 3).

When a positive pulse is applied to any one of the three "start" inputs (J1-1, J1-11, J1-12), the set-reset bistable changes state, which

enables the voice gates to open, removes the reset signals from the counter stages 2 through 5, turns off the beat rate divider, and provides a reset pulse to the first stage of the counter through capacitor C4.

- D. DIODE MATRIX - The outputs from the counter are decoded and differentiated by a diode/capacitor matrix to form specific pulse sequences. The diode matrix has 21 output tracks which are fed to the Rhythm Selector Board.
- E. RHYTHM VOICES - There are eight rhythm voices used in this rhythm unit. They are Bass Drum, Low Conga, High Conga, Claves, Snare Drum, Brush, Cymbal and Maracas. The Brush, Cymbal, Maracas, and the high frequency part of the Snare Drum are generated by shaping and formanting the output of a white noise source. The White noise is generated by a reverse biased transistor. The outputs of the white noise voices are combined and fed to a high frequency pre-amplifier whose output appears on J4 pin 2.

The remaining voices are generated by R-C oscillators which are turned on by pulse amplifiers that provide the bias current for the oscillators. The outputs of all of the R-C oscillators are mixed together and then fed into a low frequency pre-amplifier whose output appears on J4 pin 1. The outputs of both pre-amplifiers are connected to a dual volume

control, and the outputs of the volume control go to the output connector.

- F. PLAY-A-LONG VOICES - There are two pulse inverter circuits, which invert input signals from the lower manual legato trigger circuit and also from the pedal touch mode trigger circuit. The output of the lower manual inverter (J4-14) can be switched to either the Brush input (J4-14) or the Snare Drum input (J4-7) by front panel tabs. The output of the pedal inverter (J4-13) can be switched to either the Bass Drum input (J4-20) or the Cymbal input (J4-4) by front panel tabs.



T-500C

TABLE OF CONTENTS

	PAGE
INTRODUCTION -----	iv
SPECIFICATIONS -----	iv
 SECTION I - HOW THE ORGAN OPERATES	
1-1 General -----	1-1
1-2 Tone Source -----	1-1
1-3 Pedal Tones -----	1-3
1-4 Manuals -----	1-3
1-5 Pedal Keyboard -----	1-6
1-6 Harmonic Tonebars -----	1-6
1-7 Pedal Tonebar -----	1-7
1-8 Expression Pedal -----	1-7
1-9 Control Tabs -----	1-7
1-10 Preset Tabs -----	1-7
1-11 Percussion Control Tabs -----	1-7
1-12 Vibrato Tabs -----	1-8
1-13 Reverberation -----	1-8
1-14 Volume Soft, Brilliance Tab, and Reiteration Rate Control-----	1-8
1-15 Pedal Rocker Tab, Lower Left End Block -----	1-8
1-16 Tremolo Rocker Tabs, Lower Left End Block -----	1-8
1-17 Auto Chord -----	1-8
1-18 Cassette -----	1-8
1-19 Rhythm III -----	1-9
 SECTION II - THEORY OF OPERATION	
2-1 General -----	2-1
2-2 Tone Generator -----	2-1
2-3 Vibrato System -----	2-1
2-4 Manual Bus Bar Amplifiers -----	2-4
2-5 Pedal Keyboard and Switch Pedal Keyer Boards -----	2-4
2-6 Pedal Divider & Filter Board Assembly -----	2-5
2-7 Recovery and Non-Vibrato Board -----	2-5
2-8 Vibrato Board Assembly -----	2-6
2-9 Expression Pedal Circuitry -----	2-6
2-10 Power and Reverberation Amplifier Assembly -----	2-6
2-11 Power Supply Circuit -----	2-7
2-12 Phone Jack -----	2-7
2-13 Special Power Sources -----	2-7
2-14 Percussion Board Assembly -----	2-7
2-15 Auto Chord Board -----	2-11
2-16 Cassette -----	2-13
2-17 Rhythm III -----	2-14

TABLE OF CONTENTS (cont'd)

	PAGE
SECTION III - DISASSEMBLY	
3-1 General -----	3-1
3-2 Removal of Organ Top -----	3-1
3-3 Upper Manual Key Removal -----	3-1
3-4 Lower Manual Key Removal -----	3-1
3-5 Tonebar Assembly Removal (Entire or Partial) -----	3-1
3-6 Pedal Tonebar Assembly Removal -----	3-2
3-7 Lower Manual End Block Removal -----	3-2
3-8 Cassette Removal -----	3-2
3-9 Upper Manual Removal -----	3-2
3-10 Lower Manual Removal -----	3-3
3-11 Tone Generator Removal -----	3-3
3-12 Power Amplifier Removal -----	3-3
3-13 Pedal Sustain Keyer Removal -----	3-3
3-14 Pedal Switch Assembly Removal -----	3-3
3-15 Music Lamp Removal -----	3-4
SECTION IV - PRACTICAL SERVICE SUGGESTIONS	
4-1 General -----	4-1
4-2 Vibrato Drive and Recovery Board -----	4-1
4-3 Tab Replacement -----	4-1
4-4 Tremolo Speaker Maintenance -----	4-3
4-5 Raising Organ On Deep Pile Carpet -----	4-6
4-6 Overall Organ Level Adjustment -----	4-6
SECTION V - DIAGRAMS	
5-1 General -----	5-1
SECTION VI - PARTS LIST	
6-1 Parts List Index -----	6-1
PWB Parts List -----	6-15
	THRU
	6-18
APPENDIX (Not Included at this time)	
A-1 Appendix Index -----	A-1

LIST OF ILLUSTRATIONS

FIGURE	PAGE
1-1 Typical T-500 Organ Front View -----	1-1
1-2 Typical T-500 Organ Rear View -----	1-2
1-3 Magnet Location on Tone Generator -----	1-3
1-4 Filter Location and Frequency Termination on Generator ----	1-3
1-5 Manual Wiring Chart -----	1-4
1-6 Pedal Keyboard -----	1-5
1-7 Tonebars and Control Tabs (Partial View)-----	1-6
2-1 Typical Tone Generator -----	2-1
2-2 Fundamental Diagram of Vibrato System -----	2-2
2-3 Vibrato Line Box -----	2-2
2-4 Typical Drum Scanner -----	2-3
2-5 Percussion Null Adjustment -----	2-10
2-6 Percussion Decay Adjustment -----	2-11
4-1 Bottom Rail Construction -----	4-6
4-2 Placement of Glides -----	4-6
5-1 Logic Block Diagram -----	5-2
5-2 Lower Manual Bus Amplifier Board 124-000016, Layout and Schematic -----	5-3
5-3 Upper Manual Bus Amplifier Board 124-000015, Layout and Schematic -----	5-4
5-4 Recovery and Non-Vibrato Board 124-000014, Layout and Schematic -----	5-5
5-5 Vibrato Board 124-000018, Layout and Schematic -----	5-6
5-6 Pedal Keyer Boards 124-000025, 124-000026, 124-000027 Layout and Schematic -----	5-7
5-7 Pedal Divider and Filter Board 124-000178, Layout and Schematic -----	5-8
5-8 Power and Reverberation Amplifier Board 124-000176, Layout and Schematic -----	5-9
5-9 Power Supply Chassis 124-000176-178, Schematic -----	5-10
5-10 Percussion Board 124-000170, Layout and Schematic -----	5-11
5-11 Auto Chord Board 124-000179, Layout and Schematic -----	5-12
5-12 Special Effects End Block 125-000073, Layout -----	5-13
5-13 Expression Pedal 123-000061, Layout -----	5-13
5-14 Drum Scanner, 066-042874 -----	5-14
5-15 Cassette Recorder Assembly, 121-000139 & 121-000165, Schematic -----	5-15
5-16 Rhythm III Block Logic Diagram (125-000082)-----	5-16
5-17 Rhythm III Generator and Track Gate Board 124-000214, Layout and Schematic -----	5-17
5-18 Rhythm III Selector Switch Board 124-000196, Layout and Schematic -----	5-18
5-19 Rhythm III Voicing Board 124-000180 Layout and Schematic--	5-19
5-20 Rhythm III Cable Assembly -----	5-20
5-21 Rhythm III Output Matrix Timing Chart, and Voicing Pattern Chart -----	5-21

INTRODUCTION

This manual contains service information covering the T-500 Hammond Organ.

Features of the T-500 are explained in Section I.

Rhythm III with Auto Chording of the lower manual and pedal 8' & 16' voicing are the special features of this instrument. Service information for Rhythm II and Auto Chording are included in this service manual. For convenience in locating desired information, this manual is divided into the sections listed below.

- I How the Organ Operates
- II Theory of Operation
- III Disassembly
- IV Practical Service Suggestions
- V Diagrams
- VI Parts List
- Appendix

SPECIFICATIONS

CABINET SIZE

- 45" Wide
- 25" Deep
- 44½" High with Music Rack

- Weight with Bench 235 lbs.
- Power Input 1.2 Amps.
- Music Power Out 34 Watts
- (Per EIA Standards - RS-234)

SECTION III DISASSEMBLY

3-1 GENERAL - This section contains instructions for removal of specific sub-assemblies from the organ.

3-2 REMOVAL OF ORGAN TOP - After removing rear panel, remove two screws from underside of rear rail near each end of organ. Lift organ top at front to disengage spring fasteners on inside of each cheek panel. Before lifting top, disengage plug and ground wire from Rhythm III unit, also plug for music light.

3-3 UPPER MANUAL KEY REMOVAL -

(a) Remove four screws which secure metal cover on control panel assembly.

(b) Unsolder Violet and Black twisted pair wires, as well as Yellow and Black twisted pair wires, terminating directly behind lower drawbar tab, which are connected to drawbar assembly.

(c) Remove two large studs located on ends of control panel which secure it to upper manual.

(d) Fold control assembly so that it rests on shelf.

(e) To remove a Black key, loosen its key mounting screw and lift from rear.

To remove a White key, loosen its key mounting screw and those of adjacent Black keys

as required.

3-4 LOWER MANUAL KEY REMOVAL -

(a) Remove two mounting bolts from rear of upper manual end blocks.

(b) Remove one screw which passes through angle bracket into upper manual. This bracket is located on the inside surface of the cheek block on the left side. This screw is accessible from the front of organ.

(c) Tilt upper manual up and back.

(d) To remove a Black key, loosen its key mounting screw and lift from rear.

To remove a White key, loosen its key mounting screw and those of adjacent black keys as required.

3-5 TONEBAR ASSEMBLY REMOVAL (ENTIRE OR PARTIAL) - Perform steps "a" through "d" of Paragraph 3-3.

(a) Unsolder wire from tonebar contact spring to be replaced. Remove fiber stop retaining screw.

NOTE: Be certain that thin insulator is between contact spring and drawbar. Replace contact, stop, and screw and resolder wire.

(b) To replace tonebar or tonebar knob; proceed as above, but do not unsolder wire. This will permit

slider to be removed from front for its replacement, or knob replacement.

(c) To remove complete tonebar assembly, unsolder all wires from 17 tonebars and 6 wires terminating on control panel. Remove three hex head screws toward either end of tonebar assembly.

NOTE

The upper and lower tonebars can be removed individually, as well as the pedal tonebar.

3-6 PEDAL TONEBAR ASSEMBLY REMOVAL - The Pedal Tonebar Assembly can be replaced independently by removal of two screws securing the assembly to the phenolic plate. Remove assembly by sliding to the rear.

3-7 LOWER MANUAL END BLOCK REMOVAL -

- (a) For left end block, remove two round head screws that pass through left side of lower manual top cover one inch inside end block.
- (b) Remove screw that passes through angle bracket into end block.
- (c) For right-hand block. Remove two round head screws that pass through right-hand side of lower manual top cover into end block.

3-8 CASSETTE REMOVAL -

- (a) Remove six (6) phillips head screws from upper manual front strip.
- (b) Remove one 1/4" hex head screw from recessed hole in left front rail trim block.

Remove two 1/4" hex head screws from center of metal cassette mounting plate.

(c) Remove cassette cable connections from console, tip front strip for clearance and remove cassette.

3-9 UPPER MANUAL REMOVAL -

(a) Remove four screws that retain metal cover on control panel assembly.

(b) Remove two mounting rear bolts from upper manual end blocks.

(c) Remove two screws that pass through angle brackets into upper manual. These brackets are located on the inside surface of cheek blocks. These screws are accessible from front of organ.

(d) Tilt upper manual up and block in this position.

Remove upper manual front strip.

(e) Snap off harness clamp from left side of manual by pulling forward.

(f) Unsolder all wires from terminal strip.

(g) Return manual to normal position.

(h) Unplug bus bar wires from upper manual at bus amplifier.

(i) Remove all grounding terminations on rear of upper manual. Release 3 plastic cable clamps and remove line box.

Remove tonebar assembly and base, as a unit, by removing six screws securing it to upper manual.

(j) Remove manual from casework.

3-10 LOWER MANUAL REMOVAL -

- (a) Perform operations "a through d" in Paragraph 3-8.
- (b) Remove two lower control panels as described under Paragraph 3-7. Unplug bus bar wires from lower manual at bus amplifier.
- (c) Remove two mounting end blocks and loosen four screws attaching manual to front rail.
- (d) Raise upper manual and remove lower manual. Reverse procedure for re-installing.

3-11 TONE GENERATOR REMOVAL -

- (a) Unsolder all harness connections from the generator terminal strip.
- (b) Remove heavy ground wire in center of generator.
- (c) Remove the AC cover panel and unsolder the five wires from harness.
- (d) Remove the four bolts which secure tone generator to support brackets.
- (e) Remove control panel cover by removing 4 screws.

1. Remove the brown, red, orange, and yellow wires from the terminals behind the "Vibrato Small" switch.
2. Remove the green, blue, violet, grey, and white wires from the right-hand end of the line box.
3. Unplug shielded cable from pins 2 & 3 of the vibrato board.

- (f) Release all cable ties securing scanner leads.
- (g) Slide tone generator out rear of organ.

3-12 POWER AMPLIFIER REMOVAL

- (a) Release all cable ties and plastic cable clamps from chassis.
- (b) Unplug 12-pole plug on top of chassis.
- (c) On large printed circuit board, unplug wires from terminals 3-4, 5-6, 7-8, 9-10, 11-12, 19, 20, 27-28, 29-30, 31.
- (d) On small printed circuit board, unplug wires from terminals 1, 2, 3, 4, 6 (two wires), 7, 8, 9, 10.
- (e) Unplug all wires from ten-lug terminal strips near small printed circuit board.
- (f) Remove four screws securing amplifier - two at each end.

3-13 PEDAL SUSTAIN KEYS REMOVAL -

Pedal Sustain Keys are located beneath Power Amplifier Chassis.

- (a) Release all cable ties in the speaker area to the right of the speaker.
- (b) Release cable tie at right-hand side of Reverb Unit (obtain as much slack in Expression pedal cable as possible).
- (c) Remove the four screws securing power amplifier to pedal switch base and tilt back power amplifier chassis.
- (d) Pedal Sustain Keys are now accessible and can be removed by removing appropriate cable harness and mounting bolts.

3-14 PEDAL SWITCH ASSEMBLY REMOVAL

- (a) Proceed with steps "a", "d", and "f" of Paragraph 3-11.

(b) Remove mounting bolts from pedal keyer boards (six from end board, four from center board).

(c) Remove the two mounting bolts which go through the lower cabinet cross member and into the Pedal Switch Base.

(d) Tilt Pedal Switch end of organ approximately 12 inches and block.

(e) Remove the four mounting bolts which come up through the bottom of the cabinet into the Pedal Switch Base, (two at each end).

3-15 MUSIC LAMP REMOVAL - When it becomes necessary to replace one or more of the incandescent lamps in the Music Light Assembly.

(a) Remove two pieces of adhesive backed felt at the front edge of the music light lens. Tip lens up at front and slide forward to remove.

(b) To remove lamp or lamps, depress lamp into socket and twist counter-clockwise to release.

SECTION IV PRACTICAL SERVICE SUGGESTIONS

4-1 GENERAL - This section contains maintenance and practical servicing information. Peculiar techniques are explained in detail. Procedures which should be obvious are not discussed.

4-2 VIBRATO DRIVE AND RECOVERY BOARD, P/N 124-000018 - The R821 potentiometer is set at the factory, and will normally require no adjustment. Do not attempt to adjust unless absolutely necessary. See following paragraphs.

Whenever any of the vibrato circuitry has been serviced, proceed according to the following:

1. Connect a VTVM across main speaker leads. Press down the TONEBARS and PERCUSSION tab. All other tabs should be up. Swell pedal at full volume.

2. Pull upper manual 8' tonebar to position 8. Play key #8 on upper manual. Note voltage on meter (about 1.4V rms).

3. Return 8' tonebar to position 0.

4. Pull upper manual 4' tonebar to position 8.

Press down VIBRATO and BRILLIANCE tabs. Play upper manual key #8. Note voltage on meter. If voltage is within ± 2 db of reading obtained in step 2, make no adjustment. If voltage is at more than 2 db variance with step 2 reading, adjust R821 to obtain reading identical to step 2.

4-3 TAB REPLACEMENT - In the T-Series organs the tabs are suspended on three pivot rods. However, the joints between sections of rod are concealed by plastic sleeves, so that to the uninitiated, the appearance is that of one continuous rod.

The rod ends are butted in two places:

1. In the space between VIBRATO ON and REITERATE tabs.

2. In the space between THEATER BRASS 16' and CHIMES tabs.

PREPARATORY OPERATIONS -

To prepare the control assembly for replacement of a tab, remove external parts of console as required for access and proceed according to the following:

1. Loosen the control assembly by removing the large hexagon head screws and lockwashers at the bottom of the assembly at either end.

2. Place protective material between ends of control assembly and console end walls to protect finish.

3. Raise control assembly and support by means of wooden blocks inserted under the ends.

4. Loosen power switch and swing aside.

5. Pull pilot lamp, with shield, from its socket.

6. Remove screws from top of switch assembly associated with tab to be replaced. Swing aside switch assembly. This completes preparation.

TAB REPLACEMENT OPERATIONS

A 1/8 inch steel rod of sufficient length to reach from the near end of the control assembly to beyond the tab to be replaced is required. To replace a tab, proceed according to the following:

1. Note position of spring clips and plastic sleeves. Clips and sleeves must be returned to original positions on pivot rod when work is completed.

2. Remove spring clip from end of pivot rod nearest to tab being replaced. Use small light hammer to drive pivot rod as far as possible toward tab to be removed.

3. Apply end of 1/8 inch driving rod and hammer rod until it has passed through the tab to be removed.

Suggestion: Measure distance from end of control assembly to far side of tab. Mark corresponding length on driving rod. End of rod will be concealed by plastic sleeves and cannot be observed.

4. Pull back driving rod sufficiently to permit removal of tab.

NOTE

Black rubber spacers on pivot rod must be saved, and returned to original positions when inserting new tab.

5. Pull tab assembly toward rear of control assembly to remove.

CAUTION

Save tab actuating springs for re-use.

INSERTION OF NEW TAB - To insert a new tab proceed according to the following:

1. Insert tab assembly from rear of control. Position tab so that driving rod can

be pushed through tab, and push or drive rod to meet original pivot rod.

NOTE

Reinstall any rubber spacers and plastic sleeves previously removed.

2. Drive original pivot rods back to original positions.

3. Reattach spring clips to ends of pivot rods.

4. Reattach two tab actuating springs according to the following:

(a) Note condition of spring. Open ends must be well separated. Bend spring to shape if necessary.

(b) Insert double "U" bend of spring into end of a small drive socket or other similar convenient tool.

(c) By means of the tool, place spring with closed end toward tab assembly, so that closed end engages extrusion in tab bracket.

(d) With the aid of the tool, position open end of spring to engage extrusion in bottom of control.

(e) When both ends of spring are properly engaged, remove tool. If the foregoing steps have been performed properly, the spring will appear as two parallel arms.

(f) When both springs have been attached, operate tab a few times to assure that action is correct. If action is not correct, check shape

and positions of springs. Take necessary corrective measures.

COMPLETION OF WORK - After ascertaining that tab is operating properly, reattach associated switch assembly. Be sure that switch contact arms are properly seated above and below actuating edges of tabs.

Reassemble organ by reversing order of disassembly.

4-4 TREMOLO SPEAKER MAINTENANCE

- A. LUBRICATION - Motor and rotor shafts should be oiled once a year. For lubrication it is necessary to remove the Tremolo unit from the console. Hammond generator oil can be used as a lubricant.

ROTOR (DRUM) SHAFT - The outside bearing in the rotor support may be lubricated by applying a few drops of oil to the felt pad around the bearing.

The inside bearing may be lubricated the same way and is accessible through the throat of the drum. BE CAREFUL NOT TO DRIP OIL ON THE DRIVE PULLY OR SPEAKER CONE.

MOTOR - An oiling hole is provided in the front plate of the large motor to facilitate lubrication of the front bearing. This

is accessible through a large hole in the rear of the Tremolo speaker assembly.

Lubrication of the rear bearing of the large motor will require the removal of the small motor and the drive wheel.

Lubrication of the small motor bearings is accomplished by applying oil to the shafts and felt pads at each end of the motor. BE SURE THAT THE PORTION OF THE MOTOR SHAFT THAT MAKES CONTACT WITH THE DRIVE WHEEL IS FREE OF OIL.

B. SPEAKER REPLACEMENT -

1. Remove the Tremolo speaker assembly from console.
2. Remove back cover by removing nine flat head wood screws.
3. Remove acoustical material.
4. Remove four screws securing speaker to baffle.

Most routine service operations are outlined on a card located on the unit. They are also reproduced below.

The belt tension may be adjusted without removing unit from console. For belt replacement, however, or for motor lubrication and servicing, the unit should be taken out of the organ console. This may be done quite easily

by removing the (4) mounting screws which secure the unit in the console. Removal of the unit from the console does not necessitate disconnecting the motor power and speaker leads. Thus, the operation of the unit may be fully observed as adjustments are being made.

- C. BELT TENSION ADJUSTMENT -** Correct tension for the rotor drive belt is extremely important. Excessive slack will cause slow starting and slow operating speed, whereas excessive tension will cause noisy operation. A properly adjusted belt will slip very slightly when starting, but will be sufficiently tight to bring the rotor up to full speed in about 5 seconds.

To set belt tension, loosen the adjusting wing-nut which is readily accessible through the back of the unit. By means of this wing-nut the entire motor assembly may be moved as required; toward rotor reduces belt tension, away from rotor increases belt tension.

Once the motor is positioned to provide the correct belt tension, the wing-nut should be securely tightened.

- D. BELT REPLACEMENT -** After several years of normal usage a belt may become frayed or worn, and therefore noisy in its operation. Such a belt should be replaced, and to accomplish this the entire tremolo unit should be removed from the organ console

and placed on the floor, back down.

Remove the two screws holding the front rotor support assembly. Grasp the rotor with both hands and pull it straight up from the body of the unit to free the pulley and shaft from the back rotor support assembly. The belt can be slipped off of both pulleys and pulled from under the motor bracket.

Pass the replacement belt under the motor mounting bracket and hook it over the motor pulley. Holding the rotor by its front support with one hand, place belt over the rotor pulley with the other hand. Reinsert the end of the rotor shaft into the bearing, taking care that the speaker cone is not damaged in the process. Position the front rotor support properly against the body of the unit, and replace the screws which hold it. Finally, readjust the belt tension as described previously.

- E. ADJUSTMENT OF SMALL MOTOR - Remove the entire tremolo unit from the console, but keep it in upright position with all plugs connected. Make sure the small motor's armature is withdrawn to its "off" position, so that the drive shaft does not touch the rubber-tired drive wheel. Check for correct belt tension, adjusting as necessary, according to instructions given previously. Locate the motor positioning bolt, which extends from the mounting

plate through the motor laminations, with locknuts on both sides of the laminations.

Loosen the inside locknut. Then, with the small motor operating (slow speed tremolo ON) tighten the outside locknut until the motor shaft no longer touches the rubber-tired drive wheel. Next, while holding the rotor so that it cannot turn, loosen the outside locknut until motor shaft engages drive wheel just enough to turn the rotor drive pulley under the belt. (Too much pressure on the drive wheel will cause excessive wear on the tire). When this optimum adjustment has been attained, it should be secured by tightening the inside locknut. Make sure also that any oil and dirt have been removed from the motor shaft and from the rubber tire.

- F. RUBBER (NEOPRENE) TIRE REPLACEMENT - Remove the complete unit from the console and place it on the floor with back down. Detach the small motor and its mounting plate (it is held in place by four screws) so that the drive wheel will be fully accessible. Replace the tire on the wheel, taking care that it is not twisted, but it is properly seated in the wheel's outside groove. The molding seam on the tire should be the point of contact with the small motor drive shaft.

After making sure that the tire and wheel are free of oil and dirt, the motor assembly should be replaced and the drive tension should be readjusted according to the previous instructions.

- 4-5 RAISING ORGAN ON DEEP PILE CARPETING - From time to time we are informed that pedal keyboard operation is impaired because of deep pile carpeting.

This can be overcome by applying a spacer strip, of the dimensions shown in Figure 4-6, to the bottom of the console at each end. The strip may be stained to approximate the organ finish. If stain is applied, a sealer such as shellac or varnish must be applied to the strip to protect the carpeting.

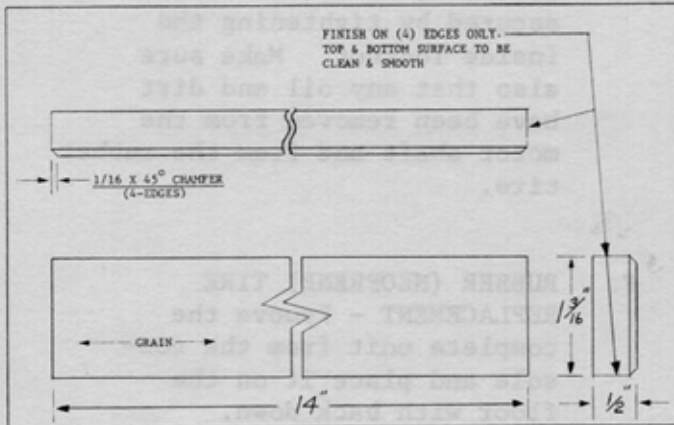

Figure 4-1
Bottom Rail Construction

NOTE
The 14" length should be increased to 15 3/4" for T-222. In addition to the spacer strip, 6 glides are required which will be supplied on a no charge basis. Order Part No. 032-041468 Plastic Glide.

GLIDER/SPACER INSTALLATION INSTRUCTIONS - Be careful not to disrupt generator mounting or other electrical components. Proceed according to the following:

1. Remove and set aside the metal glides from console.
2. Securely glue and nail spacer strip to underside of each end of cabinet and remount (4) metal glides to spacer strips, approximately 1 inch from each end.
3. Insert (2) plastic glides into legs. (Care must be taken not to split leg).
4. Remove (4) metal glides on bench and install the (4) remaining glides. This completes installation. See Figure 4-7.

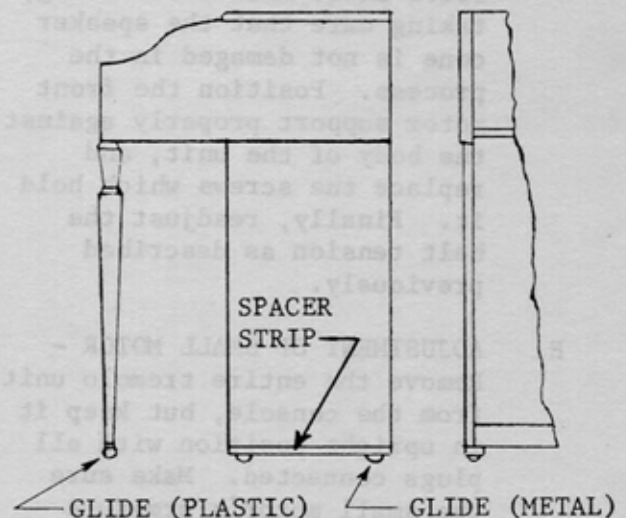

Figure 4-2
Placement of Glides

4-6 ORGAN SETUP PROCEDURE -

All tabs, tonebars, rocker switches and Rhythm III controls are to be in the "off" position unless otherwise specified.

Expression pedal maximum position unless otherwise specified.

Pedals and keys are called for by number, Number 1 being the key or pedal at the lowest frequency side of the manual.

Connect oscilloscope and AC VTVM across stationary speaker output.

A. UPPER MANUAL ADJUSTMENT

1. Depress upper manual "Tonebars and Percussion" tab.
2. Pull out upper manual 8' Tonebar and play Key #8.
3. Adjust R870 (On PWB 124-000014) for 4.0 volts peak to peak ($\pm .3$ volt).
4. Push in 8' Tonebar and pull out 4' Tonebar.
5. Place the expression pedal in minimum position.
6. Play Key #8 and observe the output to be less than .3 volts peak to peak, but that it remains audible.
7. Push in 4' Tonebar and return expression pedal to position.

B. LOWER MANUAL ADJUSTMENT

1. Place Rhythm III in Auto-Accompaniment mode.
2. Rhythm III volume to minimum (off).
3. Depress Rock push button and place Silent/Sound tab to Sound position.
4. Depress any lower manual key and adjust R11 for minimum audible output.

5. Turn off Auto-Accompaniment, place Rhythm III volume to maximum, and place Silent/Sound switch to Silent position.

6. Depress lower manual "Tonebars" tab.

7. Pull out lower manual 8' Tonebar to position 8.

8. Depress lower manual key #20 and adjust R5 on Autochord control PWB for output of 4.0 volts peak to peak ($\pm .3$ volts).

9. Turn "off" lower manual "Tonebars" tab and push in 8' Tonebar.

C. PEDAL LEVEL

1. Pull out pedal 16'/8' Tonebar to position 8.

2. Depress pedal #1 and note that the output is between 17V and 32V peak to peak.

3. Depress "Pedal Sustain" switch and play each pedal and note that the sound will sustain for approximately 1 1/4 seconds (sustain only when pedal is depressed).

4. Depress the 16'/8' switch to the "on" position (8'). Play pedal #6 and note that the 8' sound is approximately twice the frequency of the 16' sound.

D. PERCUSSION AND REITERATION NULL ADJUSTMENT

1. Depress the "Reiterate" tab and set the Reiteration Rate control at approximately mid position.

2. Depress and hold upper manual Key #8.

3. Rotate the Percussion Level control R557, full counter-clockwise (up).

4. Connect the oscilloscope to the junction of C503 and R527 on Percussion Board 124-000170.

5. Set the oscilloscope sensitivity to 10 mv/cm and rotate the Alternate Null (R519) and the Main Null (R556) controls until the pulses on the oscilloscope are adjusted to minimum amplitude.

E. PERCUSSION AND REITERATION GAIN

1. Depress "Celesta" Tab.
2. Depress "Reiteration" tab, and place rate control in approximate mid position.

3. Connect the oscilloscope to the speaker terminal and adjust vertical sensitivity to 1.0 V/cm.

4. Depress and hold down upper manual key #8. Adjust Percussion Level control (R557) until the percussion output is $7 \pm .3V$ peak to peak.

5. Return the "Celesta" to "off" position and depress the "Marimba" tab. The high percussion signal shall be 5.0V (-1.5V +2V) peak to peak. The low frequency shall be between 3.0V to 6.2V.

F. PERCUSSION DECAY TIME

1. Return all tabs to their "off" position.
2. Play upper manual Key #8 and observe for each tab

the length of time for each percussion signal to decay.

a. Chimes and Guitar decay time should be approximately three seconds.

b. All other percussion voices should decay approximately one-half second to one second.

3. Return all tabs to "off" position.

G. VIBRATO LEVEL AND CONTROLS

1. Depress the "Vibrato on Upper" tab "Tonebar and Percussion" tab, and pull the 8' tonebar to position 8.

2. Play Key #8 and adjust the vibrato level control R821 on 124-000018 PWB for 4V ($\pm .3V$) peak to peak.

3. Depress the "Vibrato Lower" and "Tonebars" tabs.

4. Pull out the lower manual 8' tonebar and play lower manual key #20. Note the output to be 4V (+ 1V -1.3V) peak to peak.

5. Return all tabs and tonebars to "off" position.

H. TREMOLO

1. Connect oscilloscope to tremolo input on baffle terminal strip.

2. Depress "Tonebars and Percussion" tab and pull out 8' tonebar to position 8.

3. Turn on "Tremolo On" tab and play Key #8 and note the output to be 4V (+1.5 -1.2) peak to peak.

I. RHYTHM III

1. High frequency level adjust and legato keying test.

a. Turn on Snare Drum switch and volume maximum.

b. Play any lower manual key approximately 5 times

Step	Test Point	Instrument	Procedure
1	Across Main Speaker	Scope	per second and adjust R129 of Rhythm III Voicing PWB for output of between 1.2V and 1.5V peak to peak.
2	Across Main Speaker	Scope	2. Low frequency level adjustment. a. Turn Rhythm III tempo control to maximum. b. Turn Silent/Sound switch to Sound and notice bass drum is heard. (No rhythm patterns switches depressed). c. Adjust R116 for 30V ± 2V peak to peak on oscilloscope.
J. HUM			
1	Across Main Speaker	Scope	1. Hum reading should be taken with the control panel cover shield, music lamp installed, and Tremolo tablet in SLOW position. Organ must meet Hum requirements with AC plug in either direction.
2	Across Main Speaker	Scope	2. Place all other tabs, tonebars, and Rhythm III switches in the "off" position and depress the following tabs: Tonebars & Percussion Brilliance Turn on Music Lamp a. Hum level should be less than .120 volts RMS with and without scanner rotating. b. T-500C - with the recorder play button depressed, recorder volume in maximum position (without tape), hum level shall be less than 70 mv RMS without scanner rotation. c. Depress the Revert I and II tabs. Hum level should be less than .070 volts RMS without scanner rotation.

CHART 4-1 ALIGNMENT & PERFORMANCE CHECK T-500C

Step	Test Point	Depress Tab or Rocker	Tonebar Registration	Play Key(s)	Adjust	Oscilloscope or Other Indication
1.	Across Main Speaker	Tonebars & Percussion	Upper Manual 8" Tonebar to position 8	#8 Upper Manual	R870 on 124-000014	3.7V to 4.3V P-P
2.	A Across Main Speaker	(1) Rhythm III in Auto-Accompaniment Mode (2) Rhythm III Volume to minimum (off) (3) Rock push button (4) Silent/Sound in Sound		Any Lower Manual	R11 on 124-000179	Minimum Audible
	B Across Main Speaker	(1) Rhythm III Volume to maximum (2) Silent/Sound in Silent position (3) Lower Manual Tonebars	Lower Manual 8" Tonebar to position 8	#20 Lower Manual	R5 on 124-000179	3.7V to 4.3V P-P
3.	A Across Main Speaker		16"/8" Pedal Tonebar to position 8	#1 Pedal		17V to 32V P-P
	B Across Main Speaker	Pedal Sustain		One at a time pedal 1 thru 13		Sustain pedal down for 1/4 seconds each
4.	A Junction C503 & R527 on 124-000170	Reiteration		#8 Upper Manual	R557 Counter-Clockwise (up) Alternate Null R519 Main Null R556	Minimum Amplitude
	B Across Main Speaker	Celesta Reiteration		#8 Hold down	Percussion Level R557	6.7V to 7.3V P-P
	C Across Main Speaker	Marimba Reiteration		#8 Hold down		High Percussion 3.5V to 7.0V P-P Low Percussion 3.0V to 6.2V P-P
D	Across Main Speaker	Chimes or Guitar		#8		Decay Approx. 3 sec.
	E Across Main Speaker	Any Other Percussion tab.		#8		Decay Approx. 1/2 sec. to 1.0 sec.
5.	A Across Main Speaker	Vibrato on upper Tonebars & Percussion	8' to position 8	#8	R821 on 124-000018	3.7V to 4.3V P-P
	B	Vibrato on lower tonebars	8' to position 8	#20		2.7V to 5V P-P
6.	Tremolo Terminal Strip on Baffle	Tonebars & Percussion Tremolo on	8' to position 8	#8		2.8V to 5.5V P-P
7.	A Across Main Speaker	Snare Drum Volume Control Maximum		Any Lower Manual approx. 5 times/sec.	R129 124-000180	1.2V to 1.5V P-P
	B Across Main Speaker	Silent/Sound to Sound			R116 124-000180	28V to 32V P-P
8.	A Across Main Speaker	Tremolo - Slow Tonebars & Percussion Brilliance Music Lamp				Hum-Less than .120V RMS (with or without scanner rotation)
	B Across Main Speaker	All 8A plus Cassette-Play Button				Hum-Less than 70mv RMS without scanner rotation
	C Across Main Speaker	All 8A plus Reverb I & I				Hum-Less than 70mv RMS (without scanner rotation)

SUBJECT: TRIGGER RELIABILITY IMPROVEMENT
REFERENCE: 124-000170 PERCUSSION BOARD

Model T-500

SYMPTOM: Intermittent $1\frac{1}{4}$ harmonic divider IC-501 triggering. ($1\frac{1}{4}$ Harmonic is part of chime voice on percussion)

CORRECTION: Replace R559 (100 ohm) with jumper.

Change C513 from .0047 to .015.

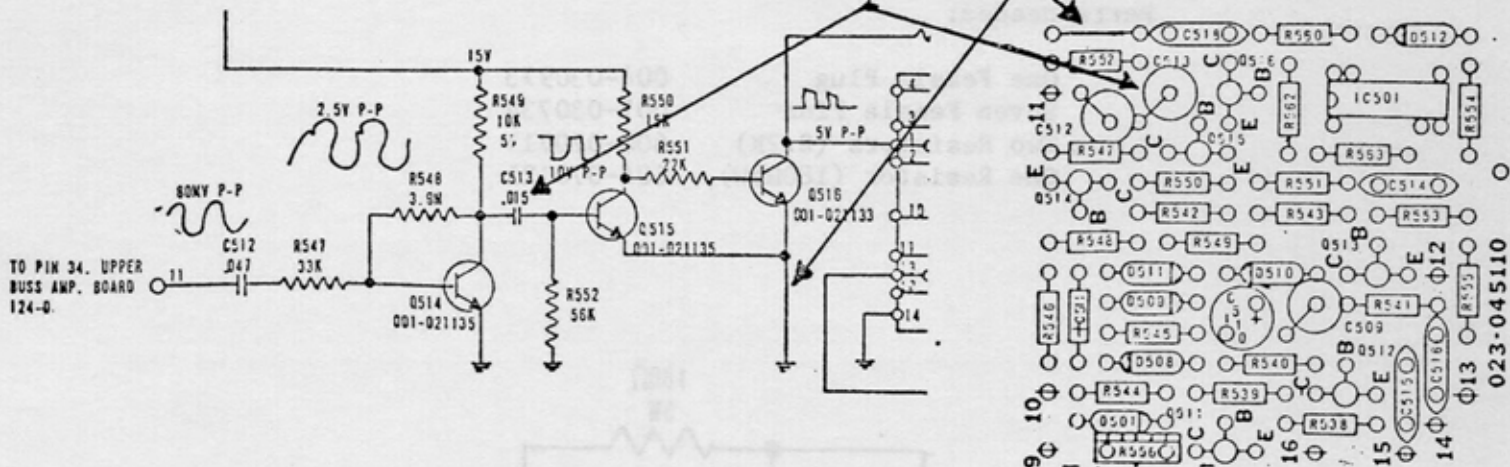

SUBJECT: PART NUMBER CORRECTIONS

NATURE OF CHANGE:

1. Refer to page 6-5, of service manual, console-top front view. Lower manual right hand end block part number should be 025-046747 instead of 025-028407.
2. Refer to page 6-6, console rear view, top connector number should be 005-043363 instead of 005-043304.

SUBJECT: RHYTHM III (124-000082) SUBSTITUTION PLUG

Purpose is to operate organ with Rhythm III removed.

Parts needed:

One Female Plug	004-030973
Seven Female Pins	007-030734
Two Resistors (8.2K)	600-020711
One Resistor (180Ω5W)	604-070121

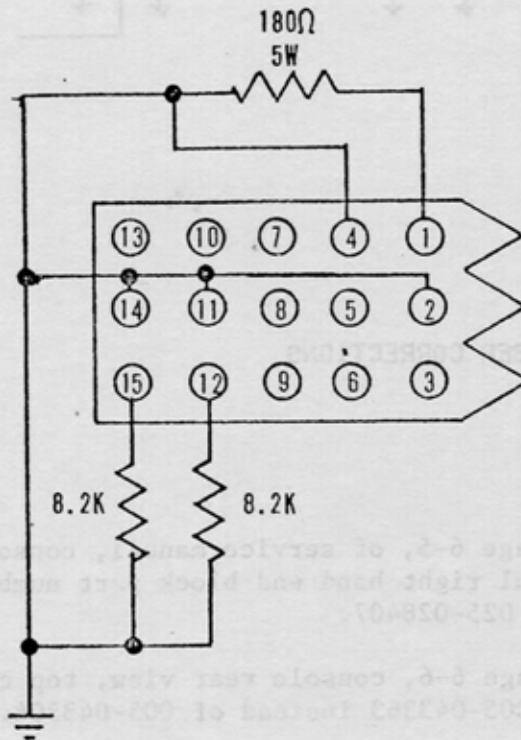

Hammond Service News

Model T-500

SUBJECT: CASSETTE KIT INSTALLATION

Previous installation instructions called for the connection of Cassette signal output to the junction of C-202 (2200 pf) and R-347 (15K). Upon investigation we find that excessive loading takes place. In other cases, connecting the unit to the opposite side of R-347 (15K) causes reduction of the Rhythm output level.

RECOMMENDATION

On later units of the T-500, a 68K resistor is located on component panel #6. Connect the Cassette signal output to the open end of the 68K resistor as shown in logic schematic below. The 68K resistor should be installed in instruments not having same. Complete Cassette connections are indicated on reverse side of this sheet.

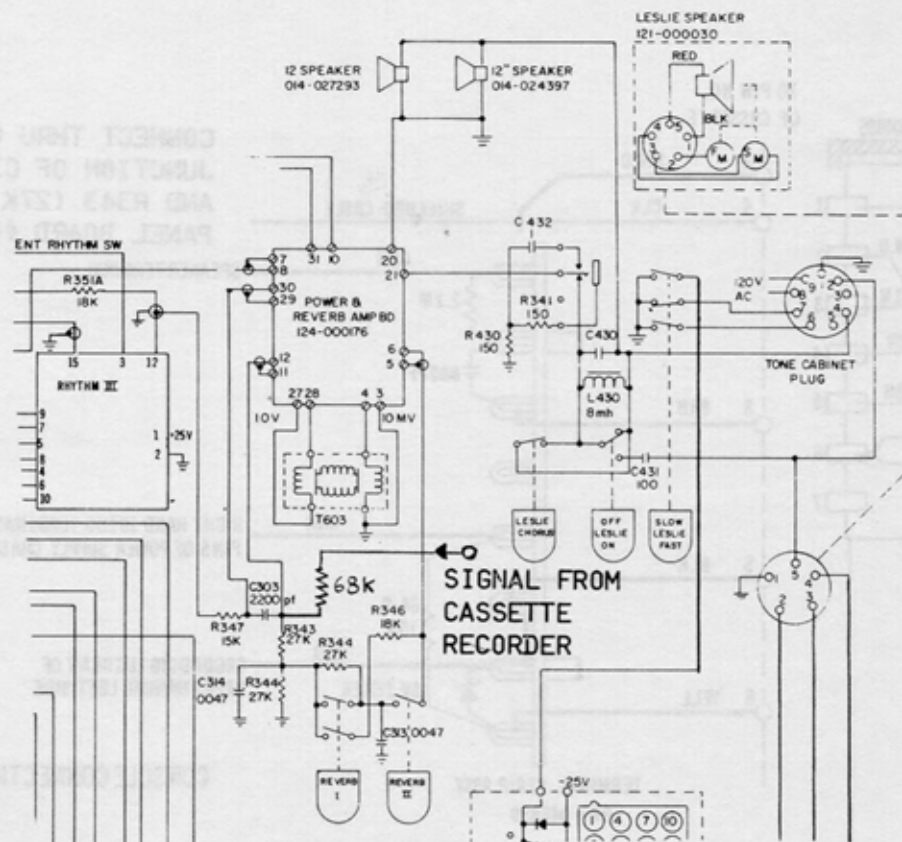

REFER TO LOGIC, PAGE 5-2, T-500 SERVICE MANUAL

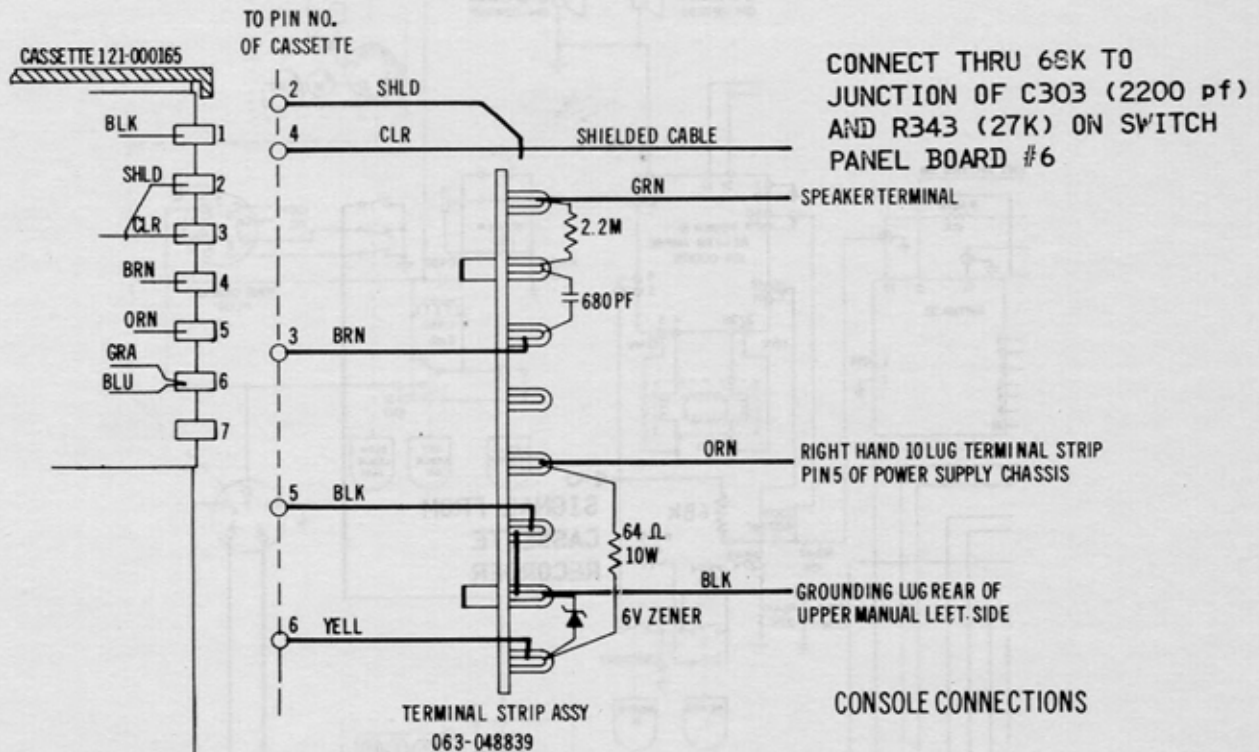
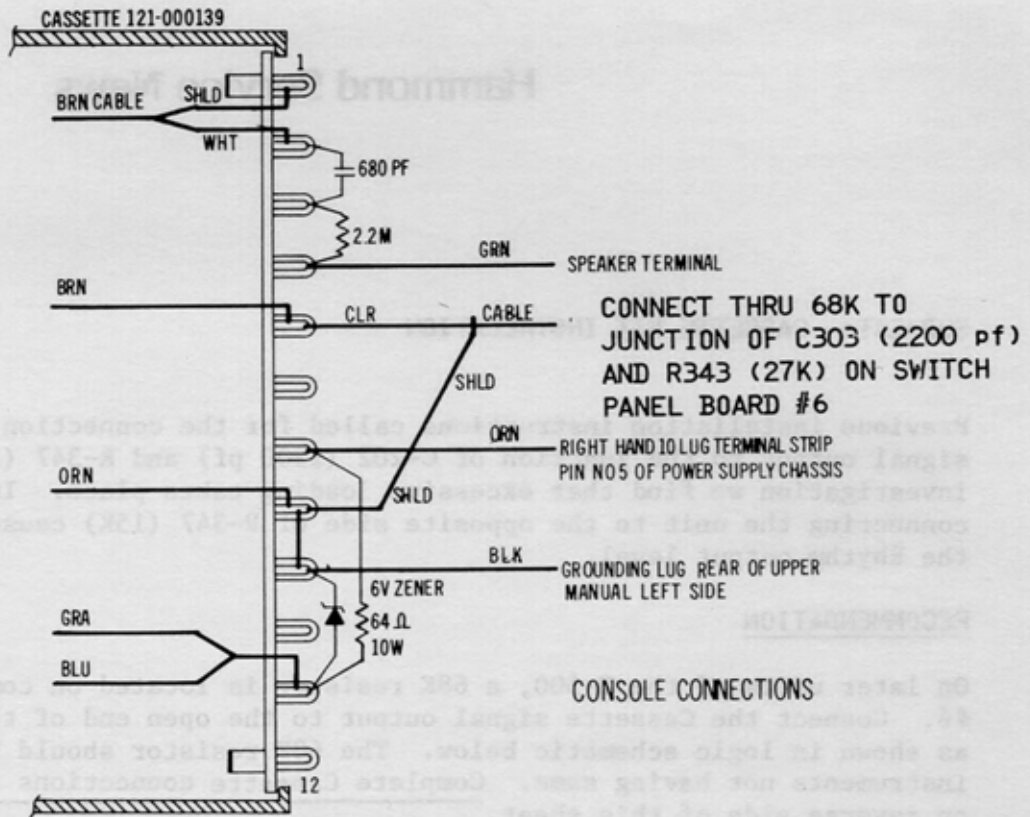

SECTION V DIAGRAMS

- 5-1. **GENERAL.** — This section contains diagrams which illustrate the foregoing text and provide information necessary to proper organ servicing.

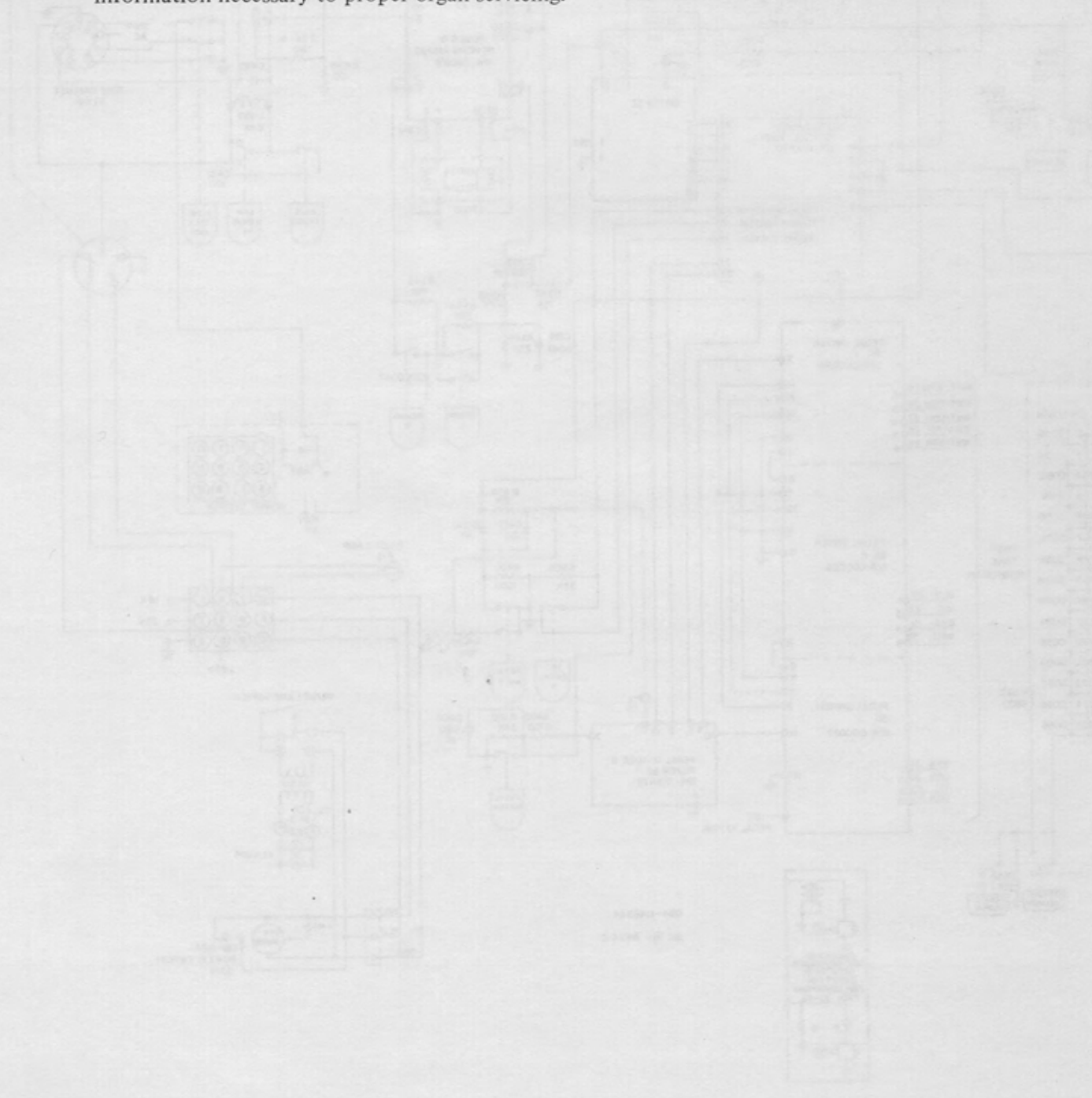

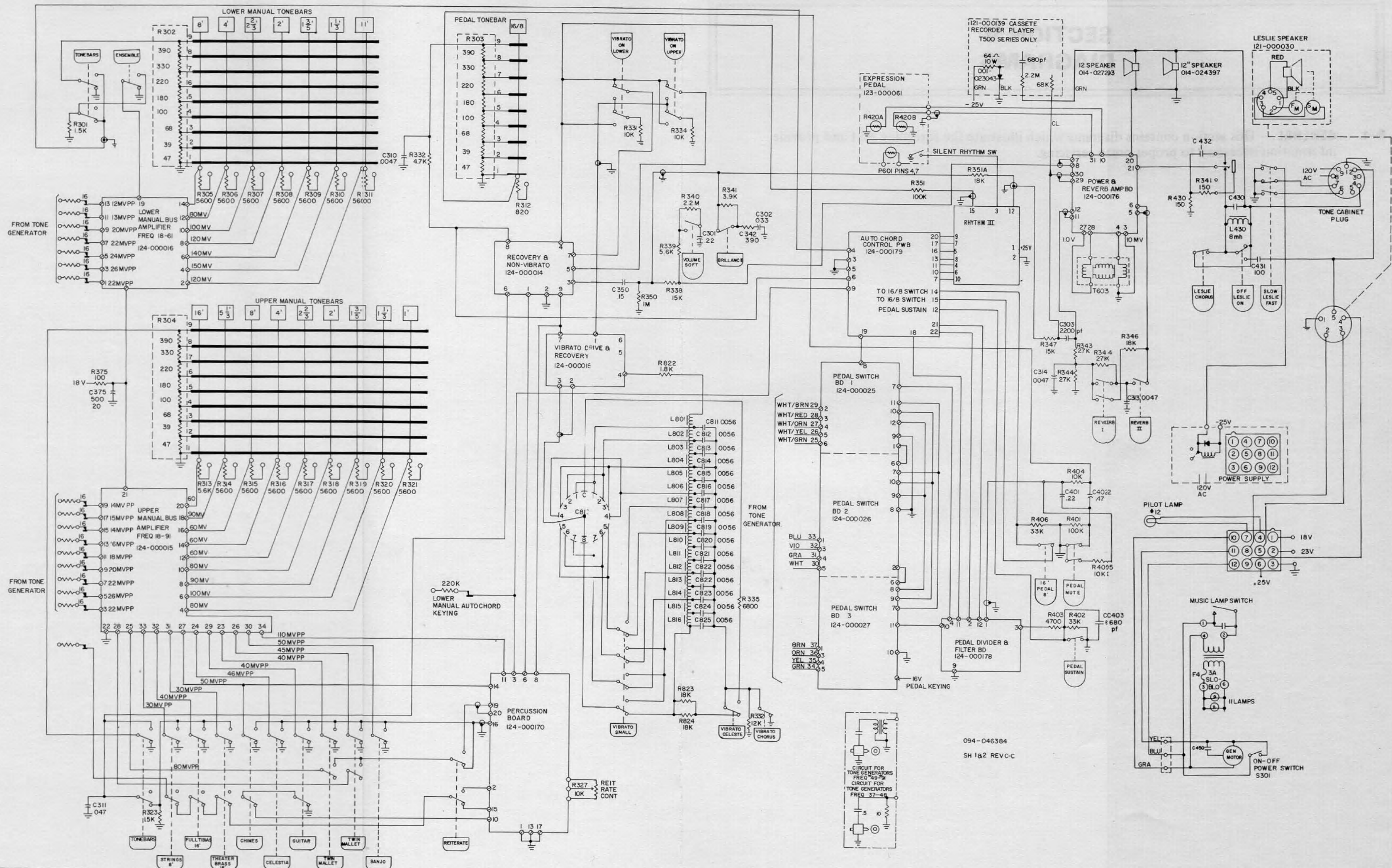
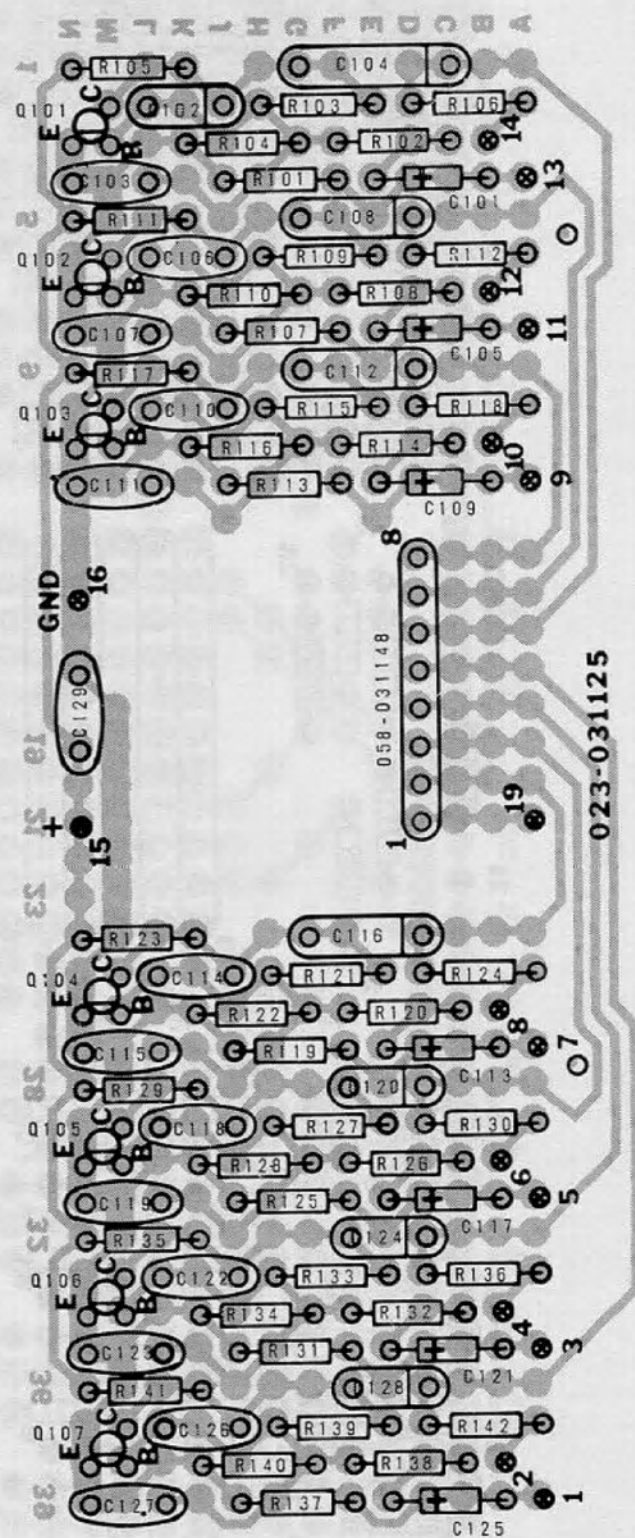
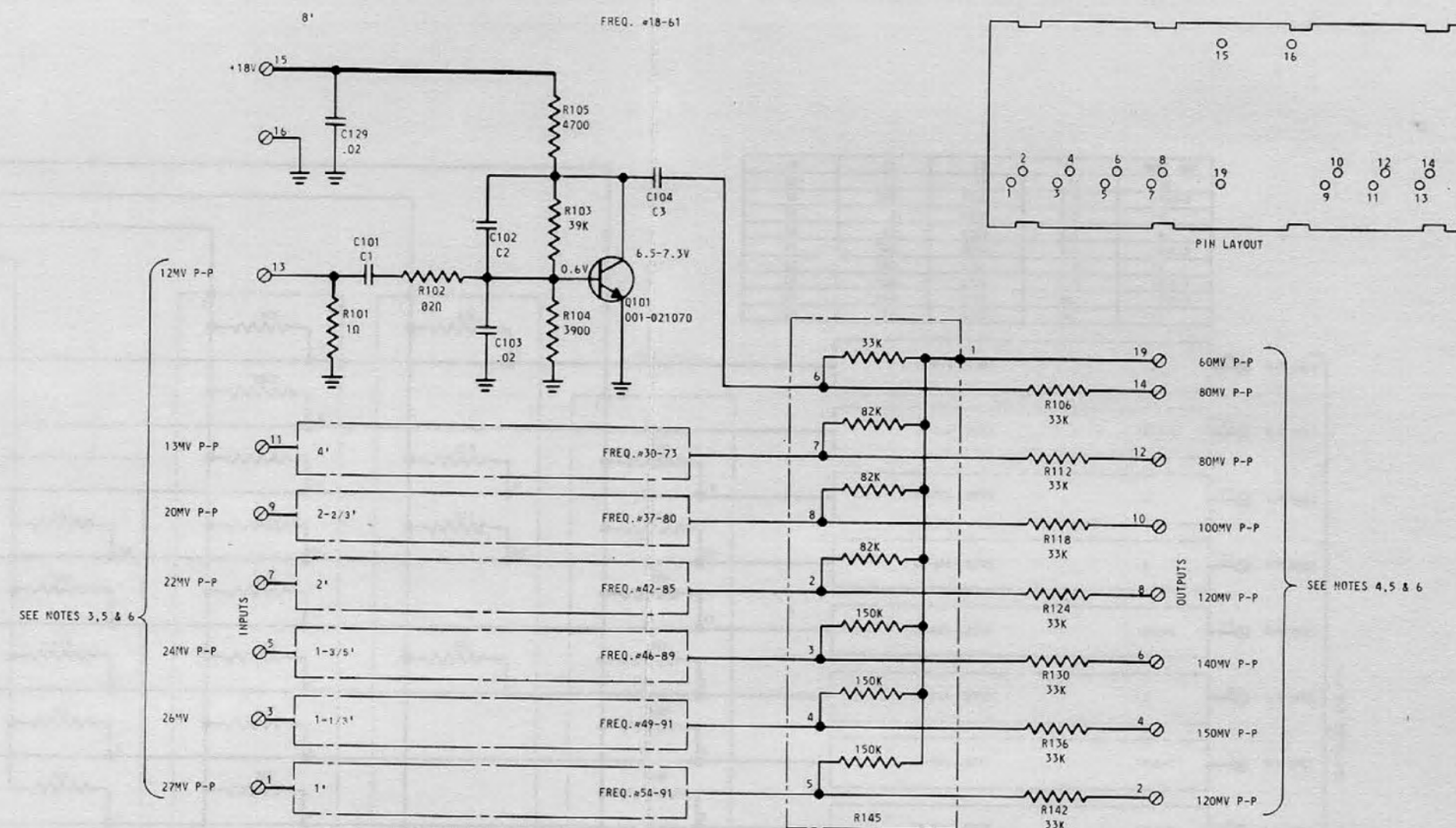

FIGURE 5-1
LOGIC BLOCK DIAGRAM



LOWER MANUAL BUS AMPLIFIER BOARD (124-000016)

PIN #	WIRE COLOR	TERMINATION
1	Violet	Bus Bar "8th" Harmonic Lower Manual
2	Violet	1' Tonebar Lower Manual
3	Blue	Bus Bar "6th" Harmonic Lower Manual
4	Blue	1-1/3' Tonebar Lower Manual
5	Green	Bus Bar "5th" Harmonic Lower Manual
6	Green	1-3/5' Tonebar Lower Manual
7	Yellow	Bus Bar "4th" Harmonic Lower Manual
8	Yellow	2' Tonebar Lower Manual
9	Orange	Bus Bar "3rd" Harmonic Lower Manual
10	Orange	2-2/3' Tonebar Lower Manual
11	Red	Bus Bar "2nd" Harmonic Lower Manual
12	Red	4' Tonebar Lower Manual
13	Brown	Bus Bar "Fund" Lower Manual
14	Brown	8' Tonebar Lower Manual
15	White/Blue	Pin #21 Upper Manual Bus Amplifier Board
16	Black	Ground Lug Back of Upper Manual
19	Violet	Ensemble 8' Tab



- NOTES:
- ⊗ SYMBOL: TERMINAL ON PRINTED WIRING BOARD.
 - UNLESS OTHERWISE SPECIFIED:
ALL RESISTORS ARE IN OHMS, ±10%, 1/2 WATT;
ALL CAPACITORS ARE IN MICROFARADS.
 - P-P VOLTAGE MEASUREMENTS TO BE MADE AT LEAD TERMINAL REMOVED FROM PIN.
 - P-P VOLTAGE MEASUREMENT TO BE MADE AT PINS WITH LEADS REMOVED.
 - WAVEFORMS ARE SINUSOIDAL.
 - MEASUREMENTS MADE WITH KEY NO. 25 ON LOWER MANUAL DEPRESSED.

094-035052-3J

**FIGURE 5-2
LOWER MANUAL
BUS AMPLIFIER BOARD 124-000016,
LAYOUT & SCHEMATIC**

BUS AMP.	C1	C2	C3	R1
16'	.15	.01	.15	150
5-1/3'	5.3	.0027	.082	82
8'	4.7	.0047	.1	82
2-3/3'	2.2	.0033	.15	82
2'	1.5	.0022	.047	82
2'	1	.0012	.047	82
1-3/5'	1	.0012	.025	82
1-1/3'	.56	.0012	.025	82
1'	.47	.0018	.01	82

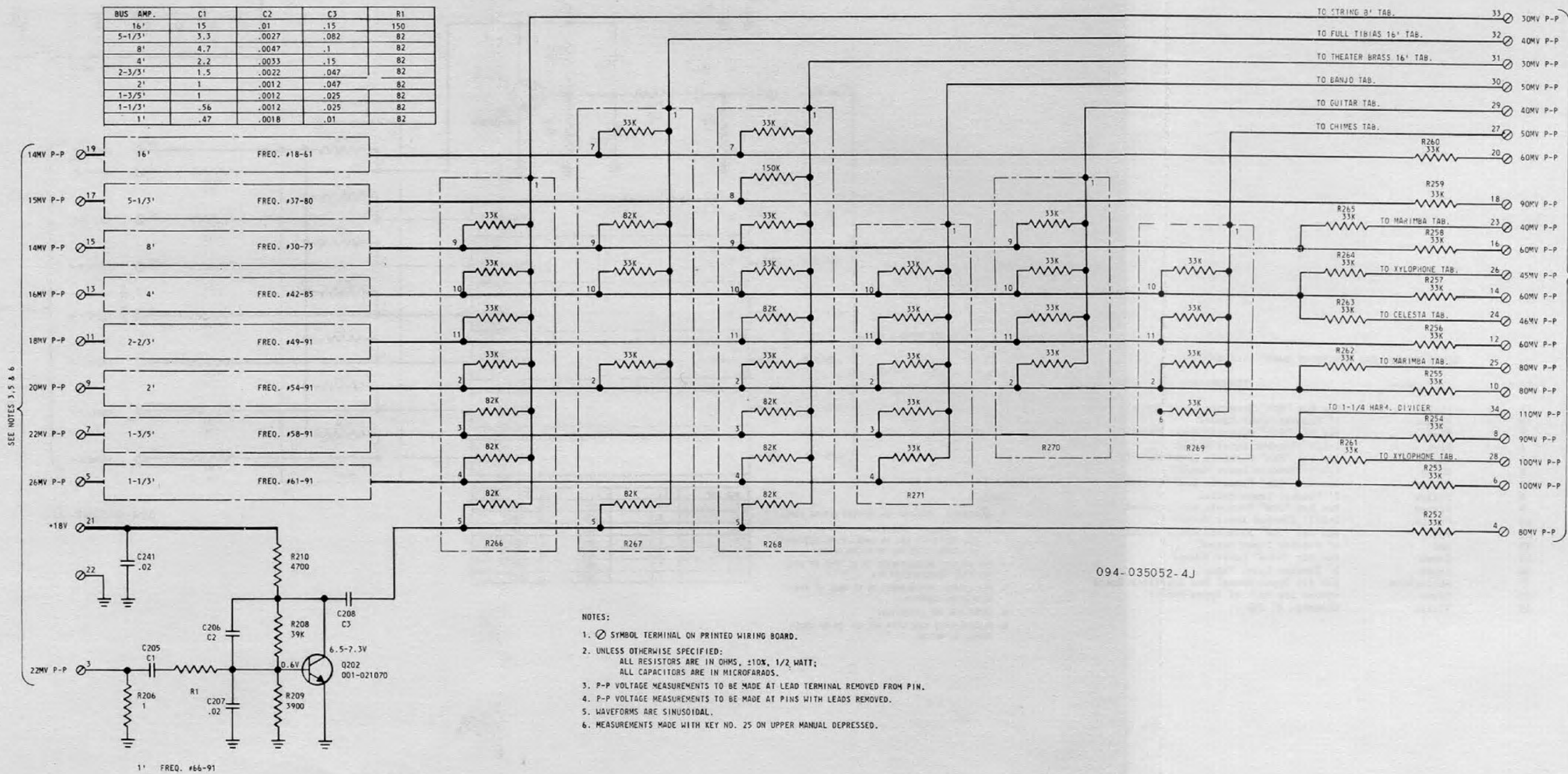

- NOTES:
1. SYMBOL TERMINAL ON PRINTED WIRING BOARD.
 2. UNLESS OTHERWISE SPECIFIED:
ALL RESISTORS ARE IN OHMS, $\pm 10\%$, 1/2 WATT;
ALL CAPACITORS ARE IN MICROFARADS.
 3. P-P VOLTAGE MEASUREMENTS TO BE MADE AT LEAD TERMINAL REMOVED FROM PIN.
 4. P-P VOLTAGE MEASUREMENTS TO BE MADE AT PINS WITH LEADS REMOVED.
 5. WAVEFORMS ARE SINUSOIDAL.
 6. MEASUREMENTS MADE WITH KEY NO. 25 ON UPPER MANUAL DEPRESSED.

UPPER MANUAL BUS AMPLIFIER BOARD (124-000015)

PIN #	WIRE COLOR	TERMINATION	PIN #	WIRE COLOR	TERMINATION
1	N/C		19	Brown	Bus Bar "Sub-Fund" Upper Manual
2	N/C		20	Brown	16' Drawbar Upper Manual
3	White	Bus Bar 8th Harmonic Upper Manual	21	White/Blue	Pin #15 Lower Manual Bus Amplifier Board.
4	White	1' Drawbar Upper Manual		White/Blue	Junction with K375 & C375 behind reiteration tab on switch panel.
5	Gray	Bus Bar 6th Harmonic Upper Manual	22	Black	Ground lug back of upper manual
6	Gray	1-1/3' Drawbar Upper Manual	23	White/Violet	Marimba tab
7	Violet	Bus Bar 5th Harmonic Upper Manual	24	Brown	Celesta tab
8	Violet	1-3/5' Drawbar Upper Manual	25	Violet	Marimba tab
9	Blue	Bus Bar 4th Harmonic Upper Manual	26	White/Gray	Xylophone tab
10	Blue	2' Drawbar Upper Manual	27	Orange	Chimes tab
11	Green	Bus Bar 3rd Harmonic Upper Manual	28	Gray	Xylophone tab
12	Green	2-2/3' Drawbar Upper Manual	29	White	Guitar tab
13	Yellow	Bus Bar 2nd Harmonic Upper Manual	30	Blue	Banjo tab
14	Yellow	4' Drawbar Upper Manual	31	Red	Theater Brass 16' tab
15	Orange	Bus Bar "Fund" Upper Manual	32	Green	Full Tibia 16' tab
16	Orange	8' Drawbar Upper Manual	33	Yellow	Strings 8' tab
17	Red	Bus Bar "Sub-3rd" Upper Manual	34	Brown	Pin #11 Percussion Board
18	Red	5-1/3' Drawbar Upper Manual			

FIGURE 5-3
UPPER MANUAL
BUS AMPLIFIER BOARD 124-000015,
LAYOUT & SCHEMATIC

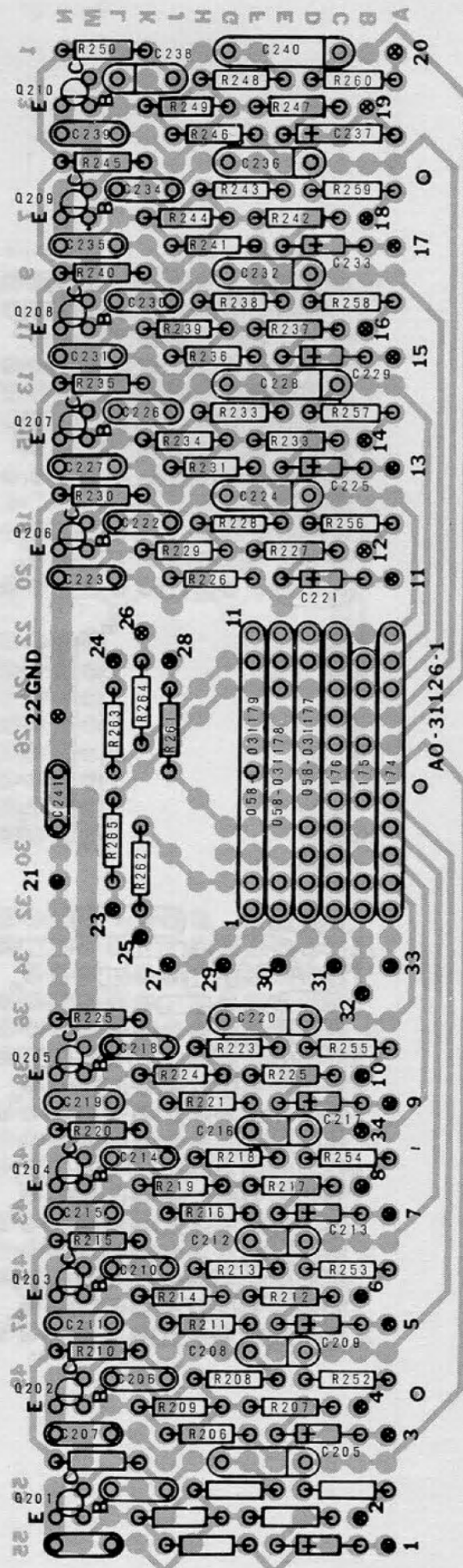

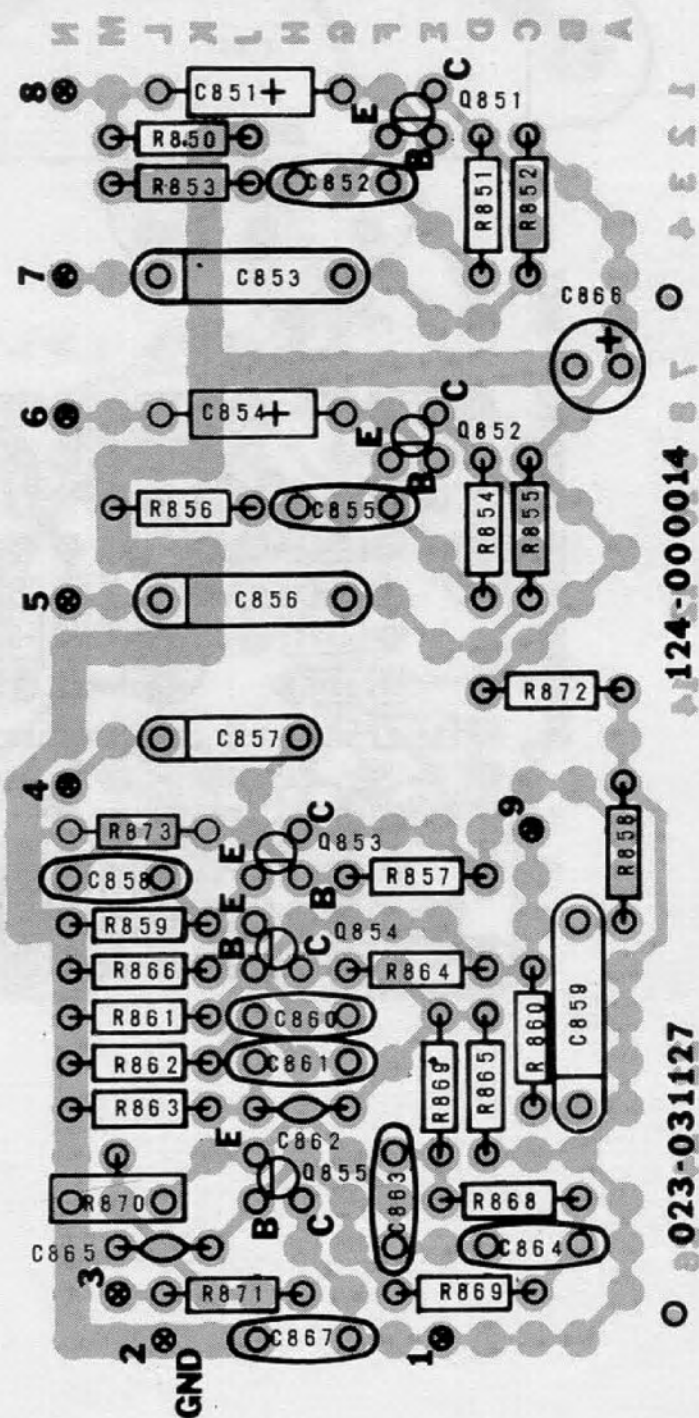

RECOVERY & NON-VIBRATO BOARD (124-000014)

PIN #	WIRE COLOR	TERMINATION
1	Yellow	Pin #6 Percussion Board
2	Black	Vibrato Chorus Switch
3	Black	Pin #6 Vibrato Board
4	Green	Switch Panel & Components Board #6
5	Yellow	Vibrato on Lower Switch (Back Terminal)
6	Green	Vibrato on Upper Switch
7	Clear	Upper Manual Tonebars Switch
8	Yellow	Vibrato on Lower Switch (Front Terminal)
	Clear	Junction with Cable B behind Lower Manual Tonebars Switch

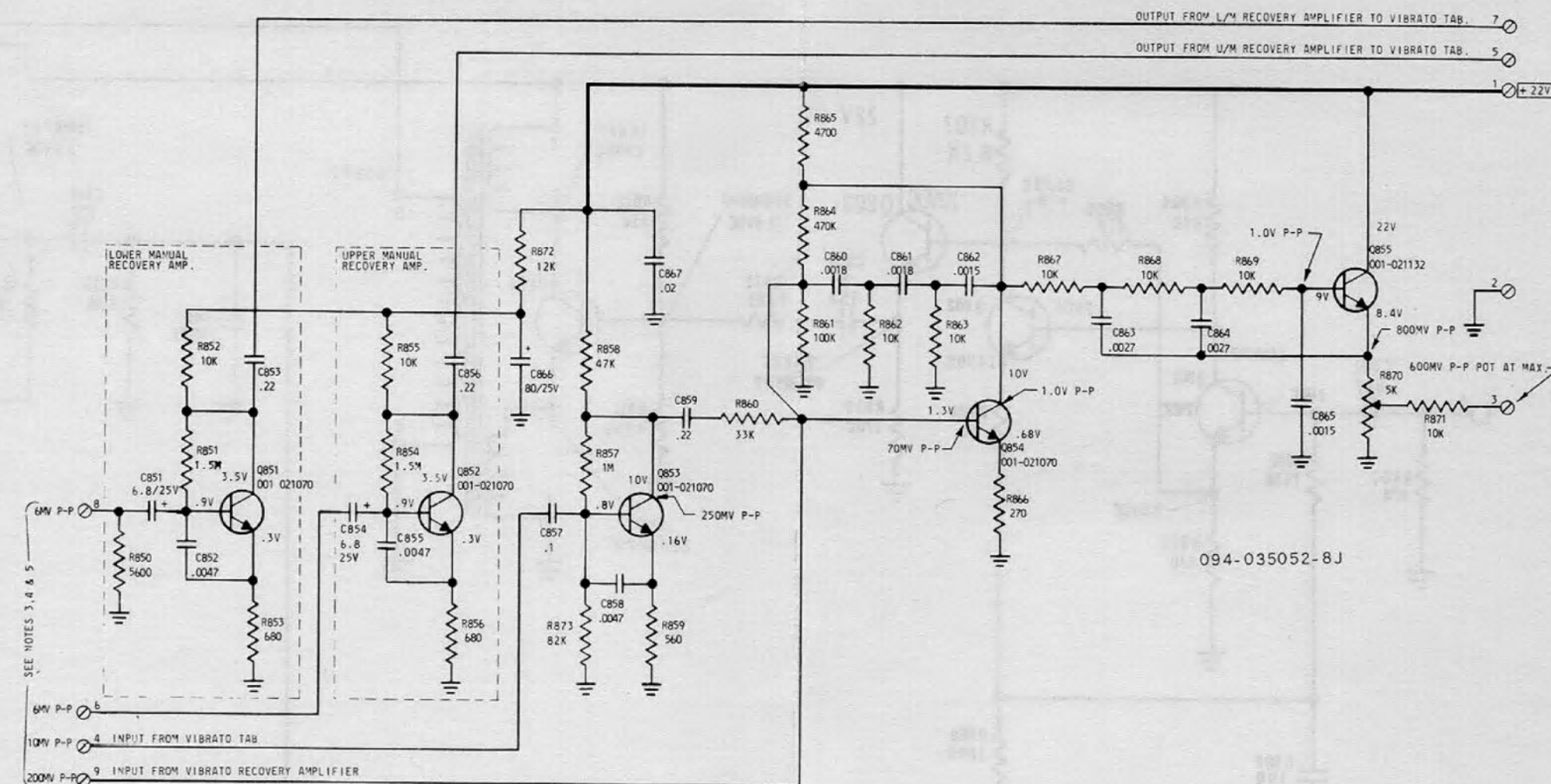

- NOTES:
1. SYMBOL: TERMINAL ON PRINTED WIRING BOARD.
 2. UNLESS OTHERWISE SPECIFIED:
ALL RESISTORS ARE 1% OHMS, ± 10%, 1/2 WATT;
ALL CAPACITORS ARE 1M MICROFARADS.
 3. P-P VOLTAGE MEASUREMENTS TO BE MADE AT LEAD TERMINAL REMOVED FROM P.I.M.
 4. WAVEFORMS ARE SINUSOIDAL.
 5. MEASURE WITH "DRAWBARS & PERCUSSION" TAB DEPRESSED, CORRESPONDING
8' DRAWBAR AT POSITION B, & KEY NO. 25 DEPRESSED.

FIGURE 5-4
RECOVERY & NON-VIBRATO
BOARD 124-000014,
LAYOUT & SCHEMATIC

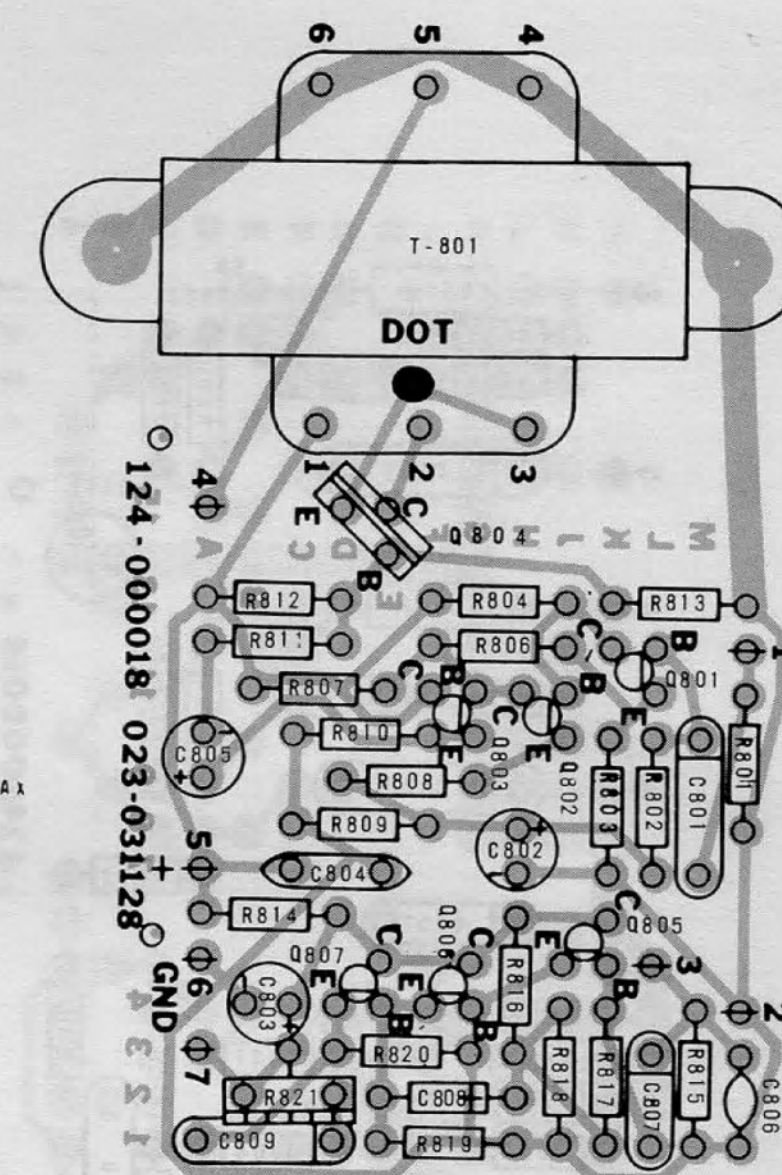
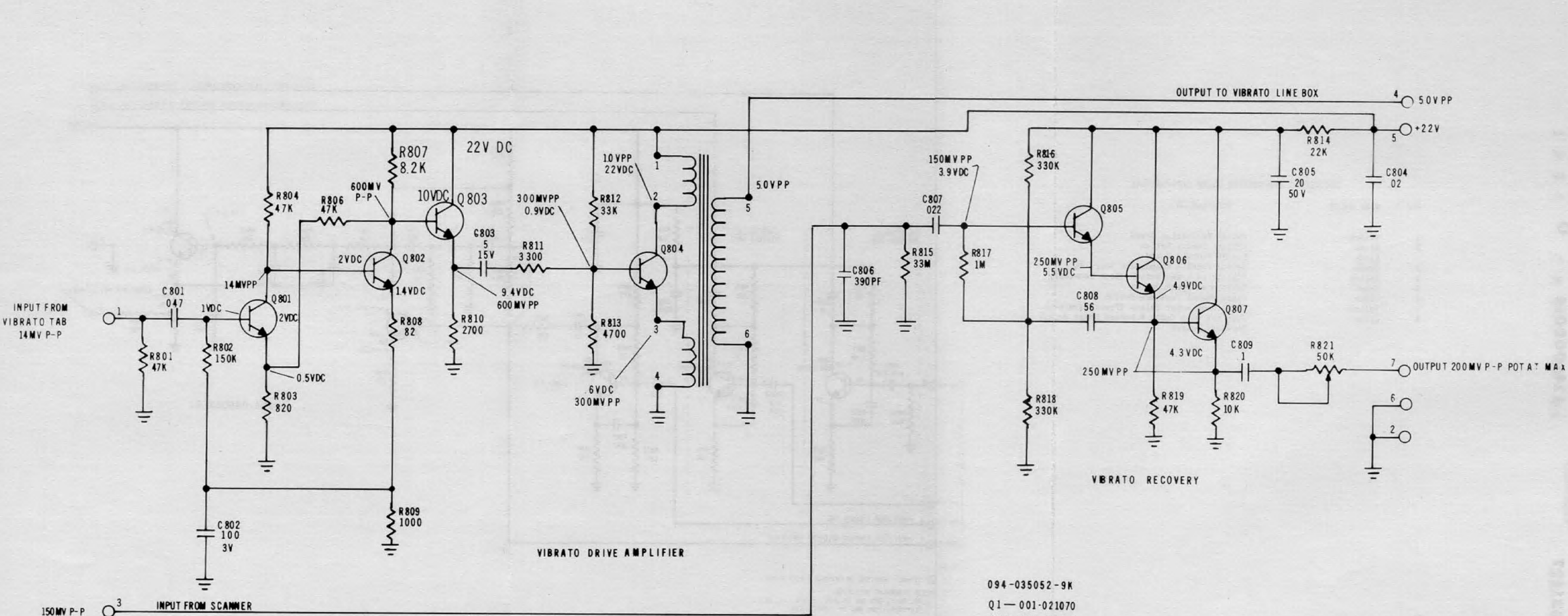

094-035052-9K
 Q1-001-021070
 Q25-001-021133
 Q4-001-021240
 Q3,6,7-001-021132

VIBRATO BOARD (124-000018)

PIN #	WIRE COLOR	TERMINATION
1	Green	Vibrato on Upper Switch
2	Shield	
3	Clear	Drum Scanner
4	Violet	Line Box Assembly
5	Red	Ph #5 Percussion Board
6	Black	Ph #2 Recovery & Non-Vibrato Board
	Black	Ground Lug Back of Upper Manual
7	Violet	Ph #9 Recovery & Non-Vibrato Board
	Violet	Ph #8 Percussion Board

FIGURE 5-5
 VIBRATO BOARD 124-000018,
 LAYOUT & SCHEMATIC

PEDAL KEYER BOARD #1 (124-000025)

PIN #	WIRE COLOR	TERMINATION
1	Brown	Pin #6 Keyer Board #2
2	White/Brown	Frequency 29 of Tone Generator
3	White/Red	Frequency 28 of Tone Generator
4	White/Orange	Frequency 27 of Tone Generator
5	White/Yellow	Frequency 26 of Tone Generator
6	White/Green	Frequency 25 of Tone Generator
7	White/Gray	Pin #4 Pedal Filter & Divider Board
8	White/Violet	Pin #19 Auto Chord Board
9	Black	Pin #8 Pedal (Filter & Divider Board)
10	Black	Pin #8 Pedal Keyer Board #2
11	Red	Terminal #3,10 Lug Terminal Strip
12	Red	Left Hand Side Top of Power Supply
11	Yellow	Pin #10 Pedal Keyer Board #2
12	Orange	Pin #7 Pedal Keyer Board #2
		Pin #9 Pedal Keyer Board #2

PEDAL KEYER BOARD #2 (124-000026)

PIN #	WIRE COLOR	TERMINATION
1	Blue	Frequency 33 of Tone Generator
2	Brown	Pin #6 Pedal Keyer Board #3
3	Violet	Frequency 32 of Tone Generator
4	Gray	Frequency 31 of Tone Generator
5	White	Frequency 30 of Tone Generator
6	Brown	Pin #1 Pedal Keyer Board #1
7	Yellow	Pin #11 Pedal Keyer Board #1
8	Black	Pin #8 Pedal Keyer Board #3
9	Orange	Pin #9 Pedal Keyer Board #1
10	Black	Pin #10 Pedal Keyer Board #3
9	Orange	Pin #12 Pedal Keyer Board #1
10	Orange	Pin #7 Pedal Keyer Board #3
11	Red	Pin #10 Pedal Keyer Board #1
12	Red	Pin #9 Pedal Keyer Board #3

PEDAL KEYER BOARD #3 (124-000027)

PIN #	WIRE COLOR	TERMINATION
1	Brown	Frequency #37 of Tone Generator
2	N/C	
3	Orange	Frequency #36 of Tone Generator
4	Yellow	Frequency #35 of Tone Generator
5	Green	Frequency #34 of Tone Generator
6	Brown	Pin #2 Pedal Keyer Board #2
7	Orange	Pin #9 Pedal Keyer Board #2
8	Yellow	Pin #7 Pedal Keyer Board #2
9	Red	Pin #10 Pedal Keyer Board #2
10	Black	Pin #8 Pedal Keyer Board #2
11	Black	Generator Terminal Ground
12	Clear	Pin #10 Pedal Filter & Divider Board
	Shield	Pin #9 Pedal Filter & Divider Board

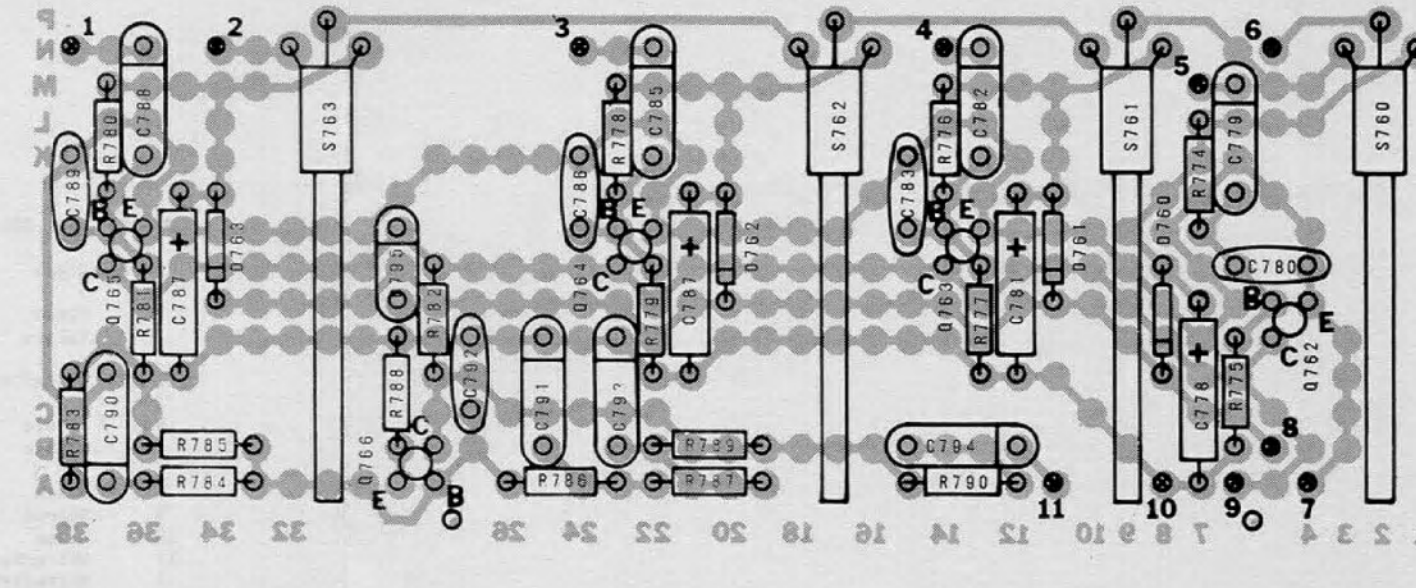
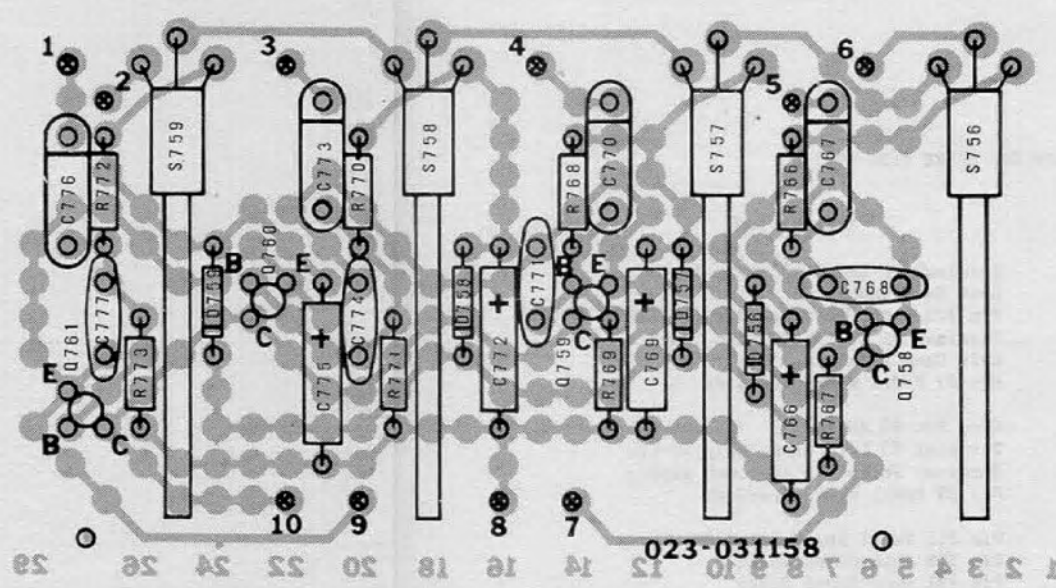
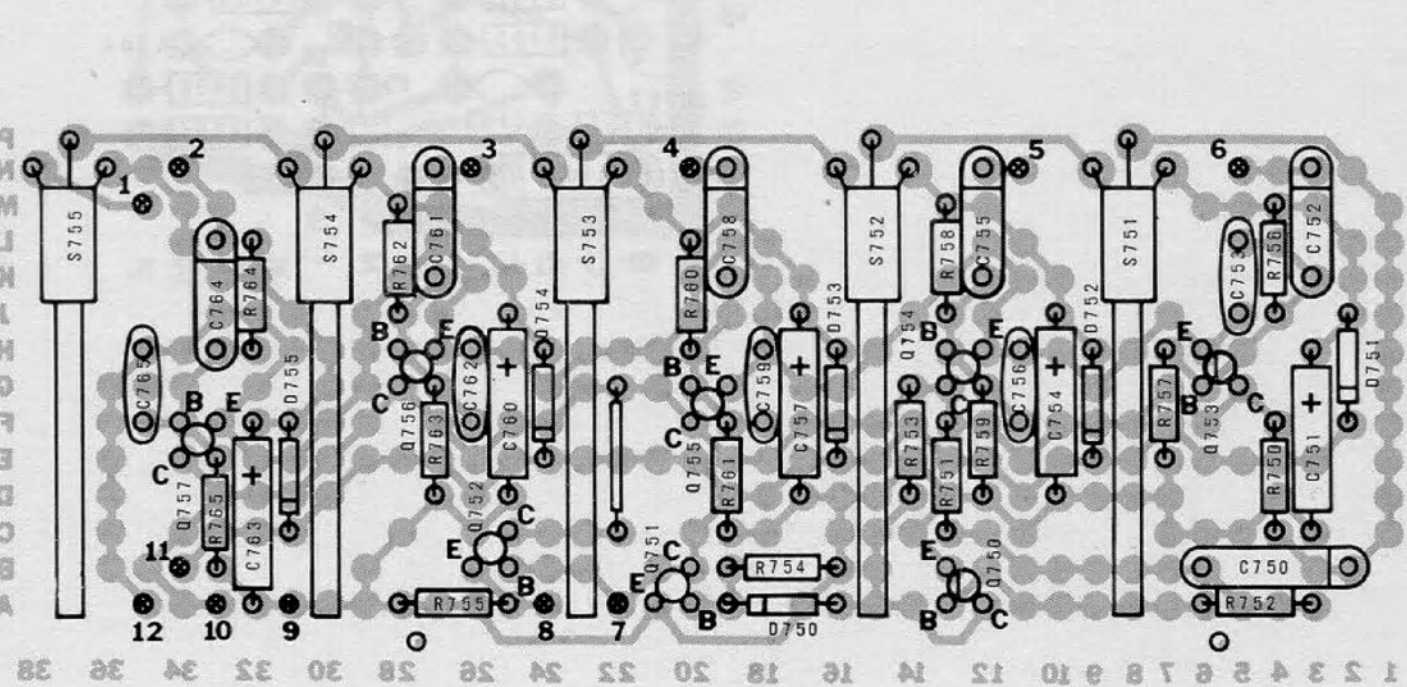
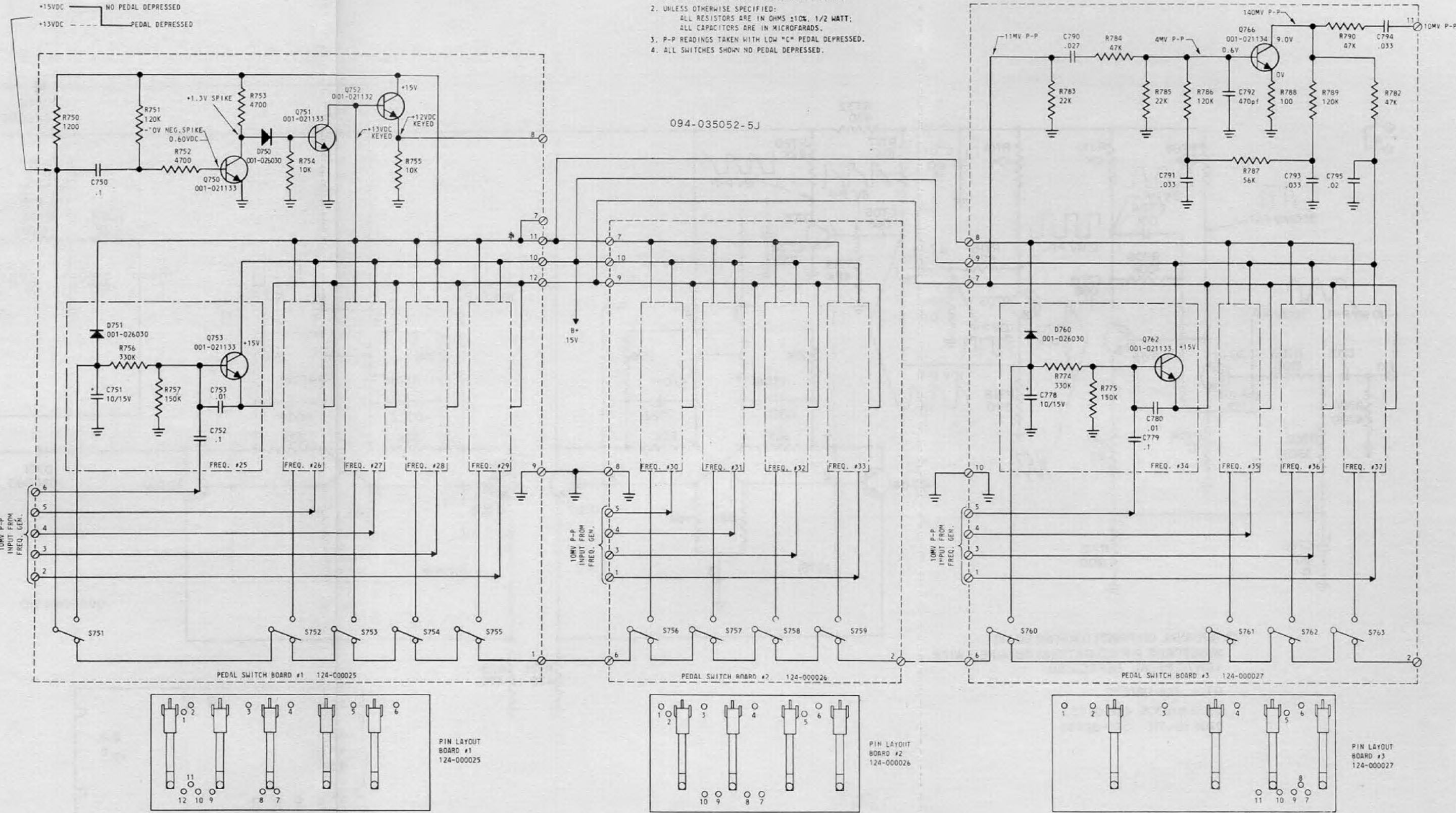
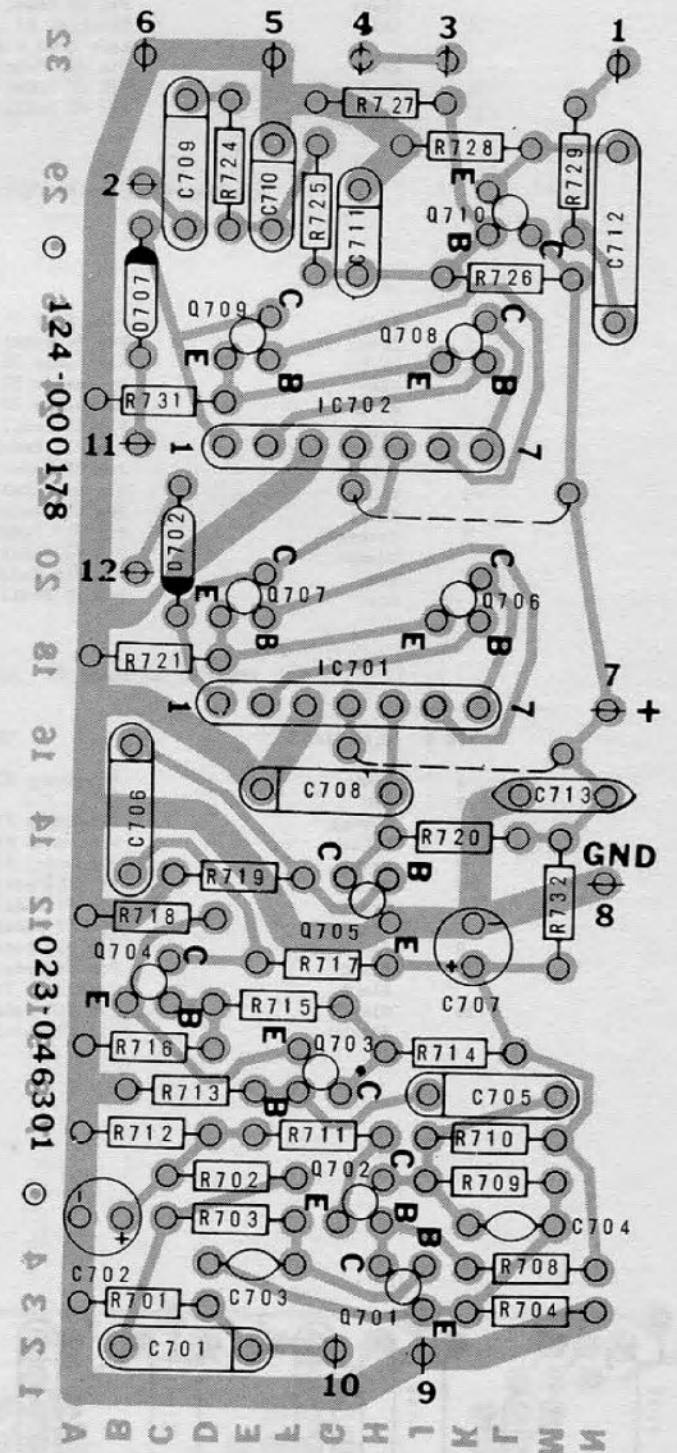
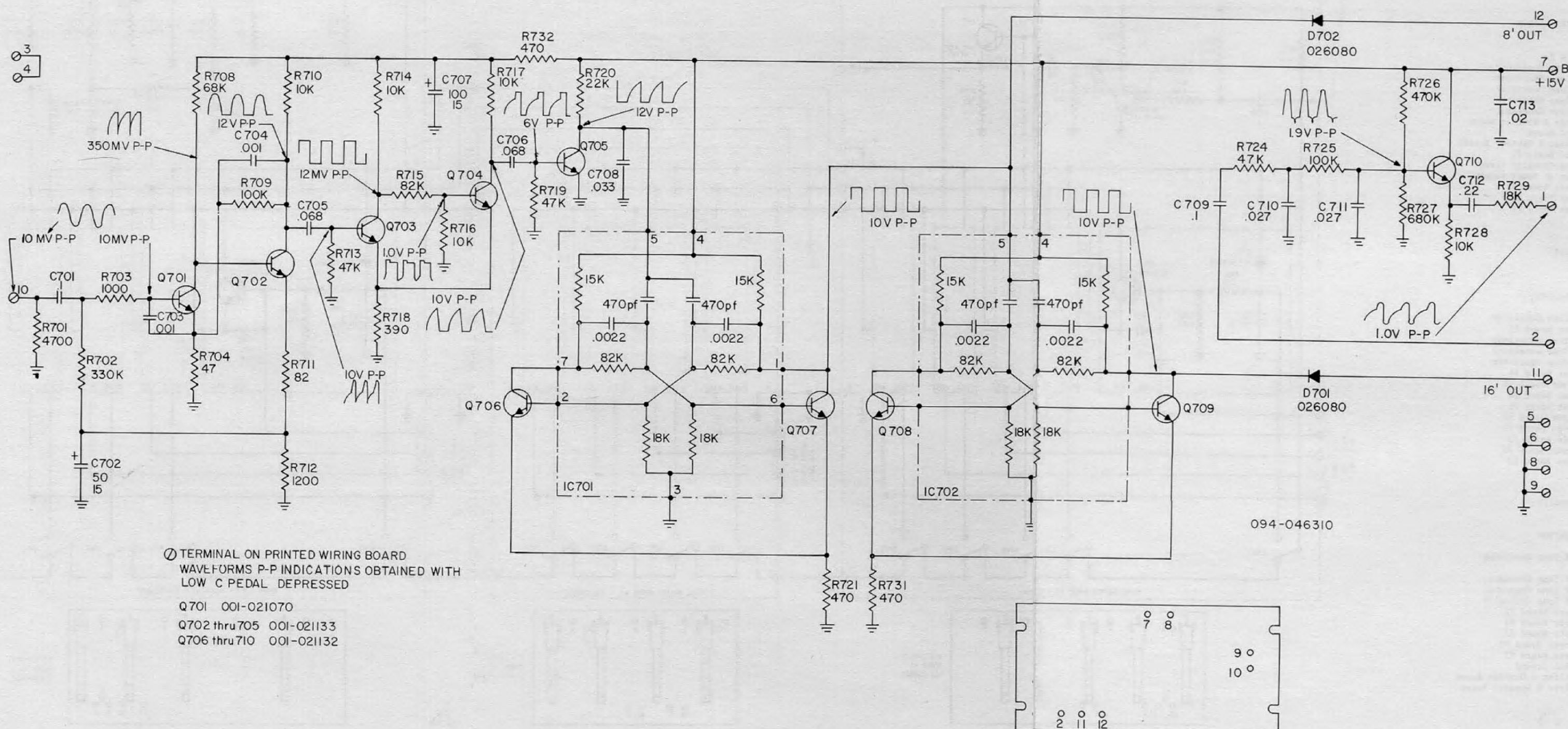

FIGURE 5-6
PEDAL KEYER BOARDS
124-000025, 124-000026, 124-000027,
LAYOUT & SCHEMATIC



PEDAL DIVIDER BOARD (124-000178)

PIN #	WIRE COLOR	TERMINATION
1	Clear	Terminal #4 Terminal Strip Lower
2	Clear	Left Hand Endblock
3	Yellow	Pin #22 Auto Chord Board Plug (Cable #76)
4	White/Gray	Terminal #1 Terminal Strip Lower
5	N/C	Left Hand Endblock
6	Shield	Pin #7 Pedal Keyer Board #1
7	Orange	(See Pin #2 Above)
8	Black	Terminal #3 Left Hand Strip 10-Lug
9	Shield	Terminal Strip Top of Power Supply
10	Clear	Pin #9 Pedal Keyer Board #1
11	White/Red	Pin #11 Pedal Keyer Board #3
12	White/Yellow	Pin #18 Auto Chord Board
		Pin #21 Auto Chord Board

FIGURE 5-7
 PEDAL FILTER & DIVIDER
 BOARD 124-000178,
 LAYOUT & SCHEMATIC