



fap

1

D376

NCA

Design

Keramic Studio

A MONTHLY MAGAZINE FOR THE
POTTER, DECORATOR AND
CRAFTSMAN



Volume Eight

MAY 1906 to APRIL 1907 INCLUSIVE



KERAMIC STUDIO PUBLISHING CO.
SYRACUSE, N. Y.

(All Rights Reserved)



KERAMIC STUDIO—Index

NATURALISTIC

MAY 1906		NOVEMBER 1906			
	PAGE		PAGE		
Lilies of the Valley.....	Maud E. Hulbert.....	3	Apples.....	Sarah Reid McLaughlin.....	147
Plums.....	H. Barclay Paist.....	10	Grapes.....	Miss Miles.....	151
Violets.....	Blanche Van Court Schneider.....	18	White Roses for Plate.....	Anne Seymour Mundy.....	153
			Plums for Jug.....	Jeanne M. Stewart.....	154, 155
JUNE 1906		DECEMBER 1906			
Roses.....	Alice Seymour, Margaret Overbeck.....	25, 37	Christmas Rose Studies.....	A. A. Robineau.....	169
Wild Roses.....	Louise E. Jenkins.....	31			
JULY 1906		JANUARY 1907			
Roses.....	Sara Wood Safford.....	52, 53, 65	Grapes.....	Henrietta Barclay Paist.....	197
Buttercup Sketches.....	Sara Wood Safford.....	55	Birds, and Apple Blossoms, Birds and Blackberries.....	Henrietta Barclay Paist.....	205
Poppy and Hollyhock.....	Sara Wood Safford.....	56	Geranium Panel.....	Henrietta Barclay Paist.....	210
Grapes.....	Sara Wood Safford.....	61, 62			
Cowslip.....	Sara Wood Safford.....	66	FEBRUARY 1907		
AUGUST 1906		Roses.....	Mrs. G. F. Camp.....	221	
Passion Flower.....	F. B. Aulich.....	75	Chrysanthemums and Gladioli.....	Panels by Maud E. Hulbert.....	223
Butterflies.....	F. Alfred Rhead.....	79	White Clematis.....	Ida M. Ferris.....	225
Gloxinia.....	Paul Putzki.....	83	Squirrels and Pine Cones.....	From the Vorbilder.....	226, 227
Christmas Rose.....	X.....	88	Yupon Berries.....	Jeanne M. Stewart.....	228, 229
Rocky Mountain Columbine.....	Emma A. Ervin.....	88	Crab Apples.....	Sarah Reid McLaughlin.....	232
Purple Clematis.....	Mrs. Chas. L. Williams.....	91	MARCH 1907		
SEPTEMBER 1906		Apples.....	Margaret Overbeck.....	241	
Small Fruit Studies.....	Ida M. Ferris.....	99	Primrose Study.....	Margaret Overbeck.....	249
Hops.....	Louise M. Smith, Sarah Reid McLaughlin, Mrs. Brame Van Kirk.....	105, 111, 118	Asters for Plate.....	Margaret Overbeck.....	253
OCTOBER 1906					
Pears.....	Sarah Reid McLaughlin.....	125	APRIL 1907		
Red Rambler Roses.....	Hattie V. Young Palmer.....	127	Plum and Apple Blossoms.....	Photographs by Helen Patter.....	265, 275
			Pussy Willows.....	Maud E. Hulbert.....	270
			Cyclamen.....	X.....	267, 276
			Ferns.....	Maud E. Hulbert.....	277
			Pink Eucalyptus.....	H. L. Bancroft.....	286

CONVENTIONAL

MAY 1906		SEPTEMBER 1906			
Fruit Plate and Bowl.....	Alice Witte Sloan.....	5	Zinnias Study, and Vase and Bowl.....	Mary Overbeck.....	101, 102, 103
Tree Design for Stein.....	Henrietta Barclay Paist.....	7	Hop Design for Stein.....	Ophelia Foley.....	104
Tree Design for Bowl.....	Mary Overbeck.....	7	Pumpkin Vine Study and Borders.....	Hannah Overbeck.....	106, 110
Punch Bowl and Cup in Grey Blue.....	Sabella Randolph.....	9	Rose Study and Vase.....	Margaret Overbeck.....	112, 113
Leaf Border Plate in Greens.....	Katherine Sinclair.....	11	Rosebud Design for Salad Set.....	Margaret Overbeck.....	114
Bonbon Dish, Bird Design.....	Edith Alma Ross.....	13	Child's Plate, Bird Design.....	Maud Myers.....	119
Laurel Design for Plate.....	S. Evannah Price.....	14	OCTOBER 1906		
Conventional Design for Cup and Saucer.....	F. Alfred Rhead.....	14	Stein, Grape Design.....	Mabel C. Dibble.....	128
Fleur de Lis Design.....	Frank S. Browne.....	15	Coupe and Salad Plates, Cup and Saucer.....	Mabel C. Dibble.....	129, 130, 131
Salad Bowl.....	Helen Patterson.....	16, 17	Daisy Vase.....	Mabel C. Dibble.....	132
Jonquil Bowl.....	M. Mae Woods.....	19	Service Plate.....	Mabel C. Dibble.....	133
			Fruit Plate.....	Mabel C. Dibble.....	134
JUNE 1906			Invalid's Tea Set.....	Mabel C. Dibble.....	135
Decorative Roses.....	Ophelia Foley, Margaret Overbeck, Mary Overbeck, Albert Pons.....	26, 27, 29, 32, 33, 38, 39, 42, 43	Ice Cream Plate and Candlestick.....	Mabel C. Dibble.....	136, 137
Rose Designs for Salad Sets.....	Ophelia Foley, Marie Crilley Wilson, Margaret Overbeck.....	28, 34, 35, 40, 41	Wild Rose Vase.....	Mabel C. Dibble.....	138
Rose Borders.....	F. Alfred Rhead.....	30, 36	Conventional Design for Plate.....	Mabel C. Dibble.....	139
JULY 1906			NOVEMBER 1906		
Buttercup Motif for Bowl.....	Sara Wood Safford.....	54	Rose Motif, for Salad Set.....	Alice B. Sharrard.....	149
Borders for Table Service.....	Sara Wood Safford.....	57, 58, 59	Punch Cup, Peacock Design.....	Alice Witte Sloan.....	153
Fruit Plates, Apples and Grapes.....	Sara Wood Safford.....	60, 63	Designs for Bonbonnieres, Plates and Tea Caddies.....	Miss Mason's Class in Design.....	156, 157, 158, 159
AUGUST 1906			Rose Design for Plate.....	Dante C. Babbitt.....	160
Borders for Punch Bowls and Cups.....	A. Witte Sloan, Russell Goodwin, Mary Overbeck.....	77	DECEMBER 1906		
Dragon Fly Plate.....	Nancy Beyer.....	81	Fireplace, Bowl and Pitcher, Elephants and Clowns Design.....	Ophelia Foley.....	170, 180, 181
Border Motif for Plate.....	Edith Alma Ross.....	85	Camel and Tree Design for Child's Table Set.....	Mary Overbeck.....	174
Decorative Wild Rose and Pitcher.....	Hannah Overbeck.....	87, 89	Humming Birds, Design for Fireplace, Bowl and Pitcher.....	Hannah Overbeck.....	175, 178, 179
Fruit Bowl in Blue and White.....	Sabella Randolph.....	89	Dutch Babies.....	Grace Blethen.....	177
Water Border for Salad Set.....	Marie Crilley Wilson.....	90			

KERAMIC STUDIO—Index

CONVENTIONAL—Continued

	PAGE		PAGE
Fireplace, Bowl and Pitcher, Knights Design Mary Overbeck	182, 187	Decorative Scotch Roses Marion H. Nelson	230, 231
Landscape for Fireplace Albert Pons	182	Aster Design for Vase A. A. Frazee	233
Child's Set, Poodle Design Ophelia Foley	183	Eve, Decorative Plaque D. M. Campana	233
Child's Set, Stork Design Nancy Beyer	184, 189	MARCH 1907	
Child's Set, Cat, Boy and Bowl Design Clara Wakeman	185	Walnut, Pine Cone and Tree Borders Margaret Overbeck	240, 242
Child's Set, Goody Two Shoes Design Albert Pons	186	Teapot, Conventional Flower and Leaf Margaret Overbeck	243
Child's Set, Japanese Lanterns Design Carrie Brosemer	188, 189	Bowl, Wild Touch-me-not Design Margaret Overbeck	243
JANUARY 1907			
Decorative Studies of Fish H. Barclay Paist	199, 200	Platters, Plates and Mugs, Poppy Seed Pod Motifs Margaret Overbeck	244, 245, 250, 251
Nasturtium Borders H. Barclay Paist	201	Vase, Peacock Feather Motif Margaret Overbeck	246
Bitter Sweet, Mountain Ash and Flam- ing Bush Borders H. Barclay Paist	202, 203	Chop Plate, Sugar Tree Blossom Margaret Overbeck	247
Grapes and Cranberries H. Barclay Paist	197, 204	Cups and Saucers, Primrose and Con- ventional Motifs Margaret Overbeck	248, 256
Birds and Apple Blossoms, Blackber- ries and Hawthorn H. Barclay Paist	206, 207	Borders for Dinner Plates Margaret Overbeck	252
Fern Dish, Butterfly Motif H. Barclay Paist	207	Child's Bowl Margaret Overbeck	253
Plates, Peacock Feather and Turkey Motifs H. Barclay Paist	209	Milk Pitcher, Milk Weed Pod Motif Margaret Overbeck	255
Plates, Eagle and Flying Geese Designs H. Barclay Paist	211	Landscape for Bowl, Vase and Fernery Margaret Overbeck	256, 257
Bowls, Byzantine and Aztec Designs H. Barclay Paist	212	APRIL 1907	
FEBRUARY 1907			
Decorative Azalea Edith Alma Ross	219	Calla Lily Design for Vase Russell Goodwin	269
		Powder Puff Box Chas. Babcock	269
		Snow Drop Design for Tile Maud Meyers	272
		Borders for Plates Ophelia Foley	270, 271
		Decorative Primroses Nancy Beyer	278

MISCELLANEOUS

MAY 1906		OCTOBER 1906	
Class Room (Firing)	1-9	Class Room (The Art of Teaching)	121-126
Tin Enameled Ware (2d paper) Prof. Chas. F. Binns	12, 13	NOVEMBER 1906	
JUNE 1906		Class Room (The Art of Teaching)	146-152
Class Room (Firing)	28-30	DECEMBER 1906	
Tin Enameled Ware (3d paper) Prof. Chas. F. Binns	36-40	Taxile Doat Irene Sargent	171-173
JULY 1906		JANUARY 1907	
Class Room (Etching)	49	Class Room (The Art of Teaching)	195, 196
Exhibitions of Chicago Ceramic Society and National League	50, 51	FEBRUARY 1907	
AUGUST 1906		Class Room (The Art of Teaching)	218-224
Class Room (Groundlaying, Tinting, Dusting, etc)	73-84	APRIL 1907	
Y. W. C. A. Art School	84, 85	Class Room (The Art of Teaching)	264-268
Tin Enameled Ware (4th paper) Prof. Chas. F. Binns	86	Alhambra Ceramic Works	272, 273
SEPTEMBER 1906		Mrs. Loomis' Hand Built Pottery	274
Class Room (Raised Paste)	98-101		

CRAFTS

MAY 1906		NOVEMBER 1906	
Raffia Stitches Madge E. Weinland	20, 21	Art in Pewter (1st Paper) Jules Brateau	161-164
Suggestions for Metal Workers Emily F. Peacock	21, 22	Rug Weaving and Dyeing (2d paper) Mabel Tuke Priestman	164-167
JUNE 1906		DECEMBER 1906	
The Making of a Metal Sconce F. S. Sanford	44, 45, 46	Printing with a Wood Block Haswell Clarke Jeffery	190-192
JULY 1906		JANUARY 1907	
The Making of a Palm-leaf Basket (1st paper) Lucy E. Shields	67, 68, 69	Art in Pewter (2d paper) Jules Brateau	213-215
New York Guild of Arts and Crafts	69, 70, 71	FEBRUARY 1907	
AUGUST 1906		National Society of Craftsmen Exhibition	234-236
The Making of a Palm-leaf Basket (2d paper) Lucy E. Shields	93, 94	Work of Pratt Institute Students	236, 237
Design for Portfolio or Frame Edith Alma Ross	92	MARCH 1907	
Providence Technical High School	94, 95	Fabric Stenciling Harry Barnes Goundrey	258-260
SEPTEMBER 1906		Art in Pewter (3d paper) Jules Brateau	260, 261
The Making of a Metal Lantern F. G. Sanford	115-118	APRIL 1907	
OCTOBER 1906		Art in Pewter (4th paper) Jules Brateau	279-281
Rug Weaving and Dyeing (1st paper) Mabel Tuke Priestman	140-142	Arts and Crafts Society of Detroit, Mich.	282, 283
		Barum Guild of Arts and Crafts, Barnstaple, England	284, 285

KERAMIC STUDIO—Index

COLOR SUPPLEMENTS

Plums	Teana McLennon Hinman..	May 1906	Orchids	Paul Putzki	November 1906
Yellow Wild Roses.....	Ida M. Ferris.....	June 1906	Child's Plate (Camels and Trees).....	Mary Overbeck.....	December 1906
Strawberries	Sara Wood Safford.....	July 1906	Poppy and Hawthorn Blossoms.....	Henrietta Barclay Paist ..	January 1907
Marigolds.....	Laura B. Overly.....	August 1906	Jacqueminot Roses.....	F. B. Aulich.....	February 1907
Zinnias	Mary Overbeck.....	September 1906	Decorative Landscape.....	Margaret Overbeck.....	March 1907
Peacock Bowl.....	Mabel C. Dibble.....	October 1906	Cyclamen	Paul Putzki.....	April 1907



KEEP THE FIRE ALIVE

KERAMIC STUDIO

CONTRIBUTORS

MR. F. B. AULICH
MR. CHARLES F. BINNS
MR. FRANK BROWNE
MISS M. E. HULBERT
MRS. T. McLENNON-HINMAN
MISS MARY OVERBECK
MRS. H. B. PAIST
MRS. S. E. PRICE
MISS EMILY F. PEACOCK
MISS HELEN V. PATTERSON
MISS SABELLA RANDOLPH
MR. F. A. RHEAD
MISS EDITH ALMA ROSS
MISS KATHERINE SINCLAIR
MISS B. VAN COURT SCHNEIDER
MRS. ALICE WITTE SLOAN
MRS. BELLE BARNETT VESEY
MISS M. MAE WOODS
MISS MADGE E. WEINLAND

MAY MCMVI

Price 40c. Yearly Subscription \$4.00

A MONTHLY MAGAZINE FOR THE POTTER AND DECORATOR

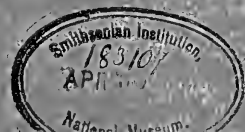

[The entire contents of this Magazine are covered by the general copyright, and the articles must not be reprinted without special permission.]

CONTENTS FOR MAY 1906

	PAGE
Editorial	I
The Class Room—"Firing"	I to 9
Lilies of the Valley	M. E. Hulbert 3
Fruit Plate and Bowl	Alice Witte Sloan 5
Tree Design for Stein	H. B. Paist 7
Tree Design for Bowl	Mary Overbeck 7
Punch Bowl and Cup	Sabella Randolph 9
Plums	H. B. Paist 10
Treatment for Heliotrope	F. B. Aulich 11
Leaf Border Plate	Katherine Sinclair 11
Tin-Enameled Ware—(2d paper)	Chas. F. Binns 12-13
Bonbon Dish	Edith Alma Ross 13
Laurel Design for Plate	S. E. Price 14
Cup and Saucer	F. A. Rhead 14
League Notes	Belle Barnett Vesey 15
Fleur De Lis Design	Frank Browne 15
Salad Bowl	Helen V. Patterson 16-17
Plums (Supplement)	Teana McLennon-Hinman 17
Violets	Blanche Van Court Schneider 18
Jonquil Bowl	M. Mae Woods 19
The Crafts—	
Raffia Stitches	Madge E. Weinland 20-21
Suggestions for Metal Workers	Emily F. Peacock 21-22

Some Leading Agencies of Ceramic Studio

We take pleasure in mentioning a few of the leading agencies for the sale of the **KERAMIC STUDIO**, where, also, subscriptions may be placed:

Boston, Mass.—Miss E. E. Page, 286 Boylston St.; Smith & McCance, Old Corner Book Store.
 Brooklyn—A. D. Mathew's Sons, Fulton Street.
 Buffalo—Mrs. Filkins, 609 Main Street.
 Chicago—A. H. Abbott & Co.; A. C. McClurg & Co.; Brentano's; Burley & Co.
 Cincinnati—Miss M. Owen, 245 Elm Street; A. B. Closson, 110 W. 4th St. Traxel & Maas, 4th Street, near Elm.
 Cleveland, Ohio—Vinson & Komer, 150 Euclid Ave.
 Columbus, Ohio—Lee Roessler, 116 So. High Street.
 Denver, Colo.—H. R. Meininger, 409 16th Street.
 Detroit, Mich.—L. B. King & Co.; Art China Co.
 Hartford, Ct.—E. M. Sill.
 Grand Rapids, Mich.—Miller, Wolfe Co.
 Indianapolis, Ind.—Ceramic Supply Co., Lemeke Building.
 Kansas City, Mo.—Emery, Bird, Thayer Co.; Geo. B. Peck Co.

Minneapolis, Minn.—Minn. Art China Co., 607 1st Ave. So.; Elizabeth Hood, 18 W. 6th St., St. Paul, Minn.
 New York City—Brentano's, Union Square; M. T. Wynne's, 11 E. 20th St.; The Fry Art Co., 11 E. 22d St.; Wanamaker's; American News Co.; J. B. Ketcham, 107 W. 25th Street.
 Newark, N. J.—Ceramic Novelty Co.
 Oakland, Cal.—Smith Bros.
 Omaha, Neb.—Megeath Stationery Co.
 Philadelphia—Wanamaker's.
 Pittsburgh, Pa.—Otto Schaffer & Bros.; Kurtz, Langbein & Schwartz, R. S. Davis & Co., 346 Fifth Ave.; John G. Yergan, 420 Penn Ave.
 San Francisco—Mrs. M. E. Perley, 207 Post Street.
 St. Louis—F. Weber & Co.; A. S. Aloe & Co., Erker Bros Optical Co.
 Syracuse—Wolcott Book Shop; W. Y. Foote; O. W. Conger; A. L. Varney & Co., 336 S. Salina Street.
 Toronto—The Art Metropole.
 Washington, D. C.—Wood & Lothrop.

The Magazine may also be ordered from any news dealer or book store in this country, who can procure it through the American News Company New York, its branches, or at the office of

Keramic Studio Pub. Co., 108 Pearl St., Syracuse, N. Y.

KERAMIC STUDIO

Vol. VIII, No. 1

SYRACUSE, NEW YORK

May, 1906

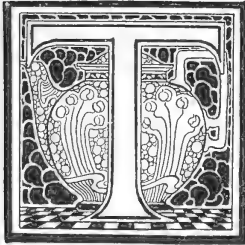

THE June Rose Competition closed April 15th. The prize designs will be given in the June KERAMIC STUDIO. The next competition will be the Christmas competition closing October 1st in order to give time for making a special Christmas supplement and holiday number. It has been thought best to discontinue the summer competitions as decorators are all too busy resting or gathering material to send in their best efforts.

The subjects for the Christmas Competition are as follows—we are giving plenty of time to be sure of results surpassing any former efforts.

I. Decoration for child's room, dado, fireplace and wash stand top in tiles, washing set to match. (Shapes of ceramic forms to be considered.)

To be executed in black and white wash with a section in color. Enough tiles only need be given to carry the design, a small sketch in pen and ink showing the completed effect.

First prize, \$25.00, Second prize \$15.00.

II. Decorative study of Christmas Rose in three to five colors, panel 8x10, with conventionalized application to punch bowl and cup, claret pitcher, and stein, in black and white wash accompanied by a color scheme. (Shapes of ceramic forms to be considered.)

First prize \$25.00, Second prize \$15.00.

Child's table set—Tray, bowl, plate and pitcher, conventionalized design in black and white wash with a section in color, (Shapes of ceramic forms to be considered.)

First prize \$25.00, Second prize \$15.00.

We will be glad to publish any notices of ceramic or arts and crafts exhibitions to be held, if sent in time; or any after notices with or without illustrations, reserving only the right to cut where necessary to occupy space.

It has been suggested that it would be interesting to our readers to give occasionally the larger part of an entire number to the illustrating of the work of some prominent ceramic decorator. We have decided to try this every third month. The initial number July will be devoted to the work of Mrs. Sara Wood Safford of New York. The second number, October, will illustrate the art of Miss Mabel Dibble of Chicago, the other artists will be announced later, with their months.

Want of space prevents us from publishing the usual "Answers to Inquiries" and "Answers to Correspondents," in this issue.

Mr. F. B. Aulich, of Chicago, has been on an extended trip to California which has proved not only very pleasant but also very profitable.

We are pleased to announce that Miss Maud Mason will be the next president of the New York Society of Ceramic Arts.

THE CLASS ROOM

Articles must be submitted by 5th of May for June competition. In order to fill up chinks in the Class Room instruction before going on to new subjects, the following subjects will be given:

Ground laying (Grounding, Tinting, Dusting, both in bright and mat colors, and backgrounds for flowers, etc.)

Raised paste and etching for gold work (includes causes of defective work with remedies.)

o o o

FIRING

Third Prize, Ella L. Adams, Yellow Springs, Ohio.

I HAVE had a limited experience with gas, gasoline, oil and charcoal kilns and found that satisfactory result could be secured with all. The only objection to gas is the fact that often sufficient pressure is lacking for a good strong flame.

Decide upon the kiln you purchase not from alluring notices but from talk with people who have tried certain kilns and found them *not* wanting.

See that your kiln is set up properly, so that the ventilation of the fire pot is good and make sure that your pipe is high enough to secure a good draught to carry away all gases and smoke from the oils and paints.

Almost all firers heat their kilns a few minutes before stacking and then turn them off. This is to make sure there is no dampness in the kiln, which would be liable to spot the china. While the kiln is cooling from this preliminary heating is a good time to carefully examine your china, to make sure there are no paint spots from fingers or brushes. Place your stilts, platten sheets and asbestos sheets where they are easy of access, for all these may be needed as the stacking develops.

Now is the time to decide just where you intend placing the various pieces so that there will be no waste of time and patience in stacking and unstacking through indecision.

A good rule to follow is to give a hard firing after the first painting, for, when a good glaze is secured, the other paintings are simplified. The hottest part of the kiln is the bottom, so stack your "first firing" china here.

China is not injured if it touches the kiln, provided that *two* sides do not touch it, for, since china expands in the firing, allowance must be made for this.

China pieces should not touch each other for two reasons; they are apt to stick together when the glaze softens, and they need spaces for the hot air to circulate.

Cups may be stacked inside each other with stilts between, or on some larger piece. Is there a tankard or large pitcher for the first firing? Do not fail to set it on a stilt to prevent its breaking in firing, for, unless so placed, large pieces, being apt to heat sooner at the bottom than at the top, may develop an annoying crack. A punch bowl for the first firing should be placed on stilts top down. This does not waste space in the kiln, for smaller pieces may be placed under the bowl, making sure of course that they do not touch each other. The inside of a pitcher, salad bowl or some other piece of similar shape may be

KERAMIC STUDIO

stacked with various small objects. If there be an unpainted surface or one that has no fresh tint, an asbestos sheet may be placed on this as a receptacle for buttons, pins and various small objects hard to stack on stilts.

In stacking plates on top of each other, make sure that the stilts are of uniform size and are evenly arranged, either around the rim or inside, to prevent the plates from tilting. Make sure that all the pieces which require a hard firing are on the bottom, utilizing every nook and corner.

All pieces decorated with hard enamel require a hard firing to bring out the glaze, so save a space for china so decorated. Lustres should be placed at the bottom, since a hard firing is always the most satisfactory for them. Now put on the shelf, making sure that no china touches its underside.

What is left for this middle part of the kiln? Mat colors do not require a hard firing, so place all first painting mat colors in the middle of the kiln. English and Belleek china do not require as hard a firing as French makes, so quite often (especially if painted with iron colors) they may be fired here the first time.

Is there paste to be fired? Here is the place for it with one exception: if water paste is used, the bottom of the kiln is where it belongs.

Gold work will stand a hard firing unless over color or on Belleek or English china when the glaze absorbs it, so it is always safer and more satisfactory to fire gold here.

All carmines, roses or pinks should be in the middle of the kiln. Hence they should not be used in the first painting if the other colors require a hard firing. All soft enamels should be fired here, also hard enamel which has been mixed with $\frac{1}{2}$ flux to give it glaze.

The top of the kiln may be used for pieces upon which are the finishing touches, or pieces decorated the second time with highly fluxed colors such as apple green, pearl grey and mixing yellow; or English and Belleek for either second or final firing.

Are all your pieces stacked with none touching another? Then close the kiln, and, if the kiln has the addition of a hood, be sure that the little hole in the hood is directly over the funnel shaped opening in the lid, for through this hole the changing process of the kiln is seen.

Light the burner and turn on very low for ten or fifteen minutes, that the china may not become heated too fast. After this first stage of low flame, turn on full head and hope for no failures.

Since different kilns require different lengths of time for firing and the same kiln will one day be ready to turn off sooner than on another day, firing cannot be done by the clock. When the inside of the kiln shows a rosy, misty glow, keep it on for about five minutes, and then turn off. If this misty glow is not explicit enough, another good test is when the china seems blacker than the iron shelf.

Pyrometric cones may be secured and experimented with until one is found which melts at the heat needed for some desired effects.

Do not attempt to open the kiln for several hours after it is turned off, for the larger pieces are liable to crack, if exposed to the air when hot, and the kiln is apt to warp. *Never* under any circumstances open the kiln while the china is being fired.

It is a good plan to have a damper in the kiln pipe. This may be shut after the kiln is turned off and it will prevent the china from cooling too rapidly.

The inside of the kiln should be whitewashed frequently since this helps the firing process.

If the kiln be full, a better firing is insured.

It is an excellent idea to keep a note book for the record of all your successes and failures. These notes may prove invaluable in time.

SOME TESTS IN FIRING.

Deep Blue Green, blues and violets should have a good glaze if fired at the right temperature in the bottom of the kiln.

Red with a blue tone has had too hard a firing or has been mixed with too much oil or flux.

Rose that fires a purplish tone is overfired. If it is brownish it is underfired. This can be retouched with Rose and fired lightly.

If Mixing Yellow comes from the kiln a grey green, it is overfired.

GLASS FIRING.

I would like to enter here a plea for glass painting and firing. This fascinating work seems so little appreciated. Difficulties are no greater than those of china, and the firing does not require as much time.

Glass may be fired in the bottom of the kiln upon powdered lime or asbestos, or on a shelf on asbestos, or its equivalent, platten. All kinds of glass may be used, but of course Bohemian glass is the best. The other glass may melt down, especially if a stem cup or bowl, and leave an undistinguishable mass.

The kiln should be turned off as soon as a cherry red heat develops, more is ruinous. No piece should be stacked on another, for glass is too frail for such treatment.

Glass for window or screen decoration should always be laid flat since otherwise it may bend.

SOME DON'TS.

Don't paint Moss Green or Brown Green on Belleek, they fire brown.

Don't use Ivory Glaze over iron reds or browns, it eats both of these.

Don't use Yellow with reds or other iron colors, for Yellow is also a cannibal. Use Silver Yellow with reds and Mixing Yellow with greens.

Don't give the pinks too hard or too frequent a firing.

Don't fire outlining black too often, it may chip off.

Don't fire enamel too often, it too may chip off.

Don't wash your china with water just before painting. It is too liable to be held on the china by the paint, and when fired the steam throws off the paint, leaving unsightly and often irreparable spots. Use turpentine or alcohol for cleansing.

Don't put on too much paint or oil, they will cause blisters on the china.

Don't paint china that has been used on the table. It is too apt to have absorbed soap or grease, thus injuring the china and often spoiling other pieces in the kiln.

Don't put stilts on Belleek or English china, they are liable to stick to it and spoil the piece.

Don't attribute failures to a defective kiln. The fault may lie in yourself, the china or the colors. A strong yellow when fired near iron colors may with its fumes destroy their effects, a yellow next to a bright green may turn it into an olive.

Don't feel satisfied unless a good glaze is secured, otherwise the china will in time grow dingy.

Don't be discouraged at the first failure, nothing worth doing is really easy.



LILIES OF THE VALLEY—M. E. HULBERT

(Treatment page 9)

Fourth Prize—Mrs. Louise Brittain, Dayton, Ohio.

[EXTRACTS ONLY.]

There are many different makes of kilns in the market now. The particular one of which I write is a Fitch gas kiln. Fuel used is natural gas.

The first point to be considered in firing a kiln is cleanliness and dryness of the firing pot in which the china is to be placed. Give the pot a wash of plaster of Paris as often as need be, not every time it is fired but when burned off so that it flakes away from the iron. After applying the wash, light the gas long enough to thoroughly dry the plaster coat, before putting any china into the kiln.

Always before firing, heat the kiln sufficiently, lid and all, to remove all moisture which gathers from standing. Turn out the gas, open the kiln and stack the china while the pot is still warm.

By the time the china is all placed, the pieces in the bottom and sides of the kiln are already warm and dry, so that when finally heat strikes them, they are ready to receive it. In most kilns, the heat is from the bottom, the burner being under the pot. A gradual heat is always safest.

Have the china to be fired, ready, all at one time upon a table or shelf near your kiln.

Separate pieces, upon which gold colors, such as Rose, Carmine, Ruby, etc., are used, from the pieces, upon which iron colors, such as Carnation, Blood Red, Capucine Red, etc., are used, giving the gold colors the places in the kiln where the heat is most intense.

Stilts made of fire clay must be placed between all pieces that are stacked one upon the other, to allow the heat to pass freely between and to keep the glazed surfaces from adhering one to the other. If the piece used as a foundation for the stack has an unglazed rim, it will not be necessary to place a stilt between it and the bottom of the kiln. If possible select a piece which is so made, as by directly resting the first piece upon the bottom of the pot the stack will be much firmer.

Stand as many pieces upright around the walls of the kiln as possible. See that all stacks of pieces are straight and firm, so that they will not slip, causing breakage when the jar of fitting the lid on the pot comes.

When all is ready, close the kiln securely, some cement the lid on with plaster of paris, or asbestos cement, but I prefer a rope of asbestos closely fitted around the seam where the lid fits into the pot. After the muffle is fitted on, and the vent pipe into the chimney is in place, see to it that your damper is all right, allowing the burnt gas to escape. You are now ready to light the gas. A very low blaze at first. At the end of ten minutes turn up gas one notch higher and so on every ten minutes for the first hour. A steam rising from the drying of the colors will be seen issuing from the two small vent pipes, soon after the fire is started. That is one reason why a gradual and slow fire is best at first, so that all the gas from the paints may escape from the kiln and not interfere with the clearness of the colors. At the end of the first hour, turn on the amount of gas necessary to finish the firing. The blaze should come up around the sides and over the lid of the kiln. Do not turn on the full pressure of gas as it is always more than can be consumed and will cause trouble. The kiln should be bright red inside at end of first hour. Keep the same amount of gas burning for one hour longer, making in all two hours from the time of starting the fire. At the end of the second hour the kiln

should show a bright haze inside. Articles that were plainly discernible a half hour before, should now be dimly visible. When this condition is reached, which should be in the time named, turn off the gas entirely and allow the china to remain within the kiln until perfectly cold, all night usually. Exposing china to the air before entirely cold causes the glaze to craze and sometimes if too hot the breakage of the piece. The greatest care should be taken to have the heat regular from the beginning of a firing, carefully timing the intervals of increasing the heat. Firing can be done in less time than I have mentioned but in my experience it is not getting the heat quickly which is desirable, but holding it, after acquired, long enough to produce perfect fusion of the colors.

Underfiring is a fault not easily corrected; even when retouched entirely and refired the piece never has the brilliant glaze of a perfectly fired one. Different colors from different manufacturers require different handling, some glaze more readily than others, while some lose in value, when others are intensified by firing. One can only learn from experience just how to allow for these things.

In case the china comes from the kiln with all the beautiful colors turned a dull smoke grey, then first of all, look for a break in the pot, which has allowed the gas to leak in. If no break is found then you have used more gas than could be consumed, or your damper was not open enough to allow the burnt gas to escape.

There are many chemical changes, which take place during firing that cannot be accounted for and that cannot be reproduced.

Do not put freshly painted china into the kiln without first drying it thoroughly as moisture from the fresh paint is liable to cloud some other piece near it.

When the colors come from the kiln, having a crawled, separated appearance, too much oil has been used, or when the color burns off in spots it is nearly always from the same cause.

Dust in the paint will give a specky appearance. Figure painting should be fired alone, as oftentimes the iron colors, lustres or other work which creates a strong gas, will mar the delicate color of a figure piece.

Work can sometimes be finished in two fires but usually three are required to thoroughly develop it.

○ ○ ○

Fifth Prize—Mrs. J. W. Gowiz, Sarnia, Ontario, Canada.

[EXTRACTS ONLY.]

After finishing the decoration of the article prior to firing, make a careful examination of it, particularly on the underside, to see that there are no daubs of paint, or gold, or finger marks. Clean all off carefully with turpentine, and place in a warm oven to dry.

A studio oven is a great convenience as china may be dried in it as soon as painted, thus insuring safety from dust; as any dust which may settle on it after it is dry may be brushed off with a piece of soft silk.

Lustre must be dried immediately after painting, as every particle of dust which settles on it will leave a white spot after being fired.

After drying the china do not handle till it is cold, for all paint is soft while warm, and finger marks will show plainly in soft paint.

Always wipe each piece gently, with a soft piece of silk, before placing in the kiln.

Dampness and dust are two of the greatest foes china decorators have to contend with. If the kiln is in a damp.

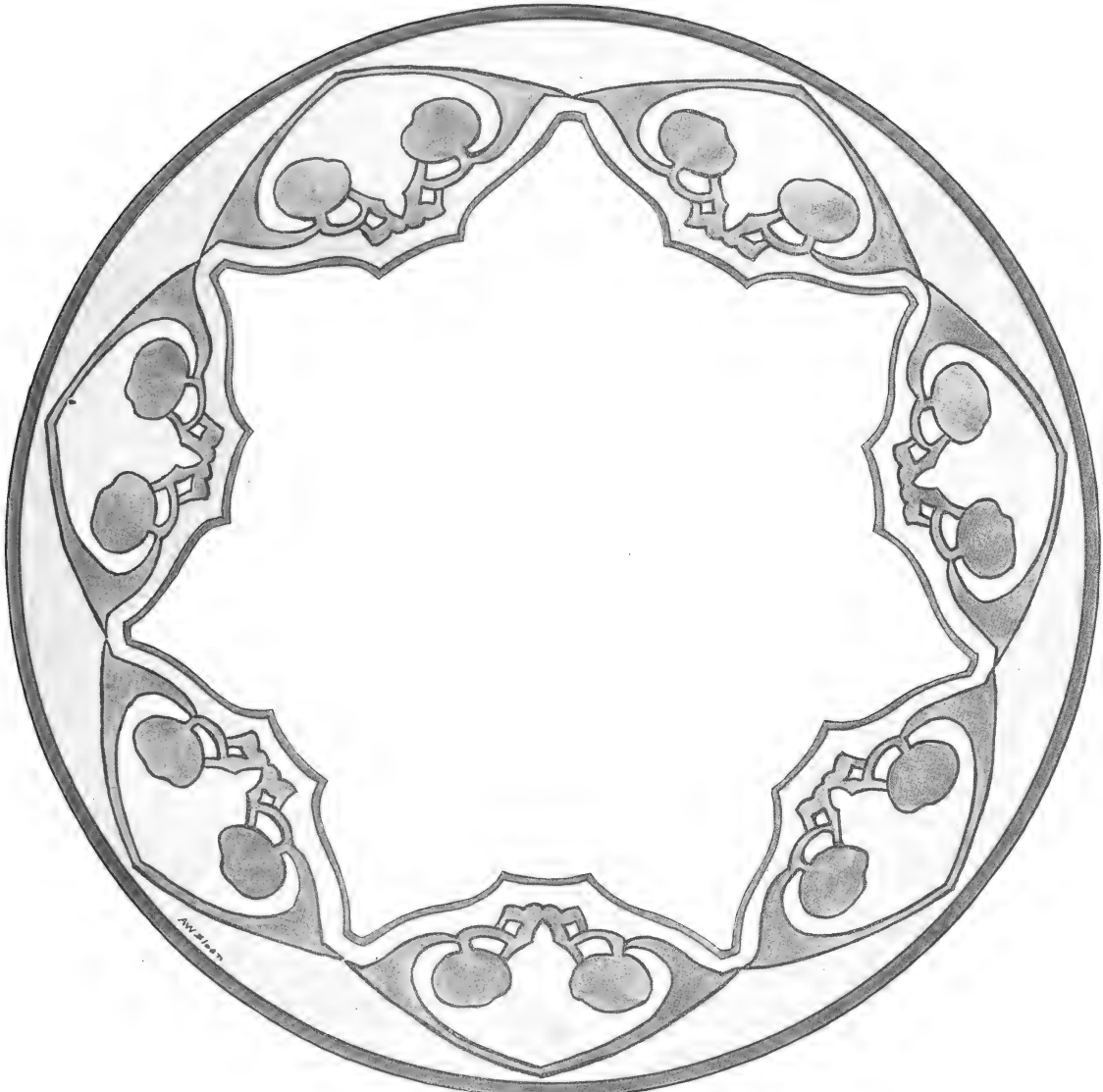

FRUIT PLATE IN DIFFERENT SHADES OF BLUE—ALICE WITTE SLOAN

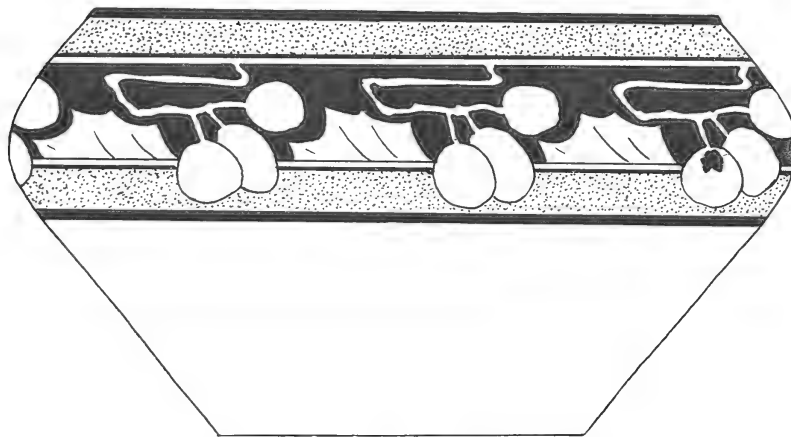

BOWL—PLUM DESIGN IN GOLD—ALICE WITTE SLOAN

or cold room, warming before stacking is very necessary as any moisture which may be there will surely accumulate and settle in round drops on the china, leaving light spots which will be plainly discernible after firing. A good plan is to whitewash the firing pot and shelves with a good heavy coat of lime about every three months or as often as it needs to be renewed. This will absorb the moisture and prevent its settling on the china.

To stack the kiln requires good judgment, careful calculation and good management. If plates and saucers are not tinted they may be separated by two or three strands of asbestos cord, if care is taken where each strand is placed. This takes up less room than the stilts and is a little more steady. It is a good plan to tie the pile of plates or saucers together with asbestos cord, as this will prevent their falling over. Cups and bowls, if not edged with gold may have other pieces placed on top of them, if a platten is put there for them to rest upon. All the spaces may be filled with small pieces. In stacking the kiln, be sure to leave sufficient room for expansion and contraction between the pieces or they will either break in the kiln or be fired together, and will have to be broken apart afterwards. Utilize every part of the kiln but do not overcrowd it. Do not allow the decoration to rest against the side of the firing pot or discoloration may result from the iron in the pot.

When decorating with lustre and mineral color it is well to do the lustre work and have it fired first as some of the mineral colors will not stand the heat required for the lustres. Over gold or gold scrolls, where unfluxed gold is used, requires a very light fire. This should be placed in the coolest part of the kiln.

Belleek china must never have a hard fire. Too great heat on this particular make of china will spoil the color and absorb the gold.

Paste for gold, and enamels are not so apt to crack or peel off if dried slowly, before firing.

Moisture in the kiln is very injurious as it prevents the colors from glazing and the gold from adhering to the china.

During the process of firing the gold will first appear quite black and will remain so, until almost done, then this blackness will gradually disappear, the entire firing pot will be filled with an orange color, and all the articles will be enveloped in a white haze. When it is sufficiently fired the black appearance of the gold will have entirely disappeared and everything will be in a mist. When done turn off the gas all at once, not gradually as we turned it on. It is a good plan to fire in the evening and let the kiln cool over night, then open it in the morning.

Sometimes a small grain of sand may be hidden away in the china where it cannot be seen and this when exposed to the fire will cause a separation.

It is a mistake to think that anything will do for the first fire. Experience teaches that if the first painting is correct the second will be comparatively easy.

As a rule, dust, smudges, daubs of paint, mistakes, crooked lines, poor drawing, are more glaring after being fired than before, and in many instances can never be obliterated or rectified.

Always use a perfectly dry cloth in cleaning the kiln. A whisk broom is better for this purpose.

I use a Wilke Studio Kiln, and find it highly satisfactory. It is convenient, clean and odorless and always ready for use. In three years it has cost nothing for repairs and the cost of operating is very small.

Arrie E. Rogers, Dubois, Pa.

[EXTRACTS ONLY]

To ascertain the hottest and coolest parts of your kiln, apply carmine to bits of broken china and distribute them through the kiln. On taking these pieces out, make a memorandum of the places where the color fired most satisfactorily. Gold may be tested in the same way.

Discolorations caused by drying in the oven all disappear when fired.

All lustres except silver require a very hard fire. Lustres may be fired with other colors, but care should be taken not to place them near the air hole, as spots are apt to appear, if you do.

When colors are underfired or come out without a glaze, they may be restored by applying a thin wash of ivory glaze or a wash of one part flux and three parts color, over each color.

During the process of firing, the kiln should be carefully watched, lest the gas should burn too high, or there is danger of the gas going off if the pressure is poor.

On taking the china from the kiln, it should be examined to see if there is any roughness. If there is, the piece may be rubbed carefully with very fine emery cloth, or some water placed on it and the roughness ground carefully with a prepared pumice stone.

The gold should be burnished with either a glass burnisher or burnishing sand. The glass burnisher always becomes more or less discolored, but should it get very dark the gold is not fired hard enough. Care should be taken that none of the particles of glass from the burnisher get into the kiln or remain on any of the pieces that are to be retouched, for if they do they will fire into the china and cause ugly marks.

o o o

Augusta H. Knight, Carthage, Mo.

[EXTRACTS ONLY]

If one has even a moderate amount of firing and can, in addition, do a little for others she will not regret the investment. One experiments in so many different ways and learns so much as to action of colors, when doing her own firing, besides saving time and being independent of the convenience of others.

Having decided on the make of kiln and the fuel, be it oil or gas, the printed instructions accompanying the same must be carefully followed; especially should one be careful with flue connections, draught, plumbing, etc. These directions as well as those pertaining to firing are sufficient for the mechanical manipulation of that particular kiln but there are so many points concerning which one is still in doubt. Indeed something can always be learned about firing.

Plates are best placed on edge and may rest against the sides of the kiln but must not touch each other. If placed one in front of another, they must be separated by stilts (which come with the kilns) and may also be stayed at the bottom to prevent slipping or rolling.

When stacking other pieces such as vases, bowls, cups, etc., place a large heavy piece on bottom, small pieces may be placed inside the larger ones providing they do not touch the sides and are not covered tightly enough to prevent a circulation of air around them.

A stilt may be placed on the large piece on which to place another piece and so on. One must make sure the pile is not too heavy for the lower piece, that it stands firmly and does not "wobble". If it seems at all uncertain

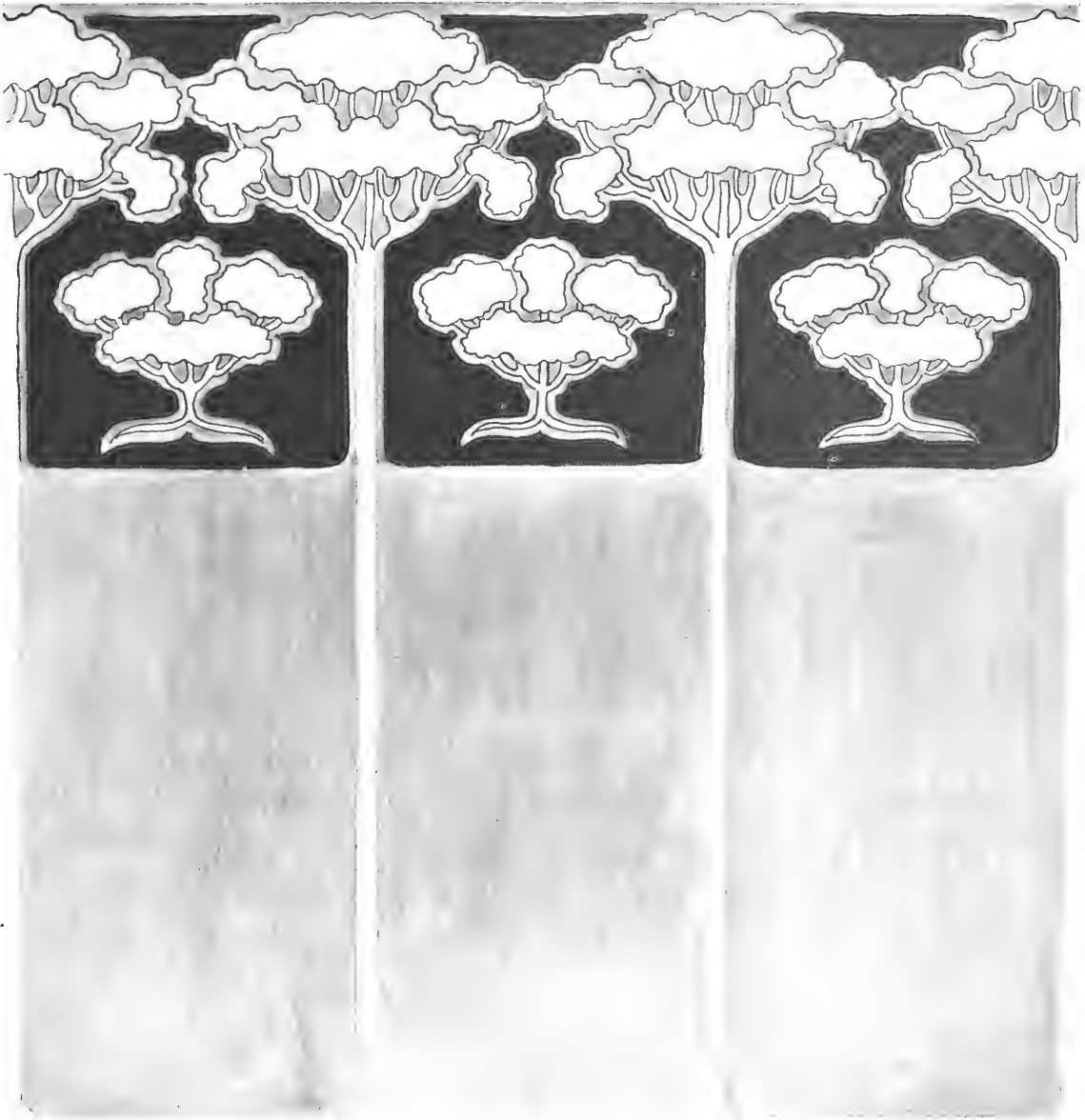

TREE DESIGN FOR STEIN—HENRIETTA BARCLAY PAIST

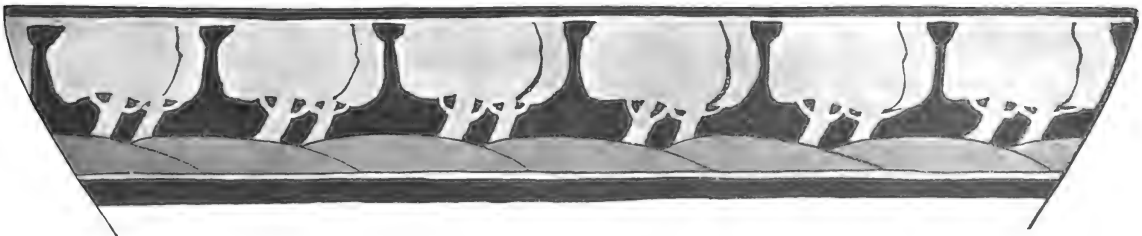

TREE DESIGN FOR BOWL—MARY OVERBECK

In dull blues or reds.

give it the benefit of the doubt and put less in the kiln rather than risk an accident.

Punch bowls should never have anything placed within them as they are difficult to fire, being large and heavy. Tilt them slightly or raise from the bottom of the kiln on stilts so that uneven expansion will not crack the bowl.

Neither must articles fit too tightly a given space, room must be allowed for expansion, at least a quarter of an inch on each side. With Belleek one must exercise still more care. The ware is very soft and easily chipped or marred. Stilts or other pieces of china must on no account be allowed to touch it save as it rests upon them. Hence it is more expensive to fire than other pieces. Do not allow two decorated surfaces to "kiss" or the result will be disastrous to both.

The only probable difficulty in lighting a gas kiln is that the gas may fly back in the mixer, in which case it becomes necessary to turn off the gas and light again. The gas has been known to perform this feat toward the end of the firing and then be willing to light without any trouble and at once. Occasionally it is impossible to light it again until the burner has somewhat cooled, thus retarding the firing. However this seldom happens.

If one has insured a good draught and good chimney connections, the only stumbling block with oil as a fuel is a too rapid feeding of oil; the burner must be hot before it will consume much oil and the proper amount for the first fifteen minutes is to have only a quarter of the surface of the pan moist increasing the amount until at the end of forty five minutes the entire bottom of the pan is wet with oil.

As soon as the first red glow appears in any kiln, the heat can be increased and after the first hour the firing should be pushed as rapidly as possible. The length of time required varies with the size of the kiln and with gas depends on pressure and quality of gas. Usually the time taken is from an hour and a quarter up. A quick firing for rose gives the best results. There is first the dull red, then a faint glow throughout the kiln; gradually each piece becomes distinct in form, then the decoration is visible, soon this blurs a little, and the color becomes uniform throughout the kiln. This is the proper time to turn off the heat for a light firing. When the shapes become less distinct, the decoration can no longer be seen and there is an intense glow within, the firing has reached white heat. The forms are much more distinct throughout the firing in an oil than in a gas kiln. The period during which the color changes from red to black is said to be the most critical period of cooling as large pieces if cooled too quickly may break or crack. Pieces underfired may be fired again. Enamel underfired may chip when refired. Gold underfired will burnish off, hence should not be burnished if it shows an inclination in that direction. Roses and reds are the chief colors which are hard to remedy if overfired, but may be improved by re-touching and a light firing.

The amateur more often underfires than overfires. When one begins to realize all these points, to understand her kiln and its peculiarities then firing loses its power to terrorize and becomes a means of education.

STUDIO NOTE

The Misses Mason sailed for Europe in April for a trip of several months. The Studio will be kept open for sale of colors, etc., by the youngest Miss Mason.

FIRING CHARCOAL KILNS

Ella L. Adams, Yellow Springs, Ohio

OF course, the kiln is stacked the same as all kilns, but the test of one's patience is in filling the space between the iron fire pot and the outside (which is of fireclay bricks) with kindling wood and charcoal. The kindling must be fine and dry and alternate layers of kindling and charcoal should be placed for three or four layers to insure a good start. The charcoal should be well packed using pieces the size of walnuts for the most part. Pack the space up to the fire pot (I have sometimes put charcoal over the lid but I should not advise it.) The iron hood is then adjusted, the pipes put in place, and the kiln lighted from the bottom.

The time required for firing is from two and a half to three hours.

When the kiln, through the funnel-shaped opening in hood, shows the requisite color for a good firing the grate is let down and the coals fall. Thus, the fire goes out. My kiln was set on a stone floor, so the coals fell with no danger of setting anything on fire. I believe some use zinc as a mat under the kiln, always use some substance that won't take fire as a ground. A cement floor is probably the best.

On one eventful day no charcoal could be purchased in the village. In desperation I resolved to use corn cobs which I had used at times for kindling the fire. The corn cobs answered, but a replenishing was needed before the kiln was brought up to the proper heat. However, the china was fired to my satisfaction and I soon forgot my corn cob trials.

In talking with a china painter who lived remote from charcoal she told me she always used corn cobs but employed a boy to throw in the cobs. My sympathy has always gone out to that boy.

The charcoal kiln can only heat gradually so there is no danger of too strong a heat at first. Another good feature is that there are no pipes to become clogged, no plumbing to overhaul, in fact nothing to get out of order.

Some prefer charcoal to gasoline since there is no danger connected with it. It is cheaper than gas which seems an advantage to slim purses.

I have said nothing about the setting of the kiln, for full directions always come with the kiln and this surely seems superfluous.



FIRING A GASOLINE KILN

Ella L. Adams, Yellow Springs, Ohio

WHAT impulse or deliberation leads one to purchase a gasoline kiln?

First—One is often situated so that a gas kiln is an impossibility.

Second—The pressure of heat can always be regulated and an even heat insured. I have known china decorators who depended on gas to be compelled to fire late at night since the gas supply was poor at other times; therefore, gasoline seems a more independent way of firing.

Third—A gasoline kiln is cheaper in price than a kerose kiln and cost is sometimes worth considering.

After having purchased a gasoline kiln, study the working parts thoroughly, which can be done through the instructions which are sent with the kiln.

A gasoline kiln should be placed on a cement floor or one that has the protection of a sheet of zinc or sheet

Iron under the kiln to prevent the floor from becoming over-heated. The directions for setting up a kiln are always sent with the kiln and are always explicit enough.

One thing can not be emphasized too strongly and that is to be sure to have good drawing qualities in the flue, for this aids in heating the pot and also in carrying off the fumes from the china. I placed the tank for the gasoline outside the kiln room which was easily done by the addition of a little more connecting pipe. This takes away any possibility of an explosion, but I have never heard of an accident in connection with a gasoline kiln. The tank is well supported with wooden braces, which seems necessary with its weight of gasoline.

Always make sure that the tank is filled with gasoline before firing for it should never be filled during the firing after stacking the kiln (some never warm a gasoline kiln first), put on the iron lid, then the iron top, then the iron hood, the openings in all three should be on a line, for these are the peep holes. After the gas is generated the burner is lit with a taper and turned on very low, not too low, however, for this may cause the gas to ignite at the mixing pipe. Should this occur the gas should be turned off and the burner lighted again. After fifteen minutes the gas can be turned on full head. When the color through the hood shows a white, misty heat the kiln should be turned off. The time required for firing varies from two to three hours, the degree turned on at first influencing this.

It is well not to hurry the first part of the firing especially if there should be large pieces in the kiln. These should heat gradually.

It is a good plan to let the kiln stand untouched at least three hours after the gas is turned off, for this prevents the china cooling too rapidly and also takes away the possibility of injury to the iron pot by too sudden exposure to the cold air. The inside of the kiln should be whitewashed occasionally since this is a special benefit.

Above all things insist upon good gasoline. Poor gasoline is apt to be diluted with water and in consequence burns a sickly yellow color instead of a clear blue flame.

A gasoline kiln should be overhauled yearly to make sure the pipes and burner are free from the sticky substance that seems to belong to all gasoline stoves.

If the burner or pipes become clogged a good strong head of gas is not possible, and the china will be under-fired.

I can think of no unsurmountable difficulties connected with a gasoline kiln and can only repeat what I said once before: thoroughly understand your kiln before trying to fire it and your firings will prove successes.



LILIES OF THE VALLEY (Page 3)

Maud E. Hulbert.

FOR CHINA. For the leaves use Deep Blue Green, Yellow Green, Moss Green, Shading and Brown Greens.

For the flowers, Brown Grey, Brown Green very thin or Grey for Flowers in the shadows. A very light wash of Deep Blue Green over the lightest ones, and Lemon Yellow over some that are in shadow.

FOR WATER COLOR. New Blue, Crimson Lake, Brown Pink (these make a good grey for the flowers), Payne's Grey, Sap Green, Hooker's Green No. 2, Olive Green and Lemon Yellow.

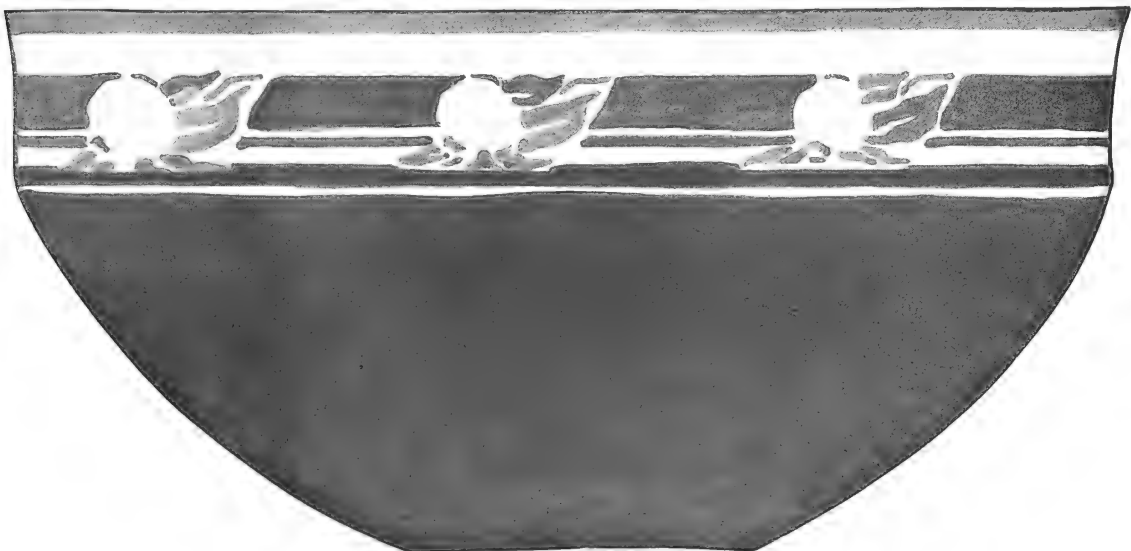
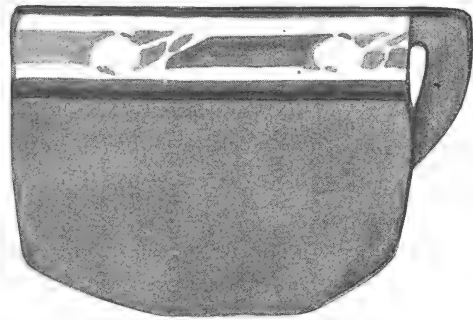

PUNCH BOWL AND CUP IN GREY BLUE—SABELLA RANDOLPH



PLUMS—HENRIETTA BARCLAY PAIST

THE colors for this study are Copenhagen Blue, Dresden Dark Blue, Albert's Yellow and Yellow Ochre, Lacroix Ruby Purple, Moss Green or Brown Green 6, Dark Green 7. The plums are painted with Copenhagen

Dark Blue for modeling. Use all three Greens for leaves—paint the stems with Copenhagen and shade with Brown Green and Yellow Brown or Sepia. Use the Yellow, Yellow Brown and Greens for background, letting the Yellow sift in to give a sunshiny effect.

TREATMENT FOR HELIOTROPE

F. B. Aulich

This study was published in the April number and was by mistake given as Lilac.

This flower which grows only a foot or two in the East attains a height of five and six feet in Southern California. There are several different varieties and colors. The kind we know best is the blue violet with yellowish center.

Take Blue Violet and mix some Turquoise Blue with it for the lighter tints, Deep Violet for the shades and accents. Yellow Green for the centers. For leaves use Yellow Green and Olive Green with a little Blue Green

in it. The distant flowers paint in Blue Violet and let the tint run over them to give them perspective. Use tint harmonizing with the flowers.



TREATMENT FOR TREE DESIGN (Page 7)

Lay in the foliage and stems with Apple Green or Moss Green. The background behind the foliage with Shading Green or Dark Green—not too heavy—and fill in the remainder of the upper half with Gold, Platinum or Platinum Lustre. The lower half may be Apple Green or Black Lustre. Outline the design carefully with Outlining Black. This design is intended for cylinder vase.



LEAF BORDER PLATE IN GREENS—KATHERINE SINCLAIR

TIN-ENAMELED WARE

Charles F. Binns

[Second Paper]

PERHAPS a few words of explanation should be added with regard to the soaping of the plaster mentioned last month. This soaping is necessary in order to prevent two plaster surfaces adhering to each other. New plaster poured upon old will unite with it so that the two form one block unless some kind of a greasy surface be interposed. Shellac or oil would answer but there is nothing more convenient than soft soap. A packet of "Pearline" is procured and on it will be found directions for making soft soap. A small quantity can be mixed and this is a great convenience. A vessel to contain the soap, another of clean water, a small paste brush and two soft sponges are provided. One of the sponges is reserved for the soap and the other for the water.

The plaster dish of which the reverse or "case" is to be made is brushed over thoroughly with the soap jelly and wiped off with the soap sponge. The water sponge is squeezed nearly dry and the soap thoroughly washed off. Then a second coat with the brush, wiped off with the soap sponge and washed with the water sponge as before. Then a third application of the soap and a final polishing with the soap sponge but this time the water sponge is not used. The plaster should now show a smooth and slightly greasy surface and is ready for the new mix to be poured. A little practice will show when the soap has been applied sufficiently. New plaster requires three or even four treatments with soap but afterwards, if the same plaster block is used a second time, one or two applications are sufficient. The mold or dish which has been soaped cannot now be used for the drying of clay. The pores which constitute its value have been closed.

The "case" is now ready for making new molds and can be used indefinitely. It takes the place of the clay mound on the turntable and is always at hand when new molds are needed. The metal band is tied around it and the plaster mixed and poured exactly as in the first case. The newly poured plaster should be allowed to heat which it will do in a few moments and if there be any difficulty in dividing the two parts the blade of a knife may be applied at the junction and one or two taps upon it with a light hammer will bring about a separation. The new plaster must be well dried before it will be of service in drying the clay.

To produce successful work in tin-enameled pottery the whole design should be completed before the form is begun. Much depends upon having shape and decoration in agreement. There are certain forms suitable to porcelain and certain others proper for faience and due regard should be had to this fact. A correct harmony in all parts of the design is essential to the production of a pleasing result. In both throwing and building the beginner will find a difficulty in persuading the clay to follow a chosen line. It is well in such cases to pay attention to the shape of the inside of the piece. The outside can be changed when partially dry, the inside cannot. In order to help this the line of the inside should be indicated on the drawing and a plaster "rib" cut to this line. In pouring plaster a little may be spilled on a flat surface so as to form a sheet about half an inch in thickness. The line of the shape can be marked on this and with a knife the form can be cut out. This form is slipped inside the vase as the shaping goes on and serves to keep the line where it is wanted. On the

wheel the same rib serves as a guide and while it is held in the left hand the right hand guides the clay from the outside. In the case of a jar or vase with a narrow mouth the rib must be cut in the shape of a sickle or crescent so that it can be removed from the opening.

Another convenient tool for use in throwing is a flat piece of wood about ten inches long with a slightly enlarged end, something like a small tennis bat with a very long handle. This greatly facilitates the shaping of the inside of vases in which the opening is too small to admit the hand.

In preparing the body, red clay need not of course be insisted upon, a white clay is quite as good, if not better, but white clays are more difficult to procure and much more expensive. There is moreover a certain pleasure, not only in making this ware as it was originally made but in using the commonest materials to produce fine results.

The pottery being duly made and dried it must be fired in biscuit. The lime in the clay will reduce the shrinkage considerably and will make the biscuit very porous. In fact it must be so. If a hard burn be given and the ware brought to vitrification not only will it not take the glaze so well but there will be a danger of the pottery collapsing entirely, for lime, while it is refractory up to a certain point, melts down a clay with great rapidity when that point is exceeded.

The next thing is the preparation of the glaze and here every worker must be prepared to do some experimental work. No two clays are exactly alike and while an enamel may be given which works to perfection under a given set of conditions it is by no means certain that with another clay and under other conditions the results will be as good.

The following are both pure white opaque enamels:

White lead	33	White lead	34
Whiting	9	Whiting	8
Feldspar	21	Feldspar	15
Flint	17	Zinc oxide	3
Tin oxide	20	Kaolin	3
		Flint	17
	100	Tin oxide	20

100

The materials can all be bought ready for use from the Roessler and Hasslacher Chemical Co., 100 William Street, New York. Feldspar, flint and kaolin are the same as those used in bodies.

If a mill is available the mixture can be ground but care must be taken not to grind too fine. The best plan is to weigh out the white lead, whiting and tin oxide and to grind these for an hour, then to add the other ingredients and to grind for ten minutes more. The glaze thus prepared will have a slightly gritty feeling and will be less liable to crawl and peel off than one which is ground fine.

In preparing by hand no fear of fine grinding need be felt. The difficulty will be to secure a perfect mix. A brass sieve should be procured having eighty meshes to the linear inch. Each material is weighed out, mixed separately with water to a thin cream and poured through the sieve. Lumps must be rubbed through but gritty particles rejected. The sieve should not be washed until after all the ingredients have been rubbed through. The batch is now thoroughly stirred and poured through the sieve two or three times. This insures a perfect mixture. Set aside for a day there will be found some clear water on the surface of the glaze. This must be carefully si-



MAY, 1906
SUPPLEMENT TO
KERAMIC STUDIO

PLUMS—JEANA McLENNAN-HINMAN

COPYRIGHT, 1906
KERAMIC STUDIO PUB. CO.
SYRACUSE, N. Y.

phoned off, it is scarcely possible to remove it all by pouring. The glaze should be nearly as thick as buckwheat batter, just so thick as to flow sluggishly when poured. It will be found useful to add a little gum tragacanth mucilage to the glaze so that the glazed pottery may be the more freely handled. Without the gum the glaze is very liable to dust off. The mucilage is prepared in the following manner: half an ounce of gum tragacanth is put to soak in a quart of cold water. The gum can be bought at any drug store either as flake or powdered. The flake is a little the cheaper but either form will do. After soaking for twenty-four hours the mixture is to be vigorously stirred with a Dover egg beater or some similar tool. This breaks the lumps of jelly into which the gum has softened and gives a further chance for the water to soak in. After standing for another twelve or eighteen hours the stirring is repeated and all lumps should have disappeared. If they have not the whole mass may be rubbed through the sieve but this is a troublesome and tedious process and is not really necessary. Of the mucilage thus made a good tablespoonful is to be added to the batch of glaze and well stirred in. If the glaze is to be kept a long time a few drops of carbolic acid will keep the gum from turning sour.

One word here as to the storing of this or any other glaze. The best plan is to use ordinary glass fruit cans, screwing down the cover air tight. The glaze will thus keep wet and good almost indefinitely but care must be taken to empty it all out of the jar when it is to be used because the heavier parts will settle to the bottom.

The glazing can only be satisfactorily accomplished in the studio by soaking the pottery to saturation first. This is not done in the factory because there one has a large tub of glaze and an expert dipper. If any one doubt the advisability of soaking let the experiment be made. Take a dry piece of ware and attempt to glaze it smoothly

in a quart of glaze fluid. No further advocacy of soaked ware will be necessary.

The pieces, then, are put to soak in clean water. They will not hurt by continued immersion but the saturation should be thorough. They are then taken out, two or three at a time, drained and wiped dry. No moisture should appear on the surface but the pores should be full. Now, the glaze being of the thickness of batter as aforesaid, the piece of pottery is taken in the left hand and the glaze scooped up with the right. First there should be a little practice as to the best way to hold the piece with one hand so as to leave no finger marks. For a very large piece it will be necessary to have assistance in pouring the glaze so that both hands may be used in holding. Also a stilt to fit the bottom should be placed in readiness.

The inside is attended to first, a little glaze being poured in and the vase turned around until every part is covered. Then taking a comfortable hold and one which will permit of several positions of the hand the glaze is gradually distributed over the whole surface. There is no hurry. Every movement should be deliberate. For a rest or to secure a fresh hold the piece may be set down in the bowl of glaze. It will take no harm and, being already satisfied with all the water it will hold, no more of the glaze is attached to the surface in one place than another. Finally, the vase being covered thickly both inside and out it is taken in one hand if small, in both if large and with second finger on the top and thumb beneath the bottom is shaken, mouth downwards, to remove all unnecessary glaze and evenly distribute that which remains. Lumps are to be removed by gently shaking, they must not be touched. Then the glazed piece is set upon the waiting stilt to dry undisturbed.

(To be continued.)

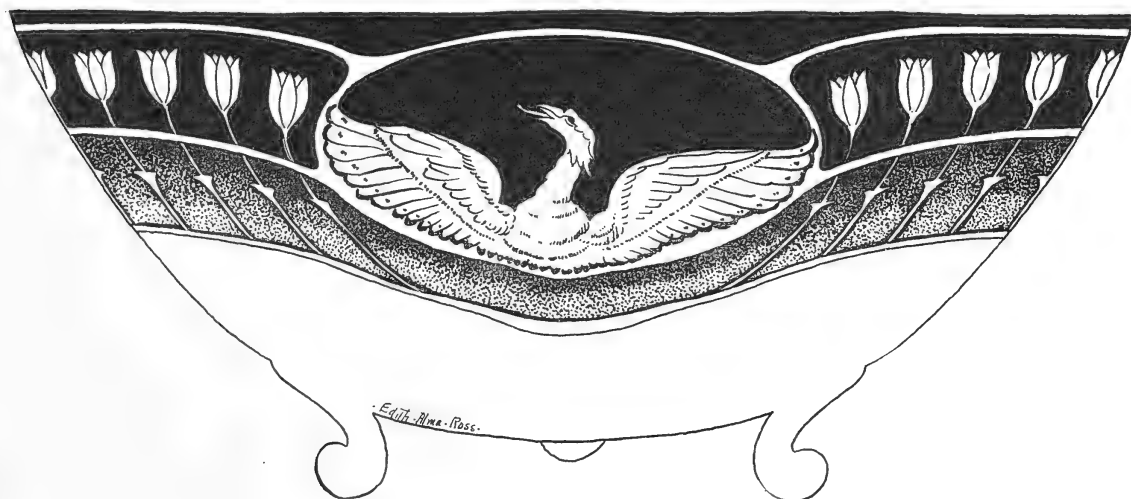

BONBON DISH—EDITH ALMA ROSS

In gold and ivory.

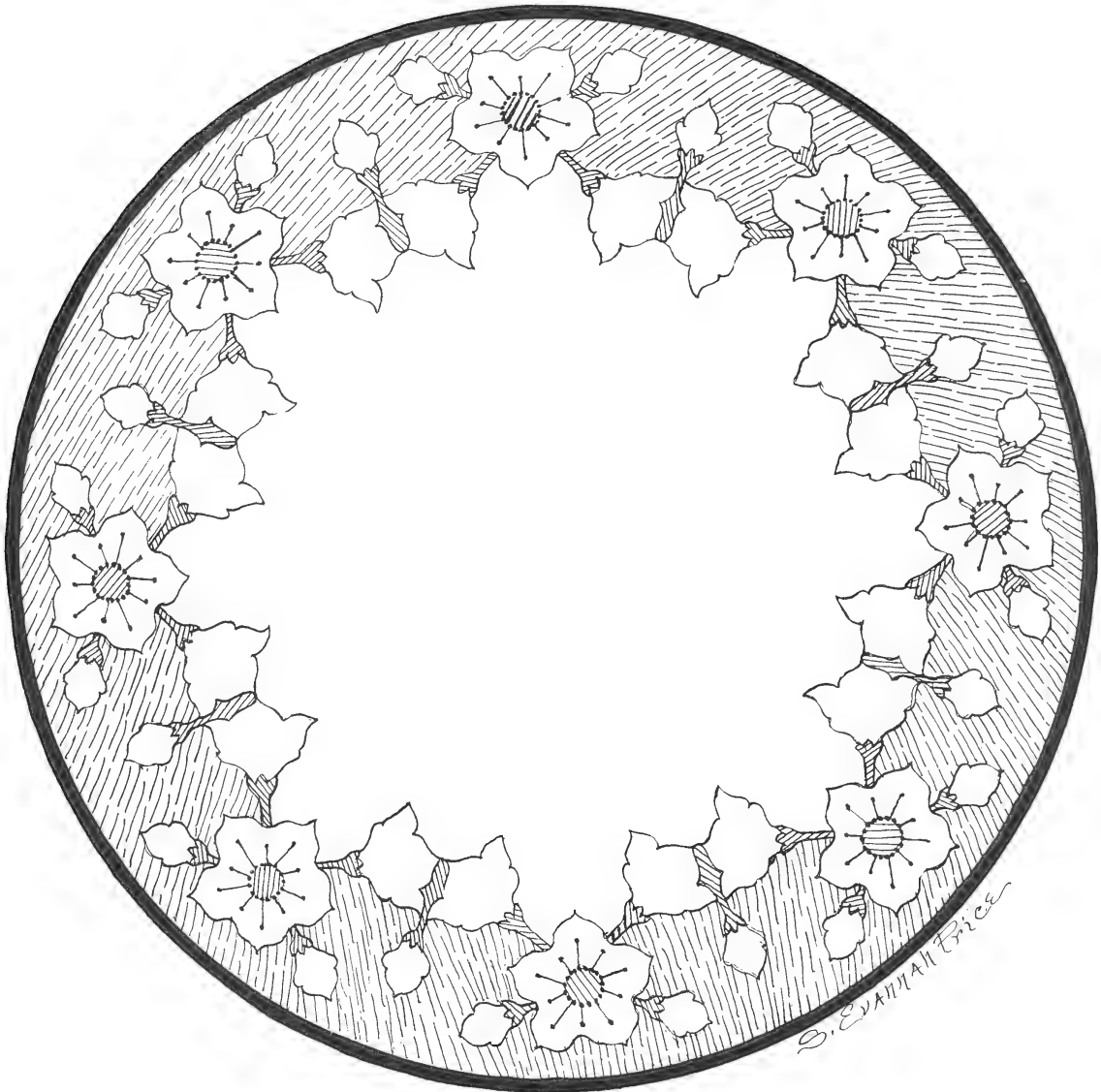

LAUREL DESIGN FOR PLATE IN PINK AND GOLD—S. EVANNAH PRICE

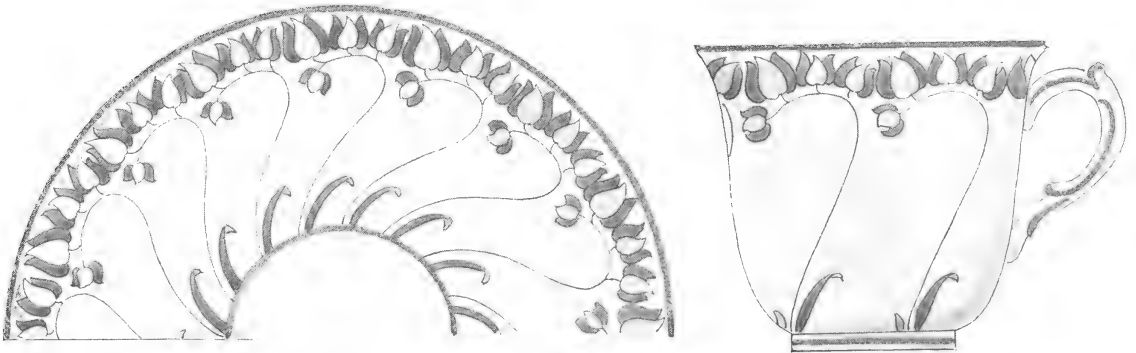

CONVENTIONALIZED DESIGN FOR CUP AND SAUCER—F. ALFRED RHEAD

Flowers in pink and red, leaves and stems olive green.

LEAGUE NOTES

THERE will be a phenomenal growth of American ceramics in the next few years. States are appropriating funds for properly equipping departments in their universities. Specialists in mineralogy and geology are in demand and potters are experimenting more widely with native chemicals.

Mural paintings, mosaics, tiles in relief and flat mineral colors are seen in our exhibitions. Good American porcelains are possible and their decoration is a necessity.

Our educational work the past three months has been a revelation. The designs for criticism show cleverness and originality, but lack of study, and an inadequate knowledge of the characteristics of the natural forms used. For instance, a currant decoration had a grape leaf, and the leaf of a dandelion was used with a poppy.

The first problem therefore, for the year 1906-7, will be facts from flowers. Study them carefully this summer and make pen drawings on ordinary writing paper, the roots, stem, leaves, buds, blossom and seeds. Make carefully, omitting accidents of growth and freaks.

Also give colors. Send the first week of September to Belle B. Vesey, 6228 Wabash Ave., Chicago, Ill.

STUDY COURSE FOR 1906-7.

Problem 1. Facts from flowers and fruit.

Grapes and Poppy, Western states. Grapes and Dandelion, Middle states. Grapes and Field Daisy, Eastern states.

Problem 2. Outline drawing for sugar bowl with two handles, to hold not less than one pint.

Problem 3. Nut bowl of clay built by hand, molded, or thrown on a wheel.

Problem 4. Coupe cake plate, geometrical decoration.

Problem 5. Vase (to be selected).

Problem 6. League punch bowl, conventional grape decoration.

If one of this year's outline drawings for punch bowl is accepted by the committee, Mr. S. Linderoth will manufacture it for us, using a porcelain body and the tin-enamel, of which Mr. Chas. Binns is now writing in the KERAMIC STUDIO.

BELLE BARNETT VESEY,
President.

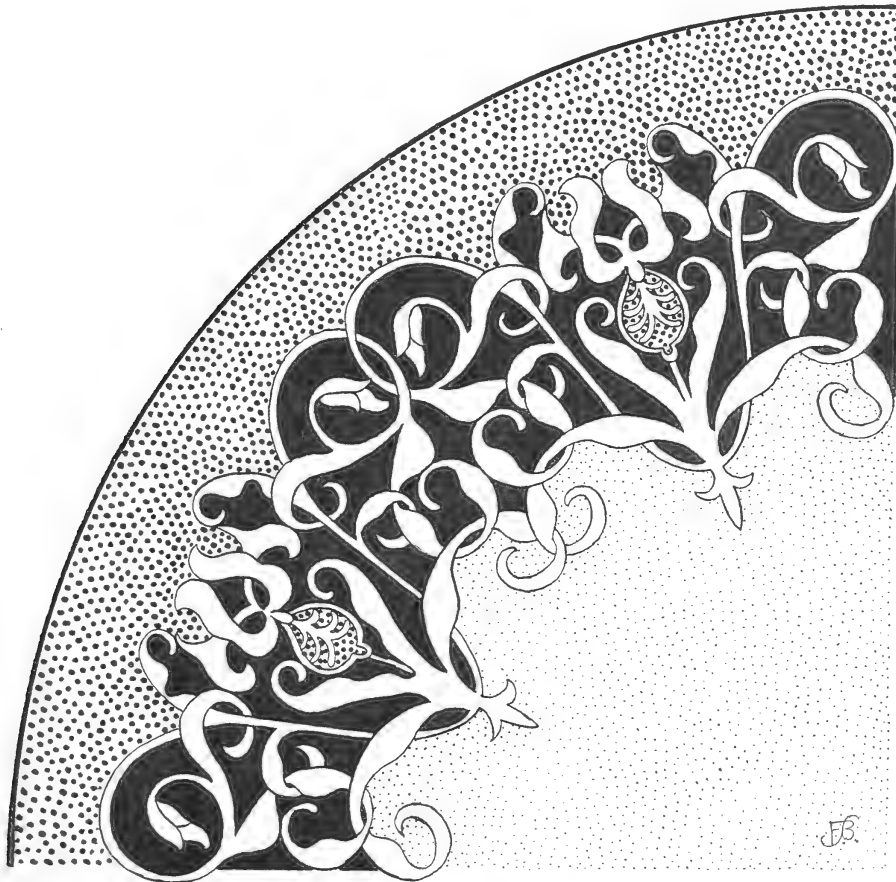

FLEUR DE LIS DESIGN—FRANK BROWN

In flat enamels and gold, with black outline on an ivory and yellow brown ground.

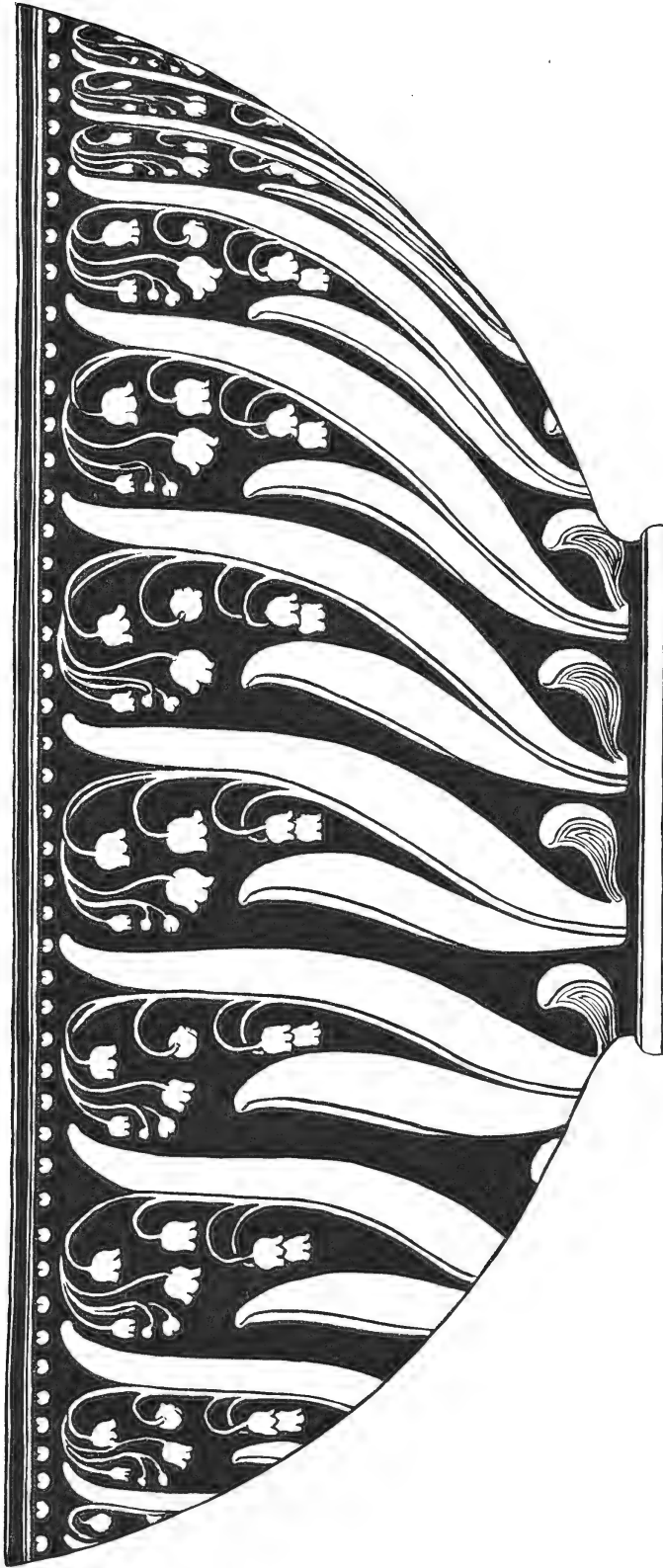

SALAD BOWL—HELEN V. PATTERSON—

In rich green and white design, with gold outline.

TREATMENT OF PLUMS (Supplement)

WATER COLOR

Teana McLennon Hinman.

THIS study is painted on tinted paper in opaque color. The paper tint makes a good background and has the advantage of being colored from the beginning, and in this way much time is saved if one desires to work from nature. It is always advisable for one who does much copying to try a study from nature occasionally, and having done this, it will be noticed that the result resembles very much in color and handling that scheme which appeals most to the one who copies, for if one is unable to secure lessons from the teacher whose work they admire a very good idea and much knowledge may be gained by copying that teacher's work. With always the studies from nature to prove how much has been gained and for steady progress and a definite idea of what one is trying to do, opaque color is undoubtedly the best. In painting the plums, tinted paper should be used and a charcoal drawing made first, then dusted over, leaving only a suggested outline. The first tone of the plums is laid in with clear color, no White, New Blue and Carmine, as the key note is the same the color may be used in each plum on the shadow side, varying the tone as one sees fit by adding more paint or more water. It would be impossible to give any rule on this part of the work, for if one is unable to secure the desired result, it is simply lack of practise, for every one who follows these rules can in time make a good copy. If one fails as some times happens, it is for this reason that one has an idea which is sure to be better than the one advanced here and the result proves that the idea was not entirely right. If the first tone is a good purple, light and dark according to light and shade of the study, lay in the lights with a little White, New Blue, and Safflower (Carmine in the half tones.)

The greens are painted in the same way, first the clear dark tone of Hooker's Green, Prussian Blue and Paynes' Grey, and for the lights a clear tone of Hooker's Green and then White and Emerald Green with a little Lemon Yellow.

The stems are made by using Burnt Sienna, Payne's Grey and Van Dyke Brown for the lights, brown, pink and white.

MINERAL COLORS

Sarah Reid McLaughlin

For plums use two-thirds Banding Blue, one-third Crimson Purple and Black. Leaves, usual greens. Background, use Alberts Yellow, with Turquoise Green shading into darker green with Olive Green and Black Green. Stems, Yellow Brown, retouched in second firing with Auburn Brown, with accents of Crimson Purple. Second firing, strengthen above colors.

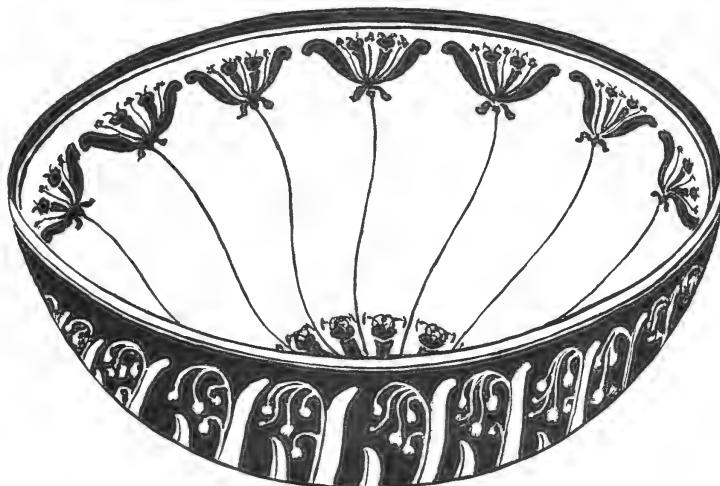

SALAD BOWL—HELEN V. PATTERSON



VIOLETS - BLANCHE VAN COURT SCHNEIDER

Blanche van Court Schneider

TREATMENT FOR VIOLETS

Blanche Van Court Schneider

FIRST FIRE.

VIOLETS are painted with a violet color made by mixing Banding Blue and Ruby. Leaves with Yellow Green shaded with Moss and Brown Green. Stems a mixture of Shading Green and Yellow Brown. Care must be taken in the first work to wipe out light violets and lights in the leaves and stems.

SECOND FIRE.

Lay in background starting with a tone of blue grey

made by using Pearl Grey and Turquoise Green. A dash of blue at the top of the bunch of violets. Greys and Yellow Brown used in the other tints. Dark part a mixture of Shading Green, Yellow Brown and Black, and a little Dark Violet.

Wash violet tone over the violets and wipe out the high lights.

THIRD FIRE.

Strengthen background using same colors as in second fire and finish violets, leaves and stems.

Powder the last fire using same colors as used in tinting.

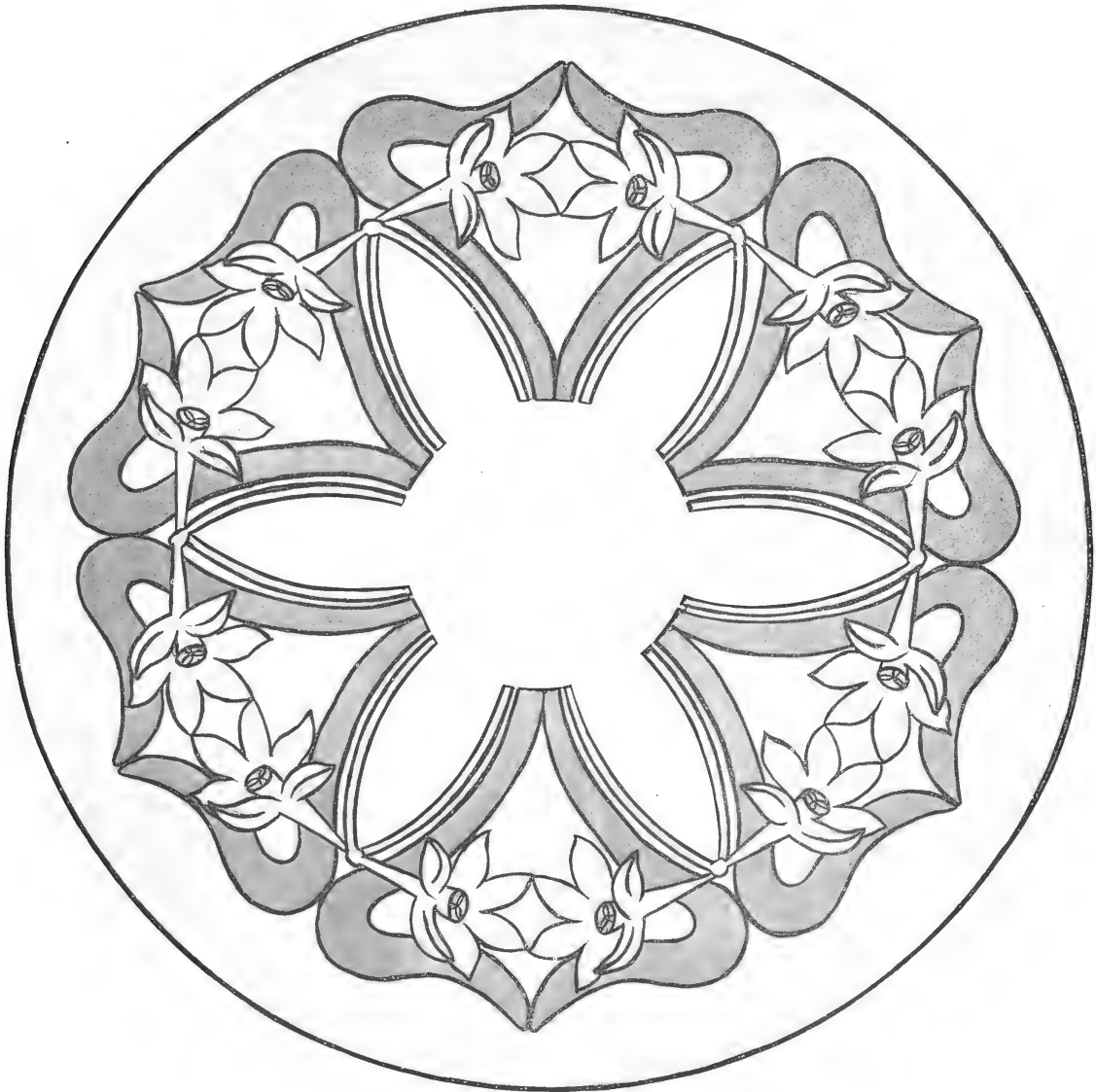

JONQUIL BOWL—M. MAE WOODS

In greens and yellows.

THE CRAFTS

WOOD CARVING AND PYROGRAPHY. LEATHER AND METAL. BASKETRY, ETC.

Under the management of Miss Emily Peacock, Room 23, 22 East 16th St., New York. All inquiries in regard to the various Crafts are to be sent to the above address, but will be answered in the magazine under this head.

All questions must be received before the 10th day of month preceding issue and will be answered under "Answers to Inquiries" only. Please do not send stamped envelope for reply. The editors will answer questions only in these columns.

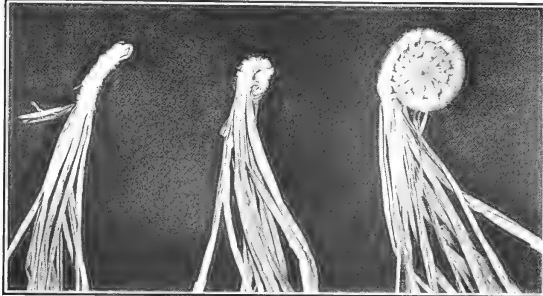

No. 1—LAZY SQUAW STITCH

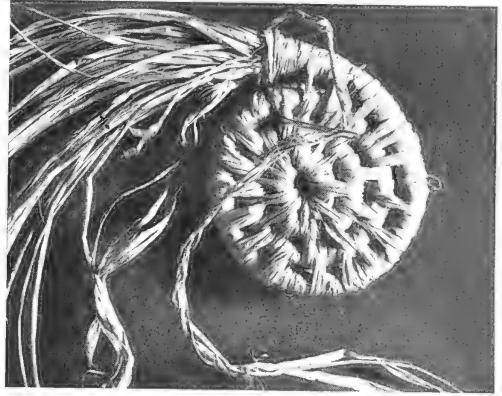

No. 2—BRIDGE STITCH

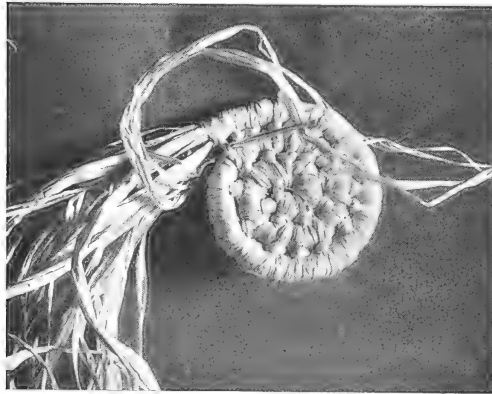

No. 3—KNOTTED STITCH

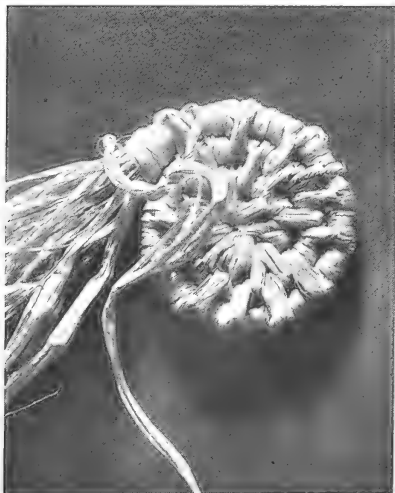

No. 4—PINE APPLE STITCH

RAFFIA STITCHES.

Madge E. Weinland.

In each of the five following stitches use the natural raffia for filling and work with a number two darning needle.

STITCH No. 1. The first and most simple stitch to be learned is that of the "Lazy Squaw" reproduced from a former number of *KERAMIC STUDIO*. With this stitch it is not as difficult to get a good shape and a firm basket as when using any of the following stitches. We may obtain different results by varying the number of windings between stitches in the "Lazy Squaw" stitch.

STITCH No. 2. The Bridge stitch is similar in character to the Lazy Squaw Stitch. With a weaver of the desired size, wind three times around, but instead of inserting the needle into the previously made roll, carry it around and underneath the roll. Repeat. (See *Illus.*) In this stitch the reed may be used for filling, but for a beginner raffia filling is preferable.

STITCH No. 3. The Knotted Stitch is the next in the series to be made. With the same sized weaver wind three times around and insert the needle underneath the previously made roll as in the Bridge Stitch. From this point bring the weaver forward between the two rolls and to the right of the stitch; now cross and insert the needle between the rolls and to the left of the stitch. Repeat. (See *Illus.*)

STITCH No. 4. This is the Pineapple Stitch which gives a rough appearance to the basket. Wind three times around and after the third winding, make a loop with the raffia weaver, pass the needle from the back underneath the previously made roll, catch in the loop (see *Illus.*), draw a little tight and pass it back underneath the roll at exactly the same point it was brought forward. Repeat from beginning. (See *Illus.*)

STITCH No. 5. The fifth stitch is a typical Indian stitch and consists of a succession of figure eights. The weaver is carried once around the filling from back to front,

SCHOOL OF CRAFTS

The meeting of representatives of various art handicrafts at the National Arts Club was attended to the full limits of seating capacity of the galleries, and great interest was displayed in the discussion. A resolution was passed at the close authorizing the Chairman to appoint a large committee to include representatives of all the leading art

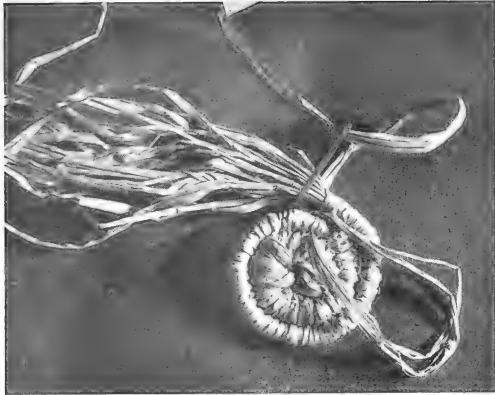

No. 5—FIGURE "8" STITCH

then pass the needle back between the filling and the roll previously made, thence from back to front under the previous roll and then over and back between the two rolls. Repeat from the first. Carefully notice the illustration.



SUGGESTIONS FOR METAL WORKERS

Emily F. Peacock

THE copper bowl and pitcher (Illus. No. 1,) by C. F. A. Vosey, London are very practical in shape, and the simple lines in both very pleasing.

The pewter bowl and pitcher (Illus. No. 2,) are good in shape and decorative quality.

The altar candlestick in silver (Illus. No. 3,) by R. Hilton, is beautiful in line and offers suggestions for other metals.

The candlesticks in hammered brass by Frances MacDonald (Illus. No. 4,) are simple in treatment and design and in Illus. No. 5, the rings of Indian workmanship are very suggestive. They are made from coin silver and with the rudest tools. Nearly every one is set with turquoise matrix, which of course the Indians cut and polish themselves.



No. 2. Pewter Bowl and Pitcher designed by George Logan, Courtesy of International Studio.

crafts, who are to report to another meeting to be called whenever convenient.

In his opening remarks Mr. Spencer Trask, President of the club, after welcoming the invited guests, expressed the feeling of the members that while the club was equally interested in what are called the fine arts, from the inception of the work of the club, a large share of energy had been directed to such encouragement of the so-called industrial arts as the present quarters allowed. Prior to moving to the Tilden Mansion on Gramercy Park and the



No. 1. Copper bowl and Pitcher by C. F. A. Vosey, London, courtesy of Dekorative Vorbilder.



No. 4. Candlesticks in beaten brass designed and executed by Frances Mac Donald Courtesy of International Studio.

Studio Annex on East Nineteenth Street it was desirable to discuss the situation as presented by the prospect of larger quarters and of galleries for exhibition, having an entrance separate from the clubhouse itself. Various suggestions had been made, such as the establishment of a school of crafts under the direction of the club and

KERAMIC STUDIO



Chased silver locket designed and executed by
Ella de Neergard.

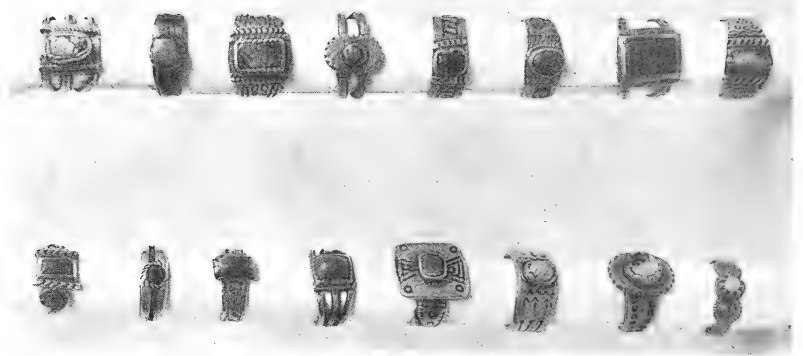

No. 5. Indian Rings.

the opening of a permanent exhibition of objects of the arts and crafts.

Mr. Frederick S. Lamb advocated a permanent exhibition for objects of industrial art, calling attention to the fact that exhibitions held by societies of painters are arranged to include the sale of paintings. He saw no reason why men and women who make their living by work apart from easel paintings and sculpture should pretend to ignore the necessity of selling their wares. As to a school of arts and crafts, he was not prepared to say that this would be feasible without a proper endowment.

Mr. Arthur Dow of the Teachers' College, Columbia University, protested against the false impression made by the use of the terms fine arts and arts and crafts, a division which confused the public, seeing that all art works are the product of craftsmen, while the superiority of fine art implied by that mode of expression did not necessarily exist. Painting and sculpture when poor are not fine art, while industrial art works, when good, are as fine as anything on canvas or in bronze.

Mrs. Anna B. Leonard, President of the New York Society of Ceramic Arts, spoke for the decorators, and a letter was read from Mr. Chas. Volkmar as a representative of the art potters. Miss Amy Hicks spoke briefly as the

leading spirit in the New York Guild of Arts and Crafts, and from Cincinnati Mr. William Watts Taylor, President of the Rookwood Pottery, sent greetings by letter. Mrs. Johnston of Richmond, Ind., described the progress of an organization of art workers in her town, showing how they had enlisted the interest of the Common Council of Richmond through the educational side of such efforts as her society had been able to make, so that it now receives financial aid from the city. The work of Berea College, Kentucky, was described by one speaker. William Taber Sears spoke of the Arts and Crafts Society of Boston and the textile handicraft pursued by ladies in Deerfield, Mass.

Mr. John Ward Stimson reviewed the efforts once made by the Metropolitan Museum to conduct a school of the arts and crafts, spoke of the Artist-Artisan Institute,

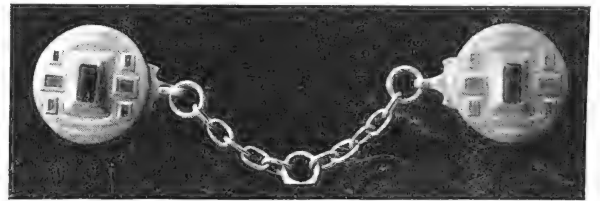

Cloak clasp in silver and amethysts designed and executed by Harry S. Whitbeck.



No. 3. Altar Candlestick in silver by R. Hilton, courtesy of International Studio.

now merged in the New York School of Art, and of the school established by him at Trenton, N. J., ending with a fiery exhortation to those present not to let the matter drop.

Charles de Kay reviewed the situation in New York, maintaining that the local art world was like a pyramid poised on its apex, because everything had been done for the fine arts, so called, while the fruitful industrial arts, out of which the fine arts should grow, had been neglected. The Arts Club is a product of the twentieth century, and should stand for modern ideas. It should do what is possible to reverse the pyramid and stand it on its base, using the widest possible spread of art crafts as an education for the people in order to prepare the ground for a greater and better-founded taste in the arts.

Other speakers considered the two questions of a school and a permanent exhibition, the majority favoring a permanent salesroom and rejecting, at least for the present, the establishment of a school. It appeared to be generally conceded, however, that these matters should be left to the committee of art workers to be appointed by the Chair. Laymen who spoke or sent letters included John J. Murphy, John DeWitt Warner, and Walter S. Logan.

KEEP THE FIRE ALIVE.

KERAMIC STUDIO

CONTRIBUTORS

MR. CHARLES F. BINNS	*	*	*	*	*
MISS OPHELIA FOLEY	*	*	*	*	*
MRS. IDA M. FERRIS	*	*	*	*	*
MISS M. E. IGLEHART	*	*	*	*	*
MISS E. LOUISE JENKINS	*	*	*	*	*
MISS MARGARET OVERBECK	*	*	*	*	*
MISS MARY OVERBECK	*	*	*	*	*
MR. ALBERT PONS	*	*	*	*	*
MR. F. ALFRED RHEAD	*	*	*	*	*
MISS ALICE SEYMOUR	*	*	*	*	*
MR. F. S. SANFORD	*	*	*	*	*
MISS MARIE CRILLEY WILSON	*	*	*	*	*

JUNE MCMVI

Price 40c. Yearly Subscription \$4.00

A MONTHLY MAGAZINE FOR THE POTTER AND DECORATOR.

CONTENTS FOR JUNE 1906

	PAGE
Editorial	23
League Notes	M. E. Iglehart 23
Club Notes—Studio Notes	24
Scotch Yellow Rose (supplement)	Ida M. Ferris 24
Roses—1st Prize Naturalistic	Alice Seymour 25
Roses—2d Prize Decorative	Ophelia Foley 26-27-29
Salad Plate—3d Prize	Ophelia Foley 28
The Class Room Firing contd	28-30
Rose Borders	F. Alfred Rhead 30 & 36
Wild Rose—2d Prize Naturalistic	E. Louise Jenkins 31
Roses —1st Prize Decorative	Margaret Overbeck 32-33
Salad Set—1st Prize	Marie Crilley Wilson 34-35
Tin-Enameled Ware	Chas. F. Binns—3d Paper 36-40
Roses—2d Prize Naturalistic	Margaret Overbeck 37
Decorative Rose—2d Prize	Mary Overbeck 38-39
Salad Set—2d Prize	Margaret Overbeck 40-41
Decorative Rose—3d Prize	Albert Pons 42-43
The Crafts—	
The Making of a Metal Sconce	F. S. Sanford 44-46
Answers to Inquirers	46-47
Answers to Correspondents	47

LIST OF BOOKS

<p>The Rose Book, containing some of the best rose studies and designs published in <i>Keramic Studio</i>..... postpaid \$ 3.00</p> <p>The Fruit Book, containing some of the best fruit studies and designs published in <i>Keramic Studio</i>..... postpaid 3.00</p> <p>Composition, by Arthur Dow..... postpaid 1.65</p> <p>Principles of Design, by E. Batchelder..... postpaid 3.00</p> <p>Decorative Studies, by J. Foord..... postpaid 12.50</p> <p>Plant Forms and Designs, by Midgley and Lilley..... postpaid 2.20</p> <p>Practical Pottery, elementary instruction for students, by Richard Lunn..... postpaid 2.50</p> <p>Grand Feu Ceramics, a practical treatise on the making of hard porcelain decorated with high temperature glazes by Taxile Doat of the Manufactory of Sevres, France..... postpaid 7.50</p> <p>Seger's Collected Writings, 2 volumes..... postpaid 15.50</p> <p>For the Collector:</p> <p style="padding-left: 20px;">Vol. II Old China, bound blue cloth..... postpaid 2.50</p> <p style="padding-left: 20px;">Vol. III Old China, bound blue cloth..... postpaid 3.50</p> <p>Anglo-American Pottery, a manual for collectors, by Edwin Atlee Barber, Curator of the Pennsylvania Museum, second edition..... postpaid 2.00</p> <p>American Glassware, old and new, by Edwin A. Barber..... postpaid 1.00</p> <p>Marks of American Potters, by Edwin A. Barber..... postpaid 2.25</p> <p>Pottery and Porcelain of the United States by Edwin A. Barber..... postpaid 3.75</p> <p>The Lace Book, by N. Hudson Moore..... postpaid 5.30</p>	<p>Tulip Ware of the Pennsylvania German Potters, by Edwin A. Barber, in paper cover..... postpaid 1.10</p> <p>Tulip Ware of the Pennsylvania Potters, by Edwin A. Barber, cloth, limited edition..... postpaid 3.75</p> <p>Encyclopedia of Ceramics, by W. P. Jervis..... postpaid 6.75</p> <p>The Old China Book, by N. Hudson Moore..... postpaid 2.18</p> <p>The Old Furniture Book, by N. Hudson Moore..... postpaid 2.18</p> <p>Old Pewter, by N. Hudson Moore..... postpaid 2.18</p> <p>Chats on English China, by Arthur Hayden..... postpaid 2.16</p> <p>Chats on Old Furniture, by Arthur Hayden..... postpaid 2.18</p> <p>China Collecting in America, by Alice Morse Earle..... postpaid 3.20</p> <p>Pottery and Porcelain, a guide to collectors, by Frederick Litchfield, the English expert..... postpaid 6.25</p> <p>French Pottery and Porcelain by Henri Frantz..... postpaid 2.68</p> <p>Dutch Pottery and Porcelain, by W. Pitcairn Knowles..... postpaid 2.68</p> <p>Old English Furniture, by Fred Fenn and B. Wyllie..... postpaid 2.68</p> <p>English Embroidery, by A. F. Kendrick..... postpaid 2.68</p> <p>French Furniture, by Andre Saglio..... postpaid 2.68</p> <p>Old Pewter, by Malcolm Bell..... postpaid 2.68</p> <p>Sheffield Plate, by B. Wyllie..... postpaid 2.68</p> <p>The Oriental Rug Book, by Mary Churchill Ripley..... postpaid 3.20</p> <p>Home Furnishing, practical and artistic, by Alice M. Kellogg..... postpaid 1.65</p> <p>William Adams, an old English potter, by William S. Turner..... postpaid 8.00</p>
---	--

Keramic Studio Pub. Co., Syracuse, N. Y.

KERAMIC STUDIO

Vol. VIII, No. 2

SYRACUSE, NEW YORK

June, 1906

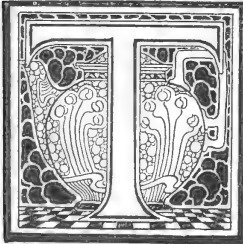

THE June competition was in every way a success; in fact so much good material was submitted that much had to be returned, notwithstanding that KERAMIC STUDIO bought enough to supply the magazine with rose studies and designs in black and white for a long time.

It is to be regretted however that so many made their studies in brown tones, we find in the reproductions that several studies which were awarded first or second prizes, did not reproduce to look as well as some which were awarded lower prizes. Bear this in mind for the next competition and work only in pure greys, black and white for reproduction. Many details and soft gradations of tone were lost as the browns reproduce so low in tone.

The prizes were awarded as follows:

Naturalistic Rose Study: First prize, Alice Seymour. Second prizes, E. Louise Jenkins and Margaret Overbeck. Third prize, Mrs. G. F. Camp. Mention, Hattie V. Young Palmer.

Decorative Rose Study with application: First prize, Margaret Overbeck. Second prizes, Ophelia Foley and Mary Overbeck. Third prizes, Albert Pons and Hannah Overbeck.

Salad Set in Conventionalized Rose: First prize, Marie Crilley Wilson. Second prizes, Margaret Overbeck and Ophelia Foley. Third prize, Alice Sharrard.



The July Keramic Studio will be devoted mainly to the work of Mrs. Sara Wood Safford of New York. It will be a very attractive and popular number. The color study will consist of four small panels of strawberries.



Readers of KERAMIC STUDIO will be interested to hear news of our fellow workers in San Francisco. Immediately after the disastrous earthquake and fire, we wrote to all our subscribers and dealers there to see what we might do in our small way to help them. There are many still unheard from, among these Mr. Dorn, but we trust nothing worse than preoccupation prevents their writing. The following evidently have not suffered from the fire as they write that their address continues the same, i. e., A. A. Blumenthal, Miss O. Oscar, Ina Hansbrough, Lottie Gerichten, Anna C. Law, Miss J. J. Dorland, Anna Oesterman, Mrs. F. E. Atkinson. These send simple change of address, so we presume their homes were destroyed: Emily Hesselmeier (winner of 1st prize in former competition), R. M. Drake, Joseph W. Phillips, Martha Korbel. "Camera Craft" lost everything except books and subscription list. The following extracts from letters will tell, better than talking, both of courage and discouragement:

Keramic Studio: By the dreadful disaster that befell our city I lost everything I possessed, my home and studio was in the heart of the burnt

district, so all is gone and from the present outlook it will be a long time before art and my work will be needed here. I have not decided what I shall do in the future. Thank you most gratefully for your kindness and sympathy.
Sincerely yours, M. E. PERLEY.

Keramic Studio Publishing Co.: Your very thoughtful letter received and I thank you for it and your kind wishes. I lost my place of business but long before the fire reached it I saved my paints and china. I walked into town and out three times on the 18th (something like 12 miles) in order to save them, other things like furniture and carpets can be replaced. I don't suppose there is a piece of white china to be had for love or money to day in San Francisco and I have enough to keep me busy for a month after I settle down to work. My greatest loss was at my home, an old fashioned book-case was filled with white china, the door flew open and it crashed down breaking everything, two high shelves filled with decorated pieces, some of it the work of my teacher and valued on that account, only two pieces are perfect (a big tankard and tray), some of the heavy Austrian pieces can be mended and used for show pieces but the French china went all to pieces. The earthquake did not chip or crack a thing in the kitchen closets, preferred the sound of china crashing in other parts of the house. The house moved east and south three inches and everything inside moved with it. I mourned over my china two or three hours. Then word came out from the thousands of fleeing people of the fire that was eating up our beautiful city. The earthquake sank into insignificance for the fire has taken seven square miles, there is nothing but suburbs left, over 250,000 people have left, but the fire cleaned up Chinatown and thousands of old shacks that were a blot on the city. In five years we will have a beautiful city without those blemishes, in the meantime I am wondering if there will be any demand for teachers and decorators in china on the coast. If you know of an opening for a teacher will you kindly let me know?
DEE WORTHINGTON.

Kindly send KERAMIC STUDIO. Have lost everything by fire.
M. L. THOMPSON.

Gentlemen: We lost everything through the fire. A. E. BENNETT

Keramic Studio: Am sorry to say that I, like hundreds and thousands of others, am homeless and penniless. Will take new courage, however, in near future and remain here.
E. M. VAN BLARCOM.

Gentlemen: My address is the same as before. I was not burnt out but lost considerable from the shock of the earthquake.
MRS. EVA M. JAKOBS.

Keramic Publishing Co.: My address is the same as before the fire, although my salesroom and stock of decorated china was burned and kiln and great quantities of white china were overthrown and broken by earthquake. Thanking you for sympathy, I remain,
MRS. F. D. ASHWORTH.

Keramic Studio Co.: Am thankful to be able to say that I am still at my old address. My loss in china through shake is about \$300, and by fire we lost several pieces of property, but are thankful to have our lives.
ANNA OESTERMANN.

Keramic Studio Publishing Co.: I lost all by fire after the earthquake, my magazines for four years also. Can I get the back numbers commencing with the educational articles, I think September to present one and how much will they be. I hope a little less than usual price as I am at present "flat busted"
MRS. S. F. LOCKWOOD.

Thanks for your kind wishes. My troubles are little compared with others, only loss of money.
(Mrs. E. J.) JOSEPHINE H. FOSTER.

We have lost everything in the fire.
NETTIE W. KING.

Keramic Studio Publishing Co.: I have lost everything by the earthquake and fire.
Yours sincerely, S. V. CULP.

A letter from Mrs. Irelan, maker of the Roblin pottery, states that she was able to save only a few pieces of her ware, while a large collection of valuable wares, which she prized highly, was lost and can never be replaced.

CLUB NOTES.

The annual election of the Chicago Ceramic Club was held May 5th, the following were chosen officers for the coming year.

Evelyn B. Beachey, President.
 Nellie A. Cross, 1st Vice-President.
 Mary J. Coulter, 2d Vice-President.
 Lulu C. Bergen, Recording Secretary.
 Cora A. Randall, Corresponding Secretary.
 Mary A. Farrington, Treasurer.

The Kansas City Ceramic Club enjoys a membership of ninety, during the last year the study course consisted of Modern Design and Flower Drawings.

The recent Exhibit is considered to be the best the Club has ever offered the public and more visitors were attracted.

Each piece, the individual work of the exhibitor, was passed upon by a Jury composed of the officers and members of the Executive Committee.

The following prominent Artists were represented in the Loan Exhibit. Mr. M. Fry, Mrs. K. E. Cherry, Mr. Franz Bischoff, Mr. F. Aulich, Mr. H. O. Punsch, Miss Dorothea Warren.



LEAGUE NOTES.

ANNUAL REPORT.

At the close of the annual meeting held at the Art Institute on May 4, 1906, after listening to the reports and letters from the presidents of the various clubs, we realized what splendid work had been accomplished and what progress the National League of Mineral Painters had made in the past year and how the art world had at last awakened to the fact that art could be executed in ceramics as well as in any other medium. It was most gratifying to the workers to know that the New York and Pittsburgh clubs, now enjoy the same privileges as Chicago in having the doors of the art galleries open to them for their annual exhibition.

Our President in her address spoke of the work as having passed a severe jury and having been admitted on merit alone, our pieces being of a high standard and of improved design being our greatest need. We want a school of Ceramics beginning with American clays and carrying it through all the processes of fire. Examples of coarse pottery, finer porcelains and the finest enamels are in our exhibition this year. The Correspondence Class in which we have been experimenting is now fully established and it promises to be the most successful undertaking of the League. The corrected lines are easily understood, while technical terms of critics previously used are as unintelligible to most of us as Greek. A careful study of the exhibition shows there is not the influence of friends or superior ability that has put a few in the lead, but an early start along the right lines and ceaseless toil. Ruskin says "If you want knowledge, you must toil for it."

The principal business was the election of six new advisory board members. The tellers reported the following unanimous elections:

Mrs. Minnie Parker, of Portland, Oregon.
 Mr. Suffolk of Pittsburgh, Duquesne Club.
 Miss S. Sanborn of Denver.
 Mrs. Katharine Lindsay of Topeka, Kansas.
 Mrs. Ida Johnson of New York.
 Mrs. J. R. Thompson, Augusta, Me.

A complete and audited report from the treasurer showed the debits to be \$518.61; credits \$362.58, leaving a balance on hand of \$156.03.

To Mrs. Burgen, Chairman of the Transportation Committee, is due the credit of a carefully planned travelling exhibition, after a two weeks successful exhibition held at the Art Institute; the comparative study course of 96 pieces left Chicago the last of May, visiting 15 cities and returning in perfect order.

The Portland Oregon exhibit was one of interest and while small, was one of excellent design and resulted in the members receiving one gold medal, one silver and seven bronze medals.

It was with pleasure that the advisory board received the new club from Topeka, Kansas, and the following individual members:

Miss. Ophelia Foley of Owensboro, Ky.
 Mrs. Margaret Daniels of Valley City, N. D.
 Mrs. Chas. Williams, of Glen Falls, N. Y.

There was a general discussion of next year's study course followed by an instructive talk from Mr. Linderoth on "The Practicability of Clay Work, Composition of Different Bodies and of Glazing, and the Possibility of Decoration on the Unfired Clay."

Meeting adjourned.

Respectfully submitted,

M. ELLEN IGLEHART.

Recording Secretary.



TREATMENT FOR SCOTCH YELLOW ROSE

(Supplement)

Ida M. Ferris.

IN CHINA COLOR

For first fire use Lemon Yellow and shade with Grey for white roses. For darker flower use Yellow Brown with same Grey. Keep the main part of background yellow on the light side shading with Copenhagen Blue and a little Black. In second fire lay in shadow leaves in background with Copenhagen Blue and Dark Green and a little Ruby with the blue. Use some Ruby in darker part of background.

Retouch roses with Dark Yellow and Grey as in first fire, with Yellow Brown in centers. A third fire with softening washes will improve it.

IN WATER COLOR

Paint flowers with Lemon Yellow and Cadmium, shade with Hooker's Green No. 2 and Indian Yellow. Leaves, No. 1 and No. 2 Hooker's Green, Burnt Sienna and Payne's Grey. Background, Lemon Yellow with overlaying shadows of Green and Payne's Grey letting the yellow shine through. Darker background, New Blue and Payne's Grey, touches of Burnt Sienna on stems and stamens.



STUDIO NOTES

Mr. F. B. Aulich has just returned from his trip to the coast. He lost everything, but is in good spirits and will be ready to open his classes in Chicago July 1st.

Mrs. Anne Seymour Mundy and Miss Venicy M. Barlow will hold an Arts and Crafts exhibition, in connection with their summer school, from July 9th to August 1st, at Coudersport, Pa.



NATURALISTIC ROSE, FIRST PRIZE—ALICE SEYMOUR

(Treatment page 26)

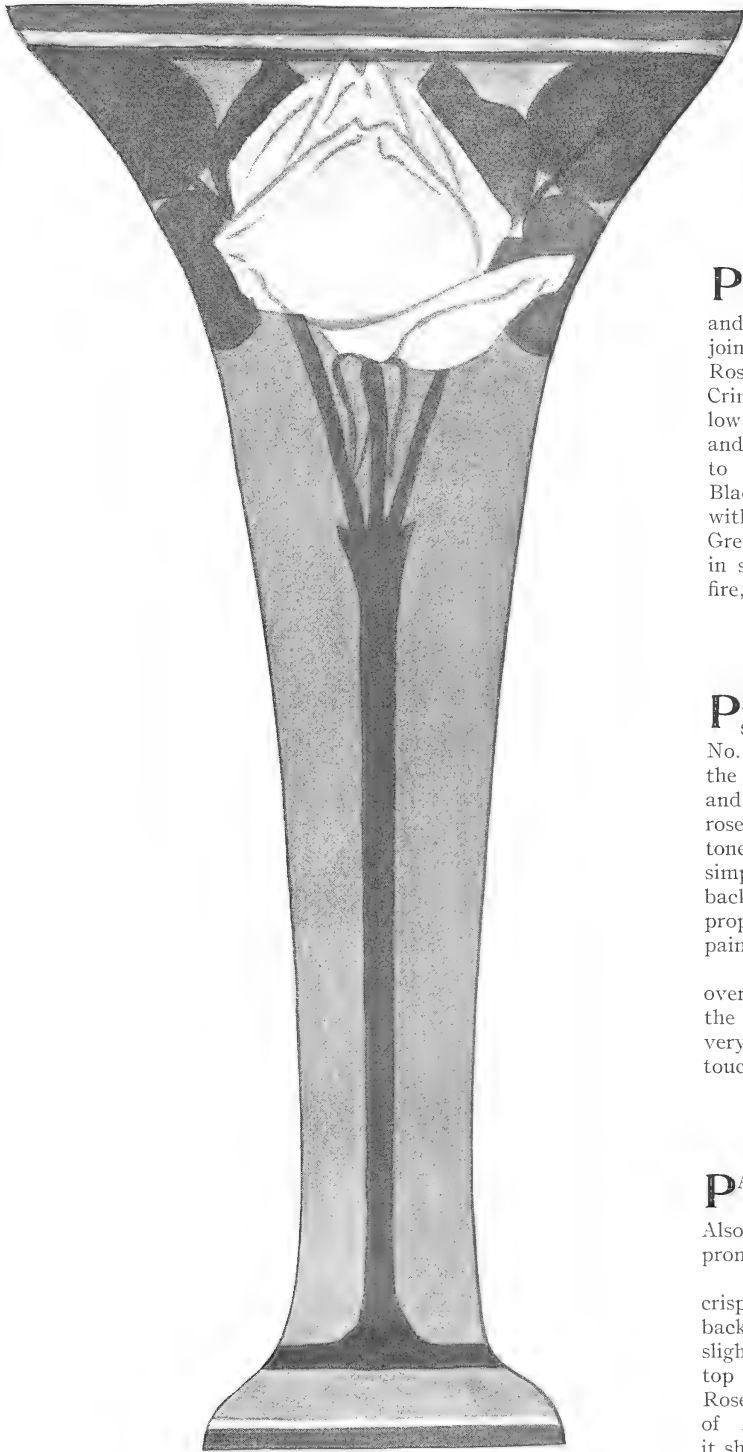

DECORATIVE ROSES, SECOND PRIZE
—OPHELIA FOLEY

DECORATIVE ROSES, SECOND PRIZE

Ophelia Foley

BACKGROUND and outline of roses, 1 part Grey for Flesh, 1 part Yellow Brown, 1 part Grey Green, For roses, 1 part Pearl Grey, $\frac{1}{2}$ part Yellow Brown, $1\frac{1}{2}$ part Yellow Red. For leaves, 1 part New Green, 1 part Grey for Flesh.



NATURALISTIC ROSES, FIRST PRIZE

Alice Seymour

PRINCIPAL rose and bud, very thin wash of Rosa. Touches of Copenhagen Grey where petal curls over, and little Albert Yellow on turned back petals where they join calyx. Centers and dark shades, American Beauty Rose; in background American Beauty Rose shaded with Crimson Purple. Light leaves, blueish green, use $\frac{2}{3}$ Yellow Green and $\frac{1}{3}$ Sea Green. Dark leaves, Olive Green and Black Green. Background, dark blueish green at top to Copenhagen Grey at bottom. For dark color use Black Green, Dark Blue and little Black. Powder top with Copenhagen Blue and lower part with Copenhagen Grey, powder over some of the design. Same colors used in second and third fires. Add shadow leaves in second fire, Dark Blue and Pompadour.



NATURALISTIC WILD ROSES, SECOND PRIZE

E. Louise Jenkins.

PAINT the background first, using for the lighter parts a soft grey lavender tone made of Yellow Green with Violet No. 1, and a bit of Rosa in the brush now and then. For the darker portions use Dark Green and Brown Green, and a little Yellow Brown to liven it up some, under the roses. Paint next the background leaves, then the lighter toned ones, using Yellow Green, and keep them flat and simple. The roses next with Bischoff's Rose, dragging the background color into the darker ones, to give them their proper greys. Retouch with the same colors for the second painting, and bring up the detail, as much as is desired.

For the third painting put a flat wash of Violet No. 2 over the background and most of the leaves. Retouch the roses with a wash of Rosa in the darker parts, and a very little of Aulich's American Beauty, for a crisp little touch of strength near the centers.



NATURALISTIC ROSES, SECOND PRIZE

Margaret Overbeck.

PAINT the roses in the light with Rose, a little Grey Green and Yellow toward the base of petals in top rose. Also use a little Grey Green in the tender shadows of less prominent ones to right and below.

For shadows use Rose darker and Ruby for a few crisp darks in centers and deepest shadows. Carry the background on while flowers are wet, blending colors slightly when forms are less distinct. Use Grey Green at top and to the left, shading into Blue, Violet and a little Rose toward the right. Make lighter part of background of Albert Yellow to left and above flowers. Let it shade into Grey Green at left, and down work into Yellow Brown, Dark Green and a little Violet of Iron in the indistinct foliage. Paint prominent leaves in Apple Green and Yellow, Olive Green shading with Brown, and Dark Green, keeping the foliage richest in the most distinct parts, letting roses and background and foliage all blend together.



DECORATIVE ROSES, SECOND PRIZE—OPHELIA FOLEY

THE CLASS ROOM

The publication of articles on Grounding, Tinting, etc., is postponed for lack of space.

FIRING WITH GASOLINE.

Edith Cornelia Wherritt.

A GASOLINE kiln is a great convenience in small towns where there is no gas and I believe is less expensive than some of the other kilns. China well fired is a source of great pleasure but badly fired most disappointing. Firing with gasoline gives the same results as those of any good kiln when fired with judgment and intelligence.

Anyone wishing to fire with gasoline, who has a Wilke gas kiln, can do so by adding the gasoline attachment, consisting of tank, generator and supply pipe and costing \$8.00. I have used a Wilke kiln with gasoline attachment for eleven years. This kiln will last a long time by re-

newing portions which may have become warped or otherwise unfit for use. Some parts of my kiln have never been replaced. A No. 4 kiln stacks to very good advantage and is about the correct number for firing articles of medium size, the firing pot being 15 inches in diameter by 19 inches deep.

The first thing to consider is a safe place for the kiln, safe, as regards the remainder of the house. The basement, if dry, is excellent for this purpose. Cover the ceiling above the kiln with asbestos paper. Protect the floor beneath with a sheet of zinc or sheet iron.

Fire with a pipe. It carries off the fumes and gives a better draft. If there is no chimney handy put pipe through a window. Surround the pipe with tin. Use the same test of gasoline which is used in stoves. The higher tests are more explosive. The tank holds two gallons



SALAD PLATE, THIRD PRIZE—OPHELIA FOLEY

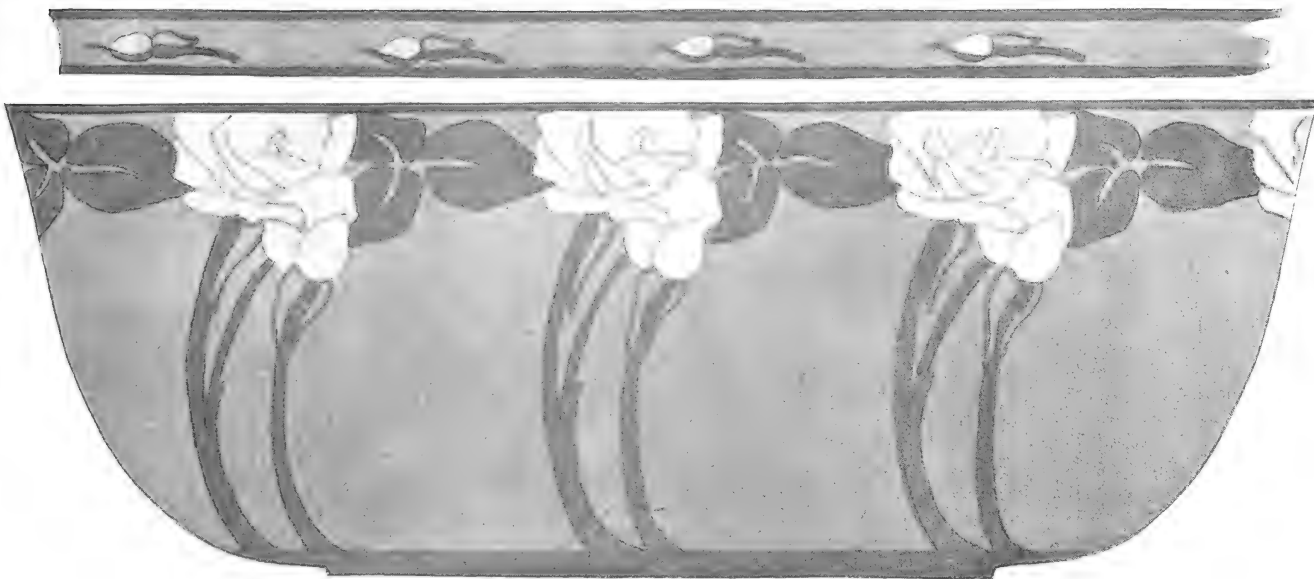

DECORATIVE ROSES, SECOND PRIZE—OPHELIA FOLEY

and can be filled any time before lighting the generator. If you are careful in handling gasoline there is no danger. A new kiln must be fired to rose heat before using. Wipe off the shelves, lids and inside of pot and the kiln is ready for use.

The kiln must always be dried out before stacking or the moisture will cause white spots on the china which at times are almost impossible to cover. Before drying your kiln, put the shelves in and all the lids on.

GENERATING THE GAS.

Open valve of generator and let the little cup run full of oil, close and light. When it is almost burned out slide the cup around to the right as far as it will go and open valve again so that the gas will ignite at top of generator. Let the generator burn until it burns evenly without puffing. Light burner with a long taper inserted through one of the openings in base. Turn on about a half head of gas for five or ten minutes until the kiln is thoroughly heated. After this is done put out the burner, leaving the generator burning low and proceed to stack the kiln. Stacking immediately after drying saves the time of generating which is from twenty to thirty minutes. If flame should fly back in mixing pipe when starting the burner, turn out burner for a few moments and light again.

FIRING.

Relight burner and let burn low for fifteen minutes. Turn on gas gradually until a full head of gas is obtained. It is not wise to allow flame to pass through hole in the second lid more than four or five inches as small particles of soot are apt to settle back in the kiln.

Watch your china through the cone shaped opening in first lid. The firing-pot first becomes rose color, then white and the china is clearly defined. When it grows a little indistinct again turn off burner and generator. Experience will teach you when to turn off your kiln. If the kiln is properly stacked according to the colors, it will not injure any of the colors to allow all of the gasoline to burn out. The time required for a firing is from 2 to 2½ hours,

but your chief object is to fire the china well whether it takes 2 or 3 hours. Be careful that the generator burns all the time during the firing or the gasoline will run into the mixing pipe, ignite and smoke badly.

The kiln will cool in about four hours but the best time to fire is in the evening so that it can cool over night. This prevents warping and prolongs the usefulness of the kiln.

○ ○ ○

FIRING WITH A WILKE GASOLINE KILN.

L. L. Marsh, Beloit, Wis.

The Wilke kiln looks very much like a large round stove. It consists of a firing-pot, jacket, and large burner under the firing-pot. The opening is at the top; and there are three covers, one for the firing-pot, one for the jacket and the hood to carry the smoke to the chimney pipe. The covers should be arranged so that the openings are in line, that it will be possible to see into the kiln while firing.

The generator is at one side near the floor. There are two screws and a switch to manipulate. The screw nearest the kiln is for the kiln burner; the other is the generator screw. Turning either screw *to the left*, turns on the gas or gasoline; turning *to the right*, shuts it off.

The switch has a cup and opening, and is used in starting the generator.

The kiln should be placed some feet away from the wall, with plenty of zinc and asbestos paper on the floor, and bricks under the feet. A good chimney connection is very desirable.

Fill the tank in the daytime and some time before firing, taking care that no gasoline is left on top of the tank after the cover is on. It is well to warm the kiln before firing, as this expels the dampness. When firing often, it is sufficient to dry the shelves and cover.

Some dry the kiln while placing the covers, but there is danger of soot from the pipe above falling into the kiln on the china. A cloth over the pipe will prevent this, while stacking, and one over the edge of the kiln will protect the sleeve, as well as the china.

In lighting the fire, have plenty of matches and a taper with one end dipped in kerosene. The first thing to be done is to heat the generator. To do this, turn the switch cup under the generator screw. Turn the screw so that the gasoline will run into the cup and fill it full. Turn the screw back and light the gasoline in the cup taking care that a breeze does not blow the flame away from the generator. When the gasoline is consumed, turn the switch to the right, so that the opening is now in front of the generator screw. Turn on the gasoline and light the generator at the same time. *The Generator should be kept burning all through the firing.* If this effort is not crowned with success, wait until the little cup has cooled before trying again, as the hot cup will evaporate the gasoline as fast as you try to fill it. All this is very much like the gasoline stove. Burning inside the generator may be corrected by increasing the flame a little, or by turning off and relighting. Water in the gasoline will make it sputter. Much depends on the generator working well, so it is wise to protect the flame from drafts.

After ten or fifteen minutes remove the damper nearest you to light the kiln burner. As you turn the screw nearest the kiln, put your lighted taper through the opening over the burner, and your fire is started. If it should burn in the mixer (the pipe to the kiln burner), it will make considerable noise, but no harm will be done. Only turn out the flame and light again.

Note the time. Increase the flame a little every five minutes until you can see the flame over the firing-pot, taking care to turn on gradually so as not to crack the china. Noises caused by the expansion of the kiln may make you think the china is cracking, but need cause you no alarm. In half an hour the fire should be going at full head and your part is to watch and wait.

At the end of the first hour, there should be a little redness in the bottom inside the kiln. By the end of the second hour the china should be red. At the end of the third hour, the cover to the firing-pot should be a bright red and inside the kiln a cherry red color. This is soon followed by a white mist which indicates that your firing is done. Three, or three and a half hours is needed for firing with the No. 3 Wilke kiln, and about five for cooling. Less time is needed with a smaller kiln and more with a larger one.

Perhaps a word should be added in regard to care of the kiln. The burners should be cleaned occasionally with a wing, as soot collects. Whiting on the shelves and on the inside of the fire pot is good. Leakage in

the screws and tank should be looked after by the hardware man. Worn out parts may be replaced.

o o o

FIRING WITH A FITCH CHARCOAL KILN.

Eleanor C. Small, Bellefourche, S. D.

If there are others like myself, who work alone, and find experience a dear teacher, perhaps what I can tell them may be of some assistance. I use a Fitch charcoal kiln No. 3 and find the work just as good as some I have done with the Revelation.

The first thing to do is to have a good shed or out-building, where there is no floor, plenty of good charcoal and kindling. In starting the fire, I usually take a big dripping pan full of charcoal and put it in the oven in the kitchen range an hour or so before I want it, and by the time I have the kiln stacked, that is burning well and gives the rest a good start.

The same care must be used to have the color dry and china clean, that is necessary in any kiln. Do not allow the least bit of moisture in the fire-pot, as it will settle on the china and injure tinting and glaze.

Stack carefully with stilts, or with unglazed portions touching. The closer the pieces are stacked without touching, the better they fire. I find more pieces can be put in at one time by putting plates and saucers flat, until stacked six high, putting the small pieces around the edge, and a grate in for the larger pieces.

Gold, enamel and lustre fire at the same time, and come out all right, if all are thoroughly dry.

After the kiln is well stacked and cover on, put a scrap of paper or cloth in the ventilator tubes, pile in the red-hot charcoal dividing it evenly on all sides, fill up to the top of the fire bricks with good coarse charcoal; wait a minute or two for the dust to settle, then open the ventilator and in a few minutes the charcoal will be red. Fill up, and stack on top of the fire-pot, and in an hour or little more you will have a good even heat.

Watch that all sides are heated alike and when you can look into the ventilator and see the "bright rose heat," do not put on any more charcoal. Let the kiln cool slowly.

Any cracks in the fire-pot, I fill with common clay. I also cover the grates and inside of the muffle or the fire-pot with a clay lining for which I use about a quart of water, a table spoon of powdered borax and clay enough to make a solution about like thin paint so I can apply it with a paint brush; after that is dry I fire red and never have any trouble with the iron muffle.



ROSE BORDER—F. ALFRED RHEAD

Roses in natural colors on lilac ground, alternate edge panels, black tracery on gold ground and white dots on dark blue ground. Gold edge.



NATURALISTIC WILD ROSE, SECOND PRIZE—E. LOUISE JENKINS (Treatment page 26)

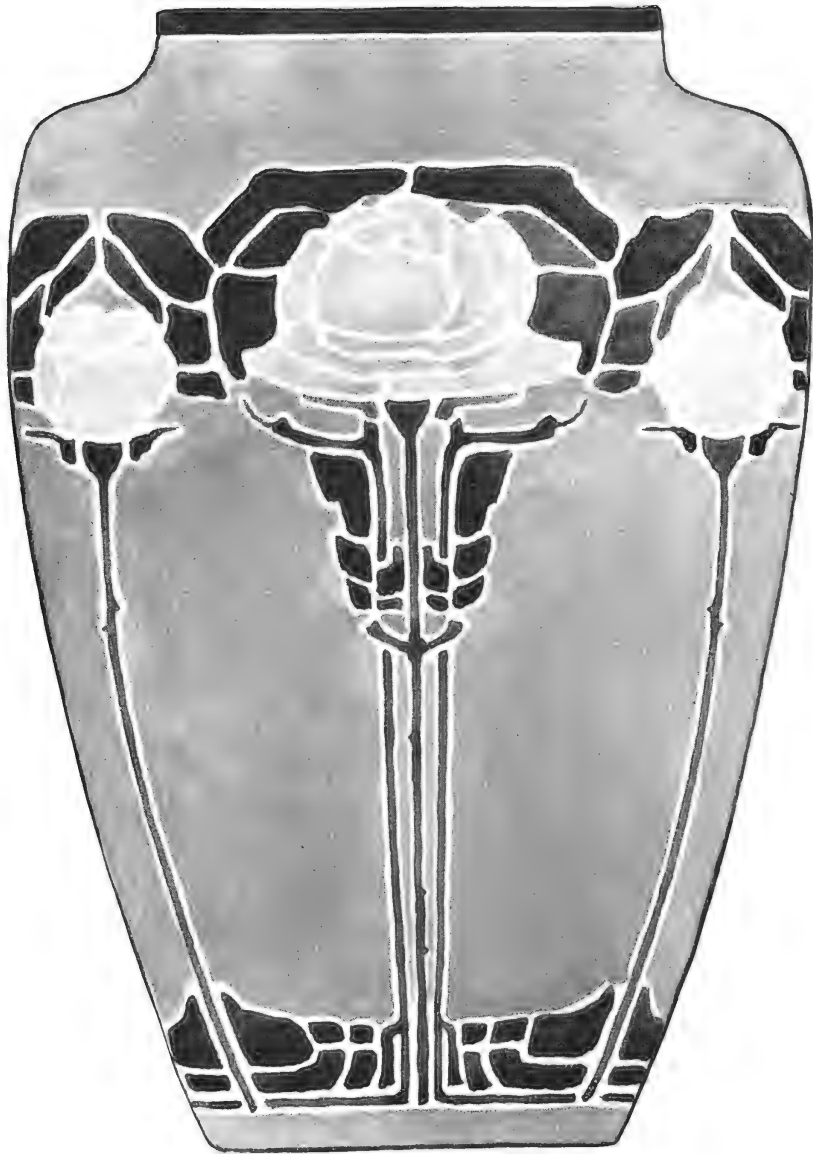

DECORATIVE ROSE, FIRST PRIZE—MARGARET OVERBECK

TINT entire vase with Ivory tone, and fire. Draw design in India ink. Tint vase a warm light brown olive, use Moss Green with Yellow Brown; wipe out design and sufficient margin to leave ivory outlines.

Paint leaves and stems in a darker olive. Tint roses either Yellow Brown with a touch of Pompadour, or reverse the proportions of Yellow Brown and Pompadour to make roses pink.



DECORATIVE ROSES, FIRST PRIZE—MARGARET OVERBECK

[WATER COLOR TREATMENT]

Tone paper first with Raw Sienna and Black. Draw study in ink and use Aligarin Crimson for roses, and Hooker's Green and Raw Sienna for foliage.

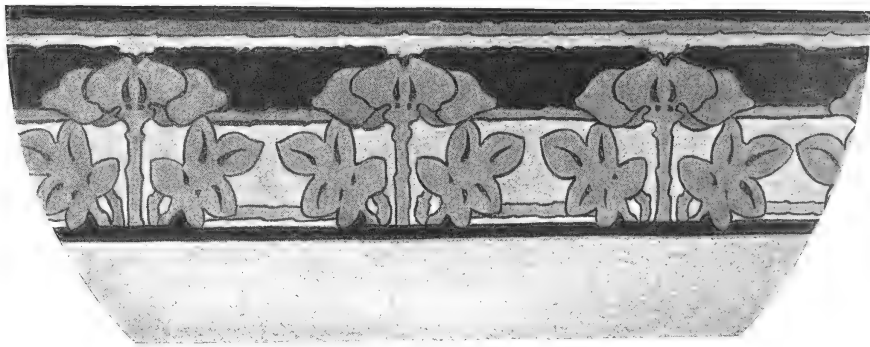

SALAD SET, FIRST PRIZE—MARIE CRILLEY WILSON

(Treatment page 42)

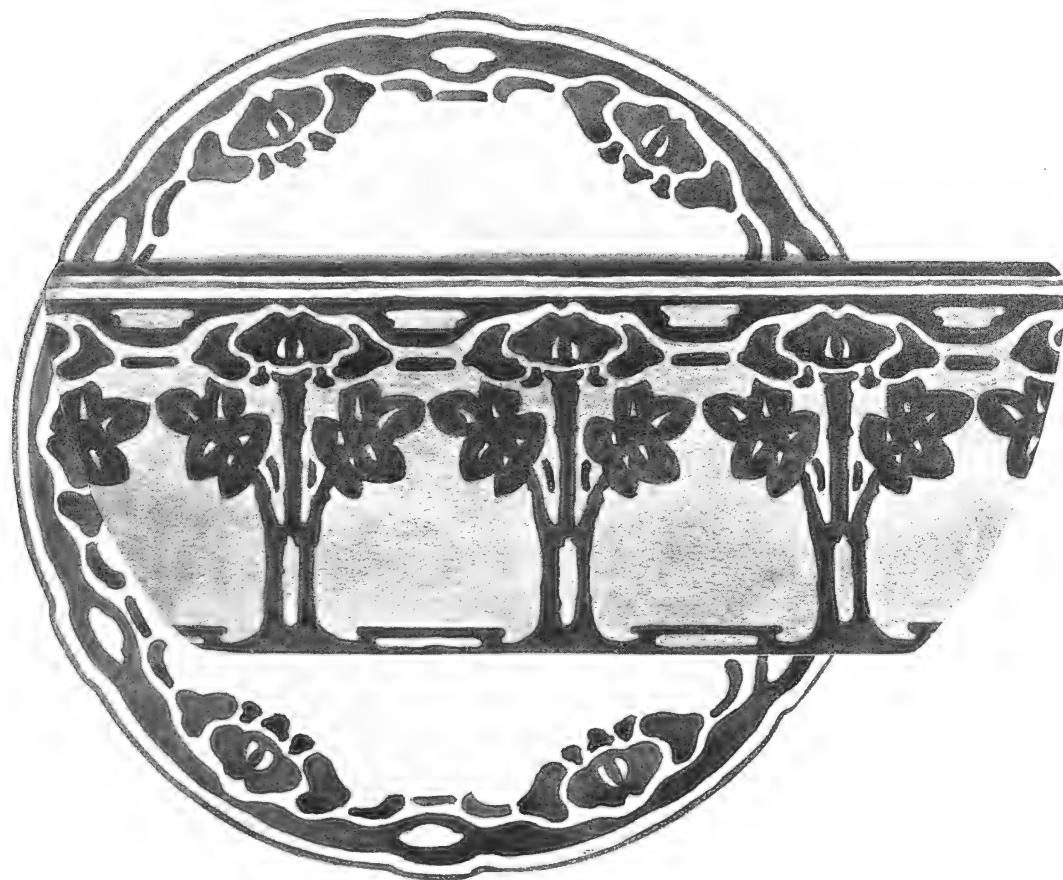

ANOTHER ARRANGEMENT OF SALAD SET, FIRST PRIZE—MARIE CRILLEY WILSON

TIN ENAMELED WARE.

Charles F. Binns.

(THIRD PAPER.)

Tiles are so admirably adapted to tin-glaze work and there is such an irresistible fascination about making and decorating them that some instruction in the procedure will now be given. First of all a mold must be prepared, for if the tiles are to be properly set they must be quite uniform in size and thickness. Most tiles are made from pulverized clay by heavy pressure but this is not possible in the studio. The plastic tile, moreover, has many advantages, it is more like pottery and less mechanical in surface and is more easily glazed. The blank tile from which the mold is to be made may be formed either from clay or plaster. In the former case a perfectly true surface, such as a sheet of glass should be prepared and upon this the clay tile is set. If a sheet of clay be rolled out half an inch, or better, five-eighths in thickness a true form can be cut from it. A convenient size is five inches square though in this individual taste must rule. The face of the tile, the angles and corners must be perfectly square and true but the edges must taper upwards a trifle making the top face about one-sixteenth of an inch smaller than the bottom.

More accurate work can be done if plaster be chosen for the model as this can be turned about in the hands as a carpenter would a piece of board. A slab of plaster of the required thickness is poured and both faces are made true and parallel. With ruler and square the tile is now marked out and cut to shape, the edges being tapered as in the case of the clay. The model, whether of clay or plaster being ready for molding—in the latter case having been well soaped—four strips of wood are prepared, each about three inches longer than the tile and two inches wider. These are to form a frame to hold the mold. The model tile is now arranged on the glass slab and the wooden pieces set up around it on edge, leaving a space of an inch and a half or thereabouts on every side of the tile. The frame may be held at the corners with a morsel of soft clay, and four bricks, one against each board, will hold them against inside pressure.

Plaster is now mixed and poured as already described and when firmly set the boards are removed, the mold turned over and the tile model taken out. The mold is now ready for use but as it is advisable to have several of these a case should be made in order to avoid the tedium of preparing a new model each time. In making the case the same process is gone through except that the mold, thoroughly soaped, is set, face upward, on the table, the four boards placed around it and the whole filled with plaster to the depth of two inches. This will give a model tile fast to a platform of the size of the mold and one mold after another can be made from this, simply soaping it each time and placing the boards as before. It may happen that in the first pouring the mold and case will not separate. Plaster swells on setting and while this helps a mold to loosen itself from a case it causes the case to tighten in the mold when being made. If this happens the

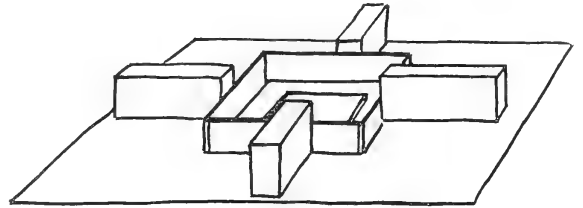

Tile model prepared for molding.

mold should be broken rather than damage the case. New molds can easily be made but the case is more difficult and therefore more valuable.

A stock of molds being made, while these are drying, attention may be turned towards the clay. The main difficulty in making tiles is to keep them straight. Clay has always a tendency to warp and unless some steps be taken to prevent this it will be impossible to secure a level lot of tiles. The reason for the warping is the plasticity of the clay. It cannot be made to shrink evenly and therefore the mass twists. The remedy is to make the clay very porous. Tiles cannot be cast, they must be made from rather stiff clay. The necessary porosity is caused

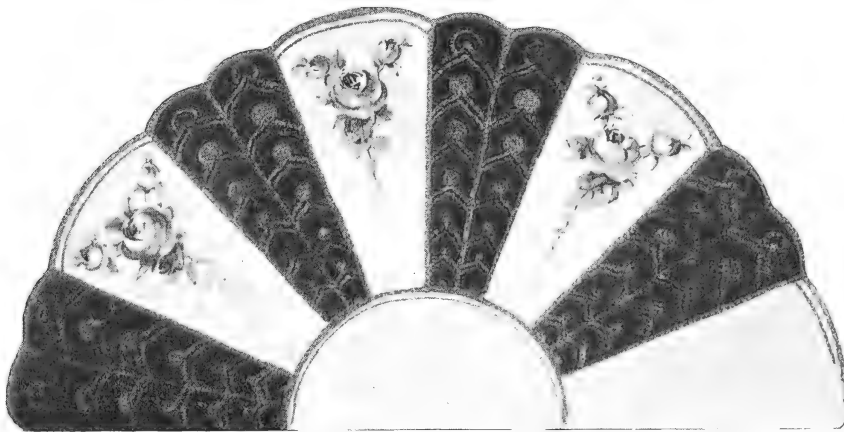

ROSES—F. ALFRED RHEAD

Roses in natural colors; panels, gold tracery on dark cobalt blue ground. Gold edge.



NATURALISTIC ROSES, SECOND PRIZE—MARGARET OVERBECK

(Treatment page 26)



DECORATIVE ROSE, SECOND PRIZE—MARY OVERBECK

MAKE all outlines and the flowers black. Place a little Black. Background rather light tone of Black with a light tone of Raw Sienna and a little Black over whole study. Leaves and stems Hooker's Green No. 1, with a little Black. When dry, wash over whole study with a little Carmine. When dry, wash over whole study with bristle brush and water.

by the use of grog. Grog is the potters' name for burned clay, broken pottery and the like which is crushed to small fragments. Grog is troublesome to prepare but no artist who desires perfect work will grudge the labor.

When a beginning has been made in the production of pottery there is never any lack of broken pieces. These may be of the ordinary red clay or of any other clay, in fact if there be not enough at hand broken bricks will answer quite well but whatever is used it must be biscuit, not glazed. An ordinary pestle and mortar will do with which to crush the pieces and two sieves must be procured one of sixteen meshes to the inch the other of thirty-five or forty meshes. The pounded pottery is sifted through the coarser on to the finer and then the dust is sifted through the latter so that the resulting grog is what will pass through a sixteen and lie upon a forty or, as described in brief, 16-40 grog.

The dust is sifted out because if it were not it would render the clay too short for use. It is not possible to say exactly how much grog is to be added to the clay for no two clays are quite alike as regards plasticity. Generally speaking the dry clay and grog are about equal in

weight, making about three parts of grog to two of dry clay by measure. To insure a repetition of results some such proposition should be weighed or measured and the mass then worked up with water. The clay should first of all be crushed and sifted through the sixteen sieve. The working of the mixed material will prove the best guide, the rule being to add all the grog that the clay will bear. The more the better so long as the mixture be plastic enough to be worked. The clay and grog as prepared should be rather soft, a little softer than would be used for building or throwing.

And now to make the tiles. It is presumed that they are to be perfectly plain and not embossed. Any embossment must be prepared in the model.

The clay is rolled out into a sheet a little thicker than the proposed tile and from this sheet blank tiles are cut with ruler and knife of the exact size of the mold. If true sharp edges are expected these blanks must drop cleanly into the molds and yet fit closely. One of the blanks is transferred to a smooth plaster bat and the face of it is polished with a steel blade. A long kitchen knife will do. If the polishing presses down the edges as it is apt

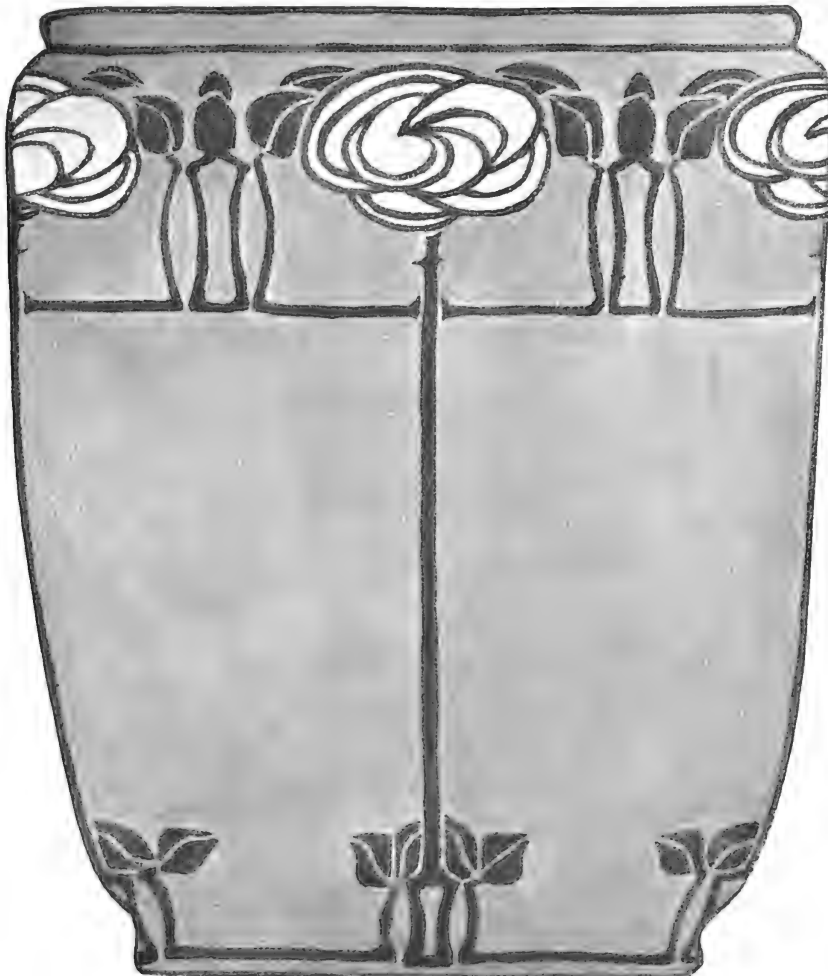

DECORATIVE ROSE, SECOND PRIZE—MARY OVERBECK

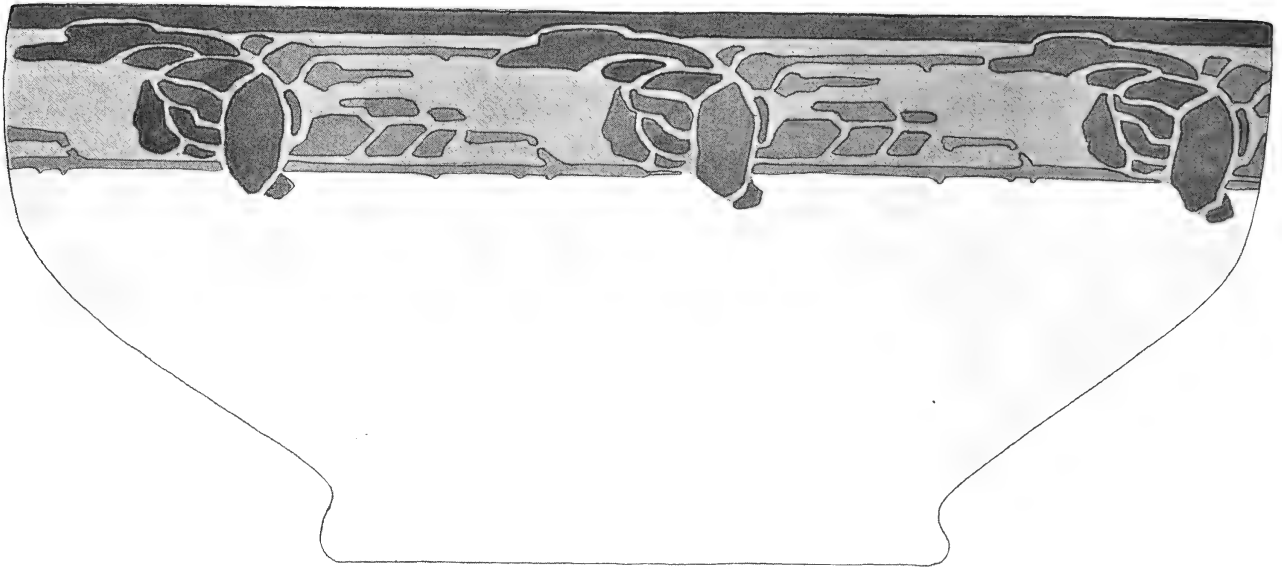

SALAD SET, SECOND PRIZE—MARGARET OVERBECK

to do the overplus must be neatly trimmed off. One of the molds is now turned over on to the clay tile and gently lowered so that the sides are not dragged in entering, then the mold, bat and tile are turned over together, the bat removed and the blank tile lies snugly in the mold with its polished face beneath against the plaster. The tile must now be pounded and pressed firmly into the mold. Professional makers use a tool like a sand bag. It is a roll of sacking or cloth in form like a stocking. In the end there is a pad of wool or lint in the middle of which is a small bag of sand to give weight. This must be made of close grained goods so that the sand will not leak out. This weapon swung in the hand forms a very effective pounding tool and the clay is pressed close in to every angle of the mold. A wire modeling tool is now taken and three or four deep grooves are scored in the back of the tile and the surface is struck off, with a straight-edge, level with the mold. After drying for an hour or so a plaster bat is placed on the mold, the whole turned over again, the mold lifted off and the tile set to dry.

The tiles thus produced will need watching. Even with all the grog one can use they are apt to warp and a flat board should be kept at hand with which they may be pressed down once or twice. As they become harder there will be less tendency to twist. The plaster bats upon which they lie should, of course, be perfectly true.

On a large scale tiles are made by slapping pieces of clay into the mold but if the studio worker will make one tile by each method and compare the results no argument will be necessary as to the advantages of the plan described. It is a little more trouble but the tiles are all good and well finished at once, whereas by the piecemeal plan more time has to be spent on the tile after molding than would be spent as directed upon the clay beforehand.

The tiles are burned just as vases would be but care must be taken to have them perfectly dry and to fire very

slowly. Solid masses of clay need time to allow the heat to permeate. In the kiln they are best set on edge with a slight air space between. The tiles are thick enough to stand so and the bevel edge which was necessary in making the molds is not now needed so it can be scraped off or rubbed down.

(To be continued)



TREATMENT FOR VASE, SECOND PRIZE

Mary Overbeck.

BODY of vase, dull olive, light wash of Yellow-Brown with a touch of Pompadour on roses. Outlines and designs made of same mixture with more red. Outlines and stems of rose should be lighter than balance of design.



TREATMENT FOR SALAD SET, THIRD PRIZE

Ophelia Foley.

OUTLINE of rose, Pearl Grey, leaves and stems, Grey for Flesh. For second firing, Tinting oil and very little Yellow Brown over the whole, padding off nearly all of it from the flowers. Dust: Roses, $\frac{1}{4}$ part Ivory Glaze, $\frac{3}{4}$ Albert Yellow; background, $\frac{1}{4}$ part Violet, $\frac{1}{4}$ Albert Yellow, $\frac{1}{2}$ Pearl Grey.

For third fire, Leaves and stems, $\frac{1}{2}$ part New Green, $\frac{1}{2}$ Grey for Flesh. Yellow Red on the small background spaces.



STUDIO NOTE

Mr. A. B. Cobden, Philadelphia, Pa., held his twentieth annual exhibition of the work of his pupils on May 17th to 19th, at his studio, 13 South Sixteenth street.



SALAD SET, SECOND PRIZE—MARGARET OVERBECK

First treatment.—Use Copenhagen Blue for leaves and background, and add to it Banding Blue for the flowers and band.

Second treatment.—Go over whole space with Meissen Brown and Yellow Red and fire. Outline design in black and paint flowers in Meissen Brown and Yellow Red, and leaves in Olive Green.

COLOR SCHEMES, SALAD SET, FIRST PRIZE

Marie Crilley Wilson

COLOR SCHEME No. 1. Tint ground Ivory with a touch of Black and fire. Paint rose and irregular dark band above dull blue either Copenhagen Blue or Dark Blue with a touch of Black. Paint rim, leaves and stems Moss Green with a touch of Apple Green and Black. In the horizontal openings at bottom of dish put same blue as at top—in vertical openings of stems near bottom put a touch of Capucine or Orange Red—also a touch may be put in the widest part of blue border, taking care always to leave a margin of the background. The straight lines connecting roses are green. The darker panels at base and light line next edge should be tinted again as for

first fire. Tint entire vase rich ivory tone and fire. Draw design in India ink. Tint vase a warm light brown olive, use Moss Green with Yellow Brown. Wipe out design and sufficient margin to leave ivory outlines. Paint leaves and stems in a darker olive, tint roses either Yellow Brown with a touch of Pompadour or reverse the proportions of Yellow Brown and Pompadour to make pink roses.

COLOR SCHEME No. 2. Tint light olive, design dark olive. Line just below edge, horizontal lines connecting roses, thorns just inside leaves and line just above base orange red.

COLOR SCHEME No. 3. Light and dark olive brown, darker outlines.—Rose, thorns and touch in openings, reddish violet.

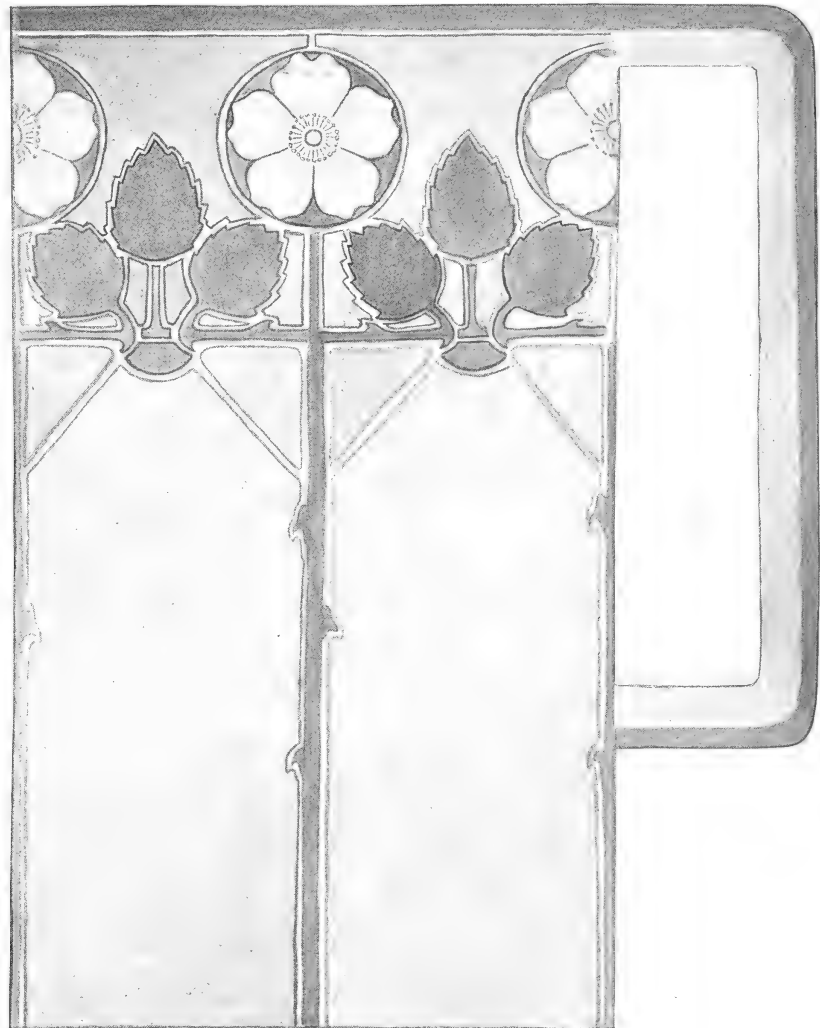

DECORATIVE ROSE, THIRD PRIZE—ALBERT PONS

The wild rose a pale yellow, the background a grey green, and the stems, bands and leaves a darker shade, outlined in dark green.



DECORATIVE ROSE, THIRD PRIZE—ALBERT PONS

Roses yellow, background grey violet and leaves and stems a grey green.

THE CRAFTS

WOOD CARVING AND PYROGRAPHY. LEATHER AND METAL. BASKETRY, ETC.

Under the management of Miss Emily Peacock, Room 23, 22 East 16th St., New York. All inquiries in regard to the various Crafts are to be sent to the above address, but will be answered in the magazine under this head.

All questions must be received before the 10th day of month preceding issue, and will be answered under "Answers to Inquiries" only. Please do not send stamped envelope for reply. The editors will answer questions only in these columns.



Method of holding tool in the making of a metal sconce.

THE MAKING OF A METAL SCONCE.

F. S. Sanford.

The following method of constructing a brass or copper sconce is simple and effective. It is really a kind of repoussé, although lacking the fineness and possibility of that method of workmanship. But as far as it goes it is honest and although rude may be handled in a most artistic manner.

It has these two great advantages, an extremely simple equipment and it does not require heating.

Procure a piece of soft board—pine, cypress, bass wood or poplar—or better still a 2" plank free from knots and measuring about 10" x 15".

Gauge 19 or 20 is about right for the metal. Cut from this metal a piece large enough to allow $\frac{1}{2}$ " margin over the size required for your design and flatten carefully with the mallet. This piece is then fastened to the wood blocks with heavy tacks or roofing nails placed not less than 2" apart all around close to the edge.

By first placing the centre nails on each side and then working toward the corners one is more likely to prevent bending up in the middle. (See Fig. 1) I have given

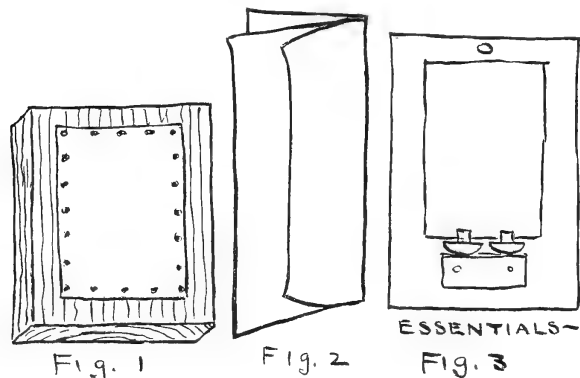

several designs, all of them as regards the decoration, executed like the one we are to consider.

In designing for all of this metal work you will arrive at results most easily with the use of shears and a medium thick unglazed manilla paper.

By folding and snipping we can design outline forms in far less time than we could draw them. So in this case cut a sufficiently large piece of paper to cover your design and fold this paper lengthwise. Then cut the outline form as in Fig. 2, and so by cutting double you will produce a symmetric pattern. Now all designing is done on $\frac{1}{2}$ this sheet. Spaces must be planned for—reflector, border, decorated space and candle bracket. (See Fig. 3, 4.) The ornamental motive is then sketched in to its allotted space and finished with a clean black line. (Fig. 4.)

Now having this clear blackline upon one half the sheet it is a simple matter to transfer to the other half by rubbing hard on the back of the lines. The completed design is pasted by the two upper corners to the brass

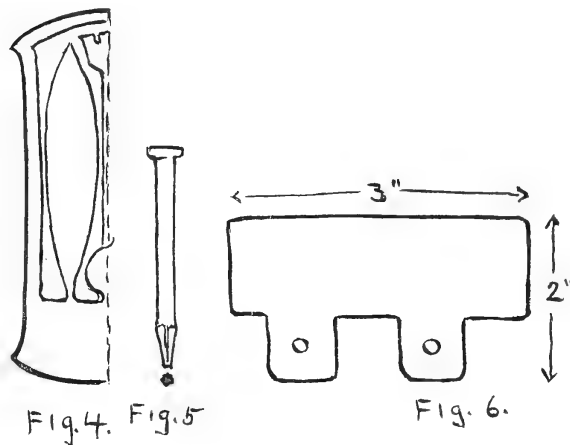

so that the outline comes well within the nail heads, and transferred by slipping a sheet of carbon paper underneath and going over the outline.

The stamping tool is a 9d nail filed to resemble Fig. 5, that is with the sharp point filed off squarely.

The background spaces, which are indicated by the dots as also the connecting lines, are all stamped in with this tool. The photograph of the boy at work shows the method of holding and striking this tool. The result is to depress and of course roughen the background and to raise the reflector and other parts in relief.

It is not desirable to get the stamping in regular rows but it is desirable to have it of even depth and scattered in a generally even way over the space.

There remains to pry off the sheet, trim it with the shears to the proper line and file and smooth these edges nicely.

Any humping in the middle or wrinkling of the edges may be lightly tapped out with a wood mallet.

The size of the impression of this nail stamp should

be varied according to the nature of the design—whether coarse in space or fine.

A could be done advantageously with a rather large end because the motive (the tulip) is open and large in design.

B and C will look best with a small point.

We have now to consider the shapes and construction of bracket and candle socket.

These parts in sconce B are a simple bracket form bent to a right angle, the lower part shaped to fit the space

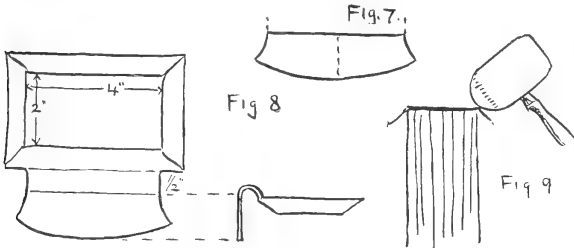

allowed on the sconce back, the upper portion upon a hollow block to form a saucer like shape sufficiently large and deep to catch the candle drippings (not less than 2" diameter). This also is the form of bracket used in sconce D. The socket is like those constructed for the candlestick except that it need have only two legs instead of four. (See Fig. 6.) In B this is rivetted like the description in the previous article on candlesticks, but in D it is simply tacked to the wood with the brass escutcheon pins.

The horizontal or tray parts of sconces A, C, and E are square cornered and consequently formed in a different manner.

As an example take the form given in A. Cut the lower part to fit the space allowed on the sconce back

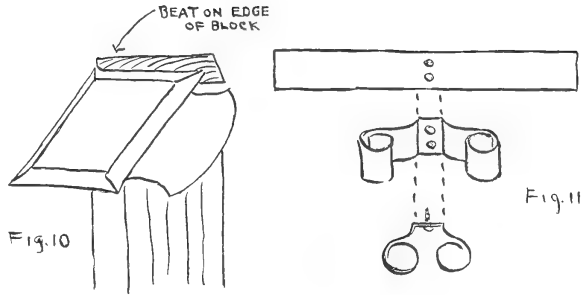

(See Fig. 7) then extended from this is $\frac{1}{2}$ " of metal for the bend and this spreads to a tray form having a base of at least 2"x 4" and a $\frac{1}{2}$ " border.

Fig. 8 shows the complete pattern before bending and after.

This pan shape is formed by beating the border down over a square block as in Fig. 9 and then finishing corners as in Fig. 10.

Sconces D and E have wooden backs, preferably well seasoned oak. These of course require saw, plane, etc., not given in our list of tools. Or you can get these cut to size by any carpenter.

The edges have a $\frac{1}{4}$ " bevel.

The candle sockets in these sconces are made of 1" strips of metal coiled up around stick or directly around a candle.

Cut the strip 1"x 8", punch the two holes in the centre line vertically, coil up and bend with the pliers to resemble Fig. E, and fasten by small round head brass screws so that this piece may be taken off and cleaned.

Fig. 11 shows the strip and manner of forming. The reflector in sconce D is a disk of metal beaten to a shallow

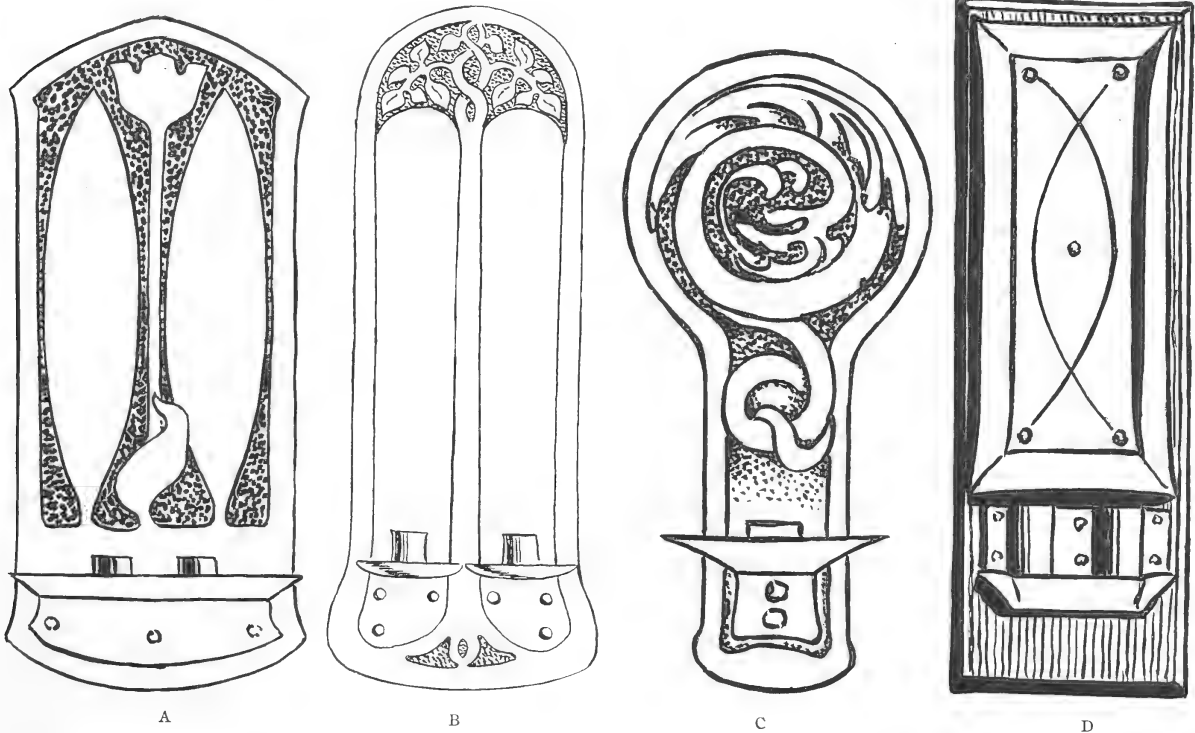

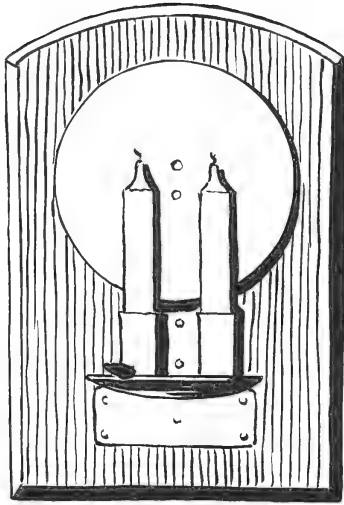

E

concave curve. The reflector in E is simply a large tray with two stamped lines upon it to break up the surface.

Before attaching the metal to the wooden backs, stain these with a dark grey green, grey brown or black oil stain made by diluting common oil colors with linseed oil. A good selection of colors is black burnt umber, bright green, burnt sienna. The first coat is rubbed off thinly

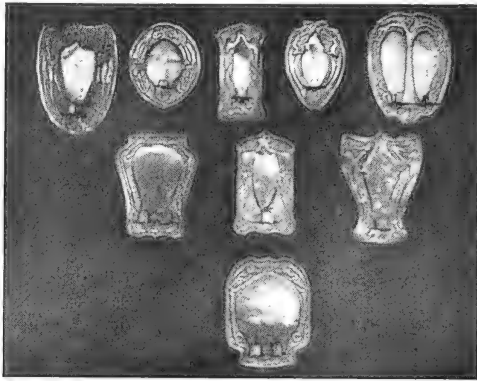

Fig. 12



Fig. 13

with clean rags, the second allowed to stand for a few hours and then rubbed off.

Sconces A, B, and C may be stained an antique green by using the following chemical solution:

- 1 part ammonia muriate,
- 1 part ammonia carbonate,
- 12 parts cold water.

Clean the metal thoroughly. Brush over it the solution and dry and apply again and again until the proper thickness of rust is produced.

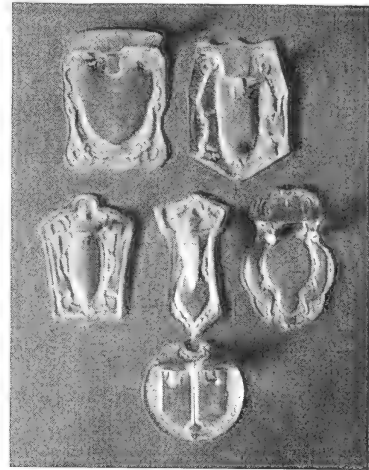
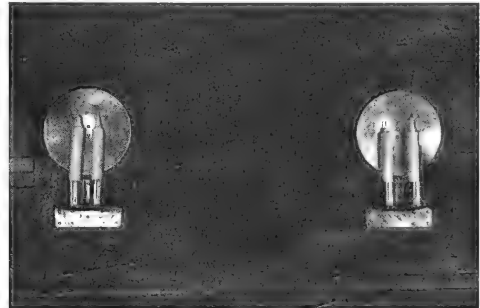

Fig. 14

Many other forms and combinations of metal and wood, as in Figs. 12, 13 and 14, will be suggested to the worker as he proceeds.



ANSWERS TO INQUIRERS

B. B.—The best cabinet makers glue is used in bindings books. Soak the glue over night and, just before it is needed, work in boiling water until it is smooth and clear, of rather thin consistency.

Mrs. S.—Holes in the edges of your leather cover could best be made with a conductor's punch having a large or small tooth. For holes in the cloth, use an agate pointed stiletto.

M. P.—To stain a green background on your cabinet, mix a little chrome yellow, a little Prussian blue, and some light red or black with benzine or turpentine. Cover the whole surface with this, using a soft cloth and rubbing well into the wood. A brush would make a streaky effect. Be sure to fill in every crevice and rub down to a clear even tone. If there are any markings in the wood this process will bring them out. Avoid the effect of paint. If your mixture is too thick, dilute it, if too thin, put on another coat. Several days are required to dry this stain. For a finish thin beeswax with turpentine over heat, until it is like cream and apply sparingly with a soft cloth, rub off to a thin even tone.

T. K.—Acid coloring for metal is more permanent but very beautiful colors are produced on copper by polishing well with powdered rouge and

oil. Then apply a gentle heat with a Bunsen burner, taking care not to get the metal too hot.

J. T.—A fine grained wood is the best for burning. Basswood and white wood are usually used.

BASKETRY—Rattan grows in tropical forests where it twines about the trees in great lengths. It is numbered by dealers according to its thickness, and Nos. 2, 3 and 4 are the best sizes for small baskets. For scrap baskets 3, 5 and 6 are the best sizes. It must be thoroughly soaked before using.

Raffia is the outer cuticle of a palm and comes mostly from Madagascar. It is advisable to wash the natural colored raffia in warm water with pure white soap, rinsing well and letting it get almost dry before using.

E. B.—Polish the ebony, by putting on two coats of copal varnish; when this is dry, rub quite smooth with fine pumice stone. Put on another coat of the varnish and rub with rotten stone. Clean and put on a flowing coat of best spirit copal varnish, when this is quite dry, polish with chamois and the palm of the hand.

T. C.—The blue color in turquoise is sometimes though not always unstable. The original, which has been bleached or exposed to sunlight, can sometimes be restored by immersing it in ammonia or by wearing the stones in such a way that they come in contact with the hand.

K. S. T.—Armenian cement has been used by the Oriental jewelers for many years. It is made by dissolving 10 parts of gum mastic in 60 parts of grain alcohol. Dissolve separately 20 parts of fish glue in 100 parts of water by slowly heating; add to this 10 parts of alcohol. Then dissolve 5 parts of ammoniacal gum in 25 parts of alcohol. Mix the first solution with the second and stir well together, add the third solution and stir. The whole must then be treated over hot water and reduced to 170 parts by evaporation.

C. P.—The leather must always be thoroughly dampened, before the color (spoken of in Miss Wilson's article) can be used.

K. R.—The ordinary coppers make a fast nankeen colored dye. Dip your material in this and then in the indigo both for dull greens.

Mrs. W.—The gilding of a mirror frame is quite a difficult undertaking. The frame must first be sized carefully then the gold leaf applied. Later we hope to have an article on "The making of a mirror frame."

T. O.—Aqua Regia is made from equal parts of nitric acid and muriatic acid mixed; sometimes 2 parts of nitric acid to one part muriatic is used.

W. H.—Etching can be done on steel with a solution, made by mixing one ounce of sulphate of copper, one quarter of an ounce of alum, and one-half a teaspoonful of salt reduced to a powder, with 1 gill of white wine vinegar and 20 drops of nitric acid. This solution will also give a frosted surface to the steel.

Mrs. C. Clute.—Address The Hingham Society of Arts and Crafts, Hingham, Mass. The industry of making Bayberry candles was revived by them. There was an article in Good Housekeeping last fall on the making of a Bayberry candle, but we do not know of any book on the subject now.



ANSWERS TO CORRESPONDENTS.

S. M. H.—Liquid silver is used the same as liquid bright gold. Use from the vial as it comes, if too thick to go on smoothly thin with oil of lavender, if too thick it rubs off after firing or forms crackled lines, if too thin it may be put on and fired again, firing should be the same as for liquid gold or lustre, a medium hard fire. The blurred effect comes either from being put on too thick, moisture on the china or handling after it is put on; the hand should never touch lustre or liquid bright gold or silver. Use always a soft old piece of silk. If once blurred no succeeding fire will improve it. Better put a tracing of gold over the blurred silver.

G.—Section of Chinese plate, September 1899, page 92, all black spaces and outlines should be gold. The flower forms in pink flat enamels of two shades. The leaf scrolls in Apple Green flat enamel and an Olive Green flat color. The dotted background should be an ivory tint, in the border it may be a deep yellow or a deep blue or green. Some touches of this border color must be introduced somewhere in the flower forms. The design on the gold ground in the border may be white if the background is yellow, or if a darker color is used, then introduce Deep Yellow, Turquoise Blue or a rich Yellow Green. This design would also be very effective carried out in gold and red only, on an ivory ground. We will endeavor to give as handsome plate borders in the new style as possible.

G. B.—The best way to know what any artist who makes his own colors uses for rose painting is to write to him personally to recommend the proper colors. Each one has his own specialty and only he and his pupils can tell you the names of the colors. You do not say what effect you wish, so we can not suggest what color to wash over Ruby to tone it. Yellow Brown with a touch of Silver Yellow should give a tint similar to champagne color.

Mrs. C.—Your color which clipped off on the handle was probably too thick, especially if you used Ruby over Black. When ground color begins to chip it is useless to refire as it will continue to chip. Nothing will remove

such a heavy color even Hydrofluoric Acid, without ruining the piece. The only thing to do is to fill in the chips with finely ground china mixed with Silicate of Soda, then paint it to match the color and varnish it.

Mrs. W. H. H.—To dust a painting when partly dry means to take powder color and brush it over the painting till no more will adhere, then brush off the surplus.

Mrs. S.—The use of enamel in retouching flowers has been entirely discontinued.

P.—For tinting with Iron Reds, add $\frac{1}{2}$ to $\frac{3}{4}$ flux. The more flux the lighter the tint.

Mrs. N.—Underglaze painting is painting on the "biscuit" or unglazed china, then glazing and firing at a temperature much higher than overglaze or painting on the glazed china. Gold in powder form comes both fluxed and unfluxed. Tinting oil and grounding oil are quite different. Tinting oil is used for light tints and grounding oil for heavy dusted color. Burnishing sand is a fine white sand which comes specially for this purpose. The Agate Burnisher is used on the flat side for large surfaces, on the point for lines and small spaces. Liquid bright gold can be used over fired color only, and then only over light tints. The conditions of the prize competitions will be found on the back cover of KERAMIC STUDIO.

R.—Gold will fire out, or rather *in* if over fired; it looks then a pale thin yellow which will not burnish. Red fires with a blueish tone if fired too hard but should be fired hard enough to glaze. No painted china is properly fired if it has not a good glaze, the higher the better, except for mat colors. If the gold looks pale and thin but still burnishes, it was put on too thin. Reds are liable to fire out and must be painted a little stronger than you wish them to appear. If Carmine or Rose put on medium heavy come out the right color, not too blue or too brickly, you have fired right.

Mrs. E. G. F.—Add a little deep blue green to your greens if too yellow—ivory black may be used with greens to grey them if desired.

The fruit borders in January KERAMIC STUDIO are supposed to extend around the entire rim of plate.

Mrs. L. N.—The best color to use over the pearl grey on the plate where it has destroyed the reds would be a green or delft blue, but doubt if you would obtain entirely satisfactory results as the glaze is already loaded with flux from the grey and reds.

L. G.—You will find articles on conventional work in KERAMIC STUDIO also in the Class Room, October to present date. Plain tints may be obtained by tinting, grounding or dusting, tinting is of course padded, see articles in next Class Room. The only remedy where yellow eats up red in firing is to retouch with the red alone rather heavily. A kiln may be fired as often as desired, naturally the more often it is fired the quicker it will wear out.

Mrs. H. D. W.—Gold may be removed with Hydro-fluoric acid, but the acid is dangerous and the glaze is also removed. Try aqua regia and save the washings, possibly they might be made up into working gold by following the recipe in KERAMIC STUDIO, we have never tried it.

M. G.—As a general rule the names of colors of all makes correspond or nearly so but some individual makes have their specialties which do not exactly correspond with anything else. The principal differently named colors which correspond to some degree to La Croix colors are as follows:

Albert Yellow—a mixture of Jonquil and Orange Yellow.

Grey Green—Celadon—or for painting, Pearl Grey with a touch of Moss Green and Delft Blue.

Royal Green—Emerald Stone Green and Moss Green mixed.

Neutral Yellow—a mixture of Ivory Yellow, Capucine and a touch of Black, giving a greyish olive yellow.

Orange Red—Capucine

Pompador Red—Carnation No. 1.

Blue Grey or Copenhagen Blue—Delft Blue with a touch of Black.

Chestnut or Hair Brown—Meissen Brown or Brown 14 with a mixture of Yellow Brown and Carnation to make a reddish warm tone.

Rose—Carmine 2.

Finishing Brown—Brown 14.

Royal Purple—Ruby Purple with Dark Blue.

Banding Blue is a pure bright blue which does not correspond with anything in La Croix color Shading Green is Dark Green 7. We know of no list of colors corresponding with the La Croix make exactly. You will have to use your judgment as to what color effect is intended and usually you can find something in La Croix which will approximate. Any special color we will try and describe to you if you will inquire. Powder colors are mixed to the consistency of tube colors with an oil composed of 6 drops oil of Copaiba to one of oil of Cloves, then thinned for painting with spirits of turpentine. If you have only subscribed recently we would advise you to send for back numbers containing the "Class Room" from the beginning, October 1905. You will find in these articles every detail of the work of mineral decoration. For dark red roses in La Croix use Ruby Purple with Carmine 1 and 2 in high lights and a touch of Black or Dark Green 7 in shadows. For pink roses Carmine 1 and 2, Apple Green in greyish shadows, Jonquil or Orange Yellow in creamy tones.

USE HIGGINS'



Drawing Inks, Blacks and Colors
 Eternal Writing Ink
 Engrossing Ink
 Taurine Mucilage
 Photo Mounter
 Drawing Board and Library Mucilage
 Office Paste
 Liquid Paste
 Vegetable Glue, etc., etc.

and learn what's what in inks and adhesives for tracing designs on china, photograph mounting, and general office and home use. Emancipate yourself from ill-smelling and dirty pastes and mucilages, and corrosive and weak-colored inks, and adopt the HIGGINS' INKS AND ADHESIVES. Their high qualities will be a revelation to you. **At Dealers Generally.**

CHAS. M. HIGGINS & CO. Originators and Manufacturers
 Refined Inks and Adhesives.
 NEW YORK CHICAGO LONDON
 Main Office and Factory, Brooklyn, N. Y., U. S. A.

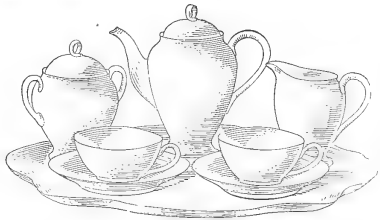

OUR "ELITE" FRENCH CHINA
 VIENNA CHINA
 BAVARIAN CHINA
 AND GERMAN CHINA
 IN WHITE
FOR DECORATING

Are sold by the leading merchants throughout the United States. All the latest shapes are illustrated
 IN OUR NEW CATALOGUE
 Now ready for mailing. Write for copy to-day.

BAWO & DOTTER
 MANUFACTURERS
 26 to 34 Barclay St., New York

White China for Decorating

We are pleasing others and we can please you if you will give us the opportunity. We have had many letters of late complimenting us on our prompt shipments of White China. We are able to make prompt shipments only by carrying a very large and complete stock. Our large Illustrated Catalogue of White China and Materials free for the asking, end to-day.

The A. T. Osborn Co.
 IMPORTERS
 224-226 Seneca Street Cleveland O.



THE FRY ART CO.
 MANUFACTURERS OF
Fry's Celebrated Vitriifiable Colors
 IN POWDER, AND
ROMAN GOLD FOR CHINA
 DEALERS IN
LUSTRES, OILS, MEDIUMS, BRUSHES
 AND ALL MATERIAL USED IN
CHINA DECORATION

Agents for Hasburg's and Marsching's Gold, The Revelation China Kiln,
 The Ceramic Studio. Send for catalogue, mentioning "Ceramic Studio."

11 East 22nd Street, - - New York
The Fry Studio Information in regard to Mr. Marshal Fry's New York classes can be had at his
 New York Studio, 58 W. 96th St.

KEEP THE FIRE ALIVE.

KERAMIC STUDIO

CONTRIBUTORS

China Decoration

MRS. SARA WOOD SAFFORD

The Crafts

MRS. LUCY E. SHIELDS

JULY MCMVI

Price 40c. Yearly Subscription \$4.00

A MONTHLY MAGAZINE FOR THE POTTER AND DECORATOR.

The entire contents of this Magazine are covered by the general copyright, and the articles must not be reprinted without special permission.

CONTENTS FOR JULY 1906

	PAGE
Editorial	49
The Class Room—Etching	49-50
League Notes—Club Notes, Studio Notes	50
Chicago Exhibition	50-51
The following contributions are made by	Sara Wood Safford
Arrangements of Roses for decoration	52
White and Pink Roses	53
Bowl—Buttercup Motif	54
Strawberries (Supplement)	55
Buttercup and Clover	55
Poppy and Hollyhock	56
Border Suggestion for Table Service	57-58-59
Fruit Plate—Apple Motif	60
Fruit Bowl	60
Grapes	61-62-63
Fruit Plate—Grape Motif	63
Roses	64-65
Cowslip Sketches	66
The Crafts	
The Making of a Palmleaf Basket	Lucy E. Shields 67-69
Art Workers Organization	69-70
Crafts Exhibitions	69
Answers to Correspondents	71

LIST OF BOOKS

The Rose Book, containing some of the best rose studies and designs published in Ceramic Studio..... postpaid \$ 3.00		
The Fruit Book, containing some of the best fruit studies and designs published in Ceramic Studio..... postpaid	3.00	
Composition, by Arthur Dow..... postpaid	1.65	
Principles of Design, by E. Batchelder..... postpaid	3.00	
Decorative Studies, by J. Foord..... postpaid	12.50	
Plant Forms and Designs, by Midgley and Lilley..... postpaid	2.20	
Practical Pottery, elementary instruction for students, by Richard Lunn..... postpaid	2.50	
Grand Feu Ceramics, a practical treatise on the making of hard porcelain decorated with high temperature glazes by Taxile Doat of the Manufactory of Sevres, France..... postpaid	7.50	
Seger's Collected Writings, 2 volumes..... postpaid	15.50	
For the Collector:		
Vol. II Old China, bound blue cloth..... postpaid	2.50	
Vol. III Old China, bound blue cloth..... postpaid	3.50	
Anglo-American Pottery, a manual for collectors, by Edwin Atlee Barber, Curator of the Pennsylvania Museum, second edition..... postpaid	2.00	
American Glassware, old and new, by Edwin A. Barber..... postpaid	1.00	
Marks of American Potters, by Edwin A. Barber..... postpaid	2.25	
Pottery and Porcelain of the United States by Edwin A. Barber..... postpaid	3.75	
The Lace Book, by N. Hudson Moore..... postpaid	5.30	
Tulip Ware of the Pennsylvania German Potters, by Edwin A. Barber, in paper cover..... postpaid	1.10	
Tulip Ware of the Pennsylvania Potters, by Edwin A. Barber, cloth, limited edition..... postpaid	5.00	
Encyclopedia of Ceramics, by W. P. Jarvis..... postpaid	6.75	
The Old China Book, by N. Hudson Moore..... postpaid	2.18	
The Old Furniture Book, by N. Hudson Moore..... postpaid	2.18	
Old Pewter, by N. Hudson Moore..... postpaid	2.18	
Chats on English China, by Arthur Hayden..... postpaid	2.16	
Chats on Old Furniture, by Arthur Hayden..... postpaid	2.18	
China Collecting in America, by Alice Morse Earle..... postpaid	3.20	
Pottery and Porcelain, a guide to collectors, by Frederick Litchfield, the English expert..... postpaid	6.25	
French Pottery and Porcelain by Henri Frantz..... postpaid	2.68	
Dutch Pottery and Porcelain, by W. Pitcairn Knowles..... postpaid	2.68	
Old English Furniture, by Fred Fenn and B. Wyllie..... postpaid	2.68	
English Embroidery, by A. F. Kendrick..... postpaid	2.68	
French Furniture, by Andre Saglio..... postpaid	2.68	
Old Pewter, by Malcolm Bell..... postpaid	2.68	
Sheffield Plate, by B. Wyllie..... postpaid	2.68	
The Oriental Rug Book, by Mary Churchill Ripley..... postpaid	3.20	
Home Furnishing, practical and artistic, by Alice M. Kellogg..... postpaid	1.65	
William Adams, an old English potter, by William S. Turner..... postpaid	8.00	

Keramic Studio Pub. Co., Syracuse, N. Y.

KERAMIC STUDIO

Vol. VIII, No. 3

SYRACUSE, NEW YORK

July, 1906

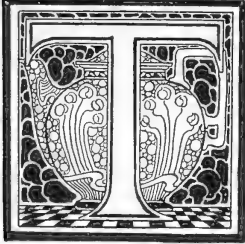

THIS issue of *KERAMIC STUDIO* is edited almost entirely by Mrs. Sara Wood Safford of New York. The October number will be edited in the same way by Miss Mabel Dibble of Chicago. Other issues by other artists will be arranged and will be announced later.

We feel that this number speaks for itself and needs no justification or commendation. We are sure that our readers will not only be pleased but will find Mrs. Safford's work very helpful.

THE CLASS ROOM

The "Class Room" will have to be shortened for this issue but will go on as usual hereafter. The next subject for the Class Room will be "The Art of Teaching" a course for beginners referring to some designs published in *KERAMIC STUDIO* for illustration. This should explain just how to start a beginner, what kind of piece to work upon, what style of work to attempt, what steps to take in the work, etc., up to the advanced and finished work.

A special extra first prize of \$10.00 will be added to the usual prizes if a sufficiently good article is sent. Articles should be received not later than August 5th.

ETCHING

First Prize—Mrs. G. B. Strait, Cazenovia, N. Y.

Etching is the process of eating out a part or the whole of the glaze on china, covering the etched portion afterwards with gold to give a relief effect. The gold should be applied rather thickly with a small stiff brush, and the china should be the best quality of French ware obtainable.

Etched china ready prepared for decorating is on the market, but the work may be done at home in an equally satisfactory manner.

A small, rather plain design is best adapted to this purpose, such as a grape vine with tendrils, a simple frost design, Roman key pattern, delicate scrolls, or even rows of dots.

PREPARATION OF GROUND.

To prepare the ground for etching, draw carefully a design in India ink. Next heat the piece and while it is still warm pour over it some melted paraffine or wax, turning it about until as much of it is covered as is necessary, allowing the extra amount to run off. This will leave a thin coat of wax all over the portion to be ornamented.

Some successful workers melt beeswax in turpentine until it is perfectly fluid, after which it is strained through thin, fine silk. To this is added black Japan or Japan varnish in the proportion of 1 to 5, allowing more of the latter if the weather is very warm, and less if it is cold.

The design may now be retraced with a steel point, leaving the pattern white.

To this the pure hydrofluoric acid is applied either by pouring on, immersing, or applying with a thin piece of damp cotton batting wound tightly about the end of a stick. If the cotton is used, run the stick into the bottle until the cotton is wet, dip in a cup of water and at once apply to the china. The acid is allowed to remain 5 or 10 minutes, or until the glaze is bitten into sufficiently.

This may be determined by holding it under running water until perfectly cleaned, and if after removing a portion of the wax it is found that any part is not etched deeply enough, the process may be repeated as many times as is necessary. Flat pieces may be immersed in an acid "well" made in the form of a square wooden frame having a square three inches deep sunk in the center, painted several times inside with Japan black. This may be covered with thin cambric.

Another method, the effect of which is the reverse of that produced by the use of the steel point in drawing is to draw the design and cover it with a thick coat of asphaltum which has been allowed to stand at least a day before using, moistening with turpentine as it grows thick. Draw a band on each side of the border with asphaltum.

Now apply the acid to the background of the design until the glaze is nearly gone, and when the piece is washed the asphaltum may be removed by the use of turpentine. Wax may be removed by heating the piece. After the design has been covered with gold and fired it may be rubbed with sand or glass brush, and the raised parts and bands brightened with the agate burnisher. Extremely delicate and rich effects may be produced in this way.

Another method of etching is the use of the vapor bath. Fluor spar is placed in a shallow vessel and sulphuric acid poured on it until the spar is covered. This produces hydrofluoric acid in vapor, and the article to be etched is placed over it until the fumes act upon the glaze and destroy it to any extent desired.

No matter whether used in vapor or liquid form, extreme care in its handling must always be maintained, the operator being careful to avoid inhaling the fumes or allowing the acid to touch the flesh.

The wearing of rubber gloves is advisable; and although the acid comes in gutta percha bottles it should not be allowed to stand near any china to be decorated, for even though tightly corked enough fumes will escape to injure the glaze.

Clear water or soda water will relieve acid burns, after which vaseline may be applied.

Fourth Prize—Bertha Morey, Ottumwa, Ia.

[EXTRACTS ONLY]

You can tell if the acid has eaten into the china by taking a hat pin and scratching along a line, if it seems rough, it is done; pour hot water on the piece and it will melt off the wax.

Be careful not to inhale the fumes as they are injurious to the lungs and cause a heavy cough.

[TO BE CONTINUED]

LEAGUE NOTES

REPORT OF CHAIRMAN ON TRANSPORTATION.

The work of the Transportation Committee last year was somewhat difficult as the Exhibit had to start from the center of the circle as it were, and to work in two directions. To please all as to time of entertaining was many times puzzling and often impossible. As it was it had to go over the same route twice in many cases, thereby incurring extra expense to the League. We are hoping to avoid all of that this year.

On May 3d, this year's exhibit started at Chicago and was entertained by the Chicago Ceramic Art Association at the Art Institute until May 27th when it was put on exhibition at Burley & Co.'s china store, to remain for two weeks.

It being so late in the summer before it could leave Chicago it was thought advisable to hold the work in storage in Chicago until fall, any members wishing to add to the exhibit can do so by sending in before the second week in August.

Send the work to Lulu C. Bergen, 7404 Harvard Ave., Chicago.

The route for the exhibit is as follows:

Chicago, May 3d to the 27th.
 Detroit, Mich., Sept. 1st to 8th.
 Pittsburg, Pa., Sept. 12th to the 15th.
 Augusta, Me. Sept. 19th to the 22d.
 Portland, Me. Sept. 24th to the 28th.
 Boston, Mass. Oct. 1st to the 8th.
 Providence, R. I. Oct. 10th to the 13th.
 Newark, N. J. { N. J. Oct. 20th to the 27th.
 Jersey City, {
 New York City, Oct. 30th to Nov. 6th.
 Brooklyn, N. Y. Nov. 8th to the 15th.
 Kansas City, Mo. Nov. 21st to the 27th.
 Denver, Col. Dec. 10th to the 17th.
 San Francisco, Cal. Jan. 2d to the 9th.
 Portland, Ore. Jan. 18th to the 25th.

Respectfully submitted,

MRS. LULU C. BERGEN,

Chairman on Transportation.



CLUB NOTES

A meeting of the California Ceramic Club was held at the studio of the president, Miss Taylor, May 26th. This being the first meeting since the disaster, much interest was shown by the members.

The general feeling among the ladies was to cling together and help each other. Many of the members lost all their possessions both at home and in the studios. The more fortunate ones kindly offered their studio materials,

kilns and so on, to any of the members who suffered loss in the recent calamity.

A vote of thanks was given the KERAMIC STUDIO PUBLISHING CO. for their generous assistance, which was very much appreciated.

STUDIO NOTES

Miss Jeanne M. Stewart will spend the months of August and September in Europe, studying, and her classes will be reopened October 15th.

Miss Mabel C. Dibble of Chicago will spend July and August in Northern Michigan.

CHICAGO EXHIBITION

The fourteenth annual exhibition of the Chicago Ceramic Art Association and the annual exhibition of the National League of Mineral Painters have filled a series of cases in the South galleries of the Art Institute.

The articles have passed the inspection of a critical jury demanding from six to ten points in excellence of shape, design and its application to shape and to the purpose of the vessel, in color and harmony in combination.

Owing to the rigid restrictions placed by the Art Institute upon ceramic entries the jury went about its task last year with the determination to rise above all difficulties and produce a showing that would be distinctly creditable, with the result of opening a small but rather extraordinary exhibition.

Anyone who looks for the old-style flower painting or imitations of Dresden or Sevres will be disappointed. The rules of the society require conventionalized forms or abstract ideas, and naturalistic painting is frowned upon. The newest efforts are seen in the low tones and the subtle contrasts of tones in the same color. The beauty developed in cool greens and blues and pale browns is fascinating and satisfying to the most exacting colorist.

Mrs. Mary J. Coulter, retiring president of the organization, has an interesting group, including a plate with apple motif, bowl with tree motif, a delicately treated bowl in pale green Sedji, and incense burners, a bowl and jar in quaint Satsuma.

A vase of oriental reflections with designs in enamel by Mrs. J. C. Long has no rival. Mary A. Farrington's plate in green and blue is unusual. Helen H. Goodman has a group beautifully executed from designs by Marshal Fry, and a green vase in which both design and execution are her own is very good.

An elaborate plate of violet motif, and a series of artistic combinations in mushroom motifs, peacock and blue—in all, seven plates—by Evelyn Brackett Beachey, show versatile talent. Ione Wheeler exhibits a delightful placque in the peacock thought. The development of a motif finds as much favor among the china painter as among writers of music, and the themes are unerringly worked out to logical conclusions.

The Chicago Ceramic Art Association registers sixty members.

The National League of Mineral Painters has representatives from the Denver Mineral Art Club, Newark Ceramic Society, New York Society of Ceramic Arts, Chicago Ceramic Art Association and individual members. Miss Ophelia Foley from Owensboro, Ky., and Mrs. Charles C. Williams of Glen Falls, N. Y. Included in this special section is a New York loan exhibit.



Estella McBride Mary A. Farrington Helen Goodman
 Mary J. Coulter Mrs. J. C. Long Mary J. Coulter

CHICAGO CERAMIC SOCIETY



NATIONAL LEAGUE—BOWLS



Helen C. Burdette Mary J. Coulter
 Blanche Wight Helen Goodman

CHICAGO CERAMIC SOCIETY



NATIONAL LEAGUE—STEINS



Evelyn Beachey Ione Wheeler
 Lulu C. Bergen Helen Goodman Belle Vesey

CHICAGO CERAMIC SOCIETY

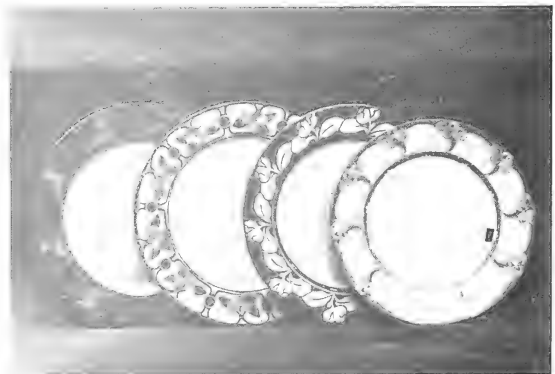

NATIONAL LEAGUE—PLATES





WHITE AND PINK ROSES



MEETINGS to you who live with flowers and wild things—you who long for the “advantages” of the city—you who feel shut away from the world—rather, indeed, extend to us your sympathy, we, who have no gardens—we who send miles for a buttercup and then keep it on ice till we may steal time in which to draw it and pet it and paint it. So few realize the value of making careful drawings from the flowers and trees growing with them—the wild flowers and grasses—wild fruits and berries and nuts. Aside from the material value of these drawings, how many know the keen joy to be had in the mere doing of them.

greens or browns for leaves and stems, keeping the flower as simple in its treatment as may be satisfying to one, personally. In making these first drawings one must be true to one's self. No one has the right to insist that another “follow a light which he does not see.” As the mind and eye become trained and the hand acquires an easier grace of technique, the sketches will become simpler and freer and more artistic; but never sacrifice the truth to an artistic effect in any of these first studies.

The pencil outlines and shadings are particularly valuable keeping one, as it does, within bounds. It is a temptation to become flighty with color, and one should not trifle with the flower that will never be in one's life again. Accept it as a help-mate and treat it fairly.

These color wash and pencil drawings on the tinted papers, make for the most interesting and valuable ma-



MOTIF TAKEN FROM BUTTERCUP

Do not try to make a pretty picture, do not think of a picture at all—but take a nice clean page and on it register a truth about some bud or leaf, some fruit or flower that appeals to you. If the eye and hand are not yet quite trained to express gracefully what the mind really sees, what matters it? If you have made an honest drawing the grace and charm of expression will follow.

One is helped greatly by working with pencil and “color wash” on tinted papers—these papers may be had in tints of gray, gray green, gray yellow and soft browns and blues.

First make a careful pencil outline drawing, with shading in leaf and stem, and where wished, suggest the shadow in the flower with pencil as well. This will make a foundation for the color wash. Use flat washes of soft

material in my possession. No attempt at composition has been made (that comes when the flowers are gone and one's winter garden not so rich.) The hollyhocks and poppy reproduced in this number are done as described and the cowslip and clover and buttercup (the one that was “iced”) are from drawings made in the same way.

And from the buttercup grew the bowl. It isn't always that one finds a composition so near at hand, but it will be seen that very little change has been made from the original growth, in the spacing as applied to the bowl. It had to become simpler—more abstract, in order to be harmonious with the whole and to enhance the beauty of the bowl. Its mission was to enrich it; it could no longer remain an independent little buttercup. It was needed to make another thing more beautiful

SARA WOOD SAFFORD

PALETTE FOR STRAWBERRIES (Supplement)

VANCE Phillips' Albert Yellow, Yellow Brown, Carnation, Blood Red, Ruby, Violet, Pearl Grey, Blue Grey, Apple Green, Yellow Green, Shading Green, Brown Green, Dark Green, Black.

Follow the directions for painting of other fruit and flowers for the different fires, use Blood and Ruby for darkest red in the first painting of berries and glaze with Carnation in the second. Paint the light berries with Yellow and Carnation, greying the more tender ones with Violet.



SHOP NOTES

Dorn's Ceramic Supply Store, (late of San Francisco) is now located at 418-420 West 21st Street, Los Angeles, Cal. Mrs. Dorn's studio at same address.

A neat little card received at this office informs us that Mrs. Magill and Miss Jessie Ivory, teachers of china painting, have opened a store at 297 5th Ave., New York, for the sale of porcelain and artists materials. Studio at same address.



BUTTERCUP AND CLOVER

These pencil and color sketches reproduced are not in any sense compositions, or "ready for use" material, but are intended to show how pleasingly studies may be collected. Not an elaborate suggestion, but a simple truth expressed as tenderly as possible. Somewhere, some one has said something about being "afraid to sing one's song for fear the method was wrong." Don't be afraid to try.

POPPY AND HOLLYHOCK

For sketch in pencil and color work.



BORDER SUGGESTIONS FOR TABLE SERVICE

A SIMPLE motif has been chosen that beginners may be interested, if possible, to do that which there is such a need of—good, quiet table service. The designs as suggested on the bowls, will make pleasing reserved border decorations for plates or cups and saucers, carried out in gold, matt silver, or in blues for a breakfast service, or

ice would be done by our painters if their first excitement was not cooled by the doing of "holding in" lines. One must *feel* the line and border limit, but there is something irritating in *seeing* it ahead of one on dozens of plates, cups or bowls. Do not mistake the thought—lawlessness is not to be encouraged in design. Flowers, lovely as they

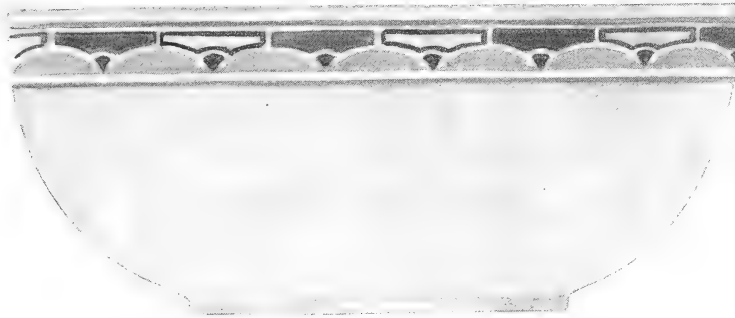

in soft greens for a cool luncheon set. No tracing is necessary. A careful planning of shapes and spaces will enable the worker to paint quite freely and easily without the aid of a traced limit line. The same, or nearly the same spacing, has been kept throughout the six bowl borders.

are, running wildly over a plate do not make for a restful table. Our plates should not intrude.

In the delight of painting a flower, one is apt to forget the use to which the thing decorated is to be put. A plate should not be a picture. Plates are not merely



Note the different designs evolved by the changing from ovals to diamonds and squares—by varying the open grey space outlined shapes, with *solid dark* space shapes.

Great care has been taken to prepare designs that may be done with freedom without the drudgery of tracing—a strong belief being held that more and better table serv-

plates—they are a table decoration. We can live best and longest with that which conforms to the laws of design—or of life. One does not admire anyone or anything so conventional as to be stupid, but one is happy and content with originality, strength, tenderness and reserve.

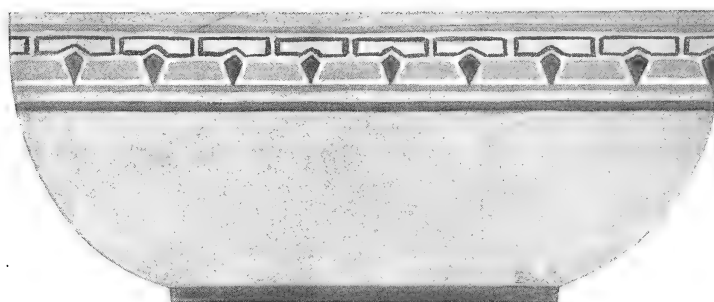
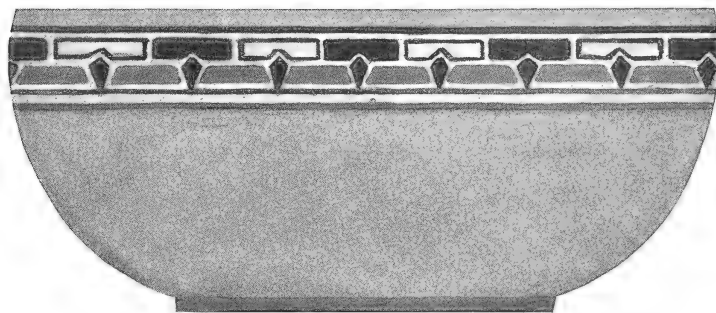

BORDER SUGGESTIONS FOR TABLE SERVICE

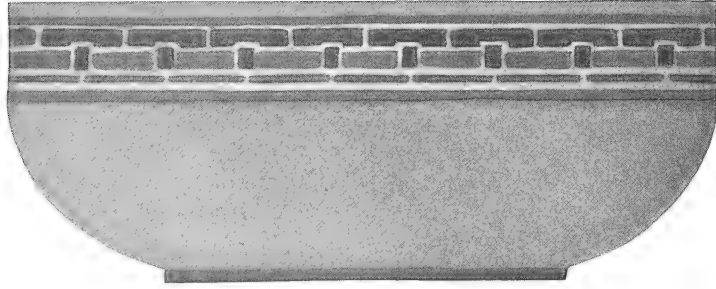

BORDER SUGGESTIONS FOR TABLE SERVICE

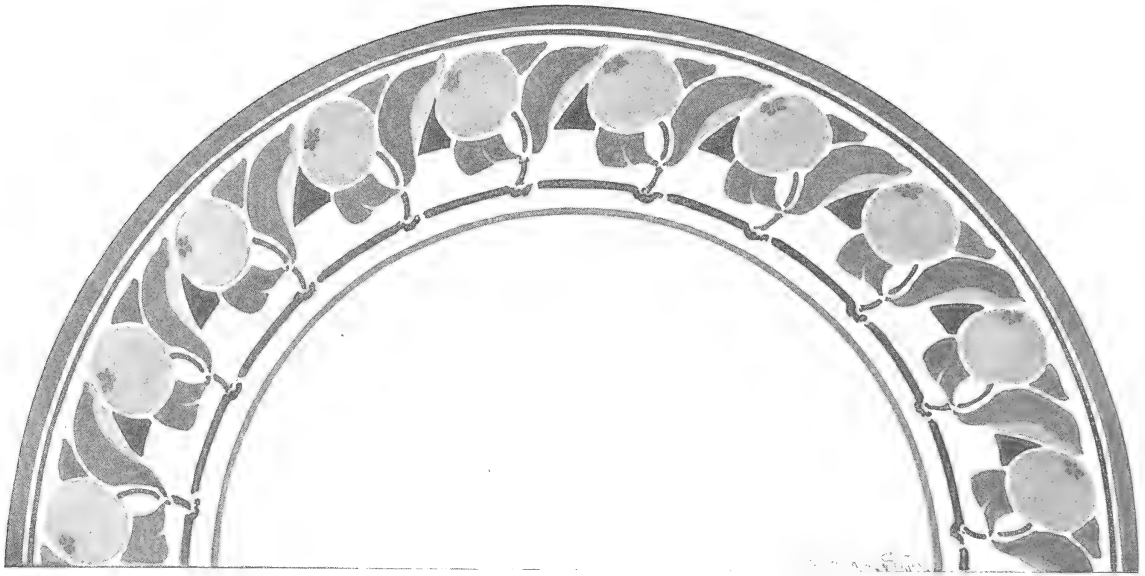

FRUIT PLATE—APPLE MOTIF

BLUES and greens as described on page 63 may be used, or design carried out in gold and white, or matt silver and white. If gold or silver is used, the under running border leaf may be painted in black. If a worker wishes to apply this motif to a cider jug or stein, a happy effect may be produced by laying the apple in flatly, with a strong tone of Carnation—the leaves with Dark Green, but strong enough only, to make a dull grey, and dry dust with Brown Green. Dry dust apples with Carnation, paint in stems with a mixed color of Brown Green and Blood Red, ground lay the body of jug with Empire Green. In the second painting, glaze

the entire border with Vance Phillips' Warm Grey. The third working is for outlines only, if they should be desired at all, and if used, make a firm bold carrying line using Finishing Brown.

After all parts of body and design are perfect and fired, envelop the entire surface with a wash of Finishing Brown, pounced evenly and firmly. A color may be pounced and left even, but if too full yet of oil, a *coarse* looking surface will be the result. A fifth firing may be necessary—it quite depending upon the success of various workings and firings.

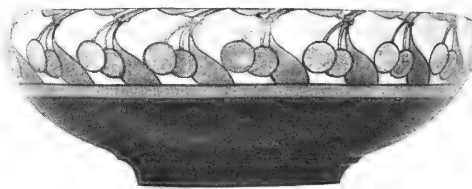

FRUIT BOWL



Handwritten signature or inscription, possibly reading "S. Wood" or similar.

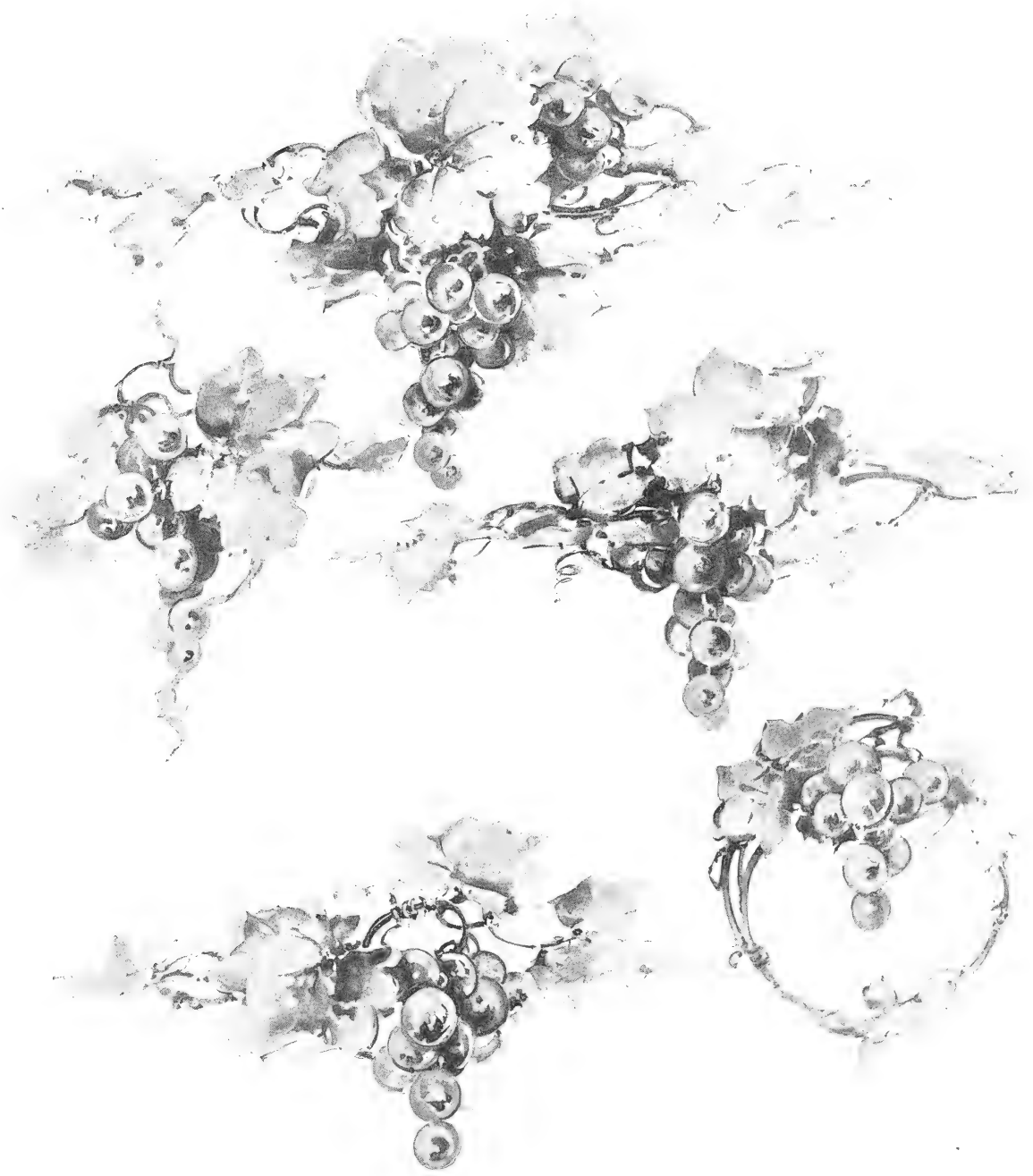

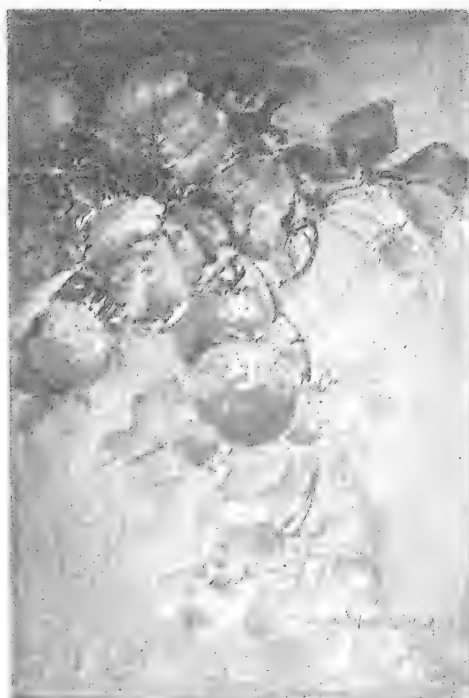
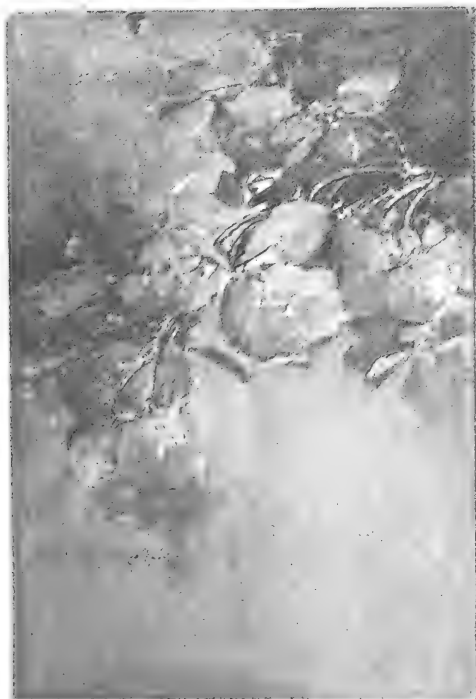

JULY, 1906
SUPPLEMENT TO
KERAMIC STUDIO

STRAWBERRIES—SARA WOOD SAFFORD

COPYRIGHT 1906
KERAMIC STUDIO PUBLISHING CO.
SYRACUSE, N. Y.

PHOTO-CHROMOTYPE ENG. CO., PHILA.

GRAPES

THREE different arrangements of the grape are given, a picture panel, a page of small decorative compositions, and a plate border design with grape motif. In copying the panel, one may paint the grapes all in purples, or in purples and reds, make a deep purple by mixing Banding Blue (two parts) and one part of Ruby, and again mix the Banding Blue and Ruby, and add enough Black to grey the mixture, mix thoroughly with the knife upon the palette, do not trust to the brush, and keep as two distinct colors. For the light soft bloom, use Vance Phillips' Violet and Deep Blue Green softly blended in the brush. For the darkest dark use the second mixed color, that is, Banding Blue, Ruby and Black, and for the medium darks use the first mixed color of Blue and Ruby.

In painting red grapes, brush with Blue and Violet over the lights to suggest a bloom. Mix with the brush Blood Red and Ruby for the deepest tone. Blood Red and Ruby with Banding Blue added, will make a warm soft

color, for the medium darks. For light leaves use Apple Green and Yellow Green greyed with Violet, for darkest leaves running into background, use the mixed purple grape color with Shading Green and Dark Green.

A warm sunny glow may be suggested back of the grapes with Yellow and Yellow Brown, but care must be taken lest too sharp and harsh a contrast be left; by toning into the background with Violet and Pearl Gray this danger may be avoided. Treat like the roses for various fires, that is, first, clean flat modeling, second, glazing with soft color washes over fruit, leaves and background. Soft blues over grapes, and sunny yellow greens or cooler blue and dark greens over leaves. Third, detail work, accenting of leaf, grape or stem.

If a fourth painting is given do not add more detail, but deepen shadows, soften edges, and work for harmonious whole. Pearl Grey washed over the entire surface helps greatly to soften and hold design and background together.

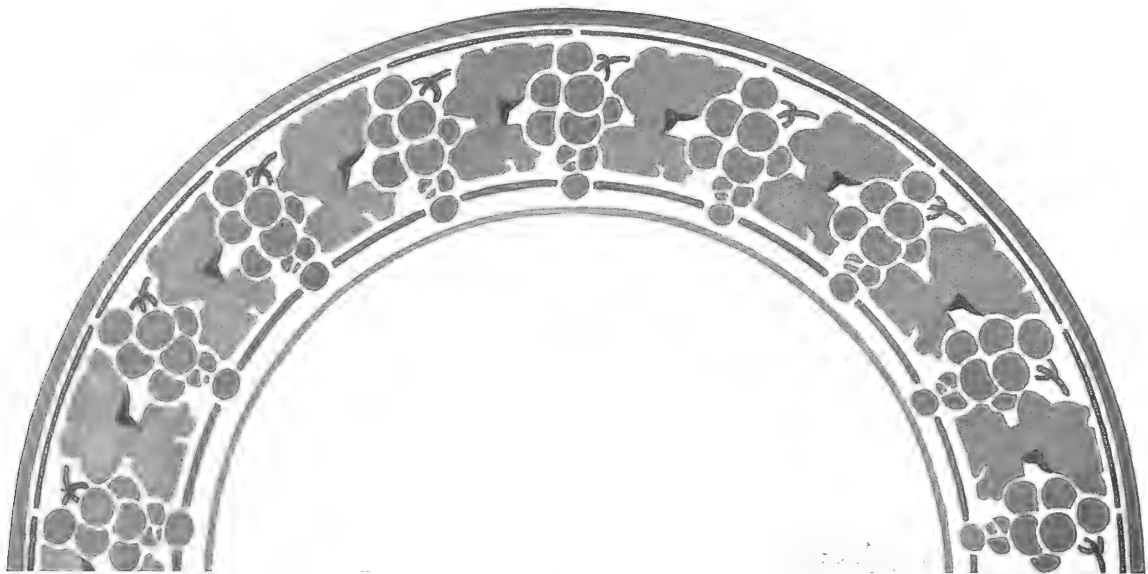

FRUIT PLATE—GRAPE MOTIF

THIS design may be carried out in tones of blue and green, gold and white or white and matt silver. If blue is desired paint smoothly and flatly with Vance Phillip's Rich Blue, using only enough oil to enable color to work easily—great care should be taken to avoid the too free use of oil, chipping is more often caused by an over amount of oil than by too much paint. If possible, while this color is yet not quite hard, dust over the entire design with some of the dry color used in painting, but before firing clean all color from the background, which must be left clear and white in order to preserve the suggested stencil effect. In the second painting deepen the blue, make firm the edges. In the third working glaze over the entire plate, border design and center as well, with a

mixed color of Pearl grey with an added "touch" of Rich Blue.

Pounce this color till it is flat, fine and firm. If green is used, lay in design with Vance Phillip's Empire Green and for the second painting, work with the green as with the blue, that is, make firm any shabby edges, deepen the tone when necessary. For the third painting, glaze the entire surface with a color made of Pearl Grey, (two parts,) and one part of Rich Blue. Pounce till firm and even and well set, though not quite hard, then dry dust with Pearl Grey. Still another fire might improve the whole, giving an opportunity for an added wash of color over the border alone. The center of the plate will hardly need to be made darker.



ROSES

Nearly everybody knows and loves a rose—that is probably why we all like to paint them. And even though our sketch is not always quite happy or successful, our attempt means something to almost everyone privileged to look at it. It certainly gives more pleasure than an equally good sketch of a rarer or a less known flower. But learn to know your rose well.

Paint the particular rose that appeals to you, the soft creamy white one or the deep hearted red one. Draw it in all positions—paint it in different lights—cover dozens of sheets with notes and facts of leaf and bud and flower, then when this is done, if it has been done honestly, the rose is yours, it is in your mind and in your heart, in your fingers, the drawings may be turned face down, and the composition made from your memory of the rose will have a charm and freedom not to be had in the direct copy of your own or another's study drawing.

The roses in the first sketch enclosed within these covers, may be treated as white and soft yellow, or as white and pink ones. A white rose is such a delicate filmy thing with its soft shadows and tender warm heart. But it will have in its shadows and in its heart something of the tones of the flowers and foliage around it. If massed with yellow ones, its petals will take a warmer note. If with pink ones, then a light blush will seem to have caught it here and there. The eye carries color from flower to flower, from leaf to leaf, from leaf to flower and back again.

TECHNICAL INSTRUCTIONS

For soft shadows in white roses use Vance Phillips' Violet and Yellow with Pearl Grey added to deepen and cool the tones. In the very light and most delicate shadows Yellow and Pearl Grey without Violet may be used. If the heart of the rose is well open, keep it rich and sunny with Yellow and Yellow Brown. If partly closed it may be deepened with Brown Green added to the Yellow Brown.

Use the same colors for shadows in petals of pink roses. But in the deep heart of the yet delicate pink rose, use Vance Phillips' Special Rose, a color for deep notes and first, hard fires. Glaze the lighter parts with Rose

and Yellow and save the high lights with thin washes of Yellow. The mixing of Yellow with Rose in the first painting of all pink flowers will greatly refine the color and help to protect the rose from turning purple under fire. If deep pink roses are desired, then add Ruby to Special Rose in the heart, and tone the whole flower lower, deepen shadows in petals, use a deeper Rose in lighter parts.

In the first painting, gray the leaves with Vance Phillips' Violet, Violet mixes well with all colors, graying without chilling the tone. A very little pure green will carry a long way, and do not fear to lay in the foliage in rather flat low tones. The lightest leaves, however, may be kept quite a clear green through the first fire until the worker knows from experience just how gray they may be painted and yet be green.

If possible, cut out the stems from against the foliage and leave clear until the second painting; then glaze with a thin wash of pure light Green. Either Blood Red or Carnation may be used with the greens, particularly with Brown Green, for a warm tawny foliage mass, and tender young leaves and stems can be suggested with Carnation and Violet.

SECOND PAINTING

Glaze the flower with Yellow over its heart, and across the tips of petals into the background. Glaze leaves with washes of Yellow Green in the light and Dark or Brown Green in the shadow. Carry Dark Green, which is in itself a deep gray green, into the background. Very little Violet, if any, is needed in the second painting which is for the purpose of softening or "pulling together" flowers, foliage and background.

THIRD PAINTING.

The detail drawing and accents should be added for this fire. The sharp thorn to the stem, the point to the leaf, the decided curl to the petal.

FOURTH PAINTING

Work for quiet subtle harmonies. Wash Pearl Grey with Violet over the entire surface, but softly blending over the edge of the petals and barely brushing the warm lights one may wish to save.

The above directions may be followed in the painting of pink roses—with the exception of special care in the use of Rose, deep hearts of flowers being painted with Vance Phillips' Special Rose.

PALETTE FOR ROSES

Vance Phillips' Albert Yellow, Violet, Pearl Grey, Yellow Brown, Blue Green, Brown Green, Apple Green, Yellow Green, Shading Green, Dark Green, Black, Blood Red or Carnation, Rose, Special Rose.



ROSES





COWSLIP FROM SKETCH IN PENCIL AND COLOR WORK

THE CRAFTS

WOOD CARVING AND PYROGRAPHY. LEATHER AND METAL. BASKETRY, ETC.

Under the management of Miss Emily Peacock, Room 23, 22 East 16th St., New York. All inquiries in regard to the various Crafts are to be sent to the above address, but will be answered in the magazine under this head.

All questions must be received before the 10th day of month preceding issue, and will be answered under "Answers to Inquiries" only. Please do not send stamped envelope for reply. The editors will answer questions only in these columns.

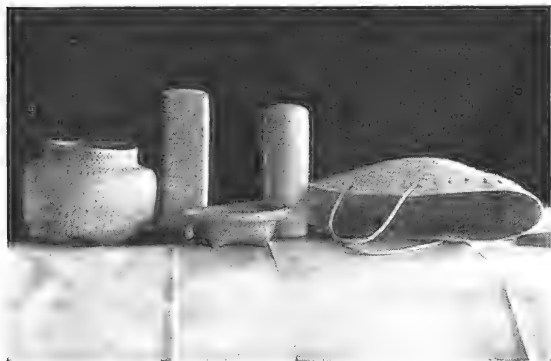

THE MAKING OF A PALMLEAF BASKET

Lucy E. Shields

THE material from which a palm leaf basket is made comes (as its name implies) from the leaves of a species of palm that grows in the West Indies. These leaves are long, measuring from one to two yards from base to tip in center, decreasing gradually in length from the center to the outer edge on either side, being, in fact, shaped like an immense fan. These leaves are put up in large bales and shipped to the manufactories.

In the early days of the industry each worker or group of workers split her own leaf, using for the purpose an implement somewhat resembling the hatchel of our grandmothers. It was set with sharp-pointed teeth, but was unlike the hatchel in having but one set of teeth, which were set in a long narrow board in groups of two, the distance between the two being determined by the width of the straw required.

For many years, however, the manufacturers have whitened and split the leaf in different widths, the straws, as they are called, ranging from $\frac{1}{4}$ to 1-16 of an inch in width. Then it is ready for the worker's order. It comes in bunches of from one to two pounds in weight and is

very damp, many times too damp for immediate use, though it must always be slightly so for the best results.

The worker's first process is trimming the leaf. Take the large end of a bunch and try each straw separately. If pliable it is all right. If not, pull up the straw till it is found to be soft and pliable. Cut off and throw away all the stiff part. When all the stiff straws have been disposed of, retie the bunch, and make the straws at this end of equal length from the tie. Now it is ready for use.

There are many kinds and shapes of baskets. The one I shall describe is a small square one, one of the simplest forms. The button is the foundation of every basket. These buttons are of many shapes and sizes, from the tiny one of the round basket, which seems but a peg to hang the basket on, to the large one which forms the whole bottom of the 9 x 17 basket.

For ours we will take from the trimmed leaf 40 straws from twelve to fourteen inches in length. Double them and

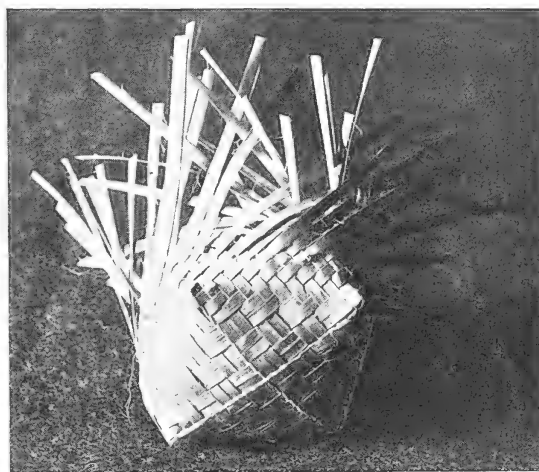

No. 2.



No. 1.

crease them in the middle. Next we must have something to tie these together so they will stay in place, while in use. For this, white thread, split straws, or raffia may be used. We will take about ten inches of thread, and in the middle of that, place one of your selected straws where it is creased. Bring either end of the thread around to the right side of the straw, so that one strand is over and one under the straw. Bring the under thread up and cross it over the upper, thus reversing the position of the two ends of the thread. Place another straw to the right of the first, draw the ends of the thread about this as before, crossing the under over the upper, and keep on in this manner, till you have tied twenty straws, or half the button. Tie the ends of the thread in a hard knot, close to the right of the last straw and cut these off within $\frac{1}{4}$ inch of the straw. Tie the other twenty in the same manner. Then lay half the button on a flat surface—your lap will do—the straws spreading out to right and left,

the tie in the center. Lay the other half across this in the opposite direction, the two ties meeting. Then from the upper half of the button above the tie, take the first ten straws at the right and put them under those beneath. Then from below the tie, take the ten upper straws at the left of this half, and put them under the ten below. (See illustration No. 1.) Now you have in your button four quarters, each containing ten upper and ten under straws. From one of these quarters take the upper straws and turn them back upon the next quarter. Then of the lower ten, leave four straws at the left. Take up and turn back the first two at the right of these, leave the next two at the right, and take up the two at the extreme right. Then lay across under the two pairs bent up, the first upper pair that were turned back.

Now beginning at the right, bring down the first pair bent up over the pair laid across. Take up the next pair at the left, bring down the next pair to the left of these, and lay the next upper pair across under those bent up. Bring down over these the pair left standing, and take up the pair farthest to the right. Lay the next upper pair across, and bring down the last pair. You have four upper straws left unused.

Lay these across like the others and leave them. Braid the other three quarters in like manner.

Thus far the button has been braided with the straws in pairs. Now starting from either corner, counting toward you, take the third pair and turn back the two upper straws. Then counting to the left from these, take up the fourth under straw. Lay across under it the first of those turned back. Take up the next under straw to the right of that one up. Put across the next upper straw. Bring down the left of the two up, and take up the next under straw to the right of the one standing. Put across the next upper straw; bring down over it the left one that is up, and take up the next right under one. Keep on like this till you reach the next corner. Here you will have one straw left up. Take up with this the first under straw in the next quarter and put under them the first upper straw in the next quarter. (It is awkward, but the thing to do, and it forms the corner of your button.) Put down as before the outer one up, and, with the one left up, take up the next under straw to the right. Lay across the next upper straw. Go on in this way till you reach the starting point, when there will be no more to take up, but put down the outer of the two up. Lay the next upper one across and bring down the last straw up. Now your button is complete. (See illustration No. 2.)

Anywhere between the corners, counting from right to left, take up the third under straw. Put the first upper one across under it. Take up the next straw to the right of the one up, put the next upper one across; bring down the outer one of the two up. Take up the next straw to the right of the one up, put the next upper one across. Continue in this manner till, as in finishing the button, you come to the place where you started, and, as before, bring down the outer of the two up. Put across the next upper straw and bring down the last one up.

We have braided a plain turn, and can keep on with these turns till the basket is five inches deep, or we can insert here a border braided "in twos."

For this we will take up the third and fourth under straws to the left, leaving two down at the right of these. Lay two upper straws across. Bring down the two left up and take up the next two at the right. Put the next two upper straws across. Keep on in this way till the turn is

completed. For the next turn, take up two under straws where there are two at the right of them down. Put the two upper ones across. Bring down over these the two up and take up the next pair at the right. Through this turn, the two straws that are put across must be over two and under two. For the next turn, bend back a pair of upper straws, and of the under ones, take up the fourth straw to the left. Lay the first upper straw across. Take up the next straw to the right. Put across another and then do as in a plain turn, the only difference being that half the time the upper straw will be over three straws and under two; the rest as before. This completes the border. The rest of the turns are plain till the basket is of the required height.

The last process is called "binding off". In this we use two three-quarter turns. These differ from the plain turn only in using one under straw at a time, so that the upper straw, when laid across, goes over two and under one. As usual, take up one under straw that has two at the right. Lay the upper one across, bring down the straw left up, and take up the next straw to the right. Do this twice more, and the third time, when you take up the straw at the right, there will be three under straws at the left of that. Take up the outer one of these, then lay your next straw across, bring down both straws left up, and take up the one at the right of each. Put the upper straw across. Do this once more. Then there will be two under straws down at the extreme left, one up, two down to the right of that, one up, and two down. Put the next upper straw across, then take the under straw at the extreme left and turn it back on the one laid across. Bring down the two straws up, over the two across; take up as before the one at the right of each one brought down. Lay the next upper one across, and turn back on it the under one at the extreme left. Keep on in this manner until you come to where there are no more straw at the extreme right to take up. Bring down the two straw left up, the one at the right finishing the first turn. Go on with second turn as before (except that the straws turned back must be slipped under the straws at right, which is the beginning of first turn), till there are no more straws to take up. There are two under straws at the left and two upper ones held down by one straw from each turn at beginning. Bend back the outer straw, slip it under the first of these, carry it to next, slip it under that. Repeat this operation and the basket is bound off.

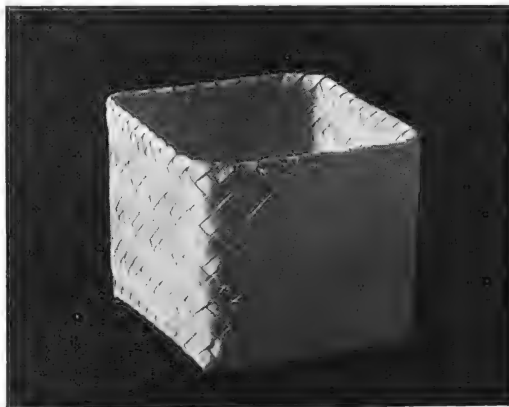

No. 3.

Take the basket in left hand, and with right, pull tight each straw turned back, so that the edge thus made may be even. Cut off both sets of straws close to basket. Dampen it, turning the edge inside the basket to the bottom, making the sides double.

Procure a square wooden block same size and depth as basket, on which place the basket. Cover with a damp cloth and that with a dry one.

Press it all over, especially the edge, with a moderately hot iron. This finishes the basket. (See illustration. No. 3.)

The cover is made exactly like the basket except that it is two, instead of five inches deep. Half of this is also turned in, making the rim double.

In pressing, stretch the cover slightly that it may fit over the basket. The covers of fine baskets must have four more straws than the basket because the button is in two parts and when put together must be halved again.

(TO BE CONCLUDED.)



CRAFTS EXHIBITIONS

The annual exhibition of The Guild of Arts and Crafts East 23d St., New York City, was held at the above address during the last week in April. The following Craftsmen sent work: Mr. Volkmar some fine big bowls and some candlesticks in matt green, Miss Frances Mac Daniel a small but good exhibit of black pottery, The Hartford Arts and Crafts some delightful candlesticks and vases. There were several attractive pieces of porcelain from The Robineau Pottery, two violet holders in quaint design and of nice color, a tall vase exquisite in tone and modeling. Mr. Herman Murphy had several of his well known mirror frames. The Misses Steel and Walker also had some very attractive ones. A. O. Westerling sent some tall, wood candlesticks carved and gilded, colonial in shape. Miss Clara Price had a very interesting portfolio of leather slightly modeled and very harmonious in color. Mrs. Busck a chair, with carved leather seat and back. Miss Hicks some stenciled fabrics.

Among the textiles a stenciled table cover in blue and white from the Trenton School of Industrial Arts deserved much credit, also the embroidered and woven table covers made by Sarah Frances Dorrance. The exhibit of metal work was not large or particularly good. Mr. Rodgers' copper bowls were interesting in color and Dr. Busck's copper tray and brass box showed good workmanship. The jewelry was not up to the usual standard and only a few of the good pieces sent were

shown to advantage, because of the poor arrangement.

The Handicrafters, Brooklyn, held their exhibition at The Club Rooms, 192 Schermerhorn St., the 5th, 6th and 7th of April. The exhibition was small, but there was some good work from the various members and other Craftsmen. The exhibits were also very well arranged. Miss Jane Hoagland sent a group of interesting pottery, Miss J. Husson and Mr. H. C. Jeffery some well carved wood, Miss M. Behr some delightful stenciled work. Miss M. Zimmerman, Miss Emily F. Peacock, Miss M. Peckham and others some very attractive and well made jewelry.

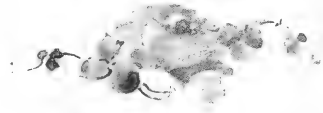

ART WORKERS ORGANIZE.

A call issued by Spencer Trask, president of the National Arts Club, to workers in arts and crafts throughout the country brought about one hundred and fifty craftsmen to the clubhouse in West 34th street. Among those present were workers in wood carving, metal work, including jewelry; textiles, all forms of woven stuffs and loom work, bookbinding, stained glass and ceramics.

A permanent organization was effected, and arrangements were made for an exhibition of arts and crafts next fall in the new home of the National Arts Club in Gramercy Park, to be the home of the organization. The announcement was made that Sir Caspar Purdon Clarke, director of the Metropolitan Museum of Art, was in hearty sympathy with the movement and would give to it his active support in every possible way.

Frederick S. Lamb presided. The organization was effected with the election of Spencer Trask, president; Arthur W. Dow, vice-president; John J. Murphy, secretary; and Emerson McMillin, treasurer. Directors, elected to serve three years, were Amy M. Hicks, Frederick S. Lamb, Charles Volkmar and Charles de Kay; directors elected to serve two years were Anna B. Leonard, Florence Foote, Charles H. Barr and Edward D. Page, and directors elected to serve one year were Mrs. Charlotte Busck, Miss E. M. Heller, J. William Fosdick and Miss Louise Cowperthwaite.

The name of the organization will be the National Society of Craftsmen, and its object will be to promote the creation and sale of products of the arts and crafts; to maintain a permanent exhibition, and to establish a bureau of information for craftsmen and clients. The membership will be professional and associate, the former to pay an annual fee of \$5 and the latter \$10.

One of the provisions of the constitution is that there shall be a jury committee of fifteen, with power to add to their number, to be elected by the professional membership, whose duty it shall be to pass upon all work submitted for exhibition or sale. Five members will constitute a quorum, one member of which must be a craftsman in the work judged.

This society, as the name implies, will embrace the entire United States. The initiative thus taken by the National Arts Club has already borne fruit.

The important question of a place for the new National Society of Craftsmen is as good as settled; it will occupy the present quarters of the Arts Club, 37 West Thirty-fourth Street, when that club takes possession of its larger clubhouse in the Tilden mansion in Gramercy Park. This is rapidly approaching completion, and the Studio Annex,

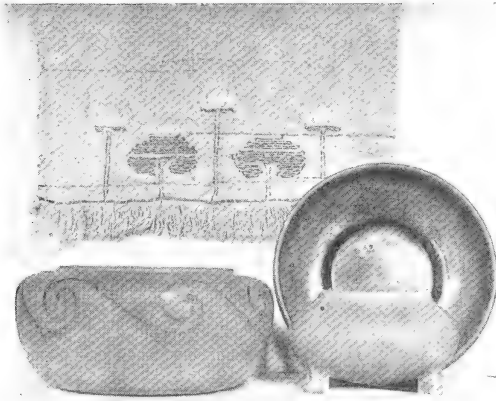

Scarf, Russian homespun, by Frances Dorrance. Pottery, by Chas. Volkmar.
New York Guild of Arts and Crafts.

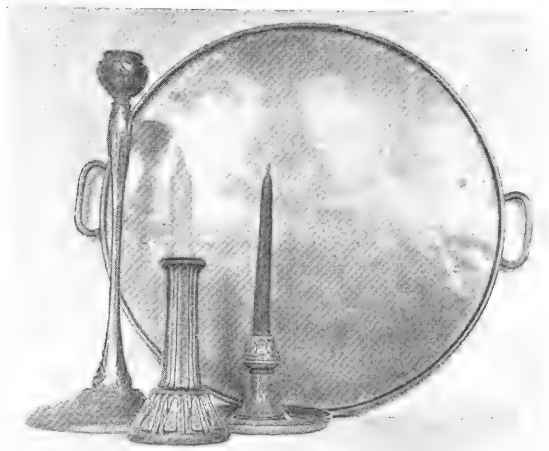

Hammered copper tray by G. F. Busck; carved candlestick overlaid with gold
by A. O. Westerling; candlesticks, Newcomb Pottery and Chas. Volkmar.
New York Guild of Arts and Crafts.

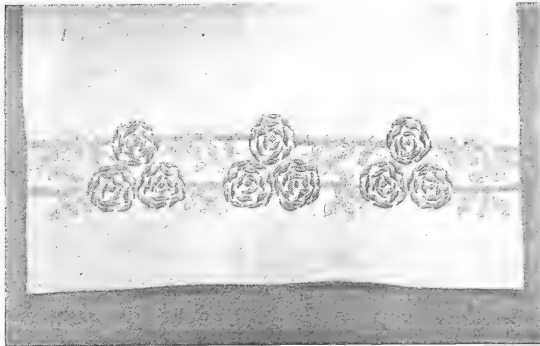

Embroidered table cover in blue and white.
New York Guild of Arts and Crafts.



Pottery, Jane Hoagland. Handicrafters Exhibition, Brooklyn.

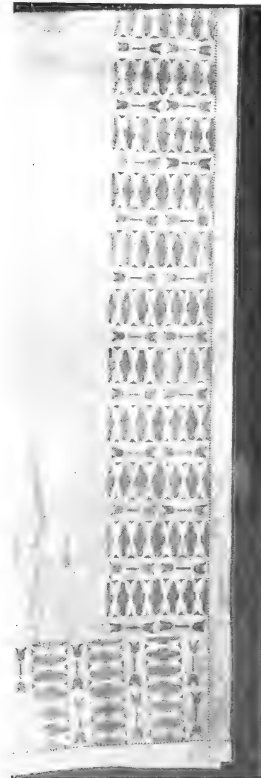

Stenciled table cover in blue and white, from Trenton School of Industrial Arts.
New York Guild of Arts and Crafts.

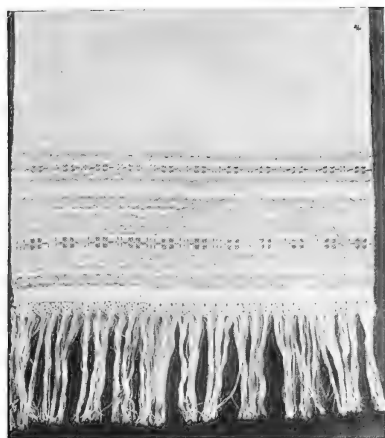

Table Cover, border darned in with blue thread.
New York Guild of Arts and Crafts.

which was retarded for six weeks by the strike of the house-smiths, is rising swiftly on East Nineteenth Street.

The organization of the Society Craftsmen at its present stage includes as Chairman Miss Amy Mali Hicks, and Secretary Mr. J. J. Murphy. Art jewelry is represented by Mr. Walter Lawrence, pottery by Mr. Chas. Volkmar, ivory carving by Mr. Fred W. Kaldenberg, printing by Mr. Theodore de Vinne, bookbinding by Miss Foote and Miss Emily Preston, textiles by Mrs. Douglas Volk, ceramics by Mrs. Leonard, metal work by Miss Charlotte Busck.



ANSWERS TO CORRESPONDENTS

S. M. H.—Liquid bright silver comes from the kiln blurred when it has been put on too heavily. The only remedy is to remove with aqua regia or some erasing fluid. Hydro-fluoric acid is the only acid with which one can remove fired paint, use it with a pointed stick, do not breathe the fumes or let it touch the skin, wash the piece in running water when the color is loosened. We do not know the cause of opal lustre blurring glass as we have never used lustre on glass. We did not know it could be so used, but as lustres are all somewhat opaque they would naturally give glass a heavy look, the iridescence seen sometimes on glass is obtained by an entirely different process which is known only to the manufacturers.

Mrs. A. L. W.—Greens are very liable to come out a mottled brownish color on Belleek, especially Royal Moss, Sevres and Brown Green. Never use these colors on Belleek. Some times part of the color will be brownish and the balance green.

M. H. M.—For your jardiniere with lion handles and separate base, we would advise finishing in black, either mat or bright. This will set off the color better than gold or a lighter color although a dark color might be used, which harmonized with the color scheme, a brown or green perhaps or a dark bronze could be used with good effect.

Mrs. J. H. P.—For the Tobacco Jar by Lottie Rhead in December KERAMIC STUDIO use ochre tinted for the lightest tone, painted for the medium light tone, Meissen Brown for the dark tone and Black for outline.

G.—For your loving cup which has been painted in currants and which you would like to redecorate, we would suggest redecorating in mat colors, raised paste or enamels and gold could be added if desired. It would, in such a case, be hardly necessary to remove the original colors.

Mrs. P. J. W.—For a rich dark blue use Dark Blue with a touch of Purple 2 if using La Croix Colors. If you use powder colors, write to the makers and ask their advice, most of the makers of colors have a special mixture for this purpose. To get a really dark color, rely on two fires; if put on heavily, for one fire, the color is liable to chip off.

R. M.—To soften water colors in pans, rub them down with water and glycerine on ground glass with a muller. It is impossible to exactly match water colors in mineral colors. We will reprint the color chart as soon as we can have it put in better shape adding the suggestions for executing water colors in mineral paints. We do not know of any good book on water color painting but any possible information we will be glad to give if you will let us know what information you wish.

M. A. C.—Chinese white in mineral colors was once used for touching in relief the tips of flowers, etc, yellow relief for gold is to be used like raised paste and gilded with liquid bright gold.

A. R.—Winsor and Newton water colors are the best. Soak your water color paper until evenly wet, perhaps ½ hour. Soak your blotter letting the surplus run off, lay blotter on board or pane of glass on board—as board will eventually warp—spread paper on blotter beginning with one edge and slowly laying down to avoid air bubbles and wrinkles. When quite smooth and free from bubbles, fasten with four ½ inch rubber bands, each crossing the other at the corners. These can be lifted and the paper straightened if necessary. We have no recipe for grounding oil but will try to obtain one for publishing. Your study was returned to the office before your letter was received by the editor so will be unable to criticize it. It is always worth while to make studies, even if not purchased or used. No one ever starts at the top. We have many, many studies and designs submitted, many of which we purchase and never use as we have more material on hand than we can publish, so often we have to refuse quite good work, but no one should be discouraged as continued and earnest work must bring success in time.



PUBLISHERS' NOTE

“Camera Craft” (one of the most interesting magazines on the subject of “Amateur Photography”) which suffered a total loss in the San Francisco disaster and is temporarily moved to Sacramento, writes to us that on account of limited facilities the May and June issues will not be up to their usual standard but will contain interesting personal experiences of the earthquake and fire. As brother publishers, we sympathize with “Camera Craft” in its loss and hope that the future will have for it a full measure of prosperity.

VANCE-PHILLIPS CERAMIC SUPPLIES

<p>Ceramic Summer School JULY AND AUGUST Instructors: L. Vance-Phillips Sara Wood Safford } New York Lillian Forbes Sherman } Blanche Van Court Schneider, Chicago For Summer School Circular Address L. Vance-Phillips, Chautauqua, N. Y.</p>		<p>Vance-Phillips Flesh Palette Mineral Colors in Powder. Each combination carefully prepared and tested. Sold in sets of ten colors. Sold in complete sets, including brushes, stiplers, mediums, etc., together with a folder giving brief instructions for use. Vance-Phillips Condensed Painting Palette High Grade Mineral Colors in Powder, containing the essentials for painting. A Line of Selected Brushes, Mediums and Materials</p>
---	--	---

Until Sept. 1st Price Lists will be sent and mail orders promptly filled from the Studio at Chautauqua, New York

USE HIGGINS'



and learn what's what in inks and adhesives for tracing designs on china, photograph mounting, and general office and home use. Emancipate yourself from ill-smelling and dirty pastes and mucilages, and corrosive and weak-colored inks, and adopt the HIGGINS' INKS AND ADHESIVES. Their high qualities will be a revelation to you. **At Dealers Generally.**

CHAS. M. HIGGINS & CO. Originators and Manufacturers
 Refined Inks and Adhesives.
 NEW YORK CHICAGO LONDON
 Main Office and Factory, Brooklyn, N. Y., U. S. A.

Drawing Inks, Blacks and Colors
 Eternal Writing Ink
 Engrossing Ink
 Taurine Mucilage
 Photo Mounter
 Drawing Board and Library Mucilage
 Office Paste
 Liquid Paste
 Vegetable Glue, etc., etc.

White China for Decorating

WE are pleasing others and we can please you if you will give us the opportunity. We have had many letters of late complimenting us on our prompt shipments of White China. We are able to make prompt shipments only by carrying a very large and complete stock. Our large Illustrated Catalogue of White China and Materials free for the asking. Send to-day.

THE A. T. OSBORN CO.
 IMPORTERS
 224-226 Seneca Street Cleveland, Ohio

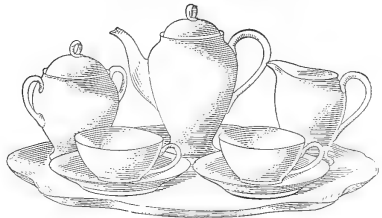

OUR "ELITE" FRENCH CHINA
 VIENNA CHINA
 BAVARIAN CHINA
 AND GERMAN CHINA
 IN WHITE
FOR DECORATING

Are sold by the leading merchants throughout the United States. All the latest shapes are illustrated
 IN OUR NEW CATALOGUE
 Now ready for mailing. Write for copy to-day.

BAWO & DOTTER
 MANUFACTURERS
 26 to 34 Barclay St., New York

L. REUSCHE & CO.
 Importers and Manufacturers
 Sole Agents for



Hancock's China and Glass Colors

An Immense Variety of

German Colors	} By the Pound or Ounce
French Colors	
English Colors	
Liquid Lustre Colors	
Lacroix Fat Oil	} By the Gallon or Pint
Dresden Thick Oil	
"Elarco" Tinting Oil	
All Other Mediums	

"Elarco" Mat Roman Gold— $\frac{1}{4}$, $\frac{1}{2}$ and 1 oz. Pots.
 Hand-made French Pencils and Brushes
 Of Unsurpassed Quality.
 All China Painters' Requisites. Write for Illustrated Catalogue.

71-73 Park Place, New York



The tiny Todkins' all agree Upon the lawn to plant a tree.

We are constantly creating and devising new ideas in Decalcomanias to meet every requirement.
 The Tiny Todkins Series is one of our latest. Send for samples.
 Our Decalcomanias are the exclusive, special kind you can't get elsewhere. Cost less, too.

CERAMIC TRANSFER CO.
 656 Broadway, New York

KEEP THE FIRE ALIVE

KERAMIC STUDIO

CONTRIBUTORS

F. B. AULICH	x	x	x	x	x	x	x	x	x
NANCY BEYER	x	x	x	x	x	x	x	x	x
CHARLES F. BINNS	x	x	x	x	x	x	x	x	x
LUCY E. CHILDS	x	x	x	x	x	x	x	x	x
EMMA A. ERVIN	x	x	x	x	x	x	x	x	x
RUSSELL GOODWIN	x	x	x	x	x	x	x	x	x
MARY TURNER MERRILL	x	x	x	x	x	x	x	x	x
LAURA OVERLY	x	x	x	x	x	x	x	x	x
HANNAH OVERBECK	x	x	x	x	x	x	x	x	x
MARY OVERBECK	x	x	x	x	x	x	x	x	x
PAUL PUTZKI	x	x	x	x	x	x	x	x	x
SABELLA RANDOLPH	x	x	x	x	x	x	x	x	x
F. ALFRED RHEAD	x	x	x	x	x	x	x	x	x
EDITH ALMA ROSS	x	x	x	x	x	x	x	x	x
ALICE WITTE SLOAN	x	x	x	x	x	x	x	x	x
BELLE BARNETT VESEY	x	x	x	x	x	x	x	x	x
SOPHIA A. WALKER	x	x	x	x	x	x	x	x	x
CARRIE WILLIAMS	x	x	x	x	x	x	x	x	x
MARIE CRILLEY WILSON	x	x	x	x	x	x	x	x	x

AUGUST MCMVI Price 40c. Yearly Subscription \$4.00

A MONTHLY MAGAZINE FOR THE POTTER AND DECORATOR

CONTENTS FOR AUGUST 1906

	PAGE
Editorial	73
League Notes	73
The Class Room—"Ground Laying and Tinting"	73 to 84
Passion Flower	75
Borders for Punch and Salad Bowls	77
Bowl Border and Punch Cup	77
Punch Cup and Bowl Border	77 and 90
Study of Butterflies	79
Dragon Fly Plate	81
Gloxinia	83
Marigold (Supplement)	84
Y. W. C. A. Art School Plate	84-85
Tin-Enameled Ware—(4th paper)	85
Wild Rose—Decorative Study	86
Christmas Rose (See editorial)	87
Club Notes	88
Rocky Mountain Columbine	88
Fruit Bowl	88
Water Pitcher—Wild Rose Motif	89
Water Borders for Salad Sets	89
Asters	90
Purple Clematis—(Virgin's Bower)	90
Design for Portfolio or Frame	91
The Crafts—	92
The Making of a Palmleaf Basket	93-94
Providence Technical High School	94-95
Answers to Correspondents.	94

LIST OF BOOKS

The Rose Book, containing some of the best rose studies and designs published in Keramic Studio postpaid \$ 3.00	Tulip Ware of the Pennsylvania German Potters, by Edwin A. Barber, in paper cover postpaid 1.10
The Fruit Book, containing some of the best fruit studies and designs published in Keramic Studio postpaid 3.00	Tulip Ware of the Pennsylvania Potters, by Edwin A. Barber, cloth, limited edition postpaid 5.00
Composition, by Arthur Dow postpaid 1.65	Encyclopedia of Ceramics, by W. P. Jervis postpaid 6.75
Principles of Design, by E. Batchelder postpaid 3.00	The Old China Book, by N. Hudson Moore postpaid 2.18
Decorative Studies, by J. Foord postpaid 12.50	The Old Furniture Book, by N. Hudson Moore postpaid 2.18
Plant Forms and Designs, by Midgley and Lilley postpaid 2.20	Old Pewter, by N. Hudson Moore postpaid 2.18
Practical Pottery, elementary instruction for students, by Richard Lunn postpaid 2.50	Chats on English China, by Arthur Hayden postpaid 2.16
Grand Feu Ceramics, a practical treatise on the making of hard porcelain decorated with high temperature glazes by Taxile Doat of the Manufactory of Sevres, France postpaid 7.50	Chats on Old Furniture, by Arthur Hayden postpaid 2.18
Seger's Collected Writings, 2 volumes postpaid 15.50	China Collecting in America, by Alice Morse Earle postpaid 3.20
For the Collector:	Pottery and Porcelain, a guide to collectors, by Frederick Litchfield, the English expert postpaid 6.25
Vol. II Old China, bound blue cloth postpaid 2.50	French Pottery and Porcelain by Henri Frantz postpaid 2.68
Vol. III Old China, bound blue cloth postpaid 3.50	Dutch Pottery and Porcelain, by W. Pitcairn Knowles postpaid 2.68
Anglo-American Pottery, a manual for collectors, by Edwin Atlee Barber, Curator of the Pennsylvania Museum, second edition postpaid 2.00	Old English Furniture, by Fred Fenn and B. Wyllie postpaid 2.68
American Glassware, old and new, by Edwin A. Barber postpaid 1.00	English Embroidery, by A. F. Kendrick postpaid 2.68
Marks of American Potters, by Edwin A. Barber postpaid 2.25	French Furniture, by Andre Saglio postpaid 2.68
Pottery and Porcelain of the United States by Edwin A. Barber postpaid 3.75	Old Pewter, by Malcolm Bell postpaid 2.68
The Lace Book, by N. Hudson Moore postpaid 5.30	Sheffield Plate, by B. Wyllie postpaid 2.68
	The Oriental-Rug Book, by Mary Churchill Ripley postpaid 3.20
	Home Furnishing, practical and artistic, by Alice M. Kellogg postpaid 1.65
	William Adams, an old English potter, by William S. Turner postpaid 8.00

Keramic Studio Pub. Co., Syracuse, N. Y.

KERAMIC STUDIO

Vol. VIII, No. 4

SYRACUSE, NEW YORK

August, 1906



SEVERAL have written asking for information in regard to the "Christmas Rose" subject of the Christmas competition. We have no very clear study, but publish in this number the only one we could find. The Christmas Rose is not a rose at all; it is a sort of Anemone which comes up through the snow and blooms about Christmas time. It is white with sometimes a tinge of pink and a yellow center. We will try to publish another study next month.

✦

There seems to be a general exodus of craftsmen and china decorators in Europe this summer. Among our well known workers are Miss Emily Peacock, Mr. Marshal Fry, The Misses Mason, Miss Stewart.

We may look for some newly inspired work in the fall and trust that the readers of KERAMIC STUDIO may reap the benefit.

✦

Do not forget to gather material for the winter work and to gather new material, find for yourselves subjects that have not been overworked and color harmonies in nature that will lend a new charm to your interpretation of her offerings. There is a large and fertile field hardly touched both in wild and garden flowers, in insects and other forms of life, in landscape and in sky.

✦ ✦

LEAGUE NOTES

The greatest opportunity of the members of the League confronts us now, the re-establishment of the San Francisco club, only those who have passed through a like experience can understand the difficulties which must be overcome. No materials, no utensils, no demand for the work, almost broken hearts but indomitable wills, is the key to the situation. The League treasury is low, but at the last Board meeting fifty dollars was voted them and a motion passed to request every member of the N. L. M. P. to give from his studio at least one study. This is asking very little, so we beg of you not to neglect or defer it. Send to day to Miss Minnie Taylor, 31 Parnassus Ave., San Francisco, Cal.

Our study course, which is no longer an experiment, will be equal to a course in design. As previously stated in the KERAMIC STUDIO, we have selected three (3) flowers; the Poppy for the west, the Dandelion for the Middle States and the Field Daisy for the East. Three vase forms are to be selected later, on which to use these flowers. Study the flower during the summer months and in September send drawings with color scheme to Belle B. Vesey, 6228 Wabash Ave., Chicago, Ill. Do not undervalue this problem. Study also the grape as that will be used later on the "Farrington" punch bowl.

In the travelling exhibition the steins only will give an idea of our work, as the bowl and plate designs were received too late to be used and sent to the exhibition.

BELLE BARNETT VESSEY,
President.

✦ ✦

THE CLASS ROOM

The next subject for the Class Room will be "The Art of Teaching," a course for beginner, referring to some designs published in KERAMIC STUDIO for illustration. This should explain just how to start a beginner, what kind of piece to work upon, what style of work to attempt, what steps to take in the work, etc., up to the advanced and finished work. A special extra first prize of \$10.00 will be added to the usual prizes if a sufficiently good article is sent. Articles should be received not later than Sept. 5th.

o o o

GROUND LAYING

First Prize—Mrs. G. B. Straits, Cazenovia, N. Y.

TECHNICAL skill may only be obtained at the price of much labor, for there are no "bargain" methods for the one who aspires to be a good painter in ceramics.

The subject of ground laying is especially important, as a successfully laid ground will enhance the beauty of any piece, while one with muddy tones or ill chosen colors will destroy the harmony of the most excellent subject.

GROUNDING.

Before beginning a piece, place all necessary materials near at hand, where they may be readily obtainable. Now draw with India ink any design desired. Cover the surface to be grounded with good grounding oil, painted on with a large brush as smoothly as possible, and pad lightly with a bit of cotton loosely covered with soft silk, until the surface is even and possibly slightly "tacky".

If the surface is even before the oil grows sticky, set the piece in some place where it will be free from dust, until it becomes so. Many put a tiny bit of lamp black in the oil so that any variation in the coat may be readily discernible. If a rather thin coat is desired add an equal amount of turpentine to the oil.

In this way it will dry quickly, the color may be laid on without delay, and the danger arising from the collection of dust will be avoided.

Now carefully remove the oil from any part not to be grounded, and with a palette knife drop on the oily surface a good quantity of powdered color which has been re-ground or sifted through a copper wire sieve or fine bolting cloth. This will prevent the heavier particles of paint making dark spots when fired.

When the surface has been covered with the paint, with a very soft brush, or a bit of cotton, push the color about until it is evenly distributed and the oil has absorbed all the color possible, while every bit of the surface appears dry. Be careful not to allow the cotton or brush to touch

the uncovered oil. The extra color may now be dusted off on a paper laid under the piece for the purpose, and replaced in the vial.

If after firing the tone is not deep enough, the process may be repeated the next fire.

When Velvet Rose, Ruby, Roman Purple or Maroon are used for grounding, the oil must be used thinner than for other colors, as otherwise they may scale in firing, or what is equally unfortunate, may fire a heavy, disagreeable brown, with no richness or transparency.

Whether grounded or dusted, all extra powder color must be carefully blown off before firing, as otherwise it is liable to come off and settle on some other piece in the kiln.

Dusted colors should never be dried by artificial heat, as the oil, which keeps open for a considerable time, may cause the colors to run.

In case the paint blisters in firing, the defective spot may be sanded off and retouched with the color used or if in a really serious condition the place may be cut out with a small knife until in as even a condition as possible when it may be further smoothed by the use of pumice stone then repainted.

Never remove a grounding color from a design, no matter whether mat or bright colors are used, until the surface is hard and dry. A sharp knife or erasing oil may then be used.

REMOVING DRY COLOR.

A good, practical eraser for removing dry, unfired color, is made by pouring several drops of fresh tar oil, procurable at any drug store, on the palette, rubbing a few shavings of good hard soap into it with a palette knife until it may be put on the painting without running.

The tiniest particle of lamp black may be added so as to render it plainly visible when applied. As this preparation thickens it may be thinned with turpentine. Take a brush heavily charged with the eraser, and paint over the thoroughly dry color that must be removed. In a short time, by wiping over the place with a small piece of cloth, the eraser and paint will both come off, leaving the china perfectly clean. In order to avoid injuring the adjacent tint, it is advisable to wipe from the edge toward the middle.

Fire hard enough to produce a good glaze at first, for if the strength is lost it may be regained by the after paintings, while it is impossible to obtain an underglaze effect without this hard fire. If the coat is heavy it must be fired slowly to avoid blistering.

TINTING, BACKGROUND, ETC.

In a background always avoid a medley of colors. Do not overwork, but strive for fresh, pure tones in a broad, simple way, working with as large brushes as are permissible, keeping the background really subordinate to the subject.

An artist once remarked that the greatest compliment he ever received on backgrounds was when a critic, on being asked concerning a ground he had painted, said, "I didn't notice what it was like, though of course it had one."

Decide what colors are to be used before beginning to tint, using such as will produce a harmonious effect, allowing no overworking of them. Let there be no sudden, "jumping off" place in the tints, but let the gradation be so subtle that one color really melts into another, as delicacy is one of the principal qualities sought for.

In naturalistic work use the same colors in the background that are found in the subject painted, possibly adding blue to give atmosphere. When large white lilies and lilies of the valley are painted, the addition of soft pinks and yellows in the ground will be charming; while with blood root blossoms a touch of the blue of the scylla will be effective.

In flower or fruit decorations the darkest color should come from back of the brightest part of the design, shadowy foliage being softly painted into the background, making them supplementary to the prominent cluster, and leaving no hard, tight edges.

When several colors are used in a background they are usually put on clear and blended into each other, though occasionally they are mixed before applying. Repeated paintings and firings are the best way to secure rich dark tints free from streaks.

For tinting, the mediums that may be bought ready prepared for the purpose are good or any of the formulas recently published in the "Class Room" may be used. The rule—as much fat oil as color, made thin with lavender oil,—is excellent.

METHODS OF APPLYING TINTS.

It is well for the beginner to tint some flat object in monochrome until accustomed to the handling of the brush, then with a large brush slightly moistened with the medium and the tip touched into the color, go quickly over the whole surface to be covered with light firm strokes, allowing the brush marks to touch each other.

While still moist, pad lightly over the entire surface not touching the same place twice unless it is to remove some spot where the tint is too heavy; or if left too oily and it settles in spots it may be softly repadded when partly dry. Where one part of the tint is to be darker than the rest, paint heavier in that portion and pad from the lighter part of the tint toward the dark.

The iron reds may fire out if too thinly painted, but this can be remedied in subsequent firings, as the same colors may be used again.

If the paint settles in spots that will not soften under the blender, it proves that the paint is too dry and should be removed.

Where one is skillful it is well to paint the background before the design, then finish the piece at one sitting, as in that way the edges are kept softened.

A wash of color over a well dried tint is possible, but requires considerable skill to do well. Defective work may sometimes be covered by an irregular design of lines in gold or black, etc., but this is seldom satisfactory.

If a tint is marred by a touch or by dropping oil or turpentine upon it, pad as quickly as possible in order to remedy the accident.

If this cannot be done, remove at once with alcohol or turpentine and begin again.

DUSTING.

As it is a difficult matter to put on a deep tint wet, the practice has grown of putting dry powder color on a damp surface painted over with colors in the usual manner. This treatment not only deepens the color tones, but the additional flux from the extra amount of paint produces an unusually high glaze.

The dusting process may be repeated any number of times if refired between each coat, and the same color used on the painted surface is generally used in dusting.

The method of application may be briefly described



PASSION FLOWER—F. B. AULICH

(See Treatment page 86)

as follows: Paint a piece with any colors desired, and when nearly dry, or so as to admit of bearing on rather heavily when rubbing in the colors, but while still moist enough to hold a thin coat of powdered paint, with a piece of cotton batting or surgeon's wool dipped into color rub over the surface, always being careful to keep color between the wool and the ground that is being covered. It is advisable to have a pile of each color used, on a separate piece of paper, with a bit of wool for each color, in order to more readily keep the colors pure.

o o o

Second Prize—Sydney Scott Lewis, Georgetown, Ky.

Under the head of Ground Laying come four very important subjects that should be thoroughly understood by the china decorator.

1. Grounding.
2. Tinting.
3. Dusting.
4. Painting in backgrounds for naturalistic work.

GROUNDING.

The color is generally grounded on if you wish a highly glazed surface, more especially if a deep tint is desired. Have the piece clean and free from dust, paint the surface to be grounded with Hancock's English grounding oil (for small spaces Osgood's oil, it dries too quickly for large spaces). Put the oil on as smoothly as possible with a large soft brush. With pads of surgeon's cotton covered with two thicknesses of clean soft silk pad until the oil sounds tacky. The longer you pad the less oily and more even the finished ground. It will be of course thinner which is more to be desired than a thick ground, for you can always get the desired depth by a second coat after firing. And thus avoid a possible chipping or scaling if the ground is put on too thick. After the oil has been padded sufficiently pour out on a plate a good lot of powdered color that is free from lumps and grit, made so by passing through bolting cloth or copper sieve. Place a clean paper under plate to collect the loose powder, this can be put back in the bottle and used to the last bit, provided it is "bolted" when it begins to be lumpy or lumpy. If there is to be a design wiped out on the ground for color, gold, paste or enamel, draw in the design with India ink before putting on the oil, then after oil is padded wipe out the oil from the design. Next take up a lot of color (powder) on your palette knife and drop it on the oiled surface, with a wad of cotton (or brush) push the powder evenly and gently over the surface, being very careful to keep a good lot of color between the oil and the pad, keeping the powder well ahead of the cotton. When the entire oiled surface has been covered with color, dust back over it several times, then wipe off all loose powder, and if there are any wet or thin looking spots, dust on some more powder until the oil has absorbed all the powder it can, then remove all loose powder, wipe out all that has adhered where the design is to be and the result should be a smooth, velvety looking ground. Set away to dry before doing more work on the piece, as it is very soft and easily scratched. Should it have a small scratch or spot this can be remedied in the second fire by painting over the spot with wet color. A larger spot can be remedied before first fire, by putting on a little oil, bringing it up to but not touching the edge of the spot and dusting powder on, then retouching with wet color the second fire. Mat colors are much used for grounding in conventional work, used with gold over

raised paste. They are grounded on just the same as bright colors. If a mat ground chips in repeated fires, fill up the chips with hard enamel and touch with powder colors. Roman Purple, Ruby and Maroon are difficult colors to ground. They should be sifted and ground down with a glass muller, the oil used very thin, else they will not be transparent and will turn brown. Maroon is a rich red when grounded. If grounded color chips off, too much oil has been used and absorbed more color than the glaze can hold, sometimes it does not chip until the second or third fire, fill up the chips with hard enamel and touch with color. Color grounded on is especially fine for borders for plates, outside of bowls, bottoms of steins and pitchers in any conventional work when a rich glazed surface is desired. A luminous black is obtained by grounding Red Brown for first fire and Dark Blue for second. The best grounded black is obtained by putting with the black either Banding Blue or Pompadour. If a very light ground is desired have oil very thin (thinned with lavender oil) pad a long time and let stand before putting on color. If the ground comes out thin and spotted when a dark ground is wanted, for the second fire mix the color and put on as a tint.

To dust on a ground of different colors, say some pure color and some mixed color, make a mixture of the colors you wish, pad in the oil, put on some pure color, then the mixture, then another pure color that has been used in the first mixture or in the second if more than one mixture has been used, then the second mixture, then pure color, working one color well into the other so there will be no spotted appearance. In the second fire bring the whole together by dusting on some single color. A heavily grounded color will not stand many fires.

Grounding oil can have a little bit of the color you are to use put in the oil to make it show plainer and you can see if the entire surface is covered and if it is padded evenly. If the ground after firing feels rough to the touch smooth with fine sand paper.

TINTING.

One of the most important things about china painting is to be able to put on a good tint, smooth, free from dust and oil and of the desired shade. Have the piece clean and dry. If a design is to be wiped out on the tint, draw it in with India ink, before tinting. Have at hand plenty of clean surgeon's cotton in different size wads, when ready to use place over this cotton two thicknesses of soft silk, this will keep the cotton from pulling through into the paint. Tube colors are better for tinting than powder, but the latter are good if rubbed thoroughly or sifted; and they require no flux, except that the iron reds like Carnation and Red Brown when put on lightly are apt to fire out, use a little flux to prevent.

Rub the powder colors to the consistency of stiff tube color, with Fry's medium, then put in about as much fat oil as you have color, rub well together and thin to the desired thinness with lavender oil. Light tints can be put on by using a good deal of medium, less lavender oil and no fat oil. After the paint seems to be mixed right try a little sample of it on an odd bit of china, if it separates and looks lumpy it needs more rubbing, if it pulls from the china it needs more oil, if it looks bubbly it is too oily. When it pads evenly and smoothly it is ready for use. For a large surface put on rapidly with a large tinting brush, be sure and have the brush perfectly clean and soft, pad rapidly, lightly and evenly over the entire surface, not in spots here and there. When



AUGUST 1906
SUPPLEMENT TO
KERAMIC STUDIO

MARIGOLDS—LAURA B. OVERLY

COPYRIGHT 1906
KERAMIC STUDIO PUBLISHING CO.
SYRACUSE, N. Y.

PHOTO-CHROMOTYPE ENG. CO., PHILA.

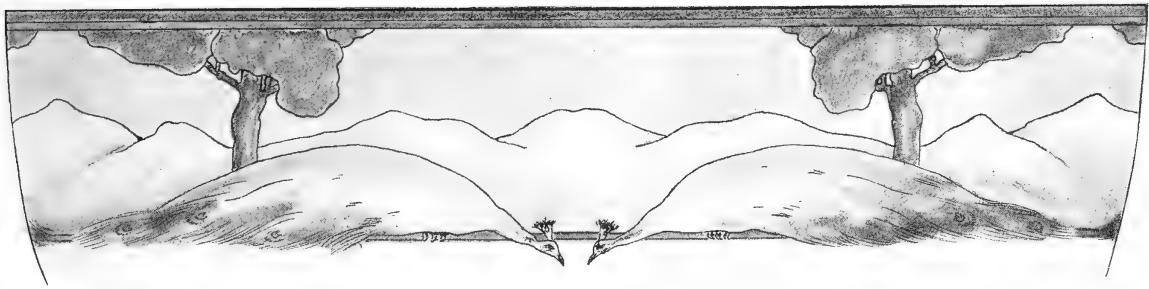

BORDER FOR PUNCH BOWL—ALICE WITTE SLOAN

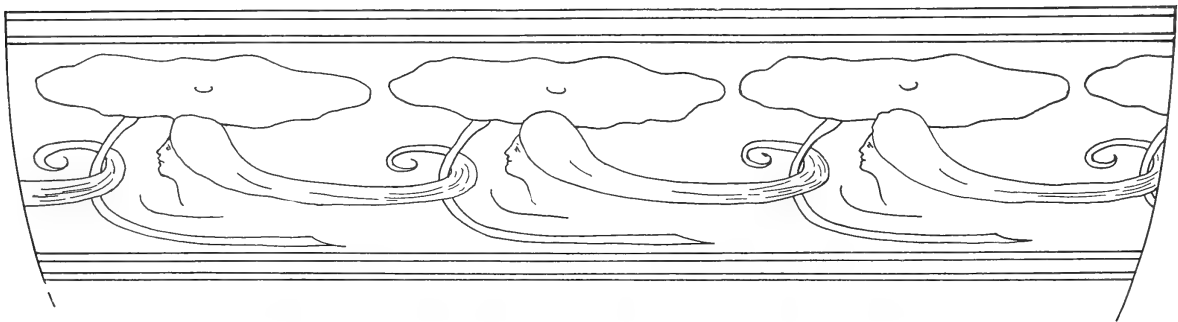

BORDER FOR SALAD BOWL—ALICE WITTE SLOAN

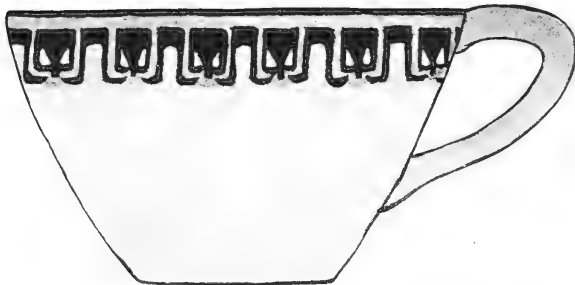

PUNCH CUP—MARY OVERBECK



PUNCH CUP—RUSSELL GOODWIN

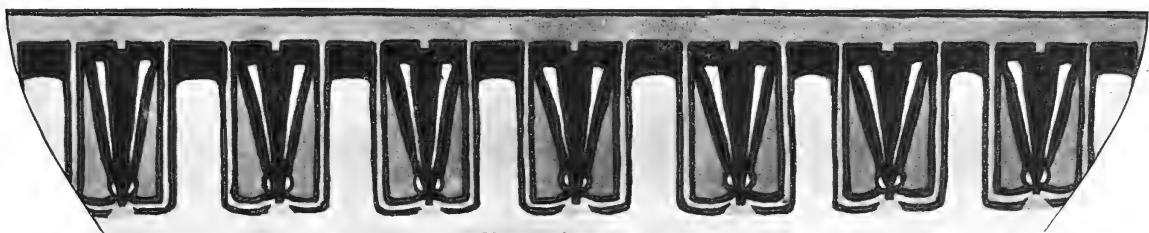

BOWL BORDER—MARY OVERBECK

the pad becomes charged with color take a fresh one, pad until the space desired tinted is covered with a clean velvety looking tint. The design then can be easily wiped out while the tint is still wet.

Mat colors are used in tinting just the same as the bright colors, they may be semi-glazed by adding 1 part flux to 4 parts color. The dark mat colors require less oil; after firing, smooth the mat surface with fine emery paper. For tinting have a few stipplers and a blender for use under handles, etc.

When the tube colors are used use $\frac{1}{3}$ flux—except in Apple Green, Mixing Yellow and Pearl Gray. The best tinting is done with Dresden thick oil, Fry's medium and lavender oil and not with a prepared tinting oil. To blend a tinted color into a powder color take some of the powdered color used in dusting and rub into the tinted edge with a brush before the tint is dry. If you wish to tint part of a piece one color and blend into another, have both tints mixed ready to use, paint on one then bring the other up to it and blend together with the daber. After a tint is dry look over it and remove any speck of dust with a fine point or dust scraper.

DUSTING.

Color is dusted on different parts of nearly dry painted china to get atmosphere, soft effects, depth and glaze, using blues to blend into skies, brown and reds to blend into dark backgrounds, also to give tone and balance to the whole.

The glazes such as Lavender, Ivory, etc., are dusted on to give a higher and more uniform glaze to the whole or part of the painting. Ivory glaze gives a cream tint but eats up reds and turns them brown. Dusting is done by rubbing gently the half dry painted surface with powdered colors. When the paint is too dry the powder will not stick, either take the paint off and do over or wait until next fire. Drop on color with palette knife and push it gently over surface with a piece of lamb's wool. In naturalistic work the color used is the same as that used in the painting, after dusting the high lights are not taken out and no patching can be done. Be careful to wipe off all loose powder as it will fly in the firing and settle on other pieces. Dark Green, dusted over Brown Green makes a rich color for backgrounds. Quite a good underglaze effect is obtained by painting the piece as usual and firing, then for the last fire ground on Ivory, Green, Lavender or any glaze, just as you would for a grounded ground. When you wish to dust with two or more colors mix on the palette with alcohol in given proportions and when dry use the mixture for dusting. After a piece has been painted in and fired for second fire, oil piece with special tinting oil, pad until tacky, allow it to stand 2 or 3 hours or sometimes over night then dust it with any mixture or pure color that is desired and you get very rich effects. This treatment is good for landscape panels, steins and pitchers. In conventional work, done in greens, reds, greys, browns, dust a part or the whole in this manner with Neutral Yellow, Pearl Gray, Gray for Flesh or Flowers, or Meissen Brown. In this way you get many beautiful and soft effects. The special tinting oil is very good mixed with these or other colors and the piece flushed and padded just as in a tint and when almost dry it can be dusted in the usual way. If you wish to put Ivory glaze on a piece already fired tint it on lightly as color, then when dry rub the powder in the surface until it has an even mat appearance. To successfully dust powder color into a painted surface the sur-

face must be just right, neither too wet nor too dry, if too wet it will lump up and rub off, if too dry it will not adhere.

BACKGROUND.

The subject of backgrounds for flowers, fruit, etc., in naturalistic work is a most important one. Generally the same colors are repeated in it that are used in painting the design itself. The darkest color in the background should come from behind the lightest spot to keep the centre of interest. There should be no great contrast of color, and a gradual passing from one color to another working the fruit, flowers, along with the background while the paint is open thus blending together the whole and avoiding hard lines. The blending may be done with a silk pad or the brush, many use the ball of the middle finger for small spaces or the soft part of the hand in fact anything that will work to the best advantage and get the best results. The background should not have a worked over look but be fresh and luminous. Much attention should be paid to harmony in color, and the relation of subject and background.

In a subject where yellow predominates, the complimentary color is violet, so we find violet shadows and tones, for red the complimentary color is green, so there we would find green and yellow and blue that go to make green. So for blue we find red and yellow. If one has a good naturalistic colored study to follow one is not apt to go astray on the background but when one has no study and just one in black and white the background is often a difficult matter and becomes more a matter of nice feeling for harmony in color. It is here that a good "sense of color" will help one out of the difficulty for without that there is apt to be discord.

When the piece is dusted, with a large soft brush clean off any superfluous paint, to prevent spots after firing.

Sometimes a background alone is dusted, while the remainder of the design is painted in the usual way. But a softer, more harmonious effect is produced if the dusting is made to go over the shadowy parts of the design, and over at least the edges of the prominent portions. Over the shadowy portion dust the background color on which it rests. This gives an underglazed effect.

Usually not more than two or three, and frequently but one color is used in dusting, and if the latter, it is put over the entire piece, lights and all. If this is done it should be a color found in both background and design, and in both lights and shades. A very heavy grounded color is liable not to bear repeated fires; but a surface lightly dusted may receive a succession of dustings and firings, with an even superior depth of color. A piece cannot be worked into after dusting, and not even a high light removed.

Colored glazes, Ivory, Green, Lavender, etc., are to be dusted on a dry, unfired decoration to increase the glaze and are not mixed with the color. They are applied the same way as dusted color, but must not be put over reds or flesh tones.

Powdered paint may also be put over a perfectly dry surface, in which case a very small amount will adhere. This will slightly tone the whole, and is called "dry dusting." If a design has been allowed to become dry before the background is painted in, when the latter is dusted the color should be allowed to go up on the shadowy portions.

To obtain an even tone of the purple found in the pansy, dusted Royal Purple may be used. New Peach

STUDY OF BUTTERFLIES—F. ALFRED RHEAD



dusted over the same produces a good pink if thin, though it is liable to chip if used heavily. Wild Rose Pink, or Pink 26 over New Peach makes an admirable color well suited to wide borders and surfaces, while Velvet Rose, Dark Blood, Celadon, Apple Green, and Olive Green 4 are good used alone. A good dusted Black of a deep tone may be obtained in any of the three following ways: Two thin coats of Black; a coat of Pompadour, then one of Banding Blue; or one of Banding Blue, then Black; in each instance firing between.

Blacks are said to be useful to dust over greens that have turned brown by firing.

TINTING AND DUSTING IN MAT COLORS.

Mat colors, which on account of a lack of flux do not glaze, are particularly adapted to grounds, and especially in combination with gold work for conventional designs, though charming for such flowers as azaleas, against a soft creamy ground.

The colors come in powder form, and being of a hard composition, it is well to first rub them down on the palette with either turpentine or alcohol, the latter acting more quickly. Then mix with fat oil until of a creamy consistency, and spread with a brush moistened with lavender oil. Any medium sold for the purpose will doubtless answer as well. The mat colors must be spread over a surface as evenly and smoothly as possible, and the tint blended at once with a dabber. Or it may be dusted in the same manner as bright colors.

If ivory or some light tint be chosen for the ground the design may be drawn on with a pencil when the paint is dry, and the paint removed with the eraser.

If the color has been made too thin it will show the china through, and if too much oil is used it will be sticky and attract dust.

Do not dry by artificial heat but allow the piece to stand overnight. If it is not perfectly dry by this time, remove and repaint.

Sometimes one tinting will not be sufficient, in which case the painting or dusting may be repeated. With plenty of practice, it is possible to put on a second coat before firing.

Any mat colors may be mixed at will with the exception of Coral Red, which not only must be used alone but can have but one fire. Any of the yellows harmonize with the browns, dark greens with light greens, reds with brown, and purple with lilac, only a light mat color cannot be used very successfully over a dark one.

If wanted in more delicate tints than they come, they may be made lighter by the addition of Mat White, remembering that light tints must be as heavily painted as dark ones.

Mat colors combine well with lustres and bronzes, and if well dried will take enamels or raised paste before firing, and the latter may also be gilded. Flat outlines of unfluxed gold may also be applied to unfired mat color.

Too light a fire, or too thin paint may cause color to rub off, while overfiring will cause a smooth appearance.

While mat colors are only suited to decorations of a simple character, except where gold is used elaborately they may be made both pleasing and effective.

Dusted bright color will not usually take gold well, so before firing the color may be removed from where the gold is to be placed.

Enamels cannot be placed over unfired dusted bright color, without their sinking in more or less, though it is possible to do this over an ordinary tinted ground.

Dead gold grounds are seldom seen, but are best used on panels for Japanese effect, swallows in black, gray or brown, with white breasts, being most pleasing.

Gold may also be used as a background surrounding tiny panels of marines or flowers, outlined with paste, leaving a place for monogram and such inscriptions as would make it suitable for a golden wedding.

o o o

Third Prize—Ella L. Adams, Yellow Springs, O.

"If to do, were as easy as to know what were good to do, chapels had been churches and poor men's cottages princes' palaces."

To one making his first effort in grounding, this quotation seems very appropriate, for all that is necessary, according to most instructions is:

To apply a coat of grounding oil, pounce it with a dabber, pour the color on the surface, spread with a piece of cotton or soft camel's hair brush and lo! the victory is yours. Of course as a side issue the china should be cleansed of paint where not needed, but to the uninitiated this consumes but a moment. This sounds alluring and free from drudgery, or is the wiping out process a joy to the majority? True, the art of grounding is not difficult only a little dexterity is necessary. If a plain band of color is the ground the china can be cleansed very rapidly, but, if some conventional or semi-conventional design is to be wiped out, the drudgery is more than semi-apparent. So many little points seem to spring up for the amateur to solve for himself. This seems a good method to follow:

First cleanse the china with alcohol or turpentine then with soap and water and let dry thoroughly. The alcohol or turpentine if left on is too apt to hold the oil or color where not wanted. Pour the powder color to be used on a dry palette or china plate and pour on enough, yes, more than enough, for it is not wasted, since what is left over can be used again. With a dry palette knife or muller rub the color until perfectly smooth and free from grain. Some use a silk sieve for this process and sift the color to make it smooth. Mix the grounding oil with water color Carmine to make a decided pink since this shows much plainer than the grounding oil alone, hence is easier wiped out where not wanted and a firing obliterates all traces of the water color. Often a little of the color to be used in grounding may be carefully mixed with the grounding oil instead of the water color.

Apply the colored grounding oil with a broad brush and then pounce with a silk dabber which has been filled with a good quality of cotton batting, for this seems to keep its shape better than surgeon's cotton. Be sure to pad until smooth and tacky.

Now, with the palette knife take up all the color and place it on one side of the china. With surgeon's cotton or a soft camel's hair brush draw the color over the oil being careful not to touch the oil with the brush or cotton.

With careful manipulation in one distribution the oil should take up its full quota of color. This is shown when the surface is not oily and is free from spots. If one application does not produce a dry, dusty surface apply more color. On to a piece of glazed paper brush all the superfluous powder color for it is easier poured into its vial from glazed paper. With a silk rag or pointed stick covered with cotton wipe off all the mixture of color and oil where not needed, and make sure that not even a dot of powder color remains where not wanted for this has an annoying way of proving very conspicuous when

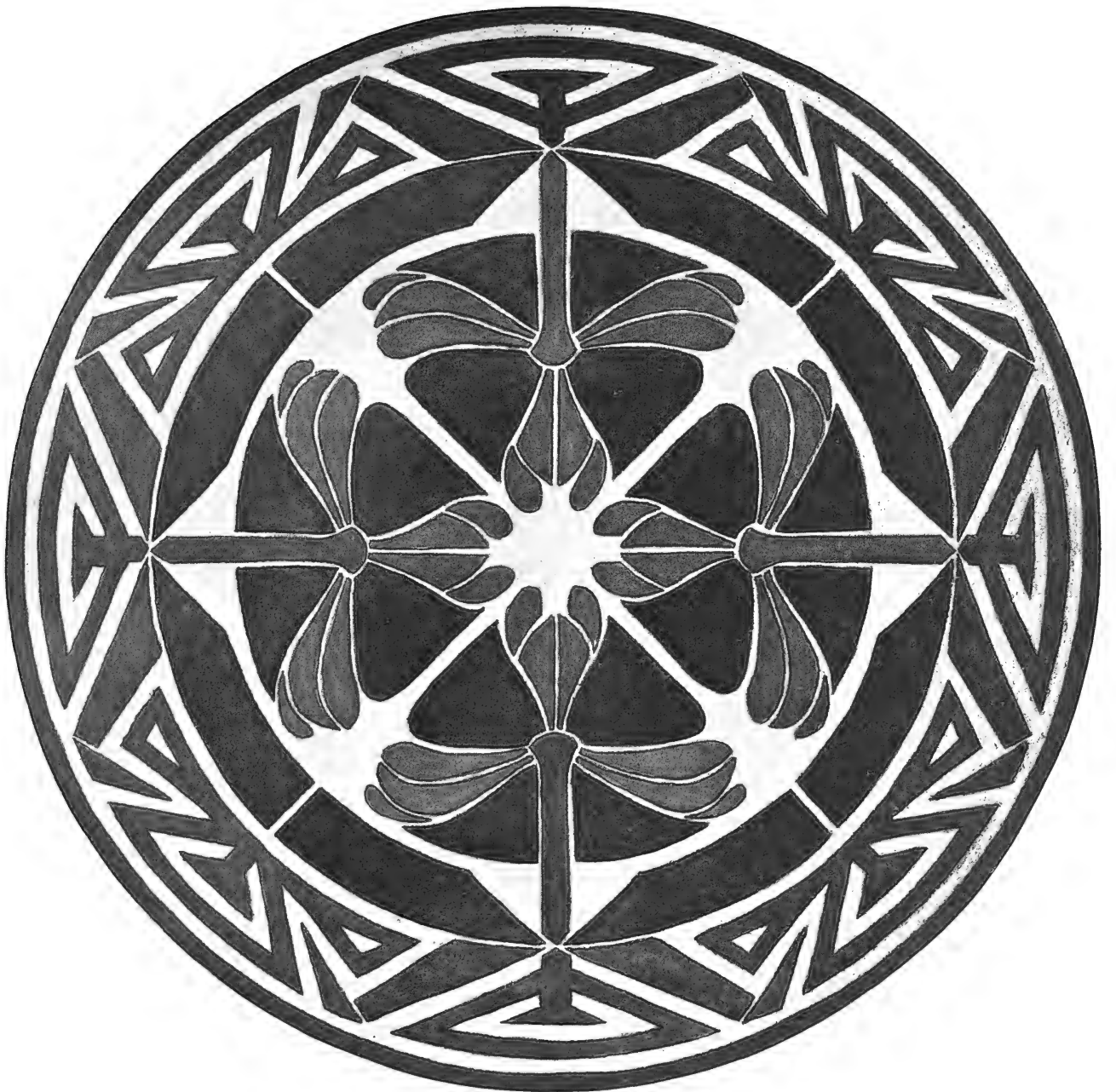

DRAGON-FLY PLATE—NANCY BEYER

To be executed in dark blue and green on a cream or grey green ground.

fired. If all this is carefully done the grounding will prove a success.

Should a design in paste or enamel be desired upon this grounding color, the color should be wiped off where the design is to be placed since paste or enamel is apt to chip off over ground color.

If a very light tint is desired either thin the grounding oil with turpentine or after applying the oil let the piece stand for some time so that it will not take up so much color. If different tones are desired in the grounding, the china should be prepared with the oil padded as before and then apply the lightest tone where desired.

Carefully brush off all superfluous powder and apply the next tone, blending into the first color. Proceed with other tones in the same manner.

If, by any perversity of fate the grounding should develop uneven places in firing, they may be smoothed out by retouching, but always strive for perfection in the first firing and if the faults are glaring rub out and try again, for this will give more satisfaction in the end.

Mat colors seem to need a more careful rubbing down than glazed colors but otherwise the same rules apply to both. There is this exception; a mat ground should not have as hard a firing as a glazed ground.

Ruby, Purple, Maroon, Coalport and Sevres Green are all difficult colors to use in grounding or its sister, dusting. For the reds thin the oil with turpentine since too thick an application may chip off in firing. The greens mentioned are apt to fire either a brown tone or a spotted effect so don't use them.

TINTING.

Good mediums for tinting should first be considered. What seems satisfactory and easy for one person to handle seems not the medium for another. Surely usage has something to do with this for let us hope that all tinting mediums have their merits.

A very little Dresden thick oil mixed with the color and the Sartorius tinting oil added until the mixture contains bubbles while being mixed is a good plan to follow in tinting large surfaces.

The tinting oil keeps the color open until it is evenly padded.

Copaiba with $\frac{1}{2}$ clove oil is a good medium on small surfaces, for this dries more rapidly than the former.

Lavender oil may be used as a tinting oil after the color has been mixed with thick oil. Many more mediums give just as satisfactory results as these.

Some find the tube colors more satisfactory for tinting than vial colors, since they are not so grainy, but a careful mixing will remove this trouble. If tube colors be used mix with turpentine before using the tinting medium. Be supplied with a good tinting brush, cotton and silk for padding.

It is best to test the tinting mixture first upon some stray piece of china. Fill the brush and convey the color to the china. Pounce with a dabber made of the silk filled with cotton. If the mixture has a tendency to cling to the pad or in other words if it makes a "sticky" noise while being padded, the proportion of tinting medium is correct. If faulty add more tinting medium. Never add turpentine since this is too rapid a dryer.

Should the silk seem to take up too much color let stand a few minutes to become drier. Color, however, is bound to be taken up with the silk. Pad rapidly over all the surface with the same dabber and some of the color on the silk will be transferred to the china in the

process. Of course the same dabber should not be used over different colors since this might make a muddy tint.

If the tint seems very wet and too dark after the first dabbing use a fresh silk and pounce again. The dryer a tint is pounced the less dust it will gather.

If too light in tint a deeper color may be dusted on when the tint is dry or else it may be deepened for the second firing. Never rest content unless the tint is evenly padded.

DUSTING.

Dusting is invaluable for strengthening backgrounds, deepening flowers or leaves or making a deeper tone in conventional work. First tint the china the desired color, let stand several hours and then it is ready to dust.

A good way to test this required time is to take a piece of surgeon's cotton (which is used for dusting) and lightly brush back and forth on the tint. If a faint scraping noise can be heard it is dry enough to begin dusting. Your powder colors should be well rubbed down and placed on a stiff paper. Blotting paper is very good.

Have a separate piece of cotton for every color and beginning with the lightest tone rub the cotton in the powder and apply to the china. This dusting should be done with a light movement and one color should be carefully blended into another.

Some prefer a camel's hair brush for dusting but the same effect is produced with either. In dusting backgrounds always decide beforehand just where you want your various colors and do not attempt any rainbow effects. The background might with this treatment prove a foreground. The simpler a background the truer to its name.

In naturalistic designs the greys and other background colors should be made up of the colors in the design. In other designs a contrast is permissible and sometimes preferable. Some of the background (in naturalistic work) should be dusted over the edges of the design or vice-versa for this holds them together and takes away the effect of the design having been cut out and pasted on. In painting a background in naturalistic work always have its darkest spot under the lightest flower or fruit for this helps to accentuate the prominent feature of the design. Strengthen this still further in dusting.

It is a very good plan to keep the dusting colors in a box ready for use with the same colors in the same places just as if they were on a palette. This plan saves time and color.

There are two ways of laying in backgrounds for naturalistic work. One is to paint the design, fire, then lay in the background and retouch design. The other way is to lay in background first and while still wet paint in the design. The second method is more difficult but it gives a softer effect. In either paint rapidly with firm even brush strokes, obliterating brush marks with soft cross strokes only using the silk dabber where absolutely necessary, for the silk pad takes away many of the strong brush effects. After this is dry strengthen the tones by dusting as previously directed always making sure there is no superfluous powder color. As a finish it is well to blow over the plate to remove any extra powder.

o o o

Fourth Prize—Bertha Morey, Ottumwa, Ia.

[EXTRACTS ONLY]

Use English grounding oil as a medium and if it is too thick it should be thinned with turpentine which has stood open for a while so that any water in it will evaporate.



GLOXINIA—PAUL PUTZKI

(See Treatment page 88)

Paint the oil over the surface with a tinting brush using it as thinly as possible. Then pounce with a dabber made of a piece of cotton covered with two thicknesses of old china silk. Pounce until it looks even and not in the least bubbly as these little bubbles cause the color to be spotty. The more oil is removed in this way the less color the oil will hold and the lighter the tint will be after firing.

TINTING.

If more than one color or shade is used, always begin at the lightest and work into the darkest. Do not work with a dabber that is too wet as it will give your work a muddy appearance.

Dark or light mat colors tinted on and then painted over for the second fire with the mat color mixed with a painting medium gives an effect almost if not quite equal to that when the color is dusted on.

MARIGOLD (Supplement)

Laura Overly

FIRST fire—For shadows in the flowers use Violet mixed with Yellow Brown. Keep the high lights clear and crisp.

Second fire—Use Primrose Yellow and Albert Yellow. In the third fire strengthen shadows with Warm Shadow, Yellow Brown and Violet mixed.

Leaves—Yellow Green, Brown Green and Dark Green.

The background can be painted with Violet and Yellow Brown using Primrose and Albert for the last fire.



Y. W. C. A. Art School, New York. No. 1.

Y. W. C. A. ART SCHOOL

IF any question why a picture of girls embroidering finds place in the KERAMIC STUDIO, a visit under the skylights of the Young Womens' Christian Association of New York City will answer the query effectually. In the meantime we explain that all these girls do good modeling and some of it is shown in the following illustrations. For instance the girl who is working a border in her own design of exquisite coloring on a black lace scarf, Miss Sylvia Williams, finished perhaps this very morning her pentagonal lantern shown in illustration No. 3. She is in the second year of the course and she has adapted here to clay her stenciled design handed in as a class exercise to the instructor in that line, Miss Hellra M. Turner

And Miss Mary Krackowizer in her first year,—the one who is outlining kittens and balls upon a knitting-bag,—modeled that gargoyle with an extra sized mouth for the swallowing of an electric wire.

The remaining work photographed was done by classmates of these girls in the first or second years of the course, all having entered without examination to learn what art is by designing and painting, drawing and composing in various materials and mediums.

The triangular lantern is by Miss Mimi Kohlmann who received the second year scholarship 1906 for the usual round of water color, cutting stencils or blocks for stamping (as upon the sash curtain in the embroidery picture), cast drawing, charcoal compositions illustrating a story, studies of museum textiles, etc. She did not take embroidery this year but it is necessary to a third year certificate.

All this time we have not introduced the teacher of art embroidery, Miss Mary Bacon Jones, who has received her art education in this school. She designed the poster behind her and has shown in other ways a fine sense of color and design in water colors as well as in clay.

Our second picture shows the famous "Griffon" of Notre Dame adapted as a lantern by Miss Genevieve Wilgus who took the 1906 scholarship for the first year work. It looks extremely devilish when the candle flashes light over face and chest. This is a part of her product in the correlated course of manual training, "Design, Mechanical Drawing, Wood Carving, and Modeling based on Historic Ornament." The girls spend a fifth of their twenty hours per week class time upon clay, but it is generally found too fascinating to drop there and much is done out of class hours; Miss Tilda Jellinghaus' swan vase was fashioned in that way from a suggestion in "the STUDIO". (Ill. 4.)

We do not use the potter's wheel since our aim is not trade but education; our clay is fired at a fireproofing place since we cannot have a kiln at present.

And now we turn back to justify ourselves for the reproduction of the first illustration. We are trying to enrich the life of the Nation by our contribution of the "all around" art girl who is cultured and can be of use and earn her salt whether at home or in a salaried position and who knows what art is because she has touched it on many sides. And whatever refinement and character she may gain in embroidery or otherwise will appear in her clay.

Sophia A. Walker.

Director of the Art School of the Y. W. C. A. of New York City.



Y. W. C. A. Art School, New York. No. 2.



Y. W. C. A. Art School, New York, No. 3.



Y. W. C. A. Art School, New York, No. 4.

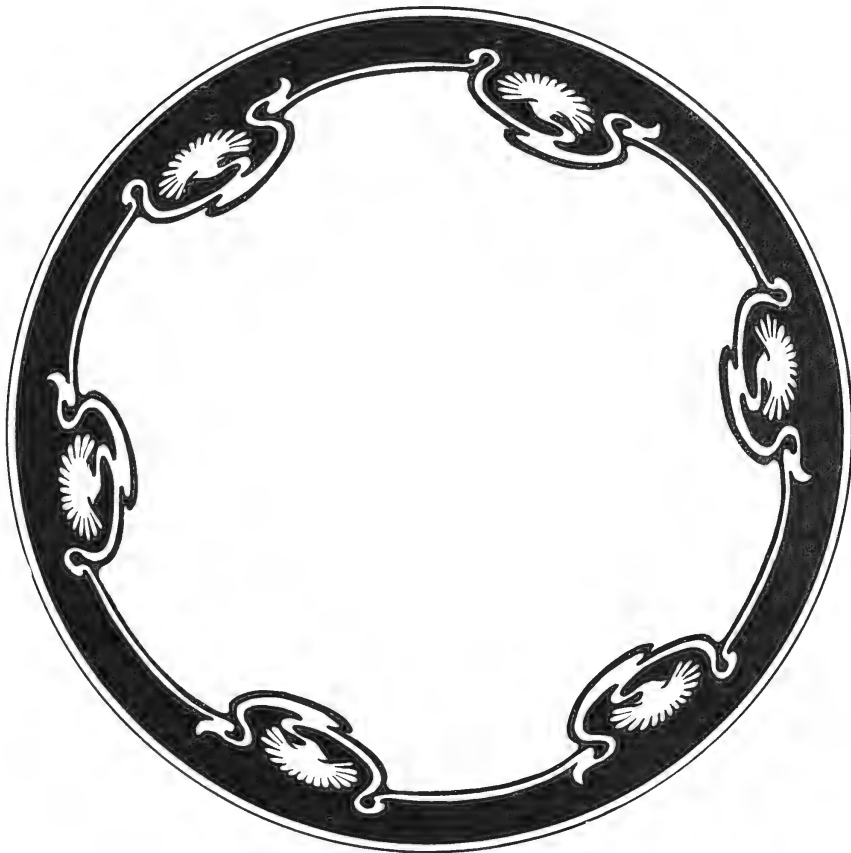

PLATE—EDITH ALMA ROSS

Design in gold outlined in black on a tinted ground.

TIN-ENAMELLED WARE

Charles F. Binns.

[Fourth Paper.]

THE ware, whether vase or tile, being glazed and dried is now ready for the decoration. An important characteristic of Delft ware is that the blue pigment is laid upon the unburned glaze. This treatment develops the peculiar tint of color which is well known to collectors and which seems impossible of attainment under any other method.

The use of gum in the glaze as advocated here has an important bearing upon the work because a glaze containing gum is, when dry, much more easy to handle and is not nearly so liable to work up under the brush of the painter. It has, however, this disadvantage. The work being more easy to perform the skill and freedom of line which belonged to the ancient workers are, to a large extent, lost, moreover the very fact of the glaze working up with the color, however troublesome it might be, was largely responsible for the pleasing tones of the blue and the perfect harmony between base and decoration. There is no need, however, to court difficulties unless some superiority be thereby gained. The surface containing the gum can be worked upon with greater freedom than the pulverulent glaze which is simply mixed in water, and if the color effect of the old style be desired a little of the glaze itself may be mixed with the blue.

The tint of color will probably cause some trouble. The underglaze blues which are made in modern times are, as a rule, crude in tint because of the purity of the ingredients from which they are made. In olden times pure chemicals could not be procured and hence the colors made were soft and harmonious. The remedy is to buy several colors and to mix them. Any firm of dealers in ceramic colors will supply samples of underglaze blues, blacks and browns and a few experimental mixtures will result in the desired hue. Blue, of course, is the foundation and a little black or brown is usually sufficient to tone down the brilliance of the commercial color. A little glaze should also be mixed with the blue. This not only helps the old fashioned appearance of the blue but also makes it melt into the glazed surface more readily.

Before sending the wares to the kiln due provision should be made for proper placing. Stilts are not very satisfactory because, if a drop of glaze does run down it attaches the stilt firmly to the piece and the result is considerable trouble, if not total loss. A better plan is to make small discs of a refractory clay and to have these exactly the size of the bottom of the vase to be burned. These discs should be burned first and then coated with an infusible wash, either equal parts of kaolin and flint, or equal parts of bone-ash and flint. If a vase be placed on one of these and if the glaze does flow it only fastens the disc and this, being of a soft clay, is easily ground off. If the glaze does not flow the disc can be used over many times.

For the successful burning of tiles some little contrivance is necessary. They must be burned flat and not reared and they must be completely protected from dust. There is no better plan than to make a number of little square saggars, each large enough to hold one tile. The tiles are not placed in these but beneath them, that is, one tile is set on a level foundation and a sagger is inverted over it. Upon the bottom of this sagger, now turned upwards, a second tile is set, then another sagger

inverted and so on. Each tile rests secure from dirt beneath its own covering and the pile can be raised as high as the kiln will allow. These little square saggars, commonly called setters, can be easily made from plastic fire clay and if a groove is formed at the base of each so that it will lock with its neighbor the work will be the more complete.

Delft ware, to be perfect, should be glazed with a second coating after the first one with the decoration, has been fired. The glaze so used is the same as the underglaze but without the tin oxide. Either of the glazes or enamels already given will form a clear, transparent glaze if the tin oxide be omitted. The procedure is the same as that already described except that the second glaze is put on very thinly. The pieces should be soaked as usual and carefully dried for even though glazed the body is still porous. The clear glaze is applied exactly as the opaque glaze was but mucilage will not be needed.

The fire should not be so severe as that for the blue and enamel but a low heat just sufficient to nicely fuse the glaze.

This second glazing is not, of course, a necessity but it adds greatly to the brilliance and quality of the ware.

The Delft potters did not confine themselves to blue and it is quite permissible to decorate further with overglaze colors if one so desire. There is, in fact, no end to the variety of effects possible. Reds and greens may be freely used and even lustres are appropriate. These can be fired in the regular overglaze kiln but care must be exercised at first lest the colors be over burned. The enamel is softer than the usual run of glazes and the colors are apt to sink in more easily. The fire should, therefore, be very gentle at first until it is seen what the glaze will stand.

It may be well to add a word of caution with regard to the thickness of the enamels. In explaining the use of matt glazes it has been stated that they can scarcely be used too thick and while this is true the same does not apply to glazes and enamels of the brilliant type. These are apt to flow under fire and if too thick will run and spoil the work. Here again a little experience will be helpful. If the enamel flows off at the bottom of the vase or if the color runs in streaks the coating is too thick. A little water must be added to the dip—a very little will suffice—and the piece must be shaken more vigorously.

It is a good plan to place vases after glazing, mouth downwards on the stilts, the glaze or enamel will then drain towards the upper part of the piece and the top will, therefore, have the thicker coating. Then on burning, the piece, of course, being set upon its base, there is not so great a liability of the enamel flowing down.



TREATMENT FOR PASSION FLOWER (Page 75)

F. B. Aulich.

THIS is a beautiful flower. Some are able to depict the sufferings of Christ by showing in the formation of the stamens the nails used to crucify our Saviour.

Take Rosa or American Beauty for the flowers and Crimson Purple for the halo around the centers. The stamens can be erased with a knife after being dry. For the greens use Blue Green, Warm Green and Olive Green. Take warmer tones for the point leaves and blueish tones for the distance. Tint to suit yourself.



WILD ROSE—DECORATIVE STUDY—HANNAH OVERBECK



CHRISTMAS ROSE

STUDIO NOTE

Miss Emily F. Peacock left New York on July 14th for a trip to France and England. All correspondence in regard to Crafts Department should be addressed to our Syracuse office during her absence.



CLUB NOTES

THE Mineral Art League of Boston, held its fourteenth annual meeting at the Westminster, Saturday afternoon, May 19, the president, Miss Ella A. Fairbanks, presiding.

The report of the recording secretary, Mrs. C. L. Swift, showed that the year had been one of unusual interest.

In addition to the regular league exhibition, held in October, the members exhibited with the National League also at Rochester, N. H., while fine lectures by Mr. C. Howard Walker, Mr. Vesper L. George, Mr. Peter Roos, Miss Amy Sacher and Miss Minnie S. Seaver were arranged for by the educational committee.

The report of the corresponding secretary, Miss Marianna Heath, was read and the report of the treasurer, Miss Augusta I. Johnson, showed that the financial affairs gave occasion for congratulation. The president, Miss Ella A. Fairbanks, was re-elected, as was also Miss E. E. Page, vice president; Miss Caroline L. Swift recording secretary; and Miss Augusta I. Johnson, treasurer; the new officers elected being Miss Elizabeth Carter, second vice-president and Miss J. Pauline Haskell, corresponding secretary. The meeting was followed by informal luncheon to active members, at which the plans for the coming year were discussed.

TREATMENT FOR STUDY OF GLOXINIA (Page 83)

Paul Putzki.

THESE flowers come in four different shades, white, pink, violet and purple, and to produce the best effect, mass white, light violet and dark purple.

In painting the white flower use Grey, and lay in the center with Albert Yellow shaded with Brown Green.

For the violet flower, use Putzki's Light Violet and shade with Dark Violet.

Paint purple flower with Ruby Purple shaded with same.

Lay in the leaves with Yellow Green, Dark Green shaded with Brown Green, and in the background use all the colors mentioned for flowers and leaves.



ROCKY MOUNTAIN COLUMBINE—EMMA A. ERWIN



FRUIT BOWL IN DARK BLUE AND WHITE—SABELLA RANDOLPH

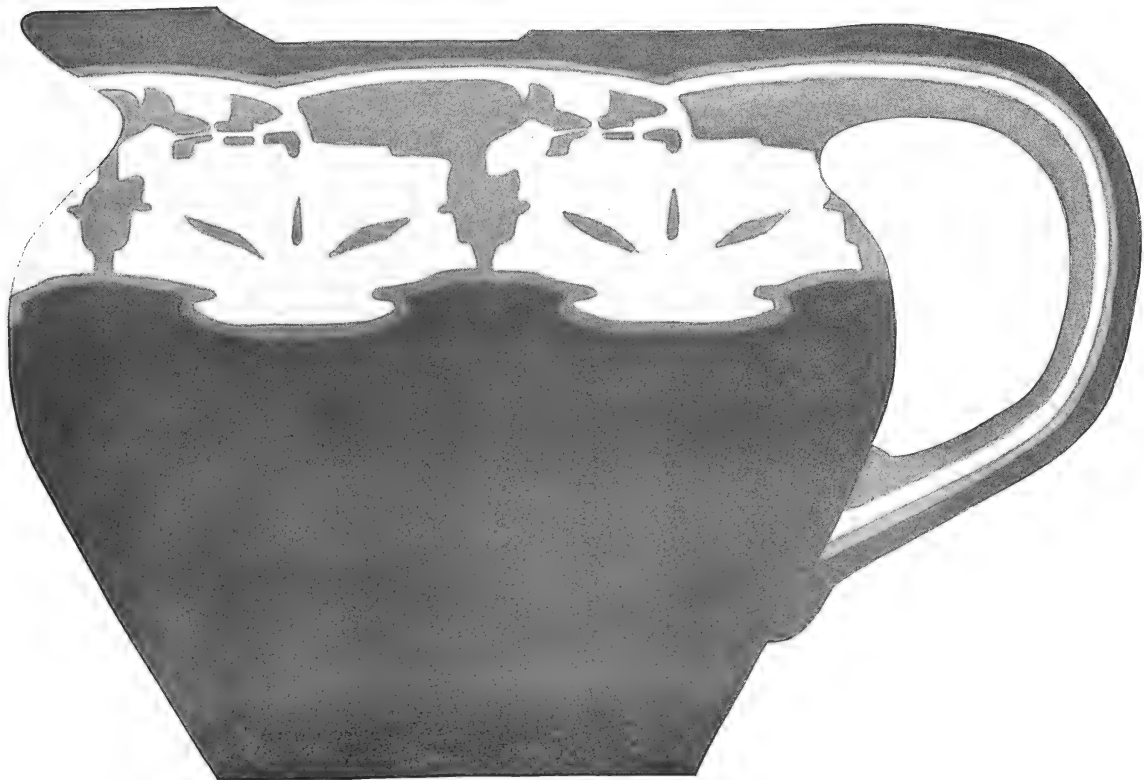

WATER PITCHER—WILD ROSE—HANNAH OVERBECK
To be executed in three tones of olive green.



PUNCH BOWL BORDER IN PURPLE AND BROWNS ON A YELLOW BROWN GROUND—RUSSELL GOODWIN

PURPLE CLEMATIS (VIRGIN'S BOWER)

Mrs. Carrie Williams.

SKETCH the design with India Ink. Paint the two prominent flowers in warm violet tones, shading from light to very rich deep tones in the shadows and markings. The shadowy flower is more greyish. The stamens showing between the sepals are greenish white. Paint the leaves with Yellow Green for lightest tones, shading with Night Green and Brown Green. Backs of leaves a greyish green. Branches and broken petioles are painted with Warm Grey shaded with Gold Grey to



ASTERS

Mary Turner Merrill.

FOR first fire: Paint the flowers a soft grey (Fry's White Rose) being careful to preserve all the high lights. The leaves, Apple Green and Mixing Yellow shaded with Shading Green. Background same colors as are used in flowers.

For second fire: Some of the flowers are almost pure rose color while others shade down to almost the purple of the common wild aster. For the rose flowers use Rose (or Osgood's Standard Pink) gradually shading down to Roman Purple, for the others use Violet No. 2 and Deep Blue with a touch of Black for the deepest tones. The leaves should only need accenting in the second fire—use Brown Green with a touch of Black and Dark Green. Centers Yellow Brown with touch of Meissen Brown.

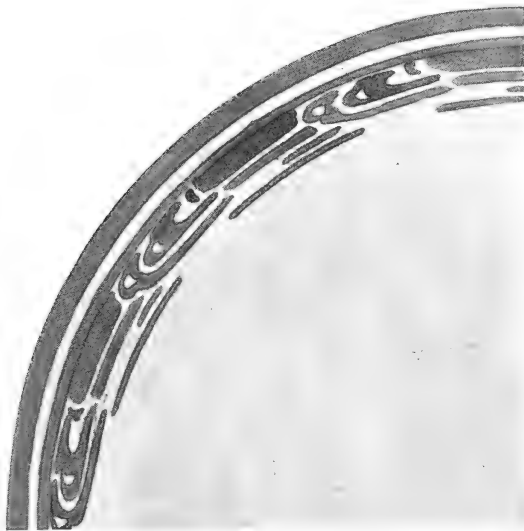

WATER BORDER FOR SALAD SET IN GREENS—MARIE CRILLEY WILSON



PURPLE CLEMATIS, (VIRGIN'S BOWER)—MRS. CARRIE WILLIAMS

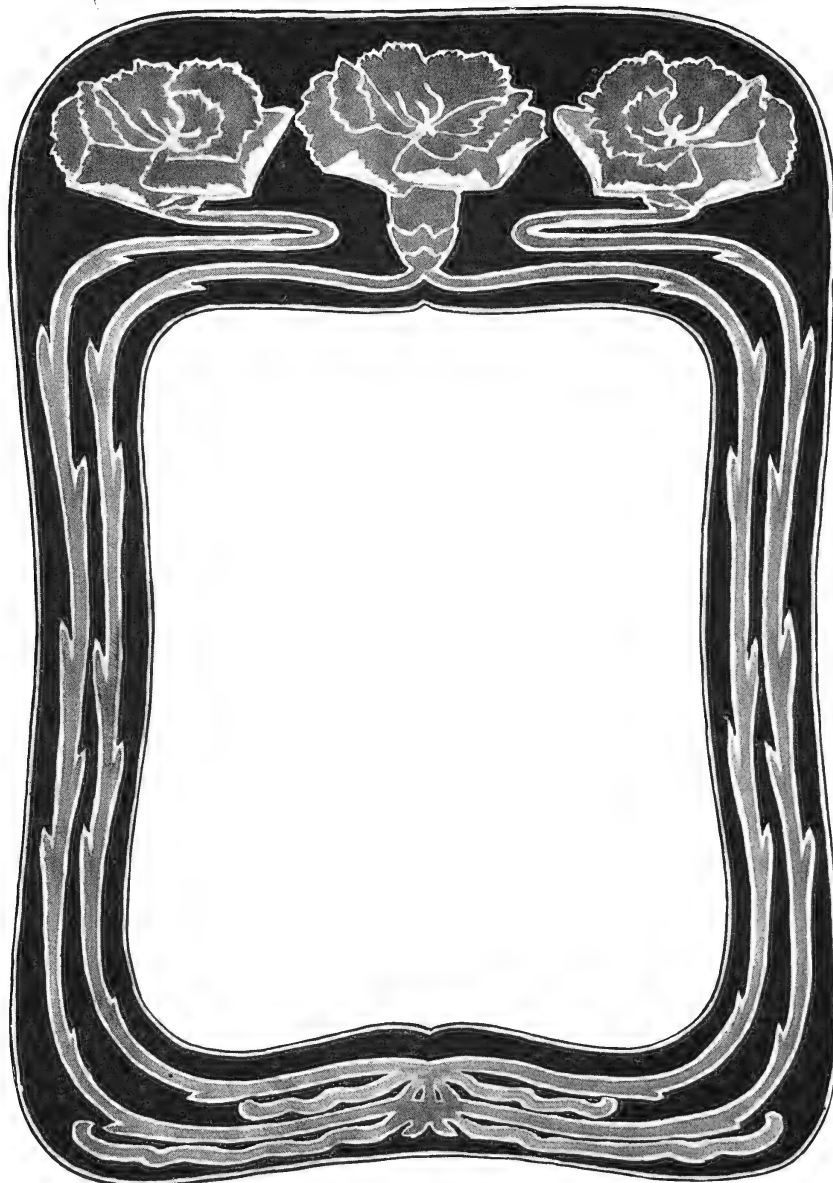

DESIGN FOR PORTFOLIO OR FRAME—EDITH ALMA ROSS

THE CRAFTS

WOOD CARVING AND PYROGRAPHY. LEATHER AND METAL. BASKETRY, ETC.

Under the management of Miss Emily Peacock, Room 23, 22 East 16th St., New York. All inquiries in regard to the various Crafts are to be sent to the above address, but will be answered in the magazine under this head.

Summer Address, care of Ceramic Studio Pub. Co., Syracuse, N. Y.

All questions must be received before the 10th day of month preceding issue, and will be answered under "Answers to Inquiries" only. Please do not send stamped envelope for reply. The editors will answer questions only in these columns.

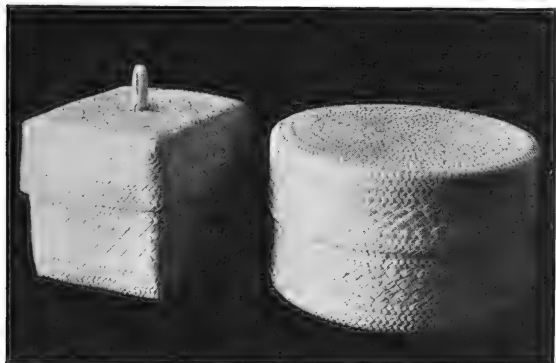

Photograph kindly loaned by the Misses Frances and Mary Allen.

THE MAKING OF A PALM-LEAF BASKET

Mrs. Lucy E. Childs*

[CONCLUDED]

A ROUND PALM-LEAF BASKET

A ROUND basket is made somewhat differently from the square basket just described. We have shown that the button of the square basket contains all of the straws used in the basket.

The button of the round basket is quite small and after it is completed other straws are added at regular intervals until the basket is of the required size. This process is called "widening".

No. 4 or 5 leaf is used for the round baskets and the leaf must be trimmed the same way as the coarse. Then take 32 straws 14 inches long, divide them into two equal parts, tie and put together in the same manner as in the square button but this is braided differently and there are but eight upper and under straws in each quarter. Bend back the upper straws in a quarter, and leaving two under ones down at the right, take up the next two at the left, lay first upper straw across under these, bring down the left of the two up, and take up the next one to the right. Lay next upper straw across, bring down left one up again, and take up the last one to the right. Lay next upper straw across, bring down left one up, lay next upper straw across and bring down the last one up. Now take up the two under straws at the left of this quarter. Lay under them the first upper straw and proceed as in the plain turn, to the end of the quarter. Braid the other quarter in the same manner. Then, anywhere between two corners, take up one under straw that has two down at the right. Lay upper straw across and bring down over it the one left up. Take up the next to the right. Go on in this manner till you reach the starting point. You have completed your button with a three-quarters turn.

There are three kinds of plain turn beside the double one (which means two turns braided at the same time, as in binding off.) The "whole turn" is one in which the upper straws are laid over two and under two. In

the "three-quarters turn" the upper straws go over two and under one. In the "half turn" the upper straw is over one and under one. This, however, is rarely used.

For the first turn after the button is made, select 16 straws, 12 inches long, and double them. Take up one under straw with two down at right and in between these two, place one of your straws so that half its length stands up above the turn, the other half below. Take another straw, slip the end under the right one of the two straws down and draw it out to the right to half its length. The other half forms the first upper straw. With the straw left up, take up the next under one to right. Lay across the first upper straw, bring down the left one up, and take up the next to right. Do the same again. Now bend down the second straw inserted and place it between the two under ones down. Take another straw and slip it under the one to the right of the one just brought down, drawing it out to the right to half its length. Braid two straws as before, then bend down the last straw inserted, turning it as it bends, and place it between the two down. Put another straw as before, tucking it under the straw at right of the one brought down.

Continue braiding like this, always braiding two straws between every two widenings, until there are but two upper straws left. Bend down the last straw inserted, take the straw left standing at beginning of turn, turning it as it bends, so that the upper side of it becomes the under, and slip it under the right of the two down and draw it out to its full length to the left. Braid the next two straws, then there is one under straw left up, which you bring down over the next upper straw. This finishes the turn. You have "widened" the first time. Now braid a three-quarters turn, then widen again "once in two," i. e., braiding two straws between every two widenings. Braid another three-quarters turn, and then widen "once in three". Braid one whole turn and one three-quarters turn and widen again once in three. Now braid two whole turns and turn this part (which is called the top) inside out. Press it, taking special pains to make the button flat.

Turning the top loosens the last turns so the straws must be pulled together till tight again. Braid three



Photograph kindly loaned by the Misses Frances and Mary Allen.

* The name of the author of this article was by mistake given in last issue as Mrs. Shields. The article is by Mrs. Lucy E. Childs, of Deerfield, Mass.

whole turns and either keep on with them till the basket is of the desired depth, or braid a border. This can be in twos, as described in the square basket or in threes. For the latter take up three under straws leaving three down at right and put across under them three upper straws, these last being over three and under three. Bring down the three up, and take up in their place the next three to right and lay three upper straws across. Keep on in this manner through the turn.

There are three under straws beneath each set of three upper ones and in the next turn both sets of three must be braided together. You must take up together the same "threes" that were used together before.

Turn back any upper set of threes. Leave down the first three under ones and take up the three at left of them. Lay the three turned back across and bring down over them the three standing, taking up the next three to right. Proceed in this way through the turn.

For the last turn of the border bend back as in the last turn a set of three upper straws. Take up the outer one of the second set of under straws i. e., counting from right to left, take the 6th straw, lay the first of the set turned back, across, take up the next under straw to right of one up, and braid the rest like any whole turn, except that the upper straws will be over five, four or three, instead of over two.

The rest of the basket is in plain turns till four and one-half inches deep. Bind off with two three-quarters turns as in the square basket, and finish in the same way. Turn the edge of the basket inside, and press on a round block four inches across.

The cover is exactly like the basket till you have widened the second time, once in three. See Illustration. As the cover must be a little larger than the basket in the next turn widen one in twelve. Before you have used double straws in widening. Now take single ones seven inches long. Take up one under straw with two down at right, and between these two place one of the seven inch straws leaving the end an inch above the turn. Take another straw and slip one end under the right one of the two down, leaving the end out an inch to right. Braid twelve straws, then repeat the widening. Keep on in this way through the turn. Braid another plain turn, then turn and press the top of the basket. Braid whole turns till the sides are $2\frac{1}{2}$ inches deep. Bind off with two three-quarters turns. Finish same as basket, turning in the edge half way, and pressing. In describing baskets, I have used the terms used by the basket makers. For instance, they never "weave" a basket, they braid it. Though there are many shapes and sizes of baskets, if any one can make a button, braid a plain turn, widen and bind off, she holds the key to the making of any palm basket.

ANSWERS TO CORRESPONDENTS

H. E. L.—It is not considered good technique to use enamel to raise any part of a naturalistically painted subject. A smooth even surface is the desideratum. You must rely on your color tone for depth. You will find in July *KERAMIC STUDIO* the information you desire as to shadow color of pink roses. For a pink tinting use Rose.

B. C. L.—The same principle holds good in any art. No one has a right to sign with his or her own name any study or design copied from the original of some one else. Many desiring the credit of the technical execution of the work sign innocently without considering this point, they should add "after design by —."

A. M. H.—We can see no objection to having the entire dinner service of 120 pieces in gold band and monogram, it would be quiet, unobtrusive, and in good taste. However, it would also be in good taste and more entertaining if some of the courses were decorated in appropriate conventional

designs in gold, into which the monogram can be worked if desired. The sets which might be thus decorated are the fish, salad, game, entree, dessert and fruit. The most elaborate decoration should be found in the dessert set.

Mrs. L. P. M.—We should judge that the trouble with your gold which you made from the *KERAMIC STUDIO* recipe by Miss Peacock and which, you say, peels off after firing and has no glaze, is that you used the general flux No. 8, instead of making it as directed. The gold is evidently not fluxed enough to use on white china. Perhaps it will work all right over color or raised paste. You can not do anything now to change it without a great deal of trouble. If the oil mixed with it is too fat wash it all in alcohol, pour off the fluid and mix up freshly.

Mrs. H. A.—The Fleur de Lis design by Miss Patterson in April *KERAMIC STUDIO* may be executed as follows: Draw design carefully in India ink. Lay in part of the flowers with Purple lustre, part with Violet, leaves in Light and Dark Green lustre. Tint inside of bowl with Ivory or Yellow Brown lustre, when dry carefully remove with a pen knife any lustre that may overlap the design. Paint in the dark ground with Roman Gold, using a good sized square shader. When dry give a second coat making the strokes at right angles to the first coat. Paint design on inside in gold, two thin coats. Second fire. First scour the gold well then go over the Purple lustre with Dark Green lustre, shade the Violet with the same color again and strengthen the Greens. Retint inside if necessary. Outline the design in Black paint. Use the Black powder color mixed with a thin sugar and water syrup. You will do well to go over the outlines twice if not practiced in making firm black lines. Retouch gold where thin. If necessary, the design may be retouched for a third fire.

Mrs. E. G. F.—White china which has been used but not discolored may be boiled up in soda and water. It will then probably decorate and fire successfully.



Technical High School, Providence, R. I. Pottery.

PROVIDENCE TECHNICAL HIGH SCHOOL

Amongst the many institutions in which the Arts and Crafts have an assured place is Providence Technical High School. This institution, founded in 1892, has been too small for a number of years, and is now in the hands of contractors by whom it will be transformed into a building capable of accomodating three times as many pupils as at present.

The students of this school have large opportunities in artistic lines, for, beside the usual shops, drafting rooms and laboratories, there is provision for photography process reproduction, copper work, wood carving, pottery, modeling, basketry and domestic arts.

Pottery, modeling, carving, cabinet work and copper work are taken in the first and second year of high school. The objects represented in the above illustrations were produced in the first and second year classes, and all in a single room in charge of Mr. W. W. Dove. The boys also took the photographs. The work in pottery is most interesting also the work in wood, particular mention should be given to the chair illustrated, also the frames.

When the new building is completed, it will be thrown open in the evening to the workers in Arts and Crafts.

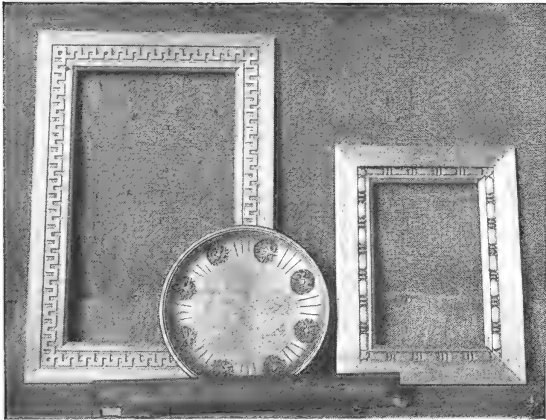

Technical High School, Providence, R. I. Wood Work.

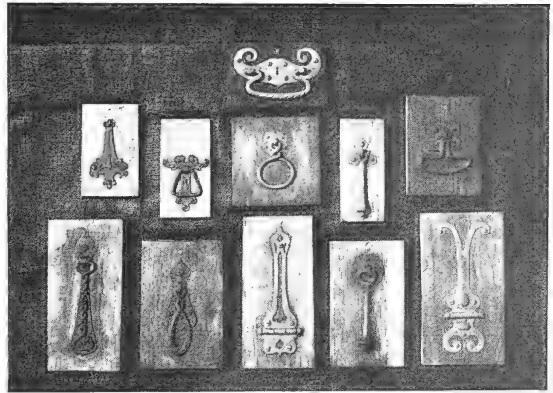

Technical High School, Providence, R. I. Metal Work.



Technical High School, Providence, R. I. Wood Work.



Technical High School, Providence, R. I. Wood Work.



Technical High School, Providence, R. I. Pottery.



Technical High School, Providence, R. I. Pottery.

**USE
HIGGINS'**



and learn what's what in inks and adhesives for tracing designs on china, photograph mounting, and general office and home use. Emancipate yourself from ill-smelling and dirty pastes and mucilages, and corrosive and weak-colored inks, and adopt the HIGGINS' INKS AND ADHESIVES. Their high qualities will be a revelation to you. **At Dealers Generally.**

CHAS. M. HIGGINS & CO. Originators and Manufacturers
Refined Inks and Adhesives.
NEW YORK CHICAGO LONDON
Main Office and Factory, Brooklyn, N. Y., U. S. A.

Drawing Inks, Blacks and Colors
Eternal Writing Ink
Engrossing Ink
Taurine Mucilage
Photo Mounter
Drawing Board and Library Mucilage
Office Paste
Liquid Paste
Vegetable Glue, etc., etc.

White China for Decorating

WE are pleasing others and we can please you if you will give us the opportunity. We have had many letters of late complimenting us on our prompt shipments of White China. We are able to make prompt shipments only by carrying a very large and complete stock. Our large Illustrated Catalogue of White China and Materials free for the asking. Send to-day.

THE A. T. OSBORN CO.

— IMPORTERS —

224-226 Seneca Street Cleveland, Ohio

KERAMIC SUPPLY CO.  Our 1906 catalogue contains directions for all china painters' material, most useful and practical information: 64 pages, many cuts, price 10 cents. We sell colors, brushes, studies, transfer, gold, kilns

China Painter's Colors, 10 cents each
658 Lemcke, . INDIANAPOLIS, IND.

VANCE-PHILLIPS CERAMIC SUPPLIES

Ceramic Summer School

JULY AND AUGUST

Instructors: L. Vance-Phillips
Sara Wood Safford } New York
Lillian Forbes Sherman }
Blanche Van Court Schneider, Chicago

For Summer School Circular Address
L. Vance-Phillips, Chautauqua, N. Y.



Vance-Phillips Flesh Palette

Mineral Colors in Powder. Each combination carefully prepared and tested. Sold in sets of ten colors. Sold in complete sets, including brushes, stippers, mediums, etc., together with a folder giving brief instructions for use.

Vance-Phillips Condensed Painting Palette
High Grade Mineral Colors in Powder, containing the essentials for painting.
A Line of Selected Brushes, Mediums and Materials

Until Sept. 1st Price Lists will be sent and mail orders promptly filled from the Studio at Chautauqua, New York.

L. REUSCHE & CO.



Importers and
Manufacturers

Sole Agents for



Hancock's China and Glass Colors

An Immense Variety of

German Colors	}	By the
French Colors		Pound
English Colors		or
Liquid Lustre Colors		Ounce
Lacroix Fat Oil		By the
Dresden Thick Oil		Gallon
"Elarco" Tinting Oil		or
All Other Mediums		Pint

"Elarco" Mat Roman Gold— $\frac{1}{4}$, $\frac{1}{2}$ and 1 oz. Pots.
Hand-made French Pencils and Brushes
Of Unsurpassed Quality.
All China Painters' Requisites. Write for Illustrated Catalogue.

71-73 Park Place, New York

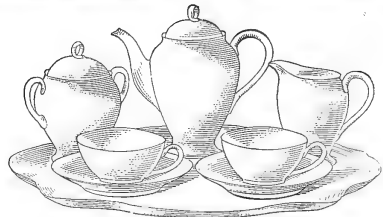

OUR "ELITE" FRENCH CHINA VIENNA CHINA BAVARIAN CHINA AND GERMAN CHINA IN WHITE

FOR DECORATING

Are sold by the leading merchants throughout the United States. All the latest shapes are illustrated
IN OUR NEW CATALOGUE
Now ready for mailing. Write for copy to-day.

BAWO & DOTTER

MANUFACTURERS

26 to 34 Barclay St., New York

KEEP THE FIRE ALIVE.

KERAMIC STUDIO

CONTRIBUTORS

IDA M. FERRIS	✎	✎	✎	✎	✎	✎
OPHELIA FOLEY	✎	✎	✎	✎	✎	✎
SARA REID McLAUGHLIN	✎	✎	✎	✎	✎	✎
MAUD MYERS	✎	✎	✎	✎	✎	✎
HANNAH OVERBECK	✎	✎	✎	✎	✎	✎
MARY OVERBECK	✎	✎	✎	✎	✎	✎
MARGARET OVERBECK	✎	✎	✎	✎	✎	✎
LOUISE M. SMITH	✎	✎	✎	✎	✎	✎
F. G. SANFORD	✎	✎	✎	✎	✎	✎
BELLE BARNETT VESEY	✎	✎	✎	✎	✎	✎
MRS. BRAME VAN KIRK	✎	✎	✎	✎	✎	✎

SEPT. MCMVI

Price 40c. Yearly Subscription \$4.00

A MONTHLY MAGAZINE FOR THE POTTER AND DECORATOR.

The entire contents of this Magazine are covered by the general copyright, and the articles must not be reprinted without special permission.

CONTENTS FOR SEPTEMBER 1906

	PAGE
Editorial Notes	97
League Notes	Belle Barnett Vesey 97
The Class Room—Raised Paste	98-101
Small Fruits	Ida M. Ferris 99
Vase and Bowl—Zinnias	Mary Overbeck 101-102
Zinnias—A Study	Mary Overbeck 103
Hop Design for Stein	Ophelia Foley 104
Hops—Plate	Louise M. Smith 105
Designs and Studies from Pumpkin Vine	Hannah Overbeck 106-110
Hops	Sara Reid McLaughlin 111
Rose Designs and Studies	Margaret Overbeck 113-114
The Crafts	
The Making of a Metal Lantern	F. G. Sanford 115-117
Answers to Correspondents	118
Zinnias—(Supplement)	Mary Overbeck 118
Hop Study	Mrs. Brame Van Kirk 118
Child's Plate in Blue Greys	Maud Myers 119

LIST OF BOOKS

The Rose Book, containing some of the best rose studies and designs published in Ceramic Studio postpaid	\$ 3.00	Tulip Ware of the Pennsylvania German Potters, by Edwin A. Barber, in paper cover postpaid	1.10
The Fruit Book, containing some of the best fruit studies and designs published in Ceramic Studio postpaid	3.00	Tulip Ware of the Pennsylvania Potters, by Edwin A. Barber, cloth, limited edition postpaid	5.00
Composition, by Arthur Dow postpaid	1.65	Encyclopedia of Ceramics, by W. P. Jervis postpaid	6.75
Principles of Design, by E. Batchelder postpaid	3.00	The Old China Book, by N. Hudson Moore postpaid	2.18
Decorative Studies, by J. Foord postpaid	12.50	The Old Furniture Book, by N. Hudson Moore postpaid	2.18
Plant Forms and Designs, by Midgley and Lilley postpaid	2.20	Old Pewter, by N. Hudson Moore postpaid	2.18
Practical Pottery, elementary instruction for students, by Richard Lunn postpaid	2.50	Chats on English China, by Arthur Hayden postpaid	2.16
Grand Feu Ceramics, a practical treatise on the making of hard porcelain decorated with high temperature glazes by Taxile Doat of the Manufactory of of Sevres, France postpaid	7.50	Chats on Old Furniture, by Arthur Hayden postpaid	2.18
Seger's Collected Writings, 2 volumes postpaid	15.50	China Collecting in America, by Alice Morse Earle postpaid	3.20
For the Collector:		Pottery and Porcelain, a guide to collectors, by Frederick Litchfield, the English expert postpaid	6.25
Vol. II Old China, bound blue cloth postpaid	2.50	French Pottery and Porcelain by Henri Frantz postpaid	2.68
Vol. III Old China, bound blue cloth postpaid	3.50	Dutch Pottery and Porcelain, by W. Pitcairn Knowles postpaid	2.68
Anglo-American Pottery, a manual for collectors, by Edwin Atlee Barber, Curator of the Pennsylvania Museum, second edition postpaid	2.00	Old English Furniture, by Fred Fenn and B. Wyllie postpaid	2.68
American Glassware, old and new, by Edwin A. Barber postpaid	1.00	English Embroidery, by A. F. Kendrick postpaid	2.68
Marks of American Potters, by Edwin A. Barber postpaid	2.25	French Furniture, by Andre Saglio postpaid	2.68
Pottery and Porcelain of the United States by Edwin A. Barber postpaid	3.75	Old Pewter, by Malcolm Bell postpaid	2.68
The Lace Book, by N. Hudson Moore postpaid	5.30	Sheffield Plate, by B. Wyllie postpaid	2.68
		The Oriental Rug Book, by Mary Churchill Ripley postpaid	3.20
		Home Furnishing, practical and artistic, by Alice M. Kellogg postpaid	1.65
		William Adams, an old English potter, by William S. Turner postpaid	8.00

Keramic Studio Pub Co., Syracuse, N. Y.

KERAMIC STUDIO

Vol. VIII, No. 5

SYRACUSE, NEW YORK

September, 1906



AMONG the old fashioned garden flowers to be found at this season, are many very decorative ones that have been little used by ceramists. The Foxglove, Larkspur, Snapdragon, Hollyhock, the Coreopsis, Marigold, Zinnia, Dolichos, Plumbago, Tuberoso and Bachelor's Button, together with the old standbys, furnish a rich harvest of designs. Now is the time to gather all the quaint seed pods of garden, wood and meadow. They will yield abundantly also to the seeker after new motifs.

+

The color study for this month, "Zinnias" by Mary Overbeck, was the first prize decorative color study of the last competition but one. We consider it one of the most artistic studies we have yet produced. Most of the designs in this number are from the three Misses Overbeck of Cambridge City, Ind. It will be interesting and instructive to follow the evolution of the design from the study especially in the case of the Zinnias of Miss Mary and the Pumpkin flower of Miss Hannah. Miss Margaret is instructor at De Pauw Institute, Greenville, Ind. Several of her designs and studies received prizes in the last Rose Competition.

+

The October number of *KERAMIC STUDIO* will be almost entirely the work of Miss Mabel Dibble, of Chicago, one of the leading disciples of the Conventional School.

The Color Supplement will be a Punch Bowl with Peacock decoration.

+

From the circular of the Jamestown Exposition we find under the Fine Arts Division the following classification:

CLASS 25.

PAINTINGS AND DRAWINGS.

Paintings on canvas, wood, metal enamel, porcelain, faience, and on various preparations, by all direct methods in oil, wax tempera and other media; mural paintings; fresco paintings on walls.

Drawings and cartoons in water color, pastel, chalk, charcoal, pencil and other media, on any material. Miniatures on ivory.

CLASS 30.

ART CRAFT.

- Art work in glass other than Mosaics.
- Art work in earthenware: pottery or porcelain.
- Art work in metal other than sculpture.
- Art work in leather.
- Art work in wood other than carvings.
- Art work in textiles.
- Artistic book-binding.
- Art work not covered by any other group.

This will be good news to ceramic workers. It will be

noted that paintings on porcelain will be admitted on the same footing as on canvas or any other medium.

+

The design of Purple Clematis in August number was by mistake given as a design by Mrs. Carrie Williams. The designer is Mrs. Chas. L. Williams of Glens Falls, N. Y.

✻ ✻

LEAGUE NOTES

Miss Bennett who is to criticise our study course again this year, was recently secured to deliver seven lectures on arts and crafts, at the biennial meeting of the General Federation of Women's Clubs. She asked for some National League pieces with which to help illustrate her talk on porcelain. She writes me that instead of one lecture a day, she averaged three a day. One formal, and two in which the women questioned, and applauded. She says, "The china was carefully installed and made a handsome showing and was of deep interest to one and all. Perhaps more so as the impression that prevails seems condemnatory to hand painted china. Some few read in art magazines that there are pieces that are liked by the most critical art workers, they are, therefore, most glad of an opportunity to see for themselves what is meant. The questions were so numerous that it kept the ladies interested in spreading art crafts knowledge, and me more than busy answering. In the display were pieces that I used, to show the proper use of floral decoration. To show that flowers are legitimate ornaments if conventionalized, that is eliminating the accidents and incidents of natural growth, and accepting and using the main characteristics in simple form. There were pieces with no floral motifs at all, purely geometrical arrangements of straight and curved lines; and again pieces that combined both floral and geometric patterns. Needless to state that the color, whether bright and jewel like, or low in tone, was always interesting and satisfactory. For it seems to me that no man or woman who succeeds in china decoration, would ever have taken it up, who did not possess a strong sense of color. Some of the work was almost complicated it was so ornamental, while other pieces were so simple and delicate they suggested fine stenciling. Several of the fine examples of the simpler type from National League members I mention as especially good. I had difficulty sometimes in convincing the spectators that some of the work did not come from abroad. I am sorry not to write more on this absorbing division of art handicraft, but you might not be prepared for a lengthy burst of eloquence and I will promptly close thanking you for your interest in the matter."

Miss Bennett's lecture has reached thousands of representative women who are working for a better, and more beautiful America. They are stimulating the artistic, musical and literary imagination, and refining the taste. Our work has been introduced, let us recognize our responsibilities. Charles B. Wyrick, 6228 Wabash Ave., Chicago, has applied for individual membership.

BELLE BARNETT VESEY
President.

THE CLASS ROOM

The next subject for the Class Room will be "The Art of Teaching," a course for beginners, referring to some design published in *KERAMIC STUDIO* for illustration. This should explain just how to start a beginner, what kind of piece to work upon, what style of work to attempt, what steps to take in the work, etc., up to the advanced and finished work. A special extra first prize of \$10.00 will be added to the usual prizes if a sufficiently good article is sent. Articles should be received not later than Sept. 5th.

o o o

RAISED PASTE

First Prize—Mrs. G. B. Strait, Cazenovia, N. Y.

Raised paste which is to be covered with gold, is useful for scrolls, conventionalized flowers or geometrical figures, for tiny wire like lines around conventional or semi-conventional designs, for modeling delicate roses to be formed into garlands whose daintiness is their chief beauty, or even rococo ornaments if the scrolls are well balanced and reversed so as to produce a dainty and pleasing effect.

MATERIALS.

The materials needed are, powder paste, fat oil, lavender oil, turpentine, small ground glass slab, paint rag, pointed sables 00 and 0 and 1 for use in fine work, flat sables 1 and 2 for larger work, a small square shader for flat paste work, and a stiff palette knife.

Paste may be purchased in various forms. Water paste, requiring only the addition of water to make it in working condition, is not considered as durable as other kinds, but is fairly satisfactory for pieces not requiring much handling. This kind of paste should only be used on the plain china, never over tints. If too much water is added when working it, the moisture must be allowed to evaporate, which may take some hours, or additional paste may be taken from the tube and mixed with it. If too wet it will spread as it dries.

Gold cannot be applied until the paste is fired, and the firing must not be at a temperature above rose heat. If very high modeling is desired apply one coat, and then another when the first is nearly dry.

To avoid a rough appearance, see that the surface of the paste is smooth and even in every place, removing any irregularities in line with a brush dampened in water. Good paste may be bought in tiny jars prepared ready for use except that turpentine is to be added to facilitate its manipulation. This is a great convenience to beginners. But the usual way of preparing paste for gold is to buy it in powder form (preferably Hancock's) and prepare it in the following manner. Take some of the powder, which is a heavy dull yellow paint, on the palette, and with a stiff palette knife mix in thoroughly a little turpentine. Now rub until every trace of grit has disappeared and the mass is perfectly smooth and free from grains; then add just enough fat oil so that the mass is thoroughly incorporated with the oil, but is not oily. It should cling together when pressed with the knife, as flour will hold together if pressed into a mass in the hand. Breathe on it several times to give a little moisture to the mixture and prevent too rapid drying out. Add enough oil of lavender to make it a trifle more thin than wanted, breathing on it again occasionally as it is worked, and until it becomes hard enough to adhere to the knife in a stringy way and will stay exactly where it is placed.

The breathing is to cause the mass to stiffen. It is

now ready for use, and should be about the thickness of heavy cream; stringing easily from the brush in a steady firm line. If it becomes thinner as it is used, and flattens out when applied, it may be breathed upon and worked over until of the right consistency. But if it becomes too hard to work well add more lavender oil or turpentine, preferably the latter. It is well to prepare a quantity of paste at once, as it may be safely kept in a small jar any length of time. Paste may also be mixed with fat oil and oil of tar, in the proportion of 2 to 1. Or with lavender oil alone. Or with Dresden thick oil to dampen the paste, and an abundance of turpentine, the evaporation of which will create the necessary oil.

Or after using enough turpentine to hold the powder in a mass, it may be mixed into a thin paste with oil of tar.

APPLICATION OF PASTE.

No matter how the paste may be mixed, the method of application is the same. Take a small bit on the tip of the brush and apply it to the china in a smooth raised mass if flowers and leaves are to be attempted. If large dots are desired, apply in much the same manner as enamel dots, touching the china delicately with a slightly rotary motion, holding the loaded brush in an upright position.

For small dots, suitable for flower centers, etc, just touch the lump of paste to the china, lift the brush straight up, and if the paste is in exactly the right condition it will settle down into the round dot wanted. If any projection or point remains it may be removed by touching lightly with a dampened brush or finger tip. If the pressure of the brush is too heavy the dot will be flattened. If misplaced it should be allowed to remain until dry, when it may be removed with the point of a pen knife without injury to adjacent dots.

In case the first application does not make the work of the desired height, a second or more applications may be made provided the first be surface dried, and looks dull and hard, which will be in from 10 minutes to one-half hour. If it takes a longer time than this to look dull, it is probable that too much oil has been used. The addition of a little alcohol will overcome this difficulty or more paste may be added.

Paste lines should be fine, firm and even in width, and free from the least roughness. This is produced by using rather more oil than is required for modeling scrolls or dots, and in drawing with rapid, short, steady strokes the bit of paste along the design drawn on the china, at each refilling of the brush going back a little on the line that no break may be discernible. If the brush becomes clogged clean it in turpentine and wipe on cloth.

When fairly large surfaces or flowers are to be covered with flat paste, the paste is prepared in the usual way and is still further thinned by the addition of lavender oil till more fluid than heavy cream, and is painted on with no trace of a brush mark.

In every instance let the size of the brush used be governed by the space to be covered, and if the design is heavily laid let the brush be used in much the same manner as though color was the medium employed. Where heavy shaded effects are desired let the shadows be more heavily painted than the lights.

If at any time the paste becomes too thick to work easily, add a very little turpentine rather than more oil, as the latter might cause the paste to blister or scale off during firing, or else cause the paste to run in an unsightly manner. Neither should any paste left on the palette



SMALL FRUITS—IDA M. FERRIS

at some previous time be added to, as the evaporation will cause excessive oiliness. While paste may be ground too much to produce good results, poor work is more liable to come from lack of grinding. Too little oil or a poor paste will also make work grainy.

When paste is cracked while it still adheres to the china, the disaster may be remedied to some extent, if not made perfect, by working fresh paste into the crack until no more can be forced in. It may then be dried, gilded and fired.

Paste should never be dried by artificial heat until the surface looks dull, when the warmth will not injure it; and it must be thoroughly dry before the gold is applied. While this may be safely done before firing, by an experienced worker, it is unwise for the beginner, who should first have the piece fired.

Paste may be placed over either heavy or light coats of unfired mat colors provided they are well dried, and also over light tints of dry over glaze colors. But when placed over heavy overglaze colors without removing the color underneath, the paste will be almost sure to blister.

Unfluxed gold, which contains but little flux, sometimes none, is best for use on raised paste. However, the home prepared fluxed gold serves the purpose admirably.

Paste is frequently used to set jewels on china. Put a dot of paste where the jewel is to be needed, then press it firmly down upon the paste allowing the paste to set up around it. This may be gilded when dry.

Raised paste may be painted over with powder colors prepared in the usual way and produce a slightly similar effect but are not as highly glazed as enamels. As the paste absorbs much color the fired colors are much darker than if the same color were placed on the white ware.

Where paste is used with lustre it is well to fire the lustre first and retouch before putting on the paste, as the least trace of lustre on paste will prevent the gold firing a good color. It is well to avoid a very hard kind of china for use with paste.

A rather uncommon but effective way of using the powder paste is to paint on the china a design suitable for a border, one of leaves and stems is good, with fat oil, to which has been added a little dry water color paint, just enough to enable one to see where the oil has been placed; and then, with a shader heavily charged with Marsching's powder paste, cover the oil until it will absorb no more. After being hard dried and covered with two coats of gold and fired, divisions or overlapping leaves may be indicated by touches of blood red paint; refire and burnish.

Beginners usually find the management of paste work difficult, but practice and patience will in time enable one to do creditable work, neatly executed.

o o o

Second Prize—Sydney Scott Lewis, Georgetown, Ky.

Paste skillfully applied and appropriately used is a joy. Abuse the use of it and it is an abomination.

Of all the branches of china painting it is one of the most difficult to do well, and has many terrors for the amateur and often one with a good deal of experience meets with disaster.

Hancock's paste is the best make. Put the powder on a ground glass slab, put in just enough fat oil to hold it together, not enough to make a paste of it, but to darken and make it crumbly. Breathe on it (not blow) and mix with palette knife (horn or steel). The breath gives

moisture, and takes the place of too much oil, cuts the oil and makes the paste work better. After the fat oil is worked in add enough lavender oil (dilute lavender oil with a little alcohol, to keep it from being too oily) to thin it, rub this into the powder with a ground glass muller, then after it has been well ground turn over and over with the palette knife, breath and mix, any number of times, adding more lavender oil as it dries out. When it is a thick, smooth, creamy paste and does not flatten out, stays put, and follows the brush in a smooth even line, it is in a condition for modeling and making dots; for lines it needs to be a little less stiff and for flat spaces, thin with lavender oil until it flows readily from the brush and covers the space desired.

To make a dot or fine line, take a little on the tip of the brush, do not fill the brush with the paste, insert the tip of the brush under the paste and pull it out with a quick upward movement, so as to keep the lump of paste on the upper side of the brush. To make dots hold the brush at right angles to the surface and touch lightly with the brush. If there is a point to the dot moisten the end of the brush or finger and touch it and it will flatten down. For a fine line fill the brush the same way and draw it along the outline. If you wish the line wider in some places put more pressure on the brush where you wish to widen it.

Modeling in paste means to raise some parts and leave others low, giving the look of the real flower. When you want some parts more modeled than others put on some of the paste, then, when that is partly dry, put on more paste.

Paste for flat spaces should be soft enough to smooth itself and not show the brush marks. To use a pen with paste, mix the powder with $\frac{1}{2}$ sugar and dilute with water, rub until smooth. This is good for fine lines and monograms. A fine well executed paste line should look like a gold wire encircling the design. All irregular paste lines can be retouched before firing by smoothing with a tracer wet with a very little turpentine.

For paste lines and dots use sable outlines No. 00 and No. 1 and flat pointed sables for modeling. Paste, provided it is kept very clean, can be kept indefinitely. Indeed some claim that the longer the better.

Paste should not be put over heavy color, may be put over a light unfired color. Gold may be put over perfectly dry unfired paste, silver should not. Paste should not be dried artificially, should not be raised too high. The dots should not have little holes, bubbles, or points, but should be smooth, round and flat on top. When paste is cracked though still staying on the china it had too much oil; take some fresh paste that has very little oil, moisten by breathing and fill up the cracks, press in as tightly as possible, put on the gold and fire.

If the paste work, however, has many defects gold will not hide them. If paste rubs off from an under fire a hard fire will remedy it. Paste will chip off over heavy color, when put in too fat, when artificially dried, or too much oil. Fill up the chips with aufsetzweis and after firing put in gold and fire again. It will burnish a little brighter than over the paste. If the paste rubs off like powder it is under-fired. It should always look dull before firing. If when working with paste it does not hold together put in a little more oil.

Paste can be grounded on just like powdered color and treated so as to look very much like etched china. Use the grounding oil and ground on the powder paste

just as you would ground a powder color. Then while the ground is still soft with a sharp point scratch out any conventional design or scroll work and fire. Then put on gold and re-fire and burnish and the effect will be very much the same as china etched with acid. A very much safer way of doing it than the acid used in inexperienced hands. Always use the unfluxed gold over paste.

○ ○ ○

Third Prize—Ella J. Adams, Yellow Springs, O.

Paste may be purchased in tubes ready for use, this is the water paste. A very little water is necessary for mixing. Only about half of what you think is needed is a very good rule. Water paste needs a harder fire than the oil paste and it has a tendency to chip off.

HANCOCK'S PASTE

Pour on a ground glass slab the quantity of paste needed and rub down with a small amount of Dresden thick oil, just enough oil to hold it together. Breathe heavily on this for the moisture will keep the paste from drying too rapidly. Mix again and repeat several times. Now thin the paste with lavender oil or turpentine. Turpentine dries more rapidly so is better for dots. Do not get the paste too thin. The proper consistency is when the paste stays in place on the china without spreading and follows the brush like a slender wire. If in using, it grows thinner and spreads, use the "breathing process" again and mix with the palette knife. If the paste becomes too stiff and unwieldy add a little more turpentine or lavender oil.

Never raise the brush from the china if you want a clear even line. Lines that are to be joined should be finished before the paste dries.

Do not attempt too much relief in paste, for the application of gold will bring it into prominence and too heavy a paste line is prone to chip off. The paste should be allowed to dry without artificial heat for otherwise it may blister.

Do not fire paste until it is a dull dry color. This shows that all superfluous oil has evaporated.

Gold may be applied on paste before it is fired if it is thoroughly dry. However, it is more satisfactory to fire it first.

Should paste come from the kiln uneven in effect (blistered) too much oil has been used. The rough places can be sand papered, filled in with paste and fired again. Paste may be put on over unfired color but if so used there is no good way to correct a mistake. Lines can be straightened with a brush slightly moistened in water since the water does not affect the oil mediums.

○ ○ ○

Fourth Prize—Bertha Morey, Ottawa, Ia.

RAISED PASTE.

Mix Hancock's paste with Fry's medium for raised paste until quite thick and let it bubble up and work with a palette knife. Or mix in a little saliva until it pulls properly.

Paste should not be fired more than three times as it will be apt to scale off. Do not use fluxed gold over paste as it soaks in and will not burnish. Allow it to stand for several days and it will get quite stiff and dry, then mix with turpentine until it works smoothly and will stand up. If used in this way it will almost never give any trouble. If it will not work, heat it over a candle and do not put wet paste into an oven to dry as it is apt to bubble up and ruin the work. Paste should be dried slowly and thoroughly before putting into kiln

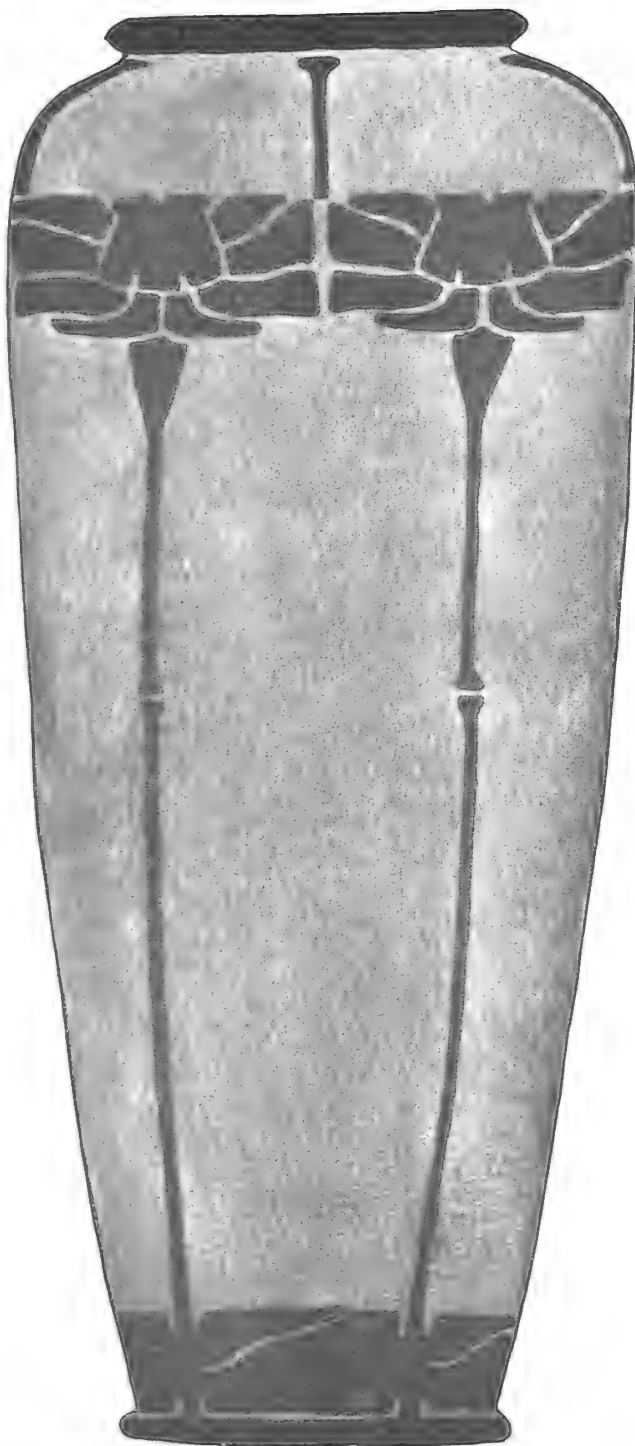

VASE—ZINNIAS

Mary Overbeck.

Flowers, Imperial Ivory and a little Black. Stems, leaves, etc., Olive Green, Black and a little Blue. Background, Dark Green and Deep Blue

ZINNIAS

Mary Overbeck.

THE study of Zinnias, in grey tones, can be carried out in a color scheme of dull red (orange red or pompadour with a touch of black) and black, for the flowers with a touch of orange yellow in centers. The leaves and stems should be a dark grey green (green 7) and black. The background should be a medium dark violet grey or a grey green.

The bowl might be a warm brown, (Meissen with a touch of red) on a green grey ground. The color study may be carried out in any other color scheme as the shades of Zinnias are varied. A dark pearl grey for the flowers with grey green leaves makes an interesting study with various backgrounds.

SMALL FRUIT DESIGNS

I. M. Ferris.

ALL but the Blackberry design may be treated in the yellows and browns with a little olive green mixed in darker places in background. For fruit, use Poppy Red with some Yellow Brown in lightest parts and Dresden Brown Red in darker ones. The Dresden Coral Red when dusted and fired gives a pretty tone for background. It is deeper and brighter than Yellow Brown and goes well with yellows and browns.

For leaves use Verdigris, Brown Green and Shading Green. The blackberries may be done with Sevres Blue Black and Deep Violet, some more red than others.

Make background Grey, Blue, Green and Purple Black. Blossoms, Grey and shadowy.

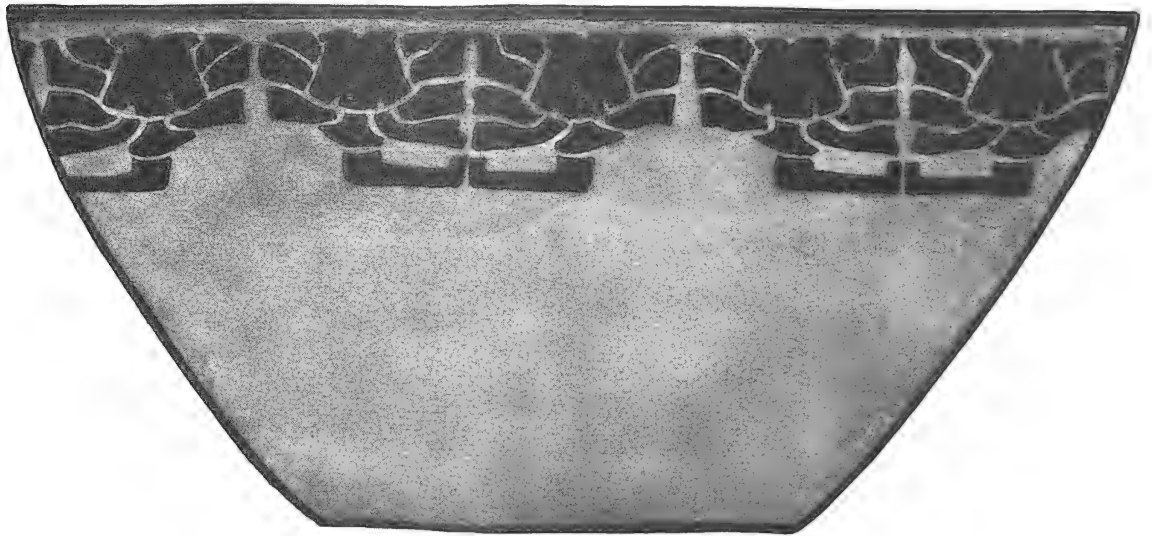

BOWL—ZINNIAS—MARY OVERBECK

Tint over the whole with Brown 4 or 17 with a touch of Black, and fire. Figures, Deep Blue Green and a little Black.



SEPTEMBER 1906
SUPPLEMENT TO
KERAMIC STUDIO

ZINNIAS—MARY OVERBECK

COPYRIGHT 1906
KERAMIC STUDIO PUBLISHING CO.
SYRACUSE, N. Y.

PHOTOCHROMOTYPE ENG. CO., PHILA.



ZINNIAS—MARY OVERBECK

THE ART PRIMERS OF THE PENN MUSEUM

Mr. Edwin A. Barber, curator of the Pennsylvania Museum has begun the publication of a series of Art Primers designed to furnish in a compact form for the use of collectors, historical and art students, and artisans, the most reliable information relating to the various industrial arts. The first monograph is one of the series of ceramic books, which, when completed, will cover the entire subject, and is on Salt Glazed Stoneware. Mr. Barber divides the subject into three groups: Stoneware of Germany and the Low Countries; Salt Glazed Wares of England; Stoneware of the United States; and every group is profusely illustrated with the most characteristic specimens in the Museum, and some from private collections.

In review of stoneware in the United States much praise is given to Mrs. Frackelton who has been the first to revive the making of artistic salt glazed stoneware in our times. There are great artistic possibilities in the

making of this ware. Another woman, Miss Hannah B. Barlow, at the Doulton Works in Lambeth, England, has in recent years attained a worldwide celebrity by her clever rendering of animals and rustic life in a few lines scratched on the wet surface of the ware before firing and salt glazing.

The price of the Pennsylvania Museum booklet is 50 cents and it is for sale at the Museum. This price will hardly pay expenses, but as Mr. Barber writes to us, this publication is a labor of love entirely. It will be a valuable addition to the library of both artisans and collectors.



STUDIO NOTE

Mrs. Vance Phillips reports a very successful season at Chautauqua with a high class of work under the tuition of Mrs. Sara Wood Safford, Mrs. Blanche Van Court Schneider, Miss Lilian Sherman and Mrs. Phillips herself.

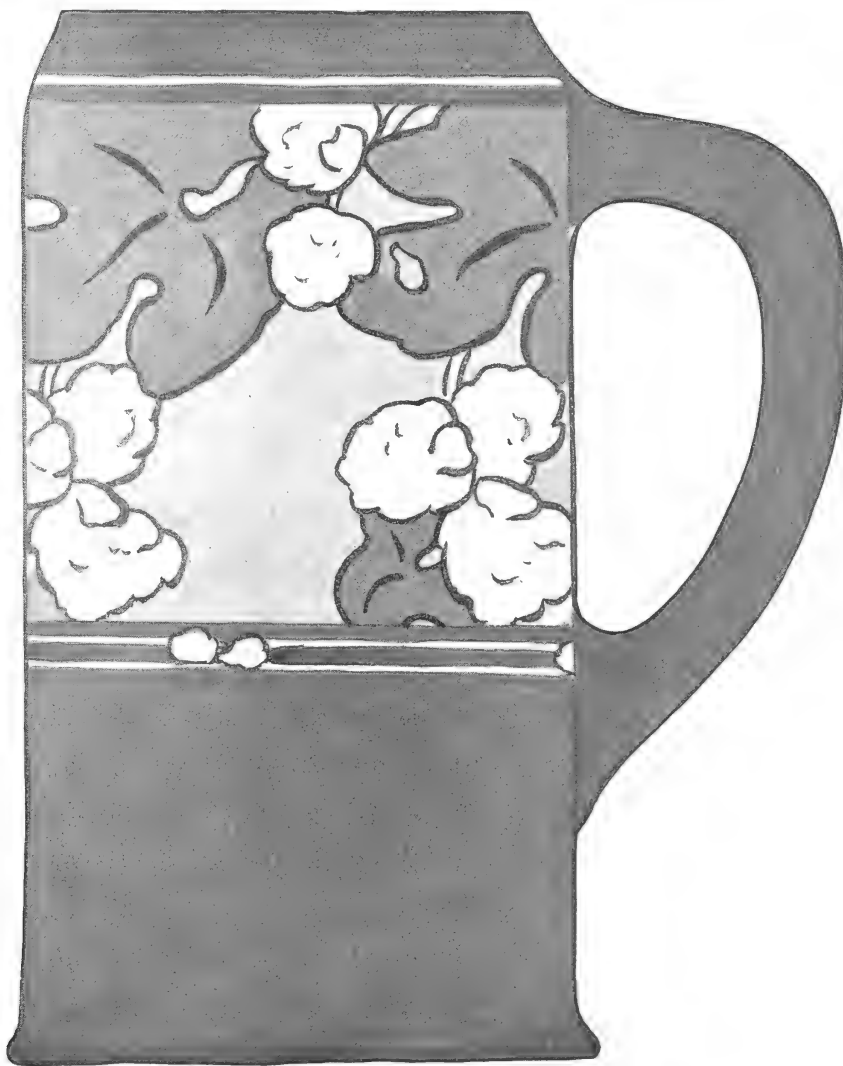

HOP DESIGN FOR STEIN IN OLIVE GREENS—OPHELIA FOLEY

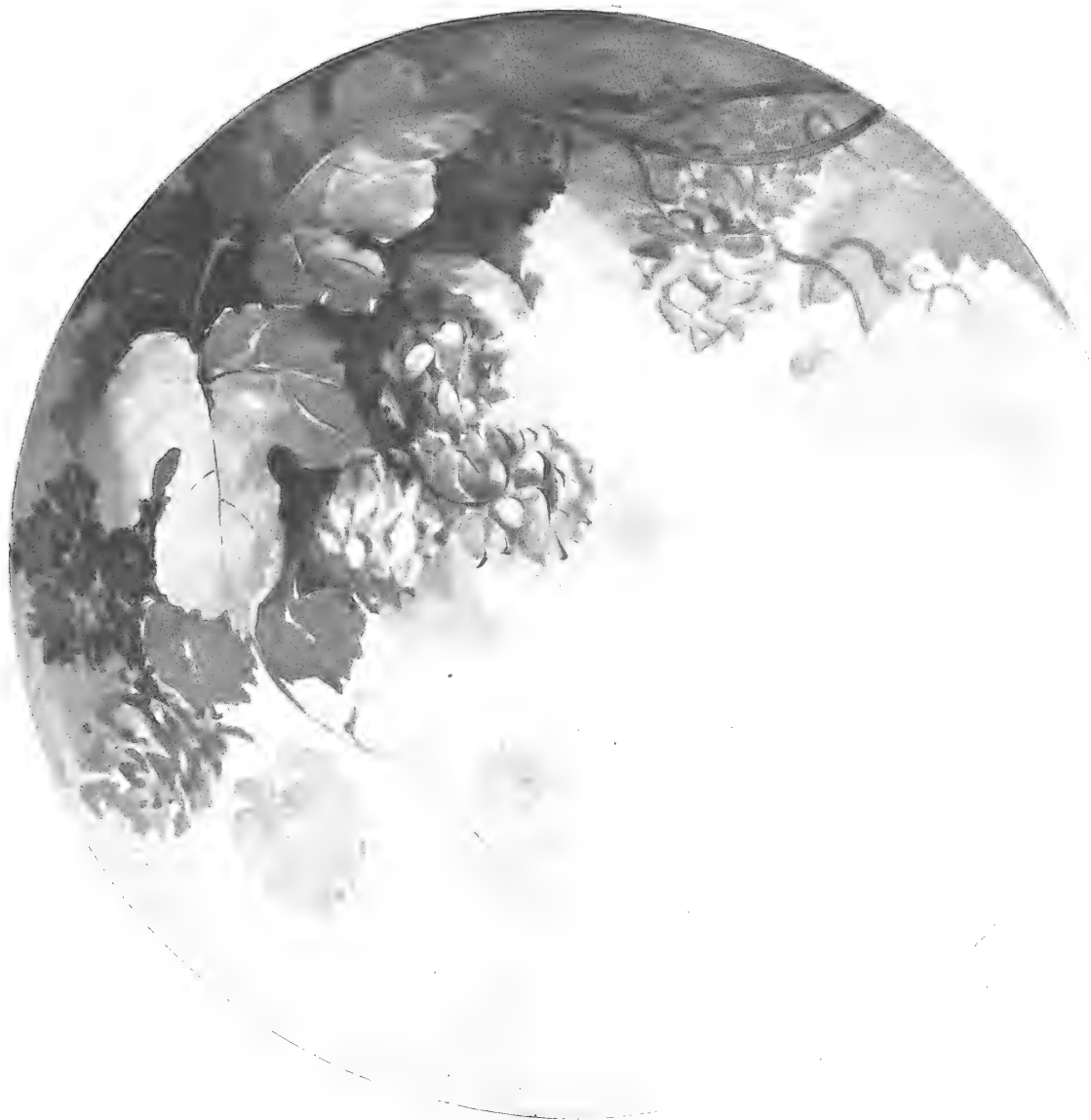

HOPS—LOUISE M. SMITH

The color scheme is very simple. Model the more prominent hops and foliage with Brown Green and Yellow Brown, using Yellow Green for the lighter tones. For darker background effects use Dark Green strengthened with a little Black. For shadowy effects use Grey Green. 2d Fire.—Wash with Albert Yellow, retouch with Brown Green and Yellow Brown adding a few touches of Hair Brown. 3d Fire, consists of washes to harmonize the whole.

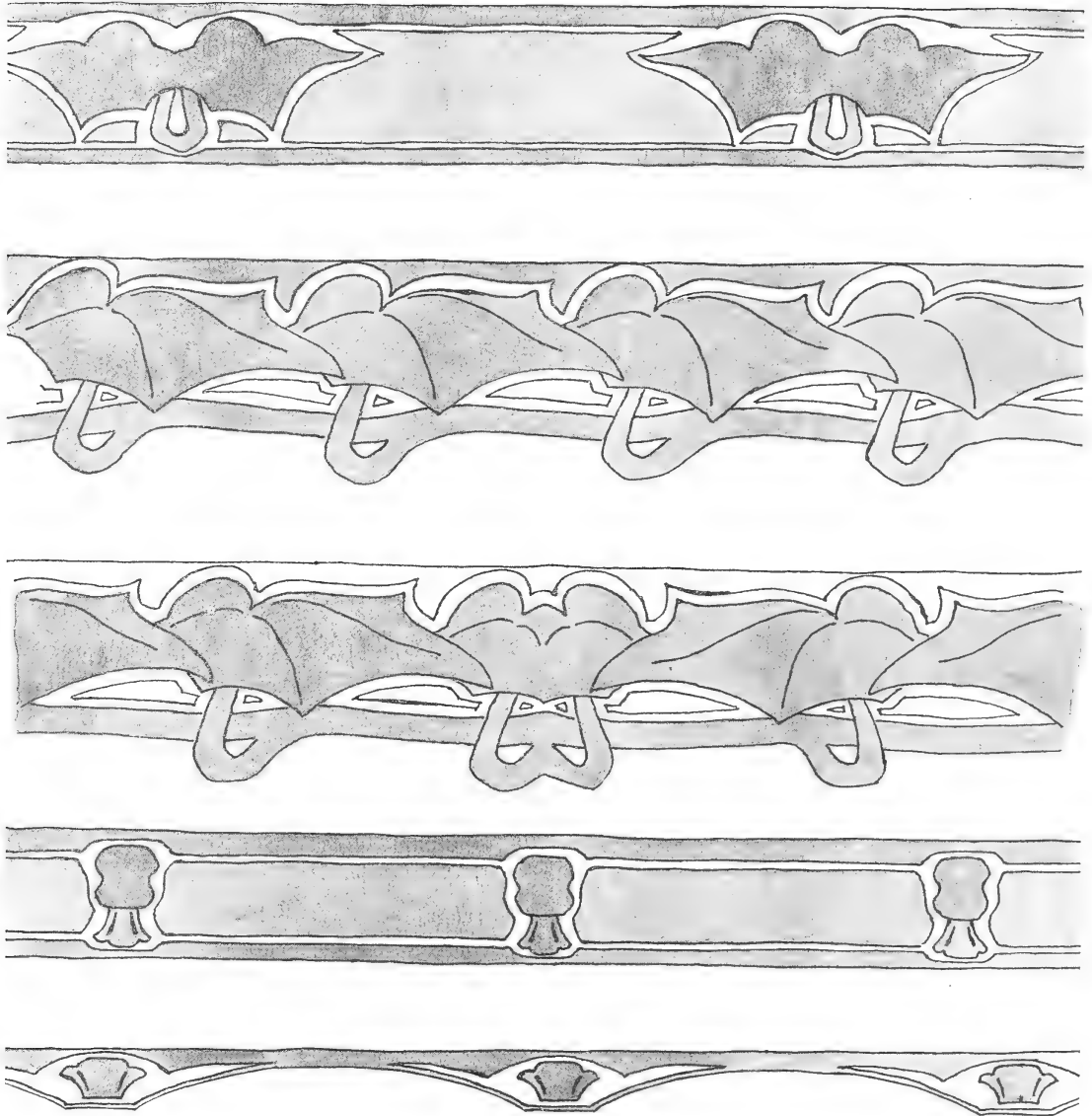

BORDERS FROM PUMPKIN VINE—HANNAH OVERBECK

THE study is in dull yellow and grey green with black outlines on a grey ground. The borders and stencils can be used in any desired color combination.

For the plate, is suggested a cream ground, a dull ochre edge and line, a grey green ornament with a touch of red; black outlines. The stein might be in dull reds and browns on a tint of ochre.

Plate with pumpkin design: outer band and inner line, Yellow Brown and Imperial Ivory; figure, Dark Blue and Black; small spot, Deep Red Brown and Yellow Brown; inside tint, pale Imperial Ivory and Black.

For Cups: Tint over whole with Warm Grey and fire. Flowers, a little Rose Pompadour, Background, Dark Blue and a little Dark Green.

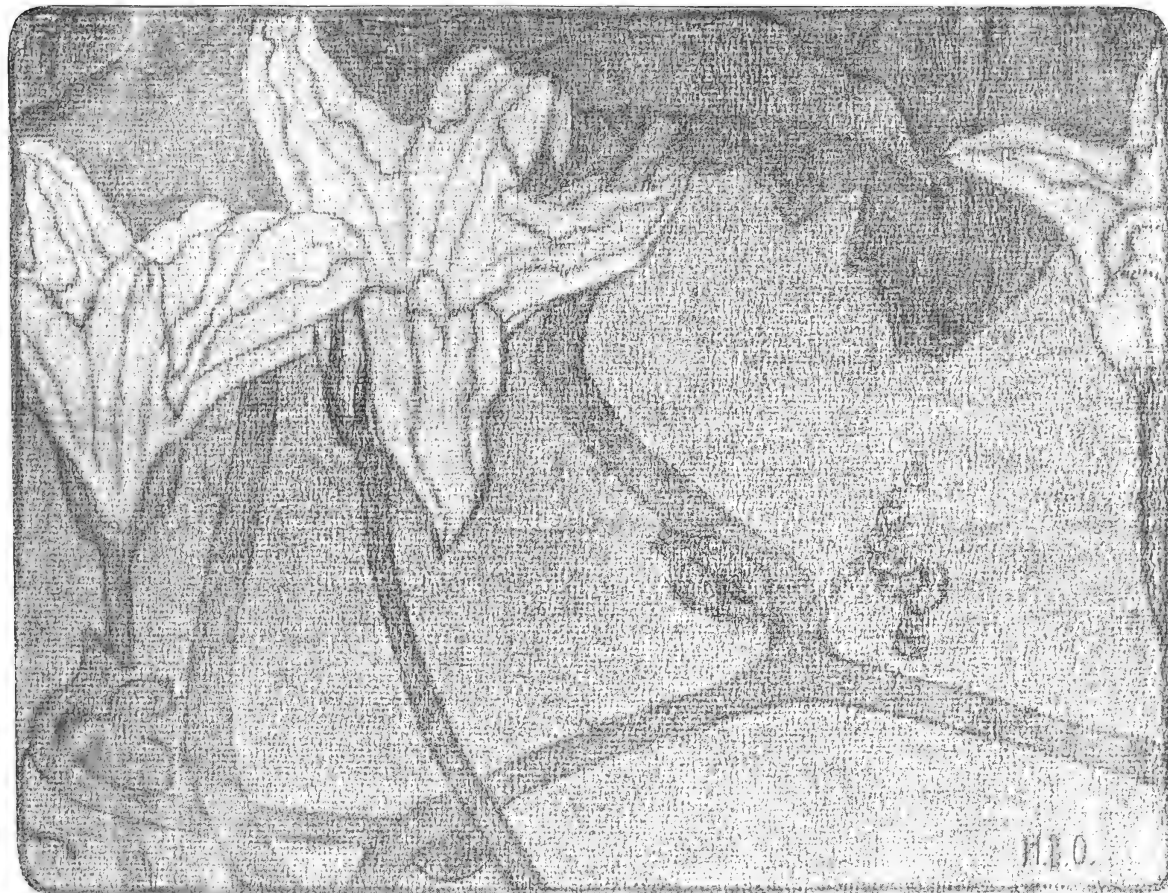

STUDY OF PUMPKIN VINE—HANNAH OVERBECK

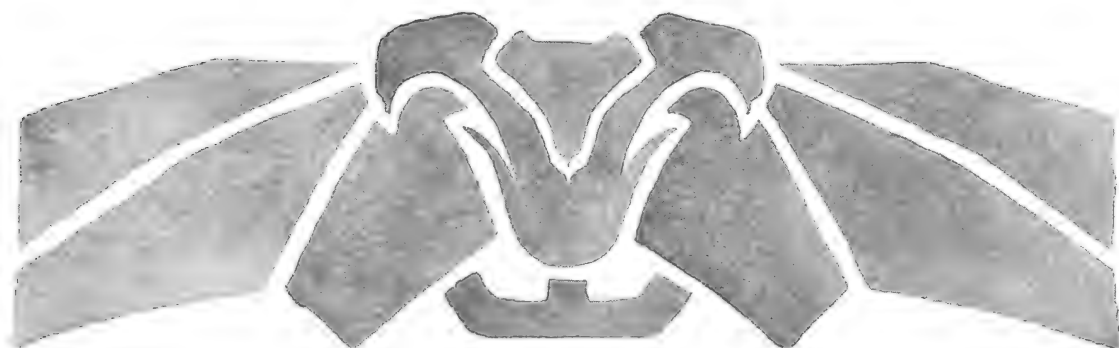

STENCIL DESIGN—PUMPKIN BLOSSOM—HANNAH OVERBECK

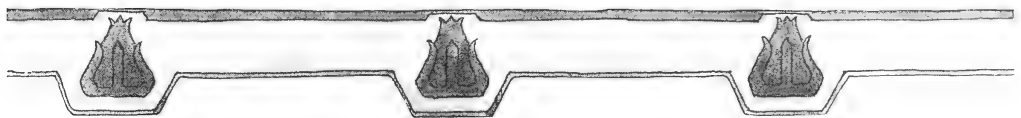
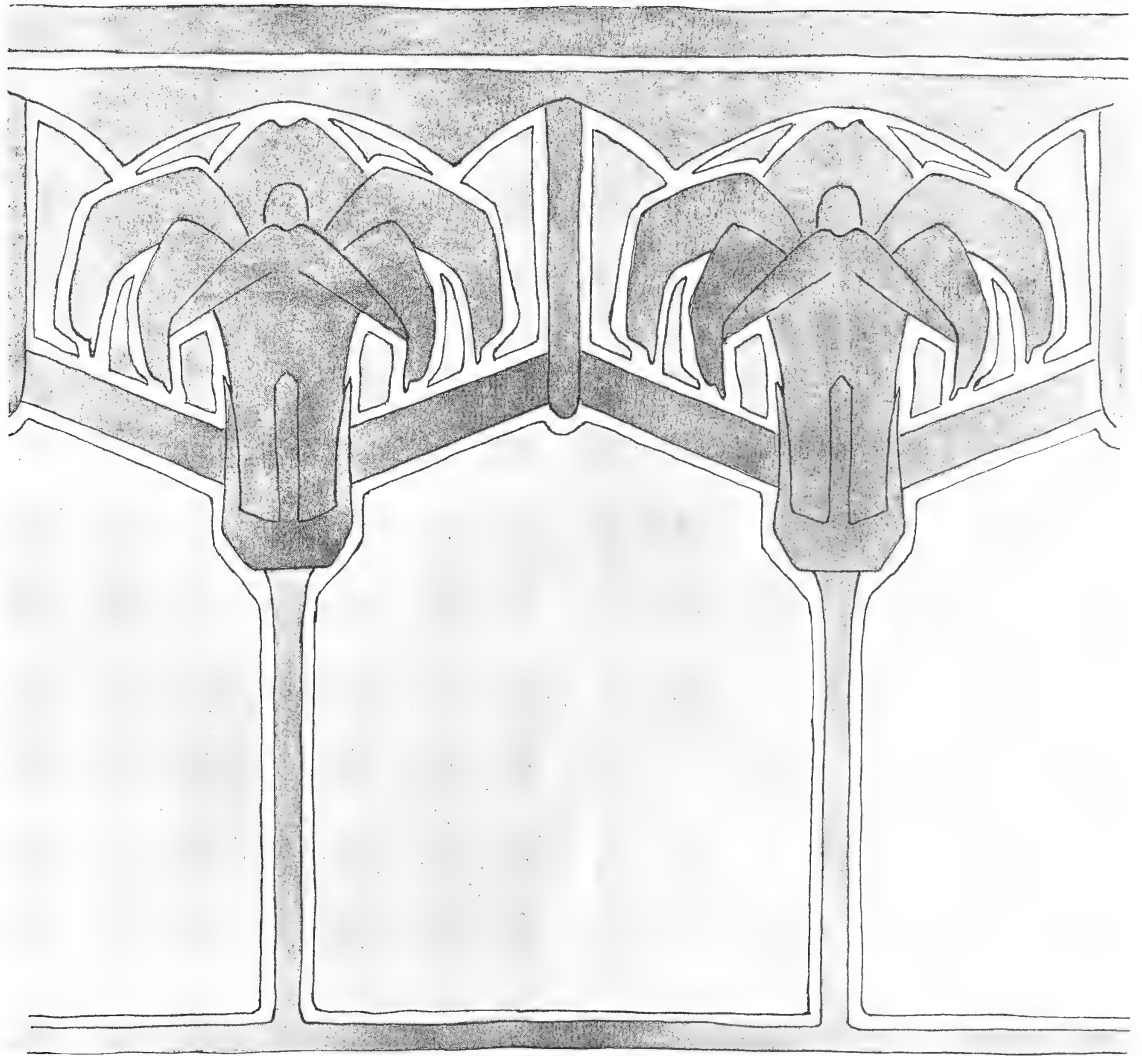

STEIN DESIGN FROM PUMPKIN FLOWER—HANNAH OVERBECK

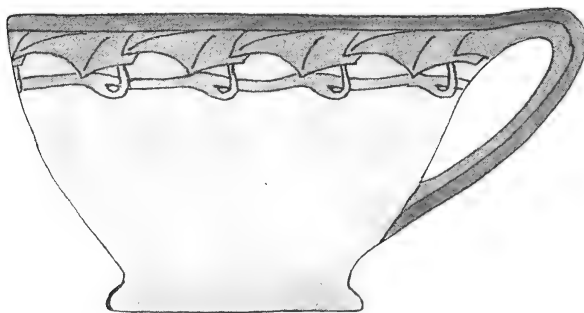

PUMPKIN VINE BORDER—HANNAH OVERBECK





PUMPKIN BORDER - HANNAH OVERBECK

Pumpkin

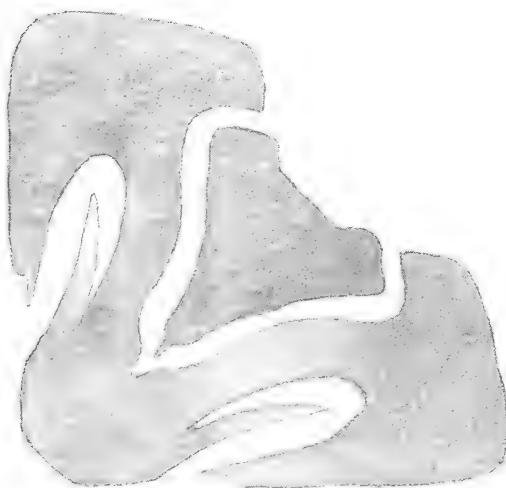

CORNER FOR STENCIL DESIGN—PUMPKIN—
HANNAH OVERBECK



PLATE—PUMPKIN MOTIF—HANNAH OVERBECK

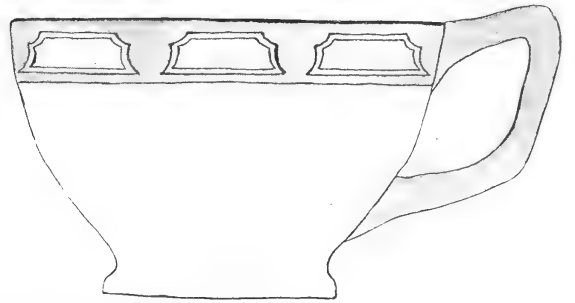

CUP BORDERS—HANNAH OVERBECK



HOPS—SARA REID MCLAUGHLIN



ROSE DESIGN FOR VASE—MARGARET OVERBECK

Ground, grey green over fired ivory tint, leaving ivory outlines. Roses, a delicate salmon pink (tint with Pompadour Red) leaves, grey green.



ROSE STUDY—MARGARET OVERBECK



ROSEBUD DESIGN FOR SALAD SET—MARGARET OVERBECK

Leaves, stems, etc., Black Green. Background, Grey Green. Centres, Orange Yellow and Black. Outline in Black.

Or: Ivory tint, fired; grey green background leaving ivory outlines; olive green stems and lines; ochre with touch of ivory yellow for bud.

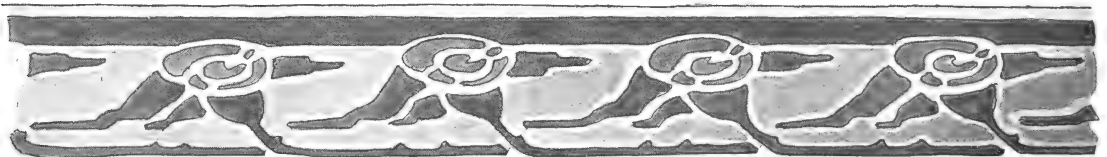

THE CRAFTS

WOOD CARVING AND PYROGRAPHY. LEATHER AND METAL. BASKETRY, ETC.

Under the management of Miss Emily Peacock, Room 23, 22 East 16th St., New York. All inquiries in regard to the various Crafts are to be sent to the above address, but will be answered in the magazine under this head.

Summer Address, care of Ceramic Studio Pub. Co., Syracuse, N. Y.

All questions must be received before the 10th day of month preceding issue, and will be answered under "Answers to Inquiries" only. Please do not send stamped envelope for reply. The editors will answer questions only in these columns.



THE MAKING OF A METAL LANTERN

F. G. Sanford

The present Chapter deals with the construction of lanterns and involves some processes described in the two previous articles (The Making of a Metal Candlestick, April, 1906; The Making of a Metal Sconce, June, 1906), which will be referred to for details of rivetting, etc.

These are lanterns for porch or hall decoration where not quantity but quality of light is wanted. We see many delightful forms on sale in our great stores, or find them in the shops of craftsmen friends. All sorts and conditions of lanterns, many of which one would like to own. But none have to me quite the charm of the old perforated brass or tin lantern of our forefathers. It is such a lantern, a little modified to fit our simple equipment and methods, that I would first consider.

Two thicknesses or gages of metal are needed. For the perforated body and roof 28 or 30 soft sheet brass, for the bottom and other parts 20 or 21 is needed.

Sheet brass may be had in rolls 12" wide. For either of the lanterns shown in Fig. 1 you will need a piece of thin metal 24" long, 12" wide.

First square one end of this piece and then mark off a piece 10"x16" for the lantern body and cut this out square and true (Fig. 2.) Mark lines carefully as shown in Fig. 3, that is 1" top and bottom, $\frac{1}{2}$ " sides and cut out the corners as shown Fig. 3. The design comes between these inner lines, the upper 1" margin forming and the lower forming the turned over borders and the end ones forming the joint. Divide the design space into sixths; it should measure just 15" and this makes an easy division into $2\frac{1}{2}$ " spaces. Three tabs or ears are left at thirds as dicated in Fig. 4, these measure $\frac{1}{2}$ " in width and come in such a way that they will not interfere with the joint. The rest of the upper and the whole of the lower borders are bent over a bevelled edge rule and then beaten down flat. Now having strengthened the edges and allowed for attaching to the roof and joining the sides the middle space is free for design. But it is seldom well to fill all of the space and in this case a 1" border top and bottom is advisable.

The patterns shown in Fig. 1 are severe and purely line and dot patterns. They are however sufficient and effective. Perhaps the tree design shown in the photo may appeal to some. In general large blank spaces should be avoided for two reasons. They do not diffuse enough light and they make an uneven bulging of the design.

The laying out of the geometric motives seems to need special description. It is simply a frame work of intersecting straight lines or parallels, capable of infinite variety. The actual drawing may be done right on the metal upon that side which will finally be the inside *i. e.* where the borders are bent over.

Punching is done upon a soft wood block with a $\frac{1}{2}$ " or suitable width chisel and a sharpened 9d nail, the curves of course with a gouge. In perforating a mass of holes try and drive the nail or chisel through with one stroke to insure evenness of size. Also take care to distribute at even distances and not to run together. After this has been finished form the joint by bending one edge one way over the other opposite. See Fig. 5. The metal will have bulged with the stamping and it is necessary to beat some of this out gently with the mallet, beating in the direction of the length of the cylinder, and this will curl it up nearly to shape. The rest of the curling may be done with the hands and the joint hooked together, and pressed down with the fingers. Finish this joining by stringing the cylinder over a rod or bar set in a vise or nail strongly in some good place. Fig. 6. Beat down closely and clinch into place by denting the joint at intervals with a nail

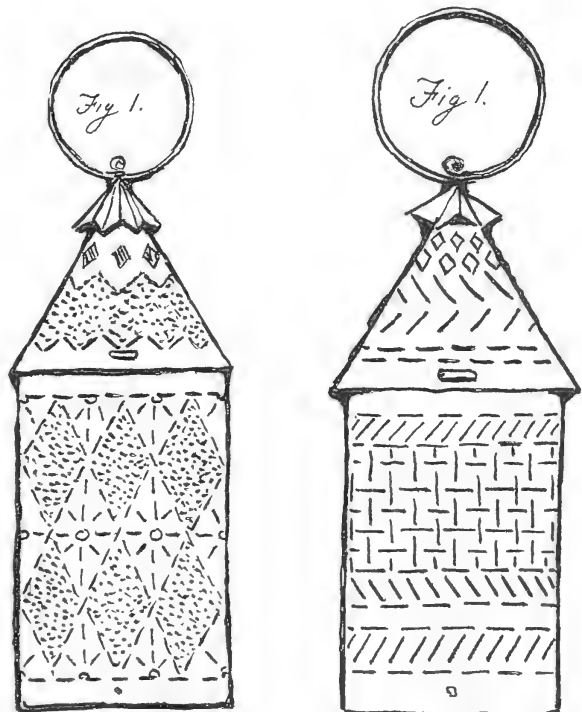

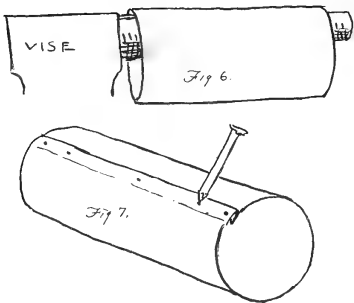
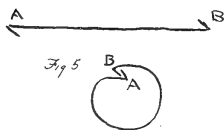
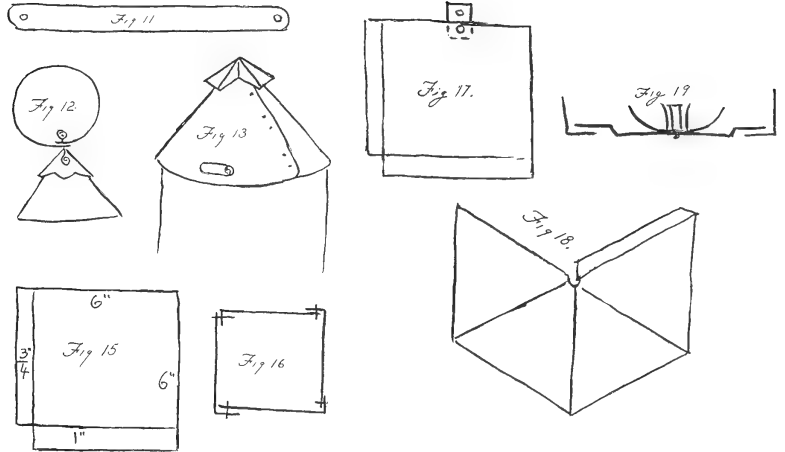
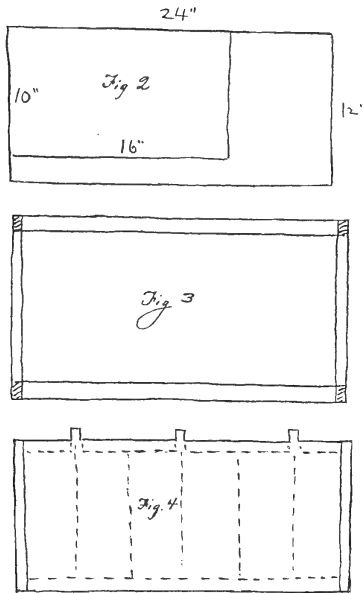

point. See Fig. 7. The cylinder or body then resembles that in the photo. Next describe a semi-circle with a six inch radius as in Fig. 8, and allow $\frac{1}{2}$ " more metal on each straight edge for the joint. In order to facilitate bending file out a hole at the centre. About $\frac{1}{2}$ " from this punch a row of good sized holes quite close together for ventilation, else the heat from the candle or small lamp will be too great.

A border along the circumference of say 1" is left, then the interval may be perforated with some motive appropriate to the lantern body. The joining of the edges is as described for the body. It will be a little more difficult but can be accomplished with a little assistance.

The proper fastening of the lantern top upon the body is explained later.

A simple form of lantern bottom is made as follows: Cut a circle of the heavier brass to fit inside the cylinder rather loosely. Beat in the centre to form a hollow drip pan, (either on a wood block or upon the pad) make and rivet to the centre a holder for the candle, (see photo). Cut equilateral notches from the edges measuring about $\frac{3}{4}$ " on a side and coming at thirds of the circumference. (Fig. 9.) Now cut from the thick metal three pieces like Fig. 10, one part square, the other cut a little smaller than the V shaped cuts in the bottom. These pieces are perforated on the square end and bent to a right angle and rivetted in the proper position directly on a line with the laps which come at the top. To adjust the bottom set it up though allowing the slits to pass these V shaped ears and turn so that it will be held upon them. It will be necessary to punch a row of holes near the edge of the bottom piece to allow a draft of air to pass up through the lantern.

In the photograph a somewhat different, but clumsier method is used. The ears are of different shape and rivetted outside with the lantern bottom bent up to catch over the points. This photo is shown as an example of

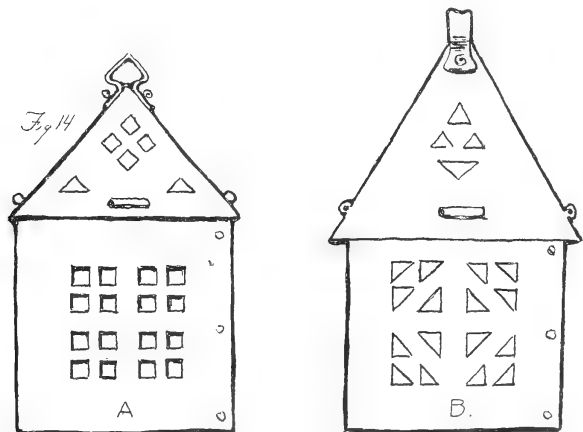
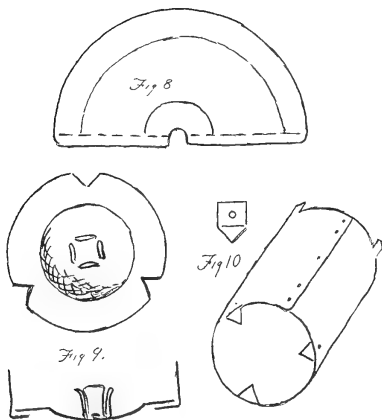

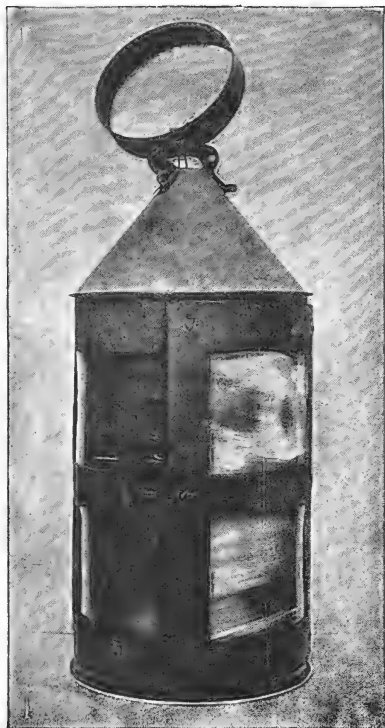

Horn Lantern made by R. R. Jarvis



Lantern in Wrought Copper, designed by Claude New
Courtesy of International Studio

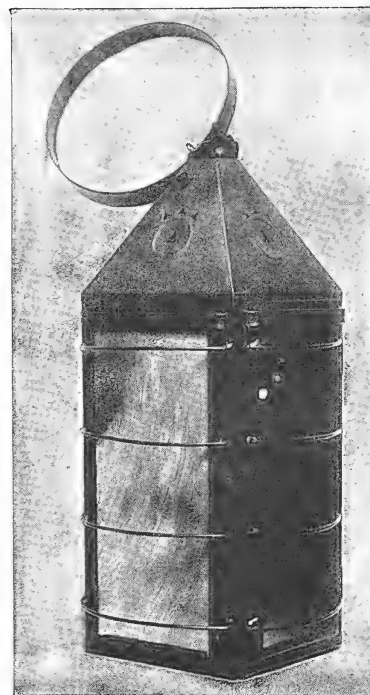

Horn Lantern made by R. R. Jarvis

the perforating and rivetting of the separate parts. The work is that of two Allendale Boys of the 7th grade.

To prevent too much heat at the top make a small hood from a 3" circle of thin brass. This is marked with diameters and bent with the pliers to resemble the one on the lantern in the photo. It is perforated in the centre with a small hole. The handle consists of a loop of heavier metal formed by cutting a strip $\frac{3}{4}$ " wide by 12" long. (Fig. 11.) Perforate at the ends and beat with the mallet so that it will curl up into an even circle.

A piece of medium thick, soft brass wire about 4" long will be needed for a fastening. Or copper wire can be used if it is easier to obtain. Roll one end of this into a loop and thread it up through the roof, the hood and the two ends of the handle and twist down tightly. (See Fig. 12)

The roof is placed upon the body and the position of the square ears carefully marked. Punch slits at these places and thread the ears up from underneath, rolling them down tightly with the pliers (See photo, also Fig. 13). The adjustment of the bottom then completes this form of lantern. After trial, if the candle within melts too rapidly enlarge the holes at the top and in the bottom for more ventilation.

The other forms of lantern (Fig. 14) are made from gage 21 soft sheet copper, the design being cut out into open spaces with a chisel. For the sides of lantern cut four pieces measuring $6\frac{3}{4} \times 7$ " marking each piece accurately like Fig. 15. The finished side will be $6" \times 6"$. This allows $\frac{3}{4}$ " lap for rivetting to the next piece and one inch for the bottom. All four pieces should fit each other accurately. The severe, square design is then cut out upon a wood block. Would advise a little practice first on a scrap of metal. Now the $\frac{3}{4}$ " edge is punched for

three copper rivets and bent inward to a right angle the bottom is also bent inward.

Fig. 16 shows in diagram the rivetting of one side to the next. In each case the lap comes inside so that the outside presents a smooth surface and even corners except for the rivets. These corners may then be finished by rounding slightly with a file. It is now necessary to punch and rivet together the four corners of the inside flaps at the bottom. Wherever possible place the outside rivets from the inside, beating down upon them as this is the more ornamental way.

Four pieces, each measuring $\frac{3}{4} \times 1\frac{1}{2}$ " are rivetted at the middle (inside) of each surface at the top edge, and punched with a single hole for wiring. (Fig. 17.) Or the end may be brought up through the top and rolled down as in the cylindrical lantern.

The roof may be cut from one piece as in Fig. 18 or made as four equilateral $6\frac{1}{2}$ " triangles and rivetted as in the sides. To make the bottom cut a square of metal which will just fit into the square opening. Attach holder and drip pan as in Fig. 19, bending the corners slightly as shown. Bottom is then set in and turned corner wise thus resting by its corners against the bent over edges.

Both the geometric lantern here shown may be constructed in this way. Instead of a candle holder a small frame made to hold a lamp of given size may be rivetted in.

The drawings show simple loop handles difficult to rivet but easily attached by copper wire.

Instead of the open work patterns sheets of colored glass may be set behind and held in place by small buttons of metal above and below. Get a glazier to cut them the size for you. The student who has followed thus far should be able to go on and create other and original forms.

ZINNIAS—(Supplement)

Mary Overbeck.

The original of this study is a tinted charcoal drawing, a most interesting treatment of the subject. For reproduction on porcelain, the charcoal graining will have to be omitted, but an attractive result may be obtained by tinting with Yellow Ochre, Pompadour and a little Black, after firing, tint again to obtain greater depth of color. Then paint on the design with the same colors adding Olive Green. Also use a touch of Orange or Albert Yellow on centers of flowers. The study is very attractive mounted on a dark manilla paper with a brown passe par tout.



STUDIO NOTE

Miss M. Helen E. Montfort will open her new studio 318 Lenox Ave., cor. 126th St., N. Y. City, on October 1st.

ANSWERS TO CORRESPONDENTS

Mrs. S. R.—If you keep your bottles of oils well corked during the summer, they should be in good condition to use in the fall. Fat oil of turpentine can be thinned with the spirits of turpentine. Other oils can be thinned with oil of cloves if you want them to keep open a long time, or with spirits of turpentine or alcohol if you wish them to dry quicker.

Mrs. P. W.—Wash your gold drainings in alcohol and pass through bolting cloth, when settled, pour off liquid and when dry, rub up with a very little fat oil and spirits of turpentine. You can use the gold then for first washes.

Mrs. H. B.—If your paste for gold is brown instead of yellow it is underfired or some dirt or color has gotten into it. If underfired it will rub off easily with a knife. Overfired or pale colors can be retouched and refired satisfactorily.

L. C.—Place plates or Service plates are in better taste decorated alike and simply. They are not the plates on which one expects to see elaborate decoration. We can not think that for such a purpose, any thing would be in good taste except a narrow conventional border in gold or color, with or without a monogram. The dessert set allows more latitude, but if landscape or flowers are used naturalistically, they should be confined to medallions in the border. One does not care to look at a landscape, a figure or flowers through a veil of pudding sauce, pie crust or even ice cream. In making a set of plates where variety is desired, the best idea would be to make the same medallion border on all and insert in the medallions different subjects as desired.

M. C.—Your vase dusted with black which is glazed on one side and not on the other, may perhaps be underfired on one side. Possibly by simply refiring, you may correct the trouble turning the unglazed side toward the hottest part of the kiln. If this does not have the desired effect dust lightly with flux and refire. If the dusted black has been put on evenly it probably will not scale in a second fire but thick spots are liable to scale off.

M. A. C.—The unfluxed gold or "Hard gold" should be used over unfired color, as well as over fired color, although the ordinary Roman gold can be used over very light tints. We will publish a design for a chocolate set in the November issue and a tea set either in October, December or January. For English violets use Banding Blue, Roman Purple and a little Black, Violet 1 and 2. The latter 2 may be used for tints adding Banding Blue if desired.



HOPS—MRS. BRAME VAN KIRK



CHILD'S PLATE IN BLUE GREYS—MAUD MYERS



ORCHIDS—PAUL PUTZKI
 Supplement for November, 1905

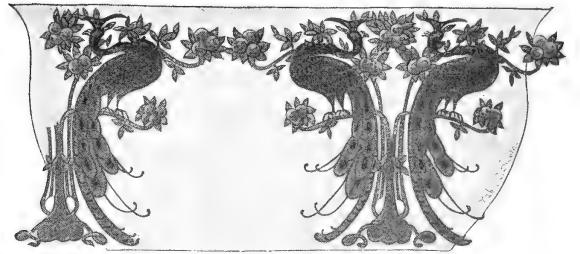

PEACOCK BOWL—MABEL C. DIBBLE
 Supplement for October, 1906



The
 Fruit
 Book

for the
 China
 Decorator
 and
 Water
 Color
 Painter

Keramic
 Studio
 Publishing
 Company
 Syracuse
 New
 York

THE FRUIT BOOK

Containing some of the best fruit studies and designs published in
 Ceramic Studio, \$3.00 net postpaid.

Size 11 x 14. Number of pages 48. Color Inserts 8. Monochrome Inserts 7.

Keramic Studio Pub. Co., Syracuse, N. Y.

KEEP THE FIRE ALIVE

KERAMIC STUDIO

CONTRIBUTORS

MABEL C. DIBBLE

SARAH REID McLAUGHLIN
HATTIE V. YOUNG PALMER
BLANCHE VAN COURT SCHNEIDER
MABEL TUKE PRIESTMAN

OCT. MCMVI

Price 40c. Yearly Subscription \$4.00

A MONTHLY MAGAZINE FOR THE POTTER AND DECORATOR

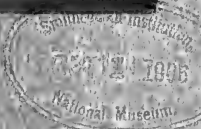

The entire contents of this Magazine are covered by the general copyright, and the articles must not be reprinted without special permission.

CONTENTS FOR OCTOBER 1906

	PAGE
Editorial Notes— League Notes	121
The Class Room	
The Art of Teaching	121-126
Roses	123
Pears	125
Red Rambler Roses	127
Editorial	128
Stein	128
Coup Plate	129
Salad Plate	130
Cup and Saucer	131
Peacock' Bowl (Supplement)	132
Daisy Vase	132
Service Plate	133
Fruit Plate	134
Invalid's Tea Set	135
Small Bowl	135
Ice Cream Plate	136
Candlestick	137
Wild Rose Vase	138
Plate—Historical Ornament	139
The Crafts—	
Rug Weaving and Dyeing	140-142
Answers to Correspondents	143

LIST OF BOOKS

The Rose Book, containing some of the best rose studies and designs published in Ceramic Studio..... postpaid	\$ 3.00		
The Fruit Book, containing some of the best fruit studies and designs published in Ceramic Studio..... postpaid	3.00	Tulip Ware of the Pennsylvania German Potters, by Edwin A. Barber, in paper cover..... postpaid	1.10
Composition, by Arthur Dow..... postpaid	1.65	Tulip Ware of the Pennsylvania Potters, by Edwin A. Barber, cloth, limited edition..... postpaid	5.00
Principles of Design, by E. Batchelder..... postpaid	3.00	Encyclopedia of Ceramics, by W. P. Jarvis..... postpaid	6.75
Decorative Studies, by J. Foord..... postpaid	12.50	The Old China Book, by N. Hudson Moore..... postpaid	2.18
Plant Forms and Designs, by Midgley and Lilley..... postpaid	2.20	The Old Furniture Book, by N. Hudson Moore..... postpaid	2.18
Practical Pottery, elementary instruction for students, by Richard Lunn..... postpaid	2.50	Old Pewter, by N. Hudson Moore..... postpaid	2.18
Grand Feu Ceramics, a practical treatise on the making of hard porcelain decorated with high temperature glazes by Taxile Doat of the Manufactory of Sevres, France..... postpaid	7.50	Chats on English China, by Arthur Hayden..... postpaid	2.16
Seger's Collected Writings, 2 volumes..... postpaid	15.50	Chats on Old Furniture, by Arthur Hayden..... postpaid	2.18
For the Collector:		China Collecting in America, by Alice Morse Earle..... postpaid	3.20
Vol. II Old China, bound blue cloth..... postpaid	2.50	Pottery and Porcelain, a guide to collectors, by Frederick Litchfield, the English expert..... postpaid	6.25
Vol. III Old China, bound blue cloth..... postpaid	3.50	French Pottery and Porcelain by Henri Frantz..... postpaid	2.68
Anglo-American Pottery, a manual for collectors, by Edwin Atlee Barber, Curator of the Pennsylvania Museum, second edition..... postpaid	2.00	Dutch Pottery and Porcelain, by W. Pitcairn Knowles..... postpaid	2.68
American Glassware, old and new, by Edwin A. Barber..... postpaid	1.00	Old English Furniture, by Fred Fenn and B. Wyllie..... postpaid	2.68
Marks of American Potters, by Edwin A. Barber..... postpaid	2.25	English Embroidery, by A. F. Kendrick..... postpaid	2.68
Pottery and Porcelain of the United States by Edwin A. Barber..... postpaid	3.75	French Furniture, by Andre Saglio..... postpaid	2.68
The Lace Book, by N. Hudson Moore..... postpaid	5.30	Old Pewter, by Malcolm Bell..... postpaid	2.68
		Sheffield Plate, by B. Wyllie..... postpaid	2.68
		The Oriental Rug Book, by Mary Churchill Ripley..... postpaid	3.20
		Home Furnishing, practical and artistic, by Alice M. Kellogg..... postpaid	1.65
		William Adams, an old English potter, by William S. Turner..... postpaid	8.00

Keramic Studio Pub Co., Syracuse, N. Y.

KERAMIC STUDIO

Vol. VIII, No. 6

SYRACUSE, NEW YORK

October, 1906



THE present number of *KERAMIC STUDIO* is chiefly edited by Miss Mabel Dibble of Chicago. This is the second of our series of "Personally conducted tours" of the studios of the most prominent decorators; and we feel sure our company will enjoy the trip.

Do not forget that the Christmas competition closes October 1st. See back of cover.

We are in receipt of some very interesting little relics of the San Francisco fire and earthquake. They resemble very much in color and texture the celebrated Massier lustres, being rather rough and cracked with much iridescence. The following extract from a letter explains the circumstances of their finding:

"These little jars are part of a crate that were buried in the brick and ashes for sixty-three days and were still hot when taken out. Originally they were green, the common ware of Japan imported by my brother for cold cream jars in his drug store. The crates had not been unpacked, and the jars were wrapped in straw, just as they arrived from Japan. They were on the ground floor of a seven-story brick building and buried in several feet of brick and debris. When taken out, in some cases the straw that had encased them was in ashes but still in shape. They have burned in most curious colors, and yet they were packed in a space of about 4x6 feet. Very few are alike. In some the glaze is completely gone and others are red or copper. If one could know the proper fire beautiful effects could be had in the large green wares to be had in the Japanese stores. There were no chemicals in the building near them, only cottons and surgical goods. ADELLA E. DUGAN."

STUDIO NOTE

The Misses Mason have returned from a delightful four months' holiday in Europe. Miss Mason writes: "We are bubbling over with enthusiasm over what we have seen and wish to do ourselves." They spent some time with Mr. Snell's class at St. Briac in Brittany, Miss Maud Mason, having studied with Mr. Snell several years.

LEAGUE NOTES

Our facts from the dandelion, poppy and daisy are here. Some of them clever and intelligent, others vague and incoherent, perhaps because our directions were not clearly enough defined. Let us, therefore, try again. Instead of a flower we will take an oak tree. We would not say its bark is white, and that it splits and peels around the trunk showing a rich yellow color, under which is still another layer of beautiful yellow brown; because we would be giving a description of a birch tree trunk; nor that the branches high on its trunk are symmetrical and regular,

spreading out like a fan and drooping gracefully; as that is characteristic of the elm. We would not give it whip-like twigs with tapering yellow green leaves that wave gently in the breeze, for such is distinctive of the willow. We would say of the oak that its roots reach down from the base of its trunk in a traingular line, not creeping along near the surface nor perpendicularly from the trunk. That its trunk is gnarled, rough, and rugged, with deep incisions; often leaning away from its natural line of growth, exposing roots bleached to whiteness. Its branches growing out and up at the same angle that the roots grow out and down, warped and twisted, one dead and bare extending beyond the foliage, others wrenched from the trunk by the winds; all telling a story of conflict with the elements, which has won for it the name "King of the Forest." The leaf at first salmon pink in color, with the softness and bloom of velvet, later develops into a dark glossy green on top, and silvery white reflection underneath, lobed and about the size of a woman's hand. Thickly massed, the leaves show purples, almost black in their intensity, while those still clinging to the tree in spring are a rich golden brown. As each tree has its individuality, so has each flower, and our educational committee has been wise in selecting this line of study. We need a perfect flower, from which we must get a correct interpretation or we will injure our cause and impose upon the public.

The problem for October is an outline drawing of a sugar bowl. Please send as before to Belle B. Vesey, 6228 Wabash avenue, Chicago, as early in the month as possible.

THE CLASS ROOM—THE ART OF TEACHING.

Special First Prize—Anne Seymour Mundy, Coudersport, Pa.

Before starting a beginner it is well to have a thorough understanding between pupil and teacher, to establish mutual confidence; and find out the motive which has led to the desire for lessons; and then, consider yourself fortunate if the result anticipated be knowledge rather than china. But whether it be ability to work independently or a desire to possess beautiful china, appreciate each pupil as a rare privilege, from whom you may learn more yourself than you can possibly impart. That is to say, if you would be sure of your own knowledge, try to tell some one else and you may find that you have a hazy idea of the subject, but not a solid rock of accurate information. To recognize your own weak points gives opportunity to strengthen your own foundation. Hence, practical knowledge is better than theory.

ONE PUPIL VS. A CLASS.

To get a thorough and practical course in teaching yourself have a class rather than private pupils. One pupil strengthens another and you can inspire more enthusiasm among students when each has an opportunity to see the other at work and profit by the mistakes or successes of others. Some teachers take no more than three or four pupils in a class, but while it is harder on the teacher it is possible to do good and successful work with a much larger class at less individual expense, provided the work is planned

carefully beforehand. The more the pupil is thrown upon his or her own resources the greater the individual benefit. It rests with the teacher of a large class to plan each step in such a way that there can be no serious mistake made that is not corrected at once.

MINIMUM EXPENSE TO PUPIL.

There should be a moral question with every teacher of the greatest good to the greatest number. The question of first expense keeps back many an otherwise interested pupil. The stock paint box with supply palette and nominal sum each week for use of teacher's paints would give more people an opportunity to find out not only whether they have ability along this line, but whether they have a strong enough desire to become proficient to carry them through the drudgery and discouragement of every day practice.

Ability to do generally comes with intensity of desire; and if the pupil "wants to hard enough," no effort will seem too great, and success will come.

That the lessening of expense would encourage many more to take lessons, does not mean to cheapen yourself or your lessons: but what are they worth, and what do the pupils get? Is it not possible to proportion the expense in such way that it may be fair to teacher and pupil and reduce to the minimum the money question if the best of art is to be produced?

STOCK BOX AND SUPPLY PALETTE.

This plan is particularly good when a class is to be taken over a course of study and the box may contain for general work:—

1 Silver Yellow	1 Yellow Brown
1 Yellow Red	1 Capucine Red
1 Deep Red Brown	1 Blood Red
4 Peach Blossom	1 Roman Purple
2 Pink No. 26	1 Ruby
2 Deep Blue Green	3 Light Violet of Gold
1 Banding Blue	4 Apple Green
2 Moss Green	1 Royal Green
1 Brown Green	1 Dark Shading Green
2 Pearl Grey	4 Grey for Flesh
2 Grey Green	1 Chocolate Brown
1 Finishing Brown	1 Each Black and flux

LESSONS—HOW OFTEN.

While some ground may be gained by weekly lessons, courses of daily lessons by week or month mean more in proportion to the pupil, in the long run, than less frequent instruction. The oftener the lessons, the more inspiration gained, the more "getting into the spirit" which is necessary to do one's best work; the fewer mistakes become bad habits; the less opportunity to lapse or forget.

DUTIES OF CLASS.

1. At beginning of lesson put clean paper on table, clean glass, fresh turpentine, brushes and necessary silk, cotton cloth, china and selected study if not already provided by teacher.

2. Work of grinding paint for supply palette divided among individual members.

3. Selection, under direction from teacher, of paint needed for individual work; the last one to cover the box. No pupil shall take all of any one color or colors without grinding more to keep supply palette intact.

4. On finishing work, clean off all paint spots or dirt from china, clean palette or slab, returning all good clean color to its individual place on the supply palette; clean brushes, soften with oil, put in place, filter turpentine, put old paint

in waste basket, return studies to drawer in good condition, fold or hang up apron, etc. Attention to these details by pupils is more than money, and keeps the teacher's mind free to guide the more important steps of the day.

TEACHER'S SUPPLY.

This should include palette knives, brushes, medium, small glasses, silk squares, lamb's wool, cotton cloth, tracing and transfer paper, wax, china pencils, plate divider, and designs suitable for copy or re-arrangement. It saves time to have an assistant to attend to this department.

While pupils may use paint from supply palette for daily practice they should provide or possess the following:

PUPIL'S SUPPLY.

1 Tile or Paint Slab.

1 Palette Knife (or two).

Set of Brushes, silk handkerchief, cotton, paint, rags and apron—all piled neatly together when day is finished.

THE PUPIL WHO WISHES TO LEARN.

While the presence of a pupil presupposes confidence in the teacher, do not be afraid of telling too much when you explain the reason for each step in the course of instruction. Some will accept blindly, others must have reasons, all work more intelligently and with greater confidence in the result if they know the reason for each step. Let us hope the teacher knows! Do not spare yourself in explanation.

Do not expect success as a teacher if you are not willing, yes glad, to give yourself for the benefit of pupils who are eager to learn.

FLAT CHINA OR OTHERWISE.

Any shape in china can be successfully managed by a beginner with proper and sufficient attention from the teacher, and with probable extra firings; but a beginner may learn with more ease and rapidity to do more things in a given time if flat china such as plates, placques or tiles are used. Some teachers will not allow a pupil to go on until at least two plates or tiles have been done well.

THE STYLE OF WORK TO ATTEMPT.

"*Notan*," or the pleasing arrangement of light and dark masses should be taught from the first, and no daintier illustration of this could be made than a border for small plate or bowl, done in two or three shades of green, given by Mrs. Sara Wood Safford in July number of *KERAMIC STUDIO*.

PLATE DESIGN ILLUSTRATED.

The plate design by L. Knotts, of Mr. Fry's New York class and illustrated in *KERAMIC STUDIO*, July 1904, affords a bolder design suitable for a breakfast plate and was done by a beginner, thus:

First Step—Use of plate divider learned, and plate divided into eight parts with china pencil, lines extended over the edge and on to the face of the plate. For breakfast plate, make extreme inside limit of design little more than two-thirds from the outside edge; line drawn with china pencil.

Second step—A section of paper was then cut exact size of one-eighth of this narrow band. This paper was folded in the middle exactly and a tiny strip cut from both ends alike. Then the design was drawn by eye as it appears in cut and to fit the paper pattern, with careful attention to proportion. Where lines did not appear true, it was done over and refined by placing tracing paper on top and with ink and fine pen correcting the mistakes. This the Japanese call refinement of design. When perfect, the center of the tracing paper which was cut an inch larger all round than the pattern, was fastened on side and end with wax, putting



ROSES—BLANCHE VAN COURT SCHNEIDER

center of design on line which marked one-eighth of the border surface. A small piece of graphite transfer paper was slipped underneath and with a sharp point the design was traced over accurately. Never go over the same line more than once, else it may look double. Be sure to trace *every* line. If the tracing paper does not fit on plate perfectly, cut the paper up to the defined and inked edge of design; then the paper may be made to fit closely over the edge and be fastened underneath with wax. When the first section is traced, take off tracing paper and apply middle of design to the next perpendicular line on the plate and fasten paper with wax, transferring as before.

Third step—Take out small quantity of Fry's special tinting oil, a tiny bit, as it dries so quickly; mix with it a few grains of grey for flesh, black or whatever the color outline is to be, and then with red sable rigger No. 0 outline the pattern carefully and smoothly, keeping oil always same consistency and having dried sufficiently, dust with same color and fire.

SECOND FIRING.

First step—Oil all background of design, also the lines of the circle on edges with special tinting oil and grey green, just enough to show whether oil is even as it goes on. With the edge of the square shader paint first along the edges of this background with sharp clear strokes. If you can keep the edges crisp there will be no wiping out process. Then, keeping brush flat, blend all together from edges of background to center, brushing over it both ways—(cross-ways) but not working it over only to even without padding. Do not pad. When dried just right dust with grey green. Give it all it will hold. Let stand a while and dust again. Fry's special oil absorbs so much even after it seems dry. This makes a more solid even ground. If this is true and even fire, but if not take out and do over. There is no merit in a conventional design done in a slipshod manner. The beauty of the piece is in the accuracy of the lines and the color scheme. But no matter what the color scheme, the beauty is all lost if not accurate in every particular.

THIRD FIRING.

First step—Paint all over everything with special tinting oil and grey for flesh (just a little.) This is called the envelope. Pay attention, go over everything, pad evenly. See that there is no dust or lint.

Second step—Dry rather dry and dust, being careful to keep plenty of powder under the lamb's wool and do not stop to look or rest till you have gone over all, or you will have a dark spot. Do not rub more in one spot than another. With a rotary motion keep moving over the powder color till all is even. For envelope use 1 part grey green, 1 part pearl grey. Fire.

REMARKS TO PUPIL.

Do not go on until you can do one plate perfectly. It may have to be taken out several times. Don't be discouraged, for when you can do this one perfectly you have learned the mechanical principle of all the rest.

Whether you intend to do conventional or naturalistic work in the end, do not neglect this "start" either by doing a tile or plate in these flat tones. It is the foundation of all work, and if you can not do this well, do not expect to make a success even of naturalistic work; for the day has gone by when you can slap paint on china with "artistic carelessness" just anywhere and have it called art. Think!

COLOR SCHEMES.

Study soft color and harmony. Make nothing finished

which has not an envelope containing some grey or grey yellow to hold the color scheme together. It need not be dark. Try to make your own designs, remembering that china is dainty and beautiful in itself. So designs which might be appropriate for wood or coarser material or textiles may be quite out of place on china.

Consider the use to which the piece is to be put in deciding character of design as well as color scheme.

Much gold is only appropriate for elaborate dinner service or for ornaments. Yellow and browns are nice for coffee or chocolate service. Grey greens with orange or *yellow* pinks, as capucine red used thinly, etc., are appropriate colors for salad sets. Shades of blue for a breakfast set. Green for tea or luncheon sets, and so on. Don't put cupids in salad bowls or roses on meat platters. Consider the use, and if you are any good as a teacher you can make the pupil soon see the principle as you do.

Do not antagonize; do not be arbitrary; respect others' views, but never sacrifice your principle by allowing things to go out which you know to be wrong, if an effort on your part can change it.

You can teach, but you can not force people to see certain things when their whole education has been on the other side. Be patient, and be confident that in the end of all things only the true will survive, and be content with the survival of the fittest.

o o o

Teana McLennan Hinman

To succeed as a teacher one must be absolutely sure of what one is trying to teach and know how to tell what one knows, so that the pupil will understand what is told.

Teaching is an art, most painting is a trick.

To show a beginner how to find what he is to draw is first, how best to place on paper what he has found, second, and the simplest method of making a composition of what he has placed on paper, the third.

All beginners should be taught how to outline the mass or main part of the study they are to undertake, and a study that one may see every day is best, for in each glance one sees a new line, a new shadow or a different composition of color effect. The every day garden flowers and the fruit and vegetables we have every day are in my opinion the studies that all beginners should have, and each day as the eye grows accustomed to the form and the value of light and shade, the hand finds it much easier to draw, for one can not put on paper what is not in the mind first. Have the study photographed in the mind and the drawing is three-quarters finished.

"Avoid complication of form and hold to values," is one of the most difficult things for a pupil to understand, and as a matter of fact very few teachers know the real meaning of the word value in painting.* Another error that most beginners make is that they always wish to put in a picture a number of things that really are not in the study from which they are working. Many times have I been asked by pupils, "Shall I paint only what I see." This is a very important part of the teacher's work, impressing on the minds of the pupils that only what they see is to go on paper. For example, most children given an object to draw—a wooden box, for instance—will not only make a drawing of that portion of the box which they see, but of

*Value in painting is the relative light and dark, or relative purity or intensity of color.—EDITOR.



PEARS—SARAH REID McLAUGHLIN

the part which they know to be at the other side, as if the box were transparent.

When a pupil has learned how to make an outline of what he sees, and by that I do not mean an exact portrait, he has the essential part of drawing, and any one can learn to draw if properly taught, as every one can learn to write. To be sure all may not be first-class draughtsmen, as all who write do not write a good hand. All students wish to acquire knowledge with as little effort as possible, and the teacher must understand how to make a fact clear. A simple fact simply told means much to a student. The teacher who does not know just what he is trying to do and why, is a most discouraging person, for when a pupil loses faith in his teacher's ability, both might as well stop, for it is a waste of time.

As a study for showing simple lines and one for the purpose of explaining how a pupil should go to work, I think the black and white study of Zinnias in the last issue of KERAMIC STUDIO one of the best I have seen. For a beginner I would suggest a charcoal study, leaving the background white, as it would be more confusing to lay in a flat tone and work into that, the study.

Make a direct line for the top of the mass of flowers, from left to right as it faces you, then down and across from right to left to the starting point. Then a square outline for the flower just below the massed outline and see that it comes just under the second flower in the body of the study, the under line being on a level with the center of the fifth flower. Next place the centers and square the petals in the outlined mass. Place a line for the top of the mass of leaves; this line will be almost at right angles with the top line in the flowers. Be always careful to keep the right proportion of the leaves as compared with the flowers. The mid-rib of the center leaf is directly below the middle of the fourth flower. This mid-rib is almost a perpendicular line. The length of the leaf is about the same as that of the flower above it, and by comparison find the length and width of each leaf and the position of them, and find that each line goes in its place as easily as if it were traced already to be worked over. This done, place the flower on the left, not in the main body, then the three at the right; the stems next, as it is always well to leave the stems for the last, a line to indicate where they are to go may be used, but I have found it better to leave them out entirely, placing the calyx when outlining the flowers.

The study is now ready for criticism. Go over each flower and leaf carefully, see that it is in the proper place and proportion. One can in this way correct any defects there may be in the drawing. The construction being right make careful outline of the outside petals and place a flat tone over the flowers, leaves and stems, then place the darkest shadows in the flowers and see why they are caused. Then the darkest shadows for the leaves and stems, and I have found that a careful drawing of the petals always helps in any flower study, even if it is to be painted, as it gives a good idea of how to proceed and an acquaintance with the flower that is invaluable. By using a sharp eraser the centers may be pushed out and the darker lines be placed to bring out the white in the centers.

TREATMENT FOR ROSES

Blanche Van Court Schneider.

USE Rosa for first firing of all roses.

Leaves, Yellow Green, Moss and Olive Green.
Stems, Yellow Green.

Tint for second firing, using Ivory at the top of piece, a little Turquoise Green dashed above the bunch of roses. Under bunch, Yellow Brown shaded into Olive for the dark part under the leaves. Lower part of piece, Ivory.

Strengthen roses with American Beauty, stems and leaves with Olive Green.

For third firing strengthen background with same colors as used in second firing, retouch darkest rose with Ruby. A little Dark Brown in stems.

PEARS

Sarah Reid McLaughlin.

PAIN'T the design in mellow tones; let yellow predominate. For pears, use Lemon Yellow, Alberts Yellow, Yellow Green, Yellow Brown. Shadow pear with leaves surrounded in Grey Greens. Second firing, strengthen above colors. A dash of Yellow Red on main pear will give a good effect. Use Sepia where it is needed. Pips and stems, Yellow Brown, strengthened in second firing with Auburn Brown. Greens as usual, using Yellow Greens, some Yellow Browns. Background, Egg Yellow near the center, Alberts Yellow, Yellow Green, Yellow Brown and Olive Green in the dark parts. Keep the tones in the pears well blended.

RED RAMBLER ROSE

Hattie V. Young Palmer.

DRAW lightly prominent roses, leaves and stems. Wash in background with quite moist color and large quill brush. Commencing at top, use Ashes of Roses softening into Lavender Glaze, and down into Lavender Glaze and Violet (mixed) under shadow side of roses and leaves, then into Russian Green and Ashes of Roses to the base of study.

Paint leaves with Purple Black and dark roses with Ruby and Purple Black (mixed). Paint light roses very delicately with Rose and Ashes of Roses (mixed).

Intensify with dry color, using Albert Yellow over background at top and shadow parts with same colors used in painting. Powder light roses with Rose and dark roses with Ruby, allowing the color to soften out into background, leaves with Verdigris.

For second fire, darken center of light roses with Rose and Ashes of Roses, wash leaves in dark part with Dark Yellow, other leaves in Verdigris and darkest leaves in Dark Yellow. Accent dark roses with Ruby and Purple Black, and stems with Purple Black and just a touch of Ruby. Wash background under roses and down to base of study with Albert Yellow, softening into Lavender Glaze.

STUDIO NOTES

Keramic enthusiasts of San Francisco are flocking back to their studios.

The California Ceramic and Kraft Shop announces its opening at 1146-48 Geary street, near Van Ness Avenue. Classes in china, water color, oil painting and leather craft by Helen A. O'Malley and Minnie C. Taylor.

Mrs. Blanche McCalvy, formerly of 460 Turk streets, announces the opening of her studio at 804 McAllister street.

Mrs. G. Dorn has returned from temporary quarters in Los Angeles, and reports a new and busy studio at 761 McAllister street.



RED RAMBLER ROSES—HATTIE V. YOUNG PALMER



AFTER spending my summer in the wilds of northern Michigan, I am more firmly convinced than ever that we can always find material for original designs; but not all can branch out at once into conventionalizing flower, leaf and branch into satisfactory designs. Do not despair, study and work—and then study and work again. I am glad so many teachers are advising this individual study, for now we may hope to see our Ceramic exhibitions show a higher and more original style of work each year.

Take anything that appeals to you. Make a sketch of flower—full front, side and back, study the way the flower and stem join, then tear it apart; sketch petal, calyx, stamen, seed-pod and leaf separately. Color these as nearly exact as possible, then lay the study away for future conventionalizing. In the winter, when one can not have the inspiration of field, forest and garden, then is the time to work out the summer's gathered treasures. So let nothing escape you. And when this message reaches those who are fortunate enough to live where there are "green things growing," let them go out and gather the nuts, leaves and berries touched by Jack Frost, and see what beauties lie all around.

If one has never seriously studied conventional work in china, but always the naturalistic, it may seem like a difficult proposition, but the pleasure you can find in it will more than repay you for the necessary serious study. At first copy good designs; study the color tones, the spacing, the arrangement of design suitable to the shape, the careful and correct drawing. You will soon find yourself able

to distinguish between good and poor conventional work and to be satisfied with only the best. And, also, you will never want to say that "conventional work is purely mechanical." Only those who know nothing about design could say that.

Do not be afraid to make tests of color schemes before applying the color to the piece of china. Make these tests and keep a memorandum of each; it will be of great value in future work.

One word more—simplify. Do not attempt merely to make an elaborate design for itself alone, with the china simply as a background for your work, but carry the thought always to make the design a part of the china, to add to its beauty solely, that the observer may say, "What a beautiful satisfying bowl or plate!" not "What a perfect rose, or bunch of grapes!" Let the shape aid the design, and the design fit the shape, making one perfect whole. And only study will enable you to compass this.

In order to avoid repetition and simplify the directions for each design, let me give a few general rules here. Where the make of paint is not specially mentioned, use La Croix. The outlining colors are Black, made of Ivory Black, two-thirds, Dark Blue one-third; Blue, made of Dark Blue, with a little Deep Purple and Dresden Brunswick Black; Red, made of Capucine Red, one-half, and Deep Red Brown, one-half; Brown, made of Brown No. 4 or 17, a little Dark Blue, Deep Purple and the Brunswick Black. These four are the only outlining colors I use. They can be bought mixed ready for use under the names of Outlining Black, Outlining Blue, Outlining Red, Outlining Brown—the "M. D." colors if one prefers.

There are two ways of outlining. Grind the colors with turpentine only, and use a fine No. 1 Tracer, or grind the



STEIN—MABEL C. DIBBLE

colors with Anise Oil only and use a fine pen. I prefer a crow-quill, but that is a matter of individual taste. The latter way is more rapid, and for many a much neater and more perfect outline can be made, but even then, when the line comes too close to a tint or color it must be washed in. Next to an unfired outline, the brush and turpentine mixed paint is much safer than the oil.

The proportion of colors and enamels given are for French china only. For softer glaze wares the proportions should be different. With these points in mind, and careful study of the treatment for each design, a student should be able to do most satisfactory work. If in doubt about a color, where several are combined, make a test by firing it on a bit of broken china, placing it exactly where the finished piece will be fired later. This is important.

The service plate in the original was ten and a quarter inch, but has been reduced in printing. Also the plate with the two narrow bands in original was eight inch. The medlar flower plate was nine inch, and the plate with historic ornament a nine and three-quarter inch. These sizes are much more effective for the designs than smaller.

MABEL C. DIBBLE

✿ ✿
STEIN

THE plain Belleek stein is the most satisfactory for this design. Dividing into thirds, outline in black, and fill in the top above design with unfluxed gold, using a little Lavender Oil to make it flow smoothly. A heavy line on handle is better than solidly gilded. Below the branches at base wash in Brown No. 4 or 17 and Brown Green No. 6, not blending them too much. Fire. For second fire, see that your gold is retouched where needed. Grapes in purple and white, alternating. For the purple, Light Violet of Gold, Dark Blue, touch of Brunswick Black and one-eighth of Hancock's Medium Enamel; shading the grapes and making some in a darker enamel of Deep Purple and Dark Blue,

with Brunswick and the Medium Enamel. White grapes, use the Hancock's Medium Enamel—of course all the readers know that it must be first ground down with small quantity of Dresden Thick Oil and turpentine, as all powder colors must be when used as enamels—slightly tinted with mixture of Apple Green and Brunswick Black, making a greenish grey. When dry shade the grapes with a thin wash of this mixture. Leaves and stems or branches, green, using the lighter and darker greens as in other designs, the lighter for upper leaves, and shading some with touches of Brown or Violet of Iron, and making the under leaves of almost clear Brown Green No. 6 and Grey for Flowers, with the one-fourth Hancock's Medium Enamel. Work up the base with the Brown and Brown Green, using no enamel in the wash. Always use Hancock's Medium Enamel, or half and half of the Hard and Soft, on Belleek, and give a Belleek fire, and there will be no trouble with enamels chipping if they are properly applied to the china.

✿ ✿
COUP PLATE

LINE the plate with seven circles in black. Outline entire design in black. Fire. Then fill in narrow bands behind single leaf design with dark blue enamel, Dark Blue, little Deep Purple and Brunswick Black (Dresden) and one-eighth Aufsetzweis, floating it in smoothly, but not too heavily. The large flower in dull soft blue. Use same mixture as above, only omit the Aufsetzweis; use a tinting oil to make it flow smoothly, and paint each petal, shading as in naturalistic work. Make the three small bands dividing petals in the dark blue enamel. The edge of plate and the other three narrow little bands, all of the leaves and the scrolls on edge of blue flower, all where it is left white in the design, make green, a soft dull green, Apple Green, a little yellow for mixing, equal amount of Grey for Flowers (Sartorius) and small quantity of Brunswick Black, one-fourth Aufsetzweis.

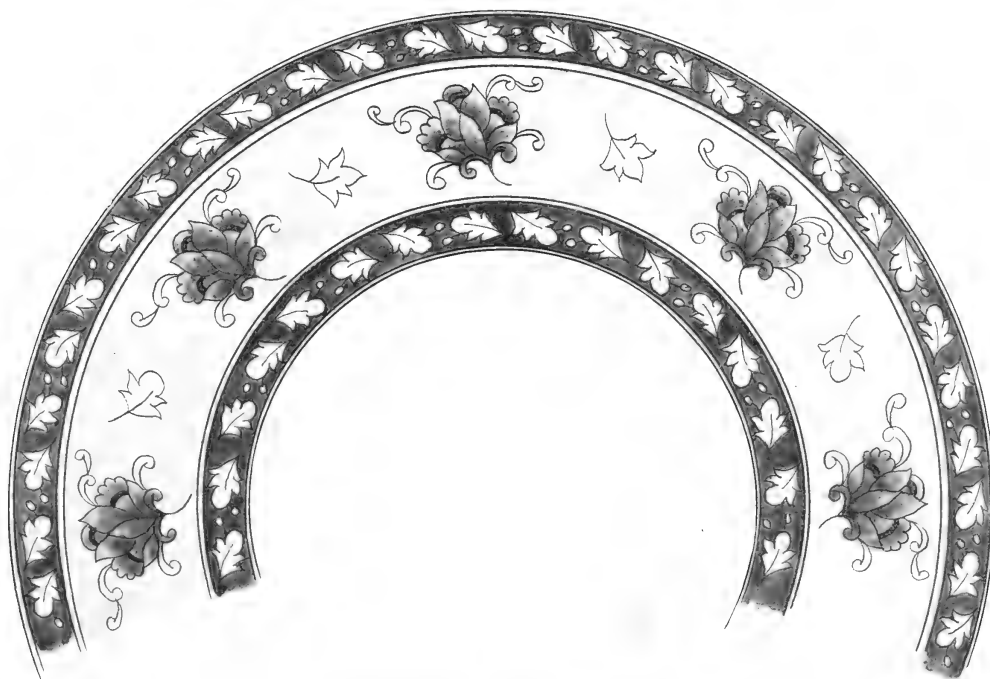

COUP PLATE—MABEL C. DIBBLE



SALAD PLATE—MABEL C. DIBBLE

MAKE the three circles in brown, and outline the entire design in the brown, single stem, leaf, mushroom and circle in center. Fire. Leaves dull green of Apple Green, Brown Green, one-fourth Aufsetzweis. Mushrooms, mixed enamel. When dry, wash over the white enamel with Violet of Iron, Brown No. 4, and Deep Red Brown,

with some touches of Yellow Ochre or Yellow Brown. Not a mixture of these, but dashes of each, or two, blending into each other; the centers the same, only lighter shading. Do not be afraid to darken the shading quite decidedly, as it is over unfired white enamel and will fire out a great deal.

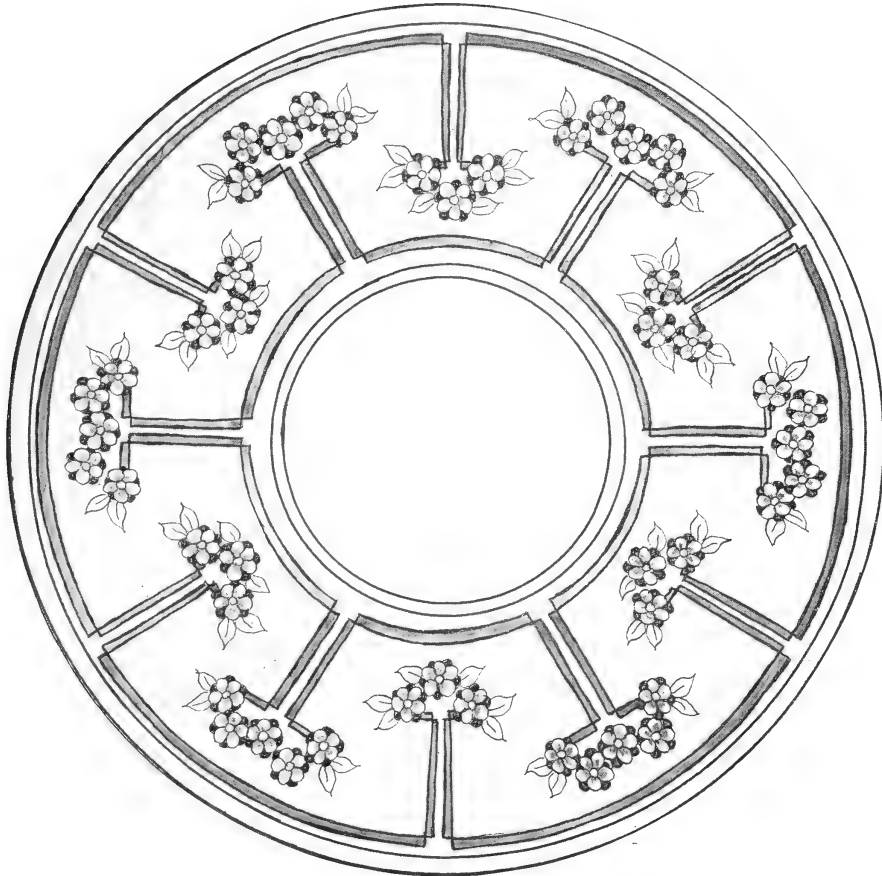
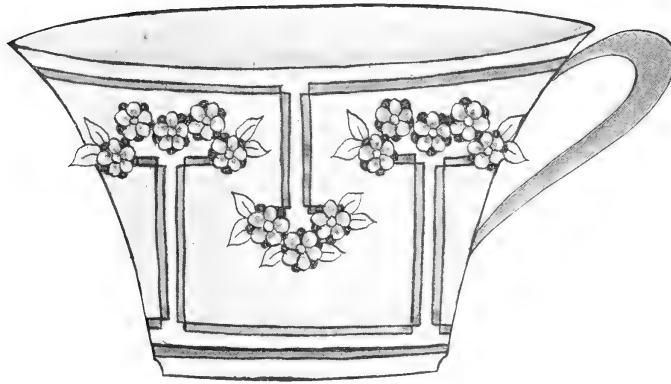

CUP AND SAUCER—MABEL C. DIBBLE

OUTLINE entire design in gold, and fire. Fill in all straight bands, and also the leaves, with a soft dark brown, any good brown that will harmonize with yellow. For blossoms use mixed enamel, adding Egg Yellow until

quite a rich golden color, for the five larger petals, and mixed enamel with Silver Yellow added for the tiny back petals. Gold centers. Gold edge on cup and saucer. Gold lines on handle, or solid gold handle.

PEACOCK BOWL (Supplement)

THIS design repeats just four times, that is,—four groups—on a belleek bowl $8\frac{1}{2}$ " in diameter by 4" high. The band for the inside exactly fits this size bowl. Outline the band and part of the peacock in black, the rest of the peacock and branches in gold. Use unfluxed gold on belleek; outline the leaves and oranges in blue; also fill in the gold spaces for the first fire.

For second fire, make oranges in yellow enamel, using Hancock's Medium Enamel, ground down with Dresden Oil, and thinned with turpentine; into this put Egg Yellow; if in powder, grind it with Dresden Oil and turpentine before adding it to enamel. Green leaves, Apple Green, yellow for mixing, and Sartorius Grey for flowers; add one fourth medium enamel; use same yellow and green in band.

For peacock tones, make them more brilliant and vibrating than the colors in study. It was not possible to print in just the tones we wished. For the darkest blue, use Dark Blue, Deep Purple and Brunswick Black; add one-eighth medium enamel; this use also in band. For next tone, use Deep Blue Green, Apple Green, Dark Blue, touch of Brunswick Black, one-eighth medium enamel. For third tone, Chrome Green B, Deep Blue Green, Apple Green, medium enamel; and for lighter green, Apple Green, yellow for mixing, touch of Brunswick Black and medium enamel. For these last two, put the mixed color into the medium enamel until you have the color desired. These four colors should tone one into the other with no violent contrasts. Have all mixed carefully, and then rapidly lay in first the head and back, the second tone on breast and blending into the darker on back; then the third tone finishing the breast and on upper part of tail, with the fourth tone finishing off the tail feathers. Fill in eyes of tail with the dark blue, also feet in blue between the tinted branches.

When perfectly dry, add the gold touches on peacock body and tail, using unfluxed gold. Also add blue dash in oranges. Touch up all gold and give a regular Belleek fire.



SERVICE PLATE

DIVIDE plate into fourteen parts. Place the flower section, having carefully traced it off, directly on a line, and with stylus or ivory point trace it clear and perfect, using the fine graphite tracing or impression paper. Repeat on every other line, and you will find the small leaf section will fall into place on the remaining seven lines. Trace all with India ink, then make the gold lines on plate. Erase where flowers cover line. Outline design in black, and fire. For second fire, tint the broad band with Chinese Yellow. Wipe out color from design and dry thoroughly before filling in the enamel. For leaves use Apple Green, one-half, Sartorius Grey for flowers, one-half; divide, and into one part add Yellow for mixing to lighten it; into the other part put more Grey for Flowers and a little Brunswick Black, then add one-fourth Aufsetzweis to each. Use the lightest green on calyx, stems and smaller leaves, and tips of large leaves, the rest in the darker green. For flowers, use Silver Yellow in mixed enamel for lighter petals, the outside of the flowers, and use Egg Yellow in mixed enamel for the inside or darker petals. When dry, wash in shadows lightly with Brown Green. The tiny dots or stamens are Brown No. 4 or 17 and Yellow Brown or Ochre mixed. For inside band the flowers are in stronger Egg Yellow, and leaves, the darker green. This inside band is all outlined in gold, and the circles or bands are in gold with gold edge.

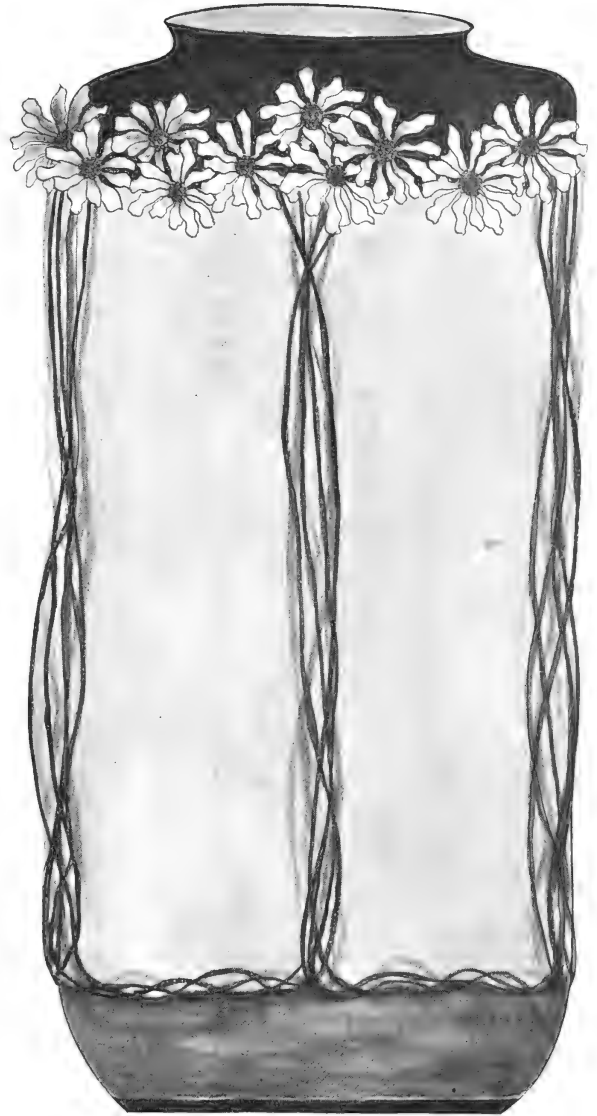

DAISY VASE—MABEL C. DIBBLE

THIS vase can be treated in a monochrome tone of blue or grey, but the most satisfactory effect is given by blending the two. Use powder colors. Copenhagen Grey and Delft Blue make a good combination. Sketch in the design and then tint the background, that below the daisies a grey, above a blue, and delicately shade the daisy petals in the blue. For second fire, powder or dust on grey again below the twisted stems at base, and dust blue heavily above the daisies. Work up the centers of the flowers, strengthen the petals and stems, and wash in a few shadowy stems. With a dark blue band at base, the twisted stems all in blue, this is simple and yet effective.

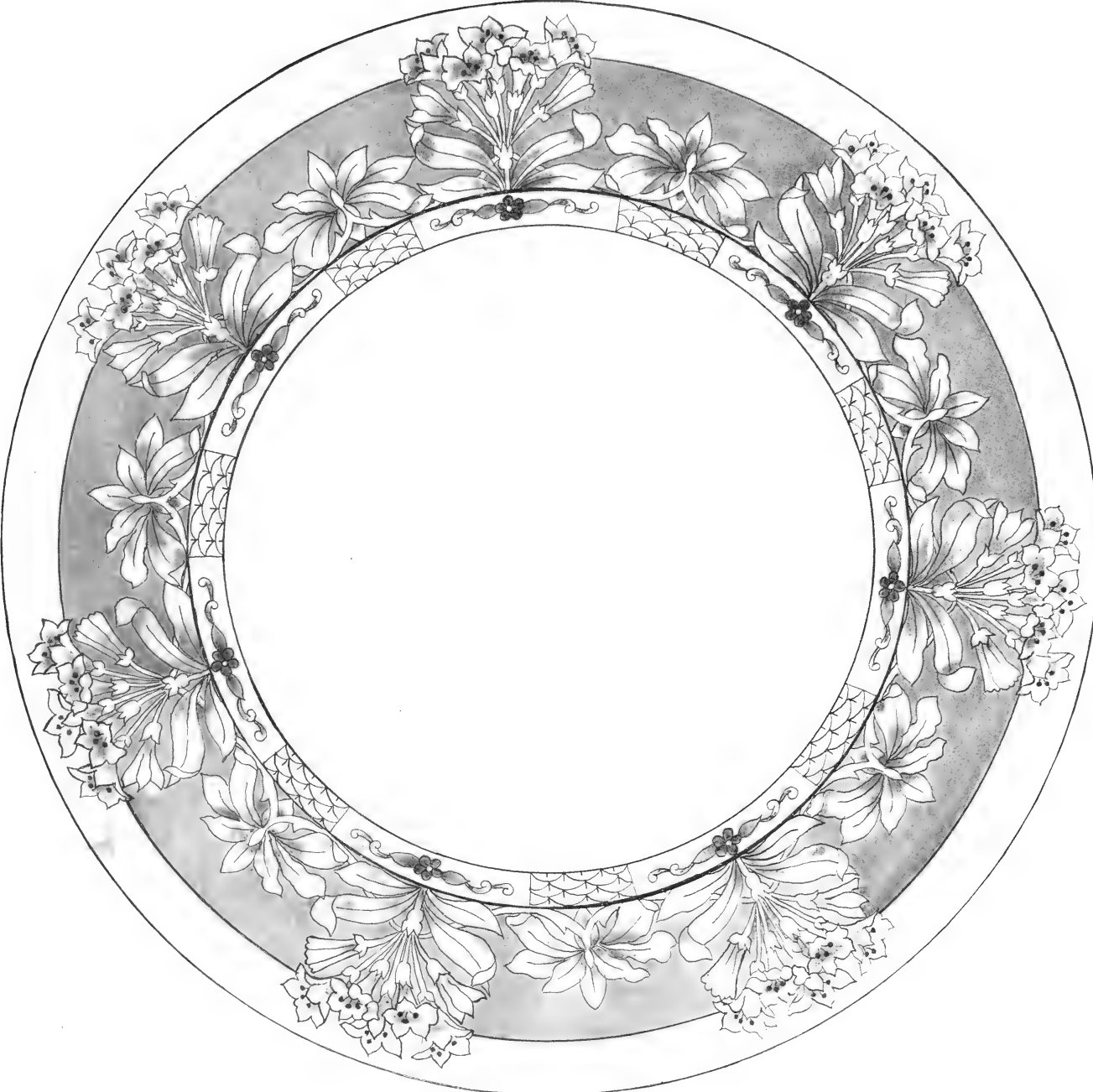

SERVICE PLATE—MABEL C. DIBBLE



FRUIT PLATE—MABEL C. DIBBLE

PLA TE 8½", coup. Divide into fifths. Make the four circles and edge gold, outline the design in Black and fire. Next, tint the two bands in Satsuma tone, using Brown 4 or 17, Dark Blue, Silver Yellow—all La Croix colors—and a little Brunswick Black, Dresden. Carefully remove all trace of color from gold lines, retouching these where necessary; also take color from design. Flowers are of mixed enamel, two-thirds Aufsetzweis, one-third Hancock's Hard White Enamel, slightly colored with Chinese Yellow and Brunswick Black, until it is a dull cream color. When enamel is thoroughly dry, wash over the outer edge of petals, a dull red, Deep Red Brown and Yellow Ochre mixed. Use this on the flower at left side; for the one at right wash the petals with Brown No. 4 or 17 quite lightly. For leaves marked with a cross, make an enamel of Apple Green, half as much Yellow for mixing, and add Brown Green No. 6—

all La Croix colors—until a dull dark green, then add one-fourth as much Aufsetzweis as you have of the paint. When dry, shade at base of leaves with Brown No. 4 or 17. In washing in these shadings over enamel, use only turpentine to grind the paint; take very little on brush and have it thin. Use a square shader. For remaining leaves use Brown No. 4 or 17, Yellow Ochre and Brown Green 6. Shade with self mixture and keep leaves light; calyx of flowers, very dark brown—Brown No. 4 or 17 and Brunswick Black.

The three burr-shaped fruits of the medlar tree in each group must be brown also, but not so dark as the calyx of the flower; use Brown 4 or 17 alone. The lines of the stamens are brown, but the little round tip is filled in with Brown 4 or 17, and Deep Red Brown mixed. Dots in white band, gold.



INVALID'S TEA SET—MABEL C. DIBBLE

DIVIDE the pieces into sections corresponding to these, if your china is not exactly the same size and style.

All lines and bands, handles and Greek key, in gold. Outline the design in black, and fire. Then fill in the background with dull red, two-thirds Deep Red Brown, one-third Capucine Red, using a very little anise oil to make the

color flow smoothly. The larger ornaments are filled in with blue enamel, Dark Blue, Deep Purple and Brunswick Black, with one-eighth Aufsetzweis. All the small scrolls and leaves in gold.

Be sure that the red is a dull dark Pompeiian red and the blue not too bright.

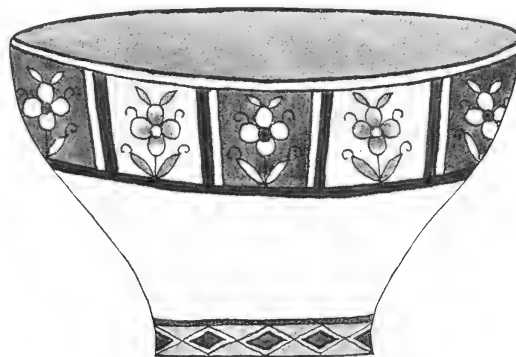

SMALL BOWL—MABEL C. DIBBLE

FOR bowl 10 $\frac{3}{4}$ " in circumference divide into fourteen sections. Make upper line red, the other lines black. In the dividing perpendicular lines, the single line is red, the others black. Every other block is left white with the flower outlined in gold, the leaves and curved lines in red; the other section is in solid gold, with entire design outlined in red. Fill in between the black lines with red, half Capucine, half Deep Red Brown; also the flower in the white section and center of flower in gold section. Flower in gold

section, the mixed white enamel; also little bud at top. Leaves all alike, Apple Green, Brown Green, Yellow for mixing and one-fourth Aufsetzweis. For band at base, center of diamonds are green, next band red, and the background gold. This is especially good in small Satsuma bowl.

But if one does not like the white background of the French china, tint it with a delicate tone of Chinese Yellow inside and out.



ICE CREAM PLATE—MABEL C. DIBBLE

THIS is one of the new designs in china, and unusually good. The border or shoulder is perfectly flat, while the center rounds down into an extremely shallow bowl effect, just the thing for ice cream in forms now used so much, and equally satisfactory for ice cream served in bulk, or home-made cream or ices; and just the thing to stand frappe or sherbet glasses on. Outline in black, and make the tiny ring background in gold, using Lavender Oil to thin the gold a trifle, and then turpentine. Always use pen for this work. Any fine pen; I prefer a crow-quill. A solid gold background can be used, but the circle gives a more dainty, shimmering effect. The outer band is Empire Green washed in also for first firing. For second fire touch up the gold rings, and go over the Empire Green. Branches are in Yellow Ochre, Brown No. 4 or 17, and touch of Brunswick Black, shading with Brown No. 4 and Black. No

enamel in this. Leaves are a grey green. For these use mixed enamel as a foundation and add Apple Green, Sartorius Grey for Flowers, touch of Brunswick Black; do not make the enamel very dark but shade the leaves with the mixture, without enamel in it. The mistletoe berries are of the mixed enamel shaded with Apple Green and Brunswick Black, just enough to give a waxy look to enamel. When dry, shade each berry with the Apple Green and Brunswick Black, using enough black to give it a dark grey look. A touch of black makes the little blow end. Gold lines, and design in dark green border is gold with white enamel little band in each circle. If you are careful to prepare the gold just right, the little rings are not difficult to do, in fact are easier to manage than the solid gold background which shows brush marks and ragged edges unless very carefully managed.

CANDLESTICK—MABEL C. DIBBLE

DIVIDE candlestick into even divisions and outline the design in black, every other one ending with the seed pod. Fill in each section of seed pod with paste for gold, and make band at base in flat gold. For second fire, flowers and buds in red—one-half Capucine, one-half Pompadour—(Dresden)—adding touch of Yellow Ochre; shade with Pompadour with touch of Brunswick Black, (Dresden). Leaves: Large flat leaf in Apple Green, Sartorius Grey for flowers, equal parts; add a little Brunswick Black and one-fourth Aufsetzweis; float color over the leaf evenly, and when dry shade at base with Apple Green, Grey and Black, adding more black, and no enamel, using flat shader instead of the fine tracer for enamel, which you are to always use for the enamel work. For stems, smaller leaves, calyx, use lighter green, Apple Green, the Grey for flowers and yellow for mixing, with one-fourth Aufsetzweis. Cover the raised paste with gold. Make the four little tips of calyx showing from behind flowers, and center dot in gold, also upper rim of candlestick. Fill in the blocks in band with red, alternating dark and light.

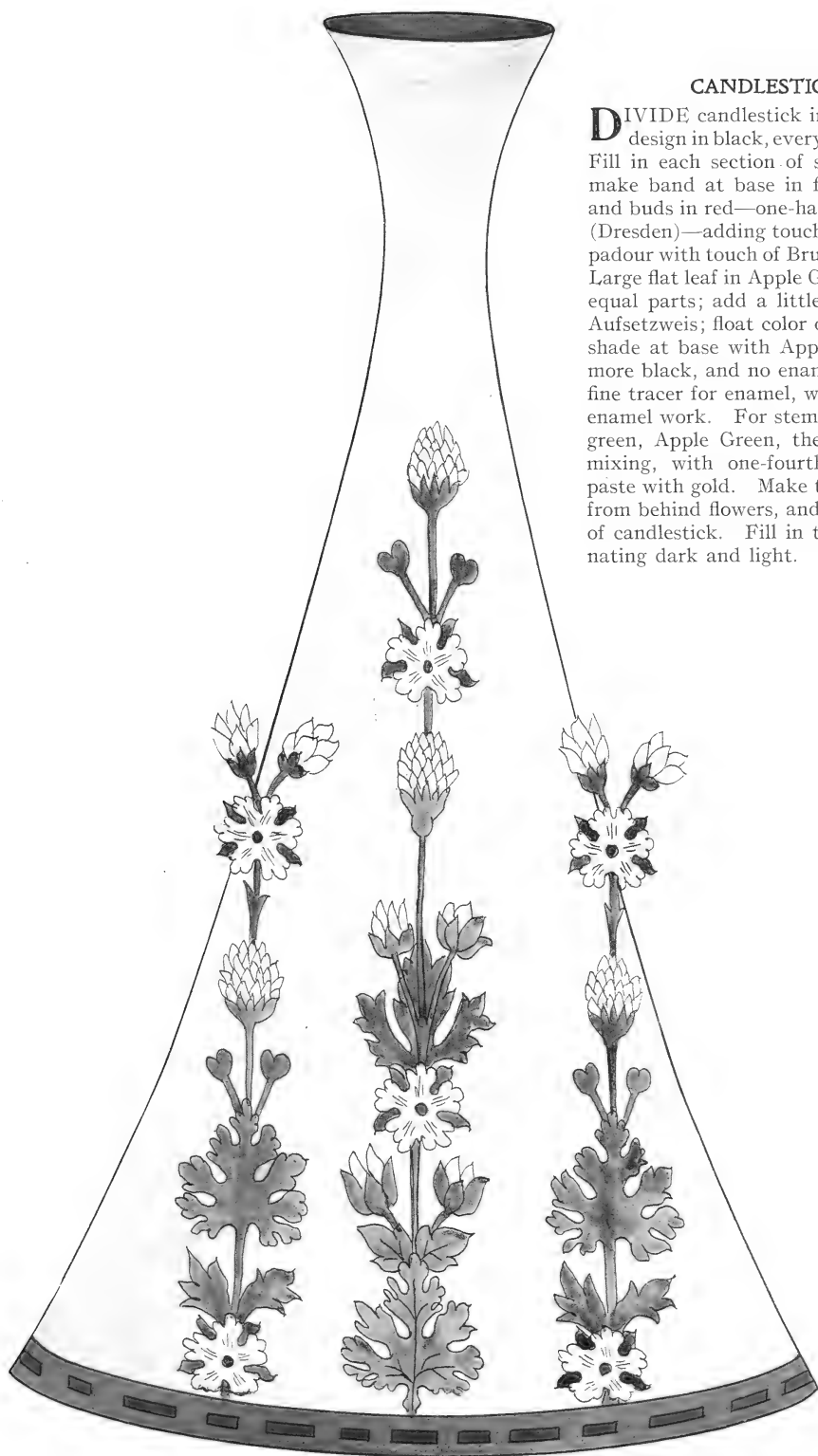

WILD ROSE VASE—MABEL C. DIBBLE

MANY of these Japanese prints are effective when adapted to vases that are Japanese in shape. Outline in black. The large rose and a few of the buds in white enamel, just the mixed enamel floated in smoothly. When dry, wash in yellow for mixing under the stamens, and shade petals with a soft grey of Chinese Yellow and Brunswick. All flowers can be in white, or make the half flowers in soft dull blue. Branches in greyish brown, using Yellow Ochre, Brown No. 4 or 17, and Brunswick Black; calyx to buds the same only lighter. In making the two tones of green, see that there is great contrast, which adds much to the effectiveness. Keep the light leaves very light, Apple Green, Grey for Flowers (Sartorius) and yellow for mixing, quite a yellowish green; add one-fourth Aufsetzweis. For the darker leaves use Apple Green, Grey for Flowers, a little Chrome Green B, and a larger quantity of Brunswick Black, with one-fourth Aufsetzweis. Bands at base can be in two shades of green or black and green. The entire vase can be tinted in soft grey, or when finished and fired the second time cover all, vase and enamels, with thin wash of Ivory Lustre, and fire lightly.

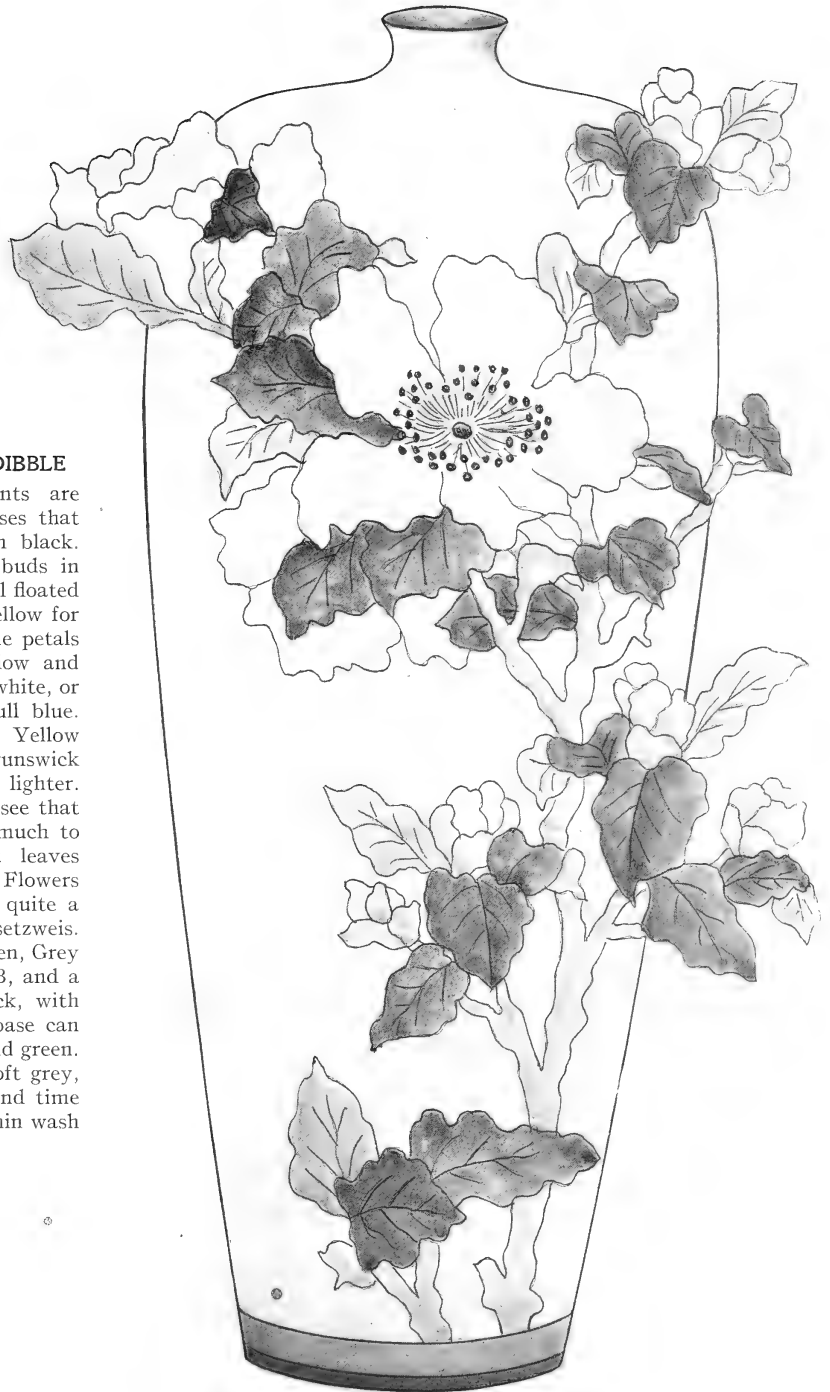



PLATE—MABEL C. DIBBLE

OUTLINE the design in black and fire before applying the enamels. The two bands, scrolls and small spray of leaves are in blue enamel. Dark Blue, a little Deep Purple, Brunswick Black (Dresden) and one-eighth Aufsetzweis. The leaves and calyx, also small scrolls that spring from outer rim, in green. Apple Green, half as much Yellow for mixing, enough Brown Green No. 6 to darken greatly, and one-fourth Aufsetzweis. The large flowers in a brownish lavender. Dark Blue, Light Violet of Gold, touch of Brunswick Black, and enough Brown No. 4 or 17 to give it a decided brown tone. Add this to mixed enamel, and by all means make tests of this mixture before applying

to the plate. Use a very small quantity of the Light Violet of Gold. The small detached forget-me-nots, centers of flowers, where there is only one circle in center, and the five small petals in upright flower, are a delicate grey blue. Deep Blue Green with touch of Apple Green and Brunswick Black, added to the mixed enamel. The lower circle in upright flower is dark blue enamel, also centers of forget-me-nots, and the band dividing the dark and light blue in upright flower, the small circles and base of flowers attached to scrolls in plain white mixed enamel. By mixed enamel I mean two-thirds Aufsetzweis and one-third Hancock's hard white enamel.

THE CRAFTS

WOOD CARVING AND PYROGRAPHY. LEATHER AND METAL. BASKETRY, ETC.

Under the management of Miss Emily Peacock, Room 23, 22 East 16th St., New York. All inquiries in regard to the various Crafts are to be sent to the above address, but will be answered in the magazine under this head.

Summer Address, care of Ceramic Studio Pub. Co., Syracuse, N. Y.

All questions must be received before the 10th day of month preceding issue, and will be answered under "Answers to Inquiries" only. Please do not send stamped envelope for reply. The editors will answer questions only in these columns.



No. 1—Cutting material with a weighted knife, which saves hours of tedious cutting with scissors, or tearing.

RUG WEAVING AND DYEING

Mabel Take Priestman

IT is a far cry from the days of our great grandmothers to the present day, but it seems strange that the same handicrafts that were occupying their leisure hours, should be of such deep interest to the women of to-day. The intense interest which is taken in all handicrafts, has brought about a wonderful revival of the useful and well made products of our ancestors. Not the least interesting of these is the art of weaving, and the demand for good hand made work has made of it an industry whereby women are able to make at home beautiful rugs and curtains, which, when they are well designed and well made, can always find a ready market. It seems strange that more has not been written on this interesting subject, especially as it is not difficult for a woman of ordinary intelligence to become an expert weaver, and also learn to make her work express her own individuality.

It is now quite a number of years since the revival of these rugs was started in America, and I have followed its advance ever since I came across the first rugs, which were an outcome of the Arts and Crafts movement. There was so little written on the subject, that in order to understand it thoroughly, I had to make personal experiments, not only in the weaving, but in the kind of materials to use, and in the dyeing of the fabrics, and therefore I can speak from my own experience in the early days.

As my desire was not to become a weaver, but to gain all the knowledge possible, for the sake of having beautiful rugs made, I at first made use of crude rag carpet weavers, who no doubt thought that I was crazy, and made feeble protests against my innovations. It was necessary for me to understand the process of weaving, as well as to gain experience from results, and I greased the wheels by paying the men just double what they

made on ordinary rag carpet weaving, and in that way was able to keep up their interest in carrying out my ideas, and although they had a supreme disdain for my experiments in color effects and pattern making, they were not going to quarrel with their means of support. It was not long before the weaver who did the best work became a complete convert and John became my most loyal and ardent supporter. Many an hour have I spent watching him weave as I directed how the borders and patterns should be evolved. He was a great favorite, not only among other weavers, but with laborers who were out of work, who used to spend their time in his workroom, debating on the subjects of the day. When I first made my appearance among this group, they used to sit like mutes, with their chairs tilted against the wall, and never uttered a word, but this was too good an opportunity to be lost, and I improved the occasion by drawing the men out, and hearing their views on the questions of the day. It was interesting to note the gradual increase of friendliness on their part, and they became so loquacious that I was able to get their view of many phases of life, that most of us do not have the opportunity of hearing first hand.

At that time it was all experimental work, as I had not the opportunity of seeing other rugs, or of knowing what was being done by other craftsmen. The chief difference between the Colonial rugs and those made to-day is, that the former were made from worn out clothing, which was torn up into strips. These were sewn and wound into balls, and a motley chain of materials and color were woven "hit or miss" into rag carpeting. Roots and barks of trees were sometimes employed from which to make vegetable dyes, and from the dye pots, the old clothing reappeared in charming rich colors, which in many cases, have retained their brilliancy after years of hard wear. These home dyed rugs, and the "hit or miss" varieties, fitted in with their simple surroundings, but



No. 2—Making experiments in weaving border designs in a narrow loom. In changing the color of the warp the brown threads have been tied to the white which was already on the loom. The lay-to is brought sharply forward to make the warp firm.

Band inside of Bowl.

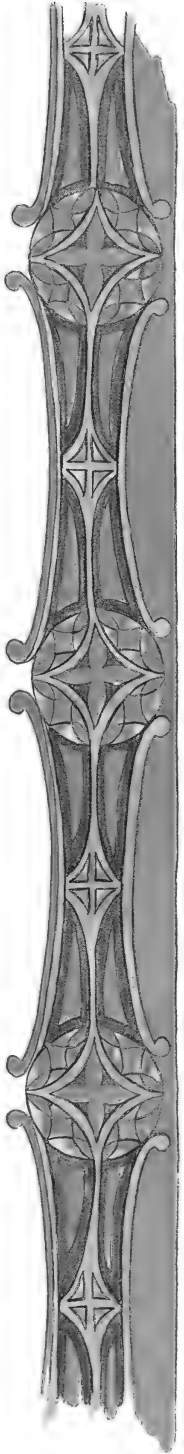

OCTOBER 1906
SUPPLEMENT TO
KERAMIC STUDIO

PEACOCK BOWL—MABEL C. DIBBLE

COPYRIGHT 1906
KERAMIC STUDIO PUBLISHING CO.
SYRACUSE, N. Y.

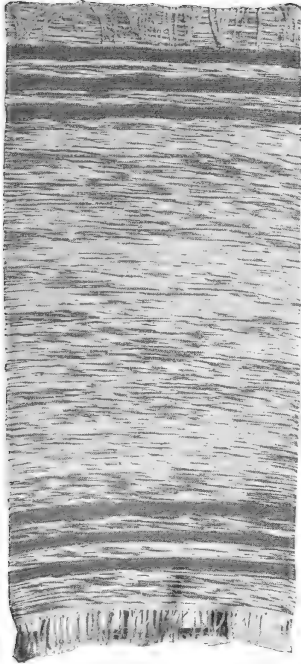

No. 3—A Priscilla Rug

the needs of to-day are more stringent, and rugs must be made of new material, or of remnants, which when dyed, possess the same qualities as new material.

MATERIALS TO BE SELECTED.

Rugs can be made from many kinds of materials such as lawns, prints, cretonnes, denims, staeens, gingham, ducks, cotton flannels, ticking, rope, roving yarns, and canton flannels. It will be seen that there is indeed a large variety to choose from. Unbleached muslin offers a field of great variety, as it can be dyed the exact colors required. The question of cost is not determined by the price of material per yard, as sometimes light material at four cents will make a more costly rug than a heavy material at 15 cents. If light material is used, it must be torn into wider strips, as it weaves into such a small space, so that it is more economical to buy a bulky material that can be cut into narrow strips.

Labor is another important item to be saved in the making of rugs. It has been proved that to buy short remnants is extravagant, as the time spent in sewing the pieces together, and in the delay in tearing and cutting them afterwards in the strips, owing to the seams, is more costly than paying more for material that is better adapted for the purpose. Remnants that have become marked, or have been discarded on account of imperfect weaving and are known as seconds, are the best kind to buy, as they can often be found in pieces of ten and fifteen yards in length. After experimenting in widths of material from half an inch to two inches, it has been found that one inch is the most attractive for all purposes.

PREPARING THE MATERIAL.

If a rough fuzzy rug is required, the material must be torn, as the rough edge can only be obtained in this way. Denims are particularly attractive after they are woven, because of this soft, fluffy edge, which shows on the surface of the rug when completed. Unbleached

muslin also has the same quality. If a very neat rug is required, new material must be purchased, and after removing the piece of wood upon which it is wound, it can be tightly bound and fastened securely with tape. It can then be placed upon a table, and a heavy meat saw with a weight at the end can be used to cut it in slices one inch thick, so that in a few minutes a belt of 50 yards is ready to be wound on the cops. (See illus.) To insure the strips being perfectly even the table should be marked out in inches, as it is essential to good workmanship that each strip should be exactly the same width. Most people cut with scissors when they require a smooth finished rug, and this is an appalling waste of time, and if the work is given out, costs six cents a pound to have it done by some old woman who makes her living by cutting materials for rag carpet weavers. The small outlay required in purchasing a good knife will pay for itself in the saving of time in the first few rugs. The strips being fifty yards long, no sewing is necessary, and this also saves time and makes the work even.

In tearing material long lengths should also be aimed at and a whole bolt of denim can quickly be torn by a little care in starting the work right. Take a tape measure and cut the cloth for a couple of inches. It is not necessary to cut off the selvage unless it is a different color, as that folds in the weaving and is not noticed. Having started the material right, it can be quickly torn, and it is often a great pleasure to children to be allowed to do this work. If they have a large room in which to do it, two strips can be taken by one child, and the next two strips by the other, and if they run in opposite directions four strips will come off simultaneously, and give the children a fine frolic at the same time. It is amusing to see how slowly beginners tear up material. They sit at a table and start to tar with both hands a few inches at a time, proceeding in this way their arms will be completely tired out by the time they have torn a 50 yard belt. A big room in the attic is the best place for such work, as

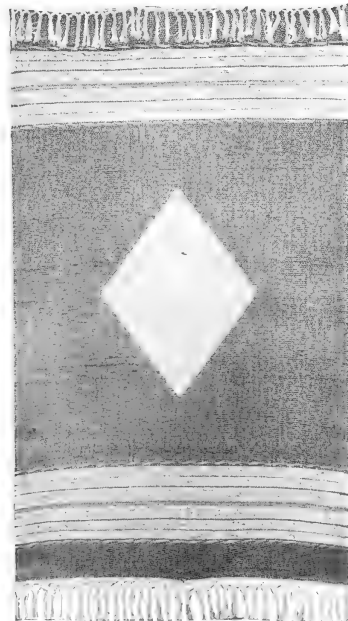

No. 4—A cretonne border on a plain ground relieved by a center ornament in contrasting color.

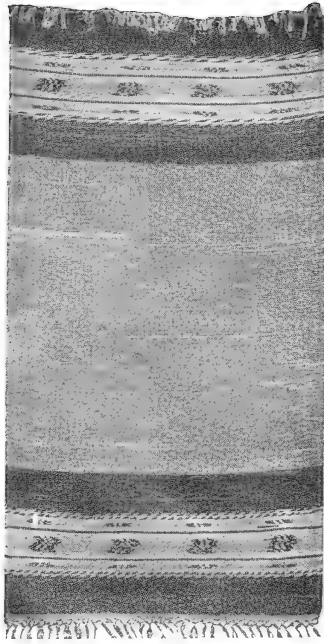

No. 5—An interesting border formed by using material with massed groups of flowers.

the duff off the material makes a fearful lint and this work is not suitable to be done in a room where there is a carpet. If the color is not too pale, it can be done in the garden, but as I said before, it is very important to take great care in seeing that the strips are started exactly the same width. If only one person is to do the tearing, fasten the end of the denim to a screw-eye fastened to a window or table and then run away with the denim.

The material must be wound into balls as it is being torn, or it will get into knots and become tangled. It is important to do this work quickly, as if it lies around the material frays too much, and the part that comes off is of course only waste. When buying denim it is important to try a piece first, to see if it tears, as one make of denim cannot be torn, and when cut, a thread works up which completely spoils the effect of the rug.

AMOUNT OF MATERIAL NEEDED.

Experience alone teaches us how much material will be required for weaving rugs, and it is best therefore to weigh every piece of material which is bought, and give the number of yards contained in the piece. When it is woven the rug can be weighed and the exact amount used in the rug ascertained in weight and in the number of yards. About $2\frac{1}{2}$ pounds, or from 5 to 7 square yards of material will make one yard of weaving. If however, the strips are cut the least little bit wider than an inch, three or four yards would be wasted in a 3 x 6 rug without improving the appearance of it.

It is not always possible to obtain materials that will hold their color, but there is a great difference in the quality of the dyes used in the materials obtainable. Indigo blues and turkey reds can be bought in two qualities. Those with "oil dyed" written on the package will be found to be very much better than the ordinary dyed ones. In selecting materials from which to make a variegated rug, cretonnes, percales and prints can be utilized, and the beauty of these depends not on the design, but on the massing

of colors. Sometimes a large red cabbage rose and very strong green leaves and altogether garish piece of material, in the end will weave into a most beautiful rug, the large spots of red giving a pleasing variety to it. A very small design will naturally only weave up into a broken surface. The denims, although not considered fast colors, do not fade in patches, so that a rug made of this material softens in color, but of course it is advisable when plain materials are used, to dye them of absolutely fast dye, and nothing gives better results than the homemade vegetable dyes. It will be found cheaper to get unbleached materials for dyeing, than pure white, the white have been bleached, thereby deteriorating the fabric, and not improving it for dyeing. I would therefore advise unbleached muslins and a coarse cheap khaki, from which soldier's uniforms are made. This is much cheaper than denim and is often heavier, and will take any of the dark colors. Whenever the khaki color can be used it would not be necessary to redye it, as it is one of the best materials to be obtained for rug making, and is more or less fast in color.

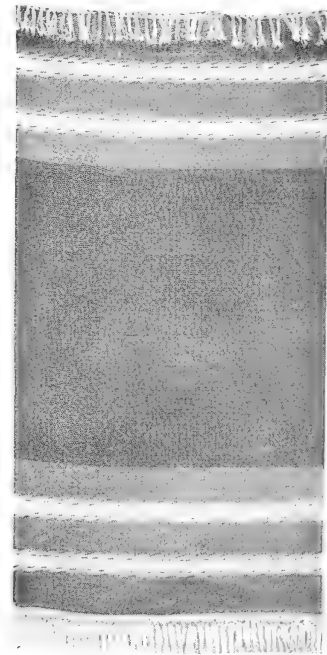

No. 6—A light border on a dark rug is always in good taste. Two rows of twist are woven running the same way.

HOW CELLULOID IS MADE

CELLULOID is a chemical substance made mainly of paper and crude camphor, to imitate ivory, tortoise shell, coral, amber, glass, etc. Considerable secrecy is maintained by the makers of celluloid as to their respective methods of manufacture, but apart from dyestuffs and acid, it may be said to consist of about equal quantities of paper and camphor. The process of its making is not a complicated one, although it is one that is highly injurious to the health of those employed in handling the ingredients. The workmen are compelled to wear clothing of rubber, and invariably bear traces of the strong action of the chemical used, their faces appearing corpse-like and ghastly. The first operation in the manufacture of celluloid is the preparation of the paper, which is composed of cotton and birch wood.

This made, it is wound upon a hollow spindle holding several hundreds yards in length. A roll of the paper is slowly unwound, being saturated with a mixture of five parts of sulphuric acid and two parts of nitric acid, which falls upon it in a fine spray. This changes the cellulose of the paper into propylin gun cotton. The excess of the acid is expelled by pressure and the paper washed. It is then ground to a pulp and bleached.

After thoroughly drying the pulp there is added to it a due proportion of camphor. This is done by carefully weighing, mixing the two ingredients thoroughly, and pressing in canvas jackets between plates. It is at this point that the dye matter is added to make the celluloid any desired color. In the next operation the mixture is subjected to the grinding and pressure of masticators. These machines are simply heavy iron rollers about four feet long, geared together to turn inward. As the grinding continues the mass becomes more and more homogeneous and nearer to the finished appearance of celluloid.

It is then taken from the masticators in the form of huge sheets, eight feet by four feet in size and one inch thick. These sheets are piled one on top of the other until they fill a heavy iron box, which latter is run under a steam-heated hydraulic press, where it remains under enormous pressure for about two hours. This is done for the purpose of welding the superimposed sheets together in the form of a solid cake.

On removal the big celluloid cake is cut into sheets of the desired thickness. This may vary from one-thousandth of an inch to a full inch or more, according to the variety of goods into which the material is to be worked. After cutting, the sheets are hung up in drying-rooms six or seven months to "season," celluloid having the peculiar warping qualities of wood if worked up without due regard to this fact.

From the seasoning rooms the sheets go to the various departments of the factory. Those taken to the novelty department are cut, turned, and pressed into any number of fancy articles. The smaller articles are cut out of the sheets of celluloid, while cold, then dipped into hot water, bent and shaped, and plunged into cold water again to retain their shape. The comb manufacture is simpler than with hard rubber. The teeth are stamped out with dies, either by hand or machinery, and are then polished with cold water and pumicestone. Combs are cut from sheets of "amber," "tortoise-shell" and "ivory" celluloid. All three of these compositions are carefully made, and the imitations of the genuine substance are so faithful as frequently to pass through the hands of experts undetected.—*Fabrics, Fancy Goods and Notions.*

ANSWERS TO CORRESPONDENTS

A. J. L.—For the Russian design for cup, page 3 May 1899, dust center of saucer and lower part of cup with Empire Green. For a light green use Dresden Yellow Green. All black portions of design to be dark blue; all white parts, scrolls, etc., light green; enamel dots, turquoise blue; handle, gold, also band at base of cup. Your plan for a decoration in ivory, yellow and gold with raised paste rose border sounds very attractive. Use the ivory padded delicately then use Albert Yellow or Orange Yellow for the deeper tone. Sorry we can not answer by mail but it is against rules.

S. F. O.—The various makes of colors may be mixed with the mediums issued by the different manufacturers.

L. G.—Decoration should always be subordinate to the shape of the china but in the case where a handle is made to look as if applied instead of being a natural outgrowth of the form, as in a ribbon handle, then the pattern should pass under the handle so that the latter is applied over the design.

A. C. H.—Light tints of blue are liable to have a greenish tone on Belleek on account of the cream tone of the china. Try Deep Blue Green for tinting.

G. B.—If you have white spots appear on your china in firing, moisture must have collected upon it. Leave the peep hole open until you have color in the kiln to let moisture escape.

S. F. O.—Powdered gold is rubbed down with a horn palette knife on a ground glass slab, using one-half fat oil and one-half tar oil, enough only to hold the powder together. Thin with spirits of turpentine.

To retouch under-fired color use a thin wash of flux slightly tinted with color used in first painting. Fire hard, then strengthen where necessary and fire again. Sometimes simply refiring hard will bring out the glaze.

For American Beauty roses Mr. Bischoff makes a special color. Write him for list of colors used in painting the roses.

E. C. B.—If turpentine disagrees with you, use oil of lavender with about one-quarter alcohol, more or less, to make it dry quicker. Instead of fat oil use copaiba with a little clove oil if it dries too fast, one drop of clove or less to six of copaiba.

S. P. H. We prefer the initial on the border of the plate. It does not seem right to see any one's name through a screen of gravy or tea. Either way of executing the monogram would be good, either flat outlined in color or raised in gold if not raised too high, perhaps with roses and cream tint the raised gold would be more in harmony, as the black would make almost too strong a note. You could, however, use a green, red or brown outline.

M. M. C.—Try heating the glass slab if the gold rolls up; may be it is old and the oil hardened. Or try oil of lavender with or without a little alcohol in place of turpentine. Possibly the trouble comes from the plate being moist with perspiration this warm weather, so the oil in the gold naturally rolls away from it. Wipe off your piece with a silk rag before gilding.

Proofs of Pouyat China for the Amateur Decorator.

As white china is the genesis of all decorative effort in ceramics it is sound logic to assume that the white china which gives the greatest amount of satisfaction to the professional, or commercial decorator must of necessity be the best for the amateur.

This is precisely the reason why Pouyat white china is so highly appreciated by amateur decorators of experience. They know that when the professional artist secures brilliant results in color and gold, they are due almost entirely to the receptive character of the glaze. They also know that these results are not those of mere chance and the caprice of fire, for the splendid color effects produced on Pouyat china may be seen in every city of the United States and Canada year after year as indisputable evidence of exact uniformity of texture which characterizes the Pouyat glaze.

Every amateur decorator realizes the desirability of dependable quality in a glaze upon which time, money and artistic effort are expended, and if further argument were needed to prove the excellence of the Pouyat glaze it is most substantially furnished in the fact that the foremost professional china decorator in America is using Pouyat white china exclusively for his best productions.

Pouyat china stands alone for that peculiar velvety quality of glaze which every experienced amateur recognizes as that desirable condition in a porcelain glaze which indicates perfect receptivity of ceramic colors. Another strong point of quality in Pouyat china is that of selections in white china for amateur decorators. When it is sold as first choice it can always be depended upon as first in every particular as it is a standard regulation of the makers of Pouyat china not to make goods cheaper than other makers but to make the best that can be made at the lowest possible price.

China decorators, using white china, whether amateur or professional, are requested to examine closely into the models and forms of Pouyat china and to suggest any changes which may be desired. Wherever it is possible to improve the forms and ornamentation of their models the manufacturers are ready and willing at any time to do so and it is their desire that amateurs as well as professionals shall take advantage of the opportunity to secure something they can refer to as a special model—look for the Pouyat Marks.

Paroutaud & Watson, 37-39 Murray St., New York, sole agents.

NEW STYLES WHITE CHINA

October First we will mail 10,000 supplements to our "Ninety Page" Catalogue.

Are You on Our Mailing List?

This Supplement will contain entire new shapes and styles in both novelties and staples in

White China for Decorating

Articles that no other dealers illustrate.

Send Us Your Name

W. A. MAURER

COUNCIL BLUFFS, IOWA

THE BOOK OF FRUIT

For the china painter and decorator, containing the best naturalistic and conventional studies of fruit, both in black-and-white and in colors, which have been published in Ceramic Studio, with eight studies in color and seven monochromes as supplements.

Price Postpaid \$3.00

Keramic Studio Pub Co.

Syracuse, New York

We Mean You!

This is a fac-simile of the enclosure we are sending to our friends. Don't YOU want to accept this offer?

AN INDUCEMENT FOR SUBSCRIBERS

TO WORK FOR KERAMIC STUDIO

SEND US ONE NEW NAME NEVER BEFORE A SUBSCRIBER TO THIS MAGAZINE and your own renewal, accompanied by eight dollars, and receive a premium of COLOR STUDIES AND DESIGNS TO THE AMOUNT OF \$3.50. State your choice as to Naturalistic or Conventional so that we may be guided in the selection. The Studies and Designs are accompanied with treatments. Catalogue sent free on request.

PRICE LIST KERAMIC STUDIO:

One year \$4.00 Six months \$2.00 Three months \$1.00 Single Copy 40 cents.

KERAMIC STUDIO PUBLISHING CO.

SYRACUSE, N. Y.

Anthropology

KEEP THE FIRE ALIVE

KERAMIC STUDIO

CONTRIBUTORS

JULES BRATEAU	•	•	•	•	•	•	•	•
MRS. DANTE C. BABBITT	•	•	•	•	•	•	•	•
ANNE SEYMOUR MUNDY	•	•	•	•	•	•	•	•
MISS MILES	•	•	•	•	•	•	•	•
MAUD M. MASON	•	•	•	•	•	•	•	•
SARAH REID McLAUGHLIN	•	•	•	•	•	•	•	•
MABEL TUKE PRIESTMAN	•	•	•	•	•	•	•	•
PAUL PUTZKI	•	•	•	•	•	•	•	•
JEANNE M. STEWART	•	•	•	•	•	•	•	•
ALICE B. SHARRARD	•	•	•	•	•	•	•	•
ALICE WITTE SLOAN	•	•	•	•	•	•	•	•
BELLE BARNETT VESEY	•	•	•	•	•	•	•	•

NOV. MCMVI Price 40c. Yearly Subscription \$4.00

A MONTHLY MAGAZINE FOR THE POTTER AND DECORATOR.



The entire contents of this Magazine are covered by the general copyright, and the articles must not be reprinted without special permission.

CONTENTS FOR NOVEMBER 1906

	PAGE
Editorial	145
League Notes	Belle B. Vesey 145
The Class Room	
The Art of Teaching	146-152
Apples	Sarah Reid McLaughlin 147
Salad Set—Roses	Alice B. Sharrard 149
Grapes	Miss Miles 151
Orchid Study (Supplement)	Paul Putzki 152
Punch Cups	Alice Witte Sloan 153
White Roses	Anne Seymour Mundy 153
Jug—Plums	Jeanne M. Stewart 154-155
Work of Design Class	Maud M. Mason 156-159
Rose Design for Plate	Mrs. Dante C. Babbitt 160
Wild Rose Border	Anne Seymour Mundy 160
The Crafts—	
Art in Pewter	Jules Brateau 161-164
Rug Weaving and Dyeing—continued	Mabel Tuke Priestman 164-167
Answers to Correspondents	167

LIST OF BOOKS

The Rose Book, containing some of the best rose studies and designs published in Ceramic Studio postpaid	\$ 3.00	Tulip Ware of the Pennsylvania German Potters, by Edwin A. Barber, in paper cover postpaid	1.10
The Fruit Book, containing some of the best fruit studies and designs published in Ceramic Studio postpaid	3.00	Cloth, limited edition postpaid	5.00
Composition, by Arthur Dow postpaid	1.65	The Primers of the Pennsylvania Museum (two already issued, Salt-glaze ware and Tin-enamelled ware) postpaid	.50 and .60
Principles of Design, by E. Batchelder postpaid	3.00	Encyclopedia of Ceramics, by W. P. Jarvis postpaid	6.75
Decorative Studies, by J. Foord postpaid	12.50	The Old China Book, by N. Hudson Moore postpaid	2.18
Plant Forms and Designs, by Midgley and Lilley postpaid	2.20	The Old Furniture Book, by N. Hudson Moore postpaid	2.18
Practical Pottery, elementary instruction for students, by Richard Lunn postpaid	2.50	Old Pewter, by N. Hudson Moore postpaid	2.18
Grand Feu Ceramics, a practical treatise on the making of hard porcelain decorated with high temperature glazes by Taxile Doat of the Manufactory of Sevres, France postpaid	7.50	Chats on English China, by Arthur Hayden postpaid	2.18
Seger's Collected Writings, 2 volumes postpaid	15.50	Chats on Old Furniture, by Arthur Hayden postpaid	2.18
For the Collector:		China Collecting in America, by Alice Morse Earle postpaid	3.20
Vol. II Old China, bound blue cloth postpaid	2.50	Pottery and Porcelain, a guide to collectors, by Frederick Litchfield postpaid	6.25
Vol. III Old China, bound blue cloth postpaid	3.50	French Pottery and Porcelain by Henri Frantz postpaid	2.68
Anglo-American Pottery, a manual for collectors, by Edwin Atlee Barber, Curator of the Pennsylvania Museum, second edition postpaid	2.00	Dutch Pottery and Porcelain, by W. Pitcairn Knowles postpaid	2.68
American Glassware, old and new, by Edwin A. Barber postpaid	1.00	Old English Furniture, by Fred Fenn and B. Wyllie postpaid	2.68
Marks of American Potters, by Edwin A. Barber postpaid	2.25	English Embroidery, by A. F. Kendrick postpaid	2.68
Pottery and Porcelain of the United States by Edwin A. Barber postpaid	3.75	French Furniture, by Andre Saglio postpaid	2.68
The Lace Book, by N. Hudson Moore postpaid	5.30	Old Pewter, by Malcolm Bell postpaid	2.68
		Sheffield Plate, by B. Wyllie postpaid	2.68
		The Oriental Rug Book, by Mary Churchill Ripley postpaid	3.20
		Home Furnishing, practical and artistic, by Alice M. Kellogg postpaid	1.65
		William Adams, an old English potter, by William S. Turner postpaid	8.00

Keramic Studio Pub Co., Syracuse, N. Y.

KERAMIC STUDIO

Vol. VIII. No. 7

SYRACUSE, NEW YORK

November, 1906

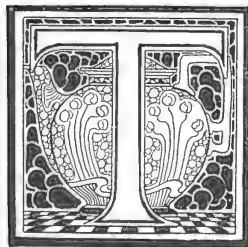

THE exhibition season is at hand and everyone will soon be making his or her supreme effort of the year. The National Society of Craftsmen will make its initial bow to the public November 30th at the rooms of the National Arts Club, Grammercy Park, New York. Great things are expected of this Society and we do not look to be disappointed.

The Art Institute of Chicago will hold its annual exhibition of arts and crafts in December. At both of these exhibitions ceramics will have a prominent place.

The New York Society of Ceramic Arts having omitted its annual showing last year is expected to do great things this year to make up for its delinquency.

We will be glad to receive notices of coming exhibitions of the various ceramic clubs, with illustrations of the work.

✦

This extract from a personal letter to the editor will be of interest to our readers:

"As you know, we have been abroad all summer, painting in England and France besides making a flying trip through Holland and Belgium. You will however be surprised to learn that we are as busy as we can be, preparing to return to London on November 3d. My mother goes with me and I shall work all winter under Swan for drawing and Paul Brangwyn for painting. I am hoping to get inspiration in London not only for painting but for ceramics. Many imagine that, because I devote so much time to landscape painting, I am necessarily giving up interest in ceramic work. On the contrary I shall devote much time and thought to the subject this winter, and shall have a summer class next season, perhaps somewhere in Long Island.

Marshal Fry."

The May, 1907, number of *KERAMIC STUDIO* will be edited by Mr. Marshal Fry. January, 1907 will be devoted to the work of Mrs. Henrietta Barclay Paist, and March, 1907 to that of Miss Margaret Overbeck, while Miss Leta Horlocker, who is now in California, has offered to edit a California flower number, which will probably make one of the summer issues.

✦

An interesting lot of class work from the pupils of Miss Maud Mason appears in this number, a little late, but it was crowded out by our special numbers.

✦

The competitions for Christmas have been closed and the results will be illustrated in the Christmas number. Some very clever work has been submitted, very little was sent in that did not have some merit of originality. We regret to say, however, that no one seems to be acquainted with the "Christmas Rose."

✦

The treatment for the plum study of Miss Jeanne M. Stewart was delayed and is published on page 167.

We begin in this number an extremely interesting series of articles on pewter by Jules Brateau, the famous French pewterer and craftsman. The artistic possibilities of pewter are little realized in this country, except perhaps by the few people who have noticed at the St. Louis Exposition the finely chased articles which were exhibited by Jules Brateau and a few other French pewterers.

The first articles will treat of the history of pewter and will be profusely illustrated with specimens from the different countries and periods. The second part will treat of the technique of the work, giving thorough and practical instruction. Tin is a soft metal, its lack of hardness and resistance makes it poorly adapted to the making of table ware and common utensils, although at times it has been so used in large quantities. But the beautiful soft grey color of the tin alloy called pewter, its flexibility, its non-oxidation under atmospheric conditions which would badly oxidise silver, make it eminently suitable to the production of fine works of art which will not be roughly handled.

✦ ✦

LEAGUE NOTES

We need more hours in the day, more days in the week, and more weeks in the month to accomplish what we plan. We need more love for the best, and more, the spirit of truth and demand of reason. Our standard must be high, and our work up to the standard. Japanese children in school learn to draw. American children in school learn to write. It is a matter of instruction. Hugo says, "There are no bad weeds and no bad children; there are only bad cultivators." We are children in Ceramic art, we need instruction and cultivation. It is the purpose of the League, and the course of study is prepared with that view. We cannot multiply the hours, lengthen the days, nor increase the months or years, but we can systematize our work, simplifying and eliminating, until we have made time for these lessons. The problems of this month are coming in, but not enough of them. We will not be satisfied until all the members are studying the course. Send Problem 3. Drawings for a nut bowl, to be made of clay, with a simple design or decoration, to

BELLE BARNETT VESEY, Pres.
6228 Wabash Ave., Chicago.

✦ ✦

N. Y. S. K. A. NOTES

The first meeting of the season was held at Miss Mason's studio on October 8th. A contest of sketches for a tea jar and stein had been previously planned. The sketches were displayed in an attractive manner on a screen and were criticised by Mr. Ralph Jonhnot of Pratt Institute. After the criticism Mr. Jonhnot gave a most interesting talk on the beauty of line and form, and those who failed to attend the meeting missed a rare treat. An equally enjoyable and instructive programme will be arranged for each meeting of the year. For the next one members are expected to submit sketches for a bowl and cup and saucer, also drawings for a club monogram or insignia.

The traveling exhibit of the National League of Mineral Painters will be installed at Miss Wynne's, 39 West 21st Street, and will be displayed from October 30th to November 3d. It was also voted to hold a small exhibition of the work of the New York Society in connection with the League exhibit. Each member is requested to send in a limited number of pieces. All articles should be plainly marked with the price and the owner's name, and should be delivered at Miss Wynne's on Monday, October 29th.

A fund for the benefit of the San Francisco Mineral Club is proposed toward which the members of the N. Y. S. K. A. are asked to contribute \$1 each.

B. MAIE WEAVER,
Cor. Sec.



THE CLASS ROOM—THE ART OF TEACHING.

First Prize—Mrs. G. B. Strait, Cazenovia, N. Y.

THE ornamentation of ceramics is no trifling affair. It has by its merits won a place in the world of art, distinctively its own, and can not be overlooked or ignored.

In any art school there is never any inquiry as to the method of teaching to be adopted. The plan is established and is seldom questioned. But in private classes there are almost as many variations in the methods of instruction as there are teachers.

While recognizing the fact that many pupils in private classes begin the study of china decoration mainly to produce something attractive for use or for a display in the home, the one who has some native ability and who is willing to work for future achievement is the one for whom these directions are given, for hard work lies at the root of all successful work in ceramics.

"The teacher should never attempt to impress his style upon the pupil, but his *methods*, that the pupil may learn to think and act for himself."

This will so inspire the earnest worker with confidence that he will not only be encouraged to grasp all technical difficulties, but will give attention to the necessary preliminary practice and the laborious collection of facts so essential if nature is to be rightly understood and interpreted. The student should be encouraged in all that will advance him in his art, and taught that the habit of observation is as necessary to the artist as to the surgeon; that art principles can not be violated; to know why and how certain effects coming under his observation are produced; and to discriminate between conscientious work and that which is meretricious.

More than all, to retain enthusiasm the teacher must take a personal interest in the work of the individual student, encouraging, directing and guiding, not sparing kindly criticism, until the learner is literally enabled to "stand alone."

KIND OF PIECE.

For the beginner, a plaque, tile or plate, something that will present a rather flat surface, will doubtless be most desirable, not only on account of the ease with which it may be handled, but because all parts may be seen at a glance, the general effect be more readily obtained, while the handling of the brush may be more quickly mastered than if a rounding surface be decorated.

Moderately hard glaze china, which is of a pure white, rather creamy tone, is generally considered preferable to the ware that is slightly blue, as it is not only more translucent, but because of the ware and glaze being similar, the

union of the two is more complete, and consequently less liable to chip, while the glaze of the extremely hard ware is only attached to, instead of being incorporated with the ware. The hardness of some wares is said to frequently account for the chipping of enamels. However, the beginner should experience no difficulty in securing a desirable bit of plain ware, free from black specks, blisters, or other flaws. Foreign china, especially the French and German makes, are usually satisfactory, but it will be wise not to choose any unmarked pieces, as they are not always reliable.

The raised designs frequently found in china, such as fancy borders, bow-knots and floral effects, which characterize certain kinds of ware, are a hindrance to the best styles of decoration, and should if possible be avoided. Poor ware, which not unfrequently is more or less warped or otherwise defective, does not bring out the colors, especially reds, greens, and rose, so satisfactorily as the better ware, and refuses the finest glaze when fired. One china dealer of long experience says if, on holding a thin piece of ware against the light, a dark spot appears, it should be rejected lest it check in firing. The good results following the selection of choice material will encourage the beginner to stronger efforts.

STYLE OF DECORATION.

Having selected the piece to be decorated, the next step is to decide upon an appropriate design. Ornamentation is designed to increase the beauty of the ceramic form, and must in a measure conform to the shape of the object and heighten its beauty without attracting more attention to the decoration than to the shape of the article decorated. Each should tend to the advantage of the other. The use for which the piece is designed will help determine the appropriateness of the decoration.

While in general it is unquestionably true that conventional designs are in the best possible taste for all styles of ceramic forms, yet if the naturalistic appeals more to the individual, that is the line along which the student is to be directed.

In the conventional style there is no shading, the flat tones showing the form of the object to be depicted without any attempt being made to secure perspective, simply suggesting nature without representing it. One plea for the use of conventional designs is that they may not only be adapted to any and all shapes of china, but colors may be used ranging from soft greys and browns in monochrome, presenting exquisite contrasts of tones in the same color, to the richest colors obtainable from the china palette. But the beginner should be careful to use the simplest palette possible, as gorgeous colors will not necessarily produce harmonious and satisfying color schemes, and are not essential to the securing of artistic combinations.

But whether the conventional or naturalistic treatments are decided upon, the principles of decorative art must be studied and followed, remembering that all good work, irrespective of style, is based on positive knowledge; and that the skilful worker can not become such without careful training and thoughtful study. Short cuts to success in china decoration are broad thoroughfares to failure.

Before attempting any work, the pupil will find it advantageous to study the following illustrated articles to be found in the *KERAMIC STUDIO*, though by no means confining himself to these, if others equally instructive are obtainable.

First, a series of articles on historic ornament, or motifs



APPLES—SARAH REID McLAUGHLIN

used in design by the Greeks, Chinese, Egyptians, etc., may be found in the first two years of the *KERAMIC STUDIO*. It is not to be understood that these designs are to be used for copies, but that a proper understanding of them must be secured "as a foundation upon which to build an individual style."

Next, the articles by Mrs. Adelaide Alsop-Robineau on *Modern Design*, *Pond Lilies*, to be found in the October 1900 number of *KERAMIC STUDIO*, *Tulips*, July 1901, *Trillium*, September 1904, *Poppy*, October 1901, and Mr. Hugo Froehlich's recent articles on *Principles of Design*, where the principles of decorative lines, color, spacing, etc., are given, should receive the pupil's attention.

Note that in all these examples as much attention is given to the spaces as to the designs themselves.

A careful study of these and similar articles, proving each theory by a practical demonstration, and also a little painstaking study of plants and flowers, will do more for the advancement of the student than the copying of many published designs. The pupil must study natural forms and learn to see well, before he can draw or use color well.

While all will concede that a sketch book full of drawings made directly from nature is to be preferred above any book of instruction, only those who have faithfully worked out the problems presented in the above mentioned articles, can in the least degree appreciate their inestimable value to the student.

MATERIALS.

The beginner frequently needs a word of caution concerning the position assumed during work, as in the anxiety to do creditably the pupil is liable to bend over the piece too closely. This not only prevents the worker getting an idea of the design as a whole, and results in a failure to secure any idea of relative values, but will in time surely weaken the eyes. A north or east light coming from the left is most desirable, and sunlight should never be allowed to fall directly on the work.

With chair standing firm, let the table be arranged in front of the pupil in the most get-at-able way possible, with the following materials, having the piece to be decorated directly in front of the worker. A bottle of Higgins' India ink, a crow-quill or other pen, plate divider, color outfit, a sheet of tracing and one of drawing paper, turpentine, old muslin, a hard and a soft pencil. A pair of dividers with reversible point, for either pencil or pen, is also desirable.

These, together with the necessary stock of patience, should soon result in creditable work.

CHOICE OF SUBJECT.

In the selection of a subject, the beginner will naturally be influenced to choose one that will appeal to him; and this is wise, as the learner will naturally be drawn toward that which is attractive to him and take an additional interest in its execution. But it will not be found advisable to attempt the most difficult thing at first, not only because of the difficulty of the manipulation of that oftentimes unruly member when in the hands of a novice, the brush, but on account of lack of knowledge of the colors. Practice in the handling of the brush can not be dreamed out. The coloring of broad surfaces and borders for practice is helpful and should not be considered a waste of time.

If the pupil knows something of drawing and is not too timid, the teacher can at the outset have him make his own designs subject to the rules and conditions of the articles suggested for preliminary study. If otherwise, some clear

subject, such as Miss French's lotus design, September 1903, may be chosen. As a matter of education, it will be well for the worker to select his own color scheme.

DRAWING.

Secure a good, clean drawing at the outset. It is an easy matter to copy a design which is to be repeated exactly, or nearly so. If exact, take a thin piece of paper, place over the design to be copied, and with a soft lead pencil trace off a single repeat. If the design has to be changed to fill in the allotted space, make one-half of the repeat perfectly on drawing paper, draw on the thin paper, fold this and trace the other half. This of course applies when the halves are exactly reversed. A simple repeat design may be made shorter or taller as desired, by deciding on the width of border, making it narrow or wide, then dividing it into as many perpendicular sections as the times it is necessary for the design to be repeated. The design must then be broadened or shortened where the sections meet.

The beginner should only choose such designs as are easy of adaptation, not attempting the more difficult ones until fairly expert.

When the design is satisfactorily drawn, rub a little oil of turpentine over the china to be decorated, and dry by artificial heat. The hardened oil, though invisible, affords a sort of roughness to the piece which will hold pencil marks. The plate divider is a sheet of paper with circles marked accurately into halves, sixths, fourteenths, etc. Place the plate face downward on this, and with a pencil mark on the rim whatever divisions are desired, allowing a section for each repeat. Turn the plate over and continue these marks so they are visible on the face. It is necessary that this be carefully done, as these are the points from which lines are to be drawn toward the center, and which are to divide the plate into sections. Put the side of the drawing where the pencil marks are next to the china, in one of these sections, and retrace the lines carefully with a hard pencil, steel tracer or sharpened stick. This will leave a faint outline on the ware, which may be traced over with a pen and India ink in order to prevent its becoming rubbed. The same tracing is to be used for the several sections, for if the lines grow too dim they may be marked over again with the soft pencil and be as good as new. Carbon paper which has been softly rubbed over with a bit of cloth to remove superfluous color, may be used, but the method just described will be found much neater. To adapt straight borders to circles, follow the directions in the illustrated article in the *KERAMIC STUDIO* for July 1901. Nothing could be more concise or more easily understood. Occasionally it becomes necessary to draw a perfect circle inside the rim of plaque or plate. It seldom happens that the edges of these are absolutely true circles, so the following suggestion may be helpful if one does not possess one of the gauges that locates centers. With the aid of the plate divider mark some sections on the rim. Use a ruler and draw lines from these clear across the plate, noting that where these meet is the center. Using this point as center, draw desired circle with compass and pen.

OUTLINING.

It is important that outlining in conventional work be done with a steady, smooth movement, free as possible from wavering strokes, firm in quality throughout its length. Nearly all designs are improved by using outlines, sometimes of gold, and again of color, so the beginner will spend much time in practicing this very necessary part of the work.

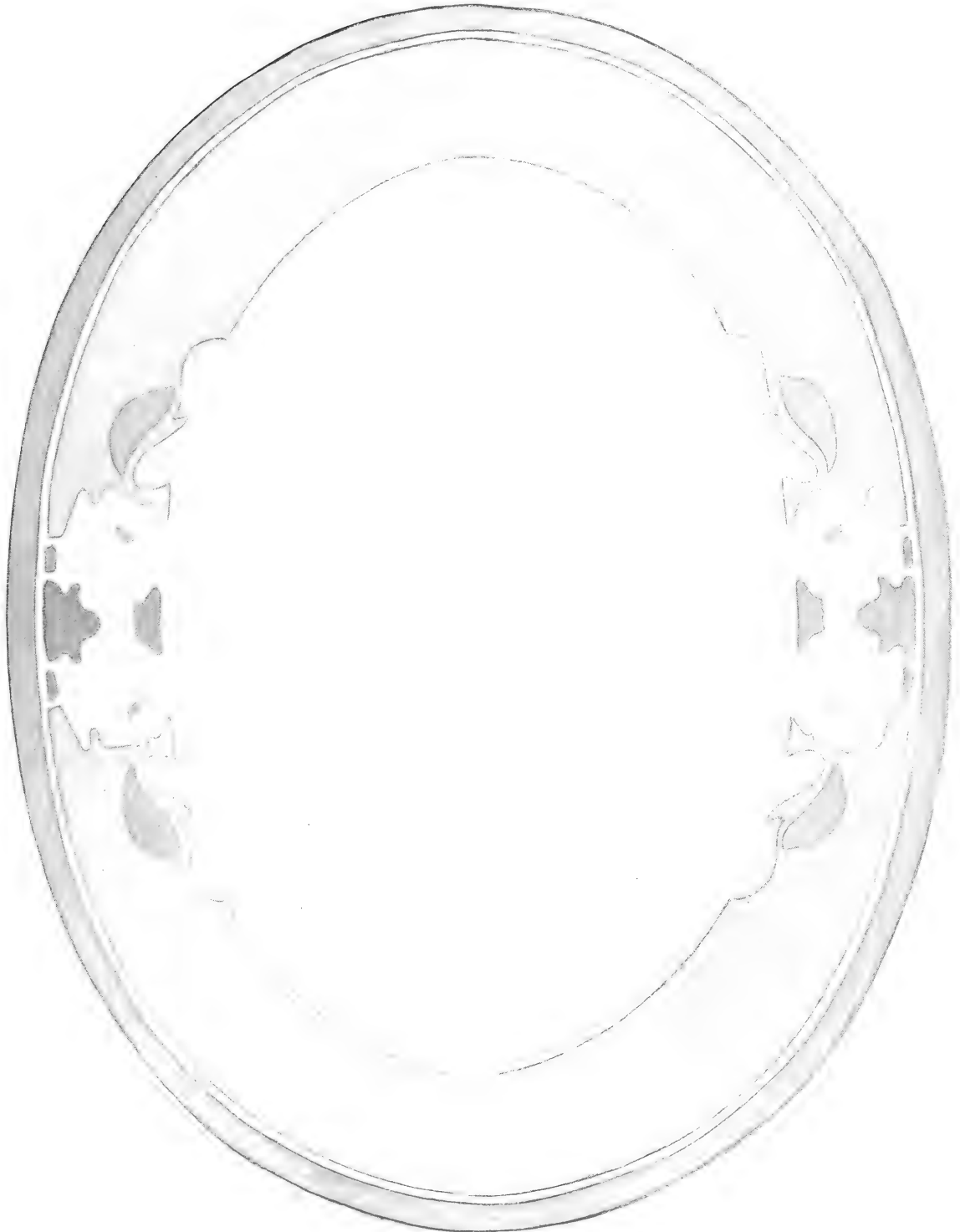

SALAD SET—ROSES—ALICE B. SHARRARD

Tint all over Ivory and fire. Tint outside border leaves and space between roses, a light olive, inside border pink, outside in gold.

A helpful way to steady the hand is to take large sheets of ruled paper, and with pen and ink to retrace these lines, first to the right, then to the left, without lifting the pen from the paper. A brush outline may be used, but a pen will do better work for gold, for colors ground with medium and turpentine, or for color mixed with sugar and water. For the latter make a thin syrup of sugar dissolved in hot water, and rub it well into dry powder color. These lines should be painted twice before firing. Place color to be used with a pen in a tiny cup or dish in order to fill pen readily.

CONVENTIONAL MONOCHROMES, ETC.

The simplest style of conventional decoration is that of one color, and may be done under the guidance of a careful teacher by the one who has ability for it, but no special training in drawing or painting.

Designs such as the plates by Emily F. Peacock in the November 1904, *KERAMIC STUDIO*, plate by Alice Witte Sloan or the one by Katherine Sinclair, May 1906, harebell design by Emily Hesselmyer, December 1903, or the one by Alice Joslyn in January 1904, are excellent examples of what may be done in monochrome. This style affords great opportunity for delicacy and beauty, though comparatively few realize the delightful effects to be obtained by it. Different shades of blue, green, dull reds, blue greys, or browns ranging from rich dark shades to pale ochre, outlined with gold or dark tones of the same, may be selected according to the taste of the worker. Copenhagen, deep red brown, chocolate brown S., shading green, delft green S., etc., are desirable colors for monochrome.

Whether one of these, or a design requiring several colors is chosen, it is well to put a soft tone of the prevailing color over the entire piece, and fire before putting in the design.

It is often advisable to make the border darker than the center, as in the case of the plate designed by A. W. Sloan, which we will consider as to method of applying color, as it plainly shows three color tones instead of two, as occurs in many conventional monochromes. These will be found in the center, the border, and the units of the design and narrow lines. The same ideas may be applied to tiles, etc.

When the design is delicately drawn on the tinted and fired surface, tint the border evenly, section by section, padding lightly as the work progresses, and when satisfactorily done wipe off any color that has been padded on to the middle of the plate or the dark portion of the design.

Now fill a large square shader with color which has been mixed to the consistency of tube color with medium and thinned with turpentine until it flows easily from the brush. With an even pressure of the brush paint over the portion of the design to be made dark, going to, but not over the outlines, laying the color so evenly that no brush marks show, although it may be heavier in some places than others. An excellent example of the effectiveness of inequality of color is to be found in the plate design by Marie Crilley Wilson, May 1904, *KERAMIC STUDIO*.

If the result is not satisfactory, rub the color off and start again. A poor beginning, patched up, will never pay in the long run.

When the color is laid and dry, outline with a pen dipped in color or gold. While color outlines are usually good when applied in two coats, dried between, it is better to use three applications of gold for a flat outline, put on after the plate is fired. As one acquires skill it is possible to finish in one fire.

Beginners in china decoration having some experience in drawing and brush work, may be able to attempt designs having more than one color, provided the designs are not too intricate.

In combining colors try to select the best color scheme from a decorative point of view, varying it from the naturalistic so far as it is essential in order to secure this, keeping the tones perfectly harmonious. When several colors are used as may be the case in the lily design by Anna B. Leonard, December 1904, they may be painted in the following or a similar color scheme: Deep cream center, dull red background for blossoms, buds and blossoms a stronger and but slightly brighter red, leaves and border dull green, turquoise ground for buds, the whole outlined with black or raised paste, and the stamens raised.

Do not paint first one color, then another, but fill in every space of a given color at one time, in order to be able to detect any variations of tone. Where the colors are padded it must be more evenly done than is necessary in naturalistic painting. When paste is used it may be applied for the first fire, then two coats of gold put on after the color is painted and dried.

Enamels are attractive, prepared according to directions given in the class Room, and applied to such designs as the dragon fly plate by Nancy Beyer, August 1906, where everything vivid should be avoided in combining the colors. A touch of black added to any color will tone it sufficiently. A pale tan ground, with design in dull red, buff, and a little green or blue on the flies, with black outline of raised enamel, will make an interesting study. If enamels are used with paste, it is best to apply them after the paste has been fired, and to put the gold on after the enamels are dry.

Many designs, of which Mrs. Sara Wood Safford's apple motif, July 1906, is an example, require to be dusted and to have repeated paintings and firings in order to draw the colors together to produce the elegance of finish and delicate softness of effect so marvelous to the uninitiated. The color used for dusting is some soft neutral tint which may be applied over the entire piece, or on the border, or over some particular portion of the design as judgment may dictate. When only used over a portion of the design, be careful to clean out the rest with a cloth slightly moistened with alcohol, before going on with the painting. Occasionally a very dark tone is wanted, and in such places grounding oil may be used, and the color dusted on before the painting is continued.

Dusted work should not be dried by artificial heat, as that will cause the oil to soften and the color to run. For an example of dusting take a design in pinks, sage or olive greens, and browns, which may be brought into beautiful harmony by a dusting of pearl grey.

If a lustre treatment be wanted, the beginner will find it advantageous to draw the design as usual, then paint the outlines lightly in black and fire before proceeding further. This is done to prevent the turpentine used in the outline color from spreading and marring the lustre. (The outlines of any color design may be fired before the spaces are filled in, if more convenient.) Then apply the lustre, dry, and remove with a pen-knife any that has overspread the outline, repainting the latter with black.

If the inked drawing is not entirely covered with the gold or color, it will eat out the lustre when fired and leave an unsightly mark. When paste is used with lustres, the lustre should be applied first and thoroughly dried, and even then it is better if they do not quite touch, as by contact one is liable to injure the other.





GRAPES—MISS MILES

NATURALISTIC EFFECTS.

If the naturalistic treatment be decided upon, and at the outset it is probable that more are attracted to this than to the conventional, a plaque or tile will make a suitable piece to paint. If a flower subject is chosen, the poppy design by Sara Wood Safford, January 1904, the prize study of arbutus by M. E. Hulbert, July 1904, or jonquils, April 1905, will afford good topics for a discussion of methods of application.

Before beginning the work, an arrangement must be decided upon, and great care taken with the drawing, which is to be done in the simplest way possible; for until the student has gained sufficient confidence to paint in a design directly, the main masses may be lightly sketched in, rigidly guarding against drawing minute details before securing the general form. The more prominent portions only are to be indicated by the pencil, all stiffness being carefully avoided, as the grace of an arrangement frequently constitutes its chief charm, while many lines only cause confusion.

There are two ways of painting naturalistic designs. First the object may be painted, then the background; or, the background may be painted in and softly blended, and while still moist wipe out the prominent leaves, stems and flowers. The latter method is more satisfactory if it can be done at first, as by so doing all hard lines will be avoided, and the crisp brush touches be retained. This necessitates more rapid work, but will amply repay the extra exertion. Have the work so carefully planned that there will be as little hesitation as possible in applying the color, which should be done with a free, clean touch.

It is not advisable for the beginner to try to remedy defective work. Better wipe off the whole piece than have muddy, patched colors stand as a testimonial to the poor judgment of the worker.

Remember that every plant and each fruit has its peculiar characteristics of growth, not only of flower, but in the texture of leaf, and habit and formation of stems, leafy bracts, and hairy or spiny projections. And these are to be suggested, if not made prominent.

Much of the success of a piece depends upon the first painting, at which time the sparing of lights is to be emphasized, as a defect here can not be remedied in subsequent paintings. Having put in the background with the principal colors to be used in the design, to which blue has been added to give a feeling of atmosphere, and carefully avoiding great contrasts of color, wipe out the prominent parts of the design. Paint in some of the misty, shadowy portions, omitting detail, and grey them so as to be subordinate to the main masses of the composition. These to be added to in second fire. Where leaves should appear dark, make them rich, and heavier in color than in the lighter portions, which in places may be so thin the china shows through. Bright touches of clear green may be used where the light shines through the leaf, the colors being softly melted together. Let the brush strokes go in the way the leaf curls, representing the rough surface of the fall anemone, or morning glory, with softened lights, and those having smooth surfaces with sharp, clear lights.

In the delineation of the flowers, fill the brush with color, and draw it carefully from the outside edge of the petal to the center, forcing the color to the darker portions, and avoiding all unnecessary manipulation of the brush. Be sure to preserve the character of the petals, but above all, avoid all sharp lines in the first painting, as these may be supplied later if necessary. Keep every edge soft and

graded carefully into the background. Apply the gold where desired, and fire.

For the second painting strengthen the leaves, flowers and background, add little marks of detail where one petal overlaps another, and accent the stems and blossom centers. Before firing again the second coat of gold may be added.

If a third painting be given, put in any additional accent marks, use light washes occasionally to bring the whole into harmony, and lightly dust the ground with the colors used in the first painting to give a richer effect. Any of the colored naturalistic studies will illustrate well the massing of color.

While first pieces may not be entirely pleasing to the beginner, this need be no cause for discouragement, as a careful and critical examination of every piece will show exactly what to avoid; and with each experiment new revelations of the possibilities open to the china decorator will be revealed to the serious student.

❁ ❁

ORCHID STUDY (Supplement)

Paul Putzki

THE tone of the whole study should be kept in browns, using for the flowers Albert Yellow, Yellow Brown, Yellow Red shaded into Carnation and Dark Brown for the darker touches. The light green effect in the centre and around is gotten by using Yellow Green shaded with Brown Green and Yellow Brown mixed. For lighter shade of leaves use Dark Green, Canary Yellow and Yellow Brown together, shaded with Brown Green and Yellow Brown mixed. The darker leaves are produced by using same colors heavier with rather more of Brown Green.

The background should be laid in with colors to harmonize with design.

❁ ❁

GRAPES

Miss Miles.

FIRST fire. Wash in background. Lay in large bunch of grapes with Violet of Iron. Underpart of grapes soft green, small bunch green; lay it in with Moss Green and Silver Yellow; shade with Brown Green. Green leaves, Silver Yellow, Moss Green, Olive Green and Dark Green. Brown leaves, Yellow Brown, Auburn Brown and Silver Yellow (dust.)

Second fire. Bring out red grapes, keeping back ones flat, using Violet of Iron, top ones light and soft, Shade green ones with Olive Green. Work up leaves with same colors as used in first fire. Strengthen background with Finishing Brown. (dust)

Third fire. Strong and sketchy lines for detail.

❁ ❁

STUDIO NOTES

Mrs. Henrietta Barclay Paist announces a change of location from her studio in St. Paul to 804 Nicollet Ave., Minneapolis.

Miss Caroline Hofman opens her new studio at 334 Madison Avenue, with a study course in design.

❁ ❁

To blacken flat pieces of aluminum, wash them in gasoline and allow to dry by evaporation. Then paint over with olive oil and hold over a gas burner or alcohol lamp. When the oil begins to dry the aluminum will turn black. Repeat the operation if the articles are not quite dark enough.

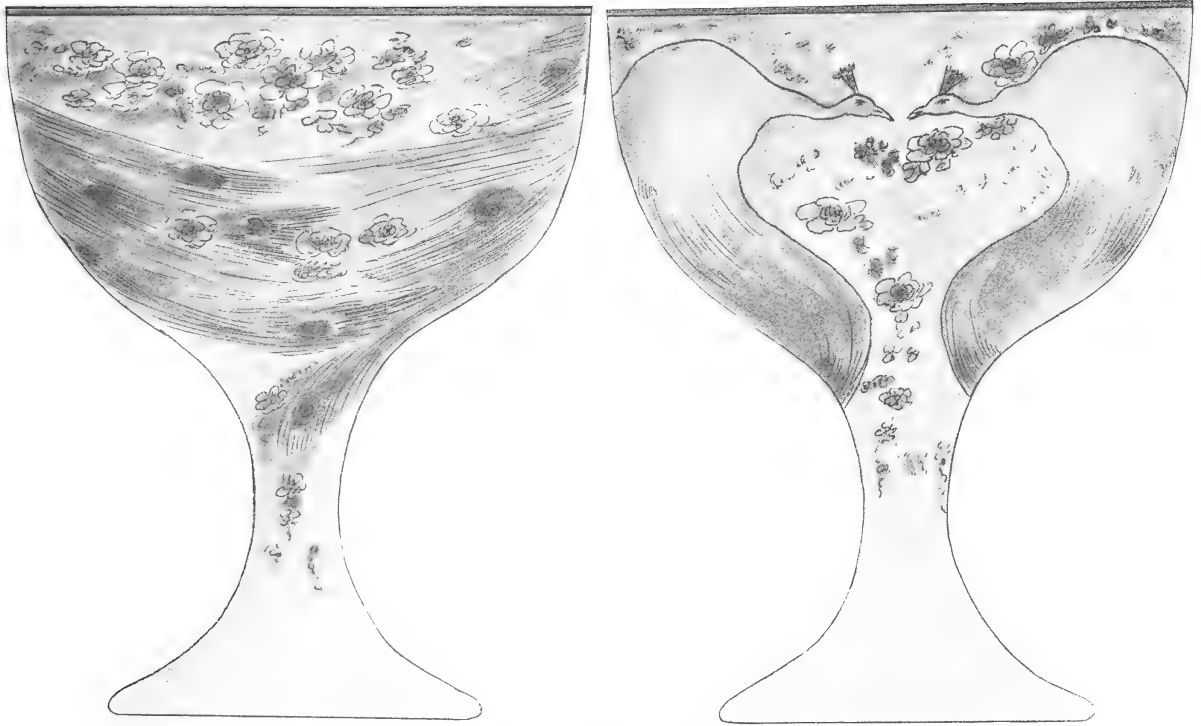

PUNCH CUPS—ALICE WITTE SLOAN

To go with Punch Bowl in *KERAMIC STUDIO*, August 1906.

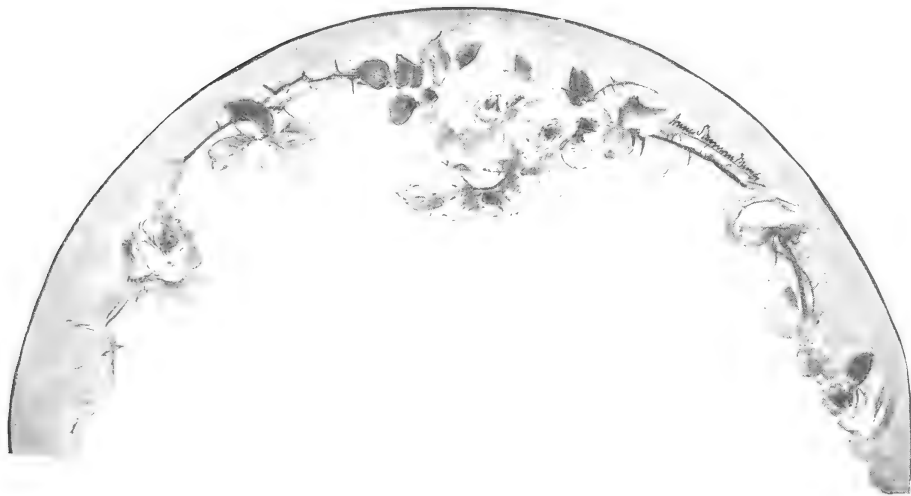

WHITE ROSES—ANNE SEYMOUR MUNDY

SILVER Yellow with tiny bit of Black to tone it; use *very thin* to shade, white china making its own high lights. Leaves and stems same as wild rose.

If the plates are done as a set for grey green use Apple

and Shading Green mixed for borders, or Brown Green with Apple dusted over. Be sure that design cuts tint clearly and flowers are washed softly out of tint, which helps to shade them.



JUG—PLUMS—JEANNE M. STEWART

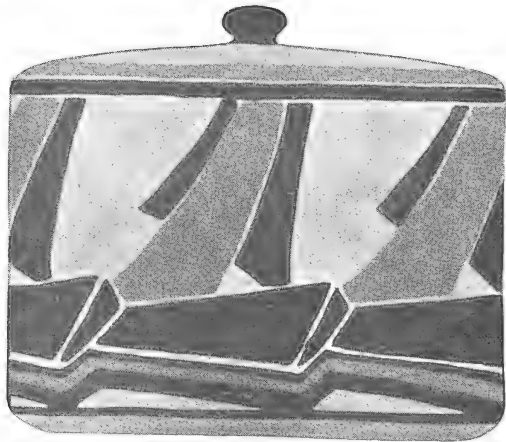

Mrs. Tuttle—Brooklyn Class.

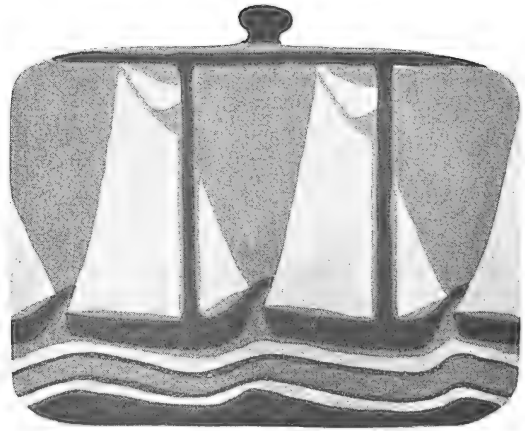

Mrs. Hale—Brooklyn Class.

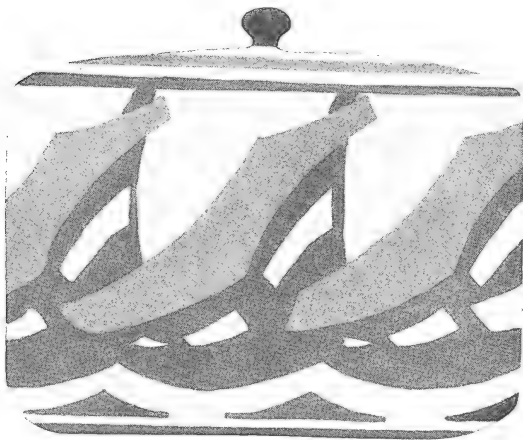

Bessie H. Proctor—Brooklyn Class.



Miss Belknap—New York Class.



Miss Walsh—New York Class.

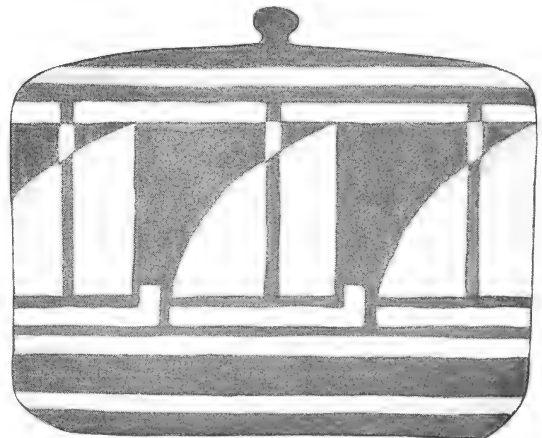

Miss Cassamajor—Brooklyn Class.

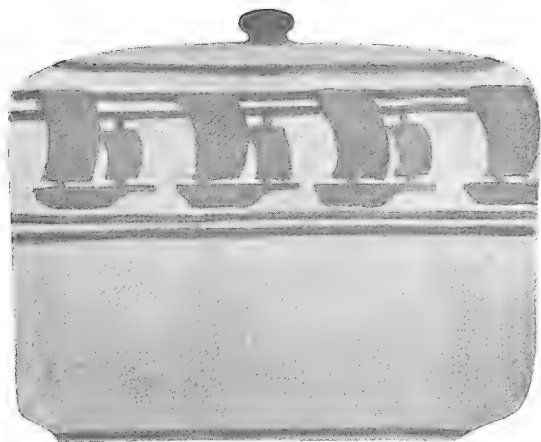

Mrs. Waterfield—New York Class.

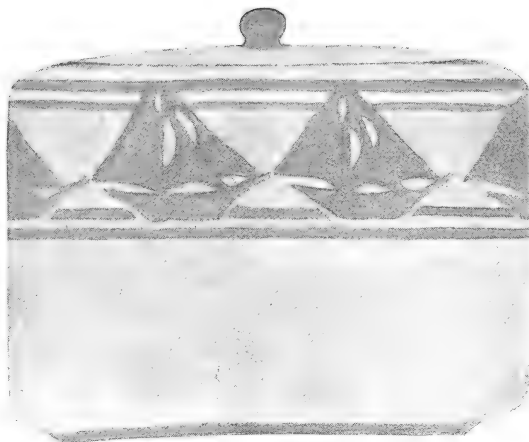

Mrs. Waterfield—New York Class.

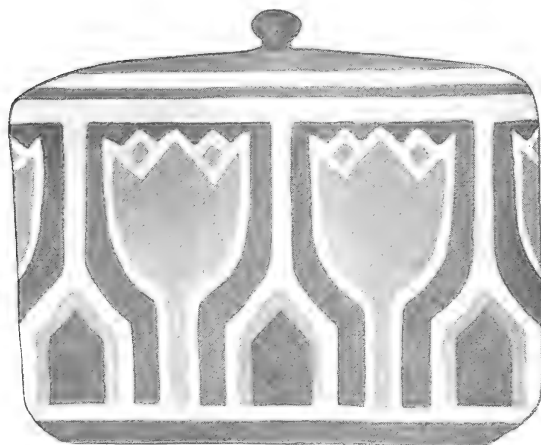

Miss Cassamajor—Brooklyn Class.



Mrs. Unger—New York Class.

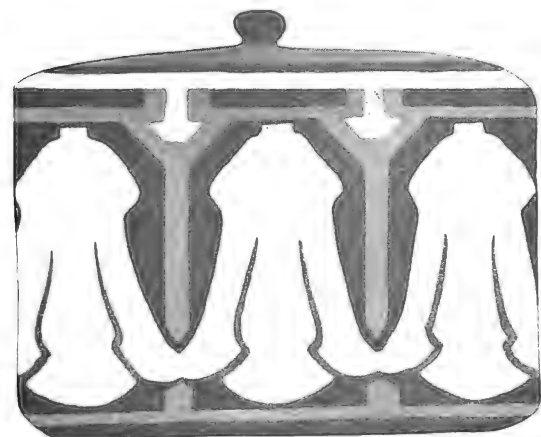

Miss Smith—Brooklyn Class.

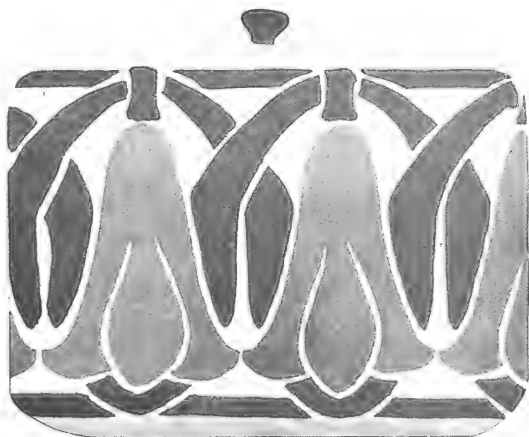

Mrs. Prince—Brooklyn Class.



M. E. Chichester—Brooklyn Class.

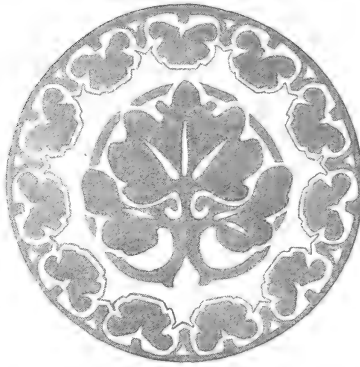

Mrs. Waterfield—New York Class.

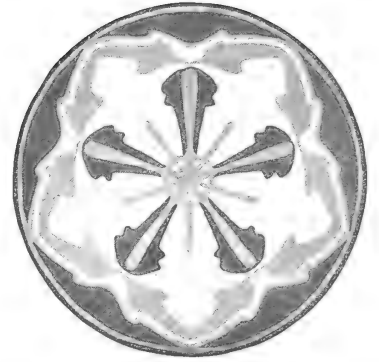

Miss Cassamajor—Brooklyn Class.



Bessie H. Proctor—Brooklyn Class.

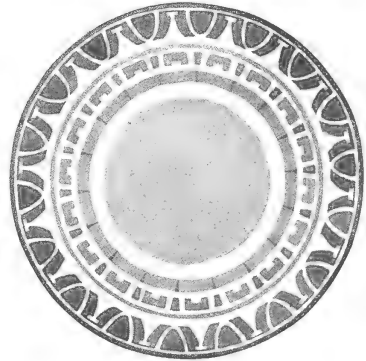

Bessie H. Proctor—Brooklyn Class.

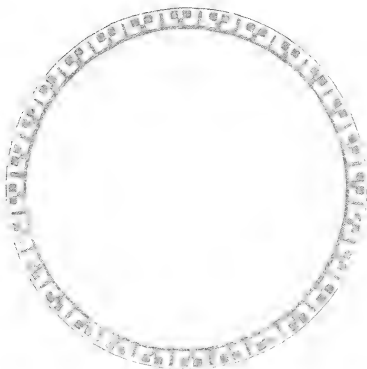

Mrs. Cuthbertson—New York Class.

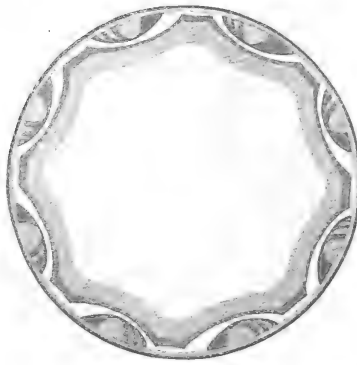

Bessie H. Proctor—Brooklyn Class.



Mrs. Waterfield—New York Class.

WORK OF DESIGN CLASS—MISS MAUD MASON

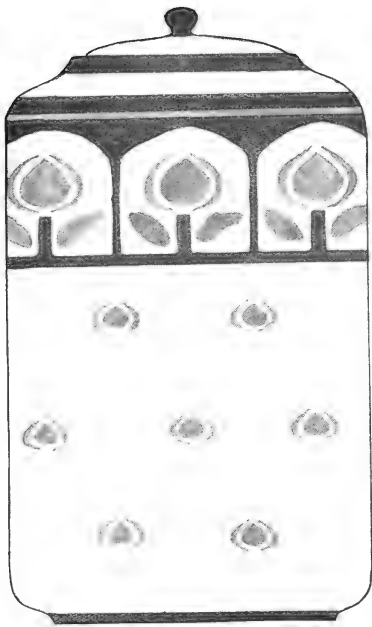

Miss Smith—Brooklyn Class.

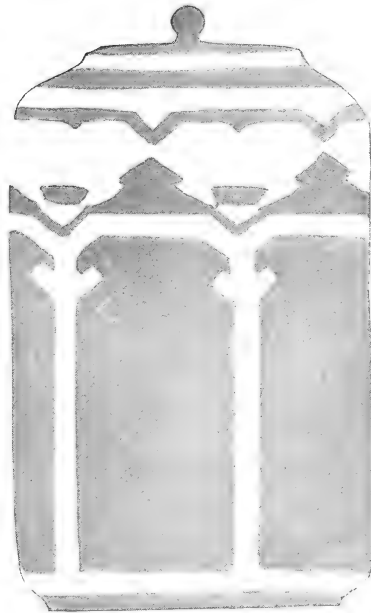

Mrs. Waterfield—New York Class.

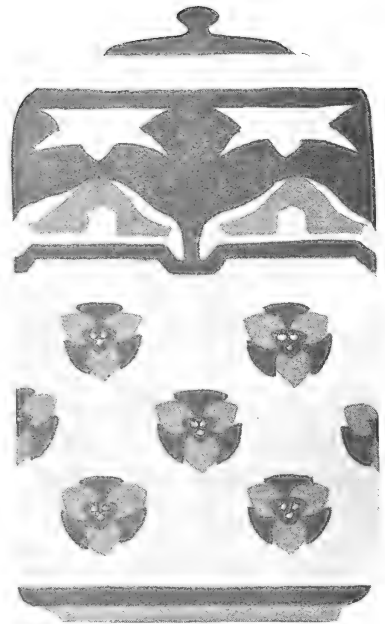

Mrs. Hale—Brooklyn Class.

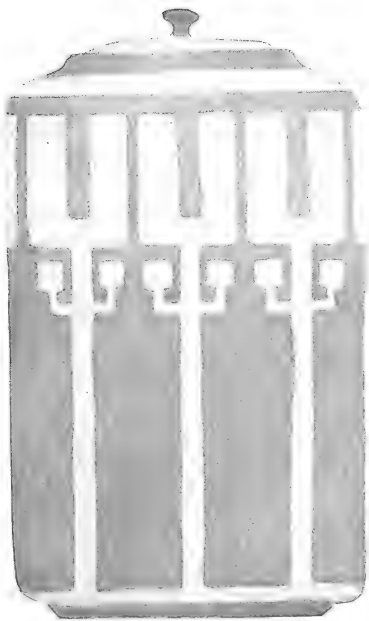

Mrs. Helen Walsh—New York Class.

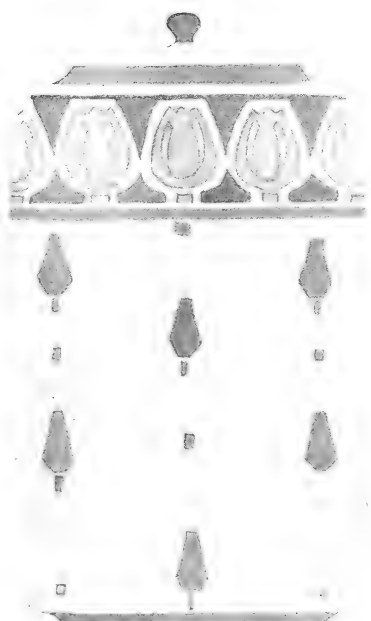

Bessie H. Proctor—Brooklyn Class.



Miss Walsh—New York Class.

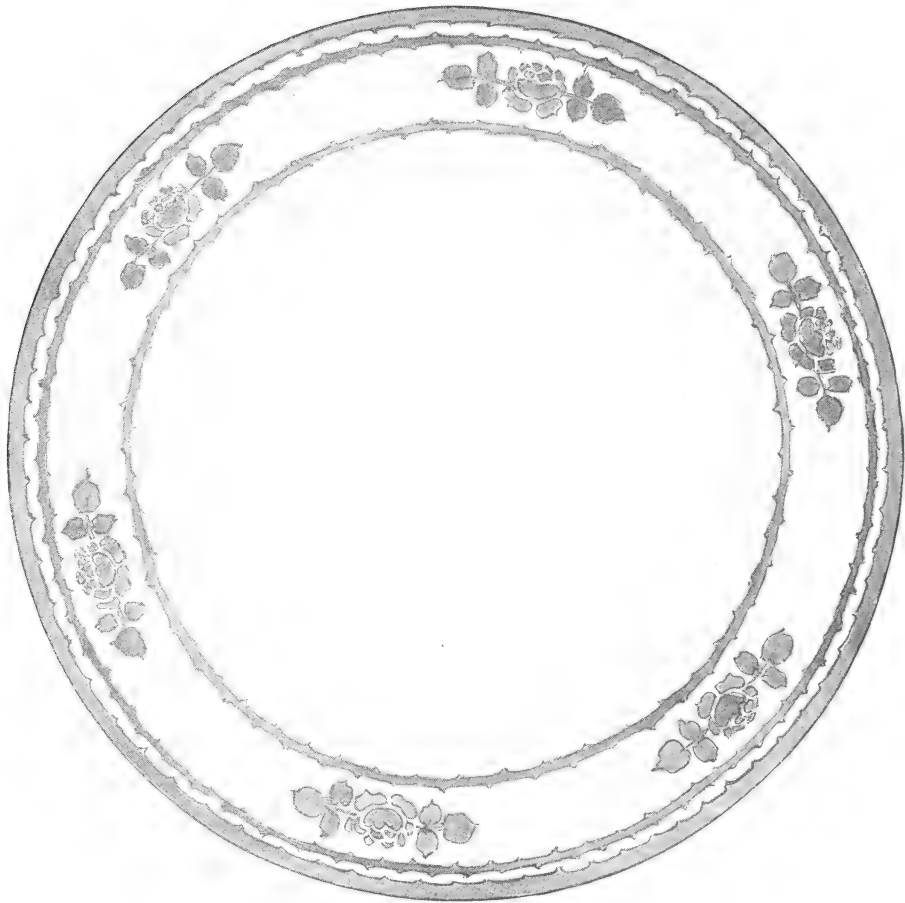

ROSE DESIGN FOR PLATE—MRS. DANTE C. BABBITT

Trace design and outline in Meissen Brown. Fill in stems and leaves in Brown and Moss Green and touch of Black, Rose, Albert Yellow. Fire and strengthen with same colors.



WILD ROSE BORDER—ANNE SEYMOUR MUNDY

ROSSES, Peach Blossom and Moss Green; centers, Silver Brown Green. Shadow leaves, Peach and Apple Green, Yellow, Yellow Brown, touch of Brown Green; stamens, Yellow Brown and Yellow Brown and Black. *Leaves.*—Apple and Moss Green, shaded at base with Brown Green. Shadow leaves, Peach and Apple Green, Yellow Brown, Apple Green and Blue. Stems of Green with a very few woody stems of Yellow Brown and Black. Prickers, thorns of same as stem.

THE CRAFTS

WOOD CARVING AND PYROGRAPHY. LEATHER AND METAL. BASKETRY, ETC.

Under the management of Miss Emily Peacock, Room 23, 22 East 16th St., New York. All inquiries in regard to the various Crafts are to be sent to the above address, but will be answered in the magazine under this head. Summer Address, care of Ceramic Studio Pub. Co., Syracuse, N. Y.

All questions must be received before the 10th day of month preceding issue, and will be answered under "Answers to Inquiries" only. Please do not send stamped envelope for reply. The editors will answer questions only in these columns.



Salt Cellar in pewter—Jules Brateau

ART IN PEWTER.

Jules Brateau

[Translated from the French by Julie Husson]

PART I.

RETROSPECTIVE VIEW OF THE EVOLUTION OF THIS BRANCH OF DECORATIVE ART.

IN the comparison of those metals which during centuries have aided races to beautify their homes, to decorate their implements and to adorn their persons, the relative importance of each must be judged from the extent of its use and the value of the part it has played as a decorative medium, rather than from its classification as a precious or a common material. These metals may differ in color, resistance and malleability, but they are equally beautiful under the hand that bends them to its will and makes them yield the best which they possess.

Tin, which is the subject of this article, has important qualities as a metal. Almost any result can be obtained from its flexibility which lends itself to the most delicate decoration. Its soft whiteness, when it is pure and of standard quality, is superior to that of silver, the cold bright surface of which is easily oxidized by the action of air and gases to the great annoyance of the silversmith. The superiority of silver over tin, as a hard material, is evident, but it disappears when only decorative qualities are considered. Tin lends to decoration a softness and delicacy which charm both the eye and the touch.

These qualities were recognized in the most ancient times, if one judges by the antiquity of the objects handed down to us; for, in museums and in private collections we find pieces of money of cast, or stamped tin, and from China, Hindostan and Persia small objects more or less decorated. No one questions the antiquity of Chinese decoration of porcelain, and evidently tin was used in these remote times. Many of the colors employed by the old Chinese potters have a basis of tin oxide. They must have thoroughly understood the trituration of tin to

have been able to extract its precious oxide, and to use it in their colors. The flexibility of the metal made the process of manufacture simple, so that this process could be handed down easily by tradition, from century to century, without danger of being lost.

Ancient Egypt also practiced the casting of tin. The Egyptians used this metal in the manufacture of many small objects, like scent boxes, toilet articles, etc., as well as in incrustations. The enamels of the Egyptians also, like Chinese porcelains, show knowledge of the use of tin oxide, since some of them could not be produced without it.

Passing from Egypt into Greece, we must refer with pleasure to the great authors who alluded to the combination of tin with the most precious materials. Homer, in the Illiad, Canto XVIII, describes the arms which Thetis asked of Vulcan for her son, Achilles. The god, glad to please Thetis, forged, soldered, hammered, and incrustated the famous shield and arms of Achilles, and, according to Homer's description, used tin in the production of this *chef d'oeuvre* of the goldsmith's art: "The god puts in the forge indomitable brass, tin, silver, precious gold; the decoration represents a beautiful vine with golden branches bending under the weight of purple grapes; silver stakes, carefully spaced, hold it up, and a hedge of tin surrounds it . . . Farther on is a herd of oxen with superb heads, in which gold and tin are combined. When the shield is finished, large and solid, the god makes the armor, the brightness of which surpasses that of the flame; he forges a heavy helmet, which is adjusted to the hero's head, and he adds to it a mane of gold; and at last he makes, with the flexible tin, beautiful knee-pieces (nemides)."

Homer lived nine or ten centuries B. C., as also did Hesiod, who is regarded as his contemporary. The latter is no less explicit when he describes the shield of Hercules, which in beauty of composition and execution could compare with that of Achilles. In verse 207 the bucolic poet says: "Vulcan has engraved the picture of a port, easy of access, the agitated waves being made of tin."

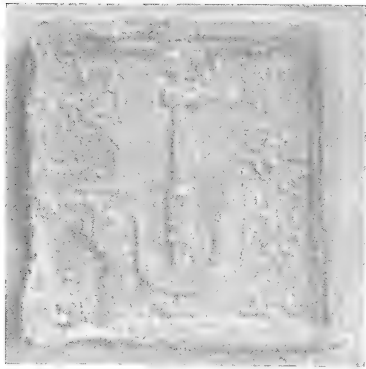

No. 1.

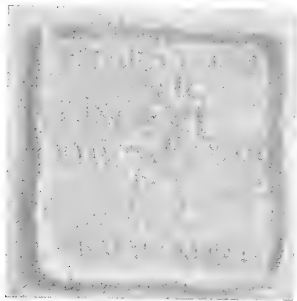

No. 2.

Greek weights in lead, 300 years B. C. Example of a technical process which will be described later on—Louvre Museum, Paris.

Was this metal incrustated or soldered with the gold and silver which surrounded it? We leave the solution of this problem to the imagination of the reader, and simply state that tin entered quite largely into the decoration of these pieces, and that poets knew of the artistic use of this metal, since they named it among those used to embellish the finest works of art.

After this for a long time we lose all trace of tin. In the ancient documents in which tin is mentioned, its use is not given. Even Homer, who often refers to the kettles of brass used by the heroes to boil their meat, says nothing of tin as used in domestic utensils.

Beckman, in his "History of Inventions, Discoveries, and Origins",* says that there must have been in ancient times art objects in tin; but he adds: "If these objects are not mentioned, and if no examples are found among Greek and Roman antiquities, it is because tin has less durability than lead or bronze, specimens of which are numerous." However this may be, we must pass over a long period before tin is again mentioned by a Greek author. Aristotle (384-322 B. C.) speaks of a tin statue attributed to Daedalus, which was greatly valued in the Electric Islands (Adriatic Sea).

In Rome we find ample data referring to tin, and a profusion of objects which, becoming more and more common, form a much more striking illustration than the most beautiful and plausible descriptions. Mr. Germain Bapst,† in his learned work on pewter, gives many facts

*Translated from the German by William Johnston, 4th. Ed., London, 2 Vol. 1856.

†Etude sur l'Etain. G. Bapst, 1884. Paris



Nos. 3 and 4.

Tin mirrors (one complete) Roman period II. Century B. C. Found in Trebizond—Louvre Museum, Paris.

instead of probabilities. In the second Century B. C. we find pewter used in table service. Plautus depicts, in one of his comedies, a feast of his time, at which all the meats are served in pewter basins. The luxury of the dishes doing service at this repast leads us to believe that tin, though an ordinary metal, was used by the rich as well as by the poor, and even in important ceremonies. Beside the pewter used in art objects, another metallic composition was used in Rome for every day purposes, and this latter may be called pewter pottery. Gallienus and Pliny indicate pewter as the best metal for pharmaceutical utensils, medicine boxes, pixidia, basins, etc. Another author recommends it for cooking utensils, for the reception of wine and preserves. Roman soldiers carried a tin pot. The common people used vessels of tin, as well as bowls of clay and wooden trays. Plautus and Seneca speak of tin mirrors as much used by the Romans and by the people under their rule.

The writer owns a pewter spoon of the Gallo-Roman period, found in the Grand Duchy of Baden, and which had been buried in the ground with a copper utensil resembling a pot. The Romans made small funeral vases of tin, with inscriptions and simple decorations, but, as Mr. Beckman, already quoted, remarks, "tin, especially if used in thin sheets, is easily oxidized when buried; then it decomposes and disappears in the earth."

We pass over another long period, without finding any exact documents relating to our subject; although in the Gallo-Roman epoch tinning holds a prominent place. The Gauls to whom all authors attribute the tradition of tinning, used this process to make their culinary vessels sani-

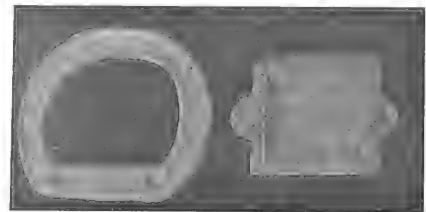

Nos. 5 and 6.

Part of a buckle and child's toy in pewter—Smyrna—Roman period II. Century B. C. —Louvre Museum, Paris.

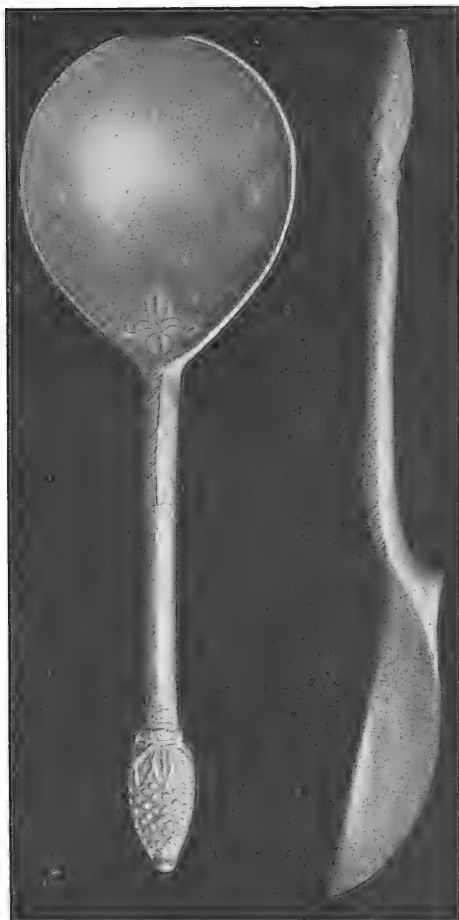

No. 7.
Pewter spoon—Gallo-Roman period—Front and side views.
Belongs to J. Brateau.

tary, to decorate their vases or fibulae, or to protect the buckles of their belts from oxidation. During the Merovingian period*, the custom of tinning was general, so much so that nine-tenths of the objects of these times found in excavations are buckles for clothing, or plates for sword belts, all being tinned. Tin was applied in thin coats to the hard, resisting brass, giving it a whiteness and brilliancy which were lasting

The Franks do not seem to have known tin utensils. Gold and silver were reserved for the chiefs while the soldiers used bowls of wood or of clay.

Incrustations of tin were in favor with the Merovingians, as nearly all excavated objects show, but there does not remain a trace of what we have called pewter pottery. We must wait until the introduction of Christianity into Gaul to find mention of pewter vases. These vases were chalices, which at first were of wood, glass, tin, gilded copper, even of lead, or of horn. The Council of Rheims (803-813) gives rules for the use of pewter in chalices. It tolerates this metal in cases of poverty, prescribes the use of gold and silver when possible, and forbids the employment of all other materials. Though we have no documents regarding church vessels previous to

*G. Bapst



No. 8.
Reproduction of the design of a chalice found in old documents in Montfaucon, Revue des Arts Decoratifs, Paris, 1883-84.

the year 813, it would be a serious mistake to believe that tin was not used before that time. Illustration No. 8 represents an old chalice, perhaps two hundred years older than the Council of Rheims. At least Bapst in his "Study of Pewter" attributes this work to the VII., but other critics think it belongs to the XII. Century. However this may be, there is undeniable proof that the art of decorating pewter was encouraged by the Church, and that theologians ranked this beautiful metal next to gold and silver.

Cruets, ampullae, crismatories, and all the accessories of the cult were nearly always of pewter. The same metal was used in the reproduction of the insignia of ecclesiastical dignitaries. In excavations made at different periods, tombs of bishops have been discovered, which contained pewter crosiers, an exact reproduction of those used by the bishops during their life. The use

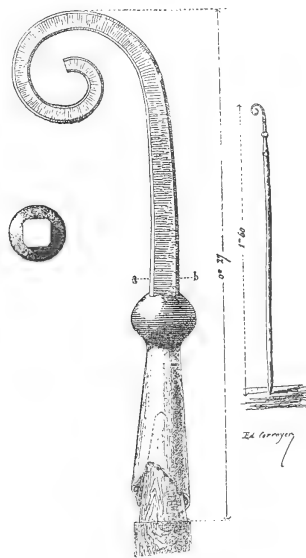

No. 9.
Pewter crosier of Robert de Torigny—XII. Century—found in his tomb (Abbaye du Mont St. Michel, Ed. Corroyer, Architecte. We are indebted to Mrs. Corroyer for the right of reproducing all illustrations from M. Corroyer's book.)

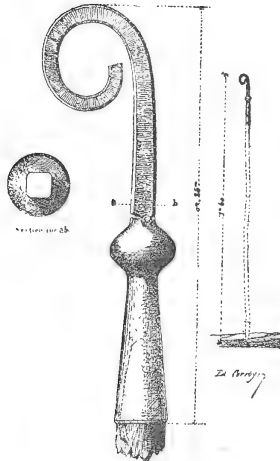

No. 10.
Pewter crosier of Dom Martin found in his tomb (Abbaye du Mont St. Michel,
Ed. Corroyer).

of pewter in the Church service has come down to us, and although artistic beauty in tin work has not been developed solely through the [making of sacred vessels, these have undoubtedly played an important part in the evolution of the art.

(TO BE CONTINUED)

RUG WEAVING AND DYEING

(CONTINUED)

Mabel Tuke Priestman

DYEING.

This is another department in successful rug making, but a most important one, and the fascination of the dye pot beguiles many women in country districts into evolving all sorts of beautiful color schemes, not obtainable in any other way. Some rugs are poorly made, but their color qualities are so apparent that they are readily bought up at the various Arts and Crafts Exhibitions where they are found.

The chief difficulty in vegetable dyeing is that those who do it, jealously guard their secrets, and will not give them away to others who want to become experts in this line. It is an advantage to use spring water, as this has some peculiar merit known only to experts. I am told that the fastness of some of the Scotch and English dyed materials depends largely upon the qualities of the water in certain parts of these two countries. I also know a country woman who has a spring in her garden and who is able to dye her material with the most permanent dyes, whereas the same process used with the water from the spigot cannot be depended upon in the same way. The truth of these statements I have not verified myself.

The following dye receipts are used by many women in Canada and New England, and many of them are handed down from mother to daughter:

INDIGO BLUE.

Blue is the most universally used of all colors for dyeing materials for rug making, as all shades of blue from sky blue to a deep blue black can be dyed in the indigo tub. This dye has the merit of being cheap as well as fast. It can be used with yellow or orange or with cop-

peras or walnut dye. A good receipt for indigo dye consists of

- 1 pound of finely powdered indigo
- 2½ to 3 pounds of green copperas (clean crystal)
- 3½ to 4 pounds of newly slaked lime

Rub or grind to a very fine powder the indigo with a little water or an alkaline lye. It must then be mixed with hot water after which the lime can be added when it must be well stirred. Now add the copperas, stirring slowly while it is being poured in. Continue to mix it when all the ingredients are added, and continue this at intervals for twenty-four hours. When ready to dye the material, ladle out what is needed into the dye vat. When it has been used several times it will need to be refreshed with a little more copperas and fresh slaked lime, always remembering to stir the sediments well from the bottom.

The indigo dye powder is a manufactured article, prepared from the plant which produces it, and can be bought when the plant cannot be obtained for dyeing. A very great quantity of the plant is required, as 250 pounds of plant will be required to produce a single pound of the prepared indigo. Some people believe that if they cannot themselves get the plant they are not getting the real indigo but this is a mistake. This dye is especially recommended for cotton.

Another receipt which is preferable for wool but can also be used for cotton is made from

- 12 pounds of fine indigo powder
- 8 pounds of madder
- 9 pounds of bran
- 24 pounds of potash water at 125 Fahrenheit

Mix indigo powder, madder, bran and water well. The potash is not added until later. At the end of 36 hours 14 pounds of potash, and 12 hours later the remaining 10 pounds are added. When fermentation and reduction of indigo are well developed, which will take about 72 hours, add the fresh slaked lime. When properly prepared a vat of this dye can be used for several months, adding, as needed, any of the constituents required.

Another blue dye recommended is made from berries and logwood.

RED DYE.

The dyeing of red with madder is a very complicated process, and the receipts given for it are so involved that very few amateurs will trouble to go through all the



No. 7.
Hand woven rugs shown at a recent Arts and Crafts exhibition.

laborious processes of mordanting and oiling the material to be dyed. The ordinary turkey red and cardinal red are extremely good dyes, and the turkey red especially is a fast dye. If the red is required, I would suggest buying the material called turkey red, termed "oil dyed." It could be deepened in tone by madder or brown when it is found that the red is too bright for ordinary use.

This is a good dye for wool: $\frac{3}{4}$ of a pound of good madder to each pound of woolen cloth. The cloth is immersed in a weak alkaline bath at boiling temperature, and is then rinsed and dried. It is afterwards impregnated with a decoction of gall nuts, when it is again dried and put into a solution of alum. After rinsing and drying it is put through a madder bath which is slowly raised to the boiling point in about an hour, the intensity of color depending upon the length of time it is boiled. Remove the material and wash slightly. This operation is repeated after which it is washed in a hot soap bath and dried. As it is impossible to get the exact quantities, it will be seen how very difficult it is for an amateur to work this out for herself.

CARMEN.

A French recipe is used by some and this dye is said to possess extra lustre and beauty. Boil one pound of powdered cochineal in three gallons of water for 15 minutes. Add one ounce of cream of tartar and continue boiling for 10 minutes. Add $1\frac{1}{2}$ ounces of powdered alum, continue boiling for 2 minutes, and remove from the fire, allowing it to stand 5 or 6 minutes. Pour into porcelain vessels until it settles. Drain and dry the deposited carmen for future use.

RUST COLOR.

This is of course a very easy dye to make, as it is obtained by allowing old iron to be left standing in water. It is absolutely permanent and makes the material a beautiful yellow.

YELLOW DYE.

One pound of fustic will dye 5 pounds of wool material. Alum, tartar, and spirits of tin make the fustic yellow light or bright. Acetate and sulphate of iron, and common salts darken it. The material dyed with this dye can be used when yellow is required, but by dipping it in the indigo vat a very permanent shade of green is given to it. Another good yellow can be obtained from dyeing with smart weed.

CINNAMON BROWN.

Immerse the material in alum, after which it should have a bath of madder. Next a bath of fustic to which a little green copperas has been added, this makes a beautiful clear brown.

WALNUT.

This is made from walnut or butternut stain by steeping the bark of the tree or the shell of the nut in the water, until the water is dark with color. Various shades of yellow, brown, dark brown, and green brown, can be obtained according to the strength of the decoction. If the nut or bark is used when green, yellow brown will be the result. It is also valuable in assisting to make blue green. The material is first dipped in the walnut stain, and then immersed in the indigo dye. It is also a very useful stain in setting the color of other dyed materials. A beautiful red can be obtained from poke berry but its fastness of color is obtained by dipping in the walnut stain.

YELLOW BROWN.

This can be made from boiling logwood chips in water, and the depth of the color is determined by the amount of logwood used.

COPPERAS.

Copperas can be bought at any country store and gives a fast nankeen colored dye. A beautiful pale green can be made by dipping the nankeen colored material in the indigo tub.

BLACK DYE.

Immerse 10 pounds of cloth into a boiling bath of water, which contains 3 pounds of sumac. Let the material steep until the concoction is quite cold, stirring it occasionally so that it is dyed equally all over. The next process is a bath of lime water. Drain the material for a few minutes and put into a solution of warm water containing two pounds of copperas. The material can now be hung up for an hour on the clothes line, when it is again passed through the bath of lime water. When it is almost dry it requires another bath in which three pounds of logwood and one pound of fustic have been added. Remove the material and add a quarter of a pound of copperas after which the material is returned to its bath, and worked well with a couple of sticks for half an hour.

Another black dye much used by the Navajo Indians is made from the twigs and leaves of the aromatic sumac, yellow ochre, and the gum of the pinon. A quantity of leaves and branches of the sumac are put into the boiler and boiled for five or six hours until a strong concoction is made. While the water is boiling the ochre can be ground to a fine powder, when it is slowly roasted over the fire until it assumes a beautiful pale brown color. It is then removed and mixed with an equal quantity of pinon gum. The mixture is then put on the fire and constantly stirred until the whole mass becomes mushy. As the roasting proceeds it gradually becomes dryer and darker until at last it is reduced to a fine black powder. When it is cool it is thrown into the decoction of sumac. This is essentially a fast black dye. Any of the dyes I have recommended would also be valuable for dyeing material for making pulled rugs.

In dyeing with vegetable dyes it will be found that natural stains and dyes can be made from numerous roots, barks, and bog plants. One reason why it is so hard to get recipes for these dyes is because the women find them out for themselves and choose to have a "dog in the manger" attitude towards others working in the same direction. How much better it would be if a co-operation in exchanging recipes and experiments could be evolved. It seems so contemptible to be selfish about helping others in the same direction.

WARPS.

The best warp to buy is known in the trade as 4-8 and a white warp is the most useful for all purposes, as nearly all the warps that come ready dyed fade, and it is extremely difficult for an amateur to keep warps in good condition if she dyes them herself. If the warps once get mixed up nothing can be done with them. The ready dyed tobacco brown warp holds its color fairly well, and the bright red also holds its color, but it is so rarely that one can ever use a red warp that it is practically ruled out for utilitarian purposes. I know that many people advise the home dyeing of warps, but after a great deal of experimenting in this direction, I have concluded that

it is impractical except in the case of blue, where the quantity of dye made is so large that one can have an even color in dyeing a large quantity. I find that the 4-8 weight of warp is not heavy enough to give the rug a very light appearance, as it sinks into the cloth and the rug possesses the color value of the weft rather than the warp.

LOOMS.

We have a wide range to choose from among the looms of to-day. They can be purchased as high as \$75.00 if the modern steel ones are preferred, but as the old wooden looms make just as good a rug, this expense seems unnecessary. Many an old loom can be picked up in a country junk shop or at country fairs, and often an advertisement in a city paper will bring you in touch with possessors of looms who are willing to sell them for from \$5.00 to \$25.00.

A very handy table loom can be bought from Lynn, Mass., and is called the Woodbury loom, and this can be used if narrow rugs can be utilized. This costs \$12.00, but of course the \$12.00 size could only be used for stair carpet width or portieres and bath rugs. Possibly they can be bought in larger sizes, but the work is not so quickly done on them as on an old fashioned treadle loom, which makes a rug a yard wide, or any narrower width desired. In buying a loom it is important to know what it should consist of as if an odd piece is missing, it might be quite expensive to have it made.

A T loom consists of a frame, a beam, heddles, a lay, a reed, several shuttles, and a wheel for winding the material usually goes with the loom. In buying one secondhand it is very important that all and every piece should be examined by a practical weaver before the purchase is made.

PREPARING LOOM FOR WEAVING.

The beaming of the warp is rather a difficult process and wherever possible should be done by a beamer. After the beam is placed in the loom the warp threads are thrown from the beam over the back cross bars, and threaded through the heddles, then through the reed, and over the front cross bar of the loom, where it is attached by an iron bar and rolled under the front cross bar. The heddles are arranged in two frames which are on two different horizontal planes when the shuttle is thrown through the warp.

PROCESS OF WEAVING.

Having divided the material up into strips and wound it in balls, it must then be wound off the balls on to an iron rod, which is attached to a wheel, a small quantity is wound which, after having been removed from the iron bar, is ready for the shuttle. After pulling the end of the material through the hole in the shuttle, it is now ready for weaving. A seat must be placed in front of the loom at the right height for having a good command of the work.

The left treadle must be pushed down with the foot which will cause a gap between the two layers of warp. Take the shuttle in the right hand and throw it between the warps, holding with the left hand that part of the loom which contains the reed; this is called the lay. Leave a couple of inches of the material sticking out at the side of the rug, this must be turned back and lapped round the warp at the side of the rug. After the shot has been thrown, pull the lay forward, and press the right foot down, releasing the left, which will make a reverse gap between

the two lays of warp. The shuttle is now placed in the left hand and is thrown from left to right between the warps, after which the lay is pulled forward as before. This simple process is repeated over and over again, until the shuttle is empty. When the new shuttlefull is added do not sew the two strips together, but cut each end into a tapered point and overlap them. This join will then be invisible, which cannot be said of work which has been sewn together.

The first four or five inches of a rug is always the same as the center. Plain bands of contrasting color can be used about a couple of inches wide. An uneven number looks better than an even. A 3x5 rug could have three stripes for borders, while a 3x7 would need five. The rug is finished off at either end with a half inch heading of warp, which keeps it from fraying. In starting the rug this must be done before the material is woven and when the rug is completed it is finished off with the warp. It is not usual to take the rugs out of the loom until the set we have in hand are completed. Sometimes as many as fifty rugs can be on the roll underneath. About twelve inches of warp must be left between each rug.



No. 8.
Group at a recent exhibition.

It is a little hard to weave from only reading a description, and a beginner will comprehend it much more readily by having a weaver show her how to use the loom. Half an hour spent in working under the guidance of someone who knows is worth a great deal in simplifying weaving. Like everything else it is very easy when you know how, but it is very bewildering at first, as one is apt to press the wrong treadle and throw at the wrong side unless one has had experience. After the rudiments are mastered it rests with each worker to become a good weaver.

DESIGNING THE BORDERS.

While the plain bands of color are very pleasing for borders, there are several ways of introducing attractive variations. Twists, or crow's feet are done by tightly twisting two contrasting colors together. These are wound on to a ball as if they were one piece, and shots of this are run across the center of a border or used to outline it. The crow's foot effect consists of two rows of

twists thrown in alternate directions. Striped materials cut horizontally can be used in rug making and give a blurred effect that makes one of the most effective kinds of borders.

In portiere making a different sort of border is advisable. The darkest color should be at the bottom of the portiere and extend up from 8 to 12 inches. A series of narrow bands either 1, 3, or 5, according to the desire of the designer, can then be added. The upper part needs no border. Another way of making patterns is to run in a few lines of white with a bodkin after the rug is finished. The disadvantage of this is that the rug will not be the same on both sides. There is no end to the developments that can be obtained in border making and as I feel that each worker should express her own individuality in her work, I would advise that every weaver strikes out a new line for herself.

Sometimes a white line thrown "hit or miss" through the rug is pleasing. In a dark blue rug, for instance, weave the white strip five inches long, and on the next pick to it add another line three inches long, and repeat these touches at intervals throughout the rug and the effect will be good. If it is too regular it loses all its charm. There are several designs in Indian rugs which suggest motifs for what is called the "inlay" work. Indian arrows, diamonds, and squares can be evolved, but as I said before, think up your own designs, and do not be guided by others.

The work of experimenting is fascinating, not only in designing borders, but in evolving good color schemes. It is a great help to make little sketches of the rugs with water colors, before you begin to experiment in the loom. A small table loom would be invaluable for experimenting with border work, as it would use so little material in width, and the strips of a series of borders could be kept at home as a guide to future rug designing.

Another variety in rug making is caused by grouping the warps three or four together by threading two or three warp threads through one heddle, but this work is too much trouble to do for one or two rugs, so that I only advise it where a number can be done at the same time. It is always advisable to group the warp separately for portiere making, as the work should be so much more loosely woven and the warps further apart. It is not necessary to change the warps on the beam only to thread them in groups through the heddles. One lay-out of warp consists of two threads in every other heddle hole, instead of one warp thread in each hole.

The demand for these rugs is so great at the present time, and the market for them is so rapidly increasing, that there is a wide field for those who enter into it in a business like way. If rugs are ordered for one of the stores, they must have a very neat and finished appearance, which would not be so attractive to an artistic class, who would buy them at an Arts and Crafts Exhibition. It is very important to remember the difference in the two markets, as the most artistic looking rug, that an artist would rave over, would be looked upon as defective by a rug buyer in a store.



ANSWERS TO CORRESPONDENTS

G.—We will soon give some good nut borders.

L. M. D.—Read the "Class Room" articles on "Backgrounds" in August number KERAMIC STUDIO.

Y. Z.—Burnish well your gold ground which is uneven, then give it two thin coats of gold making the brush strokes the second time at right angles to first coat. Fire quite hard.

S. B. P.—When paint blisters, the color is either too oily or put on too thick. We do not think firing too quickly would cause blistering, still it is a bad plan to fire quickly. All paints of various manufacturers may be used together, the tube colors as well as powder. We prefer powder colors for most things but tube colors are easier to tint with.

Mrs. C. B. S.—The scaling of the color on your pink and red roses came from too many firings. Pinks should be put on for the last firing only. They are very liable to be spoiled if refired, also the color will scale if put on too thickly. If the acid from the pickles turned the color and took off the glaze on your dish, the color was much underfired.

M. M.—The various glazes such as Ivory, Lavender glaze, etc., are supposed to be dusted over the half dry painting to give a uniform glaze. They are not used for painting. The black you mention can be used for outlining as can almost any black. You can mix colors of one make with those of another safely, if both makes are good. Black added to any color makes it darker and greyer, that is not so vivid. The Royal Worcester finish is a mat ivory glaze, it comes in powder form. It is not much used now but can be procured from any wholesale house.



APPLES

Sarah Reid McLaughlin

For apples use Lemon Yellow, Albert Yellow, Yellow Red, Carnation, Pompadour Red, blending the yellows or reds into soft yellow greens, with Copenhagen Blue for greyish blue. Keep high lights clear and brilliant; the reflected lights softer in tone. Leaves Apple Green, Yellow Green, Moss Green for lighter ones, Brown Green and Shading Green for darker ones. For shadowy leaves use Violet of Iron or color which will be harmonious with background. For stems use Copenhagen Blue for blue grey lights, strengthened in second firing with Auburn Brown. Use Yellow Brown for pips strengthened in second firing with Auburn Brown. Background Copenhagen Blue, Violet of Iron to Warm Grey, Yellow Red to Blood Red. For second firing deepen above colors adding detail.



TREATMENT FOR JUG IN PLUMS (pages 155-156)

Jeanne M. Stewart

THIS piece in blue plums is most effective with a background in dark green and purple or it may be worked in monochrome.

In case the naturalistic treatment is desired the following palette may be used:

Plums: Banding Blue, Ruby Purple, Brunswick Black, Lemon Yellow, Yellow Green.

Leaves: Yellow Green, Turquoise Green, Shading Green, Olive Green.

Background: Ivory Yellow, Lemon Yellow, Shading Green, Ruby Purple, Banding Blue.

Both depth and transparency are desirable in the first painting of the plums, the lightest tone or the "bloom" being obtained with a very thin wash of Banding Blue, while the dark is a mixture of Banding Blue, Ruby Purple and Brunswick Black.

The background may be applied in the second and third firings with a dusting of the darkest colors in the third fire.



EXHIBITION NOTE

The National Society of Craftsmen will hold a reception on the evening of November 30th, at the National Arts Club, but the exhibition will be formally opened only on December 3d.

Magill & Ivory

Importers and Dealers in

WHITE CHINA AND ARTIST MATERIALS

A premium given with all orders amounting to ten dollars and upwards. Write for list and catalogue. Classes in decorating four days every week. Estimates on large or small orders. China fired with care.

297 5th Avenue, New York City

WHITE CHINA For Decorating

NEW SHAPES NEW STYLES

A Special Bargain sheet gotten out every month; write for it.



Here is a sample of the **NOVEMBER BARGAINS**

G2758 Spoon Tray 9-in. long, plain and graceful, 26c each.

Send us your name for catalogue and new sheets.

W. A. Maurer, Council Bluffs, Iowa

THE LATEST AND BEST BOOK UPON CHINA PAINTING

18th Illustrated Edition of the OSGOOD ART SCHOOL PRACTICAL HAND BOOK in Flexible Cloth Covers, 200 pages. Sent post-paid for 75 cents. Stamps not accepted.

HOW TO APPLY	{ MATT, BRONZE, LACROIX, DRESDEN COLORS AND GOLD }	TO CHINA	A Complete and Reliable Guide for China Painters
--------------	--	----------	--

Calling attention to the principal difficulties, it tells how to remedy them.

MISS A. H. OSGOOD, 46 West 21st Street, NEW YORK

Mineral Transfers

For China Decoration in all its Branches



PALM, FECHTELER & CO.

80 FIFTH AVE., NEW YORK. 45 LA SALLE ST., CHICAGO. 1st NATIONAL BANK EAST LIVERPOOL, O.

Apply to Your Supply House for Samples and Information.

FINE FRENCH WHITE CHINA

FOR AMATEUR DECORATING

Best White China Made in Limoges

PAROUTAUD FRERES, Manufacturers



Catalogue and price list on application.

Ceramic Importing Co.

37-39 Murray St., NEW YORK.

STOCK AND IMPORT

SOLE AGENTS

Among the most successful novelties ever offered china decorators is our

HAIR RETAINER 25c

(sample nestaid) complete with china medallion to decorate. Large decorators are using hundreds to supply their trade, and home workers are ordering by the dozen to care for their friends. New china book mailed you free (postage 5c) showing over 200 new articles.

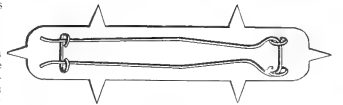

Geo. W. Davis & Co., 2356 State St., Rochester, N. Y.

KUT-PRICE-KATALOG

ARTIST'S MATERIALS

LEE ROESSLER, 116 S. High St. Columbus O.

We have a fine stock of T. and V. and Haviland's Ransom shape of

WHITE CHINA TO DECORATE!

Also a full line of German and Austrian Novelties. Shirt Waist Buttons and Medallions at 40 cents a dozen or \$4.50 a gross delivered in your home. Gold plated backs 19 cents each or \$1.80 a dozen. We deliver Fry's Paints and Lustres and Sherratt's Gold.

HUDSON CROCKERY COMPANY,

Dept. D

349 So. Salina St., Syracuse, N. Y.

FREE-- One KLEIN 6-inch by 11-inch Flower Study with every order for

China Painting Materials

NOTE—We have only a few of these large Studies by Catherine Klein left. Send your order in early and secure one of these Beautiful Studies Free. Do not hesitate as they will not last long.

Established 1879.

ERKER BROS. OPTICAL CO.

608 Olive Street.

ST. LOUIS.

ESTABLISHED 1887

FRANK DOEHLER

WHITE CHINA AND ARTIST MATERIALS IMPORTER

New prices on hat or brooch pins complete. Special prices in gross lots.

Also baby or large bar pins complete.

Doehler's Block, Rochester, N. Y.

211-213 Clinton Ave. North. One minute walk from N. Y. C. station.

DORN'S CERAMIC SUPPLY STORE

Largest Store on Pacific Coast

Devoted Exclusively to White China, Beleck and China Decorator's Supplies

Agent Ideal China Kilns and Ceramic Gold. Mail Orders filled same day as received. 759-761 McAllister Street, San Francisco, Cal.

KEEP THE FIRE ALIVE.

KERAMIC STUDIO

CONTRIBUTORS

GRACE BLETHEN 卍 卍
NANCY BEYER 卍 卍
CARRIE BROSEMER 卍 卍
OPHELIA FOLEY 卍 卍
HASWELL C. JEFFERY 卍 卍
MARY OVERBECK 卍 卍
HANNAH OVERBECK 卍 卍
ALBERT PONS 卍 卍
IRENE SARGENT 卍 卍
BELLE BARNETT VESEY 卍 卍
CLARA WAKEMAN 卍 卍

DEC. MCMVI

Price 40c. Yearly Subscription \$4.00

A MONTHLY MAGAZINE FOR THE POTTER AND DECORATOR.

Smithsonian Institution

NOV 28 1906

Entered as Second-Class Matter, October 1, 1903, under No. 1590, Post Office at Washington, D. C., and Mailed at Special Rate of Postage provided for in Act of October 3, 1917, authorized on July 1, 1918.

CONTENTS FOR DECEMBER 1906

	PAGE
Editorial and Introductory Illustrations of the Christmas Rose	169
Fireplace and Dado—First Prize Decoration for Child's Room	170
Taxile Doat	171-173
Child's Table Set—First Prize	174
Water Pitcher and Bowl—Humming Birds	175
Fireplace Dado and Wash Stand Top—Second Prize	176
Fireplace Dado and Washing Set—Third Prize	176
Dutch Babies—Third Prize Decoration for Child's Room	177
Enlarged Section of Design for Fireplace	178
Dado and Fireplace—"Humming Birds"	179
First Prize Decoration for Child's Room—"Clowns"	180-181
Bowl and Pitcher "Knights"—Second Prize	182
Suggestions for Fireplace and Dado	182
Child's Set	183
Child's Set in Blue Grey—Third Prize	184
Child's Set	185
"Goody Two Shoes" Child's Table Set—Second Prize	186
"Knights"—Second Prize Decoration for Child's Room	187
Child's Set—Japanese Lanterns	188-189
Bowl and Pitcher for Child's Set	189
League Notes	189
The Crafts—	
"Printing with a Wood Block"	190-192
Center Design for Fire Place	192
Answers to Correspondents	192-193
Child's Plate (Supplement)	192-193
Ophelia Foley	170
Irene Sargent	171-173
Mary Overbeck	174
Hannah Overbeck	175
Mary Overbeck	176
Grace Blethen	176
Grace Blethen	177
Hannah Overbeck	178
Hannah Overbeck	179
Ophelia Foley	180-181
Mary Overbeck	182
Albert Pons	182
Ophelia Foley	183
Nancy Beyer	184
Clara Wakeman	185
Albert Pons	186
Mary Overbeck	187
Carrie Brosemer	188-189
Nancy Beyer	189
Belle Barnett Vesey	189
Haswell Clarke Jeffery	190-192
Mary Overbeck	192
Mary Overbeck	192-193

LIST OF BOOKS

The Rose Book, containing some of the best rose studies and designs published in Ceramic Studio. postpaid	\$ 3.00	
The Fruit Book, containing some of the best fruit studies and designs published in Ceramic Studio. postpaid	3.00	
Composition, by Arthur Dow. postpaid	1.65	
Principles of Design, by E. Batchelder. postpaid	3.00	
Decorative Studies, by J. Foord. postpaid	12.50	
Plant Forms and Designs, by Midgley and Lilley. postpaid	2.20	
Practical Pottery, elementary instruction for students, by Richard Lunn. postpaid	2.50	
Grand Feu Ceramics, a practical treatise on the making of hard porcelain decorated with high temperature glazes by Taxile Doat of the Manufactory of Sevres, France. postpaid	7.50	
Seger's Collected Writings, 2 volumes. postpaid	15.50	
For the Collector:		
Vol. II Old China, bound blue cloth. postpaid	2.50	
Vol. III Old China, bound blue cloth. postpaid	3.50	
Anglo-American Pottery, a manual for collectors, by Edwin Atlee Barber, Curator of the Pennsylvania Museum, second edition. postpaid	2.00	
American Glassware, old and new, by Edwin A. Barber. postpaid	1.00	
Marks of American Potters, by Edwin A. Barber. postpaid	2.25	
Pottery and Porcelain of the United States by Edwin A. Barber. postpaid	3.75	
The Lace Book, by N. Hudson Moore. postpaid	5.30	
Tulip Ware of the Pennsylvania German Potters, by Edwin A. Barber, in paper cover. postpaid	1.10	
Cloth, limited edition. postpaid	5.00	
The Primers of the Pennsylvania Museum (two already issued, Salt-glaze ware and Tin-enamelled ware) postpaid,	.50 and .60	
Encyclopedia of Ceramics, by W. P. Jarvis. postpaid	6.75	
The Old China Book, by N. Hudson Moore. postpaid	2.18	
The Old Furniture Book, by N. Hudson Moore. postpaid	2.18	
Old Pewter, by N. Hudson Moore. postpaid	2.18	
Chats on English China, by Arthur Hayden. postpaid	2.18	
Chats on Old Furniture, by Arthur Hayden. postpaid	2.18	
China Collecting in America, by Alice Morse Earle. postpaid	3.20	
Pottery and Porcelain, a guide to collectors, by Frederick Litchfield. postpaid	6.25	
French Pottery and Porcelain by Henri Frantz. postpaid	2.68	
Dutch Pottery and Porcelain, by W. Pitcairn Knowles. postpaid	2.68	
Old English Furniture, by Fred Fenn and B. Wyllie. postpaid	2.68	
English Embroidery, by A. F. Kendrick. postpaid	2.68	
French Furniture, by Andre Saglio. postpaid	2.68	
Old Pewter, by Malcolm Bell. postpaid	2.68	
Sheffield Plate, by B. Wyllie. postpaid	2.68	
The Oriental Rug Book, by Mary Churchill Ripley. postpaid	3.20	
Home Furnishing, practical and artistic, by Alice M. Kellogg. postpaid	1.65	
William Adams, an old English potter, by William S. Turner. postpaid	8.00	

KERAMIC STUDIO

Vol. VIII, No. 8

SYRACUSE, NEW YORK

December, 1906



THE awards in the Christmas competition were made as follows: Decoration for Child's Room, *First Prize*—"Clowns and Elephants," Ophelia Foley, Owensboro, Kentucky. *Second Prize*—"Knights", Mary Overbeck, Cambridge City, Indiana. *Third Prize*—"Dutch Babies", Grace Blethen, Los Angeles, Cal.

Child's Table Set—*First Prize*, "Palms and Camels", Mary Overbeck, Cambridge City, Indiana. *Second Prize*, "Goody Two Shoes", Albert Pons, Cincinnati, Ohio. *Third Prize*, "Storks", Nancy Beyer, Brooklyn, N. Y.

The First Prize decoration of Child's Room unfortunately was not shown in pen and ink sketch to give a general idea of the effect. The wash stand border is not easily understood but on all counts the scheme seemed most worthy of first mention. The Second Prize failed in the forms of the washing set and the subject was perhaps a little old for a child. The Third Prize would have been better had there been a continuous border instead of the spotty effect given by so many repeated units. The

shelf in the pen and ink sketch needs support but both this sketch and the one by Miss Overbeck suggest very pleasing arrangements for decoration. A more harmonious design is the one by Miss Hannah Overbeck but the subject was not considered especially appropriate while the shapes of bowl and pitcher were not up to the standard.

The Child's Table Set by Miss Overbeck is especially pleasing in the color which we were unable to exactly reproduce. The subject seemed to suggest the coming of the wise men of the east on Christmas Eve and the whole idea seemed original and well carried out. The set by Albert Pons, while not so restful, is clever and well spaced, the border of the tray, showing the two shoes and skirts of the little girl, being well proportioned and cleverly thought out. The design of storks by Miss Nancy Beyer is clever and attractive but is so thoroughly Japanese that it suggests a simple adaptation and while no doubt original and little to be criticized, an American inspiration rather than a foreign one is the object sought in our competitions.

No sufficiently worthy study or design of Christmas Rose was submitted. A few suggestions are given by the editor on this page and the cover to introduce this decorative flower which is just now in bloom.



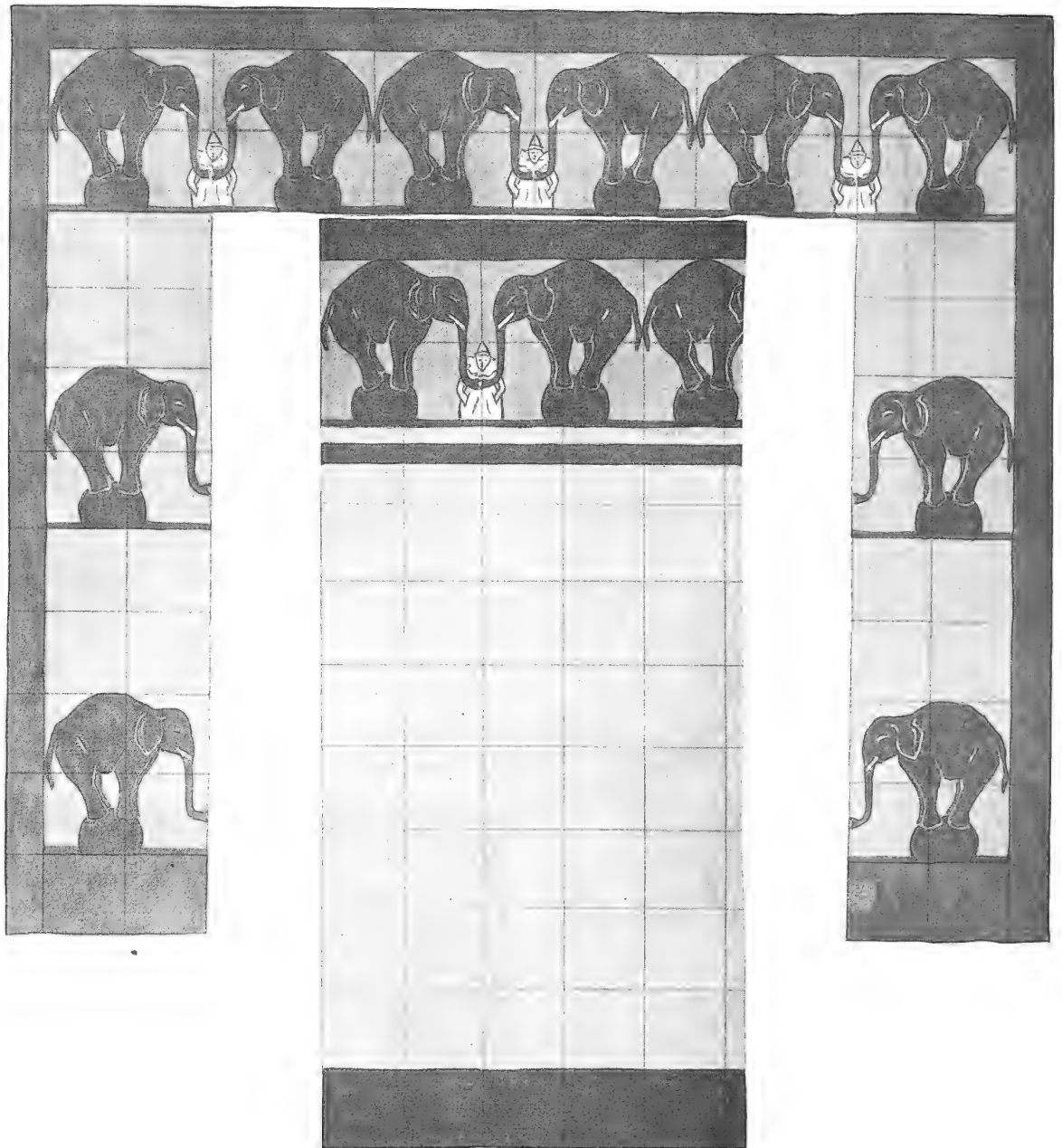

FIREPLACE AND DADO—FIRST PRIZE DECORATION FOR CHILD'S ROOM—OPHELIA FOLEY

SEVERAL color schemes are suggested for this set. 1st, light grey green ground, border design dark green blue on lighter green blue ground, clown in white or very pale tint. 2nd design, red brown, or two shades of greyed yellow brown. 3rd, light brownish grey ground, bands and globe red

brown, clown light grey, elephant Brown 4 or 17 on lighter shade of same for border. 4th, light yellow olive ground; dark olive globe and bands, a warm greyed yellow for background of border, clown white, elephant brown, outlines of clown and narrow line below border, orange.

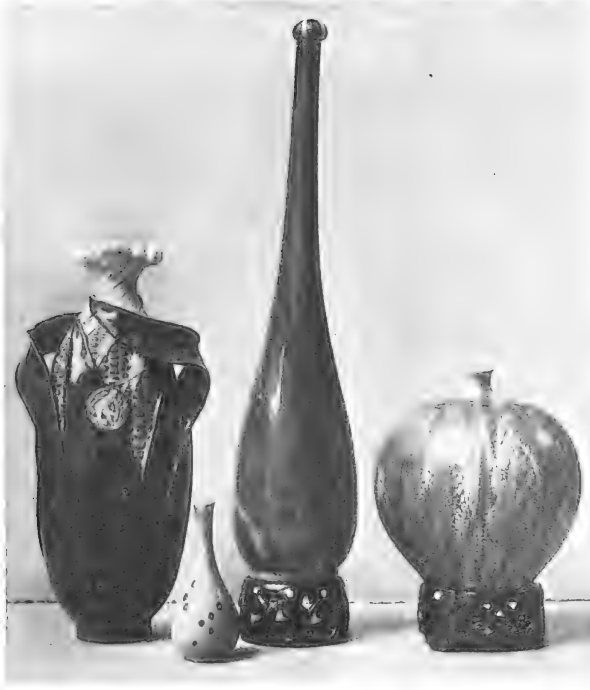

Ear of corn vase with two cameos representing the planting and harvest of corn, white on green ground. Tassels in white, kernels in mat ivory yellow, leaves in mat brown. Small vase with concentric crystallizations, dark green on light green ground. Fuselé vase in mat ivory, with veins of bright color. Stand in grès, mat iron wood color with white pearls. Apple vase with white crystallizations on sea green ground. Stand in grès, mat iron wood color.

TAXILE DOAT

Irene Sargent

The *grand feu* porcelains of M. Taxile Doat attract the critical observer like the work in other branches of decorative art produced by Lalique, Thesmar, Naudot and Brateau. They show the hand of a master technician which has put aside the obstacles raised by a stubborn medium. They often display, it is true, a complicated system of decoration undertaken with a view of seeking and multiplying, rather than of simply meeting difficulties. Therefore, such pieces do not hold the admiration of the lovers of simplicity, but even those persons must admit their claims to future honor in company with the objects of their own kind which are now recognized as classic. For surely these modern ceramics have precisely the same qualities, the same limitations which characterize the *faïences* of Palissy and the *porcelaines tendres* of Sèvres. That is, the shapes and the decoration of all these works are highly specialized, and therefore capable of appealing only to the taste of a certain period, of a certain class of individuals; while, on the other hand, their technical perfection is instantly recognized everywhere and alike by all classes of critics. Style and taste change with the coming and going of each generation. But the standards of skill are permanent, and such objects as reach the strict requirements of these standards, whether they owe their creation to an ancient or a modern master, to a man of Latin or of Germanic race, will continually advance in both artistic and commercial value.

The ideal of technical perfection is one which is especially desirable to keep before those who practise the decorative and industrial arts in our own country; consequently, all objects approaching or fulfilling this ideal should receive

the most careful study from both workers and critics. For by such means alone may be counteracted that dangerous tendency toward middle-class artistic production in quantity, which is so prevalent among us; the origin of the tendency lying in the fact that good taste is possessed by large numbers of almost amateur workers, who have not the patience and devotion, together with the fine perception requisite to assure, after long experiment, the complete mastery over some special material.

Such crude, yet ambitious attempts would seem to be the necessary evils attached to the present stage of development of the Arts and Crafts Movement in America, which, on the other hand, has proved to be of infinite good. With the view, therefore, of arresting those evils, and of fulfilling literally the purpose of its organization, the Boston Society has expressed itself, through its jury, in strong terms which have already gained wide publicity, and deserve still to be repeated.

In direct quotation the severest paragraph of these strictures reads:

"As to study, the ignorance of the simplest and most ordinary expression of materials on the part of a large body of the workers is amazing. There are certain methods of treating materials, forms and surfaces which had reached a moderate degree of perfection even in prehistoric times; and all similar combinations to-day are but variants of these methods. They are the root methods, so to speak, and should be known as thoroughly as are the letters of an alphabet. They naturally, having occurred in the past, have become historic design, and the name has been laid against them as indicating poverty of imagination, if they are re-used. This little dogma and reproach has frightened designers and they have found it easier to invent than to develop ideas; but such ease is gained at the expense of success. The designer finds himself spending hours fumbling over portions of his work of which he has no sense of the relative proportions, or being balked by miniature obstacles which were overcome centuries ago, and by wasting his energies in repeating the labors of his prehistoric an-



"Ceres"—Large cameo of *pâte sur pâte* hard porcelain inlaid on grès. Figures in white on platinum grey ground. Frame in natural mahogany.

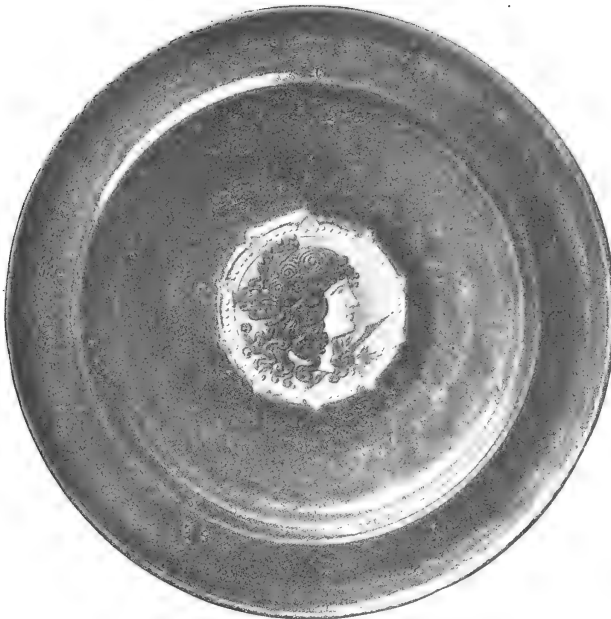

"Walkyrie"—Dish in hard porcelain. Figure in polychrome glazes on a sea green ground. Center and rim with iridescent crystalline glaze.

cestors. It is *l'art nouveau* indeed, the work of the untrained, undeveloped, unstocked brain and the faltering hand."

At the conclusion of this straightforward criticism—surely the result of much courageous thought—the jury of the Boston Society thus formulates the requisites of the objects upon which it is willing to pass judgment:

"We desire each piece, however small, to be done with skill of hand, to be finished and not left crude, and for the designs to show study of the simple fundamental principles of applicability to material, scale of areas, and of organic planning."

In these words, if they be restricted in their reference to the sole field of ceramics, we have a condensed technical description of the work produced by M. Taxile Doat, as may be shown by a mere passing allusion to our accompanying illustrations.

These, at a first glance, are found to fulfil the two great essentials of well-designed vases; while, unhappily, the superb technique of their originals must be imagined rather than perceived. The two essentials mentioned, it is perhaps trite to insist, are good proportions and a clear profile; but since, although theoretically well-known, they are often disregarded by designers, it may not be useless to indicate how they are fulfilled in our present examples.

If we select for study the ovoid, or cup-shaped vases, we shall find in these the height so far dominating the breadth, that the eye does not hesitate as to the relative importance of the elements of form; rather, it at once starts upon its agreeable journey of following the long, graceful, vitalized line springing from the base to the mouth of the objects. By such decisiveness of proportion the impression upon the mind of the spectator, received through the visual sense, becomes simple, clear and strong, or, in other words, pleasurable. These vases, therefore, are eloquent examples of the "organic planning" demanded by the Boston Society of Arts and Crafts.

Again, the more subtle forms occurring in the spindle-shaped and in the ear-of-corn vase, while much more dif-

ficult of attainment, are no less successful. In the first instance, equality of division between the body and the neck of the vase is not even suggested, as, owing to the constantly, imperceptibly diminishing swell, it is impossible to detect the point at which the one ends and the other begins. This form apparently so simple, is in reality a *tour de force*, and in some mysterious way recalls those triumphs of beauty in plant-life which Nature herself attains but occasionally in certain species of orchids. As to the ear-of-corn vase, it might have been designed by a Greek. In this we find great delicacy without weakness, and great richness of line without a hint of decadence. The bending of the husks about the upper part of the body is a beautiful artistic device, adjusted with extreme cleverness, yet addressing the eye so naturally and spontaneously that the spectator wonders why he has not seen it employed a hundred times before. This detail of treatment was plainly adopted from the suggestions offered by antique *amphoræ* of the best period, which thrust out small handles at the same relative point; while the later, more elaborate and decadent types projected these parts far above the neck, thus presenting an aggressive and fantastic profile. The vase of M. Doat is really a masterpiece. Its charming effect is due to a combination of the most refined, yet easily conceived lines: the body being a variation of the egg-form; the simulated handles showing the curves of corn-stalks moved by the wind; and the neck composed upon an unusual, but beautiful and suggestive *motif*, adapted from the "tassel" or mass of silky fibre crowning the ear.

As the vases already noted are, first of all, examples of exquisite forms, so the remaining pieces show technical skill as the chief of their many remarkable qualities.

The apple, grouped with the spindle-shaped and the ear-of-corn vases, offers an admirable field for the display of the crystals which have gained a world-wide reputation for M. Doat. In this instance, their brilliant effect against the sea-green background is not unlike that of newly-fallen

(CONCLUDED ON PAGE 193)

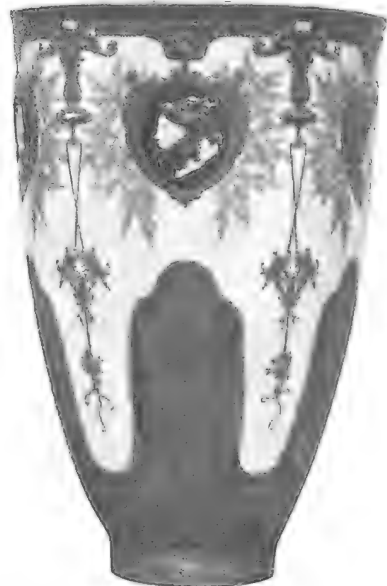

"Amazones"—Vase in hard porcelain. The cameos are raised on a blue ground. Ornaments are in platinum grey *pâte sur pâte*. Lower part of vase in mat yellow brown. The vase is entirely glazed.



Small vase with frosty crystals in mat white on a pearl grey ground.

"Gaines Bachiques"—Large vase in hard porcelain, polychrome pâtes sur pâtes. The whole decoration is mat, except the cartouches and the lower part of the vase which are glazed.

"Poeme Rustique"—Large vase in hard porcelain. Nymphs in low relief personify the meadows, the woods, the spring, the grotto and the echo. Landscapes engraved in the paste join the different parts of the composition. The decoration is mat, except the lower and upper bands which are in milky white glaze.

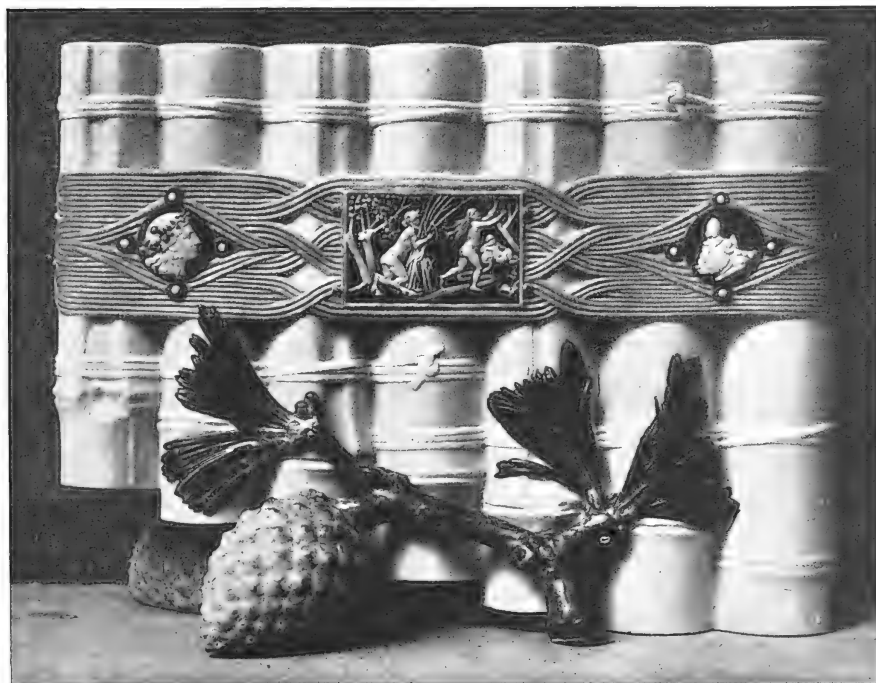

"La Flute de Pan"—Hard porcelain in mat white. The ornaments holding two low reliefs and four cameos are in pâte sur pâte. The branches and pine cones which support the piece are in mat green. The low reliefs represent: 1st, The nymph Syrinx pursued by Pan and changed into reeds; 2d, A shepherd pasturing his goats.

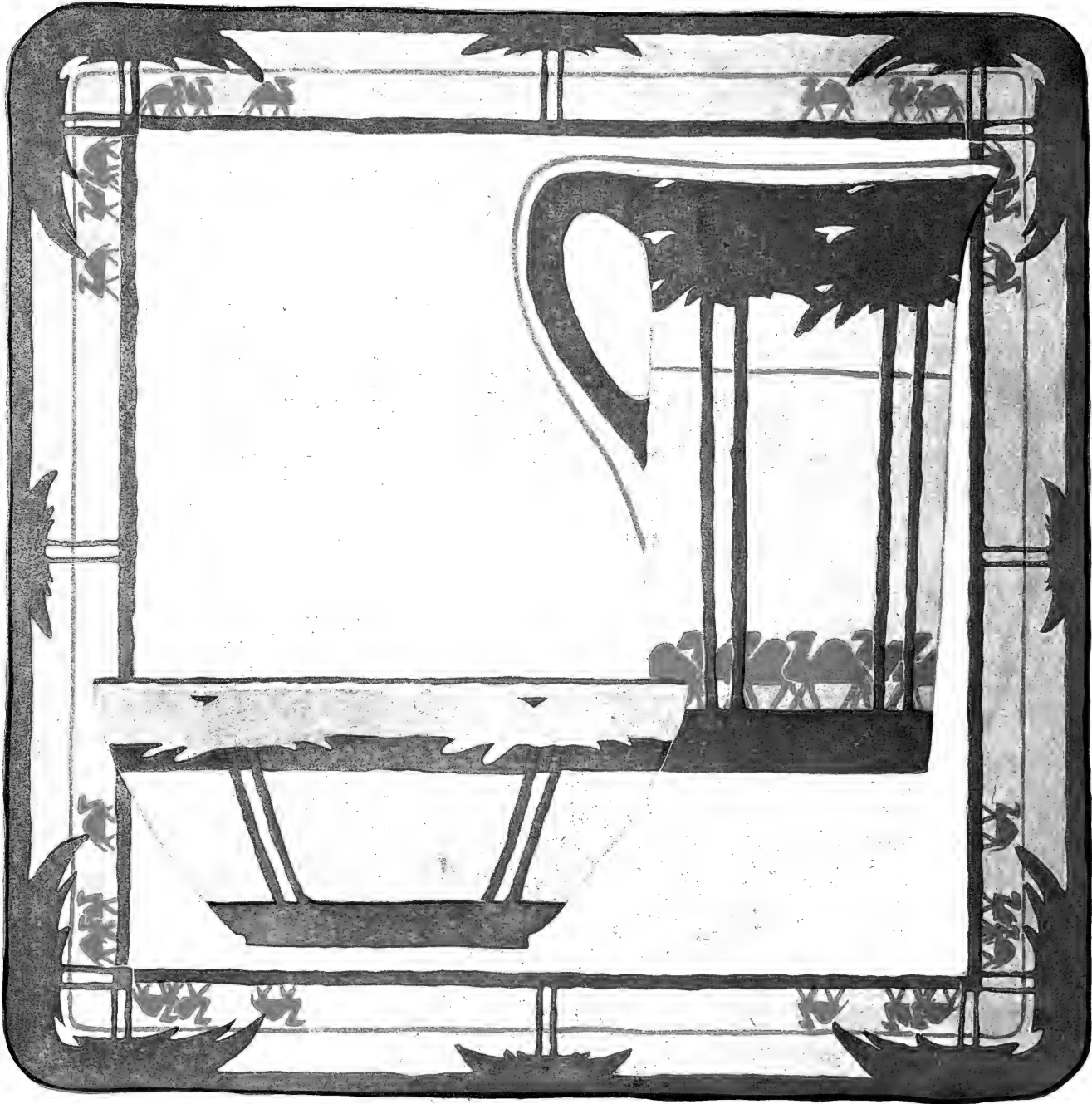

CHILD'S TABLE SET—FIRST PRIZE—MARY OVERBECK

Design in sage green and grey brown on tint of grey brown.



CHILD'S PLATE—FIRST PRIZE—MARY OVERBECK

DECEMBER 1906
SUPPLEMENT TO
KERAMIC STUDIO

COPYRIGHT 1906
KERAMIC STUDIO PUBLISHING CO.
SYRACUSE, N. Y.



WATER PITCHER—HUMMING BIRDS—HANNAH OVERBECK



BOWL BORDER—HUMMING BIRDS—HANNAH OVERBECK

KERAMIC STUDIO

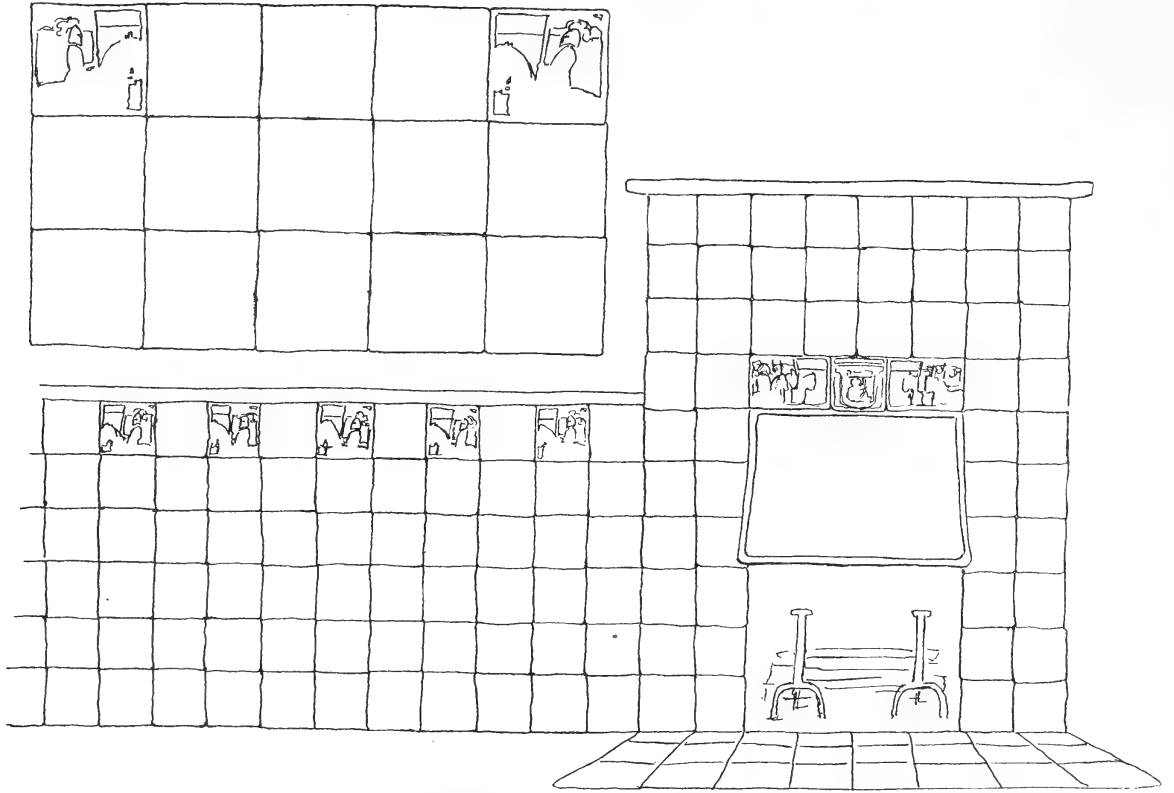

FIREPLACE' DADO AND WASH-STAND TOP—SECOND PRIZE—MARY OVERBECK

(See design page 187.)

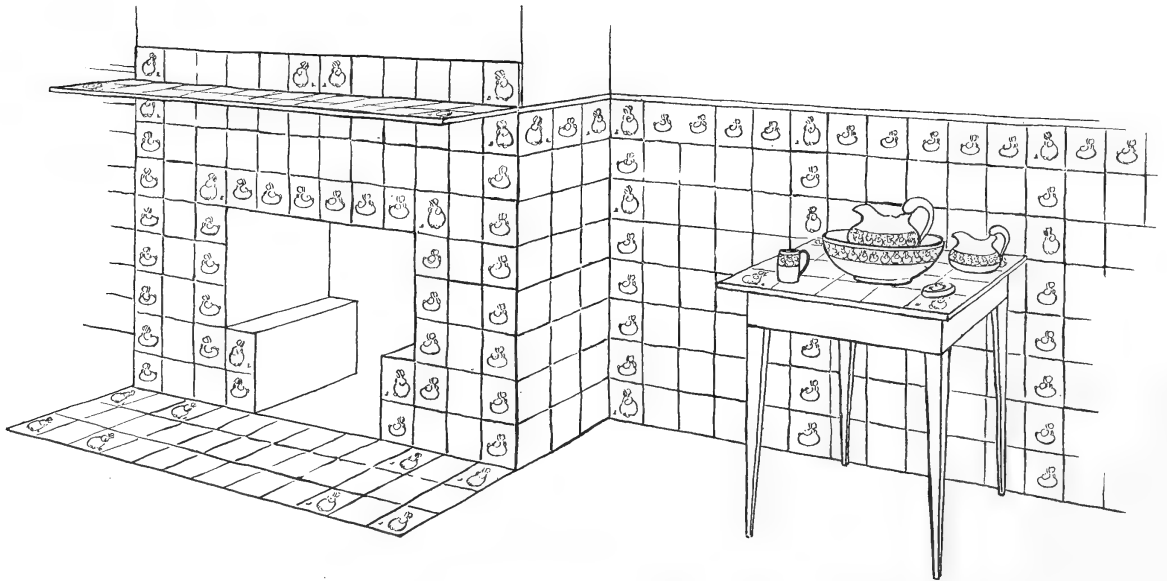

FIREPLACE, DADO AND WASHING SET—THIRD PRIZE—GRACE BLETHEN

To be executed in white grey and blue grey. (See design page 177.)

ARTS AND CRAFTS

What designer of "commercial art" has not been made weary by the vagueness and assumption of "Arts and Crafts" outgivings? We heartily accept Lowell's "indefinable something called style," but the other fellows' half-described and half-realized somethings are not good enough. Generally these gentlemen are, as you say, "dilettante carpenters, metal workers, etc." They talk vaguely about personality in art, but will not learn that their working material has a personality to which their own must be subordinated—that the object in life of cast iron is to be and to look strong and solid—of wrought iron to be and manifestly to be pliable and tough—of wood construction to be framed together and look so, and to be worked with edged tools—and of pottery to be and to appear exactly the reverse, plastic, smooth moulded, following the hand. These things are elementary—and constantly ignored. In industrial art practicability, soundness of construction must come first. Owen Jones was right: "Construction may be decorated; decoration must not be constructed." A chair that won't hold up a healthy man may be lovely; but it is not a chair. The first duty of a leak is to fast bind. It is the ladies, bless 'em, not the men, who buy arts and crafts things. Why? "It is absurd to offer originality as a substitute for efficient workmanship." An excellent theory! Let me thank you again on behalf of the men who make anvils that you may hit, hammers that you may hit 'em with, chairs that you can sit in, locks that will lock, (and open afterward on request), also screens that will stand up. Technique is not all, of course, but much of the arts and crafts product is like the hencoop of which the ingenuous one said, "It looks as though some one had made it himself."—(*New York Sun.*)

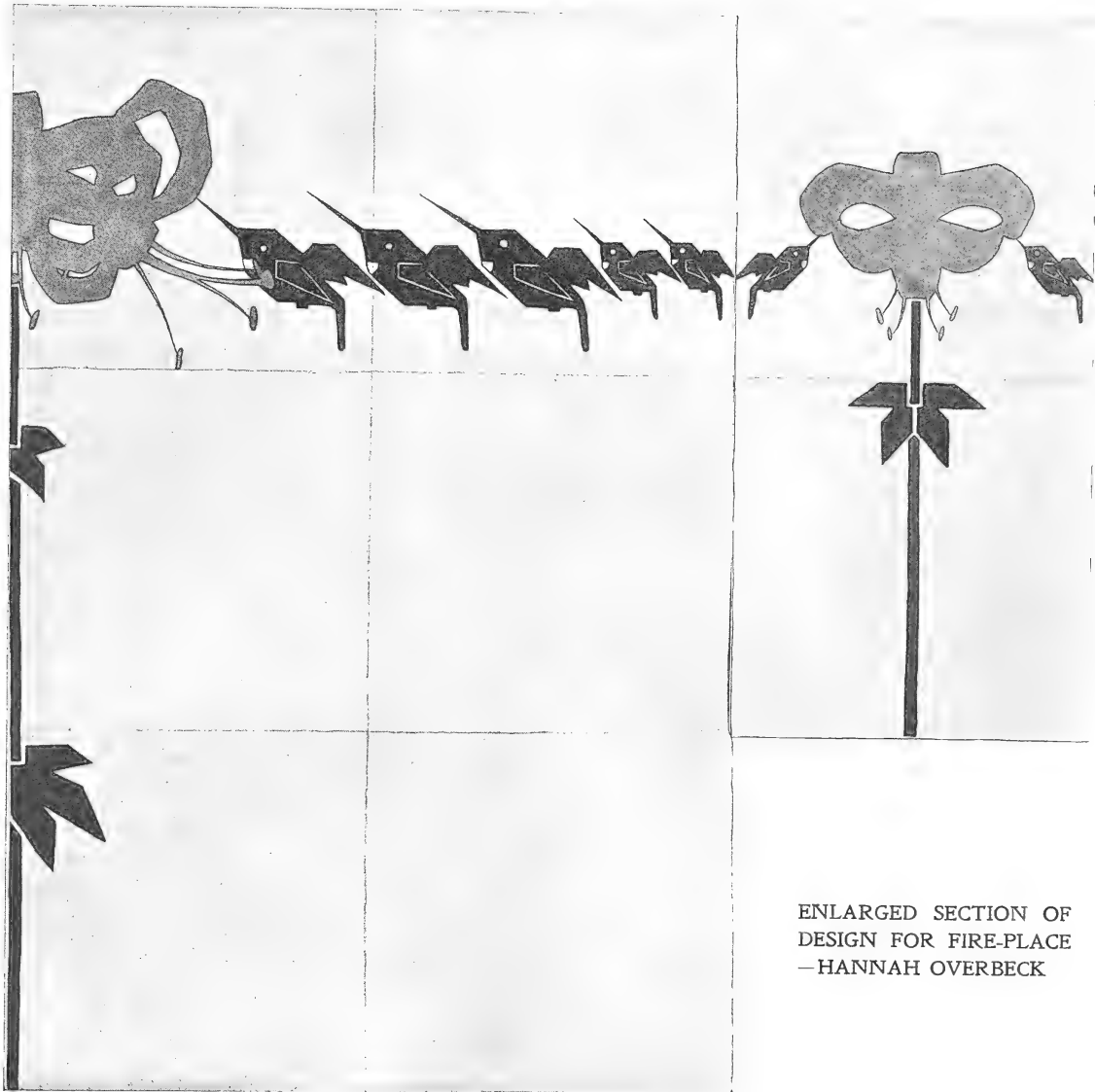

ENLARGED SECTION OF
DESIGN FOR FIRE-PLACE
—HANNAH OVERBECK

HUMMING BIRDS

Hannah Overbeck.

TILES; ground; light olive brown; lilies and throat of humming birds, dull red; leaves, stems and birds, olive green; eyes of birds, white. For the washing set, body of design, light olive brown; background of border, a lighter shade of same; lilies and throat of birds, dull red; birds and leaves and stems, olive green. A cream margin around design with black outlines

RARE PLAQUES FOR BARE WALLS

For years, or ever since the emancipation of the artistic mind from oldtime hideousness in house-furnishing, women with charming homes have struggled with the mural decorations of their dining rooms. From the chromo nightmares which pictured impossible fruits and vegetables, down through assassinated game and mounted fish, the

gamut has been run by the housewife with sublime satisfaction at the beginning of each period, and distress of mind at the end. Now she bids fair to have struck the artistic thing at last. This is no more or less than the decorative wall plaque.

These plaques are, in the main, of china, which establishes their claim to the dining room at once. Always the thing that was needed for the dining room was a distinctive something which exactly fitted. Of course these plaques are seen upon the walls of country homes in the main halls or living room, when the dining room is but a corner, and particularly is this effective when the furniture is the dark mission wood. In these cases the plaques are not confined to the plate rail, but fill in empty spaces between bookcase and window, or above or below the rail. They are suspended invisibly by wire running around the under rim.—(*Chicago Chronicle.*)

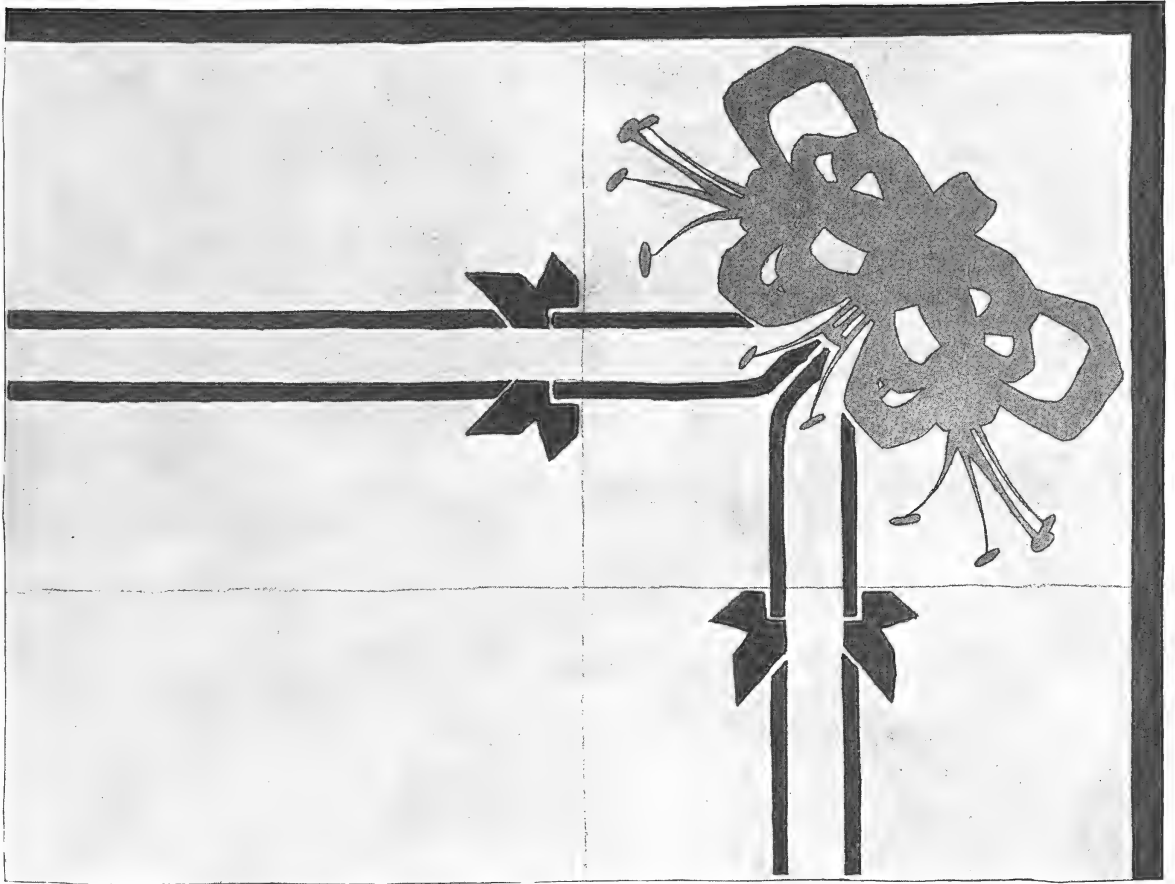

DADO AND FIREPLACE,
HEARTH CORNER FOR CHILD'S ROOM—
"HUMMING BIRDS"—HANNAH OVERBECK

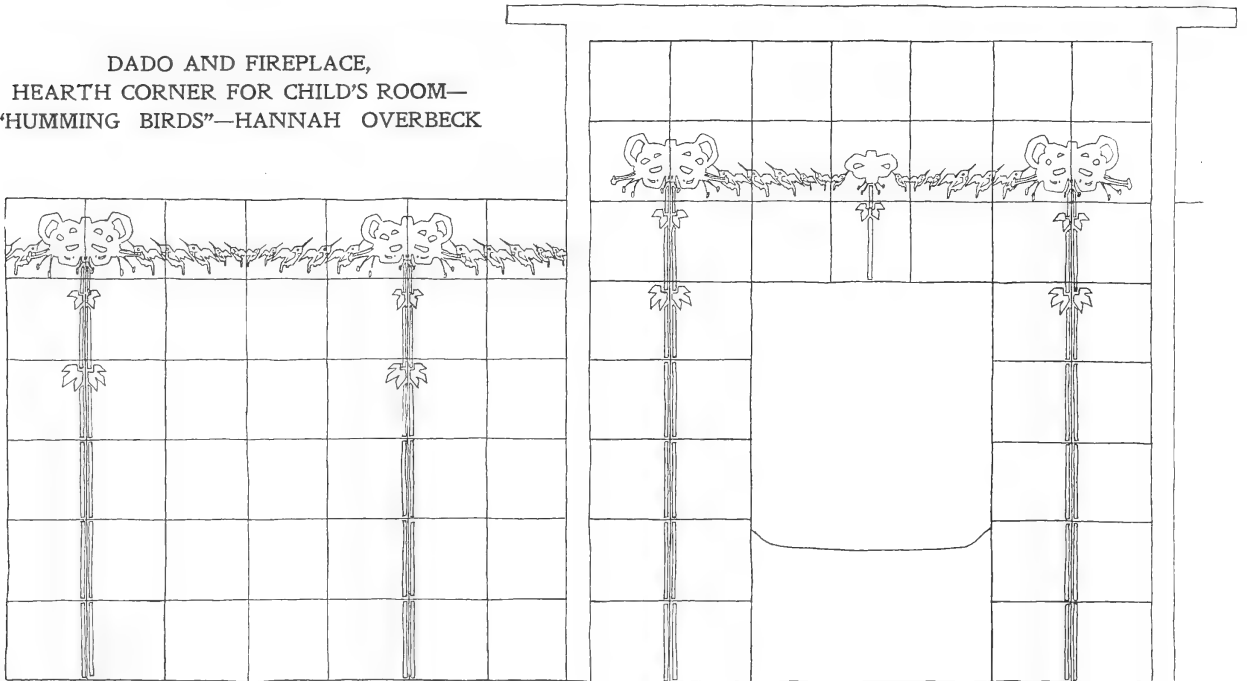



CLOWNS AND ELEPHANTS—FIRST PRIZE DECORATION FOR CHILD'S ROOM—OPHELIA FOLEY

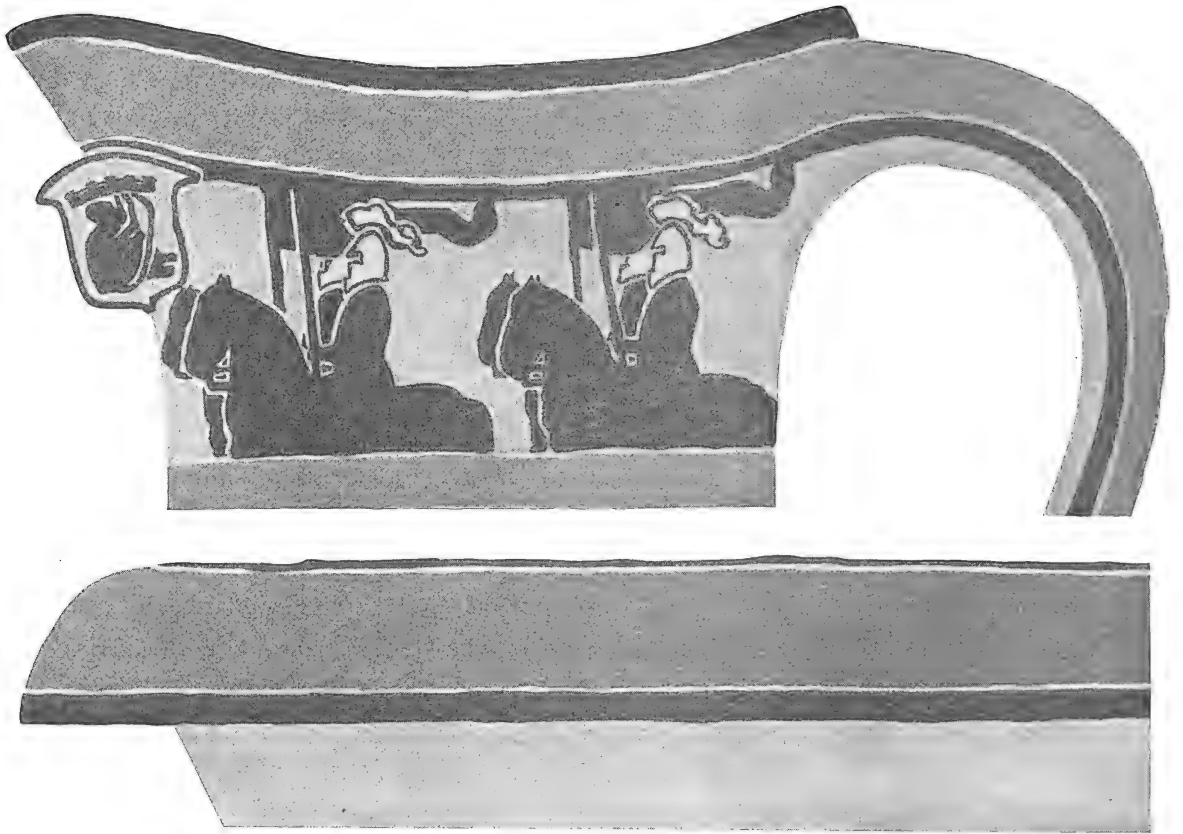

BOWL AND PITCHER—"KNIGHTS"—SECOND PRIZE—MARY OVERBECK

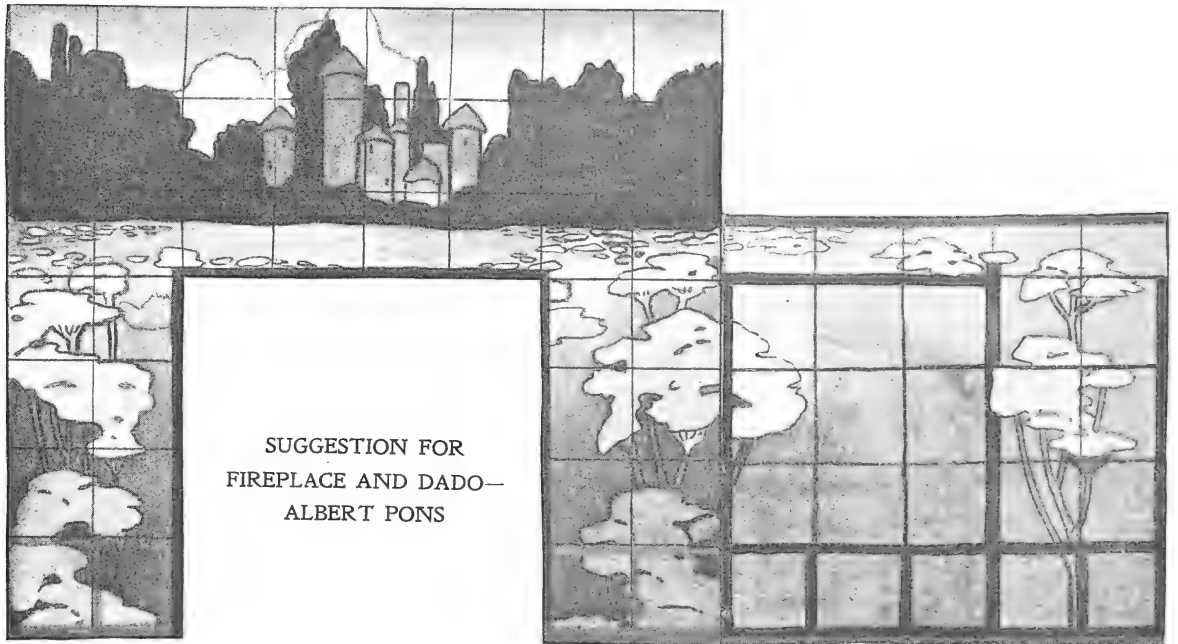

SUGGESTION FOR
FIREPLACE AND DADO—
ALBERT PONS

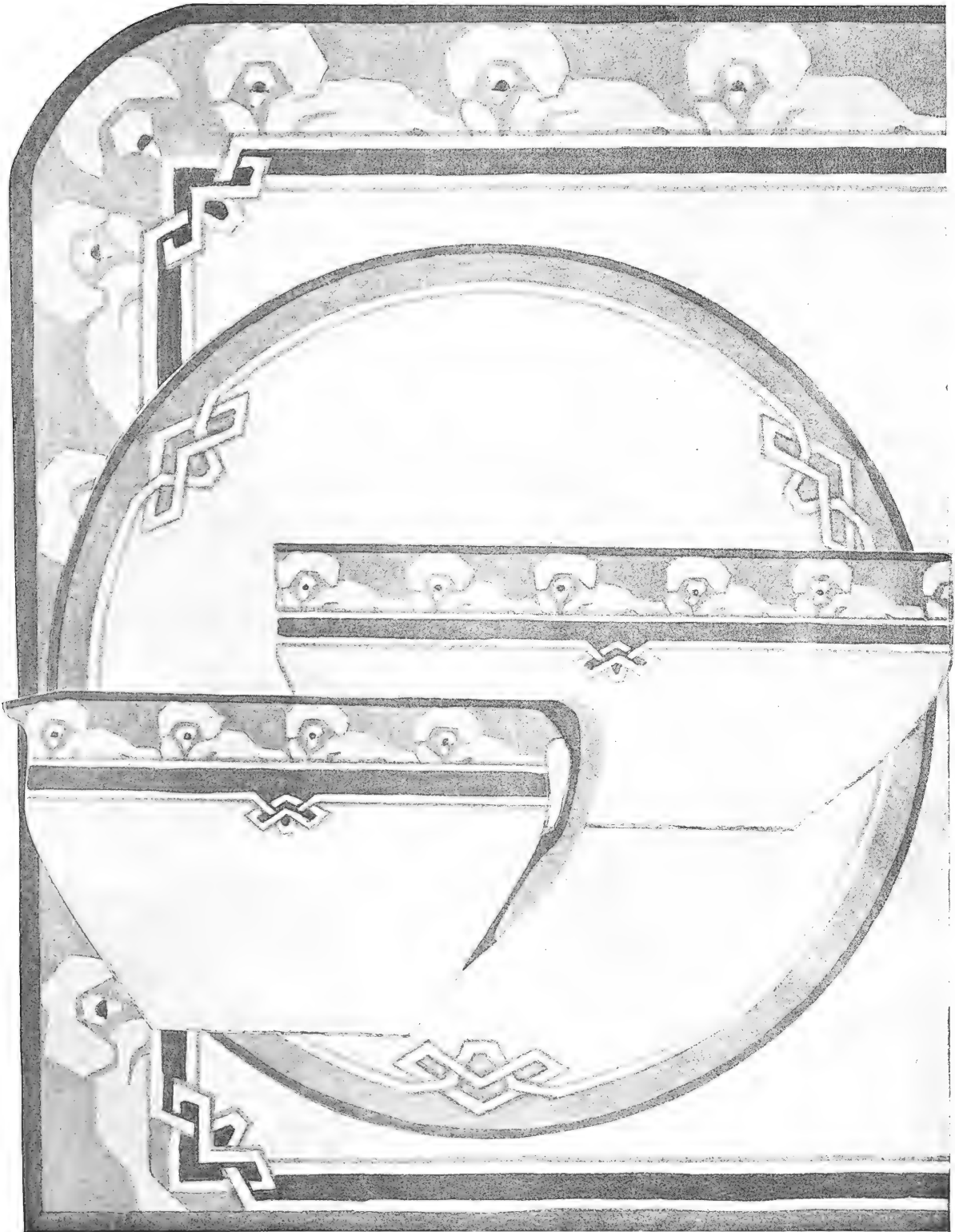

CHILD'S SET—OPHELIA FOLEY



CHILD'S TABLE SET IN BLUE GREY—THIRD PRIZE—NANCY BEYER

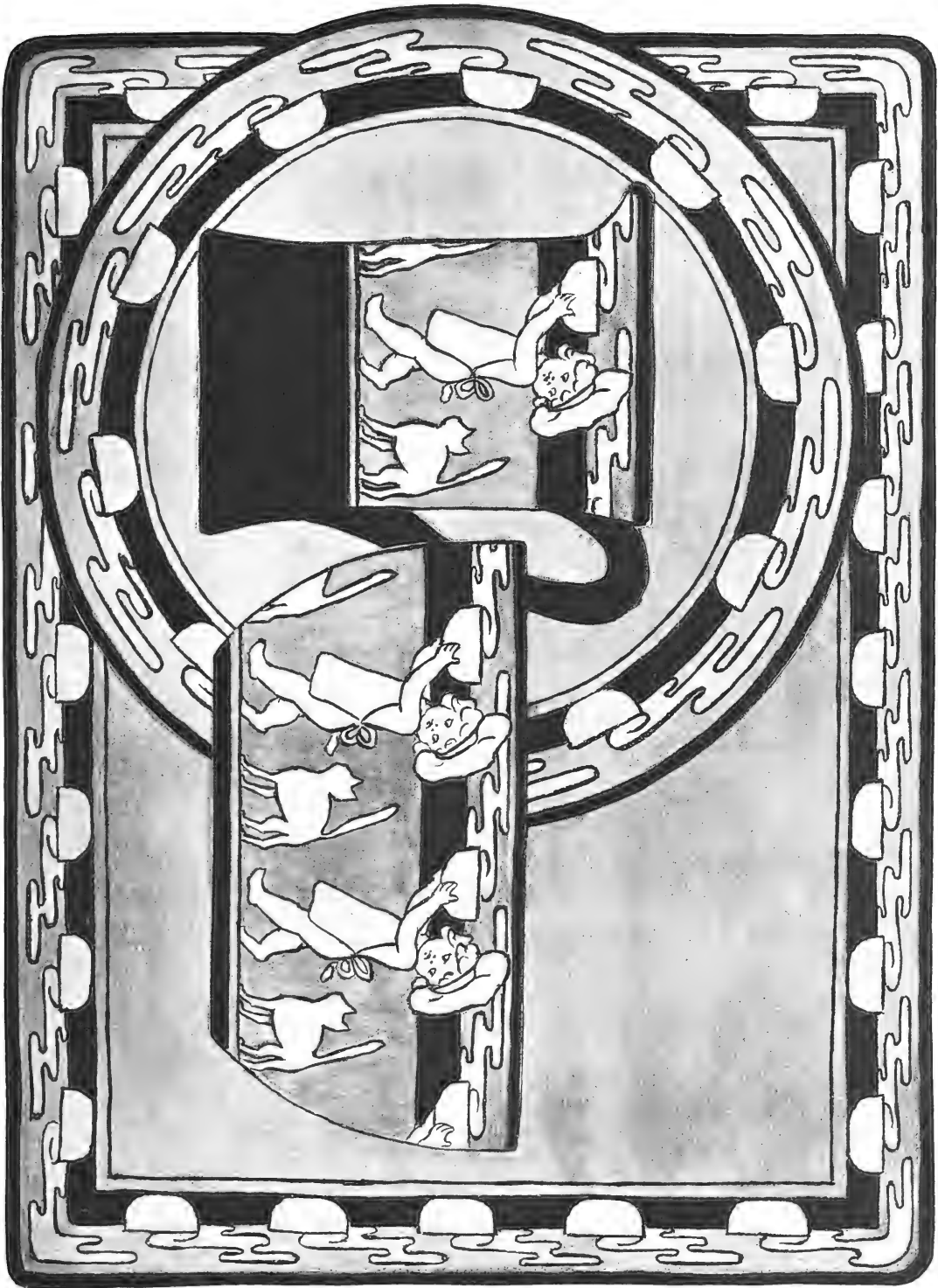

CHILD'S SET—CLARA WAKEMAN

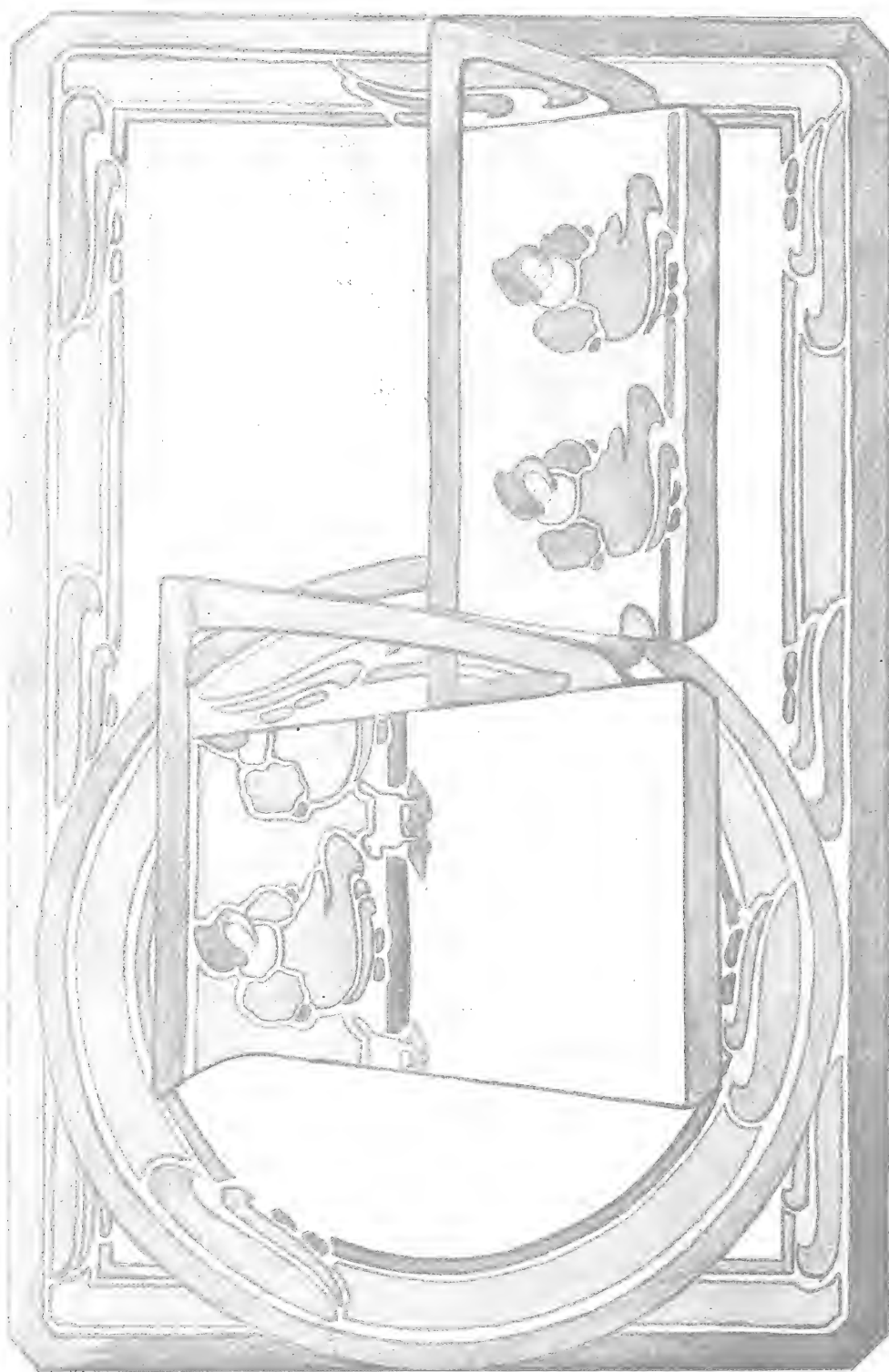

GOODY TWO SHOES—CHILD'S TABLE SET—SECOND PRIZE—ALBERT PONS

KERAMIC STUDIO

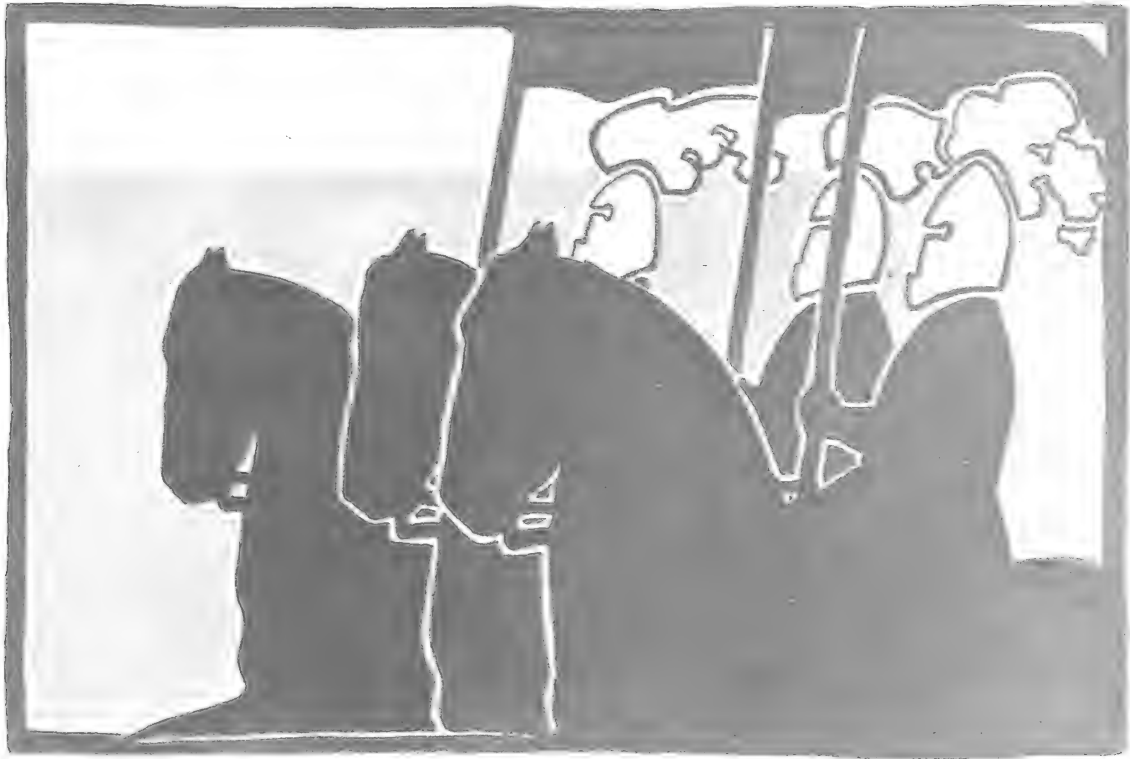

KNIGHTS—SECOND PRIZE DECORATION FOR CHILD'S ROOM—MARY OVERBECK

Design in grey, green on two shades of yellow olive brown, white helmets, plumes and outlines.





CHILD'S SET—JAPANESE LANTERNS—CARRIE BROSEMER

FIRST FIRE—Sketch in design with India Ink, and dust in background with Fry's Black. Clean out design.

SECOND FIRE—Paint in figure with Baby Blue, and a

touch of Violet II; lanterns in Pompadour, Albert Yellow and Blue Green. Back of handle of pitcher, gold, with Japanese lettering in Black.

THIRD FIRE—Retouch with same colors.

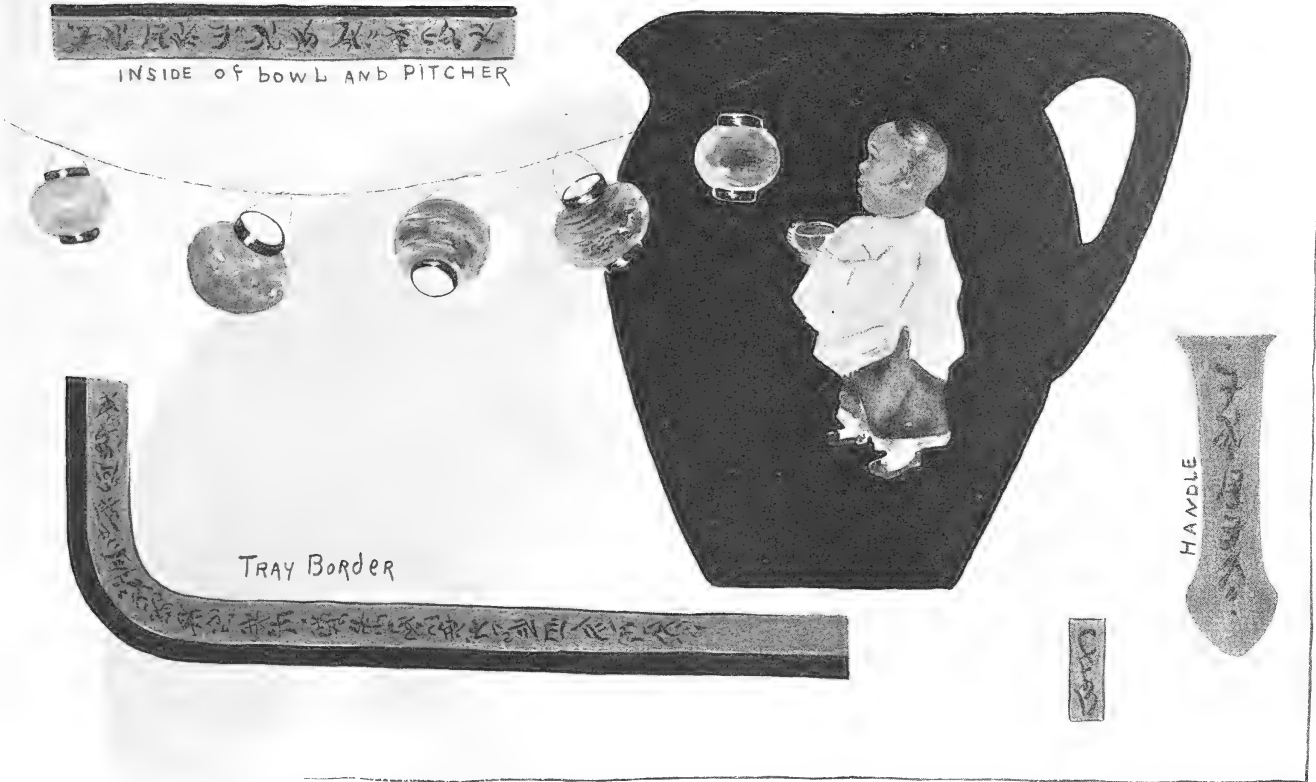

DESIGN FOR CHILD'S SET—JAPANESE LANTERNS—CARRIE BROSEMER

LEAGUE NOTES

There will be no problem for December, but for January comes the coupe cake plate with or without handles. A geometrical all over design is preferable, but a border will receive criticism. Please try to send these early in order to make way for the vases and Farrington punch bowl in the Jan. KERAMIC STUDIO.

The sugar bowl forms, submitted in outline for criticism, are so much better than anything we have had during this term of office, that we cannot refrain from mentioning them. Have you noticed those curling, almost wriggling, lines in relief around the base and top of nearly all the sugar bowls in our shops, with handles patterned after the human ear, stuck on as an afterthought, with bases threatening to tip over, spilling the contents, and marbles or rings to lift the cover? A design in subdued color no matter how good loses all dignity on such a shape. At least a half dozen of our outlines ought to be accepted by the manufacturer. They have good lines, strong bases, handles that are an adequate part, necessary to the beauty as well as a support in holding, with covers as carefully thought out as the body and with nobs that conform to the general shape. The nut bowls are not all in, but they promise well.

We are happy to announce the addition of two clubs, those of Los Angeles, Cal., and Providence, R. I.; also two individual members, Miss Helen M. Haines, Duluth, Minn., and Miss Madge L. Gibbons, Alma, Colo.

BELLE BARNETT VESEY, President,
6228 Wabash Ave., Chicago.

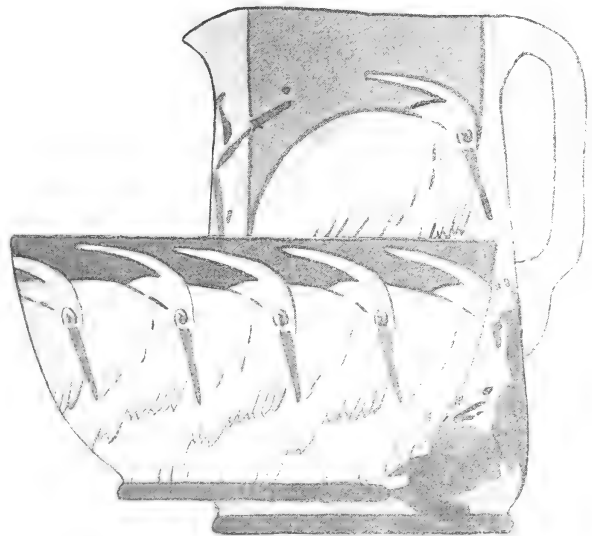

BOWL AND PITCHER FOR CHILD'S SET—
NANCY BEYER

THE CRAFTS

WOOD CARVING AND PYROGRAPHY. LEATHER AND METAL. BASKETRY, ETC.

Under the management of Miss Emily Peacock, Room 23, 22 East 16th St., New York. All inquiries in regard to the various Crafts are to be sent to the above address, but will be answered in the magazine under this head.

Summer Address, care of Ceramic Studio Pub. Co., Syracuse, N. Y.

All questions must be received before the 10th day of month preceding issue, and will be answered under "Answers to Inquiries" only. Please do not send stamped envelope for reply. The editors will answer questions only in these columns.

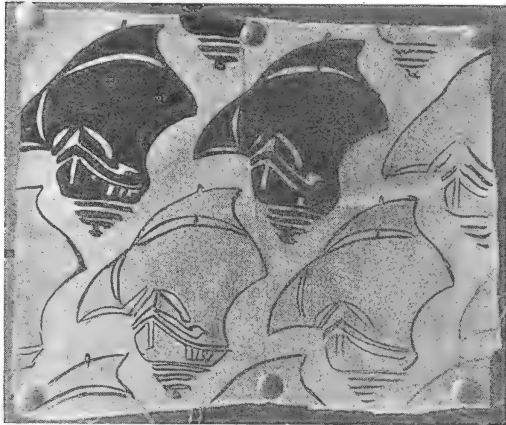

No. 8

PRINTING WITH A WOOD BLOCK

Haswell Clarke Jeffery.

FOR years the people of India, as well as of other countries, have employed the art of wood-block printing to decorate their fabrics. Both wearing apparel and hangings have thus been treated, and many examples show skill in design and excellence in application. Many designs now woven in the fabric were once stamped upon the surface. Recently the art in a simple form has been introduced into the schools. The children have taken happily to the work with interesting results; and the students more advanced in design have obtained finished pieces of good color and pattern.

The design is first drawn in charcoal on suitable paper (lead pencil can be used), and it is then traced upon Japanese paper or upon any transparent paper. The masses are filled in solid black against the white ground, and the pattern is pasted face down upon the block to be cut. As this paper is very thin, the design shows through in a reversed position. When stamped upon the cloth the reversed design on the block prints like the original drawing on the paper. In a symmetrical design it is not necessary to reverse it.

To apply the ink drawing, put the paste upon the block, lay the paper upon it ink-side down, and smooth out all creases. The ink on the design does not then become blurred. Allow the paste to dry before cutting into the wood.

The block should be made of firm wood, not too hard, and of close grain. For ordinary uses gum wood is most satisfactory. This does not split easily, and it is firm enough to resist the pressure of printing. Pine is apt to allow the edges to become rounded and to give an indistinct outline to the finished print. Cherry can be used or any hard wood if desirable; but the difficulty of cutting it is greater. For ordinary printing a block carved on the side grain is firm enough.

Clamp the block upon the bench or table as for any

wood carving, using an iron clamp, or a hand-screw, or the simple device shown in Illustration No. 1. For this method take two pieces of wood longer than the block as *A B* and *C D*. Make a wedge *E F* and place all in position given. Nail down *A B* and *C D* and tighten the wedge against the block *G*.

To carve the block use a sloyd knife, or a chisel sharpened to an angle of 45 degrees, giving one side a pointed edge, as in figure No. 1. in Illustration No. 2. The quickest and deepest cutting can be done with this chisel, using both hands, one for pressure and the other to guide the blade. First draw the point around the pattern, following the line closely. As the chisel sinks into the wood, the path of the blade becomes wider, and there is danger in small designs of wedging into the pattern. Avoid this by keeping just to the line, not on it, and later by trimming exactly on the line. After going around the design, cut out the background spaces, leaving a clean edge on the

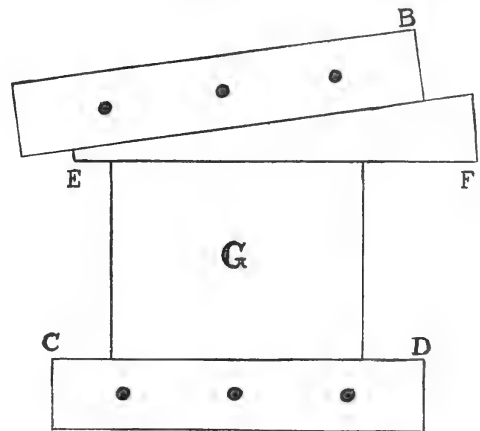

No. 1

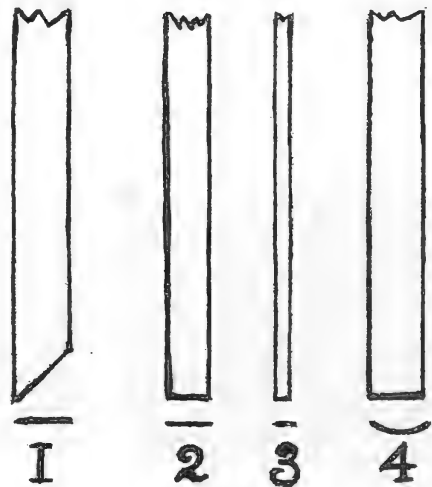

No. 2

stamping surfaces. A narrow chisel or a flat gouge, Nos. 2, 3, 4 in Illustration No. 2, are all that are necessary. A variety of gouges will facilitate the work. The difficulty in using a knife is shown when cutting under a space to be taken out. It presses over on to the pattern and dents the wood, giving an irregular edge.

A chisel 1-16 inch wide, another 1-4 inch wide, and a flat gouge 5-16 inch wide will get out the ground work easily. The "flat gouge" has a slightly curved cutting edge.

The depth of the cutting need not be more than an eighth of an inch, and in very narrow places it can be less. However, the East Indian stamps are cut from hard wood

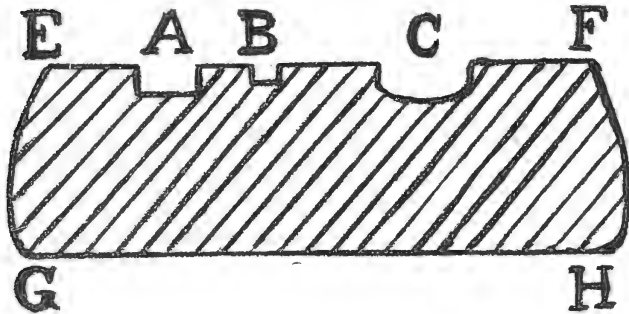

No. 3

to a depth greater than a quarter inch. In Illustration No. 3 the space at *B* is very narrow and the depth is less than that of the wide space *C*. These represent the background, and the elevated parts are the printing surfaces. Space *C*, being wide, it is cut lower at the middle, so that when printing, the cloth will not touch any part of it. When the ground work has been taken out and the pattern stands in relief, as shown in Illustrations No. 4 and No. 5, cut away the wood all around the outside, following the pattern edge as at *E* and *F* in Illustration No. 3. Then trim off the back edges of the block, as *G* and *H*, to avoid hurting the hands, under pressure of printing.

Small blocks can be 3/8 inch thick and those over 3 inches in diameter ought to be an inch thick to prevent warping.

To finish the block take a piece of fine sand paper and lay it face upward upon glass, or upon any perfectly flat surface, and grind the surface of the block upon this till all the paper is removed. It will then be perfectly level. Never remove the pattern by wetting, for it will injure the grain and make the surface rough. Last of all, oil the block with linseed oil.

For printing, mix oil colors with turpentine to the con-



No. 4

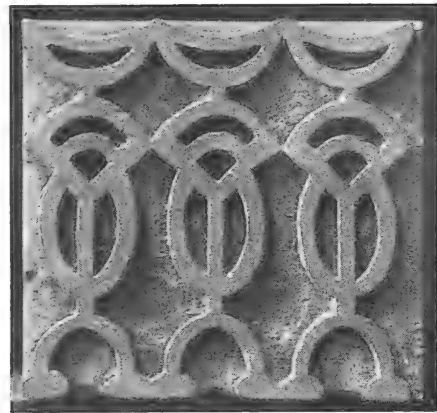

No. 5

sistency of cream. Paint on with a brush, spreading evenly, but do not let the color drag over the edges. Keep these clean. If several colors are used, paint them on their respective parts of the stamping surface, and stamp firmly upon the cloth on an ironing board. Press all parts of the block so that the cloth will take the color thoroughly. Some strike the block with a small mallet instead of using the palm, but there is danger of splitting the wood. Should a spot of paint cling to an edge and show on the cloth, scrape it with a palette knife toward the center of the color mass.

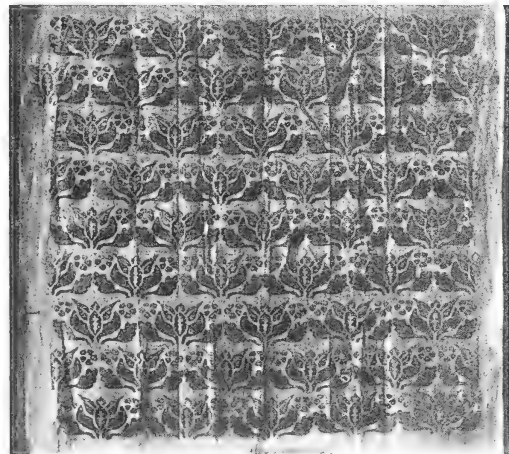

No. 6

This will help to blend it. For practice cheese cloth is good; and unbleached linen, silk, and even burlap will afford many problems of interest. The coarser the material, the more color is required on the stamp. The tone and texture of the cloth will affect the colors used, and the colors dry darker than when applied.

The placing of the pattern upon the material is a problem in spacing. Trials can be made upon paper the size of the cloth, and, when satisfactory spacing is shown, it can be duplicated on the cloth. Trials upon small pieces of cloth will determine the texture and color effects.

In printing several colors, some have used a separate block for each color. This requires care in cutting and in stamping, for a slight move in any direction will affect all

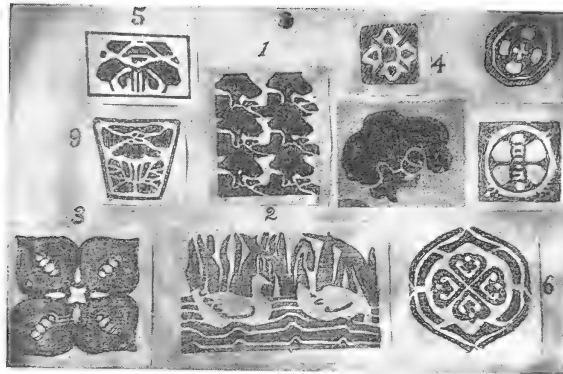

No. 9

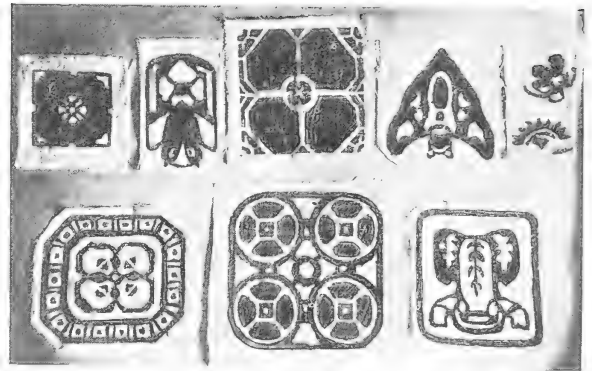

No. 10

the spaces of the design unit. Where a large repeat pattern seems to need additional spotting, according to its spacing, a supplementary block of harmonious design can be used between the larger printed masses, bringing them together. The use of blocks in this way will afford many interesting variations.

The block in Illustration No. 4 is repeated in Illustration No. 6 on unbleached linen for a pillow top, and No. 5 is used in Illustration No. 7 on silk for a scarf. The background of this border is filled in with embroidery. No. 8 shows a ship pattern on unbleached linen. A unit has been inked on the photograph. The other illustrations show design units as registered from wood blocks. With the exception of Illustration No. 8 the blocks illustrated were

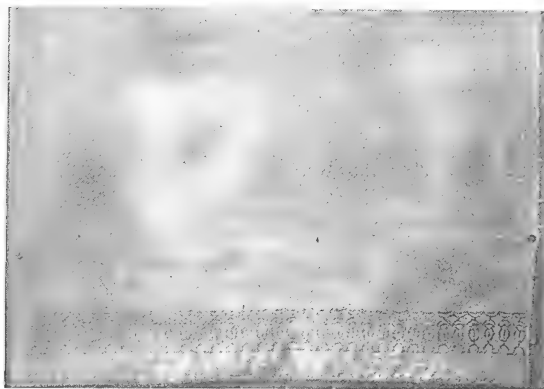

No. 7

made by the students of the normal graduating class, Pratt Institute, Brooklyn, N. Y.

As oil colors are apt to run on silk, the following mixture might be used for it:

- 1 oz. acetic acid.
- 1 oz. oil of wintergreen.
- 1 pt. spirits of turpentine.

Mix these in a bottle, let stand awhile, and shake thoroughly before using. Use smaller quantities in proportion.

To insure the permanence of printed cloth, let it stand thirty days. The thinning fluid is then dried out and the body color remains firm.

ANSWERS TO CORRESPONDENTS

S. F. P.—The old piece you speak of is either glass or old glassy soft porcelain, cannot say surely, from your description. It would be very unsafe to fire it in your overglaze kiln, as you do not know to what temperature to fire it. If you put it in the same firing as your overglaze painting, it will be absolutely spoiled. You might try to fire it at glass firing or a little higher, but it is exceedingly risky.

Mrs. G. D.—For banding large pieces in color mix as for tinting, as much fat oil as color and flux combined and thin with oil of lavender to the desired depth of color.

Mrs. C. E. F.—See article on gold etching in July, 1903, *KERAMIC STUDIO*.
M. D. B.—For thinning bright gold and lustres use oil of lavender. We will give articles on the making of grounding oil and other mediums in an early number of the "Class Room." We have no formula at present.

M. L.—See articles on Enamel in November, 1905, *KERAMIC STUDIO* for a mixture of color such as $\frac{2}{3}$ Royal Blue, $\frac{1}{3}$ Copenhagen Blue to which is added $\frac{1}{2}$ Black. When the color is mixed then add it to the enamel in the proportions mentioned in the "Class Room," as if you were using a single color. Write to the President of the National League, Mrs. Belle Vesey, 6228 Wabash Ave., Chicago, Ill. She will give you the desired information as to the league, its exhibitions and its aims. For burnishing Bronzes usually the glass brush is sufficient; if not, use burnishing sand and water. If you burnish carefully there is no need of taking off the lustre which is next to it and which should be put on first for the same fire. Blue lustre harmonizes best with soft yellow browns, of various shades. For the tree vases, the high

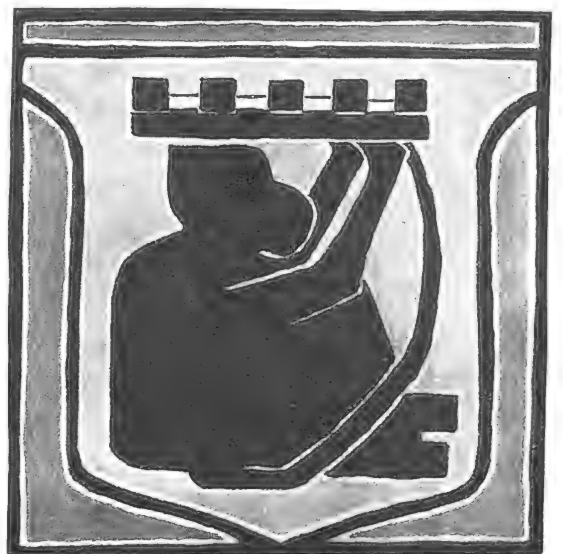

CENTRE DESIGN OF FIRE PLACE - MARY OVERBECK

polish over all is given by dusting all over with one color in which Pearl Grey predominates or with a specially prepared glaze like Ivory glaze, Azure glaze, etc. Any of these glazes can be used over any colors except that Ivory glaze is liable to destroy Iron Reds, such as Pompadour, Blood Red, Carnation, Orange Red, etc. Ruby lustre or Covering for gold give a reddish tone over gold; dark green also is good over gold. See articles on Lustres in "Class Room" KERAMIC STUDIO, which also explain how to line cups with lustre.

TAXILE DOAT

(Concluded from page 172)

and melting snowflakes, although, unhappily, their beauty can not be described in words.

The cup-shaped vases previously admired for their forms, must again be praised for their polychrome decoration, and, above all, for a superb *pate-sur-pate* treatment which can come only from the hands of such supreme masters of the ceramic art as Solon and Doat.

In passing in review these cameo pieces, each one seems especially attractive by reason of its distinctive subject, color-combinations, and surface-effects; but the masterpiece among them, as acknowledged by M. Doat himself, is the sevenfold vase, simulating reed-pipes and known as "The Flute of Pan." From the reproduction we can judge of the almost microscopic delicacy of the cameos, and the admirably devised reed *motif* which binds together the separate pipes; but we are left to imagine the quiet color-harmony made by the body of the flute with its supporting branches of pine leaves and cones.

Perfection of the kind and degree incorporated in this vase is the direct outcome of the traditions of the Sèvres factory. Enough of the old exists in the work to assert its ancestry, as the classic subject, forms, and emblems amply testify. Enough of the new vitalizes the work to witness that its parents were the brain and the hand of a thoroughly modern ceramist. Therefore, as the artistic conditions of a period may be judged by the highest attainments of that period, French ceramic art need not fear an approaching decline. Nor has it to apprehend harm resulting from the rapid progress made by the same art in Denmark. Distinctions between races are sharp. They can not be obliterated even by the free intercourse now everywhere established between nation and nation. Frenchmen keenly appreciate the beautiful; they have logical minds, and a longing after perfection that is not easily silenced. The Republic has thus far fostered the arts with the same care and enthusiasm as was earlier done by the monarchical governments. Finally, French art now stands free from any fault dependent upon *chauvinisme*. It recognizes the genius of other peoples. But it is to be hoped that it will remain faithful to its own great past; that it will renew and rejuvenate itself, but never seek to change its historical spirit.

Gold on Pouyat China.

"All that glitters is not gold," is an old adage which does not apply to gold employed in the decoration of china, for all gold mixtures, whether they be "bright" or "burnish," must be developed by fire and therefore of necessity must be produced from pure gold as a basis, no matter how far they may be extended by the admixture of oils or essences.

Much of the success in perfect and permanent gilding depends upon the nature and quality of the glaze to which it is applied. If the glaze is not receptive in its action under fire, or is lacking in perfect uniformity of texture, "burnish" gold is very apt to appear "milky" in streaks when it comes from the kiln.

This is especially true in cases where the amateur decorator attempts the risky method of "spinning out" a modicum of gold by putting in too much fat oil and turpentine. When gold thus thinned out strikes a spot or edge in the glaze that is dry or "starved," as the professional terms it, the result is a thin milky deposit which will not burnish. As this involves re-gilding and another firing, it becomes a heart-breaking operation to the amateur, as many of them will testify.

Under the same conditions, "bright" gold will turn a purple hue which is in reality an elementary purple lustre.

As previously stated the glaze to which gold is applied has much to do with the result and the amateur decorator should give as much consideration to this important factor as to any other requirement of the art.

In this respect the glaze of Pouyat China presents a perfect surface for the reception of gold and every form of gilding properly applied to Pouyat China is certain to develop under fire into a rich, full rounded line, band or scroll. Years of patient study and experiment have brought the glaze on Pouyat China to a degree of perfection that makes for the highest satisfaction in gilding. There is an indescribable texture in the Pouyat glaze that gives a firm foundation for gold and color, and the method of selecting the white china for amateur decorators leaves nothing to be desired as a uniformly satisfactory porcelain for discriminating amateurs.

Paroutaud & Watson, 37-39 Murray Street, New York.

FINE FRENCH WHITE CHINA

FOR AMATEUR DECORATING

Best White China Made in Limoges

PAROUTAUD FRERES, Manufacturers



Catalogue and price list on application.

Ceramic Importing Co.

37-39 Murray St., NEW YORK.

STOCK AND IMPORT

SOLE AGENTS

WE WILL SAVE YOU 1-4 TO 1-3 ON YOUR WHITE CHINA.

We handle only the first qualities of German and French wares. We have no expensive establishment to keep up. No high priced rent to pay. You get the benefit of these savings. Send for our price list.

B. W. TENNETT & SON,

113 N. Center St., CORY, PA.

Magill & Ivory

Importers and Dealers in

WHITE CHINA AND ARTIST MATERIALS

A premium given with all orders amounting to ten dollars and upwards. Write for list and catalogue. Classes in decorating four days every week. Estimates on large or small orders. China fired with care.

297 5th Avenue, New York City



- am getting tired

CAMPANA'S
colors cost 1/2

AS GOOD
AS ANY

NEW

The Teacher of China Painting

By D. M. CAMPANA

Better than six months lessons. 43 separate chapters of different branches of china decorations with illustrations.

CONTAINS

Conventional painting and its fundamental principles. Separate lessons in figure, flowers, fruit, leaves. Remedies for mistakes in firing, painting, glazing, etc. Everything about lustres, firing (thoroughly explained), ground-laying paste, etching and transfers, recipes for gold, oils, silver, and everything belonging to china painting. Also opaque glass painting, silk painting, tapestry, oil painting, miniature. Every one of these chapters is worth the value of the book.

Price 75 cents, postage 5 cents.

D. M. CAMPANA, - - - 112 Auditorium Building, - - - CHICAGO, ILL.

DORN'S
CERAMIC SUPPLY STORE
Largest Store on Pacific Coast
Devoted Exclusively to White China, Beleek and China Decorator's Supplies
759-761 McAllister Street, San Francisco, Cal.

KUT-PRICE-KATALOG

ARTIST'S MATERIALS

LEE ROESSLER, 116 S. High St. Columbus O

T. & V. CHINA AND HAVILAND & CO.'S RANSOM

A full line of Austrian Novelties in White China. Shirt Waist Buttons 40 cts. a dozen delivered at your homes. Gold Plated Backs at \$1.80 a dozen. We deliver Fry's Paints and Sherratt's Gold. We have no catalogues, but will send you a sample barrel full of novelties upon request with references.

HUDSON CROCKERY COMPANY,

Dept. D 349 So. Salina St., Syracuse, N. Y.

Mineral Transfers

For China Decoration in all its Branches



PALM, FECHTELER & CO.

80 FIFTH AVE., NEW YORK. 45 LA SALLE ST., CHICAGO. 1st NATIONAL BANK EAST LIVERPOOL, O.

Apply to Your Supply House for Samples and Information.

White China for Decorating

We are now prepared to fill orders for plain white china. Send for illustrated Catalogue.

ERKER BROS. OPTICAL CO.,

510 North Grand Ave. ST. LOUIS, MO. 608 Olive Street,

ESTABLISHED 1887

FRANK DOEHLER

WHITE CHINA AND ARTIST MATERIALS IMPORTER

New prices on hat or brooch pins complete. Special prices in gross lots.

Also baby or large bar pins complete.

Doehler's Block, Rochester, N. Y.

211-213 Clinton Ave. North. One minute walk from N. Y. C. station.

ARTISTS' SUPPLY CO.

Store 59 Randolph St., Masonic Temple (opposite Marshall Field & Co.) CHICAGO, ILL.

Save Time!!—and Money!!
Artists' Materials, All Makes
at Lowest Prices. 

Mail Orders a Specialty. Write for Catalogue No. 5

KEEP THE FIRE ALIVE.

KERAMIC STUDIO

CONTRIBUTORS

HENRIETTA BARCLAY PAIST

JULES BRATEAU

JAN. MCMVII Price 40c. Yearly Subscription \$4.00

A MONTHLY MAGAZINE FOR THE POTTER AND DECORATOR.

JAN 2 1907

CONTENTS FOR JANUARY 1907

	PAGE
Editorial	195
The Class Room—The Art of Teaching	195-196
Editorial by Henrietta Barclay Paist	198-199
Grapes—Naturalistic and Semi-Conventional	197
Mountain Ash	198
Decorative Studies of Fish	199
Plate and Tile—Fish Motif	200
Nasturtium Borders	201
Flaming Bush Borders	202
Plate Borders—Bitter Sweet—Flaming Bush—Mountain Ash	203
Border of High Bush Cranberries	204
Grapes in Triangle	204
Birds and Apple Blossoms, Panel	205
Birds and Blackberries, Panel	205
Cup and Saucer—Birds and Hawthorn	206
Plate—Birds and Blackberries	206
Design for Stein—Birds and Apple Blossoms	207
Fern Dish—Butterflies	207
Poppies and Cherry Blossoms (Supplement)	208
Peacock Feather Motif for Plate Design	209
Turkey Design for Plate	209
Panel—Geranium	210
Eagle Design for Plate or Bowl	211
Flying Geese Design for Game Plate	211
Small Bowls—Byzantine and Aztec Motifs	212
The Crafts	
Art in Pewter continued	Jules Brateau 213-215
Answers to Correspondents	215

LIST OF BOOKS

<p>The Rose Book, containing some of the best rose studies and designs published in Ceramic Studio postpaid \$ 3.00</p> <p>The Fruit Book, containing some of the best fruit studies and designs published in Ceramic Studio postpaid 3.00</p> <p>Composition, by Arthur Dow postpaid 1.65</p> <p>Principles of Design, by E. Batchelder postpaid 3.00</p> <p>Decorative Studies, by J. Foord postpaid 12.50</p> <p>Plant Forms and Designs, by Midgley and Lilley postpaid 2.20</p> <p>Practical Pottery, elementary instruction for students, by Richard Lunn postpaid 2.50</p> <p>Grand Feu Ceramics, a practical treatise on the making of hard porcelain decorated with high temperature glazes by Taxile Doat of the Manufactory of Sevres, France postpaid 7.50</p> <p>Segers' Collected Writings, 2 volumes postpaid 15.50</p> <p>For the Collector:</p> <p style="padding-left: 20px;">Vol. II Old China, bound blue cloth postpaid 2.50</p> <p style="padding-left: 20px;">Vol. III Old China, bound blue cloth postpaid 3.50</p> <p>Anglo-American Pottery, a manual for collectors, by Edwin Atlee Barber, Curator of the Pennsylvania Museum, second edition postpaid 2.00</p> <p>American Glassware, old and new, by Edwin A. Barber postpaid 1.00</p> <p>Marks of American Potters, by Edwin A. Barber postpaid 2.25</p> <p>Pottery and Porcelain of the United States by Edwin A. Barber postpaid 3.75</p> <p>The Lace Book, by N. Hudson Moore postpaid 5.30</p>	<p>Tulip Ware of the Pennsylvania German Potters, by Edwin A. Barber, in paper cover postpaid 1.10</p> <p style="padding-left: 20px;">Cloth, limited edition postpaid 5.00</p> <p>The Primers of the Pennsylvania Museum (two already issued, Salt-glaze ware and Tin-enamelled ware) postpaid, .50 and .60</p> <p>Encyclopedia of Ceramics, by W. P. Jervis postpaid 6.75</p> <p>The Old China Book, by N. Hudson Moore postpaid 2.18</p> <p>The Old Furniture Book, by N. Hudson Moore postpaid 2.18</p> <p>Old Pewter, by N. Hudson Moore postpaid 2.18</p> <p>Chats on English China, by Arthur Hayden postpaid 2.18</p> <p>Chats on Old Furniture, by Arthur Hayden postpaid 2.18</p> <p>China Collecting in America, by Alice Morse Earle postpaid 3.20</p> <p>Pottery and Porcelain, a guide to collectors, by Frederick Litchfield postpaid 6.25</p> <p>French Pottery and Porcelain by Henri Frantz postpaid 2.68</p> <p>Dutch Pottery and Porcelain, by W. Pitcairn Knowles postpaid 2.68</p> <p>Old English Furniture, by Fred Fenn and B. Wyllie postpaid 2.68</p> <p>English Embroidery, by A. F. Kendrick postpaid 2.68</p> <p>French Furniture, by Andre Saglio postpaid 2.68</p> <p>Old Pewter, by Malcolm Bell postpaid 2.68</p> <p>Sheffield Plate, by B. Wyllie postpaid 2.68</p> <p>The Oriental Rug Book, by Mary Churchill Ripley postpaid 3.20</p> <p>Home Furnishing, practical and artistic, by Alice M. Kellogg postpaid 1.65</p> <p>William Adams, an old English potter, by William S. Turner postpaid 8.00</p> <p style="text-align: center;">Keramic Studio Pub Co., Syracuse, N. Y.</p>
---	---

KERAMIC STUDIO

Vol. VIII, No. 9

SYRACUSE, NEW YORK

January, 1907



Extend a New Year's Greeting to our KERAMIC friends with full assurance that they will indeed enjoy this New Year's trip to the work-shop of Henrietta Barclay Paist, of Minneapolis, and that they will find in the West a vigor and originality which will be both instructive and inspiring. The next individually

edited number will be given in March. Margaret Overbeck is also a Western girl, teacher at DePaw Institute, Greencastle, Indiana. In May we return again to the East, our anniversary number being edited by Mr. Marshal Fry of New York.

The next subject for the Class Room will be "Flower Painting" under which heading will be included the subdivisions: Roses, white, pink, and crimson; Violets; Daffodils; Nasturtiums; Geraniums; Pansies; Forget-me-nots. Other flowers, white, pink, crimson, violet, purple, blue, yellow, orange and red. Miniature flowers. Prizes as before.

THE CLASS ROOM—THE ART OF TEACHING.

Second Prize—Sydney Scott Lewis, Georgetown, Ky.

Truly the art of teaching china painting is an art.

To know how to take a piece of china and decorate it, then to be able to teach others how to do it, the teacher of china painting must not only train the eye and hand, but the taste as well, and to so direct it that the pupil will learn not only what is best to decorate for different uses, and how to decorate, but why.

The writer of this article has for six years taught china painting, with but few exceptions the pupils have been beginners, the class generally changing from year to year, only an occasional one remaining long enough to become in a measure an advanced pupil, and the experience so gained may be useful to others, especially in the teaching of beginners. When she began teaching, she was a beginner herself, although having had more training than the young woman who wanted to take five or six lessons "not to become an artist but to be able to teach." She was obliged to do simple things, so naturally the pupils had to begin with simple things also, and gradually, as experience grew, to work up to more ambitious things. This plan has seemed so good to the teacher that even with the gaining of greater experience and confidence this early method has been followed.

The majority of the pupils were boarding school girls who "wanted some pretty things to take home." So it has been a fight to keep to quality of work and not quantity, to stand up for simple conventional designs on table ware, especially to wage war against bunches of flowers painted on the center of plates and dishes. However, as a result of judicious advice and the exhibition of some well chosen pieces, they were generally sent home with a fair amount of cups and saucers, plates and bowls, with

which they will be able to live in peace and pleasure, and out of which they may eat in the same state of mind.

Surely it is best that the would be china painter should have some training in drawing, but if this is not the case, try and alternate painting lessons with drawing, and if that is not to be, by all means keep them to the purely conventional style, teaching them how to make an exact tracing of a design, and how to accurately transfer it to the piece to be decorated.

If one is starting a class of beginners, say six or more, or even a less number, much can be taught them by the class method, at least much of the elementary work. See that each one has a full list of good colors, first class oils and mediums, well selected brushes and an improved palette. The first step is to show them how to mix colors and set a palette. Take one of the palettes and let them watch you mix such colors as they will need for general painting. Let them see a palette arranged "decently and in order" with clean well mixed colors, and impress on them the necessity of this in order to do satisfactory work.

Suppose one of the pupils is to do a set of plates in some simple conventional design on the border, with design wiped out from the tint, filled in with color and the whole outlined. Here is an excellent chance to instruct the entire class in dividing the plate into the desired parts, drawing and transferring the design, mixing and putting on a tint, explaining just the proportion of flux, color, medium or oil required. Have them watch the stroke with which the paint is put on, the kind of brush used, the way to make and handle the pad, the way the tinted surface should look when finished; then the very important step, cleaning out the paint from the design carefully and accurately. Next how to fill in the design with any desired color; then outline (only when the pupil does the work the piece should be fired before outlining), showing them how to take up the paint and hold the brush, in order to make long, even, unbroken lines, calling their attention to the way the piece is held, so as to avoid finger marks and spots on the fresh color. When you are doing the work yourself, be so careful, so neat, that spots and specks will be out of the question. When you make a mistake never hesitate to rub out and begin again, thus setting a good example. When you are working, impress on the students that this is the way you want them to do similar work and the chances are 9 to 10 that they will have followed you so closely in many things that they will be able to bring a piece of work through these steps without much more instruction.

Having them imitate you does not mean that their individuality is not to be encouraged, but start them the right way and their individuality will adapt itself to that just as easily as it would the wrong way. Then as experience comes, let them go at the work by any method by which they can reach the best results. But you will find that their method will more or less follow the teacher's. All well, if they have been correctly started, but, alas! quite the reverse if not.

In this class method teach them to mix and use paste and enamel, to put on gold and silver, telling them Roman

gold is for white china, unfluxed for tinted, etc. Give them a general lesson in the way to wash and put away brushes. Let them watch you put on a grounded color and paint in a background, explaining fully the difference in a ground, a tint and a background. Encourage them to ask questions of you and of each other, and to help each other. Often one will excel in putting on a design, another in grounding a color, another in outlining. Let them help each other over some of these hard places, by showing others how to do what they understand best. It makes them feel that there is something that they really can do, and gives them confidence, and will teach them how to teach, if ever the need be. Show them how to fire a kiln, to stack it and understand it in an intelligent way. Make friends with them and let them feel how personal your interest is in each one. Praise their work when it is good or shows earnest work. Teach them to have a fine enthusiasm for it all, but never allow careless or badly executed work to stand, let them understand that work like that is without merit, and have it taken out, even though it loses the work of days. Teach them that a simple design well placed and well executed is worth all the badly done, overdone pieces, even though they be gay with gold and enamel, that the use of gold is to beautify and not to cover defects, and is only beautiful when rightly used.

If some insist on trying at the first naturalistic work, let them attempt the simplest things possible, on a panel for instance. It is more difficult to select simple naturalistic designs than conventional ones, but if one must have them, most excellent ones are found in almost every number of *KERAMIC STUDIO*. Taken as a whole, often many of them are too complicated for the beginner, but parts of them may easily be worked out by following the directions given by the designers and the advice of the teacher. For small roses Mrs. Safford gives many designs and very explicit directions, follow as nearly as possible her designs and directions.

Of course the class lessons are only to show a few general elementary principles, as they come up from time to time and in such a way that beginners can take advantage of them. The more advanced students have already been taught these things and what they need the most is personal aid and advice, as their work requires. Every teacher of china painting, to be successful, must adapt herself more or less to the individual need of each pupil. There are even in a small class every variety of pupils. There will be the persevering, painstaking, hard-working one, who works for the pure love of it, but who somehow seems never to get along or turn out any creditable work. They just cannot learn how to paint china and yet insist on doing it. There is the pupil who is careless, the one who is inattentive to your instruction, the one who shirks at the hard work, expecting the teacher to do that, the one who is taking lessons to kill time or because her mother wants her to. Then there is the really talented pupil who with time and instruction will make a good decorator but who after a few lessons knows more than her teacher. For all these pupils the teacher needs to put on the armor of patience, perseverance and impartiality. Once in a while, there is the student working for art's sake, careful, painstaking, always willing to do over and over to bring a piece of work to perfection, who may never be doing any very original and brilliant work but always work that can be pronounced good. Then rarely, very rarely indeed, there comes a student both original and brilliant, who will be a joy and an inspiration for the

teacher, and may be a compensation for all less satisfactory pupils.

Many of the best teachers teach entirely by giving private lessons and doing all the work, letting the student watch the entire process from first to last. Generally the pupil watches them through the lesson and then duplicates the piece of work as nearly as possible under their supervision. Instruction in this way is only advisable after one has studied and worked enough to be able to follow one of these expert painters intelligently. But a few hours instruction from them is worth months and months of lessons from less experienced teachers.

A plain, flat piece of china (not too small) is the most advisable for a beginner to start on. A very good piece is a plate, say, a dinner plate. The beginner is to put on it some conventional design on the order of those by Mrs. Price in the *KERAMIC STUDIO*, May 1905, or some of Miss Mason's designs, many of which are to be found in the *STUDIO*.

First make a correct tracing of design, divide plate into the desired number of parts, trace design on plate and outline in India ink. Next outline with a mixture made by using $\frac{1}{2}$ Copenhagen Blue, $\frac{1}{2}$ Banding Blue and a little Black. Fire.

SECOND FIRE

Paint in background $\frac{3}{4}$ Copenhagen Blue, $\frac{1}{4}$ Banding. Mix with enough medium to paint on evenly. When nearly dry, dust with Copenhagen Blue.

THIRD FIRE

Tint the whole plate with Neutral Yellow (mix this with Fry's Tinting Oil) put on as a tint and padded. If desired, dust with Copenhagen Blue.

FOURTH FIRE

Tint whole plate Deep Blue Green.

This treatment gives a charming effect in a soft greyish greenish blue, and, in doing this piece, the pupil is taught to put on a conventional design, to outline, to paint in a one tone background, to dry dust a surface and to put on a tint. The plate is also very effective carried only through the third fire. The designs can also be treated by omitting the outline and painting in the background and wiping out the design, for first fire.

Another simple design is plate in seaweed *KERAMIC STUDIO*, November 1902, carried out in two tones of green and outlined in gold or black. The plate by Miss Smith, *KERAMIC STUDIO*, May 1905, was very easily done by a beginner by doing flowers and border in gold, leaves and stems in green gold, no outline.

For a vase the China Lily design by Emma¹ Ervin *KERAMIC STUDIO*, July 1904, is simple and effective, adapting itself readily to simple vase forms.

In the *STUDIO* may be found any number of tea tiles in conventional designs that are especially recommended to beginners. They are simple in treatment, easy to handle, and may be carried out in color, lustre or enamel. See tile by Miss E. Mason, *KERAMIC STUDIO*, September 1904.

For work in enamel, Mrs. Leonard has given many designs. A cup and saucer, October 1901, may be carried out in various enamels but is very good in blue and green. Also design in enamel by Emily F. Peacock, July 1902.

For lustre, Miss Mason's design for coffee set could be used by a beginner to good effect on a tall straight vase or one shaped somewhat like coffee pot, or on stein. The greatest difficulty would be in tracing and placing correctly the design on the piece of china. After that, outline in black paint, then put on gold where gold is indicated.



NATURALISTIC ARRANGEMENT



SEMI-CONVENTIONAL TREATMENT

(Treatment page 204)

GRAPES

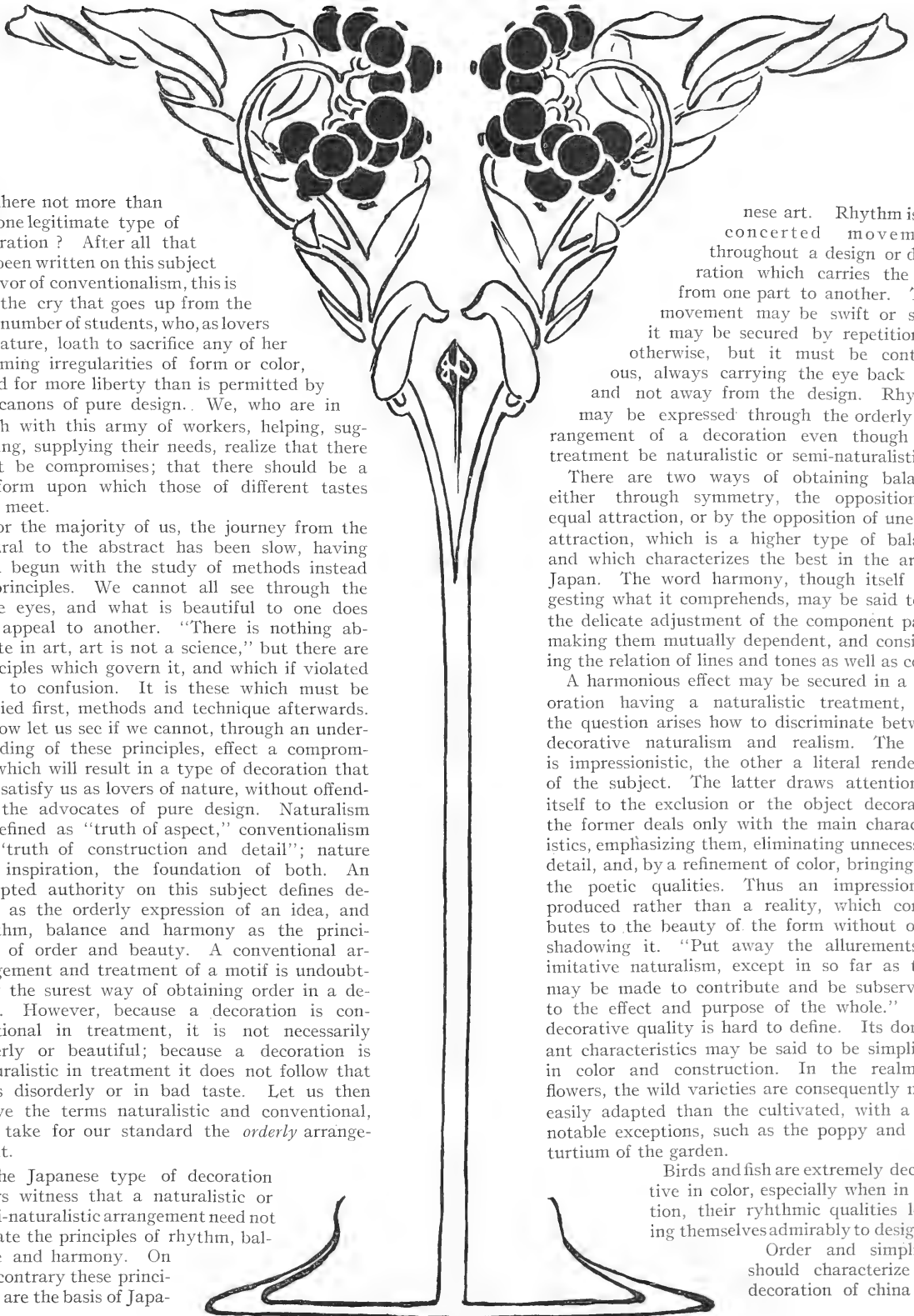

MOUNTAIN ASH

IS there not more than one legitimate type of decoration? After all that has been written on this subject in favor of conventionalism, this is still the cry that goes up from the vast number of students, who, as lovers of Nature, loath to sacrifice any of her charming irregularities of form or color, plead for more liberty than is permitted by the canons of pure design. We, who are in touch with this army of workers, helping, suggesting, supplying their needs, realize that there must be compromises; that there should be a platform upon which those of different tastes may meet.

For the majority of us, the journey from the natural to the abstract has been slow, having been begun with the study of methods instead of principles. We cannot all see through the same eyes, and what is beautiful to one does not appeal to another. "There is nothing absolute in art, art is not a science," but there are principles which govern it, and which if violated lead to confusion. It is these which must be studied first, methods and technique afterwards.

Now let us see if we cannot, through an understanding of these principles, effect a compromise which will result in a type of decoration that will satisfy us as lovers of nature, without offending the advocates of pure design. Naturalism is defined as "truth of aspect," conventionalism as "truth of construction and detail"; nature the inspiration, the foundation of both. An accepted authority on this subject defines design as the orderly expression of an idea, and rhythm, balance and harmony as the principles of order and beauty. A conventional arrangement and treatment of a motif is undoubtedly the surest way of obtaining order in a design. However, because a decoration is conventional in treatment, it is not necessarily orderly or beautiful; because a decoration is naturalistic in treatment it does not follow that it is disorderly or in bad taste. Let us then waive the terms naturalistic and conventional, and take for our standard the *orderly* arrangement.

The Japanese type of decoration bears witness that a naturalistic or semi-naturalistic arrangement need not violate the principles of rhythm, balance and harmony. On the contrary these principles are the basis of Japa-

nese art. Rhythm is the concerted movement throughout a design or decoration which carries the eye from one part to another. That movement may be swift or slow, it may be secured by repetition or otherwise, but it must be continuous, always carrying the eye back into and not away from the design. Rhythm may be expressed through the orderly arrangement of a decoration even though the treatment be naturalistic or semi-naturalistic.

There are two ways of obtaining balance, either through symmetry, the opposition of equal attraction, or by the opposition of unequal attraction, which is a higher type of balance and which characterizes the best in the art of Japan. The word harmony, though itself suggesting what it comprehends, may be said to be the delicate adjustment of the component parts, making them mutually dependent, and considering the relation of lines and tones as well as color.

A harmonious effect may be secured in a decoration having a naturalistic treatment, but the question arises how to discriminate between decorative naturalism and realism. The one is impressionistic, the other a literal rendering of the subject. The latter draws attention to itself to the exclusion of the object decorated, the former deals only with the main characteristics, emphasizing them, eliminating unnecessary detail, and, by a refinement of color, bringing out the poetic qualities. Thus an impression is produced rather than a reality, which contributes to the beauty of the form without overshadowing it. "Put away the allurements of imitative naturalism, except in so far as they may be made to contribute and be subservient to the effect and purpose of the whole." The decorative quality is hard to define. Its dominant characteristics may be said to be simplicity in color and construction. In the realm of flowers, the wild varieties are consequently more easily adapted than the cultivated, with a few notable exceptions, such as the poppy and nasturtium of the garden.

Birds and fish are extremely decorative in color, especially when in motion, their rhythmic qualities lending themselves admirably to design.

Order and simplicity should characterize the decoration of china for



POPPY AND CHERRY BLOSSOMS—HENRIETTA BARCLAY PAIST



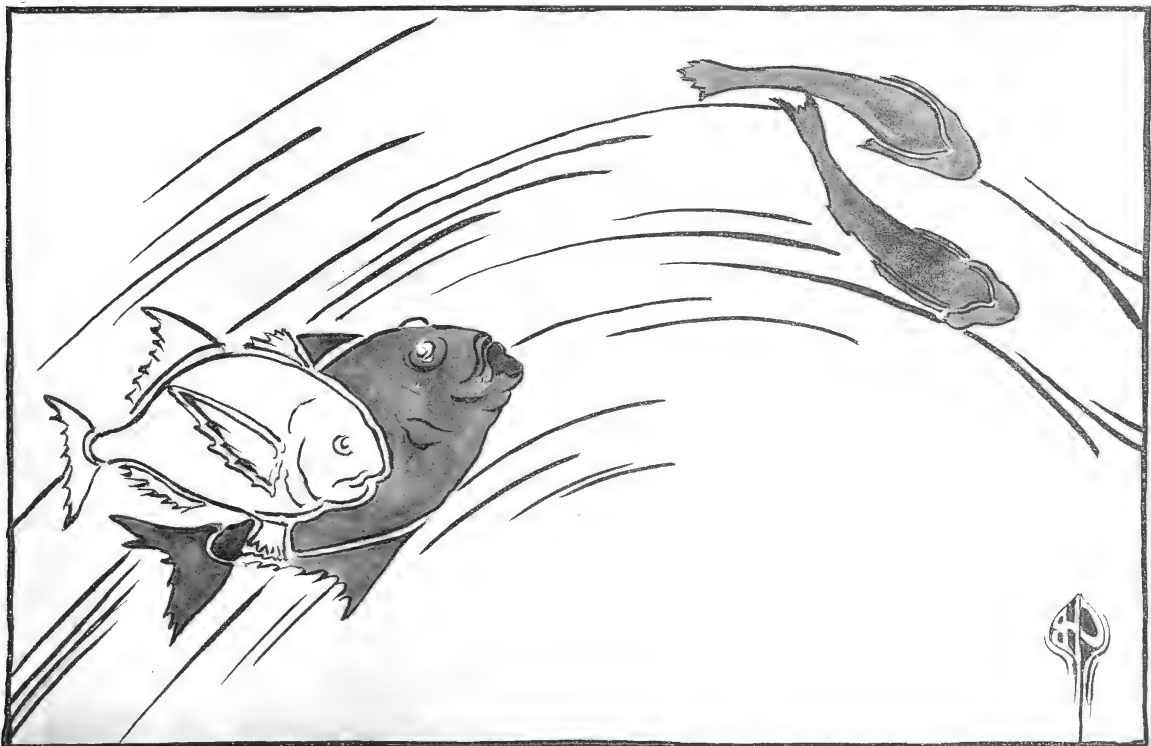

DECORATIVE STUDIES OF FISH

table service and here must be considered not only the effect of the single piece, but of a number of pieces upon each other.

Mrs. Safford's arrangements of the grape motif on page 62 of the July number are interesting examples of rhythm and balance, coupled with a decorative or semi-naturalistic treatment. An orderly and most pleasing arrangement may be obtained by a repetition of one such motif.

Border decorations are particularly appropriate to plates. A pleasing compromise in borders is a combination of the abstract design with a delicate suggestion of flowers in the background. The design tends to hold the flowers in place, and the effect of the whole is orderly. Let us then at least make our decorations more orderly in arrangement and more decorative in treatment, even though preserving entirely the identity of the motif.

So far, we have considered the decoration of objects of use. There is also a class known as objects of art. Here the article should be judged from the standpoint of beauty alone, utility not being considered. Room for interesting experiment thus is afforded in new adaptations and applications, the same principles being carefully observed, for, while art is long, it is also broad, and classifications will multiply to make room for successful experiment.

Considering the illustrations in this number, this article is not likely to be construed as an argument in favor of the naturalistic *as opposed* to the conventional in decoration, rather is it intended to encourage and make room for the conscientious student, who, while not entirely in sympathy with the purely conventional, is nevertheless open to conviction. The desire to make something beautiful is innate, and no effort in this direction should be discouraged, but instead, directed with patience and charity past the mile-stones which mark the development of taste and judgment.

Henrietta Barclay Paist

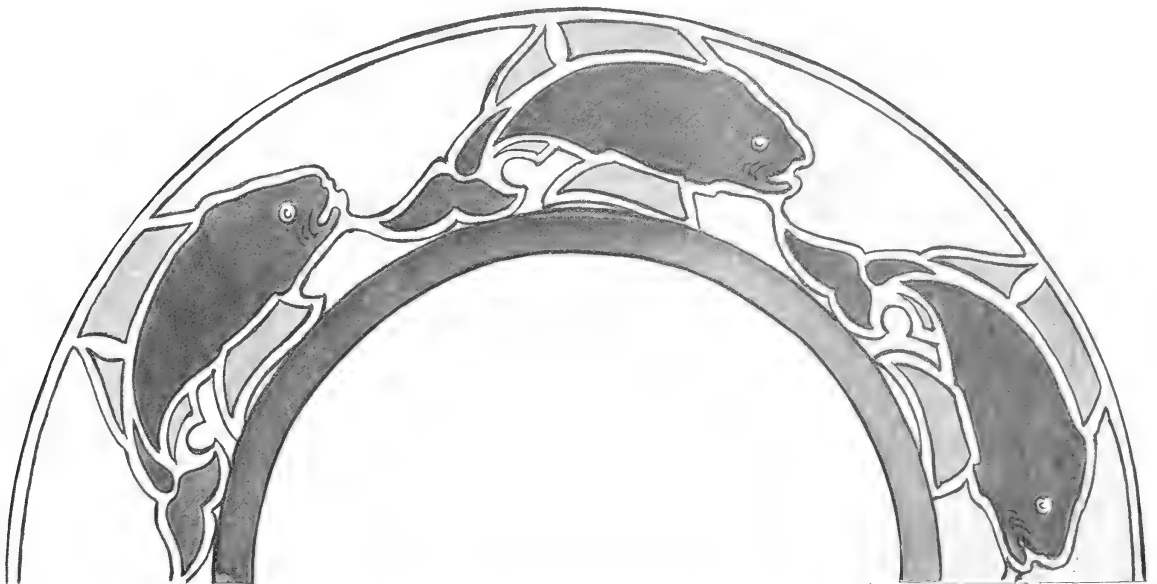

PLATE AND TILE—FISH MOTIF

After placing the design, tint all over with Grey Green, outline with Black and fire. Lay a wash of Grey Green over the finish and make the bodies a tone darker by dry dusting with same color.

The outline is so strong as to suggest a path around the design, this will need a second painting, to strengthen and make it uniform; clean out the eyes and fire. The effect is heightened by a wash of Dark Red or Yellow Green lustre over the whole.

The panels, same motif, are problems in rhythm and balance. The color and treatment same as for plate and tile.



FISH PLATE—HENRIETTA BARCLAY PAIST

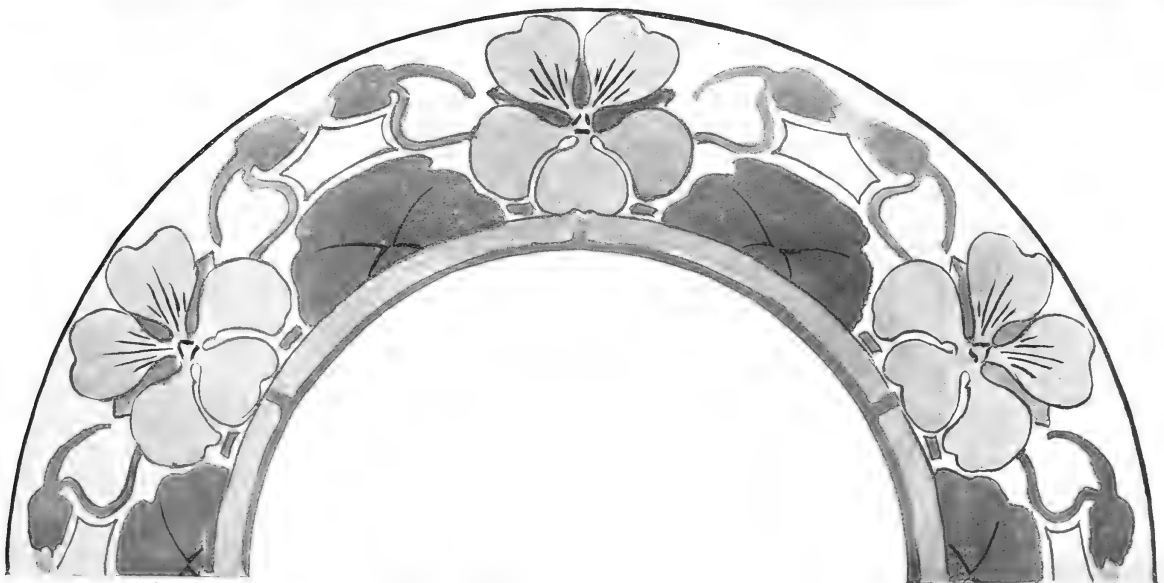
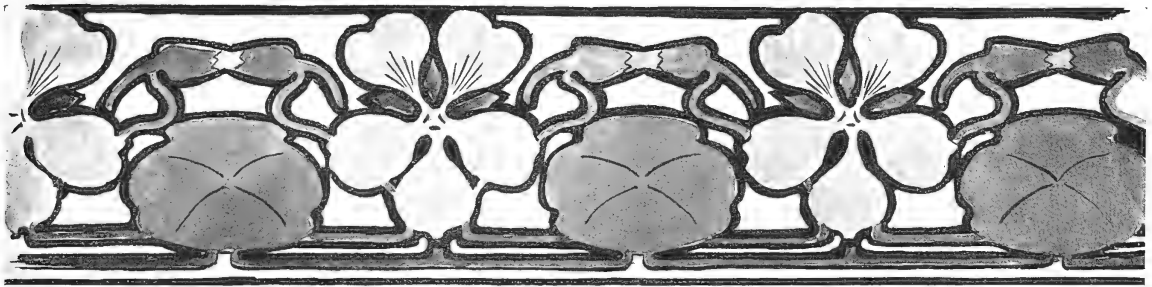

NASTURTIUM BORDERS—HENRIETTA BARCLAY PAIST

(Treatment page 211)

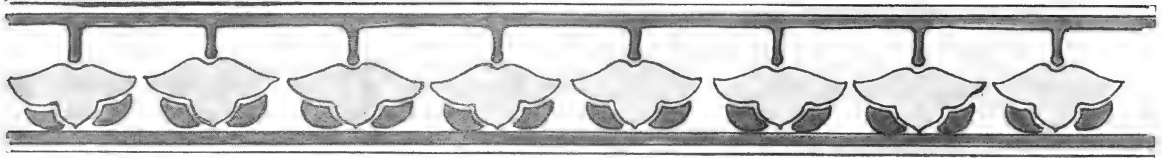

FLAMING BUSH BORDER

GENERAL DIRECTIONS

FOR carrying out the designs a few general directions will simplify and lead to a clearer understanding. In the first place it is understood that the designs, with few exceptions, are traced and outlined on china with India ink before the work is begun. To avoid repetition this is dropped from the individual directions. For outlining, when black is mentioned, Dresden Outlining Black is meant. La Croix Dark Green and Violet of Iron, Dresden Banding Blue and Finishing Brown are satisfactory colors. Outlining may be done either with brush or pen. For delicate lines the pen is best. For strong outlining the brush (a number one tracer) gives the best results. The brush outline expresses more "feeling" than the pen.

Where Neutral Yellow is recommended, Miss Mason's is the most satisfactory, but this color needs thorough grinding. A substitute may be made with a mixture of Ivory or Yellow Ochre and a touch of Black to gray it. If Yellow Ochre is used add a touch also of Deep Red Brown to keep it from turning green. Where Gray Green is mentioned, use the prepared color or, for substitutes, La Croix Dark Green softened with Neutral Yellow and used thin, or Aulich's Olive Green are satisfactory.

The frequent suggestion of the use of Neutral Yellow and Gray Green is because they are so harmonious with the majority of colors. Variety is not so much our aim as harmony, which explains the use of a limited palette.

The promiscuous use of lustres is not favored, but in the painting of butterflies and birds, especially peacocks, the judicious use of lustres will result in the most charming effects.

BORDERS IN FLAMING BUSH, BITTER SWEET AND MOUNTAIN ASH

DEEP Red Brown is used for the Flaming Bush (central plate design) very thin on the calyx and stem and deep on the berry. Blood Red may be used instead for the berry as it is stronger. For the inner band, lay a thin wash of Deep Red Brown with a line of Gold either side.

For the Bitter-Sweet, paint the calyx and stems with Yellow Brown and the berry with Capucine Red. Lay the inner band with Capucine Red (thin), with Gold for a boundary line.

The Mountain-Ash berry is painted with Capucine Red, stems with Olive Green. The color is laid flat in every case and one can with care and practice make one painting do. The outline should be gone over, however, a second time as the color has dimmed the first painting.

TWO BORDERS—FLAMING BUSH

THESE are two different positions of the same motif, and for the coloring of both see directions for this motif in plate border. A gold background is wonderfully effective if used as a border for steins, the outlines in black must be kept sharp and clean, and left for the third firing. The gold will require two coats.

MOUNTAIN ASH DESIGN (Page 198)

FOR the adaptation of this design we would suggest the use of a vase or large bowl or stein. The stem may be abbreviated to suit the height of the piece. For a background for this decoration make a choice between Vandyke Brown, Neutral Yellow and Grey Green. The berries are painted with Capucine Red, leaves and stems in Grey Green. The outlining may be done with Dark Green, Violet of Iron or Black.

The berries are not outlined, but a path is formed around them by letting in the background. If the edges are clean and sharp, no other outline is necessary.

ANCIENT MARBLE QUARRIES RE-OPENED

THE report that a Swedish company has leased the old quarries in Iona Island, and that their famous white and serpentine marble will soon be placed on the market, calls to mind that the quarries were wrought ages ago. Their output, however, says the Westminster Gazette, has long been limited to a few occasional stones for the purposes of charm and local jewelry manufacture.

The altar in the old cathedral was made entirely of white marble, quarried and cut in the island, and, although there is no record of the material being exported, it is surmised that a similar use had been found for the stone in ecclesiastical buildings elsewhere, both in this country and on the continent.

The marble of which the Iona charms and jewelry are mostly manufactured is of a fine pale greenish hue.

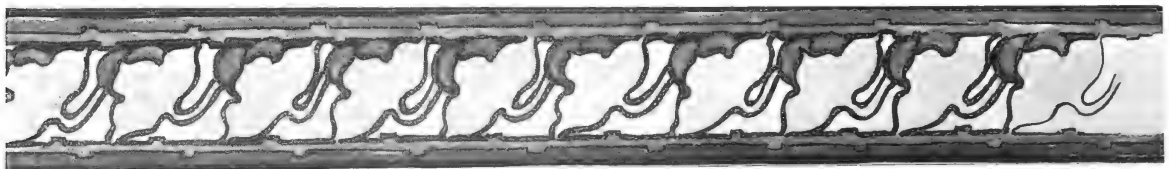

FLAMING BUSH BORDER

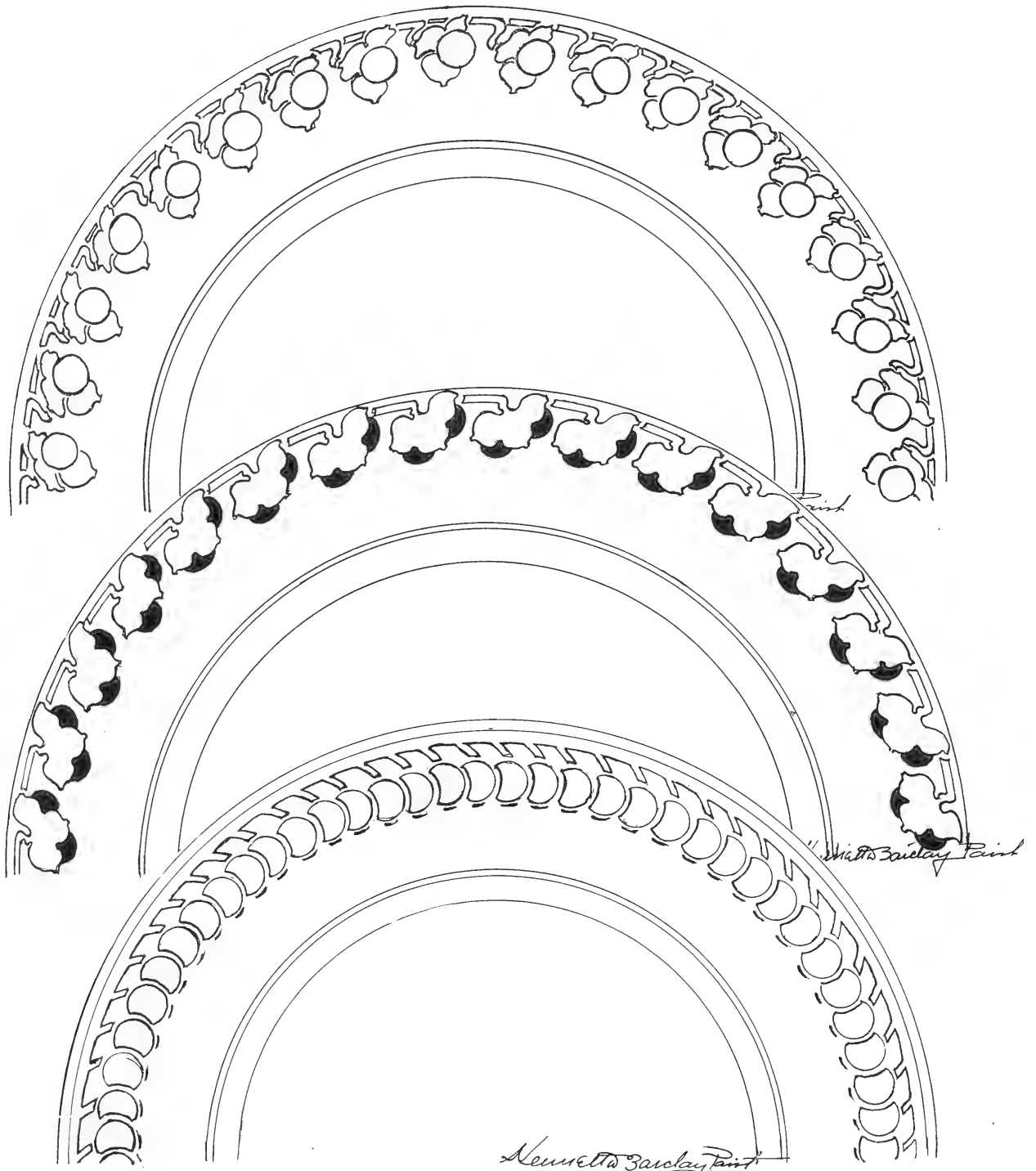
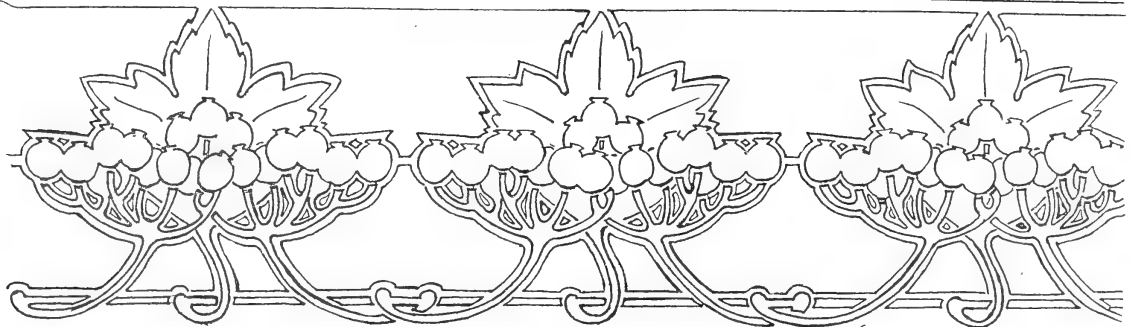

PLATE BORDERS—BITTER SWEET, FLAMING BUSH, MOUNTAIN ASH



Amelia Barclay Taint

BORDER—HIGH BUSH CRANBERRIES

BORDER—HIGH BUSH CRANBERRIES

THE design is intended for a stein, and the treatment is the same as that given for the mountain ash suggested for a bowl or vase. It may also be carried in lustres, Orange Yellow for the berries, Dark Green for leaves and stems, and Yellow for background.



GRAPE DESIGN (Page 197) Naturalistic Treatment

THIS decoration illustrates the suggestion already made of a conventional arrangement carried out with a naturalistic treatment. The decoration repeats three times on the tankard, and may be carried out in any of the natural colors. The values given in the cut would suggest the Tokay grape, the colors for these being Moss Green, Olive Green, Deep Red Brown and Violet of Iron, a thin wash of Copenhagen Blue being laid on the upper left hand portion next to the high lights. This suggests the bloom of the fruit. The stems are carried out in Yellow Brown, and Shading Brown, the leaves as usual in Olive, Moss and Dark Green. The reverse side of the lower leaf where seen, is first modeled with Copenhagen Blue glazed with Moss Green in second painting. The choice of background is between Grey Green, Vandyke Brown or Ivory, or it may be shaded, beginning at the top with Olive Green, and running into Brown Green, and Dark Green at the base.



PANEL OF GRAPES (Page 206)

ONE pleasing color scheme for this panel is in Purple, Yellow and Green. Tint the panel with Ivory Yellow to which has been added one-fourth Lemon Yellow, clean out the grapes and leaves, lay in the grapes and with a flat wash of Purple made by mixing one-half La Croix, Violet of Gold (or any Violet preferred), one-fourth Dark Blue, one-fourth Black, lay in leaves with Grey Green, stems, not too dark, with Dark Brown to which a little Black has been added to grey it. After firing, strengthen the design with the same colors keeping the washes flat with the exceptions of the stems which are accented with the original color. Outline the leaves with Dark Green. Another suggestion for this panel would be a monochrome, using grey green background, pale green grapes and darker grey green leaves.

GRAPES IN TRIANGLE

IN the original design the unit was large enough to repeat five times on a fourteen inch punch bowl. The present size is adaptable to the cups. A suggestion for its treatment is as follows:

The triangular enclosure would be better omitted, as the unit itself is suggestive of that form. Tint the bowl with Ivory, clean out the grapes and leaves, and dry thoroughly. The leaves may be laid in with Olive Green, the stems with Black and the grapes with Green Gold, the veins of the leaves and the tendrils cleaned out and filled with Green Gold. The same treatment is repeated for the second painting, care being taken to have the edges everywhere clear and sharp.

The leaves and tendrils may be outlined with Dark Green, but the grapes are most pleasing with only the path made by the background. This design may also be carried out in two shades of Gold, using Green Gold for the leaves, tendrils and stems, veining the latter with Dark Green, and the Grapes laid in with Roman Gold. In this case the entire design would be outlined with Black, leaving this to the last firing. If the gold scheme is used a still richer effect is secured by tinting the entire bowl with Dark Green Lustre for a third firing.

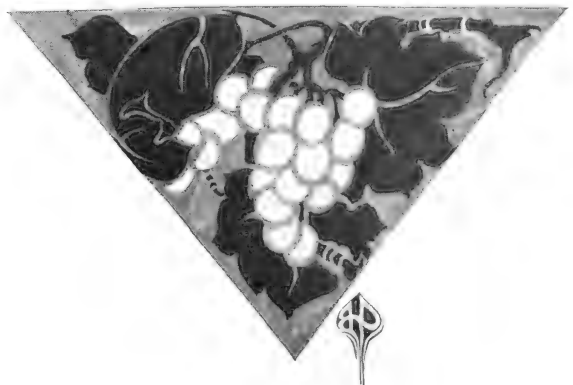



BIRDS AND APPLE BLOSSOMS



BIRDS AND BLACKBERRIES

(Treatment page 208)

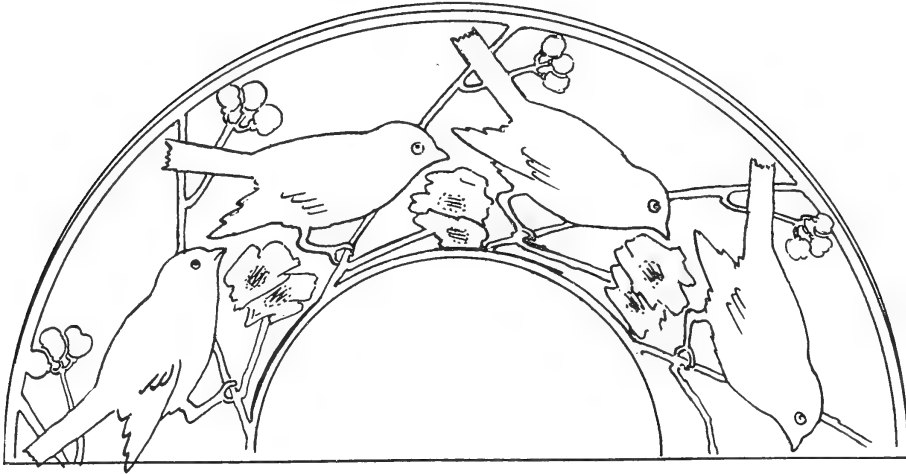

Henrietta Barclay Taint

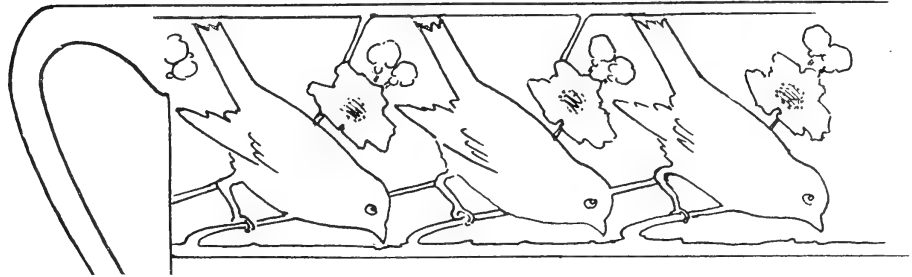

CUP AND SAUCER—BIRDS AND HAWTHORN

(Treatment page 208)

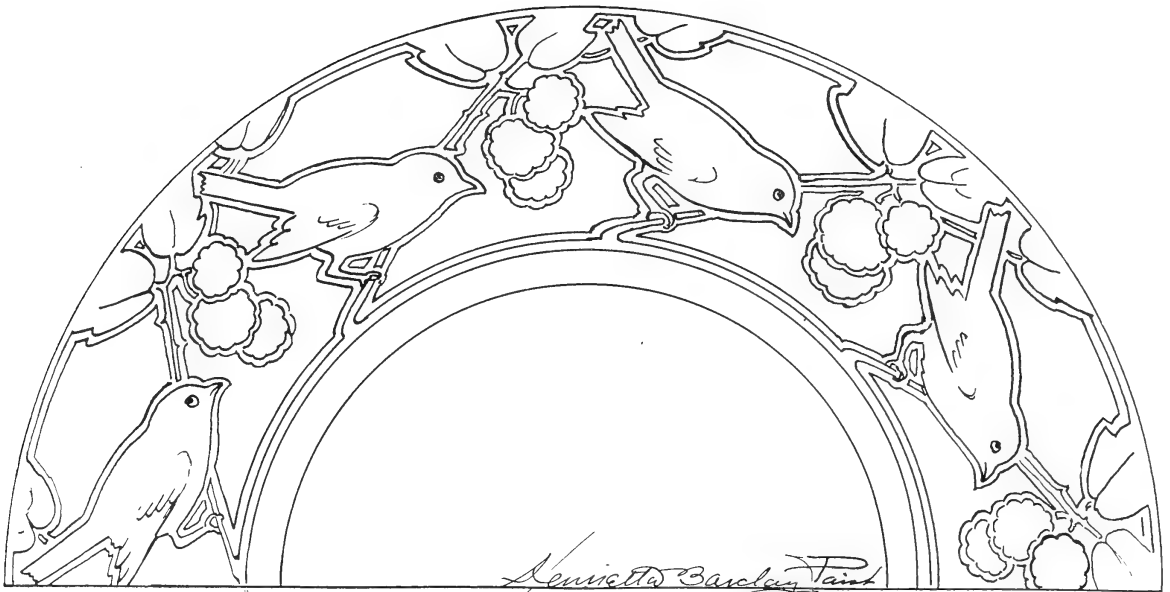

Henrietta Barclay Taint

PLATE—BIRDS AND BLACKBERRIES

(Treatment page 208)

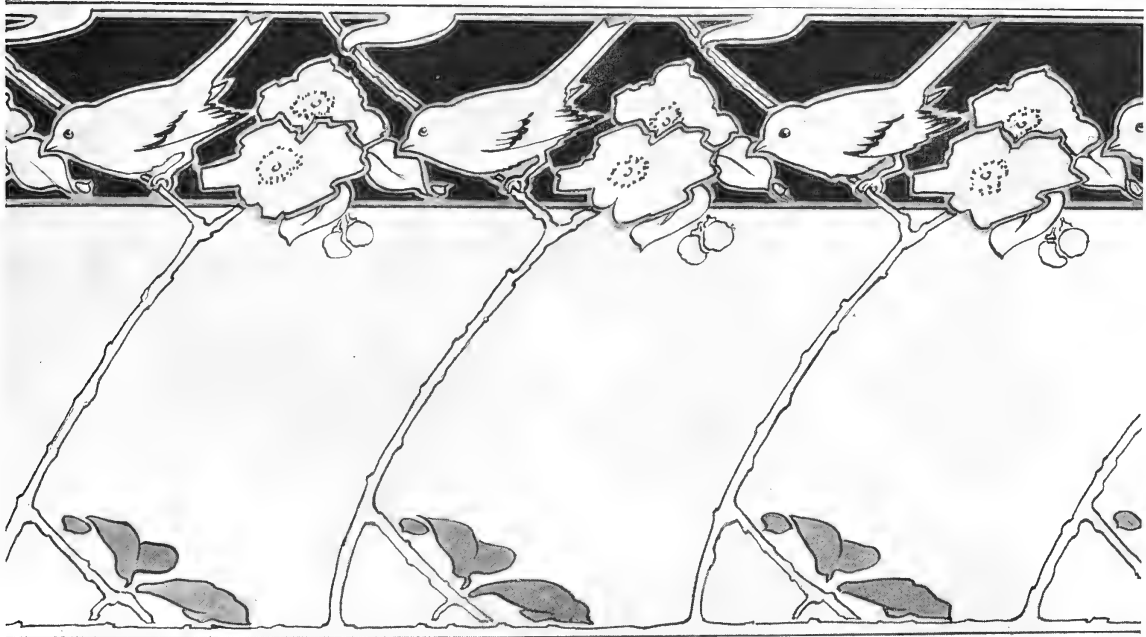

BIRDS AND APPLE BLOSSOMS—DESIGN FOR STEIN

THIS combination of birds and spring blossoms is a happy one, suggesting bird life in its natural surroundings. This little design may be adapted to a stein, cylinder vase or any article severe in outline. Let us choose Black for the band as a background for the yellow birds and pink blossoms, and for the lower portion and space above the band Ivory or Grey Green, stems in a thin wash of

Shading Brown, leaves in Grey Green, two tones darker than background. Paint the birds and center of flowers in Orange Yellow, markings of birds in Black and the flowers and buds in a thin wash of Deep Red Brown. The path around the design is the color of the lower background, the whole outlined with Black. Orange and Black Lustres are effective for birds and background in place of colors given.

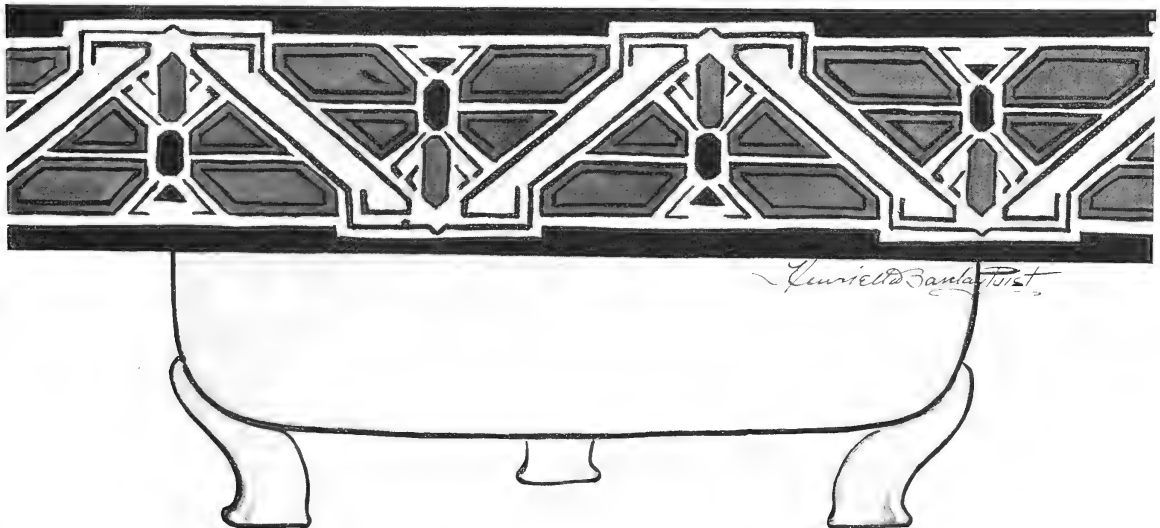

FERN DISH—BUTTERFLIES

THIS design is an abstract rendering of butterfly motif, and because of the use for which it is intended, a treatment in three shades of green is suggested. The body of the dish as well as the background of the unit may be tinted with Moss Green; the wings and the lower part of the body in Olive Green and upper part of the body in Dark Green. The outlining of the legs, antennae and the two bands

confining the border may be either Dark Green or Black. For variation Green Gold may be substituted in place of Moss Green.

The wings will be made iridescent in effect by a wash of Dark Green Lustre, or if Gold be chosen for the background the entire band may have a wash of Green Lustre for the last fire.

COLORED SUPPLEMENT

POPPY PANEL



IN carrying out the treatment for the poppy panel, use Vandyke Brown, Capucine Red, Grey Green and Black.

Tint the panel all over with Vandyke Brown, clean out the leaves, stems, and the pod in the centre of the flower and lay in a flat wash of Grey Green. Paint the stamens with Black, outline the leaves with Dark Green, the flower with Violet of Iron and fire. For the second painting, model the flower with a mixture of Vandyke Brown and one-fifth Capucine Red, strengthen the leaves where they turn over with Olive Green, and the stamens with Black. The effect is more pleasing if the outline is not too sharp.

CHERRY BLOSSOM PANEL

For this background use also Vandyke Brown. For the first firing, tint, cut out the flowers and leaves, and dry. Lay in the leaves with Olive Green, stems with Copenhagen Grey, shade the flowers just enough to separate them and outline with Grey Green. Use a touch of Albert Yellow in the centres, and suggest the stamens with Grey Green.

After firing, strengthen the leaves where necessary, shade the stems with Black, strengthen the stamens and outline the leaves with Dark Green.



PANEL—BIRDS AND APPLE BLOSSOMS (Page 205)

AFTER placing the drawing, tint the panel with Grey Green. Clean out the bird and flowers, paint the bird with Yellow Brown, greyed with Black, and Black markings. For the blossoms, model delicately with Grey Green and touch the edges of the flowers and the buds with Deep Red Brown, use a touch of Yellow in the centres and Yellow Brown for the stamens. Lay a wash of Olive Green over the leaves and a wash of Yellow Brown and Black over the stems.

For the second firing, wash the bird delicately with Yellow Ochre to which has been added a touch of Black. Strengthen the Black markings again, paint the darkest leaves with Dark Green, strengthen the centres of the flowers, accent the stems with touches of Black, and fire.



PANEL—BIRDS AND BLACKBERRIES (Page 205)

LET us choose as a background for this composition a rich yellow. For this mix Yellow Ochre and Orange Yellow in equal parts. The bird will be yellow and black, the Orange Yellow on the breast and head. For the back and wings a mixture of Yellow Ochre and Black, accented with pure Black. The berries are in varying tones of purple and black, using Copenhagen Blue for the lightest ones, modeled with the same. For the darker ones the lights are Copenhagen Blue and the modeling done with a mixture of Dark Blue, Ruby and Black in equal parts. It would be well to suggest an unripe condition in one or two of the smallest berries, this being secured with the use of Moss Green and Olive Green, with a touch of Violet of Iron to suggest the ripening process. The leaves are painted with Moss Green, Olive Green, Dark Green, Violet of Iron and Copenhagen Grey. The reverse side of the leaves painted in the latter color for the first fire, the other leaves

modeled with the first three colors, stems in Moss Green, and shaded with Violet of Iron. In the suggestion of the blossoms after the petals have fallen the center is Albert Yellow, and Moss Green for the sepals, these with the stamens being touched with Violet of Iron.



CUP AND SAUCER—BIRDS AND HAWTHORN (p. 206)

IF this is carried out in mineral color use Orange Yellow for birds, Olive Green stems, a touch of Deep Red Brown or Rose on the blossoms. Lay the background in Green Gold, outlines and flower centers in Black.



PLATE—BIRDS AND BLACKBERRIES (Page 206)

AFTER placing the design with India Ink, tint all over with Neutral Yellow. Clean out the design and the path around the design. Lay birds with Albert's Yellow, leaves with Grey Green or Olive Green, berries with a color made by mixing Banding Blue, Ruby Purple and Black, (equal parts), lay in stems with Yellow Brown, make the path around the design and the inner band with Gold. Be sure that the china is perfectly clean before applying the Gold. Now dry thoroughly and outline with Black to hold the drawing. After firing, the birds may be strengthened by having a wash of Orange Yellow. If the leaves and berries seem weak or uneven in color, repeat the wash, using same colors, lay on a second coat of Gold if it looks thin or uneven. Dry, outline again and fire.

The birds may be painted with Orange Lustre; if this is done, leave the Lustre for the third fire as the outline should be perfect and should have been fired twice before the Lustre is applied.



PLATE AND BAND—TURKEY DESIGN

TINT the borders with Neutral Yellow. After drying shade the birds with Yellow Brown and Shading Brown, leaving the Neutral Yellow for the lightest spots in the tail. For the red part of the head, use Pompadour Red; for the inner band, suggesting grass, the path around the turkeys and the outer border, Olive Green. The outline is Black. After firing, strengthen the color and outlining where they appear to be weak.



INLAID METAL WORK

RECENT advices from England say that Sherard Cowper Coles has invented a new process by which, it is claimed, metals can be burned into one another at a temperature hundreds of degrees below the melting point of any one of the metals, thus enabling new effects to be obtained and also the blending of various metals, which hitherto has been impossible. Inlaid metal work can be produced similar in effect to the finest damascening, or, on the other hand, the process readily lends itself to larger work requiring greater boldness, such as panels.

By a variation of temperature the depth of the inlay can be regulated, and at the same time one metal can be considerably raised above the other, at the will of the operator. Very pleasing effects can be obtained by the process.

—*Jewelers Circular.*

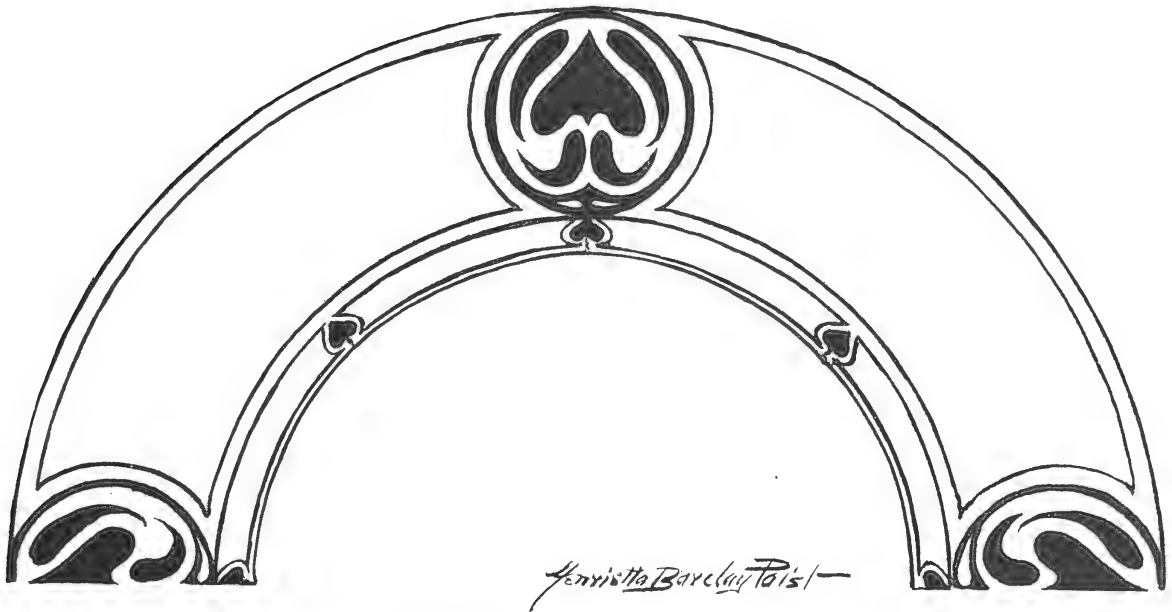

PEACOCK FEATHER MOTIF FOR PLATE DESIGN

(Treatment Page 210)

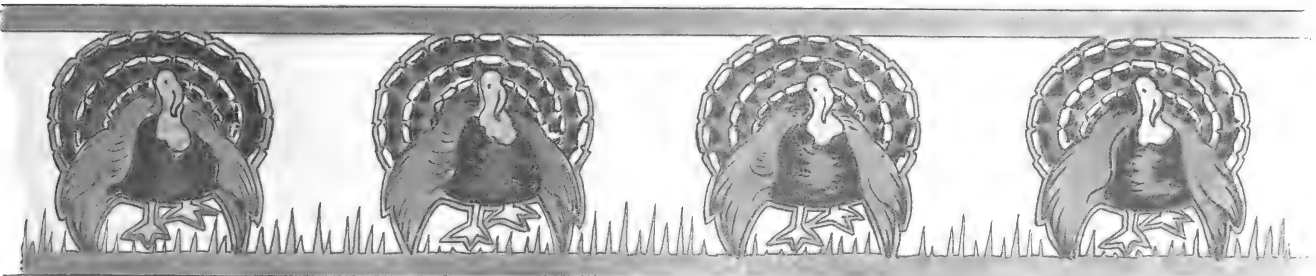
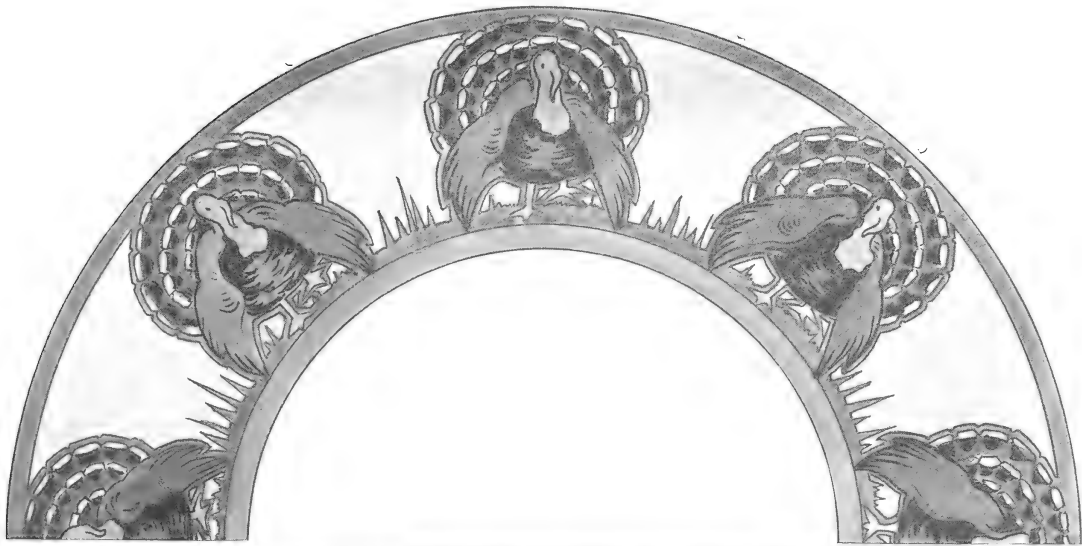

TURKEY DESIGN FOR PLATE



PANEL—GERANIUM

THIS is just a little composition, purely naturalistic in growth, conventional in treatment and quite Japanese in effect. In the original sketch which was twice this size the background was Grey Green, the leaves and stems three tones of Grey Green, the flower a flat wash of Pompadour Red and the branch in Yellow Brown, which had been grayed with Black. The outlines were in Black.

These different panels illustrative of composition may be carried out on china, or in water color on Japanese paper, mounted on some harmonious background, and framed with a narrow molding of black.



PLATE—FLYING GEESE DESIGN

TINT the plate all over with Neutral Yellow, outline design and fire. For the second painting, lay over the birds a flat wash of Yellow Brown, accenting with Finishing Brown and Black. For the part of the background indicated by the darker tone, tint with Vandyke Brown. Outline and fire. If the colors are not strong repeat the directions for second painting and fire again.

PLATE—EAGLE DESIGN

THIS decoration was intended for a ten inch plate, having a two inch border, the inner band being carried into the centre of the plate. This may be done in monochrome in two tones of Copenhagen Grey, outlined with Black, or in two tones of Brown. The unit repeats three times.



PLATE—PEACOCK FEATHER MOTIF (page 209)

AFTER tracing the design, tint the border of the plate exclusive of the design with Neutral Yellow. The central figure of the design as well as the small unit in the inner border are in Black. The light background behind the design is in Moss Green or Emerald Green. The dark spots around the central figure are in Night Green. The enclosing line and all outlines are Black, the panels of the inner band being Moss or Emerald Green. For the second painting strengthen the colors of the design and outline again. This is beautiful in Lustres, using only Black and Dark Green or Yellow Green, with a touch of Orange Yellow in the two little spots at base of unit.



DESIGN FOR PLATE AND BORDER IN NASTURTIUMS

TINT with Neutral Yellow, clean the flowers and leaves, lay in the flowers flat with Capucine Red except where the calyx shows through the petals, touch this in with Albert's Yellow.

For the leaves, use Grey Green, laying flat and not too heavy. The inner band is laid on with Capucine and the stems of Grey Green, cut the band at intervals and form a finish to the lower edge. Dry well before firing and outline with Outlining Black or Dark Green. After firing, repeat the wash on the flowers and leaves, outline again and fire. Any nasturtium color may be substituted for the one suggested, as the background tint will harmonize with all. The soft tan color found in some is beautiful and may be obtained by painting with Vandyke Brown and then dry dusting with Neutral Yellow. Vandyke Brown alone is a good nasturtium color.



PLATE—NASTURTIUM DESIGN (page 201)

THE stem and calyx of the flowers are in Grey Green, the tip of the bud and the inner band are in Capucine Red, finished on either side with Gold, the outlines Black. Neutral Yellow or Yellow Ochre is the best background for these designs.

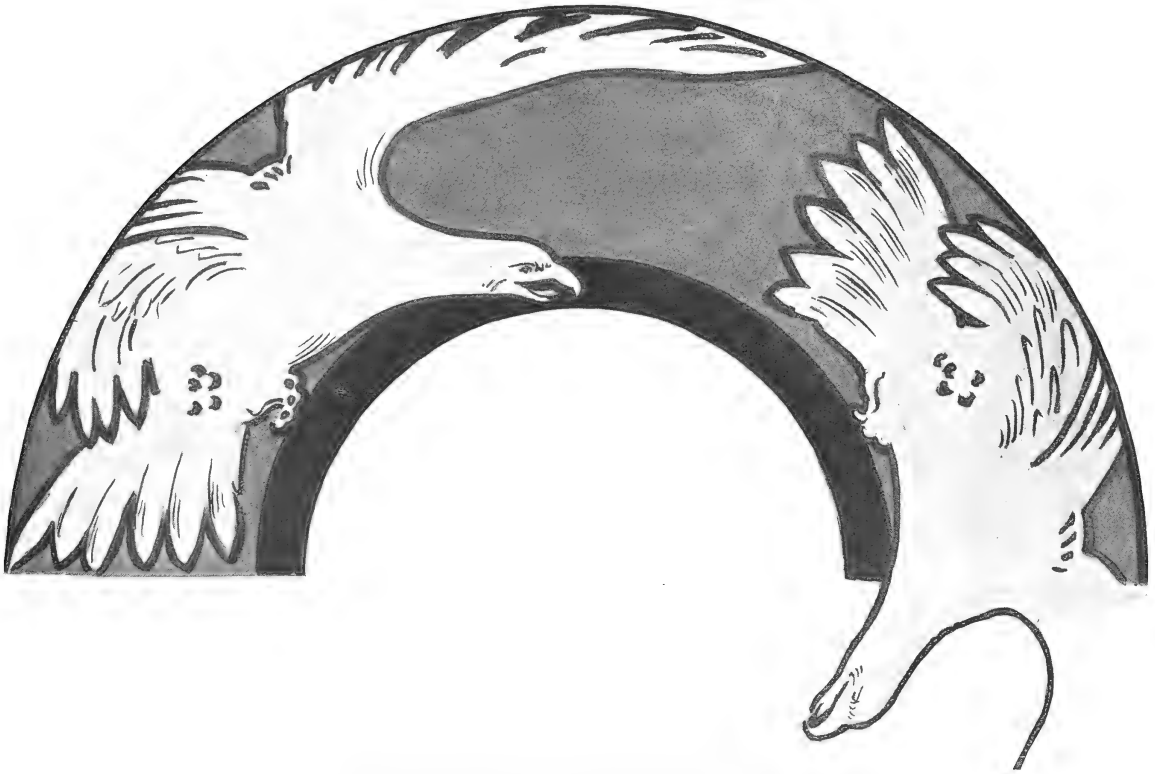

EAGLE DESIGN FOR PLATE OR BOWL

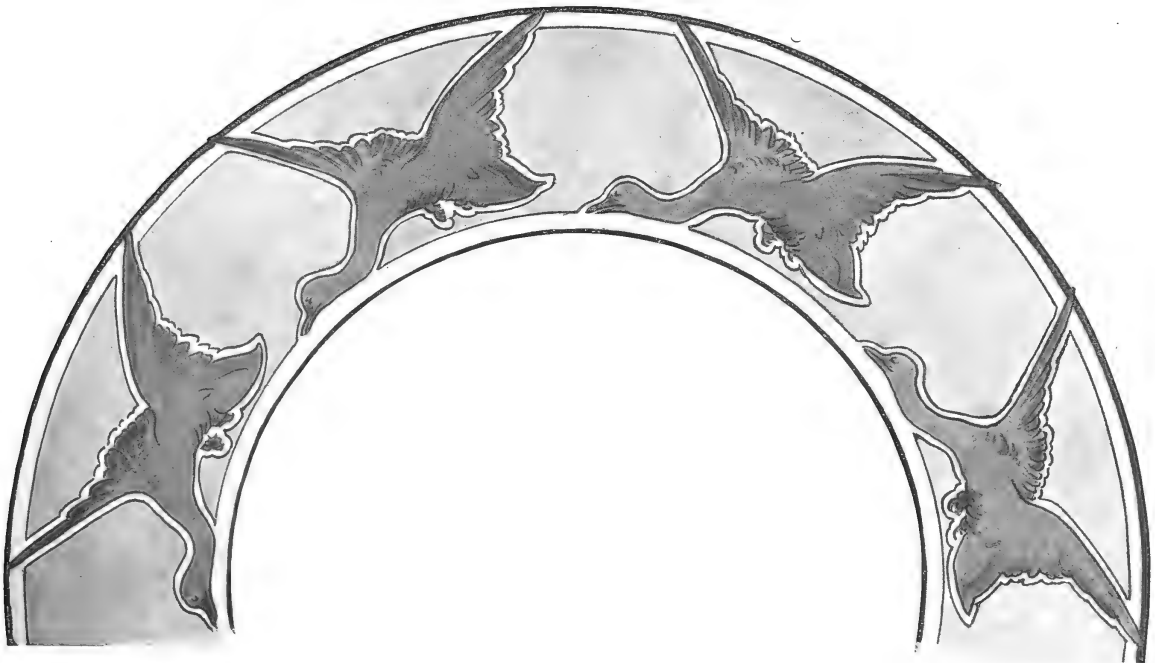

FLYING GEESE DESIGN FOR GAME PLATE

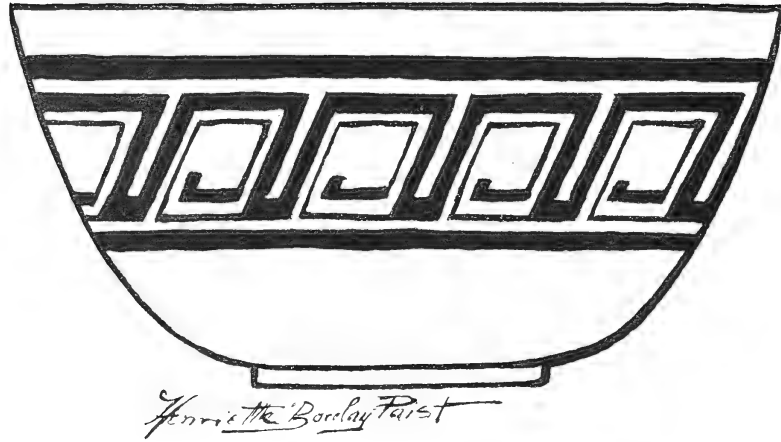

SMALL BOWL—BYZANTINE MOTIF

FOR the little bowl with border suggestive of the Byzantine motif a combination of Green and Black is effective. Tint the bowl with Moss Green, dry dust, and fire. After spacing, lay in a design (free hand) with Black. The inside of the bowl may be lined with Dark Green

Lustre. Another stunning combination is that of Fry's Imperial Ivory and Black. Proceed in the same way as for the Green and Black scheme, by tinting first with Ivory, then dry dusting to darken the color. Tint the inside of the bowl with Orange Lustre.

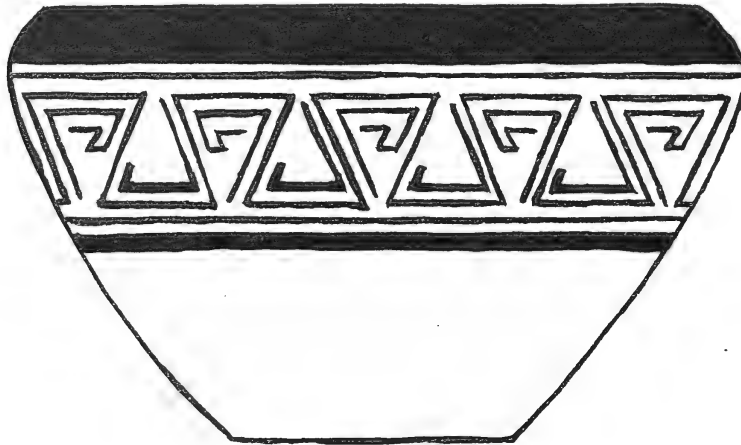

SMALL BOWL—AZTEC MOTIF

THE little bowl with Aztec border is pretty in Ivory and Black. Tint the bowl all over with Neutral Yellow except for the two black bands. Dry, and paint on the design and

bands, and fire. After firing, the Black only will need retouching. A free hand rendering of this design is entirely possible if the bowl is properly spaced before beginning.

THE CRAFTS

*Under the management of Miss Emily Peacock, Room 23, 22 East 16th St., New York. All inquiries in regard to the various Crafts are to be sent to the above address, but will be answered in the magazine under this head.
Summer Address, care of Keramic Studio Pub. Co., Syracuse, N. Y.*

All questions must be received before the 10th day of month preceding issue, and will be answered under "Answers to Inquiries" only. Please do not send stamped envelope for reply. The editors will answer questions only in these columns.



No. 14
Méreaux. Medals, Coins, Insignia in Pewter, XII, XIII, XIV. Centuries—Cluny Museum Paris

ART IN PEWTER

Jules Brateau

(CONTINUED.)

FOR several centuries during the Middle Ages, Western Europe was troubled by wars and internal disorders. There was no security in town or country. The monasteries alone were respected, and there important communities were formed, in which the artisans found a refuge and a place where they might work in peace. Charming objects were executed in these retreats, and it is doubtful whether some of them could have been made under other conditions.

The illumination of manuscripts was one of the mediaeval arts, and we speak of it because tin was used in the process of illumination, in thin pressed sheets; the soft whiteness of the metal showing beneath the interlacing of delicate ornaments. This tin is to-day as bright as when it was applied, while silver would have oxidized.

It was in monasteries that the traditions of civilization were preserved; that letters and arts still flourished in freedom. Thanks to such protection, when peace was finally restored, a galaxy of skilled artisans, sculptors, painters, architects, illuminators, pewterers, and goldsmiths, were ready to work for the newborn *bourgeoisie*, and for a nobility, still restless, but willing to spend its war booty in the decoration of castles.

Security having been assured in cities by the establishment of the Commons, the trade corporations were able

to work in peace. Pewterers fashioned many pitchers, bowls and plates, and, among peasants and people of moderate means, originated the custom of placing on the mantelpiece the utensils of daily use. Out of tin were made the measures for liquids, and other vessels for commercial purposes. Pewterers cast for the middle classes



No. 11
Chalice. Pewter, XIII. Century—Cluny Museum, Paris



No. 12
Salt Altar, Pewter, XIII. Century—Cluny Museum, Paris

many dishes of fine shapes, but simple, and with little decoration. We see nothing yet of the beautiful work which makes the glory of the XVI. century. Notwithstanding an abundant manufacture, we do not find any objects modeled and chased in fine relief. But the great development of the industry at that time led to a perfection and quality of work which we do not find in the earlier periods.

When royal ordinances reserved the use of gold and silver for the nobility, and forbade it to the middle classes, the richer men of the latter station had objects made of pewter, which were both useful and sufficiently decorated to be classed as ornaments. These they placed on dressers, so that the beauty and brilliancy of the pieces might decorate the room in which they held their feasts and gatherings.

In addition to utensils for the decoration of dressers, pewterers made small plaques, called *méreaux*, many of which are found to-day. According to G. Bapst, these *méreaux* varied much in shape, purpose, and decoration; they even passed as money in places where such use was authorized. But their most important employment was as badges for members of societies and corporations, or in the markets as a means of supervision, and on merchandise as a sign of guarantee. Some of them were decorated with the effigy and the insignia of the saint of the church in which they were sold to pilgrims. Inscribed on them were the prayers which the saint had the power to grant, and words in remembrance of the pilgrimage. There

were other *méreaux* representing profane or popular subjects.

Tiny boxes were also made, having handles, and pierced with a hole through which evidently a cord was passed, by which to suspend them. As these boxes are often delicately decorated in interesting relief, the constant handling and rubbing has given to the salient points



No. 15
Insignia in Pewter, XV. Century. (Abbaye du Mont St. Michel—Ed. Corroyer)

a brilliancy of charming effect, while the background has remained dull.

The production of these pewter objects being easy, their manufacture was extensive. In France, as well as in Germany, where the pewter industry became of great importance, the rules of the "Corporation of Tin Potters" were modified or increased as needs required, and when-

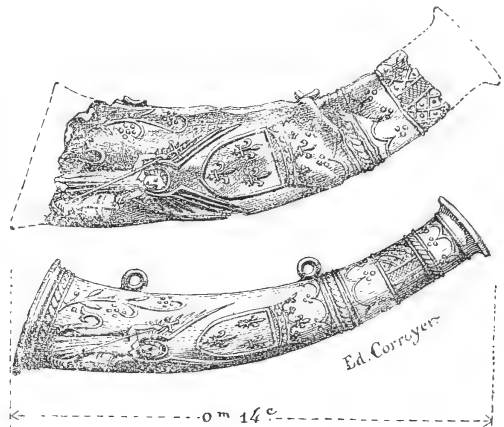

No. 16
Pilgrim Horns. Pewter, XV. Century. (Abbaye du Mont St. Michel—Ed. Corroyer)

ever new objects were manufactured, which had not yet been made of this material. These rules became more and more strict, and there were even some which related to affairs outside the workshop. The master or chief of the workshop was selected after a competition in which he was expected to produce a master piece. The artisans were called "valets."

The book of rules for the different trades controlled by the Corporations was written by Etienne Boileau (1254-1270), but from this it does not follow that pewterers had no rules of their own before that time. They were, it is

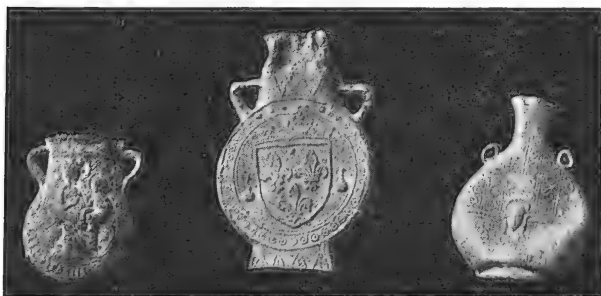

XIII. Century. XIV. Century. XVI. Century.
Small ampullae. Pewter. Traces of gilding found on the XVI. century ampulla
Cluny Museum, Paris.



No. 17

Pilgrim bell, pewter, XVI. century (Abbaye du Mont St. Michel. Ed Corroyer.)

true, well scattered over the country, or had taken refuge in monasteries, as already mentioned. Still, if for this reason we find few documents, many small facts and local details reveal to us the existence of an organized industry, which becomes easier to study after these troublous times.

If the XIV. and XV. centuries have left us few specimens worth reproducing, such is not the case with the XVI. century, which, with its unrivaled production of master pieces, has forever ennobled the beautiful metallic



No. 19

Ampulla, pewter, XVI. century. Louvre Museum, Paris.

composition called pewter. We could give an uninterrupted list of charming articles of this period, having harmonious proportions, and notable for fine chasing, and for well conceived decorative designs.

All the museums of Europe possess art work in pewter, those of Nürnberg, Munich and Breslau containing a great variety of specimens. Collections are found also at South Kensington, in the Cluny Museum, Paris, and at the Louvre, where the examples, although few in number, are of excellent quality. The Nürnberg Museum alone, by the variety of its specimens, could illustrate the



No. 20

Box for Holy Oils, pewter, XVI. century. Louvre Museum, Paris.

whole subject of artistic pewter. The last named collection is especially remarkable for an abundance of drinking vessels, pots, tankards, steins, etc.; the production of the Nürnberg pewterers of the XV. and XVI. centuries, the most prosperous period of the industry, being here fully represented, although the quantity of the examples quite obscures the quality of a few really fine pieces.

(TO BE CONTINUED)



No. 18

Ciborium, pewter, XIV. century. Louvre Museum, Paris.

ANSWERS TO CORRESPONDENTS

C. K.—Ruby is very liable to flake off if painted too thickly or subjected to repeated firings. It is almost impossible to remedy flaking as each repeated fire is liable to bring new flakes. The only thing to be done is to remove all flakes with a pen knife and repaint and refire, hoping for favorable results. The powdered colors for china are sold by many of our advertisers whose names you will find in our advertising columns, they are all good. Directions for using will be found in the October 1905 KERAMIC STUDIO. "The color palette and how to use it."

H. T.—Your inquiry came too late for the December KERAMIC STUDIO. We have been promised some articles on under glaze painting which will be published as soon as received.

Mrs. R.—In rubbing down old hard paints, use a little more oil of cloves than for powder colors, say 2 drops to 6 of Copaiba. When the oil has separated from the color, take it out on blotting paper and then mix the balance with clove and Copaiba; oil of lavender can be used in place of turpentine to keep color open longer.

Plattens are used to place or rest on top of cups bowls, etc., so that other pieces may be placed upon them which otherwise might not balance.

M. M. C.—Unfluxed gold may be used over unfired color which is well dried, care must be taken that the gold is not too thin or oily, otherwise it will spread. You can not tint with flux or ivory glaze over a painting in which the iron reds are used, especially flesh tones in which the tints are delicate, the glaze will eat out the reds. A hard fire would probably bring an even glaze over the painting and if the flesh tones paled too much they could be restored by repainting, while in the case of too much flux or glaze it would be next to impossible to restore the reds by repainting.

A. J. L.—So many shapes of china are illustrated in KERAMIC STUDIO it is impossible for us to know where they may be obtained. Write to our advertisers.

In following a color treatment where the ornament is light green, also the background, the ornament may either be in enamel or a shade lighter than ground, with the gold outline it will be distinct enough from the ground.

We do not keep anything for sale except books on art and KERAMICS. Write to our advertisers for the green bronze mentioned.

Franz A. Bischoff

Begs to announce his removal to Los Angeles, Cal., where he will continue the manufacturing of colors for china.

High Grade Specialties

Dealers are asked a favor, to secure their stock by placing their order early to save shipping expense and delay.

We have made arrangements with Favor, Ruhl & Co., of New York, and L. B. King & Co., of Detroit, Mich., who will take pleasure in filling all orders, if quick shipment is desired.

Thanking my patrons for past favors, I hope for future continuance; address all communications

FRANZ A. BISCHOFF,

Los Angeles, - - - California

Mineral Transfers

For China Decoration in all its Branches



PALM, FECHTELER & CO.

80 FIFTH AVE.,
NEW YORK.

45 LA SALLE ST.,
CHICAGO.

1st NATIONAL BANK
EAST LIVERPOOL, O.

Apply to Your Supply House for Samples and Information.

The Ceramic Art Importing Company

Of Toronto, Canada

Have opened with a full stock of everything required by ceramic artists.

- † Their importations of White China for decorating include Belleek, French, German and Austrian, in all the newest shapes and designs.
- † Their stock of Paints, Lustres, Roman and Colored Golds, is most complete.
- † A large assortment of Mineral Transfers, Brushes, Oils, Mediums, etc., etc.
- † Mail orders will receive most careful attention.

181 Yonge St., Toronto, Canada

KUT-PRICE-KATALOG

ARTIST'S MATERIALS

LEE ROESSLER, 116 S. High St. Columbus O

T. & V. CHINA AND HAVILAND & CO.'S RANSOM

A full line of Austrian Novelties in White China. Shirt Waist Buttons 40 cts. a dozen delivered at your homes. Gold Plated Backs at \$1.50 a dozen. We deliver Fry's Paints and Sherratt's Gold. We have no catalogues, but will send you a sample barrel full of novelties upon request with references.

HUDSON CROCKERY COMPANY,

Dept. D

349 So. Salina St., Syracuse, N. Y.

WILLET'S' BELLEEK CHINA

For Amateur Painters can be had of Dealers in over 600 different shapes.

Catalogue sent on receipt of three cents postage.

THE WILLET'S M'FG CO., Manufacturers
TRENTON, NEW JERSEY.

ESTABLISHED 1887

FRANK DOEHLER

WHITE CHINA AND ARTIST MATERIALS IMPORTER

New prices on hat or brooch pins complete. Special prices in gross lots.

Also baby or large bar pins complete.

Doehler's Block, Rochester, N. Y.

211-213 Clinton Ave. North. One minute walk from N. Y. C. station.

KEEP THE FIRE ALIVE.

KERAMIC STUDIO

CONTRIBUTORS

F. B. AULICH	✥	✥	✥	✥	✥	✥	✥
MRS. J. F. CAMP	✥	✥	✥	✥	✥	✥	✥
D. M. CAMPANA	✥	✥	✥	✥	✥	✥	✥
A. A. FRAZEE	✥	✥	✥	✥	✥	✥	✥
IDA M. FERRIS	✥	✥	✥	✥	✥	✥	✥
MAUD E. HULBERT	✥	✥	✥	✥	✥	✥	✥
SARAH REID McLAUGHLIN	✥	✥	✥	✥	✥	✥	✥
EDITH ALMA ROSS	✥	✥	✥	✥	✥	✥	✥
K. SODERBERG	✥	✥	✥	✥	✥	✥	✥
JEANNE M. STEWART	✥	✥	✥	✥	✥	✥	✥
BELLE BARNETT VESEY	✥	✥	✥	✥	✥	✥	✥
MISS "VIRGINIA"	✥	✥	✥	✥	✥	✥	✥

FEB. MCMVII

Price 40c. Yearly Subscription \$4.00

A MONTHLY MAGAZINE FOR THE POTTER AND DECORATOR.

JAN 28 1907

The entire contents of this Magazine are covered by the general copyright, and the articles must not be reprinted without special permission.

CONTENTS FOR FEBRUARY 1907

	PAGE
Editorial	217
League Notes	Belle Barnett Vesey 217
The Art of Teaching—3d Prize	218-220
The Art of Teaching—4th Prize	220-224
Azalea	Edith Alma Ross 219
Roses	Mrs. J. F. Camp 221
Chrysanthemums	Maud E. Hulbert 223
Gladioli	Maud E. Hulbert 223
White Clematis	Ida M. Ferris 225
Study of Squirrels from The Vorbilder	K. Soderberg 226-227
Squirrels by Prof. G. Sturm for The Vorbilder	227
Yupon Berries, Bowl and Plate	Jeanne M. Stewart 229
Jacqueminot Roses (Supplement)	F. B. Aulich 230
Scotch Roses by "Virginia"	230-231
Crab Apples	Sarah Reid McLaughlin 232
Aster Design for Vase	A. A. Frazee 233
Eve—Decorative Plaque	D. M. Campana 233
Answers to Correspondents	233 and 238
The Crafts—Exhibition of National Society of Craftsmen	234-235
Work of Pratt Institute Students	236-238

THE GEO. H. BOWMAN CO

39 Murray Street, New York

WHITE CHINA FOR DECORATING

Import Lines Now Ready

We have a splendid line of up-to-date samples on display at the above address which you cannot afford to overlook when in New York.

We can fill orders for immediate delivery from our Cleveland Store, where we carry a large stock of French and German White China.

KERAMIC STUDIO

Vol. VIII, No. 10

SYRACUSE, NEW YORK

February, 1907



REQUESTS, now and then, are received from subscribers asking that designs be given on the shapes for sale in the stores, as it is difficult for them to imagine putting any given design on anything but the shape illustrated. This general lack of imagination is a serious problem with which we have to contend,

as we can only repeat the suggestion to our designers, but must accept designs on whatever shape is submitted. We are under the necessity of publishing what designs we may be able to secure at whatever time we may be able to secure them. We cannot go out into the woods with our little shot gun and bag exactly what each subscriber desires at exactly the moment it is desired. As a matter of fact, what is the advantage of having a design displayed on any particular shape? The drawing is necessarily flat and can not, as a rule, be directly applied to any shape. One *must* exert one's intellect sufficiently to adapt a flat design to a round surface. Then what advantage if it is shown on a cream pitcher, say, of the Ransom pattern, instead of as a straight border to be adapted to anything? A curve more or less on the rim or a curl more or less on the handle cannot be taken into account in designing when the designer wants to give a suggestion to be used wherever desired on whatever shape one may select. Probably if that design were shown on the aforesaid Ransom cream pitcher the majority of our subscribers would not immediately purchase cream pitchers of that pattern in order to use the design, but would either have to struggle with the problem of disengaging the design from that particular shape and applying it to some other, or would be reduced to the same condition as those who make this request, the condition of being unable to use it at all.

To tell the truth, personally we prefer the designs shown on some simple form suggested by the design, as it helps our readers to form good taste in selecting shapes as nearly like the design as possible. This will stimulate the factories to make better and simpler shapes, to fill the demand, and so an educational feature is introduced while no advantage is lost, as it would be a real injury to our subscribers to deprive them of the necessity of using their brains. One should rather "wear out" one's thinking apparatus by use, than let it "rust out" by having no occasion for thought.

+

On the color supplement of the January number the title "Cherry Blossoms" was given to a panel of Hawthorn Blossoms. The artist notified us of the mistake when too late to change it, so she kindly gave the treatment for Cherry Blossoms, as the color scheme is identical, and so took upon herself the onus of the mistake, which is manifestly unfair. So far no one has called our attention to the misnomer. But we can not hope to escape the vigilant eye of our critic. We wish to apologize in advance and at the same time suggest to our contributors that

they would kindly label their studies or designs so we would have no excuse for mistakes.

LEAGUE NOTES

Ranged around the walls, grouped in nooks, alcoves, and in mid-floor cases, at the exhibition of arts and crafts held in The Art Institute, Chicago, during December, were over a hundred pieces of decorated porcelain, and more than two hundred pieces of pottery, silent testimonies of truth, beauty, and harmony. We viewed these expressions of experience, gained in a few short years, with reverence akin to awe. A joy of what we are to accomplish, "like tumultuous music, surges through every vein." No longer need we feel depressed at the heroic efforts of Palissy or the misfortune which proved the success of Wedgwood. We need not grieve over the tiles of Granada, nor believe that the present and future hold no such glories as the past. Already we have glazes which suggest the mystic, prismatic colors of the rainbow, and the velvety blue green mouldy look seen on ancient ware, and are fully up to the times in form and design. There were no silent deceptions, no great effort resulting only in sham, no plagiarisms. There was only *truth* uniting *use* and *beauty*. Foreigners questioning about ceramics, were incredulous when told that all were American productions, by people who had not even studied abroad. A lecture on "Recent developments in American pottery," was given during the exhibition, followed by introductions to the lecturer and light refreshments in the pottery section. Public admiration is abundant; artists are sympathetic. The value and sacredness of this new career of power open to the ceramist must not be underrated. Every advantage for more knowledge should be seized, our failures turned to success. We should not be content until the art world is apace with the commercial and scientific world of to-day. No duty should crowd out the problems for each month. There is still a week in which to send the designs for the cake plate. Letters containing vase shapes, numbers, and more explicit directions will soon be mailed to each member, as we have not the outlines for this issue of *KERAMIC STUDIO*.

BELLE B. VESEY, Pres.

EXHIBITION NOTES

The New York Society of Ceramic Arts will hold an exhibition of the work of its members from April 1 to April 15, 1907 in the galleries of the National Arts Club, Gramercy Park, New York.

The fourteenth annual exhibition of the Brooklyn Society of Mineral Painters, held at the Pouch Gallery, December fourth and fifth showed interesting progress in the work of the society. Original designs in water color applied to ceramic forms were displayed by the members of Miss M. M. Mason's class in design.

The officers of the society are: Mrs. James Masterman, President; Mrs. Theodore Field, Vice-President; Mrs. Eugene L. Hale, Recording Secretary; Miss B. H. Proctor, Corresponding Secretary; Mrs. Frank Baiseley, Treasurer; Mrs. M. F. Prince, Historian.

THE CLASS ROOM

The next subject for the Class Room will be "Flower Painting" under which heading will be included the subdivisions: Roses, white, pink, and crimson; Violets; Daffodils; Nasturtiums; Geraniums; Pansies; Forget-me-nots. Other flowers, white, pink, crimson, violet, purple, blue, yellow, orange and red. Miniature flowers. To be received not later than March 1st. For list of prizes see back cover.

o o o

THE ART OF TEACHING

Third Prize—Mrs. Dante C. Babbitt

THE teacher of ceramic art has more to contend with, I believe, than in any other branch of art. One of the greatest difficulties is that about ninety-nine per cent of the persons who attempt china painting, to use their own expression, "can't draw a straight line." When one considers that the average teacher endeavors to teach drawing, composition, coloring and the handling of china paints and their mediums all on one piece of china, it hardly causes wonder there is so much poor work seen. The fact that a pupil cannot sketch his or her own design does not necessitate the teacher doing it for them. *Insist* on a pupil's *honest* effort to sketch her designs at the very start. It is taken for granted every one taking up china painting expects to become an independent worker and sketching is the first step. Personally I prefer conventional work, but as taste must be trained and not forced I do not insist on pure conventional in direct opposition to a pupil's taste. Generally speaking one does his best work where his interest lies. Quite often the devotee to floral and other naturalistic designs will in reasonable time see the superiority of a well chosen conventional design. I impress upon pupils the value of having the necessary materials to work with and having them with them. It is hardly satisfying to ask for a bit of clean silk for tinting and either have a rumpled piece given you or be told they forgot it at home and then comes the borrowing habit which cannot be too severely frowned upon in a studio. Aside from the materials used there are a number of little conveniences within the reach of all. Plenty of soft, clean rags, cut, in preference to torn, on account of lint, in medium sized pieces, for cleaning brushes etc. A firm but soft piece of china silk washed and ironed free from all wrinkles, as the least crease in a silk pad leaves its mark on tint. This silk may be used indefinitely by washing before the paint sets and either ironed or while still wet smoothed out on a window. A separate box for brushes amply long to prevent the brush being crowded and, if care is taken to put them away clean and dry, good brushes will last a long while. An occasional wash in soap and water is good for them. Show a pupil how to gently roll a brush from side to side instead of pouncing up and down. The latter method breaks the fine hairs of which the brush is composed and shortens its time of usefulness.

A perfectly plain coupe plate is the best piece for a beginner. If your pupil prefers naturalistic designs, by the aid of a narrow border say three-eighths or three quarters according to size of plate, a certain style may be obtained not found in a purely naturalistic treatment. After drawing the line for the band, sketch the design. I prefer selecting half a dozen designs a pupil would be most liable to handle successfully and allowing them to select from that. It saves their time and is less confus-

ing than going through dozens of designs entirely beyond them. For a medium size plate, say six and a half or seven and a half inches, draw a line for a band three-eighths or one half inch wide. This may be done with a bander or by holding a slip of paper tapped over the edge of the plate and using the inner edge for a guide line. Care must be taken not to slip the paper except to move around or the band will be of uneven width. Use a fine liner No. 0 and India ink for drawing this. After your design is sketched and painted this line should be gone over in gold before first firing. In the second firing a tint that will be pleasing either through force of harmony or by contrast should be put on before retouching the inner design, and any color which pads over the gold line thoroughly cleaned before beginning to retouch. The little fruit designs by Sara Wood Safford could be made into a very pleasing fruit set. The strawberry design in July 1906 number is good, also a study of grapes of some months before.

Then there have been so many black and white studies of small fruits it would not be a difficult matter to make a simple and charming set of small plates. A border tint of rich Old Ivory would harmonize well with such a set. For the third fire any simple design could be used over the tint very effectively. I would suggest using one design for the entire set. In the March 1906 number is a toilet set by Edith Alma Ross. The mirror back is very suitable for a plate. The dark parts would be rich in a deep blue having a high glaze. The lines should be gold. The Ceramic Supply Co., of Indianapolis, have a good blue for the purpose, Royal Shading Blue. Aside from the dainty violet design in that study little sweet brier roses, lilies of the valley, butter cups, forget-me-nots and baby roses would make a good set, keeping the border the same throughout.

If one contemplates doing the set it is a good plan to draw in border on all and tint at the same time. One is more liable to secure exactness of tone. As soon as possible give beginners some simple design to try by themselves at home. It throws them on their own responsibility and as it is through errors we learn no harm is done and often much good. Be frank with a pupil and if the piece attempted alone is too poor to fire and ever hope to redeem, tell them so. Forever hold the standard of quality before quantity. Bad work may be removed before firing but nothing ever totally obliterates it afterwards.

Where the pupil's taste inclines toward conventional, the field of design is broad and unlimited. A steady hand, true eye and unlimited patience are the chief requisites for the making of a good conventional painter. A very pretty salad plate is the design of Mrs. Anna B. Leonard, February 1903 supplement. The design for the inside of salad bowl is admirable for a round plate. It is very simple and does not task either nerve or patience. The roses are also good done in a dull yellow, add a touch of Black to Silver Yellow, Lacroix, or Fry's Egg Yellow. Outline this in Meissen Brown. Then there are the quantities of simple designs to be done in soft greens and blues, or either alone, depending on the quality of the tone for the effect. There is no limit to the simple good conventional designs.

If a pupil cannot be converted to the conventional then strive to impress the necessity of appropriateness of design. Dainty little roses could be used very sweetly for some things but would hardly be satisfying for dinner



AZALEA—EDITH ALMA ROSS

plates and no matter how beautiful the roses may be done it isn't appetizing to view them through a sea of gravy. Even in dessert plates it is better taste to have the center plain. Force of comparison is a good method in training the taste, as a plate in natural roses shown by one done from one of the beautiful rose borders given in recent numbers. If this is not sufficient I would then trust some to time and expend the extra energy on more fertile ground.

Teaching should be a matter of love of the work and not simply one of dollars and cents. The conscientious teacher must give of herself and the best to be successful, always planning how best to present some truth in a way the pupil can most readily grasp it. Endeavor to have your pupils see and paint in masses instead of giving a vast amount of attention to the unimportant. Most pupils feel the necessity of lines and plenty of them. In sketching in a design avoid all lines but those necessary to block in the most salient features. Explain the necessity of broad clear washes for first firing, the avoidances of hard lines or attempt at detail or working up for the first fire. After a piece is ready for the kiln call attention to the cleaning from the back of china any finger prints, as it is none of the firer's business to clean such blemishes. Attention to such little matters often saves unsightly marks and the trouble of getting them off with acids. Endeavor to cultivate an observing eye. Happy the person to whom a rose is something more than a rose. Some attention given when looking at flowers will save numerous blunders. No two roses have foliage just alike but the manner in which some painters graft American Beauty Roses to La France stems and foliage is worthy of Burbank.

China painting must be taken up seriously, the same as drawing and painting from life, if any great success is to come of it.

o o o

Fourth Prize—Ella F. Adams, Yellow Springs, O.

The first lessons—what magic they seem to hold and yet what untold mysteries and miseries are there. Let us fervently hope that no one even dreams of learning to paint on china without first having learned something of drawing. I feel like saying, "learn to swim before going near the water" for one has so many hard trials to encounter in painting china without the additional one of learning to draw. True, one is drawing all the time one is painting but there are so many other mediums easier to handle than vitrifiable colors in the art of drawing.

In a large class I feel sure that too much is taken for granted by the teacher, and the new pupils usually dread to ask questions and thus display their lack of knowledge. There are so many minds of such a variety of executive ability that an explanation that seems sufficient to one is only a starting point for another. I regret to say that some will hold a brush wrong end up if not told otherwise while others dash madly on like runaway horses if only the color box is given them. Oh! for a happy medium where all pupils paint as directed and guess correctly at the omissions of their teachers.

I would not advise naturalistic work for the first lessons for several reasons. Naturalistic work does not seem appropriate for table ware and table ware is what a beginner should start upon. Avoid vases, panels and bonbonieres, all of which should be pieces of satisfaction produced by preliminary steps upon other china. Don't

think by this that table ware can be slighted. It should be dainty and artistic. It should have hours of time and patience spent upon it. I only wish to emphasize the fact that naturalistic work should be used more in the nature of a picture, in other words, to twist a trite phrase, "ornamental but not useful."

Naturalistic work means the using of a variety of colors and the fewer colors used by beginners the better. A large box of colors thrust upon a new pupil is like offering her Pandora's box. Alas! quite often, Pandora like, nothing but hope remains in the panic.

I would advise something semi-conventional to start with since the exact precision of conventional design is not there to puzzle and discourage the beginner. I have chosen an apple design for the first lesson and the following list of materials is necessary for the work.

Materials required for painting plate design of apples.

Palette knife,
Ground glass slab,
Covered palette, if possible,
1 large square shader,
1 medium square shader,
1 outlining brush,
1 ten cent bottle of copaiba and clove oil, mixed,
1 ten cent bottle turpentine,
1 five cent bottle lavender oil,
1 pencil for marking on china,
1 china silk rag,
Small amount of cotton,
Rags for cleaning china, wiping brushes, etc.,
Small receptacles for oil and turpentine,
Pointed stick for wiping off extra paint,
1 vial Carnation,
1 vial New Green,
1 vial Black,
1 vial Chinese Yellow,
1 vial Pearl Grey.

The list may seem a long one for a single piece of china but most of the list consists of tools necessary for all china work.

SEMI-CONVENTIONAL WORK.

For the first lesson secure a plate since a flat surface is easiest to handle. I believe every one who has never worked in colors objects to working in monochrome as a first lesson so I would suggest the plate design of Minna Meinke in the December *KERAMIC STUDIO* of 1905. This may be carried out in red and green as the treatment suggests and will not prove too difficult for a beginner. I advise the apple design because it is simple and effective. It has no inner band to puzzle the unskilled hand, for a practiced stroke seems necessary to secure a tone circle other than on the edge of a plate even if a banding wheel be available.

Purchase an eight inch rimless plate for your design. After washing the plate and drying it thoroughly divide the plate in twelve sections. A plate divider can be used for this, and since a plate divider "speaks for itself" it can be used without directions. If a divider is not available cut a paper the size of the plate. Fold this carefully once, then fold again. Divide this into thirds and thus you have the twelve sections for the plate. From this guide, mark off the plate with a "pencil for china". In each section draw (in free hand) the design of two apples, three leaves and stems, using the sectional marks as the points where the branch joins the main limb. In draw-



ROSES—MRS. J. F. CAMP

FIRST *fire*. Paint roses with Ruby and Purple Black, high lights in principal roses, Peach Blossom. Leaves, model with Purple Black leaving lightest parts white. Tint background cream in lightest part, using Lavender Glaze and Purple Black in shadows.

Second fire. Strengthen roses with Ruby and Purple Black, wash over leaves with Verdigris. Deepen tinting where necessary.

Third fire. Same as second for roses. Retouch leaves with both Verdigris and Purple Black.

ing this design observe the gnarled limb in contrast to the smooth stems and study carefully the character of the leaves emphasized in their tips. Don't fail to notice that the apples are *not* round but have characteristics of their own. If these points are studied carefully before making a line, the drawing as well as the painting will prove much easier.

Paint the apples in red (Carnation), the leaves in New Green, the background in a mixture of Pearl Grey and Chinese Yellow, and the outlines in Black.

The first thing to be done after the design is drawn is to "set your palette" or in other words, prepare your paints ready for use. This may seem drudgery to some, but it is the chrysalis out of which good and bad emerge, let us hope always the good.

For the first painting the apples, branches and leaves should be laid in with flat color. So, for the first lesson, only two paints are necessary, Carnation and New Green.

Upon your ground glass slab pour a small amount of Carnation (a quarter of an after-dinner coffee spoonful is what you will probably need) but do not be stingy with your paint for what is not used can be covered (to keep away dust) and be used at some other time. With your palette knife mix this Carnation with the copaiba mixture using only enough oil to make the paint the consistency of thick cream. Mix well so that no grains are left. With your palette knife gather your paint together and put upon your covered palette (if you are the fortunate possessor of one), or in one corner of the ground glass slab, if that be your only palette. Clean the slab with turpentine where the carnation was mixed and mix the Green in the same way, using $\frac{1}{4}$ more Green than Red. After the green has been mixed and gathered together you are ready to paint. Wash the medium square shader in turpentine, wipe dry on a rag, keeping it in shape. Fill the brush with Carnation using a zigzag motion for this. Do not attempt to put too thick a wash of color, for a thick coat may chip off after firing. Try to cover the design smoothly and not in uneven lumps. A thin coat of paint is better than a thick one, for it can be strengthened after it is fired. Paint the apples with firm decisive strokes. Two sweeps of the brush should fill in each apple. A firm stroke will place the paint smoothly and leave no brush marks. Should brush marks appear, cross stroke lightly, but remember the less paint is worried the better the effect and the less liable it is to gather dust. Paint with the intention of having the first strokes smooth. It may be easier to fill in each apple paying no attention to the blossom end. After the apples are painted, with a pointed stick wrapped in cotton wipe out the blossom end, wash well your brush in turpentine. Fill in leaves, stems and branch in Green in same way that Red was applied. Make sure there is no paint where not wanted both on upper and under side of plate. The plate is now ready for the first firing. This should be a hard firing to secure a good glaze for the design.

SECOND LESSON.

Make sure the surface is smooth, if not so rub very lightly with a very fine quality of emery paper that has had the freshness rubbed off. Wash the plate with turpentine and it is now ready for the second painting. Very likely the carnation has become dimmer in the firing and needs to be retouched. In fact the apples should be painted a tone brighter than wanted, for the yellow used in the final firing will absorb some of the red. If the leaves

are not an even tint, now is the time to remedy this defect.

If any red or green mixture was left over use it now. Soften it with turpentine and mix with the palette knife until it is smooth, then place on side of palette as in first lesson. Of course, if none of the paint is left over from the first lesson or if it has not been covered and has gathered dust, fresh color must be mixed. After the apples and leaves are retouched you are ready for the outlines which are in black. I would advise having the red and green partly if not entirely dry before outlining in black, so that there will be no oily surface for the black to flow into and thus lose the decisive outline. So mix the black after the leaves and fruit have been retouched thus giving them time to dry.

Mix almost as much black as was mixed of the red in the first lesson. This should be mixed in the same way as the red and green was mixed, using always only enough oil to make the paint the consistency of thick cream. "Gather" the black after mixing and place on one side of palette. Wash the outlining brush in turpentine, wipe dry and fill well with the black. Outline design in a firm, even line but do not make it too heavy. Make sure the plate is clean and give it a medium firing.

THIRD LESSON.

The plate is now ready for the background which should cover the entire surface, design included, since the grayish-yellow will help to hold together the design.

Take out a much greater quantity of Yellow than you did of the green in the first lesson, possibly three times as much, using $\frac{1}{4}$ as much Pearl Grey as Yellow. Mix with the copaiba mixture until about the consistency of the former mixtures. Now add one or two drops of lavender oil to thin it, for, in tinting, the mixture should be much thinner than for brush work. Add a little more copaiba mixture so that the paint shows bubbles when mixed with the palette knife.

Before applying this to the plate make a test. Apply a little of the tint on the plate. With a piece of silk filled with cotton "dab" this sample. If it dries immediately it has not enough oil. If it forms in oily bubbles when dabbed it has too much oil. Either way may be remedied, the first by adding more lavender oil, the second either by letting it stand until the extra oil dries out, (ten or fifteen minutes) or by adding more paint. If the tint is just right a sticky noise is made with the dabber. This is always a welcome sound.

Erase your test and cover the plate with the tint using the large square shader. Dab with the silk dabber until the tint seems even. The dabber will, of course, take up some of the paint but continued dabbing will replace some of this. Do not dab in one spot but rapidly cover all the surface and then retrace your steps using the same dabber. Let stand a very few minutes, then, with a fresh silk dabber dab lightly until the surface seems dull and free from oil. It is now ready for the inevitable cleaning process and then for the final firing which should be rather light since the Pearl Grey acts as a fusing medium, so does not require a hard firing.

A FEW MORE LESSONS.

CONVENTIONAL BORDER DESIGNS.

The border designs of July, 1906, pages 57, 58 and 59 are all good for a beginner. They may be used on a cup and saucer if a plate is not desired. The first step is to divide the china into sections, just as for the apple plate.



CHRYSANTHEMUMS—MAUD E. HULBERT (Treatments page 226)

GLADIOLI—MAUD E. HULBERT

These designs need not be sketched but may be drawn with the brush as suggested. A Delft blue cup and saucer painted in any of these designs will not prove too difficult. It will be found that the saucer must be divided into more sections than the cup. One or two more sections is the rule, so much depending on the flare of the cup. A band of paper the size of the rim of the cup may be folded the number of sections desired for the cup. Always remember that the sections should start at the handle. Do not make the mistake of making too many sections and in consequence making the designs too small. I would suggest the exact number of sections but since this is lesson number four, do a little thinking for yourself and thus feel that you are learning to walk, without the aid of crutches.

After dividing the cup and saucer in sections, mix a small amount of Delft Blue with the copaiba mixture just as the colors were mixed for the apple plate. With a medium pointed brush paint the design, being careful to make the bands true.

Bowl number two seems the easiest design, so attempt this first if you are content to go slowly but surely. After the design is painted wipe off the china all superfluous color and fire hard.

SECOND FIRING.

This time the china (I hope you have been brave enough to attempt a cup and saucer) should be tinted over the entire surface, mixing the Delft Blue with the copaiba mixture and lavender oil just as for tinting the plate.

The lighter tones of the border should be wiped out with the pointed sticks wrapped in cotton if three tones are desired.

The triangular dark spots may be strengthened after the tint is entirely dry but do not use the tinting mixture, since it is so thin it is prone to run. Mix a small portion of Delft for this, using as little oil as possible.

The china is now ready for the kiln and should have a hard firing since blue does not fuse at a low temperature. Two firings are all that is necessary unless a deeper tone is desired, when the china may be treated as for the second firing and fired again.

Should your ambition carry you into more elaborate fields of conventional design, painting, without first drawing the design, may prove too great a problem. For larger conventional designs the oat meal set and tea caddy of Emily F. Peacock in the October *KERAMIC STUDIO* of 1902 are good designs for a beginner. These designs may be carried out in Delft Blue as were the former ones, but I would advise transferring them instead of the free hand drawing. Either paint them as the illustrations suggest or else paint the white design in color and leave the rest of the china white or else tint it a lighter tone than the design, not forgetting to paint in the bands, using a pointed brush for this work. For either scheme transferring seems necessary.

Place a piece of transfer paper upon the design and draw one section. Upon the reverse side of this, with a small piece of cotton, rub some pencil powder, previously prepared by pulverizing some lead from a pencil. Rub turpentine or alcohol over the china and divide it into the requisite number of sections as in former lessons. Transfer the design by placing the transfer paper on the china, powder side next to the china and using either a pencil or some blunt point for marking the design, the powder acting as impression paper. A more expeditious way is

to prepare a perforated pattern on transfer paper or tin foil. The pattern is prepared in this manner. Upon the transfer paper or tin foil draw carefully one section of the design. Now with a needle, prick the design using a pillow as a surface upon which to work. Put the pinholes rather close together so that the design is followed very distinctly. After washing the china either with turpentine or alcohol (to hold the transfer), divide into sections and place the perforated designs over one section. Prepare some powdered lead pencil dust, make sure that it is dust and not grains. Now with a piece of cotton transfer some of the pencil dust on to the design and brush over the paper, making sure that the pin pricks are all filled with pencil dust. Continue in the same way in each section, using the same perforated design. It may take longer to prepare the design in this way but it is much more speedy in transferring than the former method. After the design has been transferred, proceed to paint the bands with some blue, Delft, Old Blue or Deep Blue, using in addition $\frac{1}{2}$ enamel (Dresden enamel), add a drop or two of lavender oil to help the enamel to flow from the brush. A simple way would be to outline the design, using black or blue for this, then fire a medium firing, with Delft or some other blue paint in the design leaving the rest of the china white, or else in addition, after firing the second time, tint the china all over in the same blue that was used before.

After these lessons I feel sure you will attempt something by yourself if you have not already done so. Whatever it is don't attempt anything too elaborate. Choose simple designs but don't be afraid to work by yourself and be independent enough to not always want your teacher by your side to direct your every brush stroke. On the other hand don't think that a few lessons are all that you will need, but strive to have your teacher give you good wholesome criticisms on all your work. Remember that china painting requires time, patience, thought, a little talent and a great power of concentration.

AFTER THOUGHTS.

Always wash your brushes in turpentine after using them and keep them in shape. A square shader should be wiped flat and a pointed brush rolled into a point.

A silk dabber may be cleaned by moistening in turpentine, then soaking in soap suds for half an hour, then the paint may be easily washed out. Dry on a mirror, smoothing out all wrinkles, and the surface is pleasanter to work with than if it is ironed smooth.

If you are not satisfied with your work erase and try again. He who is not afraid to erase is learning. After your work is fired it is there to stay with all its glaring faults.

Always wash your brush in turpentine before using another color and thus avoid muddy effects.

AZALEA (page 219)

Edith Alma Ross

THIS can be used as the Japanese decorate, the one spray with just a suggestion of another peeping out from the base or top on the opposite side of the vase; or it can be used as a repeat. A good color scheme could be, ground, deep pearl grey; leaves, two shades of olive green; stems, medium brown. Azaleas, a delicate rose with deeper markings, and stamens and outlines of flowers in green, or a creamy pink, almost buff, could be used, making the background a deeper greyed yellow brown.



F. B. Aulich

JACQUEMINOT ROSES—F. B. AULICH

FEBRUARY, 1937
SUPPLEMENT TO
KERAMIC STUDIO

COPYRIGHT, 1937
KERAMIC STUDIO, PUP. CO.
CHICAGO, ILL.



WHITE CLEMATIS—IDA M. FERRIS

LEAVE white china for a few of prominent flowers with light shading of Albert Yellow and Brown Green, and in cooler tones Dark Green. For back-ground use Turquoise Blue and Copenhagen Blue with a little Purple and Dark Green in deeper places and Ivory Yellow

in lightest ones. Use gray tones made of these colors to blend shadow flowers and back-ground together. Centers of flowers are Light Green.

Leaves, Moss Green, Brown Green and Dark Green with back-ground colors dusted to blend and soften.

CHRYSANTHEMUMS (page 223)

Maud E. Hulbert

IF I were to paint the chrysanthemums in monochrome on a tall slender vase, I should use Copenhagen Blue, and bend the design so that it would bend about the vase, painting them for the first firing so as to give the light and shade as nearly as possible, and with a much stronger ground at the bottom than the study suggests.

In the second firing I should strengthen both the flowers and the ground, and put in the washes that make some of the flowers look a little back of the others.

In the third firing the vase might be tinted with the color stronger at the bottom and quite light at the top, and most of the flowers and some of the leaves wiped out, being careful not to have any hard edges (avoiding hardness everywhere). I should glaze it for the last fire with an even light tint of Copenhagen Grey.

A good color scheme would be very delicate yellow flowers, and the leaves a bluish green, with a grey ground deepening into a dull blue near the flowers. For the flowers use Lemon Yellow, Warm Grey, a little Yellow Ochre, and in some of the lower flowers a little Orange Yellow. For the leaves, Deep Blue Green, Moss Green, Yellow Green and Brown Green. For the ground, Copenhagen Grey and Old Blue.

GLADIOLI (page 223)

Maud E. Hulbert

THE center stalk of flowers should be a delicate yellowish pink with a red marking, use Deep Red Brown (or Pompadour), Warm Grey, Silver Yellow (or Lemon) with a little Ochre and Brown Green in the center to give the deep look, and Yellow in the stamens.

In the flowers to the right in the background, use more Warm Grey and Ochre and less Deep Red Brown.

In the lower flowers at the left use some Blood Red and Violet of Iron with the other colors. And for the leaves, which are a bluish green, use Shading Green, Yellow and Moss Green, Brown Green and Deep Blue Green.

In the ground, Brown Green, Deep Blue Green and Ivory Glaze, or to obtain a deeper and richer effect, use Blood Red, Violet of Iron and Ivory Glaze.

A flat dull gold band, partially covered with a design done either in Outlining Black or Violet of Iron, with a

pen, might be introduced on some pieces of china with good effect.

CRAB APPLES (page 232)

Sarah Reid McLaughlin

FOR apples use Lemon Yellow, Albert Yellow, Yellow Red, Carnation, Pompadour Red, blending the yellows or reds into soft yellow greens with Copenhagen Blue for greyish blue.

Keep high lights clear and brilliant, the reflected lights softer in tone.

Leaves, Apple Green, Yellow Green, Moss Green for lighter ones, Brown Green and Shading Green for darker ones. For shadowy leaves use Violet of Iron or a color which will be harmonious with background. For stems use Copenhagen Blue for blue grey lights, strengthened in second firing with Auburn Brown. Use Yellow Brown for pips, strengthened in second firing with Auburn Brown. Background, Copenhagen Blue, Violet of Iron to Warm Grey, Yellow Red to Blood Red. For second and third firing deepen above colors adding detail.

STUDIO NOTE

Miss Mariam L. Candler of Detroit, Mich., has moved her studio to the Fine Arts Building 30 Adams Ave., West. She held in December in her new studio an exhibition which was very successful, her work in porcelain decoration as well as oil and water color attracting much attention.

STUDIES OF SQUIRRELS

The page of squirrel designs is from the "Vorbilder". The other border is an adaptation by Mrs. K. Soderberg. These designs are appropriate for nut bowls.

Suggestions for color schemes are as follows: Round Panel, ground, dark olive (Green No. 7. and Olive Green). Squirrels, white underneath shaded with Pearl Grey and Yellow Brown backs and tails, Yellow Brown shading to Meissen with a little Grey on high lights. For the borders the squirrels may be black with white and Meissen Brown trimmings or they may be a reddish brown (Meissen) with white and yellow (Yellow Ochre) trimmings. Ground dark olive; leaves, light olive; nut sheaths still lighter olive; stems and nuts in Meissen Brown.



SQUIRRELS—ADAPTED FROM THE VORBILDER BY MRS. K. SODERBERG



SQUIRRELS BY PROF. G. STURM—FROM DEKORATIVE VORBILDER



YUPON BERRIES—JEANNE M. STEWART



YUPON BERRIES—JEANNE M. STEWART

THESE bright little Southern berries are very effective with a grey background, rather dark in tone.

Careful attention should be given to light and shade on the cluster, very little detail being given in the shadows while the berries in light are brought out clearly and distinctly. Dresden Yellow, Red and Pompadour Red No. 23 in equal parts may be used for the brightest reds, Pompadour Red No. 23 alone for medium, and Stewart's Pom-

peian Red to which has been added one-third Ruby Purple for the darkest tones in the berries. After the first firing the background may be applied with Stewart's Grey to which a little Ivory Yellow is added for the lightest tints.

Above the berries in the center of the cover throw in a light tone of Lemon Yellow. To obtain depth and glaze in background dust on color in the last painting.

JACQUEMINOT ROSES (Supplement)

F. B. Aulich

AFTER drawing in the design, which is suitable to almost any shape of vases, tiles, etc., paint in the roses first with Aulich's Pompadour and Superior Black, using the Pompadour for first wash and finish with Black.

This should be done carefully and modeled nicely, taking out the high lights with the paint brush. The softer you can do this first painting, the better the result. Then let it stand until almost dry. To ascertain this, put the end of your finger softly on the paint and if sticky prepare some powder Crimson Purple on a tile and with some soft cotton batting apply this paint all over the roses. Where you left your paint light the color will adhere only slightly, while on the thicker parts it will be quite heavy. You will be astonished at the result. Of course it needs practice to do this properly. After this you can wash in the background, beginning with Dark Blue, Blue Violet and Black Green and Albert's Yellow and Yellow Brown for the foreground, finishing off with Van Dyke Brown; modeling leaves etc., with the larger brush and finishing off with a pointed one.

For the second fire give the whole a general wash in the same tones, adding a little Rose to the greens and blues. Put a wash of American Beauty over the entire Roses, Turquoise Blue for lighter and more distant parts, and shade with Crimson Purple. Do not apply the color too thick as it would blister or oxidize.

The study can be used as a picture, but a dark mat should be used to bring out the colors.

TREATMENT IN WATER COLOR

Wash in the background first with Cobalt Blue Rose Madder, Payne's Grey, Indian Yellow, Ochre and Van Dyke Brown for the foreground.

For the roses use Carmine, Burnt Carmine and Cobalt Blue and Neutral Tint mixed in for the dark parts; a slight wash of Safflower Red on the reflected lights will add brilliancy to the Rose, but use this color very sparingly.

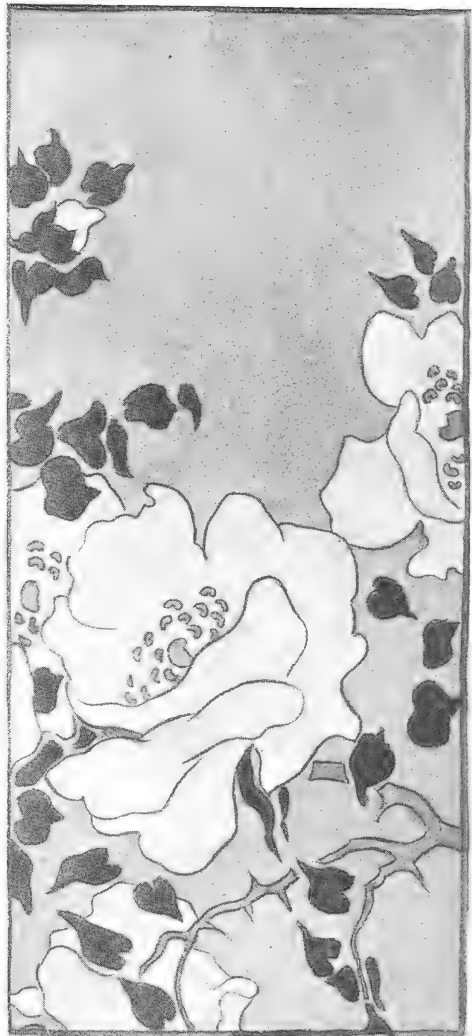

SCOTCH ROSES

"Virginia"*

OUTLINE with Brown Green and Grey for Flesh and dry thoroughly. Paint in leaves with Brown Green, Moss Green and Grey for Flesh; stems and centers of flowers with Deep Red Brown. Second Fire. Tint all over with Brown Green, Pearl Grey and Grey for Flesh equal parts. Wipe out flowers and tint them with light coat of Albert's Yellow (Dresden). When dry enough dust all over with Pearl Grey. Third Fire. Tint all over with Deep Blue Green. Wipe out flowers and re-touch if necessary, with Albert's Yellow or Ivory. After setting aside for twelve hours dust Pearl Grey over all or outline with black and fire. Make background with Meissen Brown and one-third Grey for Flesh; Flowers, Albert's Yellow and one-fifth Pearl Grey; Leaves, Moss Green and one-third Grey for Flesh. Centers and stems, Yellow Red. Dust all over with Pearl Grey. In next fire strengthen all colors to gain a warm, rich, yet soft color over all.

*The name of the designer of this study has been lost. The study sent in competition was marked "Virginia."





SCOTCH ROSES—"VIRGINIA"



CRAB APPLES— SARAH REID McLAUGHLIN

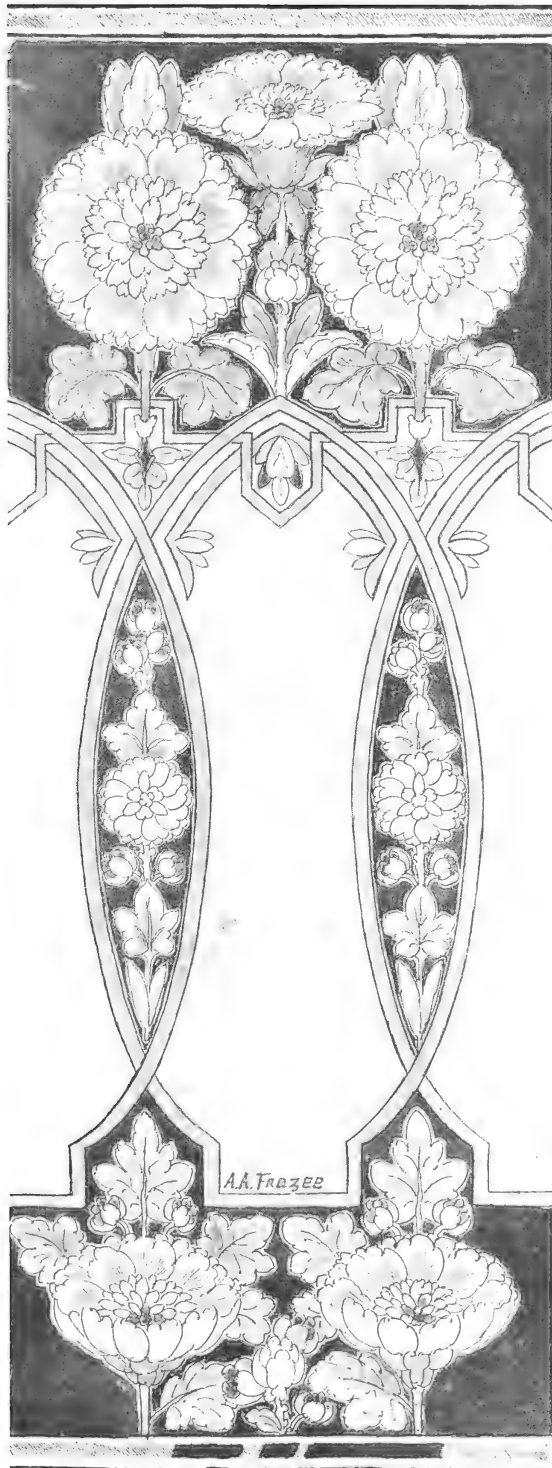

ASTER DESIGN FOR VASE

A. A. Frazee

THIS study is for a twelve inch vase. For the scheme of color here given it is better to use a gold outline. The plain panels to be soft cream. All narrow bands

(intertwining) to be a medium shade of dull brown. The leaves of course to be two shades of green, using any greens convenient but do not mix them too hot in color. The very dark background to the bands and small panels, a dark dull blue, using Dark Blue, a little Purple and Black. The outer petals of the flowers to be painted in soft Japanese red, shaded toward the center, using Capucine Red with a little Yellow Ochre. Outline very carefully done in gold. Remember a *good* outline makes the flower. Centers of flowers can be cream enamel with the center of this gold. For cream enamel use two parts Relief and one part Hard White enamel, tinting it with Mixing Yellow. Buds may be a dull blue, or soft red or cream enamel.

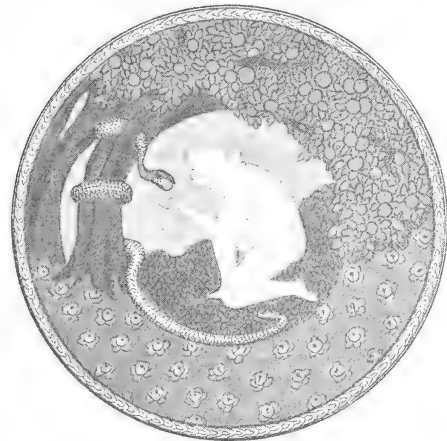

EVE—DECORATIVE PLAQUE

D. M. Campana

HIGH part of plaque in olive green with fruit in light blue. Lower part, dark grey with flower in pearl grey. Outlining in darkest green. Figure covered with bluish grey, nearly white. Background pearl grey. Decorative motive is the curve of the tree, and the snake. The leaning light figure in the center conveys also a rounding impression, well adapted to plaque decoration.

ANSWERS TO CORRESPONDENTS

Mrs. J. H. E.—If in putting lustre on a piece of china in which the design is already painted, the lustre should be washed over a portion of the painting, no particular harm would be done if the painting were quite dry except that the paint would necessarily be affected by the color of the lustre, also the glaze might not be quite as brilliant. As a matter of fact some decorators paint little flowers right over the dry lustre without ill effects except the change in color. However it is a dangerous practice, for if the color or lustre should be too wet a nasty mess would be made which could not be remedied except by taking off everything and starting fresh.

A. R.—In the public schools, drawing is taught by the teacher, putting on the blackboard an outline of some object or animal which the children copy. The blocks are a little difficult for young children as they are apt to wish to draw all four sides at once because they know they are there. There is a set of six elementary text books of art for children, published by Prang & Co., University Place, New York., which are exceptionally good, teaching color as well as black and white. If the child wishes to draw encourage him to make memory sketches. That seems the best beginning. My boy of six draws more or less every day, starting with a house with door, window, chimney, etc., he adds something new almost every time, showing that he is stocking his memory. He has a child's "painting book" which he colors. For a few days he traced the outlines of animals, figures, etc., through tracing paper, then he began to draw the outlines to see how well he could do without tracing. If a child takes naturally to it you can trust him to show you when he is ready to go a step further; if he has no particular taste for it, it would be better to follow a course such as the Prang Books. The first step in designing is the repetition of some simple unit between two horizontal lines, making a

(CONTINUED ON PAGE 238)

THE CRAFTS

Under the management of Miss Emily Peacock, 232 East 27th Street, New York. All inquiries in regard to the various Crafts are to be sent to the above address, but will be answered in the magazine under this head.

All questions must be received before the 10th day of month preceding issue, and will be answered under "Answers to Inquiries" only. Please do not send stamped envelope for reply. The editors will answer questions only in these columns.

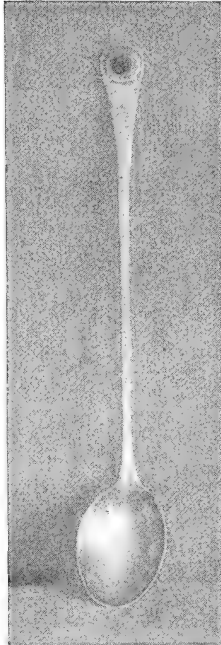

Hammered silver ladle, sardonyx in the handle—Gustave Rogers.



OVERGLAZE AND POTTERY.

Plate, Newcomb College Pottery. Bowl, boat design, Miss Mason. Stein, M. C. Armstrong. Bouillon, Martha Beach. Tea jar, Johanna Hibler.

THE EXHIBITION OF THE NATIONAL SOCIETY OF CRAFTSMEN

Mrs. A. M. Froehlich

ON December third, the National Society of Craftsmen opened its rooms with an interesting exhibition of artistic crafts work. The new quarters of the Craftsmen are at 119 East 19th St., and the society plans to maintain there a permanent salesroom for the purpose of displaying work done by craftsmen from all parts of the country. The attractive, well-lighted, gray-toned rooms are admirably adapted to exhibition purposes.

The Craftsmen have organized in order to further the interests of all the crafts, and to encourage both professional and amateur workers. This, their initial undertaking, has more than fulfilled their expectations, both in regard to the quality of work received and the extent of territory represented. The exhibition as a whole, surpasses previous



PORCELAIN BOWL—MRS. A. ALSOP-ROBINEAU

Dragon fly design and dragon fly knobs in green and brown glazes. Touches of dark blue in background of design.



POTTERY.

Tall green vase, Misses Penman & Hardenburg. Low vase with handles, Henrietta Jones. Blue grey vase, medium size, Mary S. F. Darrence. Low flat vase, Henrietta Jones. Large open mouth vase, three parted design, Jane Hoagland. Vase, smaller at top, fine violet red color, Van Briggie Pottery. Medium size vase, Grueby Pottery. Low vase to right, Charles Volkmar.

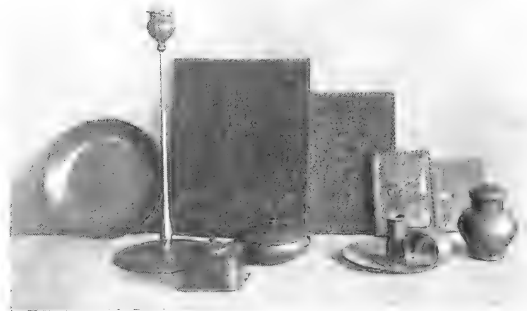

LEATHER AND COPPER.

Card case with winged lobe design in greens, Clara Rice. Card case, conventional leaf design in green and bright gold, Carrie Collin. Small portfolio, Mrs. Busek. Large portfolio, maple leaf and seed design, Mabel Rodebaugh. Ink stand, copper, H. Cleveland. Brass powder box, C. Ogden. Covered copper vase, Caroline Ogden. Candlesticks, Jarvie Shop.



JEWELRY.

Pendants, Ethel Walbridge. Stick pin, E. N. de Neergard. Stick pin, J. B. Thresher. Ring, garnet, Fred. Gardiner. Jade ring, Louise Williams. Amethyst pendant, Elizabeth Copeland. Brooch, Emily F. Peacock.

displays of like nature in New York, and its promoters expressed large hopes for future progress.

To avoid all undue advantage of place and arrangement, the usual custom of grouping all articles sent in by a single contributor was set aside. The experiment proved unfortunate, and it rendered impossible a fair judgment of any one's work as a whole.

THE POTTERY EXHIBIT.

In the pottery exhibit was representative work from leading potters as well as from promising amateurs. The

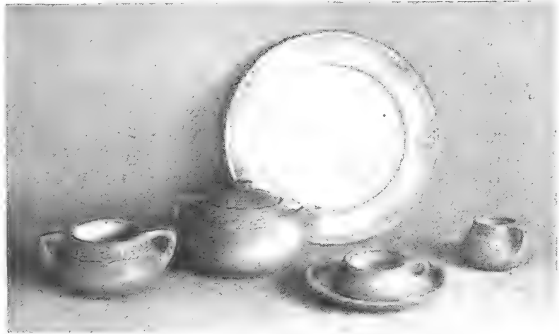

Pottery tea set, Edith Lyon. Plate, Martha Beach.

Van Briggles contributions showed the usual individuality of form and color. Especially good were a few pieces in tones of gray violet. Gruby sent a typical collection of vases, and some excellent decorative tiles, which were commendable for their severe and dignified treatment; while the Newcomb exhibit was noticeable on account of its departure from their earlier styles, new forms being used which were excellent both in line and color.

Mrs. A. A. Robineau's porcelains were unique—well conceived in form and remarkable in color treatment. Her work shows the resourcefulness of the artist in the refined treatment of ceramics. Especially to be commended for its completeness and delicacy, was the carving in pale ivory, combined with its own deeper tones.

Mr. Chas. Binns contributed some fifteen pieces, whose rare color effects are the satisfying results of years of intelligent experimentation. Volkmar, also, showed some vases in his usual good vein, and some pictorial effects in tiles, suitable for interior decoration.

Special mention should be made of the work done by Misses Penman and Hardenburgh, Jane Hoagland, Hibler and Mason.



SILVER.

Three spoons, H. S. Whitbeck. Orange spoon, Student from Pratt Institute Cream jar and silver cover with design in high relief, Robert Dulk. Two bowls, Flora Skinner. Forringer, Ida Conklin.

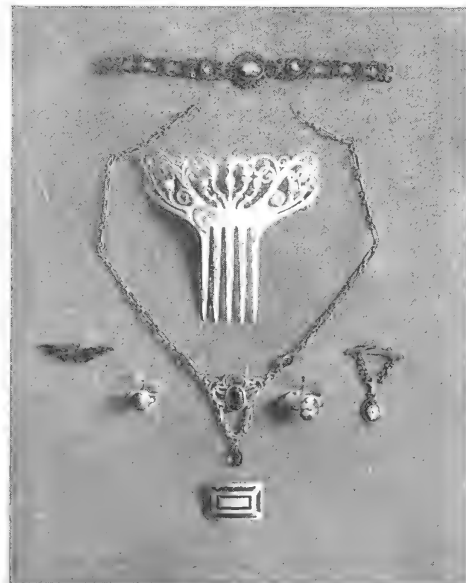

JEWELRY.

Comb, J. B. Thresher. Pendant, Ava M. Froehlich. Ring, turquoise matrix, H. C. Jeffery. Small ring, Ruth Harlow. Bracelet, Grace Hazen. Butterfly brooch, Mabel Luther. Enamel brooch, Mabel Luther.

KERAMIC STUDIO

OVERGLAZE WORK.

Miss Joanna M. Hibler displayed an excellent tea-jar of gray, with a well adapted border in two tones of gray-greens, and a bowl in the Indian treatment and color. Miss Mason had several good pieces, among them a plate with a narrow border of well arranged, abstract forms in dull blue coloring, and a bowl in warm gray-green, with a border decoration in two tones of gray orange. The best work of Miss Martha Beach was a plate which had for its finely proportioned border an arrangement of the always decorative laceflower.



PORCELAIN JAR—MRS. A. ALSOP-ROBINEAU

Frog design. Browns shading from light to dark, black and green mat glazes. Touches of dark blue in background of design.

L. Carpenter sent from Montclair, N. J., a bouillon set in gray, with a hen and chickens as a design motive, carried out in white with touches of red. Mrs. Anna B. Leonard, also, had a representative exhibition which attracted much attention. Especially noticeable were a low bowl,

open pattern border, in green and blue, and a plate in gold with the rose tree pattern.

It is to be regretted that the display of overglaze work was so limited. Many well known workers did not contribute at all.

LEATHER WORK.

Many articles in modeled leather, such as purses, card-cases and belts, received favorable attention. Chief among them were Mrs. Busck's decorative panel of a gourd design on a background of gold. The Misses Ripley's designs executed in the 16th Century spirit were unique.

JEWELRY.

The jewelry workers were very largely represented and made a most creditable showing with their various treatments of precious and semi-precious stones, metals, enamels and horn. Among those contributing were Miss Grace Hazen, Miss Margaret Rogers, Mr. H. Jeffery, Miss Emily Peacock, Miss Louise Williams, Mrs. Ida Conklin, Misses Norton and Mills, Miss Zimmerman, and Mr. Thresher.

MISCELLANEOUS.

The Misses Steele and Walker sent a good collection of carved and gilded wood frames, while Mrs. Helen Albee and Mrs. Bratten of Brecksville, O., contributed largely to the decoration of the rooms with their excellent woven rugs.

On the whole there was an absence of the weak and amateurish efforts so noticeable in former exhibitions, the work, almost without exception, taking on a more professional character. Possibly this is due to the discriminating judgment of the jury no less than to the steady improvement evidenced by workers in this field.



WORK OF PRATT INSTITUTE STUDENTS

We are sorry that we have been unable to publish before the following interesting illustrations of the work exhibited by the students at Pratt Institute, Brooklyn last June. The copper lantern, candle shades and stand for a kettle, should appeal to the lover of simple things, they all show fine feeling for proportion and design.

The work in wood has much the same quality, the clock with the latin inscription makes one wish that there were

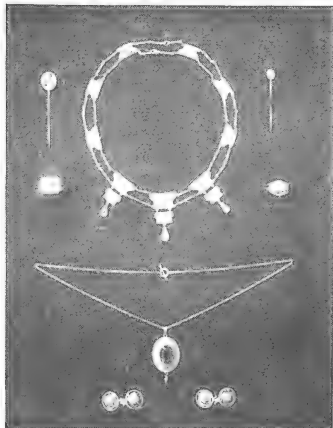

Friedman. Miss E. F. Peacock. Miss Harlow.
Johannot. Miss E. Walbridge.
Miss E. F. Peacock. Mrs. Conklin.

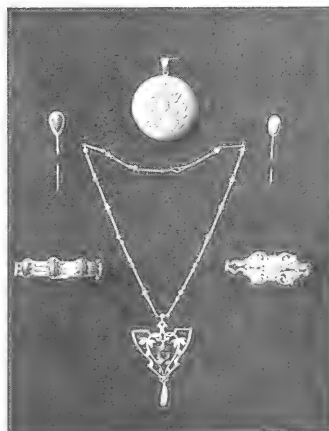

Swietzer. Miss Hazen. Friedman.
Swietzer. Swietzer. Friedman.



Miss Harlow. Jehannot. Swietzer.
Friedman. Mrs. Conklin.

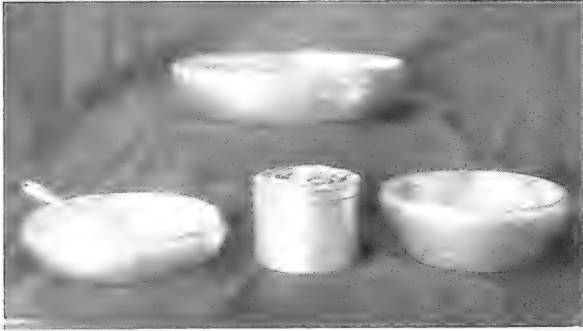

Silver bowls, box and spoon—Made by students of Pratt Institute.



Leather—Made by students of Pratt Institute.

more like it. Three pieces of oak were carefully put together to get the required thickness, and the whole was stained a dark green.

The leather work was interesting in color and good in workmanship. In the portfolio and bag, the back

or anything attempted beyond the capacity of the student. It was refreshing to see amateur work, that could compete with that done by a professional. Not that we want to be commercial, but we do want goldsmith's work and silver-smith's work at exhibitions, instead of such an array of so

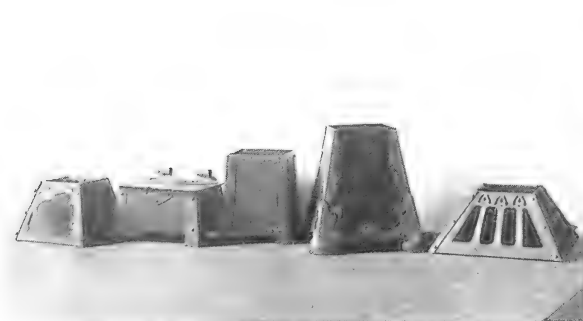

Copper—Made by students of Pratt Institute.

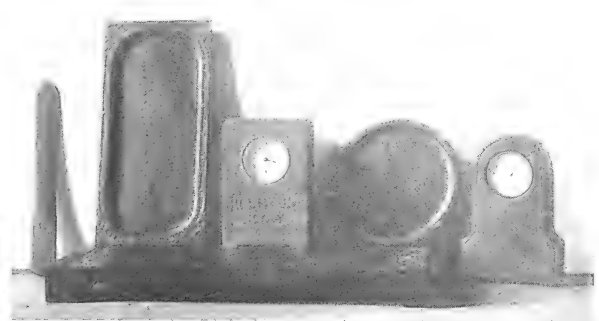

Wood—Made by students of Pratt Institute.

ground of design was cut out and lined, the centrepiece and cover for a book were tooled.

Particular mention must be made of the very excellent exhibit in jewelry. The work showed professional skill and artistic merit. There was nothing pretentious

called jewelry, that has the made for sale mark, instead of the work of the hand and brain of the true craftsman. The foundation of all good art is good workmanship, and each piece of jewelry at this exhibition showed that the student had been trained with this end in view.



Miss E. F. Peacock.
Miss E. F. Peacock. Minnis. Miss A. Walbridge
Miss E. F. Peacock.



Kobayashi. Kobayashi. Kobayashi
Miss E. F. Peacock



Jeffery. Friedman. Kelley.
Miss A. Walbridge. Miss A. Walbridge.



Kelley.
Miss E. F. Peacock. Miss Harlow. Miss E. Walbridge.
Kobayashi.

ANSWERS TO CORRESPONDENTS

(CONTINUED FROM PAGE 233)

narrow border. Then coloring the design, or they could be drawn with colored crayons. We will try to secure articles on teaching children to draw and design.

X. Y.—When the background of a design is grounded, before putting on the powder color, go over the spaces which you do not wish grounded, with a piece of damp absorbent cotton on a stick, this will remove any of the turpentine or grounding oil which may have run over the lines.

To clean out a small design, such as a line or small scroll, use a wet sharp pointed hardwood stick. Orange wood is very good. For outlining in color with a pen, make a thin syrup but plenty of color, if you thin the syrup after mixing with color you must add more color or it will be too weak. Use a

fine India ink pen if you are not accustomed to a quill pen. If the syrup and color is the right consistency you should have no trouble, you will, of course, have to experiment to find just the right proportions of syrup and color. A raised paste line can be put on over a dry or fired tint but not over grounded color fired or unfired, it must not touch the grounded color. You must trust to the gold to make the line touch the color. You can put on your paste line next the grounded color in the first fire if you are very careful not to let it touch.

Good gold should stand quite a hard fire, if it looks thin after two good coats, either the make of gold is poor or it has been badly put on, perhaps two good coats the first fire and two thin coats the second fire would be better.



Copper—Made by students of Pratt Institute.

STUDIO NOTES

After a three year's absence in other states where she has been teaching and at the same time studying new methods, Miss Mellona Butterfield has returned to her studio in Omaha where she will be pleased to receive her friends.

The managers of the Chautauqua Summer School are very fortunate in securing the services of Mrs. M. E. Perley of San Francisco for this next season. She is now studying with Mr. Aulich of Chicago and will spend June in the New York studios. Mrs. Perley is not discouraged by her bitter experience at San Francisco; but is full of hope for the future and will doubtless meet with full measure of success.

T. & V. CHINA AND HAVILAND & CO.'S RANSOM

A full line of Austrian Novelties in White China. Shirt Waist Buttons 40 cts. a dozen delivered at your homes, Gold Plated Backs at \$1.80 a dozen. We deliver Fry's Paints and Sherratt's Gold. We have no catalogues, but will send you a sample barrel full of novelties upon request with references.

HUDSON CROCKERY COMPANY,
Dept. D 349 So. Salina St., Syracuse, N. Y.

THE HANDICRAFTS COMPANY OF NEW YORK

Wishes to announce that their new catalog is now in preparation, and will be issued about March 1st.

The catalog will be printed on white paper of fine quality, illustrated throughout, and handsomely bound. It will contain over two hundred pages descriptive of supplies for KINDERGARTEN and MANUAL TRAINING.

A Limited Number will be printed, and those wishing to procure copies should apply for them not later than February 15th, and enclose twenty-five cents.

THE HANDICRAFTS COMPANY OF NEW YORK

255 East Broadway
Merchants and Manufacturers of Tools and Supplies
for the Arts and Crafts.

The Ceramic Art Importing Company Of Toronto, Canada

Have opened with a full stock of everything required by ceramic artists.

- ¶ Their importations of White China for decorating include Belleek, French, German and Austrian, in all the newest shapes and designs.
- ¶ Their stock of Paints, Lustres, Roman and Colored Golds, is most complete.
- ¶ A large assortment of Mineral Transfers, Brushes, Oils, Mediums, etc., etc.
- ¶ Mail orders will receive most careful attention.

181 Yonge Street, Toronto, Canada

KEEP THE FIRE ALIVE.

KERAMIC STUDIO

CONTRIBUTORS

MARGARET OVERBECK

HARRY BARNES GOUNDREY
JULES BRATEAU

1-8-11

MAR. MCMVII Price 40c. Yearly Subscription \$4.00

A MONTHLY MAGAZINE FOR THE POTTER AND DECORATOR.

The entire contents of this Magazine are covered by the general copyright, and the articles must not be reprinted without special permission.

CONTENTS FOR MARCH 1907

	PAGE
Editorial Notes—Studio and Shop Notes	239
League Notes	239
Editorial	240-242
Margaret Overbeck	240-242
Border—Walnut, Cone and Tree designs	241
Apple Study	242
A Few Suggestions	243
Teapot—Conventional Flower and Leaf	243
Bowl—Wild Touch-me-not	243
Platters—Poppy Seed Pod Motif	244-250
Plates and Mugs—Poppy Seed Pod Motif	245-251
Vase—Peacock Feather Design	246
Chop Plate—Sugar Tree Blossom	247
Cup and Saucer—Primrose Motif	248
Primrose Study	249
Border for Dinner Plates	252
Naturalistic Plate Design—Asters	253
Childs Bowl	253
Landscape for Tile—(Color Supplement)	254
Studies of Milkweed Seed Pod and Wild Touch-me not	254
Milk Pitcher—Milkweed Pod Motif	255
Design for Cup and Saucer	256
Adaptation of Landscape Motif to Bowl	256
Adaptation of Landscape Motif to Vase	257
Fernery and Palm Stand with Landscape Tile	257
The Crafts—Fabric Stenciling	258-259
Harry Barnes Goundrey	258-259
Art in Pewter (con'd)	260-61
Jules Brateau	260-61
Studio and Club Notes	261
Answers to Inquiries	261
Answers to Correspondents	261

LIST OF BOOKS

The Rose Book, containing some of the best rose studies and designs published in Ceramic Studio postpaid	\$ 3.00	
The Fruit Book, containing some of the best fruit studies and designs published in Ceramic Studio postpaid	3.00	
Composition, by Arthur Dow postpaid	1.65	
Principles of Design, by E. Batchelder postpaid	3.00	
Decorative Studies, by J. Foord postpaid	12.50	
Plant Forms and Designs, by Midgley and Lilley postpaid	2.20	
Practical Pottery, elementary instruction for students, by Richard Lunn postpaid	2.50	
Grand Feu Ceramics, a practical treatise on the making of hard porcelain decorated with high temperature glazes by Taxile Doat of the Manufactory of Sevres, France postpaid	7.50	
Seger's Collected Writings, 2 volumes postpaid	15.50	
For the Collector:		
Vol. II Old China, bound blue cloth postpaid	2.50	
Anglo-American Pottery, a manual for collectors, by Edwin Atlee Barber, Curator of the Pennsylvania Museum, second edition postpaid	2.00	
American Glassware, old and new, by Edwin A. Barber postpaid	1.00	
Marks of American Potters, by Edwin A. Barber postpaid	2.25	
Pottery and Porcelain of the United States by Edwin A. Barber postpaid	3.75	
The Lace Book, by N. Hudson Moore postpaid	5.30	
Tulip Ware of the Pennsylvania German Potters, by Edwin A. Barber, in paper cover postpaid	1.10	
Cloth, limited edition postpaid	5.00	
The Primers of the Pennsylvania Museum (two already issued, Salt-glaze ware and Tin-enamelled ware) postpaid,	.50 and .60	
Encyclopedia of Ceramics, by W. P. Jervis postpaid	6.75	
The Old China Book, by N. Hudson Moore postpaid	2.18	
The Old Furniture Book, by N. Hudson Moore postpaid	2.18	
Old Pewter, by N. Hudson Moore postpaid	2.18	
Chats on English China, by Arthur Hayden postpaid	2.18	
Chats on Old Furniture, by Arthur Hayden postpaid	2.18	
China Collecting in America, by Alice Morse Earle postpaid	3.20	
Pottery and Porcelain, a guide to collectors, by Frederick Litchfield postpaid	6.25	
French Pottery and Porcelain by Henri Frantz postpaid	2.68	
Dutch Pottery and Porcelain, by W. Pitcairn Knowles postpaid	2.68	
Old English Furniture, by Fred Fenn and B. Wyllie postpaid	2.68	
English Embroidery, by A. F. Kendrick postpaid	2.68	
French Furniture, by Andre Saglio postpaid	2.68	
Old Pewter, by Malcolm Bell postpaid	2.68	
Sheffield Plate, by B. Wyllie postpaid	2.68	
The Oriental Rug Book, by Mary Churchill Ripley postpaid	3.20	
Home Furnishing, practical and artistic, by Alice M. Kellogg postpaid	1.65	
William Adams, an old English potter, by William S. Turner postpaid	8.00	

Keramic Studio Pub Co., Syracuse, N. Y.

KERAMIC STUDIO

Vol. VIII, No. 11

SYRACUSE, NEW YORK

March, 1907



KERAMIC STUDIO presents in this number the work of Miss Margaret Overbeck of De Pauw University, Greencastle, Indiana. Our old subscribers who have seen designs from her pen from time to time in our pages will be glad to see more from the same source, and we are sure those who are new to KERAMIC STUDIO will be pleased to make her acquaintance.

+

The subject of the next Class Room will be "Flower Painting" under which heading will be included the subdivisions: Roses, white, pink, and crimson; Violets; Daffodils; Nasturtiums; Geraniums; Pansies; Forget-me-nots. Other flowers, white, pink, crimson, violet, purple, blue, yellow, orange and red. Miniature flowers. To be received not later than March 15th. For list of prizes see back cover.

Subscribers who wish any special subject to be taken up in the Class Room will please notify the editor.

+

The May issue of KERAMIC STUDIO will be devoted to the work of Marshal Fry of New York and his pupils.

September will be a water color number from the studio of Mrs. Teana McLennon Hinman of New York, though treatments of the flower studies will be given also in mineral colors. November will be a naturalistic number from the clever brush of Miss Jeanne Stewart of Chicago.

+

The designs published in February under the name "Virginia" are by Miss Marion H. Nelson of St. Catherines, Ontario, Canada.

+

In the account of the National Society of Craftsmen exhibition in New York, in our February number, one of the bowls was by mistake attributed to Miss Mason. This bowl, the central one in the group, is by Mrs. C. B. Doremus of Bridgeport, Conn.

+

We call attention to the editorial note in Crafts department, suggesting that designers submit to us designs for the different crafts as well as for china decoration.

✦ ✦

LEAGUE NOTES

The vase designs are coming in slowly, too slowly, because there is still the March problem to be criticised, returned, painted upon the bowl, and then sent back for exhibition. This year the exhibition should show the value of our monthly problems by correspondence. Do not

hesitate to send your designs, no matter how crude or limited. Ideas that take tangible shape, intelligible to the critic, are made practical for application.

The "Farrington" punch bowl, a new and most interesting shape, was difficult to manufacture, and the price necessarily too high to take the risk of possible damage in transportation. The advisory board substituted bowl 579½, manufactured by the Willetts Manufacturing Co., Trenton, N. J. For this bowl, instead of a specified motif for design, we suggest that it be treated in the Colonial style, that is, panels, bands ornamented with little clusters of flowers, etc., with the following color scheme: coral pink, lavender, purple, a light and dark blue, light and dark green, and dahlia colors.

We are gladdened by these additions to our membership roll. Mrs. Bird S. George, Greeley, Colo; Mrs. Sallie Patchin, Wayland, N. Y; Miss Maude M. Lapham, Springfield, Mo. and Mrs. Anna Bogenholm Sloane, Principal department of Arts and Crafts, of the Washington, D. C., School of Decorative, Industrial, and Fine Arts.

BELLE BARNETT VESEY, Pres.

A vase designed by Ione Wheeler of Chicago and made by the Belleek factory, has been chosen by the National League of Mineral Painters for their traveling exposition for the coming year.

✦ ✦

STUDIO NOTES

We hear with great regret that Mrs. T. McLennon Hinman's studio in New York has been destroyed by fire and that she is suffering from the shock. We hope she will promptly recover and resume her excellent work as teacher and water colorist. We call attention to her advertisement in which she offers to sell her china studies at \$1 each, and pictures at \$2 each. All these studies are more or less damaged but will not lose their value for students who wish to reproduce them either on china or in water colors, and we trust that there will be prompt response to that advertisement from many of our subscribers. Mrs. Magill and Miss Ivory, the importers and decorators, who had their studio and shop in the same building as Mrs. Hinman, had their stock also seriously injured by the fire.

Miss M. Helen E. Montfort, after a busy season in her studio, 318 Lenox Avenue, New York, will sail for Italy on March 9th, to be gone for a stay of seven months. On her return in October, she intends to reopen her studio at the same address.

Mrs. A. Neble announces the opening of a studio at Room 2 in the Conservative Building, 1614 Harney Street, Omaha, Neb., additional to her residence studio.

✦ ✦

SHOP NOTE

We acknowledge with thanks the receipt of an artistic calendar from L. Reusche & Co., New York,



BORDER—WALNUT DESIGN



THAT this is a period of advance in art all will admit. But it is a question whether the importance and scope of the field of ceramics is as well understood as it should be even by its own devotees. When we consider that in point of usefulness alone the table equipment is one of the first requirements in every home, what a wide opportunity presents itself, and we must meet it at least with the right intentions, whatever the result.

If we could eliminate the commercial side, we say, but commercialism must be taken largely into account, since most articles of use come through its avenues, and it is there, most of all, that art influences are needed. A glance at the shop windows, from which stock the buyer of limited means must choose and which at the same time sets his standards, is sufficient reason why many of our pupils come to us with distorted ideas of decoration, and why there is a taste for the more or less gaudy style.

On the other hand, utility, to many, is the only requisite worth considering. But may it not be possible that when the highest degree of utility is reached, the elements of beauty have been attained, and that utility is close kin to beauty.

If ceramic workers would make a more careful study of the principles of decoration and be willing to let the design be subordinate and supplementary to the thing decorated instead of its being the whole thing, then the public would learn to respect our art and follow our lead.

Consider first the piece and its use. Avoid over-ornate decoration on all pieces in the service used for meats, vegetables, etc. One has seen an exquisite tiny edge of green and gold or dull blue on a set of dinner plates, and it has seemed so satisfying, yet strange to say many a one, in painting a set of plates, will want them to look more like "hand painting," which may mean a spreading cluster of some favorite flower, never suspecting that if a plate has a decoration that is so strikingly real it is everlastingly unfitted for contact with a meat course, unless a generous treatment of hydrofluoric acid is administered. Let the more elaborate designs be reserved for other parts of the service and odd pieces.

This is only an echo of what has been said many times in the Studio, but it must be repeated.

There may be cases wherein a naturalistic treatment is advisable, and one can hardly insist upon a complete elimination of that style in the beginning. The pupil must be led gradually and cannot be expected to reach the highest point of appreciation at one jump. The route may be by way of garlands of roses, violets, and forget-me-nots, but have patience and persevere. Some say they do not like conventional designs, neither do any of us like all conventional designs, because not all are good. We must again cultivate our appreciation. Then too the simple design is not a waste of time, far from it. The truth is that the design with the fewest forms is often the best test of artistic skill, since the placing of one form in space may call for greater refinement of feeling, as to balance of line, mass, and color, than another where one may add here and there, and possibly produce, by a process of guessing, something fairly good.

Of composition, one cannot urge too strongly its importance. Your plate is a space to be broken by masses of color in a way so pleasing to the sense of proportion that it is better than the plain white plate, otherwise it is a mistake. If a border is used, it must be first wide enough, just narrow enough to leave the space within of the proper proportions for the size of the plate.

The background spaces must be as carefully studied as the forms in the design itself. And moreover the shapes in both background and unit of design must be related, not only to each other, but to the space occupied, that there may be balance and rhythm in the whole.

It hardly needs saying again that Nature is the great source of design. Careful drawings and color schemes from all sorts of plant and animal life furnish a rich store to draw from when one cannot go direct to the source. However, don't stick too closely to Nature, but set the invention to work, with the naturalistic form as a basis for design.

To study color harmony, make scales of color running through the pure spectrum colors into tints and shades, as a help toward feeling the refinement of subdued color. Experiment with the different harmonies, and take color schemes from dead twigs, mosses, lichens—anything. One must not fail to mention that invaluable source, Japanese prints. One cannot go far wrong in selecting color schemes from good prints.

Many an otherwise fair design has been spoiled by using too many strong pure colors. Two equally strong



BORDER—CONE DESIGN



APPLE STUDY

(Treatment page 252)

colors, whether contrasting or harmonizing, in theory, will in reality fight if used in such quantities as to make them complete for first place. It is possible, certainly, to use rich pure color with fine effect, but another equally strong color must not be opposed to it either in point of quantity or strength of tone. Safety lies in the greyed tones with sometimes a bit of rich brilliant color.

And let us enter a plea for better shapes. Oh! that we could be our own potters! What china painter has not felt a thrill of joy upon discovering a bowl of really fine contour, such as one cannot find in the catalogs, but which can only be picked up here and there on rare occasions. A good milk pitcher is almost as rare. One that will pour in a genteel fashion, will stand firmly, is of a shape easily cleaned, and has a handle not for ornament but by which the weight of the filled pitcher may be held with the least possible strain to the hand. When all this is accomplished in the best way it is safe to say that it will be a thing of beauty.

The difference is wide between *real art* and the desire, devoid apparently of any aim except to "decorate" and

gold. The designs have the same general arrangement with different motifs in each case. This plan admits of variety and yet the effect is somewhat uniform, which is very desirable.

A scheme of violet tones, dull blue violet for the largest spaces, with a tone a little purer and a little less blue, with a gold background, in a design that is not too open, would be pleasing for a dainty tea service.

Flat enamels applied over both the background as well as the design, leaving all about the forms a narrow band of white china as an outline, gives a charming effect for a piece that admits of a very elaborate treatment. A vase might have an allover design done in this way, with a band of design to give added interest. With a careful selection of colors the effect could be made very rich.

Shades of brown with dull red, gray blues with purer greens, and the reverse, dull orange with gray of a more or less violet quality, rose and warm gray, and a dozen more color schemes might be named, all of which might have numberless variations.

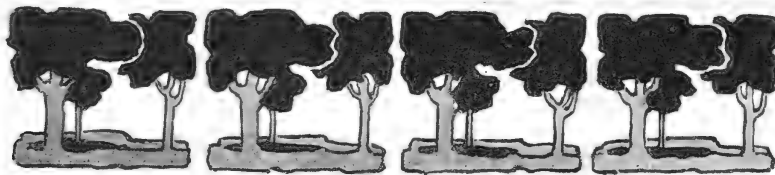

BORDER—TREE DESIGN

make "pretty" regardless of use. We can learn from the primitive man who in his need of some article of use, creates not only the thing of use but at the same time a thing that is a joy to the eye.

Let us think about quality and not quantity, and be satisfied with nothing that is not sanctioned by our own best judgment. Then ceramic decoration will have reached the high place that is its right.

Margaret Overbeck
De Pauw University, Greencastle, Ind.



A FEW SUGGESTIONS

TO those beginners who have not acquired the skill to make their own designs and who must copy, the best advice one can give is to draw freehand from the start. The experience of at least one teacher is that if a pupil cannot draw with a pencil she cannot draw with a brush, and since one must draw with every stroke of the brush in painting, is it not better to have had that intimate acquaintance with the forms in the design that only a free hand application can give? It is, however, to be deplored that such advice is necessary, since success in any line comes only with proper preparation.

A very pretty and interesting set of tea cups has the same color scheme used throughout—dull gray green background, clear warm green for design and narrow connecting band. In this band there are at intervals small oval medallions of ruby purple, and the whole is outlined in

BORDER—TREE DESIGN

BARKS, Brown Green with a little Olive Green, or use Black Green alone. Light parts, Apple Green and Black. Paint all on a fired ground of Gray Green and Pearl Gray. Browns or blues would also be effective.



BORDER—CONE DESIGN (page 240)

TINT cones Yellow Brown and needles Yellow Green. Background Dark Green, very dark. Partially outline cones in same Dark Green.



BORDER—WALNUT DESIGN (page 240)

TWO shades of brown, Brown 4 or 17 and a little Yellow Brown, on a cream ground. Greens might be used with good effect. Outline nuts with Black or the color used in the design.



PLATTER, PLATE AND MUG—POPPY SEED MOTIF (pages 250 and 251)

POD and leaf dull dark blue, Dark blue, Black and Ruby Purple. Medium grey parts of design, green made of Olive Green and Black. Background, Apple Green and Black. The latter may be put on after the first firing and carried over the whole design except the blue parts, which will need a second painting of the same dull blue.

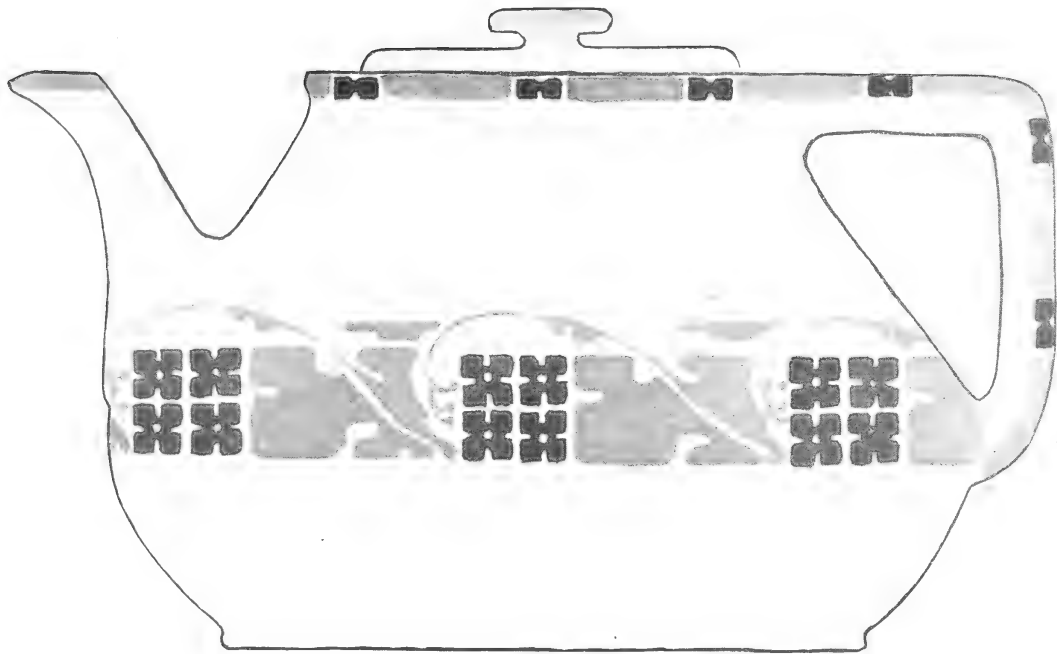

TEAPOT—CONVENTIONAL FLOWER AND LEAF

Flowers, Blood red, and leaves and stems Meissen Brown on a light yellowish ground, Yellow Brown, Imperial Ivory and Black.

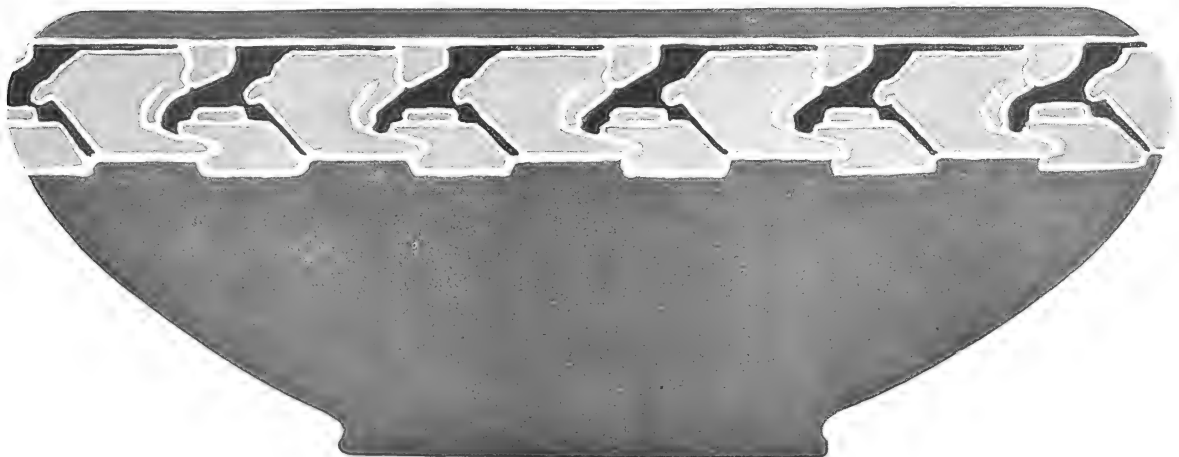

BOWL—WILD TOUCH-ME-NOT

Paint flower forms in a rich yellowish tone, Imperial Ivory with a little Meissen Brown and Black. Background, Copenhagen Blue. Body of bowl also Copenhagen Blue. For the second painting tint background in band again with Copenhagen Blue and dust with dry color. The flower forms will probably need a second painting as will also the body of bowl.

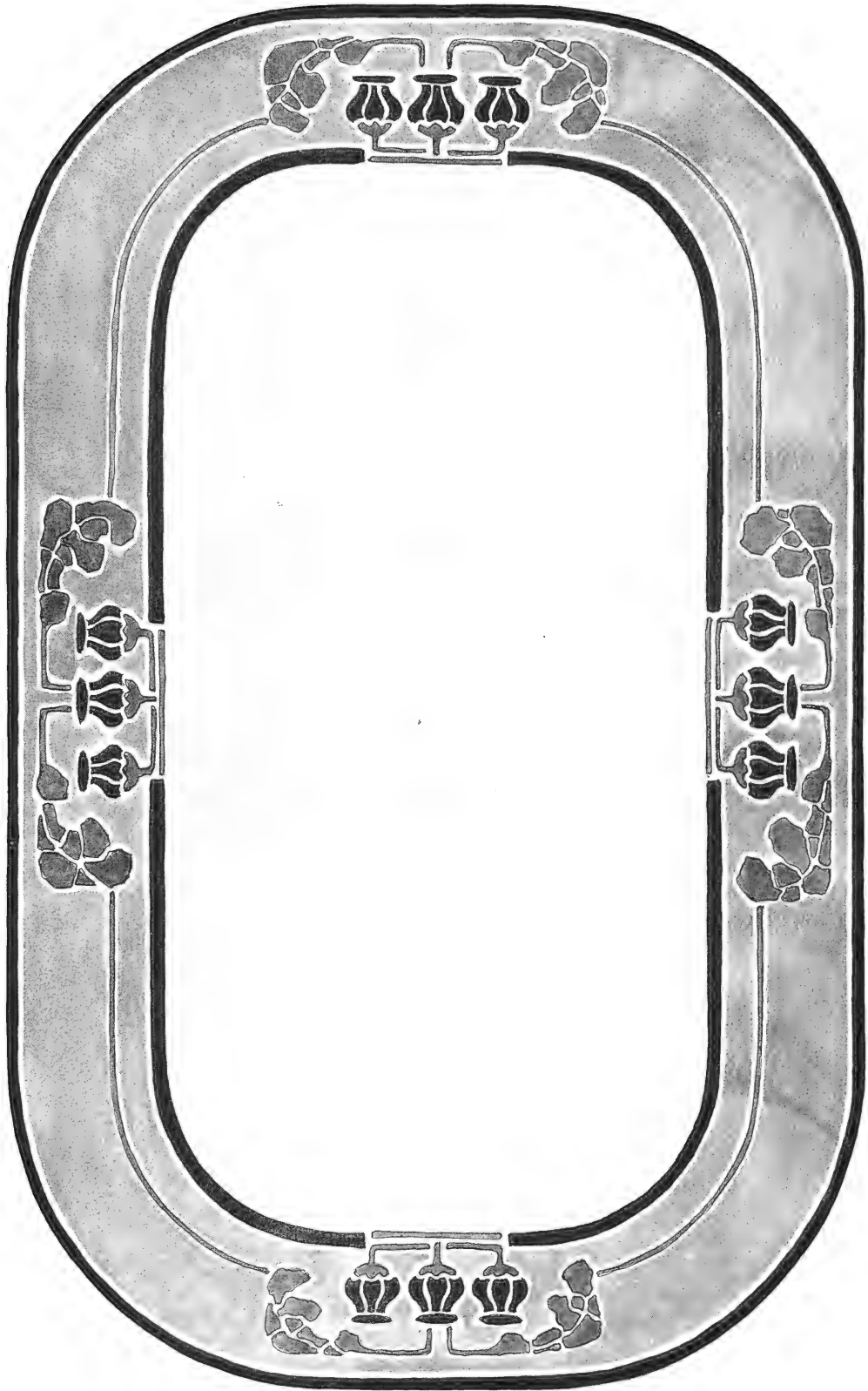

PLATTER—POPPY SEED POD MOTIF

(Treatment page 248)



PLATE AND MUG—POPPY SEED POD MOTIF

(Treatment page 248)

VASE—PEACOCK FEATHER DESIGN

FIRST TREATMENT

AFTER design is drawn in India ink, put in background with Violet No. 2 and dust with Pearl Grey. Paint dark eyes with Deep Blue and Black, shading to Violet at the lower part of the form; light grey forms at either side of dark, Grey Green. When fired tint whole with Pearl Grey and a very little Violet. Wipe out small upper light and paint with Orange Yellow toned with Black. A third painting may be necessary to obtain the desired depth of color. Design will be most effective if kept subdued in color.

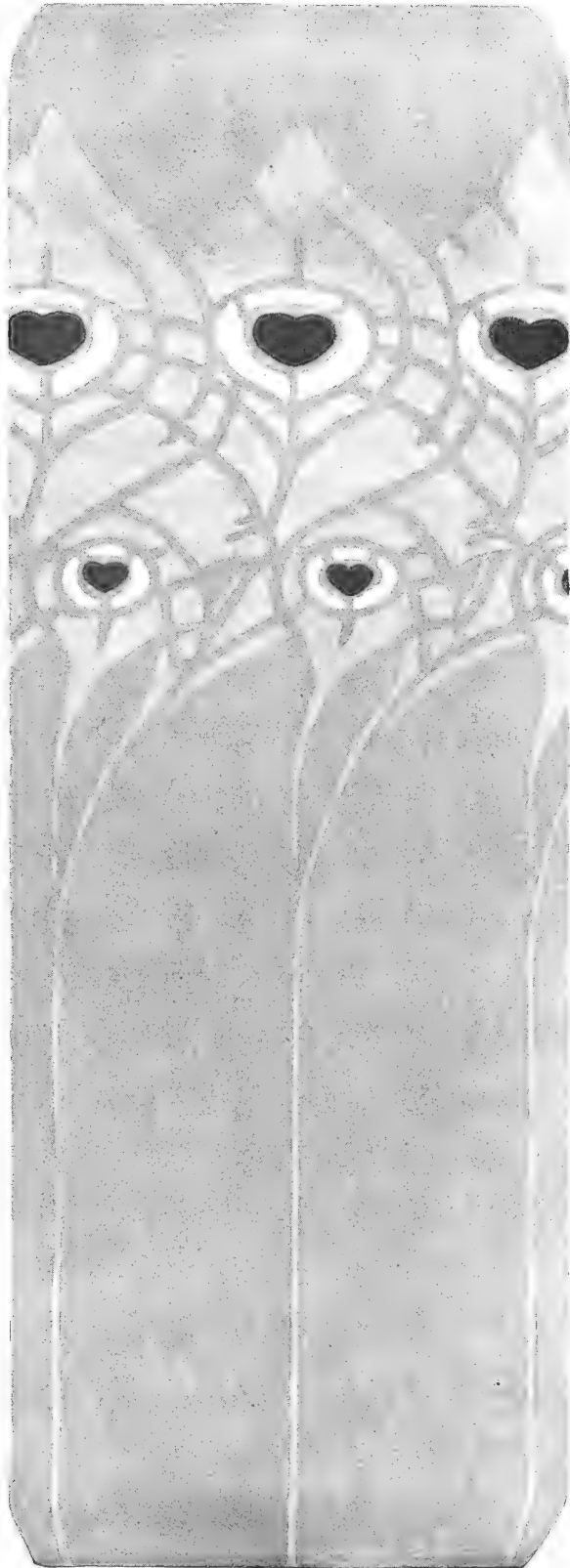

SECOND TREATMENT

For a treatment in lustres and matt colors, first paint main parts of design in Olive Green Lustre, taking great care to have china and brushes perfectly clean. Use alcohol for cleaning. Paint dark parts Deep Blue and Black. Small light above, Orange Lustre. Larger lights asides, Olive Green (tube or powder color).

After firing, tint background with Matt Bronze Green and when sufficiently dry dust with same color. Clean out design perfectly with clean brush and alcohol and go over Olive Green Lustre again, also the Orange Lustre, carrying it over the olive green forms at either side of darks. Paint dark forms again same as before.

A third painting with the same colors as for second will probably be necessary.

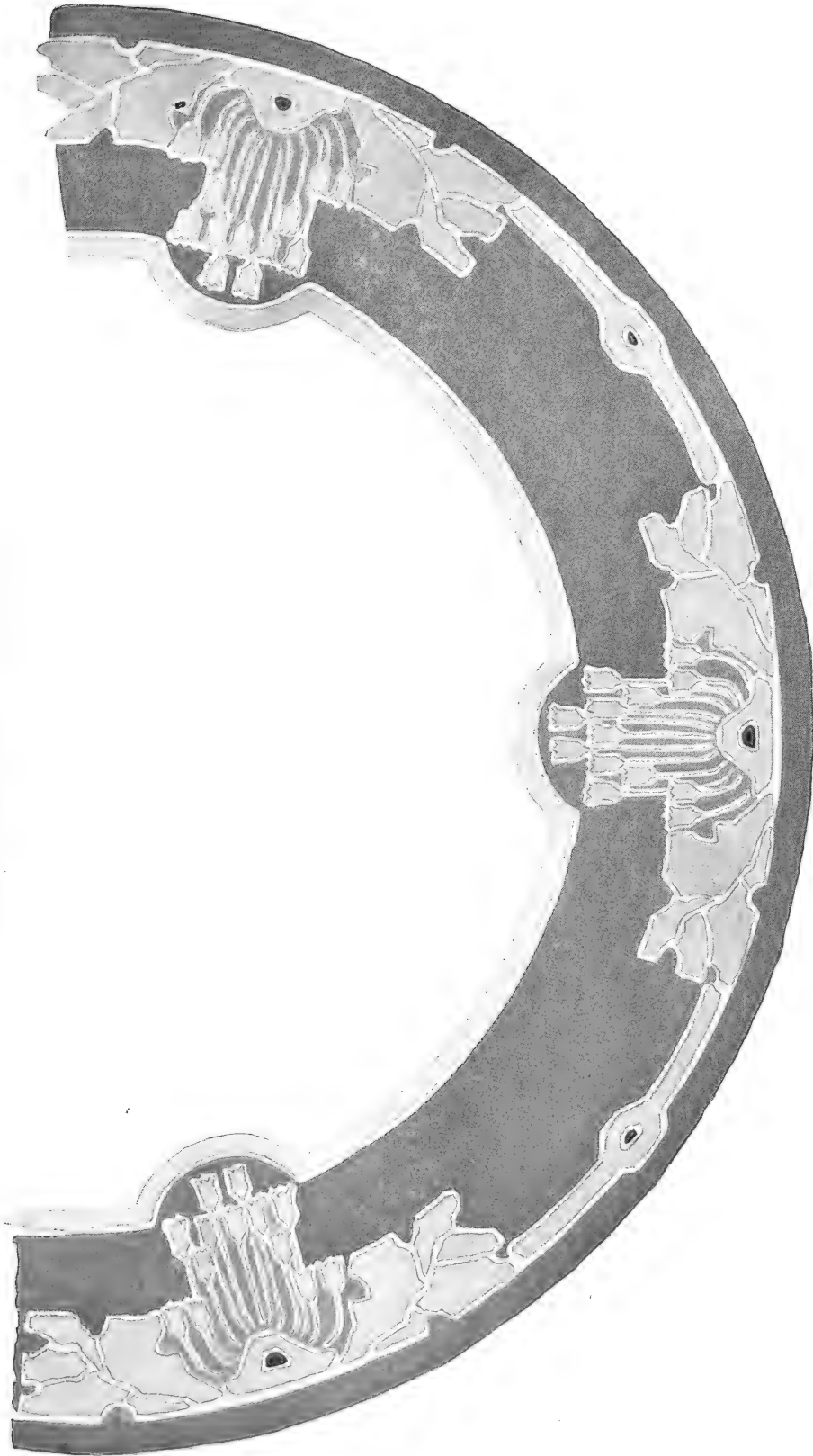

CHOP PLATE—SUGAR TREE BLOSSOM

Leaves, flowers and bands to be painted in Apple Green with a little Yellow Brown added. Tint background with Dark Green. Paint small darks in band with Ruby Purple. Strengthen for a second firing, after which outline whole with unfluxed gold.

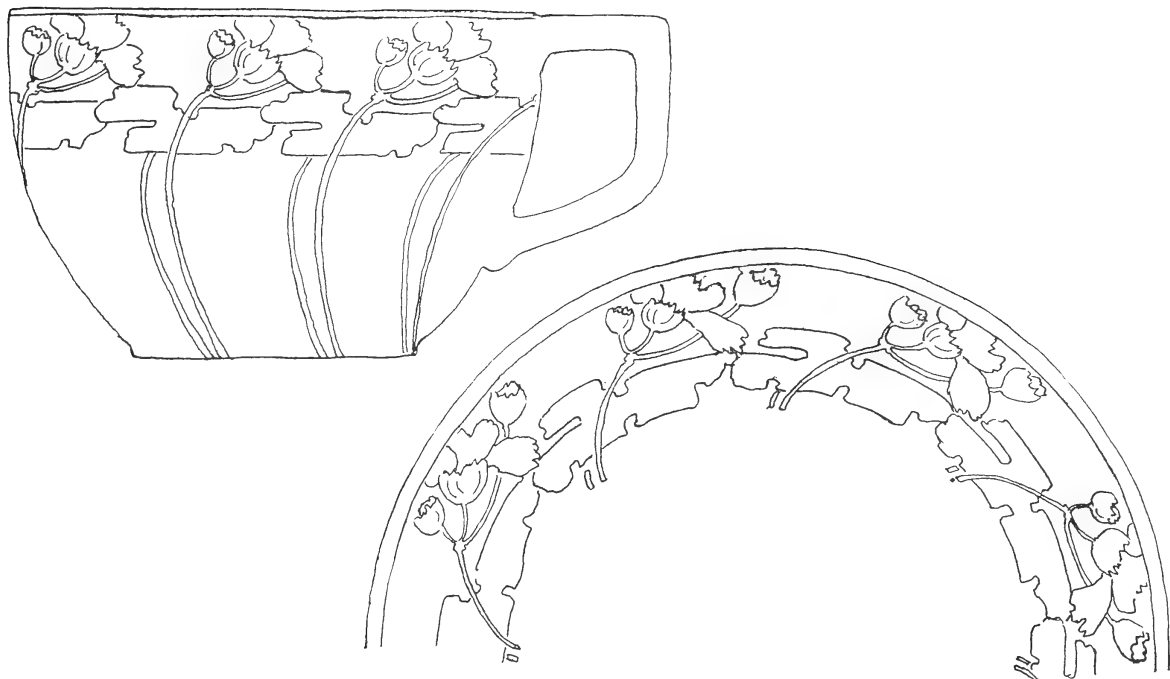

CUP AND SAUCER—PRIMROSE MOTIF

FLOWERS a violet pink, Carmine No. 1 and a touch of Violet of Gold.

Leaves and stems, Olive Green with a little Carmine shaded into the stem. Outline, Deep Red Brown with one-fourth Ruby Purple—cream background.

A treatment in Rose and Olive Green lustres might be interesting. Outline in Black and tint whole after the second firing with Orange Lustre.

the flowers newly opened are almost white and that they grow a deep pink before they wither. Keep white around centers and make center of Yellow Green, a little Yellow toward the white and a touch of Dark Green for the deepest parts. Green parts including leaves, Apple Green, Yellow Green and a little Yellow Ochre for lights. For darks, New Green, Olive Green and Dark Green with a little Rose in stems, growing deeper farther down. Carry on background with other parts. Use Pearl Gray, Gray Green and a little Imperial Ivory at top and shade downward into Dark Green and a little Ruby, the latter dusted on after the paint is almost dry. Use same colors for second firing.

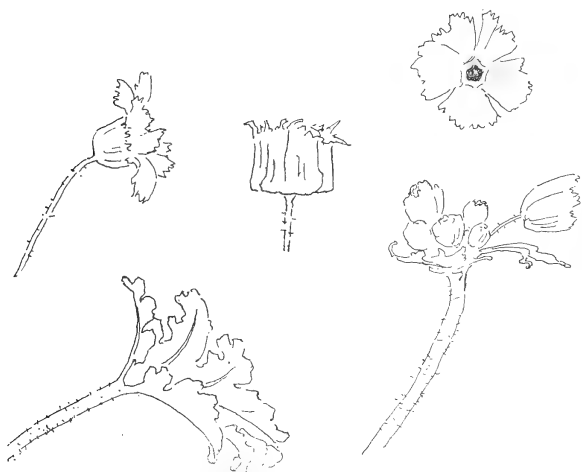

PRIMROSE STUDY

PAINT flowers in shades of Rose with Ruby for the strong darks. For shadows, Apple Green or Dark Green with Rose for the various tones. Bear in mind that

PLATTER, PLATE AND MUG—POPPY SEED MOTIF (pages 244 and 245)

TREATMENT in enamels is very suitable for this design. If Fry's enamel is used, mix first with a very little of Fry's Medium, thin with the Enamel Medium until thin enough to flow freely, if necessary add turpentine as it dries out. If Aufsetzweis is used, no oil is needed except turpentine or lavender oil to thin. To the latter add one-eighth flux to prevent chipping which sometimes occurs on hard ware.

For black parts of design use Dark Blue enamel—Dark Blue (Dresden), Ruby Purple and Black added to the enamel. It will require perhaps two parts mixed color to one of enamel to make it dark enough. Leaves and other dark gray parts, warm mellow green, Grass Green, Brown Green and Yellow for Mixing added to the enamel. Background is tinted with Dark Green. Fire only once for enamels.



PRIMROSE STUDY



PLATTER - POPPY SEED FOD MOTIF

(Treatment page 242)

MARCH 1907
SUPPLEMENT TO
KERAMIC STUDIO

DECORATIVE LANDSCAPE—MARGARET OVERBECK



COPYRIGHT 1907
KERAMIC STUDIO PUB. CO.
SYRACUSE, N. Y.

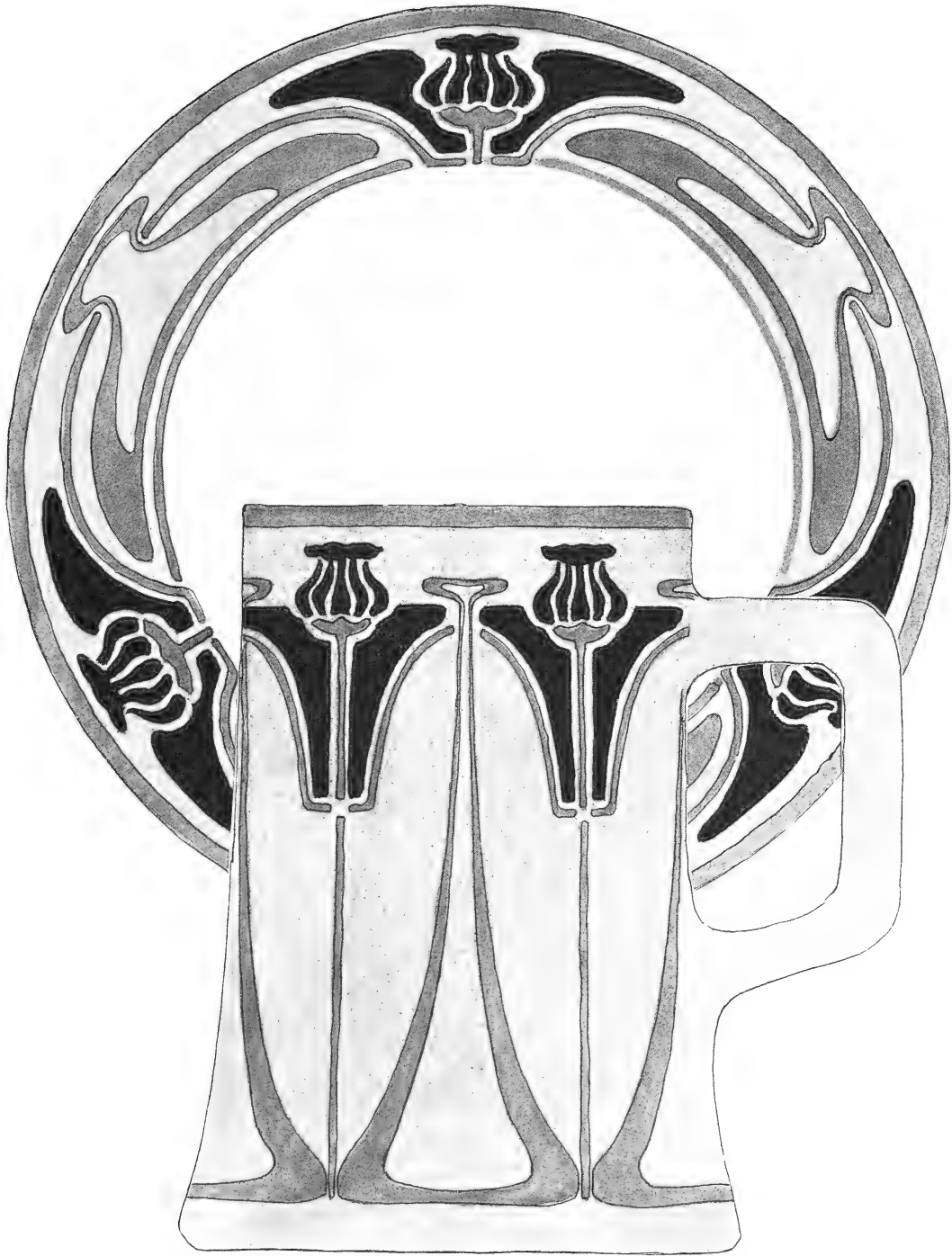

PLATE AND MUG—POPPY SEED POD MOTIF

(Treatment page 242)

APPLE STUDY (Page 241)

TINT first with Orange Yellow and Brown 4 or 17 and fire. Paint leaves in Olive Green and Black, making black turned over parts in a dark blue green tone—Russian and Dark Green. Stems, Brown 4 or 17 modeled a very little. Apples, Blood Red, Meissen Brown, Yellow Brown and Olive Green. Keep strongest color in largest one and small one above it, using more red in parts where the light and shadow meet and more green toward lower part. Darkest parts Blood Red running into Meissen Brown lower down. Use Yellow Brown with Blood Red in lights. More green and brown in the less important apples.

WATER COLOR TREATMENT

First lay on a wash of Raw Sienna and Black over the entire surface. Leaves, Flat Green, Hooker's Green No. 2, and Raw Sienna to make it quite warm.

Stems, Van Dyke Brown with a little Crimson Lake. Model slightly. For apples use Yellow Ochre, Burnt Sienna, Vermillion and Sap Green, following same plan as suggested in the mineral treatment. Outline in Ivory Black with Japanese brush, accenting lines here and there.



CHILD'S BOWL

TINT with Yellow Ochre and Black and fire. Outline with Black mixed with sugar and water, using either pen or brush. Draw figures with care to keep the character. Do whole design in Copenhagen Grey and dust, then tint body of bowl in same color. A treatment in greens would be good. First fire a tint of Brown Green. Then put in forms in Olive Green and outline in Black. Lastly a coat of Orange Lustre might be added over the entire band.



BORDERS FOR DINNER PLATES

TWO shades of green, blue, red, or brown—all more or less subdued—and gold for black parts would be an effective treatment for these simple designs. In any

case the color in the largest masses should be most subdued, depending for richness upon the gold background, and purer color in the smaller forms.



NATURALISTIC PLATE DESIGN—ASTERS

(Treatment page 254)

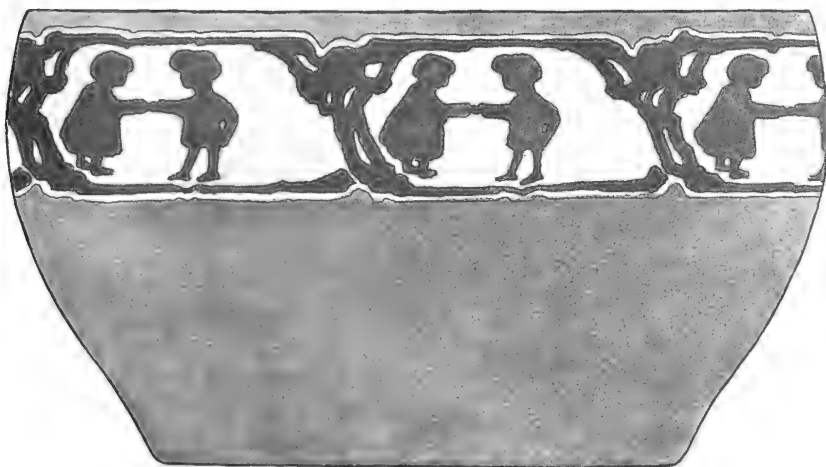

CHILD'S BOWL

NATURALISTIC PLATE DESIGN—ASTERS (page 253)

BEGIN by painting flowers in main cluster with light and medium tones of Violet, with Banding Blue in the lighter parts. Crisp darks, Ruby. Leave highest lights white. Centers, Albert Yellow and Yellow Brown. Leaves, Yellow Green and Apple Green. In putting in background Dark Green with Violet toward edge and Yellow Brown inside, care must be taken to keep the sharp edges in a few of the most prominent parts. Let colors blend in other parts. Albert Yellow for light tone at light side of larger cluster, running into Gray Green, and use Dark Green about the other clusters, connecting with Blue and Violet and Gray Green. Paint flowers at same time with background, padding in some parts to blend colors. Bands, Dark Green.

Second painting; use same colors, aiming at more strength in darks of background and in some of the more subdued parts, carrying background over flowers as well, wiping out lights.

If handled carefully two paintings will be sufficient but a third may be given if needed.

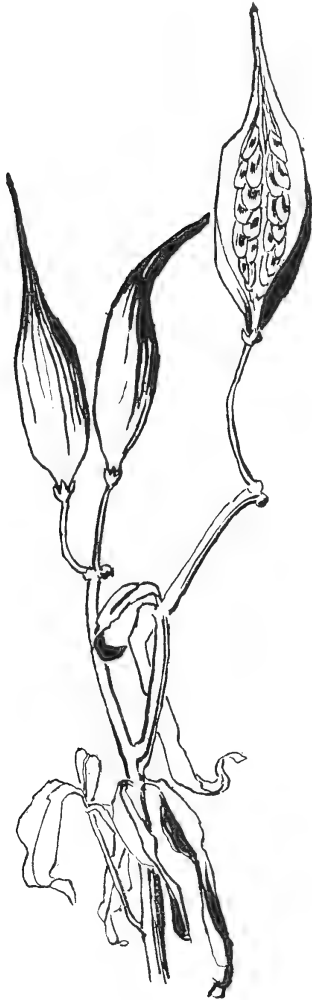

SWAMP MILK-WEED SEED POD



WILD TOUCH-ME-NOT

LANDSCAPE FOR TILE

(Color Supplement)

TINT the entire surface with Brown Green. If powder colors are used, proceed as follows: draw the design in India ink and put on outlines with German Black mixed with sugar and water. Paint sky, water and houses with Banding Blue and Black.

Trees, Olive Green with a little Yellow Brown. Tree trunks and roofs, Blood red and Meissen Brown. Distance and foreground, Black Green. Use the same colors for a third firing, observing carefully the relation of tones and colors. Have the first tint of Brown Green dark enough to hold the whole design together.

If preferred, after the first tint has been fired, the masses of color may be laid on first and the outline, (tube color or powder mixed with oil), may be put on last.

WATER COLOR TREATMENT

Tint paper first with Raw Sienna and Ivory Black. When sufficiently dry, so color does not run, wash in sky, water and houses with Cobalt, to which has been added a little Hooker's Green and Light Red. Foliage should be painted with Sap Green subdued somewhat with Indigo and Raw Sienna.

Use a wash of Sap Green and Black for distance and foreground. Tree trunks and roofs, Light Red and a little Vermilion.



MILK PITCHER—MILK WEED POD MOTIF

PAINT whole surface with Meissen Brown, Imperial Ivory, and a little Black, and fire. Draw design in India ink and tint all black parts with German Black. When sufficiently dry, depending upon temperature from four to twenty hours,

dust with the same Black. Outline next with Black mixed with sugar and water. Tint all other parts except those to be left the original tint, with Meissen Brown and a little Black. If necessary strengthen for a third firing.

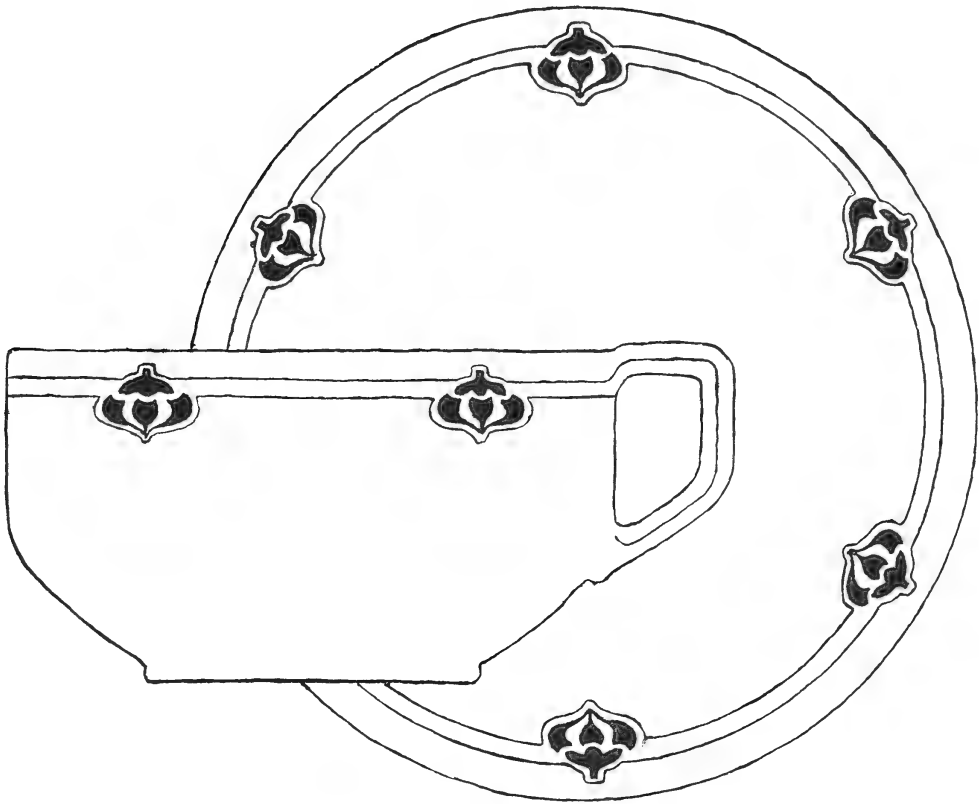

DESIGN FOR CUP AND SAUCER

Paint entire design with Grass Green to which has been added a little Yellow Brown.
Blue might be used, or gold if preferred.

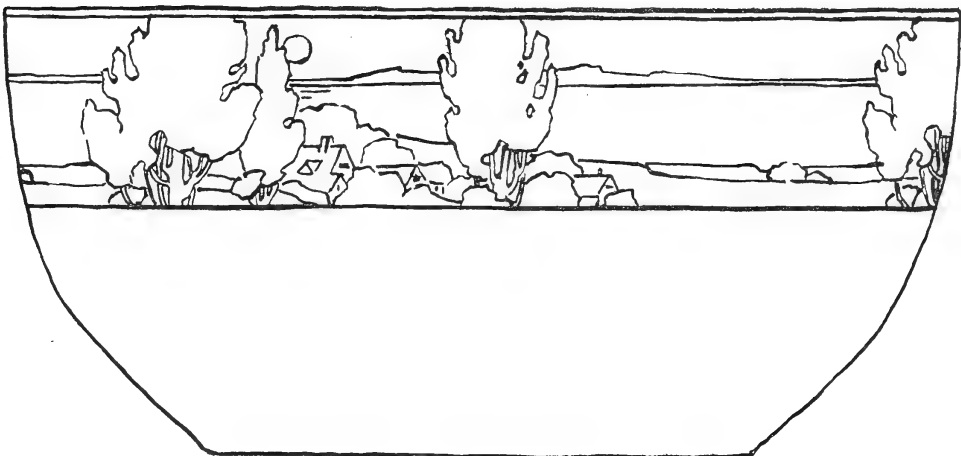

ADAPTATION OF LANDSCAPE MOTIF TO BOWL

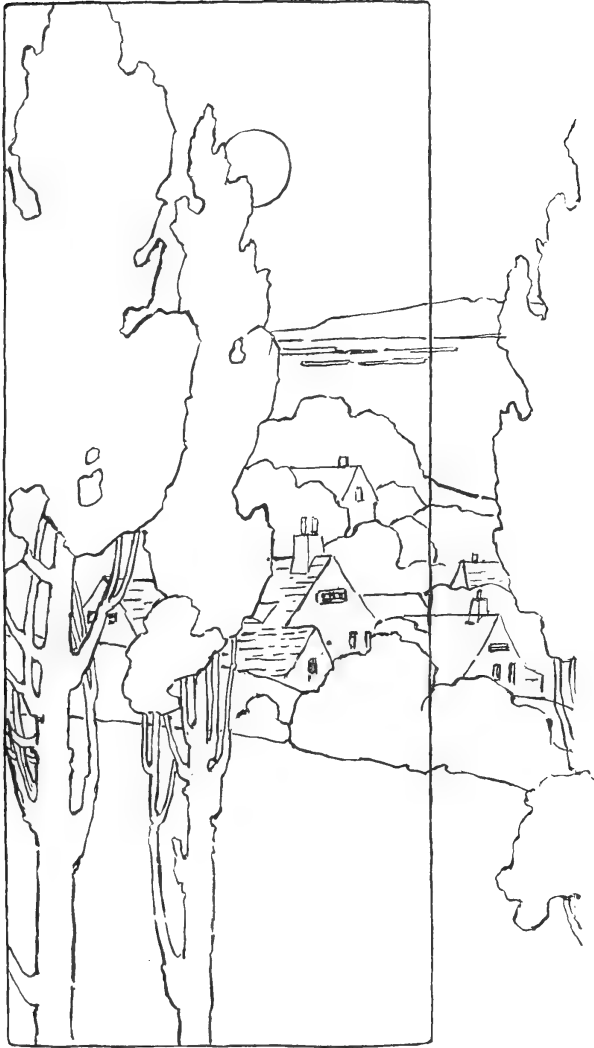

ADAPTATION OF LANDSCAPE MOTIF TO VASE

IN the adaptation of landscape motif to the vase form it will be necessary to somewhat elongate the trees, and to widen them for the bowl border. In the latter about three repeats, connected as suggested in the sketch, would be best.



FERNERY OR PALM-STAND WITH LANDSCAPE TILE

THIS stand, if made about fourteen inches high, for eight by ten inch tiles, may be used as a jardiniere, or it might be made high enough to stand upon the floor, about forty inches with the open box to receive the pots, and with a shelf ten inches from the floor. The wood used is oak, the joints are mortised and the tiles carefully fitted. Only one design is given but the other three should be a simple continuation of the landscape, done in the same colors. Finish the wood in dull brown.

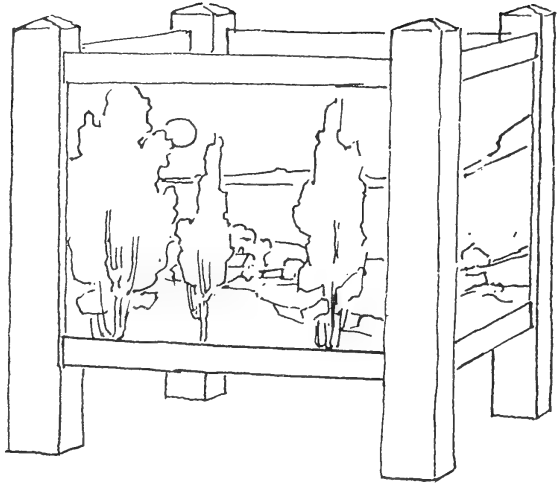

FERNERY OR PALM-STAND WITH LANDSCAPE TILE

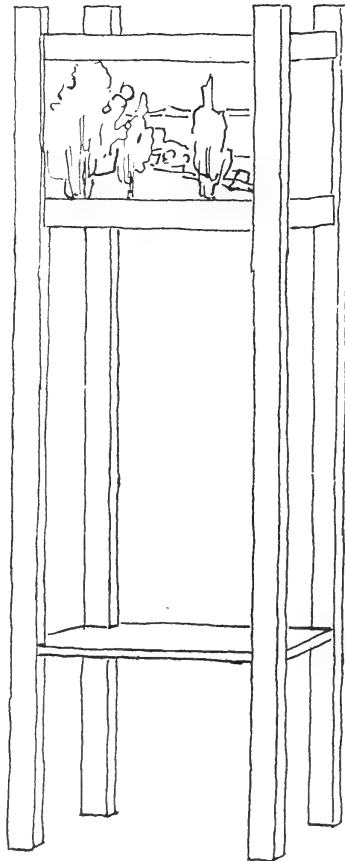

FERNERY OR PALM-STAND WITH LANDSCAPE TILE

THE CRAFTS

Under the management of Miss Emily Peacock, 232 East 27th Street, New York. All inquiries in regard to the various Crafts are to be sent to the above address, but will be answered in the magazine under this head.

All questions must be received before the 10th day of month preceding issue, and will be answered under "Answers to Inquiries" only. Please do not send stamped envelope for reply. The editors will answer questions only in these columns.

SINCE the crafts department has been established in KERICAMIC STUDIO we have published technical instructions for nearly all the important branches of craftwork. We will in the coming numbers treat of new subjects, such as work in pewter by Jules Brateau, the Javanese Batik, etc. Meanwhile we would be glad to receive designs for application to the different crafts as well as for china decoration, and would purchase all such designs which seem to us worth publishing. As much as possible, treatments should be sent with them. For instance, if a design is intended for a leather portfolio, or a carved wood tray, or a piece of pottery etc., the treatment should explain how the work must be done. However, many designers, though unfamiliar with special craftwork, may wish to submit good designs without treatment. These will be acceptable, but will not be as valuable to us as those accompanied with treatments. All designs should be submitted to Miss Emily F. Peacock, 232 East 27th Street, New York.

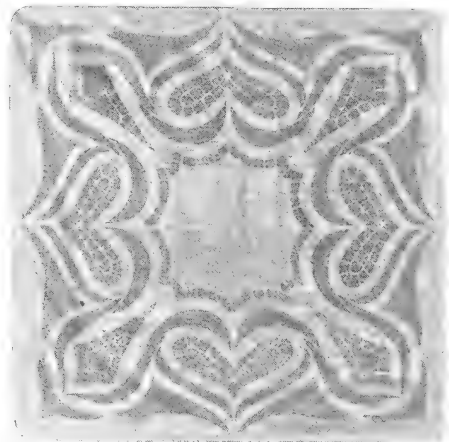

No. 1

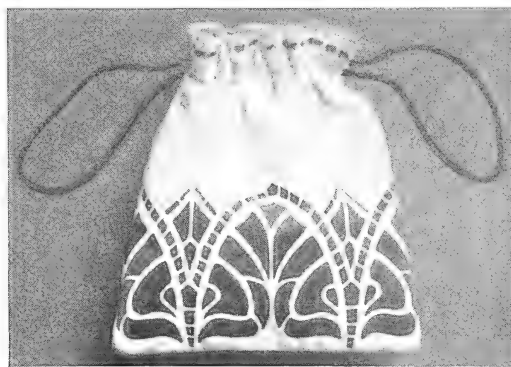

No. 2

FABRIC STENCILING

Harry Barnes Goundrey

TO lovers of the original and beautiful in decoration the art of stenciling on fabrics makes a direct appeal. To be sure the stencil has been employed for years as a means of transferring designs, and people of other countries, the Japanese particularly, have become proficient in its use, producing with stencils the most artistic effects, but it is only of late years coming into use for house-furnishings in this country. While by a study of the Japanese stencils a beginner may get hosts of ideas, they are mostly too elaborate and complicated to commence with and it is better to start with the more simple designs.

It is astonishing the great number of uses to which Fabric Stenciling may be put. Curtains, door hangings, sofa-pillow tops, table covers and so on, even to neck scarfs, collars, waists and opera bags, may be decorated in this way. The choice of materials is very great and as in the foundation material lies the principal cost it may be varied to suit all pocketbooks. For drapery stuffs there is a wide range from velour, arras-cloth, linen crash, shaiki silk, denim and so on down to unbleached factory which retails at about 15 cents a yard. For window curtains

there is also great variety, cheese cloth or cotton bunting looks exceptionally well when stenciled, and chambray, unbleached muslin, light weight linen, scrim, china silk, pongee and raw silks are a few of the numerous materials which may be used to good effect.

One advantage of this method is that one may have in his or her own home designs especially adapted to personal taste. The whole furnishings of a room may be carried out in different adaptations of one design using colors which blend well into a harmonious general effect. A living room in a sea shore cottage had designs of sea shells, sea weed, etc. stenciled on the couch cover, curtains and draperies. The colors used were principally blues, greens and a few suggestions of the violet tones of the sea. As

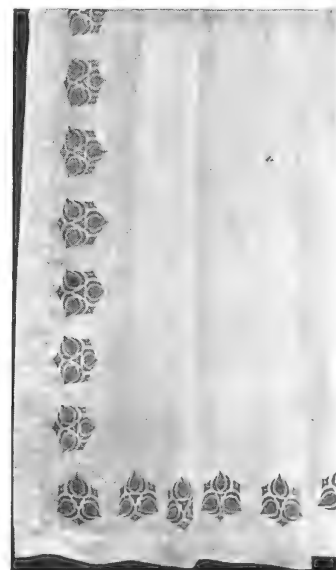

No. 3

stenciled fabrics may be washed if care is taken and not much soap or hot water used, they are particularly well suited to use in the country home where of course they need it less frequently than in the city.

Some time ago directions for Fabric Stenciling were given in this magazine but for the benefit of those who have not learned the methods a few directions may not be amiss. After selecting material the design is the next point to consider. Here let it be said that the more simple

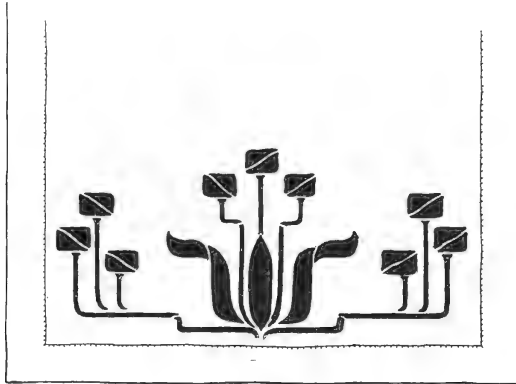

No. 4

the design the more effective and easier to apply. Persons possessing a slight knowledge of drawing can get suggestions from flowers, leaves, good wall papers, cretonnes and so on which with some adaptations may be used for a stencil. By a study of the designs accompanying this article one will see that a flower form has to be much conventionalized and that there must be certain parts of the design used to hold the other parts together so that when the stencil is cut, it will not fall apart. After the design is drawn trace it with carbon paper on to stencil board. This may be purchased under the name of oil board or stencil paper or made at home by coating both sides of a heavy manilla paper with boiled linseed oil and allowing it to dry thoroughly before using. When the design is traced on, place the stencil board on a pane of glass and, with the point of a sharp penknife, carefully cut through the outline of the design. To give the necessary clean cut edge sharpen the knife frequently on an oil stone. Allow about an inch margin all around the design. The next step is to mix the colors. Tube oil paints thinned with turpentine are the most satisfactory, the separate colors being mixed in deep saucers or old cups and a small flat bristle brush provided for each color. A most convenient thing to work on is an old drawing board or kitchen table to which the work may be securely fastened. Place a sheet of blotting paper under the material and pin it firmly down with pins or thumb tacks. After the colors are mixed try them on a sample of the cloth and it is wise to practice on some samples before beginning actual work. When ready place the stencil in position and pin it firmly, dip the brush in the color and drain off as much paint as possible on the side of the dish, then wipe it once or twice over a blotter, as the brush must be nearly dry or the colors will run under the edge of the stencil and spoil the design. Apply the paint through the openings of the stencil by holding the brush in a nearly upright position and brushing it with short quick strikes across that part of the ma-

terial showing through. At first while the brush is well filled with paint one must be very careful to go lightly and especially on the smaller openings, but after a few strokes it is perfectly safe to work the color well into the material and be sure and fill it in completely to the cut edge. Carry one color over all the parts of the design for which it is intended and repeat for each color till all the spaces have been filled, then remove the stencil and place it in position for the next repeat. The work must be done with care and deliberation as it can not be hurried without danger of having the colors run. After some of the work has been done it will be easier to know just how much color can be applied at one time without spreading. In regard to the colors used do not have them too bright, the soft subdued tones being always more satisfactory and restful to the eye. For general work try to have the foundation material as light a tone as possible but where dark materials are necessary one or two darker shades of the same color and a strong contrasting color will give a rich effect, but of course a light color will not show on a dark background as the turpentine makes the paint transparent. If white were used, that would make the colors look painty and would simply pile up on the material and not sink in. Stenciling should be done with such delicacy that the design appears almost as if woven into the material and leaves the texture the same as before the paint was applied.

In illustration No. 1 the sofa-pillow top was stenciled on pongee silk in the natural shade, the decoration was carried out in a soft brick red, pale green and dull purplish blue.

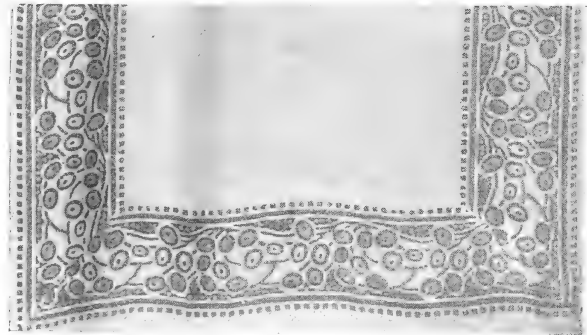

No. 5

The dainty little opera bag shown in illustration No. 2 is made of cream colored Nagasak silk and the decoration is in pale blue and green. Naturally the stenciling has to be done before the bag is made up. It is completed with a cream silk lining and cord to draw it up.

The stencil in illustration No. 3 was used on a curtain of cream colored cheesecloth to form the border just inside a deep hemstitched hem. The design was in two tones of grey blue. Illustration No. 4 is suitable for the end of a table runner or scarf and could be worked out in several color schemes. It is well adapted for a heavy crash or linen.

We are indebted to Messrs Liberty & Co., London, England for the delightful scarf in illustration No. 5. The original was a soft silk, light coffee in color, and stenciled in dull green and black. The background was used in the small oval motive in the centre of the stencil, which gave the border a better variety of tone.

As the variety in stenciled designs is limitless, this decoration can be used for a great many things in a house without danger of monotony. The work is fascinating and with care and patience beautiful things can be made which are very satisfactory because they show originality and have a personal touch.

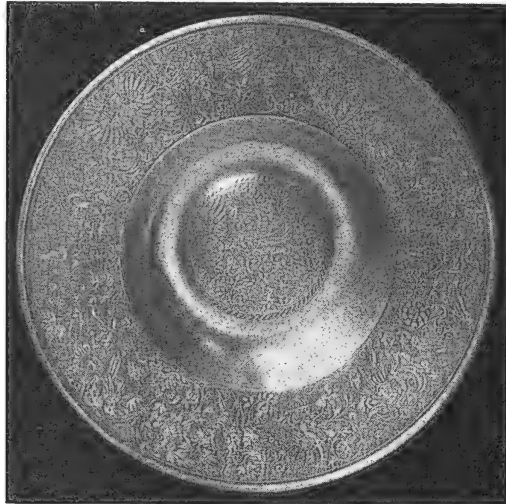

No. 21.
Basin, representing the Gods of Olympus. Pewter, German make, XV. to XVI. century. Belongs to Jules Brateau.

ART IN PEWTER
[CONTINUED]

Jules Brateau

In the Breslau Museum, there is a large tankard, cylindrical in shape, with a hinged lid surmounted by a ball. This tankard has feet and a handle, also a faucet soldered at the base. The cylinder has been broadly beveled with the hammer in panels, the flat surfaces thus



No. 22.
Tankard, Museum of Breslau, Pewter. From the *Revue des Art Decoratifs*, 1883. Paris.

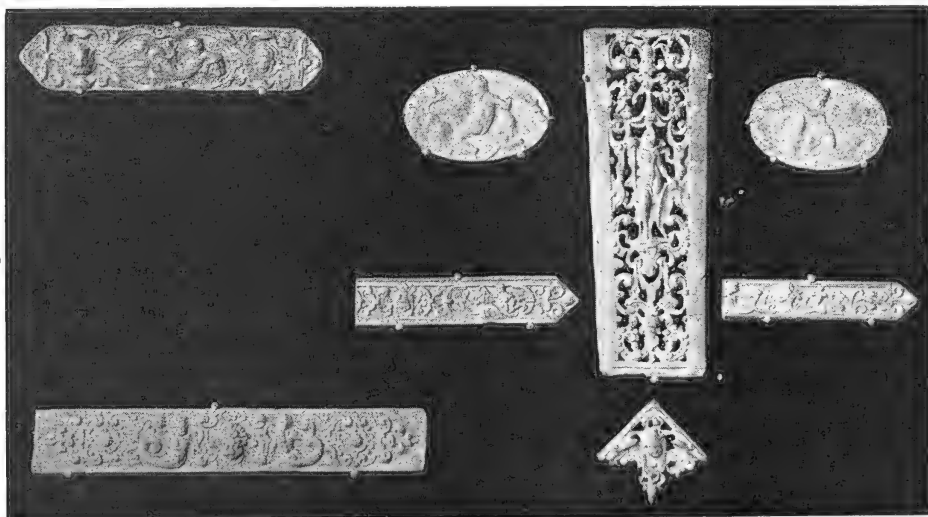

No. 23.
Small pewter objects: Book covers, clasps, coins, sheath for knife, and medals, after the manner of Jean Goujon. Very rare specimens, XVI. century. Belongs to Jules Brateau.

produced, being decorated with religious subjects, and offering a pleasing effect. We give in Ill. No. 22, a reproduction of this fine piece, which, it must be observed, was not made according to the process to be explained later, as the engraving was done directly on the piece with the graver's tool.

This brief mention is sufficient to emphasize the fact that the XVI. century was the most remarkable period of the pewter art-industry, as well as to show the importance of a movement culminating in a master piece: a work of art, which, by its artistic and technical qualities, surpasses all others of its kind. This is the ewer and basin: "Temperance," by François Briot, whose name, engraved on the façades of our monuments, has not been forgotten after 400 years.

[TO BE CONTINUED]

We regret that lack of room has prevented us from giving in every number part of the series of articles on pewter by M. Jules Brateau. In our April number the work of François Briot, the famous pewterer of the XVI. century will be commented on and illustrated.

STUDIO NOTES

Miss Emily F. Peacock has returned from Europe and resumed work at her Studio 232 East 27th St.

Mr. C. T. Hamann, instructor at Pratt Institute, Brooklyn, will have a class in advanced work in jewelry and carving in shell and horn at Miss Peacock's studio, commencing the middle of February.

CLUB NOTE

The National Society of Craftsmen are holding a reception and tea every Wednesday at 4 o'clock in their galleries at 119 East 19th St. New York City. The Society expect to hold an exhibition of craft work the first part of April, emphasizing particularly needs for summer homes. They are also arranging for a course of lectures to be given during the winter; among the first given will be one, on the wood block print, by Mr. Arthur Dow.

ANSWERS TO INQUIRIES

M. J. C.—Colors prepared for use on leather can be obtained from Mrs. B. Van Court Schneider, 102 Auditorium Building, Chicago, Ill. Russian calf is the best leather for tooling and coloring. A good deal of experimental work has to be done in coloring leather, try using the alcohol with the dye.

T. J. O.—Metal articles to be oxidized must be very thoroughly cleaned in hot potash. The simplest oxidizer is made by dissolving potassium sulphide in hot water and using the solution while hot. A piece of potassium sulphite, as large as a small nut and about a quart of water will make quite a strong solution, it can be made any desired shade by using more or less of the potassium.

M. C.—A tablespoonful of sulphuric acid in about a quart of water is the proportion for the pickle for cleansing silver, copper or brass. Mix the sulphuric acid and water in a porcelain dish, and keep it hot by placing the dish in another vessel filled with water.

ANSWERS TO CORRESPONDENTS

J. A. H.—The trouble with your kiln is not due to the new muffle, but to the draught. There is something wrong somewhere with the draught, otherwise the smoke would go through the chimney instead of coming back into the muffle through the top opening. Through the spyholes with mica shutters at top of the kiln you should be able to find out why the smoke does not go freely from the flues to the chimney.

Miss J. N.—You can procure molding clay from any dealer in art materials. You might write to the Handicraft Co., 255 E. Broadway, N. Y.,

mentioning KERAMIC STUDIO. We do not quite understand what you mean by "velvet" appearance of Blues for china. Possibly you mean the matt colors which give a dull velvety finish. Miss Mason's matt colors you will find give this effect. See adv.

M. D. B.—We have not the formula for essence for bright gold nor for grounding oil. If we obtain reliable formulas we will publish them. In place of essence for bright gold, use oil of lavender, it is much more satisfactory as it keeps the lustre open longer, so that it may be padded.

Mrs. A. W.—Dresden Thick oil and Fat oil of turpentine are made by evaporating spirits of turpentine. The thick oil is more evaporated than the fat oil. Put the spirits in a wide bowl on the back of the stove till sufficiently thickened.

X. Y.—If the color on your stein, which came out grey instead of black, does not seem too thick already, you might safely paint it over with black and dust black powder color into the partly dry padded color. Almost any black ought to dust on well but we consider the best black effect is gotten by dusting Banding Blue over fired Pompadour Red. There is more color in the black.

E. P.—In decorating a complete dinner set we would prefer at least a "family" resemblance all through. At least all pieces to be on the table at one time should have the same design and color. A simple narrow border for service plates and soups can be elaborated for the main course with special designs for special courses, such as game, salad, etc. If the same color scheme is continued all through, more latitude might be allowed in design. One color for tinting and gold for the design is dainty and effective.

K. H. C.—The methods of decorating glass are very similar to china technique. The gold, enamel, paste and color are applied in the same manner. The enamels used are the *soft* enamels, the Roman gold for china is about right to use over paste, a special gold for glass will have to be purchased for the flat work. The Hancock's paste for gold is suitable for glass decorating. Special colors for glass must be used. Some lustres come out very well on glass, such as the opalescent and yellow. Try all your lustres on broken bits of glass then you will have samples by which to be guided. The kiln should be fired to a dark red only. The glass being soft will adhere to the enamels, etc., at a much lower temperature than demanded on china. Almost any kind of glass can be decorated, but the safest for amateur is the Bohemian or Baccarat.

L.—The direction for painting the roses of Aulich to which you refer intends that you should use the Black to touch up the Pompadour before firing.

M. N. A.—Definitions of terms used in drawing. Harmony, i. e., agreement in line and color, etc., so that the entire design "moves together." Balance, i. e., division of space so that the light and dark areas are equivalent, also so that one part of the design does not have undue prominence. A balanced design in its simplest form is one in which the unit is reversed so that both sides are identical. Repose: a feeling of restfulness given by simplicity of line which is balanced so that the idea of motion is completed, i. e., a line slanting from left to right is repeated from right to left, thus completing the movement. In cases where the lines move in too many directions, a restless feeling is given. Where the slanting motion is given from left to right or right to left without balance a whirling effect is felt. Up and down and horizontal lines are most restful. Oblique lines suggest movement. Repose is the effect felt where a design is simple, dignified, few forms and complete in themselves and little or no movement. Rhythm, is the repetition of a unit at regular intervals so as to "mark the beat" as in music.

Colors bought in the bulk need to be both reground and fluxed. We have no formula for grounding oil at present.

Iowa.—You will find all information in regard to lustres in the Class Room KERAMIC STUDIO. You will find designs of water lilies in May, 1901 KERAMIC STUDIO, also in October, 1900 KERAMIC STUDIO and Dec., 1903 KERAMIC STUDIO. Color study by Miss Maud Mason, May, 1902. Try firing your oil kiln, turning on more oil from time to time, watching the chimney and giving only as much oil as you can burn with just a suspicion of smoke. We think your china will be fired quite as quickly and with less trouble than if oil is crowded on. The flame is just as hot, for only a certain amount of oil can find air enough for perfect combustion, the rest goes off in smoke, not heat. You will find all information in regard to paste for gold in Class Room KERAMIC STUDIO.

Relief enamels usually in powder are sometimes hard fire enamels, sometimes for light fire. Aufsetzweis is a hard fire enamel put up in tubes and much the most reliable for a beginner. Tube colors are mixed with oils which harden rapidly. Mix a little tar oil to keep open on palette or clove oil or oil of lavender, whichever medium you prefer. See answer to Mrs. A. W. in regard to fat oil and thick oil.

The Ceramic Art Importing Company

Of Toronto, Canada

Have opened with a full stock of everything required by ceramic artists.

- ¶ Their importations of White China for decorating include Belleek, French, German and Austrian, in all the newest shapes and designs.
- ¶ Their stock of Paints, Lustres, Roman and Colored Golds, is most complete.
- ¶ A large assortment of Mineral Transfers, Brushes, Oils, Mediums, etc., etc.
- ¶ Mail orders will receive most careful attention.

181 Yonge St., Toronto, Canada

Marsching's Roman Gold

— THE —
“STANDARD”
 Gold for China Painting

Other Golds have come and gone, but Marsching's Gold still holds its place as the best Gold on the market.

...ALWAYS UNIFORM...

If you want your Gold work to last, use Marsching's. Have no other.

FOR SALE BY ALL DEALERS AND BY

FAVOR, RUHL & CO. | NEW YORK: { 49 Barclay St.
 { 54 Park Place.
 CHICAGO, ILL: 108 Lake Street.

ARTIST'S MATERIALS OF EVERY DESCRIPTION

THE GEO. H. BOWMAN CO

39 Murray Street, New York

WHITE CHINA FOR DECORATING

Import Lines Now Ready

We have a splendid line of up-to-date samples on display at the above address which you cannot afford to overlook when in New York.

We can fill orders for immediate delivery from our Cleveland Store, where we carry a large stock of French and German White China.

KEEP THE FIRE ALIVE

KERAMIC STUDIO

CONTRIBUTORS

JULES BRATEAU	*	*	*	*	*	*	*	*	*
MRS. H. L. BANCROFT	*	*	*	*	*	*	*	*	*
NANCY BEYER	*	*	*	*	*	*	*	*	*
CHARLES BABCOCK	*	*	*	*	*	*	*	*	*
OPHELIA FOLEY	*	*	*	*	*	*	*	*	*
RUSSELL GOODWIN	*	*	*	*	*	*	*	*	*
MAUD HULBERT	*	*	*	*	*	*	*	*	*
MAUD MYERS	*	*	*	*	*	*	*	*	*
HELEN PATTEN	*	*	*	*	*	*	*	*	*
H. B. PAIST	*	*	*	*	*	*	*	*	*
PAUL PUTZKI	*	*	*	*	*	*	*	*	*
BELLE B. VESEY	*	*	*	*	*	*	*	*	*

APRIL MCMVII Price 40c. Yearly Subscription \$4.00

A MONTHLY MAGAZINE FOR THE POTTER AND DECORATOR



The entire contents of this Magazine are covered by the general copyright, and the articles must not be reprinted without special permission.

CONTENTS FOR APRIL 1907

	PAGE
Editorial Notes	263
League Notes	263
The Class Room—The Art of Teaching—Contd.	264-266-268
Plum Branch	265
Treatments Plum Branch and Apple Blossoms	268 & 270
Cyclamen	267
Calla Lily Design for Vase	269
Powder Puff Box	269
Pussy Willow	270
Plate Borders in blue and white	271
The Alhambra Ceramic Works	272-273
Snow Drop	272
Some Hand-painted Pottery	274
An Historical Collection of Rookwood Pottery	274
Apple Blossoms	275
Arts and Crafts	275
Cyclamen	276
Cyclamen (Supplement)	276
Ferns	277
Primrose Study	278
Answers to Correspondents	278
The Crafts	
Art in Pewter	
Exhibition Arts and Crafts Soc. of Detroit	279-281
Barnstable Guild of Handicraft	282-283
Pink Eucalyptus	284-285
	286
	286

LIST OF BOOKS

The Rose Book, containing some of the best rose studies and designs published in Ceramic Studio postpaid	\$ 3.00	
The Fruit Book, containing some of the best fruit studies and designs published in Ceramic Studio postpaid	3.00	
Composition, by Arthur Dow postpaid	1.65	
Principles of Design, by E. Batchelder postpaid	3.00	
Decorative Studies, by J. Foord postpaid	12.50	
Plant Forms and Designs, by Midgley and Lilley postpaid	2.20	
Practical Pottery, elementary instruction for students, by Richard Lunn postpaid	2.50	
Grand Feu Ceramics, a practical treatise on the making of hard porcelain decorated with high temperature glazes by Taxile Doat of the Manufactory of Sevres, France postpaid	5.00	
Seger's Collected Writings, 2 volumes postpaid	15.50	
For the Collector:		
Vol. II Old China, bound blue cloth postpaid	2.50	
Anglo-American Pottery, a manual for collectors, by Edwin Atlee Barber, Curator of the Pennsylvania Museum, second edition postpaid	2.00	
American Glassware, old and new, by Edwin A. Barber postpaid	1.00	
Marks of American Potters, by Edwin A. Barber postpaid	2.25	
Pottery and Porcelain of the United States by Edwin A. Barber postpaid	3.75	
The Lace Book, by N. Hudson Moore postpaid	5.30	
Tulip Ware of the Pennsylvania German Potters, by Edwin A. Barber, in paper cover postpaid	1.10	
Cloth, limited edition postpaid	5.00	
The Primers of the Pennsylvania Museum (two already issued, Salt-glaze ware and Tin-enamelled ware) postpaid	.50 and .60	
Encyclopedia of Ceramics, by W. P. Jervis postpaid	6.75	
The Old China Book, by N. Hudson Moore postpaid	2.18	
The Old Furniture Book, by N. Hudson Moore postpaid	2.18	
Old Pewter, by N. Hudson Moore postpaid	2.18	
Chats on English China, by Arthur Hayden postpaid	2.18	
Chats on Old Furniture, by Arthur Hayden postpaid	2.18	
China Collecting in America, by Alice Morse Earle postpaid	3.20	
Pottery and Porcelain, a guide to collectors, by Frederick Litchfield postpaid	6.25	
French Pottery and Porcelain by Henri Frantz postpaid	2.68	
Dutch Pottery and Porcelain, by W. Pitcairn Knowles postpaid	2.68	
Old English Furniture, by Fred Fenn and B. Wyllie postpaid	2.68	
English Embroidery, by A. F. Kendrick postpaid	2.68	
French Furniture, by Andre Saglio postpaid	2.68	
Old Pewter, by Malcolm Bell postpaid	2.68	
Sheffield Plate, by B. Wyllie postpaid	2.68	
The Oriental Rug Book, by Mary Churchill Ripley postpaid	3.20	
Home Furnishing, practical and artistic, by Alice M. Kellogg postpaid	1.65	
William Adams, an old English potter, by William S. Turner postpaid	6.00	

Keramic Studio Pub Co., Syracuse, N. Y.

KERAMIC STUDIO

Vol. VIII, No. 12

SYRACUSE, NEW YORK

April, 1907

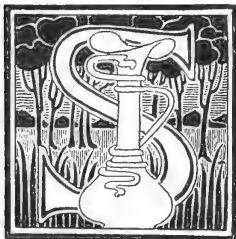

INCE it will be impossible for lack of space to give the Class Room Articles on Flower Painting before the June issue, the competition as announced on back of cover will remain open until May 1st to give any late comer a chance to add her quota to the "symposium." Make articles as concise as possible—we like to give every one a chance, but too wordy articles take up so much space that they will have to be cut down. This advice should be followed in all future articles. Make them short and to the point. Otherwise the one subject stretches over too many issues of KERAMIC STUDIO.

✦

We call special attention to the photographic studies of flowers by Miss Helen Patter, of Minneapolis. The originals are extremely artistic in tone and mounting, as well as well arranged and composed. We expect to reproduce a number of these studies which we recommend to the artist and designer who has no time or opportunity to make her own studies.

✦

Our next issue will be the eighth anniversary number of KERAMIC STUDIO. We always try to have something special for our birthday issue and this year we greet our old friends and new with a number edited by Mr. Marshal Fry. We feel sure that this will be considered a treat by one and all.

✦

We finish in this month's Class Room the series of articles on the "Art of Teaching". The next subject to be taken up is "Flower Painting."

Any one who has already sent in her article may send any additional instruction she may see fit. Many of the articles on hand so far show a general misunderstanding of the kind of instruction called for on the subject. Some have sent color studies with treatments. Some have sent a sort of general article which although interesting does not give instructions so that a beginner who can not have a teacher would know how to go to work. Some give just a list of colors. It is intended that thoroughly comprehensive instructions should be given and to that end a \$10.00 extra prize will be given to an article which will leave little to be added in the way of complete instruction. Here should be the general plan:—Flower Painting—General remarks, applicable to all flower painting.

Roses—Backgrounds, how to paint Roses, manipulation of brush, colors, etc., foliage, green and reddish. Colors for pink roses in full light and shadow, remarks. White roses, colors in light and shade, remarks. Red roses, light and dark, colors in light and shade, remarks. It is supposed that directions will be given for colors to be used for laying in for first fire and for each necessary retouching, and firing. It would be more interesting if the instructions were given under the heading of the different kinds of Roses, for instance, White "Maman Cochet" or some other white rose.

"La France" or other pink rose, "Paul Neyron" or other rose color rose, "American Beauty" or other deep rose, "Jacqueminot" or other crimson rose, etc. "Marechal Niel", or other yellow rose.

Violets—General instructions, manipulation of brush, for single or double varieties, colors for white violets and for the different shades of violet foliage, backgrounds, remarks.

Daffodils—General instructions, foliage, manipulation of brush, colors for white, yellow and orange varieties, red edge to cups of same as in "Poeticus", general remarks, backgrounds.

Nasturtiums—This should give full instructions in the obtaining of the various shades of yellow, buff, orange, pink, scarlet, dark red and mahogany tints, also color of foliage both dark and light, backgrounds.

Geraniums—Colors and manipulation, backgrounds, etc.

Pansies and Forget-me-nots.

Under the sub-title "Other flowers" opportunity is given for each to treat of their specialty if they have been painting well some flower not given in the list. It would be especially well to treat of the handling of blues in flowers, for instance, Corn flowers or Asters.

Under the sub-title "Miniature flowers," it is understood that the best method to paint simply these little flowers should be given, the number of fires required and the colors. Example: for miniature roses paint the pink ones for first fire with—. Red roses—Yellow—foliage should be — retouch with— Shadow flowers and leaves, etc.

General remarks. This will give opportunity for each to give any special ideas she may have on the subject.

✦ ✦

LEAGUE NOTES

The Annual Meeting of the National League of Mineral Painters will be held in room 36, The Art Institute, Chicago, Ill. on Friday, May 3d, at ten o'clock, a. m.

The triennial election of officers will be held. No officer having served the full term shall be eligible for reelection according to Article IV, Section 7, of our constitution.

The annual exhibition will open with a reception, Tuesday evening, April 30th, at 8 o'clock p. m. at The Art Institute, and continue until May 26th. All members of the League, and their friends, are cordially invited to be present at both the meeting and reception.

Circulars containing instructions for the exhibition will be mailed to members. We welcome Mrs. Alta Lyons-Irons, of Glenwood, Iowa, whose name has been added to our membership roll.

BELLE BARNETT VESEY, Pres.

✦ ✦

CLUB NOTE

The exhibition of the Mineral Art League of Boston, which was to take place about the middle of April at Westminster Hotel, has been postponed till Fall.

THE CLASS ROOM—THE ART OF TEACHING

Fifth Prize—Nellie DuBois Henderson

LET the beginner get a good assortment of powder colors. The powder colors stay moist longer after being mixed up, and are cleaner to have about than the tube colors. The following list will constitute a good working outfit:

Mixing Yellow	Brown Green	Violet No. 5
Yellow Brown	Dark Brown	Banding Blue
Blood Red	Grey for Flesh	Apple Green
Ruby Purple	Sea Green	Shading Green
Deep Blue Green	Orange Yellow	Black
Copenhagen Blue	Pompadour	Pearl Grey
Moss Green	Rose	Copenhagen Grey
China pencil		3 regular square shades Nos.
Agate burnisher,		4, 7, and 9,
Bottle of sand for burnishing,		1 pointed shader No. 7,
Bottle of Fry's medium,		An outlining brush,
Bottle of Fry's special tinting		Grounding brush,
oil,		Box of Roman Gold,
Small palette knife,		Plate Divider,
Scraper or curved eraser,		Turpentine and paint rags.
Palette,		

Use the border for a fruit bowl by Sabella Randolph given in the *KERAMIC STUDIO*, for August 1906, on page 89.

Take the plate divider, place the plate on the circle corresponding with the plate, and mark the plate in equal sections, then with a piece of tracing paper, just the size of one of these sections, trace off the design from the book, and make it fit to the curve of the plate. The tracing paper may be fastened to the plate by little pieces of wax, and by means of transfer paper the design may be transferred on to the plate. An agate burnisher makes a splendid tracing tool. Pour out a little of the special tinting oil, and mix with it enough Grey for Flesh to show a plain mark, then with the outline brush trace the design with a good firm even line of the oil. Let this stand until nearly dry, perhaps an hour or two, and then with a little piece of cotton, or lamb's wool preferred, rub gently into the outline some of the powder Grey for Flesh. In this dusting process, be always careful to keep the paint between the oil and the cotton. Clean off everything but the outline and have this fired. If greater haste is necessary, one may put in the outline with a little Grey for Flesh mixed with a thin syrup of sugar and water. This does not make quite as good an outline and is apt to need an extra firing to strengthen it at last. One may then proceed with the second fire treatment immediately, as the oil will not touch this outline.

SECOND FIRE.

With special tinting oil and a little Grey for Flesh, paint in the leaves and stems with a smooth thin wash of the oil, keeping the edges firm to the outline. The Grey for Flesh fires out a good deal and therefore has very little effect on the dusted color. Let this stand until almost dry, two or three hours, and then dust in, as before, the following mixture, well ground together: One part Sea Green, one part Copenhagen Grey and one part Grey for Flesh. After this is dusted and cleaned, the grapes and bands may be painted in with the oil in the same manner as before, and after drying, dusted with two parts Copenhagen Blue, one Banding Blue and one Pearl Grey. Be careful not to touch the dusted colors with the fresh oil.

THIRD FIRE.

This is an all over tint called envelope. The tinting oil with a little Grey for Flesh is painted swiftly over the

whole plate and with a small pad of cotton covered with an old soft silk cloth pad the plate until a smooth even surface is obtained, and the oil sounds tacky when padded. Let this stand for an hour and a half or two hours, where it will be free from dust, and then carefully dust with one Copenhagen Grey and one Pearl Grey. This firing will bring out a very harmonious plate in blue green and grey.

In beginning something in the naturalistic work, also start in on a smooth plate, and try at first some simple flower since it is easier and will teach the painting of color in smooth washes. Take the wild rose study by E. Louise Jenkins, given in the *KERAMIC STUDIO* for June 1906, on page 31. In mixing up the paints, it will be well to keep the colors always in the same order, somewhat like that given in the list, since it avoids confusion and one learns to know the colors quicker. Pour out about a half a thimbleful of the powder on the palette and mix with it a few drops of the medium. Grind well with the knife until all the bits of grit are out. Do not let the paint get thin, but mix with it just enough oil so that it will not run. For this piece one will need the following colors:

Mixing Yellow,	Brown Green,	Copenhagen Blue,
Rose,	Dark Green,	Moss Green,
Violet No. 2,	Yellow Brown,	Shading Green,
Apple Green,	Ruby Purple,	Pearl Grey.

If necessary sketch in the design with the china pencil, making the stem curve gracefully with the plate. Take the square shader No. 9, dip it in the turpentine and then in some of the Medium which is poured out in a small dish. Work the oil all through the brush, wriggle it back and forth on the palette until the hairs are all even and smooth, and then wipe off the brush carefully on a cloth, keeping it broad and flat. This process will have to be repeated often. Shove the brush up into the rose color pink, working the paint in and then draw back until it looks as if it would make a smooth, thin wash. Paint in thinly the petals of the roses, bearing down on the brush, so as to give a thinner wash on the high lights. Do it all with one brush stroke if possible. A bit of Mixing Yellow may be taken in the brush with the Rose for the highest lights. Toward the center shade it a little darker, taking in the brush a little Ruby with the Rose. The blossoms underneath need more Ruby and a little Pearl Grey mixed with the Ruby to lower the tone and put them in shadow. Leave the centers large and white, and paint these in with Yellow, shading with Brown and a tiny bit of Green in the center. Then with the outline brush and a little Dark Brown, softened with a bit of Yellow and Red, mark in the stamens. For the light leaves, use Moss Green shaded with Brown and Shading Green. Stroke the brush from the point of the leaf to the center, and then around from the center to the point again, shading it in toward the center, and suggesting a center vein. In the dark foliage under the flowers, use Brown Green and Shading Green and a little Blood Red mixed with the greens for a brownish tone. Violet No. 2 may be used with the green for a half tone foliage, and the shadow foliage put in with Copenhagen Blue. With the edge of the brush cut out the stems from the darkest back ground and leave white for the next painting. Paint in the dark stems with Brown Green and Brown, and some in the shadow green colors. Put the paint on smoothly and do not get any hard lines. A rim of gold will finish the plate for the first firing. Be sure that the edge is free from paint. It is best to have a separate knife for gold and be sure to have clean turpentine. Mix up part of the gold with the turpentine.



PLUM BRANCH—PHOTOGRAPH BY HELEN PATTER

(Treatment page 266)

If the gold is hard it may be warmed by a match underneath the glass. Also have a brush to use in the gold alone, as much will be wasted in cleaning out the gold each time. For a rim the tip of the finger may be dipped in the gold and holding it to the edge of the plate, turn the plate in the other hand. This gives a good even band and the gold will not be too thick. If put on with the brush too thick, it will chip off. Be sure there are no finger marks on the bottom of the plate. Dry in an oven before sending to the kiln as the paint is apt to get rubbed off in stacking.

SECOND FIRE.

Wash thinly over the high lights of the flowers with rose strengthen the shadows and centers, strengthen leaves, suggesting veins and markings. Wash Yellow Green over high lights, and over the stems left from the last firing. Strengthen the background foliage with Brown Green and Shading Green mixed in the brush, and carry this tone out into the background. In leaving the background for the second fire, one may paint over the edge of the leaves and blend them so as not to form hard lines. Let some yellow run through the background where it is lightest in the study. The rest may be painted in a greyish green, using Violet with the greens and shading out into the light grey, with a suggestion of rose very thin on the opposite side of the plate from the flowers.

THIRD FIRE.

Details may be added, such as thorns, and things left undone in the other fires. A wash of Pearl Grey with Violet over the entire background and Grey over some portions of the leaves, all being blended on the edges, will bring the whole into a harmonious piece of work. Put another wash of gold on the edge as the gold will wear better if it has a second coat.

o o o

Emma J. Evans, Houston, Tex.

When a pupil comes for her first lesson in painting, the point to begin with, of course, is to select the piece of china on which she is to work. I always endeavor to have the pupil decide on a plate, a plaque, or something that is nearly flat. The reasons for this are many. I tell her that a plate is easily handled, that she will succeed better having all the work before her at once, that inexperienced fingers often rub off the work on one side, while working on the other, as on a cup, or a vase, etc. As a general thing the plate is selected. Now then, "What are we going to have on it." As a rule she will want some kind of flowers and most likely a morning glory, a trumpet vine or some double flower that is most difficult to do. Then I begin to advise again, I say, "Now you want something that you can learn the most on with the least difficulty, don't you?" You must not have so many things to think about in the beginning or you will not do so well." She agrees to this. "Then suppose we have a single wild rose, autumn leaves, or something of that kind." Generally I carry my point, and perhaps we have the wild rose. The Wild Roses, by Miss Jenkins, published in the *KERAMIC STUDIO* of June 1902, is a good study, so we will take some part of that. In a moment I have the brushes, paints and oils necessary for the study, and begin the arrangement on the plate, unless the pupil wishes to do it herself. I simplify the study somewhat, giving only what is necessary for an artistic effect, according to the size of the plate. This being done, I ask my pupil to pour out about half a teaspoonful of thick oil in a little dish provided for the purpose, add four or five

drops of clove oil and to stir them thoroughly together with the palette knife. From the first, I have the pupil do every thing she can. I now take out the necessary paint of one color and with the medium on the end of the palette knife rub the paint down to the consistency of thick cream, explaining that the paint must be perfectly smooth and free from grains. She sees how this is done and I tell her to do the same with all the colors, keeping them far enough apart so that they will not run together. When the colors are ready we are prepared to start the painting. And here come two of the most important steps to the beginner; viz., how to handle the brush and how to get the paint into it properly. I explain that she never can paint, holding the brush in a vertical position, but must hold it more like the pen when writing, that a broad, wide sweep of the brush may be obtained—and I demonstrate as I talk. I wet the brush first in the turpentine and wipe it to see that it is clean and then apply the edge of the brush to the edge of the oil, showing how to draw out the oil into the brush. I nearly always pinch the edge of the brush lightly to be sure I have not too much oil. Usually I take up the leaves first. So with a square shader, I pass the brush a couple of times from right to left through the edge of the Yellow Green which is the foundation color of most of the leaves in this study. I wash in a leaf on a vacant part of the plate, and with the pad work it off till clear and smooth. The pad, by the way, is a bunch of cotton about the size of a walnut tied up in white china silk, or any white silk that is free from cords or figures that would leave an impression in the paint. The pad is pressed down on the paint going all over the leaf, taking up the paint and oil till one even surface is obtained. This operation is repeated by the pupil until she gets the idea. The next thing is to shade the leaf. I lay in a fresh leaf of Yellow Green and then take up a darker color, say Brown Green, sweeping the brush in the edge of the paint from right to left a couple of times and turning the brush to the left the last time, I thus get most of the paints on the left corner of the brush. I ask the pupil to notice how I put down that corner of the brush when starting, and how I spread it as the strokes come around the base of the leaf and up the midrib or outer edge as the case may be. I caution the worker that the shading must be done while the first wash is still damp, to keep from making the work looking muddy and bad generally. She gets this last idea firmly after having to take out several spoiled parts. The pupil with the study before her now goes forward with the leaves and stems, I assisting when necessary. To teach the veining, I have the pupil make some lines on the side of the plate, for criticism. Some of them will be ragged, some too thick, and perhaps she has used oil in the liner, and some has spread. I make a few strokes to show how the line should look, straight and even, and explain that she must not use oil in the brush for small lines, as she can not make sharp crisp lines if she does. I vein one leaf and the pupil finishes. Instructions for the flowers are much the same as for leaves. The light pink part of the roses is laid in first, covering the whole petal, the darker part laid over the light, and all tapped over with the pad till the surface is even and clean looking. After all the petals have been painted, the centres are made. I always leave the centres till the last, and having a brush cleaned in turpentine and dried by pinching or wiping on a clean cloth, I wash out the space for centres, giving the proper shape and size.

In centre of roses referred to, wash in the centres



CYCLAMEN

(Treatment page 276)

with the Yellow, and where indicated wash over lightly with Yellow Brown and pad off. Put in the stamens with nice lines like the veining, anthers and other parts as indicated by the study, with the liner.

I always put in the first background myself, using a large flat brush and plenty of the medium to keep the paint open till it can be worked down. The background is no exception to other parts of the work. It must be clear and clean. If you do not use sufficient oil in the brush the paints will dry before they can be worked. If they do there is no remedy but to take them off and start again. If too much oil is used the work will have a woolly look, and that won't do either. All the paints will dry more or less on the palette while one is at work, and to thin them dip the palette knife in the turpentine and with a drop or so, stir the paints up to their proper consistency. For the backgrounds I always get fresh turpentine to rinse the brush in when going from one shade to another, and have three or four fresh pads made so as not to mix the colors when blending. For turpentine have a large mouthed bottle that the brushes can be put into and keep stopped when the turpentine is not in use. For instance when you have used a pad on the pink roses don't use that on the yellow centres or you will mix the color. After the background is finished the plate is ready for the first firing. To paint for the second firing is simply a repetition of the first in order to strengthen the colors. After the plate is perfectly dry, look it over carefully and if there are any specks on it, pick them off with a needle, before sending to the kiln. If more depth of color is required on the first or second firing than what the painting gives, before the plate is dry (when perfectly dry it will feel crusty and hard to the touch) smooth some of the color that you wish to darken with the palette knife, and with a piece of cotton pick up some of the dry paint and rub it over the part to be darkened. With a soft brush dust off all that will come off.

After finishing a lesson always rinse the brushes well in turpentine and dry to preserve them.

Bertha G. Morey, Ottumwa, Ia.

To teach china painting successfully, arrange a course and start a class of beginners at the same time.

Have all the pupils paint the same thing, as it is easier for each pupil to see her own advancement.

Have each pupil keep a note book and, after the lesson is over, have them write down the way they learned to apply the paint; how they mixed it and what colors they used on the piece just painted. A note book may seem to take a great deal of time but it saves answering the same questions over a dozen times.

CHINA.

The pupils should get china that will give good results in firing. It is a waste of time and worry for the pupil to indulge too freely in cheap china.

Give them a lesson or so in simple things until they have learned their colors and the use of their brushes. Demonstrate to the class the care of their brushes and try to impress upon them the importance of cleanliness in all things in china painting.

I have arranged a list of subjects which, if taken straight through, will give a pupil a pretty good idea of naturalistic work. The use of colored studies is a help until a pupil is quite advanced and knows the colors.

I.—Currants, T. McLennan Hinman, March 1903.

II. Plums—Teana McLennan Hinman, May 1906.

- III. Little grapes—Sara Wood Safford, Nov. 1904.
- IV. Strawberries—Sara Wood Safford, July, 1906.
- V. Apples—Miss M. Mason, October, 1905.
- VI. Oranges—Miss M. Mason, December, 1905.
- VII. Pine cones—F. B. Aulich, September, 1905.
- VIII. Double violets—Marshal Fry, November, 1900.
- IX. Yellow wild roses—Ida M. Ferris, June, 1906.
- X. Fleur de lis—F. B. Aulich, September, 1901.

LUSTRE AND MATT COLOR

VI. Design for Stein—Albert Pons, p. 42, June, 1906. Flowers in yellow lustre and leaves in green lustre, the background of cream in matt colors and the base of the stein in green matt with gold handle and outlines.

ENAMEL.

VII. Bunch Berry Design for plate, November, 1904. ETCHING.

VIII. Peacock Design for Bonbonniere, 1904. Etch in design and use scheme given by designer.

PLUM BRANCH (Page 265)

Photograph by Helen Patter

Treatment by H. Barelay Paist.

AFTER sketching in the main outline of the branch tint the entire vase or panel with Grey Green or Sartorius Pearl Grey which is a delicate Grey Green. With a cloth over the finger wipe out the masses and finish the detail with cloth or bit of cotton over a stick. Dry dust with same color, clean again any color that has adhered to the design and fire. The directions for modeling same as for water color treatment, using Grey Green for flowers. Olive Green and Dark Green for leaves and glazing. Then with Moss Green for third fire.

The color for stems are Copenhagen Blue for lights and Purple Brown or Violet of Iron for modeling and glazed with Moss Green for third fire to soften.

Another pleasing background would be Van Dyke Brown. The background may be laid flat or shaded from light to dark. In case the warm pinkish background is chosen (Van Dyke Brown) the same color may be worked into the flowers also along with the Grey Green as the background color determines the modeling tint of white flowers.

WATER COLOR TREATMENT

After sketching the main outlines of the branch carefully—lay on a flat wash of Grey Green (made by mixing Paines' Grey and Gamboge). After drying repeat if the wash seems too pale. It must be lighter than the lightest leaf but dark enough to throw out the blossoms. Use the same mixture to model the flowers, paying the strictest attention to values, as that is nearly all there is in a white flower unless color is borrowed from surroundings. The same mixture can be used for the first wash of leaves using less water so as to make the color stronger. The leaves may then be darkened and modeled with a mixture of Ultramarine Blue and Indian Yellow. (This makes a fine strong green.) The lights on the stems are made by mixing Ultramarine Blue with a touch of Vermilion—(this makes a fine blue grey)—and the stems are modeled with a purplish brown made by mixing Ultramarine Blue, Crimson Lake (or Carmine) and Indian Yellow. Just enough yellow to soften the purple. This is a difficult subject and will require the closest attention to drawing and values—repeat the directions until both are attained.

Another suggestion for background is a soft pinkish brown made by greying Vermilion with Charcoal Grey. Two washes of this tint makes a beautiful color answering to Van Dyke Brown in the mineral colors.

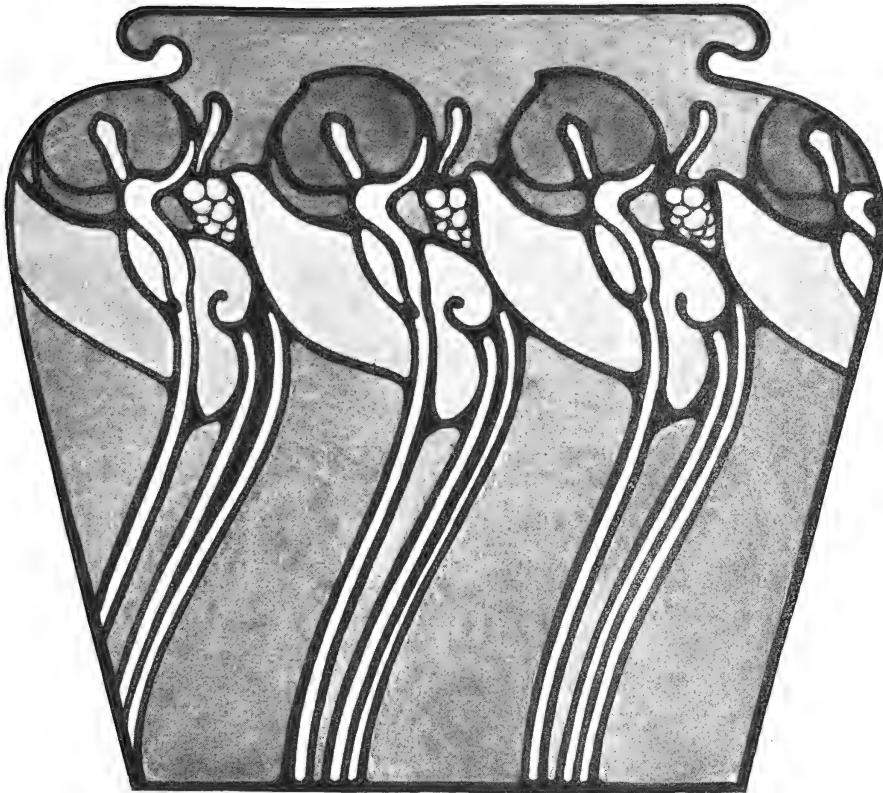

CALLA LILY DESIGN FOR VASE—RUSSELL GOODWIN

Background, Royal Green. Lily, Violet No. 2. Leaves, Moss Green. Stems, a lighter shade of Moss Green. Tongue of Lily, Silver Yellow Pale. Seed pods, Carmine. Outlines, Meissen Brown or Gold.



POWDER PUFF BOX—CHARLES BABCOCK

Black bands, gold; black figures, rich brown; middle tone, yellowish grey; flowers and background, cream; small figures could be pink and white enamels; outline, brown.

PUSSY WILLOWS

Maud E. Hulbert.

FOR the Pussy-Willows use Copenhagen Grey, Warm Grey, and Brown Green. They often show a little green through the grey and for that use Apple Green. The little bud from which the blossom has come is hard and of a dark reddish color, Violet of Iron, and the stems themselves are sometimes red and sometimes green, with a bluish bloom like that in the plums; use Brown Green, Moss Green, Finishing Brown, Copenhagen Grey and Violet of Iron.

Stems. Paint the nearer stems with Moss Green and Yellow Green and some of the larger ones in the background with Brown Green rather thin. Flush with Yellow Green and Apple Green. For the second firing tint with either Apple Green and a little Yellow Ochre or Yellow Green, picking out some of the more prominent ones and then touching them up.



FERNS

Maud E. Hulbert

PAIN'T the nearer ferns with Moss Green and Yellow Green and some of the larger ones in the background with Brown Green rather thin. Flush with Yellow Green and Apple Green.

For the second firing tint with either Apple Green and a little Yellow Ochre or Yellow Green, picking out some of the more prominent ones and then touching them up.



PLATE BORDERS IN BLUE AND WHITE

Ophelia Foley.

IN actual practice, I have never used the blue and white but the blue and grey.

First treatment. Paint in the outlines, bands and dark parts with one part Banding Blue, two parts Copenhagen Blue. Do not make the blue too dark.

Second treatment. Paint in the outlines and all darkest portions with one part Banding Blue, two parts Copenhagen Blue, dusting with the same. Second fire, tint with Deep Blue Green, very thin, padding off nearly all the oil from the lightest parts; dust with Pearl Grey. A third fire may be necessary to strengthen the blue.

Two parts Grey for Flesh, one part New Green for the darks and an "envelope" of Grey Green are satisfactory; also two tones of grey (Grey for Flesh and Pearl Grey) with a touch of pink (Yellow Red) on the flowers.

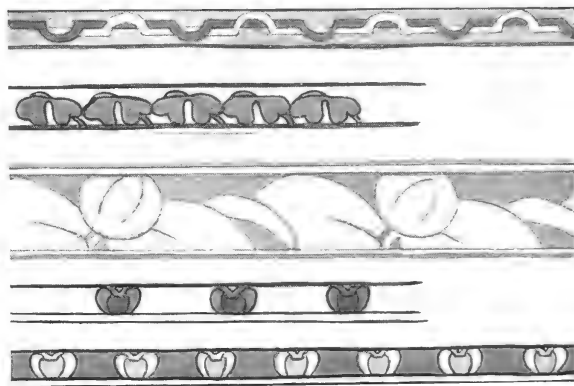

PUSSY WILLOWS

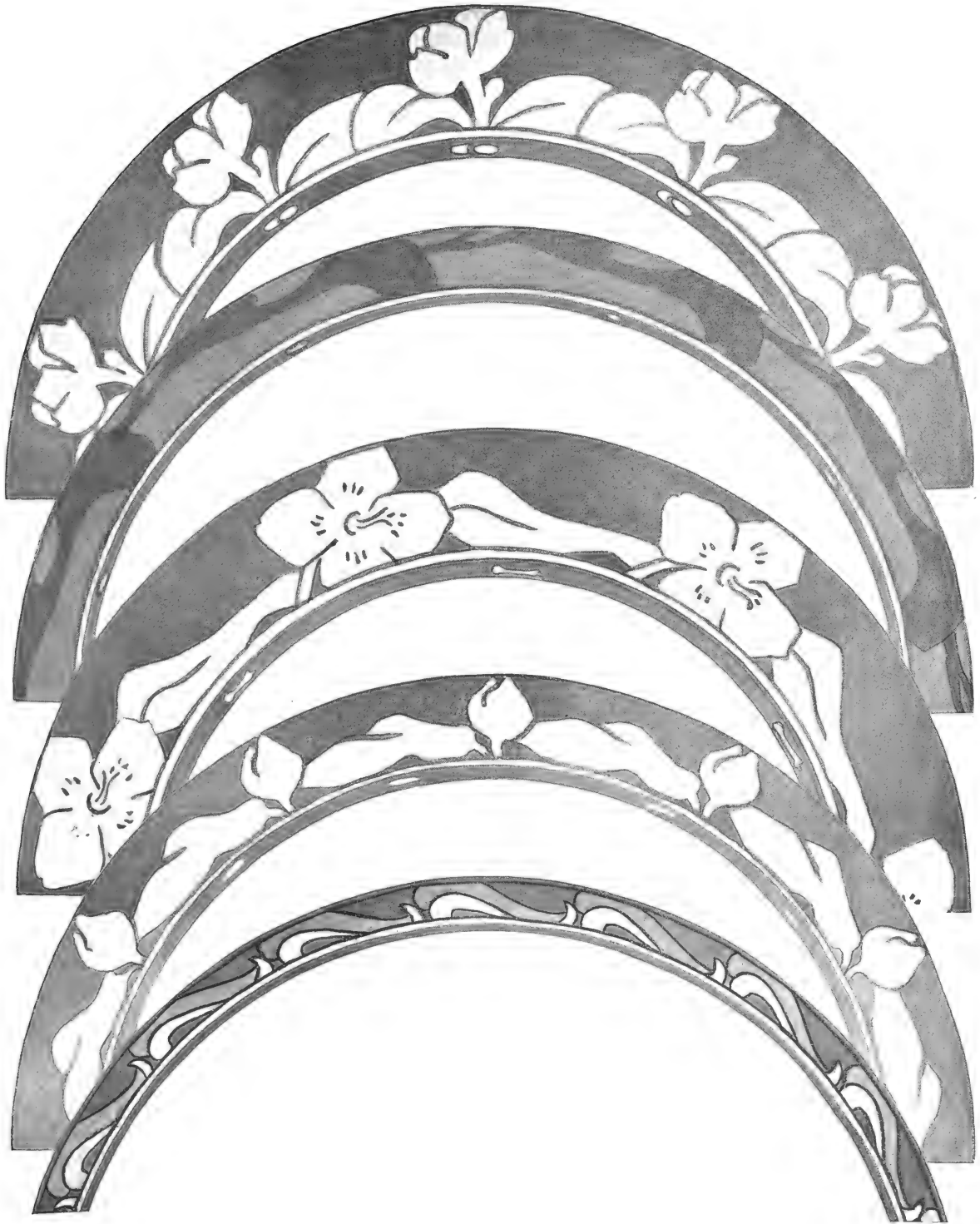

PLATE BORDERS IN BLUE AND WHITE—OPHELIA FOLEY

(Treatment page 270)



THE ALHAMBRA CERAMIC WORKS

In the outskirts of Chicago, past the well known and malodorous Packingtown, stands a small pottery owned and managed by Mr. S. Linderoth, whose name is familiar to the readers of *KERAMIC STUDIO*, on account of the interest he has taken in the work of the National League of Mineral Painters. Within the walls of this small pottery also, the members of the Atlan Club, these conscientious and clever decorators of porcelain, have tried their hand at pottery work. And a few minutes talk with such an enthusiastic and versatile keramist as Mr. Linderoth are sufficient to leave the impression that good and interesting work should in the future come from the Alhambra Ceramic Works.

Mr. Sven Linderoth is an architect who came from Sweden in 1884, after having studied architecture under an excellent master in Stockholm. Although he knew not a word of English and was not familiar with the usages and building practices of this country, in seven years he had saved about \$25,000. Wishing to introduce here the use of white tin enameled tiles, such as were made in Europe and could not be imported at a cost of less than \$125 per M., he built a small factory. From the beginning he met with nothing but failure and disappointment. American materials were not the same as Swedish materials; formulas which were used in Europe, when applied to these materials did not give the same results. A Swedish, a German and an English assistant, all experienced in the tile work of Europe, were successively employed but kiln after kiln was a failure, even with the use of imported clay, as the metallic oxides which entered into the composition of the enamel, were not as pure as those used in the old country. In a short time all Mr. Linderoth's savings were gone and his house mortgaged, but he was close to the solution and resolved to lose everything rather than give it up. A last firing was prepared, after weeks had been spent analysing and purifying all materials. This firing was made with wood, the fuel used in Sweden and lasted fifty-one hours during which Mr. Linderoth stood feeding the kiln. When the kiln was drawn two days later, it was found that a beautiful white enamel had been developed and that at last the goal had been reached.

However, Mr. Linderoth was not at the end of his trials. He was unable to obtain capital with which to continue making his enameled tiles. Forced to make an assignment, he lost everything he had and his health was badly impaired by the arduous work of his experiments. But sustained by the knowledge of his success, he immediately put up a little shanty to continue his work and began to experiment with filter tubes. He is now furnishing

filter tubes to all the big companies that use a manufactured tube in their filters, and this pays his expenses while he can devote his spare time to art work.

The illustrations we give are of work done at present at Mr. Linderoth's pottery by Mr. Le Veau, a clever Swedish modeler who has worked in European factories, among them at Rorstrand. Mr. Le Veau's taste in decoration seems to lean a little toward classic, rococo and old fashioned styles which do not appeal very much to modern ideas, but his handling of the modeling tools and especially his modeling of figures are remarkably good. We have seen a couple of statuettes in clay, one of them, a lifelike bust of Ericson, which showed better than anything else his talent as a modeler.

Mr. Linderoth has turned his attention to the manufacture of tiles. He uses a very refractory body, an inexpensive fireclay which practically shows no shrinkage in firing and permits of a firmer adherence to the cement setting than ordinary tiles. On such a body it is possible to develop good mat glazes.

In addition to mat glazes Mr. Linderoth has recently made some experiments in red glazes, both from copper and tin, his object being to reproduce the Doulton red which he claims is a tin pink enamel and not a copper glaze. But the most interesting glaze he has developed so far is certainly this beautiful white enamel which cost him his little fortune. It is absolutely white and of great purity and it is to be hoped that he will be able to place it on the market in the manufacture of white tiles. Meanwhile we would like to see the members of the Atlan Club, who work at the Alhambra Ceramic Works try their hand at the decoration of this tin enamel. This is the work in which the old faience makers of France, Italy and Holland were so wonderfully expert. It is not easy work but should tempt true artists.

SNOW DROP

Maud Myers

LEAVES, stems and cap of flower, Pale Green. Large petals and bud, Grey Blue. Center spot of flower, Albert Yellow. Outline in darker Grey Blue. Tile in Grey Blue and Green with a touch of Yellow.



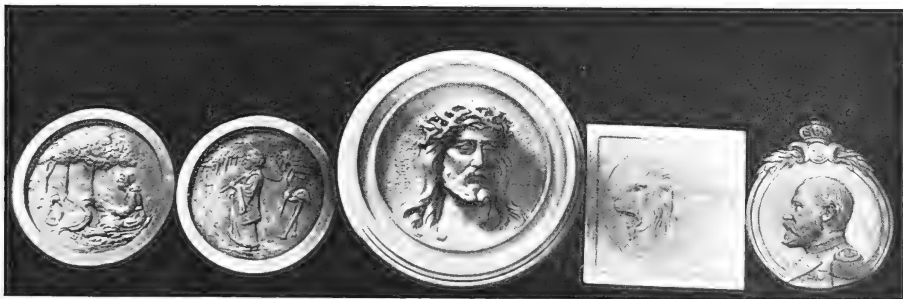
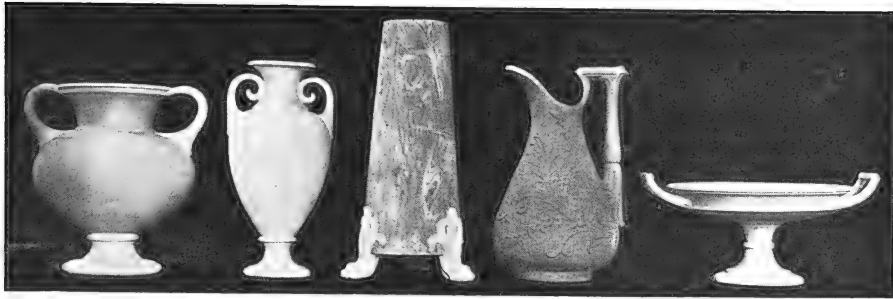



SOME HAND BUILT POTTERY

Mrs. Maria A. Loomis

We illustrate on this page the interesting work of Mrs. Maria A. Loomis of Syracuse.

Her hand built pottery is made of various clays fired at quite different temperatures, some being of Lyons clay and some of stoneware. The styles of decoration and forms are quite as varying as the clays, like the work of one so fascinated with it that she can not resist trying every method for the mere pleasure of seeing how it is done. It is probable, however, that for her own work she will settle finally upon stoneware although using a variety of materials with her pupils. Mrs. Loomis is an extremely painstaking and conscientious worker and no doubt will be better known to crafts workers before long.



AN HISTORICAL COLLECTION OF THE ROOKWOOD POTTERY

Established in 1880 by Mrs. Maria Longworth Storer, the first kiln was drawn on Thanksgiving Day of that year. Early in the history of the Pottery it became a custom to retain every year some representation of each variety of ware as it was developed. The Rookwood Museum begins with one piece from the first kiln in 1880, contains a good many pieces made in 1881, within the first twelve months of its existence, and thenceforth represents every year. The collection of two thousand specimens publicly shown in 1906 for the first time is of the greatest interest as illustrating the gradual development of an art industry from a purely local to a world-wide reputation. Though it remains the property of the Rookwood Pottery it has for safe-keeping been deposited in the Cincinnati Museum where it will be permanently installed when space can be found. For the present it can be shown only temporarily.

In connection with this collection attention should be given also to the large case of Cincinnati Pottery, in the Ceramic Gallery, where the experiments from 1875 to 1880, prior to the establishment of Rookwood, can be studied.

In examining the Rookwood Collection the following data will be helpful:

The earliest wares were light and not dark, as is usually supposed.

The yellow glaze, brown ware became characteristic of the Pottery in 1884. The Tiger Eye first appeared at the same time, and is the highest attainment in that line, being the first of all crystalline glazes, antedating those of different type afterwards produced in Europe.

At the Paris Exposition of 1889 a Gold Medal was awarded for the yellow glaze and Tiger Eye.

At the Paris Exposition of 1900 the Grand Prize was awarded in recognition of the very great variety of wares, including notably the "Iris," a light ware, then matured. Here also the mat glazes first appear.

At St. Louis in 1904 the mat glazes, added to the earlier types, secured two Grand Prizes. The most notable variety here is the "Vellum."

"Standard" or yellow glaze, including Tiger Eye, was fairly well matured by 1889.

"Iris" which began about 1886 was matured in 1900.

Mat glazes of the enamel type, starting about 1900, have advanced greatly in 1905.

"Vellum," attained in 1904, is the result of long experiment since 1886; a direct development from the "smear glaze," though altogether different in character.

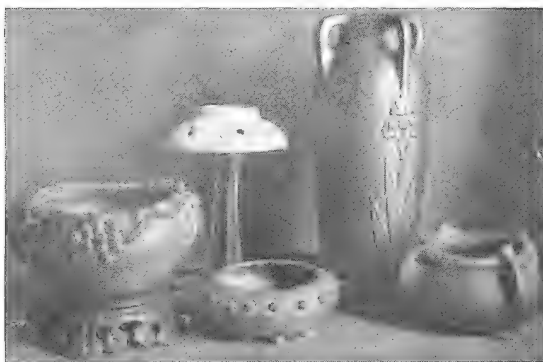

APPLE BLOSSOMS

Photograph by Helen Patter Treatment by H. Barclay Paist.

THE mineral colors for this study are Grey Green, Brown Green or Olive Green, Dark Green and Moss Green. Rose or Capucine Red for the pink of flowers (Capucine makes a beautiful Japanese pink if used thin) and Copenhagen Blue and Purple Brown for stems.

If you are adapting these studies to a vase form be sure you *adapt* and not stick slavishly to the drawing as it appears in the panel. Study the characteristics and arrange the drawing to suit your piece.

WATER COLOR TREATMENT

I can think of no better background for this study than the same soft Grey or Olive Green as suggested for the companion, the Plum. The modeling or shadow color is the same Green used delicately or stronger as the values suggest. And for the local color, the pink of the blossom, we may use Rose Madder or if a more Japanese effect be wished use Chinese Vermilion thin. The centers (stamens) are touched with Gamboge or Indian Yellow, and the leaves strengthened the same as suggested for Plum. The branches (stems) are also the same in color as the Plum, not as brown as we usually think of tree branches but grey in the lights and a purplish greyish brown in the strongest parts.

ARTS AND CRAFTS.

The Arts and Crafts idea embodies the thought that the workman shall do his task as a development of his inner self, not as a thing imposed from a driving necessity of an outward whirling, grinding machine. If it is a temporary fashion, a fad of the moment, so be it. We rejoice in even a fleeting effort to regain our normal condition of masters of our hands. We, undoubtedly, live in a time when the highest inspiration in art lies dormant, waiting for a coming spring to bring it to a new life, but the thread of effort which appears in the revival of handicrafts may be attached to a life line to bear us to some such period of artistic and spiritual safety.

Nobody, for a moment, will expect that we shall ever go back to a general time of hand labor, but the day must come when some shall do more and others not be obliged to do so much, for we still hold our vision of Utopia. The disciple of the modern Arts and Crafts school strives to reach a simplicity of living that lessens the daily round of useless drudgery, but he delights in the opportunity to use skilled hands for the production of some beautiful object, which serves a daily need and gives expression to his soul in his work. Like the old craftsman,

"Gathering from the pavement's crevice, as a floweret of the soul,

The nobility of labor—the long pedigree of toil."
Swastika.

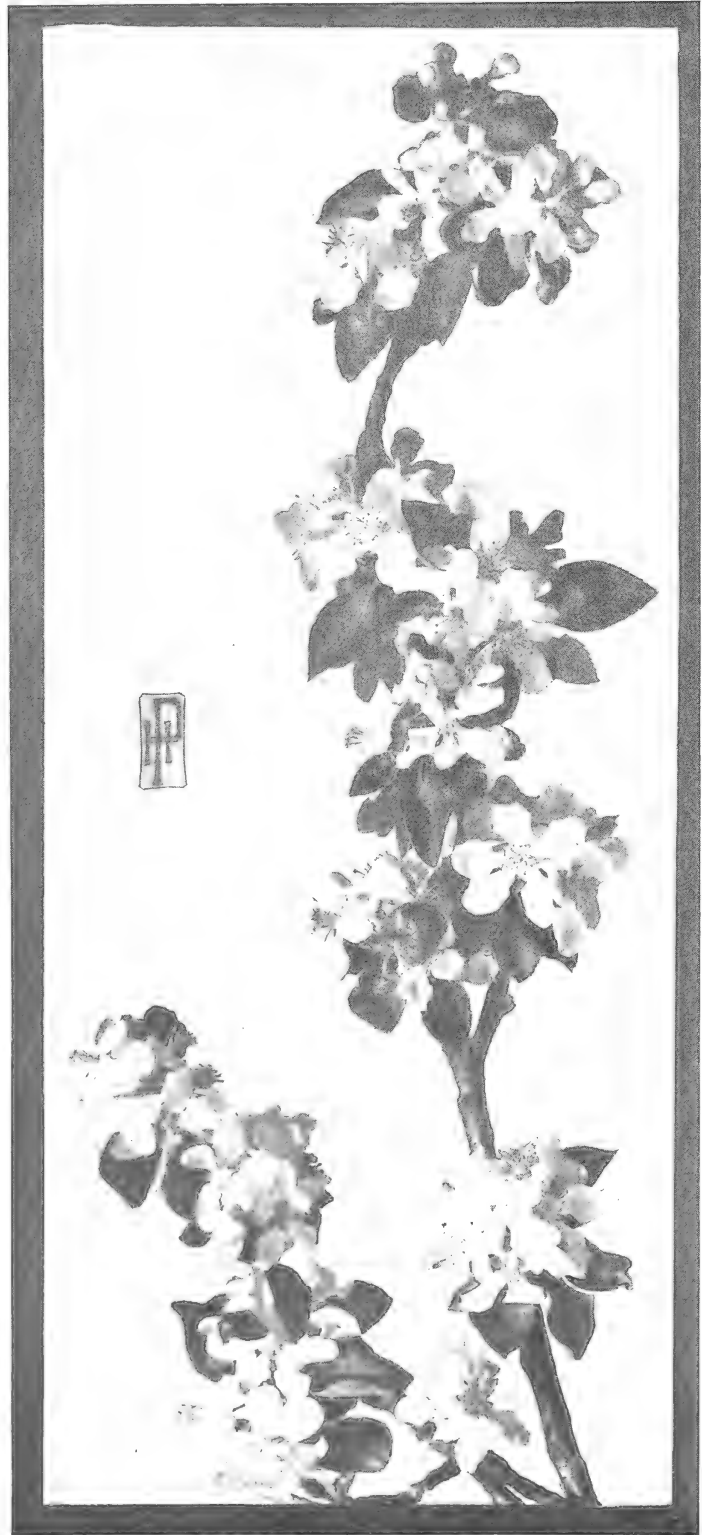

APPLE BLOSSOMS



CYCLAMEN*

CYCLAMEN*

FOR the background use Shading Green and Violet, very thin, blending into Peach Blossom and Yellow near the flowers.

For the blossoms use Peach Blossom very delicately in the lightest parts with Yellow and Violet in shadows. For dark parts of flowers use Ruby thin, on the light side, heavy touch of Ruby on the dark side.

Leaves.—Yellow Green, Shading Green and a little Violet. Stems.—Yellow Green, Brown Green with touch of Violet of Iron and Ruby near the base.

In the second firing the same colors are used, stronger where necessary.



CYCLAMEN (Supplement.)

Paul Putzki.

TO paint the study of cyclamen on china use the following: For the white flower take Grey blending towards the centre into Dark Violet and for some blossoms blend the Grey to Ruby Purple.

For the light pink flower take Carmine shading towards

centre to Ruby Purple. In some petals there is a grey tone, obtained with Grey and Yellow Brown mixed.

For the darkest flower use for the ground Dark Carmine shaded with Ruby Purple.

Leaves.—Lay in some of the green leaves with Yellowish Green shaded with Brown Green. The darker and greater number of leaves make with Dark Green shaded with Brown Green and Black Green.

For background use colors corresponding with flowers and leaves.

WATER COLOR TREATMENT

For white flowers use Neutral Grey shading to centre with Crimson Lake or on some, shade to Mauve in centre. The lighter pink blossom is produced with a wash of Rose Madder shading towards centre into a Burnt Carmine and the ends of petals should show touches of Carmine. Get the grey tone with Neutral Tint. For the darker flowers use Carmine shading with Burnt Carmine. Paint the leaves with Cobalt Blue and Sap Green shading with Olive Green and a touch of Prussian Blue. In the background use Neutral Grey, Cobalt Blue and Burnt Carmine and Olive Green, keeping the whole tone in grey effects.

*The name of the author of this study has been mislaid.



FERNS—MAUD E. HULBERT

(Treatment page 270)

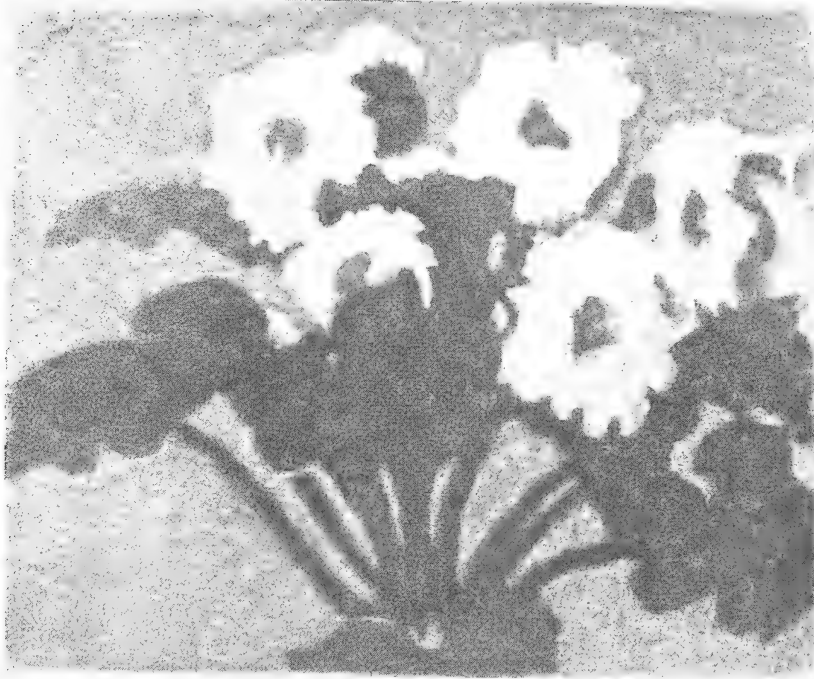

PRIMROSE STUDY—NANCY BEYER

PRIMROSE STUDY.

Nancy Beyer

MINERAL TREATMENT NO. 1.

FIRST fire—Background, Violet No. 2 with Copenhagen Blue, qualified with a little Black.
 Leaves, Copenhagen Blue and Aztec Blue.
 Flowers, Pearl Grey and Yellow Brown.
 Center of flower, Pompadour Red.
 Enveloping tone (very thin) Copenhagen Grey, if it seems cold at the end of this fire warm with Grey Yellow, take out the Pompadour spots.

WATER COLOR TREATMENT NO. 1.

Tone a piece of heavy charcoal paper, or German white paper, with Raw Sienna and Black (light tone). While the paper is damp, working on a wet blotter, lay in the study using for the darkest value, which is the leaves, Madder, Lake Deep, Prussian Blue and Indian Yellow, a light wash of Madder, Lake Deep over the flowers, in the centre of the flowers use a thin wash of Prussian Blue and Madder Lake, finally before scrubbing, wash Indian Yellow and Raw Sienna with a little Black over the entire background, then when thoroughly dry dip in a basin of water for two minutes, remove, placing it on a piece of oil cloth which has been tacked to a board, with an inch bristle brush pass quickly, but gently back and forth over the whole study holding it together with a beautiful tone.

MINERAL TREATMENT NO. 2.

First fire—Background, Grey Yellow, Yellow Brown and Grey Yellow.
 Leaves, Gold Grey, Copenhagen Blue.
 Flowers, Blood Red used thinly, lighter Violet spots, Gold Grey and Banding Blue.

Second fire—Retouch the colors that have fired out, using the same colors as before, enveloping tone, Gold Grey and Dark Yellow Brown.

WATER COLOR TREATMENT NO. 2.

Tone paper a Warm Grey tone, over the flowers wash Raw Sienna, center of flowers Vermilion, leaves and stems, Prussian Blue and Black. Before scrubbing wash a thin wash of Prussian Blue over the background, when dry scrub with a bristle brush, finally over the background wash Vermilion (very thin), allow to dry and scrub again lightly.



ANSWERS TO CORRESPONDENTS

Miss H.—You will find many designs for Tobacco Jars in *KERAMIC STUDIO*, October 1905, also scattered ones in December 1905, January 1906, December 1900, July 1900.

Mrs. C.—A high temperature kiln could be used easily for overglaze work. Matt colors are fired at the same temperature as other colors. The same oils are used for grounding with them as for other powder colors. They are applied on the same surface of china. They are used only for grounds in combination with gold and lustre.

S. W.—Miss Ida Failing (see directory) makes an enamel for mending chips on china which is very good. Sartorius makes a good cement for repairing broken pieces. These cements are for repairing in firing.

In order to paint on glass, colors especially fluxed for that purpose must be used. Hancock's paste for raised gold, same as for china. Roman gold can be used over the paste but for flat gold one must have a special preparation. Enamels also are specially prepared for glass. We have frequently given these instructions in these columns.



EXHIBITION NOTES

The Exhibition of the New York Society of Ceramic Arts which was to be held from April 2d to April 15th, at the National Arts Club, Grammercy Park, New York, will open only on April 4th.

THE CRAFTS

Under the management of Miss Emily Peacock, 232 East 27th Street, New York. All inquiries in regard to the various Crafts are to be sent to the above address, but will be answered in the magazine under this head.

All questions must be received before the 10th day of month preceding issue, and will be answered under "Answers to Inquiries" only. Please do not send stamped envelope for reply. The editors will answer questions only in these columns.



No. 24. Ewer and basin in pewter, "Temperance" by François Briot, Louvre Museum, Paris. Diameter, 0.45 centimeters.

ART IN PEWTER

Jules Brateau

(CONTINUED)

Documents of great exactitude, recently found by M. Teuty, in the archives of Montbéliard,* now give authentic information regarding the life of François Briot, which, until the time of this discovery, was obscured by indecision and probabilities.

This great craftsman was born at Damblin in Bas-signy, on the borders of Lorraine, France, but was forced to leave his native place on account of religious troubles. He took refuge in Montbéliard at the end of the year 1579, and, in this place, assumed the title of "pewter potter"; no doubt in order to receive help from the Corporation of that craft, which accepted him as a member, and whose registers show the names of his two witnesses, as well as that of his comrade, Jean Jacquemart, blacksmith, who was presented with him and who signed for both.

Briot was called upon to experiment on the press, just then invented for coining money. For such work he was fitted by his experience as a medal engraver. All the wonderful skill, acquired in the practice of medal engraving, he lavished upon the pewter basin and ewer, producing effects unknown until his time, making the metal yield all its treasure of softness and color, and, by fine decorative design, creating a lasting *chef d'oeuvre*. The

composition, the execution of the smallest ornaments of this piece are in harmony with the use of the basin (the washing of the hands), and make this unique example of pewter comparable with the most artistic objects in the precious metals. It could well stand on the dressers of princes, together with the works of the celebrated Benvenuto Cellini. There is in the execution and in the distribution of the molds, in the divisions of the body of the ewer, a perfect knowledge of the possibilities of pewter. Nothing has been overlooked, nothing neglected.

In examining an authentic pewter cast of this piece, one observes that there were slight defects in the copper mold of the large basin, and that these blemishes were repaired with great ingenuity; the basin being thus preserved from total loss.



Portrait of the master engraver, François Briot, drawn by himself on the reverse side of the basin, "Temperance," in the Louvre Museum, Paris.

*Mémoires de la Société d'Emulation de Montbéliard, Charavay, 1887, Paris.



No. 26. Pewter Basin "Mars" by François Briot. Louvre Museum. Wrongly attributed to Gaspard Enderlein. Diameter 50 centimeters.

During the thirty years which François Briot spent in Montbéliard, his time was well employed by commissions for medals, portraits, etc., which, added to his title of engraver to the Prince Regent, Frederick of Würtemberg, must have raised him to a relative prosperity. But under Prince John Frederick, who succeeded his father, a change in Briot's finances must have taken place although he did not lose his official position. We find in judicial papers the record of a series of lawsuits, instituted against him for debts which he seemed unable to pay.

Little by little, poverty advanced upon him and he lost by seizure furniture, materials and tools. The inventory of this forced sale mentions especially the copper molds of a basin and ewer, the magistrate recommending that these molds be watched and not injured in any way. Then, from judgments rendered during his absence, we find that our poor artist disappeared at times from Montbéliard. Where did he go? Where did he take refuge? Having no family requiring his presence, did he seek only to escape from his many lawsuits? It appears that at every return he brought back something with which to satisfy his most pressing debts, since his credit was extended. It is probable that, receiving no orders for engraving, or for pewter objects of his design (Montbéliard had been ruined by the wars), Briot, who did not do all kinds of work, was forced to go elsewhere, that he might gain a livelihood. This purpose he could most easily accomplish in a center of large production, and the position of Montbéliard, on the frontier of Germany, where the pewter industry flourished, especially at Nürnberg, leads us to believe that our master-engraver went to that country in order to avail himself of his talents.

We insist on this point, because there is in the Museum of the Louvre another large pewter basin in fine condition, having the god Mars as its central decorative motif, which is generally attributed to Gaspard Enderlein. This man was a rich manufacturer, who could well afford to hire as assistant, at a small expense, a poor artist having no other capital than his skill. Our technical knowledge of pewter enables us to recognize the method of chasing peculiar to each craftsman, and to affirm that the paternity of this work cannot be attributed to Gaspard Enderlein. The composition in the manner of Etienne Delaune, the arrangement of figures, the modeling, the details of



No. 27. Stein in Pewter. The figures borrowed from the basin "Mars." The allegorical accessories alone, are modified. XVI century. Belongs to J. Brateau.



No. 28. Salt cellar in Pewter. Style XVI century. Modern interpretation. Composition of J. Brateau.



No. 29. Salt cellar in Pewter. French work XVI century. Musée Cluny—Paris.

ornamentation, are characteristic of François Briot, and in the backgrounds we find the marks of the small punches which were used by him in the chasing of the basin "Temperance."

It seems then logical to believe that Gaspard Enderlein secured the assistance of the poor engraver, and if, in addition to other proofs, we add that Enderlein reproduced the basin "Temperance" (engraving on the reverse his own protrait in medallion, with the same inscription found on the Briot medallion), we must conclude either that Briot authorized Enderlein to reproduce his piece, or that Enderlein unscrupulously effaced the artist's image and substituted his own; a thing which is sometimes paralleled even in our own times. It may be said also that the reproductions of the "Temperance" ewer and basin



No. 31. Pewter Tankard. German work. XVI. century. Louvre Museum--Paris.



No. 30. Stein in Pewter. German work. XVI. century. Belongs to J. Brateau.

made in Enderlein's large factory, appear hopelessly inferior, when they are compared to specimens signed by François Briot and bearing his portrait.

This is a long digression, but we could not pass over in silence the work of a craftsman who has contributed so much to the beauty of pewter objects, and to the glory of our industrial arts.



No. 32. Pewter Plates. German work. XVI.—XVII., centuries. Belong to J. Brateau.

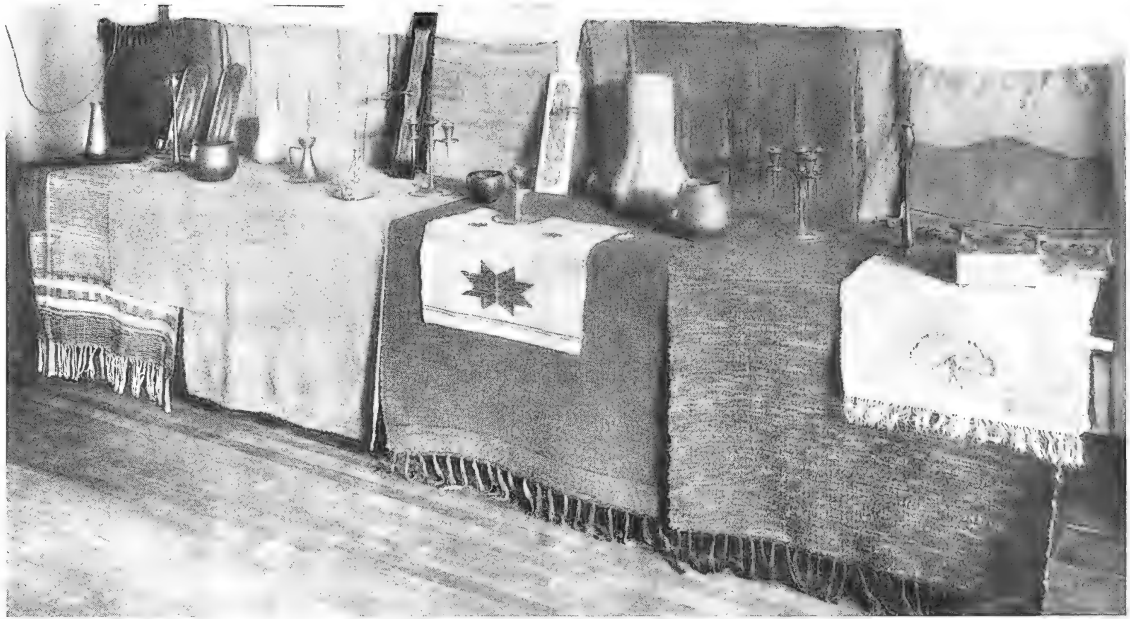

Weavings by Marie Little and Juanna Thoree. Metal work by the Busck Studios, R. R. Jarvie, Laurence Smith. Pewabic-Pottery, by Mary Chase Perry.

ARTS AND CRAFTS SOCIETY OF DETROIT, MICH.

SPECIAL EXHIBITION OF HANDWROUGHT METAL, JEWELRY,
ENAMELING AND VILLAGE INDUSTRIES.

AN exhibition showing activity, healthy striving and fair accomplishment in some of the most important decorative arts, those upon which the seamliness of life depends, is that recently given at the Arts and Crafts Society of Detroit, Michigan.

Organized in 1906, its permanent salesroom and exhibition opened in November of the same year. The Detroit Society owes its existence primarily to the initiative of two exhibitions held in 1904 and 1905 at the Museum of Art. The public interest thus aroused, resulted in the foundation of this Society, to develop a better appreciation of artistic handicraft and to be of direct educational benefit through frequent special exhibitions of modern and ancient work, and through illustrated lectures.

The setting and arrangement of the collections are in themselves a part of the exhibition, yet, of the many good things shown, nothing has been sacrificed to the decorative effect of the whole.

One of the most noteworthy, as it is numerically the strongest, of the exhibits shown, is that of the Deerfield Society of Arts and Crafts, which has seldom, save at their own "Crafts Barn", been seen to such advantage. Mrs. Madeline Yale Wynne, long associated with the Society as its founder, was represented by a number of daringly successful examples of jewelry and enameling, the metal well worked and developed to its capacity, the designs showing much feeling for line, mass and color. In stitchery, the "Blue and White Society" excel, and their table sets in the well known cool blues, and their scarfs and curtains in the quaintly designed cross-stitch of varied colors, prove them again masters of their craft.

At once practical and artistically satisfying were the

In the illustration in right column are: Baskets by Pucumtuck basket weavers, Deerfield basket weavers and New Clairvaux Society; Markham vase, Grueby vase, Candlestick, by George Parker; Rug woven by Massachusetts Institution for Blind.

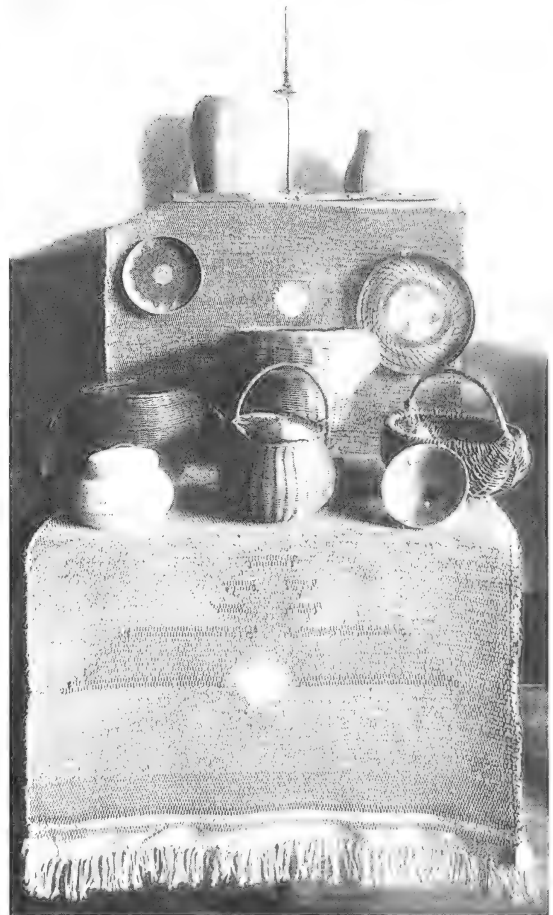



Abnakee Rugs on wall by Helen R. Albee.—Other weavings by the Deerfield Society.—Metal work by George F. Parker.—Pewabic lamp by Mary Chase Perry.

baskets in reed, willow, raffia, grasses, palm and pine needles, in a variety of pleasing shapes, sizes and qualities. Mrs. Thorn's woven rugs and Mrs. Henry's dimity tufted coverlets, with netted borders of "matrimony" and "moon light" stitch, almost complete the range of Deerfield activity, which however is rounded out and faithfully and exquisitely portrayed in Mary and Frances Allen's photographs of local scenes and subjects.

In silverware alone, this exhibition ranks well to the fore, with a coffee service of tooled and inlaid design by Mary Knight; a large compote with nicely carved border; and several smaller bowls and platters by the same artist. These pieces are all destined later for the Boston exhibition at Copley Hall, as are Jane Carson's salad set and salts and peppers, etc. Arthur Stone shows some beautifully worked spoons and ladles, a large porringer, and silver cup. Horace Potter, George F. Hunt, Adolph Kunkler, Seth Ek, and G. Gebelein are other exhibitors of finely wrought ware. The jewelry and enameling showing is of uncommon interest; for example, Grace Hazen's finely conceived "Swan" pendant, the body of the bird being of a rarely marked piece of malachite, and her poetic treatment of pink and white Baroque pearls, and silver in the "Seaweed" chain; Ethel Lloyd's Etruscan filagree work. Blanche Dillaye's sympathetic feeling for the requirements of her Egyptian scenes, and Brainerd Thresher's rhythmical combinations of line; Miss Peacock's work shows dignity and reserve, a small gold and opal brooch is one notable piece, and two chains, the links revealing unusual technical skill and intelligence united to still finer qualities. Thomas S. Clark, Mary Wright, R. R. Jarvie, Charles King, George Parker, Lawrence Smith, and G. Busck have all good

things in fire irons, candelabras, casseroles, candlesticks, trenchers, large and small bowls. G. Busck especially has several carefully thought out and well executed cigar boxes, cedar lined; a gong of resonant tones; a desk set, etc. The Busck studios are further represented by leathers from Mrs. Amalie Busck Deady and Charlotte Busck. Elizabeth Copeland, Margaret Jones, May Winlock, Catherine Jameson, Flora H. Skeimer, Margaret Rogers and Mrs. Eda Lord Young are other noted metal workers worthy of mention.

Besides the Deerfield textiles other good weavings shown are the Abnakee hooked rugs of Helen R. Albee, with their adaptation of old designs, in rich and varied vegetable colorings. Great is the range of work produced by the Massachusetts Commission for the Blind, of many textures and colors, and purposes,—towels, bedding, dress fabrics, curtains, etc., draperies, rugs. There is also Swedish weaving by Christina Nystrom, of the Wilro Shop, also represented by the etched leather of the Dolese Sisters; Louise Peppers orderly designs for hangings; the Isle La Motte Rug industry; the Kalo Shop, New Clairvaux Society,—the latter showing baskets as well, and last, the weavings of Marie Little of Woodstock, N. Y., whose perfection of coloring runs the chromatic scale of mauves, violets, warm madder, orange tawny, golden brown and green, and is almost lyrical in beauty and depth of tone. This briefly covers the more striking and meritorious of the various displays in the "Special" exhibition, which does not at all take into account the permanent exhibit of members' work in all classes of handicrafts, an exhibit designed to elevate as well as support the workers and to give to the world products both valuable and charming. H. P.

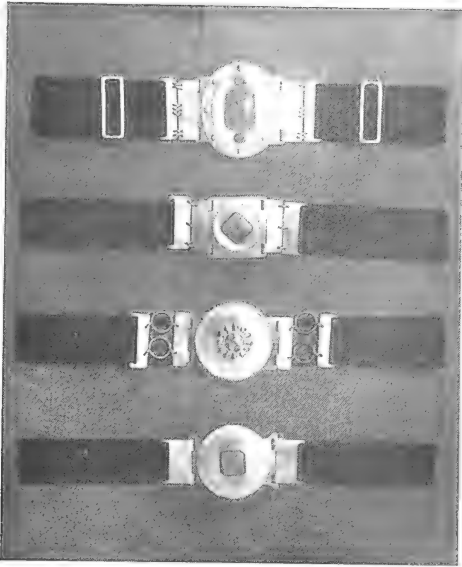

Illus. No. 1. Buckles in silver.

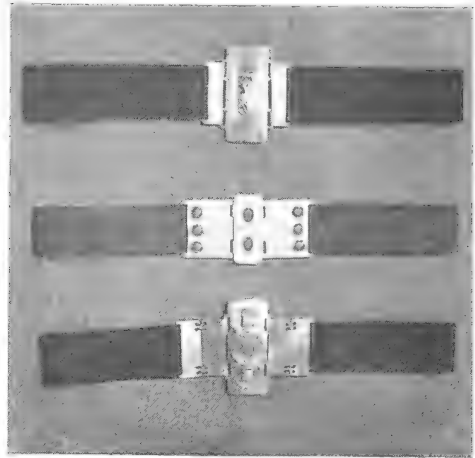

Illus. No. 2. Buckles in copper.

BARUM GUILD OF METAL WORKERS

The work illustrated was designed and executed by the members of the Barum Guild of Metal Workers, Barnstaple, England. The Guild was formed four years ago by G. L. C. Morris, architect, of London. Previous to that, some classes in metal work had been held in the local Art School, which had aroused interest in the work and really suggested the idea of a Guild. The membership at present is not very large but it is gradually increasing and some very creditable work has been exhibited.

There are some very simple and attractive buckles in Illus. Nos. 1, 2, and 3 mounted on linen crash, leather and other materials. In Illus. No. 5, the pendant, and in Illus. No. 7 the brooches are particularly pleasing.

Among the copper sconces in repoussé, Illus. No. 8, 9 and 11 show varied treatments of a simple motive with good effect.

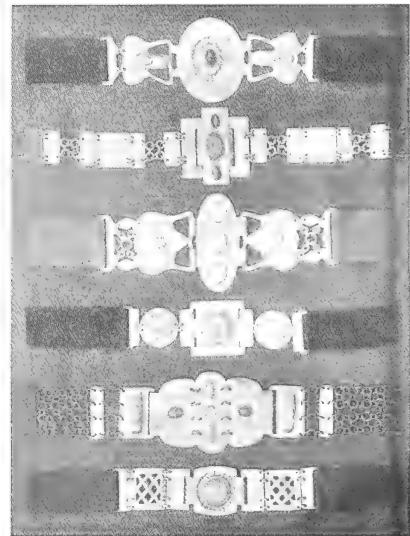

Illus. No. 4. Buckles in copper and silver.

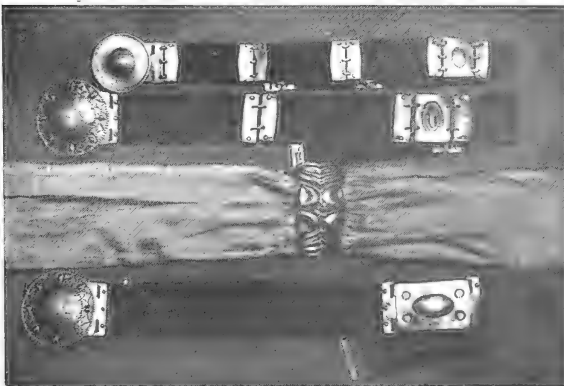

Illus. No. 3. Buckles in silver and copper.

ANSWERS TO INQUIRIES

Mrs. E. N. C.—The illustration of desk you sent would be better stained brown all over. Get some burnt umber and thin it down with turpentine, adding a little linseed oil or let the stain thoroughly dry and then rub in a finish made of beeswax and turpentine.

HOUSES OF PORCELAIN

The home of the future will be built of porcelain. It is now possible to build cheap, simple and cleanly houses with sheets of porcelain instead of bricks and slate and concrete, and to dispense with paint, wall paper and spring cleaning.

The sheet porcelain, glazed and decorated on both sides, can be produced at about \$2.50 the square yard. This cheapness and cleanliness make the porcelain house the ideal home for working people, and it is hailed as a possible solution of the problem which besets English cities, the housing of the poor.



Illus. No. 5.

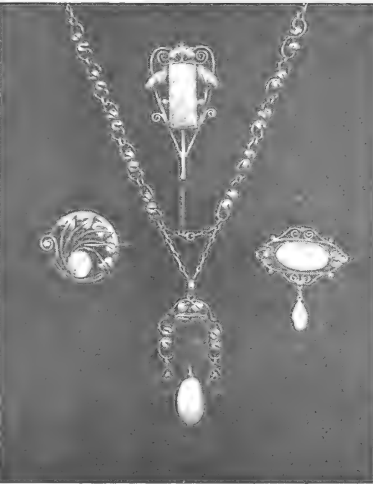

Illus. No. 6.
Pendants and brooches in silver.

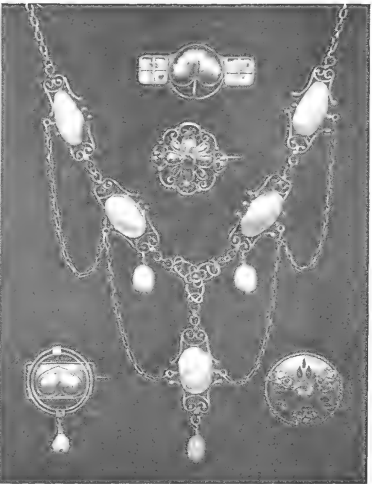

Illus. No. 7.

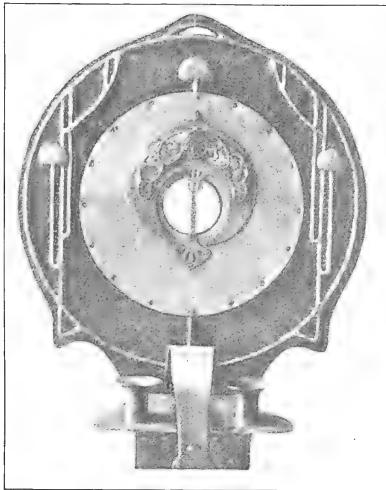

Illus. No. 8.

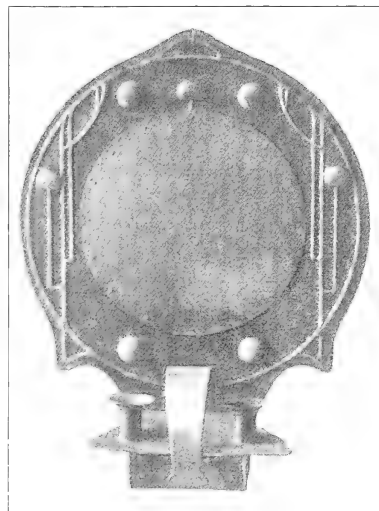

Illus. No. 9.



Illus. No. 11.

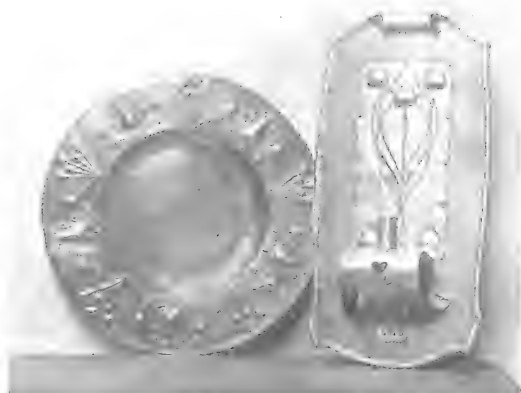

Illus. No. 10.



PINK EUCALYPTUS—MRS. H. L. BANCROFT

Flowers—Rose with darker touches of Rose and Ruby. Leaves—Yellow Green, Brown Green, Dark Green, and for warmer coloring, Brown Green and Blood Red. Shadow leaves—Copenhagen Blue.



CYCLAMENS—P. PUTZKI

April, 1907
SUPPLEMENT TO
KERAMIC STUDIO

COPYRIGHT, 1907,
KERAMIC STUDIO PUBL. CO.,
SYRACUSE, N. Y.

Orders May Be Placed Now

The Second Rose Book

Will be ready for delivery about May 15th.

With the exception of a few colored inserts which will be repeated, this book will contain material not published in the first "Rose Book," now out of print.

The following Color Inserts will brighten the pages of the new book:

Pink Roses, Rhoda H. Nicholls Wild Roses, Miss Jenkins
Jacqueminot Roses, F. B. Aulich Rose in Vase, Rhoda H. Nicholls
Yellow Wild Roses, Ida M. Ferris Salad Set, A. B. Leonard
Little Roses, Sara Wood Safford Plate in Blue and Gold, Leonard
Roses, Miss Jenkins Red Roses, McLennon

Price, postpaid, \$3.00

Keramic Studio Pub. Co., - - Syracuse, N. Y.

YOU CAN BIND MAGAZINES,
PERIODICALS, SHEET MUSIC,
AT YOUR HOME
WITH THE SIMPLEX BINDER

The "Simplex Binder" for Ceramic Studio is now made and may be ordered of any dealer in the country or at this office.

We will deliver postpaid to any part of the United States or Canada on receipt of the price,

NINETY-EIGHT CENTS EACH
Keramic Studio Pub. Co., Syracuse, N. Y.

DECORATIVE STUDIES

BY J. FOORD

A most artistic volume of the greatest value to Decorators.

Contains the following studies of flowers:

Oriental Poppy, Horse Chestnut, Lilac, Larkspur, Carnation, Columbine, Sweet Pea, Love-in-a-Mist, Rose Safrano, Lily, Wistaria, Peony, Cornflower, Escholtzia, Lavender, Parrot Tulip, Plumbago, Japanese Anemone, Laburnum, Clematis, Zinnia, Nasturtium, Campanula, Briar Rose, Michaelmas Daisy, Pink Poppy, Periwinkle, Marsh Marigold, Wild Iris, Arrowhead, Viper's Bugloss, Yellow Chrysanthemum, Single Pink Chrysanthemum, Honeysuckle, Heather, Pine, Black Bryony, Gorse, Thistle, Bramble.
The studies are in color, following closely the natural forms, but treated in a decorative way. Each study is accompanied with pen and ink drawings of motifs, seed pods, leaves, stems, etc. Average size of studies 7 x 10 inches. Postpaid \$12.50.

Keramic Studio Publishing Co.,
Syracuse, N. Y.

CLASS ROOM COMPETITION

Closes May 1st, 1907

The next subject for the Class Room will be "Flower Painting," under which heading will be included the subdivisions: Roses, white, pink, and crimson; Violets; Daffodils; Nasturtiums; Geraniums; Pansies; Forget-me-nots. Other flowers, white, pink, crimson, violet, purple, blue, yellow, orange, and red. Miniature flowers. See particulars on editorial page of this issue.

First Prize, \$5.00 Second Prize, \$4.00 Third Prize, \$3.00
Fourth Prize, \$2.00 Fifth Prize, \$1.00
Extracts Only, 50 cents.

SEND A POSTAL FOR
The Book of Back Numbers
KERAMIC STUDIO

From 1899 to September 1906, with contents and contributors of each number.
Mailed FREE on application to any address in the world.

PRICE (POSTPAID) OF THESE BACK NUMBERS

Published previous to May 1906, 35 cents per copy; \$3.00 for twelve numbers;
\$1.75 for six; \$1.00 for three.

From May 1906, to date, the price is 40 cents per copy; \$4.00 for twelve;
\$2.00 for six; \$1.00 for three.

Keramic Studio for 1907

THERE are some attractive numbers in preparation for the coming year. The January number which has been personally conducted" by Mrs. Henrietta Barclay Paist of Minneapolis, with many new ideas in decoration, studies of birds, flowers, suggestions for fish-sets, etc., has been received with much favor and praise on every side.

March was strongly edited by Margaret Overbeck, whose work this past year has called forth so much deserved admiration.

Marshal T. Fry, the foremost decorative artist of his time, will edit the May number. With his knowledge of ceramic art there will be evolved a number of *Keramic Studio* that will be of vital interest to the china painters of this and other countries, as Mr. Fry has been, for years, looked up to as authority upon those subjects. The above three numbers will be well worth the subscription price, not to speak of other numbers during the year, which will have interesting features.

The September and November numbers will be specially edited, respectively by Mrs. T. McLennon Hinman and Miss Jeanne M. Stewart, and these two numbers will undoubtedly be welcome to the lovers of good naturalistic work.

January 1908 will be a California flower number by Miss Leta Horlocker.

We mention a few of the Supplements for 1907:

January—Poppy and Cherry Blossoms, H. B. Paist.

February—Jaqueminot Red Rose, F. B. Aulleh.

March—Decorative Landscape, Margaret Overbeck.

April—Cyclamen, Paul Putzki.

May—Cactus decoration for vase, Marshal Fry, Jr.

June—Apple Blossoms, F. B. Aulleh.

August—Fleur de lis, Rhoda Holmes Nicholls.

October—Asters, T. McLennon-Hinman.

Will you not place your renewal at once so that we may keep your name on our list?

Respectfully yours,

Keramic Studio Pub. Co., Syracuse, N. Y.

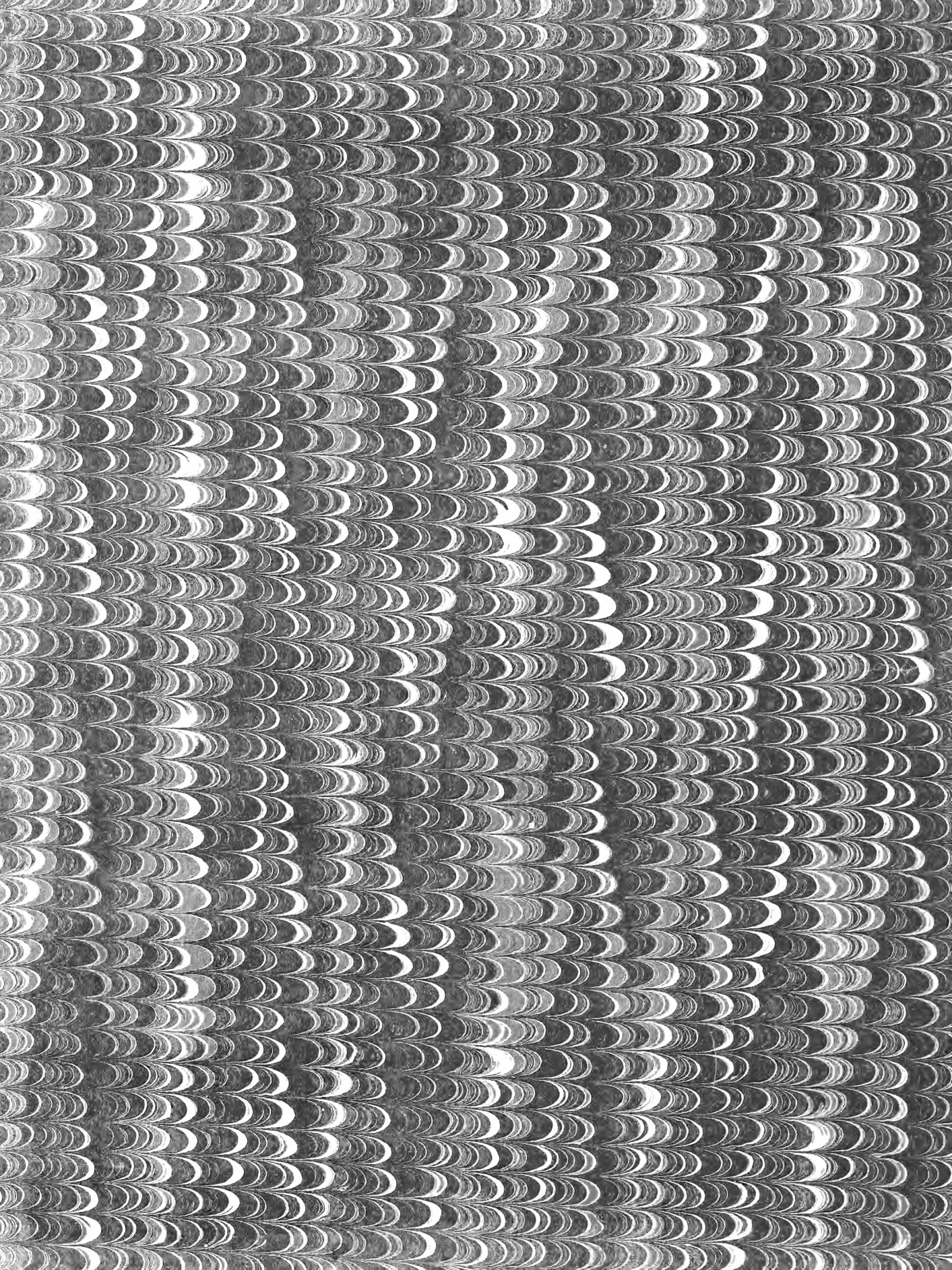

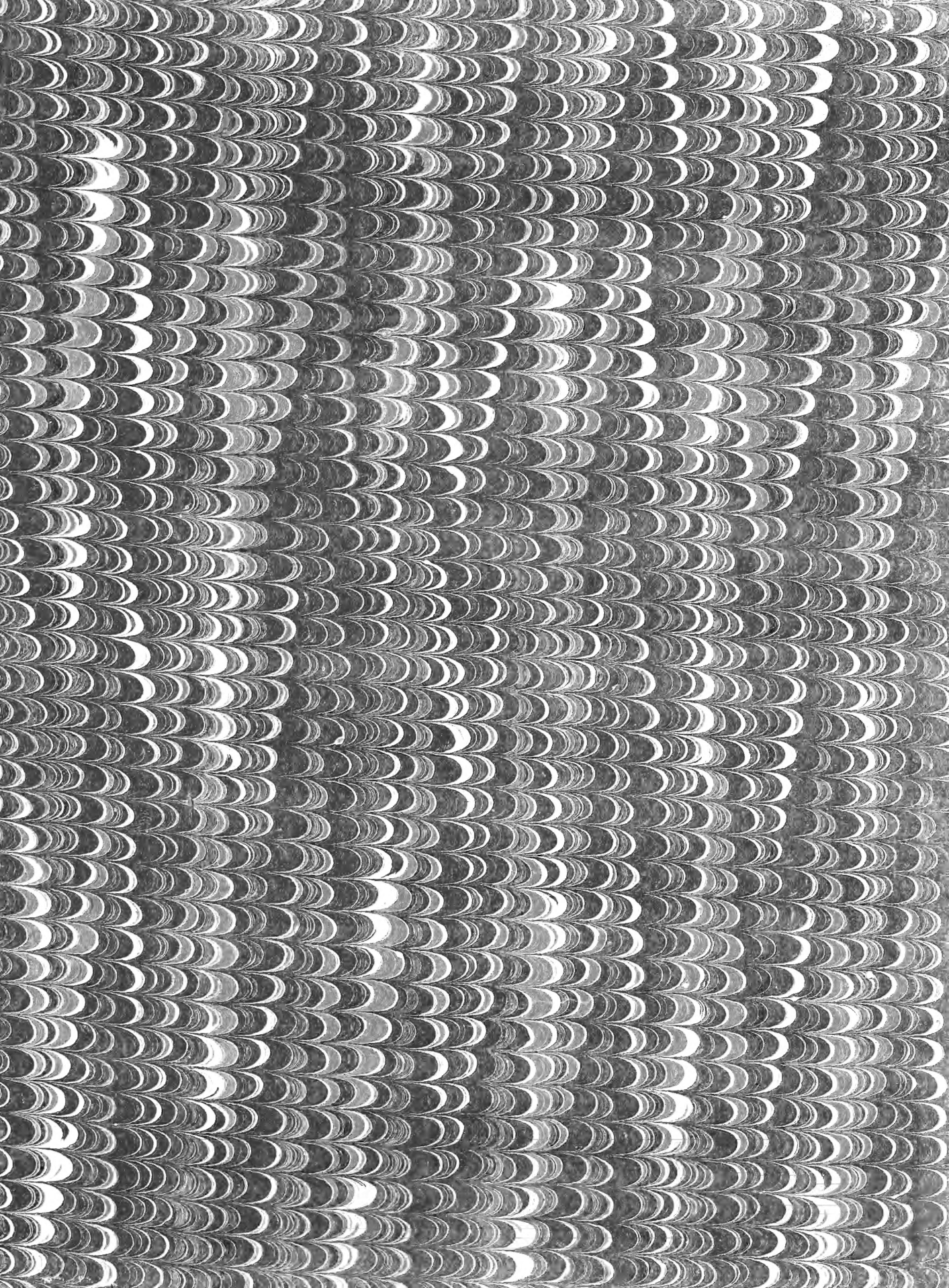

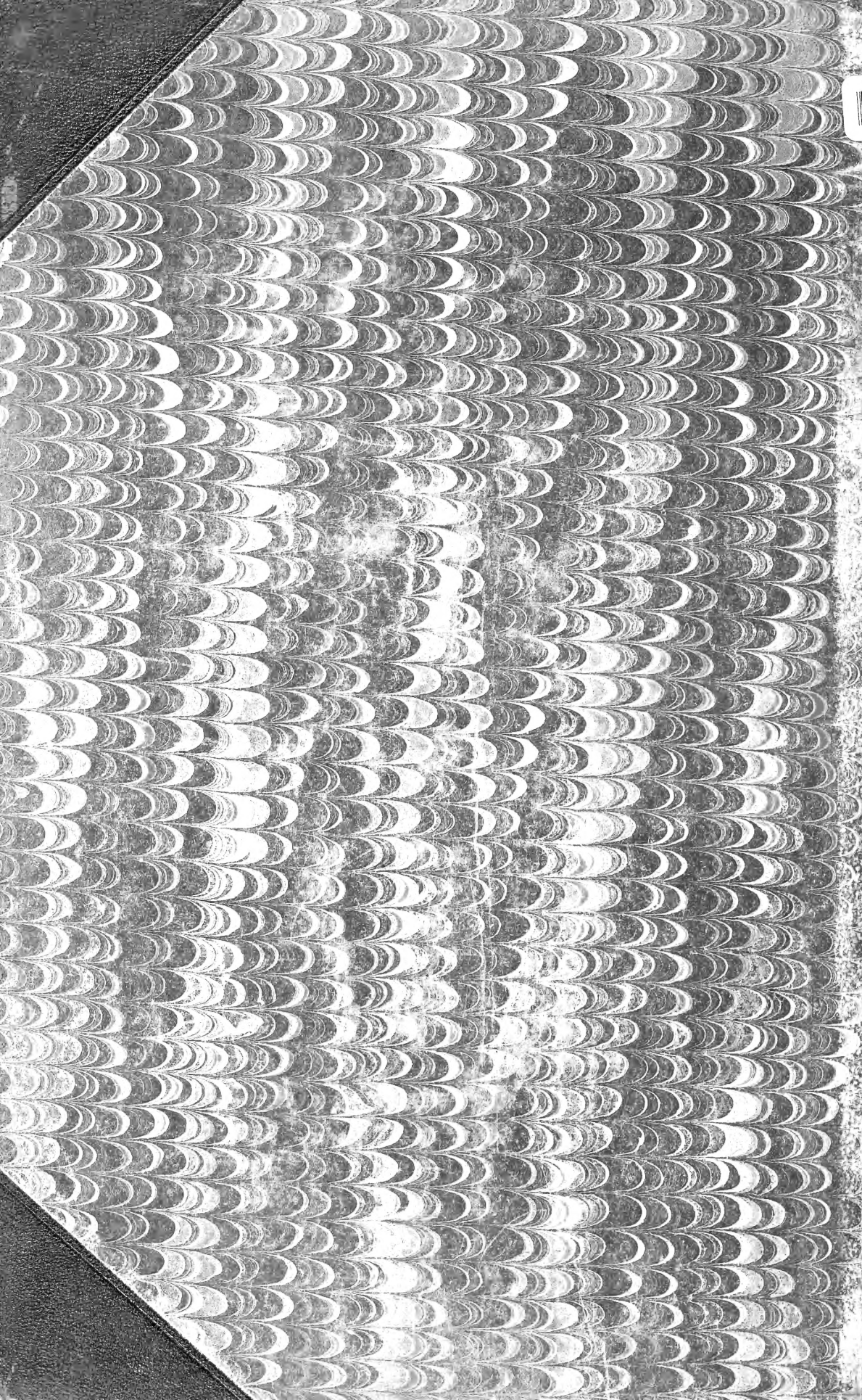

SMITHSONIAN INSTITUTION LIBRARIES



3 9088 01584 9243