

Monotype-Thompson
Adjustments

LANSTON MONOTYPE MACHINE COMPANY
PHILADELPHIA 3, U. S. A.

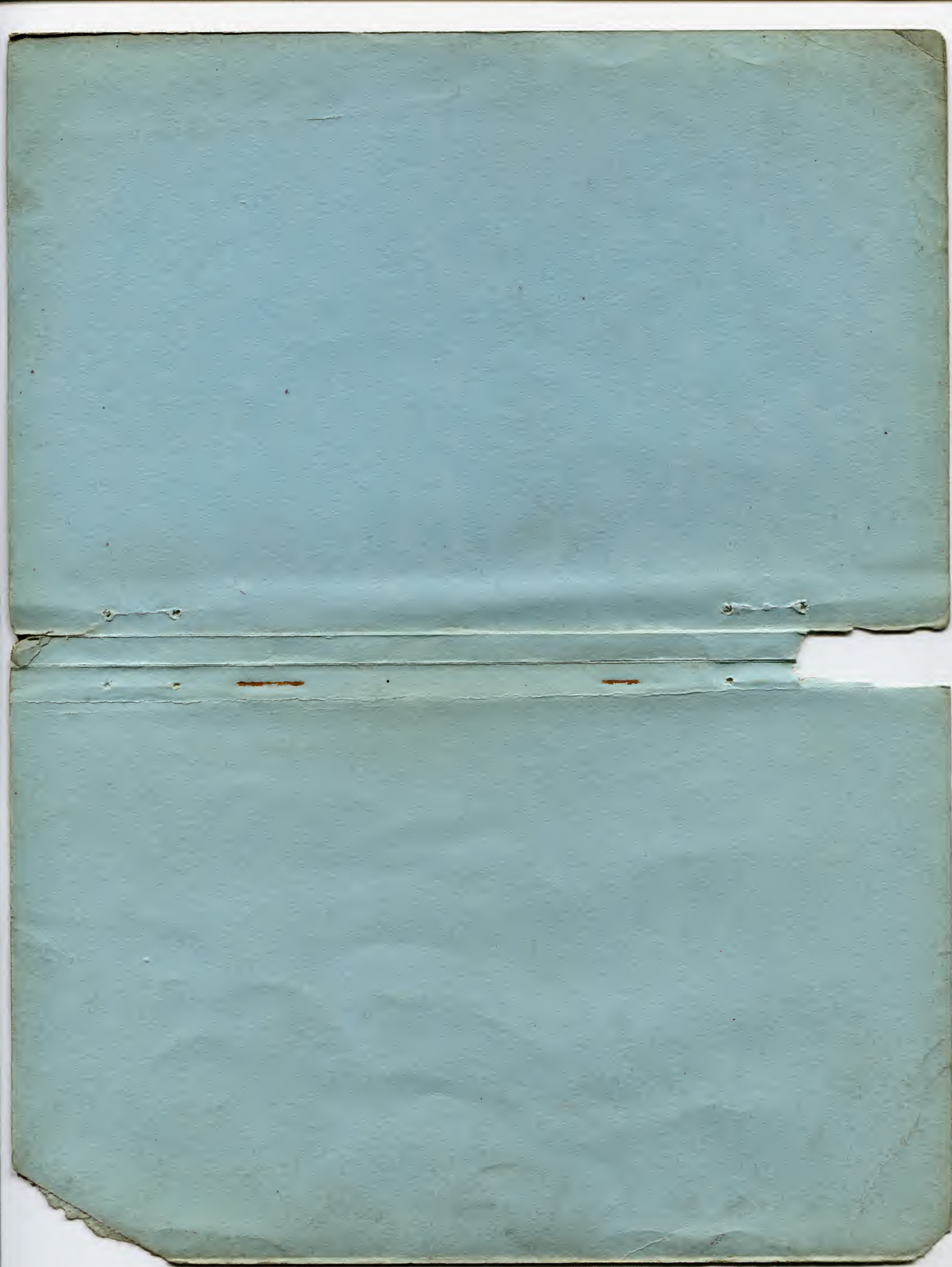

annular groove in the CLUTCH SHIFTER ROD (a10TC21) and press the CLUTCH SHIFTING KNOB (a10TC22) inward to the limit. Then lower the CLUTCH SHIFTER ROD LATCH (a11TC1) engaging it in the right hand annular groove in the CLUTCH SHIFTER ROD (a10TC21).

To stop the MACHINE shift to neutral by reversing the above operation.

Start the motor, allow it to run about half a minute then with the right hand take hold of the handle of the HAND WHEEL and turn it in its casting direction; at the same time, with the left hand, raise the CLUTCH SHIFTER ROD LATCH (a11TC1) and pull out the CLUTCH SHIFTING KNOB (a10TC22).

The MACHINE is now in high speed and ready to cast type of the smaller point sizes such as 6 Pt., 8 Pt., 10 Pt., 12 Pt., and 14 Pt. If type of the larger point sizes is to be cast lift up CLUTCH SHIFTER ROD LATCH and push in CLUTCH SHIFTING KNOB.

The FRICTION WHEEL SHIFTER OPERATING KNOB (a18TC23) is for the purpose of regulating the speed of the MACHINE in conjunction with the CLUTCH SHIFTING KNOB, both located on the lower right hand side facing the MACHINE near the HAND WHEEL. This is explained under "**Casting Speeds.**"

Pull out PUMP STOP (b77TC1), on the upper left hand front facing the MACHINE, only after all adjustments for casting are correctly made.

After running the MACHINE for at least one minute turn on the water. When casting type of the smaller bodies only a little water is required to keep the MOLD cool, but when casting the larger sizes of type a good flow of water is necessary to keep the MOLD sufficiently cool to insure a maximum casting speed.

After making the first cast remove type from the MOLD, break off jet and place type, with its nick up, alongside the LINING STANDARD on ALIGNING GAUGE to ascertain whether it is of the proper alignment. If

Oil all holes once each day. MOLD parts and MATRIX CARRIER SLIDES must be attended to every hour.

Starting Machine for Casting Type

Light the gas under the MELTING POT about forty-five minutes before starting to cast type. About three-quarters of an hour is usually required to bring the heat to the proper temperature.

Before the MOLD is adjusted it should be wiped absolutely clean and must be thoroughly oiled and free from accumulation of dirt or metal; also make sure that all OIL CUPS are filled.

Place MATRIX in MATRIX CARRIER and put the MATRIX CARRIER on the MACHINE. Then pull out knob in MATRIX CARRIER LEVER EXTENSION (30TC2T) and raise the MATRIX CARRIER FORK (30TC3T) until it fits snugly under the handle of the MATRIX CARRIER.

When the metal has been heated to the proper temperature hook the CHOKER TRIPPING TOOL (46L1) over the CHOKER VALVE LEVER ROCKER ARM (a8TC5) and press down on the end of the CHOKER TRIPPING TOOL using a ladle to catch flowing metal to make sure the CHOKER VALVE will move freely out of the hole in the NOZZLE; this must be done to make sure the metal in the NOZZLE is melted. If the metal is not thoroughly melted at this point the CHOKER VALVE will stick in the NOZZLE and break. Now wipe clean the face of the NOZZLE; also wipe clean the opening in NOZZLE PLATE and set the latter closely against the MOLD. Swing Pot against MOLD and lock it in casting position.

Turn over HAND WHEEL several times to make sure that all parts are moving freely.

The CLUTCH SHIFTING KNOB (a10TC22) is located on the right hand side of the MACHINE BASE, directly above the FRICTION WHEEL SHIFTER OPERATING KNOB (a18TC23). To shift the MACHINE from neutral into low gear raise the CLUTCH SHIFTER ROD LATCH (a11TC1) thereby disengaging it from the middle

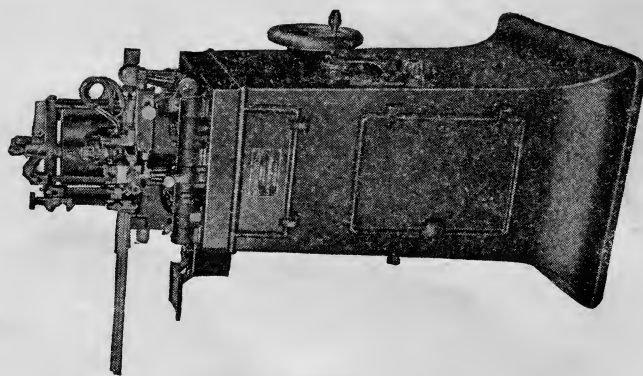

(a48TC1T), need a drop of oil. The segments between the two last named LEVERS should also be oiled.

Matrix Carrier

The MATRIX-CARRIER SLIDES (a54TC44 and (a54TC40) can be oiled through the two oil holes above them.

Small Bearings

One oil hole will be found in the top of the Pot YOKE STUD (a40TC1).

There is one oil hole in the square end of ADJUSTING SCREW (a46TC1) connecting with the MOLD-BODY PLATE, and one oil hole in the top of the MOLD-BODY LEVER (a48TC1T).

Metal Pot Levers

Oil should not be used on any of the MELTING POT LEVERS as it will burn off and cause the parts to stick or cut. For lubricating the Pot LEVERS take two parts mutton tallow and one part very fine graphite. Heat the mutton tallow and mix the graphite with it. When cold, a small amount of this mixture used daily on the METAL POT LEVERS will keep them in good working order. If fine graphite and mutton tallow are not available "Gredag" which can be purchased from us may be used.

The following are the parts on which the tallow, or Gredag, lubricant should be used; two oil holes at the rear end of the PISTON LEVER (a69TC1T) and one in the center of upper end of the PISTON STEM (a68TC9). One oil hole in each end of the CHOKER VALVE LEVER ROCKER ARM (a8TC5). A small quantity on the PISTON LINK PIN (68TC3) and the PISTON LEVER PIN (69TC3) where these pass through the PISTON LINKS (68TC2); also a small quantity on the CONNECTING PINS (71TC5) for the PISTON and CHOKER LEVER LINKS (71TC1T and 8TC6T).

If motor-driven, oil the bearings at each end of the ARMATURE SHAFT.

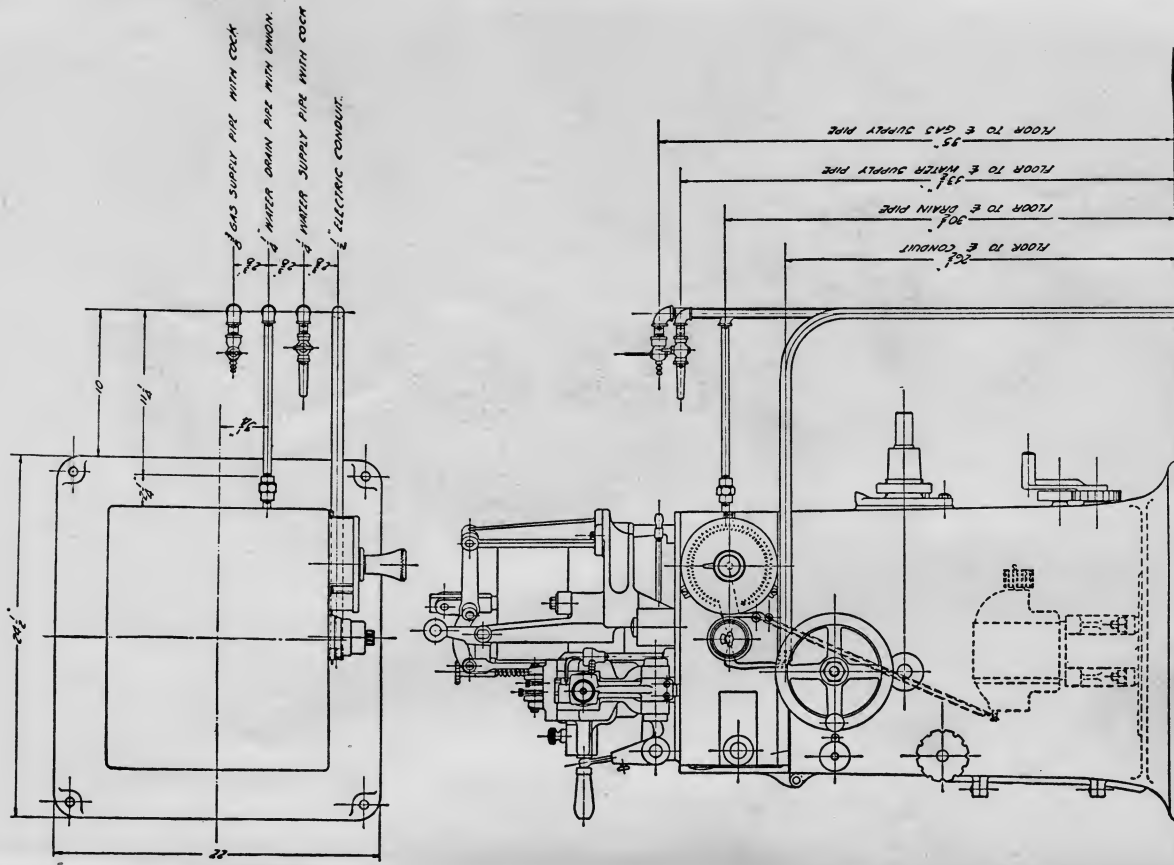

INSTALLATION SHEET
FOR
MONOTYPE-THOMPSON TYPE CASTER

CAM LEVER ROLLER has an oil hole to lubricate both rollers on the LEVER (a49TC1T). Do not neglect these rollers. Oil frequently.

Cam Shaft

There is one oil hole in each CAM SHAFT BEARING (3TC1 and 4TC1), both outside the base.

Friction Plate Shaft

The grease cup above the bearing at the rear of the MACHINE must be given a turn every day or two. "Grease-dag" is recommended as a lubricant for the grease cups.

Friction Wheel Shaft

This SHAFT carries the fibre-faced FRICTION WHEEL and the bearings at each end must be oiled frequently.

Inside the BASE, and mounted on the lower side of the FRICTION WHEEL SHIFTER YOKE, will be found a grease cup for lubricating the YOKE. It should be kept filled with cup grease and the cap should be screwed down a little every two or three days. This grease cup can be reached only through the lower base front door.

Speed Change Gears

Two oil tubes lead to the SHAFT on which the speed changing gears are mounted. They are covered by the swinging plate marked "Oil" seen when the top base door is lowered. There is also one oil hole outside the BASE on the right hand side for the SPEED CHANGE GEAR SHAFT.

Cam Levers

There is one oil hole for each of the six levers mounted on the MOLD STAND, the CHOKER CAM LEVER (a6TC1T); PUMP CAM LEVER (a76TC1T); VERTICAL MOLD BLADE CAM LEVER (a53TC1T); MATRIX CARRIER CAM LEVER (30TC1T); MOLD BODY CAM LEVER (a49TC1T); and two for the MOLD BODY LEVER

COPYRIGHT 1956, BY
LANSTON MONOTYPE MACHINE COMPANY

TRADE MARK
MONOTYPE
Reg. U. S. Pat. Off.

adequate oiling system, but all our efforts will be set at naught unless the operator puts oil into the cups provided for that purpose.

Oil should be supplied at least once an hour while running. An oil cup is located on the back wall of the MOLD STAND near the WATER TUBES and another one above the TYPE RECEIVING SHOE (x80TC). The SIGHT FEED OILER should be kept full and adjusted to feed about one drop a minute. We recommend the mixing of MONOTYPE-THOMPSON MOLD OIL and MONOTYPE-THOMPSON MOLD PASTE, which we can furnish. It will save the MOLD from cutting. Do not use a heavy, thick or cylinder oil.

Be sure to get the oil into the bearings. Oil on the outside of the MACHINE does no good; it only collects dust and dirt and is an indication of a careless operator. Be sure the oil flows freely into the oil holes and bearings and, after oiling, wipe off all oil that may run out of them. There are thirty-four oil holes and two grease cups on the MACHINE; be sure none are overlooked

Cam Rollers

Next in importance are the CAM ROLLERS. If these do not revolve freely on their studs, (and they will not unless oiled), they soon wear a flat surface at one or more points. This causes the cast-iron CAMS to wear rapidly, and the result is that all CAM LEVER movements are affected and their accurate timing destroyed.

Each of the CAM LEVERS (30TC1T and a53TC1T) has oil holes near the CAM ROLLERS. The oil hole for the PUMP CAM LEVER ROLLER is in the rear end of the LEVER (a76TC1T) and can be seen only from the back just above the BASE TOP when the METAL POT is swung back and the PUMP STOP (b77TC1) is in position under the PUMP CAM LEVER (a76TC1T). This PUMP CAM LEVER ROLLER must be oiled frequently through the oil hole to prevent the roller from wearing flat and consequently cutting the PUMP CAM. The MOLD BODY

MONOTYPE THOMPSON ADJUSTMENTS

PHILADELPHIA
LANSTON MONOTYPE MACHINE COMPANY
1956

Forward..... 7
 The Machine and its Placing..... 7
 Water Connections..... 8
 Electric Connections..... 9
 Gas Burner and Connections..... 9
 The Cams..... 10
 Cleanliness..... 11
 Oiling Mold Parts..... 11
 Cam Rollers..... 12
 Cam Shaft..... 13
 Friction Wheel Shaft..... 13
 Friction Plate Shaft..... 13
 Speed Change Gears..... 13
 Cam Levers..... 13
 Matrix Carrier..... 14
 Small Bearings..... 14
 Metal Pot Levers..... 14
 Starting Machine for Casting Type..... 15
 Casting Speeds..... 17
 The 72 Point Body Gauge..... 19
 Aligning Gauge..... 20
 Making the Alignment when the Face to be Cast is on Standard Line..... 20
 When the Face to be Cast is not on Standard Line and no Type available..... 21
 Holder for Foundry Style Matrices..... 22
 Special Matrix Carrier with Adjustable Side Wall..... 22
 To replace Foundry Style Matrix Holder with the new Style "B" Matrix Holder..... 23
 To replace Style "B" Matrix Holder with Holder for Space and Quad Matrices..... 24
 Casting Spaces and Quads..... 24
 Quotation Quads..... 27
 Type Trimming Knives..... 27
 Temperature of Metal..... 28
 Cleaning Metal..... 28
 The Micrometer Set Adjusting Device and the Type-Body Piece Plate Adjusting Screw..... 29
 The Stop Motion..... 31
 Type Mold Adjustments..... 32
 To change Jet Ejectors..... 33
 To change Mold Body Pieces..... 34
 Felt Oil Pads..... 35
 To change Foot Plow..... 35
 To remove the Type Mold..... 36
 To replace the Mold..... 38
 To check Mold Position..... 39
 To adjust the Type Receiving Shoe..... 40
 Adjustment of Vertical Mold Blade..... 41
 Adjusting the Matrix Carrier Cam Lever..... 45
 The Pump Stop..... 46
 Piston Spring Adjustment..... 46

Matrix Carrier Slide Adjustments..... 47
 Adjusting Choker Cam and Choker Cam Roller..... 48
 Connecting and Adjusting Melting Pot..... 49
 Sidewise Adjustment of Metal Pot..... 51
 Adjusting forward position of Melting Pot..... 52
 Fitting Choker Valve Point to Nozzle Plate..... 53
 Cleaning Choker Nozzle and Pump..... 54
 Grinding in Choker and Assembling..... 55
 Friction Plate and Friction Wheel..... 58
 How to remove the Friction Wheel..... 59
 Troubles and Remedies..... 62
 When Type is Hollow..... 63
 When the Type explodes as the Mold opens..... 64
 The cause of and remedies for Squirts or Splashes..... 64
 The causes of Fins and the Remedies..... 66
 When Type is too wide setwise..... 67
 When Type is oversize in body dimension..... 67
 When Type is too high to paper..... 67
 What causes defective Type Faces?..... 68
 When metal leaks out of Nozzle..... 69
 The cause of Choker Valve sticking..... 70
 When the Piston sticks. The remedy..... 71
 Gas Burner fails to generate enough heat to raise metal in Pot to required temperature. What is remedy?..... 71
 Mold works tight. What is the remedy?..... 71
 What is the cause and remedy for changing Type alignment while the Machine is in operation?..... 72
 What is the cause and remedy for a Friction Drive that slips and fails to pull the Machine?..... 73
 General Hints..... 74
 Height of Type..... 75
 Practical and Metallurgical points regarding care and handling of metals..... 77
 Impurities..... 78
 Type Formula..... 79
 Remelting Type into Pigs..... 79
 American system of Type Body dimensions..... 81
 "Didot" system of Type Body dimensions..... 81
 Parts Illustrated—back of book

Cleanliness

Cleanliness is absolutely essential in a MACHINE required to do the exacting work of typecasting. Small particles of metal, grit or dirt of every description must be kept away, particularly from the MOLD parts. A soft, clean rag should be used to wipe body pieces, etc., before putting them into the MOLD. The MATRICES and MOLD faces should also be wiped and all metal brushed away when MATRICES are changed, and if the run is a long one, remove the CARRIER occasionally and wipe the parts. The entire MOLD should be removed occasionally and drenched with gasoline or benzine and wiped clean, then thoroughly oiled and replaced. Keep the oil grooves in the MOLD free from accumulations of metal. Run a wire through the oil hole connecting the OIL PAD with the front end of the MOLD.

When MOLD bodies and similar parts are stored away coat them with Vaseline, which is better than oil as a rust preventative.

Wipe the interior faces of the CAMS to remove grit and do not allow oil to run over the MACHINE surfaces. Always keep MACHINE clean and covered, when not running.

Oiling Mold Parts

The most important thing in the operation of any MACHINE is proper lubrication. If bearings and surfaces which move in contact are not oiled the parts soon become heated and carbon is formed, which seizes the metals and causes deep cuts in their surfaces. A rapidly moving part lacking oil may be ruined in a few minutes.

In a MACHINE of this class it is absolutely essential that the MOLD parts be kept amply lubricated, and because of the intense heat near these parts the task is the more difficult. We have solved the problem with an

it generates the most heat and once adjusted it requires no further attention, unless the gas-pressure should vary greatly.

A good supply of gas is essential. Nothing smaller than a three-eighths-inch gas pipe should be used to supply the BURNER. The gas cock should be large enough to supply a free flow of gas through it to the BURNER. After the metal is melted the gas may be turned down so the metal will not be overheated but kept at an even temperature.

The Cams

Facing the front of the MACHINE, and counting from left to right, the CAMS on the CAM SHAFT have the following actions:

First is the CHOKER CAM (2TC2) which operates the CHOKER CAM LEVER (a6TC1T) through which the CHOKER VALVE LEVER LINK (8TC6T), CHOKER VALVE LEVER ROCKER ARM (a8TC5), CHOKER VALVE LEVER (8TC1T) and CHOKER VALVE (a7TC1T) are actuated.

Second is the PUMP CAM (2TC12T) which operates the PUMP CAM LEVER (a76TC1T) through which the PUMPLEVERLINK (71TC1T), PISTONLEVER (a69TC1T) and PISTON (a68TC1T) are actuated.

Third is the VERTICAL MOLD BLADE CAM (a2TC11). This CAM operates the VERTICAL MOLD BLADE CAM LEVER (a53TC1T) attached to the VERTICAL MOLD BLADE LEVER (52TC1T), which moves the VERTICAL MOLD BLADE (47TC1) up and down at the type discharge end of the MOLD CHAMBER.

Fourth is the MATRIX CARRIER CAM (a2TC7) for operating the MATRIX CARRIER CAM LEVER (30TC1T) and MATRIX CARRIER CAM LEVER EXTENSION (30TC2T) through which the MATRIX CARRIER is actuated.

Fifth and sixth are the MOLD BODY AUXILIARY CAM (a2TC10) and MOLD BODY CAM (2TC9), respectively, for operating the MOLD BODY CAM LEVER (a49TC1T) and MOLD BODY LEVER (48TC1) through which the

FOREWARD

IN WRITING these instructions we have endeavored to include such details as are necessary for the successful operation of the MONOTYPE-THOMPSON TYPECASTER. A careful study of the description and functions of the various parts of the MACHINE by the operator is essential.

The paragraphs relating to the care of the MACHINE, adjustments, oiling, cleaning, etc., should be read frequently to insure a thorough understanding of these principles.

We are glad to assist users of The MONOTYPE-THOMPSON TYPECASTER and will always be glad to answer questions. It is suggested that, before you write us, these instructions be carefully studied to ascertain if the difficulty being encountered has not already been discussed herein and the remedy provided.

In ordering repair parts always give the number of the machine, name of the part and the part number as it appears in this book. When any part of the MACHINE is sent to our factory for repairs, attach a tag to it, containing the owner's name and address, as a means of identification. The correct wording of an order will often save considerable correspondence and unnecessary delay.

This book is prepared for the use of the operator of the MONOTYPE-THOMPSON TYPECASTER, and should be available for his use at all times. It cannot serve the purpose for which it is intended if kept in the office or on the foreman's desk.

The Machine and Its Placing

The MONOTYPE-THOMPSON TYPECASTER occupies a floor space of twenty-seven by thirty inches. The weight of the complete MACHINE fully equipped is 750 pounds.

It is important that the MACHINE be placed near a window in such position that the light will fall on it from either the right or left side of the operator as he faces the MACHINE. If placed so the operator must work with his back to the window, he is obstructing the light. If he works with the MACHINE between himself and the window, the light will not fall upon the MOLD and MATRIX CARRIER as well as other working parts which it is necessary to check in order to insure perfect product. The light on a bright day falling into the operator's eyes will affect his efficiency.

When artificial light is used it should be so placed that it will fall directly upon the MOLD and MATRIX CARRIER from overhead, but low enough to well light up the working parts without shining into the operator's eyes.

The MACHINE should be placed upon a solid level surface.

Water Connections

Make water connections as shown on "Installation Sheet" on page 3.

The MONOTYPE-THOMPSON MOLD is water cooled to carry off excess heat and effect a faster delivery of type. It is important that all water connections be made so that the flow of water may be easily regulated.

The water supply pipe to the MACHINE need be no larger than quarter inch copper tubing. A good lever handle stop cock which will not leak should be provided and connected to the end of the supply pipe so that it will be convenient for the operator to regulate the flow of water as required without leaving his position in front of the MACHINE. A piece of good rubber tubing should be used to connect the stop cock on the end of supply pipe with the large inlet pipe on the MOLD.

The quarter inch waste water drain pipe, which extends about three inches beyond the back of the MACHINE TOP BASE, should be connected directly with a

three-eighths-inch copper tubing. This should be run into a drain so the waste water will be carried off.

The amount of water required to produce good type at maximum speed is governed by the metal temperature, the size of type being cast, and the speed of delivery, and can be judged by checking the water temperature as it leaves the MOLD and enters the drain.

The speed of casting type on the MONOTYPE-THOMPSON TYPECASTER is limited only by the length of time required to fill the MOLD solidly with metal and cool it sufficiently so that it may be discharged easily.

Electric Connections

The MOTOR, which is installed in the base of the MACHINE, is wired to the snap switch which is located on the right hand side of the MACHINE.

All electrical wiring must be done by the customer when the MACHINE is installed.

The local Underwriters' or Insurance Rules for wiring should always be complied with, in making the electrical connections.

Gas Burner and Connections

Gas connections with the MACHINE should be made as shown on Installation Sheet.

The GAS BURNER (Xa20TC) for heating the type metal is so constructed that the flame will spread, thus heating the metal evenly with a minimum amount of gas. The flame should be blue; if it is red it will deposit soot on the bottom of the MELTING POT (b37TC1TT), which prevents the type metal from becoming properly heated. The air-supply regulator on the lower end of the air mixer may be turned to the right or left to open or close the holes through which air passes into the mixer. Too much air will cause the gas to ignite in the MIXING CHAMBER; if that occurs, the gas must be turned off and the AIR HOLES closed up a little more before again lighting the gas. When the flame is blue

the outside of the CLUTCH SHIFTER ROD KNOB (a10TC22). This SPRING pushes the CLUTCH SHIFTER ROD (a10TC21) inward and throws the low gear into action. Now push upward the outer end of the flat STOP MOTION RELEASE SPRING (84TC29T), until the short STUD on its inner end lowers the end of the STOP MOTION WEDGE LATCH (84TC40), thereby throwing the other end of the STOP MOTION LATCH upward into path of the ACTUATING PIN inside the HAND WHEEL (10TC13T). This HAND WHEEL ACTUATING PIN actuates the STOP MOTION.

After all the above adjustments are correctly made pull out the PUMP STOP (b77TC1) and the MACHINE will now operate with an intermittent motion or dwell. The metal in the MOLD is chilled during the dwell so that the type may be quickly discharged and the next type cast at much higher speed than would be possible without the STOP MOTION.

The CRANK PIN (a84TC8) is located in the STOP MOTION CRANK DISK (a84TC6) which is fastened to the outer end of the FRICTION WHEEL SHAFT (a18TC5T). It actuates the STOP MOTION RATCHET WHEEL (84TC25T) by contact with the teeth of the RATCHET WHEEL once during each revolution of the FRICTION WHEEL SHAFT.

When the MACHINE is to be run at high speed, or when it is to be operated for several days for casting material in the smaller bodies, and the STOP MOTION is not to be used, the STOP MOTION CRANK PIN (a84TC8) should be taken out of the CRANK DISK (a84TC6). This is easily done with a screw driver; the removal of this pin prevents the operation and wear of the STOP MOTION parts, thereby prolonging their life.

Type Mold Adjustments

The MOLD can be equipped with any size BODY PIECE, either high or low, in standard sizes from 6 to 48 point.

not, follow instructions under the caption "**Making the Alignment.**"

Casting Speeds

The speed at which type may be cast on the MONO-TYPE-THOMPSON TYPECASTER is limited only by the length of time required to fill the water cooled MOLD solidly with metal and give it sufficient time to chill before it is discharged. The time required to chill the metal varies with the size of type being cast. When any TYPECASTER is operated at a speed too fast to permit the metal to solidly fill the MOLD CHAMBER the result must be hollow type.

While the following speeds are not the maximum at which some of the MONO-TYPE-THOMPSONS in use are being operated they are the average speeds suggested for best results under general conditions.

6 point—	130 to 150 casts per minute
8 point—	110 to 130 casts per minute
10 point—	85 to 110 casts per minute
12 point—	65 to 90 casts per minute
14 point—	50 to 70 casts per minute
18 point—	35 to 50 casts per minute
24 point—	25 to 40 casts per minute
*30 point—	18 to 30 casts per minute
*36 point—	14 to 25 casts per minute
*42 point—	11 to 20 casts per minute
*48 point—	9 to 15 casts per minute

*These sizes are cast with the use of the Stop Motion and as a cast is made only one every second revolution the R. P. M. should be twice the number of casts per minute.

The first figures in the above table are the number of casts per minute of the em set characters; the larger figures are those at which the thinnest characters, such as the lowercase "i" and "l" and the punctuation marks, should be cast. The speed of the MACHINE should be regulated between the minimum and maximum given in the table when casting the varying set-sizes from the thinnest to the widest characters. The operator will

soon learn the speeds that will give the best results for the different sets.

Before trying to set the MACHINE for the proper speed at which to cast type the operator should thoroughly familiarize himself with the means for changing the speed of the MACHINE as set forth in the following directions:

The MONOTYPE-THOMPSON TYPECASTER is designed so that any speed between the high and low limits can be readily obtained. This is accomplished by means of a friction drive and high and low gear.

The FRICTION WHEEL SHIFTER OPERATING SCREW KNOB (a18TC23) on the right side of the MACHINE BASE, controls the FRICTION DRIVE. Turning the FRICTION WHEEL OPERATING SCREW KNOB (a18TC23) in a clockwise direction moves the FRICTION WHEEL (a18TC1T) towards the center of the FRICTION PLATE (17TC1T) and reduces the speed of the MACHINE. To increase the speed of the MACHINE turn the FRICTION WHEEL OPERATING SCREW KNOB (a18TC23) in a counter clockwise direction. This operation moves the FRICTION WHEEL (a18TC1T) towards the rim of the FRICTION PLATE (17TC1T).

Never turn the FRICTION WHEEL OPERATING SCREW KNOB (a18TC23) unless the power is on. If the FRICTION WHEEL (a18TC1T) is moved while the FRICTION PLATE (17TC1T) is at rest a flat spot will be worn on the FIBRE FRICTION RING (18TC2) with the result that the FRICTION DRIVE will not operate properly.

Small type should be cast at high speed; large type should be cast at low speed. Large type cannot be cast as fast as small type as it takes longer for a large volume of metal to cool and solidify than for a small volume. If the MACHINE is run faster than the interior of the type can solidify, the type will swell or explode upon being ejected from the MOLD. The efficient water cooling system on the MONOTYPE-THOMPSON MACHINE

the type is being cast. Move the TYPE BODY PIECE PLATE ADJUSTING NUT (a46TC2) clock-wise until the TYPE BODY PIECE PLATE (45TC1) is brought up firmly against its stop, the SET DEVICE STOP (a41TC8), taking up all the play in the TYPE BODY PIECE and MOLD CAM LEVERS. Tighten the INSIDE LOCK NUT (a46TC4) and the OUTSIDE LOCK NUT (a46TC3) to complete locking of the device. Turn the MACHINE over by hand slowly to check this adjustment. If the MACHINE turns over hard the TYPE BODY PIECE PLATE ADJUSTING NUT (a46TC2) is too tight and should be readjusted.

The Stop Motion

The STOP MOTION is located on the right hand side of the MACHINE BASE (a1TC1T) between the CLUTCH SHIFTER ROD KNOB (a10TC22) and the FRICTION WHEEL SHIFTER OPERATING SCREW KNOB (a18TC23). With it in operation the output of type, and quads, of the sizes larger than 24 point can be increased at least fifty per cent. The STOP MOTION can be thrown into, or out, of operation in less than thirty seconds.

Before throwing the STOP MOTION into operation have MATRIX CARRIER in position and all adjustments made so that the machine is ready for casting; be sure to have the PUMP STOP (b77TC1) in its inward position to prevent metal from passing through the NOZZLE into the MOLD.

To throw the STOP MOTION into operation, first raise the CLUTCH SHIFTER ROD LATCH (a11TC1) and press its end behind the flat LATCH RETAINING SPRING (84TC32), thereby disengaging the LATCH from the middle annular groove in the CLUTCH SHIFTER ROD (a10TC21) and preventing it from falling down into any of the annular grooves in the CLUTCH SHIFTER ROD while the STOP MOTION is in operation.

The STOP MOTION MAIN SPRING (84TC16T) must now be pushed over so that its upper end bears against

Step One—Loosen the OUTSIDE LOCK NUT (a46TC3) and the INSIDE LOCK NUT (a46TC4) and back off the ADJUSTING NUT (a46TC2). This will release the tension of the TYPE BODY PIECE PLATE (45TC1) against the MICROMETER SET ADJUSTING DEVICE STOP (a41TC8).

Step Two—The MICROMETER SET ADJUSTING DEVICE (Xa41TC) is located at the right end of the MOLD on the MOLD STAND. The SET DEVICE STOP (a41TC8) is movable through its MICROMETER MEASURING SCREW (a41TC2) along the SET DEVICE BODY (a41TC1T) within the range of the SET DEVICE BODY SCALE, and can be locked in any position by tightening the SET DEVICE STOP CLAMP SCREW (41TC9).

When the indicator line O on the SET DEVICE STOP (a41TC8) is in line with the ZERO line of the scale on the SET DEVICE BODY (a41TC1T) and the indicator line on the right end of the SET DEVICE BODY (a41TC1T) lines up with the ZERO line on the scale of the SET DEVICE GRADUATED COLLAR (a41TC4), the left end of the TYPE BODY PIECE (44TC1) is flush with the VERTICAL MOLD BLADE (47TC1) and the set-size will be negative or no opening will exist in the MOLD.

One full turn of the KNURLED KNOB (a41TC6) of the MEASURING SCREW (a41TC2) in clock-wise direction will move the SET DEVICE STOP (a41TC8) 3 points; to move the STOP 36 points as shown in Plate 7, the KNURLED KNOB would have to be moved 12 complete turns from ZERO and the GRADUATED COLLAR should stop on ZERO.

Point sizes and fractions of points in eighths can be obtained through reading of this graduated collar.

Lock the SET DEVICE STOP by locking to the SET DEVICE BODY with the SET DEVICE STOP CLAMP SCREW (41TC9).

Step Three—The TYPE BODY PIECE PLATE ADJUSTING SCREW holds the TYPE BODY PIECE PLATE (45TC1) firmly against the SET DEVICE STOP (a41TC8) as

makes it possible to run it faster on large sizes of type than any other MACHINE of its kind.

Type will have a "Frosty" face if cooled too quickly. It is, therefore, absolutely necessary that the water supply to the MOLD is not too great. When the water flowing out of the MOLD is lukewarm to the touch the proper amount is being supplied.

The 72 Point Body Gauge

To gauge the body size of the type you are casting place a sufficient number of pieces of type, with nicks on the side, in the 72 point GAUGE (x21TC), so as to fill it snugly. For example, if casting 6 point type it will require 12 pieces of type to fill the GAUGE; if casting 12 point type it will require 6 pieces of type to fill the GAUGE; if casting 24 point type it will require 3 pieces of type to fill the GAUGE. This type when placed in the GAUGE must fit snugly, not too tight or too loose.

If the type is too large the fault undoubtedly is due to some foreign substance having become lodged between the TYPE BODY PIECE and the MOLD TOP BLOCK (c42TC46T), or between the TYPE BODY PIECE and the MOLD BOTTOM BLOCK (d42TC16T). Remove TYPE BODY PIECE and wipe thoroughly clean of any dirt or metal; then wipe the MOLD TOP BLOCK (c42TC46T) and the MOLD BOTTOM BLOCK (d42TC16T) free from all dirt and metal. After the TYPE BODY PIECE and the MOLD TOP and BOTTOM BLOCKS have been wiped clean insert TYPE BODY PIECE in MOLD and clamp MOLD TOP BLOCK in position sufficiently tight so that the TYPE BODY PIECE moves freely. If all parts are clean the type will be perfect in size.

When the type fits loosely in the 72 point GAUGE (X21TC) it is undoubtedly due to the MOLD having become chilled by too great a flow of water. In this case reduce the flow of water slightly. After operating the MACHINE a few minutes the type will assume the proper body size.

Aligning Gauge

The ALIGNING GAUGE (Xa23L) is to be used for accurately reading the alignment of type. Place the type you wish to test for alignment on the GAUGE, with the nick up, alongside the LINING STANDARD (21L1), for the same size body as the type. Hold the ALIGNING GAUGE, (Xa23L), with the left hand, and with the thumb press both the type and the LINING STANDARD against the movable blade.

With the fingers of the right hand turn the SCREW until the sharp edge of the BLADE is in line with the edge of the face of the type and the edge of the LINING STANDARD (21L1). The ALIGNING GAUGE (Xa23L) must be held so the light will fall directly on the edge of the BLADE, or it cannot be read accurately.

If the line of the type you are casting does not accurately agree with the LINING STANDARD (21L1) correct the alignment as explained in the following procedure.

Making the Alignment When the Face to Be Cast Is on Standard Line

Put the capital "H" MATRIX of the face and body you are about to cast into the MATRIX CARRIER and place the CARRIER into position on the MACHINE. Do not connect it to the MATRIX CARRIER LEVER, as it is desirable to move it toward and from the MOLD by hand so that you may see whether the aligning position of the MATRIX is approximately correct. The lower end of the face when the MATRIX is in position on the MACHINE should be about even with the upper surface of the MOLD BOTTOM BLOCK SHOE, which forms the lower side of the MOLD CAVITY. If necessary, turn the GRADUATED KNOB on top of MATRIX CARRIER (Xa26TC) to bring the bottom edge of the MATRIX FACE on a line with the bottom side of the MOLD CAVITY. Now connect the MATRIX CARRIER to the LEVER and cast one or two pieces of type by turning the MACHINE over by hand. Place the type on the ALIGNING GAUGE with the

burned out, soft if tin and antimony are both reduced. It is generally possible to arrange with a metal supply company to renew metal at a small cost per pound.

For detailed information regarding type metal see article under caption "Practical and Metallurgical Points Regarding Care and Handling of Metal."

The Micrometer Set Adjusting Device and the Type Body Piece Plate Adjusting Screw

The set size of type can be easily made and held accurate by a thorough understanding of the above mentioned devices. The matrices of the chosen font should be sorted according to their set size, and type cast starting with the smaller set matrices and working up to the largest set-size as the SET ADJUSTING DEVICE is mechanically adapted to this procedure. Both devices are illustrated with their proper symbols on Plate No. 7 and further reference is based on these illustrations.

The movement of the TYPE BODY PIECE (44TC1) to the right or set-size position is controlled by the position of the SET ADJUSTING DEVICE STOP (a41TC8) which acts as a stop for the TYPE BODY PIECE PLATE (45TC1). The TYPE BODY PIECE PLATE ADJUSTING SCREW (a46TC1) located in the top end of the MOLD BODY LEVER (a48TC1T)—serves to hold the TYPE BODY PIECE PLATE (45TC1) against the SET ADJUSTING DEVICE STOP (a41TC8) as type is cast. Three simple but important procedures are necessary to properly adjust both devices to take care of any set-size.

Caution—The MACHINE must be in casting position while making the following adjustments. Casting position can be determined by position of the HAND WHEEL HANDLE (10TC14). When this handle is at its lowest position all MACHINE parts including the MOLD are ready to receive the cast of metal; any deviation from the proper location of the HAND WHEEL HANDLE will result in serious damage to the MACHINE.

When casting type with kerns or overhangs, the top or bottom TRIMMING KNIVES must be removed to permit the overhangs to pass.

Temperature of Metal

A suitable THERMOMETER, such as is furnished with the MONOTYPE-THOMPSON TYPECASTER, is essential. The temperature at which the metal is to be run depends on the grade of metal used. If old type-foundry metal is used the temperature should be about 735 degrees Fahrenheit; good type metal purchased from a first class metal maker should also be run at about the same temperature. If softer grade of metal is used the temperature should be lower. Linotype metal should be run about 650 degrees when casting thin set-size characters. The temperature may be reduced when casting large type.

A good rule is to run the metal at the lowest temperature possible to get good sharp faces and solid bodies. The operator must be careful not to overheat the metal, as that burns out the tin, separates the antimony from other metals of which good type metal is composed and therefore, destroys its flowing and wearing qualities. It is of the first importance, and an essential to successful results, to use the metal at the proper temperature and not to damage it by over heating. A product or uneven type at once indicates improper handling of metal or a poor or unsuitable quality of metal.

Cleaning Metal

The metal in the MELTING POT of the CASTER should be cleaned once every day or two. Place the required amount of MONOTYPE METAL CLEANER into the molten metal and stir thoroughly (this will wash all the metal out of the dross), then skim off the dross. This treatment improves the metal.

After metal has been cast into type, several times it is apt to become brittle or soft; brittle if the tin is

LINING STANDARD to test it for alignment. If the line is high or low, bring the MATRIX up or down by turning the GRADUATED KNOB on the CARRIER to bring the MATRIX in proper position. When the alignment is correct, tighten the SLOTTED NUT in the center of the GRADUATED KNOB to prevent it from turning and consequently changing the alignment.

When the Face to Be Cast Is Not on Standard Line and No Type Available

Align the top of the capital "T" as high on the body as it will go without being trimmed. Then align the capital "H" with the bottom of the "T". Now cast the lower-case "m" in alignment with the bottom of the capital "H". Then lower-case "o" to align with "m". As the round letters are always larger than the others allow the bottom of the "o" to extend a little below the "m" and then turn both letters over on the ALIGNING GAUGE, you should find that the "o" is a trifle higher than the top of the "m". Now align all round-bottom characters with the "o" and all square-bottom characters with the "m". Cast the lowercase "x" to align with the bottom of the "m" and align the lower-case "v", "w", and "y" with the top of the "x". Align such characters as "g", "p", and "q" with the top of the "o". Proceed with the capitals the same way, using the capital "H" and "O" as guides.

Once you have cast a face that is not on standard line save a few type of the capital "H" and lower-case "m" for standards with which to align that face and size in the future. These standard type may be saved for future use by putting them in a small envelope, properly labeled.

Accurate alignment cannot be made from old worn type because the sharp edges of the face have become rounded.

Holder for Foundry Style Matrices

To insert a MATRIX in the HOLDER, loosen the CLAMPING SCREW (a33TC10), place the MATRIX between the jaws of the HOLDER and tighten the CLAMPING SCREW (a33TC10). This brings the TOP JAW (33TC14) down to the end of the MATRIX and the CLAMPING PLATE (33TC7) against the back of the MATRIX at the same time, thereby locking the MATRIX firmly in the HOLDER. Use the fingers only to tighten the CLAMPING SCREW; to use pliers may result in damage to the HOLDER.

To adjust the TYPE BODY PIECE for set-size of the character, when using Foundry Style MATRICES make the setwise adjustment as explained under the caption "THE MICROMETER SET ADJUSTING DEVICE. TYPE BODY PIECE PLATE ADJUSTING SCREW."

Special Matrix Carrier With Adjustable Side Wall

The special ADJUSTABLE MATRIX CARRIER, is necessary to cast type from foundry style MATRICES, as it enables the operator to cast the character in any desired position on the type body.

To change the position of the character on the type body, first place the foundry style MATRIX in the HOLDER and tighten the CLAMPING SCREW (a33TC10) slightly so that the MATRIX can be shifted sideways if necessary. Then release the small CLAMPING SCREW that passes through the left side wall of the MATRIX CARRIER into the ADJUSTING WEDGE (a27TC10). Next turn the WEDGE ADJUSTING SCREW (a27TC11) in the necessary direction to move the ADJUSTING WEDGE (a27TC10) to the right, or to the left, in order to bring the MATRIX in the desired position in front of the MOLD so that the character will be cast in the desired sidewise position on the type body. Tighten the small CLAMPING SCREW to hold the ADJUSTING WEDGE firmly against the MATRIX CARRIER SIDE WALL; loosen the MATRIX

SCREWS drives the right hand MATRIX CARRIER SLIDE firmly against the MATRIX CARRIER and holds it rigidly in position while casting quads or spaces. CAUTION — At this point check the left side of MATRIX TOE to make certain that the TOE is slightly inside the left hand surface of the MOLD and clears the VERTICAL MOLD BLADE on its upward stroke.

Now make the setwise adjustment as explained under the caption, "Making the Setwise Size of Type With the Micrometer Set Adjusting Device."

Once all adjustments are made it is not necessary to remove the MATRIX from the MOLD when changing from the thinnest space to the widest quad as all set-size changes are made with the MICROMETER SET ADJUSTING DEVICE.

Quotation Quads

Quotation, or hollow quad mats are located in the same manner but the MATRIX CARRIER is hooked up to its lever by the CARRIER FORK and the QUOTATION QUADS cast the same as regular type.

Type Trimming Knives

There are two TYPE TRIMMING KNIVES, one is the upper TYPE TRIMMING KNIFE (80TC8), which is located in the Top TYPE RECEIVING SHOE (X80TC), the other is the lower TYPE TRIMMING KNIFE (79TC2) and is located in the bottom TYPE RECEIVING PLATE (a79TC1). These KNIVES trim the bodies at the face end of the type as they pass between their cutting edges.

As these TRIMMING KNIVES must be kept sharp they must be removed from the upper TYPE RECEIVING SHOE (X80TC) and the lower TYPE RECEIVING PLATE (a79TC1) whenever they are sharpened. They are easily adjusted by the SCREWS (a80TC9) that pass through slotted holes in the TRIMMING KNIVES and should be set so the end of the last tooth is even or level with the surfaces of both the TYPE RECEIVING SHOE (X80TC) and the TYPE RECEIVING PLATE (a79TC1).

At this point it is important to check the sliding fit of the MATRIX CARRIER and eliminate unnecessary play, as too much play will result in a false location of the STEEL QUAD MATRIX when the MATRIX CARRIER is locked in position.

Proceed by backing off the MOLD TOP BLOCK ADJUSTING SCREWS (a54TC13) in the MOLD STAND CAP and raising the MOLD TOP BLOCK (c42TC46T) sufficiently high to allow the MATRIX to be brought into the MOLD opening. Bring the MATRIX HOLDER down until the bottom of the MATRIX TOE rests on the top of the MOLD BOTTOM BLOCK (d42TC16T). When the MATRIX is in position, bring the MOLD TOP BLOCK (c42TC46T) down to bearing on the TYPE BODY PIECE (44TC1) and adjust the MOLD BLOCK ADJUSTING SCREWS.

Since the toe of the STEEL QUAD MATRIX is slightly smaller than the point size of the TYPE BODY PIECE (44TC1) this adjustment should in no way clamp the MATRIX in the MOLD. Check by carefully moving MATRIX CARRIER in and out to assure proper position up and down, of the STEEL QUAD MATRIX.

When the MATRIX is adjusted so its TOE will enter the MOLD CHAMBER freely, press the MATRIX CARRIER forward until the MATRIX is tight against the face of the MOLD; the TOE of the MATRIX then rests against the forward side of the SPACE and QUAD BODY. Lock the MATRIX CARRIER firmly in its casting position by first releasing the fillister head CLAMPING SCREW, which passes through the middle of the right hand forward extension of the front wall of the MOLD STAND (a54TC1) into the MATRIX CARRIER SLIDE (a54TC40); then tighten the long SLIDE ADJUSTING SCREW (a54TC41), the head of which is in the right hand end of the front wall of the MOLD STAND. Next tighten the short SLIDE ADJUSTING SCREWS (a54TC42) that pass through the forward end of the MOLD STAND forward extension; tightening these two SLIDE ADJUSTING

CARRIER CLAMPING SCREW (a33TC10), push the MATRIX firmly against the MATRIX CARRIER ADJUSTING WEDGE (a27TC10), and then tighten the MATRIX HOLDER CLAMPING SCREW (a33TC10) to hold the MATRIX firmly in position.

Place the MATRIX CARRIER in the MACHINE and adjust the MOLD BODY for the set-size desired, as described in a preceding paragraph under the caption, "THE MICROMETER SET ADJUSTING DEVICE. TYPE BODY PIECE PLATE ADJUSTING SCREW."

Cast one or two pieces of type and if the set-size is found to be correct, and the character in the desired position, proceed with casting. If the character is not in the desired position, on the body, remove the MATRIX CARRIER, move the MATRIX to the right, or to the left, in the HOLDER, to bring the character into the desired position making the necessary adjustments as explained in the second paragraph under this caption.

To Replace Foundry Style Matrix Holder With the New Style "B" Matrix Holder

The Style "B" MATRIX HOLDER, is for both wide and narrow MONOTYPE-THOMPSON MATRICES. It must be used on MACHINES with the MICROMETER SET ADJUSTING DEVICE; it cannot be used on MACHINES where the SET ADJUSTING BLOCKS and the SET ADJUSTING LINER (42TC33) are still in use.

Remove the Foundry Style MATRIX HOLDER, by first releasing the NUT in the top center of the GRADUATED KNOB on top of the MATRIX CARRIER; turn this GRADUATED KNOB to the left until the MATRIX HOLDER is disengaged from the ADJUSTING SCREW. This will allow the HOLDER to be withdrawn from the MATRIX CARRIER.

Place the Style "B" MATRIX HOLDER in the CARRIER and screw it into position by turning the GRADUATED KNOB to the right until the HOLDER is drawn

well up into the CARRIER. Then release the small CLAMPING SCREW that passes through the left side wall of the MATRIX CARRIER into the ADJUSTING WEDGE; next turn the ADJUSTING WEDGE SCREW to the left in order to bring the ADJUSTING WEDGE downward until its inner edge rests snug against the side of the Style "B" MATRIX HOLDER. Tighten the small CLAMPING SCREW to hold the ADJUSTING WEDGE firmly against the MATRIX CARRIER SIDE WALL; this brings the RIB, which projects beyond the forward end of the ADJUSTING WEDGE just eight points from the Style "B" MATRIX HOLDER and acts as a side guide for both wide and narrow MONOTYPE MATRICES.

To Replace Style "B" Matrix Holder With Holder for Space and Quad Matrices

Remove the Foundry Style MATRIX HOLDER by first releasing the NUT in the top center of the GRADUATED KNOB on top of the MATRIX CARRIER; next turn this GRADUATED KNOB to the left until the MATRIX HOLDER is disengaged from the ADJUSTING SCREW. This will allow the HOLDER to be easily removed from the MATRIX CARRIER.

Place the MATRIX CARRIER ADJUSTING BLOCK (a31-TC1T), in the CARRIER and screw it into position by turning the GRADUATED KNOB to your right. Insert QUAD MATRIX in position and place MATRIX HOLDER firmly against MATRIX to keep it in place.

Make the necessary adjustments for casting spaces and quads as explained under the caption, "QUAD AND SPACE MATRICES."

Casting Spaces and Quads

The equipment for casting spaces and quads consists of low space and quad bodies and a special SPACER to be used in the TYPE MOLD, also steel SPACE and QUAD MATRICES. To use this equipment proceed as follows:

Remove the MOLD, as explained under the caption, "To Remove the Type Mold." Then take out the two small fillister head screws that pass through the MOLD FRONT WALL; this releases the SPACER which can now be withdrawn from the MOLD. Replace this with the SPACER for space and quad bodies by sliding it into the place against the MOLD FRONT WALL from which you have just removed the TYPE BODY SPACER. Fasten it firmly in position with the two fillister head screws.

The SPACER for space and quad bodies is thicker than the one for type bodies and makes up the difference in height between the space and the type bodies, so the SPACE BODY and JET EJECTOR will fit correctly between the MOLD BACK WALL and the SPACER against the MOLD FRONT WALL.

Now slide the TYPE BODY PIECE PLATE (45TC1) into the MOLD, put the JET EJECTOR and the space and quad body, of the desired size, into the MOLD and move them back and forth to make certain that they are not too tight. If they bind it indicates that there is dirt between some of the parts you have just assembled; all dirt must then be removed before the MOLD is placed into the MOLD STAND.

Replace the MOLD on the MACHINE as instructed under the caption, "To replace the Mold."

Only one steel MATRIX is required to cast all set-sizes of spaces and quads for any one body. Select the SPACE and STEEL QUAD MATRIX for the size body you have in the MOLD, place it in the style "B" MATRIX HOLDER, press it firmly against the MATRIX CARRIER SIDE WALL and tighten the knurled head CLAMPING SCREW to hold it firmly in place.

Take the MATRIX CARRIER FORK (30TC3T) out of the MATRIX CARRIER CAM LEVER EXTENSION (30TC2T), as it must not be left on the MACHINE while casting spaces and quads.

is not tighter between the SLIDES at one end than the other, then tighten the MATRIX CARRIER SLIDE CLAMPING SCREW (a54TC43), thus pulling the SLIDE (a54TC40) firmly against the ends of the ADJUSTING SCREWS (a54TC42 and a54TC41) and locking it.

Adjusting Choker Cam and Choker Cam Roller

The CHOKER CAM (2TC2) should be so adjusted that it will bring the CHOKER VALVE (a7TC1T) against its seat in the CHOKER VALVE BUSHING (a37TC2) at the same instant that the PISTON (a68TC1T) is ready to drop.

To make the above adjustment proceed as follows:

Unlock the MELTING POT, swing it back, away from the MOLD, release the tension of the PISTON SPRING so that it will give only a slight pull in the PUMP CAM LEVER; then pull forward the PUMP STOP so that the roller on the PUMP CAM will drop into the recessed portion of the CAM when the CAM SHAFT is rotating in the clock-wise or casting direction.

Now turn the CAM SHAFT very slowly by hand until the PUMP CAM LEVER ROLLER drops into the recessed part of the PUMP CAM. Then pull the HAND WHEEL backward, toward you, so that the end of the PUMP CAM LEVER butts against the recessed portion of the CAM. In other words, pull the HAND WHEEL backward until the CAM is brought to an abrupt stop by the LEVER. The MACHINE is then in position for making the CHOKER CAM ADJUSTMENT.

Loosen the hexagon head cap SCREW which passes through the slot in the CHOKER CAM (2TC2) and move the CAM either forward or backward until the CHOKER CAM LEVER ROLLER is in contact with the top of the CAM at the end nearest the operator. Fasten the hexagon head cap SCREW firmly.

Once this adjustment is properly made you need never change it, whether casting 48 point, 6 point, or any other size type.

The entire MOLD should be wiped absolutely clean and must be thoroughly oiled and free from accumulation of dirt or metal. All BODY PIECES and JET EJECTORS, before every insertion into the MOLD, should be carefully wiped with a clean rag.

There are three sizes of JET EJECTORS, the smallest, No. 1, designed to use when casting type from 5 to 14 point inclusive, the medium, or No. 2, when casting type from 18 to 30 point inclusive, and the No. 3 is used from 36 to 48 point inclusive.

To Change Jet Ejectors

Release the PUMP STOP (Xb77TC) under the PUMP CAM LEVER (a76TC1T) by moving the finger grip to the left and turning the MACHINE by hand. This will automatically lock out the PUMP. Unlock MELTING POT YOKE (X38TC) by turning MELTING POT YOKE LOCK HANDLE (39TC2) and swing MELTING POT away from MOLD. Remove MATRIX CARRIER (Xa26TC) and the NOZZLE PLATE (X63TC) and TOP TYPE RECEIVING SHOE (X80TC). Loosen the knurled head MOLD STAND CAP ADJUSTING SCREWS (a54TC15 and a54TC16), which pass through the MOLD STAND CAP at both ends of JET BLOCK, until ends are even with the underside of the MOLD STAND CAP (b54TC3T). Insert the large end of the PIN WRENCH (49L1) in the hole in the JET BLOCK ADJUSTING ECCENTRIC (54TC8) and turn to the right until the JET BLOCK touches the MOLD STAND CAP (b54TC3T). This lifts the JET BLOCK ASSEMBLY so that the JET EJECTOR may be removed. To remove JET EJECTOR turn HAND WHEEL (10TC13T) until JET EJECTOR is at extreme right hand position, then raise JET EJECTOR by inserting sharp end of BODY LIFTING TOOL (48L1) in groove on underside of right hand end of JET EJECTOR, raising it by a slight downward pressure on the end of MOLD BODY LIFTING TOOL. Then push the JET EJECTOR forward to the left, take hold of JET EJECTOR with fingers and remove. To insert an-

other JET EJECTOR reverse above operation. Never change BODY PIECES unless a JET EJECTOR is in place. CAUTION: If JET EJECTOR or BODY PIECE is clamped too tightly the parts will slide with difficulty and the BODY PIECE or JET EJECTOR may become scored. If clamped too loose metal will collect between the EJECTOR and the upper and lower JET BLOCKS and the type cast will be large in body and have a burr. Further care must be exercised in adjusting SCREW (a54TC15) as too much pressure will strain and tip the JET BLOCK resulting in burrs on the JETS cast. Just bring this SCREW to bearing point after setting SCREW (a54TC16). Make the adjustment so there is just enough pressure to insure the casting of smooth type and jets. The pressure of the KNURLED SCREWS (a54TC15 and a54TC16) must be slackened as soon as a few casts have been made and the MOLD is hot to prevent the JET EJECTOR from becoming scored.

To Change Mold Body Pieces

Be sure the MELTING POT is swung away from MOLD and the MATRIX CARRIER, the NOZZLE PLATE and TOP TYPE RECEIVING SHOE have been removed as in the case of changing JET EJECTORS. Then loosen knurled head MOLD STAND CAP ADJUSTING SCREWS (a54TC12 and a54TC13) that pass through the MOLD STAND CAP at both ends of the MOLD TOP BLOCK (c42TC46T) until ends are even with the underside of MOLD STAND CAP (b54TC3T). Insert large end of the PIN WRENCH (49L1) in the hole in MOLD TOP BLOCK ADJUSTING ECCENTRIC (54TC4) and turn it to the right until the MOLD TOP BLOCK (c42TC46T) is brought up against the MOLD STAND CAP (b54TC3T). Now insert the sharp end of the BODY LIFTING TOOL (48L1) in groove on underside of right hand end of the TYPE BODY PIECE (44TC1), raising it by a slight downward pressure on the end of the MOLD BODY LIFTING TOOL. Then push the TYPE BODY PIECE forward toward the left, take

To increase the tension on the PISTON SPRING (72-TC1) turn the crank on the PISTON SPRING TENSION PULLEY RATCHET (74TC6), located outside the rear BASE about six inches above the floor, in a clock-wise direction. To decrease the tension turn it in a counter clock-wise direction. In order to turn the PISTON SPRING TENSION PULLEY RATCHET (74TC6) in a counter clock-wise direction, first release it by raising the lever end of the PISTON SPRING TENSION PULLEY PAWL (75TC1) high enough to clear the top of the RATCHET TEETH, this must not be done, however, unless you are holding onto the HANDLE of the PISTON TENSION RATCHET (74TC6). After the tension is correct the lever end of TENSION PULLEY RATCHET PAWL (75TC1) must be lowered to again engage the TEETH of the PISTON TENSION RATCHET. The proper spring tension is easily arrived at after a little experience.

Matrix Carrier Slide Adjustments

If the MATRIX CARRIER (Xa26TC) is not snug between the MATRIX CARRIER SLIDES (a54TC44 and a54TC40) in the MOLD STAND (a54TC1 and b54TC2T) it will affect the alignment of the type. When necessary to adjust this proceed as follows:

Loosen the FILLISTER HEAD CLAMPING SCREW (a54TC43), which passes through the right hand forward extension of the front wall of the MOLD STAND (b54TC2T) into the MATRIX CARRIER SLIDE (a54TC40) midway between the short SLIDE ADJUSTING SCREW (a54TC42) and the long SLIDE ADJUSTING SCREW (a54TC41). Then turn the short SLIDE ADJUSTING SCREW (a54TC42) and the long SLIDE ADJUSTING SCREW (a54TC41) to the right; this drives the right hand MATRIX CARRIER SLIDE (a54TC40) toward the MATRIX CARRIER (Xa26TC). Turn these SCREWS just enough to allow the MATRIX CARRIER to slide forward and back on the SLIDES freely without binding, and without any side play. Be sure the MATRIX CARRIER

PIN (30TC15) and moving this PIN in or out. This SPRING pressure is adjusted at the factory to take care of 48 point type.

Should you experience trouble keeping the MATRIX or MOLD SEAT clean or should the pressure of metal entering the MOLD CHAMBER force a separation of the seal between the MOLD SEAT and MATRIX, additional pressure can be applied by moving the PIN clock-wise and locking the NUT. Experience alone will teach you as to the amount of spring pressure required.

The Pump Stop

The PUMP STOP (b77TC1) stops the action of both the CHOKER and the PISTON when it is in its rear or off position, thus stopping the flow of metal to the MOLD. It is located on the MAIN STAND (a23TC1) just under the left end of the CAM LEVER SHAFT (5TC1).

When it is in its rear position the fingered end holds the CHOKER VALVE LEVER ROCKER ARM LINK (8TC-6T) out from connection with the CHOKER CAM LEVER (a6TC1TT) and its stop pad rests under the PUMP CAM LEVER (a76TC1T) preventing LEVER from operating.

The PUMP STOP is actuated in its forward and rear movement by two springs. To put the stop in operation pull the GRIP HANDLE straight forward and lock it by a slight movement to the right. This will place the CHOKER and PUMP in operation. To move the STOP to the rear in order to shut off the pump, strike the grip lightly to the left and its spring will move the PUMP STOP to the rear, arresting the action of the CHOKER and PISTON. The PUMP STOP can be put in operation or shut off at any point in the cycle of the MACHINE.

Piston Spring Adjustment

It is obvious that in casting different sizes of type the tension on the PISTON SPRING (72TC1) must be varied. Larger sizes of type require more tension on the PISTON SPRING (72TC1) than smaller sizes.

hold of it with the fingers and remove it from the MOLD. Wipe new BODY PIECE and MOLD cavity carefully and insert the BODY PIECE from left hand end of the MOLD, pushing it back until it catches into the TYPE BODY PIECE PLATE (45TC1). Before seating the BODY PIECE, be sure that no dirt or metal remains in the MOLD to prevent the BODY PIECE engaging the TYPE BODY PIECE PLATE (45TC1). Turn the MOLD TOP BLOCK ADJUSTING ECCENTRIC (54TC4) until the MOLD TOP BLOCK (c42TC46T) is snugly seated on the new BODY PIECE, and then bring the MOLD STAND CAP ADJUSTING SCREWS (a54TC12 and a54TC13) to a light bearing on top of the MOLD TOP BLOCK (c42TC46T). Exercise the same care in adjusting SCREW (a54TC12) for the MOLD TOP BLOCK as too much pressure will result in type out of parallel point wise. Just bring this SCREW to bearing point after setting SCREW (a54TC13). Turn the MACHINE slowly backwards and forwards by hand to test the adjustment. It should be snug but must not bind. Do not make it too tight. The pressure must be slackened as soon as a few casts have been made. Never change a BODY PIECE unless the JET EJECTOR is in place.

Felt Oil Pads

To carry oil direct to the BODY PIECE and JET EJECTOR the MONOTYPE-THOMPSON MOLD is provided with three OIL PADS. One of these is located in the MOLD BOTTOM BLOCK, one in the MOLD TOP BLOCK and one in the UPPER JET BLOCK.

When through long and constant use these OIL PADS shrink so they are no longer in contact with the BODY and JET EJECTOR they will not properly lubricate the parts and the MOLD may become scored or cut.

To Change Foot Plow

When the JET EJECTOR (43TC1) is changed it is necessary to change the FOOT PLOW (16TC1). Three thick-

nesses of Foot Plows are furnished corresponding to the different thicknesses of Jet Ejectors. Be sure the Foot Plow Bracket (a16TC3) is perfectly clean so the Foot Plow will be in proper position for grooving the type. The Foot Plow (16TC1) should be adjusted to cut no deeper than just enough to remove the rough portion left on the foot end of the type where the jet was removed.

To Remove the Type Mold

First remove MATRIX CARRIER (Xa26TC), Nozzle Plate (X63TC) and TOP TYPE RECEIVING SHOE (X80TC). Then loosen the VERTICAL MOLD BLADE ADJUSTING SCREW, the head of which, is located on the MOLD STAND (a54TC1) to the left of the MATRIX CARRIER SLIDE (a54TC44). Now loosen the hexagon NUT on the knurled head UPPER ADJUSTING SCREW (53TC2) and the SCREW itself that passes through the top of VERTICAL MOLD BLADE CAM LEVER (a53TC1T), then raise the PUMP-CAM LEVER YOKE (a76TC10) and slide the VERTICAL MOLD BLADE LEVER (52TC1T) to the left as far as it will go. This draws the VERTICAL MOLD BLADE LIFTING BLOCK (52TC2) out of the recessed portion of the VERTICAL MOLD BLADE (47TC1). Now lift out the VERTICAL MOLD BLADE. (CAUTION: On the right hand end of the MOLD STAND (b54TC2T) immediately under the MOLD is the MOLD LOCATING SCREW (54TC34). This SCREW is NOT to be disturbed when the MOLD is removed from the MOLD STAND as it was adjusted previously to hold the MOLD in its correct position in relation to the MATRIX CARRIER). Next loosen the small screw that passes downward through the back right hand end of the TYPE BODY PIECE PLATE (45TC1) and withdraw the TYPE BODY PIECE PLATE CONNECTING PIN (45TC2). This dis-connects the TYPE BODY PIECE PLATE ADJUSTING SCREW (a46TC1).

Adjusting the Matrix Carrier Cam Lever

The proper seating of the MATRIX against the MOLD front face is controlled by the action of the MATRIX CARRIER CAM LEVER (30TC1T). Two adjustments are necessary to control the movement of the MATRIX CARRIER (Xa26TC).

First—To assure proper seating of the MATRIX on the MOLD front face as metal enters the MOLD CAVITY.

Procedure—Locate the MATRIX in MATRIX CARRIER HOLDER and the MATRIX CARRIER (Xa26TC) on MACHINE. Couple the MATRIX CARRIER to the MATRIX CARRIER CAM LEVER (30TC1T) by engaging the EXTENSION FORK (30TC3T). NOTE: Proper engaging of the EXTENSION FORK with the MATRIX CARRIER is determined by the movement of the EXTENSION FORK releasing PIN KNOB (30TC6) to the rear, as the inner end of the RELEASING PIN engages the annular groove in the bottom of the EXTENSION FORK.

Turn the MACHINE to casting position, HAND WHEEL HANDLE (10TC14) in lowest position, and adjust the MATRIX CARRIER SPRING BOLT (30TC12) located just below the releasing PIN KNOB. Loosen the NUT (30TC13) on the SPRING BOLT and move the SPRING BOLT in or out until 1/64" clearance or play exists between the WASHER (30TC14) and the NUT (30TC13) as the MATRIX seats against the MOLD face and is taken up as soon as the MATRIX CARRIER is moved away from the MOLD. Lock the NUT and re-check the clearance or play.

Second—To hold the MATRIX firmly against the MOLD front face, under sufficient spring pressure to withstand the pressure of metal entering the MOLD CHAMBER.

Procedure—With the MATRIX CARRIER coupled to the MATRIX CARRIER LEVER, turn the MACHINE to casting position. The spring pressure can be varied by loosening the SPRING PIN NUT (30TC17) on the SPRING

Repeat until the .004 clearance is maintained and the MACHINE shows no sign of drag, while turning over by hand.

Third—Position of the VERTICAL MOLD BLADE SUPPORTING PLUG (54TC27) adding additional support to the VERTICAL MOLD BLADE (47TC1) when in casting position enabling the VERTICAL MOLD BLADE to withstand the pressure of metal entering the MOLD opening. THIS ADJUSTMENT IS IMPORTANT to maintain a clean seal between the end of the MOLD and the face of the VERTICAL MOLD BLADE (47TC1).

Procedure—With the VERTICAL MOLD BLADE at its top stroke or casting position and held firmly against the MOLD by pressure of the VERTICAL MOLD BLADE SHOE ADJUSTING SCREW (a54TC23). Loosen the LOCK NUT (54TC28) on the VERTICAL MOLD BLADE SUPPORT PLUG SCREW (54TC28) located in the MOLD STAND at the point the MOLD BODY LEVERS (a48TC1T and a49TC1T) join.

Facing the MACHINE from the rear place the index finger of the right hand in contact with both the lower end of the VERTICAL MOLD BLADE (47TC1) and the MOLD STAND and move the VERTICAL MOLD BLADE SUPPORTING PLUG SCREW in or out with two fingers of the left hand until you sense a movement of the VERTICAL MOLD BLADE by the pressure of the SUPPORTING BRASS PLUG (a54TC23). At the point where movement of the VERTICAL MOLD BLADE is first sensed lock the SUPPORT PLUG SCREW NUT.

Should any metal collect between the face of the MOLD and the VERTICAL MOLD BLADE, the fault lies in improper adjustment of the important BRASS SUPPORT PLUG (a54TC23). Metal collecting at this point will cause severe scoring of BLADE and MOLD face and plugging of oil holes with metal.

Now loosen the knurled head MOLD STAND CAP ADJUSTING SCREWS (a54TC12 and a54TC13) and the MOLD JET BLOCK ADJUSTING SCREWS (a54TC15 and a54TC16), which pass through the MOLD STAND CAP, until the ends of these ADJUSTING SCREWS are even with the underside of MOLD STAND CAP. Insert large end of PIN WRENCH (49L1) in the hole in MOLD TOP BLOCK ADJUSTING ECCENTRIC (54TC4) and MOLD JET BLOCK ADJUSTING ECCENTRIC (54TC8) and turn each ADJUSTING ECCENTRIC to the right until the MOLD TOP BLOCK and the JET BLOCK are brought up against the MOLD STAND CAP. Now insert the sharp end of the BODY LIFTING TOOL (48L1) in the groove on underside of MOLD BODY (44TC1), raising it by a slight downward pressure on the outer end of the MOLD BODY LIFTING TOOL; push the MOLD BODY forward toward the left, take hold of it with the fingers and remove it from the MOLD. Now remove the JET EJECTOR in the same manner.

With the small screw driver remove the two JET BLOCK LIFTING STUD SCREWS (a42TC67) and two TOP BLOCK LIFTING STUD SCREWS (42TC48). Next take out the four MOLD STAND CAP SCREWS (54TC20) and remove the MOLD STAND CAP (b54TC3T) and JET BLOCK LIFTING STUD YOKES (a42TC40) from the machine.

The MOLD can now be lifted out of the MOLD STAND. Should the MOLD fit very tight in the MOLD STAND care must be exercised in removing it, using only a piece of brass rod or a hard wood stick for a lever to raise the MOLD out of its position. Place the MOLD on the bench and lift out the MOLD TOP BLOCK (c42TC46T) and the JET BLOCK. Be very careful not to damage any of the parts in doing this; use only a piece of brass rod or a hard wood stick for a lever to raise the parts out of the MOLD. Flush all the MOLD parts with benzine or gasoline and wipe them clean; also run a piece of wire into the hole that runs from the front of the MOLD BOTTOM BLOCK (d42TC16T) through it to the lower felt PAD to

be sure oil will flow freely through it to lubricate the side of the VERTICAL MOLD BLADE (47TC1) and the end of the MOLD where they come in contact one with the other.

After thoroughly cleaning all the MOLD parts wipe them with a piece of clean cloth dipped in fine lubricating oil and assemble the MOLD ready to put it on the MACHINE.

To Replace the Mold

Before replacing the MOLD, after cleaning, be sure that all surfaces of the MOLD, and that part of the MOLD STAND (a54TC1 and b54TC2T) into which the MOLD fits, is absolutely clean and free from metal or dirt. There is no allowance for dirt and a slight amount will throw the MOLD out of position. Take care, also, before replacing the MOLD that the MOLD-TOP BLOCK (c42T-C46T) and the JET BLOCK are not raised so high that they prevent the MOLD STAND CAP (b54TC3T) being screwed down firmly.

Place the MOLD into the MOLD STAND, press it down firmly and push it to the right until the lower right hand edge of the MOLD comes firmly against the inner side of the head of MOLD LOCATING SCREW (54TC34). Put the MOLD STAND CAP (b54TC3T) in position, place the four MOLD STAND CAP SCREWS (54TC20) in place and bring them down to a light bearing.

After wiping it with a clean cloth saturated with clean oil, insert the VERTICAL MOLD BLADE and press it down to its lowest position. Now release the MOLD STAND CAP SCREWS just a trifle and then tighten the VERTICAL MOLD BLADE ADJUSTING SCREW so as to press the VERTICAL MOLD BLADE firmly against the end of the MOLD, thereby forcing the MOLD snugly against the MOLD LOCATING SCREW at the right end of the MOLD STAND. Now again tighten the MOLD STAND CAP SCREWS (54TC20) down firmly.

BLADE LEVER (52TC1T) in position. Maintain the same position for the TYPE BODY PIECE as in the first adjustment, the TYPE BODY PIECE extending beyond the face of the MOLD by almost one-quarter of an inch and the VERTICAL MOLD BLADE down against its stop held lightly against the MOLD face by pressure of the ADJUSTING SCREW (a54TC23).

By hand move the UPPER ADJUSTING SCREW (53TC2) so that it will force the VERTICAL MOLD BLADE down against its STOP SCREW (85TC1) then by moving the LOWER ADJUSTING SCREW (53TC4) in, using the pin wrench, it will take up all the play between both levers at this position. Now lock both LOCK NUT (6TC7) and CLAMPING SCREW (a53TC5) and check clearance between top of VERTICAL MOLD BLADE (47TC1) and bottom of TYPE BODY PIECE (44TC1) with a .004 FEELER GAGE to see if the adjustment has been properly made.

At this point check the clearance after added pressure has been applied by VERTICAL MOLD BLADE ADJUSTING SCREW to simulate operating conditions.

Perfect adjustment can be made by proper manipulation of the UPPER and LOWER ADJUSTING SCREWS but care must be taken to make certain that there is no play at the point where both ADJUSTING SCREWS clamp the VERTICAL MOLD BLADE LEVER (52TC1T) and that the clearance of .004 is maintained. Since the VERTICAL MOLD BLADE is now adjusted the MACHINE can be turned over by hand to re-check. Should the MACHINE prove hard to turn over, the VERTICAL MOLD BLADE is being held too tightly against its STOP SCREW (85TC1) and should be relieved by backing off the UPPER SCREW slightly and tightening the LOWER SCREW to take up the play between both LEVERS. Should a check of the clearance show less than .004 the LOWER ADJUSTING SCREW should be backed off slightly and the upper SCREW moved in to take up the play between both LEVERS.

in. Now force the VERTICAL MOLD BLADE (47TC1) down against its stop by hand pressure and then turn the MACHINE slowly by hand until the TYPE BODY PIECE (44TC1) projects about one-quarter of an inch beyond the end of the MOLD. At this position check the clearance between the top of the VERTICAL MOLD BLADE (47TC1) and the bottom of the TYPE BODY PIECE (44TC1) by inserting a .004 FEELER GAGE. Raise the VERTICAL MOLD BLADE (47TC1) by moving the STOP SCREW (85TC1) counter-clockwise until the proper clearance .004 is effected. Tighten the STOP SCREW NUT (85TC2) and re-check for final clearance.

Note—Any variation from this .004 clearance will result in serious damage. Should the clearance be more than .004 the type will not carry over into the TYPE RECEIVING SHOE causing the MACHINE to jam possibly breaking the TYPE RECEIVING SHOE or MOLD BODY CAM LEVER. Should the clearance be less than .004 the TYPE BODY PIECE will strike against the VERTICAL MOLD BLADE, thus damaging both the VERTICAL MOLD BLADE and TYPE BODY PIECE and possibly breaking the MOLD BODY CAM LEVERS.

Second—Adjust the VERTICAL MOLD BLADE LEVER (52TC1T) to properly hold the VERTICAL MOLD BLADE (47TC1) down against its SCREW STOP (85TC1) while MACHINE is ejecting type from the MOLD into the TYPE RECEIVING SHOES.

Procedure—Back off the LOWER ADJUSTING SCREW (53TC4) by first loosening the CLAMPING SCREW (a53TC5) and turning the SCREW down, using the PIN WRENCH, then back off the UPPER ADJUSTING SCREW (53TC2) and its LOCK NUT (6TC7). These SCREWS are part of the VERTICAL MOLD BLADE CAM LEVER (a53TC1T) plate 12. Move the VERTICAL MOLD BLADE LEVER (52TC1T) over to the right allowing the VERTICAL MOLD BLADE LIFTING BLOCK (52TC2) to engage the VERTICAL MOLD BLADE (47TC1) then drop the YOKE (a76TC10) to hold the VERTICAL MOLD

Release the VERTICAL MOLD BLADE ADJUSTING SCREW just a trifle, push the VERTICAL MOLD BLADE LEVER (52TC1T) to the right until the VERTICAL MOLD BLADE LIFTING BLOCK (52TC2) is in the recessed portion of the VERTICAL MOLD BLADE; press the PUMP CAM LEVER YOKE (a76TC10) down into its locked position.

Now with the PIN WRENCH (49L1) tighten the UPPER ADJUSTING SCREW (53TC2) that passes through the top of VERTICAL MOLD BLADE CAM LEVER (a53TC1T) until it holds the VERTICAL MOLD BLADE LEVER (52TC1T) firmly in position; then turn the MACHINE by hand and adjust the pressure of the VERTICAL MOLD BLADE ADJUSTING SCREW so the VERTICAL MOLD BLADE, in its up and down motion, will be seated snugly against the end of the MOLD without too much pressure but tight enough to prevent metal from being forced between them.

To Check Mold Position

A study of Plate 2 shows an arrow indicating a riser point where the MOLD STAND (a54TC1 and b54TC2T) are joined together. This riser serves as an unvarying checking point to position the MOLD.

Procedure—When the MOLD is in place on the MACHINE, held against its MOLD LOCATING SCREW (54TC34) by pressure of the VERTICAL BLADE and held down lightly by the MOLD STAND CAP SCREWS (54TC20), the opening between the left side of the vertical and the riser should be .008 as measured by a FEELER GAUGE. To establish this position move the STOP SCREW (54TC34) in or out to re-position the MOLD. When re-checking make sure the vertical is held tightly against the left MOLD FACE by the VERTICAL BLADE ADJUSTING SCREW (a54TC23) and tighten the MOLD STAND CAP SCREWS (54TC20) to hold MOLD in place.

This adjustment applies to VERTICAL BLADES of stock size .498. Should the VERTICAL MOLD BLADE become scored or damaged and require regrinding, determine its present size with a micrometer and any amount in thousandths under the stock size .498 must be added to the standard FEELER size of .008.

Example— $.498 - .495 = .003$. This .003 added to standard size .008 = .011 size of FEELER GAUGE to use.

To Adjust the Type Receiving Shoe

When one size body is changed for another size the TOP TYPE RECEIVING SHOE (X80TC) must be adjusted so the size type to be cast will fit under it without being too tight or too loose.

First remove the TOP TYPE RECEIVING SHOE, (X80TC), then turn the HAND WHEEL over by hand until the end of the TYPE BODY PIECE (44TC1) is at the extreme end of its stroke outside of the left hand end of the MOLD. Now place a type, with its nick up, of the same size as the body in the MOLD, on top of the lower TYPE RECEIVING PLATE (a79TC1) and at its extreme left end; then put the TYPE RECEIVING SHOE (X80TC) back on the MOLD STAND (a54TC1), the right end of the RECEIVING SHOE (X80TC) will then rest on the projecting end of the BODY PIECE and the left end will rest on the type. Tighten the TYPE RECEIVING SHOE ADJUSTING SCREWS (80TC2) using the PIN WRENCH (49L1), to fasten the SCREWS (80TC2) firmly. If the TOP TYPE RECEIVING SHOE (X80TC) is not down in proper position the FOOT PLOW (16TC1) and the TYPE TRIMMING KNIVES (79TC2 and 80TC8) will not properly trim the type. The TYPE STRIPPER SPRING (80TC6) will also fail to strip the type from the body and hold it. If pressed down too tightly the end of the TYPE BODY PIECE (44TC1) may be damaged, or the TOP TYPE RECEIVING SHOE (X80TC), or the TYPE RECEIVING PLATE (a79TC1) may be cut by the end of the TYPE BODY PIECE. In casting the larger sizes of

type, from 14 point to 48 point, it is good practice to place a piece of tissue paper on top of the TYPE BODY PIECE (44TC1) when setting the TOP TYPE RECEIVING SHOE (X80TC) to prevent damage to those parts. This tissue paper passes through the RECEIVING SHOES with the type as they are cast.

Adjustment of Vertical Mold Blade

Strict adherence to the following procedure will result in the VERTICAL MOLD BLADE being held flat against the end of the MOLD, thus producing sharp type bodies, minus burrs or fins on the VERTICAL MOLD BLADE side of type.

Three equally important adjustments are necessary to properly control the movement of the VERTICAL MOLD BLADE:

First—To control the position of the VERTICAL MOLD BLADE (47TC1) on the completion of its downward stroke to insure clearance of four thousandths (.004") between the top of the VERTICAL MOLD BLADE (47TC1) and the bottom of the TYPE BODY PIECE (44TC1). This clearance can be checked by having the TYPE BODY PIECE (44TC1) project about one-quarter of an inch beyond the left face of the MOLD and checking the above-mentioned clearance with a .004 feeler gage, while holding the VERTICAL MOLD BLADE (47TC1) down tightly against its stop, the VERTICAL MOLD BLADE STOP SCREW (85TC1).

Procedure—Remove all dirt and oil from the end of the MOLD and the VERTICAL MOLD BLADE (47TC1), using a lint-free cloth. Loosen the LOCK NUT on the VERTICAL MOLD BLADE STOP SCREW (85TC1) located on the top of the MAIN STAND directly under the VERTICAL MOLD BLADE (47TC1) and turn this SCREW clockwise down into the MAIN STAND. Place VERTICAL MOLD BLADE (47TC1) into position and bring it to a light bearing against the end of the MOLD by moving the VERTICAL MOLD BLADE ADJUSTING SCREW (a54TC23)

found necessary only after the MACHINE has been in use for some time. Do not grind the VALVE unless it is absolutely necessary and then proceed in accordance with the directions given in this book under the heading, "**Grinding in Choker Valve and Assembling.**"

Hollow type will also be produced by the MACHINE if the temperature of the metal is too high. On the other hand, if the temperature of the metal is too low, the metal will not be sufficiently fluid to flow into and completely fill the MOLD with the result that the face will not be sharp and perfect. See "**Temperature of Metal.**"

Hollow type may be the result of incorrect location of the MELTING POT. If the MELTING POT is too far to the right or the left the opening in the NOZZLE PLATE (63TC1) may be obstructed by part of the JET EJECTOR (43TC1) or the VERTICAL MOLD BLADE (47TC1) to such an extent that it is impossible for sufficient metal to enter the MOLD. Correct method of making left and right MELTING POT adjustment is given under the caption "**Sidewise Adjustment of Melting Pot.**"

When the Type Explodes as the Mold Opens

Type explodes when ejected from the MOLD if it has not cooled sufficiently prior to the opening of the MOLD. This may be due to an insufficient supply of water circulated through the MOLD or may be the result of running the MACHINE too fast. A combination of the above may also be the seat of the trouble. If you are experiencing trouble of this kind read "**Casting Speeds.**"

The Cause of and Remedies for Squirts or Splashes

A MONOTYPE-THOMPSON TYPECASTER will never "s squirt" or "splash" unless the metal is too hot, through improper adjustment of its various parts, because of dirt or foreign matter being lodged between any of several parts an opening is left through which metal can escape.

To adjust the CHOKER CAM LEVER ROLLER (6TC2) to bring the CHOKER VALVE against the seat in the CHOKER VALVE BUSHING (37TC2), with just enough pressure to prevent leakage, proceed as follows: Put the MATRIX CARRIER in position, lock the POT in its casting position against the MOLD and have all adjustments made as when ready to cast type, and pull out the PUMP STOP. Now turn the MACHINE over by hand until the CHOKER CAM LEVER ROLLER (6TC1) is in contact with the CHOKER CAM (2TC2); then loosen the hexagon LOCKNUT (6TC7) on the CHOKER CAM LEVER ROLLER ADJUSTING SCREW (6TC6). Hook the CHOKER TRIPPING TOOL (46L1) over the CHOKER VALVE LEVER ROCKER ARM (a8TC5) right above the ROCKER ARM LINK (8TC6T), press down on the end of the CHOKER TRIPPING TOOL as far as it will go until the CHOKER VALVE (a7TC1T), is pressed against its seat in the CHOKER VALVE BUSHING just tight enough to prevent leakage of metal between the seat when the PISTON drops. Now, with a small screw driver, loosen the CHOKER CAM LEVER ROLLER ADJUSTING SCREW (6TC6), to make sure it is not too tight, and then tighten it until the CHOKER VALVE is pressed against its seat in the CHOKER VALVE BUSHING, just tight enough to prevent metal leakage and insure the casting of solid type, but without any unnecessary pressure or strain on the CHOKER VALVE or the CHOKER LEVER as that would break the CHOKER VALVE or the CHOKER VALVE LEVER (8TC1T).

Connecting and Adjusting Melting Pot

The metal in the MELTING POT (b37TC1TT), must be thoroughly melted before it is locked into casting position against the MOLD; if it is locked up while the surface metal or metal in the NOZZLE (62TC1) is not fully melted it will cause leakage at the NOZZLE HOLE. When lighting the BURNER under the POT to melt the metal the POT must be away from the MOLD. While it

is in this position, just before locking it against the MOLD, the CHOKER should be moved back and forth to make certain it does not stick in the NOZZLE (62TC1) or CHOKER VALVE BUSHING (37TC2). To move the CHOKER VALVE use the CHOKER TRIPPING TOOL (46L1). Hook it over the CHOKER ROCKER ARM (8TC5) at the point above the CHOKER ROCKER ARM LINK (8TC6T). Press down on the end of the CHOKER TRIPPING TOOL (46L1) until the metal flows freely from the hole in the NOZZLE (62TC1); move the end of the TRIPPING TOOL quickly up and down a few times to move the CHOKER VALVE back and forth. The JET BOX (22TC1) or the LADLE should be held in front of the NOZZLE to catch the molten metal as it flows out.

Wipe the NOZZLE (62TC1) and the NOZZLE PLATE (63TC1) absolutely clean; also see that no dirt or metal lies between the NOZZLE PLATE (63TC1) and the MOLD. Turn the POT YOKE LOCK HANDLE (39TC2) far enough so that the flat surface of the toe of the POT YOKE (38TC1) will pass under the flat side of the POT YOKE LOCK (39TC1T); then swing the MELTING POT around toward the MOLD, at the same time holding up the PISTON LEVER (a69TC1T) so that the opening in the lower end of the PISTON LEVER LINK (71TC1T) will engage the end of the PUMP CAM LEVER (a76TC1T). Now turn the POT YOKE HANDLE (39TC2) in the proper direction to lock the POT against the MOLD.

If the POT YOKE LOCK HANDLE (39TC2), does not turn freely examine the NOZZLE (62TC1) for escaping metal; also make certain that there is no dirt or metal on the toe of the POT YOKE (38TC1) where the POT YOKE LOCK (39TC1T) engages it, as this may prevent the MELTING POT from coming forward into locking position.

There is a rear POT ADJUSTING SCREW (38TC2) that passes through the PISTON LEVER SUPPORT (a38TC12) against the rear lug of the POT (b37TC1T). This should be tight enough to hold the POT against the

3. Increase the temperature of the metal in the POT from 25 to 30 degrees above normal casting temperature. Because the amount of heat that must be conducted from the metal by the MOLD, and the water circulating through it, is greater, the time required for the type metal to solidify will be greater.

4. Increase the PISTON SPRING pressure slightly. This will cause the metal to be forced into the MOLD more positively and with greater speed, and will therefore allow the MOLD to be filled before the metal has had too much time to cool. The pressure should not be increased excessively, especially for the smaller body sizes. Excessive SPRING pressure is as bad as too little pressure. A little experience will make it possible for the operator to correctly judge the proper amount of PISTON SPRING pressure to give the best results.

5. Carefully adjust the MELTING POT to the right or left so that there is a maximum opening of the NOZZLE to the MOLD. If the opening is too small metal will enter the MOLD too slowly with the result that it may start cooling before the MOLD CAVITY has been completely filled.

From the above, it will be seen that the casting of narrow spaces and type of small setwise dimensions is dependent generally upon heat and upon the time required for cooling of the metal as it enters the MOLD. It is well, therefore, to keep these matters well in mind while casting narrow set material. If any unusual difficulty is encountered it is often easily overcome by trying to imagine what is taking place in the MOLD and then locating the difficulty by logical reasoning.

When Type Is Hollow

Improper seating of the CHOKER VALVE on the CHOKER VALVE SEAT may be the cause of hollow type. Leakage at the CHOKER VALVE SEAT may be due to improper seating because of wear. In this case it will be necessary to regrind the VALVE to a seat. This will be

CLUTCH GEAR (b10TC1T) according to their respective markings for proper timing.

“C” — The procedure for removal of FRICTION WHEEL is exactly the same as in method “A” excepting this assembly is driven by a key fit into the shaft and GEAR as a driving medium to replace the DOWEL PIN.

In re-assembly make sure that the key in the shaft lines up with the key in the gear.

Troubles and Remedies

Causes and remedies for hollow spaces and type of small setwise dimensions are discussed here.

The cause of this type of trouble is usually a combination of two or more adjustments being improperly made. Thin spaces and characters are usually the most difficult to cast solid. This is because certain laws of physics that have only a slight effect when casting type of large setwise dimensions become prominent when casting thin type. The length of time required for the type to cool is directly proportional to the ratio between the volume of metal entering the MOLD and the area of inside walls of the MOLD. In the case of thin spaces and characters of small setwise dimensions, the area of the walls of the MOLD cavity is large while the volume of the metal required to fill the cavity is comparatively small. For this reason, the ratio is small and the time of cooling is very short. In order, therefore, to cast solid spaces and type of small setwise dimensions the metal must be injected into the MOLD as quickly as possible and the temperature of the MOLD must not be kept too low. In order to accomplish this the following should be done:

1. Increase the speed of the MACHINE. This results in the complete casting operation being done very quickly and does not allow much time for cooling.
2. Decrease water and oil supply. This allows the temperature of the MOLD to go up with the result that the incoming metal will not be cooled too quickly.

MOLD and prevent leakage of metal between the Nozzle (62TC1) and the Nozzle Plate (63TC1) while casting type. It is very important that this pressure is not excessive, as that would cause the VERTICAL MOLD BLADE (47TC1) or the JET EJECTOR (43TC1) to stick as they move along the face of the Nozzle Plate (63TC1). It is also very important that the MELTING Pot (b37TC1TT) sets square with the back of the MOLD to prevent squirts.

When the Pot (b37TC1TT) requires adjusting proceed as follows: First lock the Pot into casting position, being sure that the PUMP STOP (b77TC1) is in position under the PUMP CAM LEVER (a76TC1T) to prevent leakage of metal through the Nozzle while the adjustment is being made. Then loosen the hexagon head Pot Screws (37TC8) that pass through the side lugs of the Pot into the Pot Yoke (38TC1); also loosen the rear Pot Adjusting Screw (38TC2) by first loosening the hexagon Lock Nut thereon and then turning the Adjusting Screw (38TC2) to the left.

Now turn the Pot Adjusting Screw (38TC2) to the right enough only to move the Pot (b37TC1TT) forward until it presses against the MOLD without binding the Nozzle Plate (63TC1) too tightly between the Nozzle (62TC1) and the MOLD. Tighten the hexagon head Pot Screws (37TC8) down firmly to hold the Pot in position on the Pot Yoke (38TC1).

After the Pot pressure adjustment has been made, take hold of the wire Nozzle Plate Handle (63TC2) and move the Nozzle Plate (63TC1) with a rocking motion between the Nozzle (62TC1) and the MOLD while the Pot is locked in its casting position to ascertain whether the pressure of the Pot against the MOLD is correct.

Sidewise Adjustment of Metal Pot

When it is necessary to adjust the MELTING Pot, either to the right or to the left, in order to bring the

hole in the NOZZLE (62TC1) and the NOZZLE PLATE (63TC1) directly in front of the JET opening in the MOLD proceed as follows: First lock the POT into casting position, being sure that the PUMP STOP (b77TC1) is in position under the PUMP CAM LEVER (a76TC1T) to prevent leakage of metal through the NOZZLE (62TC1) while the adjustment is being made. Loosen the hexagon head POT SCREWS (37TC8), that hold the POT on the POT YOKE (38TC1); also loosen the rear POT ADJUSTING SCREW (38TC2), and the hexagon head CHOKER VALVE LEVER ADJUSTING SCREW (8TC3) which holds the CHOKER VALVE LEVER (8TC1T) in place.

Now move the POT to the right, or to the left, by first loosening the large head POT ADJUSTING SCREW (38TC4), on that side of the POT to which it is to be shifted and then tighten the POT ADJUSTING SCREW (38TC4) on the other side until the POT is moved over as far as required. Be sure to tighten all the SCREWS that hold the POT sidewise, forward, and down, and the CHOKER VALVE LEVER SCREW (8TC3) that holds the CHOKER VALVE LEVER in place before attempting to cast type.

Adjusting Forward Position of Melting Pot

It is usually necessary to readjust the forward position of the MELTING POT (b37TC1TT) after the NOZZLE (62TC1) has been replaced.

There is a rear POT ADJUSTING SCREW (38TC2) in the PISTON LEVER SUPPORT (a38TC12) that should be slacked off by loosening its LOCKNUT (38TC3) after the metal is hot, and the POT is swung against the MOLD and locked into casting position. The two hexagon head POT SCREWS (37TC8), which hold the POT down on the POT YOKE (38TC1), must be loosened just enough to allow moving the POT forward without permitting it to be raised up.

The rear POT ADJUSTING SCREW (38TC2) must then be brought against the POT until it presses the NOZZLE

Remove the CAM SHAFT by taking out the four bearing CAP SCREWS and lift the CAM SHAFT from the MACHINE.

Remove two OIL GUARDS and two OIL FEED PIPES that lead to the transmission and drive SHAFT GEARS.

Loosen the CLUTCH GEAR SHIFTER YOKE SCREWS (a10TC26) and remove the CLUTCH SHIFTER (10TC20) by pulling it out to the right.

Remove the HAND WHEEL (10TC13T) and take out the four SCREWS that fasten the CLUTCH GEAR YOKE (a10TC24) at the point where it enters the MACHINE base. Tapping lightly on the CLUTCH GEAR YOKE will loosen the YOKE so that it may be moved to the left and lifted from the MACHINE.

Disconnect the PISTON SPRING LEVER FULCRUM PIN (73TC3) and remove the PISTON SPRING LEVER (73TC1).

Remove both NUTS from the left end of the FRICTION WHEEL OPERATING SCREW (18TC22) and turn the ADJUSTING SCREW counter-clockwise to free the SCREW from the FRICTION WHEEL SHIFTER (18TC18).

To remove the FRICTION WHEEL assembly from the MACHINE loosen the FRICTION WHEEL SHAFT BEARING SET SCREWS (18TC7) on the left side of the MACHINE BASE and remove the STOP MOTION CRANK DISC (a84TC6) located on the right end of the FRICTION WHEEL SHAFT. At this point the FRICTION WHEEL ASSEMBLY is free to move to the left to release it from its bearings and lift it out of the MACHINE from the top as a complete unit.

Slip the FRICTION WHEEL off the SHAFT and remove the SHIFTER (18TC18) by loosening the three retaining RING SCREWS.

Replace worn ring, mount on a mandril and machine the fiber face on a lathe until the surface just cleans up.

To assemble follow a reverse procedure exercising care to mesh the CAM SHAFT GEAR (2TC5) with the

the TAPER PIN or it will not pass freely through the hole in the SPEED GEAR.

Next take out the FRICTION SHAFT BEARING SET SCREW (18TC7), which holds the FRICTION WHEEL SHAFT BEARING (18TC6) in the hole in the left hand side of the BASE (a1TC1T); loosen the SET SCREW (18TC9) in the FRICTION WHEEL SHAFT COLLAR (18TC9). Place a round piece of wood against the end of the FRICTION WHEEL SHAFT (18TC5T) on the HAND WHEEL side of the BASE and, with a heavy hammer, drive the SHAFT toward the other side; this drives out the BEARING (18TC6) with the SHAFT.

The SHAFT may now be pulled out from the left hand side of the BASE, care being taken to hold the GEARS, SHAFT COLLAR and FRICTION WHEEL from falling on the floor of the BASE and injuring them as the FRICTION WHEEL SHAFT (18TC5T) is pulled out of these.

After the SHAFT is out the FRICTION WHEEL will rest on the inside bottom of the BASE, with its SHAFT bearing held in the hole of the FRICTION WHEEL SHIFTER (18TC18). Now take out the three FRICTION WHEEL SHIFTER RETAINING RING SCREWS (18TC21) and lift off the FRICTION WHEEL SHIFTER RETAINING RING (18TC20). The FRICTION WHEEL (18TC1T) can now be taken out of the BASE, then placed on a MANDREL and the face of the FIBRE RING (18TC2) turned off true in a lathe.

"B"—This type of construction allows for the removal of the FRICTION WHEEL and shaft without disturbing the four inch driving gear from its position on the shaft.

Remove the METAL POT and METAL POT YOKE from the MACHINE as one unit.

Remove all LEVERS from the MACHINE.
Remove two BOLTS and two SCREWS that clamp the MACHINE BASE TOP to the MACHINE BASE BOTTOM and lift the MACHINE BASE TOP and the MOLD STAND from the MACHINE as one unit.

to a snug bearing against the NOZZLE PLATE and the MOLD. Do not force it forward. There should be only enough pressure to prevent metal leakage between the NOZZLE, NOZZLE PLATE and MOLD. Tighten the LOCK-NUT (38TC3) on rear POT ADJUSTING SCREW (38TC2) and tighten down the two hexagon head POT SCREWS (37TC8) on both sides of the POT.

Fitting Choker Valve Point to Nozzle Plate

After the metal is melted to its casting temperature compress the CHOKER ROD SPRING (9TC8) by turning the CHOKER SPRING ROD KNOB (a9TC6) to the left until the SPRING is tight enough to hold the CHOKER VALVE point seat firmly against the inside seat of the hole in NOZZLE (62TC1), with the CHOKER point protruding beyond the point of the NOZZLE. Hook the CHOKER TRIPPING TOOL (46L1) over the CHOKER VALVE LEVER ROCKER ARM (a8TC5) at the point above the CHOKER VALVE LEVER ROCKER ARM LINK (a8TC6T), moving the TRIPPING TOOL (46L1) up and down a few times. This moves the CHOKER VALVE backward and forward. At the same time hold the JET BOX (22TC1) or the LADLE under the NOZZLE to catch the molten metal.

With the left hand hold the NOZZLE PLATE (63TC1) in position against the NOZZLE (62TC1) and if the CHOKER VALVE POINT extends through the hole in the NOZZLE PLATE dress off the point with a very fine file until it comes even with the face of the NOZZLE PLATE (63TC1). It must not extend through or it will prevent the CHOKER VALVE point from closing when the POT is locked in casting position against the MOLD; neither must it be too short as that would allow metal to gather in the NOZZLE PLATE hole between the MOLD and the CHOKER VALVE POINT. This metal would chill while the type is ejected from the MOLD and prevent the casting of type with good faces and solid bodies.

Cleaning Choker Nozzle and Pump

Swing back the MELTING POT and remove the PISTON (a68TC1T) by loosening the square head PISTON LEVER SUPPORT SET SCREW (a38TC15) in the top of the PISTON LEVER (a69TC1T) and pull PISTON LEVER PIN (69TC3) outward and lift the PISTON out of the POT. If the PISTON sticks in the PUMP WELL swing the PISTON LINKS (68TC2) upward, push a piece of round rod through the holes in PISTON LINKS and turn the PISTON (a68TC1T) back and forth at the same time raising it up out of the well.

Drop a small lump of MONOTYPE METAL CLEANER in the POT and stir thoroughly until the dross is well separated from the metal; then skim off the dross.

Now place the INGOT MOLD under the NOZZLE (62TC1) and drain all the metal from the METAL POT by hooking the CHOKER TRIPPING TOOL (46L1) over the CHOKER VALVE LEVER ROCKER ARM (a8TC5) at the point above the CHOKER VALVE ROCKER ARM LEVER LINK (8TC6T), and press down on the end of the CHOKER TRIPPING TOOL until the metal flows freely out of the NOZZLE into the INGOT MOLD. The LADLE should be held before the NOZZLE to guide the molten metal into the INGOT MOLD.

Now take out the CHOKER VALVE LEVER ADJUSTING SCREW (8TC3) and remove the CHOKER VALVE LEVER (8TC1T).

Place the hexagon BOX WRENCH (No. 8238) on the NOZZLE (62TC1) and move it up and down until the NOZZLE is loose. If the NOZZLE sticks, loosen it by striking a sharp blow on the end of the BOX WRENCH (No. 8238). Clean all metal and oxides out of the inside of the NOZZLE.

Now take the CHOKER VALVE (a7TC1T) out of the POT and clean off all metal or oxides while it is still hot.

With a stick of wood, clean out the CHOKER VALVE BUSHING, making sure no dirt is left in the BUSHING or

(a18TC1T) must be taken out of the MACHINE and the FIBRE RING faced off true in a lathe.

Three methods of procedure, depending on the mechanical construction of the FRICTION WHEEL SHAFT, are necessary to remove the FRICTION WHEEL from the MACHINE for replacement of the FIBRE RING (18TC2).

MACHINES having a DOWEL PIN through the four inch drive gear to key the gear to the FRICTION WHEEL SHAFT (18TC5T), proceed as in instructions "A".

Machines prior to No. (10725) proceed as in instructions "B".

Machine No. (10726) and following inclusive, proceed as in instructions "C".

How to Remove the Friction Wheel

"A" — To remove the FRICTION WHEEL (18TC1) proceed as follows: First loosen the FRICTION PLATE SPRING ADJUSTING NUT (17TC10) on the FRICTION PLATE SHAFT BEARING (17TC4) until all pressure against the FRICTION PLATE SPRING (17TC8) is entirely removed. Then cut a piece of wood just a little longer than the distance between the face of the FRICTION PLATE (17TC1T) and the edge of the side door opening in the MACHINE BASE (a1TC1T), about four inches long will do. Force this piece of wood between the face of FRICTION PLATE and door opening to hold the FRICTION PLATE away from contact with the FRICTION WHEEL (a18TC1T).

Now turn the FRICTION WHEEL (a18TC1T) very slowly until, by looking through the lower front door opening of the BASE (a1TC1T), you can see the small end of the SHAFT GEAR DOWEL PIN (18TC13) which passes through the HUB of the 4-inch SPEED GEAR (18TC12) and the FRICTION WHEEL SHAFT (18TC5T). Then with a piece of brass rod, placed against the small end of the DOWEL PIN (18TC13), drive the PIN out of the SPEED GEAR by striking the other end of the brass rod with a hammer; be careful not to bruise the end of

(68TC2) and fastening it with the square head PISTON LEVER SUPPORT SET SCREW (a38TC15).

Friction Plate and Friction Wheel

The FRICTION WHEEL (a18TC1T), which has a FIBRE RING (18TC2), is mounted on the FRICTION WHEEL SHAFT (a18TC5T); its periphery bears against the face of the FRICTION PLATE (17TC1T) which is mounted on the end of the FRICTION PLATE SHAFT (17TC3).

The FRICTION PLATE (17TC1T) is held in contact with the FRICTION WHEEL (a18TC1T) by the FRICTION PLATE SPRING (17TC8).

If the FRICTION DRIVE slips it may be due to oil or grease on the FRICTION PLATE and the FRICTION WHEEL, or the pressure of the FRICTION PLATE against the FRICTION WHEEL may require adjusting.

With a clean cloth, saturated with gasoline or benzine, thoroughly clean off all grease from the FRICTION WHEEL (a18TC1T), the FIBRE FRICTION RING (18TC2) and the face of the FRICTION PLATE (17TC1T), then wipe perfectly dry with a clean cloth.

If, after cleaning, the FRICTION DRIVE still slips it may be necessary to tighten the tension on the FRICTION PLATE SPRING (17TC8) to increase the pressure of the FRICTION PLATE against the FRICTION WHEEL.

To tighten the tension on the FRICTION PLATE SPRING (17TC8) use the PIN WRENCH (49L1) and turn the threaded FRICTION PLATE SPRING ADJUSTING NUT (17TC10), which is on the FRICTION PLATE SHAFT BEARING (17TC4), to the right only a little at a time until the pressure of the FRICTION PLATE (17TC1T) against the FRICTION WHEEL (a18TC1T) is just enough to prevent slipping. The tension of this, as of all other parts, should be only sufficient to do the work.

Also carefully examine the periphery, or face, of the FIBRE FRICTION RING (18TC2) to see if there are any flat spots on it. If there are the FRICTION WHEEL

the NOZZLE hole in the POT, and immediately turn off the gas or electric current so the POT will cool.

Immediately after turning off the gas or electric current, and while the POT is still hot, clean out the PUMP WELL in the MELTING POT with a wooden stick and a rag.

If there is an accumulation of oxides in the NOZZLE or on the CHOKER VALVE it can be removed by heating them in the flame of a Bunsen Burner, or a Blow Torch, until they are a dull red (do not get them too hot), and then clean off the oxides.

Grinding in Choker and Assembling

Examine the CHOKER VALVE BUSHING SEAT and the seat on the CHOKER VALVE. If either is not perfectly smooth they must be ground in by putting a little oil and fine emery flour, or some fine grinding compound, on the CHOKER VALVE SEAT, inserting the CHOKER VALVE in the CHOKER VALVE BUSHING and turning the CHOKER VALVE back and forth while pressing it against the CHOKER VALVE BUSHING SEAT.

To turn the CHOKER VALVE (a7TC1T) back and forth while grinding in the seat hold the forward end of the CHOKER VALVE with the CHOKER VALVE SEAT GRINDING TOOL, being careful not to touch the point of the CHOKER VALVE (a7TC1T) where it fits into the NOZZLE hole, as bruising or damaging this point will cause metal to leak out of the NOZZLE (62TC1).

After grinding the CHOKER VALVE BUSHING SEAT, as well as the CHOKER VALVE SEAT, they must be wiped clean to be sure no emery or oil remains on them.

The point of the CHOKER VALVE (a7TC1T) should be ground into the NOZZLE (62TC1) with a little fine emery flour, or grinding compound, the same as was used for grinding in the CHOKER VALVE SEAT to the CHOKER VALVE BUSHING. To do this proceed as follows: Be sure the point of the CHOKER VALVE and the inside of the NOZZLE are perfectly clean and free from metal

or dress. Place the shank of the CHOKER VALVE (a7TC1T) in the small hole of the NOZZLE GRINDING TOOL; put a little fine valve grinding compound on the point of the CHOKER VALVE and place the NOZZLE SHANK into the tapered hole of the NOZZLE GRINDING TOOL. Holding the NOZZLE and GRINDING TOOL together with the left hand, take hold of the shank of the CHOKER VALVE, extending beyond the end of the NOZZLE GRINDING TOOL, with the right hand and turn the CHOKER VALVE back and forth until a clean smooth seat is ground at and around the small hole inside the NOZZLE and around the point of the CHOKER VALVE. Now clean off all grinding compound from both the CHOKER VALVE and NOZZLE.

If the PISTON (a68TC1T) was tight when it was taken out of the WELL it was most likely due to oxides adhering to the PISTON or the PUMP BORE WALL. In that case put some flux on the PISTON, place it in the WELL and work it up and down with a turning motion; do not use emery as that may grind the PISTON down too small. Then clean off flux thoroughly, both out of the BORE and from the PISTON.

Now place the CHOKER VALVE in its BUSHING in the POT, push it back as far as it will go so its point will be in the NOZZLE HOLE while the latter is being driven into the POT; be sure the shank of the NOZZLE and the NOZZLE HOLE in the POT are absolutely clean. Place the NOZZLE into the POT, turn it back and forth a few times to make sure it will seat itself correctly when driven in. Put the NOZZLE DRIVING TOOL (45L1) over the NOZZLE and, with a medium sized hammer, strike the end of the NOZZLE DRIVING TOOL until the NOZZLE is firmly seated in the POT. CAUTION:—We wish to caution you to exercise care at all times when driving the NOZZLE into the MELTING POT. If you will observe the following rule the hole in the POT into which the NOZZLE fits will not become enlarged, as it does in case too much force is used in driving the NOZZLE into position.

Be sure the NOZZLE HOLE in the MELTING POT is perfectly clean before the NOZZLE is put into place. Also be sure the POT is perfectly cold before the NOZZLE is placed in it. When driving the NOZZLE into position tap the driving tool slightly with the hammer, as it is held tightly by the taper of the hole in the POT and the shank of the NOZZLE that fits into it. A heavy blow will enlarge the NOZZLE hole in the POT and after a short time make the hole so large the NOZZLE will no longer fit tightly.

If the NOZZLE (62TC1) has been driven in straight its hole will be concentric with the point of the CHOKER VALVE and the CHOKER VALVE can be moved forward and backward without sticking in the NOZZLE HOLE. Test this by putting the CHOKER VALVE LEVER (8TC1T), or CHOKER VALVE LEVER ROCKER ARM (a8TC5), into place in the POT and move the CHOKER VALVE in and out by hand. If the point of the CHOKER VALVE sticks in the NOZZLE it indicates that the latter was not driven in perfectly straight. In that case ascertain which side of the CHOKER VALVE binds in the NOZZLE HOLE, then push CHOKER VALVE back out of the NOZZLE (62TC1) and with the NOZZLE DRIVING TOOL (45L1) against the NOZZLE, tap it lightly with a hammer on the side on which the CHOKER VALVE binds. Repeat this, if necessary, until the CHOKER VALVE can be moved freely by hand in and out of the NOZZLE.

Now replace the CHOKER VALVE LEVER (8TC1T), fasten it in position with the hexagon head CHOKER VALVE LEVER ADJUSTING SCREW (8TC3).

Fill the MELTING POT (b37TC1TT) with metal, light the gas, and heat up to proper temperature.

When the metal is melted put the PISTON (a68TC1T) into the molten metal, but not into the WELL. After the PISTON is as hot as the metal it may be placed in the WELL and connected by pushing the PISTON LEVER PIN (69TC3) through the holes in the PISTON LINKS

PLATE 1

Xa2/TC	Matrix Carrier Complete.
d42TC16T	Mold Bottom Block, Assembled.*
c42TC46T	Mold Top Block, Assembled.*
a54TC1	Mold Stand (R. H.)*
b54TC2T	Mold Stand (L. H.)*
38TC1	Pot Yoke.
a76TC10	Pump Cam Lever Yoke.
52TC1T	Vertical Mold Blade Lever.
a48TC1T	Mold Body Lever.
a49TC1T	Mold Body Cam Lever.
a61TC1TT	Choker Cam Lever.
a76TC1T	Pump Cam Lever.
a53TC1T	Vertical Mold Blade Cam Lever.
71TC1T	Piston Lever Link.
8TC6T	Choker Valve Lever Rocker Arm Link.
a9TC6	Choker Spring Rod Knob.
8TC1T	Choker Valve Lever.
a69TC1T	Piston Lever.
a38TC12	Piston Lever Support.
69TC3	Piston Lever Pin.
a68TC1T	Piston.
37TC4	Pot Jacket (Upper).
5TC1	Cam Lever Shaft.
22TC1	Jet Box.
a54TC23	Vertical Mold Blade Adjusting Screw.
50TC1	Mold Body Lever Shaft.
a54TC15	Jet Block Adjusting Screw (Small Head).
30TC3T	Matrix Carrier Extension Fork.
30TC6	Matrix Carrier Extension Fork Releasing Pin Knob.
a46TC4	Type Body Piece Plate Adj. Screw Lock Nut (inside).
a46TC1	Type Body Piece Plate Adjusting Screw.
a54TC12	Mold Top Block Adjusting Screw (Small Head).
80TC2	Type Receiving Shoe Adjusting Screw.
68TC2	Piston Links.
68TC3	Piston Link Pin.
a46TC3	Type Body Piece Plate Outside Lock Nut.
a46TC2	Type Body Piece Plate Adjusting Nut.
70TC1	Piston Lever Fulcrum Pin.
81TC2	Type Stick Plate.
a9TC1	Choker Spring Rod.
a9TC2	Choker Spring Rod Block.
a9TC9	Choker Spring Rod Abutment.
9TC4	Choker Spring Rod Collar.
8TC11	Choker Valve Lever Rocker Arm Trunions.
a8TC5	Choker Valve Lever Rocker Arm.
9TC8	Choker Rod Spring.
a51TC1	Mold Body Lever Cross Block.
54TC8	Jet Block Adjusting Eccentric.
54TC4	Mold Stand Adjusting Eccentric (Mold Top Block).
37TC10	Splash Guard.
b54TC3T	Mold Stand Cap.
30TC12	Matrix Carrier Spring Bolt.
30TC2T	Matrix Carrier Cam Lever Extension.
30TC1T	Matrix Carrier Cam Lever.
54TC37	Oil Cups (Short).
54TC34	Mold Locating Screw.
b41HH	Thermometer.
54TC36	Sight Feed Oiler Elbow.
54TC35	Sight Feed Oiler for Mold.
a76TC10	Pump Lever Yoke.
82TC1	Type Box Bracket.

*Must be fitted in our factory.

If the VERTICAL MOLD BLADE (47TC1) does not bear evenly against the end of the MOLD an opening may be left that will result in a squirt. When making this adjustment care should be taken to see that no dirt or foreign matter becomes lodged between the parts. It is clear that if anything should get between the parts they cannot be brought into contact with one another. The result is an opening. See "Adjusting Vertical Mold Blade" for method of making correct adjustment.

Dirt or any foreign matter on the front side of the MATRIX will prevent it from seating properly upon the MOLD. This may cause a "squirt."

Squirts on face of MOLD are caused by improper spring pressure. See instructions for adjusting MATRIX CARRIER LEVER.

If the JET BLOCK or the MOLD TOP BLOCK are not down on the JET EJECTOR or the BODY PIECE, either due to improper adjustment or due to dirt or foreign matter having lodged between them, there will be an opening through which metal will escape. For the proper method of adjusting these parts see "To change Jet Ejectors" and "To Change Type Body Pieces."

Dirt or foreign matter on the front side of the NOZZLE PLATE (63TC1) will prevent its seating properly against the MOLD. This will leave an opening through which metal may be forced. Dirt or foreign matter on the NOZZLE (62TC1) or in the part of the NOZZLE PLATE (63TC1) which receives the NOZZLE, will prevent a tight joint being made between these parts with the result that there may be a "squirt." If the MELTING POT is not tightly locked up, or if the adjustment of the MELTING POT is not proper, the NOZZLE PLATE (63TC1) will not completely fill up the space between the NOZZLE (62TC1) and the MOLD with the result that an opening will be left through which metal may be forced. For instructions as to making the proper MELTING POT adjustments, see "Fitting Choker Valve Point To

Nozzle Plate” and “Adjusting Forward Position of Melting Pot.”

The cause of a “squirt” is always quite easily located by looking for the place from which the metal escaped.

The Causes of Fins and the Remedies

A Fin on a piece of type is a miniature squirt. The causes and remedies are identical. Dirt lodged between parts of the MOLD or improper MOLD adjustments are always the cause. Whenever a Fin appears on any part of the type or on the JET it is positive evidence that there is an opening between parts of the MOLD. The seat of the trouble can always be located by observing on what part of the type or its Jet the Fin appears.

If a Fin appears on the left hand side of the type as it comes from the MACHINE it indicates that there is an opening between the VERTICAL MOLD BLADE (47TC1) and the MOLD. To remedy, clean the parts thoroughly and adjust according to the instructions under the caption “**Adjusting Vertical Mold Blade.**”

Horizontal Fins on either the top or bottom of the right hand side of the type as it comes from the MACHINE indicates that there is an opening between the TYPE BODY PIECE and either the MOLD TOP BLOCK or the lower part of the MOLD. The remedy is to remove the BODY PIECE and the JET EJECTOR, thoroughly clean them and the parts of the MOLD with which they come in contact and then replace the parts and adjust them in the manner described under the captions, “**To Change Jet Ejectors**” and “**To Change Type Body Pieces.**”

A Fin on the shoulder of the type indicates that there is an opening between the MATRIX and the MOLD. This may be due to dirt or metal being lodged on the face of the MATRIX or on the part of the MOLD with which the MATRIX comes in contact. It may also be due to improper adjustment of the MATRIX CARRIER LEVER

SPRING BOLT (30TC12). In this connection see "**Adjusting Matrix Carrier Lever.**"

A Fin at the base of the Jet indicates that there is an opening between the NOZZLE PLATE (63TC1) and the MOLD. This may be due to the MELTING POT being improperly locked up or to dirt or to improper POT adjustment. In this connection read, "**Adjusting Forward Position of Melting Pot.**"

When Type Is Too Wide Setwise

If type is oversize in the setwise dimensions the trouble is due to faulty adjustment of the VERTICAL MOLD BLADE (47TC1) or to dirt or metal having become lodged between the MOLD and the VERTICAL MOLD BLADE (47TC1). The remedy is to remove and thoroughly clean the VERTICAL MOLD BLADE, being sure to carefully clean all other parts with which the VERTICAL MOLD BLADE comes in contact. Then replace and adjust in accordance with the directions under "**Adjusting Vertical Mold Blade.**"

When Type Is Oversize in Body Dimension

Type that is oversize in the body dimension is the result of dirt being lodged between the TYPE BODY PIECE and the MOLD, or of the MOLD TOP BLOCK not being far enough down. It must be in actual close contact with the TYPE BODY PIECE. The best remedy for type oversize in body dimension is to remove the TYPE BODY PIECE, thoroughly clean it and the MOLD CAVITY, replace and carefully adjust in accordance with the directions given under "**To change Type Body Pieces.**"

When Type Is Too High To Paper

If the height of the type is oversize it is due to the MATRIX not seating properly against the MOLD. This may be due to dirt being lodged on the face of the MATRIX or on the MOLD. The best remedy is to thor-

oughly clean the parts. It may also be due to improper adjustment of the MATRIX CARRIER LEVER SPRING BOLT (30TC12). In this connection see "Adjusting Matrix Carrier."

What Causes Defective Type Faces?

One of the commonest type face defects is that known as a "frosty face." This is caused by sudden cooling of the metal as it enters the MOLD. The first few pieces of type cast on a cold MACHINE usually have frosty faces. This difficulty will disappear after the MOLD has had time to warm up unless too much water is circulating through the MOLD. If the water leaving the MOLD is warm to the touch it is properly adjusted. If it is cold, cut down the supply and the difficulty will disappear. If the MOLD is flooded with oil, imperfect faces will also result. There is a difference in the appearance of frosty faces and faces defective because of too much oil. Too much oil prevents the hot metal from flowing evenly over the surface of the MOLD CAVITY and the MATRIX. With a little experience it will be easy to recognize type made imperfect because of excessive oil. The remedy is to cut down the oil supply and run the MACHINE, casting type, until the oil is worked out of the MOLD. Care should be taken not to cut down the oil supply so far that the MOLD will not be sufficiently lubricated. To do so is liable to cause damage to the MOLD by cutting and scoring.

If the type is cast with too low a temperature of the metal it will be solid but will be imperfect in the face and body. One of the most noticeable characteristics of type cast with metal that is too cold is that the edges of the type body and type face will not be sharp. When metal is too cold it will not flow freely. The result is that it will not flow into all of the corners and crevices. As soon as metal that is low in temperature strikes the MATRIX or walls of the MOLD CAVITY it is suddenly cooled beyond the point where it will flow.

American System of Type Body Dimensions

The following table gives the equivalent of the various points in thousandths of an inch:

Points	Inch	Points	Inch	Points	Inch
1/4	.00346	9 1/2	.13148	21 1/2	.29756
1/2	.00692	10	.13840	22	.30448
1	.01384	10 1/2	.14532	22 1/2	.31140
1 1/4	.01730	11	.15224	23	.31832
1 1/2	.02076	11 1/2	.15916	23 1/2	.32524
2	.02768	12	.16608	24	.33216
2 1/4	.03114	12 1/2	.17300	25	.34000
2 1/2	.03460	13	.17992	26	.35084
3	.04152	13 1/2	.18684	27	.37368
3 1/4	.04498	14	.19376	28	.38752
3 1/2	.04844	14 1/2	.20068	29	.40136
4	.05536	15	.20760	30	.41520
4 1/4	.05882	15 1/2	.21452	31	.42904
4 1/2	.06228	16	.22144	32	.44288
5	.06920	16 1/2	.22836	33	.45672
5 1/4	.07266	17	.23528	34	.47056
5 1/2	.07612	17 1/2	.24220	35	.48440
6	.08304	18	.24912	36	.49824
6 1/2	.08996	18 1/2	.25604	38	.52592
7	.09688	19	.26296	40	.55360
7 1/2	.10380	19 1/2	.26988	42	.58128
8	.11072	20	.27680	44	.60896
8 1/2	.11764	20 1/2	.28372	46	.63664
9	.12456	21	.29064	48	.66432

The American Standard Height of type is .918"

"Didot" System of Type Body Dimensions

The following table gives the equivalent of the various Didot points in thousandths of an inch:

Didot Points	Inch	Didot Points	Inch	Didot Points	Inch
1	0.0148	7	0.1036	24	0.3553
2	0.0296	8	0.1184	28	0.4145
2 1/2	0.0370	9	0.1332	30	0.4441
3	0.0444	10	0.1480	32	0.4737
3 1/2	0.0518	11	0.1628	36	0.5329
4	0.0592	12	0.1776	40	0.5922
4 1/2	0.0666	14	0.2072	42	0.6218
5	0.0740	16	0.2369	44	0.6514
5 1/2	0.0814	18	0.2665	48	0.7106
6	0.0888	20	0.2961		
6 1/2	0.0962	22	0.3257		

"Didot" Height of type is .928"

Do not use the MONOTYPE METAL CLEANER until the metal has reached a temperature of 750 degrees.

Fill the cup on the CLEANING ROD with MONOTYPE METAL CLEANER. Light a large piece of paper and place it on top of the dross on top of the metal. Plunge the cup of METAL CLEANER on the rod to the bottom of the metal POT and use the cup and rod to agitate the metal, stirring around the bottom of the POT. As the METAL CLEANER melts, it passes through the holes in the cup and causes the metal to boil and cleans it. The gasses, coming to the top of the POT, are ignited by the burning paper, thus forming a blanket of gas that prevents oxidation and melts the tin and antimony in the dross and causes it to amalgamate with the baser metal in the POT. Continue stirring till the dross ceases to burn and all the METAL CLEANER is consumed.

With melting furnaces from which the type metal is ladled from the top, the dross should now be skimmed off and the metal poured into pigs or ingots as quickly as possible. Use a suitable size ladle and dip it to the bottom of the pot at each filling.

With automatic furnaces having a spout through which the metal is drawn from the bottom of the furnace, the metal should be well stirred, but to reduce oxidation the dross may be allowed to remain on the surface of the metal until nearly all of the type metal has been drawn from the POT. The dross should then be skimmed off to prevent its clogging the valve or gate when the last of the type metal is drawn out.

Note—The Cup on the Cleaning Rod holds two and one-half ounces of CLEANER, which is sufficient to thoroughly clean 1000 pounds of metal. Don't use more CLEANER than is necessary. For 500 pounds of metal fill the cup half full of CLEANER.

The result is that the body and face of the type will not have a smooth, plane surface but it will be uneven.

Type with uneven surfaces and rounded edges is often the result of worn out or poor metal. Tin in type metal makes it fluid. If the metal has been overheated, or has been used over a period of time, the proportion of tin becomes low through a process of oxidation. It may also become low due to skimming the metal from the top of the POT. The metal should always be separated from the oxides or dross by putting a little MONOTYPE METAL CLEANER into the POT and stirring well. Dross or oxides always appear as a black powder and not as thick, more or less unfluid metal. See **‘Practical and Metallurgical Points Regarding Care and Handling of Metal.’** The remedy is to replace the defective metal with new metal or to add the missing ingredient to the defective metal.

When Metal Leaks Out of Nozzle

Leaking of metal out of the NOZZLE is liable to happen during the time that the metal is being melted. It does not indicate, however, that anything is wrong. If the leak does not stop after the metal is melted and up to casting temperature, hook the CHOKER TRIPPING TOOL (46L1) over the CHOKER LEVER ROCKER ARM (8TC5) at a point above the CHOKER LEVER ROCKER ARM LINK (8TC6T); hold the JET BOX (22TC1) or the LADLE in front of the NOZZLE (62TC1) and pull downward on the end of the CHOKER TRIPPING TOOL. This will open the CHOKER VALVE and allow the metal to run from the NOZZLE (62TC1). Then suddenly release the pressure on the end of the CHOKER TRIPPING TOOL, thereby allowing the CHOKER VALVE to close suddenly. Application of naphtha soap to CHOKER VALVE POINT and NOZZLE has a tendency to disperse dross and stop dripping.

The foregoing operation will allow any chilled metal in the NOZZLE (62TC1) to escape. If the leak does not

stop it indicates that the CHOKER VALVE is not properly seating in the NOZZLE. This may be due to insufficient pressure on the CHOKER ROD SPRING (9TTC8). To increase the pressure on this SPRING turn the CHOKER SPRING ROD KNOB (a9TC6) in a counter-clockwise direction. Care should be taken not to tighten the CHOKER ROD SPRING (9TTC8) excessively. To do so will produce undue strain on the parts and may damage the forward seat in the NOZZLE (62TC1). About $\frac{3}{8}$ " compression of the CHOKER ROD SPRING (9TTC8) is usually sufficient.

It is also possible that the NOZZLE (62TC1) has not been driven in straight. To remedy, relieve all of the pressure on the CHOKER ROD SPRING (9TTC8) by turning the CHOKER SPRING ROD KNOB (a9TC6) in a clockwise direction and give the NOZZLE (62TC1) a light tap with the NOZZLE DRIVING TOOL furnished with every MACHINE. Apply the pressure of the tool at a point opposite to the point at which the metal escapes. The point of the CHOKER VALVE should move freely in and out of the opening in the NOZZLE without the pressure of the CHOKER ROD SPRING (9TTC8). If it does not, it indicates that the NOZZLE (62TC1) is not driven in straight and it will leak.

If any of the above means of stopping the leak prove ineffective it is pretty clear that the NOZZLE (62TC1) and the CHOKER VALVE (a7TC1T) are hindered in their operation by an accumulation of oxides; or that the CHOKER VALVE needs grinding. To correct these difficulties proceed as directed under "**Cleaning Choker Valve, Nozzle and Piston.**" If the desired result is not then accomplished, proceed to grind the CHOKER VALVE as directed under "**Grinding In Choker Valve and Assembling.**"

The Cause of Choker Valve Sticking

A sticking CHOKER VALVE (7TC1) is invariably caused by dirt or oxides becoming lodged in the Noz-

Formulae

The following percentages of ingredients for metals for different classes of work will be found to give practical service results.

Foundry Type Metal

Tin.....	12%
Antimony.....	22%
Lead.....	66%
	100%

Special Monotype Metal

Tin.....	9%
Antimony.....	19%
Lead.....	72%
	100%

Standard Monotype Metal

Tin.....	7%
Antimony.....	17%
Lead.....	76%
	100%

Metal for Spaces, Quads, Leads, Slugs

Tin.....	4%
Antimony.....	12%
Lead.....	84%
	100%

Remelting Type Into Pigs

Type metal is a mechanical as well as a chemical mixture. On account of the difference in the specific gravity of the lead, tin and antimony of which it is composed it is most important that the entire mixture be kept in constant agitation, from the time it becomes molten until it is poured into pigs. Otherwise there will not be a perfect amalgamation of the lead, tin and antimony.

therefore, that when metal is overheated the oxidation or dross formation, which results from contact of air and surface metal in the Pot, is greater than when the metal is run at its proper temperature. Therefore, in order to reduce this oxidation to a minimum and keep the metal in good condition for the longest possible time it should be worked, both in the TYPECASTER and in the remelting Pot, at the lowest temperature at which the best type can be cast.

(3) When a plant is using more than one grade of metal they may become mixed. The utmost care should be taken, therefore, not to mix the different grades, as such mixing will unbalance the proportion of tin, lead and antimony and change the formulae.

Impurities

Carelessness on the part of the workman when he throws the old metal into the remelting Pot may result in zinc etchings, iron shavings or flings, sweepings or other impurities, which may also contain arsenic, being introduced and melted with the metal which will surely deteriorate the good metal mixture. Zinc causes the metal to be sluggish and gives poor faces and bodies. Zinc will also attack the PUMP, CHOKER and other parts of the TYPECASTER Pot mechanism.

Arsenic is an impurity often present in virgin, as well as in used metal, and cannot be removed in the printing plant. If the metal contains the impurity in excess of one-eighth of one per cent the only remedy is to dispose of it to the refinery in exchange for new, clean, free-flowing metal.

ZLE (62TC1) and on the CHOKER VALVE. To remedy, proceed as directed under the caption "**Cleaning Choker Valve, Nozzle and Piston.**"

When The Piston Sticks. The Remedy

As in the case of a sticking CHOKER VALVE, a PISTON (a68TC1T) that sticks is the result of a collection of oxides or dirt in the PUMP WELL or on the PISTON (a68TC1T). To correct, follow the directions given under "**Cleaning Choker Valve, Nozzle and Piston.**"

Gas Burner Fails To Generate Enough Heat To Raise Metal in Pot To Required Temperature. What Is Remedy?

If the BURNER fails to generate enough heat to raise the metal to the proper temperature, it is evident that the supply of air to the burner is not sufficient to burn all of the gas. This fault is easily remedied by properly adjusting the BURNER AIR REGULATING PLATE (20TC2). This part is located immediately under the BURNER MIXER (20TC4). To adjust, turn BURNER AIR REGULATING PLATE (20TC2) to the right, or to the left, until the flame is blue. If the flame is all yellow, or if it shows up yellow at the top, it indicates that there is not sufficient air entering the MIXER to burn all the gas. If the BURNER AIR REGULATING PLATE is turned so that too much air enters the MIXER, the flame will "strike back" into the MIXER. In this case it will be necessary to extinguish the flame and re-light after adjustment has been made to decrease the amount of air entering the BURNER MIXER. A few trials at the adjustment of the BURNER will thoroughly acquaint the operator with the operation of the BURNER so that no further difficulty will be experienced.

Mold Works Tight. What is The Remedy?

The MOLD may work tight as a result of the lack of oil or as the result of being set too tightly at the begin-

ning. If the MOLD runs tight as the result of insufficient oil supply the result is liable to be serious. Insufficient oil is the cause of a cut MOLD. Hardened steel parts, such as the MOLDS are made of, will always cut if run together without oil. The remedy is obviously to supply the oil. Care should be taken, however, not to supply an over amount. To do so will result in imperfect faces. See **"What Causes Defective Type Faces."**

The MOLD may actually be set too tight at the beginning and still work freely. It works tight as the result of the expansion of the MOLD parts due to heat, the MOLD being cool at the time it is originally set. After a few casts have been made the incoming metal will heat up the MOLD sufficiently to cause the several parts to expand and work tight. The remedy is to stop the MACHINE and reset the MOLD as directed under **"Type Mold Adjustments."**

What Is The Cause and Remedy For Changing Type Alignment While The Machine Is In Operation?

When the MONOTYPE-THOMPSON TYPECASTER leaves the factory all adjustments are properly made. If, however, the parts of the MATRIX CARRIER should work loose through wear the proper adjustment can be easily made as follows: Remove the MATRIX CARRIER (Xa26TC) loosen the SLOTTED NUT in the center of the GRADUATED KNOB, then turn the GRADUATED KNOB to the left until the MATRIX CARRIER ADJUSTING BLOCK is almost out of the MATRIX CARRIER (Xa26TC). The small headless SET SCREW that passes through the back of the MATRIX CARRIER ADJUSTING BLOCK, against the split BRONZE BUSHING, must now be tightened to compress the split BRONZE BUSHING just enough so there will be no lost motion of the MATRIX CARRIER ADJUSTING SCREW in the split BRONZE BUSHING.

if the depth of face varies with different size bodies, and we will make the height of the MOLD, so type cast from the MATRICES to be used will give the customer type of the "height-to-paper" he wants.

Practical and Metallurgical Points Regarding Care and Handling of Metals

Type metals are alloys of Tin, Lead and Antimony. The finest working type metal is that alloy of correct formula which most closely approaches a state of chemical purity. It is not commercially possible or practical to produce a metal that is 100% chemically pure. But every user of a MONOTYPE-THOMPSON TYPECASTER should endeavor to use only such metal as will give the best results. The best type metal obtainable is none too good for a MACHINE that is built with the accuracy and precision of the MONOTYPE-THOMPSON. Remember that the service results of a good metal will be in proportion to the care you give it in casting and remelting. There are two fundamental reasons why type metals deteriorate while in use:

(1) The unbalancing of the proportions of lead, tin and antimony, or, in other words, the changing of formulae.

(2) The introduction of impurities into the metal while it is being remelted and worked.

The unbalancing of the lead, tin and antimony results generally from three causes:

(1) Skimming of metal when it is too cold. When molten type metal is maintained near the solidifying point there is a tendency for the tin and antimony to segregate at the surface. Skimming then takes off a greater amount of these two important ingredients. This is especially the case with metals having a high tin and antimony content.

(2) Oxidation or Burning of Metal. Tin has a greater affinity for oxygen than antimony, while antimony has a greater affinity for oxygen than lead. It follows,

standard for this in the United States, Canada, England and Australia is 0.918 inch.

The "depth-of-face" in the MATRIX is the depth of the hole in which the character is cast.

Types of various sizes of bodies but all of equal height cannot be cast in one MOLD unless the "depth-of-face" in the MATRICES are all equal.

The "height-to-paper" of the type cast equals the sum of the "height of MOLD" and the "depth-of-face" in the MATRIX.

It is easily seen that, if a MATRIX having a shallower "depth-of-face" is substituted for a deeper one, the "height-to-paper" will be less; if the "depth-of-face" in the MATRIX is more, the "height-to-paper" will be more. For this reason, a MOLD of different height is required for each different "depth-of-face" in MATRIX when type of uniform height is to be cast.

The depth of face in MONOTYPE-THOMPSON MATRICES as well as Linotype and Intertype MATRICES is uniform, namely, 0.043 inch. The height of the MONOTYPE-THOMPSON MOLD for these MATRICES is such that a blank cast therein measures 0.875 inch high, adding 0.043 inch to 0.875 inch we have 0.918 inch, which is the American and English standard "height-to-paper."

The "height-to-paper" (overall height of the type) varies in different countries outside the United States and Great Britain. The LANSTON MONOTYPE MACHINE COMPANY can make the MOLD so that type may be cast of any desired, predetermined height from matrices of any depth of face, provided, the following information is furnished:

When MATRICES to be used on the MONOTYPE-THOMPSON TYPECASTER are obtained from some source other than the LANSTON MONOTYPE MACHINE COMPANY we must know the depth of face in the MATRIX, and the overall height of type ("height-to-paper") the customer wants to cast; or better still, furnish us with a sample MATRIX and a sample type, one for each size

This operation compresses the MATRIX CARRIER BLOCK BUSHING and makes it fit the MATRIX CARRIER ADJUSTING SCREW more closely. The adjustment is correct if the MATRIX CARRIER GRADUATED KNOB can just be turned with the fingers. Do not tighten the SET SCREW so much that it is necessary to use a PIN WRENCH to turn the MATRIX CARRIER GRADUATED KNOB.

What Is The Cause and Remedy For a Friction Drive That Slips and Fails To Pull The Machine?

The cause of a slipping FRICTION DRIVE is usually an excess of oil. Inside of the rim of the FRICTION WHEEL (a18TC1T) a groove has been provided to catch any oil that may be thrown from the shaft or bearing by centrifugal force. If this is wiped out occasionally with a piece of cotton waste or rag no difficulty in this respect will be encountered. If, however, this difficulty is experienced, it can be easily corrected by wiping the face of the FRICTION PLATE (17TC1T) and the FRICTION RING (18TC2) with gasoline or benzine. This will remove all of the oil from the parts and eliminate the trouble. After long use the FRICTION RING (18TC2) may become worn with the result that the pressure of the FRICTION PLATE (17TC1T) against the FRICTION RING (18TC2) may not be sufficient to pull the MACHINE. In order to correct this the pressure on the FRICTION PLATE SPRING may be increased by turning the FRICTION PLATE SPRING ADJUSTING NUT (17TC10) in a clock-wise direction. Care should be taken not to make the spring pressure excessive. The pressure should only be enough to drive the MACHINE. If the tension is too great the pressure of the FRICTION PLATE (17TC1T) against the FRICTION RING (18TC2) will be excessive with the result that flat spots are liable to be worn on the FRICTION RING (18TC2). In this case the friction drive will fail to operate satisfactorily and the only remedy is to remove the FRICTION WHEEL ASSEMBLY from the MACHINE, place it in a lathe and turn

the fibre FRICTION RING (18TC2) in order to remove the flat spots. When this is necessary follow instructions under the caption "**How To Remove The Friction Wheel.**" With ordinary care of the parts in question no repairs should be necessary for years. MONO-TYPE-THOMPSON TYPECASTERS have been in use for long periods without the necessity of removing any of the FRICTION DRIVE PARTS.

General Hints

When through with the day's work swing the MELTING POT away from the MOLD only far enough so the center toe of the POT YOKE still rests on the planed part of the BASE TOP.

When leaving the MACHINE with the POT swung away from the MOLD be sure that the CHOKER VALVE is properly closing the NOZZLE. Otherwise when the POT is lighted up the metal will flow out of the NOZZLE until the metal heats enough to allow the VALVE to close.

Allow the MACHINE to stand a few minutes with the POT connected before starting work to permit the MOLD to become heated sufficiently to make a good cast. Now swing the POT away from the MOLD; then hook the CHOKER TRIPPING TOOL (46L1) over the CHOKER LEVER ROCKER ARM (a8TC5) and move the CHOKER VALVE back and forth, as explained under the caption "**Starting Machine for Casting Type,**" to make sure no chilled metal remains in the NOZZLE. This should be done whenever the MACHINE has been at rest for half an hour or more.

Do not turn MACHINE over and permit the PUMP CAM LEVER (a76TC1T) to drop when the POT is disconnected. The blow may break the LEVER. Have the PUMP STOP (b77TC1) in its off or rear position to support the LEVER and prevent damage.

If the CHOKER CAM is set too far forward, or too far back, it will not operate the CHOKER VALVE in proper

time to allow the PUMP to force metal into the MOLD. It can be readily shifted to find the best location.

The TYPE STRIPPER SPRING (80TC6) must be set so as to engage all type as they are ejected. If it does not do so the type may pull back in the MOLD and cause a "squirt." When it is acting properly it will show a slight cut in the forward edge of the type about one point back. It should be set so as to project through the SHOE about $1/32$ of an inch.

The TYPE NICK CUTTERS (80TC3) must not be turned over and should be set to cut but a light groove in the type. Four different combinations are possible; one cast nick only, the forward CUTTER only and the cast nick, the rear CUTTER only and the cast nick, and both cutters and the cast nick.

Never use pliers on the KNURLED SCREW heads. If wrenches or pliers were intended to be used the heads would not have been knurled.

Do not leave the MACHINE with the JET EJECTORS (43TC1) exposed to the flame of the METAL POT. Turn the MACHINE so as to draw the EJECTOR into the MOLD while it is not running.

If it becomes necessary to sharpen the TYPE TRIMMING KNIVES (79TC2 and 80TC8) rub them across the surface of a large oil stone, all teeth bearing at once on the stone. Grind off the back of the teeth so the cutting edges will be only one-sixty-fourth of an inch wide.

The tension of the FRICTION DRIVE can be increased by turning in on the threaded COLLAR on the FRICTION PLATE SHAFT behind the MACHINE. The tension of this, as of all other parts, should be only sufficient to do the work.

Height of Type

The dimension from the foot of the type to the surface of its face is called the "height-to-paper"; the

PLATE 1

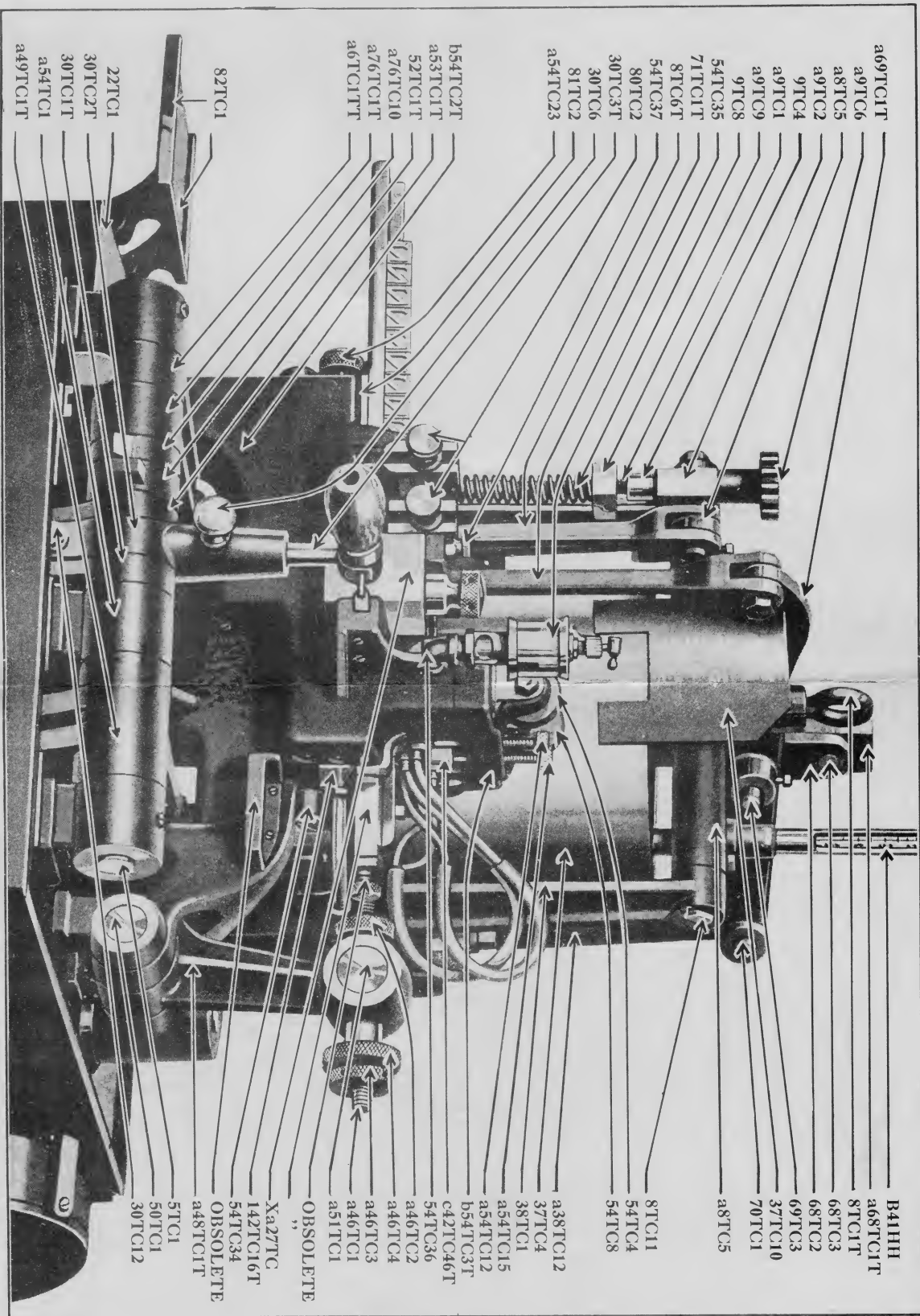

PLATE 2

8TC1T	Choker Valve Lever Assembled.
a68TC1T	Piston.
68TC3	Piston Link Pin.
68TC2	Piston Links.
70TC1	Piston Lever Fulcrum Pin.
a69TC1T	Piston Lever.
8TC11	Choker Lever Rocker Arm Trunion.
b37TC1TT	Melting Pot.
a37TC4	Pot Jacket (Upper).
9TC4	Choker Spring Rod Collar.
a9TC1	Choker Spring Rod
a9TC9	Choker Spring Rod Abutment (Adjustable).
a9TC3	Choker Spring Block Guide Rod.
9TC8	Choker Rod Spring.
37TC8	Pot Screws.
38TC2	Rear Pot Adjusting Screw.
38TC4	Pot Adjusting Screw.
71TC2	Jet Breaker.
a38TC5	Melting Pot Yoke Bracket.
a37TC3	Pot Jacket (Lower).
38TC1	Pot Yoke.
38TC10	Pot Yoke Handle.
a38TC6	Melting Pot Yoke Bracket Cover Plate.
b40TC3	Pot Yoke Stud
8TC6T	Choker Valve Lever Rocker Arm Link.
71TC1T	Piston Lever Link.
a83TC5	Water Drain Pipe $\frac{1}{4}$ " Union.
a9TC6	Choker Spring Rod Knob.
a9TC2	Choker Spring Rod Block.
a8TC12	Choker Valve Lever Rocker Arm Trunion Set Screws.
8TC1T	Choker Valve Lever.
62TC1	Nozzle.
a51TC1	Mold Body Lever Cross Block.
a48TC1T	Mold Body Lever.
a46TC2	Type Body Piece Plate Adjusting Nut.
a46TC1	Type Body Piece Plate Adjusting Screw.
45TC2	Type Body Piece Plate Connecting Pin.
a54TC15	Jet Block Adjusting Screw (Small Head).
54TC8	Jet Block Adjusting Eccentric.
54TC4	Mold Top Block Adjusting Eccentric.
b54TC3T	Mold Stand Cap.
83TC1	Water Drain Cup.
63TC1	Nozzle Plate.
54TC37	Oil Cup (Front) (Short).
54TC21	Vertical Mold Blade Adjusting Shoe.
X80TC	Type Receiving Shoe.
Xa79TC	Type Receiving Plate (Bottom).
a16TC5	Foot Plow Clamping Nut.
16TC1	Foot Plow.
a16TC8	Foot Plow Bracket.
81TC2	Type Stick Plate.
81TC1	Type Stick
a54TC23	Vertical Mold Blade Adjusting Screw.
Riser	
a54TC1	Mold Stand (R. H.)
52TC1T	Vertical Mold Blade Lever.
5TC1	Cam Lever Shaft.
39TC1T	Pot Yoke Lock.
a39TC4	Pot Yoke Lock Bracket.
39TC2	Pot Yoke Lock Handle.
54TC28	Vertical Mold Blade Supporting Plug Set Screw.
a49TC1T	Mold Body Cam Lever.
a48TC1T	Mold Body Lever.
a27TC1T	Cam Shaft.

PLATE 2

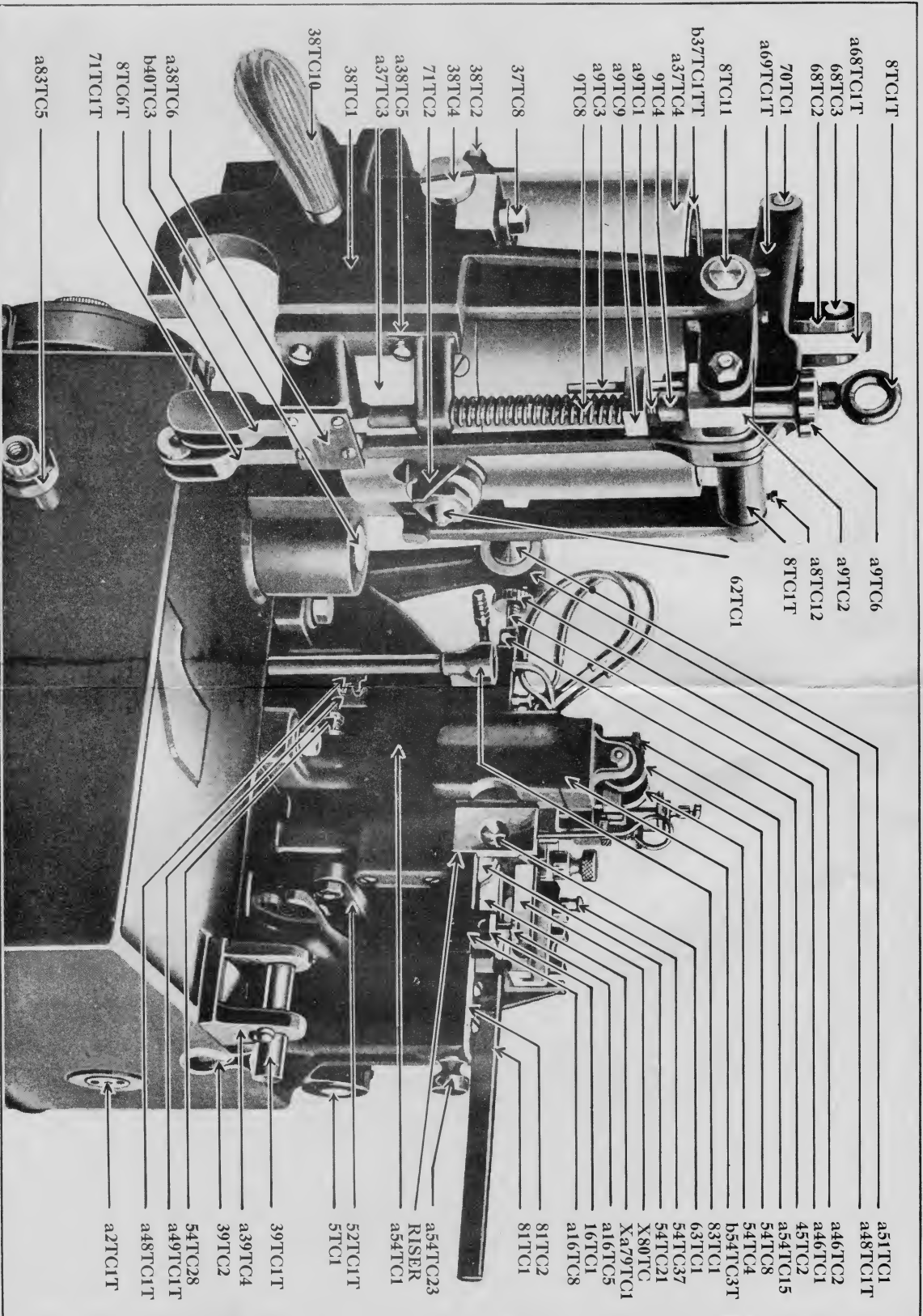

PLATE 3

Cam Shaft and Gear Yoke Assembly

- a2TC11 Vertical Mold Blade Cam.
- 2TC12T Pump Cam.
- 2TC13 Pump Cam Block.
- 2TC2 Choker Cam.
- a2TC7 Matrix Carrier Cam.
- 10TC11 Shaft Gear, 7-inch.
- 10TC3T Clutch Gear, 3½-inch (Left).
- a10TC24 Clutch Gear Yoke.
- 2TC5 Cam Shaft Gear.
- 2TC9 Mold Body Cam.
- a2TC1T Cam Shaft.
- a2TC10 Mold Body Auxiliary Cam.
- b10TC7T Clutch Gear—Double.
- b10TC1T Clutch Gear, 7-inch (Right).
- a10TC10 Clutch Shaft.
- a10TC24 Clutch Gear Yoke.
- a10TC21 Clutch Shifter Rod.
- a10TC22 Clutch Shifter Rod Knob.
- 10TC20 Clutch Gear Shifter.

PLATE 4

72TC1	Piston Spring.	a10TC21	Clutch Shifter Rod.
17TC8	Friction Plate Spring.	a11TC1	Clutch Shifter Rod Latch.
17TC7	Friction Plate Shaft Cover.	24TC1	Main Stand Key.
17TC6	Grease Cup, $\frac{1}{4}$ -inch Shank.	a18TC5T	Friction Wheel Shaft.
17TC4	Friction Plate Shaft Bearing.	73TC1	Piston Spring Lever.
17TC3	Friction Plate Shaft.	73TC2	Piston Spring Lever Bracket.
17TC1T	Friction Plate.	73TC3	Piston Spring Lever Fulcrum Pin.
a10TC24	Clutch Gear Yoke.	18TC3	Friction Wheel Clamping Ring.
a59TC2	Motor Pinion.	18TC2	Friction Wheel Ring (Fibre).
10TC13T	Hand Wheel.	a18TC1T	Friction Wheel.
10TC14	Hand Wheel Handle.	a67TC1	Oil Pipe Cover.
b10TC1T	Clutch Gear, 7-inch (Right).	66TC3	Oil Pipe Clamp.
b10TC7T	Clutch Gear—Double.	66TC1	Oil Feed Pipe (Short).
10TC3T	Clutch Gear, $3\frac{1}{2}$ -inch (Left).	66TC2	Oil Feed Pipe (Long)
10TC11	Shaft Gear, 7-inch.	10TC20	Clutch Gear Shifter.
a10TC22	Clutch Shifter Rod Knob.	a14TC1	Base Door (Upper).

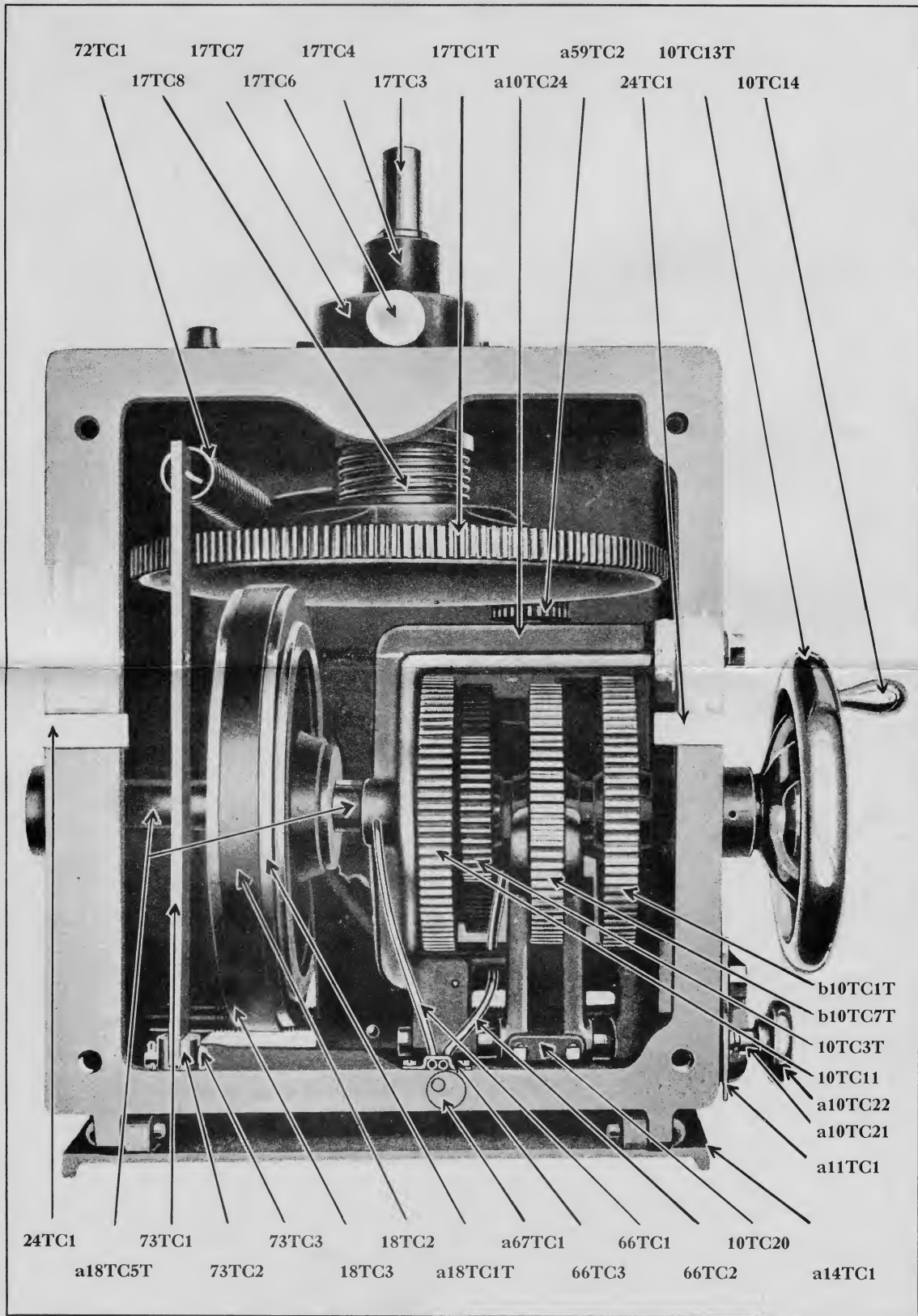
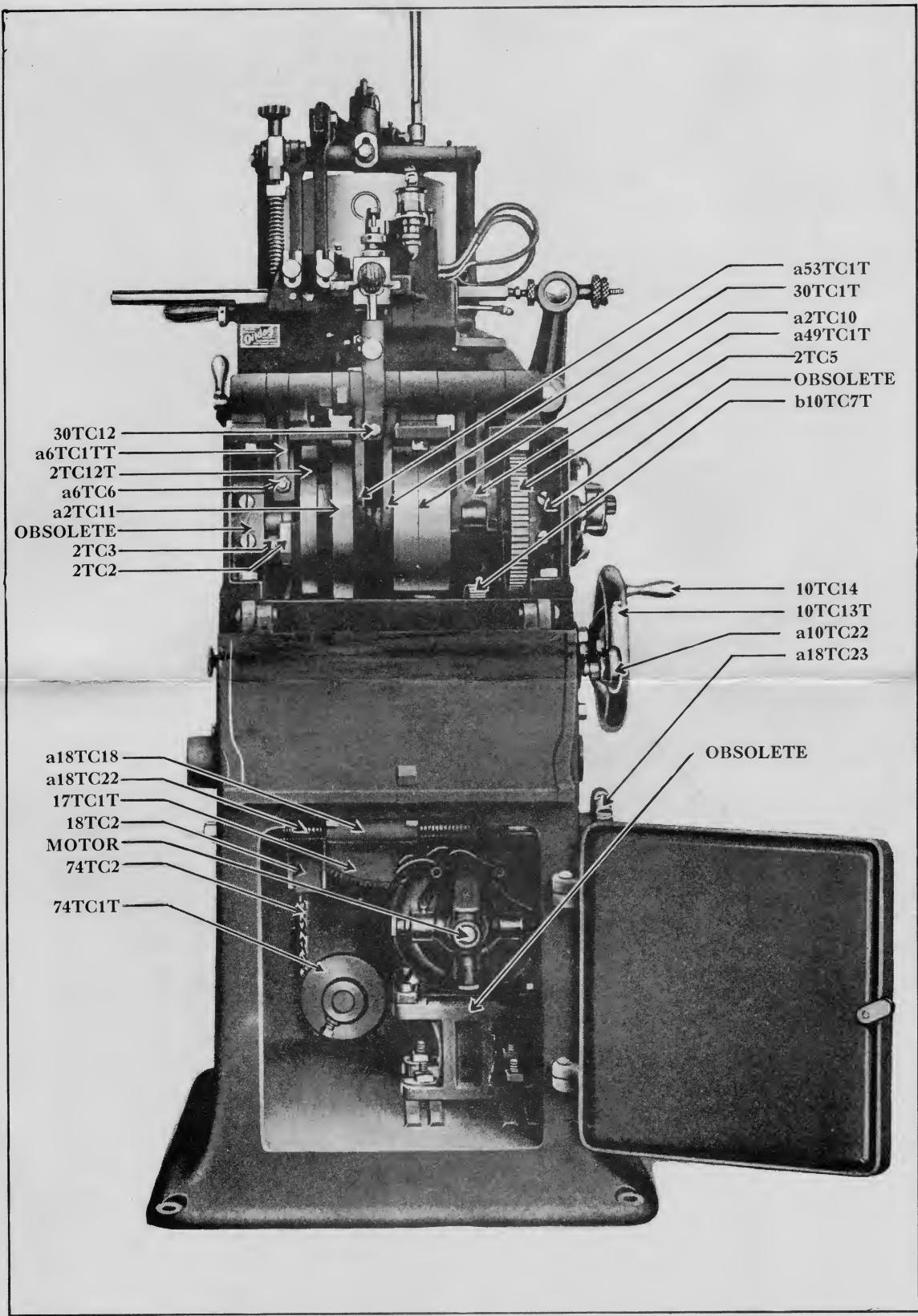

PLATE 4

PLATE 5

30TC12	Matrix Carrier Spring Bolt.	74TC2	Piston Spring Tension Pulley Chain.
a6TC1TT	Choker Cam Lever.	74TC1T	Piston Spring Tension Pulley.
2TC12T	Pump Cam.	a53TC1T	Vertical Mold Blade Cam Lever.
2TC3	Choker Cam Screw.	30TC1T	Matrix Carrier Cam Lever.
a2TC11	Vertical Mold Blade Cam.	a2TC10	Mold Body Auxiliary Cam.
4TC1	Cam Shaft Bearing (L. H.)	a49TC1T	Mold Body Cam Lever.
a6TC6	Choker Cam Lever Roller Yoke Adjusting Screw.	2TC5	Cam Shaft Gear.
2TC2	Choker Cam.	b10TC7T	Clutch Gear—Double.
a18TC18	Friction Wheel Shifter.	10TC14	Hand Wheel Handle.
a18TC22	Friction Wheel Operating Screw.	10TC13T	Hand Wheel.
17TC1T	Friction Plate.	a10TC22	Clutch Shifter Rod Knob.
18TC2	Friction Ring (Fiber).	a18TC23	Friction Wheel Shifter Operating Screw Knob.



- a53TC1T
- 30TC1T
- a2TC10
- a49TC1T
- 2TC5
- OBSOLETE
- b10TC7T
- 30TC12
- a6TC1TT
- 2TC12T
- a6TC6
- a2TC11
- OBSOLETE
- 2TC3
- 2TC2
- 10TC14
- 10TC13T
- a10TC22
- a18TC23
- OBSOLETE
- a18TC18
- a18TC22
- 17TC1T
- 18TC2
- MOTOR
- 74TC2
- 74TC1T

PLATE 5

PLATE 6

80TC2	Adjusting Screw for Type Receiving Shoe.	a79TC1	Type Receiving Plate (Bottom).
80TC3	Type Nick Cutters.	44TC1	Type Body Piece. (When ordering give point size of type to be cast with same).
80TC8	Type Trimming Knife (Upper).		Nozzle Driving Tool.
80TC6	Type Stripper Spring.	45L1	Equipment Box. (Equipment not included).
X80TC	Type Receiving Shoe (Top) (group).	95TC1	Aligning Gauge.
a16TC2	Foot Plow Adjusting Screw.	62TC1	Nozzle.
a16TC5	Foot Plow Clamping Nut.	63TC1	Nozzle Plate.
a16TC6	Foot Plow Clamping Nut Screw.	63TC2	Nozzle Plate Handle.
a16TC4	Screws for Foot Plow Bracket (Long).	45TC2	Connecting Pin for Type Body Piece Plate.
a16TC3	Foot Plow Bracket.	43TC1	Jet Ejector—Three sizes, Nos. 1, 2 and 3.
37TC10	Melting Pot Splash Guard.	21L1	Lining Standards.
81TC3	Type Stick Plate Screw.	X21TC	72-Point Body Gauge.
81TC1	Type Stick.	Xa7TC	Choker Valve.
a81TC4	Type Stick Plate Screw.	47TC1	Vertical Mold Blade.
16TC1	Foot Plow—Three sizes, Nos. 1, 2 and 3.	a16TC10	Foot Plow Screw (Short).
a79TC3	Type Trimming Knife Screw.		
79TC2	Type Trimming Knife (Lower).		



PLATE 7

Xa26TC	Matrix Carrier. Old style, see plate 8 new style Xa27TC
X32TC	Matrix Holder, Style B, for both wide and narrow Thompson Matrices.
a46TC3	Lock Nut (Outside).
a46TC4	Lock Nut (Inside).
a46TC1	Type Body Piece Plate Adjusting Screw.
X46TC	Type Body Piece Plate Adjusting Screw (group).
42TC77	Space and Quad Steel Matrix.
42TC78	Quotation Quad Matrix.
a41TC2	Measuring Screw Micrometer-Set Adjusting Device.
a41TC1	Micrometer Set Adjusting Device Body.
a41TC8	Micrometer Set Adjusting Device Stop.
a41TC4	Micrometer Set Adjusting Device Measuring Screw Collar.
Xa41TC	Micrometer Set Adjusting Device (group).
41TC9	Micrometer Set Adjusting Device Clamping Screw.
a41TC6	Micrometer Set Adjusting Device, Knurled Knob for measuring Screw.
a46TC2	Adjusting Nut.
a51TC1	Mold Body Lever Cross Block

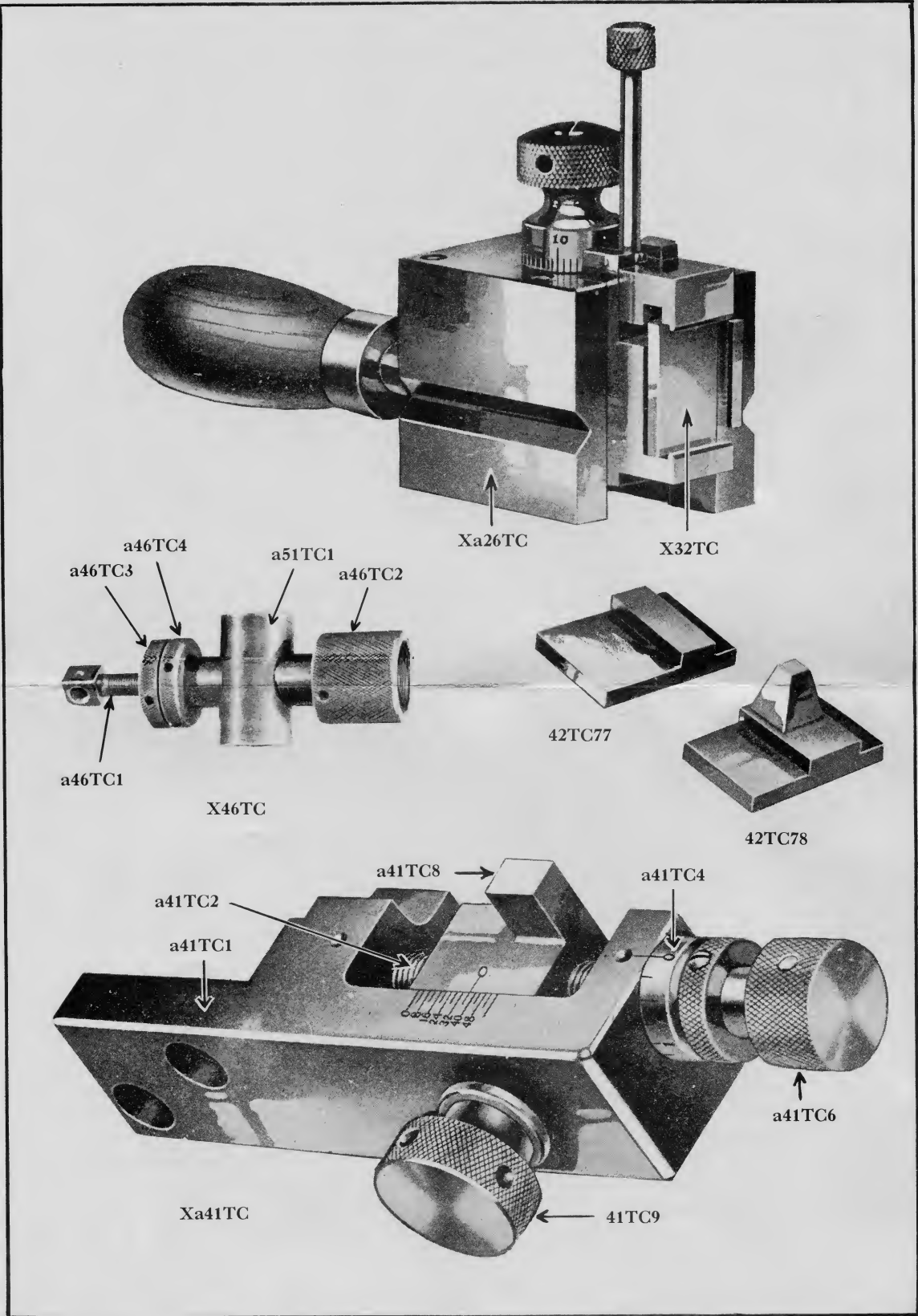

PLATE 8

X33TC	Adjustable Matrix Holder for Foundry Style Matrices.
Xa27TC	Adjustable Side Wall Matrix Carrier.
a27TC11	Matrix Carrier Wedge Adjustment Screw.
27TC12	Matrix Carrier Wedge Clamp Screw.
a32TC8	Matrix Holder Clamp Screw Knob.
a32TC18	Set Screw for a32TC8 (not shown).

PLATE 8

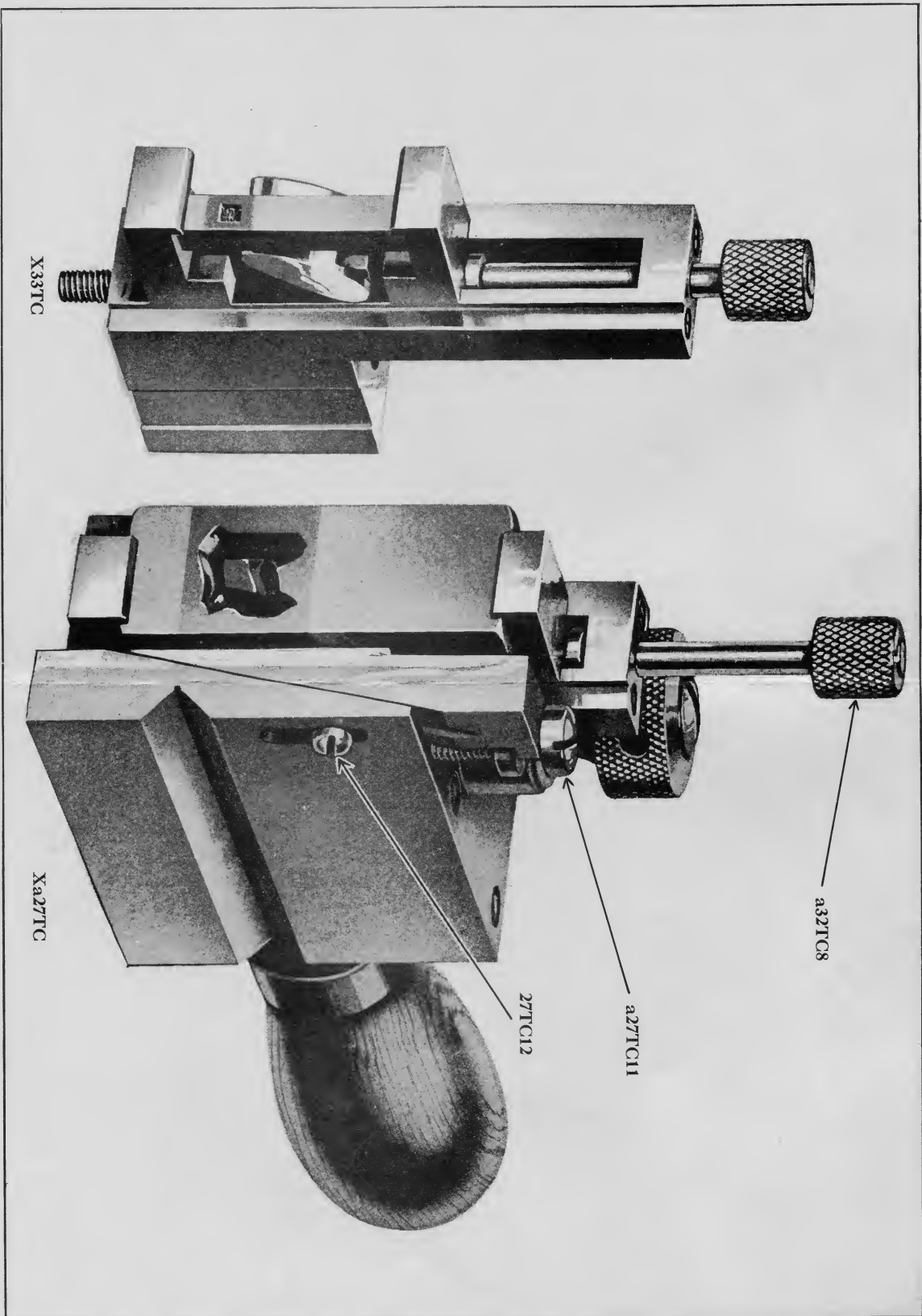

PLATE 9

17TC1T	Friction Plate.
17TC2	Friction Plate—Ball Bearing (complete).
17TC3	Friction Plate Shaft.
17TC5	Friction Plate Shaft Bearing Screws.
17TC10	Friction Plate Spring Adjusting Nut.
17TC4	Friction Plate Shaft-bearing.
17TC9	Friction Plate Spring—Adjusting Pins.
17TC6	Friction Plate Shaft Bearing Grease Cup $\frac{1}{4}$ " Shank.
17TC12	Friction Plate Spring—Stop Collar.
17TC11	Friction Plate Spring Bushing.
17TC7	Friction Plate Shaft-Cover.
17TC8	Friction Plate Spring.

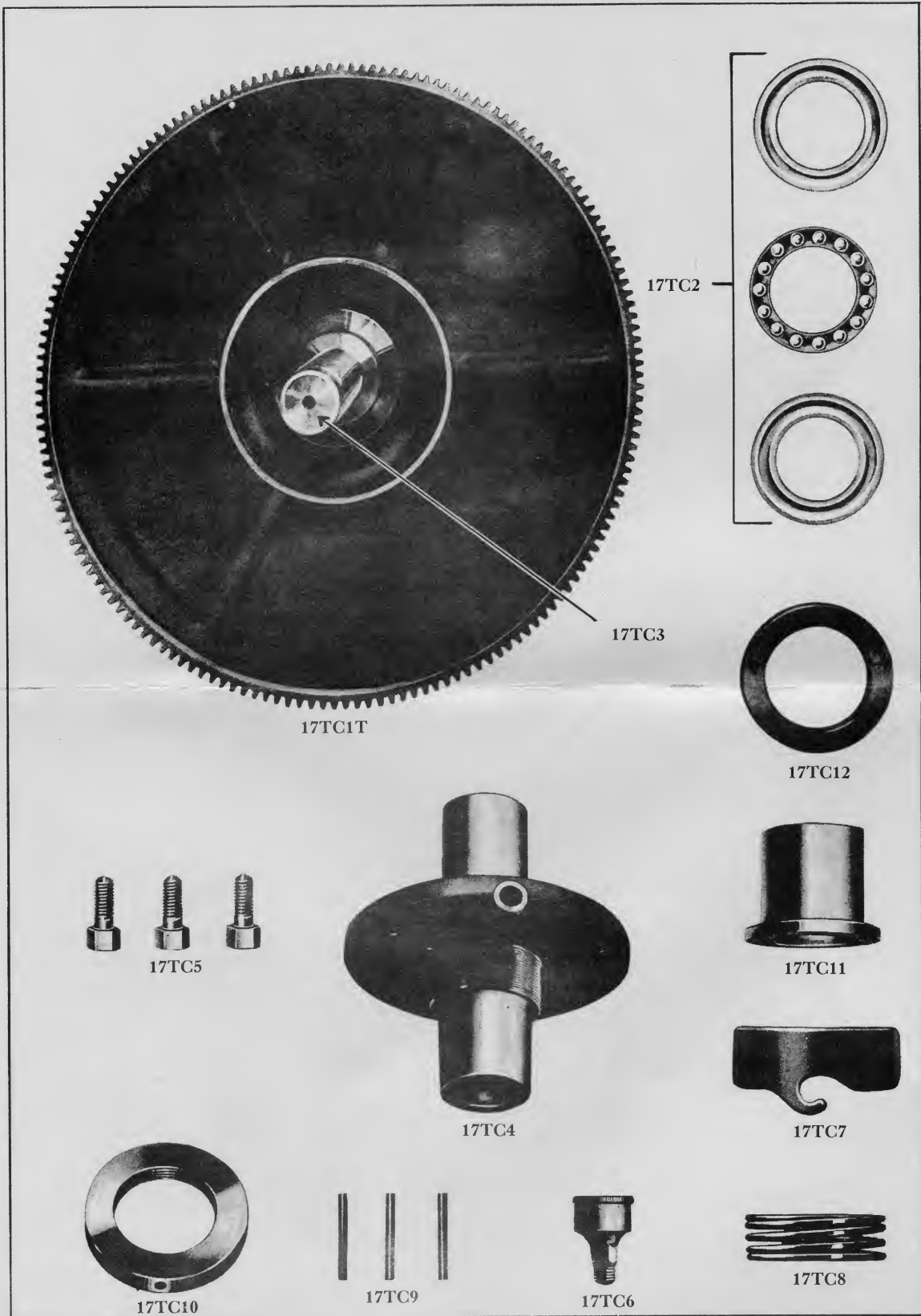

PLATE 10

a18TC24	Friction Wheel Shifter Operating Screw Knob Pin.
a18TC23	Friction Wheel Shifter Operating Screw Knob.
a18TC1T	Friction Wheel.
18TC3	Friction Wheel Clamping Ring.
18TC2	Friction Ring—(Fibre).
a18TC4	Friction Wheel Clamping Ring Screws.
a18TC22	Friction Wheel Operating Screw.
a18TC12	Shaft Gear—4".
a18TC18	Friction Wheel Shifter.
a18TC8	Friction Wheel Shaft Collar.
a18TC9	Friction Wheel Shaft Collar Set Screw.
a18TC13	Shaft Gear Set Screw.
a18TC11	Friction Wheel Shaft Key Screws.
a18TC20	Friction Ring Shifter Retaining Ring.
a18TC21	Friction Ring Shifter Retaining Ring Screws.
a18TC10	Friction Wheel Shaft Key.
18TC17	Large and Small Shaft Gear Pin.
18TC15	Shaft Gear—3½".
a18TC14T	Shaft Gear—7". Assembled with 18TC15 and 18TC17.
18TC19	Friction Wheel Shifter—Grease Cup ¼" Shank.
a18TC7	Friction Shaft Bearing Screw.
a18TC6	Friction Shaft Bearing.
a18TC5T	Friction Wheel Shaft.



PLATE 10

PLATE 11

10TC3T	Clutch Gear— $3\frac{1}{2}$ " (Left).
b10TC7T	Clutch Gear—Double.
b10TC1T	Clutch Gear—7" (Right).
10TC11	Clutch Shaft Gear—7".
10TC14	Hand Wheel Handle.
a10TC26	Clutch Gear Yoke Screws.
10TC12	Clutch Shaft Gear Key.
10TC13T	Hand Wheel.
a10TC2	Clutch Gear Key (not shown) (same as 10TC15).
10TC15	Clutch Shaft Key—Hand Wheel end.
a10TC10	Clutch Shaft.
a10TC24	Clutch Gear Yoke.
10TC20	Clutch Gear Shifter.
10TC23	Clutch Gear Shifter Set Screws.
a11TC1	Clutch Shifter Rod Latch.
10TC16	Hand Wheel Nut.
10TC17	Clutch Shaft Hand Wheel Stud (For Stop Motion) (not shown).
a10TC22	Clutch Shifter Rod Knob.
a10TC21	Clutch Shifter Rod.
a11TC2	Clutch Shifter Rod Latch Screw.

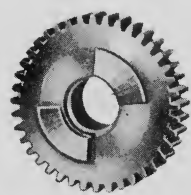

10TC3T

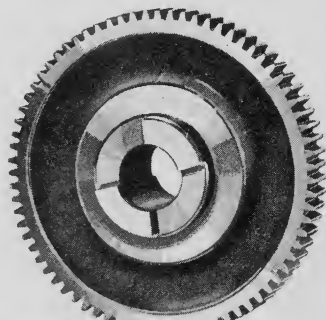

b10TC7T

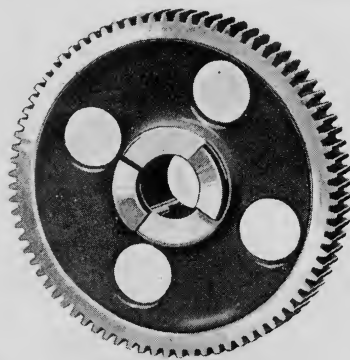

b10TC1T

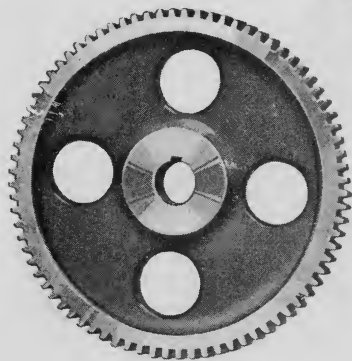

10TC11

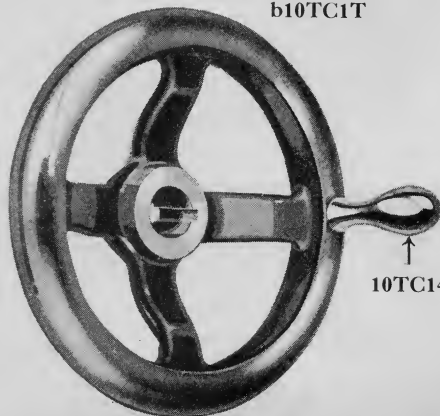

10TC14

10TC13T

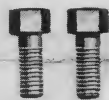

a10TC26



10TC12



10TC15

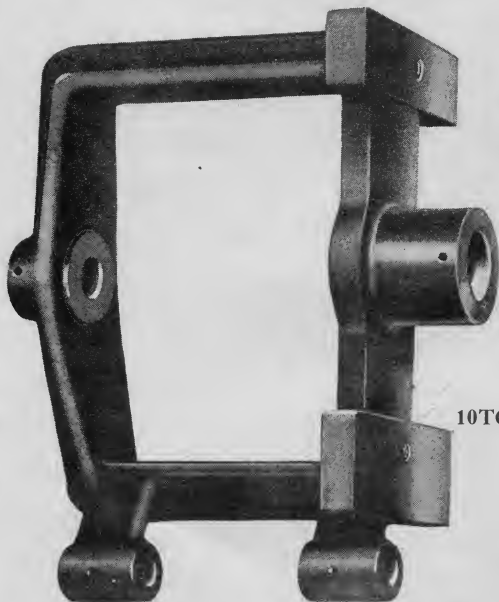

a10TC24

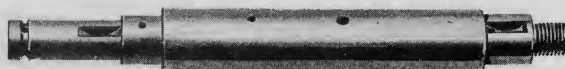

a10TC10

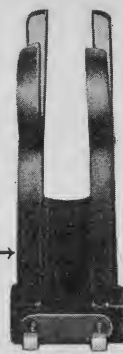

10TC20

10TC23



a11TC1



10TC16



a11TC2



a10TC22

a10TC21

PLATE 12

b77TC2	Plate Latch Screw.	6TC5T	Choker Cam Lever Roller Yoke (assembly).
b77TC1	Pump Stop.	6TC3	Choker Cam Lever Roller Pin.
a77TC5	Pump Stop Plate.	6TC2	Choker Cam Lever Roller.
a77TC7	Pump Stop Plate Spring Post (and Stud).	6TC9	Spring for Choker Cam Lever Roller.
a77TC8	Plate Latch.	6TC7	Upper Locknut for Choker Cam Lever Roller Adjusting Screw.
Xb77TC	Pump Stop.	a6TC12	Choker Cam Lever Spring Screw.
a77TC6	Plate Spring.	a53TC5	Lower Clamping Screw for Vertical Mold Blade Adjusting Screw.
a77TC10	Plate Latch Spring.	53TC2	Upper Adjusting Screw for Vertical Mold Blade Lever.
53TC6	Cam Rollers.	5TC1	Cam Lever Shaft.
a76TC9	Screw for Pump Cam Roller Stud.	52TC2	Vertical Mold Blade Lifting Block.
76TC8	Washer for Pump Cam Roller Stud.	52TC4	Vertical Mold Blade Lifting Block Stud Nut.
a76TC1T	Pump Cam Lever.	52TC3	Stud for Vertical Mold Blade Lifting Block.
a76TC6	Pump Cam Roller Stud.	53TC4	Lower Adjusting Screw for Vertical Mold Blade Lever.
a76TC10	Pump Cam Lever Yoke.	52TC1	Vertical Mold Blade Lever.
6TC11	Spring for Choker Cam Lever.	53TC7	Vertical Mold Blade Cam Lever Roller Stud.
a6TC10	Screws for Choker Cam Lever Roller Spring.	a53TC1	Vertical Mold Blade Cam Lever.
a6TC1	Choker Cam Lever.	53TC3	Upper Adjusting Screw Nut.
6TC8	Choker Cam Lever Yoke Fulcrum Pin.	53TC8	Roller Stud Nut.
a77TC12	Pump Stop Plate Screw Collar.	a76TC11	Pump Cam Lever Yoke Screw.
b77TC2	Pump Stop Plate Screw.	76TC5	Pump Cam Lever Roller.
a77TC11	Pump Stop Plate Latch Spring Post.		
77TC13	Pump Stop Plate Latch Screw Nut.		
54TC39	Set Screw (for 5TC1)		



PLATE 12

PLATE 13

30TC1T	Matrix Carrier Cam Lever.
30TC2T	Matrix Carrier Lever Extension.
30TC6	Matrix Carrier Fork Releasing Knob.
30TC7	Matrix Carrier Fork Releasing Pin Spring.
30TC5	Matrix Carrier Fork Releasing Pin.
30TC13	Matrix Carrier Cam Lever Spring Bolt Nut.
30TC11	Matrix Carrier Cam Lever Spring.
30TC14	Matrix Carrier Concave Washer.
30TC9	Matrix Carrier Cam Lever Roller Studs.
30TC3T	Matrix Carrier Fork.
30TC4	Matrix Carrier Fork Pins.
30TC12	Matrix Carrier Lever Spring Bolt.
a51TC1	Mold Body Lever Cross Block.
a49TC4	Mold Body Cam Lever Roller Stud.
a49TC1	Mold Body Cam Lever.
a48TC1	Mold Body Lever.
49TC2	Mold Body Cam Lever Roller (center).
a48TC2	Mold Body Lever Clamping Screws.
50TC1	Mold Body Lever Shaft.
54TC18	Cap Screws for Mold Stand Cap.
10TC18	Oil Cups.
54TC36	Street Elbow for R. H. Mold Stand Oil Cup.
54TC35	Sight Feed Oiler For Mold.
30TC10	Roller Stud Nut.
49TC3	Mold Body Cam Lever Roller (side).



PLATE 14

a54TC23	Vertical Mold Blade Adjusting Screw.	54TC21	Vertical Mold Blade Adjusting Shoe.
a54TC10	Mold and Jet Block Adjusting Eccentric Studs.	b42TC49	Mold Block Lifting Studs.
54TC9	Mold and Jet Block Adjusting Eccentric Pins.	b42TC38	Jet Block Lifting Stud.
54TC8	Jet Block Adjusting Eccentric.	Xa54TC	Assembled—Mold Stand Complete. These parts are never shipped separately.
a54TC17	Nuts for Mold Block Adjusting Screw and Mold and Jet Block Fulcrum Studs.	54TC32	Vertical Mold Blade Gib Adjusting Screw.
54TC4	Mold Top Block Adjusting Eccentric.	a54TC31	Vertical Mold Blade Gib Screw.
54TC30	Vertical Mold Blade Gib.	54TC27	Vertical Mold Blade Supporting Plug.
a54TC48	Matrix Carrier Slide Gib Adjusting Screw.	54TC29	Vertical Mold Blade Supporting Plug Set Screw Nut.
54TC25	Vertical Mold Blade Adjusting Screw Plug.	54TC28	Vertical Mold Blade Supporting Plug Set Screw.
54TC22	Vertical Mold Blade Adjusting Shoe Fulcrum Pin.	a54TC41	Matrix Carrier Slide Adjusting Screw—Long.
a54TC12	Mold Block Adjusting Screw—Small Head.	54TC47	Matrix Carrier Slide Gib.
a54TC13	Mold Block Adjusting Screw—Large Head.	a54TC44	Matrix Carrier Slide, (L. H.)
54TC26	Vertical Mold Blade Adjusting Shoe Spring.	a54TC40	Matrix Carrier Slide, (R. H.)
54TC34	Mold Locating Screw.	a54TC42	Matrix Carrier Slide Adjusting Screw—Short.
54TC33	Vertical Mold Blade Gib Adjusting Screw Lock Nut.	a54TC3	Mold Stand Cap.
a54TC16	Jet Block Adjusting Screw—Large Head.	a54TC45	Matrix Carrier Slide (L. H.) Clamping Screw.
a54TC15	Jet Block Adjusting Screw—Small Head.	a54TC43	Matrix Carrier Slide (R. H.) Clamping Screw.
a42TC67	Mold and Jet Block Lifting Stud Nuts.		

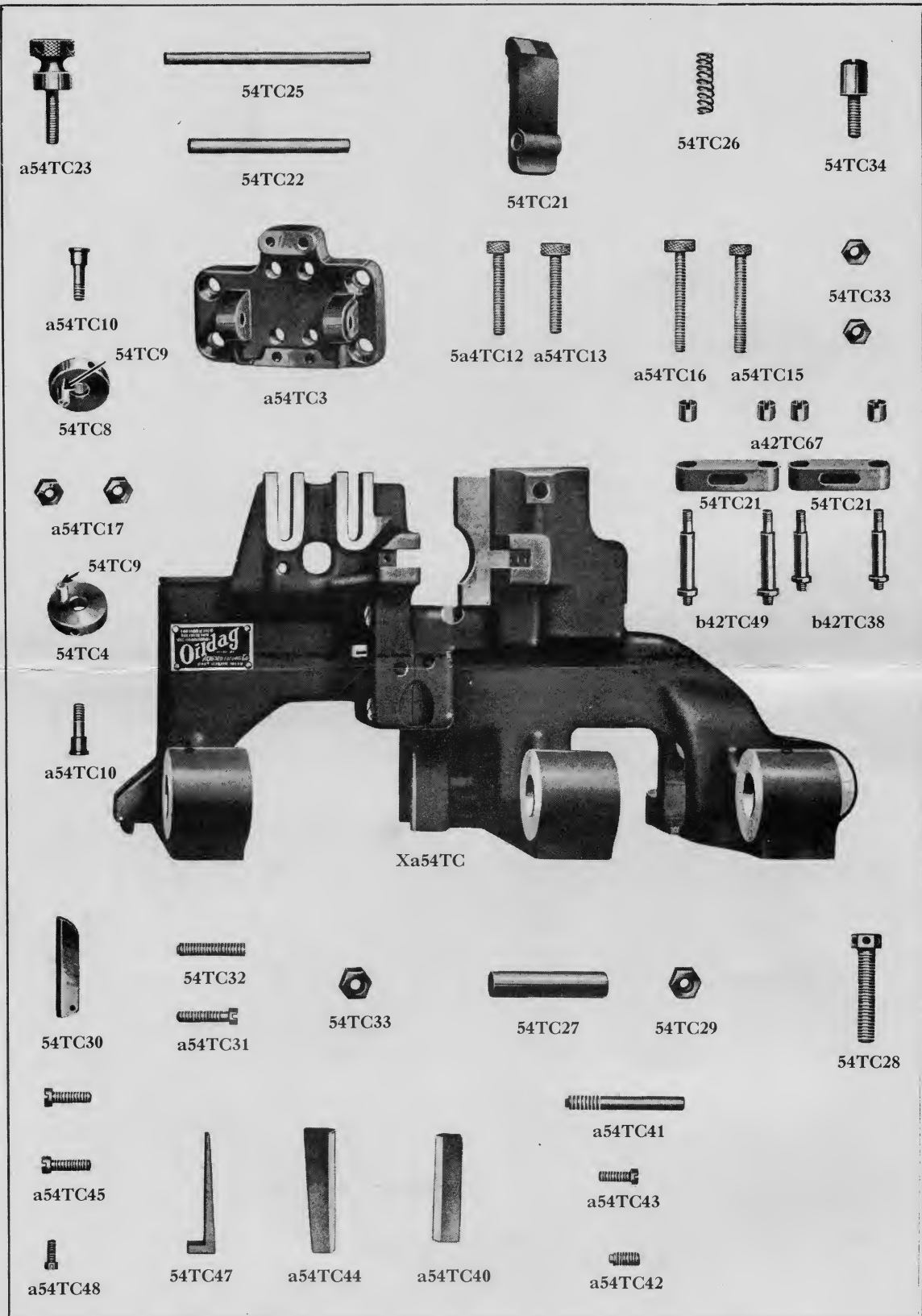

PLATE 15

37TC4	Pot Jacket—Upper.	9TC4	Choker Spring Rod Collar.
b37TC1	Melting Pot.	a9TC9	Choker Spring Rod Abutment.
71TC5	Piston Lever Link Pin (top).	a9TC1	Choker Spring Rod.
68TC2	Piston Links.	a69TC1T	Piston Lever.
68TC3	Piston Link Pin.	a37TC5	Pot Jacket Screws.
71TC3	Jet Breaker Screws.	a37TC3	Pot Jacket—Lower.
71TC2	Jet Breaker.	8TC10	Choker Rocker Arm Link Spring.
71TC1T	Piston Lever Link.	a9TC7	Pin for Choker Spring Rod Knob.
8TC8	Nut for Choker Rocker Arm Link Pin.	9TC8	Choker Rod Spring.
a68TC1T	Piston.	8TC4	Choker Lever Adjusting Screw Washer.
69TC3	Piston Lever Pin.	8TC3	Choker Valve Adjusting Screw.
62TC1	Nozzle.	70TC1	Piston Lever Fulcrum Pin.
a37TC2	Choker Valve Bushing.	8TC1T	Choker Valve Lever.
a7TC1T	Choker Valve.	71TC4	Piston Lever Link Pin.
37TC8	Pot Screws.	8TC6T	Choker Lever Rocker Arm Link.
37TC9	Pot Screw Washers.	a8TC12	Choker Lever Rocker Arm Trunion Set Screws.
8TC7	Choker Rocker Arm Link Pin.	8TC11	Choker Lever Rocker Arm Trunion.
a9TC6	Choker Spring Rod Knob.	a69TC4	Piston Lever Set Screw.
a9TC2	Choker Spring Rod Block.	a8TC5	Choker Lever Rocker Arm.
a9TC3	Choker Spring Block Guiding Rod.	8TC9	Choker Valve Lever Link Pin

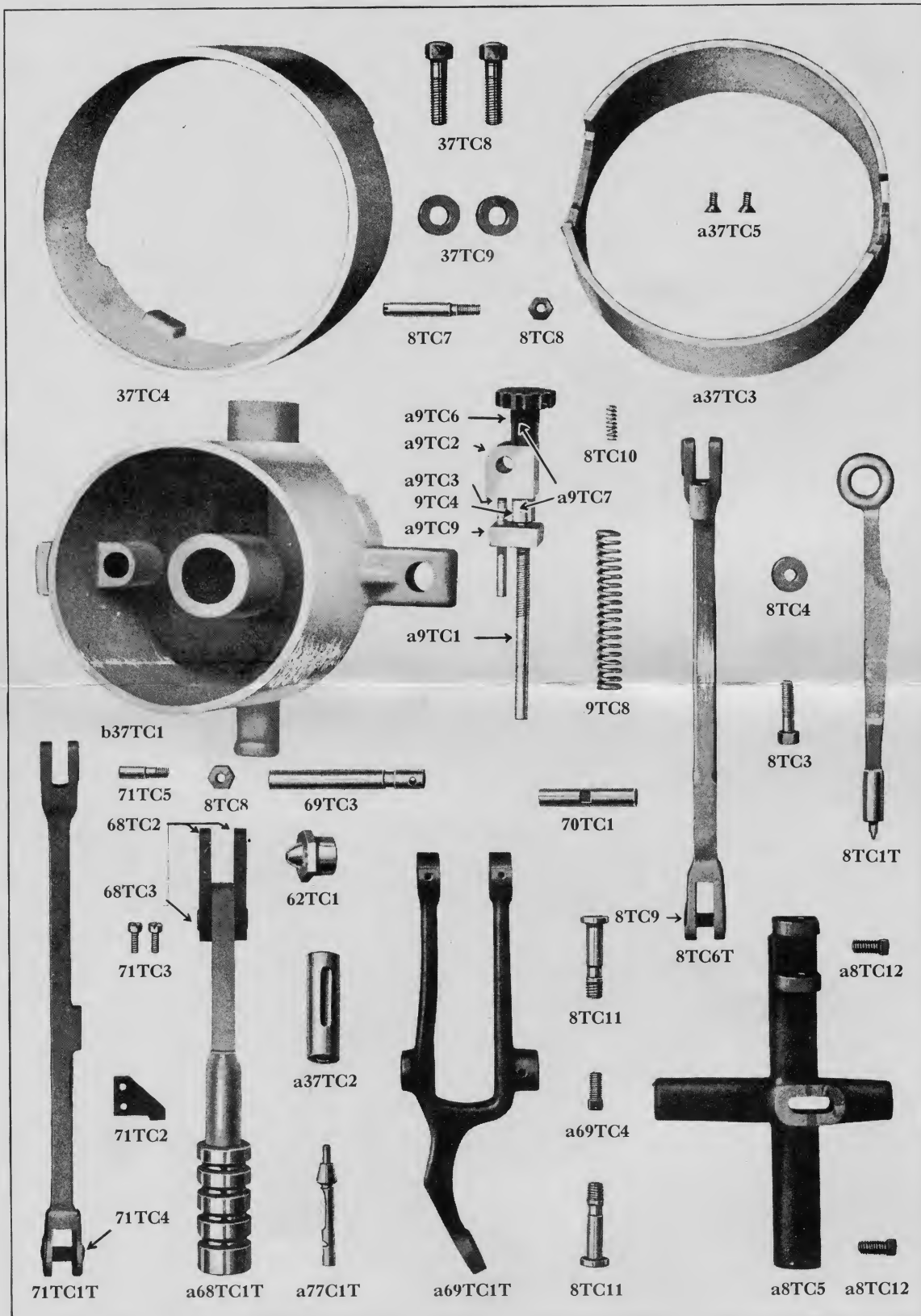

PLATE 16

38TC14	Piston Lever Support Screws.
38TC9	Bracket Screws.
a38TC12	Piston Lever Support.
38TC1	Pot Yoke.
a38TC5	Bracket.
20TC11	Burner Supporting Stud Nut.
20TC10	Burner Supporting Stud.
a38TC15	Piston Lever Support Set Screw.
20TC14	Burner Bolts and Nuts.
38TC2	Rear Pot Adjusting Screw.
38TC3	Pot Adjusting Screw Lock Nut—(Rear).
20TC13	Burner Top Plate.
20TC6	Burner Connecting Nipple.
20TC4	Burner Mixer.
20TC5	Burner Mixer Nipple.
a20TC1	Burner.
20TC3	Burner Mixer Plate Spring.
20TC2	Air Regulating Plate.
20TC8	Burner Elbow $\frac{1}{8}$ ".
20TC7	Burner Pipe $\frac{1}{8}$ ".
a20TC12	Burner Supporting Stud Set Screw.
20TC9	Burner Hose Connection.
38TC10	Pot Yoke Handle.
38TC11	Pot Yoke Handle Stud.
a38TC6	Bracket Cover Plate.
38TC4	Pot Adjusting Screw.



PLATE 16

PLATE 17

a2TC11	Vertical Mold Blade Cam.
a2TC8	Matrix Carrier Cam Screws.
a2TC7	Matrix Carrier Cam
and	
a2TC10	Auxiliary Cam.
2TC5	Cam Shaft Gear.
a2TC1T	Cam Shaft.
2TC14	Pump Cam Block Dowels.
2TC13	Pump Cam Block.
2TC15	Pump Cam Block Screw.
2TC2	Choker Cam.
2TC4	Choker Cam Screw Washer.
2TC3	Choker Cam Screw.
2TC12T	Pump Cam.
a84TC6	Crank Disc.
a84TC8	Crank Pin.
2TC9	Mold Body Cam.
84TC10	Clutch Shifting Fork.
84TC11	Clutch Shifting Fork Fulcrum Pin.
84TC29T	Release Spring.
a84TC1T	Bracket.
84TC16T	Main Spring.
Xa84TC	Stop Motion Group.
a84TC35	Wedge Cover Plate.
a84TC40	Wedge Latch.
84TC26	Ratchet Wheel Screw (Stud).
84TC12T	Hand Wheel Stud Spring.
84TC32	Retaining Spring (For Latch)
84TC25T	Ratchet Wheel.
a84TC19	Main Spring Screw Washer.

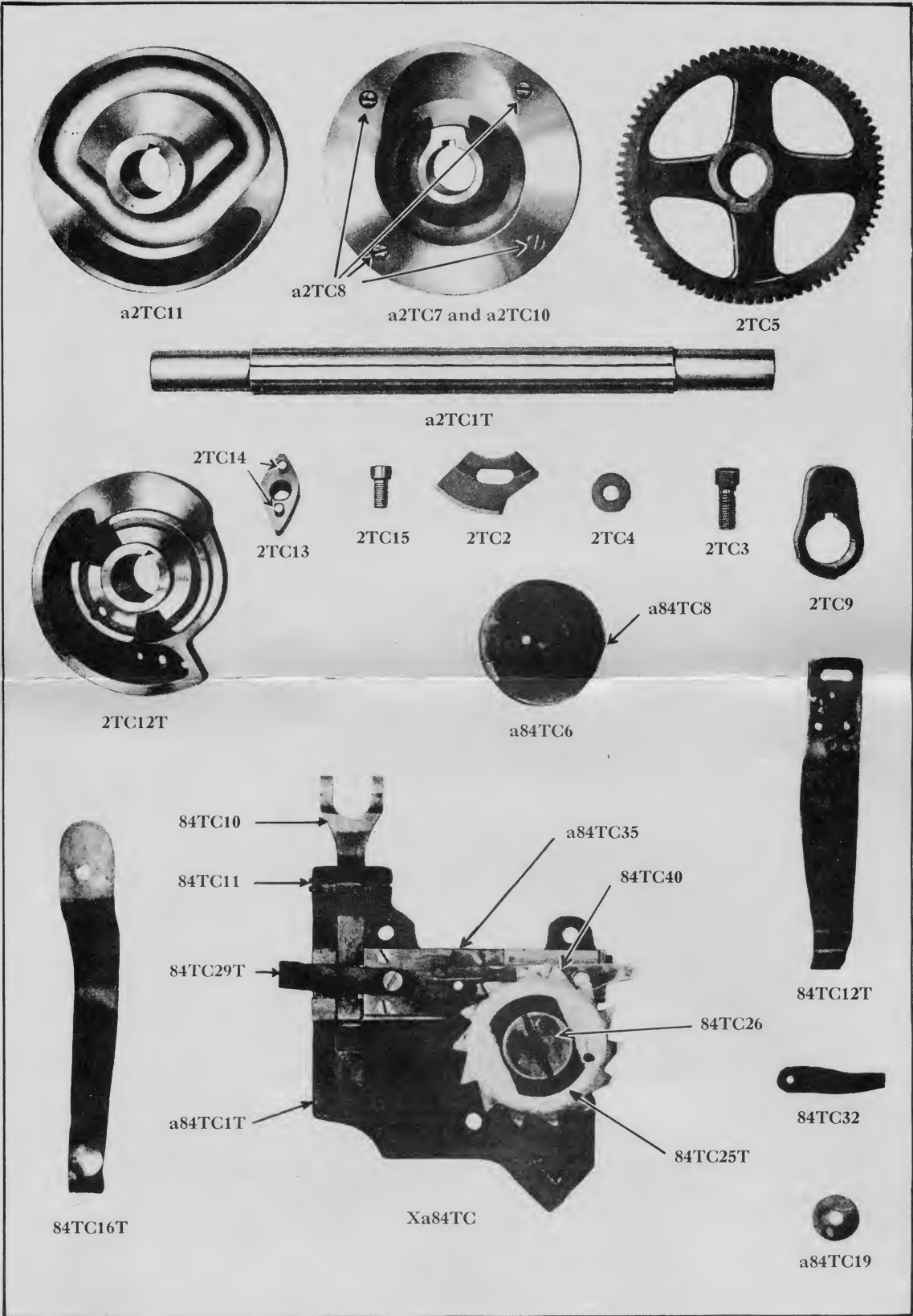

PLATE 18

39TC5	Pot Yoke Lock Bracket Screws.	74TC1T	Piston Spring Tension Pulley.
a39TC4	Pot Yoke Lock Bracket.	72TC1	Piston Spring.
39TC3	Pot Yoke Lock Stop Pin.	73TC2	Piston Spring Lever Bracket.
39TC1T	Pot Yoke Lock.	a67TC2	Oil Pipe Cover Screw.
39TC2	Pot Yoke Lock Handle.	a67TC1	Oil Pipe Cover.
a39TC6	Pot Yoke Lock Bracket Set Screw.	73TC4	Piston Spring Lever Fulcrum Pin Cotter Key.
54TC18	Mold Stand Cap Screws.	a83TC2	Water Drain Pipe—Vertical.
75TC1	Piston Spring Tension Pulley Pawl.	74TC5T	Piston Spring Tension Pulley Shaft.
74TC2	Piston Spring Chain.	15TC1	Base Door—Upper Spring.
54TC20	Mold Stand Screws (a54TC1 to b54TC2).	a15TC2	Base Door—Upper—Spring Screw.
75TC2	Piston Spring Tension Pulley Pawl Stud.	19TC1	Friction Wheel Shaft Bearing, Oil Cups.
74TC4	Piston Spring Tension Pulley Set Screw.	66TC1	Oil Feed Pipe—Short.
a40TC1	Pot Yoke Stud.	66TC2	Oil Feed Pipe—Long.
a40TC2	Pot Yoke Stud Nut.	66TC3	Oil Feed Pipe Clamp.
74TC3	Piston Spring Chain Fulcrum Pin.	a66TC4	Oil Pipe Clamp Screws.
73TC1	Piston Spring Lever.	73TC3	Piston Spring Lever Fulcrum Pin.
a78TC1	Pump Cam Cover Plate.	83TC4	Water Drain Pipe $\frac{1}{4}$ " Elbow.
a78TC2	Pump Cam Cover Plate Screw.	83TC3	Water Drain Pipe—Horizontal.
83TC1	Water Drain Cup.	a83TC5	Water Drain Pipe $\frac{1}{4}$ " Union.
74TC7	Piston Spring Tension Ratchet Pin.	24TC1	Base and Mold Stand Key.
74TC6	Piston Spring Tension Pulley Ratchet.	a57TC1	

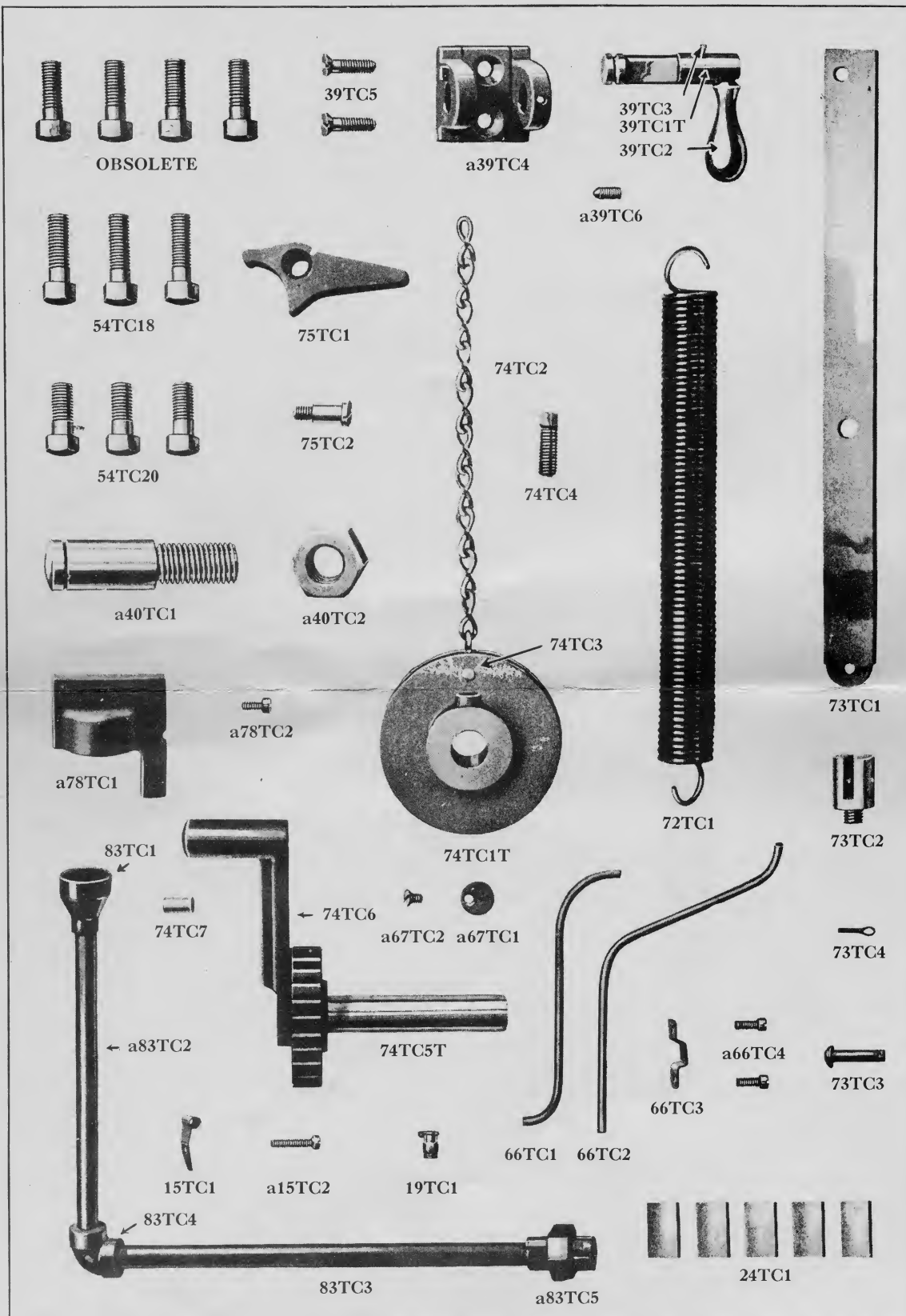

PLATE 18

