

# NACOMATIC

Effective: 08-April-2010

Expires: 03-June-2010

**Your Ad Here**

~ 100,000 Page views/month

**Contact:**

Doug Ranz

248-318-0011

[NACOMATIC@hotmail.com](mailto:NACOMATIC@hotmail.com)

# Warranty

I make absolutely no warranty nor guarantee whatsoever about the accuracy, availability, applicability and/or correctness of any of the information in this document.

The official, original NACO documents are available for your downloading pleasure from: <http://naco.faa.gov/index.asp?xml=naco/onlineproducts>

# Copyright

This compilation is protected by US copyright laws and international copyright treaties.

# Limitations

The sale, hosting and/or distribution of this document in any and all forms, is prohibited.

# Release from Liability

All users of this compilation must agree to be legally bound hereby, that Douglas R. Ranz ("Released Party") SHALL NOT BE LIABLE FOR MY DEATH OR INJURY TO MY PERSON, OR FOR ANY LOSS FOR DAMAGE TO MY PROPERTY OR REPUTATION caused in any manner whatsoever, whether attributable to the negligence of the Released Party, or for any other reason, occurring during the time that I am operating an aircraft.

I do hereby waive any right of action against the Released Party from any and all causes or claims that I may have against them from the beginning of time. I further agree not to sue on any such cause or claim. This agreement shall not release liability for gross negligence or willful misconduct of the Released Party. I agree to indemnify and hold the Released Party harmless for any losses, judgments, damages or fees he may incur, including but not limited to attorneys fees, arising out any lawsuit related to the planning, flight and/or enforcement of or legal challenge to this agreement. It is my intention that this agreement be interpreted and enforced to the maximum extent allowed by Michigan law.

00HI =>	26
03N =>	42
ANG =>	44
AWK =>	45
BKH =>	27
BSF =>	24
FAQ =>	20
GRO =>	43
GSN =>	43
GUM =>	23
HDH =>	33
HFS =>	38
HHI =>	38
HNL =>	35
HNM =>	30
ITO =>	25
JHM =>	32
JRF =>	37
KOA =>	26
KWA =>	40
LIH =>	28
LNK =>	29
LUP =>	32
MAJ =>	41
MDY =>	42
MKK =>	33
MUE =>	27
NPS =>	34
OGG =>	30
PAK =>	28
PLCH =>	39
PM64 =>	39
PNI =>	21
PPG =>	20
ROI =>	41
ROR =>	44
TKK =>	22
TNI =>	44
TTK =>	21
UPP =>	27

# GENERAL INFORMATION

This Chart Supplement is a Civil Flight Information Publication, published and distributed every 8 weeks by the FAA, Department of Transportation, National Aeronautical Navigation Services, Silver Spring, Maryland 20910. It is designed for use with the Flight Information Publication Enroute Charts, and the Sectional Aeronautical Chart covering the State of Hawaii and that area of the Pacific served by U.S. facilities.

This Chart Supplement contains an Airport/Facility Directory, ATC procedures and terminal SID, STAR and IAP charts applicable to the Pacific area.

The official ATC procedures for operating in the Pacific, outside sovereign US airspace are prescribed by ICAO and are contained in ICAO documents 4444, 7030 and Annexes 2 and 11.

## CORRECTIONS, COMMENTS, AND/OR PROCUREMENT

**CRITICAL** information such as equipment malfunction, abnormal field conditions, hazards to flight, etc., should be reported as soon as possible to the nearest FAA facility, either in person or by reverse charge telephone call. **NOTE:** Requests for the creation or revision to Airport Diagrams should be in accordance with FAA Order 7910.4B

**FOR AIRPORT SUPPLEMENT REVISIONS FORM VISIT WEB SITE:** <http://nfdc.faa.gov/portal/airportchanges.do>

FAA, Aeronautical Information Services, ATO-R, Rm 626  
800 Independence Ave., SW  
Washington, DC 20591  
Telephone 1-866-295-8236  
Fax 202-267-5322  
Email 9-ATOR-HQ-AIS-AIRPORTCHANGES@FAA.GOV

NOTICE: Changes must be received by the Aeronautical Information Services as soon as possible but not later than the "cut-off" dates listed below to assure publication on the desired effective date.

Effective Date	Airport Information Cut-off date	Airspace Information* Cut-off date
8 Apr 10	24 Feb 10	4 Feb 10
3 Jun 10	21 Apr 10	1 Apr 10
29 Jul 10	16 Jun 10	27 May 10
23 Sep 10	11 Aug 10	22 Jul 10
18 Nov 10	6 Oct 10	16 Sep 10
13 Jan 11	1 Dec 10	11 Nov 10

\*Including changes to preferred routes, SID'S, STAR'S, IAP'S and graphic depictions on charts.

**New or Changed Information**—To alert users of new information or changes to information from the previous issue, a vertical line will be portrayed in the outside margin and extending the full length of the new and/or revised data. This will not apply to the front cover nor the airport/facility directory listing.

The following publications for use in the Pacific area are available from the FAA, National Aeronautical Navigation Services:

**PACIFIC CHART SUPPLEMENT.** This supplement is issued every 56 days.

**HAWAIIAN ISLAND-MARIANA ISLANDS SECTIONAL CHART.** Issued semi-annually. Consult the Visual Chart Bulletin in this Supplement for date of the current edition.

**NORTH PACIFIC OCEAN ROUTE CHARTS.** Charts are issued every 56 days at 1:12,000,000 composite or four 1:7,000,000 area charts.

FAA, National Aeronautical Navigation Services  
REDIS/Distribution Team  
10201 Good Luck Road  
Glenn Dale, MD 20769-9700  
Online at <http://www.aeronav.faa.gov>  
Email 9-AMC-Chartsales@faa.gov  
Telephone 1-800-638-8972  
FAX 301-436-6829  
or any authorized chart agent.

**IFR ENROUTE PACIFIC OCEAN AND HAWAIIAN ISLAND CHART.** Available from the National Geospatial-Intelligence Agency, provides coverage of Pacific areas served by US facilities.

NGA Combat Support Center, ATTN: DDCP  
Washington, D.C. 20315-0020  
Telephone (301) 227-2495 or Toll Free 1-800-826-0342

NEW OR CHANGED INFORMATION — To alert users of new information or changes to information from the previous issue, a vertical line will be portrayed in the outside margin and extending the full length of the new and/or revised data. This will not apply to the front cover nor the aerodrome/facility directory listings.

## AMENDMENT NOTICE

A change notice will only be issued for safety considerations such as when an amended or original instrument approach procedure is issued.

UPON RECEIPT, THE AMENDMENT NOTICE SHOULD BE ATTACHED TO THIS PAGE SO THAT USERS HAVE ALL SIGNIFICANT CHANGES AVAILABLE.

This publication comprises part of the following sections of the United States Aeronautical Information Publication (AIP): GEN, AGA 3, COM 2.

## ICAO INTERNATIONAL PHONETIC ALPHABET/MORSE CODE

A	· -	Alfa	(AL-FAH)
B	— . . .	Bravo	(BRAH-VOH)
C	— . - .	Charlie	(CHAR-LEE) (or SHAR-LEE)
D	— . .	Delta	(DELL-TAH)
E	.	Echo	(ECK-OH)
F	. . - .	Foxtrot	(FOKS-TROT)
G	— - .	Golf	(GOLF)
H	. . . .	Hotel	(HOH-TEL)
I	. .	India	(IN-DEE-AH)
J	. - - - -	Juliett	(JEW-LEE-ETT)
K	— . .	Kilo	(KEY-LOH)
L	. - . . .	Lima	(LEE-MAH)
M	— -	Mike	(MIKE)
N	— .	November	(NO-VEM-BER)
O	— - -	Oscar	(OSS-CAH)
P	. - - - .	Papa	(PAH-PAH)
Q	— - . -	Quebec	(KEH-BECK)
R	. - . .	Romeo	(ROW-ME-OH)
S	. . .	Sierra	(SEE-AIR-RAH)
T	—	Tango	(TANG-GO)
U	. . -	Uniform	(YOU-NEE-FORM) (or OO-NEE-FORM)
V	. . . -	Victor	(VIK-TAH)
W	. - -	Whiskey	(WISS-KEY)
X	— . . .	Xray	(ECKS-RAY)
Y	— . - -	Yankee	(YANG-KEY)
Z	— - . .	Zulu	(ZOO-LOO)
1	. - - - -	One	(WUN)
2	. . - - -	Two	(TOO)
3	. . . - -	Three	(TREE)
4	. . . . -	Four	(FOW-ER)
5	. . . . .	Five	(FIFE)
6	— . . . .	Six	(SIX)
7	— - . . .	Seven	(SEV-EN)
8	— - - . .	Eight	(AIT)
9	— - - - .	Nine	(NIN-ER)
0	— - - - -	Zero	(ZEE-RO)

SAMPLE



CITY NAME

§ AIRPORT NAME (ORL) 4 E UTC-5 N28°32.75' W81°20.18' HAWAIIAN-MARIANA

200 B S4 FUEL 100 OX 1 TPA-1000(800) AOE Class IV, ARFF Index A NOTAM FILE HNL Not insp. 2-H IAP



18 → RWY 07-25: H6000X150(ASPH-PFC) S-90, D-160, DT-300  
-PCN 80 R/B/W/T HIRL CL 0.4% UP E

RWY 07: ALSF1.Trees.  
RWY 25: REIL. Thld displcd 600'. Rgt tfc.  
RWY 13-31: H4620X100(ASPH) HIRL  
RWY 13: VASI(V2L)—GA 3.3° TCH 89'. Pole.  
RWY 31: VASI(V2L)—GA 3.1° TCH 36'. Tree. Rgt tfc.

LAND AND HOLD SHORT OPERATIONS

LANDING	HOLD SHORT POINT	DIST AVBL
RWY 25	13-31	3000
RWY 13	07-25	4000

RUNWAY DECLARED DISTANCE INFORMATION  
RWY 07: TORA-6000 TODA-6000 ASDA-6000 LDA-6000  
RWY 25: TORA-6000 TODA-6000 ASDA-6000 LDA-5400

19 → AIRPORT REMARKS: Special Air Traffic Rules—Part 93, see Regulatory Notices. Attended 1200-0300Z. Parachute Jumping. Cattle and deer on arpt. Fee for all airline charters, travel clubs and certain revenue producing acft. Flight Notification Service (ADCUS) available.

20 → WEATHER DATA SOURCES: AWOS-1 120.3 (202) 426-8000. LLWAS.

21 → COMMUNICATIONS: ATIS 127.25 UNICOM 122.95  
NAME FSS (ORL) on arpt. 123.65 122.65 122.2.

NAME APP/DEP CON 128.35 (1200-0400Z)  
TOWER 118.7 GND CON 121.7 GCO 135.075 (ORLANDO CLNC) CLNC DEL 125.55 PRE TAXI CLNC 125.5

22 → AIRSPACE: CLASS B See VFR Terminal Area Chart.

23 → RADIO AIDS TO NAVIGATION: NOTAM FILE MCO. VHF/DF ctc FSS.  
(H) ABORTAC 112.2 MCO Chan 59 N28°32.50' W81°20.10' at fld. 1110/8E.  
TWB avbl 1300-0100Z. VOR unusable 050°-060° byd 15 NM blo 5000'.  
HERNY NDB (LOM) 221 OR N28°30.33' W81°26.02' 067° 5.4 NM to fld.  
ILS/DME 108.5 I-ORL Chan 22 Rwy 18. Class IIE. LOM HERNY NDB.  
ASR/PAR (1200-0400Z)

24 → COMM/NAV/WEATHER REMARKS: Emerg frequency 121.5 not avbl on twr.

187 TPA 1000(813)  
WATERWAY 13-31: 5000X300 (WATER)  
SEAPLANE REMARKS: Birds roosting and feeding areas along river banks.

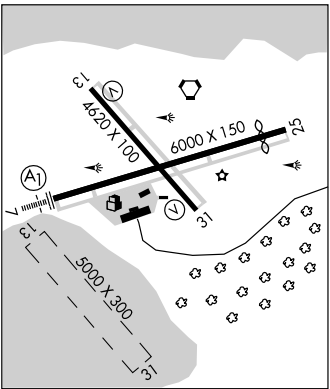

§ D AIRPORT NAME (MCO) 6.1 SE UTC-5 N28°25.92' W81°19.49' HAWAIIAN-MARIANA

96 B FUEL 100, JET A, MOGAS LRA NOTAM FILE HNL 2-G IAP

RWY 18R-36L: H12004X300 (CONC-GRVD) S-100, D-200, DT-400 HIRL IAP

RWY 18R: ALSF1. REIL. Rgt tfc. 0.3% up. RWY 36L: ALSF1. 0.4% down.  
RWY 18L-36R: H12004X200 (ASPH) S-165, D-200, DT-400 HIRL

RWY 18L: LDIN. ALSF1. TDZL. REIL. VASI(V4L)—GA 3.5° TCH 36'. Thld displcd 300'. Trees. Rgt tfc. Arresting device.

AIRPORT REMARKS: Attended 1200-0300Z. ACTIVATE HIRL Rwy 18L-36R—CTAF.  
COMMUNICATIONS: CTAF 124.3 ATIS 127.75 UNICOM 122.8

NAME FSS (MCO) LC 894-0869. NOTAM FILE MCO.  
NAME RCO 122.4 112.2T 122.1R (NAME RADIO)

APP CON 124.8 (337°-179°) 120.1 (180°-336°) DEP CON 120.15  
TOWER 124.3 (1200-0400Z) GND CON 121.85 CLNC DEL 134.7

AIRSPACE: CLASS D svc 1100-0400Z other times CLASS E.  
RADIO AIDS TO NAVIGATION: NOTAM FILE MCO.

(H) VORTAC 112.2 MCO Chan 59 N28°32.51' W81°20.12' 173° 5.7 NM to fld. 1110/8E

ILS 109.3 I-MCO Rwy 18L. BC unusable. Unmonitored.  
MLS Chan 514 Rwy 36R.

E AIRPORT NAME (See PLYMOUTH)

ALL DISTANCES ARE NAUTICAL MILES UNLESS OTHERWISE SPECIFIED  
ALL BEARINGS AND RADIALS UNLESS OTHERWISE SPECIFIED ARE MAGNETIC  
HORIZONTAL DATUM: HAWAIIAN ISLANDS ARE NORTH AMERICAN DATUM 1983 (NAD 83), WHICH FOR CHARTING PURPOSES IS CONSIDERED EQUIVALENT TO WORLD GEODETIC SYSTEM 1984 (WGS 84). ALL OTHER AREAS ARE BASED ON WORLD GEODETIC SYSTEM 1984 EXCEPT THOSE AREAS THAT ARE UNKNOWN DATUM IDENTIFIED IN THE "AIRPORT LOCATOR INDEX" WITH AN ASTERISK.  
ALL TIMES ARE UTC EXCEPT AS NOTED  
T—Transmit R—Receive x—On request





10042  
LEGEND



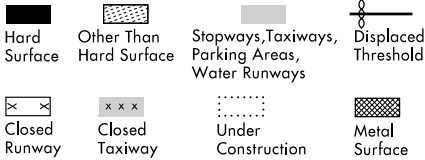

INSTRUMENT APPROACH PROCEDURES (CHARTS)

AIRPORT DIAGRAM/AIRPORT SKETCH

Runways



Helicopter Alighting Areas     

Negative Symbols used to identify Copter Procedures landing point.....    

Runway Threshold elevation.....THRE 123  
Runway TDZ elevation.....TDZE 123  
Runway Slope..... — 0.3% DOWN  
(shown when runway slope is greater than or equal to 0.3%)  
..... 0.8% UP —

ARRESTING GEAR: Specific arresting gear systems; e.g., BAK12, MA-1A etc., shown on airport diagrams, not applicable to Civil Pilots. Military Pilots refer to appropriate DOD publications.

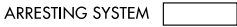

REFERENCE FEATURES

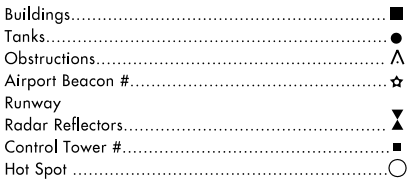

# When Control Tower and Rotating Beacon are co-located, Beacon symbol will be used and further identified as TWR.

Runway length depicted is the physical length of the runway (end-to-end, including displaced thresholds if any) but excluding areas designated as stopways.

A  symbol is shown to indicate runway declared distance information available, see appropriate A/FD, Alaska or Pacific Supplement for distance information.

Runway Weight Bearing Capacity/or PCN Pavement Classification Number is shown as a codified expression.

Refer to the appropriate Supplement/Directory for applicable codes e.g.,  
RWY 14-32 S75, T185, ST175, TT325  
PCN 80 F/D/X/U

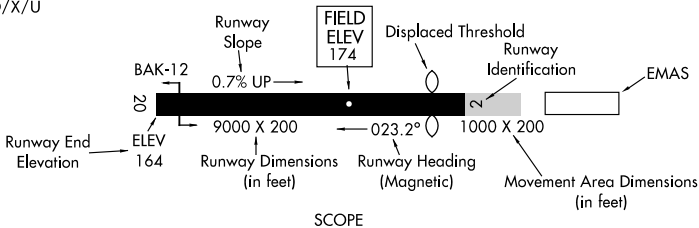

SCOPE

Airport diagrams are specifically designed to assist in the movement of ground traffic at locations with complex runway/taxiway configurations and provide information for updating Computer Based Navigation Systems (I.E., INS, GPS) aboard aircraft. Airport diagrams are not intended to be used for approach and landing or departure operations. For revisions to Airport Diagrams: Consult FAA Order 7910.4.

Approach light symbols are shown in the Flight Information Handbook.

Airport diagram scales are variable.

True/magnetic North orientation may vary from diagram to diagram

Coordinate values are shown in 1 or 1/2 minute increments. They are further broken down into 6 second ticks, within each 1 minute increments.

NOTE:

All new and revised airport diagrams are shown referenced to the World Geodetic System (WGS) (noted on appropriate diagram), and may not be compatible with local coordinates published in FLIP. (Foreign Only)

LEGEND

## LEGEND

This Directory is an alphabetical listing of data on record with the FAA on all airports that are open to the public, associated terminal control facilities, air route traffic control centers and radio aids to navigation within the conterminous United States, Puerto Rico and the Virgin Islands. Airports are listed alphabetically by associated city name and cross referenced by airport name. Facilities associated with an airport, but with a different name, are listed individually under their own name, as well as under the airport with which they are associated.

The listing of an airport in this directory merely indicates the airport operator's willingness to accommodate transient aircraft, and does not represent that the facility conforms with any Federal or local standards, or that it has been approved for use on the part of the general public.

The information on obstructions is taken from reports submitted to the FAA. It has not been verified in all cases. Pilots are cautioned that objects not indicated in this tabulation (or on charts) may exist which can create a hazard to flight operation.

Detailed specifics concerning services and facilities tabulated within this directory are contained in Aeronautical Information Manual, Basic Flight Information and ATC Procedures.

The legend items that follow explain in detail the contents of this Directory and are keyed to the circled numbers on the sample on the preceding page.

### ① CITY/AIRPORT NAME

Airports and facilities in this directory are listed alphabetically by associated city and state. Where the city name is different from the airport name the city name will appear on the line above the airport name. Airports with the same associated city name will be listed alphabetically by airport name and will be separated by a dashed rule line. All others will be separated by a solid rule line. (Designated Helipads and Seaplane Landing Areas (Water) associated with a land airport will be separated by a dotted line.)

### ② NOTAM SERVICE

§— NOTAM "D" (Distance teletype dissemination) and NOTAM "L" (local dissemination) service is provided for airport. Absence of annotation § indicates NOTAM "L" (local dissemination) only is provided for airport. Airport NOTAM file identifier will be shown as "NOTAM FILE IAD" for all public-use airports. See AIM, Basic Flight Information and ATC Procedures for detailed descriptions of NOTAM. Real time Military NOTAMs are available using the DoD Internet NOTAM Distribution System (DINS) [www.notams.jcs.mil](http://www.notams.jcs.mil).

### ③ LOCATION IDENTIFIER

A three or four character code assigned to airports. These identifiers are used by ATC in lieu of the airport name in flight plans, flight strips and other written records and computer operations.

### ④ AIRPORT LOCATION

Airport location is expressed as distance and direction from the center of the associated city in nautical miles and cardinal points, i.e., 4 NE.

### ⑤ TIME CONVERSION

Hours of operation of all facilities are expressed in Coordinated Universal Time (UTC) and shown as "Z" time. The directory indicates the number of hours to be added to/subtracted from UTC to obtain local standard time UTC-10 or UTC +10.

### ⑥ GEOGRAPHIC POSITION OF AIRPORT—AIRPORT REFERENCE POINT (ARP)

Positions are shown in degrees minutes and hundredths of a minute and represent the approximate geometric center of all usable runway surfaces.

### ⑦ CHARTS

The Sectional Chart and Low and High Altitude Enroute Chart and panel on which the airport or facility is located.

### ⑧ INSTRUMENT APPROACH PROCEDURES

IAP indicates an airport for which a prescribed (Public Use) FAA Instrument Approach Procedure has been published.

### ⑨ ELEVATION

The highest point of an airport's usable runways measured in feet from mean sea level. When elevation is sea level it will be indicated as (00). When elevation is below sea level a minus (-) sign will precede the figure.

### ⑩ ROTATING LIGHT BEACON

B indicates rotating beacon is available. Rotating beacons operate dusk to dawn unless otherwise indicated in AIRPORT REMARKS.

### ⑪ SERVICING

S1: Minor airframe repairs.

S2: Minor airframe and minor powerplant repairs.

S3: Major airframe and minor powerplant repairs.

S4: Major airframe and major powerplant repairs.



**12 FUEL**

CODE	FUEL	CODE	FUEL
80	Grade 80 gasoline (Red)	B+	Jet B—Wide-cut turbine fuel with icing inhibitor, freeze point—50° C.
100	Grade 100 gasoline (Green)	J8	(JP-8 Mil Spec) Jet A-1, Kerosene with icing inhibitor, freeze point—50°C.
100LL	Grade 100LL gasoline (low lead) (Blue)	J8+100	(JP-8 Mil spec) Jet A-1, Kerosene with FS-II (Fuel System Icing Inhibitor), FP (Freeze Point) minus 47°C, with fuel additive package that improves thermo stability characteristics of JP-8.
115	Grade 115 gasoline		
A	Jet A—Kerosene freeze point—40° C.		
A1	Jet A-1—Kerosene freeze point—47°C.		
A1+	Jet A-1—Kerosene with icing inhibitor, freeze point—47° C.		
B	Jet B—Wide-cut turbine fuel, freeze point—50° C.	MOGAS	Automobile gasoline which is to be used as aircraft fuel.

**NOTE:** Automobile Gasoline. Certain automobile gasoline may be used in specific aircraft engines if a FAA supplemental type certificate has been obtained. Automobile gasoline which is to be used in aircraft engines will be identified as "MOGAS", however, the grade/type and other octane rating will not be published.

Data shown on fuel availability represents the most recent information the publisher has been able to acquire. Because of a variety of factors, the fuel listed may not always be obtainable by transient civil pilots. Confirmation of availability of fuel should be made directly with fuel dispensers at locations where refueling is planned.

**13 OXYGEN**

- OX 1 High Pressure
- OX 2 Low Pressure
- OX 3 High Pressure—Replacement Bottles
- OX 4 Low Pressure—Replacement Bottles

**14 TRAFFIC PATTERN ALTITUDE**

Traffic Pattern Altitude (TPA)—The first figure shown is TPA above mean sea level. The second figure in parentheses is TPA above airport elevation.

**15 AIRPORT OF ENTRY, LANDING RIGHTS, AND CUSTOMS USER FEE AIRPORTS**

**U.S. CUSTOMS USER FEE AIRPORT**—Private aircraft operators are frequently required to pay the costs associated with customs processing.

**AOE**—Airport of Entry—A customs Airport of Entry where permission from U.S. Customs is not required, however, at least one hour advance notice of arrival must be furnished.

**LRA**—Landing Rights Airport—Application for permission to land must be submitted in advance to U.S. Customs. At least one hour advance notice of arrival must be furnished.

**NOTE:** Advance notice of arrival at both an AOE and LRA airport may be included in the flight plan when filed in Canada or Mexico, where Flight Notification Service (ADCUS) is available the airport remark will indicate this service. This notice will also be treated as an application for permission to land in the case of an LRA. Although advance notice of arrival may be relayed to Customs through Mexico, Canadian, and U.S. Communications facilities by flight plan, the aircraft operator is solely responsible for insuring that Customs receives the notification. (See Customs, Immigration and Naturalization, Public Health and Agriculture Department requirements in the International Flight Information Manual for further details.)

US Customs Air and Sea Ports, Inspectors and Agents  
Pacific Sector (WA, OR, CA, HI and AK) 407-975-1800

**16 CERTIFICATED AIRPORT (14 CFR PART 139)**

Airports serving Department of Transportation certified carriers and certified under 14 CFR part 139 are indicated by the Class and the ARFF Index; e.g. Class I, ARFF Index A, which relates to the availability of crash, fire, rescue equipment. Class I airports can have an ARFF Index A through E, depending on the aircraft length and scheduled departures. Class II, III, and IV will always carry an Index A.

14 CFR PART 139 CERTIFICATED AIRPORTS  
AIRPORT CLASSIFICATIONS

Type of Air Carrier Operation	Class I	Class II	Class III	Class IV
Scheduled Air Carrier Aircraft with 31 or more passenger seats	X			
Unscheduled Air Carrier Aircraft with 31 or more passengers seats	X	X		X
Scheduled Air Carrier Aircraft with 10 to 30 passenger seats	X	X	X	

## AIRPORT/FACILITY DIRECTORY LEGEND

## 14 CFR—PART 139 CERTIFICATED AIRPORTS

## INDICES AND AIRCRAFT RESCUE AND FIRE FIGHTING EQUIPMENT REQUIREMENTS

Airport Index	Required No. Vehicles	Aircraft Length	Scheduled Departures	Agent + Water for Foam
A	1	<90'	≥1	500#DC or 450#DC + or HALON 1211 100 gal H <sub>2</sub> O
B	1 or 2	≥90', <126' ----- ≥126', <159'	≥5 ----- <5	Index A + 1500 gal H <sub>2</sub> O
C	2 or 3	≥126', <159' ----- ≥159', <200'	≥5 ----- <5	Index A + 3000 gal H <sub>2</sub> O
D	3	≥159', <200' >200'	≥5 <5	Index A + 4000 gal H <sub>2</sub> O
E	3	≥200'	≥5	Index A + 6000 gal H <sub>2</sub> O

> Greater Than; < Less Than; ≥ Equal or Greater Than; ≤ Equal or Less Than; H<sub>2</sub>O—Water; DC—Dry Chemical.

NOTE: The listing of ARFF index does not necessarily assure coverage for non-air carrier operations or at other than prescribed times for air carrier. ARFF Index Ltd.—indicates ARFF coverage may or may not be available, for information contact airport manager prior to flight.

### 17 FAA INSPECTION

All airports not inspected by FAA will be identified by the note: Not insp. This indicates that the airport information has been provided by the owner or operator of the field.

### 18 RUNWAY DATA

Runway information is shown on two lines. That information common to the entire runway is shown on the first line while information concerning the runway ends are shown on the second or following line. Lengthy information will be placed in the Airport Remarks.

Runway direction, surface, length, width, weight bearing capacity, lighting, slope and appropriate remarks are shown for each runway. Direction, length, width, lighting and remarks are shown for sealanes. The full dimensions of helpads are shown, i.e., 50X150.

#### RUNWAY SURFACE AND LENGTH

Runway lengths prefixed by the letter "H" indicate that the runways are hard surfaced (concrete, asphalt). If the runway length is not prefixed, the surface is sod, clay, etc. The runway surface composition is indicated in parentheses after runway length as follows:

(AFSC)—Aggregate friction seal coat	(GRVD)—Grooved	(TURF)—Turf
(ASPH)—Asphalt	(GRVL)—Gravel, or cinders	(TRTD)—Treated
(CONC)—Concrete	(PFC)—Porous friction courses	(WC)—Wire combed
(DIRT)—Dirt	(RFSC)—Rubberized friction seal coat	

#### RUNWAY WEIGHT BEARING CAPACITY

Runway strength data shown in this publication is derived from available information and is a realistic estimate of capability at an average level of activity. It is not intended as a maximum allowable weight or as an operating limitation. Many airport pavements are capable of supporting limited operations with gross weights in excess of the published figures. Permissible operating weights, insofar as runway strengths are concerned, are a matter of agreement between the owner and user. When desiring to operate into any airport at weights in excess of those published in the publication, users should contact the airport management for permission. Runway strength figures are shown in thousands of pounds, with the last three figures being omitted. Add 000 to figure following S, D, 2S, 2T, AUW, SWL, etc., for gross weight capacity. A blank space following the letter designator is used to indicate the runway can sustain aircraft with this type landing gear, although definite runway weight bearing capacity figures are not available, e.g., S, D. Applicable codes for typical gear configurations with S=Single, D=Dual, T=Triple and Q=Quadruple:

CURRENT	NEW	NEW DESCRIPTION
S	S	Single wheel type landing gear (DC3), (C47), (F15), etc.
D	D	Dual wheel type landing gear (BE1900), (B737), (A319), etc.
T	D	Dual wheel type landing gear (P3, C9).
ST	2S	Two single wheels in tandem type landing gear (C130).
TRT	2T	Two triple wheels in tandem type landing gear (C17), etc.
DT	2D	Two dual wheels in tandem type landing gear (B707), etc.
TT	2D	Two dual wheels in tandem type landing gear (B757, KC135).
SBBT	2D/D1	Two dual wheels in tandem/dual wheel body gear type landing gear (KC10).

<b>CURRENT</b>	<b>NEW</b>	<b>NEW DESCRIPTION</b>
None	2D/2D1	Two dual wheels in tandem/two dual wheels in tandem body gear type landing gear (A340–600).
DDT	2D/2D2	Two dual wheels in tandem/two dual wheels in double tandem body gear type landing gear (B747, E4).
TTT	3D	Three dual wheels in tandem type landing gear (B777), etc.
TT	D2	Dual wheel gear two struts per side main gear type landing gear (B52).
TDT	C5	Complex dual wheel and quadruple wheel combination landing gear (C5).

AUW—All up weight. Maximum weight bearing capacity for any aircraft irrespective of landing gear configuration.

SWL—Single Wheel Loading. (This includes information submitted in terms of Equivalent Single Wheel Loading (ESWL) and Single Isolated Wheel Loading). SWL figures are shown in thousands of pounds with the last three figures being omitted.

PSI—Pounds per square inch. PSI is the actual figure expressing maximum pounds per square inch runway will support, e.g., (SWL 000/PSI 535).

Omission of weight bearing capacity indicates information unknown.

The ACN/PCN System is the ICAO method of reporting pavement strength for pavements with bearing strengths greater than 12,500 pounds. The Pavement Classification Number (PCN) is established by an engineering assessment of the runway. The PCN is for use in conjunction with an Aircraft Classification Number (ACN). Consult the Aircraft Flight Manual or other appropriate source for ACN tables or charts. Currently, ACN data may not be available for all aircraft. If an ACN table or chart is available, the ACN can be calculated by taking into account the aircraft weight, the pavement type, and the subgrade category. For runways that have been evaluated under the ACN/PCN system, the PCN will be shown as a five part code (e.g. PCN 80 R/B/W/T). Details of the coded format are as follows:

- (1) The PCN NUMBER—The reported PCN indicates that an aircraft with an ACN equal or less than the reported PCN can operate on the pavement subject to any limitation on the tire pressure.
- (2) The type of pavement:
- R — Rigid
  - F — Flexible
- (3) The pavement subgrade category:
- A — High
  - B — Medium
  - C — Low
  - D — Ultra-low
- (4) The maximum tire pressure authorized for the pavement:
- W — High, no limit
  - X — Medium, limited to 217 psi
  - Y — Low, limited to 145 psi
  - Z — Very low, limited to 73 psi
- (5) Pavement evaluation method:
- T — Technical evaluation
  - U — By experience of aircraft using the pavement

NOTE: Prior permission from the airport controlling authority is required when the ACN of the aircraft exceeds the published PCN or aircraft tire pressure exceeds the published limits.

**RUNWAY LIGHTING**

Lights are in operation sunset to sunrise. Lighting available by prior arrangement only or operating part of the night only and/or pilot controlled and with specific operating hours are indicated under airport remarks. Since obstructions are usually lighted, obstruction lighting is not included in this code. Unlighted obstructions on or surrounding an airport will be noted in airport remarks. Runway lights nonstandard (NSTD) are systems for which the light fixtures are not FAA approved L-800 series: color, intensity, or spacing does not meet FAA standards. Nonstandard runway lights, VASI, or any other system not listed below will be shown in airport remarks.

Temporary, emergency or limited runway edge lighting such as flares, smudge pots, lanterns or portable runway lights will also be shown in airport remarks.

Types of lighting are shown with the runway or runway end they serve.

- |   |   |
|---|---|
| NSTD—Light system fails to meet FAA standards.  | SALS—Short Approach Lighting System.  |
| LIRL—Low Intensity Runway Lights.   | SALSF—Short Approach Lighting System with Sequenced Flashing Lights.                                      |
| MIRL—Medium Intensity Runway Lights.  | SSALS—Simplified Short Approach Lighting System.  |
| HIRL—High Intensity Runway Lights.  | SSALF—Simplified Short Approach Lighting System with Sequenced Flashing Lights.                           |
| REIL—Runway End Identifier Lights.  | SSALR—Simplified Short Approach Lighting System with Runway Alignment Indicator Lights.                   |
| CL—Centerline Lights.   | ALSAF—High Intensity Approach Lighting System with Sequenced Flashing Lights.                             |
| TDZL—Touchdown Zone Lights.   | ALSF1—High Intensity Approach Lighting System with Sequenced Flashing Lights, Category I, Configuration.  |
| ODALS—Omni Directional Approach Lighting System.  | ALSF2—High Intensity Approach Lighting System with Sequenced Flashing Lights, Category II, Configuration. |
| AF OVRN—Air Force Overrun 1000' Standard Approach Lighting System.                      | VASI—Visual Approach Slope Indicator System.  |
| LDIN—Lead-In Lighting System.   |   |
| MALS—Medium Intensity Approach Lighting System.   |   |
| MALSF—Medium Intensity Approach Lighting System with Sequenced Flashing Lights.         |   |
| MALSR—Medium Intensity Approach Lighting System with Runway Alignment Indicator Lights. |   |

NOTE: Civil ALSF-2 may be operated as SSALR during favorable weather conditions.

## VISUAL GLIDESLOPE INDICATORS

APAP—A system of panels, which may or may not be lighted, used for alignment of approach path.	PNIL APAP on left side of runway
	PNIR APAP on right side of runway
PAPI—Precision Approach Path Indicator	
	P2L 2-identical light units placed on left side of runway
	P2R 2-identical light units placed on right side of runway
	P4L 4-identical light units placed on left side of runway
	P4R 4-identical light units placed on right side of runway
PVASI—Pulsating/steady burning visual approach slope indicator, normally a single light unit projecting two colors.	
	PSIL— PVASI on left side of runway
	PSIR— PVASI on right side of runway
SAVASI—Simplified Abbreviated Visual Approach Slope Indicator	
	S2L 2-box SAVASI on left side of runway
	S2R 2-box SAVASI on right side of runway
TRCV—Tri-color visual approach slope indicator, normally a single light unit projecting three colors.	
	TRIL TRCV on left side of runway
	TRIR TRCV on right side of runway
VASI—Visual Approach Slope Indicator	
	V2L 2-box VASI on left side of runway
	V2R 2-box VASI on right side of runway
	V4L 4-box VASI on left side of runway
	V4R 4-box VASI on right side of runway
	V6L 6-box VASI on left side of runway
	V6R 6-box VASI on right side of runway
	V12 12-box VASI on both sides of runway
	V16 16-box VASI on both sides of runway

NOTE: Approach slope angle and threshold crossing height will be shown when available; i.e., -GA3.5° TCH37'.

## PILOT CONTROL OF AIRPORT LIGHTING

Key Mike	Function
7 times within 5 seconds	Highest intensity available
5 times within 5 seconds	Medium or lower intensity (Lower REIL or REIL-Off)
3 times within 5 seconds	Lowest intensity available (Lower REIL or REIL-Off)

Available systems will be indicated in the Airport Remarks, as follows:

ACTIVATE MALSR Rwy 7, HIRL Rwy 7-25-122.8 (or CTAF).  
or  
ACTIVATE MIRL Rwy 18-36-122.8 (or CTAF).  
or  
ACTIVATE VASI and REIL, Rwy 07-122.8 (or CTAF).

Where the airport is not served by an instrument approach procedure and/or has an independent type system of different specification installed by the airport sponsor, descriptions of the type lights, method of control, and operating frequency will be explained in clear text. See AIM, "Basic Flight Information and ATC Procedures," for detailed description of pilot control of airport lighting.

## RUNWAY SLOPE

Runway slope will be shown only when it is 0.3 percent or more. On runways less than 8000 feet: When available the direction of the slope upward will be indicated, i.e., 0.3% up NW. On runways 8000 feet or greater: When available the slope will be shown on the runway end line, i.e., RWY 13: 0.3% up., RWY 21: Pole. Rgt tfc. 0.4% down.

## RUNWAY END DATA

Lighting systems such as VASI, MALSR, REIL; obstructions; displaced thresholds will be shown on the specific runway end. "Rgt tfc"—Right traffic indicates right turns should be made on landing and takeoff for specified runway end.

## LAND AND HOLD SHORT OPERATIONS (LAHSO)

LAHSO is an acronym for "Land and Hold Short Operations." These operations include landing and holding short of an intersection runway, an intersecting taxiway, or other predetermined points on the runway other than a runway or taxiway. Measured distance represents the available landing distance on the landing runway, in feet. Specific questions regarding these distances should be referred to the air traffic manager of the facility concerned. The Aeronautical Information Manual contains specific details on hold-short operations and markings.

## RUNWAY DECLARED DISTANCE INFORMATION

TORA—Take-off Run Available. The length of runway declared available and suitable for the ground run of an aeroplane take-off.

TODA—Take-off Distance Available. The length of the take-off run available plus the length of the clearway, if provided.

ASDA—Accelerate-Stop Distance Available. The length of the take-off run available plus the length of the stopway, if provided.

LDA—Landing Distance Available. The length of runway which is declared available and suitable for the ground run of an aeroplane landing.

**19 AIRPORT REMARKS**

The Attendance Schedule is the months, days and hours the airport is actually attended. Airport attendance does not mean watchman duties or telephone accessibility, but rather an attendant or operator on duty to provide at least minimum services (e.g., repairs, fuel, transportation).

Landing Fee indicates landing charges for private or non-revenue producing aircraft, in addition, fees may be charged for planes that remain over a couple of hours and buy no services, or at major airline terminals for all aircraft.

Remarks—Data is confined to operational items affecting the status and usability of the airport.

Unless otherwise stated remarks including runway ends refer to the runway's approach end.

**20 WEATHER DATA SOURCES**

AWOS—Automated Weather Observing System

AWOS-A—reports altimeter setting (all other information is advisory only).

AWOS-1—reports altimeter setting, wind data and usually temperature, dewpoint and density altitude.

AWOS-2—reports the same as AWOS-1 plus visibility.

AWOS-3—reports the same as AWOS-1 plus visibility and cloud/ceiling data.

See AIM, Basic Flight Information and ATC Procedures for detailed description of AWOS.

ASOS—Automated Surface Observing System. Reports the same as an AWOS-3 plus precipitation identification and intensity, and freezing rain occurrence (future enhancement).

SAWRS—identifies airports that have a Supplemental Aviation Weather Reporting Station available to pilots for current weather information.

LAWRS—Limited Aviation Weather Reporting Station where observers report cloud height, weather, obstructions to vision, temperature and dewpoint (in most cases), surface wind, altimeter and pertinent remarks.

LLWAS—indicates a Low Level Wind Shear Alert System consisting of a center field and several field perimeter anemometers.

HIWAS—See RADIO AIDS TO NAVIGATION

TDWR—indicates airports that have Terminal Doppler Weather Radar.

When the automated weather source is broadcast over an associated airport NAVAID frequency (see NAVAID line), it shall be indicated by a bold ASOS, AWOS, HIWAS followed by the frequency identifier and phone number, if available.

**21 COMMUNICATIONS**

Airport terminal control facilities and radio communications associated with the airport shall be shown. When the call sign is not the same as the airport name the call sign will be shown. Frequencies shall normally be shown in descending order with the primary frequency listed first. Frequencies will be listed, together with sectorization indicated by outbound radials, and hours of operation. Communications will be listed in sequence as follows:

Single Frequency Approach (SFA), Common Traffic Advisory Frequency (CTAF), Automatic Terminal Information Service (ATIS) and Aeronautical Advisory Stations (UNICOM) or (AUNICOM) along with their frequency is shown, where available, on the line following the heading "COMMUNICATIONS." When the CTAF and UNICOM frequencies are the same, the frequency will be shown as CTAF/UNICOM 122.8.

The FSS telephone nationwide is toll free 1-800-WX-BRIEF (1-800-992-7433). When the FSS is located on the field it will be indicated as "on arpt". Frequencies available at the FSS will follow in descending order. Remote Communications Outlet (RCO) providing service to the airport followed by the frequency and FSS RADIO name will be shown when available.

FSS's provide information on airport conditions, radio aids and other facilities, and process flight plans. Airport Advisory Service (AAS) is provided on the CTAF by FSS's for select non-tower airports or airports where the tower is not in operation. (See AIM, Para 4-1-9 Traffic Advisory Practices at Airports Without Operating Control Towers or AC 90-42C.)

Aviation weather briefing service is provided by FSS specialists. Flight and weather briefing services are also available by calling the telephone numbers listed.

Remote Communications Outlet (RCO)—An unmanned air/ground communications facility that is remotely controlled and provides UHF or VHF communications capability to extend the service range of an FSS.

Civil Communications Frequencies—Civil communications frequencies used in the FSS air/ground system are operated on 122.0, 122.2, 123.6; emergency 121.5; plus receive-only on 122.1.

- a. 122.0 is assigned as the Enroute Flight Advisory Service frequency at selected FSS RADIO outlets.
- b. 122.2 is assigned as a common enroute frequency.
- c. 123.6 is assigned as the airport advisory frequency at select non-tower locations. At airports with a tower, FSS may provide airport advisories on the tower frequency when tower is closed.
- d. 122.1 is the primary receive-only frequency at VOR's.
- e. Some FSS's are assigned 50 kHz frequencies in the 122-126 MHz band (eg. 122.45). Pilots using the FSS A/G system should refer to this directory or appropriate charts to determine frequencies available at the FSS or remotod facility through which they wish to communicate.

Emergency frequency 121.5 and 243.0 are available at many Flight Services Stations, most Towers, Approach Control and RADAR facilities.

Frequencies published followed by the letter "T" or "R", indicate that the facility will only transmit or receive respectively on that frequency. All radio aids to navigation (NAVAID) frequencies are transmit only.

## TERMINAL SERVICES

CTAF—A program designed to get all vehicles and aircraft at uncontrolled airports on a common frequency.

ATIS—A continuous broadcast of recorded non-control information in selected areas of high activity.

D-ATIS—Digital ATIS provides ATIS information in text form outside the standard reception range of conventional ATIS via landline & data link communications and voice message within range of existing transmitters.

AUNICOM—Automated UNICOM is a computerized, command response system that provides automated weather, radio check capability and airport advisory information selected from an automated menu by microphone clicks.

UNICOM—A non-government air/ground radio communications facility utilized to provide general airport advisory service.

APP CON—Approach Control. The symbol **(R)** indicates radar approach control.

TOWER—Control tower.

GND CON—Ground Control.

GCO—GROUND COMMUNICATION OUTLET—An unstaffed, remotely controlled, ground/ground communications facility. Pilots at uncontrolled airports may contact ATC and FSS via VHF to a telephone connection to obtain an instrument clearance or close a VFR or IFR flight plan. They may also get an updated weather briefing prior to takeoff. Pilots will use four "key clicks" on the VHF radio to contact the appropriate ATC facility or six "key clicks" to contact the FSS. The GCO system is intended to be used only on the ground.

DEP CON—Departure Control. The symbol **(R)** indicates radar departure control.

CLNC DEL—Clearance Delivery.

PRE TAXI CLNC—Pre taxi clearance.

VFR ADVSY SVC—VFR Advisory Service. Service provided by Non-Radar Approach Control.

Advisory Service for VFR aircraft (upon a workload basis) ctc APP CON.

TOWER, APP CON and DEP CON RADIO CALL will be the same as the airport name unless indicated otherwise.

**(22) AIRSPACE**

Information concerning Class B, C, and part-time D and E surface area airspace shall be published with effective times.

Class D and E surface area airspace that is continuous as established by Rulemaking Docket will not be shown.

CLASS B—Radar Sequencing and Separation Service for all aircraft in CLASS B airspace.

CLASS C—Separation between IFR and VFR aircraft and sequencing of VFR arrivals to the primary airport.

TRSA—Radar Sequencing and Separation Service for participating VFR Aircraft within a Terminal Radar Service Area.

Class C, D, and E airspace described in this publication is that airspace usually consisting of a 5 NM radius core surface area that begins at the surface and extends upward to an altitude above the airport elevation (charted in MSL for Class C and Class D). Class E surface airspace normally extends from the surface up to but not including the overlying controlled airspace.

When part-time Class C or Class D airspace defaults to Class E, the core surface area becomes Class E. This will be formatted as:

**AIRSPACE: CLASS C** svc "times" ctc **APP CON** other times CLASS E;

or

**AIRSPACE: CLASS D** svc "times" other times CLASS E.

When a part-time Class C, Class D or Class E surface area defaults to Class G, the core surface area becomes Class G up to, but not including, the overlying controlled airspace. Normally, the overlying controlled airspace is Class E airspace beginning at either 700' or 1200' AGL. This will be formatted as:

**AIRSPACE: CLASS C** svc "times" ctc **APP CON** other times CLASS G, with CLASS E 700' (or 1200') AGL & abv.;

or

**AIRSPACE: CLASS D** svc "times" other times CLASS G with CLASS E 700' (or 1200') AGL & abv.;

or

**AIRSPACE: CLASS E** svc "times" other times CLASS G with CLASS E 700' (or 1200') AGL & abv.

**NOTE; AIRSPACE SVC "TIMES" INCLUDE ALL ASSOCIATED ARRIVAL EXTENSIONS.** Surface area arrival extensions for instrument approach procedures become part of the primary core surface area. These extensions may be either Class D or Class E airspace and are effective concurrent with the times of the primary core surface area. For example, when a part-time Class C, Class D or Class E surface area defaults to Class G, the associated arrival extensions will default to Class G at the same time. When a part-time Class C or Class D surface area defaults to Class E, the arrival extensions will remain in effect as Class E airspace.

**NOTE: CLASS E AIRSPACE EXTENDING UPWARD FROM 700 FEET OR MORE ABOVE THE SURFACE, DESIGNATED IN CONJUNCTION WITH AN AIRPORT WITH AN APPROVED INSTRUMENT PROCEDURE.**

Class E 700' AGL (shown as magenta vignette on sectional charts) and 1200' AGL (blue vignette) areas are designated when necessary to provide controlled airspace for transitioning to/from the terminal and enroute environments. Unless otherwise specified, these 700'/1200' AGL Class E airspace areas remain in effect continuously, regardless of airport operating hours or surface area status. These transition areas should not be confused with surface areas or arrival extensions.

(See Chapter 3, AIRSPACE, in the Aeronautical Information Manual for further details)

**23 RADIO AIDS TO NAVIGATION**

The Airport Facility Directory lists by facility name all Radio Aids to Navigation, except Military TACANS, that appear on FAA, National Aeronautical Navigation Services Visual or IFR Aeronautical Charts and those upon which the FAA has approved an Instrument Approach Procedure. All VOR, VORTAC ILS and MLS equipment in the National Airspace System has an automatic monitoring and shutdown feature in the event of malfunction. Unmonitored, as used in this publication for any navigational aid, means that monitoring personnel cannot observe the malfunction or shutdown signal. The NAVAID NOTAM file identifier will be shown as "NOTAM FILE IAD" and will be listed on the Radio Aids to Navigation line. When two or more NAVAIDS are listed and the NOTAM file identifier is different than shown on the Radio Aids to Navigation line, then it will be shown with the NAVAID listing. NOTAM file identifiers for ILS's and their components (e.g., NDB (LOM) are the same as the identifiers for the associated airports and are not repeated. Automated Surface Observing System (ASOS), Automated Weather Observing System (AWOS), and Hazardous Inflight Weather Advisory Service (HIWAS) will be shown where this service is broadcast over selected NAVAID's.

NAVAID information is tabulated as indicated in the following sample:

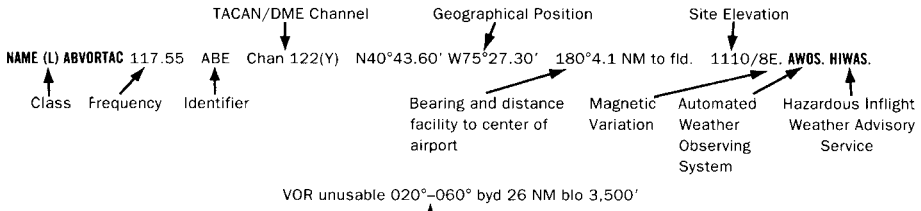

Restriction within the normal altitude/range of the navigational aid (See primary alphabetical listing for restrictions on VORTAC and VOR/DME).

Note: Those DME channel numbers with a (Y) suffix require TACAN to be placed in the "Y" mode to receive distance information.

## AIRPORT/FACILITY DIRECTORY LEGEND

**HIWAS**—Hazardous Inflight Weather Advisory Service is a continuous broadcast of inflight weather advisories including summarized SIGMETs, convective SIGMETs, AIRMETs and urgent PIREPs. HIWAS is presently broadcast over selected VOR's throughout the U.S.

**ASR/PAR**—Indicates that Surveillance (ASR) or Precision (PAR) radar instrument approach minimums are published in the U.S. Terminal Procedures. Only part-time hours of operation will be shown.

### RADIO CLASS DESIGNATIONS

VOR/DME/TACAN Standard Service Volume (SSV) Classifications

SSV Class	Altitudes	Distance (NM)
(T) Terminal	1,000' to 12,000'	25
(L) Low Altitude	1,000' to 18,000'	40
(H) High Altitude	1,000' to 14,500'	40
	14,500' to 18,000'	100
	18,000' to 45,000'	130
	45,000' to 60,000'	100

NOTE: Additionally, (H) facilities provide (L) and (T) service volume and (L) facilities provide (T) service. Altitudes are with respect to the station's site elevation. Coverage is not available in a cone of airspace directly above the facility.

The term VOR is, operationally, a general term covering the VHF omnidirectional bearing type of facility without regard to the fact that the power, the frequency protected service volume, the equipment configuration, and operational requirements may vary between facilities at different locations.

AB _____	Automatic Weather Broadcast.
DF _____	Direction Finding Service.
DME _____	UHF standard (TACAN compatible) distance measuring equipment.
DME(Y) _____	UHF standard (TACAN compatible) distance measuring equipment that require TACAN to be placed in the "Y" mode to receive DME.
GS _____	Glide Slope.
H _____	Non-directional radio beacon (homing), power 50 watts to less than 2,000 watts (50 NM at all altitudes).
HH _____	Non-directional radio beacon (homing), power 2,000 watts or more (75 NM at all altitudes).
H-SAB _____	Non-directional radio beacons providing automatic transcribed weather service.
ILS _____	Instrument Landing System (voice, where available, on localizer channel).
IM _____	Inner marker.
ISMLS _____	Interim Standard Microwave Landing System.
LMM _____	Compass locator station when installed at middle marker site (15 NM at all altitudes).
LOM _____	Compass locator station when installed at outer marker site (15 NM at all altitudes).
MH _____	Non-directional radio beacon (homing) power less than 50 watts (25 NM at all altitudes).
MLS _____	Microwave Landing System.
MM _____	Middle marker.
OM _____	Outer marker.
S _____	Simultaneous range homing signal and/or voice.
SABH _____	Non-directional radio beacon not authorized for IFR or ATC. Provides automatic weather broadcasts.
SDF _____	Simplified Direction Facility.
TACAN _____	UHF navigational facility-omnidirectional course and distance information.
VOR _____	VHF navigational facility-omnidirectional course only.
VOR/DME _____	Collocated VOR navigational facility and UHF standard distance measuring equipment.
VORTAC _____	Collocated VOR and TACAN navigational facilities.
W _____	Without voice on radio facility frequency.
Z _____	VHF station location marker at a LF radio facility.

### ILS FACILITY PERFORMANCE CLASSIFICATION CODES

Codes define the ability of an ILS to support autoland operations. The two portions of the code represent Official Category and farthest point along a Category I, II, or III approach that the Localizer meets Category III structure tolerances.

Official Category: I, II, or III; the lowest minima on published or unpublished procedures supported by the ILS.

Farthest point of satisfactory Category III Localizer performance for Category I, II, or III approaches: A – 4 NM prior to runway threshold, B – 3500 ft prior to runway threshold, C – glide angle dependent but generally 750–1000 ft prior to threshold, T – runway threshold, D – 3000 ft after runway threshold, and E – 2000 ft prior to stop end of runway.

ILS information is tabulated as indicated in the following sample:

ILS/DME 108.5 I-ORL Chan 22 Rwy 18. Class IIE. LOM HERNY NDB.

ILS Facility Performance  
Classification Code



# AIRPORT/FACILITY DIRECTORY LEGEND

## FREQUENCY PAIRING PLAN AND MLS CHANNELING

The following is a list of paired VOR/ILS VHF frequencies with TACAN channels and MLS channels.

TACAN CHANNEL	VHF FREQUENCY	MLS CHANNEL	TACAN CHANNEL	VHF FREQUENCY	MLS CHANNEL	TACAN CHANNEL	VHF FREQUENCY	MLS CHANNEL
2X	134.5	-	47Y	111.05	600	81X	113.40	-
2Y	134.55	-	48X	111.10	530	81Y	113.45	622
11X	135.4	-	48Y	111.15	602	82X	113.50	-
11Y	135.45	-	49X	111.20	-	82Y	113.55	624
12X	135.5	-	49Y	111.25	604	83X	113.60	-
12Y	135.55	-	50X	111.30	532	83Y	113.65	626
17X	108.00	-	50Y	111.35	606	84X	113.70	-
17Y	108.05	540	51X	111.40	-	84Y	113.75	628
18X	108.10	500	51Y	111.45	608	85X	113.80	-
18Y	108.15	542	52X	111.50	534	85Y	113.85	630
19X	108.20	-	52Y	111.55	610	86X	113.90	-
19Y	108.25	544	53X	111.60	-	86Y	113.95	632
20X	108.30	502	53Y	111.65	612	87X	114.00	-
20Y	108.35	546	54X	111.70	536	87Y	114.05	634
21X	108.40	-	54Y	111.75	614	88X	114.10	-
21Y	108.45	548	55X	111.80	-	88Y	114.15	636
22X	108.50	504	55Y	111.85	616	89X	114.20	-
22Y	108.55	550	56X	111.90	538	89Y	114.25	638
23X	108.60	-	56Y	111.95	618	90X	114.30	-
23Y	108.65	552	57X	112.00	-	90Y	114.35	640
24X	108.70	506	57Y	112.05	-	91X	114.40	-
24Y	108.75	554	58X	112.10	-	91Y	114.45	642
25X	108.80	-	58Y	112.15	-	92X	114.50	-
25Y	108.85	556	59X	112.20	-	92Y	114.55	644
26X	108.90	508	59Y	112.25	-	93X	114.60	-
26Y	108.95	558	60X	133.30	-	93Y	114.65	646
27X	109.00	-	60Y	133.35	-	94X	114.70	-
27Y	109.05	560	61X	133.40	-	94Y	114.75	648
28X	109.10	510	61Y	133.45	-	95X	114.80	-
28Y	109.15	562	62X	133.50	-	95Y	114.85	650
29X	109.20	-	62Y	133.55	-	96X	114.90	-
29Y	109.25	564	63X	133.60	-	96Y	114.95	652
30X	109.30	512	63Y	133.65	-	97X	115.00	-
30Y	109.35	566	64X	133.70	-	97Y	115.05	654
31X	109.40	-	64Y	133.75	-	98X	115.10	-
31Y	109.45	568	65X	133.80	-	98Y	115.15	656
32X	109.50	514	65Y	133.85	-	99X	115.20	-
32Y	109.55	570	66X	133.90	-	99Y	115.25	658
33X	109.60	-	66Y	133.95	-	100X	115.30	-
33Y	109.65	572	67X	134.00	-	100Y	115.35	660
34X	109.70	516	67Y	134.05	-	101X	115.40	-
34Y	109.75	574	68X	134.10	-	101Y	115.45	662
35X	109.80	-	68Y	134.15	-	102X	115.50	-
35Y	109.85	576	69X	134.20	-	102Y	115.55	664
36X	109.90	518	69Y	134.25	-	103X	115.60	-
36Y	109.95	578	70X	112.30	-	103Y	115.65	666
37X	110.00	-	70Y	112.35	-	104X	115.70	-
37Y	110.05	580	71X	112.40	-	104Y	115.75	668
38X	110.10	520	71Y	112.45	-	105X	115.80	-
38Y	110.15	582	72X	112.50	-	105Y	115.85	670
39X	110.20	-	72Y	112.55	-	106X	115.90	-
39Y	110.25	584	73X	112.60	-	106Y	115.95	672
40X	110.30	522	73Y	112.65	-	107X	116.00	-
40Y	110.35	586	74X	112.70	-	107Y	116.05	674
41X	110.40	-	74Y	112.75	-	108X	116.10	-
41Y	110.45	588	75X	112.80	-	108Y	116.15	676
42X	110.50	524	75Y	112.85	-	109X	116.20	-
42Y	110.55	590	76X	112.90	-	109Y	116.25	678
43X	110.60	-	76Y	112.95	-	110X	116.30	-
43Y	110.65	592	77X	113.00	-	110Y	116.35	680
44X	110.70	526	77Y	113.05	-	111X	116.40	-
44Y	110.75	594	78X	113.10	-	111Y	116.45	682
45X	110.80	-	78Y	113.15	-	112X	116.50	-
45Y	110.85	596	79X	113.20	-	112Y	116.55	684
46X	110.90	528	79Y	113.25	-	113X	116.60	-
46Y	110.95	598	80X	113.30	-	113Y	116.65	686
47X	111.00	-	80Y	113.35	620	114X	116.70	-

TACAN CHANNEL	VHF FREQUENCY	MLS CHANNEL	TACAN CHANNEL	VHF FREQUENCY	MLS CHANNEL	TACAN CHANNEL	VHF FREQUENCY	MLS CHANNEL
114Y	116.75	688	119X	117.20	-	123Y	117.65	-
115X	116.80	-	119Y	117.25	698	124X	117.70	-
115Y	116.85	690	120X	117.30	-	124Y	117.75	-
116X	116.90	-	120Y	117.35	-	125X	117.80	-
116Y	116.95	692	121X	117.40	-	125Y	117.85	-
117X	117.00	-	121Y	117.45	-	126X	117.90	-
117Y	117.05	694	122X	117.50	-	126Y	117.95	-
118X	117.10	-	122Y	117.55	-			
118Y	117.15	696	123X	117.60	-			

### 24 COMM/NAV/WEATHER REMARKS:

Pertinent remarks concerning communications, NAVAIDs, and weather.

### 25 AIRPORT SKETCH

The airport sketch, when provided, depicts the airport and related topographical information as seen from the air and should be used in conjunction with the text. It is intended as a guide for pilots in VFR conditions. Symbolology that is not self-explanatory will be reflected in the sketch legend. The airport sketch will be oriented with True North at the top. Airport sketches will be added incrementally.

## ABBREVIATIONS

NOTE: s may be added for plural, or as appropriate.

AAF — Army Air Field	GS — Glide Slope	PAR — Precision Approach Radar
ACC — Area Control Center	GWT — gross weight	PAEW — personnel and equipment working
acft — aircraft	hr — hour	PPR — Prior Permission Required
ADF — Automatic Direction Finder	ident — identification	rad — radial
AFB — Air Force Base	ident — Instrument Flight Rules	RAPCON — Radar Approach Control
AFSS — Automated Flight Service Station	IFSS — International Flight Service Station	RATCF — Radar Air Traffic Control Facility (Navy)
AGL — Above Ground Level	intl — international	RCAG — Remote Communications Air/Ground Facility
AHP — Army Heliport	invoF — in the vicinity of	RCAGL — Remote Center Air/Ground Facility Long Range
AID — Airport Information Desk	kHz — kilohertz	RCO — Remote Communications Outlet
ALF — Auxiliary Landing Field	LAA — Local Airport Advisory	rqr — require
ARFF — Aircraft Rescue and Fire Fighting	LDOCF — Long Distance Operations Control Facility	RRP — Runway Reference Point
arpt — airport	LFR — Low/Medium frequency radio range	RSRS — reduced same runway separation
ARS — Air Reserve Station	MAA — maximum author-ized altitude	rwy — runway
ARTCC — Air Route Traffic Control Center	mag — magnetic	RVR — Runway Visual Range
ASR — Airport Surveillance Radar	maint — maintenance	SFL — Sequence Flashing Lights
ATC — Air Traffic Control	MEA — minimum enroute IFR altitude	Sked — schedule
awy — airway	mem — memorial	SM — statute mile/s
BC — back course	MHz — megahertz	SPB — Seaplane Base
bldg — building	mi — mile	SR — sunrise
brg — bearing	MM — Middle Marker ILS	SS — sunset
CERAP — Combined Center Radar Approach Control	MOCA — minimum obstruction clearance altitude	SSB — single sideband
CG — Coast Guard	MRA — minimum reception altitude	svc — service
clsd — closed	MSAW — minimum safe altitude warning	TCH — Threshold Crossing Height
const — construction	MSL — Mean Sea Level	tfc — traffic
crs — course	muni — municipal	TPA — Traffic Pattern Altitude
ctc — contact	MWARA — Major World Air Route Area	UC — Under construction
DF — direction finder	NAS — Naval Air Station	UFN — until further notice
elev — elevation	navaid — navigation aid	USB — Upper Side Band
emerg — emergency	NM — nautical mile/s	VFR — visual flight rules
fac — facility	NOTAM — Notice to Airman	VOLMET — Meteorological Information for Aircraft in Flight
FBO — fixed-base operator	npi — non precision instrument	VOT — VOR Receiver Testing Facility
fld — field	NSTD — nonstandard	WIP — work in progress
flt — flight	ntc — notice	WSO — Weather Service Office
FM — fan marker	obsn — observation	WSFO — Weather Service Forecast Office
freq — frequency	OM — outer marker ILS	wx — weather
FSS — Flight Service Station	O/R — On Request	
GCA — Ground Controlled Approach	OTS — out of service	
gnd — ground		

AIRPORT LOCATOR INDEX

**AMERICAN SAMOA**

OFU ISLAND  
Ofu .....16  
TAU ISLAND  
Fitiuta .....16  
TUTUILA ISLAND  
Pago Pago Intl.....16

**FEDERATED STATES OF MICRONESIA**

KOSRAE ISLAND  
Kosrae .....17  
POHNPEI ISLAND  
Pohnpei Intl .....17  
\* ULITHI ATOLL  
Ulithi.....18  
WENO ISLAND  
Chuuk Intl.....18  
YAP ISLAND  
Yap Intl .....19

**GUAM**

Guam Intl .....19

**HAWAII**

HAWAII  
Bradshaw AAF .....20  
Hilo Intl .....21  
Kaupulehu Heliport .....22  
Kona Intl At Keahole .....22  
Upolu .....23  
Waimea-Kohala .....23

**KAUAI**

Lihue .....24  
Port Allen .....24  
Princeville.....25

**LANAI**

Lanai .....25

**MAUI**

Hana.....26  
Kahului .....26  
Kapalua .....27

**MOLOKAI**

Kalaupapa .....27  
Molokai .....28

**OAHU**

Dillingham Airfield .....28  
Ford Island NALF .....29  
Honolulu Intl .....30  
Kalaeloa (John Rodgers Fld).....32  
Wheeler AAF .....33

**TERN ISLAND**

French Frigate Shoals .....33

**KIRIBATI**

KIRITIMATI (CHRISTMAS ISLAND)  
Cassidy Intl.....34

**KURE ISLAND**

\* Kure.....34

**MARSHALL ISLANDS**

\* ARNO ATOLL  
Ine.....34  
Tinak .....35

\* JABOR JALUIT ATOLL

Jaluit .....35

\* KILI ISLAND

Kili.....35

**KWAJALEIN ATOLL**

Bucholz AAF .....35  
Dyess AAF .....36

**MAJURO ATOLL**

Marshall Islands Intl .....36

\* MEJIT ATOLL

Mejit .....36

\* MILI ATOLL

Mili .....36

\* NAMORIK ATOLL

Namorik .....36

\* TAORA ISLAND/MALOELAP ATOLL

Malaelap .....36

\* UTIRIK ATOLL

Utirik.....37

\* WOTJE ATOLL

Wotje .....37

**MIDWAY ATOLL**

MIDWAY ATOLL/SAND ISLAND  
Henderson Fld.....37

**NORTHERN MARIANA ISLANDS**

PAGAN ISLAND  
Pagan Airstrip .....37

**ROTA ISLAND**

Rota Intl .....38

**SAIPAN ISLAND**

Commonwealth Health Center Heliport .....38  
Francisco C Ada/Saipan Intl.....38

**TINIAN ISLAND**

Tinian Intl .....39

**PALAU**

ANGAUR ISLAND  
Angaur Airstrip .....39

**BABELTHUAP ISLAND**

Babelthuap/Koror .....39  
Peleliu .....40

**WAKE ISLAND**

Wake Island Airfield .....40

\* indicates unknown datum

## AMERICAN SAMOA

## OFU ISLAND

§ OFU (Z08) (NSAS) 1 SE UTC-11 S14°11.06' W169°40.20' HAWAIIAN-MARIANA  
 9 Class III, ARFF Index A NOTAM FILE HNL  
 RWY 08-26: H2000X60 (CONC-WC)  
 RWY 08: Tree. RWY 26: Tree.  
 AIRPORT REMARKS: Attended during scheduled flights only. To land ctc airport manager Pago Pago Intl, call 699-9101. Brush and trees Rwy 08-26 along ldg area encroach into imaginary sfc defined by FAR PART 77. Boulders/rocks adjacent to Rwy 08 apch. 400' MSL powerlines between OFU and Olosega Islands. Numerous high voltage transformer boxes 3' high along N side of rwy. Numerous hydrants 4+ along N side of rwy.  
 COMMUNICATIONS: CTAF 122.9  
 COM/NAV/WEATHER REMARKS: For arpt information ctc New Zealand NOTAM and briefing office (643) 358-1688.

## TAU ISLAND

FITUITA (FAQ)(NSFQ) 0 N UTC-11 S14°12.97' W169°25.41' HAWAIIAN-MARIANA  
 110 B Class III, ARFF Index A NOTAM FILE HNL  
 RWY 12-30: H3200X75 (CONC-GRVD) S-12.5 MIRL  
 RWY 12: REIL. PAPI(P2L)—GA 3.0° TCH 40'. RWY 30: REIL. PAPI(P2L)—GA 3.0° TCH 40'.  
 AIRPORT REMARKS: Attended 1600-0400Z. Rwy 12 and Rwy 30 PAPI OTS indef. ACTIVATE MIRL Rwy 12-30, PAPI and REIL Rwy 12 and Rwy 30—CTAF.  
 COMMUNICATIONS: CTAF 122.9  
 COM/NAV/WEATHER REMARKS: For arpt information ctc New Zealand NOTAM and briefing office (643) 358-1688.

## TUTUILA ISLAND

§ PAGO PAGO INTL (PPG) (NSTU) 3 SW UTC-11 S14°19.90' W170°42.69' HAWAIIAN-MARIANA  
 32 B FUEL 100, JET A1+ LRA Class I, ARFF Index C NOTAM FILE NSTU 11-B-D  
 RWY 05-23: H10000X150 (ASPH-GRVD) S-75, D-170, DT-250, DDT-600 HIRL IAP  
 RWY 05: MALSR. VASI(V4L)—GA 3.25° TCH 51'. Thld dspclcd 1000'. Hill. Rgt tfc.  
 RWY 23: PAPI(P4L)—GA 3.0° TCH 75'. Thld dspclcd 800'. Fence.  
 RWY 08-26: H3800X100 (ASPH) S-75, D-150, DT-230, DDT-550 HIRL  
 RWY 08: Thld dspclcd 1600'. Rgt tfc.  
 RUNWAY DECLARED DISTANCE INFORMATION  
 RWY 05: TORA-9200 TODA-10200 ASDA-9200 LDA-8200  
 RWY 23: TORA-10000 TODA-10000 ASDA-10000 LDA-9200  
 AIRPORT REMARKS: Attended continuously. Olotele Mt. 1617' MSL 3.5 miles W of thld Rwy 08. 399' MSL obstruction light on LOG NDB located on hill 2.0 SM SW of thld Rwy 05. Permanent tramway cable crossing middle of Pago Pago Harbor approximately 4 SM NE of airport rises abruptly to 1609' MSL Mt. Alava on north side of harbor—EXTREMELY HAZARDOUS TO AIRCRAFT. Permanently lighted and marked 226' tower atop Mt. Alava 4.3 SM NNE of airport. All flights (except scheduled) prior permission from airport manager required with 24 hours prior notice. All aircraft transitioning Pago Pago (except commercial carriers) must make fuel arrangements with PPG at 684-733-3158. No fuel will be released otherwise. All acft exceeding 100,000 lbs GWT upon touchdown taxi to thld turn around before taxiing to apron. Acft under 100,000 lbs may make a turn-around wherever feasible. Sea spray from surf and blow holes may drift across Rwy 05-23 under rough sea conditions. Minor power plant repairs only. Customs available. ACTIVATE HIRL Rwy 05-23, MALSR Rwy 05, VASI Rwy 05, PAPI Rwy 23, HIRL Rwy 08-26 and twy lgt—118.3. Landing fee.  
 COMMUNICATIONS: CTAF 122.9  
 FALEOLO APP/DEP CON 126.9  
 RADIO AIDS TO NAVIGATION: NOTAM FILE NSTU.  
 (H) VORTAC 112.5 TUT Chan 72 S14°19.96' W170°42.50' at fld. 10/12E. VORTAC unmonitored.  
 VOR portion unusable:  
 070°-210° byd 23 NM blo 4,000' 229°-249° byd 17 NM blo 3,200'  
 VORTAC unusable:  
 010°-040° byd 13 NM blo 4,000' 265°-345° byd 30 NM blo 16,000'  
 010°-040° byd 30 NM blo 7,000' 295°-010° byd 13 NM blo 8,000'  
 220°-265° byd 24 NM blo 4,000' 345°-005° byd 5 NM all alts  
 265°-295° byd 13 NM blo 5,000' 345°-360° byd 25 NM blo 16,000'  
 360°-010° byd 30 NM blo 16,000'  
 NDB (HHW) 403 TUT S14°19.93' W170°43.17' at fld. Unmonitored.  
 LOGOTALA HILL NDB (MHW) 242 LOG S14°21.23' W170°44.94' 048° 2.6 NM to fld.  
 Unmonitored.  
 ILS/DME 110.3 I-TUT Chan 40 Rwy 05. Unmonitored.  
 COM/NAV/WEATHER REMARKS: For IFR clearances ctc Faleolo Air Traffic Control unit phone 685-42050 or frequency 126.9. Christchurch NZ NOF is issuing agency for PAGO PAGO Intl NOTAMS ctc NR 64 33581688.

LOGOTALA HILL S14°21.23' W170°44.94'  
NDB (MHW) 242 LOG 047° 2.6 NM to Pago Pago Intl. Unmonitored.

HAWAIIAN-MARIANA  
11-C

## FEDERATED STATES OF MICRONESIA

### KOSRAE ISLAND

**KOSRAE** (TTK) (PTSA) 6 NW UTC+11 N05°21.42' E162°57.50'

1-C

11 FUEL JET A1 NOTAM FILE PTSA

IAP

RWY 05-23: H5751X150 (ASPH-GRVD) D-152, ST-175 MIRL

RWY 05: REIL. PAPI(P4L)—GA 3.0° TCH 50'. RWY 23: REIL. PAPI(P4L)—GA 3.0° TCH 50'. Rgt tfc.

**AIRPORT REMARKS:** Attended Mon-Fri 1900-0300Z, Sat 2000-0100Z, Sun on call. Fit plan must be filed 12 hrs prior to estimated time of arrival, include Pohnpei Intl (PTPN) as address of fit plan. PPR for landing to be filed 48 hr in advance with FSM Secretary of Transportation, Communications and Infrastructure. Unmarked/unlighted terrain at elev 797' MSL located approximately 7200' southeast of arpt. Ship vessels with mast as high as 200' MSL may be traversing harbor entrance located South of rwy. For fuel transient acft must make prior arrangements by calling 691-370-2477. ACTIVATE MIRL Rwy 05-23, PAPI and REIL Rwy 05 and Rwy 23—CTAF.

**COMMUNICATIONS:** CTAF 123.6

KOSRAE RADIO 123.6

**RADIO AIDS TO NAVIGATION:** NOTAM FILE TTK.

NDB/DME (MHW) 393 UKS Chan 100 N05°21.18' E162°57.42' at fld.

### POHNPEI ISLAND

**POHNPEI INTL** (PNI)(PTPN) 1 N UTC+11 N06°59.11' E158°12.54'

1-C

8 B FUEL 100, 100LL, JET A1+ AOE NOTAM FILE PTPN

IAP

RWY 09-27: H6001X150 (ASPH-GRVD) S-75, D-170, ST-175, DT-290 MIRL

RWY 09: REIL. PAPI(P4L)—GA 3.0° TCH 50'.

RWY 27: REIL. PAPI(P4L)—GA 3.0° TCH 50'. Rgt tfc.

**AIRPORT REMARKS:** Attended Mon-Fri 1900-0400Z, Sat 1900-0200Z, Sun 0600-1300Z. PPR for landing to be filed 48 hr in advance with Federated States of Micronesia Secretary of Transportation, Communications and Infrastructure. Security on duty 24hr/7 days, ARFF and SAWR on duty for non-scheduled flights. 110' tower located at 06°58'58"N, 158°12'32"E, obstruction lighted. Fit plan must be filed 12 hrs prior to estimated time of arrival, ctc arpt manager (691) 320-2682. One hour notice required to clear rwy. Center of rwy has asph patch, hard breaking not recommended. Obstruction lighted 662' Peipalap Peak located 4900' SW of threshold. CAUTION—Ships with maximum height of 150' in Pohnpei channel 400' off approach end of Rwy 09. For advisory contact Pohnpei Radio prior to final approach or departure. Construction in progress on airfield. Fuel 100 and 100LL stored off airport. Available on request. For fuel unscheduled acft prior notice required call 671-649-8861. ACTIVATE MIRL Rwy 09-27 and Twy lgts—CTAF. For rotating beacon, PAPI Rwy 09 and Rwy 27, REIL Rwy 09 and Rwy 27, wind cone lgts ctc Pohnpei Radio—123.6. Landing fee.

**COMMUNICATIONS:** CTAF 123.6

RADIO 123.6 LAA. 5205X USB emerg only, 2182 emerg only.

**RADIO AIDS TO NAVIGATION:**

NDB/DME (HW) 366 PNI Chan 47 N06°58.35' E158°11.51' at fld.

DME channel 47 is paired with VHF freq 111.0. DME unusable 090°-249° blo 19,000' 250°-270° byd 30 NM blo 2,000'.

**COMM/NAV/WEATHER REMARKS:** LAA available 1 hr prior to scheduled acft arrivals and until ½ hr after departure.

**ULITHI ATOLL****ULITHI** (TTØ2) 0 N UTC+10 N10°01.00' E139°48.00'

6 NOTAM FILE HNL

**Rwy 09-27:** H3300X150 (ASPH)**AIRPORT REMARKS:** Unattended. Rwy usable for emergency only. PPR from HICOMTERPACIS. Saipan. Closed SS to SR.**COMMUNICATIONS:** CTAF 123.6**KOROR RADIO** 123.6 daylight only.

1-B

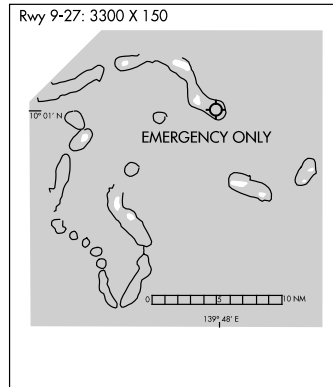
**WENO ISLAND****§ CHUUK INTL** (TKK) (PTKK) 0 SE UTC+10 N07°27.71' E151°50.58'

10 B FUEL 100LL, JET A1+ AOE NOTAM FILE PTKK

**Rwy 04-22:** H6006X150 (ASPH-GRVD) S-115, D-176, ST-175, DD-313, DDT-840 MIRL**Rwy 04:** REIL. PAPI(P4L)—GA 3.0° TCH 50'. Berm.**Rwy 22:** REIL. PAPI(P4L)—GA 3.0° TCH 45'. Thld dsplcd 200'. Berm. Rgt tfc.

**AIRPORT REMARKS:** Attended Mon-Fri 1730-0230Z, Sat 1730-0230Z, Sun 0500-1300Z. Closed SS-SR. Flt plan must be filed 12 hrs prior to estimated time of arrival, include Pohnpei Intl (PTPN) as address of flt plan. PPR from Chief, Immigration and Labor, Federated States of Micronesia, Kolonia, Pohnpei 96941. 24 hr notice to Chuuk Arpt Manager and Chuuk Chief of Immigration stating acft type and registration, persons on board and their citizenship. PPR for ldg must be filed 48 hrs in advance with the Federated States of Micronesia Secretary of Transportation, Communication and Infrastructure. Rwy 04 and Rwy 22 concrete berm at each end of rwy pavement. Rwy 04 and Rwy 22 NSTD distance remaining markers both sides of rwy. For current information on landing, remain over night and parking fees contact Chuuk Arpt Manager, Office of the Governor, Chuuk, ECI 96942. PPR for rotating beacon contact Chuuk Radio 123.6. ACTIVATE MIRL VASIS and REILS Rwy 4-22-123.6. Transient acft must make prior arrangements For fuel by calling (691) 370-2477. Lighted tower 150' AGL located approximately 1950' 080° from SW end runway. Fast rising terrain to 751' MSL within .5 mile immediately SE of runway.

**COMMUNICATIONS:** CTAF 123.6**CHUUK RADIO** 123.6 LAA, 5205X USB emerg only, 2182 emerg only.**RADIO AIDS TO NAVIGATION:** NOTAM FILE TKK.**TRUK NDB/DME (HW)** 375 TKK Chan 111 N07°27.43' E151°50.43' at fld.**COMM/NAV/WEATHER REMARKS:** DME Chan 111 paired with 116.4.

1-C

IAP

**TRUK** N07°27.43' E151°50.43' NOTAM FILE TKK.**NDB/DME (HW)** 375 TKK Chan 111 at Chuuk Intl.

DME unusable:

040°-060° byd 20 NM blo 7,000'

061°-210° byd 25 NM blo 20,000'

061°-210° byd 10 NM blo 11,000'

## YAP ISLAND

**§ YAP INTL** (T11)(PTYA) 00 SW UTC+10 N09°29.94' E138°04.95' 1-B  
IAP

91 B FUEL A1 AOE NOTAM FILE PTYA

**RWY 07-25:** H6000X150 (ASPH-GRVD) S-75, D-160, DT-230 MIRL

**RWY 07:** REIL. PAPI(P4L)—GA 3.0° TCH 50'. Ground. **RWY 25:** REIL. PAPI(P4L)—GA 3.0° TCH 50. Ground.

**AIRPORT REMARKS:** Attended Mon-Fri 1730-0230Z, Sat on call, Sun on call. Sat 24 hrs PPR with filed Flt plan or phone 691-350-2128 Fax (691) 350-2344. PPR for ldg to be filed 48 hrs in advance with the Secretary of Transportation, Federated States of Micronesia, P.O. Box PS-2, Pohnpei, FSM 96941, phone (011) 691-320-2865. Be alert when taxiing, cracks on right and left side of twy. Landing fee. ACTIVATE MIRL VASI and REIL Rwy 07-25 - 123.6. Transient acft must make prior arrangements for fuel with Mobil Oil Guam, expect delay.

**COMMUNICATIONS:** CTAF 123.6

**YAP RADIO** 123.6 LAA. 5205X USB emerg only, 2182 emerg only.

**RADIO AIDS TO NAVIGATION:**

**NDB/DME (HW)** 317 YP Chan 122 N09°29.97' E138°05.31' at fld.

**COMM/NAV/WEATHER REMARKS:** Chan 122 paired with VHF freq 117.5. DME unusable 010°-035° blo 12,000 byd 10 NM, 035°-075° blo 4,000' byd 25 NM, 280°-360° blo 12,000' byd 25 NM.

## GUAM

## GUAM

**§ GUAM INTL** (GUM) (PGUM) 3 NE UTC+10 N13°29.03' E144°47.83' HAWAIIAN-MARIANA  
1-A-B  
IAP

298 B S2 FUEL 100LL, JET A1 OX 1, 2, 3 TPA-1300(1002) LRA

Class I, ARFF Index E NOTAM FILE PGUM

**RWY 06L-24R:** H10015X150 (ASPH-CONC-GRVD) S-135, D-235, DT-390, DDT-780 HIRL

**RWY 06L:** MALSR. PAPI(P4L)—GA 3.0° TCH 68'. Tower. 0.5% up.

**RWY 24R:** PAPI(P4L)—GA 3.0° TCH 76'. Rgt tfc. 0.7% down.

**RWY 06R-24L:** H10014X150 (ASPH-CONC-GRVD) S-135, D-235, DT-390, DDT-780 MIRL

**RWY 06R:** MALSR. PAPI(P4L)—GA 3.0° TCH 76'. Tower. 0.8% up.

**RWY 24L:** PVASI(P4L)—GA 3.0° TCH 75'. Thld dspld 1004'. Hill. Rgt tfc. 0.5% down.

**AIRPORT REMARKS:** Attended continuously. Lighted tower 780' 1.3 NM ENE of Rwy 24L thld. Rising terrain 75' from Rwy 24L thld 140' east of centerline extended +8'. Departing VFR acft maintain rwy heading until past departure end of rwy and reaching 1000' AGL; right pattern 24L/R do not exceed 1500' AGL in tfc pattern. For parking information all acft ctc ramp control. All acft dep terminal parking ctc ramp control for engine start and pushback. Transient acft provide 24 hrs advance information to Executive Manager Guam Intl Arpt Authority, Mon-Fri 2200-0700Z 1-671-646-0300/01/02 or Fax 1-671-646-8823. Rwy 24L Visual glide angle: Angle 3.0° Sat coverage added restricted to 4° left and 6° right of centerline. Customs available 24 hours daily. Landing fee. Consult special notice section of International NOTAMS.

**WEATHER DATA SOURCES:** ASOS (671) 472-7399.

**COMMUNICATIONS:** ATIS 119.0

**Ⓡ GUAM CERAP APP/DEP CON 119.8**

**AGANA TOWER 118.1 GND CON 121.9 CLNC DEL 121.9 RAMP CON 121.6**

**RADIO AIDS TO NAVIGATION:** NOTAM FILE PGUM.

**NIMITZ (H) VORTACW 115.8 UNZ** Chan 105 N13°27.27' E144°44.00' 063° 4.1 NM to fld. 658/2E.

**MT MACAJNA NDB (HW) 385 AJA** N13°27.21' E144°44.22' 061° 4.0 NM to fld.

**ILS/DME 110.3 I-GUM** Chan 40 Rwy 06L. Back course unusable. I-GUM No-NOTAM MP Tue, Thu 2000-2300Z.

**ILS/DME 110.9 I-AWD** Chan 46 Rwy 06R.

**COMM/NAV/WEATHER REMARKS:** For radar advisory beyond 25 NM ctc Guam Center on 118.7. SSB receiving capability available on all HF freq. Aeronautical Radio, Inc. (ARINC) see Associated Data.

## GUAM ARTCC (ZUA) (PGZU)

118.7, 119.8, 120.5 remoted at Mount Santa Rosa. 118.4 remoted at Saipan. 1-A-B

## MT MACAJNA N13°27.21' E144°44.22' NOTAM FILE PGUM.

**NDB (HW) 385 AJA** 061° 3.9 NM to Guam Intl. HAWAIIAN-MARIANA  
1-B

## NIMITZ N13°27.27' E144°44.00' NOTAM FILE PGUM.

**(H) VORTACW 115.8 UNZ** Chan 105 063° 4.1 NM to Guam Intl. 658/2E. HAWAIIAN-MARIANA  
1-A-B

Unusable 200°-238° byd 14 NM below 7000'.

## HAWAII

## HAWAII

**BRADSHAW AAF** (BSF)(PHSF) 9 W UTC-10 N19°45.60' W155°33.23'

HAWAIIAN-MARIANA

6190 FUEL JET A

2-G

**RWY 09-27:** H3695X90 (ASPH) S-12 PCN 13 F/B/W/T 2.9% UP E MIRL**RWY 09:** PAPI(P4L). Rgt tfc. **RWY 27:** Terrain. Rgt tfc.

**AIRPORT REMARKS:** Attended Mon-Fri 1700-0100Z except holidays. 72 hrs PPR for hazardous cargo ops, fixed wing and codes, overflight of ammo supply point located 3300' South of airfield is prohibited. No acft with skids on Fixed Wing ramp. 72 hr PPR for practice approaches. CAUTION—located in R-3103. 500' asph overrun each end of Rwy 09-27. 7' lip at W end of overrun. Overrun available for takeoff Rwy 27 end. 75' of lava rock each side of rwy for dust control. Extensive dust hazard to fixed wing acft on E and W copter park ramps. Overruns unavailable for takeoff. High winds and low level wind shear may exist. Base wx station open Mon-Fri 1700-0100Z exc holidays. Wx observers view obstructed by buildings SSW. Remote wx briefings avbl from 17 OWS wx Squadron 24 hrs at DSN/COMM 449-8333, 2 hr prior notice required for brief. Terrain rises rapidly N of fld to 13,796 MSL. Tfc pattern R/W N of rwy. Extensive copter tfc vicinity of arpt. Fixed wing acft takeoff and landing not authorized when tower closed. High FOD potential in all areas of airfield. When twr closed, acft remain N of Saddle Road and establish two-way communication with Range Control prior to entry R-3103. Hazardous cargo on/off load approach end Rwy 09 only. Hazardous cargo advise twr IAW AR 95-27/AFR 55-14/OPNAVINST. Ltd ARFF facilities for scheduled flights during airfield opr hrs. No aerospace ground equipment, transit alert or maintenance svc. Limited acft parking. Overflight or landing at Kawaihae Docks is prohibited for military acft. Flight within 4900' or direct overflight blo 9000' over Mauna Kea State Park located 8200' ESE of airfield is prohibited. Flt within 3/4 NM or overflight below 7,000' of Waikii Ranch 7.9 NM NW prohibited. Fuel 24 hr PPR 1730-0030Z Mon-Fri except holidays. ACTIVATE MIRL Rwy 09-27 and PAPI Rwy 09-121.7.

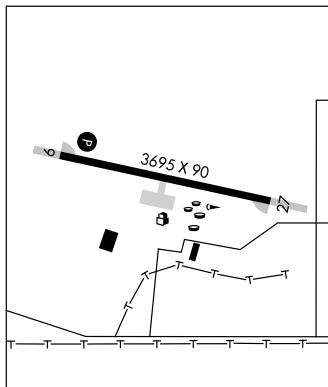
**COMMUNICATIONS:** CTAF 126.3 ATIS 124.70**KAMUELA RCO** 122.1R 113.3T (HONOLULU RADIO)**HONOLULU CONTROL FACILITY APP/DEP CON** 126.0 (1800-0100Z Except Holidays)**TOWER** 126.3 (Mon-Fri 1715-0100Z except holidays)**HICKAM METRO** 346.6 Remote brief avbl. **RANGE** 125.2 38.3 (Opr 24 hrs)**PMSV METRO** 122.75**AIRSPACE:** CLASS D svc effective Mon-Fri 1715-0100Z except holidays other times CLASS G.**RADIO AIDS TO NAVIGATION:** NOTAM FILE ITO.**HILO (H) VORTAC** 116.9 ITO Chan 116 N19°43.28' W155°00.66' 263° 30.8 NM to fld. 23/11E.**NDB (HW)** 339 BSF N19°45.80' W155°35.66' 084° 2.3 NM to fld. NOTAM FILE BSF.**COMM/NAV/WEATHER REMARKS:** PMSV unreadable blo 6190' and vicinity mountains. Svc is avbl only when afd is opr.



**§ HILO INTL** (ITO)(PHTO) 2 E UTC-10 N19°43.22' W155°02.91' HAWAIIAN-MARIANA  
 38 B S1 **FUEL** 100LL, JET A LRA Class I, ARFF Index C NOTAM FILE ITO 2-H  
**RWY 08-26:** H9800X150 (ASPH-GRVD) S-75, D-250, SBTT-450, DT-350, DDT-850 HIRL IAP  
**RWY 08:** ODALS. VASI(V6L)—Upper GA 3.25° TCH 110'. Lower GA 3.0° TCH 60'. Tree.  
**RWY 26:** MALSR. VASI(V4L)—GA 2.6° TCH 52'. Tree.  
**RWY 03-21:** H5600X150 (ASPH) S-75, D-80, SBTT-230, DT-140, DDT-410 MIRL  
**RWY 03:** REIL. VASI(V4L)—GA 3.25° TCH 48'. Thld dsplcd 349'. Fence. **RWY 21:** Pole.  
**AIRPORT REMARKS:** Attended 1700-0630Z. Rwy 03-21 closed to turbine actf 0400-1600. Be alert—occasional bird flocks on arpt and in flight across Rwy 08-26 and Rwy 03-21. For fuel advance notice required, for 100LL call 808-960-5146/864-0236 or ctc freq 128.95, for JET A call 808-935-7757 or ctc freq 130.8. ARFF avbl 24 hrs, ctc 118.1 or 808-934-5830/5831. Avoid overflight of noise sensitive residential areas north, west and southwest of arpt. The 1325' paved area at approach end Rwy 08 marked by chevrons not usable for landing, takeoff, overrun or stopway and cannot be used in computing takeoff data for Rwy 08-26. Obstruction lighted 181' smoke stack located ½ mile south of field. Stationary construction crane 180' MSL (155' AGL) located 1.5 miles west-southwest of arpt. Tower controls entry/exit traffic on taxiways F and E to east terminal ramp. Class A and B explosives prohibited. PPR from arpt manager for transportation of Class C explosives and hazardous material in or out of arpt. Rwy 03-21 no jet operations between 0400-1600Z. PPR from arpt manager for transient parking. Customs available. Rwy 03 VASI usable distance limited to 4NM from thld due to obstructions. ACTIVATE MIRL Rwy 3-21, HIRL Rwy 08-26, MALSR Rwy 26 and ODALS Rwy 08—118.1. 100 grade fuel available Mon-Sat 1800-0300Z call 808-961-6601 or 925-7395/889-6460 (nights and Sundays). Jet fuel available Mon-Sat 1800-0300Z call 808-935-6881/6122 or 961-6601. NOTE: See Area Notices—General Information On Flying To Hawaii.  
**WEATHER DATA SOURCES:** ASOS (808) 961-2077.  
**COMMUNICATIONS:** CTAF 118.1 ATIS 126.4  
**RCO** 122.6 122.2 122.1R (HONOLULU RADIO)  
**APP/DEP CON** 119.7 120.25 (1600-0800Z)  
**HONOLULU CONTROL FACILITY APP/DEP CON** 126.6 (0800-1600Z)  
**TOWER** 118.1 (1600-0800Z) **GND CON** 121.9  
**AIRSPACE:** CLASS D svc effective 1600-0800Z other times CLASS E.  
**RADIO AIDS TO NAVIGATION:** NOTAM FILE ITO.  
**(H) VORTAC** 116.9 ITO Chan 116 N19°43.28' W155°00.66' 257° 2.1 NM to fld. 23/11E.  
**ILS/DME** 110.7 I-TO Chan 44 Rwy 26. Class IA. Back course unusable. ILS unmonitored when twr clsd.

**KAMUELA** N19°59.88' W155°40.19' NOTAM FILE MUE. HAWAIIAN-MARIANA  
**(H) VOR/DME** 113.3 MUE Chan 80 at Waimea-Kohala Fld. 2670/11E. 2-6  
 VOR portion unusable:  
 001°-030° byd 10 NM blo 6,000'  
 070°-084° byd 25 NM blo 7,000'  
 070°-084° byd 35 NM blo 13,000'  
 085°-210° byd 15 NM blo 15,500'  
 290°-360° byd 10 NM blo 7,500'  
 290°-030° byd 20 NM blo 16,000'  
 DME unusable:  
 070°-084° byd 25 NM blo 7,000'  
 070°-084° byd 35 NM blo 13,000'  
 085°-210° byd 15 NM blo 15,500'  
 290°-030° byd 10 NM  
**RCO** 122.1R 113.3T (HONOLULU RADIO)

**KAUPULEHU HELIPORT** (ØØHI) 16 N UTC-10 N19°49.95' W155°58.90'

HAWAIIAN-MARIANA

43 TPA—800(757)

RWY HI: 1155X45 (TRTD)

HELIPORT REMARKS: Attended dawn to dusk. Private use.

COMMUNICATIONS:

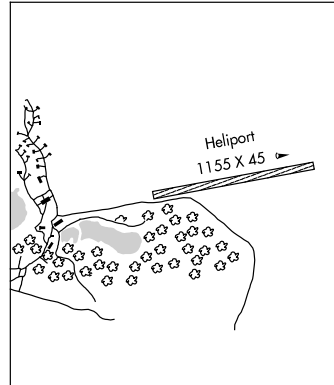

**KILAUEA** N19°26.15' W155°16.37'

RCO 123.6 (HONOLULU RADIO)

HAWAIIAN

2-G

§ **KONA INTL AT KEAHOLE** (KOA) (PHKO) 6 NW UTC-10 N19°44.33' W156°02.74'

HAWAIIAN-MARIANA

47 B FUEL 100, JET A TPA—See Remarks LRA Class I, ARFF Index D NOTAM FILE KOA 2-G

RWY 17-35: H11000X150 (ASPH-GRVD) S-75, D-200, DT-400, DDT-850 HIRL IAP

RWY 17: MALSR. PAPI(P4L)—GA 3.0° TCH 60'. Terrain. Rgt tfc. RWY 35: PAPI(P4L)—GA 3.0° TCH 60'.

**AIRPORT REMARKS:** Attended 1600-0800Z. Migratory bird activity within a 5 NM radius of arpt. All wide-body aircraft contact tower prior to engine start. Kona Tower not responsible for movement on ramp within demarcation line. Request four engine acft taxi with outboard engines at idle due to narrow twy. Minor powerplant repairs available. Traffic pattern altitudes small aircraft 800(753) large aircraft 1500(1453). Rwy 17-35 double dual tandem wheel for DC10-10 450,000 lbs GWT, B747-SP 700,000 lbs GWT, B747-100 850,000 lbs GWT. Ramp immediately in front of twr limited to acft weighing 30000 lbs or less. PPR from arpt manager for transient parking call 808-327-9520. Itinerant acft parking at the base of the twr shall enter and exit via Twy Delta. Class A and B explosives prohibited. PPR from arpt manager for transportation of Class C explosives and hazardous material in and out of arpt. Use minimum power to taxi lane and out of parking spots. Push back/pull out required from terminal parking positions for all acft, no power out. Helicopter operations on and in/ov Twy Alpha. All helicopters confine operations to paved areas. Jet A and 100 octane fuel available daily 1800-0300Z, other times with prior arrangements, call 808-329-4682. U.S. Customs located on north ramp. Jet acft on cargo and south ramp ctc twr prior to engine start. ACTIVATE HIRL Rwy 17-35 and twy lgtS—CTAF.

**WEATHER DATA SOURCES:** ASOS (808) 329-0412. LAWRS.

**COMMUNICATIONS:** CTAF 120.3 ATIS 127.4

RCO 122.1R 115.7T (HONOLULU RADIO)

HONOLULU CONTROL FACILITY APP/DEP CON 126.0

TOWER 120.3 (1600-0800Z) CLNC DEL 121.9

**AIRSPACE:** CLASS D svc effective 1600-0800Z other times CLASS E.

**RADIO AIDS TO NAVIGATION:** NOTAM FILE KOA.

(H) VORTAC 115.7 IAI Chan 104 N19°39.27' W156°01.49' 336° 5.2 NM to fld. 50/11E.

ILS/DME 109.7 I-KOA Chan 34 Rwy 17. Unmonitored when tower closed. DME unmonitored 24 hours. LOC backcourse unusable 25° left and right of centerline.

**PAHOA** N19°32.47' W154°58.33' NOTAM FILE ITO.

HAWAIIAN-MARIANA

NDB (HW) 332 POA 327° 11.6 NM to Hilo Intl. Unmonitored when twr clsd.

2-H

§ **UPOLU** (UPP)(PHUP) 3 NW UTC-10 N20°15.91' W155°51.60' HAWAIIAN-MARIANA  
 96 B TPA—See Remarks NOTAM FILE UPP 2-6  
**RWY 07-25:** H3800X75 (ASPH) S-30, D-129, ST-156 MIRL  
**RWY 07:** PAPI(P2L)—GA 3.0° TCH 29'.  
**RWY 25:** PAPI(P2L)—GA 3.0° TCH 32'. Hill. Rgt tfc.  
**AIRPORT REMARKS:** Unattended. No facilities. PPR for transient parking.  
 PPR from arpt manager phone 808-327-9520 for transportation of Class A and B explosives in or out of arpt. Occasional flocks of birds on and in/ov arpt. All helicopters confine ops to paved areas only. Traffic pattern altitudes small acft 800 (704), large acft 1500 (1404). ACTIVATE MIRL Rwy 07-25 and PAPI Rwy 07 and Rwy 25—CTAF. NOTE: See Area Notices—TRAFFIC ADVISORIES AT NON-TOWER AIRPORTS.  
**COMMUNICATIONS:** CTAF 122.9  
**UPOLU POINT RCO 122.1R 112.3T** (HONOLULU RADIO)  
**RADIO AIDS TO NAVIGATION:** NOTAM FILE UPP.  
**UPOLU POINT (H) VORTAC 112.3** UPP Chan 70 N20°12.03' W155°50.60' 335° 4.0 NM to fld. 1760/11E.

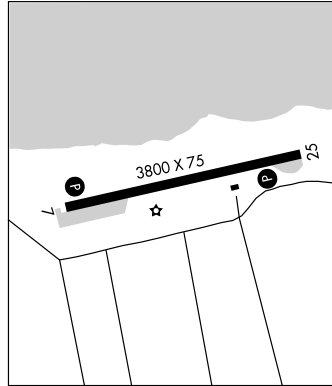

**UPOLU POINT** N20°12.03' W155°50.60' NOTAM FILE UPP. HAWAIIAN-MARIANA  
 (H) VORTAC 112.3 UPP Chan 70 335° 4.0 NM to Upolu. 1760/11E. 2-6  
 RCO 122.1R 112.3T (HONOLULU RADIO)

§ **WAIMEA-KOHALA** (MUE)(PHMU) 1 SW UTC-10 N20°00.08' W155°40.09' HAWAIIAN-MARIANA  
 2671 B FUEL 100LL TPA—See Remarks NOTAM FILE MUE 2-6  
**RWY 04-22:** H5197X100 (ASPH) S-55, D-90, ST-100, TRT-263, DT-150 MIRL IAP  
**RWY 04:** REIL. VASI(V4R)—GA 2.5° TCH 43'. Rgt tfc. **RWY 22:** REIL. VASI(V4L)—GA 3.0° TCH 36'. Fence.  
**AIRPORT REMARKS:** Attended 1600-0530Z. For fuel call 808-885-3300. Telephone line 1000' from approach end Rwy 04. Rwy 04 30' trees 275' rgt of centerline 3000' from approach end rwy. PPR for transient parking. PPR from arpt manager phone 808-327-9520 for transportation of Class A and B explosives in or out of arpt. Occasional flocks of pigeons on arpt and near Rwy 04-22. Glider activity on and in/ov arpt. All helicopters confine ops to paved areas only. Traffic pattern altitudes small acft 3500 (829), large acft 4200 (1529). VASI Rwy 04 unusable byd 8° left of centerline. VASI Rwy 22 unusable byd 5° left and right of centerline. ACTIVATE MIRL Rwy 04-22—CTAF. NOTE: See Area Notices—TRAFFIC ADVISORIES AT NON-TOWER AIRPORTS.  
**WEATHER DATA SOURCES:** AWOS-3 120.0 (808) 887-8127.  
**COMMUNICATIONS:** CTAF 122.9  
**HONOLULU CONTROL FACILITY APP/DEP CON 126.0**  
**AIRSPACE:** CLASS E svc Mon-Fri 1800-0400Z other times CLASS G.  
**RADIO AIDS TO NAVIGATION:** NOTAM FILE MUE.  
**KAMUELA (H) VOR/DME 113.3** MUE Chan 80 N19°59.88' W155°40.19' at fld. 2670/11E.

**KAUAI**  
**BARKING SANDS PMRF** (BKH)(PHBK) N22°01.37' W159°47.10' HAWAIIAN-MARIANA  
 AIRSPACE CLASS D svc Mon-Fri 1700-0400Z except holidays. 2-F

§ **LIHUE** (LIH) (PHLI) 2 E UTC-10 N21°58.56' W159°20.34' HAWAIIAN-MARIANA  
 153 B S2 FUEL 100, JET A TPA—See Remarks LRA Class I, ARFF Index C NOTAM FILE LIH 2-F  
 RWY 17-35: H6500X150 (ASPH-GRVD) S-75, D-175, SBTT-430, DT-250, DDT-630 HIRL IAP  
 RWY 17: REIL. PAPI(P4L)—GA 3.0° TCH 55'. RWY 35: MALSR. PAPI(P4L)—GA 3.0° TCH 55'. Rgt tfc.  
 RWY 03-21: H6500X150 (ASPH-GRVD) S-75, D-200, SBTT-550, DT-350, DDT-730 MIRL 1.1% UP SW  
 RWY 03: REIL. PAPI(P4L)—GA 3.0° TCH 46'. Rgt tfc.  
 RWY 21: REIL. VASI(V4L)—GA 3.0° TCH 52'. Thld dsplcd 205'. Tree.

**AIRPORT REMARKS:** Attended 1600-0800Z. Extensive bird activity on landings and takeoffs. Stadium flood lights 125' AGL/282' MSL 2400' SW from Rwy 03 threshold. PPR for parking transient aircraft with parking access to passenger/cargo gates/facilities between 0800-1600Z; any group of 3 or more aircraft operating in consort, call 246-1400/1462 or write airport manager for parking arrangements. PPR for parking all transient acft between the hours of 1800-0200Z. Pilot or lcl ground handler is required to obtain permission from arpt mgr at 808-246-1400 or 808-246-1462 or write arpt mgr describing arrangements needed. LIH is noise sensitive. Acft needing engine runups for other than normal start-up and taxi out are required to coordinate these runups with arpt mgr. Normal runup area is on Twy Alpha north of Twy B and alpha intersection. Acft orientation is dependent on wind and with twr approval. Power setting will not cause damage to lgts and signs, if run may cause damage an alternate location will be selected. 405' of Rwy 17-35 500' south of Twy D and Rwy 17-35 intersection not visible from twr. Due to nonvisibility twr unable to provide air traffic control svc between acft and/or vehicles on Twy B from 220' to 500' S of Twy D. Tfc departing and entering movement areas ctc twr. Intersection departures from Twy D on Rwy 17-35 not authorized. ARFF available 24 hrs. 100 octane fuel available 1900-0300Z. For JET A fuel call 1-800-776-2138 or 1-800-821-3122. Military acft make fuel arrangements before arrival. PPR for transportation of class A, B, C explosives and hazardous material in and out of arpt. Rwy 17-35 weight limit DC 10-10 340,000 lbs, DC 10-30 430,000 lbs. TPA single engine 1000(847), Multi engine 1500(1347). Rwy 03 PAPI unusable byd 1.5 NM and offset 9.5° E of centerline due to rapidly rising terrain. ACTIVATE HIRL Rwy 17-35, REIL Rwy 17, MALSR Rwy 35, MIRL Rwy 03-21, REIL and PAPI Rwy 03, REIL Rwy 21 and taxiway lgts—CTAF.

**WEATHER DATA SOURCES:** ASOS (808) 246-3707.

**COMMUNICATIONS:** CTAF 118.9 ATIS 127.2

RCO 122.4 122.1R 113.5T (HONOLULU RADIO)

Ⓡ **HONOLULU CONTROL FACILITY APP/DEP CON** 126.5

TOWER 118.9 (128.4 Helicopters) (1600-0800Z) GND CON 121.9

**AIRSPACE:** CLASS D svc 1600-0800Z other times CLASS E.

**RADIO AIDS TO NAVIGATION:** NOTAM FILE LIH.

(H) VORTAC 113.5 LIH Chan 82 N21°57.92' W159°20.29' at fld. 110/11E.

VORTAC unusable 185°-298° byd 11 NM, 298°-308° byd 11 NM, 308°-350° byd 11 NM.

ILS/DME 110.9 I-LIH Chan 46 Rwy 35. Class IE. Localizer unusable beyond 25° West of centerline. Unmonitored when tower clsd.

**COMM/NAV/WEATHER REMARKS:** When twr closed IFR tfc on the ground ctc Honolulu Center on 126.5.

HELIPAD H1: H64X64 (ASPH)

HELIPORT REMARKS: Helicopter pads 1 through 20 located west of control twr.

**NORTH KAUAI** N22°12.55' W159°26.63' HAWAIIAN-MARIANA  
 RCO 122.3 (HONOLULU RADIO) 2-F

§ **PORT ALLEN** (PAK) (PHPA) 1 SW UTC-10 N21°53.82' W159°36.19' HAWAIIAN-MARIANA  
 24 TPA-800(776) LRA NOTAM FILE LIH 2-E  
 RWY 09-27: H2450X60 (ASPH) S-18  
 RWY 09: Thld dsplcd 189'. Rgt tfc.

**AIRPORT REMARKS:** Unattended. Skydiving on and invof arpt. Daily helicopter activity on and invof arpt. Arpt restricted by owner to aircraft weighing less than 12,500 lbs. Avoid overflight of the salt pond, state recreational beach park, residential and commercial areas N of airfield. Ultralights on and invof arpt. No airfield security, overnight acft parking not authorized. Vehicles parked along shoreline fronting approach end Rwy 09. NOTE: See Area Notices—TRAFFIC ADVISORIES AT NON-TOWER AIRPORTS.

**COMMUNICATIONS:** CTAF 122.9

LIHUE RCO 122.6 122.1R 113.5T (HONOLULU RADIO)

**RADIO AIDS TO NAVIGATION:** NOTAM FILE LIH.

SOUTH KAUAI (H) VORTAC 115.4 SOK Chan 101 N21°54.02' W159°31.73' 256° 4.2 NM to fld. 630/11E.

**COMM/NAV/WEATHER REMARKS:** Between 0800-1600Z IFR traffic on the ground contact Honolulu Control Facility on 126.5. LIHUE RCO frequency 122.6 OTS indef.

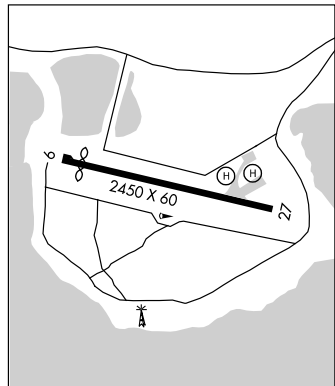

---

**PRINCEVILLE** (HI01) 3 E UTC-10 N22°12.55' W159°26.73' HAWAIIAN-MARIANA  
 344 TPA 1100 (756) 2-F  
**RWY 05-23:** H3560X60 (ASPH) S-30 LIRL (NSTD)  
**RWY 05:** Trees. **RWY 23:** P-line.  
**AIRPORT REMARKS:** Unattended. Daytime VFR operations only. Tree line with trees up to 60' approximately 200' N of rwy centerline near midfield. Tree line with 20' trees 125' N and S of rwy centerline. Ctc Princeville 808-826-3040, 1900-0300Z for ldg authorization and ops requirements. No helicopter operations permitted except for existing operations by resident tour operator. Rwy 05 rising terrain at approximately 5% slope. Acft parking not to exceed 45 minutes due to limited ramp space. Landing fee. NSTD LIRL OTS indef.  
**COMMUNICATIONS:**  
**NORTH KAUI RCO 122.3** (HONOLULU RADIO)  
**RADIO AIDS TO NAVIGATION:** NOTAM FILE LIH.  
**LIHUE (H) VORTAC 113.5** LIH Chan 82 N21°57.92' W159°20.29' 327° 15.8 NM to fld. 110/11E.

---

**SOUTH KAUAI** N21°54.02' W159°31.73' NOTAM FILE LIH. HAWAIIAN-MARIANA  
**(H) VORTAC 115.4** SOK Chan 101 256° 4.2 NM to Port Allen. 630/11E. 2-E  
**VORTAC unusable:**  
 031°-072° byd 28 NM blo 7,500' 250°-270° byd 18 NM blo 7,000'  
 090°-100° byd 25 NM blo 3,500' 310°-030° byd 10 NM blo 18,000'  
 117°-180° byd 14 NM blo 10,000'  
**RCO 122.1R 115.4T** (HONOLULU RADIO)

---

**LANAI**

§ **LANAI** (LNY) (PHNY) 3 SW UTC-10 N20°47.14' W156°57.09' HAWAIIAN-MARIANA  
 1308 B TPA—See Remarks Class I, ARFF Index A NOTAM FILE LNY 2-6  
**RWY 03-21:** H5001X150 (ASPH) S-75, D-110, ST-128, TRT-288, TDT-517 MIRL IAP  
**RWY 03:** VASI(V4L)—GA 3.0° TCH 50'. **RWY 21:** PAPI(P4L)—GA 3.0° TCH 43'. Antenna.  
**AIRPORT REMARKS:** Attended 1600-0530Z. 24 hrs PPR for Class A and B explosives and 4 hrs PPR for hazardous material in/out of arpt ctc 808-565-7333/6757. Arpt CLOSED to air carrier ops with more than 10 passenger seats 0530-1600Z except PPR, call 808-565-7333/6757. Traffic pattern altitudes small acft 2100 (792) large acft 2800 (1492). Possible severe updrafts/downdrafts from 2 mile final apch to Rwy 3 thld. Due to ramp limitations all acft parking limited to one hour except via PPR call 808-565-6757/6611 or 808-872-3880. Fixed wing transient parking SW side of ramp. Pheasants on and invof arpt. Rwy 21 PAPI unusable byd 2 NM due to terrain. ACTIVATE MIRL Rwy 03-21—CTAF. NOTE: See Area Notices—TRAFFIC ADVISORIES AT NON-TOWER ARPTS.  
**WEATHER DATA SOURCES:** ASOS 118.375 (808) 565-6586  
**COMMUNICATIONS:** CTAF 122.9  
**RCO 122.1R 117.7T** (HONOLULU RADIO)  
**HONOLULU CONTROL FACILITY APP/DEP CON 119.3**  
**AIRSPACE:** CLASS E svc continuous.  
**RADIO AIDS TO NAVIGATION:** NOTAM FILE LNY.  
**(H) VORTAC 117.7** LNY Chan 124 N20°45.87' W156°58.13' 027° 1.6 NM to fld. 1250/11E.  
**VORTAC unusable** 020°-060° byd 27 NM blo 5,000'. DME unusable 005°-063° byd 20 NM blo 15,000'.  
**NDB (HHW) 353** LLD N20°46.35' W156°58.41' 047° 1.5 NM to fld.  
**ILS/DME 111.1** I-LNY Chan 48 Rwy 03. GS unusable byd 5° left of course. Unmonitored.

---

## MAUI

**S HANA** (HNM)(PHHN) 3 NW UTC-10 N20°47.74' W156°00.87'

HAWAIIAN-MARIANA

78 B TPA—See Remarks NOTAM FILE HNM

**RWY 08-26:** H3606X100 (ASPH) S-34, D-48, DT-80 MIRL

**RWY 08:** PAPI(P2L)—GA 2.75' TCH 17'. **RWY 26:** Rgt tfc.

**AIRPORT REMARKS:** Attended 1745-0230Z. Wild boars on and in/ovf arpt. Arpt CLOSED to helicopters sunset-sunrise except PPR 808-872-3875. Helicopter pilot training maneuvers will be conducted at the approach end of Rwy 26 only. Ultralights on and in/ovf arpt. 24 hrs PPR for Class A and B explosives and 4 hrs PPR for other hazardous cargo in/out of arpt ctc 808-872-3888. Rwy 08-26 35' trees along both sides of rwy 200' from centerline. Helicopter parking on grass infield areas between ramp and runway. ACTIVATE MIRL (only high intensity avbl) Rwy 8-26—CTAF. Rwy 08 PAPI daylight ops only. Rwy 08 PAPI OTS indef. Traffic pattern altitudes small acft 800 (722) large acft 1500 (1422). NOTE: See Area Notices—TRAFFIC ADVISORIES AT NON-TOWER AIRPORTS.

**WEATHER DATA SOURCES:** AWOS-3—118.325 (808) 248-8471. AWOS visibility unreliable.

**COMMUNICATIONS:** CTAF 122.9

**HANA RCO** 122.3 (HONOLULU RADIO)

**HONOLULU CONTROL FACILITY APP/DEP CON** 126.0 278.3

**CLNC DEL** 122.3

**RADIO AIDS TO NAVIGATION:** NOTAM FILE OGG.

**MAUI (H) VORTAC** 115.1 OGG Chan 98 N20°54.39' W156°25.26' 095° 23.8 NM to fld. 30/11E. Voice OTS indef.

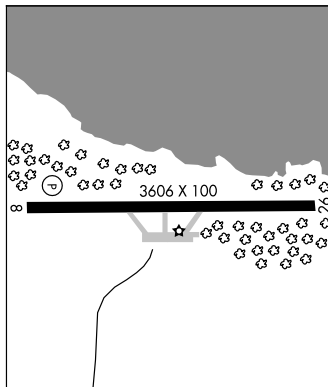

2-G

**S KAHLULI** (OGG)(PHOG) 3 E UTC-10 N20°53.92' W156°25.83'

HAWAIIAN-MARIANA

54 B S2 **FUEL** 100, JET A LRA Class I, ARFF Index D NOTAM FILE OGG

**RWY 02-20:** H6995X150 (ASPH-GRVD) S-130, D-170, DT-360, DDT-750 HIRL

0.6% UP SW

**RWY 02:** MALSR. VASI(V4L)—GA 3.0° TCH 65'. Stack. Rgt tfc.

**RWY 20:** PAPI(P4L)—GA 3.0° TCH 76'. Building.

**RWY 05-23:** H4990X150 (ASPH-GRVD) S-130, D-170, DT-270 MIRL

**RWY 05:** VASI(V4L)—GA 3.0° TCH 40'. Trees. **RWY 23:** Pole. Rgt tfc.

**AIRPORT REMARKS:** Attended continuously. ARFF available 24 hrs. 24 hrs PPR for Class A and B explosives and 4 hrs PPR for other hazardous cargo in/out of arpt; ctc 808-872-3830 1745-0230Z other times 808-872-3888. Lighted tower 570' MSL approximately 3 miles west of airport. Migratory bird activity blo 1500' within 5 NM radius of arpt during August-May. Twy G clsd to acft over 30,000 lbs. Acft above 80,000 lbs ldg Rwy 02 unable to turn off onto Rwy 05 due to Rwy 05 pavement condition. Due to nonvisibility twr unable to provide ATC svc between acft and ground vehicles on the commuter air terminal S of Taxiway F and the helicopter air terminal E of apch end Rwy 02. Due to nonvisibility twr unable to determine if following area is clear of obstructions and/or tfc: portion of Taxiway F between the commuter air terminal and apch end Rwy 05. Ramp area E side Rwy 02 under state authority. Transient parking located on northeast section of E ramp. FAA not responsible for direction and control gnd tfc in area. Area E of apch end Rwy 02 designated as helicopter operations area. No fixed wing acft may operate on helipad during operational hours SR-SS. PPR for fixed wing acft operations on helipad during nonoperational hours call 808-872-3880 1515-0800Z. Access to helipad from Twy C only. Military helicopter ops restricted to HAZMAT area N of Rwy 05-23. Commuter terminal ramp restricted to acft 140,000 lbs or less. Jet A fuel avbl 1700-0400Z, other times by prior arrangement with FBO 24 hrs, (808) 871-5572, or (808) 873-6060. 100 octane fuel avbl 24 hrs self-service. Rwy 05 VASI unusable byd 4 NM from thid due to rapidly rising terrain. Twy F clsd to left turns from Rwy 02 acft above 80,000 lbs. When twr unattended ACTIVATE MALSR Rwy 02, HIRL Rwy 02-20 and MIRL Rwy 05-23—CTAF. Flight Notification Service (ADCUS) available. NOTE: See General Notices—Entry and Departure Requirements. NOTE: See Area Notices—Landing Rights Airports—Gatehold Procedures—Hazards, Cautions and Warnings—CLASS C Airspace—Arrival/Departure Routes—Noise Sensitive Areas—Informal Runway Use Program.

**WEATHER DATA SOURCES:** ASOS (808) 877-6282. LAWRs (1600-0900Z).

**COMMUNICATIONS:** CTAF 118.7 ATIS 128.6 UNICOM 122.95

**(R) HONOLULU CONTROL FACILITY APP/DEP CON** 120.2 (North) 119.5 (South) (1600-0900Z)

**MAUI TOWER** 118.7 (1600-0900Z) **MAUI GND CON** 121.9 **MAUI CLNC DEL** 120.6

**AIRSPACE:** CLASS C svc 1600-0900Z ctc **MAUI APP CON**

**RADIO AIDS TO NAVIGATION:** NOTAM FILE OGG.

**MAUI (H) VORTAC** 115.1 OGG Chan 98 N20°54.39' W156°25.26' at fld. 30/11E. Voice OTS indef.

**VALLEY ISLAND NDB (MHW)** 327 VYI N20°52.85' W156°26.56' 022° 1.3 NM to fld. Unmonitored when tower closed. NDB unusable 075°-160°/225°-310° byd 5 NM.

**ILS/DME** 110.1 I-OGG Chan 38 Rwy 02. Localizer front unusable blo 3000' byd 15° left of course. Unmonitored when tower clsd.

CONTINUED ON NEXT PAGE

**CONTINUED FROM PRECEDING PAGE**

**COMM/NAV/WEATHER REMARKS:** Between 0900Z and 1600Z IFR tfc on the ground ctc Honolulu Control Facility on 119.3. All tfc is requested to follow the procedures described for Traffic Advisories at Non-Tower Airports under Area Notices except to utilize Maui tower freq 118.7 instead of 122.9.

**HELIPAD H1:** H125X125 (ASPH)

§ **KAPALUA** (JHM)(PHJH) 5 NW UTC-10 N20°57.78' W156°40.38' **HAWAIIAN-MARIANA**  
256 Class I, ARFF Index A NOTAM FILE JHM **2-6**

**RWY 02-20:** H3000X100 (ASPH) D-44

**RWY 20:** Tree. Rgt tfc.

**AIRPORT REMARKS:** Attended 1615-0415Z. ARFF hrs 1615-0415Z. Private use only. Arpt restricted to Part 121 and Part 135 FAR operators with PPR, ctc Kahului arpt ops 808-872-3880 (24 hrs). No helicopter ops permitted. No jet powered acft allowed. No practice and training flights permitted. Special noise level standards for acft operating at arpt. Restriction on number of daily flts depending on acft capacity and size. Rapidly rising terrain up to 300' MSL along the full length of Rwy 02-20 approximately 160' E of centerline.

**WEATHER DATA SOURCES:** AWOS-3—118.525 (808) 665-6101.

**COMMUNICATIONS:** CTAF/UNICOM 122.7

**AIRSPACE:** CLASS E svc effective 1600-0430Z other times CLASS G.

**RADIO AIDS TO NAVIGATION:** NOTAM FILE OGG.

**MAUI (H) VORTAC** 115.1 OGG Chan 98 N20°54.39' W156°25.26' 272° 14.6 NM to fld. 30/11E. Voice OTS indef.

**COMM/NAV/WEATHER REMARKS:** AWOS-3 118.525 OTS indef.

**MAUI** N20°54.39' W156°25.26' NOTAM FILE OGG. **HAWAIIAN-MARIANA**  
**(H) VORTAC** 115.1 OGG Chan 98 at Kahului. 30/11E. Voice OTS indef. **2-6**

**VORTAC unusable:**

065°-084° byd 30 NM blo 7,000'

085°-089° byd 30 NM blo 10,000'

106°-160° byd 19 NM blo 24,000'

**VOR portion unusable:**

090°-105° byd 31 NM blo 12,500'

161°-165° byd 23 NM blo 7,000'

210°-240° byd 6 NM blo 9,000'

210°-240° byd 17 NM blo 20,000'

241°-249° byd 27 NM blo 20,000'

250°-285° byd 27 NM blo 20,000'

**DME unusable:**

085°-089° byd 28 NM blo 7,000'

090°-105° byd 28 NM blo 12,500'

161°-165° byd 19 NM blo 7,000'

210°-285° byd 19 NM blo 20,000'

**RCO** 123.6 122.1R 114.3T (HONOLULU RADIO)

**VALLEY ISLAND** N20°52.85' W156°26.56' NOTAM FILE OGG. **HAWAIIAN**  
**NDB (MHW)** 327 YV1 022° 1.3 NM to Kahului. **2-6**  
Unmonitored when tower closed. NDB unusable 075°-160°/225°-310° byd 5 NM.

**MOLOKAI**

§ **KALAUPAPA** (LUP)(PHLU) 2 N UTC-10 N21°12.66' W156°58.42' **HAWAIIAN-MARIANA**  
24 B TPA-800(776) NOTAM FILE MKK **2-6**

**RWY 05-23:** H2700X75 (ASPH) S-17 MIRL

**RWY 05:** PAPI(P2L)—GA 2.75' TCH 25'. **RWY 23:** Rgt tfc.

**AIRPORT REMARKS:** Attended Mon-Fri 1700-0130Z. PPR from State Department of Health, Communicable Disease Division to enter settlement area phone Honolulu 808-586-4580. 24 hrs PPR for Class A and B explosives and 4 hrs PPR for other hazardous material in/out of arpt ctc 808-567-6140/6008. Deer and wild animals on and invof arpt at night. Deep ruts along NE rwy shoulder caused by wild boars. Oct-May large waves impacting shoreline resulting in salt water sprays 40' high. Rwy 05-23 MIRL OTS indef. Rwy 05 PAPI OTS indef. ACTIVATE MIRL Rwy 05-23 high and med ints only freq 122.9. PAPI Rwy 05 operational daylight hrs only. NOTE: See Area Notices—TRAFFIC ADVISORIES AT NON-TOWER ARPTS.

**COMMUNICATIONS:** CTAF 122.9

**MOLOKAI RCO** 122.1R 116.1T (HONOLULU RADIO)

**RADIO AIDS TO NAVIGATION:** NOTAM FILE MKK.

**MOLOKAI (H) VORTAC** 116.1 MKK Chan 108 N21°08.29' W157°10.05' 057° 11.7 NM to fld. 1421/11E.

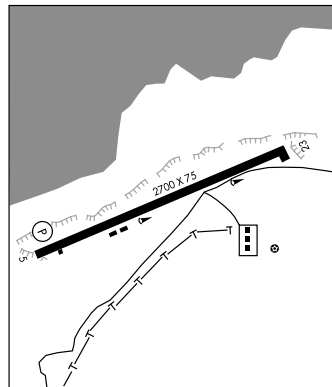

CONTINUED FROM PRECEDING PAGE

**COMM/NAV/WEATHER REMARKS:** Between 0900Z and 1600Z IFR tfc on the ground ctc Honolulu Control Facility on 119.3. All tfc is requested to follow the procedures described for Traffic Advisories at Non-Tower Airports under Area Notices except to utilize Maui tower freq 118.7 instead of 122.9.

• • • • •  
**HELIPAD H1:** H125X125 (ASPH)

§ **KAPALUA** (JHM)(PHJH) 5 NW UTC-10 N20°57.78' W156°40.38' HAWAIIAN-MARIANA  
 256 Class I, ARFF Index A NOTAM FILE JHM 2-6

**RWY 02-20:** H3000X100 (ASPH) D-44  
**RWY 20:** Tree. Rgt tfc.

**AIRPORT REMARKS:** Attended 1615-0415Z. ARFF hrs 1615-0415Z. Private use only. Arpt restricted to Part 121 and Part 135 FAR operators with PPR, ctc Kahului arpt ops 808-872-3880 (24 hrs). No helicopter ops permitted. No jet powered acft allowed. No practice and training flights permitted. Special noise level standards for acft operating at arpt. Restriction on number of daily flts depending on acft capacity and size. Rapidly rising terrain up to 300' MSL along the full length of Rwy 02-20 approximately 160' E of centerline.

**WEATHER DATA SOURCES:** AWOS-3—118.525 (808) 665-6101.

**COMMUNICATIONS:** CTAF/UNICOM 122.7

**AIRSPACE:** CLASS E svc effective 1600-0430Z other times CLASS G.

**RADIO AIDS TO NAVIGATION:** NOTAM FILE OGG.

**MAUI (H) VORTAC** 115.1 OGG Chan 98 N20°54.39' W156°25.26' 272° 14.6 NM to fld. 30/11E. Voice OTS indef.

**COMM/NAV/WEATHER REMARKS:** AWOS-3 118.525 OTS indef.

-----  
**MAUI** N20°54.39' W156°25.26' NOTAM FILE OGG. HAWAIIAN-MARIANA  
**(H) VORTAC** 115.1 OGG Chan 98 at Kahului. 30/11E. Voice OTS indef. 2-6

VORTAC unusable:

- 065°-084° byd 30 NM blo 7,000'
- 085°-089° byd 30 NM blo 10,000'
- 106°-160° byd 19 NM blo 24,000'

VOR portion unusable:

- 090°-105° byd 31 NM blo 12,500' 210°-240° byd 17 NM blo 20,000'
- 161°-165° byd 23 NM blo 7,000' 241°-249° byd 27 NM blo 20,000'
- 210°-240° byd 6 NM blo 9,000' 250°-285° byd 27 NM blo 20,000'

DME unusable:

- 085°-089° byd 28 NM blo 7,000' 161°-165° byd 19 NM blo 7,000'
- 090°-105° byd 28 NM blo 12,500' 210°-285° byd 19 NM blo 20,000'

**RCO** 123.6 122.1R 114.3T (HONOLULU RADIO)

-----  
**VALLEY ISLAND** N20°52.85' W156°26.56' NOTAM FILE OGG. HAWAIIAN  
**NDB (MHW)** 327 YI 022° 1.3 NM to Kahului. 2-6  
 Unmonitored when tower closed. NDB unusable 075°-160°/225°-310° byd 5 NM.

**MOLOKAI**

§ **KALAUPAPA** (LUP)(PHLU) 2 N UTC-10 N21°12.66' W156°58.42' HAWAIIAN-MARIANA  
 24 B TPA-800(776) NOTAM FILE MKK 2-6

**RWY 05-23:** H2700X75 (ASPH) S-17 MIRL

**RWY 05:** PAPI(P2L)—GA 2.75' TCH 25'. **RWY 23:** Rgt tfc.

**AIRPORT REMARKS:** Attended Mon-Fri 1700-0130Z. PPR from State Department of Health, Communicable Disease Division to enter settlement area phone Honolulu 808-586-4580. 24 hrs PPR for Class A and B explosives and 4 hrs PPR for other hazardous material in/out of arpt ctc 808-567-6140/6008. Deer and wild animals on and invof arpt at night. Deep ruts along NE rwy shoulder caused by wild boars. Oct-May large waves impacting shoreline resulting in salt water sprays 40' high. Rwy 05-23 MIRL OTS indef. Rwy 05 PAPI OTS indef. ACTIVATE MIRL Rwy 05-23 high and med ints only freq 122.9. PAPI Rwy 05 operational daylight hrs only. NOTE: See Area Notices—TRAFFIC ADVISORIES AT NON-TOWER ARPTS.

**COMMUNICATIONS:** CTAF 122.9

**MOLOKAI RCO** 122.1R 116.1T (HONOLULU RADIO)

**RADIO AIDS TO NAVIGATION:** NOTAM FILE MKK.

**MOLOKAI (H) VORTAC** 116.1 MKK Chan 108 N21°08.29' W157°10.05' 057° 11.7 NM to fld. 1421/11E.

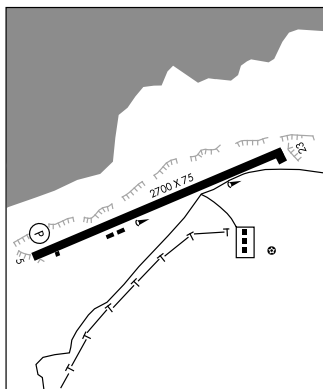



**MOLOKAI** (MKK) (PHMK) 6 NW UTC-10 N21°09.17' W157°05.78' HAWAIIAN-MARIANA  
 454 B TPA—See Remarks Class I, ARFF Index A NOTAM FILE MKK 2-6  
**RWY 05-23:** H4494X100 (ASPH-GRVD) S-30, D-48 MIRL 0.4% up NE IAP  
**RWY 05:** REIL. PAPI(P4L)—GA 3.0° TCH 25'. **RWY 23:** Thld dspcd 593'. Brush.  
**RWY 17-35:** H3118X100 (ASPH) S-13 MIRL 0.6% up N  
**RWY 17:** Thld dspcd 426'. Fence. **RWY 35:** Fence.  
**AIRPORT REMARKS:** Attended 1600-0545Z. CAUTION Egrets and pigeons on and in vicinity of arpt. TPAs small acft 1250 (796) large acft 1950 (1496). Arpt CLOSED to air carrier operations with more than 10 passenger seats Mon thru Sun 0530-1600Z except PPR call 808-567-6140/6008. 24 hrs PPR for Class A and B explosives and 4 hrs PPR for other hazardous material in/out of arpt ctc 808-567-6140/6008. Large acft with wingspan greater than 78' may not use Twy A or Rwy 05-23 for simultaneous ops. Mountain approximately 1280' MSL located 2.8 NM from threshold Rwy 05 on extended centerline. Rwy 05 PAPI not authorized 1.8 NM byd landing thld due to rapidly rising terrain. When twr closed ACTIVATE MIRL Rwy 05-23 and Rwy 17-35, REIL Rwy 05—CTAF. PAPI Rwy 05 operational daylight hrs only.  
**WEATHER DATA SOURCES:** ASOS (808) 567-6106.  
**COMMUNICATIONS:** CTAF 125.7 ATIS 128.2  
**MOLOKAI RCO** 122.1R 116.1T (HONOLULU RADIO)  
**HONOLULU CONTROL FACILITY APP/DEP CON** 124.1  
**TOWER** 125.7 (1600-0430Z) **GND CON** 121.9  
**AIRSPACE:** CLASS D svc 1600-0430Z other times CLASS G.  
**RADIO AIDS TO NAVIGATION:** NOTAM FILE MKK.  
**(H) VORTAC** 116.1 MKK Chan 108 N21°08.29' W157°10.05' 066° 4.1 NM to fld. 1421/11E.  
 Unusable 275°-285° byd 25 NM blo 3,500'

**OAHU**

**DILLINGHAM AIRFIELD** (HDH) (PHDH) 2 W UTC-10 N21°34.77' W158°11.84' HAWAIIAN-MARIANA  
 14 S4 FUEL100 TPA-800(786) NOTAM FILE HNL 2-F  
**RWY 08-26:** H9007X75 (ASPH-RFSC) S-40, D-152, DT-180  
**RWY 08:** Thld dspcd 1993'.  
**RWY 26:** Thld dspcd 1995'. Trees. Rgt tfc.  
**AIRPORT REMARKS:** Attended 1700-0130Z. Parachute Jumping. PPR for civil acft 12,501 pounds and over, ctc airside operations manager at 808-836-6428 Mon-Fri, 1745-0230Z. Sky diving activity on and in vicinity of arpt. Large sea birds on and in vicinity of arpt November through April. Ultralights on and invof arpt. Tree line with 90' trees N and S of rwy approximately 425' from centerline. Marked depression invof the automated fuel pump on southwest apron. Open to civil use thru agreement between the US Army and the State of Hawaii, check NOTAM's prior to use. CLOSED to Civil acft SS-SR. A 5000' x 75' rwy for light powered acft has been painted in the center of the existing 9007' x 75' paved area for civil use starting approximately 2000' from each rwy end. Powered acft shall keep base leg in close and cross the airport boundary fences at or above 600' MSL in order to assure safe separation from sailplanes using the first 2000' (short of the dspcd thld). CAUTION—extensive military helicopter and glider operations daily. No running landings with skid type helicopters on Rwy approved taxiways only. Aerobatic training offshore N of airfield above 1500'. All acft must contact Dillingham UNICOM prior to entering traffic pattern and maintain contact on 123.0 while operating in the Dillingham area. All night flights into airfield must be coordinated with US Army Hawaii Range Control 808-655-4892. Ltd ARFF support available 1700-0130Z. NOTE: See Area Notices—TRAFFIC ADVISORIES AT NON-TOWER AIRPORTS.  
**COMMUNICATIONS:** CTAF/UNICOM 123.0 (1900-0300Z)  
**RADIO:** 122.6 (HONOLULU RADIO)  
**RADIO AIDS TO NAVIGATION:** NOTAM FILE HNL  
**HONOLULU (H) VORTAC** 114.8 HNL Chan 95 N21°18.50' W157°55.83' 306° 22.0 NM to fld. 10/11E.

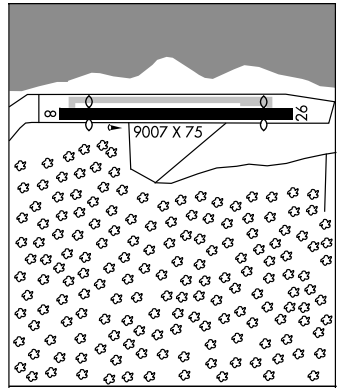

**EWABE** N21°19.49' W158°02.93' NOTAM FILE HNL HAWAIIAN  
**NDB (MHW/LOM)** 242 HN 218° 1.6 NM to Kalaeloa (John Rodgers Fld). 2-E

§ **FORD ISLAND NALF** (NPS) (PHNP) 6 NW UTC-10 N21°21.89' W157°57.59'

HAWAIIAN-MARIANA

18 TPA-600(582) NOTAM FILE HNL

2-E

**RWY 04-22** H4000X150 (ASPH) S-48, D-62

**RWY 22:** Trees. Rgt tfc.

**AIRPORT REMARKS:** Unattended. Arpt CLOSED to civil operations. Tall trees in flt path E of approach end of Rwy 22. When operating blo 982' AGL invof arpt be alert to potential conflict with acft operating at 582' AGL in arpt tfc pattern. SPECIAL VFR CLEARANCE PROHIBITED.

**COMMUNICATIONS:** CTAF/UNICOM 122.9

**RADIO AIDS TO NAVIGATION:** NOTAM FILE HNL.

**HONOLULU (H) VORTAC** 114.8 HNL Chan 95 N21°18.50' W157°55.83' 323° 3.8 NM to fld. 10/11E.

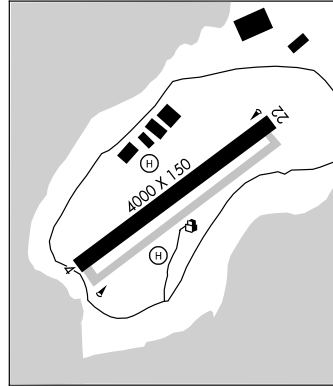

**HONOLULU CONTROL FACILITY** (ZHN) (PHZH)

2-F

**HAMAKUA RCAG**

126.6 Primary for area 90 NM E of Denny, Ebber and Fites DME fixes.

**KOKEE RCAG**

119.9 Primary for area S of Honolulu and area W and NW of Lihue.

**MT HALEAKALA RCAG**

119.3 Primary for Maui area.

124.1 Primary for area NE and E of HNL VORTAC out to about 90 NM.

126.0 Primary for Hilo area.

127.6 Freq used about 90 NM NE and E of Oahu to vicinity of Apack, Bitta, Cluts, and Zigie DME fixes.

**MT KAALA RCAG**

119.9 Back up for area S of Honolulu and for area W and NW of Lihue.

126.5 Primary for area W and NW of Honolulu and Lihue.

135.4 Secondary for all Mt. Kaala RCAG frequencies.

**MAUNA KAPU RCAG**

126.5 Back up for Mount Kaala freq.

135.4 Back up for Mount Kaala freq.

**WAIMANALO RCAG**

119.3 Back up for Haleakala freq.

124.1 Back up for Haleakala freq.

126.0 Back up for Haleakala freq.

127.6 Back up for Haleakala freq.

**§ HONOLULU INTL** (HNL)(PHNL) 3 NW UTC-10 N21°19.12' W157°55.35' **HAWAIIAN-MARIANA**  
 13 B S4 **FUEL** 80, 100, JET A, A1+, B OX 1, 2, 3, 4 TPA—See Remarks **2-E-F**  
 LRA Class I, ARFF Index E NOTAM FILE HNL **IAP**

**RWY 08L-26R:** H12300X150 (ASPH-GRVD) S-100, D-200, ST-175, SBTT-593, DT-400, TRT-566,  
 DDT-780 HIRL

**RWY 08L:** MALSR. PAPI(P4L)—GA 3.0° TCH 80'.

**RWY 26R:** REIL. VASI(V6L)—Upper GA 3.25° TCH 96'. Lower GA 3.0° TCH 52'.

**RWY 08R-26L:** H12000X200 (ASPH-GRVD) S-80, D-170, ST-175, DT-400, DDT-780 HIRL

**RWY 08R:** REIL. VASI(V6L)—Upper GA 3.25° TCH 96'. Lower GA 3.0° TCH 52'.

**RWY 26L:** MALSF. PAPI(P4L)—GA 3.0° TCH 75'. 3 cranes.

**RWY 04R-22L:** H9000X150 (ASPH-GRVD) S-100, D-200, ST-175, DT-400, DDT-850 HIRL

**RWY 04R:** MALSR. PAPI(P4L)—GA 3.0° TCH 71'. Tree.

**RWY 22L:** REIL. VASI(V4L)—GA 3.0° TCH 52'. Stack.

**RWY 04L-22R:** H6952X150 (ASPH) S-100, ST-175, D-200, DT-400, DDT-850 MIRL

**RWY 04L:** REIL. PAPI(P4L)—GA 3.0° TCH 50'. **RWY 22R:** REIL. Antenna. Thld displcd 150'.

#### LAND AND HOLD SHORT OPERATIONS

LANDING	HOLD SHORT POINT	DIST AVBL
<b>RWY 04L</b>	08L-26R	3700
<b>RWY 04R</b>	08L-26R	6250
<b>RWY 08L</b>	04L-22R	9300

#### RUNWAY DECLARED DISTANCE INFORMATION

**RWY 04L:** TORA-6948 TODA-6948 ASDA-6398 LDA-6398

**RWY 22R:** TORA-6948 TODA-6948 ASDA-6948 LDA-6798

#### ARRESTING GEAR/SYSTEMS

**RWY 04R** BAK-14 BAK-12B (1500')

HOOK MB 60 (200') → **RWY 26R**

BAK-14 BAK 12B(B) (1500) **RWY 26L**

**AIRPORT REMARKS:** Attended continuously. 80 and 100 octane fuel avbl thru FBO. Bird strike hazard all runways. See FLIP AP/3 Supplementary arpt information, route and area rstd, and Oakland FIR fit haz. PAEW 600'-1300'E Rwy 22L and Rwy 22R thld, 1700-0130Z Mon-Fri. Rws CLOSED 1730-1930Z every month as follows: Rwy 04R-22L first Tue; Rwy 08R-26L second Tue; and Rwy 08L-26R third Tue. Crane 280' AGL 300' north terminal control concourse until 01 Jan 2009. Rwy 08R-26L 200' pavement width with lgts outside, pavement striped 150' wide. Hold line in effect for twy RA between portion of twy crossing apch zone for Rwy 04L and Rwy 04R. Thld of Rwy 08L difficult to determine due to Twy T. To minimize foreign object damage potential, all acft should use minimum thrust, especially outboard engines, when taxiing past the F-15 alert facility on Twy Tango. Twy P clsd to acft over 12,500 lbs GWT. Wide body and four engine turbo-jets lgbl on Rwy 04R roll to end of rwy, no left turn at Twy K without twr approval. Twy K not a high speed exit twy. Twy L lights btn gate 50 and gate 59 OTS indef. Twy G lighted sign OTS at Rwy 08L-26R Twy G intersection. Twys G and L between Twy A and Inter-Island ramp clsd to wide-bodied and 4-engine turbo-jet acft under power without PPR from arpt ops manager 808-836-6428 Mon-Fri 1745-0230Z. Tfc pattern overhead altitude 2000(1987), restricted to HIANG acft. Tfc pattern altitude for small acft entering from NW 800(787). Tfc pattern altitude for small acft entering from S 1000(987). Tfc pattern altitude for large acft entering from S 1500(1487). No F-16 transient support avbl in accordance with Area Control Center LSET flash safety 06-02. Transient F-16 units should provide their own maintenance support. PPR all acft units planning to stage ops from Hickam AFB must ctc 15 OSS/OSX DSN 315-449-3129 no later than 3 weeks prior regardless. All military acft rqr Customs/Agriculture/Immigration inspection must ctc Hickam Pilot to Dispatcher or if Air Mobility Command ctc Hickam AMCC, no later than 3 hrs prior to arrival with estimated block time, number of Civilian/Military Passengers/Foreign Nationals/and Distinguished Visitor codes. All transient acft, not on an Air Mobility Command mission, will provide a 2-3 hr out call, as well as 20-30 minute out call on 292.5 to the 15 AW/CP (KOA Control). Upon arrival, crews will proceed directly to Command Post (Bldg 2050) and complete an outbound setup sheet to facilitate departure requirements. No COMSEC material avbl thru Hickam Airfield Ops. Transient aircrews should plan to arrive with appropriate amount of COSMEC to complete entire mission. 613AOC/AMD Coronet Msn Commander will meet acft upon arr, all Coronet W tankers use 311.0 for tanker-fighter inter-plane on launch day. After duty hr DSN 448-8888 613AOC/AMD, Fit Management. Due to non-visibility twr unable to determine if the following areas are clear of obstructions and/or tfc: portions of Twy RB between Twy B and Rwy 08R, portions of inter-island acft parking ramp. Due to location of twr, controllers unable to determine whether acft are on correct final apch to Rwy 04L, Rwy 04R, Rwy 22L and Rwy 22R. Remain at least 1 mile offshore of Waikiki Diamond Head Koko Head and EWA Beach. Arrival Rwy 08L, fly ILS apch procedure or a close-in base leg remaining over center of Pearl Harbor Channel. Arrival Rwy 26L and Rwy 26R, remain at tfc pattern altitudes as long as possible before beginning descent for ldg. All military acft with VIP code 7 or avb ctc 15AB command post or relay thru HF/SSB airway 1 hour out to confirm blocktime. All acft inbd to Hickam should address fit plan to PHIK. All inbound helicopters ctc HIK ramp at fld boundary prior to ldg. Hickam Base WX station open Mon-Fri 1400Z-0800Z, clsd weekends/holidays except during local flying, as manning permits.

**CONTINUED ON NEXT PAGE**

CONTINUED FROM PRECEDING PAGE

Limited wx brief support. Remote flt wx briefings ctc 17th Wx Sq 24 hr, DSN 315-449-7924/8333/8335, FAX DSN 315-449-8336; 2 hr prior notice rqr for timely brief. Official obsn taken by FAA. Cooperative wx watch procedures do not exist between Wx and ATC. Recreational boating activities on and invof waterways. During periods of repeated precipitation anticipate wet rwy conditions, if current conditions rqr confirmation ctc Honolulu twr on initial ctc. Rwy 22L VASI unusable byd 2NM from thld. Rwy 26R VASI unusable byd 3.6 NM from thld/obstruction. Rwy 04R-22L DC-10 450,000 L-1011 450,000+ Rwy 04L-22R DC-10 450,000+ L-1011 450,000+ Rwy 08L-26R DC-10 400,000 L-1011 410,000 Rwy 08R-26L DC-10 415,000 L-1011 400,000. ASDE-X surveillance system in use: pilots should opr transponders on all twys and rwys. Flight Notification Service (ADCUS) avbl, 2 hrs advance notice rqr outside regular business hrs. Ldg fee and storage charges collectable on arrival. PPR from arpt manager for transportation of Class A and B explosives in and out of HNL. SPECIAL VFR OPERATIONS PROHIBITED to fixed wing acft.

NOTE—See Area Notices. NOTE—See General Notices—GENERAL INFORMATION ON FLYING TO HAWAII.

NOTE—See Special Notices—Tower Data Link System, Continuous Power Facilities.

WEATHER DATA SOURCES: ASOS (808) 836-0449. WSP.

COMMUNICATIONS: D-ATIS 127.9

HONOLULU FSS (HNL) on arpt. 123.6 122.6 122.2 122.1R

Ⓡ HONOLULU CONTROL FACILITY APP CON 118.3

TOWER 118.1 123.9 GND CON 121.9 ADVISORY RAMP 121.8 (HNL INTL) 133.6 (HICKAM) CLNC DEL 121.4

Ⓡ HONOLULU CONTROL FACILITY DEP CON 118.3 (West) 124.8 (East)

AIRSPACE: CLASS B: See VFR Terminal Area Chart.

VOLMET 13282 8828 6679 2863 Broadcast H+ 00 and 30.

RADIO AIDS TO NAVIGATION: NOTAM FILE HNL.

(H) VORTAC 114.8 HNL Chan 95 N21°18.50' W157°55.83' at fld. 10/11E.

VOR Unusable:

000°-085° byd 15 NM blo 5,500'	251°-260° byd 24 NM blo 2,200'
000°-085° byd 25 NM blo 7,500'	261°-280° byd 20 NM blo 3,000'
100°-115° byd 30 NM blo 4,000'	281°-305° byd 20 NM blo 7,500'
120°-140° byd 35 NM blo 5,000'	306°-330° byd 30 NM blo 7,500'
170°-210° byd 20 NM blo 3,000'	331°-340° byd 32 NM blo 5,500'
240°-250° byd 30 NM blo 3,000'	351°-359° byd 25 NM blo 7,500'
241°-250° byd 35 NM blo 4,000'	

DME Unusable:

000°-085° byd 15 NM blo 5,500'	281°-305° byd 20 NM blo 7,500'
000°-085° byd 25 NM blo 7,500'	306°-330° byd 30 NM blo 7,500'
251°-260° byd 20 NM blo 2,200'	331°-340° byd 32 NM blo 5,500'
261°-280° byd 20 NM blo 3,000'	351°-360° byd 25 NM blo 7,500'

EWABE NDB (MHW/LOM) 242 HN N21°19.49' W158°02.93' 082° 7.1 NM to fld.

ILS 111.7 I-HNL Rwy 08L. LOM EWABE NDB.

ILS/DME 110.5 I-IUM Chan 42 Rwy 04R. Class IE.

LDA/DME 109.1 I-EPC Chan 28 Rwy 26L. Unusable byd 25° N of centerline due to terrain.

COMM/NAV/WEATHER REMARKS: Aeronautical Radio, Inc. (ARINC) see Associated Data. Excessive needle oscillation can be expected over mountainous terrain NE of NDB—CAUTION advised. Hickam ramp twr (Non-ATC facility) All acft on HIK flightline including haz cargo pad will ctc HIK Ramp prior to eng start/taxi. HIK Ramp will provide advisory directions and will relay to AFLD Ops via VHF capable acft. All acft departing to CONUS must complete USDA inspection prior to eng start/taxi.

• • • • •  
WATERWAY 08-26: 5000X300 (WATER)

WATERWAY 04-22: 3000X150 (WATER)

SEAPLANE REMARKS: Rwy 04W-22W and Rwy 08W-26W recreational boating activities on and invof waterways.

<b>§ KALAELOA (JOHN RODGERS FLD)</b>	(JRF) (PHJR) 2 S UTC-10 N21°18.44' W158°04.22'	<b>HAWAIIAN-MARIANA</b>
30 B FUEL 100LL (N106-25) TPA—See Remarks NOTAM FILE JRF		2-E-F
<b>RWY 04R-22L:</b> H8000X200 (ASPH) ST-175, SBT-479, DT-287, TRT-565, DDT-840 HIRL		IAP
<b>RWY 04R:</b> MALSF. PAPI(P4L)—GA 3.0° TCH 30'. <b>RWY 22L:</b> PAPI(P4L)—GA 3.0° TCH 30'.		
<b>RWY 11-29:</b> H6000X200 (ASPH) S-74, D-167, DT-327, DDT-800 MIRL 0.3% up NW		
<b>RWY 11:</b> PAPI(P4L)—GA 3.0° TCH 30'. Rgt tfc. <b>RWY 29:</b> PAPI(P4L)—GA 3.0° TCH 30'.		
<b>RWY 04L-22R:</b> H4500X200 (ASPH) MIRL		
<b>RWY 04L:</b> PAPI(P2L)—GA 3.0° TCH 30'. <b>RWY 22R:</b> PAPI(P2L)—GA 3.0° TCH 30'.		
<b>AIRPORT REMARKS:</b> Attended 1630-0100Z. Traffic pattern alt small aircraft 830 (800), large aircraft 1030 (1000). Avoid overflight refineries west of airport, gaseous exhaust plumes and flames may rise to 267'AGL without warning. Noise abatement procedure: Rwy 11 departure only, Rwy 29 arrival only. Avoid overflight residential areas and schools N and E of airport. Occasional bird hazard approach end Rwy 04L and Rwy 04R. Potential hydroplaning all aircraft due to standing water at intersection Rwy 04R and Rwy 11. PPR all aircraft 225,000 lbs GWT or over, ctc Honolulu Intl airport duty manager at (808) 836-6515. Military helicopter operations on and in/ovf arpt due to U.S. Coast Guard military helipad near Rwy 04R. When ATCT CLOSED ACTIVATE HIRL Rwy 04R-22L, MIRL Rwy 04L-22R, and MIRL Rwy 11-29. MALSF Rwy 04R and twy lights—CTAF. PAPI Rwy 04R and Rwy 22L, Rwy 04L and Rwy 22R, Rwy 11 and Rwy 29 operate continuously.		
<b>WEATHER DATA SOURCES:</b> ASOS (808) 673-7454.		
<b>COMMUNICATIONS:</b> CTAF 132.6 ATIS 119.8		
<b>HONOLULU CONTROL FACILITY APP/DEP CON 118.3</b>		
<b>KALAELOA TOWER 132.6 (1600-0800Z) GND 123.8 CLNC DEL 121.7</b>		
<b>VFR ADVSY SVC</b> ctc HONOLULU APP CON		
<b>AIRSPACE:</b> CLASS D svc 1600-0800Z other times CLASS E.		
<b>RADIO AIDS TO NAVIGATION:</b> NOTAM FILE HNL.		
<b>HONOLULU (H) VORTAC 114.8 HNL</b> Chan 95 N21°18.50' W157°55.83' 259° 7.8 NM to fld. 10/11E.		
<b>EWABE NDB (MHW/LOM) 242 HN</b> N21°19.49' W158°02.93' 218° 1.6 NM to fld.		
<b>COMM/NAV/WEATHER REMARKS:</b> Twr operated by Air National Guard. GCA OTS indef.		
<b>KANEIHE BAY MCAS</b>	(NGF)(PHNG) N21°27.28' W157°46.33' NOTAM FILE PHNG.	<b>HAWAIIAN-MARIANA</b>
<b>AIRSPACE:</b> CLASS D svc Mon-Thu 1700-1000Z, Fri 1700-0800Z, Sat 1800-0300Z (CLASS D svc only),		2-F
Closed Sun and Holidays other times CLASS E.		
<b>KOKO HEAD</b>	N21°15.91' W157°42.18' NOTAM FILE HNL	<b>HAWAIIAN-MARIANA</b>
<b>(H) VORTAC 113.9 CKH</b> Chan 86 274° 12.7 NM to Honolulu Intl. 640/11E.		2-E-F
VOR portion unusable:		
285°-294° byd 27 NM blo 8,000'		
295°-360° byd 21 NM blo 5,500'		
295°-360° byd 32 NM blo 8,000'		
<b>RCO 122.1R 113.9T (HONOLULU RADIO)</b>		
<b>WAIMANALO</b>	N20°19.21' W157°40.90'	<b>HAWAIIAN</b>
<b>RCO 122.2 (HONOLULU RADIO)</b>		2-F

§ **WHEELER AAF** (HHI) (PHHI) 1 SW UTC-10 N21°29.01' W158°02.38'

HAWAIIAN-MARIANA

2-F

837 B TPA—See Remarks

**RWY 06-24:** H5604X295 (ASPH) PCN 51 F/B/W/T HIRL

**RWY 06:** Rgt tfc. **RWY 24:** Rgt tfc.

**AIRPORT REMARKS:** Attended Mon-Fri 1730-0900Z, other times by NOTAM. Rwy 06-24 5000' available. All acft arriving from N after 0400Z will cross airport at 2500' enter tfc from the S. South traffic only. TPA Rotary Wing 1500(663) fixed wing 2000(1163). No transient acft service available. Extensive helicopter tfc in vicinity of arpt. Night vision goggle training A311 500' and below from 1 hr after SS thru 1 hr before SR. Practice approaches by non-tenant acft restricted and approved only contingent upon tenant acft activity—hours of day and etc. PPR for full stop landing, parking and for non-tenant acft use of Wheeler AAF contact operations on commercial 808-656-1282 or V456-1282. Extremely noise sensitive area. Avoid overflight communities surrounding Wheeler AAF. Rotating bcn 1/2 mile N of twr. ACTIVATE HIRL Rwy 06-24—CTAF. Pilot to Metro Service part time.

**COMMUNICATIONS:** CTAF 126.3 ATIS 242.4 119.675

**HONOLULU CONTROL FACILITY APP/DEP CON 118.3**

**TOWER 126.3** (Mon-Fri 1730-0900Z other times by NOTAM.)

**GND CON 121.85**

**PMSV METRO 125.1** (Full svc Mon-Fri 1730-0900Z, except holidays. Remote briefing avbl Hickam Metro 346.6.

**AIRSPACE:** CLASS D svc Mon-Fri 1730-0900Z except holidays other times CLASS G. Class E 700' AGL and above.

**RADIO AIDS TO NAVIGATION:** NOTAM FILE HNL.

**HONOLULU (H) VORTAC 114.8** HNL Chan 95 N21°18.50' W157°55.83' 319° 12.0 NM to fld. 10/11E.

**NDB (HW) 373** HHI N21°28.48' W158°01.85' at fld. Unmonitored 0900-1730Z.

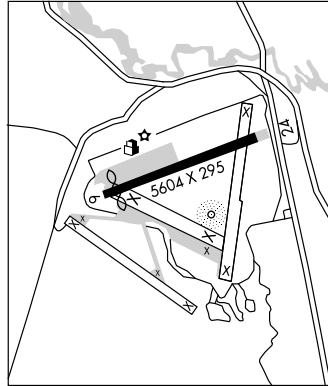

**TERN ISLAND**

**FRENCH FRIGATE SHOALS** (HFS) (PHHF) Ø N UTC-11 N23°51.84' W166°17.08'

1D

6

**RWY 06-24:** 3000X200 (CORAL)

**AIRPORT REMARKS:** CLOSED except in emergency or PPR Fish and Wildlife. Phone Honolulu 541-1201.

**COMMUNICATIONS:**

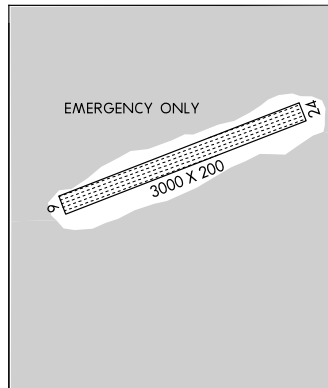

## KIRIBATI

## KIRITIMATI (CHRISTMAS ISLAND)

CASSIDY INTL (PLCH) UTC-10 N01°59.17' W157°20.99'

1-D

5 FUEL 100, JET A1

RWY 08-26: H6900X98 (ASPH) LIRL PCN 45 F/B/X/T

RWY 08: REIL. PAPI—TCH 57' RWY 26: REIL.

**AIRPORT REMARKS:** Attended SR-SS with 48 hr prior notice, manned only when flights are opr. PPR for 600 gal fuel or more. 150' mast 2 NM SW of arpt. Half turns in turning nodes rqr for acft over 12,566 lbs. All non-sked flights are required to notify civ aviation, Tarawa, not later than 1 week prior to arr giving ETA and ETD. Rwy 08-26 edge lgts now spaced in rows at intervals of 312' apart.  
NOTE: See Area Notices—KIRIBATI.

**COMMUNICATIONS:**

RADIO 118.1 13300 11339 3425 8924X 8867 8846 6575X 6553

**RADIO AIDS TO NAVIGATION:**

NDB 333 XI N01°59.28' W157°21.20' at fld.

**COMM/NAV/WEATHER REMARKS:** NDB No aux power. Avbl for notified movements.

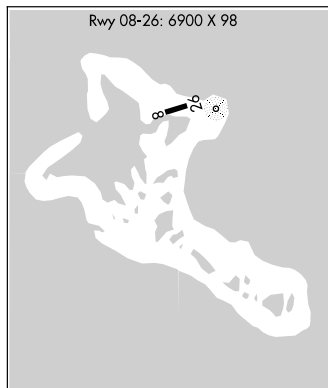

CHRISTMAS ISLAND N01°59.28' W157°21.20' NOTAM FILE

NDB (MHW) 333 XI at Cassidy Intl.

## KURE ISLAND

KURE (PM64) UTC-12 N28°23.00' W178°18.00'

1-C

12

RWY 06-24: 4000X200 (CORAL)

**AIRPORT REMARKS:** Closed except emergency or prior permission 14th CG District Honolulu. Phone 541-2500. 631' tower 1500' NE of rwy.

**COMMUNICATIONS:**

RADIO 9630 5063 4050 12205.

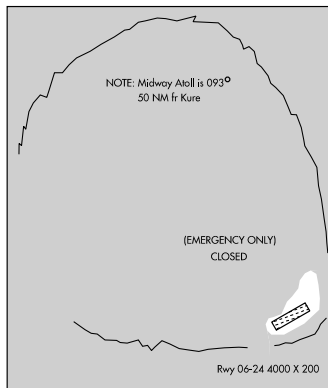

## MARSHALL ISLANDS

## ARNO ATOLL

INE (N20) 0 NW UTC+12 N07°01.00' E171°29.00'

4 NOTAM FILE HNL

Not insp.

RWY 08-26: 2450X50 (GRVL)

**AIRPORT REMARKS:** Attended on call.**COMMUNICATIONS:** CTAF 122.9

**TINAK** (N18) 0 N UTC+12 N07°08.00' E171°55.00'  
 4 NOTAM FILE HNL Not insp.  
**RWY 05-23:** 2850X45 (GRVL)  
**AIRPORT REMARKS:** Attended on call.  
**COMMUNICATIONS:** CTAF 122.9

## JABOR JALUIT ATOLL

**JALUIT** (N55) 1 SE UTC+12 N05°54.40' E169°38.50'  
 4 **FUEL** 100 NOTAM FILE HNL Not insp.  
**RWY 03-21:** 5000X60 (GRVL)  
**AIRPORT REMARKS:** Attended on call. Fuel used for local operations only. For refueling contact Air Marshall Islands (692) 93731.  
**COMMUNICATIONS:** CTAF 122.9

## KILI ISLAND

**KILI** (Q51) 0 N UTC+12 N05°39.00' E169°07.00'  
 5 NOTAM FILE HNL Not insp.  
**RWY 04-22:** 4400X100 (GRVL)  
**AIRPORT REMARKS:** Attended on call.  
**COMMUNICATIONS:** CTAF 122.9

## KWAJALEIN ATOLL

**BUCHOLZ AAF** (KWA) (PKWA) UTC+12 N08°43.21' E167°43.90' 1-C

9 B **FUEL** JET B+ OX 1, 2 LRA NOTAM FILE PKWA  
**RWY 06-24:** H6668X198 (ASPH) S-158, D-205, DT-308  
 PCN 43 F/A/W/T HIRL  
**RWY 06:** REIL. PAPI(P4L)—GA 3.0° TCH 50'.  
**RWY 24:** PAPI(P4L)—GA 3.0° TCH 51'.

**AIRPORT REMARKS:** Attended 1730-0930Z. 24 hr PPR thru Commander, US Army Kwajalein Atoll, P.O. Box 26 APO AP 96555, ATTN: Base Ops, C805-355-2131, Continental United States DSN 254-2131, HI/C 471-1836 X2131, HI/DSN 480-2131. Limited staffing, no transient service. 250' tower 8.5 NM PKWA bearing 300°. Electro-magnetic radiation may exist 24 hrs daily within 5 NM from surface to 30,000'. **CAUTION**—Pilots have experienced vertigo during night operations especially during periods of reduced visibility due to lack of visual cues. Portions of Twy E not visible from tower. Avoid rain catchments on N side of rwy and taxiway. **CAUTION**—men equipment and vehicles may be operating in close proximity to rwy. Acft with explosive cargo require a special PPR and any additional cost of operation may be charged to shipper. Acft with explosive cargo should plan to arrive between 2030-0530Z. Numerous trees and other obstructions within 300' S of rwy. TACAN tower 75' high lctd 164' N of Twy E centerline. Approved wx available 24 hrs. Report on initial call up with Awos Wx info avbl on freq 119.675 or call 805-355-8161. Reduced airfield staffing Sun-Mon. Use of parallel Taxiway E limited to C-141 and smaller acft. **NOTE:** See Area Notices—MARSHALL ISLANDS. Twy A and Twy E are weight restricted for the following acft: B737, B757, B767, C-5, C-17, C-130, C-141, and DC-8 back taxi and 180° turn on rwy will be required, for either arr or dep. Exceptions may be granted for Twy A, in order to access explosive cargo parking locations.

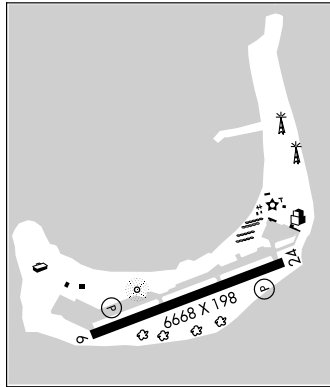

### COMMUNICATIONS:

**SAN FRANCISCO ARINC** (KWA). NOTAM FILE PKWA.

**KWAJALEIN TOWER** 126.2 (Tue-Sat 2200-0600Z excluding Federal holidays. Base ops provides advisory service on 118.8 when twr clsd.)

**AIRSPACE:** CLASS D svc effective Mon 0000-0800Z, Tue-Sat 1745-0930Z other times CLASS G.

**RADIO AIDS TO NAVIGATION:** NOTAM FILE HNL.

**NDB (HW)** 359 NDJ N08°43.25' E167°43.67' at fld.



§ **DYESS AAF** (ROI) UTC+12 N09°23.81' E167°28.25' 1-C  
 14 B NOTAM FILE HNL  
**RWY 04-22:** H4499X150 (ASPH) S-58 PCN 11 F/B/W/T  
**RWY 04:** REIL. VASI(V4L).  
**AIRPORT REMARKS:** No facilities—ARFF available. No transient acft authorized. Electro-magnetic radiation will exist 24 hrs daily within 10 NM radius of Dyess AAF from surface to 50,000'. Acft within the abv airspace will be exposed to direct radiation which may produce harmful effect to persons and equipment. REIL available Rwy 04 with prior notice. Five lighted antennae; 263' dish located .6 NM E, 175' dish located .7 NM ENE, 273' located 1.3 NM SE, 150' located 800'S, 210' located .4 NM NNW. Military rotating beacon atop 137' water tower 950' SE. Taxiway lighted. NOTE: See Area Notices—MARSHALL ISLANDS.  
**COMMUNICATIONS:**  
**SAN FRANCISCO ARINC** (HNL) NOTAM FILE HNL.  
**ROI RADIO 118.1**  
**KWAJALEIN APP/DEP CON 126.2** (Mon 0000-0800Z, Tue-Sat 1745-0930Z)

**MAJURO ATOLL**

§ **MARSHALL ISLANDS INTL** (MAJ) (PKMJ) 7 SW UTC+12 N07°03.90' E171°16.32' 1-C  
 6 B **FUEL 115, JET A1+** LRA NOTAM FILE PKMJ IAP  
**RWY 07-25:** H7897X150 (ASPH-GRVD) S-120, D-171, DT-290 PCN 64 F/B/X/T MIRL  
**RWY 07:** PAPI(P4L)—GA 3.0° TCH 54'. Fence. **RWY 25:** PAPI(P4L)—GA 3.0° TCH 45'. Tree.  
**AIRPORT REMARKS:** Attended on request. PPR for Idg from arpt manager 24 hrs in advance. Transient aircraft must make prior arrangements for fuel with MOBILE OIL Guam. After sender has confirmed fuel delivery, he must give 24 hours advance notice to Airport Superintendent and Immigration Officer, Majuro, Marshall Islands. If ETA is between 0400Z Fri to 2200Z Mon, 48 hours advance notice must be given to Airport Superintendent. Message will include name of sender, type of aircraft, aircraft identification number, ETA purpose of landing, such as ferry flight, number of crew, passengers and citizenships, and that sender has obtained fuel confirmation from MOBILE OIL Guam including quantity and type of fuel. Include RON in message if applicable. Airport Superintendent available 1930-0430Z Mon-Fri. 200' tower located at N07°06.25' E171°22.37' obstruction lighted. ACTIVATE MIRL Rwy 07-25 and VASI Rwys 07 and 25—CTAF.  
**COMMUNICATIONS:** CTAF 123.6  
**MAJURO RADIO 123.6** LAA 126.6 emerg only 5205X USB emerg only 2182 emerg only.  
**RADIO AIDS TO NAVIGATION:**  
**MAJURO NDB/DME (HW) 316** MAJ Chan 114 N07°04.13' E171°16.91' at fld.  
**COMM/NAVAID REMARKS:** DME Channel 114 paired with VHF freq 116.7.

-----  
**MAJURO** N07°04.13' E171°16.91' NOTAM FILE HNL 1-C  
**NDB/DME (HW) 316** MAJ Chan 114 at Marshall Island Intl.  
**COMM/NAVAID REMARKS:** Chan 114 paired with VHF freq 116.7.

-----  
**MEJIT** (Q3Ø) 0 NE UTC+12 N10°17.00' E170°53.00'  
 5 NOTAM FILE HNL Not insp.  
**RWY 07-25:** 3000X50 (GRVL)  
**AIRPORT REMARKS:** Attended on call.  
**COMMUNICATIONS:** CTAF 122.9

**MILI ISLAND**

**MILI** (1Q9) 0 N UTC+12 N06°05.00' E171°44.00'  
 4 NOTAM FILE HNL Not insp.  
**RWY 05-23:** 2850X75 (TURF)  
**AIRPORT REMARKS:** Attended on call.  
**COMMUNICATIONS:** CTAF 122.9

**NAMORIK ATOLL**

**NAMORIK** (3NØ) 0 NE UTC+12 N05°37.90' E168°07.50'  
 15 NOTAM FILE HNL Not insp.  
**RWY 07-25:** 2900X45 (GRVL)  
**AIRPORT REMARKS:** Attended on call.  
**COMMUNICATIONS:** CTAF 122.9

**TAORA ISLAND/MALOELAP ATOLL**

**MALOELAP** (3N1) 0 E UTC+12 N08°42.50' E171°14.00'  
 4 NOTAM FILE HNL Not insp.  
**RWY 04-22:** 3500X150 (TURF)  
**AIRPORT REMARKS:** Attended on call.  
**COMMUNICATIONS:** CTAF 122.9

**UTIRIK** (Ø3N) 0 SE UTC+12 N11°14.00' E169°51.00'  
 4 NOTAM FILE HNL Not insp.  
**RWY 07-25:** 2400X50 (GRVL)  
**AIRPORT REMARKS:** Attended on call.  
**COMMUNICATIONS:** CTAF 122.9

**WOTJE** (N36) 0 E UTC+12 N09°28.00' E170°14.00'  
 4 NOTAM FILE HNL Not insp.  
**RWY 13-31:** 4275X75 (TURF)  
**AIRPORT REMARKS:** Attended on call.  
**COMMUNICATIONS:** CTAF 122.9

## MIDWAY ATOLL

### MIDWAY ATOLL/SAND ISLAND

**HENDERSON FLD** (MDY)(PMDY) 0 SW UTC-11 N28°12.09' W177°22.88' 1-C  
 18 B Class IV, ARFF Index A NOTAM FILE MDY IAP  
**RWY 06-24:** H7800X150 (ASPH) S-195, D-260, ST-175, DT-390 HIRL  
**RWY 06:** PAPI(P4L)—GA 3.0° TCH 55'. **RWY 24:** REIL. PAPI(P4L)—GA 3.0° TCH 55' Trees.

#### RUNWAY DECLARED DISTANCE INFORMATION

**RWY 06:** TORA-7800 TODA-7800 ASDA-7800 LDA-7800  
**RWY 24:** TORA-7800 TODA-7800 ASDA-7400 LDA-7400

**AIRPORT REMARKS:** Attended 1900-0400Z. Use freq 126.2 for all inbound and outbound communications. PPR for landing from arpt manager 24 hrs in advance due to heavy bird activity call 808-674-1237. Be alert for heavy bird strike hazards at all times. Current bird activity status avbl during initial ctc inbound and prior to txf and ldg on freq 126.2. Scheduled acft ops permitted only during hrs of darkness Nov-Jun due to heavy bird activity. Rwy 06-24 PAEW 25' from rwy edges. Fuel avbl J-P5. PPR for fuel ctc arpt manager 808-674-1237 24 hrs prior to air carrier ops. Except when necessary for txf and lndg, all acft maintain minimum alt of 5,000 MSL within 12 miles of arpt. Arpt ctc 1900-0400Z 808-674-1237. Emergency pager 24 hrs 480-768-2500 ID 881631492770. Frequency 126.2 monitored 1900-0400Z daily and during approved acft ops. Water hazard on Twy A during and after rain. Landing fee. ACTIVATE HIRL Rwy 06-24, PAPI Rwy 06 and Rwy 24, REIL Rwy 06 and Rwy 24-126.2.

**WEATHER DATA SOURCES:** ASOS 118.325 (808) 674-9286

**COMMUNICATIONS:** CTAF 122.9

**RADIO AIDS TO NAVIGATION:** NOTAM FILE MDY.

**MIDWAY NDB (HW)** 400 MDY N28°12.25'W 177°22.75' at fld.

**COMM/NAV/WEATHER REMARKS:** No ATCT ops. Inbound acft ctc 100 NM out for advisories. CTAF not monitored ctc freq 126.2. Freq 126.2 monitored 1900-0400Z and during approved acft ops.

**MIDWAY** N28°12.25' W177°22.75' NOTAM FILE MDY. 1-C  
**NDB (HW)** 400 MDY at Henderson Fld.

## NORTHERN MARIANA ISLANDS

### PAGAN ISLAND

**PAGAN AIRSTRIP** (TTØ1) 0 S UTC+10 N18°07.47' E145°46.12'  
 34 NOTAM FILE HNL Not insp.

**RWY 11-29:** 1500X120 (TURF-GRVL) S-4 1.5% up E

**RWY 11:** Trees. **RWY 29:** Brush.

**AIRPORT REMARKS:** Unattended. Arpt CLOSED indefinitely. Survey marker 1 foot high on centerline, approach end of Rwy 11.

**COMMUNICATIONS:** CTAF 122.9

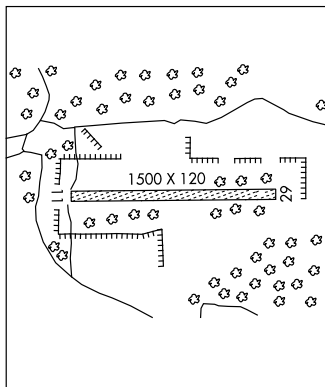

**ROTA ISLAND**

§ **ROTA INTL** (GRO) (PGRO) 6 NE UTC+10 N14°10.46' E145°14.47' HAWAIIAN-MARIANA  
 607 B TPA—See Remarks LRA Class I, ARFF Index A NOTAM FILE PGRO 1-A-B  
**RWY 09-27:** H7000X150 (ASPH-GRVD) S-90, D-130, ST-175, DT-220 MIRL 0.3% up E IAP  
**RWY 09:** REIL. PVASI(PSIL)—GA 3.0° Thld dspld 1000'. **RWY 27:** PAPI(P4L). Rgt tfc.  
**AIRPORT REMARKS:** Attended 2000-1030Z. Radio operator, ARFF personnel, and weather observation daily  
 2000-1030Z. Lgtd twr 1798' MSL (262'AGL) located 4 miles southwest of arpt. PPR for unscheduled acft ops  
 from executive direct or Commonwealth Ports Authority call Mon-Fri 670-237-6500. Immigration customs and  
 quarantine avbl during scheduled acft operations, other times prior arrangements must be made with field  
 supervisors 670-532-9446/9455/9493/4006 respectively. TPA—Large and Turbine powered acft 2001  
 (1494), small acft 1501 (994). MIRL Rwy 09-27, PSIL and REIL Rwy 09, PAPI Rwy 27, twy lghts and windcone  
 operate 2000-1030Z. After 1030Z and during emergencies ACTIVATE MIRL Rwy 09-27, PSIL and REIL Rwy 09,  
 PAPI Rwy 27, twy lights and windcone—CTAF.  
**WEATHER DATA SOURCES:** SAWRS (2000-0930Z±).  
**COMMUNICATIONS:** CTAF 123.6  
**ROTA RADIO** 123.6  
**GUAM ARTCC APP/DEP CON** 120.5  
**RADIO AIDS TO NAVIGATION:** NOTAM FILE HNL.  
**NDB (HW)** 332 GRO N14°10.30' E145°14.39' at fld.

**SAIPAN ISLAND**

**COMMONWEALTH HEALTH CENTER HELIPORT** (C21) 01E UTC+10 HAWAIIAN-MARIANA  
 N15°12.58' E145°43.28'  
 16 NOTAM FILE HNL Not insp.  
**RWY H1:** H45X45 (CONC)  
**HELIPORT REMARKS:** Attended continuously. Rwy H1 110' hotel bldgs W and 85' water tank E of helipad.  
**COMMUNICATIONS:** CTAF 125.7

§ **FRANCISCO C ADA/SAIPAN INTL** (GSN) (PGSN) 4 S UTC+10 N15°07.14' E145°43.76' HAWAIIAN-MARIANA  
 215 B FUEL 100, 100LL, JET A1+ TPA—See Remarks AOE Class I, ARFF Index D 1-A-B  
 NOTAM FILE PGSN IAP  
**RWY 07-25:** H8700X200 (ASPH-GRVD) S-87, D-175, ST-175, DT-350, DDT-690 HIRL  
**RWY 07:** MALSR. VASI(V4L)—GA 3.0° TCH 55'. Rgt tfc.  
**RWY 25:** REIL. VASI(V6L)—Upper GA 3.25° TCH 105'. Lower GA 3.0° TCH 60'.  
**AIRPORT REMARKS:** Attended continuously. PPR from Executive Director, Commonwealth Ports Authority, Saipan call  
 670-237-6500 Mon-Fri 2130-0630Z other times call 288-5568/69. For Apt Security call 670-237-6529.  
 Immigration and Customs available during scheduled operations. Other times prior arrangements must be made  
 with Chief Immigration, Saipan call 664-3131/32. CLOSED to unscheduled air carrier operations with more than  
 30 passenger seats except PPR call or write arpt manager 670-237-6500/670-483-1512(cell), P.O. Box  
 501055 Saipan MP 96950. Traffic pattern altitude for large and turbine powered acft 1700(1485), small aircraft  
 1200(985).  
**WEATHER DATA SOURCES:** ASOS (670) 288-5017. SAWRS.  
**COMMUNICATIONS:** ATIS 127.2  
 Ⓡ **GUAM ARTCC APP/DEP CON** 118.4  
**TOWER** 125.7 **GND CON** 121.8  
**AIRSPACE:** CLASS D svc continuous.  
**RADIO AIDS TO NAVIGATION:**  
**NDB (HW)** 312 SN N15°06.69' E145°42.62' 066° 1.2 NM to fld.  
**ILS/DME** 109.9 I-GSN Chan 36 Rwy 07.

**TINIAN ISLAND**

**TINIAN INTL** (TNI) (PGWT) 1 N UTC+10 N14°59.95' E145°37.16' HAWAIIAN-MARIANA

271 B TPA—See Remarks Class I, ARFF Index A NOTAM FILE HNL 1-A-B

**RWY 08-26:** H8600X150 (ASPH-CONC-GRVD) S-75, D-200, DT-400, DDT-832 MIRL IAP

**RWY 08:** REIL. PAPI(P4L)—GA 3.0° TCH 44'. Hill. 0.4% up.

**RWY 26:** REIL. PAPI(P4L)—GA 3.0° TCH 46'. Rgt tfc.

**AIRPORT REMARKS:** Attended 1600-0600Z†, other times PPR from Executive Director, Commonwealth Ports Authority, Saipan call Mon-Fri 664-3500/01/02. Arpt CLOSED to unscheduled air carrier operations with more than 10 passenger seats except 24 hrs PPR in writing to arpt manager. P.O. Box 501055, Saipan, MP 96950-1055. ARFF svc available 1600-0530Z and for air carrier ops with more than 9 passenger seats. Immigration and customs available during scheduled operations. Other times prior arrangements must be made with Chief Immigration Saipan call 664-3131/32. Traffic pattern altitude for large and turbine powered acft 1803(1532); small acft 1303(1032). For MIRL Rwy 08-26, PAPI Rwy 08 and Rwy 26, REIL Rwy 08 and Rwy 26 ctc airport 1600-0600Z† on CTAF 123.6. For emergencies between 0600-1600Z† lgts can be requested by contacting port police 670-433-9295/9294 or CTAF 123.6

**WEATHER DATA SOURCES:** SAWR5 (2000-0900Z)

**COMMUNICATIONS:** CTAF 123.6

**GUAM ARTCC APP/DEP CON** 118.4

**RADIO AIDS TO NAVIGATION**

**SAIPAN NDB(HW)** 312 SN N15°06.69' E145°42.62' 216° 8.7 NM to fld.

**PALAU****ANGAUR ISLAND**

**ANGAUR AIRSTRIP** (ANG) 30 SW UTC+9 N06°54.00' E134°09.00' 1-B

20 NOTAM FILE HNL

**RWY 05-23:** 7000X150 (GVL)

**RWY 05:** Trees. **RWY 23:** Trees.

**AIRPORT REMARKS:** Unattended.

**COMMUNICATIONS:** CTAF 122.9

**BABELTHUAP ISLAND**

**BABELTHUAP/KOROR** (ROR) (PTRO) 4 NE UTC+9 N07°22.04' E134°32.66' 1-B

176 B FUEL 115, JET A1 LRA NOTAM FILE PTRO IAP, AD

**RWY 09-27:** H7200X150 (ASPH-CONC-PFC) S-75, D-190, DT-300 MIRL

**RWY 09:** REIL. PAPI(P4L)—GA 3.0° TCH 52'. **RWY 27:** REIL. PAPI(P4L)—GA 3.0° TCH 49'. Trees.

**AIRPORT REMARKS:** Attended continuously. CAUTION: Large number of birds on rwy at night. A1+ jet fuel stored at arpt, 100 and 300 octane in dock area. ARFF avbl 2 hrs prior to scheduled acft arr and until 1 hr after dep. All unscheduled flts must file a flt plan at least 7 days prior to arr and all flts must ctc Koror Communications on 123.6 at least 20 min prior to arr. Entry permit rqr call 011-680-488-2498, fax 011-680-488-4385, ldg permit rqr must give 7 days notice call 011-680-488-2111 fax 011-680-3207. For MIRL and rotating beacon contact KOROR RADIO 123.6. All acft exceeding 100,000 lbs GWT taxi to thld turn around before taxing to apron. Acft under 100,000 lbs GWT may make a turn around where feasible.

**COMMUNICATIONS:** CTAF 123.6

**KOROR RADIO** 123.6 AAS, 5205X USB emerg only, 2182 emerg only.

**RADIO AIDS TO NAVIGATION:**

**KOROR NDB/DME (HW)** 371 ROR Chan 104 N07°22.13' E134°33.02' at fld.

**COMM/NAV/WEATHER REMARKS:** DME unusable 020°-080° byd 30 NM blo 5,000'. LAA available 2hrs prior to scheduled acft arrival and until 1hr after departure.

---

**KOROR** N07°21.82' E134°31.98' NOTAM FILE HNL 1-B

**NDB/DME (HW)** 371 ROR Chan 104 At Babelthuap/Koror Airport.

**RADIO** 123.6 AAS, 5205X USB emerg only, 2182 emerg only.

DME unusable 020°-080° byd 30 NM blo 5,000'.

**PELELIU** (C23) 20 SW UTC+9 N07°00.00' E134°14.00'

1-B

9 NOTAM FILE HNL

**RWY 04-22:** 6000X40 (GRVL)

**RWY 04:** Trees. **RWY 22:** Trees.

**AIRPORT REMARKS:** Unattended. Rwy 04-22 first 1000' Rwy 04 unusable.

**COMMUNICATIONS:** CTAF 122.9

## WAKE ISLAND

**WAKE ISLAND AIRFIELD** (AWK) (PWAK) 0 N UTC+12 N19°16.95' E166°38.20'

1-C

23 B **FUEL** See remarks NOTAM FILE PWAK Not insp.

**RWY 10-28:** H9844X150 (ASPH) PCN 75 F/A/W/T HIRL

**RWY 10:** REIL. PAPI(P4L)—GA 3.0° TCH 71'.

**RWY 28:** REIL. PAPI(P4L)—GA 3.0° TCH 71'.

**AIRPORT REMARKS:** Attended Mon-Sat 1930-0530Z, except holidays.

See Flip Ap/3 route and area restricted. Wake Island closed to foreign acft. PPR for all acft at least 24 hr in advance. PPR phone DSN 424-2101, C(808)424-2101, FAX DSN 315-424-2165, C808-424-2165 or e-mail WAKEAIROPS@HAWAIIAN.NET. RSTD: Very limited opr status, avbl for emergency ldg and minimal priority tfc. No aircraft maintenance available. New twy line restriction located at intersection of Twy Echo and Delta.

Continues West onto the warm-up pad, does not provide wingtip clearance to acft with wingspan greater than 60'. CAUTION—bird hazard on approach to Rwy 10 and Rwy 28 departure. Ocean vessels with mast approximately 125' periodically located at mooring buoys 3600' W of thld Rwy 10. Tfc pattern—right break Rwy 10 all acft, left break Rwy 28 all acft. Flight crew required to assist in refueling. J5. Fluid-W, SP, Presair. DD-1801 WX briefing/forecast avbl via DSN 449-8332 C808 449-8332. When normal satcom out of svc, IMARSAT is available. Space avbl passengers are not allowed to remain overnight on islands unless prior approval has been obtained.

### COMMUNICATIONS:

**WAKE OPERATIONS** 128.0 (2000-0500Z)

### RADIO AIDS TO NAVIGATION:

(H) **VORTACW** 113.5 AWK Chan 82 N19°17.10' E166°37.65' 121° at fld. 14/7E.

**COMM/NAV/WEATHER REMARKS:** Inbound aircraft should expect descent and approach clearances from Oakland ARTCC through San Francisco ARINC. Wake Operations monitors 121.5 and 243.0. Inbound aircraft contact Wake Operations 100 NM out for airport advisory service and advise servicing requirements. Make all departure reports to ARTCC via HF. No ATC available to overflights.

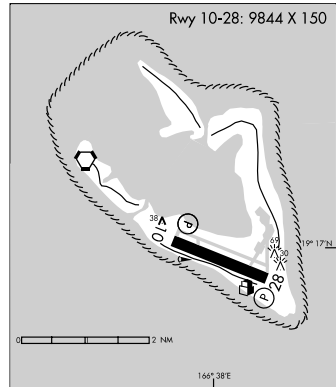

## 2010 U.S. & CANADIAN MILITARY AERIAL AIRCRAFT/PARACHUTE DEMONSTRATIONS

During CY 2010, the U.S. and Canadian Military Aerial Demonstration Teams (Thunderbirds, Blue Angels, Snowbirds, and Golden Knights) will be performing on the dates and locations listed below.

Pilots should expect Temporary Flight Restrictions (TFR) in accordance with 14 CFR Section 91.145, Management of aircraft operations in the vicinity of aerial demonstrations and major sporting events. The dimensions and effective times of the TFRs may vary based upon the specific aerial demonstration event and will be issued via the U.S. NOTAM system. Pilots are strongly encouraged to check FDC NOTAMs to verify they have the most current information regarding these airspace restrictions.

The currently scheduled 2010 aerial demonstration locations, subject to change without notice, are:

DATE:	USAF Thunderbirds	USN Blue Angels	USA Golden Knights	Canadian Snowbirds
April	10-11	Eglin AFB, FL		
	11		NAS Key West, FL	
	17		Charleston AFB, SC	
	17-18	Lakeland, FL		
	24-25	Barksdale AFB, LA	Vidalia, GA	Ft. Lauderdale, FL
	24-25			Galena, FL
May	1	Dyess AFB, TX		
	2	Altus AFB, OK		
	1-2		St. Joseph, MO	
	8-9	Shaw AFB, SC	Tuscaloosa, AL	Shaw AFB, SC
	8-9			Niagara Falls, NY
	13		Tuscaloosa, AL	
	13		Union, NJ	
	15-16	Columbus AFB, MS	Andrews AFB, MD	Columbus AFB, MS
	15-16			Andrews AFB, MD
	22	Grand Forks AFB, ND		
	22-23		MCAS Cherry Point, NC	
	26	Colorado Springs, CO	Annapolis, MD	
	29-30	Janesville, WI	Jones Beach, NY	Jones Beach, NY
	29-30			Janesville, WI
June	5-6	Ocean City, MD	Eau Claire, WI	Eau Claire, WI
	5-6			Florence, SC
	12-13		Milwaukee, WI	Milwaukee, WI
	19-20		Cape Girardeau, MO	Cape Girardeau, MO
		Tinker AFB, OK		Gaylord, MI
	19-20			Findlay, OK
	26-27	North Kingstown, RI	St. Cloud, MN	
July	3			Madison, WI
	3			Dubuque, IA
	3-4		Traverse City, MI	
	4			Ft Bragg, NC
	10		Pensacola Beach, FL	
	10-11	Gary, IN		Gary, IN
	17-18	Duluth, MN	Dayton, OH	
	24-25	Fairchild AFB, WA	Idaho Falls, ID	
	28	Cheyenne, WY		
	29			Goshen, IN
	29			Ft AP Hill, VA
	31	Rockford, IL	Anchorage, AK	Rockford, IL
	31			Elmendorf AFB, AK
	31			Johnstown, PA
August	1	Rockford, IL	Anchorage, AK	Rockford, IL
	1			Johnstown, PA
	7-8	TDB	Seattle, WA	
	14-15		Chicago, IL	Chicago, IL
	21-22	Westfield, MA		Westfield, MA
	21-22			Kansas City, MO
	25			Atlantic City, NJ

## SPECIAL NOTICES

DATE:	USAF Thunderbirds	USN Blue Angels	USA Golden Knights	Canadian Snowbirds	
26			Ft Monroe, VA		
28-29	Coney Island (Brooklyn), NY	Portsmouth, NH	Coney Island (Brooklyn), NY		
28-29			Portsmouth, NH		
September	4-5	Martinsburg, WV		Cleveland, OH	
	4-5			Martinsburg, WV	
	4-6		Cleveland, OH		
	11-12	Corapolis (Pittsburgh), PA	Scott AFB, IL	Corapolis (Pittsburgh), PA	
	11-12		Scott AFB, IL		
	18-19	Whiteman AFB, MO	NAS Oceana, VA	Whiteman AFB, MO	Reno, NV
	25-26	McConnell AFB, KS	MCAS Kaneohe Bay, HI		
October	1-3		MCAS Miramar, CA		MCAS Miramar, CA
	2-3	Salinas, CA		MCAS Miramar, CA	
	2-3			Jackson, MS	
	9-10	Little Rock AFB, AR	San Francisco, CA	Little Rock, AFB, AR	Daytona Beach, FL
	16-17	El Paso, IX	Dobbins AFB, GA	El Paso, TX	Atlanta, GA
	23-24	Houston, TX	NAS Jacksonville, FL	Washington, DC	
	30-31	Cocoa Beach, FL	Ft Worth Alliance, TX	Ft Worth Alliance, TX	
November	6-7	Lackland AFB, TX	Homestead ARB, FL	Lackland AFB, TX	
	6-7			Homestead ARB, FL	
	11-14			Ft Bragg, NC	
	12-13		NAS Pensacola, FL		
	13-14	Nellis AFB, NV			

Note: Dates and locations are scheduled "show dates" only and do not reflect arrival or practice date TFR periods that may precede the specific aerial demonstration events listed above. Again, pilots are strongly encouraged to check FDC NOTAMs to verify they have the most current information regarding any airspace restrictions.

**NOTICES TO AIRMEN**

Special Notices of a **permanent** nature will be carried for two issues and then incorporated in the appropriate section of this publication or other applicable publication however, operational requirement may necessitate certain notices being carried for a longer period. Notices of a **temporary** nature will be carried in this section for the life of the notice. **New** or **modified** notices are emphasized by an outline and the date of first issuance at the top of the notice. Outline will be eliminated from temporary notices after two issues and issuance date will be relocated at the end of the notice.

A Special Notices section concerning **NEW FEATURES** appears below and contains notices of new requirements or major modifications of existing flight information publications. New feature notices will be carried for two issues and then dropped. In the event there are no new features, the word "NONE" shall be centered within the new feature box.

**NEW FEATURES**



## HONOLULU INTL AIRPORT TOWER DATA LINK SYSTEM

Tower Data Link System (TDLS) operational, Predeparture Clearance (PDC) available at Honolulu International Airport. To participate, email 9-AWA-ATS-PDC@faa.gov or contact Gary Norek at FAA, Airspace and Procedures, ATO-T, 800 Independence Ave., SW, Washington, DC, 20591, telephone (202) 385-8510.

### LASER LIGHT OPERATION

#### Keck Observatory, Gemini Observatory and Subaru Observatory

A permanent laser light operation is being conducted nightly between sunset and sunrise at Keck Observatory and Gemini Observatory N19-49-26/W155-28-09, Kamuela VOR (MUE) 122 degree radial at 16 nautical miles. The laser beam may be injurious to eyes if viewed on axis. Cockpit illumination and flash blindness may also occur if the beam enters the cockpit. Honolulu Control Facility, (808) 840-6201 is the FAA coordination facility.

#### Maui Space Surveillance Complex

A permanent laser light operation is being conducted nightly between sunset and sunrise at the Maui Space Surveillance Complex (MSSC) N204231/W1561528, Maui VOR (OGG) 131 degree radial at 15 nautical miles. The laser beam may be injurious to eyes if viewed on axis. Cockpit illumination and flash blindness may also occur if the beam enters the cockpit. Honolulu Control Facility, (808) 840-6201 is the FAA coordination facility.

### CONTINUOUS POWER FACILITIES

In order to insure that a basic ATC system remains in operation despite an areawide or catastrophic commercial power failure, key equipment and certain airports have been designated to provide a network of facilities whose operational capability can be utilized independent of any commercial power supply.

In addition to those facilities comprising the basic ATC system, the following approach and lighting aids have been included in this program for a selected runway.

1. ILS (Localizer, Glide Slope, COMLO, Inner, Middle and Outer Markers)
2. Wind Measuring Capability
3. Approach Light System (ALS) or Short ALS (SALS)
4. Ceiling Measuring Capability
5. Touchdown Zone Lighting (TDZL)
6. Centerline Lighting (CL)
7. Runway Visual Range (RVR)
8. High Intensity Runway Lighting (HIRL)
9. Taxiway Lighting
10. Apron Light (Perimeter Only)

The following have been designated "Continuous Power Airports," and have independent back up capability for the equipment installed.

Airport/Ident	Runway No.	Airport/Ident	Runway No.
Albuquerque, NM (ABQ) .....	08	Milwaukee, WI (MKE) .....	01L
Anchorage, AK (ANC) .....	07R	Minneapolis, MN (MSP) .....	30L
Andrews AFB, MD (ADW) .....	01L	Nashville, TN (BNA) .....	02L
Atlanta, GA (ATL).....	09R	New Orleans, LA (MSY) .....	10
Baltimore, MD (BWI)	10	New York, NY (JFK) .....	04R
Bismarck, ND (BIS) .....	31	New York, NY (LGA) .....	22
Boise, ID (BOI).....	10R	Newark, NJ (EWR).....	04R
Boston, MA (BOS) .....	04R	Oklahoma City, OK (OKC) .....	35R
Charlotte, NC (CLT) .....	36L	Omaha, NE (OMA) .....	14R
Chicago, IL (ORD).....	14R	Ontario, CA (ONT).....	26L
Cincinnati, OH (CVG) .....	36C	Philadelphia, PA (PHL) .....	09R
Cleveland, OH (CLE) .....	06R	Phoenix, AZ (PHX).....	08
Dallas/Fort Worth, TX (DFW).....	17C	Pittsburgh, PA (PIT) .....	10L
Denver, CO (DEN) .....	35R	Reno, NV (RNO) .....	16R
Des Moines, IA (DSM) .....	31	Salt Lake City, UT (SLC) .....	34L
Detroit, MI (DTW) .....	03R	San Antonio, TX (SAT).....	12R
El Paso, TX (ELP) .....	22	San Diego, CA (SAN).....	09
Fairbanks, AK (FAI) .....	01L	San Francisco, CA (SFO) .....	28R
Great Falls, MT (GTF).....	03	San Juan, PR (SJU).....	08
Honolulu, HI (HNL) .....	08L	Seattle, WA (SEA) .....	16C
Houston, TX (IAH).....	26L	St. Louis, MO (STL) .....	30R
Indianapolis, IN (IND) .....	05L	Tampa, FL (TPA) .....	36L
Jacksonville, FL (JAX).....	07	Tulsa, OK (TUL) .....	36R
Kansas City, MO (MCI).....	19R	Washington, DC (DCA) .....	01
Los Angeles, CA (LAX).....	24R	Washington, DC (IAD) .....	01R
Memphis, TN (MEM) .....	36L	Wichita, KS (ICT) .....	01L
Miami, FL (MIA).....	08R		

**NOTE**—The existing CPA runway is listed. Pending and future changes at some locations will require a revised runway designation.

## CHANGE NOTICE

A Change Notice will only be issued for safety considerations such as when an amended or original instrument approach procedure is issued.

### VMC FLIGHT (VFR)

1. The Oakland oceanic CTA/FIR, unless otherwise specified, is classified as class A airspace above FL055 (IFR only). VMC flights are not authorized in class A airspace but may operate within the Oakland FIR as follows:

- a. At or below FL055 (class G).
- b. VMC procedures are authorized in class D and E airspace.
- c. VFR flights may be conducted in the airspace surrounding Pacific islands located within the Oakland oceanic CTA/FIR with the following restrictions:
  - i. Between sunrise and sunset; and
  - ii. When operating less than 100 nautical miles of shoreline of any landmass; and
  - iii. Below FL200:

Note: VMC Flights operating within 100nm of landfall are not considered to be "over water" flights (AC91-70).

2. All "over water" VMC flights planning to operate outside of controlled airspace (class G) but on routes within the Oakland FIR are required for national security to submit an ICAO flight plan with Flight Service (FSS).

- a. The flight plan shall contain reporting points along the route not more than 80 minutes apart.
- b. It is the VMC pilots' responsibility to open and close their VMC flight plan with FSS.

3. All over water VMC flights are required to maintain a continuous listening watch on the appropriate frequency, and make position reports not more than 80 minutes apart on the appropriate HF frequencies.

Note: Satphones do not meet the "continuous listening watch" requirements as prescribed by ICAO.

4. Flight following and alerting services are provided by ATC for all over water flights.

5. State owned aircraft (military, customs etc.) may operate VFR within Oakland oceanic FIR if exercising "Due regard."

### LATERAL AND VERTICAL LIMITS OF OCEANIC CONTROL AREAS

The Oakland oceanic control area (CTA) is aligned laterally to coincide with the Oakland Flight Information Region (FIR). The Oakland CTA has a lower limit of FL055, except where Class D or E airspace is designated; there is no upper limit.

### ADDRESSING FLIGHT PLANS WITH OAKLAND CENTER

With the introduction of a new computer system with the Oakland oceanic airspace (Ocean 21), all aircraft entering Oakland's international oceanic airspace (KZAK) should address the new computer KZCEZQZX AND KZAKZRZX.

### OCEANIC IFR SEPARATION STANDARDS

LONGITUDINAL: At least 10 minutes between turbojet aircraft on the same or continuously diverging course. Non-turbojets, at least 15 minutes.

CROSSING: All aircraft at least 15 minutes.

LATERAL: At least 100 nautical miles between intended routes, 50 nautical miles using RNP-10 and 30 nautical miles using RNP-4 in specified areas. Lateral separation minima may be reduced in some cases when suitable nav aids are available and/or when Required Navigational Performance (RNP) is authorized.

VERTICAL: At least 1,000 feet from the lower limit to flight level 290. Above flight level 290 at least 2,000 feet. Vertical separation above FL290 may be reduced when Reduced Vertical Separation Minimum (RVSM) is authorized.

**LOWER SEPARATION MINIMA – OAKLAND OCEANIC FIR**

In accordance with ICAO Rgnl Supplementary Procedures–DOC 7030 PAC/RAC–1 6.4, notice is hereby given that separation lower than specified in 6.1 and 6.2 may be applied in accordance with PANS–RAC DOC 4444–RAC 501 Part 1.11, sections 7, 8 and 9 within the Oakland Oceanic FIR. The use of lower separation standards within the airspace listed below is contingent upon satisfactory and current flight check data of the navigational aids.

**AIRSPACE**

100 NM seaward of the boundary  
of the Honolulu Domestic area  
50 NM of Guam  
130 NM of Wake Island  
40 NM of Wake Island  
130 NM of Midway Island  
40 NM of Midway Island  
50 NM of Majuro Island  
50 NM of Kwajalein Island  
130 NM of Kwajalein Island  
40 NM of Kwajalein Island  
50 NM of Weno Island/Chuuk  
50 NM of Yap Island  
50 NM of Ponape Island  
50 NM of Saipan Island  
50 NM of Babelthuap Island/Koror

**NAVIGATIONAL AIDS**

SOK, LIH, HNL, MKK, LNY,  
OGG, ITO, UPP and IAI VORTACS  
AJA NDB  
AWK VORTAC FL180–450  
AWK VORTAC SFC–FL180  
NQM TACAN FL180–450  
NQM TACAN SFC–FL180  
MAJ NDB/DME  
NDJ NDB  
NDJ TACAN FL180–450  
NDJ TACAN SFC–FL180  
TKK NDB/DME  
YP NDB/DME  
PNI NDB/DME  
SN NDB  
ROR NDB/DME

**MACH NUMBER TECHNIQUE**

The minimum longitudinal separation between aircraft may be reduced with the application of Mach Number Technique (MNT) thereby improving airspace utilization.

**APPLICATION**

1. MNT may be used only between turbojet aircraft following the same or continuously diverging track, which have reported over a common point.
2. MNT can only be applied between aircraft that are assigned a single cardinal altitude or the aircraft concerned are in level, climbing or descending flight.
3. Longitudinal separation between aircraft using MNT is based on the aircraft maintaining the assigned Mach number at all times, including during climb and descent. If it is not feasible, for operational reasons, to maintain the last assigned Mach number, the pilot shall advise ATC at the time of the initial clearance or subsequent climb/descent request or clearance.
4. Aircraft shall adhere to the Mach number assigned by ATC and shall obtain approval before making any change to the Mach number. If it is essential to make an immediate change in Mach number (i.e. due to turbulence) ATC shall be notified as soon as possible that such a change has been made.

MNT SEPARATION MINIMA. When the lead aircraft maintains the same Mach number of the following aircraft, the minima when using MNT is 10 minutes.

REDUCTIONS TO SEPARATION WHEN APPLYING MACH NUMBER TECHNIQUE. To apply reductions, it must be possible to ensure that the required time interval will exist at the common point from which the aircraft either follow the same track or continuously diverging tracks.

Both turbojet aircraft will be assigned an appropriate Mach number. The lead aircraft will be assigned a Mach number greater than the following aircraft. Separation minima are as follows:

Difference in Mach number between aircraft	Minimum separation between aircraft
0.02 Mach	9 Minutes
0.03 Mach	8 Minutes
0.04 Mach	7 Minutes
0.05 Mach	6 Minutes
0.06 Mach	5 Minutes

MACH NUMBER TECHNIQUE WITH FASTER AIRCRAFT BEHIND. Mach Number Technique may be applied when a faster aircraft will follow another aircraft at the same flight level. In this case, longitudinal separation may be established during transition from offshore airspace to the oceanic control area, or when both aircraft are within oceanic airspace. Sufficient longitudinal separation will be applied to ensure at least 10 minutes separation until another form of separation is achieved.

## NAVIGATIONAL PERFORMANCE IN OCEANIC AREAS

In any air traffic control environment there is a need to ensure that aircraft adhere to the centerline of the cleared route. Demonstrated navigational accuracy provides the basis for determining lateral spacing and separation minima necessary with respect to traffic which may be operating outside but adjacent to the airspace protected for a given route. To sustain or refine the separation minima, adherence to cleared route must be demonstrated. The best available measurement of such adherence is obtained by radar observation of each aircraft's proximity to centerline prior to its coming into coverage of short range navigation aids at the end of the oceanic navigated portion of flight. If observation indicates that an aircraft was not reasonably within airspace normally protected, the reasons for the apparent deviation from centerline must be determined and steps must be taken to prevent recurrence and to improve overall navigational performance.

Where radar is available to monitor organized oceanic route systems, Oceanic Navigational Error Reports (ONER) will be recorded on observed lateral deviations of 20 NM or more. ONERs will be investigated to determine causal factors. Pilots should understand that these reports are instrumental in providing data for detecting significant changes in the navigational environment which may require corrective action.

### BASIC OCEANIC LONG-RANGE NAVIGATION AND COMMUNICATION REQUIREMENTS

Any operation which is conducted in international airspace on an IFR flight plan, a VFR controlled flight plan, or at night, and is conducted beyond the published range of normal airways navigation facilities (NDB,VOR/DME), is considered to be a long range navigation operation. Long range navigation in controlled airspace (CTA) requires aircraft to be navigated within the degree of accuracy required for air traffic control, meaning that aircraft must make every effort to follow the centerline of the assigned route, to maintain assigned flight level and speed filed or assigned. Accurate navigational performance is necessary to support the separation minima applied by ATC. These separation minima can be found in the International Civil Aviation Organization (ICAO) Rgnl Supplementary Procedures Document 7030. For flights conducted within international airspace under United States jurisdiction, the Air Traffic Control Handbook, Chapter 8—Offshore/Oceanic Procedures (FAA Order 7110.65) provides a simplified version of these separation minima.

Federal Aviation Regulation (FAR) 91.703 requires that civil aircraft must comply with ICAO Annex 2 when operating over the high seas. Annex 2 requires that "Aircraft shall be equipped with suitable instruments and with navigation equipment appropriate to the route being flown." ICAO Annex 6, Part II stipulates that an airplane operated in international airspace must be provided with navigation equipment which will enable it to proceed in accordance with the flight plan and in accordance with the requirements of air traffic services. This means that navigation equipment should be capable of providing the pilot with ability to navigate the aircraft with required accuracy.

Annex 2 also requires that an aircraft shall adhere to the "current flight plan unless a request for change has been made and clearance obtained from the appropriate air traffic control facility;" and "unless otherwise authorized or directed by the appropriate air traffic control unit, controlled flights shall, insofar as practicable: a) when on an established ATS route, operate along the centerline of that route; or b) when on any other route, operate directly between the navigation facilities and/or points defining that route."

If a flight inadvertently deviates from an ATC cleared route immediate action should be taken to rejoin the track as soon as possible. When a deviation from track is discovered, air traffic control must be informed so that appropriate actions may be taken to resolve any potential hazards to other aircraft which may have been created by the deviation. Any navigation error which results in an aircraft straying from the centerline of its cleared route and beyond its protected airspace could create a significant hazard, since the error could not normally be observed by air traffic control.

ICAO Annex 6, Part II contains standards and recommended practices adopted as the minimum standards for all general aviation airplanes engaged in international air navigation. It requires that airplanes operated in accordance with Instrument Flight Rules, at night, or on a VFR controlled flight, have installed and approved radio communication equipment capable of conducting two-way communication at any time during the flight with such aeronautical stations and on such frequencies as may be prescribed by the appropriate authority.

Note: Satellite telephones do not meet the two-way communication at any time requirements as stated in ICAO Annex 6 part II.

All of the aforementioned requirements contained in Annex 2 and Annex 6, as supplemented by Rgnl Supplementary Procedures Document 7030, are incorporated in section 91.1 and 91.703 of the FAR for aircraft operating under United States civil certification in international oceanic airspace.

**A. USE OF VERY HIGH FREQUENCY (VHF) AND HIGH FREQUENCY (HF) FOR COMMUNICATIONS.** Due to the inherent "line of sight" limitations of VHF radio equipment when used for communications in international oceanic airspace, those aircraft operating on an IFR or controlled VFR flight plan beyond the communications capability of VHF will be required as per ICAO annex 2 to maintain a continuous listening watch and communications capability on the assigned HF frequencies. These frequencies are listed in Section IV of this Chart Supplement as part of the general purpose communication facilities operated by Aeronautical Radio, Incorporated (ARINC). These facilities will be responsible for the relay of position reports and other pertinent information between the aircraft and Air Traffic Control.

**Note:** Use of satellite telephones does not provide "a continuous listening watch" and therefore does not meet minimum ICAO requirements.

**B. SPECIAL PACIFIC AREA COMMUNICATIONS.** Frequency 123.45 MHz has been designated for use in air-to-air communications between aircraft operating in the Pacific area out of range of VHF ground stations to exchange operational information and facilitate resolution of operational problems.

**C. GUARD OF VHF EMERGENCY FREQUENCY.** Pilots should remember that there is a need to continuously guard the VHF emergency frequency 121.5 MHz when on long over-water flights, except when communications on other VHF channels, equipment limitations, or cockpit duties prevent simultaneous guarding of two channels. Guarding of 121.5 MHz is particularly critical when operating in proximity to flight information region (FIR) boundaries since it serves to facilitate communications with regard to aircraft which may experience in-flight emergencies, communications, or navigational difficulties. (Reference ICAO Annex 10, Vol II, Paragraphs 5.2.2.1.1.1 and 5.2.2.1.1.2)

**D. USE OF NONDIRECTIONAL BEACON (NDB) FOR NAVIGATION.** The use of NDB as the "primary" source of navigation for long range oceanic flight presents the operator with numerous limitations and restrictions that are inherent in low frequency radio equipment and low frequency signals. These include:

1. NDB of the highest power (2000 watts or more), which are maintained and flight checked as suitable for navigation, are limited in their usable service and/or reception range to no more than 75 NM from the facility at any flight level.
2. Though the operator may be able to receive standard (AM/amplitude modulation) broadcast stations with NDB equipment, primary dependence on the facilities for air navigation is a questionable operating practice. The following are some of the inherent problems associated with reception of these stations:
  - a. Infrequent identification of the station.
  - b. Identification of foreign language stations may be impossible without some knowledge of the language.
  - c. Transmitter sites are not always collocated with studio facilities.
  - d. Termination of service without notice.
  - e. Weather systems causing erratic and unreliable reception of signal.
  - f. Atmospheric disturbances causing erratic and unreliable reception of signal.
  - g. No flight checks conducted to verify the suitability and reliability of the facility and its signal for use in air navigation.
  - h. Fluctuation (bending) of signal due to "shoreline/mountain" effect.
  - i. Standard broadcast stations are not dedicated for air navigation purposes.
3. Considering the limitations, the operator should make every effort to navigate the aircraft so as to maintain the "track/course" and the "tolerances" specified in the ATC clearance as per Annex 2 and the Rgnl Supplementary Procedures Document 7030. An error of 10 degrees at a distance of 2000 miles equates to approximately 350 NM of course deviation; the inadequacies of the NDB as the sole source of navigation for oceanic flight must be evaluated carefully.

## AMERICAN SAMOA

PAGO PAGO INTERNATIONAL AIRPORT

## PROCEDURES

**Inbound.** About 30 miles from the airport, monitor 118.3 for broadcasts from other aircraft. At 15 miles from the airport broadcast your position, altitude and intentions. Follow this with your position on downwind, base leg and final approach.

**Outbound.** Monitor 118.3 for broadcasts from other aircraft before taxiing. Broadcast your position on the airport and intentions. Follow this with an announcement before you taxi onto the runway for takeoff.

**HAZARDS, CAUTIONS AND WARNINGS**

**AMERICAN SAMOA – POWER LINES:** Permanently installed power lines between island of Ofu and Olosega 400 feet ASL unlighted and unmarked.

## HONOLULU CTA/HAWAII

**GENERAL INFORMATION ON FLYING TO HAWAII**

(Entry and Departure Requirements)

Air Commerce Regulations of the United States, Part 6, place certain responsibilities upon owners and operators of aircraft engaging in flights to and from foreign countries.

Customs and other agencies concerned desire to facilitate air travel to the fullest extent possible while carrying out their responsibilities. Aircraft operators can assist by familiarizing themselves with the regulations and by complying with them under all circumstances. Failure to do so may incur substantial penalties.

The following sets forth the principal requirements of concern to private plane operators engaging in international flights.

**ARRIVAL AND DEPARTURE MANIFESTS.** All aircraft departing from the continental United States or Alaska or Hawaii are exempt from filing an arrival or departure manifest. Aircraft arriving from any other place are required to file arrival and departure manifests.

**ADVANCE NOTICE REQUIRED.** Advance notice of each arrival must be furnished to U.S. Customs officials at or nearest to the place of intended first landing who will notify the Immigration and Public Health officials.

Advance notice should be sent so as to be received in sufficient time to enable the officers designated to inspect the aircraft to reach the place of landing before the arrival of the aircraft. At most airports, at least 2 hours advance notice is required for this purpose.

Notification may be made by telephone, which is preferable, or by telegram or radio. The notice should specify the following: (a) Type of aircraft; (b) Identification number (NC number); (c) Name of pilot; (d) Place of last departure; (e) Airport of entry; (f) Number of alien and citizen passengers; and (g) Estimated time of arrival (Indicating whether H.S.T., P.S.T., etc).

Aircraft may use the following method of notifying customs when departing from a country or remote area where a predeparture flight plan cannot be filed or an "advise customs" message cannot be included in a predeparture flight plan: Call the nearest domestic or international FAA flight service station as soon as it is estimated that radio communication can be established and file a VFR (DVFR) flight plan and include as the last item "advise customs". The station with which such a flight plan is filed will forward it to the appropriate FAA station who will notify the customs office responsible for the destination airport. If the pilot fails to include "advise customs" in the radioed flight plan, it will be assumed that he has made other arrangements and FAA will not advise customs.

FAA assumes no responsibility for delays in advising customs if the flight plan is given to the FAA too late for timely delivery to customs before arrival of the aircraft. FAA cannot relay an "advise customs" flight plan if the pilot indicates a destination airport where flight service notice to customs is NOT available.

**AIRPORTS FOR ENTRY OR REENTRY.** If the operator of a private aircraft returning to or visiting the United States wishes to land at any airport of entry, advance notice of arrival is necessary. This advance notice should be sent also to the immigration and public health officers at or nearest the intended place of first landing.

If he intends to land at a place not designated as an airport of entry, he must obtain permission to make such landing and give advance notice of arrival to the customs office nearest the intended place of first landing. It is not necessary that separate requests be sent to immigration and public health officers in these cases.

**WHAT TO REPORT.** The advance notice should specify the type of aircraft, registration marks, name of commander, place of last departure, international airport, number of alien passengers, number of citizen passengers, and the estimated time of arrival. This advance notice should be sent in time to enable officers, designated to inspect the aircraft, to reach the place of landing before the aircraft arrives.

Upon arrival, the operator and passengers will be examined in the same manner as any international traveler. They must declare any articles acquired abroad. If any passengers or cargo are carried, an inward manifest must be filed. Customs officers can supply forms for both types of declaration, although operators should have their own supply.

**IN CASE OF EMERGENCY.** If an emergency landing is made in the United States, the aircraft operator should report as promptly as possible to the nearest customs, immigration and public health officers. The aircraft operator should not permit any merchandise or baggage to be removed, or any passengers to depart, without official permission unless necessary for preservation of life or property.

**THE MATTER OF CHARGES.** No charges are made for services during business hours when a landing takes place at any airport of entry; except that, when an aircraft arrives on a Sunday or holiday, or during other than regular hours, OVERTIME PAY WILL BE COLLECTIBLE. These charges are required by law. They may amount to as much as two days pay for each officer for any service performed on a Sunday or holiday. However, the charges are prorated where more than one aircraft is processed.

If the landing is made at a place other than an airport of entry, any expenses incurred by Government officers in going to and from the place of landing are payable by the plane operator. In addition, if the aircraft arrives on a Sunday or holiday, or during other than regular hours, OVERTIME PAY WILL BE COLLECTIBLE.

**UNITED STATES LANDING RIGHTS AIRPORTS.** At the following airports an application for permission to land must be submitted in advance to U.S. Customs. At least two hours advance notice of arrival must also be furnished to U.S. Customs. Advance notice of arrival may be included in your flight plan filed in Canada or Mexico if destined to an airport where flight notification service is available; this notice will be treated as an application for permission to land.

#### **HAWAII**

Lihue/Lihue Airport  
Hilo/Hilo Intl  
Honolulu/Honolulu Intl  
Kahului/Kahului Airport

NOTE: Flight Service notification to U.S. Customs available through Honolulu Radio. Hawaii has no airport of entry as above defined. Request for permission to land at a Hawaiian landing rights airport should be directed to 808-861-8462 ext 0.

### **RADAR SERVICE – HONOLULU DOMESTIC AREA**

In an effort to eliminate the mid-air collision potential in the Honolulu Domestic area, civil aircraft are encouraged to take one of the following two courses of action: (1) File an IFR flight plan, if the pilot is qualified and aircraft properly equipped; (2) Take advantage of the VFR radar advisory service provided by Honolulu Control Facility, by contacting Honolulu Control Facility on 119.3 MHz for aircraft SE of Oahu, 126.5 MHz when W of Oahu, or on 124.1 MHz when NE of Oahu. Aircraft desiring this service should request VFR radar advisory service and give aircraft identification, type, altitude, position with reference to the nearest navaid or geographical location, heading and destination. If controller workload permits, radar traffic advisories will be issued after radar identification is accomplished by aircraft position correlation, or aircraft identifying turns. This is in addition to the radar services provided by Maui and Honolulu Approach Controls for aircraft in their respective areas.

### **RADAR SERVICE – KONA DOMESTIC AREA**

Primary radar service unavailable below 5000 feet MSL east of Haleakala and south of Maunakea. In the area as described, radar services are available only to transponder equipped aircraft.

### **GLIDE SLOPE SIGNALS ON LOCALIZER BACK COURSE**

Localizer Back Course instrument approach procedures do not utilize glide path information. In most back course areas, however, extraneous glide slope signals emanating from the front course site can be detected—THESE GLIDE SLOPE SIGNALS SHOULD BE DISREGARDED WHEN CONDUCTING LOCALIZER BACK COURSE APPROACHES.

The FAA has conducted an airborne survey to determine the level of extraneous glide slope signal at each location. Where a significant level of "fly down" glide slope signal is present, the approach chart will be annotated as an additional alert to the pilot.

### **VFR FLIGHT WITHIN HAWAII**

NOTE: CAUTION – HIGH DENSITY COMMUTER AND SIGHTSEEING TRAFFIC

#### VFR Cruising altitude at or below 3,000 feet AGL

In order to reduce traffic conflict between interisland flights at or below 3,000 feet, an informal cruising altitude program is in use in the Hawaiian islands. Recommended eastbound altitudes: 2500, 1500, 500 feet; recommended westbound altitudes: 3000, 2000, 1000 feet.

**SPECIAL ALERTNESS RECOMMENDED:** Pilots engaged in sightseeing Hawaii must be sure their attention is not diverted from their primary responsibility for the safe operation of their aircraft. There is extensive VFR traffic operating along shorelines of all islands. Aircraft range in size from Cessna 152 to DeHavilland DHC-7 (4-engine). These aircraft generally operate from the shoreline to three miles offshore, at altitudes below 4500 feet.

Pilots should be aware of the high density traffic areas listed below.

#### **NORTH SHORE MOLOKAI–MAUI**

The route from Koko Head (CKH) VORTAC to and along the north shore of Molokai and Maui is extremely heavily traveled by aircraft engaged in commuter and sightseeing operations. As many as seven aircraft may be operating along Molokai north shore in both east and west bound directions, simultaneously and on a routine basis. The number may be up to 15 aircraft during peak traffic periods. VFR CHECKPOINTS: ILIO POINT, KALAUPAPA, and CAPE HALAWA on Molokai; NAKALELE POINT on Maui.

The following precautions are recommended:

- Maintain an especially alert watch for other aircraft. Traffic becomes concentrated in the vicinity of Ilio Point, Kalaupapa (airport), Cape Halawa, and Nakalele Point. Altitude changes should be avoided in these areas.
- Maintain an alert listening watch on 122.9 MHz and announce aircraft position, direction of flight and altitude when passing the VFR checkpoints named above.

EXAMPLE: ROYAL 76, ILIO POINT EASTBOUND 1500  
TANGO 34, CAPE HALAWA WESTBOUND 2000

-Landing aircraft-Molokai Airport: Before crossing within one mile of the shoreline, or before passing abeam the VFR checkpoints noted above, arriving aircraft should broadcast position, altitude and intentions on 122.9 MHz prior to contacting Molokai Tower.

EXAMPLE: ROYAL 76 THREE WEST ILIO POINT, 1500, LANDING MOLOKAI

-Landing aircraft-Kalaupapa Airport: Aircraft landing at Kalaupapa Airport should comply with transiting procedures and, when approximately five miles from the airport, broadcast position, altitude and intentions on 122.9 MHz (remaining clear of the Molokai Airport Traffic Area). Follow this up with appropriate announcements on downwind, base leg and final approach. When departing Molokai for Kalaupapa, request frequency change to 122.9 MHz after departure, in order to make these broadcasts.

## HONOLULU CLASS B AIRSPACE

### OPERATING RULES AND PILOT/EQUIPMENT REQUIREMENTS

Regardless of weather conditions, an ATC authorization is required prior to operating within Class B airspace. Pilots should not request an authorization to operate within CLASS B unless the requirements of sections 91.215 and 91.131 of the FAR are met. Included among these requirements are:

- (1) Unless otherwise authorized by ATC, the aircraft must be equipped with an operable two-way radio capable of communicating with ATC on appropriate frequencies for that terminal control area.
- (2) No person may takeoff or land a civil aircraft at an airport within CLASS B or operate within CLASS B unless:
  - (a) The pilot in command holds at least a private pilot certificate; or
  - (b) The aircraft is operated by a student pilot who has met the requirements of FAR section 61.95.
- (3) Unless otherwise authorized by ATC, each person operating a large turbine engine-powered airplane to or from a primary airport shall operate at or above the designated floors while within the lateral limits of CLASS B.
- (4) Unless otherwise authorized by ATC, the aircraft must be equipped with an operable VOR or TACAN receiver.
- (5) Unless otherwise authorized by ATC, the aircraft must be equipped with a 4096 code transponder with automatic altitude reporting equipment.

NOTE. ATC may, upon notification, immediately authorize a deviation from the altitude reporting requirement; however, a request for a deviation from the 4096 code transponder equipment requirement must be submitted to the controlling ATC facility at least one hour before the proposed operation.

### FLIGHT PROCEDURES

#### A. IFR Flights

Aircraft operating within the Honolulu CLASS B airspace must be operated in accordance with ATC clearances and instructions.

#### B. VFR Flights

1. Arriving aircraft, or aircraft desiring to transit CLASS B should contact Honolulu Control Facility on the frequency depicted for the sector of flight with reference to the geographical center of the airport. Pilots should state, on initial contact, their position, direction of flight and destination. If holding of VFR aircraft is required, the holding point will be specified by ATC and will be a prominent geographical fix, landmark or VOR radial.
2. Aircraft departing the primary airports are requested to advise the Honolulu clearance delivery position prior to taxiing of the intended route of flight and altitude. Aircraft departing from other than the primary airports should give this information on appropriate ATC frequencies or as directed by ATIS information if the route penetrates CLASS B.
3. Aircraft desiring to transit CLASS B will obtain clearance on an equitable "first-come, first-served" basis, providing the requirements of FAR 91 are met.

### ATC PROCEDURES

All aircraft will be controlled and separated while operating with CLASS B, except helicopters may not be separated from other helicopters. Although radar separation will be the primary standard used, approved visual and other nonradar procedures will be applied as required or deemed appropriate. Traffic information on observed targets will be provided on a workload permitting basis to aircraft operating outside of CLASS B.

NOTE: Assignments of radar headings and/or altitudes are based on the provision that a pilot operating in accordance with visual flight rules is expected to advise ATC if compliance with an assigned route, radar heading or altitude will cause the pilot to violate such rules.



**CLASS D/CLASS E AIRSPACE**

Elimination of Special VFR (FAR 91.157) Operations within Certain CLASS D/CLASS E airspace (FAR 93.113)

Special VFR flight operations by fixed-wing aircraft have been suspended within Honolulu CLASS D/CLASS E airspace which contains the following airports:

- Honolulu International Airport
- Ford Island Auxiliary Landing Field

At all other CLASS D/CLASS E airspace, Special VFR operations will be permitted only if IFR operations are not delayed.

Requests for relief from the special VFR prohibition will be considered for certain frequently recurring flight operations, including agricultural, industrial, and flights conducted by IFR-rated pilots in IFR equipped aircraft.

The ruling affects only Special VFR operations. VFR operations may continue to be conducted.

**TRAFFIC ADVISORIES AT NON-TOWER AIRPORTS**

The following procedures are supplemental to those described in the FAA Aeronautical Information Manual (AIM).

**1. AT A NON-FSS, NON-UNICOM AIRPORT**

- a. When inbound, tune to 122.9 MHz about 15 miles from the airport (if IFR, when the controller advises: "CHANGE TO ADVISORY FREQUENCY APPROVED") and listen for broadcasts from any other aircraft. Then, about 5 miles from the airport broadcast your position, altitude, and intentions. Follow this up with appropriate announcements of your position on downwind, base and final approach.
- b. When outbound, tune to 122.9 MHz before taxiing and listen for broadcasts from any other aircraft. Then broadcast your position on the airport and intentions. Follow this up with an announcement before you taxi onto the runway for takeoff.

**2. AT A NON-FSS AIRPORT LISTED AS HAVING UNICOM**

- a. When inbound, tune to 122.8 MHz about 15 miles from the airport (if IFR, when the controller advises: "CHANGE TO ADVISORY FREQUENCY APPROVED") and listen for any other aircraft communicating with the UNICOM operator. Then, about 5 miles from the airport, inform the UNICOM operator of your position, altitude and intentions.
- b. When outbound, contact the UNICOM operator on 122.8 MHz before taxiing and furnish your position on the airport and intentions.
- c. In both cases, the UNICOM operator will provide runway, wind, and at his discretion, traffic information.

**3. PART TIME TOWER (WHEN CLOSED)**

- a. When inbound at about 15 miles from the airport (if IFR, when the controller advises; "CHANGE TO ADVISORY FREQUENCY APPROVED") tune to and listen for broadcasts from other aircraft on the appropriate frequency listed below. Then, about 5 miles from the airport, broadcast your position, altitude and intentions. Follow this up with appropriate announcements of your position on downwind, base and final approach.

1. Hilo Intl – 118.1 MHz
2. Kahului Airport – 118.7 MHz
3. Keahole Airport – 120.3 MHz
4. Lihue Airport – 118.9 MHz
5. Molokai Airport – 125.7 MHz

- b. When outbound, tune to the appropriate frequency before taxiing and listen for broadcasts from any other aircraft. Then broadcast your position on the airport and intentions. Follow with an announcement before you taxi onto the runway for takeoff.

**HONOLULU TERMINAL AREA – VFR CLASS B DEPARTURE ROUTES****RESPONSIBILITIES**

VFR CLASS B DEPARTURE ROUTES WILL BE ISSUED ONLY UPON REQUEST. Detailed departure instructions will be furnished to others. All procedures and altitudes described in this letter are subject to weather and traffic conditions. Pilots are not relieved of their responsibilities to see and avoid other traffic, to maintain appropriate terrain and obstruction clearance, and to remain in weather conditions equal to or better than the minima required by FAR 91.155. When compliance with an assigned route, heading, or altitude is likely to compromise pilot responsibility with respect to terrain, obstruction clearance, and/or weather minima, approach control should be so advised.

**DEPARTURE PROCEDURES**

Before taxiing, pilots shall contact clearance delivery on 121.4/281.4 and state the current ATIS information code and requested departure procedure. Clearance delivery will issue the departure route clearance and assign transponder code. Unless otherwise directed by ATC, pilots shall depart CLASS B via the cleared route.

Example: Pilot – N86DD SHORELINE THREE DEPARTURE WITH INFORMATION QUEBEC.

ATC – N86DD IS CLEARED OUT OF CLASS B VIA SHORELINE THREE DEPARTURE SQUAWK 0271.

NOTE: Large acft expect clearance via radar vectors, initial heading 140°/200°

**Runway 04/08L Procedures****Shoreline Four Departure**

Departing runways 4 maintain runway heading to the H-1 freeway. Departing runway 8L maintain runway heading to Nimitz Highway. Turn right, parallel Nimitz Highway proceeding direct to the center of Honolulu Harbor. Fly one mile offshore passing abeam Kewalo Basin thence direct to one mile due south of Diamond Head. Turn left and resume own navigation, remaining within 2 miles of the shoreline until departing the Class B. Maintain 1500 feet while within CLASS B. Departure control frequency will be 124.8/317.6. Intended for twin-engine aircraft.

**Freeway Four Departure**

Departing runway 4 maintain heading to the H-1 freeway, departing runway 8L turn left to parallel runway 4 to the H-1 freeway. Then turn right, resume own navigation via the H-1 freeway eastbound, then via the Kalanianaʻole Highway until passing abeam Koko Head. Maintain 1500 feet while in CLASS B. Departure Control frequency will be 124.8/317.6. This departure is intended for single-engine aircraft.

**Redhill Three Departure**

Departing runways 4 maintain runway heading to the Moanalua Road (State Highway 78), departing runway 8L turn left and fly parallel to runways 4 to Moanalua Road. Then, turn left, fly OVER Moanalua Road northwestbound until departing CLASS B. Maintain 1500 feet while in CLASS B. Departure Control frequency will be 119.1/239.05. Restricted to small category aircraft only, large aircraft can expect radar vectors.

**CAUTION:** VFR traffic proceeding inbound to the H-1/H-2 interchange descending to 1500 feet and below.

**Runway 22/26R Procedures**

NOTE: All aircraft turn on landing lights while in CLASS B.

**Kona Three Departure**

After departure, turn left heading 180 degrees for radar vectors eastbound. Expect to be vectored 5 miles or more south of Diamond Head to avoid Runway 26L LDA final approach course. Maintain 1500 feet while in CLASS B. Departure Control frequency will be 124.8/317.6.

**West Loch Three Departure**

After departure, turn right as soon as practicable until north of Runway 26R. Then fly direct to center of West Loch of Pearl Harbor. Maintain 1500 feet while in the CLASS B. Departure control frequency will be 119.1/239.05.

**CAUTION:** VFR traffic proceeding eastbound from the west shoreline to the H-1/H-2 interchange descending to 2000 feet or below.

**ARRIVAL PROCEDURES**

Arrivals contact Approach Control and receive CLEARANCE BEFORE entering CLASS B. The HNL CLASS B is established from the HNL VORTAC. High density traffic in vicinity H-1/H-2 interchange.

**North Two Arrival**

Contact App Con 119.1/239.05 prior to H-1/H-2 interchange at or above 2000'. PROCEDURE WHEN CLEARED: From the H-1/H-2 interchange, proceed direct to and cross Ford Island at 1500', then descend to pattern altitude direct to the Navy/Marine Golf Course. Enter left downwind Runway 4L or right downwind Runway 22R as assigned by App Con.

**West Two Arrival**

Contact App Con 119.1/239.05 prior to Kahe Power Plant at or above 2000'. PROCEDURE WHEN CLEARED: From Kahe Power Plant, proceed direct to H-1/H-2 interchange at 2000', then proceed direct to and cross Ford Island at 1500'. Descend to pattern altitude direct to the Navy/Marine Gold Course. Enter left downwind Runway 4L or right downwind Runway 22R as assigned by App Con. Note: Aircraft below 2000' should contact Kalaeloa Tower on 132.6 prior to Kahe Power Plant.

**East Two Arrival**

Runways 04/08 configuration. Contact App Con 119.1/239.05 prior to NORBY intersection (MKK262 radial 20 DME or CKH 112 radial 12 DME). PROCEDURE WHEN CLEARED: From NORBY, proceed inbound on the MKK 262 radial at or below 3500'. Expect radar vectors for right base to Runway 4R.

**Freeway Two Arrival**

Runways 04/08 configuration. Contact App Con 119.1/239.05 prior to Koko Head at or above 2000'. PROCEDURE WHEN CLEARED: From Koko Head, proceed direct to Waiialae Golf course, then follow the H-1 Freeway to enter left downwind to Runway 4L. Maintain 2000' until advised by tower.

**Kona Arrival**

Runways 22/26R configuration. Contact App Con 119.1/239.05 prior to NORBY intersection at or below 3000'. PROCEDURE WHEN CLEARED: Proceed to Koko Head, then direct to Waiialae Golf Course. Follow the H-1 Freeway to enter left base to Runway 22L. Use caution: Turbojet aircraft will be inbound along the south shoreline.

**SIMULTANEOUS OPERATIONS**

Simultaneous take-offs and landings on intersecting runways are common at the Honolulu International Airport. IT IS THE RESPONSIBILITY OF THE PILOT TO DETERMINE WHETHER HE/SHE CAN COMPLY WITH A HOLD-SHORT RESTRICTION. Upon acceptance of a "HOLD-SHORT" instruction, pilots should acknowledge for such clearances with a read back of "roger, hold-short, aircraft ID."

**HONOLULU INTERNATIONAL AIRPORT****Gatehold Procedures**

THE FOLLOWING GATEHOLD PROCEDURES ARE ESTABLISHED FOR ALL OVERSEAS TURBOJET DEPARTURES FROM HONOLULU AIRPORT:

1. Advise clearance delivery: "identification, 10 minutes to taxi, destination, requested flight level".
2. The statement "10 minutes to taxi" means that you will depart the blocks, taxi, tow or pushback within 10 minutes after receiving enroute ATC clearance. Failure to push-back within 10 minutes after receipt of your clearance may result in ATC canceling your clearance when other aircraft are requesting the same altitude/route assignment and is/has pushed from the gate.
3. When ATC specifies a release (take-off) time for your requested route and altitude, alternatives with no or less delay will be offered, if available. If your choice involves a release time, call for push-back at least 10 minutes prior to your release (take-off) time (the intent of this procedure is to have you at the departure runway at your release time). Failure to push back 10 minutes prior to your release time may result in ATC canceling your clearance when other aircraft are requesting the same altitude/route assignment and is/has pushed from the gate.
4. ATC will not contact you if time elapses and your clearance is cancelled; it is the pilots responsibility to push-back in a timely manner. In the event the allotted time expires contact clearance delivery to verify the status of your clearance prior to calling for push-back.
5. If you wish to depart the gate and absorb the delay in a holding area closer to the departure, advise ground control of your desire.
6. When two aircraft are requesting the same altitude/route and call for clearance at approximately the same time, the first aircraft to call will receive the altitude/route. The second aircraft will receive the alternatives. The first aircraft may lose their assigned altitude/route if all the following occurs:
  - a. The first aircraft has not pushed from the gate in the specified time in paragraphs 2 or 3.
  - b. The second aircraft is/has pushed from the gate.
  - c. The second aircraft requests that altitude after push back.
7. Enroute clearances are based on accurate "10 minute to taxi" declarations. Those flight that taxi without receiving any enroute clearance will receive no altitude/route priority.

NOTES: 1. Compliance will ensure an orderly sequence of altitude/route assignments during peak traffic movements.  
2. Oceanic departures are sequenced with Hilo and Kahului traffic.

**Informal Runway Use Program**

Unless runway closures, wind, weather or traffic conditions, aircraft emergencies, actual air defense missions or operational necessities require otherwise, all turbojet aircraft and all aircraft having a maximum passenger capacity of more than 30 seats or a maximum payload capacity of more than 7,500 pounds, including all models of the Convair 240, 350, and 440; Martin 202 and 404; F-27 and FH227; Hawker Siddeley 748; military fighter interceptor turbojet; and any other aircraft with a minimum zero fuel weight in excess of 35,000 pounds will be assigned runway as follows:

**GROUP I**

Turbojet aircraft capable of 300,000 pounds gross takeoff weight or more 4 or more engine turbojet, and military fighter interceptor turbojet type aircraft  
(DC10, L1011, DC8, B747, B707, KC135, B52, F15, F16, E6, etc).

**TRADE (NORTHEAST) WIND CONDITIONS**

Departures: 8R  
Arrivals: 8L

**KONA (SOUTHWEST) WIND CONDITIONS**

Departures: 26L or 22R/L  
Arrivals: 26L

**GROUP II**

Other turbojet, turbine; powered and propeller driven type aircraft.  
(B727, B737, MD80, C130, etc).

8L  
4R/L or 8L

22R/L or 26R  
26L

**AIRCRAFT LANDING RUNWAY 8L:** Fly the ILS approach procedure or fly a base leg over Kalaeloa (John Rodgers Fld) maintaining 3000 feet until established on the final approach course. Large jet or smaller aircraft may fly a close-in base leg remaining over the center of Pearl Harbor channel.

**AIRCRAFT LANDING RUNWAY 26L/R:** Remain at traffic pattern altitudes as long as possible before beginning descent for landing.

**DEPARTURES – ALL RUNWAYS:** Turn southward as soon as possible after takeoff. Remain at least one mile offshore of Waikiki, Diamond Head, Koko Head and Ewa Beach.

- NOTES: 1. Cooperation of all users is expected to preclude disruption or creation of conflicting traffic flows.  
2. Pilots unable to comply with the program should advise Honolulu Ground or Approach Control as soon as possible for traffic adjustments.

#### **KAHALUI AIRPORT**

##### **Gatehold Procedures**

THE FOLLOWING GATEHOLD PROCEDURES ARE ESTABLISHED FOR OVERSEAS TURBOJET DEPARTURES FROM KAHULUI AIRPORT:

1. Advise clearance delivery: "Identification, 10 minutes to taxi, destination, requested flight level".
2. The statement "10 minutes to taxi" means that you will depart the blocks, taxi, tow or pushback within 10 minutes after receiving enroute ATC clearance.
3. When ATC specifies a release (takeoff) time of more than 15 minutes for your requested altitude/route, alternatives with no or less delay will be offered, if available. If your choice involves a release time of more than 15 minutes, advise Clearance Delivery if you desire to wait at the gate.
4. Depart the blocks within 10 minutes after receiving enroute clearance when release time is less than 15 minutes. Ready to taxi means ready to immediately depart the blocks/taxi, tow or pushback. Failure to do so will result in ATC canceling your clearance when other aircraft are requesting the same altitude/route and are ready to taxi.
5. Enroute clearances are based on accurate "10 minute to taxi" declarations. Those flights that taxi without receiving any enroute clearance will receive no altitude/route priority.

- NOTES: 1. Compliance will ensure an orderly sequence of altitude/route assignments during peak traffic movements.  
2. Oceanic departures are sequenced with Honolulu and Hilo traffic.

#### **KONA INTL AT KEAHOLE**

##### **Gatehold Procedures**

THE FOLLOWING GATEHOLD PROCEDURES ARE ESTABLISHED FOR OVERSEAS TURBOJET DEPARTURES FROM KONA INTL AT KEAHOLE AIRPORT:

1. Advise clearance delivery: "Identification, 10 minutes to taxi, destination, requested flight level."
2. The statement "10 minutes to taxi" means that you will depart the block, taxi, tow, or pushback within 10 minutes after receiving enroute ATC clearance.
3. When ATC specifies a release (takeoff) time of more than 15 minutes for your requested altitude/route, alternatives with no or less delay will be offered, if available. If your choice involves a release time of more than 15 minutes, advise Clearance Delivery if you desire to wait at the gate.
4. Depart the blocks within 10 minutes after receiving enroute clearance when release time is less than 15 minutes. Ready to taxi means ready to immediately depart the blocks/taxi, tow, or pushback. Failure to do so will result in ATC canceling your clearance when other aircraft are requesting the same altitude/route and are ready to taxi.
5. Enroute clearances are based on accurate "10 minutes to taxi" declarations. Those flights that taxi without receiving any enroute clearance will receive no altitude/route priority.

- NOTES: 1. Compliance will ensure an orderly sequence of altitude/route assignments during peak traffic movements.  
2. Oceanic departures are sequenced primarily with Honolulu, Maui, and Hilo traffic.

**LIHUE AIRPORT****Gatehold Procedures**

THE FOLLOWING GATEHOLD PROCEDURES ARE ESTABLISHED FOR OVERSEAS TURBOJET DEPARTURES FROM LIHUE AIRPORT:

1. Advise clearance delivery: "Identification, 10 minutes to taxi, destination, requested flight level."
2. The statement, "10 minutes to taxi" means that you will depart the blocks, taxi, tow, or pushback within 10 minutes after receiving enroute ATC clearance.
3. When ATC specifies a release (takeoff) time of more than 15 minutes for your requested altitude/route, alternatives with no or less delay will be offered, if available. If your choice involves a release time of more than 15 minutes, advise Clearance Delivery if you desire to wait at the gate.
4. Depart the blocks within 10 minutes after receiving enroute clearance when release time is less than 15 minutes. Ready to taxi means ready to immediately depart the blocks/taxi, tow, or pushback. Failure to do so will result in ATC canceling your clearance when other aircraft are requesting the same altitude/route and are ready to taxi.
5. Enroute clearances are based on accurate "10 minutes to taxi" declarations. Those flights that taxi without receiving any enroute clearance will receive no altitude/route priority.

NOTES: 1. Compliance will ensure an orderly sequence of altitude/route assignments during peak traffic movements.  
2. Oceanic departures are sequenced with Honolulu, Maui, Hilo, and Keahole traffic.

**Informal Runway Use Program**

The area directly south of Lihue Airport and west of Carters Point has been designated as a noise sensitive area. The opening of Rwy 17-35 has given us the opportunity to significantly reduce aircraft noise in the vicinity of schools and homes. This program is the result of the cooperative efforts of state, local and federal government and is designed in accordance with the U.S. Department of Transportation Aviation Noise Abatement Policy.

**A. GENERAL** Unless runway closures, weather, traffic conditions, aircraft emergencies, actual air defense missions, or operational necessity requires, aircraft will be assigned runways and routings as described in this section. Pilots are requested to adhere to these procedures during all hours, including 2100 to 0700 local.

**B. ITINERANT DEPARTURES** All jet and multi-engine propeller aircraft should depart on Rwy 03, 17, or 35. Aircraft to initiate turns seaward as soon as possible following takeoff.

**C. ITINERANT ARRIVALS** All jet and multi-engine propeller aircraft should land on Rwy 35, 21, or 17. All approaches should occur from a seaward direction.

**D. LOCAL OPERATIONS (Touch-and-Go and Low Approach)** Preferred runways for local operations of jet and multi-engine propeller aircraft are Rwy 17-35. Downwind leg for Rwy 17-35 should be at least 1 mile east of the coastline.

**E. TOWER ADVISORY** When the runway specified in these procedures is other than the runway most nearly aligned with the wind, controllers shall preface their instructions with the phrase "For Noise Abatement". If in the interest of safety a runway different from that specified is preferred the pilot is expected to advise Lihue Tower accordingly. Lihue Tower will honor such requests and advise the pilot that the runway requested is noise sensitive.

**HILO INTERNATIONAL AIRPORT****Gatehold Procedures**

THE FOLLOWING GATEHOLD PROCEDURES ARE ESTABLISHED FOR OVERSEAS TURBOJET DEPARTURES FROM HILO INTERNATIONAL AIRPORT:

1. Advise clearance delivery: "identification, 10 minutes to taxi, destination, requested flight level".
2. The statement "10 minutes to taxi" means that you will depart the blocks, taxi, tow or pushback within 10 minutes after receiving enroute ATC clearance.
3. When ATC specifies a release (takeoff) time of more than 15 minutes for your requested altitude/route, alternatives with no or less delay will be offered, if available. If your choice involves a release time of more than 15 minutes, advise Clearance Delivery if you desire to wait at the gate.
4. Depart the blocks within 10 minutes after receiving enroute clearance when release time is less than 15 minutes. Ready to taxi means ready to immediately depart the blocks/taxi, tow, or pushback. Failure to do so will result in ATC canceling your clearance when other aircraft are requesting the same altitude/route and are ready to taxi.
5. Enroute clearances are based on accurate "10 minute to taxi" declarations. Those flights that taxi without receiving enroute clearance will receive no altitude/route priority.

NOTES: 1. Compliance will ensure an orderly sequence of altitude/route assignments during peak traffic movements.  
2. Oceanic departures are sequenced primarily with Honolulu, Maui, and Keahole traffic.

**Preferred Departure Routing**

Hilo departures planning U.S. Mainland destinations via the Composite Route System-Hawaii to U.S. Mainland will be cleared as follows:

R578 VIA THE ITO 345 RADIAL 39 MILE DME FIX AND THE UPP 066 RADIAL TO FITES.  
 R577 VIA THE ITO 345 RADIAL 55 MILE DME FIX AND THE UPP 048 RADIAL TO EBBER.  
 R465 VIA THE ITO 345 RADIAL 158 MILE DME FIX AND THE OGG 027 RADIAL TO CLUTS.  
 R463 AND NORTH VIA V25 ARROW DIRECT APACK.

Flight plan format for these routes is as follows:

IT0345039	FITES	R578
IT0345055	EBBER	R577
IT0345158	CLUTS	R465

Your cooperation in filing flight plans in accordance with the above data will be appreciated.

**HAZARDS, CAUTIONS, AND WARNINGS**

**HAWAII – POHAKULOA TRAINING AREA:** Extensive military aircraft training in and near R3103 at speeds of 250 knots. All pilots flying over the island of Hawaii within 10 NM of R3103 (SFC to 30,000 feet) should be alert for high speed maneuvering aircraft.

**HAWAII – TRAFFIC PATTERN VOLCANIC ERUPTION AREA:** During eruptions in the Hawaii Volcanos Parks area, left hand elliptical traffic patterns will be established up wind of the eruption area for all aircraft. Minimum altitude 2000 feet above the terrain. Remain clear of smoke. Pilots are requested to maintain an alert listening watch on 122.9 MHz and announce aircraft position, direction of flight, altitude and intentions.

**HAWAII:** Caution advised all airports on Kauai, Oahu, Molokai, Lanai and Maui. Migratory bird activity surface to 1500 feet within a 5 NM radius of the airports from August–May.

**HAWAII – TOUR AIRCRAFT:** High volume tour aircraft operating over Hawaii. For traffic information, monitor 127.05 NW of ITO VOR 215 radial, monitor 122.85 SE of ITO VOR 215 radial.

**KAUAI – NAVIGATIONAL WARNING:** Electromagnetic radiation will continuously exist within a 2500 foot radius and 2500 feet above unified S band antenna located at N22°06.81' /W159°39.83' near Kokee NASA Telemetry Station, Kauai. Helicopters and slow speed aircraft flying within the airspace will be exposed to direct radiation which may produce harmful effects to personnel and equipment. Radiation cannot be seen and must be presumed by all pilots to continuously exist.

**KAUAI – HANG GLIDING NEAR LIHUE AIRPORT:** Hang gliding operations will be conducted from Kalepa Ridge 2 miles North of Lihue Airport from 1800 to 0500Z daily 2000 feet and below. Exercise extreme caution when transiting the area.

**KAUAI – PORT ALLEN AIRPORT:** Warning – Exercise extreme caution in the vicinity of Port Allen due to high volume of Tour Rotorcraft and Fixed Wing, Glider, and Military Operations.

**KAUAI – TOUR AIRCRAFT:** High volume tour aircraft operating over Kauai. Monitor 127.05 for traffic information.

**LANAI – LANAI AIRPORT RAMP AREA:** Due to ramp space limitations, all transient aircraft must contact arpt manager 808–872–3830 PPR for parking or depart within one hour of arrival. The apron area has been divided as follows: West Corner–light acft transient parking, South Corner–HAZARDOUS MATERIAL Handling, East Corner–Heavy acft transient parking, North Corner–Airline and Air Cargo Operations.

**LANAI –TOUR AIRCRAFT:** High volume tour aircraft operating over Lanai. Monitor 122.9 for traffic information.

**MAUI – KAHOOLOWE ISLAND:** Flying below the altitude of 300 feet or landing on the island of Kahoolawe, Hawaii is inherently dangerous. Live unexploded munitions are on the surface of the island. Rotor and prop wash may disturb these items, resulting in a detonation. Anyone desiring to land on Kahoolawe Island must contact the Kahoolawe Island Reserve Commission at (808) 243–5029 or 243–5022.

**MAUI – KAHULUI AIRPORT/HELIPORT:** The area east of the approach end of Rwy 02 has been designated as a helicopter operating area. No fixed wing operations approved except via PPR. Contact arpt manager 808–872–3880.

**MAUI – KAHULUI AIRPORT RAMP AREA:** Yellow segmented and solid lines painted on the apron area fronting the passenger terminal represents the line of demarcation between the authority of the FAA and the State. The FAA is responsible for the control and direction of all ground traffic from the solid yellow line outward toward the field. That area is considered to be an active operating area. Aircraft, vehicles, and/or ground equipment entering this area must have prior clearance from the tower. The area lying between the line and the terminal building falls under the jurisdiction of the State. The acft pilot and ground vehicle operator crossing from the taxiway is responsible for avoiding collisions, accidents, and using safe operating procedures. Ramp area East of RWY 02–20 falls under the jurisdiction of the State. The FAA is not responsible for control or direction of ground traffic in that area. Yellow demarcation lines cross east ramp taxiway entrances.

**MAUI – HALEAKALA CONTROLLED FIRING AREA:** The Haleakala Controlled Firing Area is described as follows: From 10,000 feet MSL to unlimited within a circular area with a 1 NM radius from the Mount Haleakala Maui Observatory (located at the 10,000 foot level at N20°42.42' /W156°15.38') and expanding outward and upward in a conical shape from this 1 NM radius based on an angle from the observatory of 15 degrees above the horizontal. The conical boundary leaves the 1 NM radius at 10,000 feet MSL and passes through 20,000 feet MSL at the 7.22NM radius and through 42,000 feet at the 20.90 NM radius. Pulsed Ruby Laser operations potentially hazardous to eyesight will be conducted within this area intermittently for 5 to 30 minute periods generally at night and advertised by NOTAM. Laser operations are predicted on the non-interference with IFR operations through coordination with the Honolulu Control Facility. Pilots of aircraft flying VFR should avoid the controlled firing area during its advertised time of use. As a precautionary measure however Laser operations will be suspended if an aircraft penetrates the area of concern. The status of the controlled firing area can be obtained by contacting FAA Honolulu FSS.

**MAUI–KAHOLOWE CONTROLLED FIRING AREA:** The Kahoolawe Hawaii Controlled Firing Area is described as follows: From SFC up to and including 5000'MSL within that area bounded by N20°37'30"/W156°32'48", to N20°34'48"/W156°30'24", to N20°28'56"/W156°30'24", to N20°28'06"/W156°41'48", to N20°20'30"/W156°44'12", to N20°33'12"/W156°44'30", to N20°37'30"/W156°36'24", thence to point of beginning. The CFA includes the entire island of Kahoolawe. Ordnance

disposal/demolition work potentially hazardous to aircraft shall be conducted by NOTAM during daylight hours only. The controlling agency is FAA Honolulu Control Facility. The status of the CFA can be obtained by contacting the FAA Honolulu AFSS.

**MAUI – PARASAILING AREA:** Parasailing off-shore Lahaina (OGG VORTAC 250R/014 DME) 1000'/below, sunrise to sunset.

**MAUI – AEROBATIC OPERATIONS:** 1 NM radius (OGG VORTAC 175R/011 DME) from 0315–0415Z Sundays 1500' and below.

**MAUI – ULTRALIGHT OPERATIONS:** Extensive ultralight operations from atop Mt. Haleakala to Kalama Park (OGG VORTAC 175R/011DME). Unpowered ultralights remain over land. It is recommended that aircraft arriving from the south remain offshore, west of the OGG 175R until 11 DME before turning inbound to Kahului airport.

**MAUI – TOUR AIRCRAFT:** High volume tour aircraft operating over Maui. Monitor 120.65 for traffic information.

**MOLOKAI – TOUR AIRCRAFT:** High volume tour aircraft operating over Molokai. Monitor 121.95 for traffic information.

**OAHU – HONOLULU INTERNATIONAL AIRPORT – RAMP AREA:** Broken yellow lines, ramps and taxiways indicate the edge of full strength bearing pavement. Pilots are cautioned to avoid taxiing main gear over stabilized taxiway and apron shoulders. Shoulder pavement is stabilized only and not load bearing. Exercise care in following taxiway centerlines at all times especially on turns and at intersections. Yellow non movement area boundary lines painted on the apron area fronting the terminal complex represents a line of demarcation between the authority of the FAA and the airport operator (State). The FAA is responsible for the control and directing of all ground traffic from the non movement area boundary line outward toward the field. This area is considered an air operation area (AOA). Aircraft, vehicles and/or ground equipment entering this area must have proper clearance from the air traffic control tower. The area lying between the non movement area boundary lines inbound toward the concourse falls under the jurisdiction of the airport operator (State). The aircraft pilot and ground vehicle equipment operator crossing the non movement boundary lines from the taxiway is responsible for avoiding collisions, accidents, and using safe operating procedures in the non movement area.

**OAHU – HONOLULU INTERNATIONAL AIRPORT AND METROPOLITAN AREA:** Numerous cranes at the airport and metropolitan areas up to 500' AGL.

**OAHU – HONOLULU INTERNATIONAL AIRPORT – PROXIMITY TO KALAELOA (JOHN RODGERS FLD):** All pilots are reminded of the proximity of Honolulu Airport to Kalaeloa (John Rodgers Fld). Exercise caution when approaching Honolulu Airport as both fields have parallel Runways 04. Several landings have been made at Kalaeloa (John Rodgers Fld) by pilots mistaking it for Honolulu Airport. Minimum IFR altitude for aircraft overflying Kalaeloa (John Rodgers Fld) is 2200 feet.

**OAHU – KANEHOE BAY MCAS – HIGH PERFORMANCE AIRCRAFT:** Kaneohe Bay MCAS advises high performance aircraft will make maximum performance VFR climbs from takeoff Rwy 04/05 at various times following a warning broadcast on Kaneohe Tower and Approach Control frequencies. Request all aircraft contact Kaneohe Tower prior to transiting CLASS D airspace northeast of Rwy 04/05.

**OAHU – KANEHOE BAY MCAS – CONTROLLED FIRING AREA:** The MCAS Kaneohe Bay Controlled Firing Area is described as follows: From the surface to, but not including 3,000 feet MSL within that area bounded on the east by latitude N21°30.81', longitude W157°40.33', to latitude N21°25.91', longitude W157°40.34', on the south by a line extending to latitude N21°25.91', longitude W157°44.04', on the west by a line extending to latitude N21°30.81', longitude W157°44.04', and on the north by a line extending to the point of beginning. Machine gun, rifle and mortar firing operations within Ulupau Crater potentially hazardous to aircraft will be conducted at periods between 0600 to 2300 local time Monday through Friday and 0600 to 1800 local time on Saturday and Sunday, as required. These weapons training activities are predicated on non-interference with aircraft. The controlling authority, Commanding Officer, MCAS Kaneohe Bay, has agreed to cease any activity hazardous to aircraft upon being advised of the approach of aircraft to or within the controlled firing area. In that regard, such activity will be suspended if aircraft are observed by the controlling authority to be within or entering the controlled firing area. All aircraft operators should, nevertheless, remain alert for the possibility of hazardous activity when operating within the controlled firing area.

**OAHU – KALAELOA (JOHN RODGERS FLD):** Tanker vessels with mast height up to 170 feet intermittently operating 2 NM South of approach end Rwy 04.

**OAHU – GLIDER OPERATIONS:** Caution – Gliders operating over central Oahu, 20 NM Radius of the Wheeler (HHI) NDB (excluding HNL TCA), surface to 22,000 feet during mountain wave conditions. Occasional higher operations in unusually strong conditions. Gliders aren't normally transponder equipped and aren't visible on ATC radar.

**OAHU – HAZARD AREAS:** (1) Pilots are cautioned to avoid, or maintain a minimum of 500 feet AGL over the following ammunition storage areas due to significant threat to life and property posed by possible forced landing or other mishap.

AREA	DIMENSIONS	LOCATION FROM HNL VORTAC
NAD Waikalei	1.5 NM Radius	353 radial at 5.2 DME
NAD Luualualei	2.5 NM Radius	316 radial at 9.7 DME

(2) All pilots are cautioned to avoid Kaena Point land mass within 1½NM (9,120 feet). Potential personnel and electro explosive device hazards exist due to high power radio frequency transmitters.

**OAHU – HANG GLIDING:** Hang gliding operations will be conducted from Makapuu Point 3 miles west along ridge to Waimanalo Beach from 1800 to 0500Z daily, 2000 feet and below. Exercise extreme caution when transiting the area.

**OAHU – ULTRALIGHT OPERATIONS:** Extensive ultralight operations conducted between Makapuu Point and Manana (Rabbit Island).

**OAHU – TOUR AIRCRAFT:** High volume tour aircraft operating over Oahu. Monitor 122.85 for traffic information.

**OAHU – EARTH TRACKING STATION:** Effective immediately and UFN all pilots are requested to avoid overflights below 1000 feet AGL of Com Earth Tracking Station located at HNL300023 DME fix at all times.

**OAHU – RIFLE/PISTOL RANGE:** Military rifle/pistol range located on west side of Pearl Harbor channel entrance between Ewa Beach and Keahi Point (HNL264R 3.0 DME) (N21°18.81'/W157°58.84') active Monday through Friday between 0700 to 1700 HST. Danger area from the shoreline extends one nautical mile southeast, 4500 feet wide, from the surface to 200 feet. All aircraft inbound to HNL Rwy 4R/L and 8R/L, remain above 200 feet until east of this area.

**OAHU – NAVIGATIONAL WARNING:** Electromagnetic radiation will continuously exist within a 2800 foot radius and 2800 feet above all antenna systems along a three mile stretch of mountain ridge between N21°33.81'/W158°13.83' and N21°33.81'/W158°15.83' as part of the Kaena Point Satellite Tracking Station, Oahu, Hawaii. Helicopters and slow speed

aircraft, including hang gliders, flying within the above airspace will be exposed to direct radiation which may produce harmful effects to personnel and equipment. Radiation is not visually apparent and must be presumed by all pilots to continuously exist.

**OAHU – LIGHTS-OUT MILITARY TRAINING:** Extensive military rotary wing traffic in and near Alert Area A-311. Unlighted military rotary wing training conducted within boundaries of A-311 from 1 hour after sunset through 1 hour before sunrise, surface to 500 feet AGL.

**OAHU – AIRBORNE HAZARD:** Fireworks Displays will be conducted every Friday between 7:00 pm and 9:00 pm, for three minutes at Hilton Hawaiian Village (HNL VORTAC 096R/5NM), 600 ft and below, ½ NM radius. Avoidance Advised.

**HELICOPTER PILOTS – KAPALAMA HELIPAD:** Additional high tension electrical line installed on West border of helipad. Use Caution.

**HAWAII – OIL POLLUTION REPORTS**

Pilots observing oil slicks are requested to report them to a Flight Service Station by radio as soon as possible. If a pilot cannot file by radio, he should report by telephone or in person at the next point of landing or at destination. The report should include the approximate location using prominent landmarks, size of slick, type of vessels observed in vicinity, and other pertinent information.

**KIRIBATI**

Full details of all aeronautical facilities in the Kiribati, which includes the Line Islands, are promulgated in the New Zealand Aeronautical Information Publication, South Pacific Flight Guide.

**TARAWA – BONRIKI AIRFIELD:** Operates during daylight hours only. Field is not lighted at night. Tarawa authorities request that pilots arrive before dark.

**KIRITIMA TI (CHRISTMAS ISLAND) – CASSIDY INTL:** Operates during daylight hours for any flight which has given 48 hours prior notice. Airport not manned unless flights are known to be operating. Fuel is available during daylight hours with prior notice.

**Non-scheduled Flight Procedures**

1. If an operator intends to carry out a non-scheduled flight in transit across, or make non-traffic stops in the territory of Kiribati, he may do so without the necessity of obtaining prior permission. However, the attention of operators is drawn to the need for prior notification in respect to navigation aids.
2. If an operator intends to perform a non-scheduled flight into Kiribati for the purpose of taking on or discharging passengers, cargo, or mail he shall apply to:
 

Postal Address:	Director of Civil Aviation P.O. Box 487 Betio, Tarawa Kiribati
Telegraphic Address:	AVIATION, BETIO, Tarawa
3. The application for permission to carry out such operations must include the following information in the same order as shown hereunder:
  - A. Name and address of applicant.
  - B. Type of aircraft and registration marks.
  - C. Date and times of arrival and departure from airfields in Kiribati.
  - D. Place or places of embarkation or disembarkation, as the case may be, of passengers and/or freight.
  - E. Purpose of flight and number of passengers, and/or nature and amount of freight.
  - F. Name, address and business of charterer, if any.
4. Normally the time required for consideration of applications is brief, but applicants should make allowances for communication delays.

**FEDERATED STATES OF MICRONESIA  
WENO ISLAND-CHUUK INTERNATIONAL AIRPORT**

1. Prior permission required for all non-scheduled aircraft from Civil Aviation Directorate, Department of Transportation, Communications and Infrastructure, Division of Civil Aviation, P. O. Box PS 2, Palikir, Pohnpei, FM 96941-0000; Tel (691) 320-2865; Fax (691) 320-5853; e-mail [TransFSM@mail.fm](mailto:TransFSM@mail.fm)
2. A copy of clearance and schedule must then be submitted to:
  - a) Chuuk International Airport, P. O. Box 189, Weno, Chuuk State, FM 96942; Tel-Office (691) 330-5940, SWARS (691) 330-2352; FAX (691) 330-4242; e-mail [ChuukAirport@mail.fm](mailto:ChuukAirport@mail.fm). The Chuuk Airport Executive Manager must be notified three (3) days prior for the ETA of the aircraft. A flight plan must be filed 12 hours prior for the ETA, include Pohnpei Intl Airport (PTPN) as an additional address of the Fit Plan.
  - b) Immigration Office, P. O. Box 666, Weno, Chuuk State, FM 96942; Tel. (691) 330-2355; FAX (691) 330-4135; e-mail [CIL@mail.fm](mailto:CIL@mail.fm)
  - c) Customs Office, P. O. Box 610, Weno, Chuuk State, FM 96942; Tel. (691) 330-4482; FAX (691) 330-5893; e-mail [CTAChk@mail.fm](mailto:CTAChk@mail.fm)
  - d) Quarantine Office, Tel (691) 330-3720; FAX (691) 330-3721; e-mail [ChuukQuart@mail.fm](mailto:ChuukQuart@mail.fm)
3. Transient aircraft must make prior arrangements with Mobil Oil Guam for fuel and also Mobil Oil Micronesia-Chuuk, P. O. Box 130, Weno, Chuuk State, FM 96942, Tel (691) 330-2540; FAX (691) 330-2688.

**GUAM CTA/MARIANA ISLANDS**

**GUAM-APRA HARBOR—DROTE POINT**

In the interest of national security, the Commander, Naval Forces Marianas (COMNAVMAR) requests all civil aircraft avoid overflying U.S. Naval ships and military property west of a line between Santa Rita and Piti below 1500 feet.



**RADAR SERVICE PROGRAM GUAM TERMINAL AREA**

The VFR radar service program in the Guam Terminal Area provides full time radar advisory and sequencing service to VFR aircraft within 25 miles of the Nimitz VORTAC and radar advisory sequencing and separation within the Andersen TRSA and arriving Andersen AFB. Pilots of VFR aircraft arriving airports in Guam Terminal Area should contact Guam Approach Control when 25 NM from the Nimitz VORTAC. All aircraft use 269.0 or 119.8 MHz. Approach control will issue runway, wind and traffic information, and vectors as necessary for proper sequencing with other arriving aircraft at Andersen AFB and Agana airports. When a pilot reports the aircraft he is to follow in sight, he will be advised to follow it. Departing VFR aircraft desiring traffic information should request VFR radar service on initial contact with Andersen Ground Control or Agana Tower, and advise direction of flight. Tower will advise when to contact departure control and frequency. Since this is a voluntary program, the procedures are not to be interpreted as relieving pilots of their responsibilities to see and avoid other traffic operating in basic VFR weather conditions, to maintain appropriate terrain and obstruction clearance, or to remain in weather conditions equal to or better than the minima required by FAR 91.155. Whenever compliance with an assigned route or heading is likely to compromise pilot responsibility respecting terrain and obstruction clearance and weather minima, Guam approach control should be so advised so that the heading may be revised as appropriate.

- NOTES: 1. A graphic depiction of the Guam Terminal Area and Andersen TRSA may be found at the end of this section.  
2. Information on flying within a TRSA may be located in Section V of this supplement or in the Aeronautical Information Manual.

**TINIAN INTL AIRPORT – COMMUNICATION**

NON-FSS airport with UNICOM available from 2000–0930Z. When inbound tune to 123.6 about 15 miles from the airport (if IFR when the controller advises CHANGE TO ADVISORY FREQUENCY APPROVED) and listen for any other aircraft communicating with the UNICOM operator. When about 5 miles from the airport inform the operator of your position, altitude and intentions. When outbound contact the UNICOM operator before taxiing and furnish your position on the airport and intentions. In both cases the UNICOM operator will provide runway, wind and traffic information.

**HAZARDS, CAUTIONS, AND WARNINGS**

**GUAM – SATELLITE TRACKING OPERATIONS:** Because of possible interference with satellite tracking operations and to avoid a potentially hazardous radiation field, pilots are advised to avoid the area within 1 NM of the UNZ VORTAC 033R at 12.2 DME at and below 3100 feet.

**GUAM – BALLOON RELEASE:** National Weather Service Guam Observatory releases twice ascending balloon borne atmospheric sensing instruments at N13°33'/E144°50' between 1100–1115Z and 2300–2315Z. Instrument equipment consists of 6 foot diameter rubber balloon with string train 100 feet in length containing a red paper parachute and small white plastic radiosonde instrument. Equipment estimated to ascend to altitudes of 10,000 feet within a 5 mile radius by 1130Z and 2330Z. Ascends to 50,000 feet by 1215Z and 0015Z. Ascends to 100,000 feet by 1300Z and 0100Z respectively.

**AUCKLAND OCEANIC FIR****1. Altimeter Setting Requirements**

- 1.1 Within the Auckland Oceanic FIR, the vertical position of aircraft shall be maintained by reference to standard pressure value of 1013.2 hPa, except that:
  - a. Aircraft shall change to and from the appropriate zone QNH value upon entering and leaving the QNH zones;
  - b. Where the aerodrome of destination or departure is not within a QNH zone aircraft shall use the appropriate aerodrome QNH value when at or below 13,000 feet within 100NM of the shoreline of the landmass on which the destination or departure aerodrome is situated.
- 1.2 Within the New Zealand domestic, Samoa, Tonga and Cook Area QNH Zones, when at or below 13,000 feet aircraft shall maintain vertical position by reference to the appropriate zone QNH, except that aircraft landing and taking off or operation within a control zone shall use the appropriate aerodrome QNH. However, a QFE altimeter setting may be used in accordance with paragraph 1.7.
- 1.3 The transition layer between the transition altitude of 13,000 feet and the transition level of FL150 provides adequate separation between aircraft observing different pressure values when the QNH is above 980 hPa. However, when the zone QNH is 980 MB or less, the minimum usable flight level above the zone involved shall be FL160.
- 1.4 The transition layer shall not be used except when ascending or descending. While passing through the transition layer, vertical position shall be expressed in terms of flight levels (1013.2 hPa) when ascending and in terms of altitude (QNH) when descending.
- 1.5 Pilots departing from an aerodrome where no QNH value is available shall set the aerodrome elevation on the altimeter prior to departure and shall obtain the appropriate altimeter setting as soon as possible and in any case before entering IMC.
- 1.6 QNH values passed to aircraft will be rounded down to the nearest whole hPa.
- 1.7 Use of QFE Altimeter Setting.
  - 1.7.1 Where suitable equipment is available, a QFE altimeter setting will be provided, on request, for flights operating by visual reference within an aerodrome traffic circuit. Additionally, foreign operators normally using a QFE altimeter setting for instrument approaches will be provided, on request, with a QFE for the aerodrome elevation except for:
    - a. An instrument runway, if the runway threshold is 7 feet or more below the aerodrome elevation;
    - b. A precision approach runway; in which case the QFE for the relevant threshold elevation will be provided.
  - 1.7.2 QFE values passed to an aircraft will be rounded down to the nearest whole hPa.

**2. Enroute Communications**

- 2.1 Aircraft enroute within the Auckland Oceanic FIR shall maintain a continuous listening watch on the frequency assigned by the Air/Ground control station.  
NOTE: The requirement to maintain a continuous listening watch may be met by the use of approved automatic signaling devices such as SELCAL.
- 2.2 Aircraft inbound to Auckland Oceanic FIR shall establish RTF contact with ATC on Auckland Oceanic frequencies at the Auckland boundary. Outbound aircraft shall transfer to route frequency when instructed by ATC.
- 2.3 Aircraft entering the Samoa, Tonga, Cook or New Zealand domestic sectors, will be instructed when to change from route frequency to the frequency of the appropriate ATC unit. Aircraft leaving these sectors will be instructed by ATC when to change to the route frequency.

**3. Enroute Air Navigation Facilities and Service Charges**

Airways Corporation, the ATC service provider in the upper airspace of the Auckland Oceanic FIR, levies charges for enroute air navigation services provided to aircraft. Operators of any aircraft for which navigation services are made available in the Auckland Oceanic FIR should be aware that they may be obligated to pay charges for the services provided.

**OAKLAND OCEANIC FIR/CTA****INTERNATIONAL PILOT WEATHER BRIEFING**

Honolulu Automated Flight Service Station (HNL AFSS) conducting international pilot weather briefing test program.

Call HNL AFSS at 1-800-WX-BRIEF (1-800-992-7433) or 1-866-766-0820 for the list of foreign aerodromes served.

**CENTRAL EAST PACIFIC (CEP)**

1. The Central East Pacific (CEP) is the organized route system between Hawaii and California. Seven ATS routes, R463, R464, R465, R585, R576, R577, R578 and associated transition waypoints are within the CEP. Reduced Vertical Separation Minimum (RVSM) and Required Navigation Performance 10 (RNP-10) are required for aircraft operating within the CEP at FL290 through FL410. Non-approved aircraft can expect FL280 and below or FL430 and above, traffic permitting.
2. Flight levels normally assigned in the CEP are in accordance with ICAO Appendix 3a, (East odd, West even).
3. Applicable ATC procedures can be found in FAA Orders 7110.65 and 8400.12 and in ICAO Document 7030 – PAC/RAC, Annex 2, Appendix 3, and Document 9574.

**COMPOSITE SEPARATION**

Composite separation is achieved by using a combination of at least 50 NM lateral separation and 1000 feet vertical separation. Composite separation may only be applied to aircraft established within the CEP and/or aircraft leaving/joining the CEP.

**RNP-10 SEPARATION**

RNP-10 lateral separation (50 NM) may be applied within the Oakland Oceanic FIR between RNP-10 approved aircraft. RNP-10 lateral separation is based on the equipment qualifier filed by the aircraft. Operators shall determine that the appropriate state authority has approved the aircraft and the aircraft will meet the RNP-10 requirements for the filed route of flight and any planned alternate routes. The letter "R" in field 10 (equipment) of the ICAO standard flight plan indicates RNP-10 approved aircraft. This equipment qualifier should be filed provided the aircraft will maintain RNP-10 eligibility for the entire route segment within the Oakland FIR. RNP-10 approval is required for all PACOTS and for all aircraft operating within the CEP at FL290 through FL410. Non-RNP approved aircraft can expect FL280 and below or FL430 and above, traffic permitting.

**RVSM SEPARATION**

Reduced Vertical Separation Minimum (RVSM-1,000-foot vertical separation between RVSM approved aircraft) may be applied within the Oakland Oceanic FIR between FL290 and FL410. Aircraft operating within this airspace between FL290 and FL410 require RVSM approval. RVSM vertical separation will be based on the equipment qualifier filed by the aircraft. The operators shall determine that the appropriate state authority has approved the aircraft and the aircraft will meet the RVSM requirements for the filed route of flight and any planned alternate routes. The letter "W" in field 10 (equipment) of the ICAO standard flight plan indicates RVSM approved aircraft.

**1. Non-RVSM Equipped Civil Aircraft:**

A. Non-RVSM equipped civil aircraft unable to fly to an appropriate destination at or below FL280 and unable to fly at or above FL430 may flight plan at RVSM flight levels in the RVSM stratum provided one of the following conditions exists:

- 1) The aircraft is being initially delivered to the state of registry or operator; or
- 2) The aircraft was formerly RVSM approved but has experienced an equipment failure and is being flown to a maintenance facility for repair in order to meet RVSM requirements and/or obtain approval; or
- 3) The aircraft is being utilized for mercy or humanitarian purposes.

B. The approval for non-RVSM is intended exclusively for the purposes indicated above.

**2. Non-RVSM Equipped State Aircraft:**

Non-RVSM state aircraft may flight plan at RVSM flight levels in Oakland, Anchorage, Tokyo and Naha's airspace without prior coordination. State aircraft should include in the remark section "STS/Military NON-RVSM" in field 18 of the ICAO flight plan.

**3. Suspension of RVSM:**

ATC will consider suspending RVSM procedures within affected areas of the Oakland Oceanic FIR when there are pilot reports of greater than moderate turbulence. Within areas where RVSM procedures are suspended, the vertical separation minimum between all aircraft will be 2000 ft.

**CONTROLLER PILOT DATA LINK COMMUNICATIONS (CPDLC)**

Oakland ARTCC has full CPDLC capability and normal service in the entire Oakland Oceanic FIR for FANS-1/A capable aircraft. The Oakland Oceanic FIR log-on address is "KZAK"; the facility is "OAKODYA."

**1. HF Communications Requirement**

Prior to entering the Oakland Oceanic FIR, contact ARINC on HF and identify the flight as CPDLC equipped. Provide SELCAL, departure and destination, aircraft registration number and SATVOICE telephone number, if available. Expect to receive primary and secondary HF frequency assignments from ARINC for the entire route of flight within the Oakland Oceanic FIR. Pilots must maintain HF communications capability with ARINC at all times within the Oakland Oceanic FIR.

**2. Log-On****GENERAL**

For aircraft departing from airports along the west coast of North America and Hawaii, Oakland center request that data-link aircraft not logon to Oakland oceanic (KZAK) until after leaving 10,000 FEET. This request is made to eliminate ADS periodic reports for aircraft that are still on the ground which will assist in the transition from our domestic airspace automation environment. Additionally, this should reduce operator cost.

A. Aircraft entering the Oakland Oceanic FIR CPDLC service area from non-CPDLC airspace: Log on to CPDLC at least 15 but not more than 45 minutes prior to entering the Oakland Oceanic FIR CPDLC service area. Contact ARINC on HF and inform them you are a CPDLC flight. Send a position report when CPDLC is established.

B. Aircraft entering the Oakland Oceanic FIR CPDLC service area from adjacent CPDLC airspace: Pilots should determine the status of the CPDLC connection. If KZAK is the active center, the pilot shall contact ARINC on HF, identify the flight as a CPDLC flight, and send a position report via CPDLC. If KZAK is not the active center, the pilot shall, within 5 minutes after the boundary is crossed, terminate the CPDLC connection, then log on to KZAK, contact ARINC on HF and advise ARINC that they are a CPDLC flight. Send a position report when CPDLC ATC COM is established.

**3. CPDLC Position Report Message Format**

Oakland Center Oceanic (KZAK) cannot accept position reports containing latitude and longitude (lat/Long) in the ARINC 424 format, which is limited to five characters (e.g. 40N50). Position reports in the KZAK CPDLC service area containing Lat/Long waypoints will be accepted in complete latitude and longitude format only. Flights unable to send position reports in complete latitude and longitude format must accomplish position reporting via HF voice communications.

**4. Flights Over-flying Honolulu Control Facility Airspace.**

Prior to entering Honolulu Control Facility airspace aircraft will receive an END SERVICE message that will result in termination of CPDLC. Aircraft shall re-plot on to CPDLC prior to reentering Oakland Oceanic FIR airspace when Honolulu Control Facility advises to contact en route communications or ARINC.

**5. Flights Entering Guam ARTCC Airspace.**

Contact Guam CERAP 250 miles out on 118.7, squawk 2100.

**6. Flights Overflying Guam ARTCC Airspace.**

Maintain the CPDLC connection with Oakland ARTCC; however, do not use CPDLC for ATC COM until Guam CERAP advises you to again contact en route communications or ARINC.

**BEACON CODE REQUIREMENTS**

Upon entering the Oakland Oceanic FIR and after radar service is terminated, each aircraft should adjust their transponder to display code 2000 on their display. Aircraft should maintain code 2000 thereafter until otherwise directed by air traffic control. (FAA Order 7110.66)

**DIRECT SATVOICE CAPABILITY**

Oakland Oceanic FIR Oceanic control has the capability for air/ground and ground/air satellite telephone service (SATVOICE). Direct SATVOICE contact between the pilot and Oakland Oceanic FIR shall be limited to distress and urgency situations or other exceptional circumstances only. Aircraft desiring to contact Oakland Center Oceanic should use the following INMARSAT security numbers:

<u>INMARSAT number</u>	<u>Commercial Telephone Number</u>
436697	510-745-3415 or 3416

**PACIFIC ORGANIZED TRACK SYSTEM (PACOTS) GUIDELINES**

**1. General Information**

**A. Geographical Boundary**

PACOTS tracks may be established within the Oakland, Tokyo, Naha, Manila, Anchorage, Tahiti, Auckland, Nadi, Port Moresby, and Brisbane FIRs.

**B. Track Definition Message (TDM)**

Oakland ARTCC is using the TDM format for PACOTS tracks. Questions regarding published PACOTS tracks should be directed to Oakland ARTCC Traffic Management Unit (TMU), at (510) 745-3771.

**C. Number and Designator of PACOTS Tracks**

Oakland ARTCC or Japan Air Traffic Flow Management (ATFMC) may develop more or fewer tracks according to user needs, military activity, significant weather, or other limitations.

ROUTES	TRACK DESIGNATORS
(1) Hawaii to Japan _____	A & B
(2) Japan to Hawaii _____	11 & 12
(3) North America to Japan _____	C, D, E, F & G
(4) Japan to North America _____	1, 2, 3 & 4
(5) Dallas Ft. Worth to Japan _____	M
(6) Japan to Dallas Ft. Worth _____	8
(7) North America to Hong Kong/Taipei _____	H, I, J & K
(8) Hong Kong/Taipei to San Francisco _____	14
(9) Hong Kong/Taipei to Los Angeles _____	15
The following PACOTS are on request only:	
(10) California to Australia/New Zealand _____	W & X
(11) Australia/New Zealand to California _____	20 & 21
(12) North America to Manila _____	L

Note: To be included in the TDM list for tracks W, X, 20 and 21 and L call (510) 745-3450.

The following track designators are used when Dynamic Aircraft Route Planning (DARP) testing are used:

(13) California to Australia/New Zealand (DARPS) _____	Y & Z
--	-------

**D. Usable Flight Levels**

All IFR flight levels at or above FL290, except the Westbound North America–Japan PACOTS which also includes FL280 in the Oakland Oceanic FIR. The Westbound North America–Japan PACOTS are included in the Track Advisory Program. Certain restrictions may apply for non-PACOTS traffic operating in the opposite direction to the published PACOTS system.

**E. City Pair Tracks**

Where ATC has identified a requirement for flight planning restrictions on a particular city pair, these restrictions will be published by Class 1 NOTAM or as part of the daily track message. Users crossing 165–east longitude between 0930–1230 UTC will file eastbound PACOTS Track 2 (or 4 when published) to KSFO and Track 3 (or 4 when published) to KLAX.

**F. Lateral Spacing of Tracks**

PACOTS Tracks are established at least 50 nautical miles apart. Tracks are defined using latitude/longitude expressed in whole degrees or named fixes with the exception of FIR crossing points.

**G. Flight Planning**

The following flight planning restrictions and rules only apply within the oceanic control areas of the respective FIRs. Furthermore, these restrictions do not affect aircraft filing on ATS routes in the CEP route system or the NOPAC Composite Route System unless individual routes within these systems are specifically identified as unusable in NOTAMS.

## 1) Participating Aircraft.

a) Aircraft requesting altitudes at or above FL280 may file via route notified in the daily NOTAM or track message.

b) Aircraft may file to leave or join an outer PACOTS track at any reporting point. Aircraft leaving an outer track should file routes that diverge, within 10 degrees of longitude, to at least 50NM from the nearest PACOTS track. Flight level assignment for aircraft joining an outer track will be based on traffic.

2) Non-Participating Aircraft. Random routes under the PACOTS at FL270 and below are permitted, unless prohibited by NOTAM.

**H. ATC Procedures**

1) For flight planning and initial clearances, crossing between PACOTS tracks at FL280 and above will not be permitted. Once established on the PACOTS track, changes may be approved as traffic permits.

2) Aircraft should not expect to climb into the PACOTS unless filed on a route corresponding to a PACOTS track. In this case, climb into the PACOTS will be approved as traffic permits.

3) The minimum longitudinal separation between aircraft crossing the Tokyo FIR boundary on the same track at the same flight level will be 10 minutes using Mach number technique.

**I. Position Reporting**

Within the Oakland and Anchorage oceanic control areas position reports shall be made using latitude/longitude coordinates or named fixes as specified in the track definition messages (TDM). Position reports shall comprise information on present position, estimated next position, and ensuing position in accordance with ICAO Doc 7030/PAC procedures. Reporting points of reference not specified in the TDM and/or rounding off geographical coordinates is prohibited.

**2. Eastbound Japan–Hawaii PACOTS****A. Time Frame**

Effective daily 1000–2100 UTC for aircraft crossing 160–east longitude between 1200 and 1600 UTC.

**B. Preparation of Japan–Hawaii PACOTS**

Japan Air Traffic Flow Management (ATFMC) will complete at or before 2200 UTC daily preparation of the selected PACOTS tracks. The ATFMC will coordinate the tracks with Oakland ARTCC. The Japan–Hawaii PACOTS will be comprised of one or two tracks. When two tracks are used, they will be separated by at least 50 NM laterally within the airspace between the Tokyo and Honolulu gateways. The North track will be designated as Track 11 and the South track as Track 12. When military airspace is active, the North track will include a restriction requiring aircraft to cross a designated fix, at or before a specified time. This will allow aircraft to clear the military airspace before activation. In some instances, a single track may be required, which will be designated as Track 11.

**C. Notification of Japan–Hawaii PACOTS**

Notification of the geographical coordinates of Track 11 and Track 12 will be transmitted by TDM and NOTAM at approximately 2200 UTC daily by Japan Air Traffic Flow Management (ATFMC).

**D. Flight Planning**

Participating eastbound departing from or traversing Central West Japan and crossing 160–east longitude between 1200 UTC to 1600 UTC should flight plan as described in the daily TDM and NOTAM.

**3. Westbound Hawaii–Japan PACOTS****A. Time Frame**

Effective daily 1900–0800 UTC for aircraft crossing 160–east longitude between 2300 and 0600 UTC.

**B. Preparation of the Hawaii–Japan PACOTS**

Preparation of the geographical coordinates of the Hawaii–Japan selected PACOTS tracks will be made daily by Oakland ARTCC. Normally, two tracks will be developed. The northernmost PACOTS track is designated “A” and the southernmost PACOTS track is designated “B.” A third weather avoidance track may be developed if necessary.

**C. Notification of the Hawaii–Japan PACOTS**

Notification of the geographical coordinates of the selected PACOTS tracks will be transmitted by TDM and NOTAM at approximately 1100 UTC daily by Oakland ARTCC.

**D. Flight Planning**

Participating westbound aircraft departing Hawaii to Japan and crossing 160–east longitude between 2300 UTC and 0600 UTC should flight plan as described in the daily TDM and NOTAM.

**4. Eastbound Japan–North America PACOTS****A. Time Frame**

Effective daily from 0700 UTC to 2300 UTC applies to traffic crossing 160–east longitude between 0900 UTC and 1600 UTC.

**B. Preparation of Japan–North America PACOTS**

Preparation of selected PACOTS Tracks will be completed daily by Japan Air Traffic Flow Management (ATFMC). Normally two tracks from Japan to California and one track from Japan to the Pacific Northwest will be developed.

**C. Notification of the Japan–North America PACOTS**

Notification of the geographical coordinates of the selected PACOTS tracks will be transmitted by TDM and NOTAM at approximately 2200 UTC daily by Japan Air Traffic Flow Management (ATFMC). Number will designate tracks with the northernmost being referred to as TRACK 1.

**D. Flight Planning**

Participating aircraft from or over Japan to North America and crossing 160–east longitude between 0900 UTC and 1600 UTC should flight plan as follows:

1) As described in the daily TDM and NOTAM.

2) Portions of G344 and R591 may be included as a PACOTS track. When operating on G344 and R591 NOPAC procedures apply.

**5. Westbound North America–Japan PACOTS****A. Time Frame**

1) Effective daily from 1900 UTC to 0800 UTC. Required for traffic crossing 160–east longitude between 0200 UTC and 0600 UTC.

2) The Westbound TDM or NOTAM identifies tracks subject to Track Advisory procedures for aircraft entering the tracks between 1900 UTC and 0100 UTC. Aircraft participating in Track Advisory procedures receive priority over nonparticipating aircraft (see TRACK ADVISORY PROCEDURES section).

**B. Preparation of Westbound PACOTS Routes**

Preparation of selected PACOTS will be completed daily by Oakland ARTCC. Normally two tracks from California and one or two tracks from the Pacific Northwest into the Tokyo FIR will be developed. Tracks are to be designated alphabetically with the letters “C” and “D” designating the tracks from the Pacific Northwest (letters A and B are reserved for Westbound Hawaii–Japan PACOTS). The tracks from California will be designated “E,” “F” and “G.”

**C. Notification of Tracks**

Notification of selected PACOTS tracks will be transmitted by TDM and NOTAM at approximately 1100 UTC daily by Oakland ARTCC. The number of tracks each day will be determined by the position of the jet stream.

**D. Flight Planning**

Participating aircraft flying from North America to the Tokyo FIR and crossing 160–east longitude between 0200 UTC and 0600 UTC should flight plan as follows:

1) As described in the daily TDM and NOTAM.

2) Aircraft using NOPAC Route R591 and G344 should comply with the applicable time restrictions as follows:

R591 cross AKISU at or before 0600 UTC

G344 cross CUTEE at or before 0600 UTC

(3) Aircraft may request revised NOPAC routing from Anchorage Center once established within their radar/VHF coverage area.

**6. California, Australia/New Zealand PACOTS****A. Time Frame**

As indicated in the daily track Message.

**B. Preparation of California–Australia/New Zealand PACOTS Routes**

Preparation of selected PACOTS tracks will be completed daily by Oakland ARTCC. Normally six tracks are generated daily, Track X KLAX to NZAA, Track W KLAX to ASSY, DARPS Track Y KLAX to NZAA, DARPS Track Z KLAX to YSSY, Track 21 NZAA to KLAX and Track 20 YSSY to KLAX.

Note: These PACOTS are only published to users wishing to receive daily TDM messages. To be added to the receiving list contact Oakland Center at (510) 745–3320.

**C. Notification of Tracks**

Notification of selected PACOTS tracks will be transmitted by track message before 0000 UTC daily by Oakland ARTCC.

**D. Flight Planning**

Participating aircraft flying both directions between KLAX and the South Pacific and crossing 160–west longitude between 0700 UTC and 1800 UTC should flight plan as described in the TDM and NOTAM.

**7. Westbound North American–Taipei, Hong Kong and Manila PACOTS**

The westbound PACOTS were expanded to include destinations of Taipei, Hong Kong, and Manila. Westbound PACOTS tracks serving these destinations are published twice daily.

**A. Time Frame**

As indicated in the daily track messages NOTAM.

**B. Preparation of North American–Taipei, Hong Kong and Manila PACOTS**

Oakland ARTCC will complete preparation of selected PACOTS serving Taipei and Hong Kong twice daily. Normally two tracks will be developed. Tracks are to be designated alphabetically with the letters “H,” “T,” “J” and “K”. Preparation of a single PACOTS serving Manila will be published as needed and identified by the letter “L”.

**C. Notification of Tracks**

Notification of PACOTS “H” and “I” will be transmitted by TDM and NOTAM at approximately 1100 UTC. Notification of PACOTS “J”, “K” and “L” will be by TDM and NOTAM at approximately 0000 UTC.

**D. Flight Planning**

Participating aircraft flying between North America and Taipei, Hong Kong and Manila should flight plan as follows:

1) As described in the daily TDM and NOTAM.

2) Participating aircraft departing from California between 0500 UTC and 1200 UTC with destinations of Taipei, Hong Kong or Manila should file PACOTS tracks “J”, “K” or “L.”

**8. Track Advisory Procedures**

Track Advisory consists of Oakland ARTCC Traffic Management Unit (TMU) publishing Westbound PACOTS tracks and users submitting their requested departure time with associated preferred routes and altitudes. This is followed by Oakland ARTCC TMU assigning user–requested flights to the tracks in a manner that effects efficient utilization of airspace. Oakland ARTCC TMU then publishes a Gateway Reservation List (GRL) that contains oceanic release times and associated route and altitude assignments. Dispatcher user guides for Track Advisory may be obtained from the Oakland ARTCC TMU office during administrative hours, telephone (510) 745–3450.

**A. The Westbound PACOTS NOTAM** identifies tracks subject to Track Advisory procedures for aircraft entering the tracks between 1900 UTC and 0100 UTC. Aircraft participating in Track Advisory procedures receive priority over nonparticipating aircraft. Users who are unable to comply with time constraints will be accommodated to the extent feasible.

**B. Conventions**

1) Pilots, who determine their assigned departure times cannot be met, are required to coordinate immediately with their dispatcher for an acceptable alternative.

2) Pilots are allowed a 10–minute departure window. The window begins at the assigned take off time and ends 10 minutes later.

3) Longitudinal separation is applied at the PACOTS entry fix. Aircraft not over the entry fix within 10 minutes after the entry fix time may not receive their initial reserved en route altitude.

4) The Track Advisory program will only accept right way cardinal altitudes at or above FL280, FL300, FL320, FL340 and FL360.

**GUAM AREA PREFERENTIAL ROUTING**

Due to traffic congestion within the Oakland CTA/FIR north, south and west of the Guam CTA airspace (a 250 NM radius of N1332/E14455), preferred routings have been established. This notice applies to all turbojet aircraft at or above FL280 operating within the Oakland CTA/FIR north, south, or west of the Guam CTA. The following are the Guam area preferential routings within the Oakland Oceanic CTA/FIR. Aircraft operators must ensure that these preferential routes are indicated in Field 15 of the ICAO flight plan. The acronym FPRD means flight plan route to destination.

Southbound aircraft en route from the Fukuoka FIR and terminating within the Guam CTA:

OVER KEITH– KEITH R584 OTTRE FPRD  
 OVER PAKDO– PAKDO G339 SHAWS FPRD  
 OVER MONPI– MONPI A597 REEDE FPRD  
 OVER OMLET– OMLET B586 WINZR FPRD  
 OVER TEGOD– TEGOD G205 GUYES or TEGOD A337 SNAPP W21 HIRCH FPRD

Northbound aircraft originating with the Guam CTA and en route to the Fukuoka FIR:

OVER MIKYY– MIKYY R584 KEITH FPRD  
 OVER NATSS– NATSS G339 PAKDO FPRD  
 OVER RICHH– RICHH A597 MONPI FRPD  
 OVER TOESS– TOESS B586 OMLET FPRD  
 OVER TERYY– TERYY G205 TEGOD FPRD  
 OVER TEEDE– TEEDE A337 TEGOD FPRD

Northbound or Southbound aircraft west of the Guam CTA but within the Oakland CTA/FIR:

OVER KEITH– KEITH A339 SHREE or KEITH R204 KALIN FPRD  
 OVER SHREE– SHREE A339 KEITH FPRD  
 OVER KALIN– KALIN R204 KEITH FPRD

Eastbound or Westbound aircraft operating within the Oakland CTA/FIR and the Guam CTA:

OVER ENDAX– ENDAX G467 KITSS FPRD  
 OVER KITSS– KITSS G467 ENDAX FPRD

The following Eastbound or Westbound fix-to-fix routes are approved:

OVER LADSS– DIRECT KYWEE DIRECT TIDEL  
 OVER TIDEL– DIRECT KYWEE DIRECT LADSS

Aircraft within the Oakland CTA/FIR and transiting the Guam CTA must flight plan to enter/exit Guam Center airspace on an appropriate ATS route(s) or other established compulsory reporting points (e.g., FATUM or JOBSS).

Aircraft flight planning at or above FL280 with filed routes other than those described above should expect to be re-routed to the preferential route. Requests for alternate routes will be considered on a real-time basis as traffic conditions permit. However, aircraft should file for and be prepared to fly the entire preferential route. Aircraft operating EAST of 150E longitude will not be affected.

**MARSHALL ISLANDS****General Information****A. Flight Plans**

File flight plans for flights out of Majuro prior to arrival. If possible, file the Majuro departure flight plan at the same time as the flight plan into Majuro is filed. If en route, file with Honolulu FSS, if possible, or through ARINC before arrival at Majuro. If on the ground at Majuro and filing a flight plan with Majuro Radio is necessary, file at least three hours in advance of proposed departure time, if possible.

**B. Clearances**

When requesting descent clearance into Majuro and the ground stop will be one hour or less, advise ATC and request a through clearance. When requesting an IFR clearance while on the ground, make every effort to communicate through ARINC. If unable to contact ARINC, make the request to Majuro Radio on 123.6 MHz allowing at least 30 minutes for communication delays. If unable to receive a clearance through any of the above means and you elect to depart VFR in accordance with ICAO Annex 2 and Document 7030, continue efforts to establish communication and obtain a clearance as soon as possible.

Note: Rules pertaining to VFR flight may be found within Section III—General Notices of this supplement.

**C. Hazards**

1) Kwajalein Atoll–Dyess AAF: Electromagnetic radiation will exist 24 hours daily within 10 NM radius of Dyess AAF from the surface to 50,000 feet. Aircraft within this airspace may be exposed to direct radiation, which may be harmful to personnel and equipment.

2) Kwajalein Atoll–180 NM Radius: Hazardous military activity will be conducted at all altitudes and flight levels within a 180 NM radius of Bucholz TACAN until further notice. All nonparticipating VFR pilots are advised to remain well clear of the area. IFR flights under ATC jurisdiction may expect possible reroute to and from Bucholz Airport. For further information, contact USAKA Range Safety Officer (805) 355–1516 at Bucholz Tower or Oakland ARTCC.

3) Kwajalein Atoll–Bucholz AAF: Electromagnetic radiation may exist 24 hours daily within 5 NM radius of Bucholz AAF from surface to 30,000 feet.



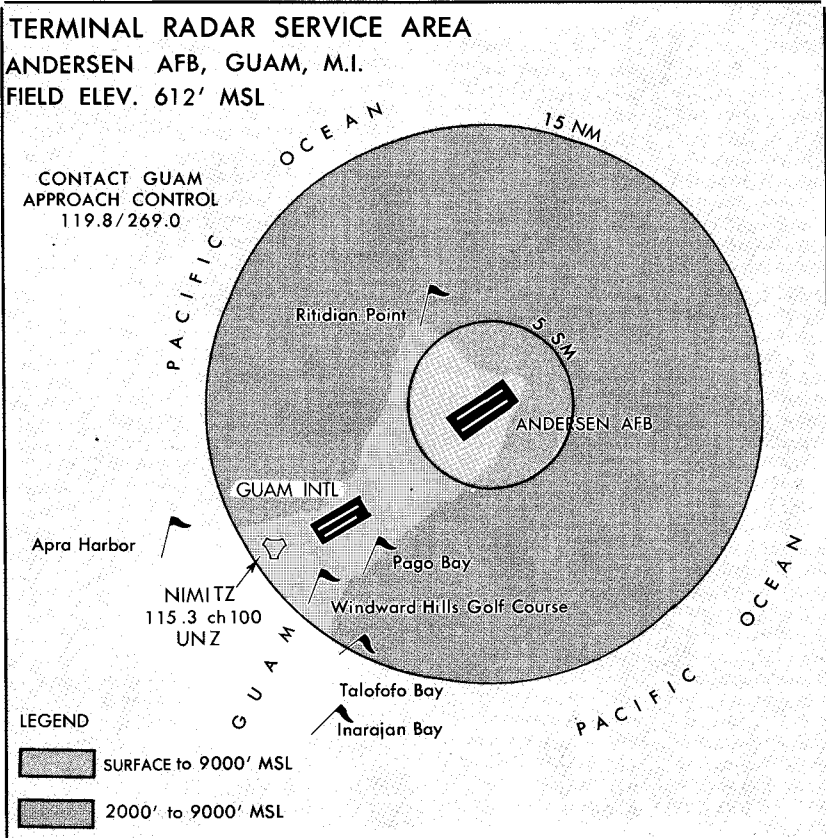

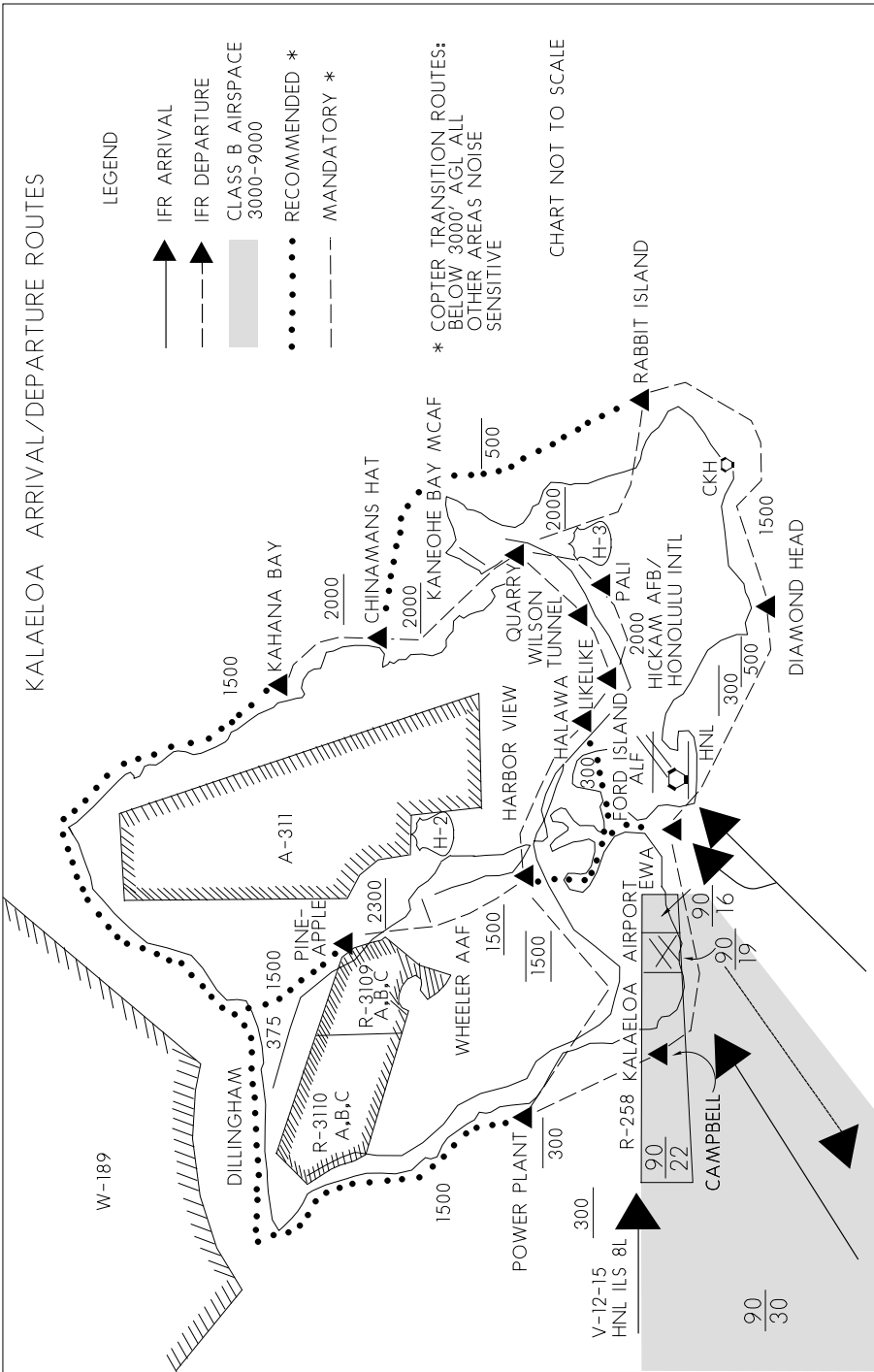

## GUAM TERMINAL AREA

Heavily travelled routes for high performance aircraft arriving and departing Guam Intl and Andersen AFB should be avoided by light aircraft pilots flying VFR. The largest concentration of aircraft occurs within a radius of approximately 15 miles of the airports and at an altitude up to and including 4000 feet.

In addition to the above there are two areas of activity to be avoided, both outside the Agana Class D airspace. The first - ALFA - is a light aircraft low altitude training area within a 6 mile radius of Inarajan Bay. Aircraft training in this area should operate at or below 1800 feet and should monitor Guam Approach Control on freq 119.8. The second area - BRAVO - is a light aircraft high altitude training area for use up to 10,000 feet. This area is within a 5 mile radius of Cocos Island. Aircraft in this area should also monitor Guam Approach Control on 119.8.

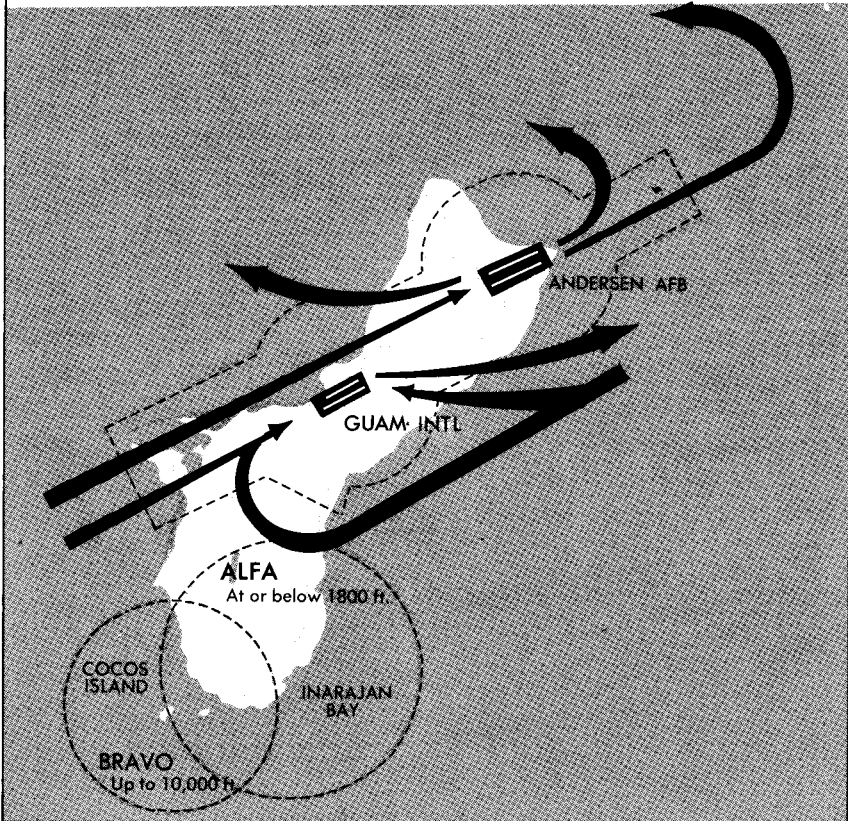

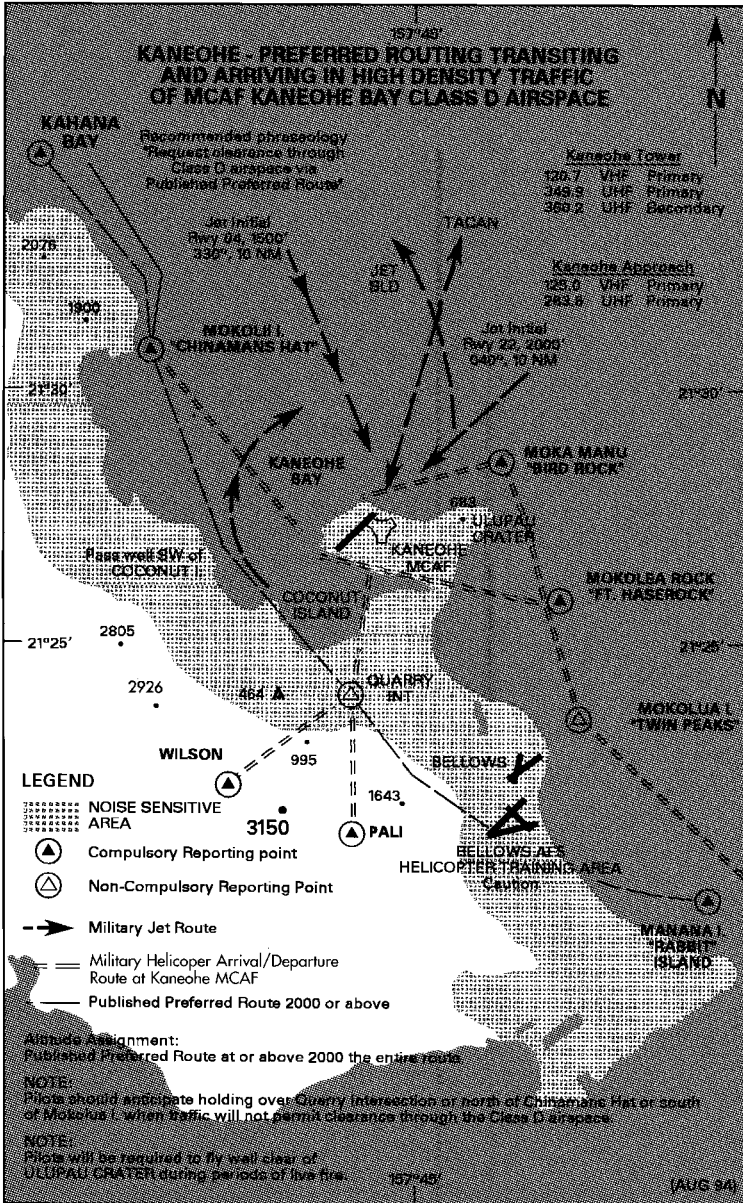

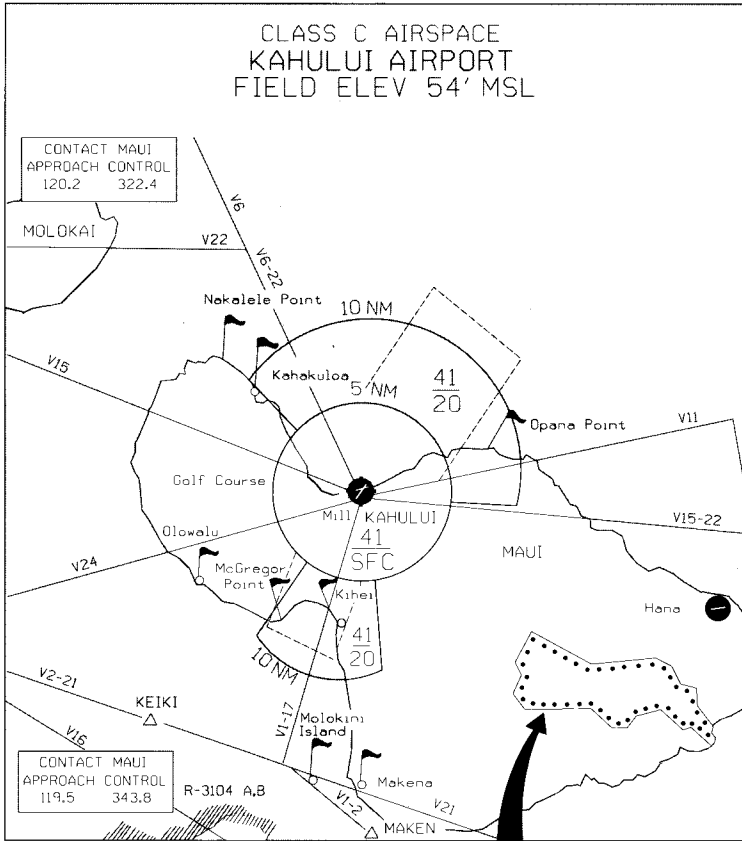

LEGEND

VFR CHECK POINTS 

FLOOR IN HUNDREDS OF FEET MSI  $\frac{41}{20}$

CEILING IN HUNDREDS OF FEET MSL  $\frac{41}{20}$

HALEAKALA NATIONAL PARK

Public law prohibits flight of VFR helicopters or Fixed-wing aircraft below 9500 feet MSL over the following areas in Haleakala National Park: Haleakala Crater, Crater Cabins, the Scientific Research Reserve, Halemahu Trail, Kaupo Gap Trail or any designated tourist viewpoint.

CLASS C AIRSPACE ENTRY PROCEDURES

VFR AIRCRAFT PROPOSING TO ENTER KAHULUI AIRPORT CLASS C AIRSPACE ARE REQUIRED TO CONTACT ATC PRIOR TO ENTRY. INITIAL CONTACT: REFER TO CHARTED VFR CHECK POINTS OR 10 DME FROM THE OGG VORTAC. INITIAL CALLS IN CLOSE PROXIMITY TO THE AIRSPACE BOUNDARY MAY RECEIVE INSTRUCTIONS TO "REMAIN CLEAR OF CHARLIE AIRSPACE AND STANDBY." INITIAL CALLS FROM THE MORE DISTANT CHECK POINTS ARE PREFERRED. FREQUENCIES: NORTH OF V15 - 120.2, SOUTH OF V15 - 119.5.

**KAHULUI, MAUI**

Shown are the most heavily traveled routes for high performance aircraft arriving and departing Kahului Airport, Maui. Light plane pilots flying VFR in these areas should maintain an alert lookout and monitor Maui Approach Control frequency. Aircraft transiting north of the Kahului Airport in VFR conditions are requested to remain at least 8 NM north of the airport at or below 4500 ft. if westbound, 3500 ft. if eastbound, or following the shoreline at or below 2500 ft. and be responsive to routing changes issued by Maui Approach Control or Maui Tower. The area depicted as "ALFA" is a light aircraft local training area. Area is outside Kahului Airport Class C airspace. Aircraft training in area normally operate at or below 3000 ft. and monitor Maui Approach Control.

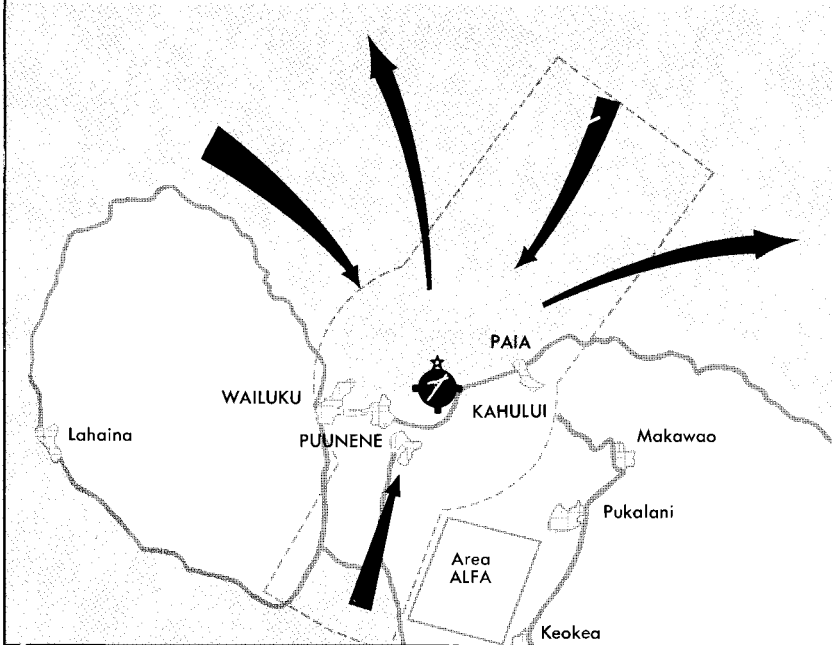

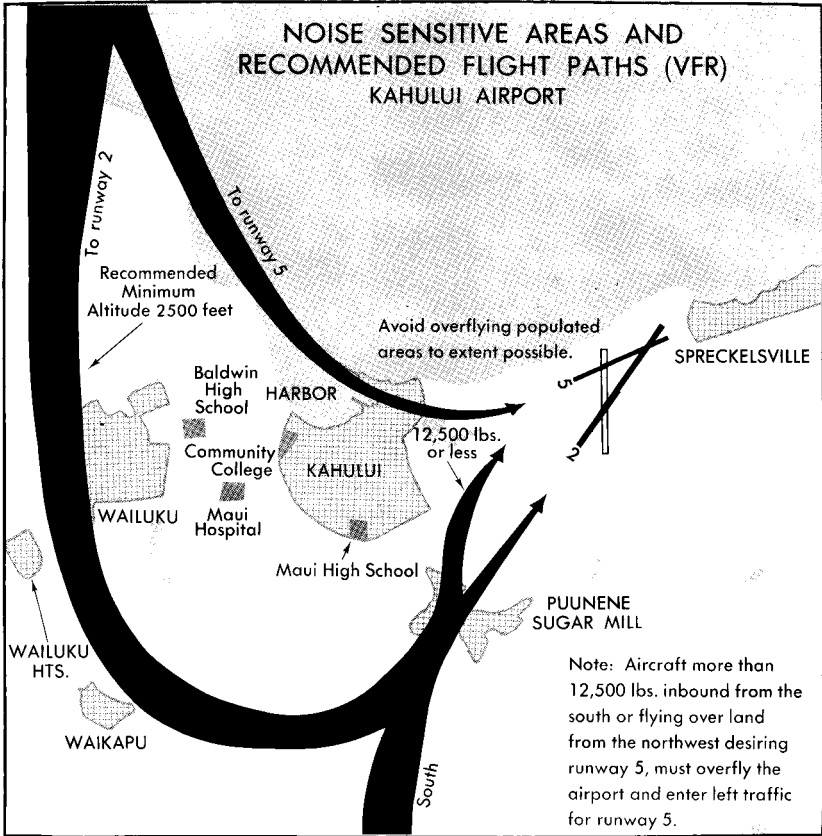

**INFORMAL RUNWAY USE PROGRAM—KAHULUI ARPT, MAUI**

Aircraft noise complaints from Spreckelsville Beach area located adjacent to Kahului Airport have become a matter of serious concern. To alleviate the situation, noise abatement departure runways and flight patterns have been developed. All pilots are urged to follow these procedures to the maximum extent possible consistent with operational and safety requirements. Runway 2 is designated as the noise abatement departure runway for both large and jet powered aircraft. Departure flight pattern runway 2: - Climb straight ahead until one mile clear of shoreline before commencing turns. If takeoff on runway 5 is necessary, both large and jet powered aircraft are requested to: if east or westbound, turn left as soon as possible and proceed one mile clear of shoreline; if southbound, turn right as soon as possible if traffic permits, otherwise turn left.

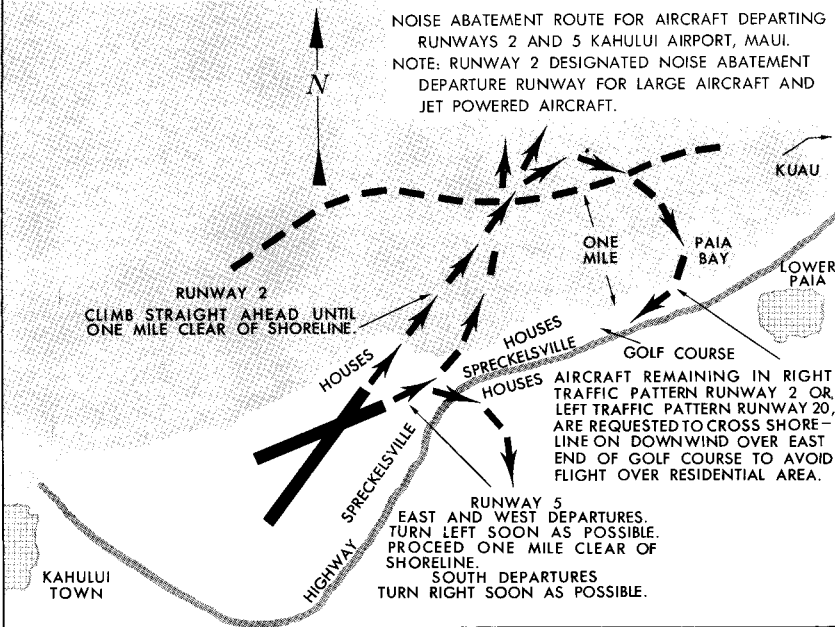



## KONA INTERNATIONAL AT KEAHOLE AIRPORT, HAWAII



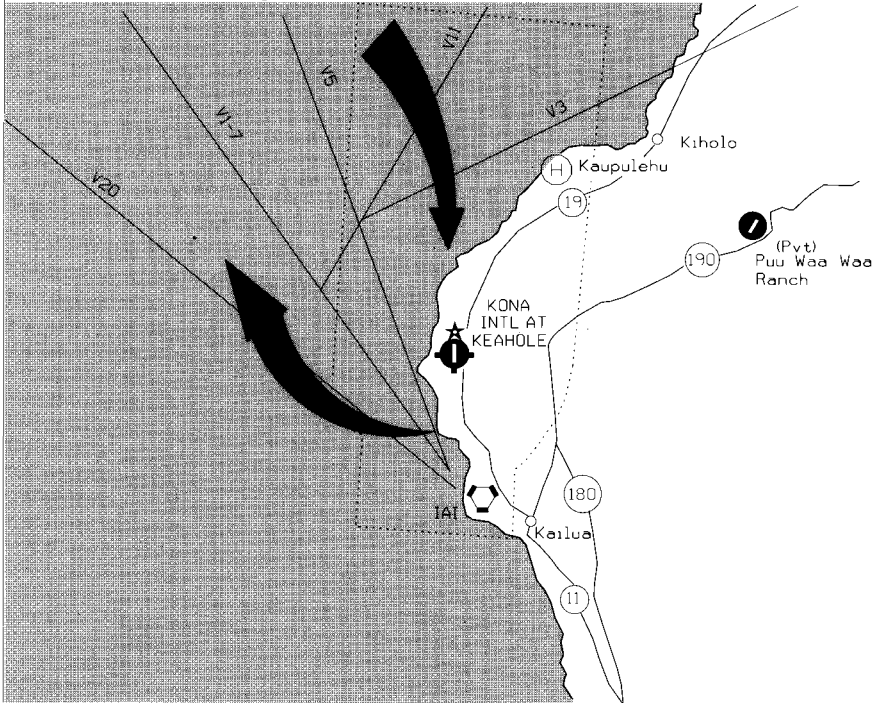

Depicted on this chart are the most heavily traveled routes for high performance aircraft arriving and departing Kona Intl At Keahole Airport, Kona, Hawaii.

General Aviation pilots flying VFR should be extra alert in these areas. Contact Kona Tower on frequency 120.3 for traffic advisories.



# PREFERRED VFR ROUTING LIHUE AIRPORT, LIHUE, KAUAI

## LEGEND

-  PREFERRED VFR ARRIVAL ROUTES
-  PREFERRED VFR DEPARTURE ROUTES
-  IFR ARRIVAL/DEPARTURE ROUTES
-  REQUEST CENTER ADVISORIES PRIOR TO TRANSITING AREA 126.5

AIRCRAFT INBOUND TO LIHUE FROM THE EAST CONTACT HONOLULU CENTER 126.5 BY MID-CHANNEL.

VFR AIRCRAFT DEPARTING LIHUE AIRPORT VIA RUNWAY 3/35 EASTBOUND, FLY OUTBOUND ON OR NORTH OF LIH 105 RADIAL UNTIL 25 MILES EAST.

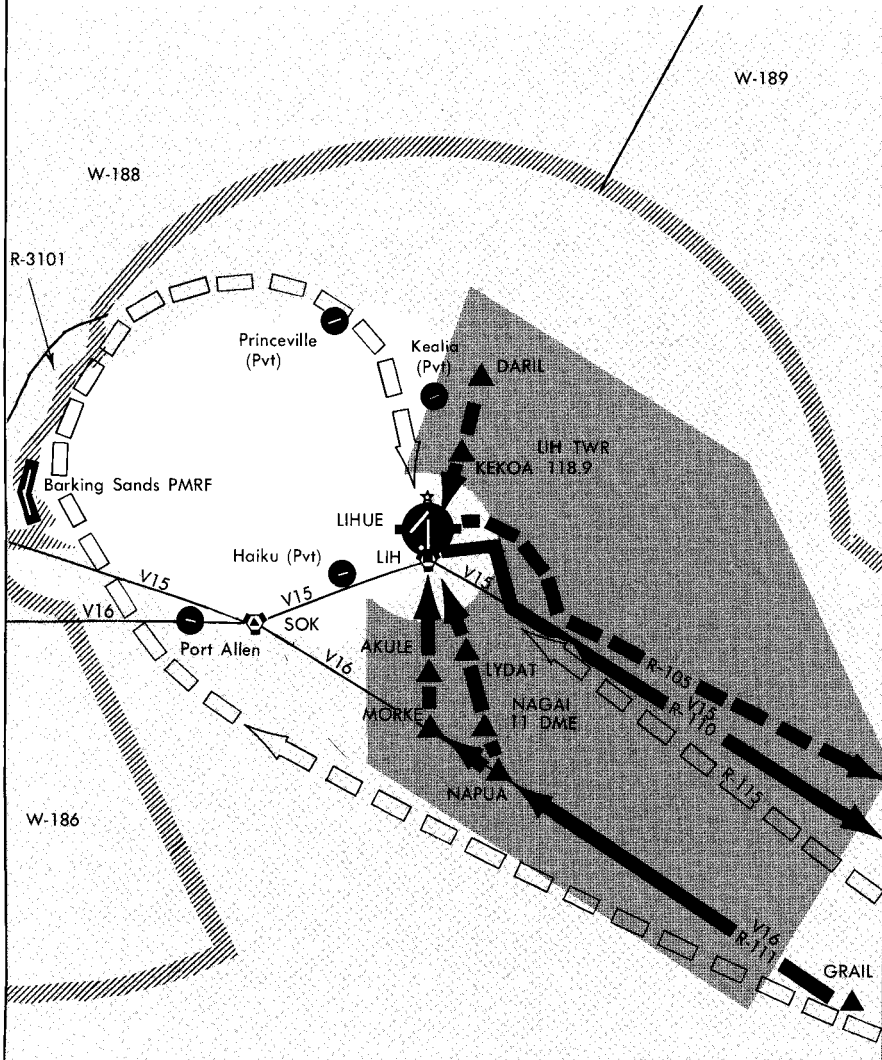

## Bucholz Army Airfield (Kwajalein Atoll) VFR Arrival/Departure RF Avoidance Routing

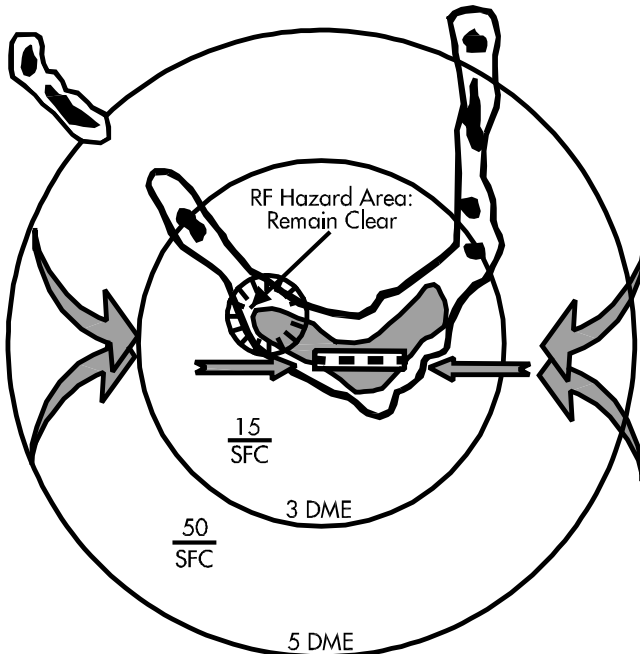

1. VFR arriving or departing aircraft must maintain indicated altitudes in vicinity of Bucholz Army Airfield. A high intensity radiated field can exist in vicinity of Bucholz and the possibility of interference exists if procedure is not followed.
2. Avoid overflight of indicated area at NW corner of Kwajalein.

PREFERRED VFR ROUTING AT SAIPAN AND WEST TINIAN AIRPORTS

Tradewind Condition

(Northeast Winds, Rwy 07, Rwy 08 In Use)

1. VFR turbo jet aircraft arriving Saipan from the southwest should proceed northbound along the west coast of Tinian. VFR turbo jets from the north-northwest should proceed southbound about 10 miles west of Saipan. They should intercept the I-GSN localizer at 10 DME and proceed inbound on the localizer maintaining at or above 2300' above mean sea level until passing KORDY (localizer/7 DME).
2. VFR twin engine aircraft arriving at Saipan from Tinian, Rota/Guam should proceed to Unai Masalok and direct to Puntan Opyan.
3. VFR single engine aircraft arriving Saipan from Tinian should turn left after takeoff and proceed northbound via BROADWAY to the traffic circle, then northeast to Asiga Point, then across Saipan channel for straight-in to Rwy 07.
4. VFR twin engine aircraft from Saipan should make right traffic to Naftan Point, then southwest bound to Puntan Masalok, then enter left traffic for Rwy 08 at West Tinian.
5. VFR single engine aircraft from Saipan should make left traffic downwind to Puntan Agingan, across Saipan channel to Puntan Tahgong (north tip of Tinian), direct to 8th Avenue traffic circle, thence via 8th Avenue to enter left traffic for Rwy 08 at West Tinian.

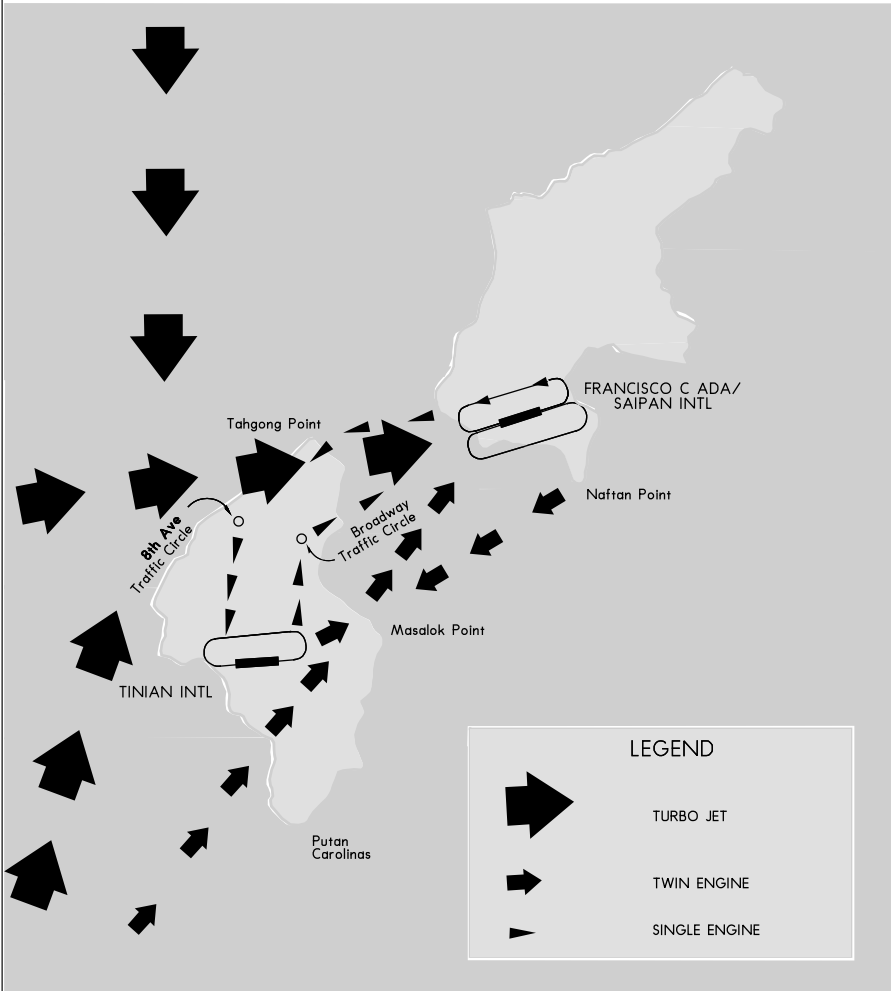

PREFERRED VFR ROUTING AT SAIPAN AND WEST TINIAN AIRPORTS

Southwest Wind Condition  
(Rwy 25 and Rwy 26 In Use)

1. VFR single engine aircraft from Saipan Rwy 25 to West Tinian, direct across Saipan Channel to Broadway Traffic Circle, via BROADWAY to enter a right base leg for Rwy 26.
2. VFR twin engine aircraft from Saipan Rwy 25 left turn direct Unai Masalok, make straight-in to Rwy 26 at West Tinian.
3. VFR twin and single engine aircraft from West Tinian, Rwy 26 to Saipan, right turn follow 8th Avenue to Traffic Circle, direct to Puntan Tahgong across Saipan Channel to Agingan Point, enter right downwind for Rwy 25 at Saipan.

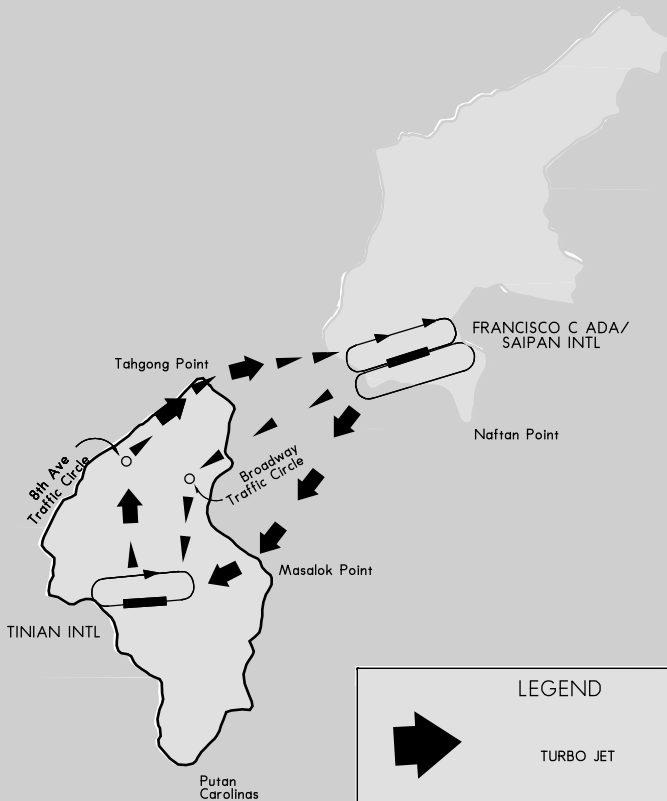

### HILO INTL, HILO

Depicted on this chart are the most heavily traveled routes for high performance aircraft arriving and departing Hilo Intl, Hilo, Hawaii.

General aviation pilots flying VFR should be extra alert in these areas. Contact Hilo Approach Control on frequency 119.7 for traffic advisories.

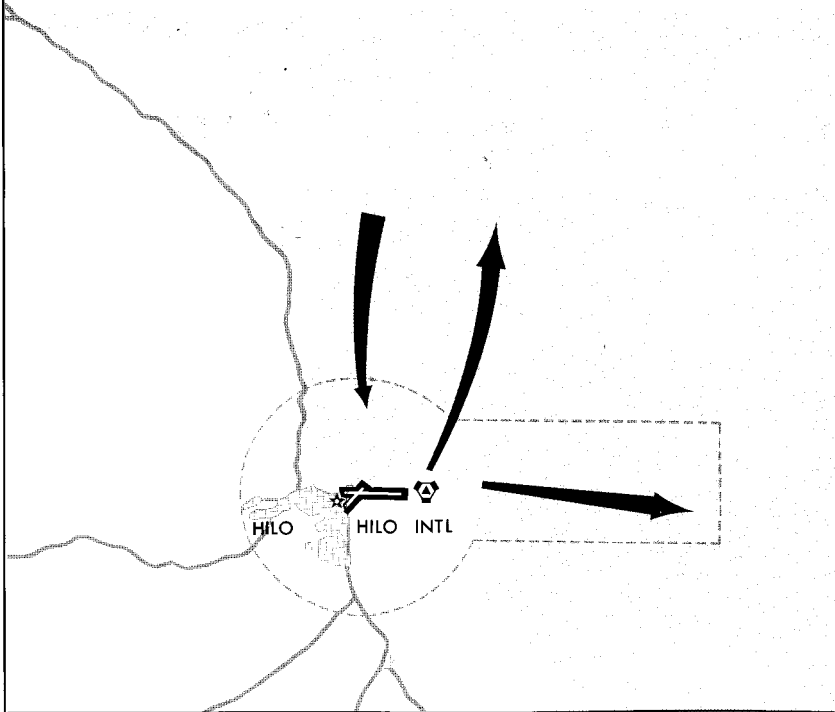

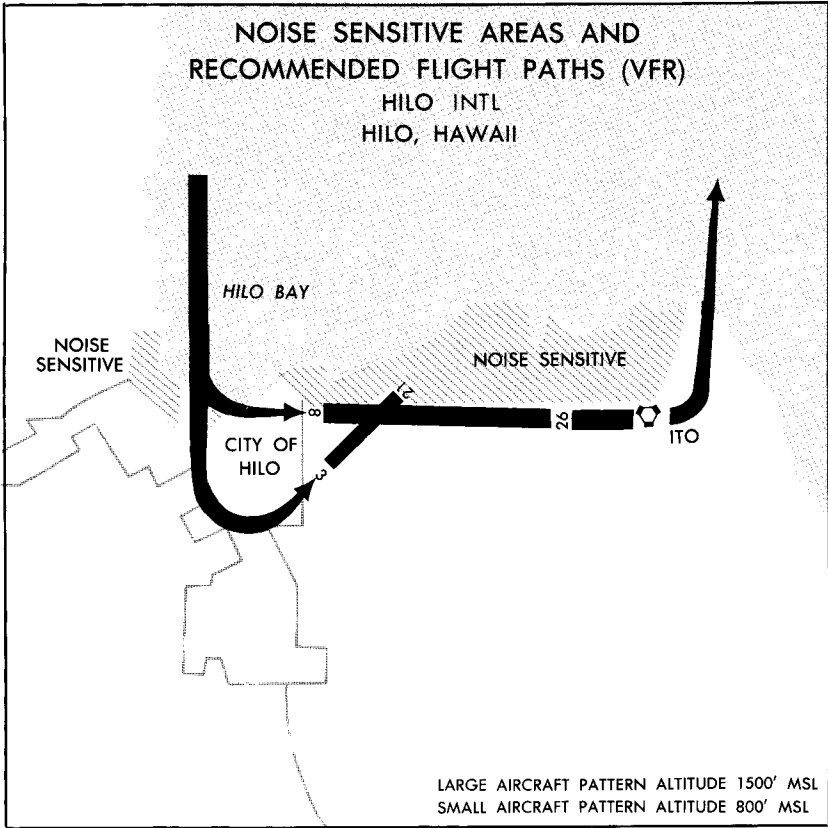

DILLINGHAM AIRFIELD, OAHU

**Glider Operations:** Gliders are normally air-towed and routinely depart the traffic pattern to the South. (Right turn after takeoff Rwy 08, left turn after takeoff Rwy 26.) Gliders normally fly the ridge line to the south of the airport, within 5 NM. Most gliders are not radio equipped. The powered aircraft towing the gliders have radios and routinely use the glider traffic pattern, entering the traffic pattern from the South.

**Sky Dive Operations:** Extensive parachute operations occur daily at 16,000' and below. Parachutists normally exit the aircraft upwind of the airport and during strong winds may exit as far as 3 NM from the drop zone. Parachutes are usually opened between 2,000' and 4,500' altitude, and then flow to the drop zone entering an abbreviated left traffic pattern (Rwy 08) or right traffic pattern (Rwy 26). During light and no wind conditions, the parachutes may open directly above the airport and adjacent beach area.

TRAFFIC PATTERN

SMALL AIRCRAFT 800' MSL  
 SAILPLANES AND TOWPLANES 700' MSL  
 ALL TRAFFIC TO NORTH OF RUNWAY  
 MAXIMUM AUTHORIZED LANDING WEIGHT:  
 S-40, D-152, DT-180.

Left turn after Rwy 08 takeoff,  
 avoid parachute drop zone.  
 Right turn after Rwy 26 takeoff,  
 avoid parachute drop zone.

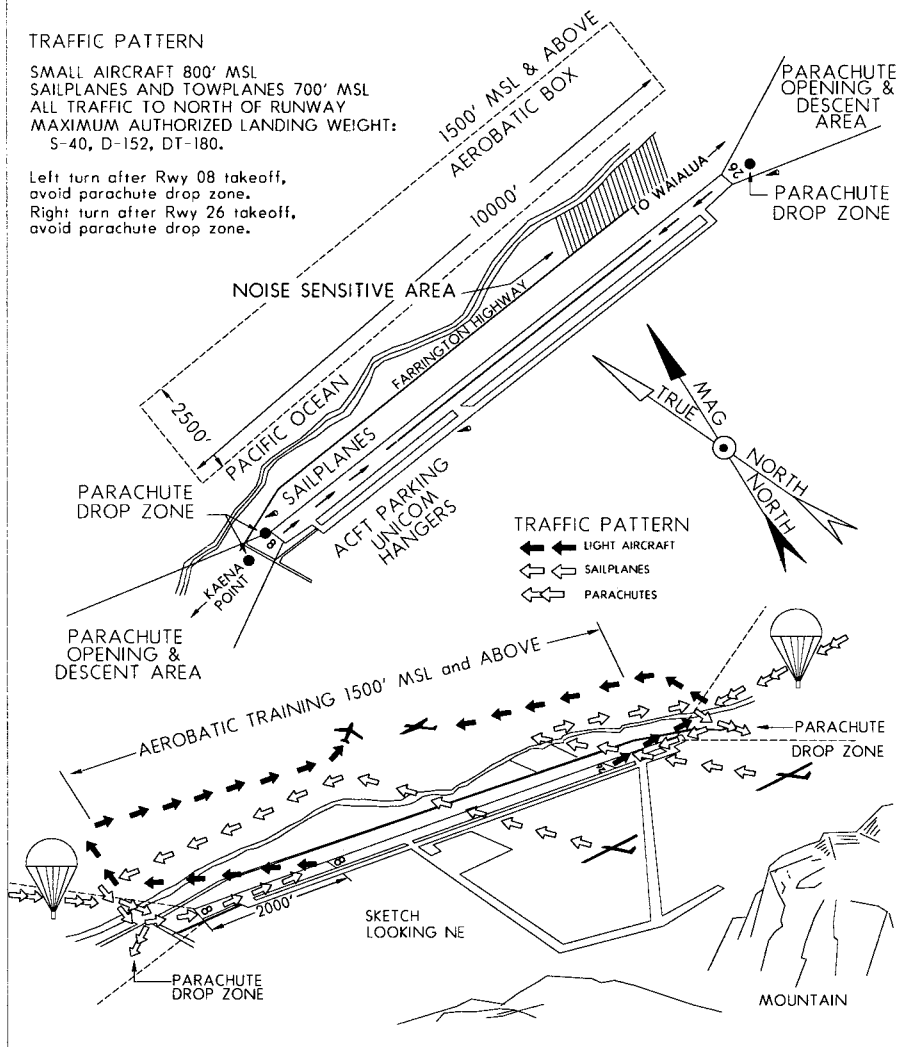



ARRIVAL/DEPARTURE GRAPHICS

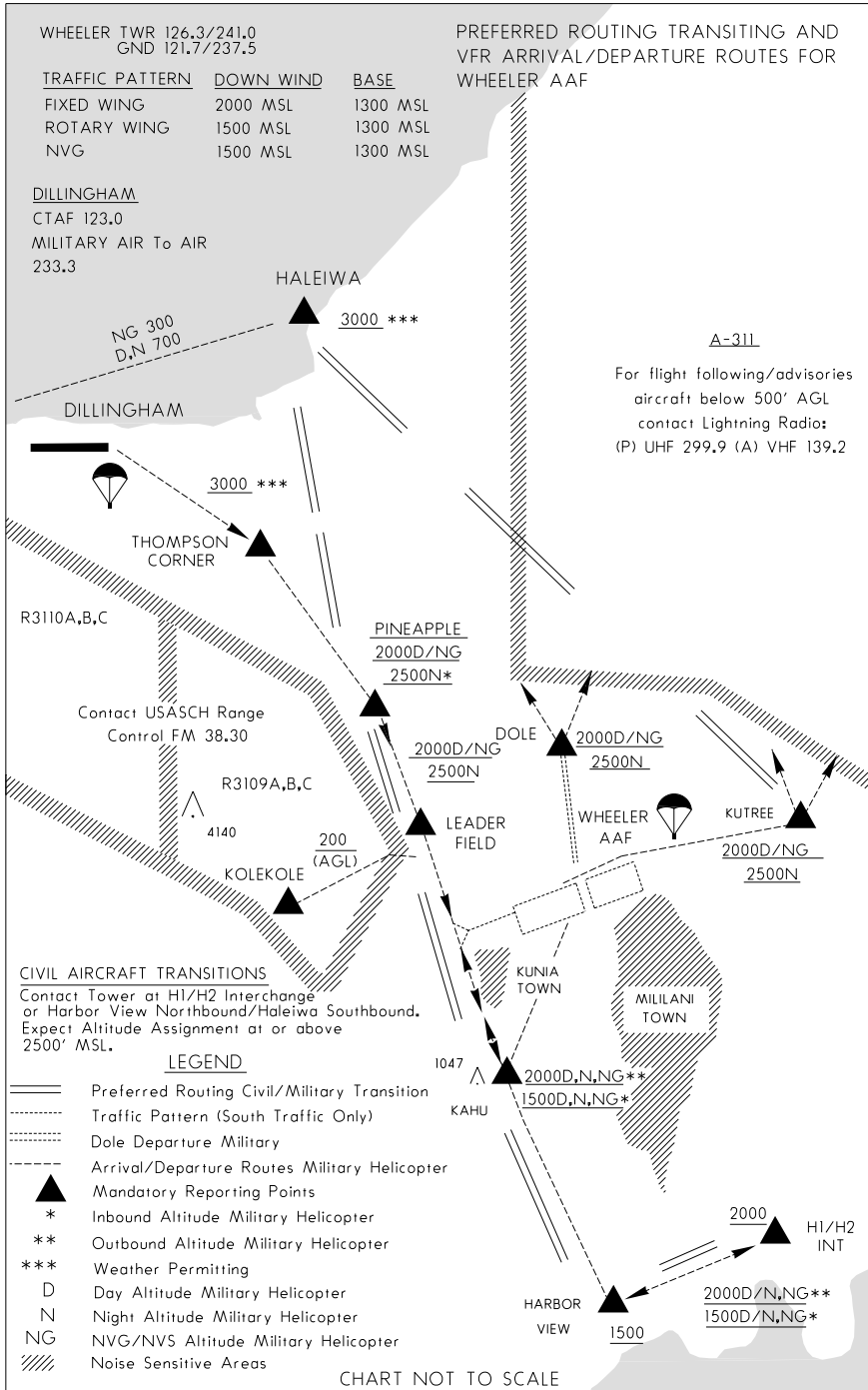

# HAWAIIAN ISLAND REPORTING SERVICE FLIGHT WATCH STATION AND CHECK POINTS

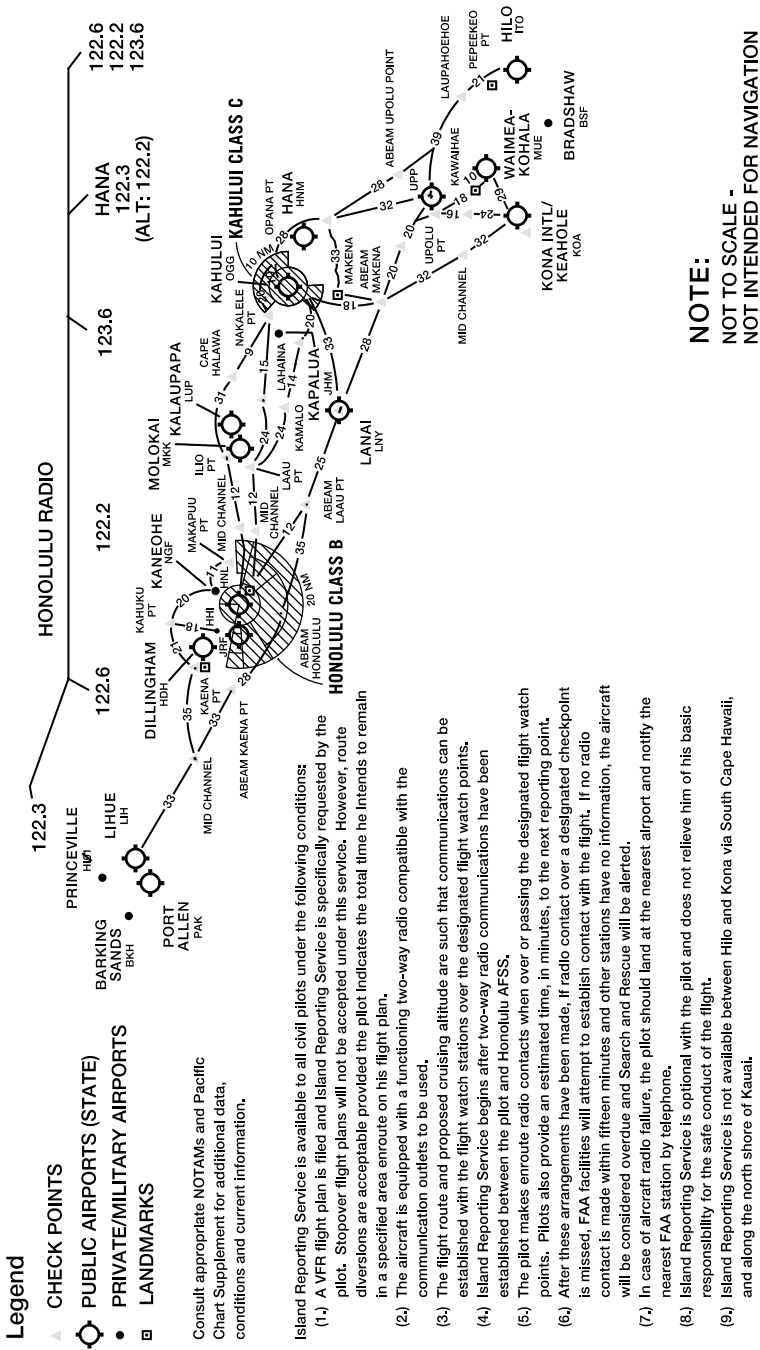

**ASSOCIATED DATA**  
**SECTION IV**  
**TABLE OF CONTENTS**

	<b>Page No.</b>
Radio Navigation Aids by Identification.....	87
VOR Receiver Check.....	87
ARINC.....	88
Meteorological Information (HF-VOLMET).....	88
Parachute Jumping Areas.....	89
Special Use Airspace .....	89
Key to Aerodrome Forecast (TAF) and Aviation Routine Weather Report (METAR).....	92
FSS NWS Offices .....	94
Key Air Traffic Facilities .....	95
Aeronautical Chart Bulletin.....	97
Military Training Routes .....	98
Conversion Tables .....	100

**RADIO NAVIGATIONAL AIDS BY IDENT**

Ident	Name	Ident	Name
AJA	Mt. Macajna (NDB)	NDJ	Bucholz (NDB)
AWK	Wake (VORTAC)	OGG	Maui (VORTAC)
BSF	Bradshaw (NDB)	PNI	Pohnpei (NDB/DME)
CKH	Koko Head (VORTAC)	POA	Pahoa (NDB)
GRO	Rota (NDB)	ROR	Koror (NDB/DME)
HHI	Wheeler (NDB)	SN	Saipan (NDB)
HN	Ewabe (NDB)	SOK	South Kauai (VORTAC)
HNL	Honolulu (VORTAC)	TKK	Truk (NDB/DME)
IAI	Kona (VORTAC)	TUT	Pago Pago (NDB)
ITO	Hilo (VORTAC)	TUT	Pago Pago (VORTAC)
LIH	Lihue (VORTAC)	UKS	Kosrae (NDB/DME)
LLD	Lanai (NDB)	UNZ	NIMITZ (VORTAC)
LNY	Lanai (VORTAC)	UPP	Upolu Point (VORTAC)
LOG	Logotala Hill (NDB)	VYI	Valley Island (NDB)
MAJ	Majuro (NDB/DME)	XI	Christmas Island (NDB)
MDY	Midway (NDB)	YP	Yap (NDB/DME)
MKK	Molokai (VORTAC)		
MUE	Kamuela (VOR/DME)		

**VOR RECEIVER CHECK**

Airborne and ground checkpoints consist of certified radials that should be received at specific points on the airport surface, or over specific landmarks while airborne in the immediate vicinity of the airport.

Should an error in excess of  $\pm 4^\circ$  be indicated through use of the ground check, or  $\pm 6^\circ$  using the airborne check, IFR flight should not be attempted without first correcting the source of the error. CAUTION: No correction other than the "correction card" figures supplied by the manufacturer should be applied in making these VOR receiver checks.

**AIRBORNE RECEIVER CHECKPOINTS**

STATION	RADIAL	DISTANCE	LOCATION
Hilo	323	8.5 NM	Pepeekeo Lighthouse 1000'
Honolulu	322	12 NM	Intersection of H-2 and Wheeler AFB Rwy 6 Centerline extended. 1500' MSL
Maui	055	6.8 NM	Pauwela Lighthouse 1000' MSL. OTS indef.
Pago Pago	060	9.4 NM	Radio tower in center of town on Aunnu I. 1500' MSL

**GROUND RECEIVER CHECKPOINTS**

STATION	RADIAL	DISTANCE	LOCATION
Hilo	258	2.6 NM	Runup pad South of approach end Rwy 08. Out of svc indefinitely.
Lihue	338	1.0 NM	Intersection Twy G and Twy A.
	342	1.1 NM	Twy F and Twy A.
Nimitz	063	3.3 NM	Twy A between Rwy 06L and Rwy 06R.
Pago Pago	241	9 NM	Radio tower in center of town on Aunnu Island.
	309	0.4 NM	On Ramp at twy D.

**VOR TEST FACILITIES (VOT)**

STATION	FREQ.	TYPE VOT FACILITY
Honolulu	111.0	G

**AERONAUTICAL RADIO, INC. (ARINC)****(Services available for aircraft engaged in international flight)**

ARINC using Pacific common air/ground ATC frequency networks shared with other ground stations are listed below. The frequencies in use will depend on the time and conditions which affect radio propagation.

**CENTRAL WEST PACIFIC (CWP) NETWORK FREQUENCIES**

San Francisco MWARA—2998, 3455, 4666, 5652, 6532, 8903, 11384, 13300, 17904 and 21985 kHz

ⓑ LDOC (See "c" below)

**NORTH PACIFIC (NP) NETWORK FREQUENCIES**

San Francisco MWARA—2932, 5628, 5667, 6655, 8915, 8951, 10048, 11330, 13273, 13339, 17946, and 21925 kHz

ⓑ LDOC (See "c" below)

**CENTRAL EAST PACIFIC ONE (CEP-1) NETWORK FREQUENCIES**

San Francisco Extended Range VHF ⓐ 131.95 MWARA—3413, 5574, 8843, 13288, 13354, 3452, 6673 and 10057 kHz

ⓑ LDOC (See "c" below)

Seattle Pre-flight checks

**CENTRAL EAST PACIFIC TWO (CEP-2) NETWORK FREQUENCIES**

San Francisco Extended Range VHF ⓐ—131.95 MWARA—2869, 5547, 11282, 13288 and 21964 kHz

ⓑ LDOC (See "c" below)

**SOUTH PACIFIC (SP) NETWORK FREQUENCIES**

San Francisco MWARA—3467, 5643, 8867, 13261, and 17904 kHz

ⓑ LDOC (See "c" below)

Only SSB capability available on all HF frequencies. All frequencies are monitored all the time.

- Ⓐ Extended Range VHF. Coverage includes area within approximately 200 NM of Hawaiian Islands and along the Hawaii–Mainland US tracks extending outward approximately 250 NM from HNL, SFO, and LAX areas.
- Ⓑ For pre-flight checks of aircraft HF equipment, call on any HF frequency is necessary. To use VHF to arrange for HF radio and SELCAL checks call SFO ARINC. On-ground at HNL and GUM, call on 131.95 MHz. On-ground at SFO and LAX, call on 130.8 MHz. On-ground at SEA, call on 129.85 MHz. Enroute SEA–ANC and on-ground ANC, call on 129.4 MHz. If airborne in Extended Range VHF areas described above, call on 131.95 MHz.
- Ⓒ Long Distance Operational Control (LDOC) service available in all areas on frequencies 3494, 6640, 8933, 11342, 13348, 17925, 21964. Aircraft flying on Polar Routes can call SFO ARINC through our Barrow, AK site on LDOC frequencies. LDOC message and phone-patch communications are limited to operational matters only. Public correspondence (personal messages) to/from crew or passengers cannot be accepted. LDOC frequencies can be used for ATC purposes in unusual or emergency situations.

**SATCOM VOICE AVAILABLE AS ALTERNATIVE COMMUNICATIONS MEDIUM:**

Effective on June 1, 1996, ARINC began normal operational use of SATCOM Voice as an acceptable alternative communications medium for oceanic long range ATC communications. It is intended that SATCOM Voice will augment HF radio, in that HF will remain primary for all air-ground-air communications between ARINC Communications Centers and enroute oceanic aircraft. Aircraft desiring to contact the SFO Communications Center should use the following INMARSAT Security Numbers:

<u>Oceanic Area</u>	<u>Communications Center</u>	<u>IMARSAT Number</u>	<u>Public Telephone Number</u>
Pacific	SFO	436625	925-371-3920

ARINC will also utilize SATCOM Voice as a normal operational backup to HF to initiate communications from ground-to-air on the rare occasion when HF communications cannot be established in a timely manner. SATCOM Voice may be used for either ATC or AOC (Aeronautical Operation Control) Communications. This capability will be on a "search, find and contact" basis initially, which may require some delay in contacting flights. Aircraft operators with aircraft currently cockpit SATCOM Voice equipped should contact ARINC at 1-800-621-0140 to provide, update, or verify aircraft AES ID codes which are required to initiate ground-to-air calls.

**METEOROLOGICAL INFORMATION (HF-VOLMET)**

Honolulu	H+00-05/ 2863 6679 8828	Aerodrome Forecasts, Honolulu, Hilo, Agana, Honolulu. SIGMET. Hourly Report, Honolulu, Hilo, Kahului, Agana, Honolulu.
13282	H+05-10/ H+35-40 H+25-30/ H+55-60	Hourly Reports, San Francisco, Los Angeles, Seattle, Portland, Sacramento, Ontario, Las Vegas. SIGMET. Aerodrome Forecasts, San Francisco, Seattle, Los Angeles. Hourly Reports, Anchorage, Elmendorf, Fairbanks, Cold Bay, King Salmon, Vancouver. SIGMET. Aerodrome Forecasts, Anchorage, Fairbanks, Cold Bay, Vancouver.

PARACHUTE JUMPING AREAS

The following tabulation lists all known jumping sites. Unless otherwise indicated, all activities are conducted during daylight hours and under VFR conditions.

AREA NAME	LOCATION	REMARKS
Agat Bay Drop Zone, GU	245 radial, 9.0 NM, UNZ VORTAC	2 NM radius. Intermittent. Up to 10,000 ft MSL. Military use only.
Anderson	054 radial, 13.5 NM, UNZ VORTAC	2 NM radius. Intermittent. Up to 18,000 ft.
Apra Harbor	265 radial, 4.0 NM, UNZ VORTAC	2 NM radius. Intermittent. Up to 12,000 ft.
Dillingham, HI	310 radial, 21.5 NM, HNL VORTAC	3 NM radius. Daily. Up to 16,000 ft.
	306 radial, 22.1 NM, HNL VORTAC	3 NM radius.
East Range/Taro Drop Zone, HI	332 radial, 11.8 NM, HNL VORTAC	.5 NM radius. Intermittent Greatest activity on weekends. Military. Maximum altitude 12,500 ft MSL.
Ferguson Hill Drop Zone, GU	040 radial, 9.5 NM, UNZ VORTAC	2 NM radius. Intermittent. Up to 14,000 ft. MSL. Military use only.
Guam Intl, GU	080 radial, 5.8 NM, UNZ VORTAC	1 NM radius. Daily. Up to 14,000 MSL FSS HNL.
Kanes Drop Zone, HI	351 radial, 22.6 NM, HNL VORTAC	Intermittent. FSS HNL. Military. Maxium Alt 12,500 ft AGL.
Mangilao Drop Zone, GU	090 radial, 4.6 NM, UNZ VORTAC	2 NM radius. Daily. Up to 14,000 MSL. FSS HNL.
Micro Beach Drop Zone, MP	005 radial, 7.0 NM, SN NDB	2 NM radius. Daily. Up to 10,000 ft. FSS HNL.
Nikko Beach Drop Zone, MP	024 radial, 9.2 NM, SN NDB	2 NM radius. Daily. Up to 10,000 ft. FSS HNL.
Orote Point	254 radial, 5.5 NM, UNZ VORTAC	2 NM radius. Intermittent. Up to 12,000 ft.
Pokai Bay, HI	285 radial, 17.5 NM, HNL VORTAC	.5 NM radius. Intermittent. Military training jumps up to 3,000 ft.
Port Allen, HI	256 radial, 4.2 NM, SOK VORTAC	2 NM radius. Daily. Max altitude 10,000 ft MSL.
Puukapu Drop Zone, HI	345 radial, 22.6 NM, HNL VORTAC	Intermittent. FSS HNL. Military.

SPECIAL USE AIRSPACE

No.	Name	Altitude	Time	Controlling Agency
				Using Agency
A-311	Wheeler AAF	To 500' AGL	1900-0800Z	Lightning Control VHF 139.2 UHF 299.9 FM 39.35 25th Infantry Division, Schofield Barracks, HI
W-186		To 9,000'	Cont	FAA, Honolulu Control Facility CO PMRFAC HAWAREA
W-187		To 18,000'	Mon-Fri 1700-0800Z Sat-Sun 1800-0200Z other times by NOTAM	FAA, Honolulu Control Facility FACSFAC PH, Pearl Harbor, HI
W-188		Unltd	Cont	FAA, Honolulu Control Facility CO PMRFAC HAWAREA
W-189		Unltd	Mon-Fri 1700-0800Z Sat-Sun 1800-0200Z Other times by NOTAM	FAA, Honolulu Control Facility FACSFAC PH, Pearl Harbor, HI

## ASSOCIATED DATA

## SPECIAL USE AIRSPACE (Continued from preceding page)

No.	Name	Altitude	Time	Controlling Agency
				Using Agency
W-190		Unltd	Mon-Fri 1700-0800Z	FAA, Honolulu Control Facility
			Sat-Sun 1800-0200Z Other times by NOTAM	FACSFAC PH, Pearl Harbor, HI
W-191		To 3000'	Mon-Fri 1700-0800Z	FAA, Honolulu Control Facility
			Sat-Sun 1800-0200Z Other times by NOTAM	FACSFAC PH, Pearl Harbor, HI
W-192		Unltd	Mon-Fri 1700-0800Z	FAA, Honolulu Control Facility
			Sat-Sun 1800-0200Z Other times by NOTAM	FACSFAC PH, Pearl Harbor, HI
W-193		Unltd	Mon-Fri 1700-0800Z	FAA, Honolulu Control Facility
			Sat-Sun 1800-0200Z Other times by NOTAM	FACSFAC PH, Pearl Harbor, HI
W-194		Unltd	Mon-Fri 1700-0800Z	FAA, Honolulu Control Facility
			Sat-Sun 1800-0200Z Other times by NOTAM	FACSFAC PH, Pearl Harbor, HI
W-196		to 2,000'	on-Fri 1700-0800Z	FAA, Honolulu Control Facility
			Sat-Sun 1800-0200Z Other times by NOTAM	FACSFAC PH, Pearl Harbor, HI
W-517	Guam	Unltd	By NOTAM	FAA GUAM CERAP COMNAVMARIANAS
R-3101	PMRF Barking	Unltd	Mon-Fri 1600-0400Z	FAA, Honolulu Control Facility
	Sands 4		Other times by NOTAM	CO Pacific Missile Range Fac
R-3103	Humuula	to 30,000'	By NOTAM	FAA, Honolulu Control Facility Commanding Gen. US Army Schofield Barracks, HI

**SPECIAL USE AIRSPACE** (Continued from preceding page)

No.	Name	Altitude	Time	Controlling Agency
				Using Agency
R-3107	Kaula Rock	to 18,000'	Mon-Fri 1700-0800Z, Sat-Sun 1800-0200Z, other times by NOTAM	FAA, Honolulu Control Facility
				FACSFAC PH, Pearl Harbor, HI  issued at least 24 hours in advance.
R-3109A	Schofield-Makua	to 8,999'	By NOTAM	FAA, Honolulu Control Facility US Army Schofield Barracks, HI
R-3109B	Schofield-Makua	9,000' to 18,999'	Intermittent	FAA, Honolulu Control Facility US Army Schofield Barracks, HI
R-3109C	Schofield-Makua	to 8,999'	By NOTAM	FAA, Honolulu Control Facility US Army Schofield Barracks, HI
R-3110A	Schofield-Makua	to 8,999'	By NOTAM	FAA, Honolulu Control Facility US Army Schofield Barracks, HI
R-3110B	Schofield-Makua	9,000' to 18,999'	Intermittent	FAA, Honolulu Control Facility US Army Schofield Barracks, HI
R-3110C	Schofield-Makua	to 8,999'	By NOTAM	Honolulu Twr US Army Schofield Barracks, HI
R-7201	Farallon de Medinilla Is.	To FL600	By NOTAM	FAA Guam CERAP COMNAVMARIANAS Fleet Support Officer

Altitude given in feet. P—Prohibited R—Restricted A—Alert W—Warning

Unauthorized flight is not permitted within a Prohibited Area, or within a Restricted Area during the time of use and between the altitudes noted in the tabulation. In Warning Areas flights are not restricted, but avoidance is advised during use.

(Authorization may be granted by the controlling agency or by Executive Order of the President).



## KEY to AERODROME FORECAST (TAF) and AVIATION ROUTINE WEATHER REPORT (METAR)

**TAF** KPIT 091730Z 091818 15005KT 5SM HZ.FEW020 WS010/31022KT  
FM1930 30015G25KT 3SM SHRA OVC015 TEMPO 2022 1/2SM +TSRA  
OVC008CB  
FM0100 27008KT 5SM SHRA BKN020 OVC040 PROB40 0407 1SM -RA BR  
FM1015 18005KT 6SM -SHRA OVC020 BECMG 1315 P6SM NSW SKC

**METAR** KPIT 091955Z COR 22015G25KT 3/4SM R28L/2600FT TSRA OVC010CB  
18/16 A2992 RMK SLP045 T01820159

Forecast	Explanation	Report
<b>TAF</b>	Message type: <u>TAF</u> -routine or <u>TAF AMD</u> -amended forecast, <u>METAR</u> -hourly, <u>SPECI</u> -special or <u>TESTM</u> -non-commissioned ASOS report	<b>METAR</b>
<b>KPIT</b>	ICAO location indicator	<b>KPIT</b>
<b>091730Z</b>	Issuance time: ALL times in UTC " <u>Z</u> ", 2-digit date, 4-digit time	<b>091955Z</b>
<b>091818</b>	Valid period: 2-digit date, 2-digit beginning, 2-digit ending times In U.S. <b>METAR</b> : <u>COR</u> rected ob; or <u>AUTO</u> mated ob for automated report with no human intervention; omitted when observer logs on	<b>COR</b>
<b>15005KT</b>	Wind: 3 digit true-north direction, nearest 10 degrees (or <u>VaRiaBle</u> ); next 2-3 digits for speed and unit, <u>KT</u> (KMH or MPS); as needed, <u>Gust</u> and maximum speed; 00000KT for calm; for <b>METAR</b> , if direction varies 60 degrees or more, <u>Variability</u> appended, e.g. 180V260	<b>22015G25KT</b>
<b>5SM</b>	Prevailing visibility: in U.S., <u>Statute Miles</u> & fractions; above 6 miles in <b>TAF</b> <u>Plus6SM</u> . (Or, 4-digit minimum visibility in meters and as required, lowest value with direction) Runway Visual Range: <u>R</u> ; 2-digit runway designator <u>Left</u> , <u>Center</u> , or <u>Right</u> as needed; <u>"/"</u> ; <u>Minus</u> or <u>Plus</u> in U.S., 4-digit value, <u>FeeT</u> in U.S., (usually meters elsewhere); 4-digit value <u>Variability</u> 4-digit value (and tendency <u>Down</u> , <u>Up</u> or <u>No</u> change)	<b>3/4SM</b>  <b>R28L/2600FT</b>
<b>HZ</b>	Significant present, forecast and recent weather: see table (on back)	<b>TSRA</b>
<b>FEW020</b>	Cloud amount, height and type: <u>SKy</u> Clear 0/8, <u>FEW</u> >0/8-2/8, <u>SCaTtered</u> 3/8-4/8, <u>BroKeN</u> 5/8-7/8, <u>OVerCast</u> 8/8; 3-digit height in hundreds of ft; <u>Towering CU</u> mulus or <u>CumulonimBus</u> in <b>METAR</b> ; in <b>TAF</b> , only <u>CB</u> . <u>Vertical Visibility</u> for obscured sky and height "VV004". More than 1 layer may be reported or forecast. In automated <b>METAR</b> reports only, <u>CLeaR</u> for "clear below 12,000 feet" T <u>em</u> perature: degrees Celsius; first 2 digits, temperature <u>"/"</u> last 2 digits, dew-point temperature; <u>Minus</u> for below zero, e.g., M06 Altimeter setting: indicator and 4 digits; in U.S., <u>A</u> -inches and hundredths; ( <u>Q</u> -hectoPascals, e.g., Q1013)	<b>OVC010CB</b>  <b>18/16</b>  <b>A2992</b>

# KEY to AERODROME FORECAST (TAF) and AVIATION ROUTINE WEATHER REPORT (METAR)

Forecast	Explanation	Report
<p><b>WS010/31022KT</b></p> <p><b>FM1930</b></p> <p><b>TEMPO 2022</b></p> <p><b>PROB40 0407</b></p> <p><b>BECMG 1315</b></p>	<p>In U.S. <b>TAF</b>, non-convective low-level (<math>\leq 2,000</math> ft) <u>Wind Shear</u>; 3-digit height (hundreds of ft); <u>"T"</u>; 3-digit wind direction and 2-3 digit wind speed above the indicated height, and unit, <u>KT</u></p> <p>In <b>METAR</b>, <u>ReMaRk</u> indicator &amp; remarks. For example: <u>Sea-Level Pressure</u> in hectoPascals &amp; tenths, as shown: 1004.5 hPa; <u>Temp/dew-point</u> in tenths °C, as shown: temp. 18.2°C, dew-point 15.9°C</p> <p><u>FroM</u> and 2-digit hour and 2-digit minute <b>beginning</b> time: indicates significant change. Each FM starts on new line, indented 5 spaces.</p> <p><u>TEMPO</u>rary: changes expected for &lt; 1 hour and in total, &lt; half of 2-digit hour <b>beginning</b> and 2-digit hour <b>ending</b> time period</p> <p><u>PROB</u>ability and 2-digit percent (30 or 40): probable condition during 2-digit hour <b>beginning</b> and 2-digit hour <b>ending</b> time period</p> <p><u>BECoMinG</u>: change expected during 2-digit hour <b>beginning</b> and 2-digit hour <b>ending</b> time period</p>	<p><b>RMK</b> <b>SLP045</b> <b>T01820159</b></p>

**Table of Significant Present, Forecast and Recent Weather - Grouped in categories and used in the order listed below; or as needed in TAF, No Significant Weather.**

<b>QUALIFIER</b>			
<b>Intensity or Proximity</b>			
- Light	"no sign"	Moderate	+ Heavy
VC Vicinity: but not at aerodrome; in U.S. <b>METAR</b> , between 5 and 10SM of the point(s) of observation; in U.S. <b>TAF</b> , 5 to 10SM from center of runway complex (elsewhere within 8000m)			
<b>Descriptor</b>			
MI Shallow	BC Patches	PR Partial	TS Thunderstorm
BL Blowing	SH Showers	DR Drifting	FZ Freezing
<b>WEATHER PHENOMENA</b>			
<b>Precipitation</b>			
DZ Drizzle	RA Rain	SN Snow	SG Snow grains
IC Ice crystals	PL Ice pellets	GR Hail	GS Small hail/snow pellets
UP Unknown precipitation in automated observations			
<b>Obscuration</b>			
BR Mist ( $\geq 5/8SM$ )	FG Fog ( $< 5/8SM$ )	FU Smoke	VA Volcanic ash
SA Sand	HZ Haze	PY Spray	DU Widespread dust
<b>Other</b>			
SQ Squall	SS Sandstorm	DS Duststorm	PO Well developed dust/sand whirls
FC Funnel cloud	+FC tornado/waterspout		

- Explanations in parentheses "(" )" indicate different worldwide practices.
- Ceiling is not specified; defined as the lowest broken or overcast layer, or the vertical visibility.
- NWS **TAFs** exclude turbulence, icing & temperature forecasts; NWS **METARs** exclude trend fcsts
- Although not used in US, Ceiling And Visibility OK replaces visibility, weather and clouds if: visibility  $\geq 10$  km; no cloud below 5000 ft (1500 m) or below the highest minimum sector altitude, whichever is greater and no CB; and no precipitation, TS, DS, SS, MIFG, DRDU, DRSA or DRSN.

**UNITED STATES DEPARTMENT OF COMMERCE**

**NOAA/PA 96052      National Oceanic and Atmospheric Administration—National Weather Service**

## ASSOCIATED DATA

### FLIGHT SERVICE STATIONS NATIONAL WEATHER SERVICE OFFICES

**Flight Service Station (FSS):** Flight Planning and Weather Briefing Services are available from the FSS. National FSS telephone numbers are provided for direct contact with FSS from anywhere in the United States, including Hawaii and Puerto Rico, except as noted.

**Telephone Information Briefing Service (TIBS):** A service of FSS that provides continuous recordings of meteorological and/or aeronautical information including area and/or route briefings, airspace procedures and special announcements. A touch-tone telephone is required to fully utilize this service.

**National Weather Service Office (WSO):** Only general weather information is available on the National Weather Service Office (WSO) telephone numbers listed. NOTE: National Weather Service Offices in the United States are not authorized to provide official Pilot Weather Briefings—contact FSS.

#### NATIONAL FSS TELEPHONE NUMBER

Pilot Weather Briefings ..... 1-800-WX-BRIEF (1-800-992-7433) \*

#### OTHER FSS TELEPHONE NUMBERS (except in Alaska)

Clearance Delivery ..... 1-888-766-8267

Lifeguard Flights Only ..... 1-877-LIF-GRD3 (1-877-543-4733)

TIBS (see description above) ..... 1-877-4TIBS-WX (1-877-484-2799)

Location	Frequencies
Hilo	116.9T (ITO) 115.7T (IAI) 113.3T (MUE) 122.6 122.2 122.1R 255.4 233.7
	Remarks: WSO – 933-6941, operates 1000-0200Z.
Honolulu, Oahu	117.7T (LNY) 116.9T (ITO) 116.1T (MKK) 115.7T (IAI) 114.8T (HNL) 114.3T (OGG) 113.9T (CKH) 113.5T (LIH) 113.3T (MUE) 112.3T (UPP) 115.4T (SOK) 123.6 122.6 122.2 122.1R 255.4 296.7
	Remarks:
	FSS—1-800-WX-BRIEF, operates 24 hours.
	WSO—973-5286, operates 24 hours.
	Surface weather reports available on request via air/ground voice communication frequencies.
	Best VHF enroute communication coverage due to location of RCO sites: 122.2—Molokai & Lanai routes, 122.6—Lihue routes, 123.6—Maui & Hawaii routes
	Volmet broadcast, Honolulu area 00-05 and 30-35, Oakland area 5-10 and 35-40, Anchorage area 55-00 and 25-30, each hr on 2863 6679 8828 13282.
	Honolulu Volmet forecast Sequence—Honolulu/Hilo/Guam.
	Routine and selected special reports—Honolulu/Hilo/Kahului/Guam.
	Terminal forecast—Honolulu/Hilo/Guam.
Lihue	WSO—245-2420, operates 1000-0200Z.

R—Receive only T—Transmit only

Emerg Freq. 121.5 and 243.0 are available at most stations and are not tabulated.

\* Outer Islands may be required to dial LD 808-833-8440 for FSS weather briefing and flight planning svc.

KEY AIR TRAFFIC FACILITIES

Air Traffic Control System Command Center

Main Number .....703-904-4400

RGNL AIR TRAFFIC DIVISIONS

REGION	TELEPHONE
Alaskan	907-271-5464
Central	816-329-2500
Eastern	718-553-4502
Great Lakes	847-294-7202
New England	781-238-7500
Northwest Mountain	425-227-2500
Southern	404-305-5500
Southwest	817-222-5500
Western Pacific	310-725-6500

AIR ROUTE TRAFFIC CONTROL CENTERS (ARTCCs)

ARTCC NAME	*24 HR RGNL DUTY OFFICE TELEPHONE #	BUSINESS HOURS	BUSINESS TELEPHONE #
Albuquerque	817-222-5006	7:30 a.m.-4:00 p.m.	505-856-4300
Anchorage	907-271-5936	7:30 a.m.-4:00 p.m.	907-269-1137
Atlanta	404-305-5180	7:30 a.m.-5:00 p.m.	770-210-7601
Boston	781-238-7001	7:30 a.m.-4:00 p.m.	617-455-3100
Chicago	847-294-8400	8:00 a.m.-4:00 p.m.	630-906-8221
Cleveland	847-294-8400	8:00 a.m.-4:00 p.m.	440-774-0310
Denver	425-227-1389	7:30 a.m.-4:00 p.m.	303-651-4100
Ft. Worth	817-222-5006	7:30 a.m.-4:00 p.m.	817-858-7300
Houston	817-222-5006	7:30 a.m.-4:00 p.m.	281-230-5300
Indianapolis	847-294-8400	8:00 a.m.-4:00 p.m.	317-247-2231
Jacksonville	404-305-5180	8:00 a.m.-4:30 p.m.	904-549-1501
Kansas City	816-329-3000	7:30 a.m.-4:00 p.m.	913-254-8500
Los Angeles	661-265-8200	7:30 a.m.-4:00 p.m.	661-265-8200
Memphis	404-305-5180	7:30 a.m.-4:00 p.m.	901-368-8103
Miami	404-305-5180	7:00 a.m.-3:30 p.m.	305-716-1500
Minneapolis	847-294-8400	8:00 a.m.-4:00 p.m.	651-463-5580
New York	718-995-5426	8:00 a.m.-4:40 p.m.	516-468-1001
Oakland	310-725-3300	6:30 a.m.-3:00 p.m.	510-745-3331
Salt Lake City	425-227-1389	7:30 a.m.-4:00 p.m.	801-320-2500
Seattle	425-227-1389	7:30 a.m.-4:00 p.m.	253-351-3500
Washington	718-995-5426	8:00 a.m.-4:30 p.m.	703-771-3401

MAJOR TERMINAL RADAR APPROACH CONTROLS (TRACONs)

TRACON NAME	*24 HR RGNL DUTY OFFICE TELEPHONE #	BUSINESS HOURS	BUSINESS TELEPHONE #
Atlanta	404-305-5180	7:00 a.m.-3:30 p.m.	404-669-1200
Chicago	847-294-8400	8:00 a.m.-4:00 p.m.	847-608-5509
Dallas/Ft. Worth	817-222-5006	7:30 a.m.-4:00 p.m.	972-615-2500
Denver	425-227-1389	7:30 a.m.-4:00 p.m.	303-342-1500
Houston	817-222-5006	7:30 a.m.-4:00 p.m.	281-230-8400
New York	718-995-5426	8:00 a.m.-4:30 p.m.	516-683-2901
Northern CA	310-725-3300	7:00 a.m.-3:30 p.m.	916-366-4001
Potomac	718-995-5426	8:00 a.m.-4:30 p.m.	540-349-7500
Southern CA	310-725-3300	7:30 a.m.-4:00 p.m.	858-537-5800

\*Facilities can be contacted through the Rgnl Duty Officer during non-business hours.

## KEY AIR TRAFFIC FACILITIES DAILY NAS REPORTABLE AIRPORTS

AIRPORT NAME	*24 HR RGNL DUTY OFFICE TELEPHONE #	BUSINESS HOURS	BUSINESS TELEPHONE #
Albuquerque Intl Sunport, NM	817-222-5006	8:00 a.m.-5:00 p.m.	505-842-4366
Andrews AFB, MD	718-995-5426	8:00 a.m.-4:30 p.m.	301-735-2380
Baltimore/Washington Intl Thurgood Marshall, MD	718-995-5426	8:00 a.m.-4:30 p.m.	410-962-3555
Boston Logan Intl, MA	617-238-7001	7:30 a.m.-4:00 p.m.	617-561-5901
Bradley Intl, CT	617-238-7001	7:30 a.m.-4:00 p.m.	203-627-3428
Burbank/Bob Hope, CA	301-725-3300	7:00 a.m.-5:30 p.m.	818-567-4806
Charlotte Douglas Intl, NC	404-305-5180	8:00 a.m.-4:30 p.m.	704-344-6487
Chicago Midway, IL	847-294-8400	8:00 a.m.-4:00 p.m.	773-884-3670
Chicago O'Hare Intl, IL	847-294-8400	8:00 a.m.-4:00 p.m.	773-601-7600
Cleveland Hopkins Intl, OH	847-294-8400	8:00 a.m.-4:00 p.m.	216-898-2020
Covington/Cincinnati, OH	708-294-7401	8:00 a.m.-4:30 p.m.	606-767-1006
Dallas/Ft. Worth Intl, TX	817-222-5006	8:30 a.m.-5:00 p.m.	972-615-2531
Dayton Cox Intl, OH	847-294-8400	7:30 a.m.-4:00 p.m.	937-454-7300
Denver Intl, CO	425-227-1389	7:30 a.m.-4:00 p.m.	303-342-1600
Detroit Metro, MI	847-294-8400	8:00 a.m.-4:00 p.m.	734-955-5000
Fairbanks Intl, AK	907-271-5936	7:30 a.m.-4:00 p.m.	907-474-0050
Fort Lauderdale Intl, FL	404-305-5180	7:00 a.m.-3:30 p.m.	305-356-7932
George Bush Intercontinental/Houston, TX	817-222-5006	7:30 a.m.-4:00 p.m.	713-230-8400
Hartsfield-Jackson Atlanta Intl, GA	404-305-5180	7:00 a.m.-3:30 p.m.	404-669-1200
Honolulu Intl, HI	310-643-3200	7:30 a.m.-4:00 p.m.	808-840-6100
Houston Hobby, TX	817-222-5006	8:00 a.m.-5:00 p.m.	713-847-1400
Indianapolis Intl, IN	847-294-8400	8:00 a.m.-4:00 p.m.	317-484-6600
Kahului/Maui, HI	310-643-3200	7:30 a.m.-4:00 p.m.	808-877-0725
Kansas City Intl, MO	816-329-3000	7:30 a.m.-4:00 p.m.	816-329-2700
Las Vegas McCarran, NV	310-725-3300	7:30 a.m.-4:00 p.m.	702-262-5978
Los Angeles Intl, CA	310-725-3300	7:00 a.m.-3:30 p.m.	310-342-4900
Louis Armstrong New Orleans Intl, LA	817-222-5006	7:00 a.m.-4:30 p.m.	504-471-4300
Memphis Intl, TN	404-305-5180	7:30 a.m.-4:00 p.m.	901-322-3350
Miami Intl, FL	404-305-5180	7:00 a.m.-4:00 p.m.	305-869-5400
Minneapolis/St. Paul, MN	847-294-8400	8:00 a.m.-4:00 p.m.	612-713-4000
Nashville Intl, TN	404-305-5180	7:00 a.m.-3:30 p.m.	615-781-5460
New York Kennedy Intl, NY	718-995-5426	8:00 a.m.-4:30 p.m.	718-656-0335
New York La Guardia, NY	718-995-5426	8:00 a.m.-4:30 p.m.	718-335-5461
Newark Liberty Intl, NJ	718-995-5426	8:00 a.m.-4:30 p.m.	973-645-3103
Norman Y. Mineta San Jose Intl, CA	310-643-3200	7:30 a.m.-4:00 p.m.	408-982-0750
Ontario Intl, CA	310-643-3200	7:30 a.m.-4:00 p.m.	909-983-7518
Orlando Intl, FL	404-305-5180	7:30 a.m.-5:00 p.m.	407-850-7000
Philadelphia Intl, PA	718-995-5426	8:00 a.m.-4:30 p.m.	215-492-4100
Phoenix Sky Harbor Intl, AZ	310-643-3200	7:30 a.m.-4:00 p.m.	602-379-4226
Pittsburgh Intl, PA	718-995-5426	8:00 a.m.-4:30 p.m.	412-269-9237
Portland Intl, OR	425-227-1389	7:30 a.m.-4:00 p.m.	503-493-7500
Raleigh-Durham, NC	404-305-5180	8:00 a.m.-4:30 p.m.	919-840-5544
Ronald Reagan Washington National, DC	718-995-5426	8:00 a.m.-4:30 p.m.	703-413-1535
Salt Lake City, UT	425-227-1389	7:30 a.m.-4:00 p.m.	801-325-9600
San Antonio Intl, TX	817-222-5006	8:00 a.m.-4:30 p.m.	210-805-5507
San Diego Lindbergh Intl, CA	310-725-3300	8:00 a.m.-4:30 p.m.	619-299-0677
San Francisco Intl, CA	310-643-3200	7:00 a.m.-3:30 p.m.	650-876-2883
San Juan Intl, PR	404-305-5180	7:30 a.m.-5:00 p.m.	809-253-8663
Seattle-Tacoma Intl, WA	425-227-1389	7:30 a.m.-4:00 p.m.	206-768-2900
St. Louis Lambert, MO	816-329-3000	7:30 a.m.-4:00 p.m.	314-890-1000
Tampa Intl, FL	404-305-5180	7:30 a.m.-4:00 p.m.	813-371-7700
Ted Stevens Anchorage Intl, AK	907-271-5936	7:30 a.m.-4:00 p.m.	907-271-2700
Teterboro, NJ	718-995-5426	8:00 a.m.-4:30 p.m.	201-288-1889
Washington Dulles Intl, DC	718-995-5426	8:00 a.m.-4:30 p.m.	703-661-6031
West Palm Beach, FL	404-305-5180	8:00 a.m.-4:30 p.m.	561-683-1867
Westchester Co, NY	718-995-5426	8:00 a.m.-4:30 p.m.	914-948-6520

\*Facilities can be contacted through the Rgnl Duty Officer during non-business hours.

## AERONAUTICAL CHART BULLETIN

The purpose of this bulletin is to provide major changes in aeronautical information that have occurred since the last publication date of each Sectional Aeronautical, VFR Terminal Area, and Helicopter Route Charts listed. The general policy is to include only those changes to controlled airspace and special use airspace that present a hazardous condition or impose a restriction on the pilot, and major changes to airports and radio navigational facilities, thereby providing the VFR pilot with the essential data necessary to update and maintain chart currency. The data is grouped by type and then by effective date. When a new edition of the Aeronautical Chart is published, the corrective tabulation will be removed from this bulletin. Inasmuch as this Bulletin provides major changes only, pilots should consult the airport listing in this directory for all new information. Users of U.S. World Aeronautical Charts (WAC) and U.S. Gulf Coast VFR Aeronautical Charts should consult the appropriate Sectional and VFR Terminal Area Charts for revisions.

Military Training Routes (MTRs) are shown on Sectional Aeronautical Charts, VFR Terminal Area, and Helicopter Route Charts. Only the route centerline, direction of flight and the route designator are shown — route widths and altitudes are not shown. Since these routes are subject to change every 56 days and the charts are reissued generally every 6 months, routes with a change in the alignment of the charted route centerline will be listed in this Aeronautical Chart Bulletin below. You are advised to contact the nearest FSS for route dimensions and current status for those routes affecting your flight.

---

## HAWAIIAN ISLANDS SECTIONAL CHART

81st Edition, 22 Oct 2009

**OBSTRUCTIONS****22 Oct 2009 – 11 Feb 2010** No Major Changes.**8 Apr 2010** Add obst 562' MSL (300' AGL) UC, 14°57'24"N, 145°38'33"E.**AIRPORTS****22 Oct 2009 – 8 Apr 2010** No Major Changes.**NAVAIDS****22 Oct 2009 – 8 Apr 2010** No Major Changes.**AIRSPACE****22 Oct 2009 – 8 Apr 2010** No Major Changes.**SPECIAL USE AIRSPACE****22 Oct 2009 – 8 Apr 2010** No Major Changes.**MILITARY TRAINING ROUTES****22 Oct 2009 – 8 Apr 2010** No Major Changes.**MISCELLANEOUS****22 Oct 2009 – 8 Apr 2010** No Major Changes.

- 
1. National security depends largely on the deterrent effect of our airborne military forces. To be proficient, the military services must train in a wide range of airborne tactics. One phase of this training involves "low level" combat tactics. The required maneuvers and high speeds are such that they may occasionally make the see-and-avoid aspect of VFR flight more difficult without increased vigilance in areas containing such operations. In an effort to ensure the greatest practical level of safety for all flight operations, the Military Training Route program was conceived.
  2. The Military Training Routes (MTR) program is a joint venture by the FAA and the Department of Defense (DOD). MTR routes are mutually developed for use by the military for the purpose of conducting low-altitude, high-speed training. There are IFR (IR) routes located in the Marianas Islands. These routes are flown from FL200 or as assigned by ATC to 1,000 feet MSL. Points of entry/exit and altitudes along the route are charted for use in preflight pilot briefings. Pilots should review this information to acquaint themselves with these routes that are located along their route of flight and in the vicinity of airports on Guam, Rota, Tinian and Saipan.
  3. Non participating aircraft are not prohibited from flying within an MTR, however, extreme vigilance should be exercised when conducting flight through or near these routes. Pilots should contact Guam CERAP or Saipan radio to obtain information on route usage in their vicinity.
  4. Marianas Islands Military Training Routes are also published in the Mariana Islands Sectional Aeronautical Chart, the DOD Flight Information Publication (enroute). Chart 1, Panel B and the DOD FLIP are planning document AP/3.

**MILITARY TRAINING ROUTES**

The DOD Flight Information Publication AP/1B provides textual and graphic descriptions and operating instructions for all military training routes (IR, VR, SR) and refueling tracks/anchors. Complete and more comprehensive information relative to policy and procedures for IRs and VRs is published in FAA Handbook 7610.4 (Special Military Operations) which is agreed to by the DOD and therefore directive for all military flight operations. The AP/1B is the official source of route data for military users.

MILITARY TRAINING ROUTES  
 MARIANAS ISLANDS  
 IR-983

Hours of Operation—Continuous

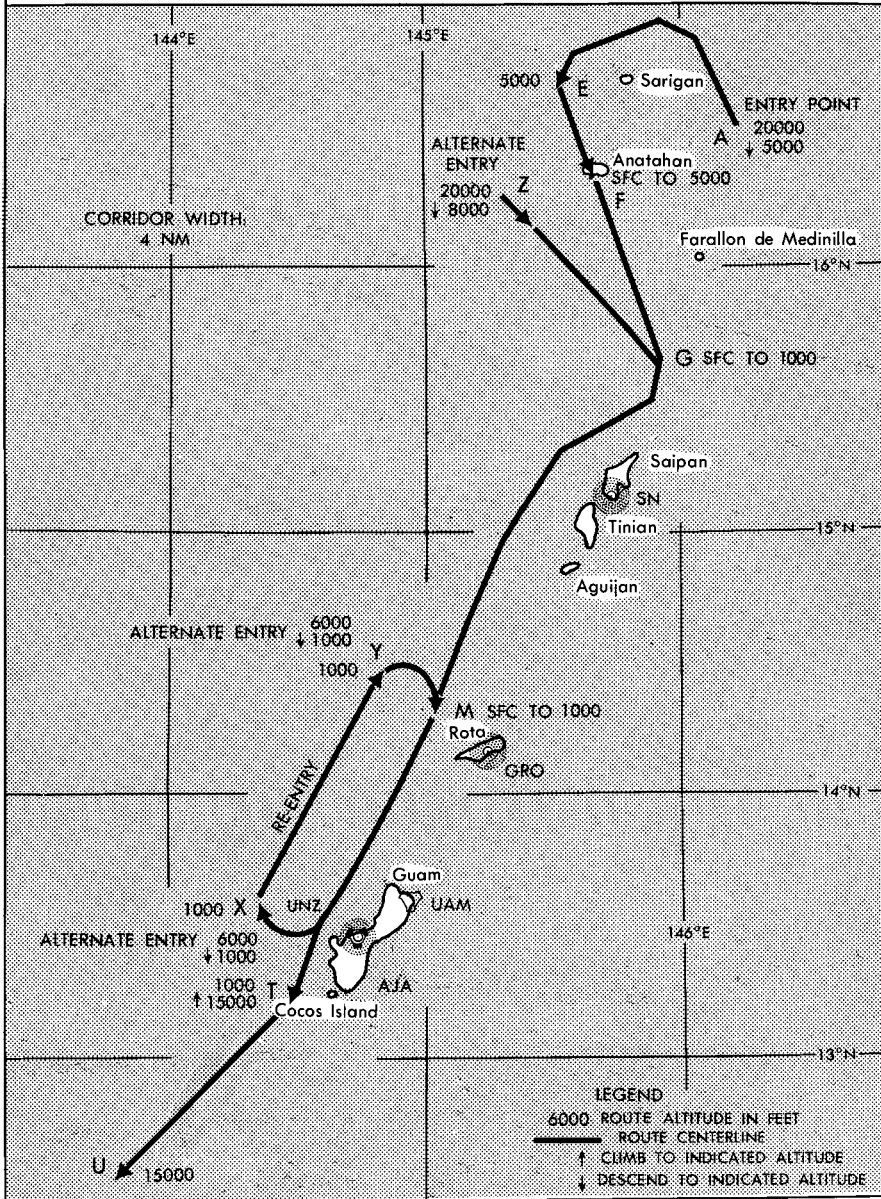



## DISTANCES

METERS/FEET		
MTRS	FT/MTRS	FT
0.305	1	3.281
0.610	2	6.562
0.914	3	9.843
1.219	4	13.123
1.524	5	16.404
1.829	6	19.685
2.134	7	22.966
2.438	8	26.247
2.743	9	29.528
3.048	10	32.808
6.096	20	65.617
9.144	30	98.425
12.192	40	131.233
15.240	50	164.042
18.288	60	196.850
21.336	70	229.658
24.384	80	262.467
27.432	90	295.275
30.480	100	328.083
60.960	200	656.2
91.440	300	984.3
121.920	400	1312.3
152.400	500	1640.4
304.800	1000	3280.8
609.601	2000	6561.7
914.402	3000	9842.5
1219.202	4000	13123.3
1524.003	5000	16404.2

NAUTICAL MILES TO		
KM	NM	SM
0.185	0.1	0.115
0.370	0.2	0.230
0.556	0.3	0.345
0.741	0.4	0.460
0.926	0.5	0.575
1.111	0.6	0.690
1.296	0.7	0.806
1.482	0.8	0.921
1.667	0.9	1.036
1.85	1	1.15
3.70	2	2.30
5.56	3	3.45
7.41	4	4.60
9.26	5	5.75
11.11	6	6.90
12.96	7	8.06
14.82	8	9.21
16.67	9	10.36
18.52	10	11.51

NAUTICAL MILES TO		
KM	NM	SM
37.04	20	23.02
55.56	30	34.52
74.08	40	46.03
92.60	50	57.54
111.12	60	69.05
129.64	70	80.55
148.16	80	92.06
166.68	90	103.57
185.20	100	115.08
370.40	200	230.16
555.60	300	345.23
740.80	400	460.31
926.00	500	575.39
1111.20	600	690.47
1296.40	700	805.54
1481.60	800	920.62
1666.80	900	1035.70
1852.00	1000	1150.78

MTRS	NM
100	0.054
500	0.270
1000	0.540
2000	1.080
3000	1.620
4000	2.160

MTRS	NM
5000	2.700
6000	3.240
7000	3.780
8000	4.320
9000	4.860
10,000	5.399

## MILLIBARS TO INCHES

mb	0	1	2	3	4	5	6	7	8	9
	INCHES									
940	27.76	27.79	27.82	27.85	27.88	27.91	27.94	27.96	27.99	28.02
950	28.05	28.08	28.11	28.14	28.17	28.20	28.23	28.26	28.29	28.32
960	28.35	28.38	28.41	28.44	28.47	28.50	28.53	28.56	28.59	28.61
970	28.64	28.67	28.70	28.73	28.76	28.79	28.82	28.85	28.88	28.91
980	28.94	28.97	29.00	29.03	29.06	29.09	29.12	29.15	29.18	29.21
990	29.23	29.26	29.29	29.32	29.35	29.38	29.41	29.44	29.47	29.50
1000	29.53	29.56	29.59	29.62	29.65	29.68	29.71	29.74	29.77	29.80
1010	29.83	29.85	29.88	29.91	29.94	29.97	30.00	30.03	30.06	30.09
1020	30.12	30.15	30.18	30.21	30.24	30.27	30.30	30.33	30.36	30.39
1030	30.42	30.45	30.47	30.50	30.53	30.56	30.59	30.62	30.65	30.68
1040	30.71	30.74	30.77	30.80	30.83	30.86	30.89	30.92	30.95	30.98
1050	31.01	31.04	31.07	31.10	31.12	31.15	31.18	31.21	31.24	31.27

## TEMPERATURE SCALES IN DEGREES

°C	°F	°C	°F	°C	°F	°C	°F	°C	°F	°C	°F	°C	°F	°C	°F
-40	-40.0	-28	-18.4	-16	3.2	-4	24.8	8	46.4	20	68.0	32	89.6	44	111.2
-39	-38.2	-27	-16.6	-15	5.0	-3	26.6	9	48.2	21	69.8	33	91.4	45	113.0
-38	-36.4	-26	-14.8	-14	6.8	-2	28.4	10	50.0	22	71.6	34	93.2	46	114.8
-37	-34.6	-25	-13.0	-13	8.6	-1	30.2	11	51.8	23	73.4	35	95.0	47	116.6
-36	-32.8	-24	-11.2	-12	10.4	0	32.0	12	53.6	24	75.2	36	96.8	48	118.4
-35	-31.0	-23	-9.4	-11	12.2	1	33.8	13	55.4	25	77.0	37	98.6	49	120.2
-34	-29.2	-22	-7.6	-10	14.0	2	35.6	14	57.2	26	78.8	38	100.4	50	122.0
-33	-27.4	-21	-5.8	-9	15.8	3	37.4	15	59.0	27	80.6	39	102.2		
-32	-25.6	-20	-4.0	-8	17.6	4	39.2	16	60.8	28	82.4	40	104.0		
-31	-23.8	-19	-2.2	-7	19.4	5	41.0	17	62.6	29	84.2	41	105.8		
-30	-22.0	-18	-0.4	-6	21.2	6	42.8	18	64.4	30	86.0	42	107.6		
-29	-20.2	-17	1.4	-5	23.0	7	44.6	19	66.2	31	87.8	43	109.4		

**PROCEDURES**  
**SECTION V**  
**TABLE OF CONTENTS**

	<b>Page No.</b>
Flight Plans .....	104
Altimeter Setting–Oakland Oceanic FIR .....	104
Air Traffic Control Radar Beacon System (ATCRBS) .....	104
Oceanic Position Reporting Procedures .....	105
Position Reports Over Oakland FIR/CTA Boundary .....	106
Climb Times/Changes of Flight Level .....	109
VFR Advisory Information .....	110
Terminal Radar Service Areas.....	111
Class C Airspace .....	112
Operation in Proximity to Heavy Jet Aircraft.....	112
ESCAT Procedures .....	112
Air Defense Identification Zones (ADIZ) .....	114

**FAA FORM 7233-1 FLIGHT PLAN**

Form Approved OMB No. 2120-0026

U.S. DEPARTMENT OF TRANSPORTATION FEDERAL AVIATION ADMINISTRATION		(FAA USE ONLY) <input type="checkbox"/> PILOT BRIEFING <input type="checkbox"/> VNR			TIME STARTED	SPECIALIST INITIALS
<b>FLIGHT PLAN</b>				<input type="checkbox"/> STOPOVER		
1. TYPE VFR IFR DVFR	2. AIRCRAFT IDENTIFICATION	3. AIRCRAFT TYPE/SPECIAL EQUIPMENT	4. TRUE AIRSPEED KTS	5. DEPARTURE POINT	6. DEPARTURE TIME PROPOSED (Z)    ACTUAL (Z)	
8. ROUTE OF FLIGHT						
9. DESTINATION (Name of airport and city)		10. EST. TIME ENROUTE HOURS    MINUTES		11. REMARKS		
12. FUEL ON BOARD HOURS    MINUTES		13. ALTERNATE AIRPORT(S)		14. PILOT'S NAME, ADDRESS & TELEPHONE NUMBER & AIRCRAFT HOME BASE		15. NUMBER ABOARD
				17. DESTINATION CONTACT-TELEPHONE (OPTIONAL)		
16. COLOR OF AIRCRAFT		CIVIL AIRCRAFT PILOTS: FAR Part 91 requires you file an IFR flight plan to operate under instrument flight rules in controlled airspace. Failure to file could result in a civil penalty not to exceed \$1,000 for each violation. (Section 901 of the Federal Aviation Act of 1958, as amended). Filing of a VFR flight plan is recommended as a good operating practice. See also Part 99 for requirements concerning DVFR flight plans.				

FAA Form 7233-1 (8-82)

CLOSE VFR FLIGHT PLAN WITH \_\_\_\_\_ FSS ON ARRIVAL

**FAA FORM 7233-4 INTERNATIONAL FLIGHT PLAN**

**CIVIL AIRCRAFT PILOTS:** FAR Part 91 states that each person operating a civil aircraft of U.S. registry over the high seas shall comply with Annex 2 to the Convention of International Civil Aviation, International Standards - Rules of the Air. Annex 2 requires the submission of a flight plan containing items 1-19 prior to operating any flight across international waters. Failure to file could result in a civil penalty not to exceed \$1000 for each violation (Section 901 of the Federal Aviation Act of 1958, as amended).

PRIORITY INDICATOR		ADDRESS INDICATOR(S)		<< =		
FILING TIME		ORIGINATOR INDICATOR	SPECIFIC ADDRESSES AND/OR ORIGINATOR IDENTIFICATIONS			<< =
3. DESCRIPTION	7. AIRCRAFT IDENTIFICATION AND SSR DATA	8. FLIGHT RULES AND TYPE OF FLIGHT	9. NO. & TYPE AIRCRAFT AND WAKE TURBULANCE DATA	10. EQUIPMENT		<< =
13. AERODROME OF DEPARTURE AND TIME		FIR BOUNDARIES AND ESTIMATED TIME(S)				<< =
15. CRUISING SPEED	LEVEL	ROUTE				
17. AERODROME OF DESTINATION AND TIME		ETA	ALTERNATE AIRPORT(S)	18. OTHER (Control) INFORMATION		<< =
<b>SUPPLEMENTAL INFORMATION - Not Transmitted (To Be Completed By Pilot)</b>						
19. FUEL/	\$ POB/	\$ RDO/121.5	\$ 243	\$ 500	\$ 8364	<< =
LIGHT \$ FLUORESEN \$		<< =	DINGHIES	\$ COVER	\$ RMK/	<< =

FAA Form 7233-4 (10-83)

NAME OF PILOT-IN-COMMAND

SIGNATURE OF PILOT

**CLOSE FLIGHT PLAN UPON ARRIVAL**  
(SEE REVERSE)

## PROCEDURES

### FLIGHT PLANS

Due to the critical workload in the processing of flight data and the increased time in transit due to the volume of messages it is strongly recommended that ICAO flight plan messages be filed and transmitted to the appropriate ACC not less than one hour before estimated time of departure.

ICAO Annex 2 requires a flight plan to be submitted for any flight across international borders. This permits en route stations and the destination station to render better service by having prior knowledge of flights. Aircraft on VFR flight plans must make regular position reports to ATC for flight following, for weather safety advisories, and for prompt search and rescue action in the proper area if necessary. Flight plans may be submitted to the nearest flight service station either in person or by telephone. Aircraft radio may be used if no other means are available. If a flight service station cannot be reached, ARINC will accept flight plans by radio.

#### Filing Mach Number in Flight Plan

For oceanic departures, Mach speed and flight level should be specified in the flight plan in one of the following ways:

Preferred method: Mach number and flight level immediately preceding the initial domestic portion of the route of flight.

Example of field 15 of ICAO Flight Plan for Honolulu to San Francisco:

MO84F340 MOLOKAI 3 CLUTS R465 CLUKK/N0494F360 OSI

Alternate Method: True airspeed and flight level in field 15, and Mach number in the remarks section, field 18, of ICAO Flight Plan.

Example of Field 15 and Field 18 of ICAO flight Plan for Honolulu to San Francisco:

N0480F340 MOLOKAI 3 CLUTS R465 CLUKK/N0490F360 OSI  
MO84 REG/N123XX SEL/ABCD EET/KZAK0043 KZAK0415

#### Filing an EET in Flight Plan

In accordance with ICAO DOC 4444, flight plans with routes entering the Oakland oceanic flight information region (KZAK), must contain the elapsed time (EET) in field 18, an entry point for KZAK and an estimated time. It is not mandatory to file the boundary crossing point in field 15 of the route of flight but it is permitted. Omission of an EET in field 18 causes rejection of the flight plan.

## ALTIMETER SETTING OAKLAND OCEANIC FIR

Each person operating an aircraft shall maintain the cruising altitude or flight level of the aircraft by reference to an altimeter that is set:

- a. Within the Honolulu domestic area, within 100 NM of the Nimitz VORTAC, within 35 NM of Saipan NDB and within 100 NM of Kwajalein:
  - (1) At FL 180 and above, to standard altimeter setting 29.92 inches of mercury (QNE).
  - (2) Below 18,000' MSL, to current altimeter setting (QNH).
- b. Within all other areas of the Oakland Oceanic FIR, at or above 5,500' MSL, to standard altimeter setting 29.92 inches of mercury (QNE).

## AIR TRAFFIC CONTROL RADAR BEACON SYSTEM (ATCRBS)

ATCRBS is similar to and compatible with military coded radar beacon equipment. Civil Mode A is identical to military Mode 3. The Radar Beacon Code Employment Plan is designed to minimize the number of code changes and to enable a controller to display and quickly identify only those Mode 3/A responses from aircraft operating within his area of jurisdiction.

Accordingly, pilots of aircraft equipped with a functioning coded radar beacon transponder, and operating on an IFR flight plan in an area covered by radar, will be instructed by ATC to reply on the appropriate code. Flights assigned a particular code by ATC are expected to remain on that code until further advised by ATC. (NOTE: See also Beacon Code Requirements within this section.) Within the Honolulu domestic Area and the Guam ADIZ, pilots of aircraft equipped with functioning coded radar beacon transponder will adjust their transponders to reply on Mode 3/A codes specified below, unless a different code has been assigned by advance coordination or via direct communication with ATC. If possible, coordination shall be effected with the appropriate ATC facility when special military operations preclude compliance with this requirement.

Code 4000 – For all operations within restricted/warning areas.

Code 1200 – For all VFR operations not being provided radar services by ATC facilities.

Should the pilot of an aircraft equipped with a coded radar beacon transponder experience a loss of two-way radio capability he should:

- a. Adjust his transponder to reply on Mode A/3, Code 7700 for a period of 1 minute.
- b. Then change to Code 7600 and remain on 7600 for period of 15 minutes or the remainder of flight, whichever occurs first.
- c. Repeat steps a and b, as practicable.

The pilot should understand that he might not be in an area of radar coverage. Many radar facilities are not presently equipped to automatically display Code 7600 and will interrogate 7600 only when the aircraft is under direct radar control at the time of radio failure. Replying on Code 7700 first increases the probability of early detection of a radio failure condition.

**OCEANIC POSITION REPORTING PROCEDURES  
OAKLAND OCEANIC FIR****GENERAL**

For non ADS equipped aircraft "any" waypoint filed in the route of flight (Item 15 of the ICAO flight plan) must be reported as a position report whether the filed waypoint is compulsory or not. If a non compulsory waypoint is not filed in item 15, it does not need to be reported.

Aircraft with an active ADS connection should make one CPDLC position report over the FIR boundary and discontinue CPDLC position reporting after the FIR report.

**A. POSITION REPORTS**

1. When operating on a fixed or NOTAMd route report and estimate the designated reporting points using the specified names of such points or coordinates as specified in the NOTAM.
2. When operating on a random route:
  - a. Flights whose tracks are predominantly east and west shall report over each 5 degrees or 10 degrees (10 degrees will be used if the speed of the aircraft is such that 10 degrees will be traversed within 1+20 or less) meridian longitude extending east and west from 180 degrees.
  - b. Flights whose tracks are predominantly north and south shall report over each 5 degrees or 10 degrees (10 degrees if traversed within 1+20) parallel of latitude extending north and south of the equator.
3. ATC may require specific flights to report more frequently than each 5 degrees for aircraft with slow ground speeds.
4. Position reports shall be transmitted at the time of crossing the designated reporting point or as soon thereafter as possible.

**B. CONTENTS OF POSITION REPORT**

Position reports shall comprise information on present position, estimated next position, and ensuing position in sequence as indicated below. Forward planned flight level change information while in the Oakland FIR.

1. **PRESENT POSITION** – Information shall include:
  - a. The word "position".
  - b. Aircraft Identification.
  - c. Reporting point name, or if not named:
    - (1) Latitude (2 digits or more) and,
    - (2) Longitude (3 digits or more).
  - d. Time over reporting point (4 digits UTC).
  - e. Altitude (Flight Level). When forwarding an altitude report within the Oakland FIR, pilots should report their present altitude and their assigned altitude exactly as cleared if the present and assigned altitude differ. A restriction to cross a point at an altitude is not a block altitude assignment and should not be reported as a block of altitudes.
2. **ESTIMATED NEXT POSITION**
  - a. Reporting point name, or if not named, latitude and longitude as in 1c(1) and (2) above and,
  - b. Estimated time over next position (4 digits UTC).
3. **ENSUING FIX**

Name only of the next succeeding fix whether compulsory or not, or if not named, latitude and longitude as in 1c(1) and (2) above.

**4. PREPLANNING FLIGHT LEVELS**

Within the Oakland FIR, pilots should forward the time requesting the next subsequent cardinal flight level.

**C. WEATHER REPORTS**

Weather reports shall be included as provided in Section 3 of Standard AIREP Form by all flights unless exempted from weather reporting by the Weather Service and/or ATC.

**D. FLIGHT PLANNING**

All operators are requested to include the following data in the route definition portion of flight plans:

1. Coordinates for all turning points.
2. Names, where applicable, or coordinates of points associated with transition from oceanic areas to airways/areas where national procedures apply.
3. Names of airways or descriptions of routes within such national airspace.
4. Coordinates for each 10 degrees of latitude or longitude depending on the predominant direction of flight (subject to the limitations of A2a or A2b above) unless this point generally coincides with a turning point or named intersection.

**E. ADHERENCE TO ATC APPROVED ROUTE**

If an aircraft, notwithstanding all action taken to adhere to the route specified in the ATC clearance, inadvertently deviates from this route, action shall be taken to regain it as soon as reasonable and not further ahead than 200 nautical miles from the DR position at which the heading was altered to regain the route specified in the ATC clearance. Action to regain this route shall not be delayed in anticipation of obtaining a requested reclearance.

**F. EXCEPTIONS TO POSITION REPORTING PROCEDURES**

1. Within Oakland FIR, no 5 degree report need be made that would fall within 100 NM of Guam. Aircraft cleared via terminal area routes report compulsory reporting fixes. Other aircraft report 100 NM from Nimitz VORTAC. Where other island destinations within the Oakland FIR are not more than one-degree latitude-longitude from a 5 degrees fixed line reporting point, the ETA and arrival report may be substituted in lieu of the adjacent fixed line report.

2. To the east of the Hawaiian Islands it will not be necessary to report the 155 degree west position if position will be reported at the entry/exit fixes on the Honolulu Domestic/Oceanic boundary. To the west of Honolulu 160-degree west need not be reported.

**G. POSITION REPORTS OVER OAKLAND OCEANIC FIR/CTA BOUNDARIES**

1. Aircraft entering the Oakland FIR/CTA are requested to forward boundary position reports via ARINC or CPDLC as follows:

- a. Boundary fixes that are compulsory reporting points.
- b. Filed fixes when they coincide with the FIR Boundary.
- c. The boundary between the Manila, Ujung Pandang, Biak, Port Moresby and Nauru FIR's and the Oakland FIR.
- d. The Open Area Uncontrolled Airspace west of Mazatlan ACC and the Oakland FIR along 120 west longitude.
- e. Outbound from the Guam CERAP area at the 250 NM ARC from the UNZ VORTAC.
- f. Outbound from the Kwajalein (Bucholz Tower) Area at the 180 NM ARC from the NDJ TACAN.
- g. Eastbound PACOTS Flights should report only those fixes detailed in the published route.
- h. When requested by ATC.

2. Aircraft leaving the lateral limits of the Oakland FIR and entering uncontrolled airspace shall forward the time over the boundary outbound.

**SPECIAL PROCEDURES FOR IN-FLIGHT CONTINGENCIES IN OCEANIC AIRSPACE****A. INTRODUCTION**

1. Although all possible contingencies cannot be covered, these procedures provide for the more frequent cases such as:

(a) Inability to maintain assigned flight level due to meteorological conditions, aircraft performance or pressurization failure;

(b) En route diversion across the prevailing traffic flow; and

(c) Loss of, or significant reduction in, the required navigation capability when operating in airspace where the navigation performance accuracy is a prerequisite to the safe conduct of flight operations.

2. These procedures are applicable primarily when rapid descent and/or turn-back or diversion is required. The pilot's judgment shall determine the sequence of actions to be taken, having regard to the prevailing circumstances. Air traffic control shall render all possible assistance.

**B. GENERAL PROCEDURES**

1. If an aircraft is unable to continue the flight in accordance with its ATC clearance, and/or an aircraft is unable to maintain the navigation performance accuracy specified for the airspace, a revised clearance shall be obtained, whenever possible, prior to initiating any action.

2. The radiotelephony distress signal (MAYDAY) or urgency signal (PAN PAN) preferably spoken three times shall be used as appropriate. Subsequent ATC action with respect to that aircraft shall be based on the intentions of the pilot and the overall air traffic situation.

3. If prior clearance cannot be obtained, an ATC clearance shall be obtained at the earliest possible time and, until a revised clearance is received, the pilot shall:

(a) Leave the assigned route or track by initially turning \*90 degrees to the right or to the left. When possible, the direction of the turn should be determined by the position of the aircraft relative to any organized route or track system. Other factors which may affect the direction of the turn are:

- (1) The direction to an alternate airport, terrain clearance;
- (2) Any lateral offset being flown, and the flight levels allocated on adjacent routes or tracks.

\*FAA EXPLANATORY NOTE: a turn of less than or greater than 90 degrees may be required, depending on the type of contingency and whether the pilot intends to continue in the same direction or reverse course.

(b) Following the turn, the pilot should:

- (1) If unable to maintain the assigned flight level, initially minimize the rate of descent to the extent that is operationally feasible;
- (2) Take account of other aircraft being laterally offset from its track;
- (3) Acquire and maintain in either direction a track laterally separated by 28 km (15 NM) from the assigned route; and
- (4) Once established on the offset track, climb or descend to select a flight level which differs from those normally used by 150 m (500 ft);
- (c) Establish communications with and alert nearby aircraft by broadcasting, at suitable intervals: aircraft identification, flight level, position (including the ATS route designator or the track code, as appropriate) and intentions on the frequency in use and on 121.5 MHz (or, as back-up, on the inter-pilot air-to-air frequency 123.45 MHz);
- (d) Maintain a watch for conflicting traffic both visually and by reference to ACAS (TCAS) (if equipped);
- (e) Turn on all aircraft exterior lights (commensurate with appropriate operating limitations);
- (f) Keep the SSR transponder on at all times; and
- (g) Take action as necessary to ensure the safety of the aircraft.

4. When leaving the assigned track to acquire and maintain the track laterally separated by 28 km (15 NM), the flight crew, should, *where practicable*, avoid overshooting the track to be acquired, particularly in airspace where a 55.5 km (30 NM) lateral separation minimum is applied.

#### 5. EXTENDED RANGE OPERATIONS (ETOPS) BY AIRCRAFT WITH TWO-TURBINE POWER-UNITS

If the contingency procedures are employed by a twin-engine aircraft as a result of an engine shutdown or failure of an ETOPS critical system, the pilot should advise ATC as soon as practicable of the situation, reminding ATC of the type of aircraft involved, and request expeditious handling.

#### Weather Deviation Procedures For Oceanic-Controlled Airspace

##### General

1. The following procedures are intended to provide guidance. All possible circumstances cannot be covered. The pilot's judgment shall ultimately determine the sequence of actions taken and ATC shall render all possible assistance.
2. If the aircraft is required to deviate from track to avoid weather and prior clearance cannot be obtained, an air traffic control clearance shall be obtained at the earliest possible time. In the meantime, the aircraft shall follow the procedures detailed in paragraph g.8 below.
3. The pilot shall advise ATC when weather deviation is no longer required, or when a weather deviation has been completed and the aircraft has returned to the centerline of its cleared route.

##### Obtaining Priority From ATC When Weather Deviation Is Required

1. When the pilot initiates communications with ATC, rapid response may be obtained by stating "WEATHER DEVIATION REQUIRED" to indicate that priority is desired on the frequency and for ATC response.
2. The pilot still retains the option of initiating the communications using the urgency call "PAN PAN PAN" (*preferably spoken three times*) to alert all listening parties to a special handling condition which will receive ATC priority for issuance of a clearance or assistance.



**Actions To Be Taken When Controller–Pilot Communications Are Established**

1. The pilot notifies ATC and requests clearance to deviate from track, advising, when possible, the extent of the deviation expected. ATC will take one of the following actions:
  - (a) If there is no conflicting traffic in the horizontal dimension, ATC will issue clearance to deviate from track, or
  - (b) If there is conflicting traffic in the horizontal dimension, ATC will separate aircraft by establishing vertical separation, or
  - (c) If there is conflicting traffic in the horizontal dimension and ATC is unable to establish vertical separation, ATC shall:
    - (1) Advise the pilot unable to issue clearance for requested deviation.
    - (2) Advise pilot of conflicting traffic.
    - (3) Request pilot's intentions.

**PHRASEOLOGY—**

*“Unable (requested deviation), traffic is (call sign, position, altitude, direction), advise intentions.”*

1. The pilot will take the following actions:
  - (a) Advise ATC of intentions by the most expeditious means available.
  - (b) Comply with air traffic control clearance issued, or
  - (c) Execute the procedures detailed in para 8(a) below. (ATC will issue essential traffic information to all affected aircraft.)
  - (d) If necessary, establish voice communications with ATC to expedite dialogue on the situation.

**Actions To Be Taken If a Revised Air Traffic Control Clearance Cannot Be Obtained:**

1. The pilot shall take the actions listed below under the provision that the pilot may deviate from rules of the air (e.g., the requirement to operate on route or track centerline unless otherwise directed by ATC), when it is absolutely necessary in the interests of safety to do so.
  - (a) If a revised air traffic control clearance cannot be obtained and deviation from track is required to avoid weather, the pilot shall take the following actions:
    - (1) If possible, deviate away from an organized track or route system.

Route center line track	Deviations >10 NM	Level change
EAST (000–179 magnetic)	LEFT RIGHT	DESCENT 300 ft CLIMB 300 ft
WEST (180–359 magnetic)	LEFT RIGHT	CLIMB 300 ft DESCEND 300 ft

**NOTE—**

*Subparagraphs 8(a)(2) and 8(a)(3) below call for the pilot to: broadcast aircraft position and pilot's intentions, identify conflicting traffic and communicate air-to-air with near-by aircraft. If the pilot determines that there is another aircraft at or near the same FL with which his aircraft might conflict, then the pilot is expected to adjust the path of the aircraft, as necessary, to avoid conflict.*

- (2) Establish communications with and alert nearby aircraft by broadcasting, at suitable intervals: flight identification, flight level, aircraft position (including the ATS route designator or the track code), and intentions (including the magnitude of the deviation expected) on the frequency in use, as well as on frequency 121.5 MHz (or, as a back-up, the VHF inter-pilot air-to-air frequency 123.45).
- (3) Watch for conflicting traffic both visually and by reference to ACAS (if equipped).
- (4) Turn on all aircraft exterior lights (commensurate with appropriate operating limitations).
- (5) For deviations of less than 10 NM, aircraft should remain at the level assigned by ATC.
- (6) For deviations of greater than 10 NM, when the aircraft is approximately 10 NM from track initiate a level change based on the criteria in the table below.
- (7) If contact was not established prior to deviating, continue to attempt to contact ATC to obtain a clearance. If contact was established, continue to keep ATC advised of intentions and obtain essential traffic information.
- (8) When returning to track, be at its assigned flight level, when the aircraft is within approximately 10 NM of centerline.

**STRATEGIC LATERAL OFFSETS IN OCEANIC AIRSPACE TO MITIGATE WAKE TURBULENCE AND TO MITIGATE COLLISION RISK**

1. Pilots should use the Strategic Lateral Offset Procedure as standard operating practice in the course of normal oceanic operations to mitigate collision risk and wake turbulence. The Strategic Lateral Offset Procedure will be applied throughout the Oakland and Anchorage oceanic FIRs. This procedure is to be used for **both** wake vortex encounters, and to mitigate the heightened risk of collision when non-normal events such as operational altitude deviation errors and turbulence induced altitude deviations occur.

2. Strategic Lateral Offset Procedures will be applied using the following guidelines:

(a) Strategic lateral offsets executed to mitigate collision risk and those executed to mitigate the effects of wake turbulence are to be made to the **right** of a route or track;

(b) In relation to a route or track, there are three positions that an aircraft may fly: centerline, 1 NM or 2 NM **right**; and,

(c) Offsets are not to exceed 2 NM **right** of centerline.

3. The intent of this procedure is to reduce risk (increase the safety margin) by distributing aircraft laterally and equally across the three available positions. In this connection, pilots must take account of the following:

(a) Aircraft without automatic offset programming capability **must** fly the centerline;

(b) Aircraft capable of being programmed with automatic offsets may fly the centerline or offset 1 NM or 2 NM **right** of centerline to obtain lateral spacing from nearby aircraft;

(c) Pilots should use whatever means are available (e.g. communications, visual acquisition, GPWS or TCAS/ACAS) to determine the best flight path to fly;

(d) Any aircraft overtaking another aircraft is to offset within the confines of this procedure, if capable, so as to create the least amount of wake turbulence for the aircraft being overtaken;

(e) For wake turbulence purposes, pilots are also to fly one of the three positions at 2b above and never offset to the left of centerline nor offset more than 2 NM **right** of centerline;

**NOTE.** *It is recognized that the pilot will use his/her judgment to determine the action most appropriate to any given situation and has the final authority and responsibility for the safe operation of the aeroplane. The use of air-to-air channel, 123.45, may be used to co-ordinate the best wake turbulence offset option.*

(f) Pilots may apply an offset outbound at the oceanic entry point but must return to centerline at the oceanic exit point.

(g) Aircraft transiting radar-controlled airspace (e.g. Guam or Vancouver Center) may remain on their established offset positions but must advise the radar controller on initial contact of their offset status;

(h) There is no ATC clearance required for this procedure and, except as stated in paragraph (g), above it is not necessary that ATC be advised; and,

(i) Voice position reports are to be based on the current ATC route/course clearance and not the exact co-ordinates of the offset position.

**CLIMB TIMES/CHANGE OF FLIGHT LEVEL  
OAKLAND OCEANIC FIR****CLIMB TIMES**

A distinction should be made between the time at which higher flight level is requested and the time at which the next higher flight level can be accepted.

**CHANGE OF FLIGHT LEVEL**

Pilots are advised that when an aircraft is proceeding from one Oceanic Control Area to another at the time that a change of flight level is desired, coordination must be effected between the Oceanic Control Centers concerned before an ATC clearance can be issued. A flight level request shown on a filed flight plan does not constitute authority for an aircraft to change flight level; a specific ATC clearance for the flight level change is required.

## VFR ADVISORY INFORMATION

VFR advisory information is provided by numerous radar and nonradar approach control facilities to those pilots intending to land at an airport served by an approach control tower. This information includes wind, runway, traffic, and NOTAM information. Such information will be furnished upon initial contact with concerned approach control facility. The pilot will be requested to change to the tower frequency at a pre-determined time or point to receive further landing information. Where available, use of this procedure will not hinder the operation of VFR flights by requiring excessive spacing between aircraft or circuitous routing. Radio contact points will be based on time or distance rather than on landmarks. Compliance with this procedure is not mandatory but pilot participation is encouraged.

**RADAR TRAFFIC INFORMATION SERVICE** – When VFR advisory information is provided by appropriate control facilities, pilots are advised of information on any aircraft observed on the radar scope which, in the judgement of the controller, appears to constitute a potential conflict to the operation of their aircraft.

a. Purpose of the Service–Radar traffic information service is not intended to relieve the pilot of his responsibility for continual vigilance to see and avoid other aircraft. It is provided to aid the pilot in visual surveillance by calling to his attention a specific direction in which radar indicates possible conflicting traffic to exist. Pilots are reminded that the surveillance radar used by ATC does not provide altitude information unless the aircraft is equipped with Mode C and the radar facility is capable of displaying flight level information.

b. Provision of the Service–The provision of this service is not mandatory. Many factors (such as limitations of radar, volume of traffic, controller workload and communication frequency congestion) could prevent controllers from providing this service. The controller possesses complete discretion for determining whether he is able to provide or continue to provide this service in a specific case. His reason against providing or continuing to provide the service in a particular case is not subject to question and need not be communicated to the pilot. In other words, the provision of this service is entirely dependent upon whether the controller believes he is in a position to provide it. Subject to the foregoing limitations;

(1) Traffic information is routinely provided to all aircraft operating on IFR flight plans except when the pilot advises he does not desire the service.

(2) Traffic information may be provided for flights not operating on IFR flight plans when requested by pilots of such flights.

NOTE: Participation by VFR pilots in formal programs at certain terminal locations constitutes pilot request. This also applies to participating pilots at locations where arriving VFR flights are encouraged to make their first contact with the tower on approach control frequency.

c. Issuance of Traffic Information – Traffic information will include the following concerning the “target” constituting traffic:

1. Azimuth from the aircraft, in terms of the twelve hour clock;
2. Distance from the aircraft in nautical miles; and
3. Direction in which the “target” is proceeding.

EXAMPLE: “Traffic 10 o'clock, 3 miles, westbound.”

The pilot may, upon receipt of traffic information, request a vector (heading) to avoid such traffic. The vector will be provided to the extent possible as determined by the controller.

**TERMINAL RADAR SERVICE AREAS (TRSA)**

Services provided in a TRSA include:

1. Radar vectoring and sequencing on a full time basis for all IFR and VFR aircraft landing at the primary airport.
2. Separation of all participating IFR/VFR aircraft operating in the Terminal Radar Service Area.
3. Radar advisories on all unidentified aircraft are provided on a workload permitting basis. Service provided in a TRSA is also called Stage III service.

**Flight Procedures**

1. IFR FLIGHTS – Aircraft operating within a TRSA shall be operated in accordance with current IFR procedures.
2. VFR FLIGHTS
  - a. Airports within a TRSA:
    - (1) Arriving aircraft landing at airports within a TRSA are expected to contact Approach Control on specified frequencies in relation to geographical fixes depicted on TRSA charts.
    - (2) Departing aircraft will be advised by the tower when to contact Departure Control and given the frequency to be used.
  - b. Airports underlying a TRSA:

Unless the flight will be conducted below the floor of the TRSA, arriving aircraft are expected to contact Approach Control on specified frequencies in relation to geographical fixes listed on individual TRSA charts.
  - c. Transiting aircraft:

Aircraft desiring to transit a TRSA are expected to contact Departure/Approach Control on the specified frequencies and in relation to geographical fixes listed on individual TRSA charts.
  - d. Frequencies:

Aircraft not equipped for two way communication on the listed frequencies should transmit on simplex frequencies and listen on the appropriate frequencies specified on individual TRSA charts.

**ATC Procedures**

1. A TRSA is primarily a radar environment and control will be predicated thereon. This does not preclude application of nonradar separation as required or deemed appropriate.
2. To facilitate radar identification of arriving and transiting VFR aircraft, ATC may request such aircraft to report their position in relation to fixes (prominent geographical or radio) within or outside the perimeter of the TRSA.
3. Radar headings and, if required, altitude assignments may be given to VFR flights operating within the TRSA.

NOTE: Assignment of radar headings and/or altitudes are based on the provision that a pilot operating in accordance with VFR is expected to advise ATC if compliance with an assigned route, radar heading or altitude will cause the pilot to violate applicable rules.
4. Traffic information on observed but unidentified radar targets will be provided on a workload permitting basis.
5. When VFR aircraft are being held within a TRSA and control is based thereon, the ATC clearance will specify the distance (radius) and, if appropriate, the direction from the geographical fix within which holding is to be accomplished. In such case, the pilot will be advised when to EXPECT FURTHER CLEARANCE.
6. During weather conditions equal to or better than basic VFR, 500 feet vertical separation may be employed between VFR flights and/or between VFR and IFR flights operating within a TRSA.
7. During weather conditions equal to or better than basic VFR, visual separation may be employed between VFR flights and/or between VFR and IFR flights operating within a TRSA when a pilot reports the other aircraft in sight and advises that he can maintain his own separation from such aircraft.
8. When IFR flights operating in VFR weather conditions are being sequenced with other traffic, and the pilot reports the aircraft he is to follow is in sight, the pilot may be advised to follow such traffic and may be cleared for a "visual approach".

For additional information see AIM, Basic Flight Information and ATC procedures – Terminal Radar Programs for VFR aircraft, Stage III Service.

## PROCEDURES

### CLASS C AIRSPACE

#### CLASS C Dimensions

A. CLASS C (a basic standard design with minor site specific variations). CLASS C airspace consists of two circles, both centered on the primary/CLASS C airport. The inner circle has a radius of 5NM. The outer circle has a radius of 10NM. The airspace of the inner circle extends from the surface of CLASS C airport up to 4,000 feet above the airport. The airspace area between the 5 and 10NM rings begins at a height 1,200 feet AGL and extends to the same altitude cap as the inner circle.

B. OUTER AREA. The normal radius will be 20NM with some variations based on site specific requirements. The outer area extends outward from the primary/CLASS C airport and extends from the lower limits of radar/radio coverage up to the ceiling of the approach control's delegated airspace, excluding CLASS C and other airspace as appropriate.

#### CLASS C is Regulatory Airspace

##### ARRIVALS AND OVERFLIGHTS:

Two-way radio communications must be established with ATC facility having jurisdiction over CLASS C airspace prior to entry and thereafter as instructed by ATC.

##### DEPARTURES:

(a) Primary or Satellite Airport with an operating control tower: Two-way radio communications must be established and maintained with the control tower in accordance with Federal Aviation Regulations (FAR) 91.129 and thereafter as instructed by ATC.

(b) Satellite Airports without an operating control tower: Two-way radio communications must be established as soon as practicable after departing with the ATC facility having jurisdiction over CLASS C and thereafter as instructed by ATC.

##### ATC SERVICES WITHIN CLASS C AIRSPACE:

- (a) Sequencing of all arriving aircraft to the primary/CLASS C airport.
- (b) Standard IFR separation between IFR aircraft.
- (c) Between IFR and VFR aircraft—traffic advisories and conflict resolution so that radar targets do not touch, or 500 feet vertical separation.
- (d) Between VFR aircraft—traffic advisories and as appropriate, safety alerts.

##### CLASS C AIRSPACE REQUIREMENTS:

- Student pilot or better
- Two-way radio
- Mode C transponder

For additional information see the AIM/FARS.

### OPERATION IN PROXIMITY TO HEAVY JET AIRCRAFT

1. Recent tests indicate the previous precautionary measures regarding operation in proximity to B747/C5A aircraft were somewhat excessive as to the separation required and insufficient as to the scope of application.
2. The studies showed that "heavy jet", i.e. those capable of 300,000 pounds or more, generate greater wake turbulence, both on the ground and in the air.
3. Pilots should:
  - a. Review material in the AIM Part I and Advisory Circular 90-23 (as revised) pertaining to wake turbulence.
  - b. Avoid flight within five miles behind a heavy jet when operating at the same altitude or within less than 1,000 feet below.
  - c. Use extreme caution when taxiing behind a heavy jet. Static test data indicate that the area of concern is within 750 feet behind the tail of the heavy jet aircraft.
  - d. When operating in the same environment as a heavy jet and being provided radar sequencing/vectors, pilots can expect to be vectored at least five miles behind the heavy jet. Pilots not being provided radar sequencing/vectors are expected to maintain adequate spacing to ensure that wake turbulence problems are not encountered.
4. Additionally, test data indicate potential wake turbulence problems may exist when parallel runways separated by less than 2,500 feet are being used by any four engine jet aircraft. Pilots should be aware that under crosswind conditions, the wake turbulence created by these operations on one runway may drift across and affect operations on the other runway. Pilots should exercise caution when such conditions exist.

Aircraft in the aviation fleet currently defined as "Heavy Jets" include:

Concorde	E3	L62	MD11
EA30	EC137	IL76	
EA32	B52	C5	
B707-300/400	B1	C141	
B747-100/200/300/400	KC135R	L1011	
B747SP	BA10/VC10	DC10	
B767	Vulcan	DC85	

### ESCAT PROCEDURES

(Emergency Security Control of Air Traffic)

The ESCAT Plan contains responsibilities of military authorities, Federal Aviation Administration, and Federal Communications Commission in regard to actions to be taken for security control of air traffic and air navigation aids in defense of the United States during defense emergencies. The ESCAT Plan provides that, in the defense of the United States during defense emergencies, the military will direct actions to be taken in regard to landing, grounding, diversion or dispersal of aircraft, and in regard to the control of air navigation aids.

At the time that ESCAT is implemented, ATC facilities will broadcast instructions received from the military over available ATC frequencies. Depending on instructions received from the military, VFR flights may be directed to land at the nearest available airport; IFR flights will be expected to proceed as directed by ATC. Pilots on the ground may be required to file a flight plan and obtain approval (through FAA) before conducting flight operations.

In view of the above, all pilots should guard an ATC or Flight Service Station frequency at all times while conducting flight operations.

## NATIONAL SECURITY

### General

- a. National security in the control of air traffic is governed by Title 14 of the U.S. Code of Federal Regulations, Part 99.
- b. All aircraft entering domestic U.S. airspace from points outside must provide for identification prior to entry. To facilitate early aircraft identification of all aircraft in the vicinity of U.S.–International airspace boundaries, Air Defense Identification Zones (ADIZ) have been established. (See Figures 1–4–1, 1–4–2, 1–4–3, and 1–4–4.)
- c. Operational requirement for aircraft entering or flying within the ADIZ areas are as follows:
  1. Flight plan requirements. Except as specified in subparagraphs d and e, an instrument flight rules (IFR) or defense visual flight rules (DVFR) flight plan must be on file with the appropriate aeronautical facility as follows:
    - (a) Generally, for all operations that enter an ADIZ.
    - (b) For operations that will enter or exit the United States and which will operate into, within, or across the contiguous U.S. ADIZ, regardless of true airspeed.
    - (c) The flight plan must be filed before departure except for operations associated with the Alaska ADIZ when the airport of departure has no facility for filing a flight plan; in which case, the flight plan may be filed immediately after takeoff or when within range of the aeronautical facility.
  2. Two–way radio requirements. For the majority of operations associated with an ADIZ, an operating two–way radio is required. See 14 CFR Part 99.1 for exceptions.
  3. Transponder requirements. Unless otherwise authorized by ATC, each aircraft conducting operations into, within, or across the Contiguous U.S. ADIZ must be equipped with an operable radar beacon transponder having altitude reporting capability (Mode C), and that transponder must be turned on and set to reply on the appropriate code or as assigned by ATC.
  4. Position reporting requirements.
    - (a) For IFR flight, normal IFR position reporting.
    - (b) For DVFR flights, the estimated time of ADIZ penetration must be filed with the aeronautical facility at least 15 minutes prior to penetration except for flight in the Alaskan ADIZ; in which case, report prior to penetration.
    - (c) For inbound aircraft of foreign registry, the pilot must report to the aeronautical facility at least 1 hour prior to ADIZ penetration.
  5. Aircraft position tolerances:
    - (a) Over land, the tolerance is within plus or minus 5 minutes from the estimated time over a reporting point or point of penetration and within 10 NM from the centerline of an intended track over an estimated reporting point or penetration point.
    - (b) Over water, the tolerance is plus or minus 5 minutes from the estimated time over a reporting point or point of penetration and within 20 NM from the centerline of the intended track over an estimated reporting point or point of penetration (to include the Aleutian Islands).
  - d. Except when applicable under 14 CFR 99.7, Part 99 does not apply to aircraft operations.
    1. Within the 48 contiguous states and the District of Columbia, or within the State of Alaska, and remains within 10 NM of the point of departure.
    2. Over any island, or within 3 NM of the coastline of any island, in the Hawaii ADIZ.
    3. Associated with any ADIZ other than the contiguous U.S. ADIZ, when the aircraft is operating at true airspeed of less than 180 knots.
  - e. Authorizations to deviate from the requirements of Part 99 may also be granted by an Air Route Traffic Control Center (ARTCC), on a local basis, for some operations associated with an ADIZ.
  - f. A VFR flight plan makes an aircraft subject to interception for positive identification when entering an ADIZ. Pilots are urged to file the required Defense VFR (DVFR) flight plan either in person or by telephone prior to departure.

### Special Security Instructions

- a. During a defense emergency or air defense emergency conditions, additional special security instructions may be issued in accordance with the Security Control of Air Traffic and Air Navigation Aids (SCATANA) Plan.
- b. Under the provisions of the SCATANA Plan, the military will direct the action to be taken in regard to landing, grounding, diversion, or dispersal of aircraft and the control of air navigation aids in the defense of the United States during emergency conditions.
- c. At the time a portion or all of SCATANA is implemented, ATC facilities will broadcast appropriate instructions received from the military over available ATC frequencies. Depending on instructions received from the military, VFR flights may be directed to land at the nearest available airport, and IFR flights will be expected to proceed as directed by ATC.
- d. Pilots on the ground may be required to file a flight plan and obtain an approval (through FAA) prior to conducting flight operation.
- e. In view of the above, all pilots should guard an ATC or FSS frequency at all times while conducting flight operations.







Fig 1-4-3. Guam Air Defense Identification Zone and Defense Area

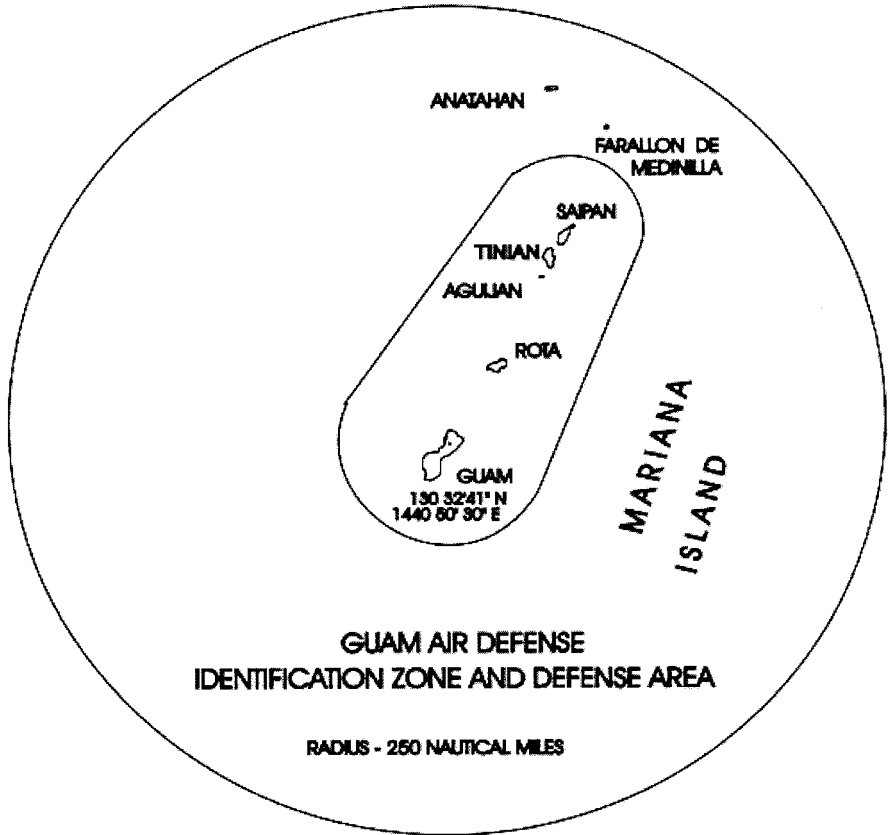
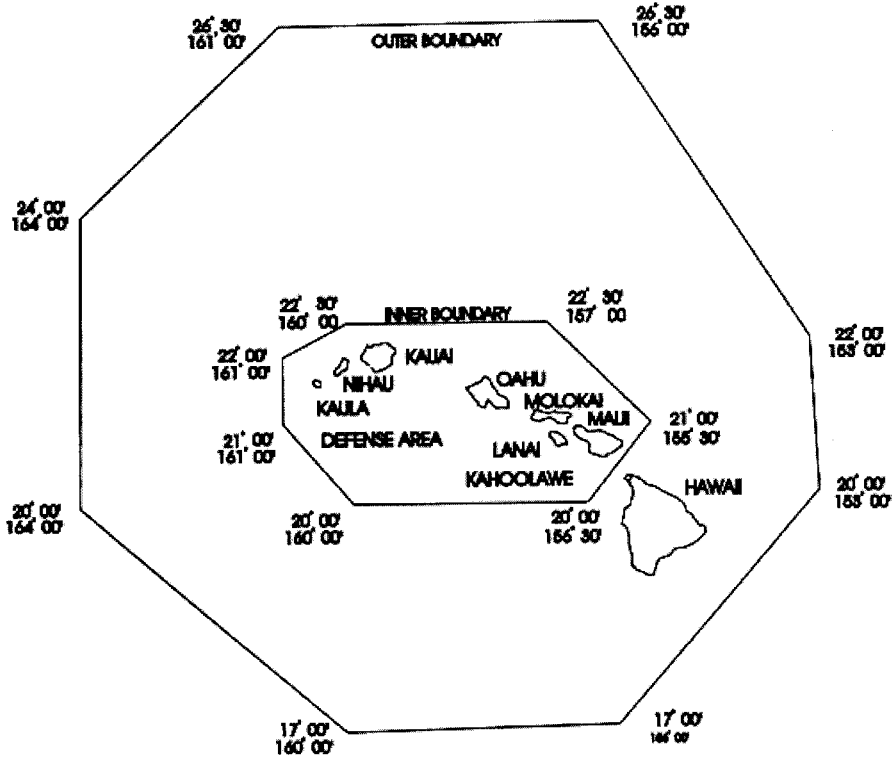

Fig 1-4-4. Hawaiian Air Defense Identification Zone and Defense Area



## EMERGENCY PROCEDURES

### INTERCEPTION SIGNALS

### ICAO STANDARD

SIGNALS INITIATED BY INTERCEPTING AIRCRAFT AND  
RESPONSES BY INTERCEPTED AIRCRAFT

SERIES	INTERCEPTING AIRCRAFT SIGNALS	MEANING	INTERCEPTED AIRCRAFT RESPONSE	MEANING
1	<p><b>AIRPLANES:</b> DAY—Rocking wings from a position slightly above and ahead of, and normally to the left of, the intercepted aircraft and, after acknowledgement, a slow level turn, normally to the left, on to the desired heading.</p> <p>NIGHT—Same and, in addition, flashing navigational lights at irregular intervals.</p> <p>NOTE 1.—Meteorological conditions or terrain may require the intercepting aircraft to take up a position slightly above and ahead of, and to the right of, the intercepted aircraft and to make the subsequent turn to the right.</p> <p>NOTE 2.—If the intercepted aircraft is not able to keep pace with the intercepting aircraft, the latter is expected to fly a series of race-track patterns and to rock its wings each time it passes the intercepted aircraft.</p>	<p>You have been intercepted. Follow me.</p>	<p><b>AIRPLANES:</b> DAY—Rocking wings and following.</p> <p>NIGHT—Same and, in addition, flashing navigational lights at irregular intervals.</p> <p><b>HELICOPTERS:</b> DAY or NIGHT—Rocking aircraft, flashing navigational lights at irregular intervals and following.</p>	<p>Understood, will comply.</p>
2	<p>DAY OR NIGHT—An abrupt breakaway maneuver from the intercepted aircraft consisting of a climbing turn of 90 degrees or more without crossing the line of flight of the intercepted aircraft.</p>	<p>You may proceed.</p>	<p><b>AIRPLANES:</b> DAY or NIGHT—Rocking wings.</p> <p><b>HELICOPTERS:</b> DAY or NIGHT—Rocking aircraft.</p>	<p>Understood, will comply.</p>
3	<p>DAY—Circling aerodrome, lowering landing gear and overflying runway in direction of landing or, if the intercepted aircraft is a helicopter, overflying the helicopter landing area.</p> <p>NIGHT—Same and, in addition, showing steady landing lights.</p>	<p>Land at this aerodrome.</p>	<p><b>AIRPLANES:</b> DAY—Lowering landing gear, following the intercepting aircraft and, if after overflying the runway landing is considered safe, proceeding to land.</p> <p>NIGHT—Same and, in addition, showing steady landing lights (if carried).</p> <p><b>HELICOPTERS:</b> DAY or NIGHT—Following the intercepting aircraft and proceeding to land, showing a steady landing light (if carried).</p>	<p>Understood, will comply.</p>

INTERCEPTION SIGNALS  
ICAO STANDARD

SIGNALS INITIATED BY INTERCEPTING AIRCRAFT AND  
RESPONSES BY INTERCEPTED AIRCRAFT

SERIES	INTERCEPTING AIRCRAFT SIGNALS	MEANING	INTERCEPTED AIRCRAFT RESPONSE	MEANING
4	AIRPLANES: DAY—Raising landing gear while passing over landing runway at a height exceeding 300m (1,000 ft) but not exceeding 600m (2,000 ft) above the aerodrome level, and continuing to circle the aerodrome.	Aerodrome you have designated is inadequate.	DAY OR NIGHT—If it is desired that the intercepted aircraft follow the intercepting aircraft to an alternate aerodrome, the intercepting aircraft raises its landing gear and uses the Series 1 signals prescribed for intercepting aircraft.	Understood, follow me
	NIGHT—Flashing landing lights while passing over landing runway at a height exceeding 300m (1,000 ft) but not exceeding 600m (2,000 ft) above the aerodrome level, and continuing to circle the aerodrome. If unable to flash landing lights, flash any other lights available.		If it is decided to release the intercepted aircraft, the intercepting aircraft uses the Series 2 signals prescribed for intercepting aircraft.	
5	AIRPLANES: DAY or NIGHT—Regular switching on and off of all available lights but in such a manner as to be distinct from flashing lights.	Cannot comply.	DAY or NIGHT—Use Series 2 signals prescribed for intercepting aircraft.	Understood.
6	AIRPLANES: DAY or NIGHT—Irregular flashing of all available lights.	In distress.	DAY or NIGHT—Use Series 2 signals prescribed for intercepting aircraft.	Understood.
	HELICOPTERS: Day or Night—Irregular flashing of all available lights.			

DISTRESS INTERCEPTION SIGNALS

SIGNAL BY INTERCEPTED AIRCRAFT	MEANING	RESPONSE BY INTERCEPTOR
DAY—Porpoising NIGHT—Switching on landing lights and holding steady beam.	In Distress	DAY OR NIGHT—Use appropriate interception signals as shown above.

**NOTE TO INTERCEPTION SIGNALS**  
(See preceding page)

The word "interception" in this context does not include intercept and escort service provided, on request, to an aircraft in distress.

An aircraft which is intercepted by another aircraft shall immediately:

- a. follow the instructions given by the intercepting aircraft, interpreting and responding to visual signals on preceding page;
- b. notify, if possible, the appropriate air traffic services unit;
- c. attempt to establish radio communication with the intercepting aircraft or with the appropriate intercept control unit, by making a general call on the emergency frequency 243.0, MHz and repeating this call on the emergency frequency 121.5 MHz, if practicable, giving the identity and position of the aircraft and the nature of the flight;
- d. if equipped with SSR transponder select Mode 3/A Code 7700, unless otherwise instructed by the appropriate air traffic services unit.

If any instructions received by radio from any sources conflict with those given by the intercepting aircraft by visual or radio signals, the intercepted aircraft shall request immediate clarification while continuing to comply with the instructions given by the intercepting aircraft.

## SEARCH AND RESCUE

**National Search and Rescue Plan.**—Under the National Search and Rescue Plan, the U.S. Coast Guard is responsible for coordination of search and rescue for the Maritime Region, and the U.S. Air Force is responsible for coordination of search and rescue for the Inland Region. In order to carry out this responsibility, the Air Force and the Coast Guard have established Rescue Coordination Center to direct search and rescue activities within their regions. This service is available to all persons and property in distress, both civilian and military. Normally, for aircraft incidents, information will be passed to the Rescue Coordination Centers through the appropriate Air Route Traffic Control Center.

Search and Rescue is a life-saving service provided through the combined efforts of the FAA, Air Force, Coast Guard, State Board of Aeronautics, Aeronautic Commissions or other similar State agencies who are assisted by other organizations such as the Civil Air Patrol, Sheriffs Air Patrol, State Police, etc. It provides search, survival aid, and rescue of personnel of missing or crashed aircraft.

Prior to departure on every flight, local or otherwise, someone at the departure point should be advised of your destination and the route of flight if other than direct. Search efforts are often wasted and rescue is often delayed because of pilots who thoughtlessly take off without advising anyone where they are going.

All you need to remember to obtain this valuable protection is:

- (1) File a Flight Plan with a FAA Flight Service Station in person or by telephone or radio.
- (2) File an Arrival Report.

(3) If you land at a location other than intended destination, report the landing to the nearest FAA Flight Service Station.

**Close your Flight Plan.**—The control tower does not automatically close your VFR flight plan since many of the landing aircraft are not operating on flight plans. It remains the responsibility of a pilot who has filed a flight plan to close it. This will prevent a needless search. Remember, the lives of other pilots are sometimes sacrificed when searching for overdue pilots. For an emergency occurring in flight, send a distress message if possible by radio. The facility receiving your message will alert the rescue organization serving your area.

To assure survival and rescue in the event of a crash landing, the following advice is given:

(1) For flight over uninhabited land areas it is wise to take suitable survival equipment depending on type of climate and terrain.

(2) If forced landing occurs at sea, chances for survival are governed by degree of crew proficiency in emergency procedures and by effectiveness of water survival equipment.

(3) If it becomes necessary to ditch, distressed aircraft should make every effort to ditch near a surface vessel. If time permits, the position of the nearest vessel can be obtained from a Coast Rescue Coordination Center through the FAA facility.

(4) The rapidity of rescue on land or water will depend on how accurately your position may be determined. If flight plan has been followed and your position is on course, rescue should be prompt.

(5) Unless you have good reason to believe that you will not be located by search aircraft, it is better to remain near your aircraft and prepare means for signalling whenever aircraft approach your position.

Search and rescue facilities made available to all pilots include the following:

- (a) Rescue coordination centers;
- (b) Search and rescue aircraft;
- (c) Rescue vessels;
- (d) Pararescue and ground rescue teams;
- (e) Emergency radio fixing.

The Air Rescue Service and the U.S. Coast Guard extend a welcome invitation to all pilots to visit any of their rescue units. By so doing, pilots may become more familiar with the actual means whereby this vital phase of aviation safety is carried out. The location and address of your nearest rescue unit may be obtained from the FAA or any AF or CG Rescue Coordination Center.

Report of crashed or missing aircraft may be made by any individual by a telephone call to the nearest FAA facility or to any Air Force or Coast Guard facility.

**HONOLULU AND WAKE SEARCH AND RESCUE SECTORS:**

Search and Rescue Sector for Honolulu Area established with following coordinates:

From 5°S, 110°W to 40°N, 150°W to 40°N, 160 °W to 23°N, 169°W to 23°N, 177°W to 3°30'N, 180° to 5°S, 180° to 5°S, 110°W.

Search and Rescue Sector for Wake Area established with following coordinates:

27°N, 160°E to 27°N, 165°E to 23°N, 176° E to 23°N, 177°W to 3°30'N, 177°W to 3°30 'N, 160°E to 27°N, 160°E.

Rescue Coordination Center (RCC) at Honolulu has coordination responsibility in the Honolulu and Wake SAR Sectors. (Telephone in Honolulu 808-531-1112)

**MIDWAY SEARCH AND RESCUE SECTOR:**

Search and Rescue Sector for Midway Area established with following coordinates:

From 23°N, 169°W to 40°N, 160°W to 40°N, 165°E to 27°N, 165°E to 23°N, 176°E to 23°N, 169°W.

Rescue Coordination Center (RCC) at Midway has coordination responsibility in this area.

**GUAM SEARCH AND RESCUE SECTOR:**

Search and Rescue Sector for Guam area established with following coordinates:

From 3°30'N, 160°E to 27°N, 160°E to 27°N, 155°E to 21°N, 155°E to 21°N, 130°E to 6°N, 132°E to 3°30'N, 132°E to 3°30'N, 160°E.

Guam Joint Search and Rescue Coordination Center (JSARCC) at Guam has coordination responsibility in this area.

**COAST GUARD RESCUE COORDINATION CENTERS:** Coast Guard Rescue Coordination Centers are served by major radio stations which guard 500kHz (CW), 8364 kHz (CW), and 2182 kHz (Voice). In addition to these major radio stations, the 247 Coast Guard units along the sea coasts of the United States and shores to the Great Lakes guard 2182 kHz (Voice). All of these facilities are available for reporting distress or potential distress. THE CALL "NCU" (CW) or "COAST GUARD" (VOICE) ALERTS ALL COAST GUARD RADIO STATIONS WITHIN RANGE.

## EMERGENCY PROCEDURES

1. A pilot in any emergency phase (uncertainty, alert, or distress) should do three things to obtain assistance:

**a. If equipped with IFF, switch to "Emergency" position.**

**b.** Contact controlling agency and give nature of distress and pilots intentions.—If unable to contact controlling agencies attempt to contact any agency on assigned frequency or any of the following frequencies (transmit and receive):

Frequency	Emission	Effective Range in Nautical Miles	Guarded By
121.5 MHz	Voice	Generally limited to Radio line-of-sight	All military twrs, most civil twrs, VHF direction finding stns, radar facilities, flight service stns, ocean station vessels.
243.0 MHz	Voice	Generally limited to radio line-of-sight	All military twrs, most civil twrs, VHF direction finding stns, radar facilities, flight service stns, ocean station vessels.
2182 kHz	Voice	Generally less than 300 miles for average aircraft installations	Some ships and boats at sea, most Coast Guard stations, most commercial coast stations.
500 kHz	CW	Generally less than 100 miles for average aircraft installations.	Most large ships at sea, most Coast Guard radio stations, most commercial coast stations.
8364 kHz	CW	Up to several thousand miles, depending upon propagation conditions. Subject to "skip".	U.S.N. direction finding stations, ocean station vessels and most Coast Guard radio stations.

Transmit as much of the following as possible:

1. MAYDAY, MAYDAY, MAYDAY (if distress), or PAN, PAN, PAN (if uncertainty or alert). If CW transmission use SOS (distress) or XXX (uncertainty or alert).
2. Aircraft identification repeated three times.
3. Type of aircraft.
4. Position or estimated position (stating which).
5. Heading (True or Magnetic) (stating which).
6. True airspeed or estimated true airspeed (stating which).
7. Altitude.
8. Fuel remaining in hours and minutes.
9. Nature of distress.
10. Pilot's intentions (bailout, ditch, crash landing, etc.).
11. Assistance desired (fix, steer, bearing, escort, etc.).
12. Two 10-second dashes with mike (voice) or key (CW) followed by aircraft identification (once) OVER (Voice) or K (CW).

**c. Comply with instructions received.**—Accept the “communications control” offered to you by the ground radio station, silence interfering radio stations, and do not shift frequency or shift to another ground station unless absolutely necessary.

II. Pilots on IFR flights experiencing two-way radio failure are expected to adhere to prescribed procedures.

The pilot should remember that he has two means of declaring an emergency.

- (1) Emergency IFF and/or mode A/3 Code 7700.
- (2) Sending emergency message.

Ground stations have **three** electronic means of assisting:

- (1) Receipt of emergency message;
- (2) Radar detection of IFF signal; and
- (3) DF bearings.

**THE PILOT SHOULD REMEMBER THE FOUR C'S:**

**a. Confess** your predicament to any ground radio station. Do not wait too long. Give SAR a chance!

**b. Communicate** with your ground link and pass as much of the distress message on first transmission as possible.

We need information for best SAR action!

**c. Climb** if possible for better radar and DF detection. If flying at low altitude, the chance for establishing radio contact is improved by climbing, also chances of alerting radar systems are sometimes improved by climbing or descending.

NOTE.—Climbing or descending under IFR conditions within controlled air space is not permitted except in EMERGENCY. Air traffic control will operate on the assumption that the provisions of FAR 91.185 are being followed by the pilot.













**d. Comply—especially Comply—**with advices and instructions received, if you really want to help. Assist the ground “communications control” station to control communications on the distress frequency on which you are working (as that is the distress frequency for your case). Tell interfering stations to maintain silence until you call. Cooperate!

III. For bail-out, set radio for continuous emission. For ditching or crash landing, the radio equipment should if it is considered that there is no additional risk of fire and if circumstances permit, be set for continuous transmission.

When a pilot is in doubt of his position, or feels apprehensive for his safety, he should not hesitate to request assistance. Search and Rescue facilities, including Radar, Radio and DF stations, are ready and willing to help. There is no penalty for using them. Delay has caused crashes and cost lives. Take action!

## INTERNATIONAL GROUND/AIR EMERGENCY CODE

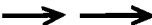
EMERGENCY SIGNALS  
GROUND-AIR VISUAL CODE FOR USE BY SURVIVORS

No.	MESSAGE	CODE SYMBOL
1	Require assistance	
2	Require medical assistance	
3	No or Negative	
4	Yes or Affirmative	
5	Proceeding in this direction	
If in doubt use International symbol		<b>S O S</b>
GROUND-AIR VISUAL CODE FOR USE BY GROUND SEARCH PARTIES		
NO	MESSAGE	CODE SYMBOL
1	Operation completed	
2	We have found all personnel	
3	We have found only some personnel	
4	We are not able to continue, Returning to base	
5	Have divided into two groups, Each proceeding in direction indicated.	
6	Information received that aircraft is in this direction	
7	Nothing found, Will continue search.	

**1. INSTRUCTIONS**

- a. Lay out symbols by using strips of fabric or parachutes, pieces of wood, stones, or any available material.
- b. Provide as much color contrast as possible between material used for symbols and background against which symbols are exposed.
- c. Symbols should be at least 10 feet high or larger. Care should be taken to lay out symbols exactly as shown.
- d. In addition to using symbols every effort is to be made to attract attention by means of radio, flares, smoke, or other available means.
- e. On snow-covered ground, signals can be made by dragging, shoveling or tramping. Depressed areas forming symbols will appear black from the air.
- f. Pilot should acknowledge message by rocking wings from side to side.



## TABLE OF CONTENTS

Inoperative Components	
Table. . . . .	AA1
Explanation of Terms/Landing Minima	
Format. . . . .	A1
Index of Terminal Charts	
and Minimums. . . . .	B1
IFR Take-off Minimums and	
Departure Procedures. . . . .	C1
Rate of Climb Table. . . . .	D1
IFR Alternate Airport Minimums. . . . .	E1
General Information	
and Abbreviations. . . . .	F1
Legend ---- IAP Planview. . . . .	G1
Legend ---- IAP Profile. . . . .	H1
Legend ---- DP and STAR Charts. . . . .	I1
Legend ---- Airport Diagram/Sketch. . . . .	K1
Legend ---- Approach Lighting Systems. . . . .	L1
MLS Channeling and Frequency	
Pairing. . . . .	M1
Radar Minimums. . . . .	N1
Land and Hold Short Operations (LAHSO). . .	O1
Hotspots. . . . .	P1
Standard Terminal Arrival Charts. . . . .	Z1
Terminal Charts. . . . .	Page 1
Rate of Descent Table. . . . .	Inside Back Cover

# INOP COMPONENTS

10098

## INOPERATIVE COMPONENTS OR VISUAL AIDS TABLE

Landing minimums published on instrument approach procedure charts are based upon full operation of all components and visual aids associated with the particular instrument approach chart being used. Higher minimums are required with inoperative components or visual aids as indicated below. If more than one component is inoperative, each minimum is raised to the highest minimum required by any single component that is inoperative. ILS glide slope inoperative minimums are published on the instrument approach charts as localizer minimums. This table may be amended by notes on the approach chart. Such notes apply only to the particular approach category(ies) as stated. See legend page for description of components indicated below.

### (1) ILS, MLS, PAR and RNAV (LPV line of minima)

Inoperative Component or Aid	Approach Category	Increase Visibility
ALSF 1 & 2, MALSR, & SSALR	ABCD	¼ mile

### (2) ILS with visibility minimum of 1,800 RVR

ALSF 1 & 2, MALSR, & SSALR	ABCD	To 4000 RVR
TDZL RCLS	ABCD	To 2400 RVR*
RVR	ABCD	To ½ mile

\*1800 RVR authorized with the use of FD or AP or HUD to DA.

### (3) VOR, VOR/DME, TACAN, LOC, LOC/DME, LDA, LDA/DME, SDF, SDF/DME, GPS, ASR and RNAV (LNAV/VNAV and LNAV line of minima)

Inoperative Visual Aid	Approach Category	Increase Visibility
ALSF 1 & 2, MALSR, & SSALR	ABCD	½ mile
SSALS, MALS, & ODALS	ABC	¼ mile

### (4) NDB

ALSF 1 & 2, MALSR, & SSALR	C	½ mile
MALS, SSALS, ODALS	ABD	¼ mile
	ABC	¼ mile

## CORRECTIONS, COMMENTS AND/OR PROCUREMENT

FOR CHARTING ERRORS,  
OR FOR CHANGES, ADDITIONS,  
RECOMMENDATIONS ON  
PROCEDURAL ASPECTS CONTACT:

FAA, National Aeronautical Navigation Services  
SSMC-4, Sta. #4259  
1305 East West Highway  
Silver Spring, MD 20910-3281  
Telephone 1-800-626-3677  
Email 9-AMC-Aerochart@faa.gov

FOR PROCUREMENT CONTACT:

FAA, National Aeronautical Navigation Services  
REDIS/Distribution Team  
10201 Good Luck Road  
Glenn Dale, MD 20769-9700  
Online at <http://aeronav.faa.gov>  
Email 9-AMC-Chartsales@faa.gov  
Telephone 1-800-638-8972  
Fax 301-436-6829  
or any authorized chart agent

Frequently asked questions (FAQ) are answered on our website at <http://aeronav.faa.gov>. See the FAQs prior to contact via toll free number or email.

Request for the creation or revisions to Airport Diagrams should be in accordance with FAA Order 7910.4.

# INOP COMPONENTS

09071

# TERMS/LANDING MINIMA DATA

## IFR LANDING MINIMA

The United States Standard for Terminal Instrument Procedures (TERPS) is the approved criteria for formulating instrument approach procedures. Landing minima are established for six aircraft approach categories (ABCDE and COPTER). In the absence of COPTER MINIMA, helicopters may use the CAT A minimums of other procedures. The standard format for RNAV minima and landing minima portrayal follows:

### RNAV (GPS) MINIMA

CATEGORY	A	B	C	D
LPV DA	1540/24 258 (300-½)			
LNAV/VNAV DA	1600/24	318 (400-½)	1600/40 318 (400-¾)	
LNAV MDA	1840/24	558 (600-½)	1840/50 558 (600-1)	1840/60 558 (600-1¼)
CIRCLING	1840-1	545 (600-1)	1840-1½ 545 (600-1½)	1860-2 565 (600-2)

NOTE: The **W** symbol indicates outages of the WAAS vertical guidance may occur daily at this location due to initial system limitations. WAAS NOTAMS for vertical outages are not provided for this approach. Use LNAV minima for flight planning at these locations, whether as a destination or alternate. For flight operations at these locations, when the WAAS avionics indicate that LNAV/VNAV or LPV service is available, then vertical guidance may be used to complete the approach using the displayed level of service. Should an outage occur during the procedure, reversion to LNAV minima may be required. As the WAAS coverage is expanded, the **W** will be removed.

RNAV minimums are dependent on navigation equipment capability, as stated in the applicable AFM, AFMS, or other FAA approved document, and as outlined below.

### GLS (Global Navigation Satellite System (GNSS) Landing System)

The GLS (NA) minima line will be removed from existing RNAV (GPS) approach charts when LPV minima is published.

### LPV (An Approach Procedure with Vertical Guidance (APV) based on WAAS lateral and vertical guidance)

Must have WAAS avionics approved for LPV approach.

### LNAV/VNAV (Lateral navigation/Vertical navigation)

Must have either:

- a.) WAAS avionics approved for LNAV/VNAV approach, or
- b.) A certified Baro-VNAV system with an IFR approach approved GPS, or
- c.) A certified Baro-VNAV system with an IFR approach approved WAAS, or
- d.) An approach certified RNP-0.3 system with barometric vertical guidance (Baro-VNAV).

Other RNAV systems require special approval.

NOTES:

1. LNAV-VNAV minima not applicable for Baro-VNAV equipment if chart is annotated "Baro-VNAV NA" or when below the minimum published temperature, e.g., Baro-VNAV NA below -17°C (2°F).
2. DME/DME based RNP-0.3 systems may be used only when a chart note indicates DME/DME availability; e.g., "DME/DME RNP-0.3 Authorized." Specific DME facilities may be required; e.g., "DME/DME RNP-0.3 Authorized. ABC, XYZ required."

### LNAV (Lateral navigation)

Must have IFR approach approved GPS, WAAS, or RNP-0.3 system. Other RNAV systems require special approval.

NOTE: DME/DME based RNP-0.3 systems may be used only when a chart note indicates DME/DME availability; e.g., "DME/DME RNP-0.3 Authorized." Specific DME facilities may be required; e.g., "DME/DME RNP-0.3 Authorized. ABC, XYZ required."

### LANDING MINIMA FORMAT

In this example airport elevation is 1179, and runway touchdown zone elevation is 1152.

CATEGORY	A	B	C	D
S-ILS 27	1352/24		200 (200-½)	
S-LOC 27	1440/24	288	(300-½)	1440/50 288 (300-1)
CIRCLING	1540-1 361 (400-1)	1640-1 461 (500-1)	1640-1½ 461 (500-1½)	1740-2 561 (600-2)

DA: DA (DA) (DA) (DA) (DA)  
 Visibility (RVR 100's of feet)  
 Aircraft Approach Category HAT/HATh  
 MDA: MDA (MDA) (MDA) (MDA) (MDA)  
 HAA: HAA (HAA) (HAA) (HAA) (HAA)  
 Visibility in Statute Miles

Straight-in ILS to Runway 27  
 Straight-in with Glide Slope Inoperative or not used to Runway 27  
 All weather minimums in parentheses not applicable to Civil Pilots. Military Pilots refer to appropriate regulations.

# TERMS/LANDING MINIMA DATA

09239

## TERMS/LANDING MINIMA DATA

## COPTER MINIMA ONLY

CATEGORY	COPTER		
H-176°	680-½	363	(400-½)

Copter Approach Direction

Height of MDA/DA  
Above Landing Area (HAL)

No circling minimums are provided

## RADAR MINIMA

	RWY	GS/TCH/RPI	CAT	DA/ MDA-VIS	HAT/ HATH/ HAA	CEIL-VIS	CAT	DA/ MDA-VIS	HAT/ HATH/ HAA	CEIL-VIS
PAR (c)	10	2.5°/42/1000	ABCDE	195/16	100	(100-¼)				
(d)	28	2.5°/48/1068	ABCDE	187/16	100	(100-¼)				
ASR	10		ABC	560/40	463	(500-¾)	D	560/50	463	(500-1)
			E	580/60	463	(500-1¼)				
	28		AB	600/50	513	(600-1)	C	600/60	513	(600-1¼)
			DE	600-1½	513	(600-1½)				
CIR (b)	10		AB	560-1¼	463	(500-1¼)	C	560-1½	463	(500-1½)
	28		AB	600-1¼	503	(600-1¼)	C	600-1½	503	(600-1½)
	10, 28		DE	660-2	563	(600-2)				

Visibility in Statute Miles

All minimums in parentheses not applicable to Civil  
Pilots. Military Pilots refer to appropriate regulations.

## Radar Minima:

1. Minima shown are the lowest permitted by established criteria. Pilots should consult applicable directives for their category of aircraft.
2. The circling MDA and weather minima to be used are those for the runway to which the final approach is flown- not the landing runway. In the above RADAR MINIMA example, a category C aircraft flying a radar approach to runway 10, circling to land on runway 28, must use an MDA of 560 feet with weather minima of 500-1½.

▲ Alternate Minimums not standard. Civil users refer to tabulation. USA/USN/USAF pilots refer to appropriate regulations.

▲ NA Alternate minimums are Not Authorized due to unmonitored facility or absence of weather reporting service.

▼ Take-off Minimums not standard and/or Departure Procedures are published. Refer to tabulation.

## AIRCRAFT APPROACH CATEGORIES

Aircraft approach category indicates a grouping of aircraft based on a speed of VREF, if specified, or if VREF not specified, 1.3 VSO at the maximum certificated landing weight. VREF, VSO, and the maximum certificated landing weight are those values as established for the aircraft by the certification authority of the country of registry. Helicopters are Category A aircraft. An aircraft shall fit in only one category. However, if it is necessary to operate at a speed in excess of the upper limit of the speed range for an aircraft's category, the minimums for the category for that speed shall be used. For example, an airplane which fits into Category B, but is circling to land at a speed of 145 knots, shall use the approach Category D minimums. As an additional example, a Category A airplane (or helicopter) which is operating at 130 knots on a straight-in approach shall use the approach Category C minimums. See following category limits:

## MANEUVERING TABLE

Approach Category	A	B	C	D	E
Speed (Knots)	0-90	91-120	121-140	141-165	Abv 165

## Comparable Values of RVR and Visibility

The following table shall be used for converting RVR to ground or flight visibility. For converting RVR values that fall between listed values, use the next higher RVR value; do not interpolate. For example, when converting 1800 RVR, use 2400 RVR with the resultant visibility of 1/2 mile.

RVR	Visibility (statute miles)	RVR (feet)	Visibility (statute miles)
1600	¼	4500	⅝
2400	½	5000	1
3200	⅝	6000	1¼
4000	¾		

## TERMS/LANDING MINIMA DATA

**INDEX**

10098

**INDEX OF TERMINAL CHARTS AND MINIMUMS**

NAME	PROC	SECT PG	NAME	PROC	SECT PG
<b>HENDERSON FIELD</b>			<b>GUAM, GQ</b>		
---SEE MIDWAY ATOLL, MQ			<b>GUAMINTL(GUM)</b>		
<b>BABELTHUAP, KOROR</b>			TAKE-OFF MINIMUMS .....	C	
<b>BABELTHUAP/KOROR(ROR)</b>			ALTERNATE MINIMUMS .....	E	
TAKE-OFF MINIMUMS .....	C		IAPS ..... ILS OR LOC RWY 6L .....	9	
ALTERNATE MINIMUMS .....	E		ILS OR LOC RWY 6R .....	10	
IAPS ..... RNAV (GPS) RWY 9 .....	1		RNAV (GPS) Y RWY 6L .....	11	
RNAV (GPS) RWY 27 .....	2		RNAV (GPS) Y RWY 6R .....	12	
NDB RWY 9 .....	3		RNAV (GPS) Y RWY 24L .....	13	
AIRPORT DIAGRAM .....	4		RNAV (GPS) Y RWY 24R .....	14	
<b>BABELTHUAP/KOROR</b>			RNAV (RNP) Z RWY 6L .....	15	
---SEE BABELTHUAP, KOROR, PS			RNAV (RNP) Z RWY 6R .....	16	
<b>CHUUK INTL</b>			RNAV (RNP) Z RWY 24L .....	17	
---SEE WENO ISLAND, FM			RNAV (RNP) Z RWY 24R .....	18	
<b>DALAP, RM</b>			VOR/DME OR TACAN RWY 6L .....	19	
<b>MARSHALL ISLANDS INTL(MAJ)</b>			TACAN RWY 24R .....	20	
TAKE-OFF MINIMUMS .....	C		VOR-A .....	21	
ALTERNATE MINIMUMS .....	E		NDB/DME RWY 24R .....	22	
IAPS ..... RNAV (GPS) RWY 7 .....	5		AIRPORT DIAGRAM .....	23	
RNAV (GPS) RWY 25 .....	6		<b>HANA, HI</b>		
NDB RWY 7 .....	7		<b>HANA(HNM)</b>		
NDB RWY 25 .....	8		TAKE-OFF MINIMUMS .....	C	
<b>FRANCISCO C. ADA/SAIPAN INTL</b>			IAPS ..... RNAV (GPS) RWY 26 .....	24	
---SEE SAIPAN, CQ			DPS ..... LINDBERG ONE (RNAV) (OBSTACLE) .....	25	
<b>GUAMINTL</b>			<b>HILO, HI</b>		
---SEE GUAM, GQ			<b>HILO INTL(ITO)</b>		
			TAKE-OFF MINIMUMS .....	C	
			ALTERNATE MINIMUMS .....	E	
			IAPS ..... ILS OR LOC RWY 26 .....	26	
			RNAV (GPS) RWY 21 .....	27	
			RNAV (GPS) RWY 26 .....	28	
			VOR/DME OR TACAN RWY 26 .....	29	
			VOR/DME OR TACAN-A .....	30	
			VOR-B .....	31	
			AIRPORT DIAGRAM .....	32	
			DPS ..... PARIS FOUR (OBSTACLE) .....	33	

**INDEX**

10098

## INDEX

10098

## INDEX OF TERMINAL CHARTS AND MINIMUMS

NAME	PROC	SECT PG	NAME	PROC	SECT PG
<b>HONOLULU, HI</b>			<b>KAILUA-KONA, HI</b>		
<b>HONOLULU INTL(HNL)</b>			<b>KONA INTL AT KEAHOLE(KOA)</b>		
TAKE-OFF MINIMUMS .....		C	TAKE-OFF MINIMUMS .....		C
ALTERNATE MINIMUMS .....		E	ALTERNATE MINIMUMS .....		E
STARS .. BOOKE EIGHT .....		Z1	STARS .. KAYAK FOUR .....		Z14
JULLE FOUR .....		Z3	VECKI SIX .....		Z10
MAGGI THREE .....		Z6	IAPS ..... ILS OR LOC/DME RWY 17 .....		72
OPACA FOUR .....		Z7	RNAV (GPS) RWY 17 .....		73
SAKKI FOUR .....		Z8	RNAV (GPS) Y RWY 35 .....		74
IAPS ..... ILS RWY 4R .....		35	RNAV (GPS) Z RWY 35 .....		75
ILSRWY 8L .....		36	LOC BC RWY 35 .....		76
RNAV (GPS) RWY 4L .....		37	VOR/DME OR TACAN RWY 17 .....		77
RNAV (GPS) RWY 8R .....		38	VOR OR TACAN RWY 35 .....		78
RNAV (GPS) Y RWY 4R .....		39	AIRPORT DIAGRAM .....		79
RNAV (GPS) Y RWY 8L .....		40	DPS ..... AMERY TWO .....		80
RNAV (RNP) RWY 26L .....		41			
RNAV (RNP) Z RWY 4R .....		42	<b>KALAELOA (JOHN RODGERS FIELD)</b>		
RNAV (RNP) Z RWY 8L .....		43	<b>--SEE KAPOLEI, HI</b>		
LDA/DME RWY 26L .....		44	<b>KAMUELA, HI</b>		
VOR/DME OR TACAN OR GPS-B .....		45	<b>WAIMEA-KOHALA(MUE)</b>		
VOR OR TACAN OR GPS-A .....		46	TAKE-OFF MINIMUMS .....		C
VOR OR TACAN RWY 4R .....		47	ALTERNATE MINIMUMS .....		E
AIRPORT DIAGRAM .....		48	IAPS ..... RNAV (GPS) RWY 4 .....		81
DPS ..... HONOLULU ONE (OBSTACLE) .....		49	RNAV (GPS) RWY 22 .....		82
KEAHI THREE .....		51	VOR/DME RWY 4 .....		83
KEOLA TWO .....		52	VOR/DME-A .....		84
MOLOKAI FOUR .....		53			
OPIHI TWO .....		55	<b>KAPOLEI, HI</b>		
PALAY TWO .....		57	<b>KALAELOA (JOHN RODGERS FIELD)(JRF)</b>		
<b>KAHULUI, HI</b>			TAKE-OFF MINIMUMS .....		C
<b>KAHULUI(OGG)</b>			ALTERNATE MINIMUMS .....		E
TAKE-OFF MINIMUMS .....		C	IAPS ..... VOR/DME RWY 4R .....		85
ALTERNATE MINIMUMS .....		E	NDB RWY 4R .....		86
STARS .. CAMPS TWO .....		Z2	AIRPORT DIAGRAM .....		87
IAPS ..... ILS OR LOC RWY 2 .....		58	<b>KAUNAKAKAI, HI</b>		
RNAV (GPS) RWY 2 .....		59	<b>MOLOKAI(MKK)</b>		
RNAV (GPS) RWY 20 .....		60	TAKE-OFF MINIMUMS .....		C
RNAV (GPS) RWY 23 .....		61	ALTERNATE MINIMUMS .....		E
LOC/DME BC RWY 20 .....		62	IAPS ..... RNAV (GPS)-B .....		88
VOR/DME OR TACAN RWY 20 .....		63	VOR OR TACAN OR GPS-A .....		89
VOR RWY 20 .....		64	AIRPORT DIAGRAM .....		90
NDB/DME RWY 2 .....		65	DPS ..... BLUSH ONE .....		91
SMOKE STACK VISUAL RWY 2 .....		66	HAPAI TWO .....		92
AIRPORT DIAGRAM .....		67			
DPS ..... BARBY ONE .....		68	<b>KONA INTL AT KEAHOLE</b>		
BEACH TWO .....		69	<b>--SEE KAILUA-KONA, HI</b>		
MAUI FIVE .....		70			
SWEEP ONE .....		71			

## INDEX

10098

**INDEX**

10098

**INDEX OF TERMINAL CHARTS AND MINIMUMS**

NAME	PROC	SECT PG	NAME	PROC	SECT PG
<b>KOSRAE</b>			<b>PAGO PAGO INTL</b>		
---SEE KOSRAE,FM			---SEETUTUILA,AQ		
<b>KOSRAE,FM</b>			<b>POHNPEI ISLAND,FM</b>		
<b>KOSRAE(TTK)</b>			<b>POHNPEI INTL(PNI)</b>		
TAKE-OFF MINIMUMS .....	C		TAKE-OFF MINIMUMS .....	C	
ALTERNATE MINIMUMS .....	E		ALTERNATE MINIMUMS .....	E	
IAPS ..... RNAV (GPS) RWY 5 .....	93		IAPS ..... RNAV (GPS) RWY 9 .....	117	
RNAV (GPS) RWY 23 .....	94		RNAV (GPS) RWY 27 .....	118	
NDB/DME-A .....	95		NDB/DME OR GPS-A .....	119	
			NDB/DME RWY 9 .....	120	
			NDB OR GPS-B .....	121	
			NDB OR GPS-C .....	122	
<b>LANAI CITY, HI</b>			<b>ROTA INTL</b>		
<b>LANAI(LNY)</b>			---SEESAIPAN,CQ		
TAKE-OFF MINIMUMS .....	C		<b>SAIPAN,CQ</b>		
ALTERNATE MINIMUMS .....	E		<b>FRANCISCO C. ADA/SAIPAN INTL(GSN)</b>		
IAPS ..... ILS RWY 3 .....	96		TAKE-OFF MINIMUMS .....	C	
RNAV (GPS) RWY 3 .....	97		ALTERNATE MINIMUMS .....	E	
VOR OR TACAN OR GPS-A .....	98		IAPS ..... ILS OR LOC/DME RWY 7 .....	123	
VOR OR TACAN RWY 3 .....	99		GPS RWY 7 .....	124	
			GPS RWY 25 .....	125	
			NDB/DME RWY 7 .....	126	
			NDB/DME RWY 25 .....	127	
			NDB RWY 7 .....	128	
			AIRPORT DIAGRAM .....	129	
<b>LIHUE, HI</b>			<b>ROTA INTL(GRO)</b>		
<b>LIHUE(LIH)</b>			TAKE-OFF MINIMUMS .....	C	
TAKE-OFF MINIMUMS .....	C		ALTERNATE MINIMUMS .....	E	
ALTERNATE MINIMUMS .....	E		IAPS ..... GPS RWY 9 .....	130	
IAPS ..... ILS OR LOC RWY 35 .....	100		GPS RWY 27 .....	131	
RNAV (GPS) RWY 17 .....	101		NDB RWY 9 .....	132	
RNAV (GPS) Y RWY 21 .....	102		NDB RWY 27 .....	133	
RNAV (GPS) Y RWY 35 .....	103				
RNAV (RNP) Z RWY 21 .....	104				
RNAV (RNP) Z RWY 35 .....	105				
VOR/DME OR TACAN RWY 21 .....	106				
VOR OR TACAN RWY 35 .....	107				
VOR-A .....	108				
AIRPORT DIAGRAM .....	109				
DPS ..... DIANE ONE .....	110				
LIHUE FIVE .....	111				
RICHE TWO .....	112				
<b>MARSHALL ISLANDS INTL</b>			<b>TINIAN ISLAND,CQ</b>		
---SEEDALAP,RM			<b>TINIAN INTL(TNI)</b>		
<b>MIDWAY ATOLL,MQ</b>			TAKE-OFF MINIMUMS .....	C	
<b>HENDERSON FIELD(MDY)</b>			ALTERNATE MINIMUMS .....	E	
ALTERNATE MINIMUMS .....	E		IAPS ..... RNAV (GPS) RWY 8 .....	134	
IAPS ..... RNAV (GPS) RWY 6 .....	113		RNAV (GPS) RWY 26 .....	135	
RNAV (GPS) RWY 24 .....	114		NDB-A .....	136	
NDB RWY 6 .....	115				
NDB RWY 24 .....	116				
<b>MOLOKAI</b>					
---SEE KAUNAKAKAI, HI					

**INDEX**

10098

**INDEX**

10098

**INDEX OF TERMINAL CHARTS AND MINIMUMS**

NAME	PROC	SECT PG	NAME	PROC	SECT PG
------	------	---------	------	------	---------

**TUTUILA,AQ****PAGOPAGOINTL(PPG)**

TAKE-OFF MINIMUMS .....	C
ALTERNATE MINIMUMS .....	E
IAPS ..... ILS/DME RWY 5 .....	137
VOR/DME OR TACAN-A .....	138
VOR/DME OR TACAN-B .....	139
VOR-D .....	140
NDB-C .....	141
AIRPORT DIAGRAM .....	142

**WAIMEA-KOHALA**

---SEE KAMUELA, HI

**WENO ISLAND,FM****CHUUK INTL(TKK)**

TAKE-OFF MINIMUMS .....	C
ALTERNATE MINIMUMS .....	E
IAPS ..... RNAV (GPS) RWY 4 .....	143
GPS RWY 22 .....	144
NDB/DME RWY 4 .....	145
NDB OR GPS-A .....	146
NDB OR GPS-B .....	147

**YAP ISLAND,FM****YAP INTL(T11)**

TAKE-OFF MINIMUMS .....	C
IAPS ..... RNAV (GPS) RWY 7 .....	148
RNAV (GPS) RWY 25 .....	149
NDB/DME RWY 7 .....	150
NDB/DME RWY 25 .....	151
NDB RWY 7 .....	152
NDB RWY 25 .....	153

**INDEX**

10098





# TAKE-OFF MINIMUMS AND (OBSTACLE) DEPARTURE PROCEDURES



## INSTRUMENT APPROACH PROCEDURE CHARTS IFR TAKE-OFF MINIMUMS AND (OBSTACLE) DEPARTURE PROCEDURES

### Civil Airports and Selected Military Airports

ALL USERS: Airports that have Departure Procedures (DPs) designed specifically to assist pilots in avoiding obstacles during the climb to the minimum enroute altitude, and/or airports that have civil IFR take-off minimums other than standard, are listed below. Take-off Minimums and Departure Procedures apply to all runways unless otherwise specified. Altitudes, unless otherwise indicated, are minimum altitudes in MSL.

DPs specifically designed for obstacle avoidance are referred to as Obstacle Departure Procedures (ODPs) and are described below in text, or published separately as a graphic procedure. If the (Obstacle) DP is published as a graphic procedure, its name will be listed below, and it can be found in either this volume (civil), or a separate Departure Procedure volume (military), as appropriate. Users will recognize graphic obstacle DPs by the term "(OBSTACLE)" included in the procedure title; e.g., TETON TWO (OBSTACLE). If not assigned a SID or radar vector by ATC, an ODP may be flown without ATC clearance to ensure obstacle clearance.

Graphic DPs designed by ATC to standardize traffic flows, ensure aircraft separation and enhance capacity are referred to as "Standard Instrument Departures (SIDs)". SIDs also provide obstacle clearance and are published under the appropriate airport section. ATC clearance must be received prior to flying a SID.

CIVIL USERS NOTE: Title 14 Code of Federal Regulations Part 91 prescribes standard take-off rules and establishes take-off minimums for certain operators as follows: (1) Aircraft having two engines or less - one statute mile. (2) Aircraft having more than two engines - one-half statute mile. These standard minima apply in the absence of any different minima listed below.

MILITARY USERS NOTE: Civil (nonstandard) take-off minima are published below. For military take-off minima, refer to appropriate service directives.

#### NAME TAKE-OFF MINIMUMS

##### **BABELTHUAP, KOROR, PS**

BABELTHUAP/KOROR (ROR)

AMDT 1 09015 (FAA)

TAKE-OFF MINIMUMS: **Rwy 27**, 400-1 or std. with a min. climb of 296' per NM to 500.

DEPARTURE PROCEDURE: **Rwy 9**, climb runway heading to 700 then as cleared.

##### **DALAP, RM**

MARSHALL ISLANDS INTL (MAJ)

ORIG 10098 (FAA)

NOTE: **Rwy 7**, antenna on building 215' from DER, 446' left of centerline, 48' AGL/54' MSL. Obstruction light on AMOM 44' from DER, 269' left of centerline, 33' AGL/39' MSL. Obstruction light on WSK 10' from DER, 245' right of centerline, 23' AGL/29' MSL. Tree 934' from DER, 243' left of centerline, 39' AGL/45' MSL. Bush 555' from DER, 187' right of centerline, 17' AGL/23' MSL. **Rwy 25**, obstruction light on WSK 11' from DER, 246' left of centerline, 23' AGL/29' MSL. Post 51' from DER, 252' right of centerline, 8' AGL/14' MSL. Tree 996' from DER, 39' left of centerline, 31' AGL/37' MSL. Tree 563' from DER, 5' right of centerline, 20' AGL/26' MSL. Bushes beginning 207' from DER, from 124' left to 207' right of centerline, up to 14' AGL/20' MSL. Vehicle on roadway 130' from DER, 241' right of centerline, 15' AGL/20' MSL.

#### NAME TAKE-OFF MINIMUMS

##### **GUAM, GQ**

GUAM INTL (GUM)

ORIG -A 09071 (FAA)

TAKE-OFF MINIMUMS: **Rwys 6L, 6R**, 500-1 or std. with a min. climb 360' per NM to 800. **Rwys 24L, 24R**, 500-1 or std. with a min. climb of 300' per NM to 1400.

DEPARTURE PROCEDURE: **Rwys 6L, 6R**, climb runway heading to 800 before turning. **Rwys 24L, 24R** climb runway heading to 1400 before turning.

##### **HANA, HI**

HANA (HNM)

ORIG 05244 (FAA)

DEPARTURE PROCEDURE: Use LINDBERG DEPARTURE.

##### **HILO, HI**

HILO INTL (ITO)

AMDT 6 05356 (FAA)

DEPARTURE PROCEDURE: Use PARIS DEPARTURE.

##### **HONOLULU, HI**

HONOLULU INTL (HNL)

AMDT 7 85269 (FAA)

DEPARTURE PROCEDURE: use HONOLULU DEPARTURE.



# TAKE-OFF MINIMUMS AND (OBSTACLE) DEPARTURE PROCEDURES



PAC



## TAKE-OFF MINIMUMS AND (OBSTACLE) DEPARTURE PROCEDURES



### KAHULUI, HI

KAHULUI (OGG)

AMDT 6 09015 (FAA)

TAKE-OFF MINIMUMS: **Rwy 23**, NA-ATC.

DEPARTURE PROCEDURE: **Rwy 2**, climb on a heading between 310° CW to 053° from departure end of runway.

**Rwy 5**, climb on a heading between 307° CW to 040° from departure end of runway. **Rwy 20**, climb on a heading of 185° from departure end of runway.

NOTE: **Rwy 2**, bush/trees beginning 190' from departure end of runway, 362' left of centerline, up to 60' AGL/79' MSL. Pipe on building 339' from departure end of runway, 289' right of centerline, 20' AGL/25' MSL. Bush beginning 902' from departure end of runway, 637' right of centerline, up to 20' AGL/39' MSL. **Rwy 5**, trees 2359' from departure end of runway, 512' left of centerline, 56' AGL/75' MSL. Fence beginning 20' from departure end of runway, 299' right of centerline, up to 7' AGL/31' MSL. Bush/trees beginning 291' from departure end of runway, 300' right of centerline, up to 76' AGL/95' MSL. **Rwy 20**, bush 22' from departure end of runway, 236' right of centerline, 2' AGL/55' MSL. Bush/trees beginning 24' from departure end of runway, 173' left of centerline, up to 29' AGL/68' MSL.

### KAILUA-KONA, HI

KONA INTL AT KEAHOLE

DEPARTURE PROCEDURE: **Rwy 17**, northwest-bound climb runway heading to 500 then climbing right turn to assigned route: eastbound climb runway heading to 500 then climbing right turn, heading 360°, to 2000, then climb via V3. **Rwy 35**, northwestbound climb runway heading to 500 then climbing left turn to assigned route: eastbound climb runway heading to 2000 then climb via V3.

### KAMUELA, HI

WAIIMEA-KOHALA (MUE)

AMDT 1 05076 (FAA)

TAKE-OFF MINIMUMS: **Rwy 4**, 400-2 or std. with a min. climb of 240' per NM to 3100.

DEPARTURE PROCEDURE: **Rwy 4**, climb via heading 041° to 3100 then climbing right turn via heading 080° and MUE VOR/DME R-057 to 6000 to VELLA INT, then as assigned. **Rwy 22**, climb via heading 233° and MUE VOR/DME R-234 to 5000 to JASON INT, then as assigned.

NOTE: **Rwy 4**, windsock 158' from departure end of runway, 299' right of centerline, 25' AGL/2702' MSL. Fence 2754' from departure end of runway, 323' right of centerline, 12' AGL/2741' MSL. Tree 5200' from departure end of runway, 179' right of centerline, 50' AGL/2817' MSL. Tree 5331' from departure end of runway, 110' left of centerline, 50' AGL/2829' MSL. Tree 1.3 NM from departure end of runway, 739' right of centerline, 50' AGL/2864' MSL. Tree 1.3 NM from departure end of runway, 1741' left of centerline, 50' AGL/2889' MSL. Antenna 1.8 NM from departure end of runway, 1094' left of centerline 152' AGL/2992' MSL. Rising terrain beginning 1.5 NM from departure end of runway, 3.9 NM left of centerline, up to 13796' MSL. **Rwy 22**, cactus at departure end of runway, 191' left of centerline, 10' AGL/2668' MSL. Tree at departure end of runway, 353' right of centerline, 50' AGL/2687' MSL. Bush 673' from departure end of runway, 186' left of centerline, 30' AGL/2673' MSL. Pole 1058' from departure end of runway, 124' left of centerline, 20' AGL/2683' MSL. Rapidly rising terrain beginning 1.5 NM from departure end of runway, 4209' left of centerline, up to 5513' MSL.

### KAPOLEI, OAHU ISLAND, HI

KALAELOA (JOHN RODGERS FIELD) (JRF)

ORIG 09295 (FAA)

DEPARTURE PROCEDURE: DME Required. **Rwys 4L, 4R, 11**, climb heading 200° to intercept HNL VORTAC R-241 to GECKO/HNL 22.4 DME before proceeding on course. **Rwys 22L, 22R**, climb heading 224° to intercept HNL VORTAC R-241 to GECKO/HNL 22.4 DME before proceeding on course. **Rwy 29**, climb heading 210° to intercept HNL VORTAC R-241 to GECKO/HNL 22.4 DME before proceeding on course.

NOTE: **Rwy 11**, tree 1533' from DER, 831' left of centerline, 60' AGL/70' MSL. **Rwy 22L**, vehicles on road 305' from DER, 195' left of centerline, 15' AGL/26' MSL. **Rwy 29**, tree 1794' from DER, 573' left of centerline, 60' AGL/99' MSL.



## TAKE-OFF MINIMUMS AND (OBSTACLE) DEPARTURE PROCEDURES





## TAKE-OFF MINIMUMS AND (OBSTACLE) DEPARTURE PROCEDURES



10088

### KAUNAKAKAI, HI

MOLOKAI (MKK)  
AMDT 5 05300 (FAA)

TAKE-OFF MINIMUMS: **Rwy 5**, std. with a min. climb of 395' per NM to 1600 or 1900-2½' for climb in visual conditions. **Rwy 23**, std. with a min. climb of 446' per NM to 1600 or 1900-2½' for climb in visual conditions. **Rwy 35**, 200-1 or std. with a min. climb of 441' per NM to 800.

DEPARTURE PROCEDURE: **Rwy 5**, climb via heading 040° to 1500 then climbing left turn direct MKK VORTAC, or climb in visual conditions to cross Molokai Airport southwestbound at or above 1800 via the MKK R-067 to MKK VORTAC, thence...

**Rwy 17**, climb via heading 169° to 1500 then climbing right turn direct MKK VORTAC, thence...

**Rwy 23**, climbing left turn via heading 170° to 1700 then climbing right turn direct MKK VORTAC or climb in visual conditions to cross Molokai Airport southwestbound at or above 1800 via the MKK R-067 to MKK VORTAC, thence...

**Rwy 35**, climb via heading 349° to 1500 then climbing left turn direct MKK VORTAC, thence...

...climb in MKK VORTAC holding pattern (hold NE, right turn, 236° inbound) to cross MKK at or above MCA/MEA for route of flight.

NOTE: **Rwy 5**, pole 2254' from departure end of runway, 222' right of centerline, 45' AGL/565' MSL, tree 1.12 NM from departure end of runway, 720' right of centerline, 50' AGL/675' MSL. Fenceline beginning 147' from departure end of runway, 177' left of centerline, up to 12' AGL/471' MSL. Multiple trees and bushes beginning 50' from departure end of runway, 273' left of centerline, up to 50' AGL/551' MSL. Obstruction light 1366' from departure end of runway, 79' right of centerline, 30' AGL/528' MSL. Multiple poles beginning 3065' from departure end of runway, 644' left of centerline, up to 45' AGL/623' MSL. Multiple trees beginning 4155' from departure end of runway, 184' right of centerline, up to 50' AGL/714' MSL. **Rwy 23**, tree 2.44 NM from departure end of runway, 747' right of centerline, 100' AGL/1264' MSL. Tree 2.82 NM from departure end of runway, 1753' right of centerline, 60' AGL/819' MSL. Tree 2.73 NM from departure end of runway, 2001' left of centerline, 60' AGL/919' MSL. Tree 2.03 NM from departure end of runway, 2006' left of centerline, 100' AGL/919' MSL. Pole 8021' from departure end of runway, 867' left of centerline, 42' AGL/642' MSL. **Rwy 35**, tree 2990' from departure end of runway, 1030' right of centerline, 50' AGL/648' MSL. Tree 3033' from departure end of runway, 740' right of centerline, 50' AGL/637' MSL. Tree 2497' from departure end of runway, 1106' right of centerline, 50' AGL/615' MSL. Tree 3835' from departure end of runway, 76' right of centerline, 50' AGL/620' MSL. Tree 3041' from departure end of runway, 728' right of centerline, 50' AGL/600' MSL. Tree 3569' from departure end of runway, 116' right of centerline, 50' AGL/596' MSL. Bush 28' from departure end of runway, 289' left of centerline, 15' AGL/461' MSL. Multiple bushes and trees 48' from departure end of runway, 48' right of centerline, up to 200' AGL/648' MSL. Multiple bushes and trees 28' from departure end of runway, 34' left of centerline up to 41' AGL/489' MSL. Multiple bushes beginning 107' from departure end of runway, 133' right of centerline, up to 15' AGL/492' MSL. Multiple bushes beginning 133' from departure end of runway, 43' left of centerline, up to 15' AGL/517' MSL. Road/vehicle 200' from departure end of runway, 62' right of centerline, 15' AGL/487' MSL. Pole 1.32 NM from departure end of runway, 867' left of centerline, 42' AGL/642' MSL.

### KOSRAE, FM

KOSRAE (TTK)  
ORIG-A 09071 (FAA)

CAUTION: Ships with masts to 200' traverse harbor entrance located on west side of runway.  
DEPARTURE PROCEDURE: **Rwy 5**, left turn. **Rwy 23**, right turn, climb to 2000 or above before turning east.

### LANAI CITY, HI

LANAI (LNY)  
AMDT 5 09239 (FAA)

TAKE-OFF MINIMUMS: **Rwy 3**, 400-1 or std. w/ min. climb of 370' per NM to 2700 or 2500-3 for climb in visual conditions.

DEPARTURE PROCEDURE: **Rwy 3**, climb heading 033° to 1720 before turning left. Climb heading 300° or 180° to intercept route or airway, then continue as cleared. Maintain maximum 210 kts until turn is completed or for climb in visual conditions cross LNY VORTAC eastbound at or above 3700. **Rwy 21**, climb heading 213° to assigned altitude. Eastbound - climb westbound to cross LNY VORTAC eastbound at or above 2700 and climb as cleared. Westbound - climb direct LNY VORTAC then via assigned route.

NOTE: **Rwy 3**, multiple poles, trees, and terrain beginning 2108' from DER, 1011' left of centerline, up to 200' AGL/2202' MSL. **Rwy 21**, lighted windsock 8' from DER, 191' right of centerline, 30' AGL/1323' MSL.

### LIHUE, HI

LIHUE (LIH)  
AMDT 8 00279 (FAA)

TAKE-OFF MINIMUMS: **Rwy 21**, 2400-3. Use DIANE DEPARTURE PROCEDURE.

DEPARTURE PROCEDURE: **Rwys 3, 35**, to V15, climb runway heading to 500 then climbing right turn, heading 125°, then as assigned. **Rwy 17**, to V15, climb runway heading to 500 then climbing left turn, heading 045°, then as assigned. To LIH-150 climb runway heading to 500 then climbing left turn, heading 120°, then as assigned. **Rwy 21**, to V15, climb runway heading to 550 then climbing left turn, heading 090°, to intercept LIH R-110, maintain 5000, direct BOOKE INT or as assigned. To LIH-148, climb runway heading to 550, then climbing left turn, heading 120°, to intercept LIH R-148, maintain 3000, direct NAPUA INT or as assigned.

### POHNPEI ISLAND, FM

POHNPEI INTL (PNI)  
AMDT 2 80079 (FAA)

TAKE-OFF MINIMUMS: **Rwys 9, 27**, 400-1½.

DEPARTURE PROCEDURE: **Rwy 9**, climb runway heading to 500 then left turn for north or west departure. **Rwy 27**, climb runway heading to 500 then right turn for north or east departure. Climb runway heading to 1500 before turning for south departure.

CAUTION: Ships with superstructure to 150', traverse Ponape channel, 400' off approach end of Rwy 9, closing airport at times.



## TAKE-OFF MINIMUMS AND (OBSTACLE) DEPARTURE PROCEDURES



PAC



## TAKE-OFF MINIMUMS AND (OBSTACLE) DEPARTURE PROCEDURES



### SAIPAN, CQ

FRANCISCO C. ADA/SAIPAN INTL (GSN)  
ORIG-A 09071 (FAA)

DEPARTURE PROCEDURE: **Rwys 7, 25**, climb on runway heading to 1600 before climbing on course.

### ROTA INTL (GRO)

AMDT 1A 09071 (FAA)

DEPARTURE PROCEDURE: **Rwy 9**, climb runway heading to 1000 before turning. **Rwy 27**, climb runway heading to 2000 or above before turning south.

### TINIAN ISLAND, CQ

TINIAN INTL (TNI)

AMDT 1 09239 (FAA)

NOTE: **Rwy 8**, trees beginning 694' from DER, 507' left of centerline, up to 100' AGL/363' MSL. Multiple trees beginning 569' from DER, 471' right of centerline, up to 100' AGL/389' MSL. **Rwy 26**, multiple trees beginning 743' from DER, 508' right of centerline, up to 100' AGL/363' MSL.

### TUTUILA, AQ

PAGO PAGO INTL (PPG)

ORIG-A 09071 (FAA)

TAKE-OFF MINIMUMS: **Rwy 23**, std. w/min. climb of 320' per NM to 800, or 2700-3 for climb in visual conditions. **Rwy 26**, NA-obstacles.

DEPARTURE PROCEDURE: **Rwys 5, 8**, climbing right turn southbound between TUT R-090 clockwise to R-180 to 2800, then proceed on course. **Rwy 23**, climbing left turn heading 150° southbound between TUT R-090 clockwise to R-180 to 2800, then proceed on course. For climb in visual conditions: cross Pago Pago Intl Airport at or above 2600 before proceeding on course.

NOTE: **Rwy 5**, bush 1' from departure end of runway, 237' right of centerline, 3' AGL/12' MSL. Bush 379' from departure end of runway, 362' left of centerline, 14' AGL/23' MSL. Ship 998' from departure end of runway, 57' right of centerline, 150' AGL/150' MSL. **Rwy 8**, bush 689' from departure end of runway, 360' left of centerline, 15' AGL/23' MSL. Ship 1435' from departure end of runway, 304' left of centerline, 150' AGL/150' MSL. **Rwy 23**, multiple trees beginning 352' from departure end of runway, 173' left of centerline, up to 20' AGL/132' MSL. Multiple trees beginning 881' from departure end of runway, 296' right of centerline, up to 20' AGL/172' MSL. Multiple trees and poles beginning 1.6 NM from departure end of runway, 38' right of centerline, up to 367' AGL/554' MSL. Tree 2.3 NM from departure end of runway, 2126' left of centerline, 20' AGL/387' MSL.

### WENO ISLAND, FM

CHUUK INTL (TKK)

AMDT 2 10042 (FAA)

DEPARTURE PROCEDURE: **Rwy 4**, climb heading 041° to 1100 before proceeding on course. **Rwy 22**, climb heading 221° to 1500 before proceeding on course.

NOTE: **Rwy 4**, bush 205' from DER, 203' right of centerline, 7' AGL/17' MSL. **Rwy 22**, bush 5' from DER, 241' right of centerline, 14' AGL/24' MSL. Bush 221' from DER, 85' right of centerline, 7' AGL/17' MSL. **CAUTION:** Ships with superstructure to 150' traverse channels west of runway 4/22.

### YAP ISLAND, FM

YAP INTL (T11)

AMDT 2 94342 (FAA)

DEPARTURE PROCEDURE: **Rwys 7**, climbing right turn to 1500 via 090° bearing from YP NDB/DME, then climb on course. **Rwy 25**, climb to 500, then climb on course.



D1

10042

## CLIMB TABLE

THE RATE OF CLIMB TABLE HAS BEEN  
INTENTIONALLY REMOVED.

PLEASE SEE THE INSIDE  
BACK COVER PAGE FOR  
THE COMBINED  
CLIMB/DESCENT TABLE.

CLIMB TABLE

PAC, 08 APR 2010 to 03 JUN 2010



## ALTERNATE MINS

E1



## INSTRUMENT APPROACH PROCEDURE CHARTS

## IFR ALTERNATE AIRPORT MINIMUMS

Standard alternate minimums for non precision approaches are 800-2 (NDB, VOR, LOC, TACAN, LDA, VORTAC, VOR/DME, ASR or WAAS LNAV); for precision approaches 600-2 (ILS or PAR). Airports within this geographical area that require alternate minimums other than standard or alternate minimums with restrictions are listed below. NA - means alternate minimums are not authorized due to unmonitored facility or absence of weather reporting service. Civil pilots see FAR 91. IFR Alternate Minimums: Ceiling and Visibility Minimums not applicable to USA/USN/USAF. Pilots must review the IFR Alternate Minimums Notes for alternate airfield suitability.

## NAME ALTERNATE MINIMUMS

**BABELTHUAP, KOROR, PS**

BABELTHUAP/KOROR ..... NDB Rwy 9<sup>1</sup>  
 RNAV (GPS) Rwy 9  
 RNAV (GPS) Rwy 27

NA except standard for operators with approved weather reporting service.

<sup>1</sup>Categories A,B, 900-2; Category C, 900-2<sup>1</sup>/<sub>4</sub>;  
 Category D, 900-2<sup>1</sup>/<sub>2</sub>.

**DALAP, RM**

MARSHALL ISLANDS INTL ..... NDB Rwy 7<sup>1</sup>  
 NDB Rwy 25<sup>1</sup>  
 RNAV (GPS) Rwy 7<sup>2</sup>  
 RNAV (GPS) Rwy 25<sup>2</sup>

<sup>1</sup>NA when Majuro Radio closed.

<sup>2</sup>NA when local weather not available.

**GUAM, GQ**

GUAM INTL ..... ILS or LOC Rwy 6L<sup>1</sup>  
 ILS or LOC Rwy 6R<sup>1</sup>  
 RNAV (GPS) Y Rwy 6R<sup>2</sup>  
 RNAV (GPS) Y Rwy 24L<sup>4</sup>  
 RNAV (GPS) Y Rwy 24R<sup>3</sup>  
 RNAV (RNP) Z Rwy 24L<sup>4</sup>  
 RNAV (RNP) Z Rwy 24R<sup>4</sup>  
 TACAN Rwy 24R<sup>5</sup>

<sup>1</sup>ILS,LOC, Categories A,B, 1200-2; Categories C,D, 1200-3.

<sup>2</sup>Category D, 800-2<sup>1</sup>/<sub>4</sub>.

<sup>3</sup>Category C, 800-2<sup>1</sup>/<sub>4</sub>; Category D, 800-2<sup>1</sup>/<sub>2</sub>.

<sup>4</sup>Categories A, B, C, D, 900-3.

<sup>5</sup>Categories A, B, 900-2; Category C, 900-2<sup>1</sup>/<sub>4</sub>;  
 Category D, 900-3.

**HILO, HI**

HILO INTL ..... ILS or LOC Rwy 26  
 ILS, Category D, 700-2.  
 NA when control tower closed.

## NAME ALTERNATE MINIMUMS

**HONOLULU, HI**

HONOLULU INTL ..... ILS Rwy 4R<sup>1</sup>  
 LDA/DME Rwy 26L<sup>1</sup>  
 RNAV (GPS) Y Rwy 4R<sup>2</sup>  
 RNAV (GPS) Y Rwy 8L<sup>3</sup>  
 VOR/DME or TACAN or GPS-B<sup>4</sup>  
 VOR or TACAN or GPS-A<sup>1</sup>  
 VOR or TACAN Rwy 4R<sup>5</sup>

<sup>1</sup>Category E, 1500-3.

<sup>2</sup>Category D, 900-2<sup>1</sup>/<sub>2</sub>; Category E, 1500-3.

<sup>3</sup>Category D, 900-2<sup>1</sup>/<sub>2</sub>; Category E, 1700-3.

<sup>4</sup>Category E, 900-3.

<sup>5</sup>Category D, 800-2<sup>1</sup>/<sub>2</sub>.

**KAHULUI, HI**

KAHULUI ..... ILS or LOC Rwy 2<sup>1</sup>  
 LOC/DME BC Rwy 20<sup>23</sup>  
 NDB/DME Rwy 2<sup>2</sup>  
 RNAV (GPS) Rwy 23<sup>4</sup>  
 VOR/DME or TACAN Rwy 20<sup>5</sup>

<sup>1</sup>ILS, LOC, Categories A, B 1500-2; Categories C, D, E, 1500-3.

<sup>2</sup>NA when control tower closed.

<sup>3</sup>Category E, 1400-3.

<sup>4</sup>NA when local weather not available.

<sup>5</sup>NA when control tower closed, except for operators with approved weather reporting service.

**KAILUA-KONA, HI**

KONA INTL AT  
 KEAHOLE ..... ILS or LOC/DME Rwy 17  
 NA when control tower closed.

**KAMUELA, HI**

WAIMEA-KOHALA ..... VOR/DME-A  
 VOR/DME Rwy 4<sup>1</sup>  
 Categories A,B, 1100-2, Category C, 1100-3,  
 Category D, 1300-3.  
<sup>1</sup>Categories A,B, 900-2, Category C, 900-2<sup>1</sup>/<sub>2</sub>,  
 Category D, 1300-3.



## ALTERNATE MINS

E1

PAC





**ALTERNATE MINS**

10042

**NAME** ALTERNATE MINIMUMS  
**KAPOLEI, OAHU ISLAND, HI**  
 KALAELOA (JOHN RODGERS ..... **NDB Rwy 4R**  
 FIELD)  
 Category C, 800-2¼; Category D, 800-2½.

**KAUNAKAKAI, HI**  
 MOLOKAI ..... **VOR or TACAN or GPS-A**  
 Categories A,B, 1200-2; Categories C,D,  
 1200-3.

**KOSRAE, FM**  
 KOSRAE ..... **NDB/DME-A<sup>12</sup>**  
**RNAV (GPS) Rwy 5<sup>3</sup>**  
**RNAV (GPS) Rwy 23<sup>4</sup>**

<sup>1</sup>NA when NDB (UKS) not monitored or local weather not available. Both NDB (UKS) monitored and local weather available Monday through Saturday from 2100 UTC to 0500 UTC (0800 local to 1600 local).

<sup>2</sup>800-3.

<sup>3</sup>NA except standard for operators with approved weather reporting service.

<sup>4</sup>NA except categories A,B, standard, Category C, 800-2¼, Category D 800-2½, for operators with approved weather reporting service.

**LANAI CITY, HI**  
 LANAI ..... **ILS or LOC Rwy 3**  
**VOR or TACAN or GPS-A**

NA when local weather not received except for operators with approved weather reporting service.

**LIHUE, HI**  
 LIHUE ..... **ILS or LOC Rwy 35<sup>1</sup>**  
**RNAV (GPS) Rwy 17<sup>2</sup>**  
**RNAV (GPS) Y Rwy 21<sup>2</sup>**  
**RNAV (GPS) Y Rwy 35<sup>3</sup>**

<sup>1</sup>ILS,LOC,NA when control tower closed; LOC,Category E, NA.

<sup>2</sup>Category B, 900-2; Category C, 1000-2¾; Category D, 1000-3.

<sup>3</sup>Category C, 800-2¼; Category D, 800-2½.

**MIDWAY ATOLL, MQ**  
 HENDERSON FIELD ..... **NDB Rwy 6**  
**NDB Rwy 24**  
**RNAV (GPS) Rwy 6**  
**RNAV (GPS) Rwy 24**

NA except standard for operators with approved weather reporting service.



**NAME** ALTERNATE MINIMUMS  
**POHNPEI ISLAND, FM**  
 POHNPEI INTL ..... **NDB or GPS-B<sup>1</sup>**  
**NDB or GPS-C<sup>1</sup>**  
**NDB/DME or GPS-A<sup>1</sup>**  
**NDB/DME Rwy 9, 800-3**  
**RNAV (GPS) Rwy 9<sup>2</sup>**  
**RNAV (GPS) Rwy 27<sup>1</sup>**

NA when local weather not available.

<sup>1</sup>Category D, 800-2¼.

<sup>2</sup>Categories A,B, 1000-2¼; Category C, 1000-2¾; Category D, 1000-3.

**SAIPAN, CQ**  
 FRANCISCO C. ADA/  
 SAIPAN INTL ..... **GPS Rwy 7**  
**GPS Rwy 25**

NA except standard for operators with approved weather reporting service.

ROTA INTL ..... **GPS Rwy 9<sup>1</sup>**  
**GPS Rwy 27<sup>1</sup>**  
**NDB Rwy 9<sup>23</sup>**  
**NDB Rwy 27<sup>23</sup>**

<sup>1</sup>NA except standard for operators with approved weather reporting service.

<sup>2</sup>NA when terminal weather not available 0900 UTC to 2000 UTC except for operators with approved weather reporting service. Terminal weather available on Rota Radio 123.6 from 2000 UTC to 0900 UTC.

<sup>3</sup>Category D, 800-2¼.

**TINIAN ISLAND, CQ**  
 TINIAN INTL ..... **NDB-A<sup>12</sup>**  
**RNAV (GPS) Rwy 8<sup>34</sup>**  
**RNAV (GPS) Rwy 26<sup>34</sup>**

<sup>1</sup>Category C, 800-2¼; Category D, 800-2½.

<sup>2</sup>NA when local weather not available except for operators with approved weather reporting service.

<sup>3</sup>Category D, 800-2¼.

<sup>4</sup>NA when local weather not available.

**TUTUILA, AQ**  
 PAGO PAGO INTL ..... **ILS/DME Rwy 5<sup>1</sup>**  
**NDB-C<sup>2</sup>**  
**VOR-D<sup>34</sup>**

<sup>1</sup>ILS, Categories C,D, 700-2.

<sup>2</sup>Category D, 800-2¼.

<sup>3</sup>NA when control zone not in effect.

<sup>4</sup>Categories A,B, 1100-3; Categories C,D, 1100-3.



**ALTERNATE MINS**



**ALTERNATE MINS**

E3



NAME ALTERNATE MINIMUMS

**WENO ISLAND, FM**

CHUUK INTL ..... **NDB/DME Rwy 4<sup>1</sup>**  
**NDB or GPS-A<sup>1</sup>**  
**NDB or GPS-B<sup>1</sup>**  
**RNAV (GPS) Rwy 4<sup>2</sup>**

<sup>1</sup>800-3.<sup>2</sup>NA except standard for operators with approved weather reporting service.**YAP ISLAND, FM**

YAP INTL ..... **NDB Rwy 25<sup>1</sup>**  
**NDB/DME Rwy 25<sup>2</sup>**

<sup>1</sup>Categories A,B, 900-2; Category C, 900-2<sup>3</sup>/<sub>4</sub>; Category D, 900-3.<sup>2</sup>Categories A,B, 900-2; Category C, 900-2<sup>1</sup>/<sub>2</sub>; Category D, 900-2<sup>3</sup>/<sub>4</sub> .**ALTERNATE MINS**

E3

PAC





# GENERAL INFO

## GENERAL INFORMATION

This publication is issued every 56 days and includes Standard Instrument Approach Procedures (SIAPs), Standard Instrument Departures (SIDs), Standard Terminal Arrivals (STARs), IFR Take-off Minimums and (Obstacle) Departure Procedures (ODPs), IFR Alternate Minimums, and Radar Instrument Approach Minimums for use by civil and military aviation. The organization responsible for SIAPs, Radar Minimums, SIDs, STARs and graphic ODPs is identified in parentheses in the top margin of the procedure; e.g., (FAA), (USA), (USAF), (USN). SIAPs with the (FAA) designation are regulated under 14 CFR, Part 97. See 14 CFR, Part 91.175 (a) and the AIM for further details. 14 CFR, Part 91.175 (g) and the Special Notices section of the Airport/Facility Directory contains information on civil operations at military airports.

### STANDARD TERMINAL ARRIVALS AND DEPARTURE PROCEDURES

The use of the associated codified STAR/DP and transition identifiers are requested of users when filing flight plans via teletype and are required for users filing flight plans via computer interface. It must be noted that when filing a STAR/DP with a transition, the first three coded characters of the STAR and the last three coded characters of the DP are replaced by the transition code. Examples: ACTON SIX ARRIVAL, file (AGN.AQN6); ACTON SIX ARRIVAL, EDNAS TRANSITION, file (EDNAS.AQN6). FREEHOLD THREE DEPARTURE, file (FREH3.RBV), FREEHOLD THREE DEPARTURE, ELWOOD CITY TRANSITION, file (FREH3.EWC).

**RNAV DP and STAR.** Effective March 15, 2007, these procedures, formerly identified as Type-A and Type-B, will be designated as RNAV 1 in accordance with amended Advisory Circular (AC) and ICAO terminology.

Refer to AC 90-100A U.S. TERMINAL AND EN ROUTE AREA NAVIGATION (RNAV) OPERATIONS and the Aeronautical Information Manual for additional guidance regarding these procedures.

#### **Standard RNAV 1 Procedure Chart Notes**

NOTE: RNAV 1

NOTE: DME/DME/IRU or GPS required





Some procedures may require use of GPS and will be identified by a "GPS required" note.

#### **RNAV 1 Procedure Characteristics and Operations**

1. Require use of an RNAV system with DME/DME/IRU, and/or GPS inputs.
2. Require use of a CDI, flight director, and/or autopilot, in lateral navigation mode, for flight guidance while operating on RNAV paths (track, course, or direct leg). Other methods providing an equivalent level of performance may be acceptable.
3. RNAV paths may start as low as 500 feet above airport elevation.

### PILOT CONTROLLED AIRPORT LIGHTING SYSTEMS

Available pilot controlled lighting (PCL) systems are indicated as follows:

1. Approach lighting systems that bear a system identification are symbolized using negative symbology, e.g.,   .
2. Approach lighting systems that do not bear a system identification are indicated with a negative "0"  beside the name. A star (\*) indicates non-standard PCL, consult Directory/Supplement, e.g., .

To activate lights, use frequency indicated in the communication section of the chart with a  or the appropriate lighting system identification e.g., UNICOM 122.8   .

<u>KEY MIKE</u>	<u>FUNCTION</u>
7 times within 5 seconds	Highest intensity available
5 times within 5 seconds	Medium or lower intensity (Lower REIL or REIL-off)
3 times within 5 seconds	Lowest intensity available (Lower REIL or REIL-off)

### CHART CURRENCY INFORMATION

Date of Latest Revision                      09365

The Date of Latest Revision identifies the Julian date the chart was added or last revised for any reason. The first two digits indicate the year, the last three digits indicate the day of the year (001 to 365/6) in which the latest revision of any kind has been made to the chart.

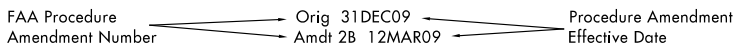

The FAA Procedure Amendment Number represents the most current amendment of a given procedure. The Procedure Amendment Effective Date represents the AIRAC cycle date on which the procedure amendment was incorporated into the chart. Updates to the amendment number & effective date represent procedural/criteria revisions to the charted procedure, e.g., course, fix, altitude, minima, etc.

NOTE: Inclusion of the "Procedure Amendment Effective Date" will be phased in as procedures are amended. As this occurs, the Julian date will be relocated to the upper right corner of the chart.

### MISCELLANEOUS

- ★ Indicates a non-continuously operating facility, see A/FD or flight supplement.
- "Radar required" on the chart indicates that radar vectoring is required for the approach.
- Distances in nautical miles (except visibility in statute miles and Runway Visual Range in hundreds of feet). Runway Dimensions in feet. Elevations in feet. Mean Sea Level (MSL). Ceilings in feet above airport elevation. Radials/bearings/headings/courses are magnetic. Horizontal Datum: Unless otherwise noted on the chart, all coordinates are referenced to North American Datum 1983 (NAD 83), which for charting purposes is considered equivalent to World Geodetic System 1984 (WGS 84).

Terrain is scaled within the neat lines (planview boundaries) and does not accurately underlie not-to-scale distance depictions or symbols.

## GENERAL INFO

10042

GENERAL INFO

ABBREVIATIONS

ADF..... Automatic Direction Finder  
 ALS..... Approach Light System  
 ALSF..... Approach Light System with  
 Sequenced Flashing Lights  
 AP..... Autopilot System  
 APCH..... Approach  
 APP CON..... Approach Control  
 ARR..... Arrival  
 ASOS..... Automated Surface Observing  
 System  
 ASR/PAR..... Published Radar Minimums at  
 this Airport  
 ATIS..... Automatic Terminal Information  
 Service  
 AWOS..... Automated Weather Observing  
 System  
 AZ..... Azimuth  
 BC..... Back Course  
 BND..... Bound  
 C..... Circling  
 CAT..... Category  
 CCW..... Counter Clockwise  
 Chan..... Channel  
 CLNC DEL..... Clearance Delivery  
 CNF..... Computer Navigation Fix  
 CTAF..... Common Traffic Advisory  
 Frequency  
 CW..... Clockwise  
 DA..... Decision Altitude  
 DER..... Departure End of Runway  
 DH..... Decision Height  
 DME..... Distance Measuring Equipment  
 ELEV..... Elevation  
 EMAS..... Engineered Material Arresting  
 System  
 FAF..... Final Approach Fix  
 FD..... Flight Director System  
 FM..... Fan Marker  
 FMS..... Flight Management System  
 GCO..... Ground Communications Outlet  
 GPI..... Ground Point of Interception  
 GPS..... Global Positioning System  
 GS..... Glide Slope  
 HAA..... Height above Airport  
 HAL..... Height above Landing  
 HAT..... Height above Touchdown  
 HATH..... Height Above Threshold  
 HGS..... Head-up Guidance System  
 HIRL..... High Intensity Runway Lights  
 HUD..... Head-up Display  
 IAF..... Initial Approach Fix  
 ICAO..... International Civil Aviation  
 Organization  
 IF..... Intermediate Fix  
 IM..... Inner Marker

INT..... Intersection  
 LDA..... Localizer Type Directional Aid  
 Ldg..... Landing  
 LDIN..... Lead in Light System  
 LIRL..... Low Intensity Runway Lights  
 LOC..... Localizer  
 LR..... Lead Radial. Provides at least  
 2 NM (Copter 1 NM) of lead to  
 assist in turning onto the  
 intermediate/final course.  
 MALS..... Medium Intensity Approach  
 Light System  
 MALSR..... Medium Intensity Approach  
 Light System with RAIL  
 MAP..... Missed Approach Point  
 MDA..... Minimum Descent Altitude  
 MIRL..... Medium Intensity Runway Lights  
 MLS..... Microwave Landing System  
 MM..... Middle Marker  
 N/A..... Not Applicable  
 NA..... Not Authorized  
 NDB..... Non-directional Radio Beacon  
 NFD..... National Flight Database  
 NM..... Nautical Mile  
 NoPT..... No Procedure Turn Required  
 (Procedure Turn shall not be  
 executed without ATC  
 clearance)  
 ODALS..... Omnidirectional Approach  
 Light System  
 ODP..... Obstacle Departure Procedure  
 OM..... Outer Marker  
 PRM..... Precision Runway Monitor  
 R..... Radial  
 RA..... Radio Altimeter setting height  
 RAIL..... Runway Alignment Indicator  
 Lights  
 RCLS..... Runway Centerline Light  
 System  
 REIL..... Runway End Identifier Lights  
 RF..... Radius-to-Fix  
 RNAV..... Area Navigation  
 RNP..... Required Navigation  
 Performance  
 RPI..... Runway Point of Intercept(ion)  
 RRL..... Runway Remaining Lights  
 Rwy..... Runway  
 RVR..... Runway Visual Range  
 S..... Straight-in  
 SALS..... Short Approach Light System  
 SSALR..... Simplified Short Approach  
 Light System with RAIL  
 SDF..... Simplified Directional Facility  
 TAA..... Terminal Arrival Area

GENERAL INFO

08045

**GENERAL INFO****ABBREVIATIONS**

TAC.....	TACAN
TCH.....	Threshold Crossing Height (height in feet Above Ground level)
TDZ.....	Touchdown Zone
TDZE.....	Touchdown Zone Elevation
TDZ/CL.....	Touchdown Zone and Runway Centerline Lighting
TDZL.....	Touchdown Zone Lights
THR.....	Threshold
THRE.....	Threshold Elevation
TODA.....	Take-off Distance Available
TORA.....	Take-off Run Available
VASI.....	Visual Approach Slope Indicator
VDP.....	Visual Descent Point
VGSI.....	Visual Glide Slope Indicator
WP/WPT.....	Waypoint (RNAV)

**GENERAL INFO**

08045

LEGEND

INSTRUMENT APPROACH PROCEDURES (CHARTS)

PLANVIEW SYMBOLS

TERMINAL ROUTES

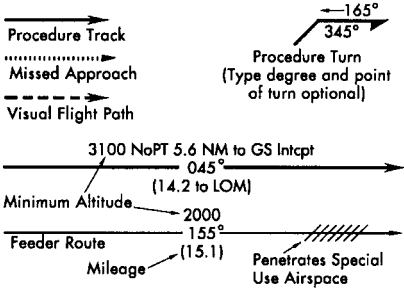

HOLDING PATTERNS

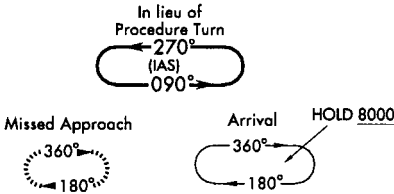

Holding pattern with max. restricted airspeed: (175K) applies to all altitudes. (210K) applies to altitudes above 6000' to and including 14000'. Arrival Holding Pattern altitude restrictions will be indicated when they deviate from the adjacent leg. Limits will only be specified when they deviate from the standard. DME fixes may be shown.

FIXES/ATC REPORTING REQUIREMENTS

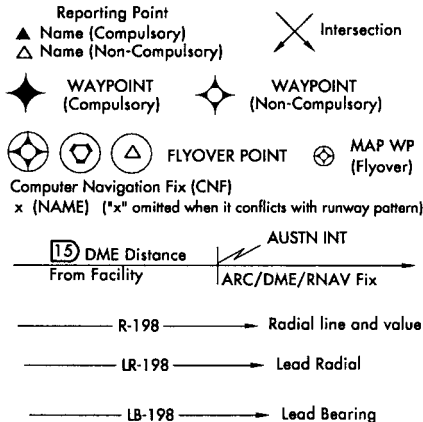

RADIO AIDS TO NAVIGATION

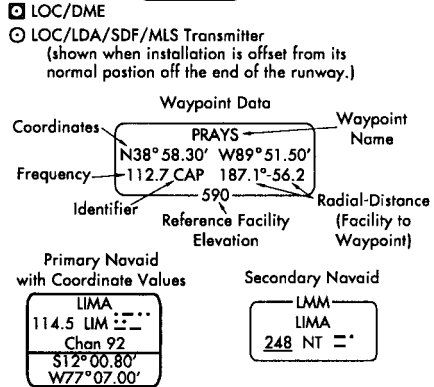
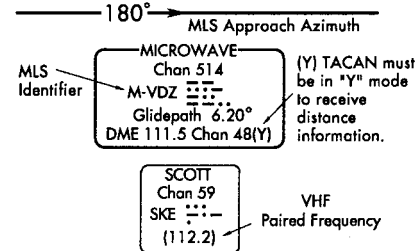
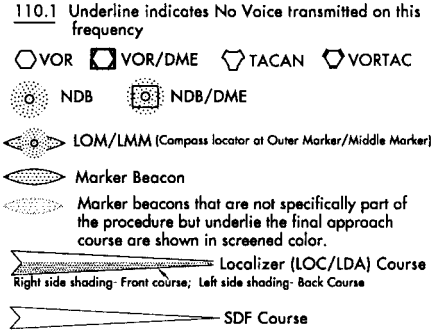

MISCELLANEOUS

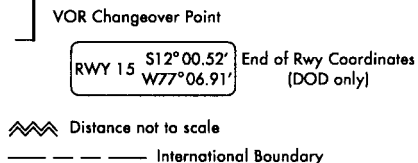

LEGEND

INSTRUMENT APPROACH PROCEDURES (CHARTS)

PLANVIEW SYMBOLS

MINIMUM SAFE ALTITUDE (MSA)

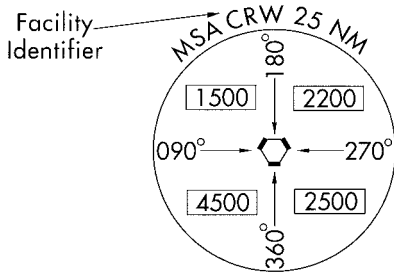

(arrows on distance circle identify sectors)

TERMINAL ARRIVAL AREA (TAA)

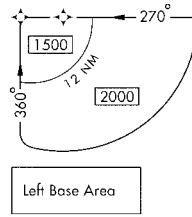
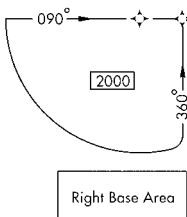
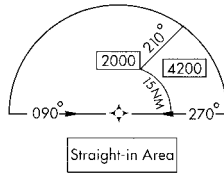

SPECIAL USE AIRSPACE



R-Restricted      W-Warning  
P-Prohibited      A-Alert

OBSTACLES

- Spot Elevation
- ▲ Obstacle
- △ Highest Obstacle
- Highest Spot Elevation
- ▲ Group of Obstacles
- ± Doubtful accuracy

AIRPORTS

- Primary and Secondary (named in planview)
- ✕ Seaplane Base

LEGEND

INSTRUMENT APPROACH PROCEDURES (CHARTS)

PROFILE VIEW

Two different methods are used for vertical guidance:

a. "GS" indicates an electronic glide slope or barometric vertical guidance is present. In the case of an Instrument Landing System (ILS) and Wide Area Augmentation System (WAAS) LPV approach procedures, an electronic signal provides vertical guidance. Barometric vertical guidance is provided for RNP and LNAV/VNAV instrument approach procedures. All ILS, LPV, RNP, and LNAV/VNAV will be in this format  $\text{GS } 3.00^\circ$ , located in the lower left or right corner.

b. Other charts without electronic or barometric vertical guidance will be in this format  $\text{TCH } 55^\circ$ , indicating a non-precision vertical descent angle to assist in preventing controlled flight into terrain. On Civil (FAA) procedures, this information is placed above or below the procedure track following the fix it is based on.

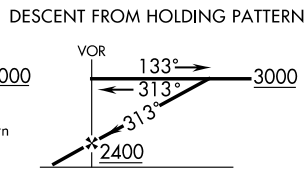
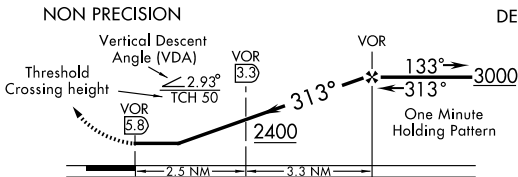
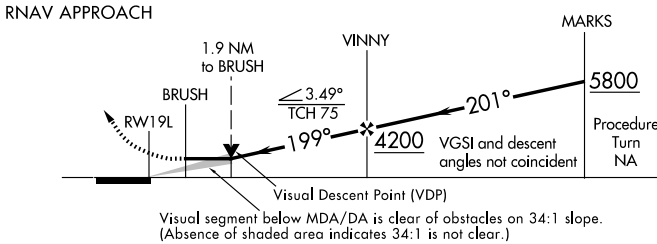
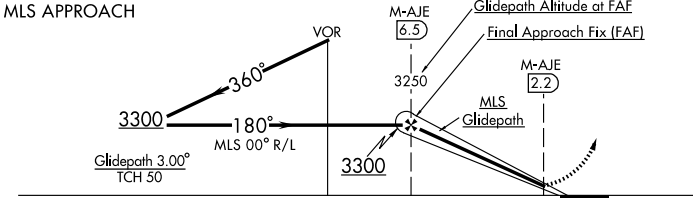
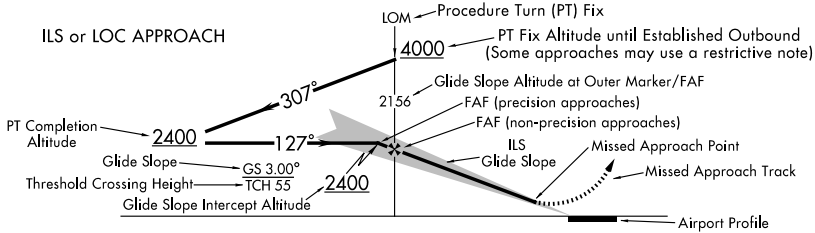

ALTITUDES

5500	Mandatory Altitude	3000	Recommended Altitude
2500	Minimum Altitude	5000	Mandatory Block Altitude
4300	Maximum Altitude	3000	Altitude

PROFILE SYMBOLS

	Glide Slope/Glide Path Intercept Altitude and final approach fix for vertically guided approach procedures.		Visual Flight Path
	Visual Descent Point (VDP)		Facilities and waypoints are depicted as a solid vertical line while fixes and intersections are depicted as a dashed vertical line.

LEGEND

LEGEND

LEGEND

STANDARD TERMINAL ARRIVAL (STAR) CHARTS  
DEPARTURE PROCEDURE (DP) CHARTS

RADIO AIDS TO NAVIGATION

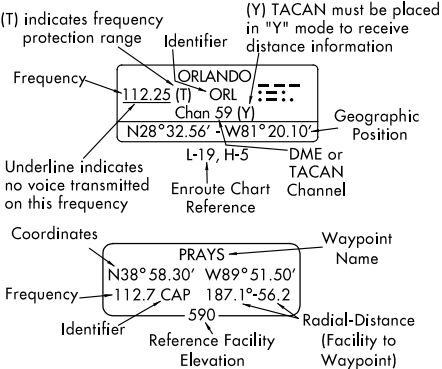
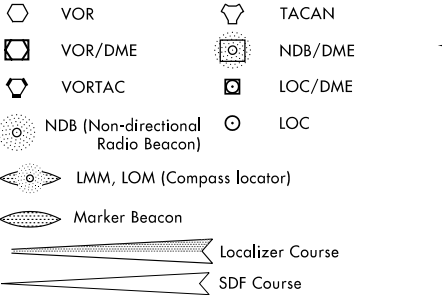

FIXES/ATC REPORTING REQUIREMENTS

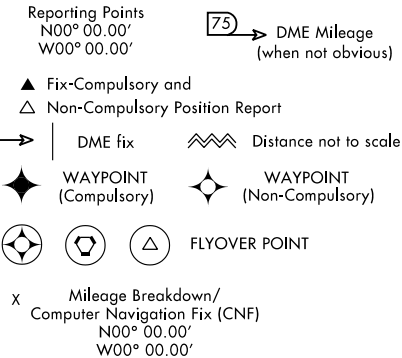

ROUTES

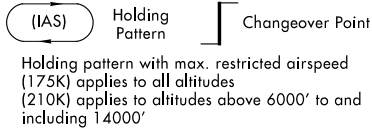
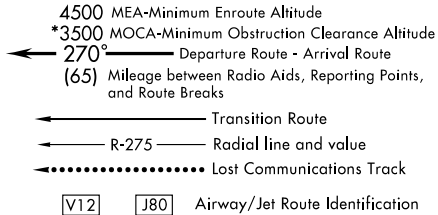

SPECIAL USE AIRSPACE

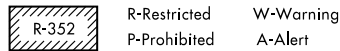

ALTITUDES

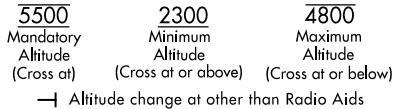

CROSSING ALTITUDES

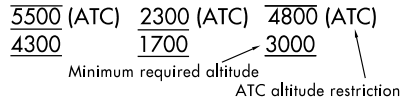

AIRPORTS

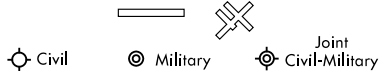

NOTES

- All mileages are nautical.
- \* Indicates a non-continuously operating facility, see A/FD or flight supplement.
- All radials, bearings are magnetic.
- All altitudes/elevations are in feet-MSL.
- MRA- Minimum Reception Altitude.
- MAA- Maximum Authorized Altitude.
- (NAME2.NAME) - Example of DP flight plan Computer Code.
- (NAME.NAME2) - Example of STAR flight plan Computer Code.
- SL-0000 (FAA) - Example of a chart reference number.
- Take-Off Minimums not standard and/or Departure Procedures are published.

LEGEND



INSTRUMENT APPROACH PROCEDURES (CHARTS)

AIRPORT DIAGRAM/AIRPORT SKETCH

Runways

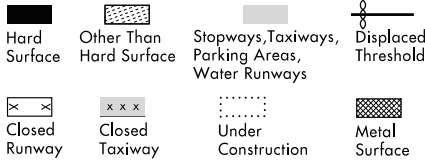

ARRESTING GEAR: Specific arresting gear systems; e.g., BAK12, MA-1A etc., shown on airport diagrams, not applicable to Civil Pilots. Military Pilots refer to appropriate DOD publications.

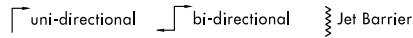

ARRESTING SYSTEM

REFERENCE FEATURES

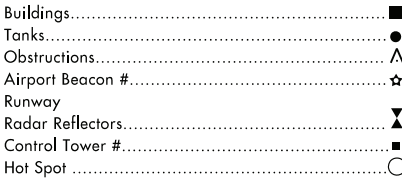

# When Control Tower and Rotating Beacon are co-located, Beacon symbol will be used and further identified as TWR.

Runway length depicted is the physical length of the runway (end-to-end, including displaced thresholds if any) but excluding areas designated as stopways.

A symbol is shown to indicate runway declared distance information available, see appropriate A/FD, Alaska or Pacific Supplement for distance information.

Runway Weight Bearing Capacity/or PCN Pavement Classification Number is shown as a codified expression. Refer to the appropriate Supplement/Directory for applicable codes e.g., RWY 14-32 S75, T185, ST175, TT325 PCN 80 F/D/X/U

Helicopter Alighting Areas   
Negative Symbols used to identify Copter Procedures landing point.....

Runway Threshold elevation.....THRE 123  
Runway TDZ elevation.....TDZE 123  
Runway Slope.....0.3% DOWN  
(shown when runway slope is greater than or equal to 0.3%)  
.....0.8% UP

NOTE:  
Runway Slope measured to midpoint on runways 8000 feet or longer.  
 U.S. Navy Optical Landing System (OLS) "OLS" location is shown because of its height of approximately 7 feet and proximity to edge of runway may create an obstruction for some types of aircraft.

Approach light symbols are shown in the Flight Information Handbook.

Airport diagram scales are variable.

True/magnetic North orientation may vary from diagram to diagram

Coordinate values are shown in 1 or 1/2 minute increments. They are further broken down into 6 second ticks, within each 1 minute increments.

NOTE:  
All new and revised airport diagrams are shown referenced to the World Geodetic System (WGS) (noted on appropriate diagram), and may not be compatible with local coordinates published in FLIP. (Foreign Only)

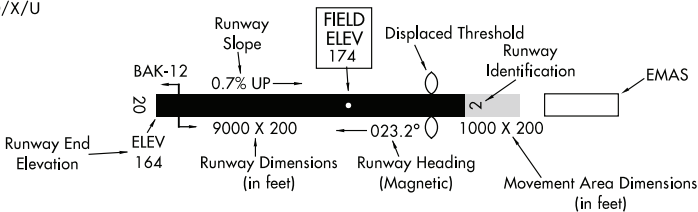

Airport diagrams are specifically designed to assist in the movement of ground traffic at locations with complex runway/taxiway configurations and provide information for updating Computer Based Navigation Systems (I.E., INS, GPS) aboard aircraft. Airport diagrams are not intended to be used for approach and landing or departure operations. For revisions to Airport Diagrams: Consult FAA Order 7910.4.

09239

**LEGEND**

INSTRUMENT APPROACH PROCEDURES (CHARTS)  
**APPROACH LIGHTING SYSTEM - UNITED STATES**

Approach lighting and visual glide slope systems are indicated on the airport sketch by an identifier, e.g., (A2), (V), etc.

A dot "•" portrayed with approach lighting letter identifier indicates sequenced flashing lights (F) installed with the approach lighting system e.g., (A1). Negative symbology, e.g., (A1), (V) indicates Pilot Controlled Lighting (PCL).

<p><b>RUNWAY TOUCHDOWN ZONE AND CENTERLINE LIGHTING SYSTEMS</b></p> <p><b>TDZ/CL</b>          TDZL CL          RUNWAY CENTERLINE LIGHTS</p>	<p><b>SHORT APPROACH LIGHTING SYSTEM</b></p> <p>(A2)</p> <p><b>SALS/SALSF</b>          (High Intensity)</p> <p>SAME AS INNER 1500' OF ALSF-1</p>	<p><b>OMNIDIRECTIONAL APPROACH LIGHTING SYSTEM</b></p> <p>(A2)</p> <p><b>ODALS</b></p> <p>THRESHOLD          36          1500'          SEQUENCED FLASHING LIGHTS          LENGTH 1500 FEET</p>
<p>AVAILABILITY of TDZ/CL will be shown by NOTE in SKETCH e.g. "TDZ/CL Rwy 15"</p>	<p><b>SIMPLIFIED SHORT APPROACH LIGHTING SYSTEM with Runway Alignment Indicator Lights</b></p> <p>(A3)</p> <p><b>SSALR</b></p> <p>2400' / 3000'          GREEN          WHITE          SEQUENCED FLASHING LIGHTS</p> <p>(High Intensity)          LENGTH 2400/3000 FEET</p>	<p>(V)</p> <p><b>VISUAL APPROACH SLOPE INDICATOR VASI</b></p> <p>VISUAL APPROACH SLOPE INDICATOR WITH STANDARD THRESHOLD CLEARANCE PROVIDED.</p> <p>ALL LIGHTS WHITE — TOO HIGH          FAR LIGHTS RED — ON GUIDE SLOPE          NEAR LIGHTS WHITE — ON GUIDE SLOPE          ALL LIGHTS RED — TOO LOW</p> <p>VASI 2 VASI 4          THRESHOLD THRESHOLD          36 36          100' 100'          300' 300'          VASI 12          THRESHOLD          36</p>
<p><b>APPROACH LIGHTING SYSTEM ALSF-2</b></p> <p>500'          1000'          2400' / 3000'          GREEN          WHITE          RED          WHITE          SEQUENCED FLASHING LIGHTS</p> <p>NOTE: CIVIL ALSF-2 MAY BE OPERATED AS SSALR DURING FAVORABLE WEATHER CONDITIONS</p> <p>(High Intensity)          LENGTH 2400/3000 FEET</p>	<p><b>MEDIUM INTENSITY (MALS and MALSF) OR SIMPLIFIED SHORT (SSALS and SSALF) APPROACH LIGHTING SYSTEMS</b></p> <p>(A4)</p> <p>1000'          400'          1400'          GREEN          WHITE          SEQUENCED FLASHING LIGHTS FOR MALSF/SSALF ONLY</p> <p>LENGTH 1400 FEET</p>	<p>(V3)</p> <p><b>VISUAL APPROACH SLOPE INDICATOR VASI</b></p> <p>VISUAL APPROACH SLOPE INDICATOR WITH A THRESHOLD CROSSING HEIGHT TO ACCOMMODATE LONG BODIED OR JUMBO AIRCRAFT.</p> <p>VASI 6 VASI 16          THRESHOLD THRESHOLD          36 36</p>
<p><b>APPROACH LIGHTING SYSTEM ALSF-1</b></p> <p>1000'          2400' / 3000'          RED          GREEN          WHITE          SEQUENCED FLASHING LIGHTS</p> <p>(High Intensity)          LENGTH 2400/3000 FEET</p>	<p><b>MEDIUM INTENSITY APPROACH LIGHTING SYSTEM with Runway Alignment Indicator Lights</b></p> <p>(A5)</p> <p><b>MALSR</b></p> <p>SAME LIGHT CONFIGURATION AS SSALR.</p>	

**LEGEND**

**LEGEND**

**INSTRUMENT APPROACH PROCEDURES (CHARTS)  
APPROACH LIGHTING SYSTEM - UNITED STATES**

Each approach lighting system indicated on Airport Diagrams will bear a system identification indicated in legend.

A dot "•" portrayed with approach lighting letter identifier indicates sequenced flashing lights (F) installed with the approach lighting system e.g., (A<sub>1</sub>). Negative symbology, e.g., (A<sub>1</sub>), (A<sub>2</sub>) indicates Pilot Controlled Lighting (PCL).

**(P) PRECISION APPROACH PATH INDICATOR**  
**PAPI**

Legend: □ White ■ Red

**(V<sub>2</sub>) PULSATING VISUAL APPROACH SLOPE INDICATOR**  
**PVASI**

**CAUTION:** When viewing the pulsating visual approach slope indicators in the pulsating white or pulsating red sectors, it is possible to mistake this lighting aid for another aircraft or a ground vehicle. Pilots should exercise caution when using this type of system.

**(V<sub>1</sub>) "T"-VISUAL APPROACH SLOPE INDICATOR**  
**"T"-VASI**

"T" ON BOTH SIDES OF RWY  
ALL LIGHTS VARIABLE WHITE.  
CORRECT APPROACH SLOPE-  
ONLY CROSS BAR VISIBLE.  
UPRIGHT "T"- FLY UP.  
INVERTED "T"- FLY DOWN.  
RED "T"- GROSS  
UNDERSHOOT.

**(V<sub>4</sub>) TRI-COLOR VISUAL APPROACH SLOPE INDICATOR**  
**TRCV**

**CAUTION:** When the aircraft descends from green to red, the pilot may see a dark amber color during the transition from green to red.

**(V<sub>5</sub>) ALIGNMENT OF ELEMENTS SYSTEMS**  
**APAP**

Above glide path      On Glide Path      Below Glide Path

Pointed panels which may be lighted at night.  
To use the system the pilot positions the aircraft  
so the elements are in alignment.

04162

## MLS FREQ PAIRING

MLS CHANNELING AND FREQUENCY PAIRING TABLE

MLS CHANNEL	VHF FREQUENCY	TACAN CHANNEL	MLS CHANNEL	VHF FREQUENCY	TACAN CHANNEL	MLS CHANNEL	VHF FREQUENCY	TACAN CHANNEL
500	108.10	18X	568	109.45	31Y	636	114.15	88Y
502	108.30	20X	570	109.55	32Y	638	114.25	89Y
504	108.50	22X	572	109.65	33Y	640	114.35	90Y
506	108.70	24X	574	109.75	34Y	642	114.45	91Y
508	108.90	26X	576	109.85	35Y	644	114.55	92Y
510	109.10	28X	578	109.95	36Y	646	114.65	93Y
512	109.30	30X	580	110.05	37Y	648	114.75	94Y
514	109.50	32X	582	110.15	38Y	650	114.85	95Y
516	109.70	34X	584	110.25	39Y	652	114.95	96Y
518	109.90	36X	586	110.35	40Y	654	115.05	97Y
520	110.10	38X	588	110.45	41Y	656	115.15	98Y
522	110.30	40X	590	110.55	42Y	658	115.25	99Y
524	110.50	42X	592	110.65	43Y	660	115.35	100Y
526	110.70	44X	594	110.75	44Y	662	115.45	101Y
528	110.90	46X	596	110.85	45Y	664	115.55	102Y
530	111.10	48X	598	110.95	46Y	666	115.65	103Y
532	111.30	50X	600	111.05	47Y	668	115.75	104Y
534	111.50	52X	602	111.15	48Y	670	115.85	105Y
536	111.70	54X	604	111.25	49Y	672	115.95	106Y
538	111.90	56X	606	111.35	50Y	674	116.05	107Y
540	108.05	17Y	608	111.45	51Y	676	116.15	108Y
542	108.15	18Y	610	111.55	52Y	678	116.25	109Y
544	108.25	19Y	612	111.65	53Y	680	116.35	110Y
546	108.35	20Y	614	111.75	54Y	682	116.45	111Y
548	108.45	21Y	616	111.85	55Y	684	116.55	112Y
550	108.55	22Y	618	111.95	56Y	686	116.65	113Y
552	108.65	23Y	620	113.35	80Y	688	116.75	114Y
554	108.75	24Y	622	113.45	81Y	690	116.85	115Y
556	108.85	25Y	624	113.55	82Y	692	116.95	116Y
558	108.95	26Y	626	113.65	83Y	694	117.05	117Y
560	109.05	27Y	628	113.75	84Y	696	117.15	118Y
562	109.15	28Y	630	113.85	85Y	698	117.25	119Y
564	109.25	29Y	632	113.95	86Y			
566	109.35	30Y	634	114.05	87Y			

MLS FREQ PAIRING

N1

## **RADAR MINS**

95313

### **RADAR INSTRUMENT APPROACH MINIMUMS**

**THERE ARE NO RADAR PROCEDURES  
FOR THIS VOLUME**

PC-1

### **RADAR INSTRUMENT APPROACH MINIMUMS**

## **RADAR MINS**

95313

09015

### LAND AND HOLD SHORT OPERATIONS (LAHSO)

LAHSO is an acronym for "Land and Hold Short Operations." These operations include landing and holding short of an intersection runway, an intersecting taxiway, or other predetermined points on the runway other than a runway or taxiway. Measured distance represents the available landing distance on the landing runway, in feet.

Specific questions regarding these distances should be referred to the air traffic manager of the facility concerned. The Aeronautical Information Manual contains specific details on hold-short operations and markings.

CITY/AIRPORT	LDG RWY	HOLD-SHORT POINT	MEASURED DISTANCE
HONOLULU, HI HONOLULU INTL (HNL) (PHNL)	04L	08L/26R	3,700 feet
	04R	08L/26R	6,250 feet
	08L	04L/22R	9,300 feet

09015

## HOT SPOTS

An "airport surface hot spot" is a location on an aerodrome movement area with a history or potential risk of collision or runway incursion, and where heightened attention by pilots/drivers is necessary.

A "hot spot" is a runway safety related problem area on an airport that presents increased risk during surface operations. Typically it is a complex or confusing taxiway/taxiway or taxiway/runway intersection. The area of increased risk has either a history of or potential for runway incursions or surface incidents, due to a variety of causes, such as but not limited to: airport layout, traffic flow, airport marking, signage and lighting, situational awareness, and training. Hot spots are depicted on airport diagrams as open circles or polygons designated as "HOT<sup>1</sup>", "HOT<sup>2</sup>", etc. and tabulated in the list below with a brief description of each hot spot. Hot spots will remain charted on airport diagrams until such time the increased risk has been reduced or eliminated.

CITY/AIRPORT	HOT SPOT	DESCRIPTION *
KAHULUI, HI KAHULUI (OGG)(PHOG)	HOT <sup>1</sup> HOT <sup>2</sup>	Rwy 5, Twy A, Twy F, and Twy G. Rwy 2/20, Twy E and the ramp.

\*See appropriate A/FD, Alaska or Pacific Supplement HOT SPOT table for additional information.

07074

ST-754 (FAA)

HONOLULU INTL (HNL) (PHNL)  
HONOLULU, HAWAII

**BOOKE EIGHT ARRIVAL (BOOKE.BOOKE8)**

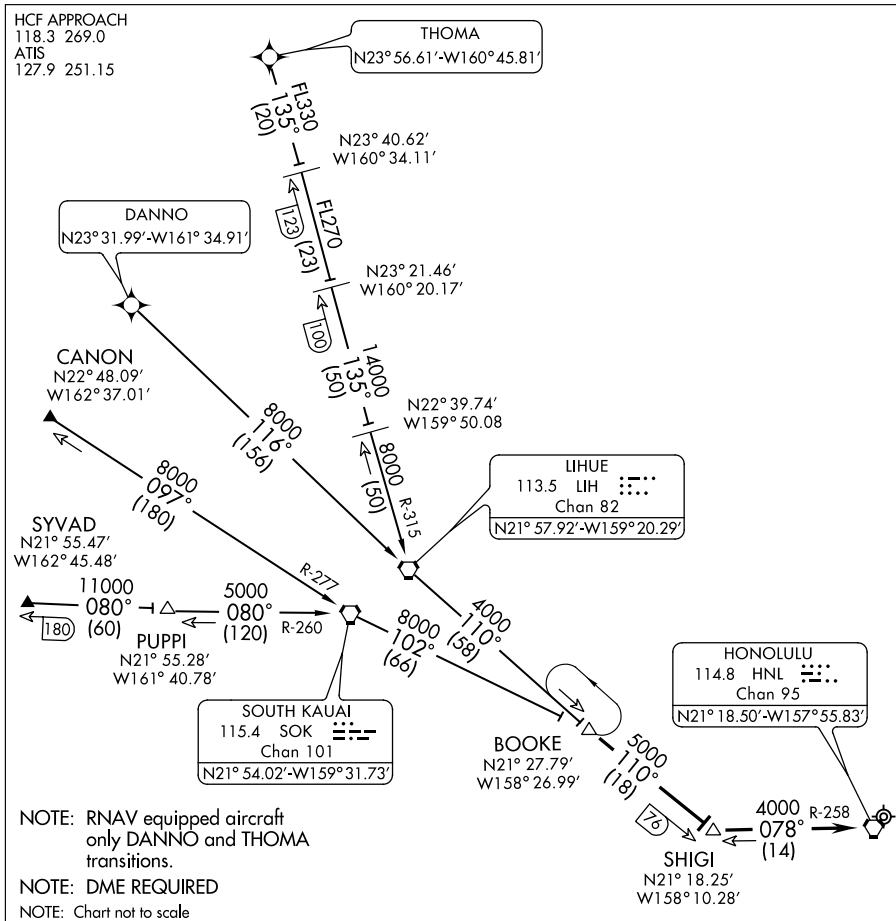

**ARRIVAL DESCRIPTION**

**CANON TRANSITION (CANON.BOOKE8):** From over CANON INT via SOK R-277 to SOK VORTAC. Then via SOK R-102 to BOOKE DME. Thence....

**DANNO TRANSITION (DANNO.BOOKE8):** From over DANNO WP via RNAV 116° course to LIH VORTAC. Then via LIH R-110 to BOOKE DME. Thence....

**SYVAD TRANSITION (SYVAD.BOOKE8):** From over SYVAD INT via SOK R-260 to SOK VORTAC. Then via SOK R-102 to BOOKE DME. Thence....

**THOMA TRANSITION (THOMA.BOOKE8):** From over THOMA WP via RNAV 135° course to LIH 123 DME, then LIH R-315 to LIH VORTAC. Then via LIH R-110 to BOOKE DME. Thence....

....From over BOOKE DME via LIH R-110 and HNL R-258 to HNL VORTAC. Expect radar vectors.

**BOOKE EIGHT ARRIVAL (BOOKE.BOOKE8)**

HONOLULU, HAWAII  
HONOLULU INTL (HNL) (PHNL)

07074



CAMPS TWO ARRIVAL (CAMPS.CAMPS2)

KAHULUI (OGG)(PHOG)  
KAHULUI, HAWAII

ATIS  
128.6  
HCF APPROACH  
119.5 343.8  
MAUI TOWER★  
118.7 279.6

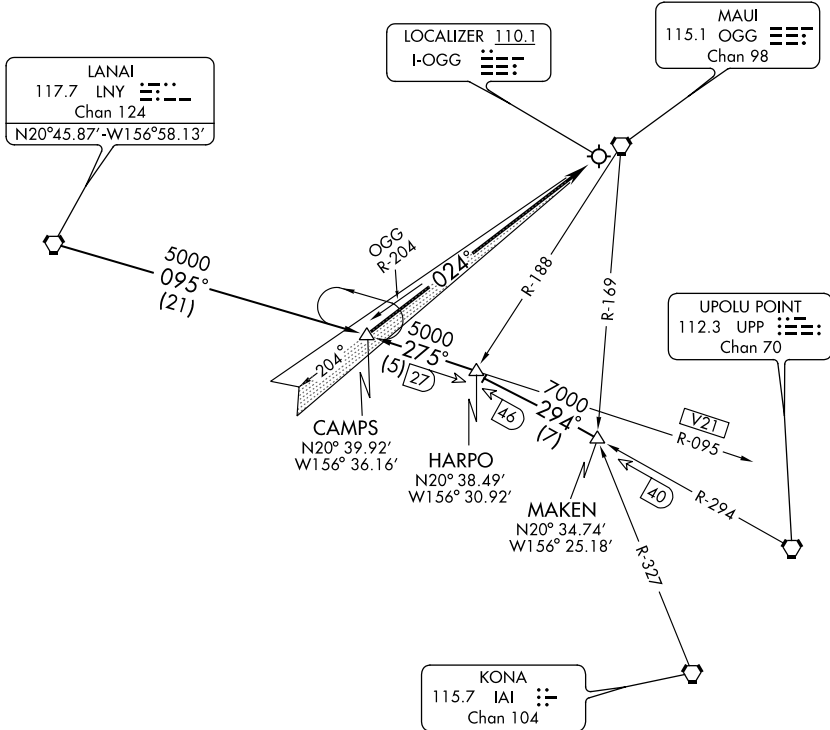

NOTE: Chart not to scale.

LANAI TRANSITION (LNY.CAMPS2): From over LNY VORTAC via LNY R-095 to CAMPS INT. Thence . . . .

MAKEN TRANSITION (MAKEN.CAMPS2): From over MAKEN INT via UPP R-294 and LNY R-095 to CAMPS INT. Thence . . . .

. . . . From over CAMPS INT via I-OGG localizer course to KAHULUI AIRPORT.

CAMPS TWO ARRIVAL (CAMPS.CAMPS2)

KAHULUI, HAWAII  
KAHULUI (OGG)(PHOG)





(KAYAK.KAYAK4) 07018

KAILUA-KONA/  
KONA INTL AT KEAHOLE (KOA) (PHKO)  
ST-5761 (FAA) KAILUA-KONA, HAWAII**KAYAK FOUR ARRIVAL**

## ARRIVAL DESCRIPTION

BARBY TRANSITION (BARBY.KAYAK4): From over BARBY INT via IAI R-351, UPP R-212 and IAI R-339 to KAYAK INT. Thence....

FIRES TRANSITION (FIRES.KAYAK4): From over FIRES INT via MUE R-274, LNY R-119 and IAI R-339 to KAYAK INT. Thence....

HEFTI TRANSITION (HEFTI.KAYAK4): From over HEFTI INT via LNY R-119 and IAI R-339 to KAYAK INT. Thence....

LANAI TRANSITION (LNY.KAYAK4): From over LNY VORTAC via LNY R-119 and IAI R-339 to KAYAK INT. Thence....

MOLOKAI TRANSITION (MKK.KAYAK4): From over MKK VORTAC via MKK R-108 and IAI R-339 to KAYAK INT. Thence....

OKALA TRANSITION (OKALA.KAYAK4): From over OKALA INT via MUE R-077 to MUE VOR/DME. Then via MUE R-245 to KAYAK INT. Thence....

UPOLU TRANSITION (UPP.KAYAK4): From over UPP VORTAC via UPP R-212 and IAI R-339 to KAYAK INT. Thence....

....From over KAYAK INT via IAI R-339 to BILGE DME.

**KAYAK FOUR ARRIVAL**  
(KAYAK.KAYAK4) 07018KAILUA-KONA/  
KONA INTL AT KEAHOLE (KOA) (PHKO)  
KAILUA-KONA, HAWAII

07018

ST-754 (FAA)

# MAGGI THREE ARRIVAL (MAGGI.MAGGI3)

HONOLULU INTL (HNL) (PHNL)  
HONOLULU, HAWAII

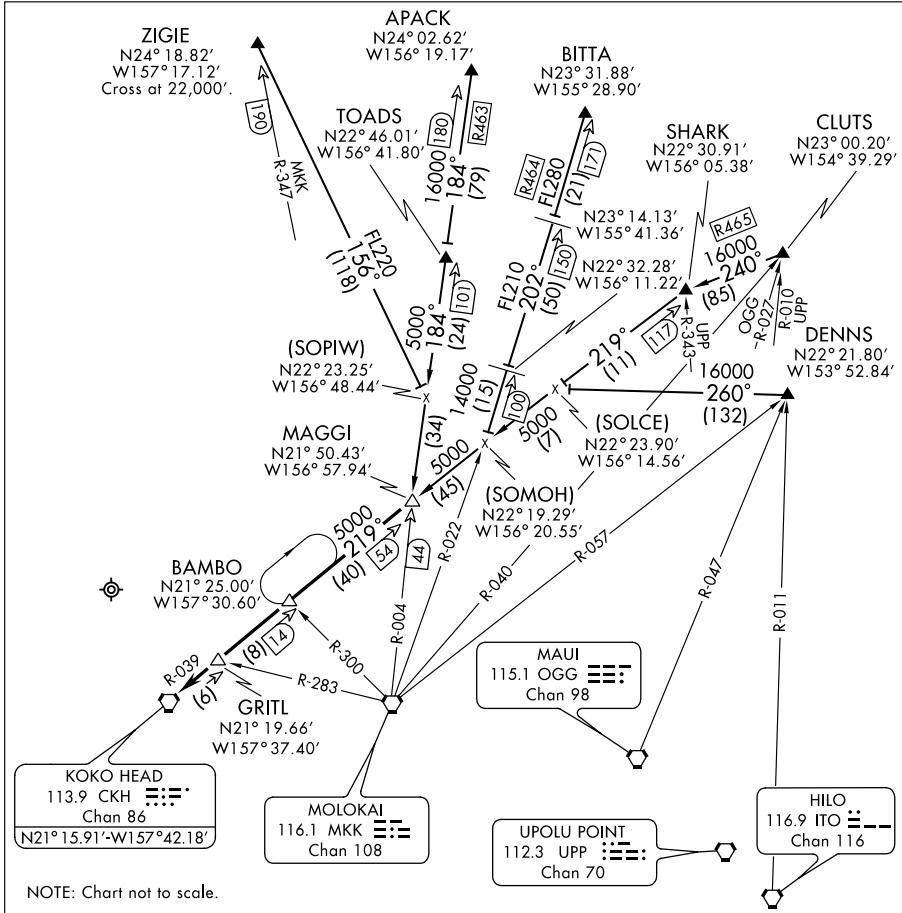

## ARRIVAL DESCRIPTION

**APACK TRANSITION (APACK.MAGGI3):** From over APACK DME via MKK R-004 to MAGGI INT. Thence....

**BITTA TRANSITION (BITTA.MAGGI3):** From over BITTA DME via MKK R-022 to intercept CKH R-039 to MAGGI INT. Thence....

**CLUTS TRANSITION (CLUTS.MAGGI3):** From over CLUTS DME via heading 240° to intercept CKH R-039 to MAGGI INT. Thence....

**DENNS TRANSITION (DENNS.MAGGI3):** From over DENNS INT via heading 260° to intercept CKH R-039 to MAGGI INT. Thence....

**ZIGIE TRANSITION (ZIGIE.MAGGI3):** From over ZIGIE DME via heading 156° to intercept MKK R-004 to MAGGI INT. Thence....

....From over MAGGI INT via CKH R-039 to CKH VORTAC then radar vectors for approach to airport.

# MAGGI THREE ARRIVAL (MAGGI.MAGGI3)

HONOLULU, HAWAII

07018

HONOLULU INTL (HNL) (PHNL)

07018

ST-754 (FAA)

OPACA FOUR ARRIVAL (OPACA.OPACA4)

HONOLULU INTL (HNL) (PHNL)  
HONOLULU, HAWAII

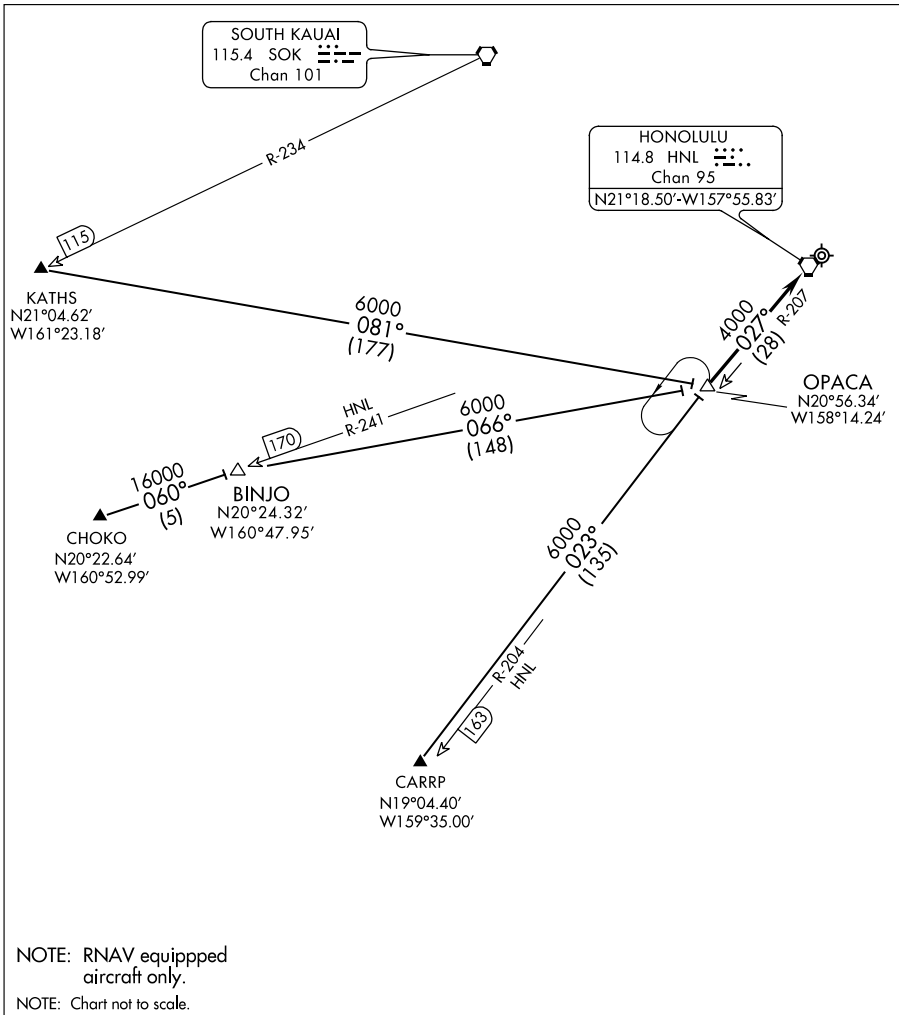

ARRIVAL DESCRIPTION

CARRP TRANSITION (CARRP.OPACA4): From over CARRP WP, RNAV direct to OPACA DME. Thence....  
CHOKO TRANSITION (CHOKO.OPACA4): From over CHOKO WP, RNAV direct to BINJO DME, then direct to OPACA DME. Thence....  
KATHS TRANSITION (KATHS.OPACA4): From over KATHS WP, RNAV direct to OPACA DME. Thence....  
 ....From over OPACA DME via HNL R-207 to HNL VORTAC, expect radar vectors to final approach course.

OPACA FOUR ARRIVAL (OPACA.OPACA4)

HONOLULU, HAWAII  
HONOLULU INTL (HNL) (PHNL)

07018

# SAKKI FOUR ARRIVAL (SAKKI.SAKKI4)

HONOLULU INTL (HNL) (PHNL)  
HONOLULU, HAWAII

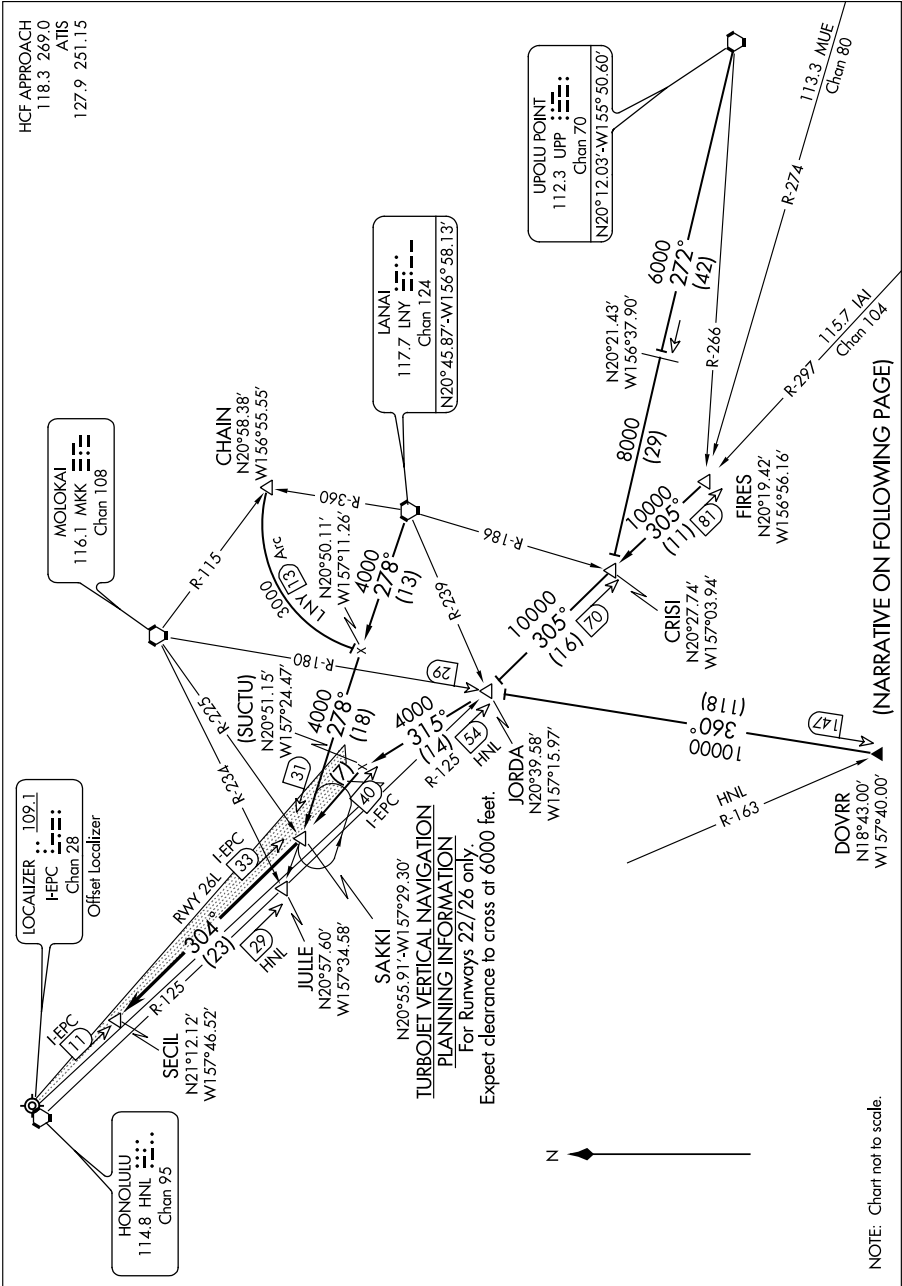

# SAKKI FOUR ARRIVAL (SAKKI.SAKKI4)

HONOLULU, HAWAII  
HONOLULU INTL (HNL) (PHNL)

07018

ST-754 (FAA)

**SAKKI FOUR ARRIVAL (SAKKI.SAKKI4)**HONOLULU INTL (HNL) (PHNL)  
HONOLULU, HAWAII

## ARRIVAL DESCRIPTION

CHAIN TRANSITION (CHAIN.SAKKI4): From over CHAIN INT via LNY 13 DME Arc to intercept LNY R-278 to SAKKI INT. Thence....

DOVRR TRANSITION (DOVRR.SAKKI4): From over DOVRR INT via MKK R-180 to JORDA INT, left turn heading 315° to join I-EPC LDA course at 40 DME to SAKKI INT. Thence....

FIRES TRANSITION (FIRES.SAKKI4): From over FIRES INT via HNL R-125 to JORDA INT, right turn heading 315° to join I-EPC LDA course at 40 DME to SAKKI INT. Thence....

LANAI TRANSITION (LNY.SAKKI4): From over LNY VORTAC via LNY R-278 to SAKKI INT. Thence....

UPOLU TRANSITION (UPP.SAKKI4): From over UPP VORTAC via UPP R-272 and HNL R-125 to JORDA INT, right turn heading 315° to join I-EPC LDA course at 40 DME to SAKKI INT. Thence....

....For Runways 22/26 only: From over SAKKI INT via the LDA/DME Runway 26L course to SECIL DME.

**SAKKI FOUR ARRIVAL (SAKKI.SAKKI4)**

07018

HONOLULU, HAWAII  
HONOLULU INTL (HNL) (PHNL)





(VECKI.VECKI6) 07018

**VECKI SIX ARRIVAL**KAILUA-KONA/ KONA INTL AT KEAHOLE (KOA) (PHKO)  
ST-5761 (FAA)

KAILUA-KONA, HAWAII

**ARRIVAL DESCRIPTION**

BARBY TRANSITION (BARBY.VECKI6): From over BARBY INT via IAI R-351 and I-KOA localizer course to VECKI INT. Thence....

LANAI TRANSITION (LNY.VECKI6): From over LNY VORTAC via LNY R-119 and I-KOA localizer course to VECKI INT. Thence....

MOLOKAI TRANSITION (MKK.VECKI6): From over MKK VORTAC via MKK R-108, IAI VORTAC R-339, LNY R-119 and I-KOA localizer course to VECKI INT. Thence....

OKALA TRANSITION (OKALA.VECKI6): From over OKALA INT via MUE VOR/DME R-077 to MUE VOR/DME. Thence from over MUE VOR/DME via MUE R-245 to VECKI INT. Thence....

UPOLU TRANSITION (UPP.VECKI6): From over UPP VORTAC via UPP R-209 and I-KOA localizer course to VECKI INT. Thence....

....From over VECKI INT via I-KOA localizer course to KEAHOLE-KONA INTL AIRPORT.

**VECKI SIX ARRIVAL**  
(VECKI.VECKI6) 07018KAILUA-KONA, HAWAII  
KAILUA-KONA/ KONA INTL AT KEAHOLE (KOA) (PHKO)

**INTENTIONALLY  
LEFT  
BLANK**

BABELTHUAP, KOROR, PS

AL-6432 (FAA)

APP CRS	Rwy Idg	<b>7200</b>
<b>090°</b>	TDZE	<b>176</b>
	Apt Elev	<b>176</b>

# RNAV (GPS) RWY 9

BABELTHUAP/ KOROR (ROR)(PTR0)

**⚠** Circling not authorized north of Rwy 9-27.  
**⚠** Obtain local altimeter setting on CTAF; when not received, procedure not authorized.  
 DME/DME RNP-0.3 NA.  
 No controlled airspace below 5500.

MISSED APPROACH: Climb to 1900 direct ITAZU WP and hold.

KOROR RADIO  
**123.6 (CTAF) 0**

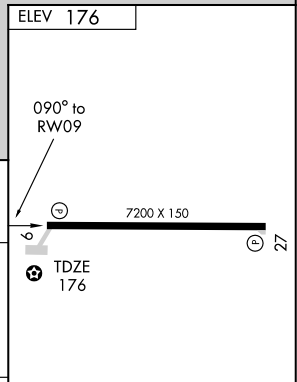
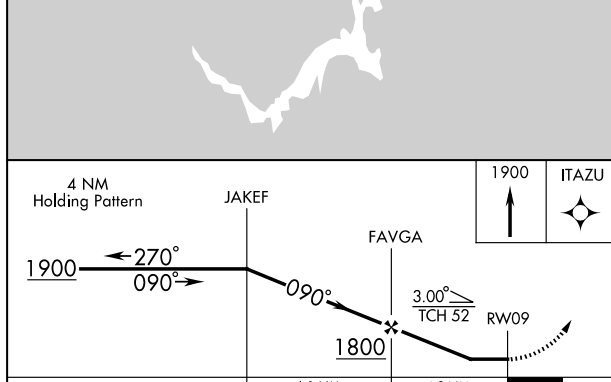
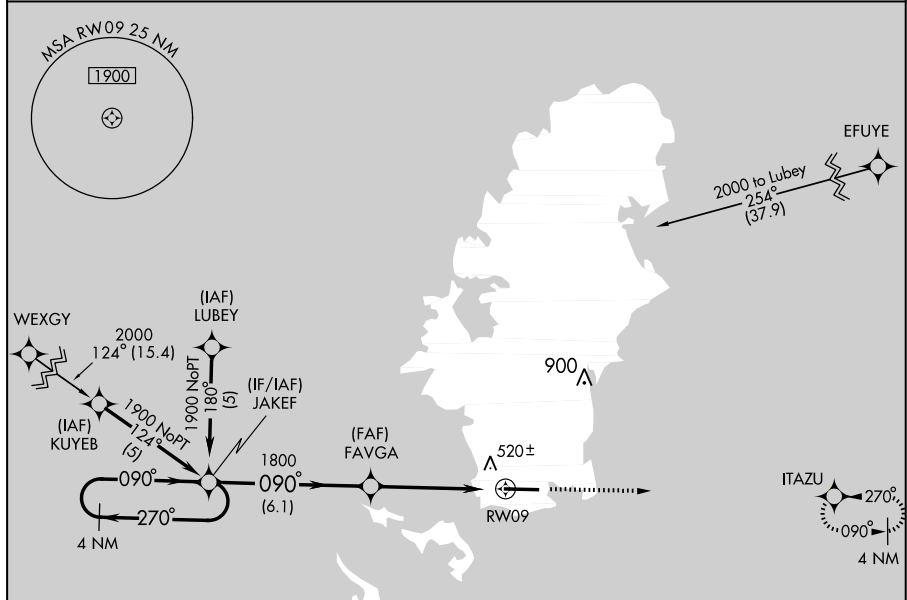

CATEGORY	A	B	C	D
LNAV MDA	720-1	544 (600-1)	720-1½ 544 (600-1½)	720-1¾ 544 (600-1¾)
CIRCLING	720-1	544 (600-1)	760-1½ 584 (600-1½)	780-2 604 (700-2)

MIRL Rwy 9-27 0  
 REIL Rws 9 and 27

BABELTHUAP, KOROR, PS  
 Orig-A 09015

07° 22' N-134° 33' E

# BABELTHUAP/ KOROR (ROR)(PTR0)

## RNAV (GPS) RWY 9

BABELTHUAP, KOROR, PS

AL-6432 (FAA)

# RNAV (GPS) RWY 27

BABELTHUAP/ KOROR (ROR)(PTRO)

APP CRS <b>270°</b>	Rwy Idg <b>7200</b>
	TDZE <b>176</b>
	Apt Elev <b>176</b>



Circling not authorized north of Rwy 9-27.  
Obtain local altimeter setting on CTAF; when not received, procedure not authorized.  
DME/DME RNP-0.3 NA.  
No controlled airspace below 5500.

MISSED APPROACH: Climb to 1900 direct JAKEF WP and hold.

KOROR RADIO  
**123.6 (CTAF) 0**

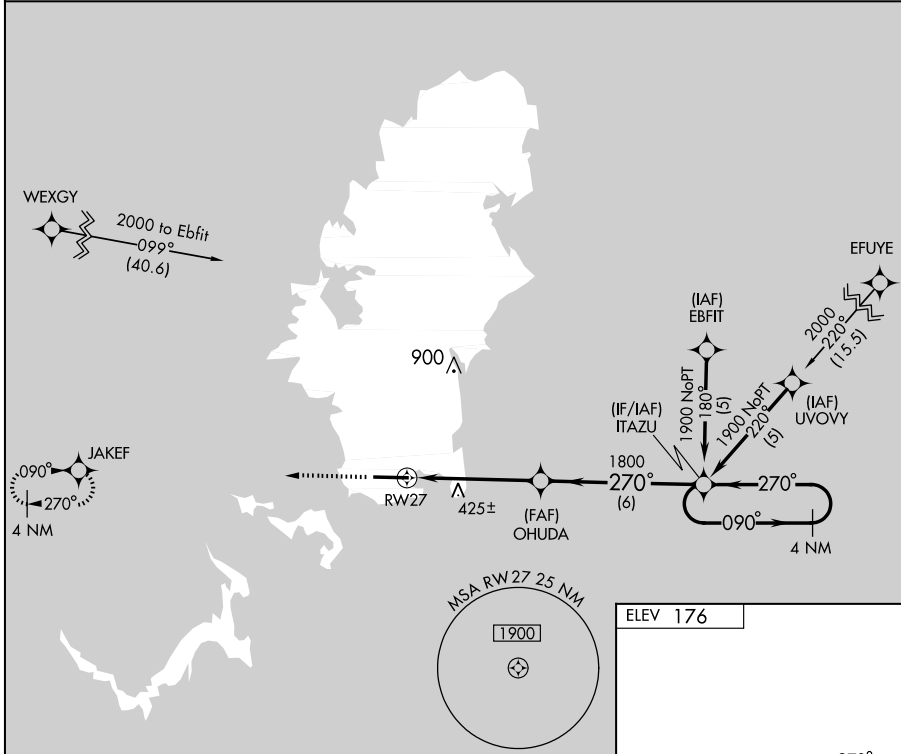

ELEV 176

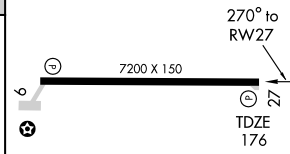
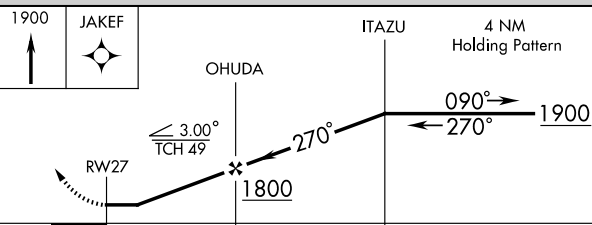

CATEGORY	A	B	C	D
LNAV MDA	680-1 504 (600-1)		680-1½ 504 (600-1½)	
CIRCLING	680-1 504 (600-1)	700-1 524 (600-1)	760-1½ 584 (600-1½)	780-2 604 (700-2)

MRL Rwy 9-27 0  
REIL Rwys 9 and 27

BABELTHUAP, KOROR, PS  
Orig-A 09015

07° 22'N-134° 33'E

# RNAV (GPS) RWY 27

BABELTHUAP, KOROR, PS

AL-6432 (FAA)

NDB/DME ROR <b>371</b>	APP CRS <b>087°</b>	Rwy Idg <b>7200</b>
Chan <b>104 (115.7)</b>	TDZE <b>176</b>	Apt Elev <b>176</b>

**NDB RWY 9**  
BABELTHUAP/KOROR (ROR)(PTRO)



Circling not authorized north of Rwy 9-27.  
Obtain local altimeter setting on CTAF; when not received procedure not authorized.  
No controlled airspace below 5500.

MISSED APPROACH: Climb to 1900 via 090° bearing from ROR NDB, then right turn direct ROR NDB and hold.

KOROR RADIO  
**123.6 (CTAF)**

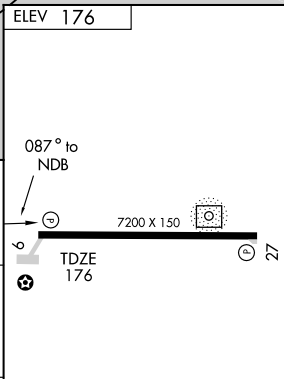
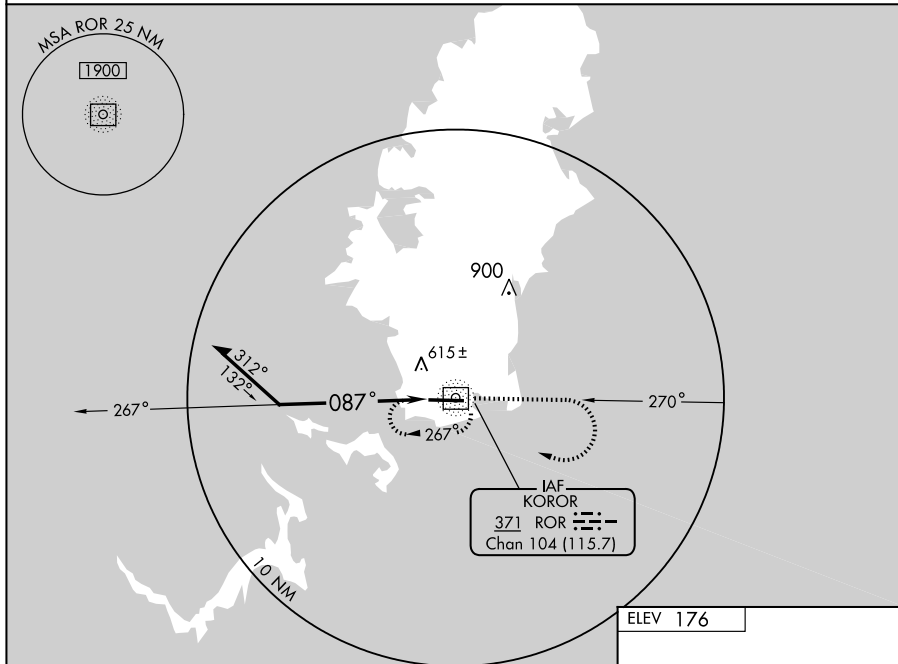

Remain within 10 NM

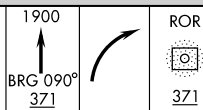
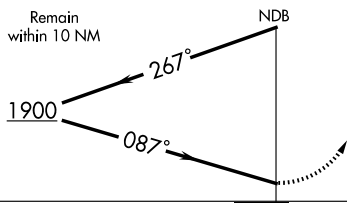

CATEGORY	A	B	C	D
S-9	980-1 804 (900-1)	980-1¼ 804 (900-1¼)	980-2¼ 804 (900-2¼)	980-2½ 804 (900-2½)
CIRCLING	980-1 804 (900-1)	980-1¼ 804 (900-1¼)	980-2¼ 804 (900-2¼)	980-2½ 804 (900-2½)

MIRL Rwy 9-27  
REIL Rwys 9 and 27

BABELTHUAP, KOROR, PS  
Orig-A 09015

07°22'N-134°33'E

BABELTHUAP/KOROR (ROR)(PTRO)  
**NDB RWY 9**

09015

# AIRPORT DIAGRAM

AL-6432 (FAA)

BABELTHUAP/KOROR (ROR) (PTRO)

BABELTHUAP, KOROR, PS

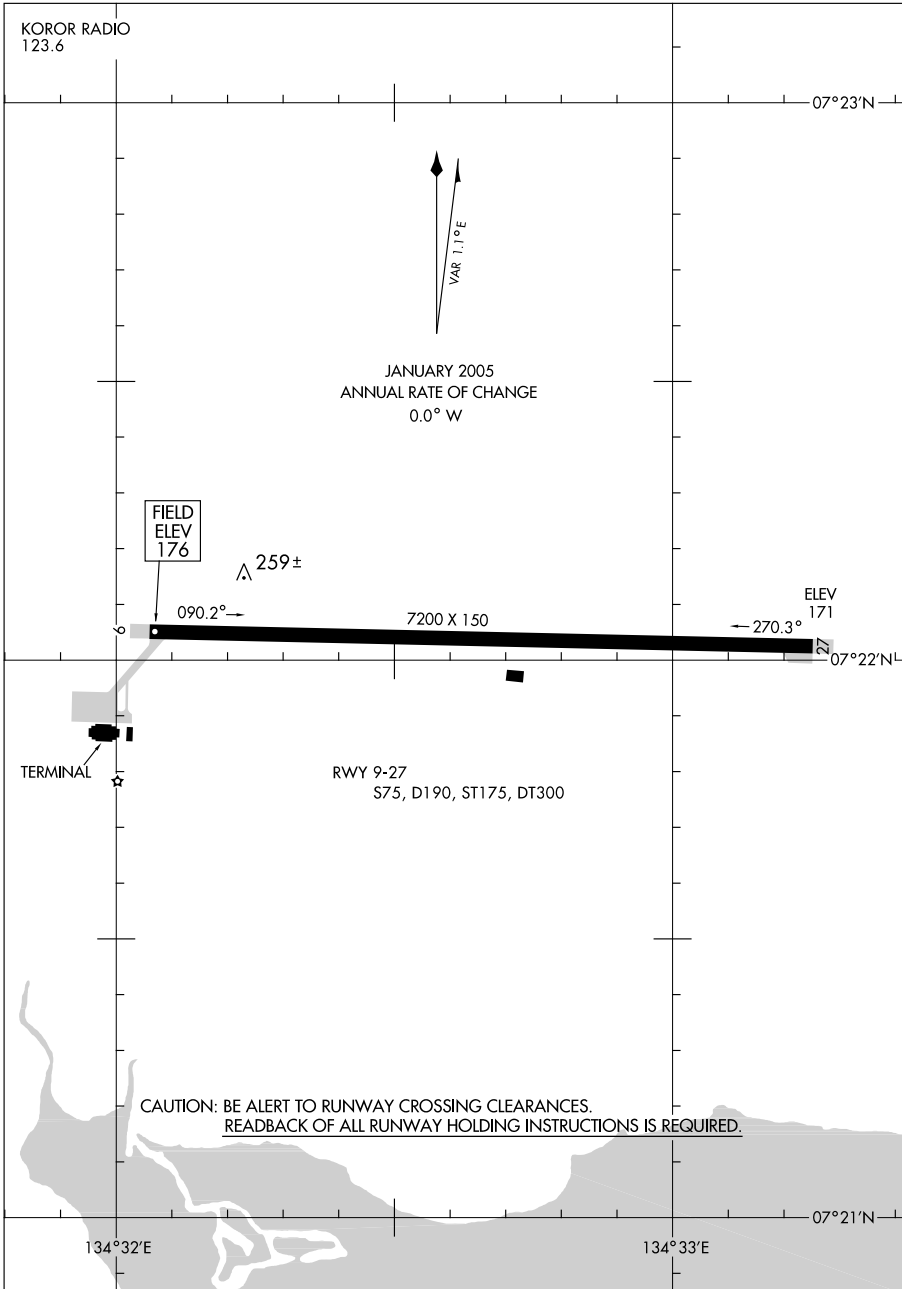

# AIRPORT DIAGRAM

09015

BABELTHUAP, KOROR, PS

BABELTHUAP/KOROR (ROR) (PTRO)

DALAP, RM

AL-6049 (FAA)

APP CRS	Rwy Idg	<b>7897</b>
<b>066°</b>	TDZE	<b>6</b>
	Apt Elev	<b>6</b>

# RNAV (GPS) RWY 7

DALAP/MARSHALL ISLANDS INTL (MAJ) (PKMJ)

**▲** Obtain local altimeter setting on CTAF; when not received, procedure NA.  
 No controlled airspace below 5500.  
 DME/DME RNP-0.3 NA.

MISSED APPROACH: Climb to 1700 direct TOZTU WP and hold.

MAJURO RADIO  
**123.6 (CTAF)**

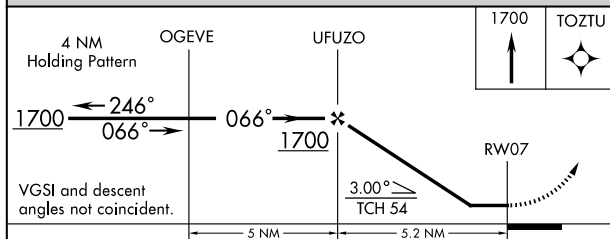
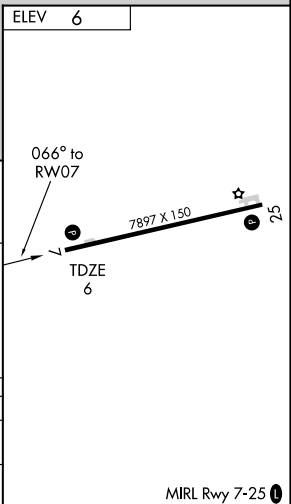
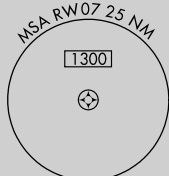
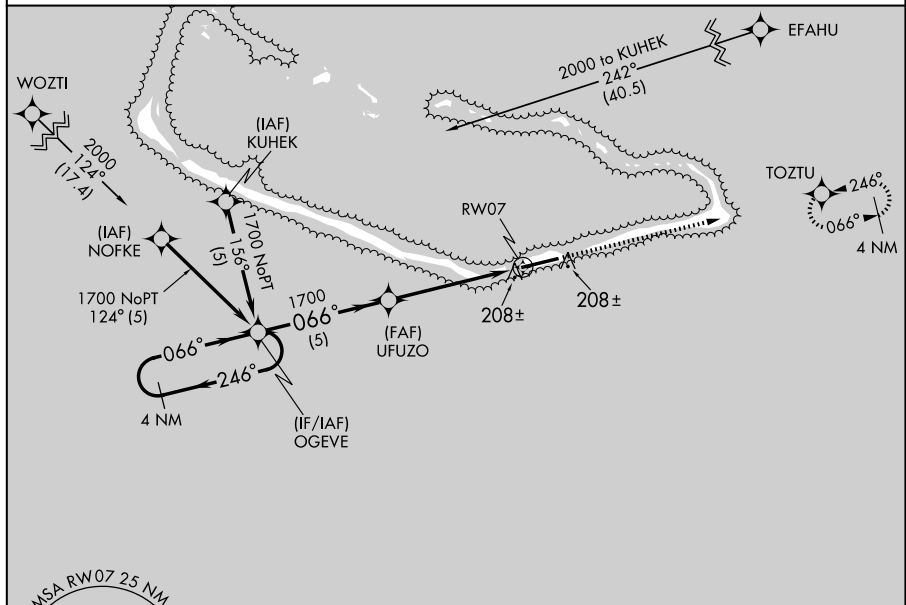

CATEGORY	A	B	C	D
LNAV MDA	460-1	454 (500-1)	460-1¼ 454 (500-1½)	460-1½ 454 (500-1½)
CIRCLING	520-1	514 (600-1)	520-1½ 514 (600-1½)	560-2 554 (600-2)

DALAP, RM  
 Orig-B 09071

DALAP/MARSHALL ISLANDS INTL (MAJ) (PKMJ)  
 07°04'N-171°16'E  
**RNAV (GPS) RWY 7**



DALAP, RM

AL-6049 (FAA)

APP CRS <b>246°</b>	Rwy Idg <b>7897</b>
	TDZE <b>6</b>
	Apt Elev <b>6</b>

# RNAV (GPS) RWY 25

DALAP/MARSHALL ISLANDS INTL (MAJ) (PKMJ)

**A** Obtain local altimeter setting on CTAF; when not received, procedure NA.  
No controlled airspace below 5500.  
DME/DME RNP-0.3 NA.

MISSED APPROACH: Climb to 1700 direct OGEVE WP and hold.

MAJURO RADIO  
**123.6 (CTAF) 0**

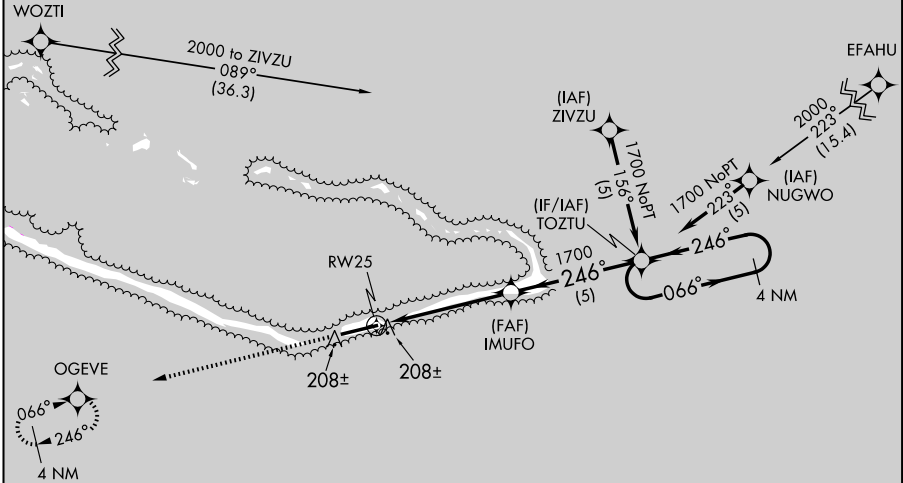

ELEV **6**

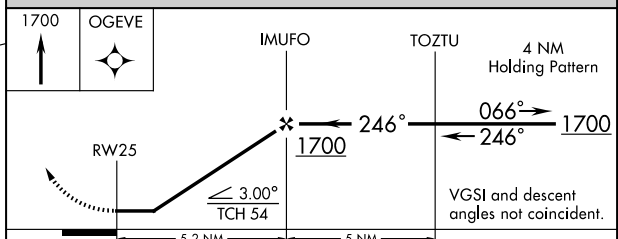
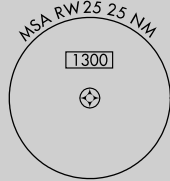
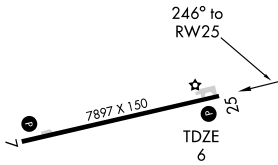

CATEGORY	A	B	C	D
LNAV MDA	460-1	454 (500-1)	460-1¼ 454 (500-1¼)	460-1½ 454 (500-1½)
CIRCLING	520-1	514 (600-1)	520-1½ 514 (600-1½)	560-2 554 (600-2)

MIRL Rwy 7-25 0

DALAP, RM  
Orig-B 09071

DALAP/MARSHALL ISLANDS INTL (MAJ) (PKMJ)  
07°04'N-171°16'E  
**RNAV (GPS) RWY 25**

DALAP, RM

AL-6049 (FAA)

NDB/DME MAJ <b>316</b>	APP CRS <b>064°</b>	Rwy ldg <b>7897</b> TDZE <b>6</b> Apt Elev <b>6</b>
Chan <b>114 (116.7)</b>		

# NDB RWY 7

DALAP/MARSHALL ISLANDS INTL (MAJ) (PKMJ)

**⚠** Obtain local altimeter setting on CTAF; when not received procedure not authorized. MISSED APPROACH: Climbing right turn to 1200 in MAJ NDB/DME holding pattern.

MAJUO RADIO  
**123.6 (CTAF)** **📻**

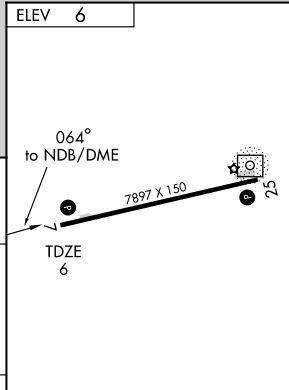
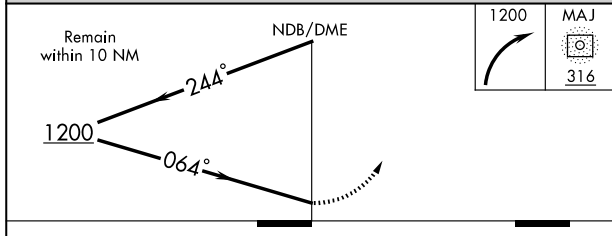
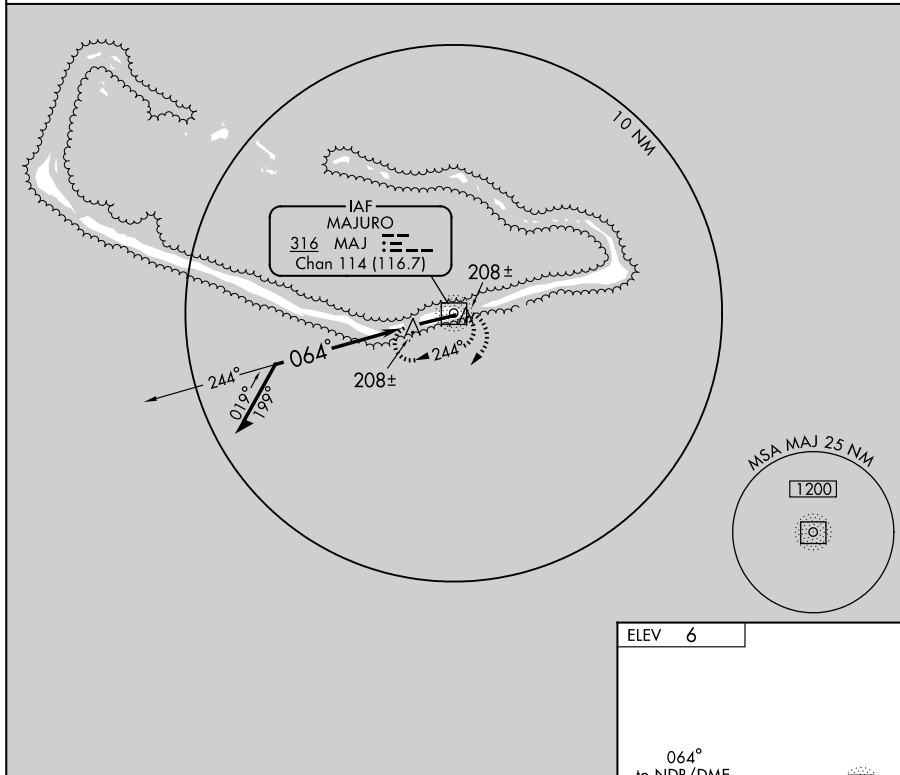

CATEGORY	A	B	C	D
S-7	560-1	554 (600-1)	560-1½ 554 (600-1½)	560-1¾ 554 (600-1¾)
CIRCLING	560-1	554 (600-1)	560-1½ 554 (600-1½)	560-2 554 (600-2)

MIRL Rwy 7-25 **📻**

DALAP, RM  
Orig-B 09071

DALAP/MARSHALL ISLANDS INTL (MAJ) (PKMJ)  
07°04'N-171°16'E

# NDB RWY 7

DALAP, RM

AL-6049 (FAA)

NDB/DME MAJ <b>316</b>	APP CRS <b>255°</b>	Rwy Idg <b>7897</b> TDZE <b>6</b> Apt Elev <b>6</b>
Chan <b>114 (116.7)</b>		

# NDB RWY 25

DALAP/MARSHALL ISLANDS INTL (MAJ) (PKMJ)

**A** Obtain local altimeter setting on CTAF; when not received procedure not authorized.

MISSED APPROACH: Climbing right turn to 1200 in MAJ NDB/DME holding pattern.

MAJURO RADIO  
**123.6 (CTAF) 0**

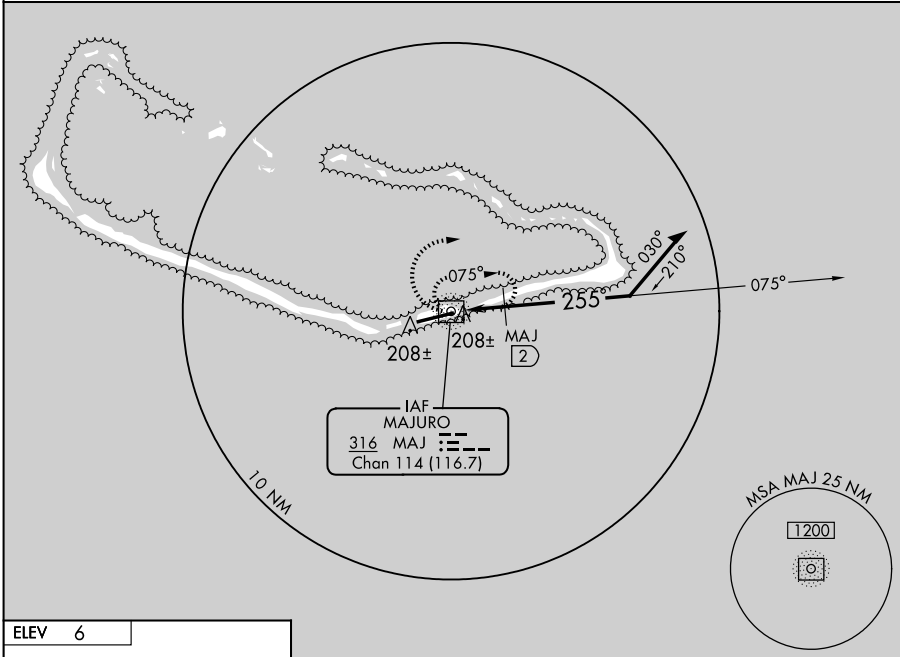

ELEV **6**

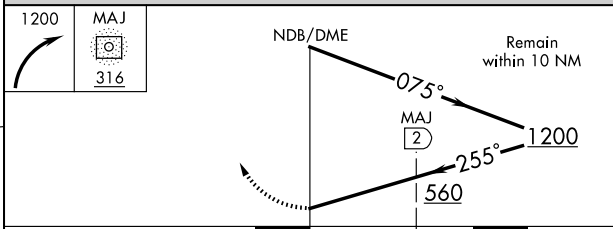
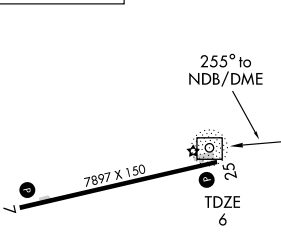

CATEGORY	A	B	C	D
S-25	560-1	554 (600-1)	560-1½ 554 (600-1½)	560-1¾ 554 (600-1¾)
CIRCLING	560-1	554 (600-1)	560-1½ 554 (600-1½)	560-2 554 (600-2)
DME MINIMUMS				
S-25	460-1	454 (500-1)	460-1¼ 454 (500-1¼)	460-1½ 454 (500-1½)
CIRCLING	560-1	554 (600-1)	560-1½ 554 (600-1½)	560-2 554 (600-2)

MIRL Rwy 7-25 0

DALAP, RM  
Orig-B 09071

DALAP/MARSHALL ISLANDS INTL (MAJ) (PKMJ)  
07°04'N-171°16'E

# NDB RWY 25



GUAM, GQ

AL-2146 (FAA)

LOC/DME I-AWD <b>110.9</b> Chan 46	APP CRS <b>063°</b>	Rwy Idg <b>10014</b> TDZE <b>258</b> Apt Elev <b>298</b>
--	------------------------	--

**ILS or LOC RWY 6R**  
GUAM INTL (GUM)(PGUM)

**⚠** Circling NA southeast of Rwy 6R-24L.  
**⚠** DME or RADAR required.  
When local altimeter setting not received, procedure NA.

MALSR 

MISSED APPROACH: Climb to 2100 then climbing right turn to 3000 direct UNZ VORTAC and via I-AWD to MEMKE/I-AWD 14.1 DME/RADAR and hold.

ATIS <b>119.0</b>	GUAM APP CON <b>119.8 269.0</b>	AGANA TOWER <b>118.1 340.2</b>	GND CON <b>121.9 336.4</b>	CLNC DEL <b>121.9</b>
----------------------	------------------------------------	-----------------------------------	-------------------------------	--------------------------

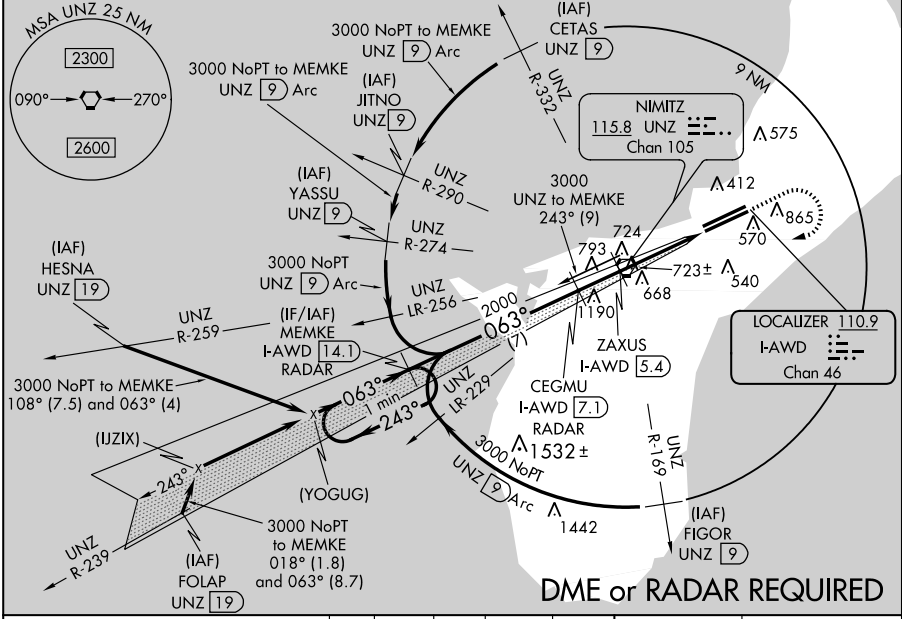

**DME or RADAR REQUIRED**

Use I-AWD DME when on localizer course.  
VGSI and ILS glidepath not coincident.

One Minute Holding Pattern  
MEMKE I-AWD 14.1 RADAR

CEGMU I-AWD 7.1 RADAR  
ZAXUS I-AWD 5.4  
I-AWD 3.9  
I-AWD 1.8

ELEV 298

2100 3000 UNZ I-AWD 110.9 MEMKE I-AWD 14.1

3000 ← 243° → 063° → 063°

GS 3.00° TCH 57

2000 \*1440

7 NM 1.7 NM 1.5 NM 2.1 NM

341±  
0.5% UP → 1001.5 X 150  
0.5% DOWN  
352 554  
0.5% UP → 0.7% DOWN

270± TDZE 258  
063° 5.3 NM from FAF

CATEGORY	A	B	C	D
S-ILS 6R		577-3/4	319 (300-3/4)	
S-LOC 6R	1440-3/4 1182 (1200-3/4)	1440-1 1182 (1200-1)	1440-2 1/2	1182 (1200-2 1/2)
CIRCLING	1440-1 1/4 1142 (1200-1 1/4)	1440-1 1/2 1142 (1200-1 1/2)	1440-3	1142 (1200-3)
ZAXUS DME MINIMUMS				
S-LOC 6R	980-1/2	722 (700-1/2)	980-1 1/2 722 (700-1 1/2)	980-1 3/4 722 (700-1 3/4)
CIRCLING	980-1	682 (700-1)	980-2 682 (700-2)	980-2 1/4 682 (700-2 1/4)

HIRL Rwy 6L-24R  
MIRL Rwy 6R-24L

FAF to MAP 5.3 NM

Knots	60	90	120	150	180
Min:Sec	5:18	3:32	2:39	2:07	1:46

GUAM, GQ  
Orig-B 10042

13°29'N - 144°48'E

**GUAM INTL (GUM)(PGUM)**  
**ILS or LOC RWY 6R**

GUAM, GQ

AL-2146 (FAA)

# RNAV (GPS) Y RWY 6L

GUAM INTL (GUM)(PGUM)

APP CRS	Rwy Idg <b>10015</b>
<b>063°</b>	TDZE <b>256</b>
	Apt Elev <b>298</b>

<b>NA</b>	Circling NA southeast of Rwy 6R-24L. DME/DME RNP-0.3 NA.	<b>MALSRR</b>		<b>MISSED APPROACH:</b> Climb to 3000 direct WABOX and hold.
-----------	---	---------------	--	--

<b>ATIS</b> <b>119.0</b>	<b>GUAM CERAP</b> <b>119.8 269.0</b>	<b>AGANA TOWER</b> <b>118.1 340.2</b>	<b>GND CON</b> <b>121.9 336.4</b>	<b>CLNC DEL</b> <b>121.9</b>
-----------------------------	---	--	--------------------------------------	---------------------------------

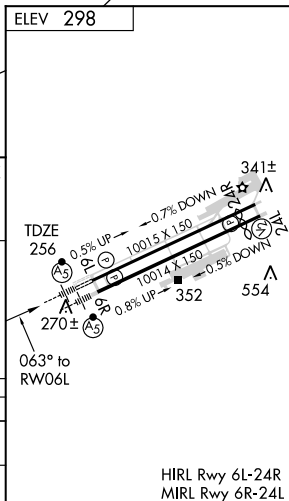
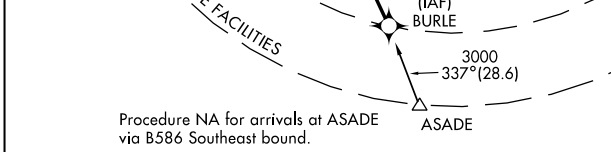
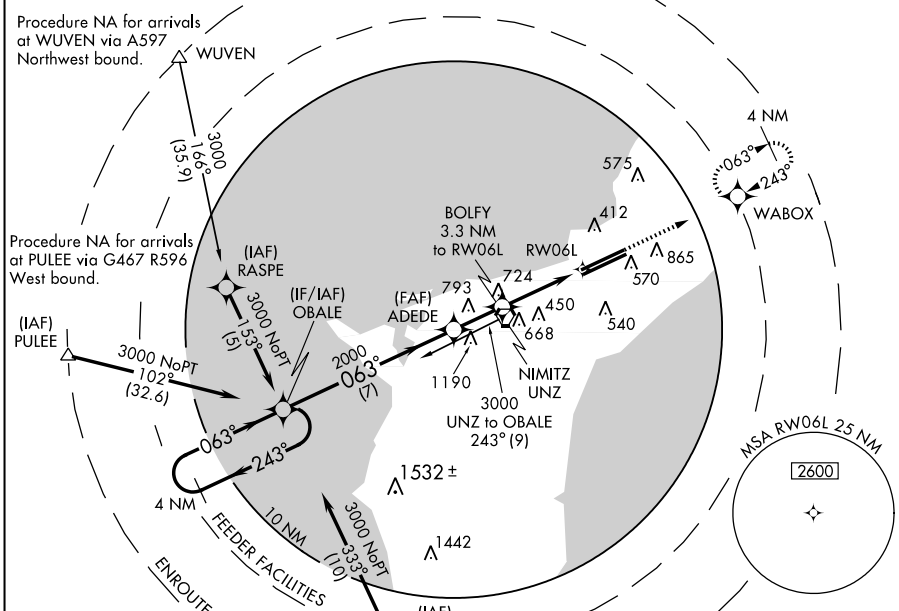

CATEGORY	A	B	C	D
INAV MDA	720-1/2	464 (500-1/2)	720-3/4 464 (500-3/4)	720-1 464 (500-1)
CIRCLING	760-1	462 (500-1)	760-1/2 462 (500-1/2)	860-2 562 (600-2)

GUAM, GQ  
Amdt 1A 10042

13°29'N-144°48'E

## GUAM INTL (GUM)(PGUM) RNAV (GPS) Y RWY 6L

GUAM, GQ

AL-2146 (FAA)

# RNAV (GPS) Y RWY 6R

GUAM INTL (GUM)(PGUM)

APP CRS	Rwy Idg	<b>10014</b>
<b>063°</b>	TDZE	<b>258</b>
	Apt Elev	<b>298</b>

	Circling NA southeast of Rwy 6R-24L. DME/DME RNP-0.3 NA.		MISSED APPROACH: Climb to 3000 direct CIBOL and hold.

ATIS	GUAM CERAP	AGANA TOWER	GND CON	CLNC DEL
<b>119.0</b>	<b>119.8 269.0</b>	<b>118.1 340.2</b>	<b>121.9 336.4</b>	<b>121.9</b>

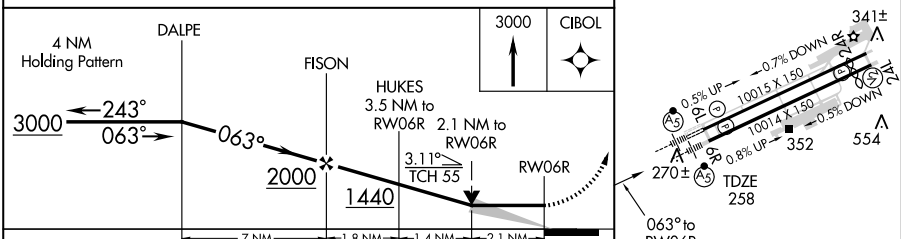
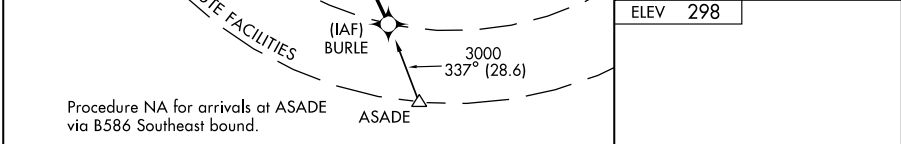
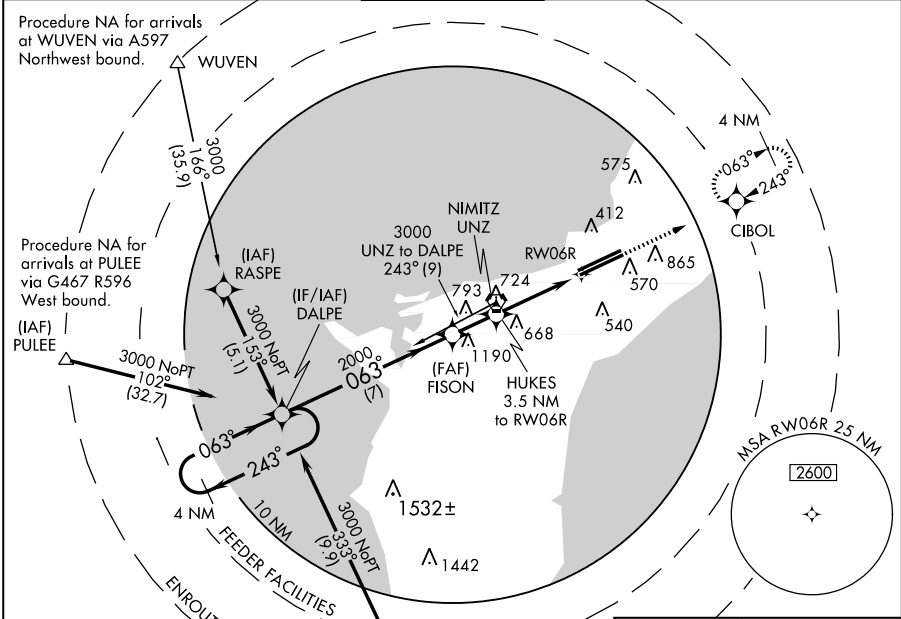

CATEGORY	A	B	C	D
RNAV MDA	980-1 722 (700-1)		980-2 722 (700-2)	980-2 722 (700-2 1/4)
CIRCLING	980-1 682 (700-1)		980-2 682 (700-2)	980-2 682 (700-2 1/4)

GUAM, GQ Amdt 1A 10042

13° 29' N - 144° 48' E

GUAM INTL (GUM)(PGUM)

## RNAV (GPS) Y RWY 6R

HIRL Rwy 6L-24R  
MIRL Rwy 6R-24L

GUAM, GQ

AL-2146 (FAA)

# RNAV (GPS) Y RWY 24L

GUAM INTL (GUM)(PGUM)

APP CRS	Rwy Idg	<b>9010</b>
<b>243°</b>	TDZE	<b>293</b>
	Apt Elev	<b>298</b>

**⚠** Circling NA southeast of Rwy 6R-24L.  
DME/DME RNP-0.3 NA.  
Visibility reduction by helicopters NA.

MISSED APPROACH: Climb to 3000 direct DALPE and hold.

ATIS <b>119.0</b>	GUAM CERAP <b>119.8 269.0</b>	AGANA TOWER <b>118.1 340.2</b>	GND CON <b>121.9 336.4</b>	CLNC DEL <b>121.9</b>
----------------------	----------------------------------	-----------------------------------	-------------------------------	--------------------------

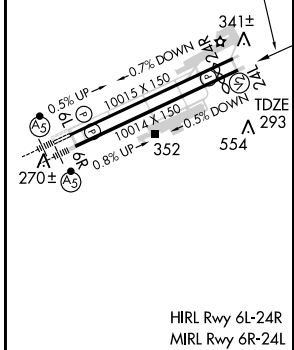
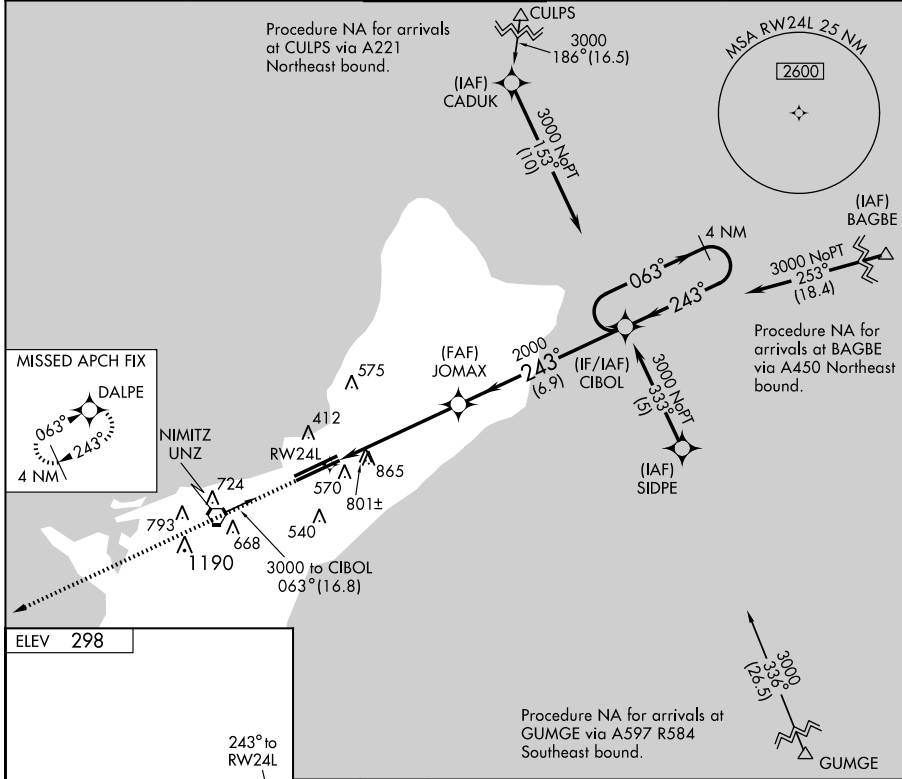

3000	DALPE	VGSI and descent angles not coincident.	4 NM Holding Pattern
↑	✦		
		JOMAX	CIBOL
		2000	3000
		243°	063°
		← 243°	→ 063°
		5.1 NM	6.9 NM

CATEGORY	A	B	C	D
LNNAV MDA	1180-1¼	887 (900-1¼)	1180-2¾ 887 (900-2¾)	1180-3 887 (900-3)
CIRCLING	1180-1¼	882 (900-1¼)	1180-2¾ 882 (900-2¾)	1180-3 882 (900-3)

GUAM, GQ  
Amdt 1B 10042

13° 29'N-144° 48'E

# GUAM INTL (GUM)(PGUM)

## RNAV (GPS) Y RWY 24L



GUAM, GQ

AL-2146 (FAA)

APP CRS **243°**  
Rwy Idg **10015**  
TDZE **297**  
Apt Elev **298**

**RNAV (GPS) Y RWY 24R**  
GUAM INTL (GUM)(PGUM)

**▼** Circling NA southeast of Rwy 6R-24L.  
**▲** DME/DME RNP-0.3 NA.  
Visibility reduction by helicopters NA.

MISSED APPROACH: Climb to 3000 direct OBALE and hold.

ATIS  
**119.0**

GUAM CERAP  
**119.8 269.0**

AGANA TOWER  
**118.1 340.2**

GND CON  
**121.9 336.4**

CLNC DEL  
**121.9**

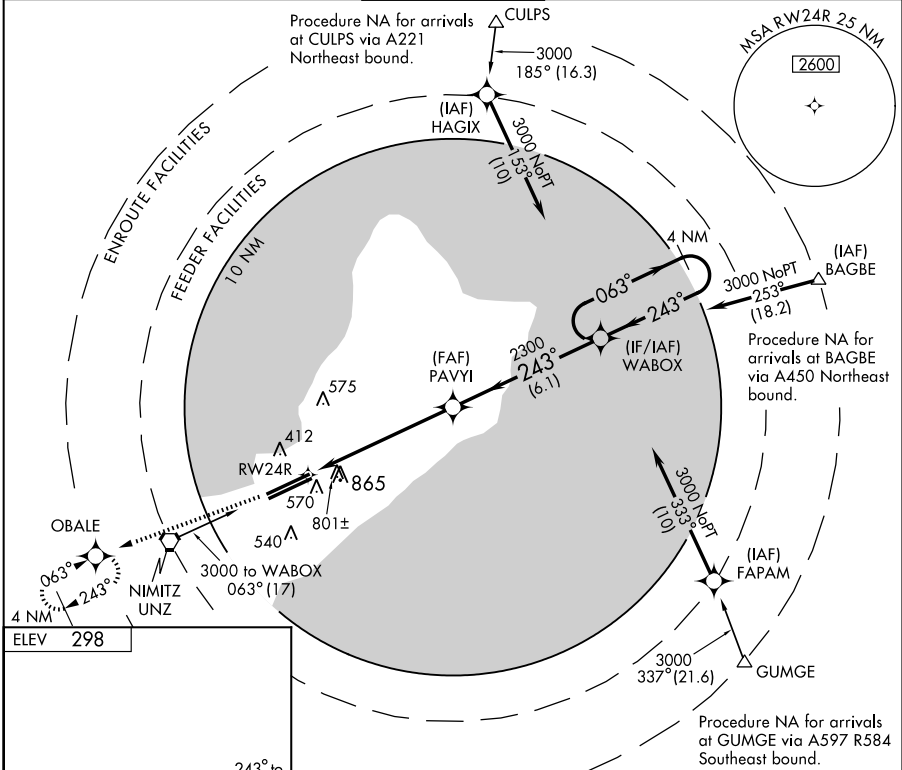

ELEV 298

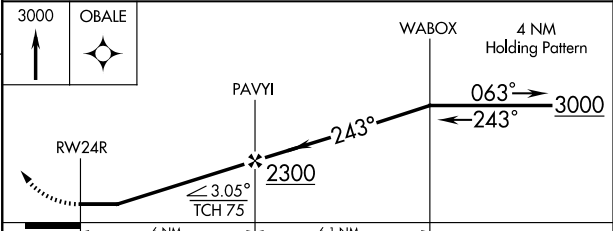
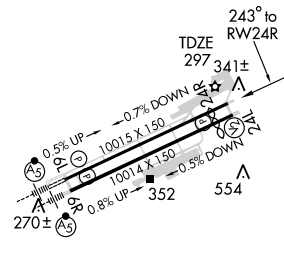

CATEGORY	A	B	C	D
LNVA MDA	1060-1 763 (800-1)	1060-1¼ 763 (800-1¼)	1060-2¼ 763 (800-2¼)	1060-2½ 763 (800-2½)
CIRCLING	1060-1 762 (800-1)	1060-1¼ 762 (800-1¼)	1060-2¼ 762 (800-2¼)	1060-2½ 762 (800-2½)

HIRL Rwy 6L-24R  
MIRL Rwy 6R-24L

GUAM, GQ

Amdt 1A 10042

13°29'N-144°48'E

GUAM INTL (GUM)(PGUM)

**RNAV (GPS) Y RWY 24R**



GUAM, GQ

AL-2146 (FAA)

10042

APP CRS <b>063°</b>	Rwy Idg <b>10014</b>
	TDZE <b>258</b>
	Apt Elev <b>298</b>

# RNAV (RNP) Z RWY 6R

GUAM INTL (GUM)(PGUM)

**▼** For uncompensated Baro-VNAV systems, procedure NA below 19°C (66°F) or above 48°C (119°F).  
GPS required. Visibility reduction by helicopters NA.  
\*Missed approach requires a minimum climb of 285 feet per NM to 1400.



MISSED APPROACH: Climb to 3000 via track 063° to CIBOL and hold.

ATIS <b>119.0</b>	GUAM CERAP <b>119.8 269.0</b>	AGANA TOWER <b>118.1 340.2</b>	GND CON <b>121.9 336.4</b>	CLNC DEL <b>121.9</b>
----------------------	----------------------------------	-----------------------------------	-------------------------------	--------------------------

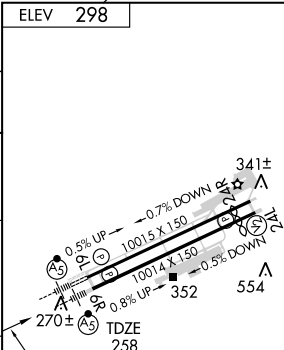
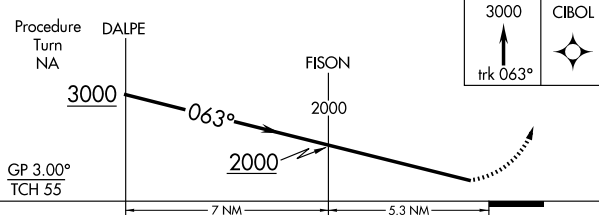
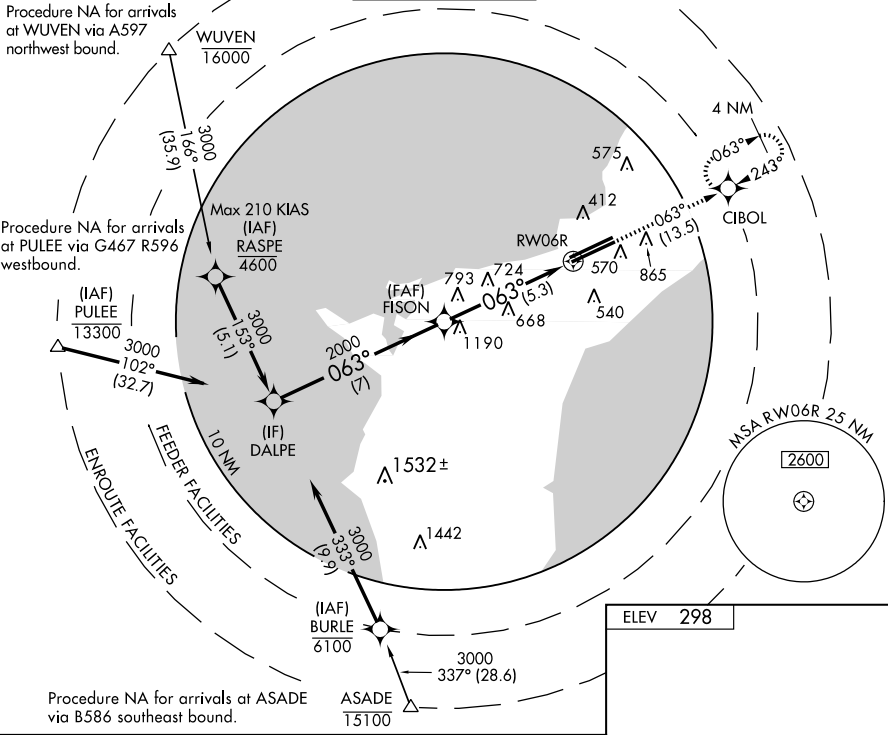

GP 3.00° TCH 55	7 NM	5.3 NM		
CATEGORY	A	B	C	D
RNP 0.30* DA		508-1/2	250 (300-1/2)	
RNP 0.30 DA		656-1	398 (400-1)	

**SPECIAL AIRCRAFT & AIRCREW AUTHORIZATION REQUIRED**

HIRL Rwy 6L-24R  
MIRL Rwy 6R-24L

GUAM, GQ  
Orig-B 22OCT09

13°29'N - 144°48'E

GUAM INTL (GUM)(PGUM)  
**RNAV (RNP) Z RWY 6R**

PAC, 08 APR 2010 to 03 JUN 2010

GUAM, GQ

AL-2146 (FAA)

10042

APP CRS	Rwy Idg	<b>9010</b>
<b>243°</b>	TDZE	<b>293</b>
	Apt Elev	<b>298</b>

# RNAV (RNP) Z RWY 24L

GUAM INTL (GUM)(PGUM)

**⚠** For uncompensated Baro-VNAV systems, procedure NA below 19°C (66°F) or above 48°C (119°F).  
**⚠** GPS required. Visibility reduction by helicopters NA.  
 Procedure NA at night.

MISSED APPROACH: Climb to 3000 via track 243° to DALPE and hold.

ATIS <b>119.0</b>	GUAM CERAP <b>119.8 269.0</b>	AGANA TOWER <b>118.1 340.2</b>	GND CON <b>121.9 336.4</b>	CLNC DEL <b>121.9</b>
----------------------	----------------------------------	-----------------------------------	-------------------------------	--------------------------

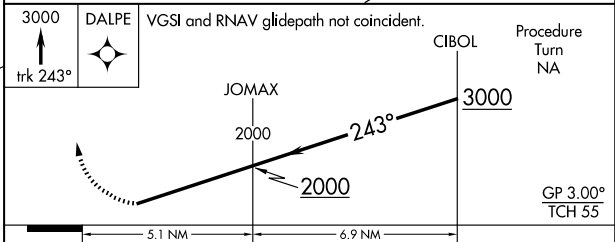
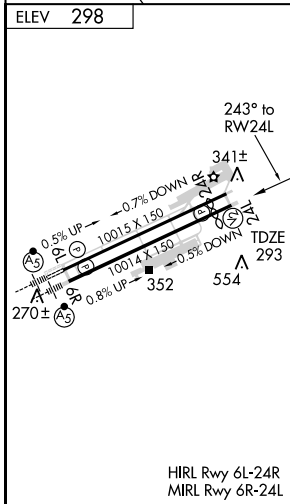
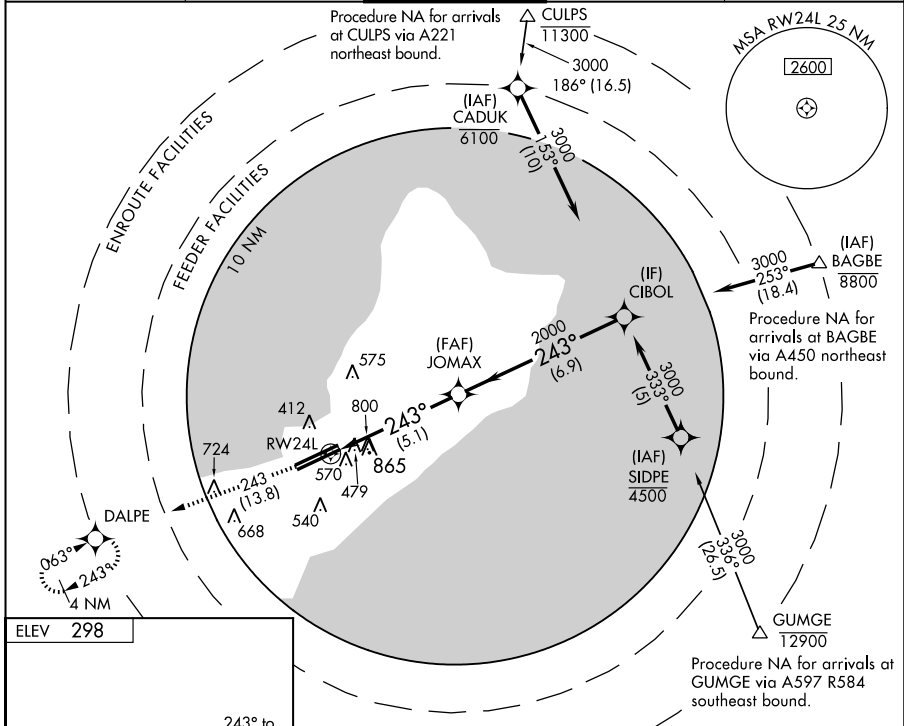

CATEGORY	A	B	C	D
RNP 0.20 DA		1103-2 3/4	810 (900-2 3/4)	
RNP 0.30 DA		1140-3	847 (900-3)	

**SPECIAL AIRCRAFT & AIRCREW AUTHORIZATION REQUIRED**

GUAM, GQ  
Orig-D 22OCT09

13°29'N - 144°48'E

GUAM INTL (GUM)(PGUM)  
**RNAV (RNP) Z RWY 24L**

PAC, 08 APR 2010 to 03 JUN 2010

GUAM, GQ

AL-2146 (FAA)

10042

APP CRS <b>243°</b>	Rwy Idg <b>10015</b> TDZE <b>297</b> Apt Elev <b>298</b>
------------------------	--

# RNAV (RNP) Z RWY 24R

GUAM INTL (GUM)(PGUM)

**⚠** For uncompensated Baro-VNAV systems, procedure NA below 19°C (66°F) or above 48°C (119°F).  
**⚠** GPS required. When VGSI inoperative, procedure NA at night.  
Visibility reduction by helicopters NA.

MISSED APPROACH: Climb to 3000 via track 243° to OBALE and hold.

ATIS <b>119.0</b>	GUAM CERAP <b>119.8 269.0</b>	AGANA TOWER <b>118.1 340.2</b>	GND CON <b>121.9 336.4</b>	CLNC DEL <b>121.9</b>
----------------------	----------------------------------	-----------------------------------	-------------------------------	--------------------------

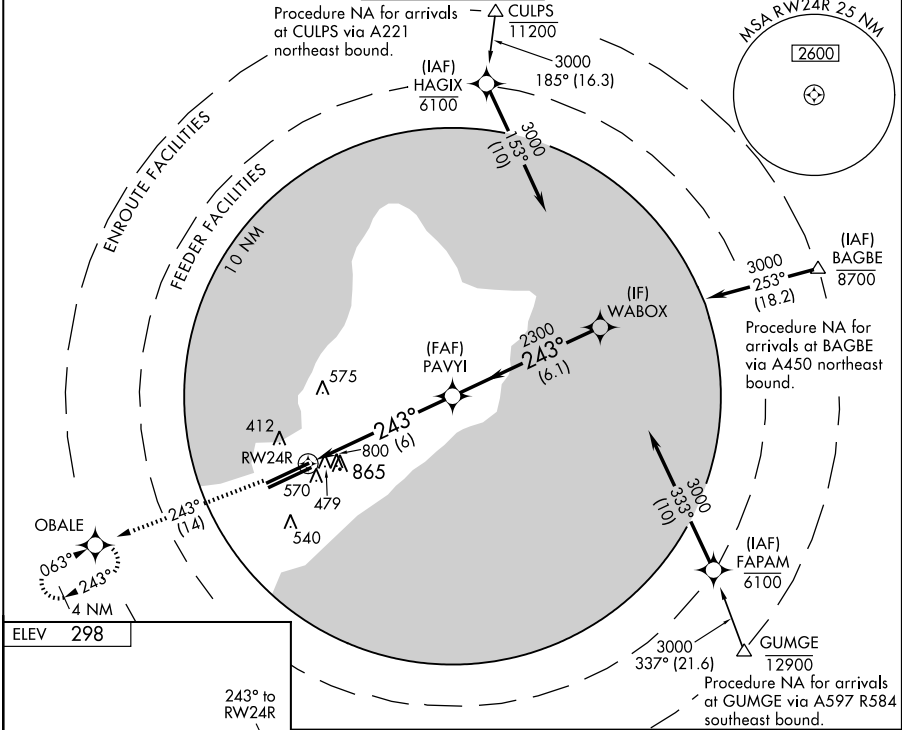

ELEV 298

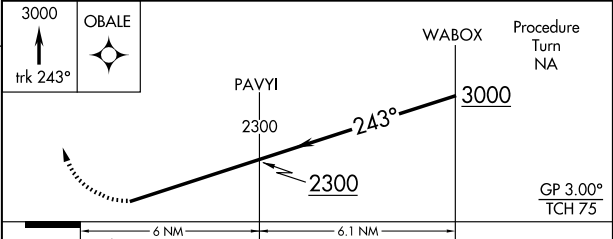
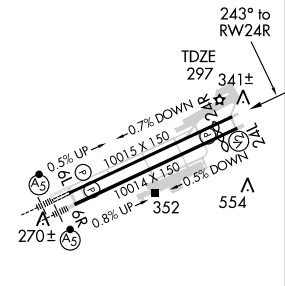

CATEGORY	A	B	C	D
RNP 0.24 DA		1117-2 <sup>3</sup> / <sub>4</sub>	820 (900-2 <sup>3</sup> / <sub>4</sub> )	
RNP 0.30 DA		1140-3	843 (900-3)	

**SPECIAL AIRCRAFT & AIRCREW AUTHORIZATION REQUIRED**

GUAM, GQ  
Orig-B 22OCT09

13°29'N - 144°48'E

GUAM INTL (GUM)(PGUM)  
**RNAV (RNP) Z RWY 24R**

GUAM, GQ

AL-2146 (FAA)

VORTAC UNZ <b>115.8</b> Chan <b>105</b>	APP CRS <b>062°</b>	Rwy Idg <b>10015</b> TDZE <b>256</b> Apt Elev <b>298</b>
---	------------------------	--

# VOR/DME or TACAN RWY 6L

GUAM INTL (GUM) (PGUM)

<p>Circling NA southeast of Rwy 6R-24L DME from UNZ VORTAC.</p>	<p>MALS R</p>	<p>MISSED APPROACH: Climb to 2600 then right turn via UNZ R-242 to FLAKE/7 DME and hold.</p>		
		<p>ATIS <b>119.0</b></p>	<p>GUAM CERAP <b>119.8 269.0</b></p>	<p>AGANA TOWER <b>118.1 340.2</b></p>

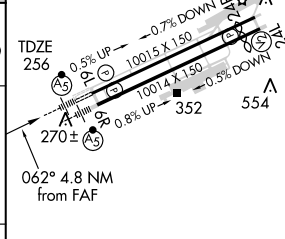
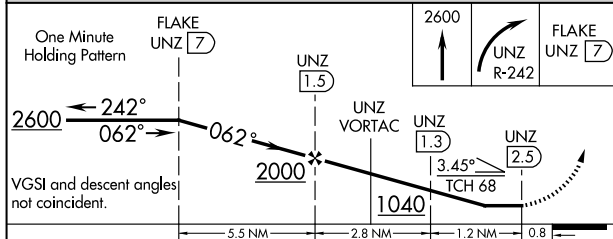
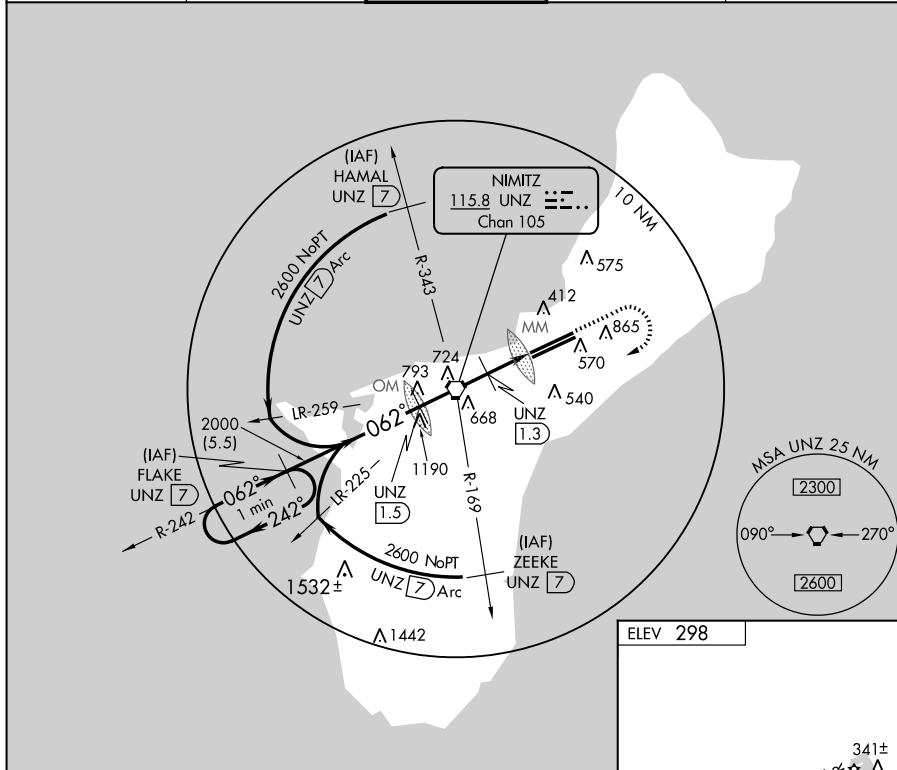

CATEGORY	A	B	C	D
S-6L	660-1/2 404 (400-1/2)		660-3/4 404 (400-3/4)	660-1 404 (400-1)
CIRCLING	760-1 462 (500-1)		760-1 1/2 462 (500-1 1/2)	860-2 562 (600-2)

GUAM, GQ  
Orig-D 10042

13°29'N-144°48'E

GUAM INTL (GUM) (PGUM)

# VOR/DME or TACAN RWY 6L

GUAM, GQ

AL-2146 (FAA)

VORTAC UNZ <b>115.8</b> Chan <b>105</b>	APP CRS <b>242°</b>	Rwy Idg <b>10015</b> TDZE <b>297</b> Apt Elev <b>298</b>
---	------------------------	--

# TACAN RWY 24R

GUAM INTL (GUM)(PGUM)

**⚠** Circling NA southeast of Rwy 6R-24L. DME from UNZ VORTAC. MISSED APPROACH: Climb to 2300, then turn left via UNZ R-062 to FIBEE/1.5 DME and hold.

ATIS <b>119.0</b>	GUAM CERAP <b>119.8 269.0</b>	AGANA TOWER <b>118.1 340.2</b>	GND CON <b>121.9 336.4</b>	CLNC DEL <b>121.9</b>
----------------------	----------------------------------	-----------------------------------	-------------------------------	--------------------------

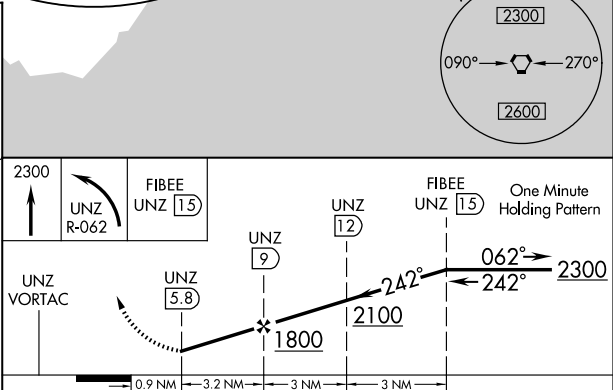
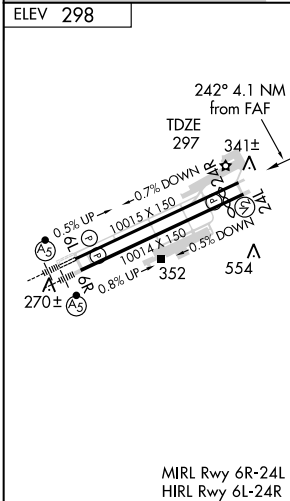
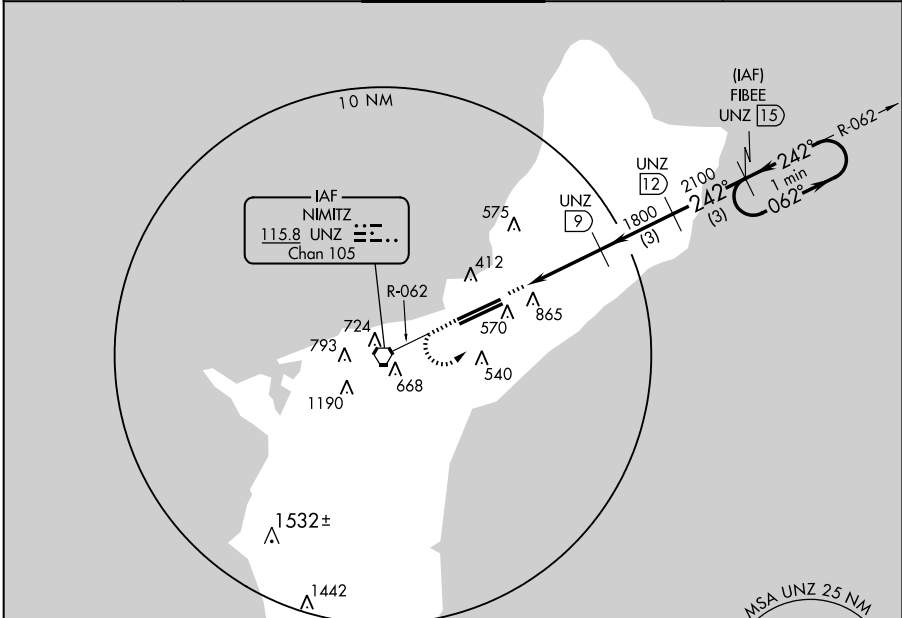

CATEGORY	A	B	C	D
S-24R	1180-1¼	883 (900-1¼)	1180-2¾ 883 (900-2¾)	1180-3 883 (900-3)
CIRCLING	1180-1¼	882 (900-1¼)	1180-2¾ 882 (900-2¾)	1180-3 882 (900-3)

GUAM, GQ  
Orig-B 10042

13° 29' N - 144° 48' E

# GUAM INTL (GUM)(PGUM) TACAN RWY 24R

GUAM, GQ

AL-2146 (FAA)

VORTAC UNZ <b>115.8</b> Chan <b>105</b>	APP CRS <b>062°</b>	Rwy Idg TDZE Apt Elev <b>N/A</b> <b>N/A</b> <b>298</b>
---	------------------------	---

**VOR-A**  
GUAM INTL (GUM)(PGUM)

<b>▼</b> Circling NA southeast of Rwy 6R-24L. DME from UNZ VORTAC.	MISSED APPROACH: Climb to 2600 then turn right direct UNZ VORTAC.
---	--

ATIS <b>119.0</b>	GUAM CERAP <b>119.8 269.0</b>	AGANA TOWER <b>118.1 340.2</b>	GND CON <b>121.9 336.4</b>	CLNC DEL <b>121.9</b>
----------------------	----------------------------------	-----------------------------------	-------------------------------	--------------------------

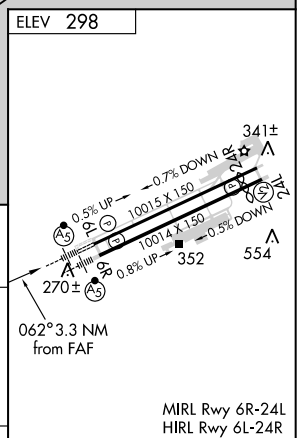
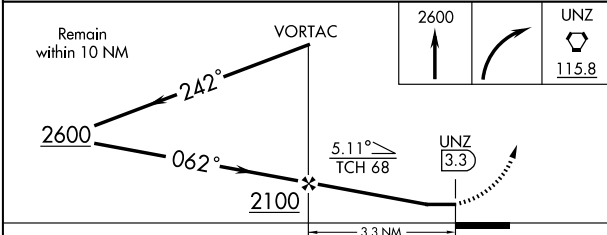
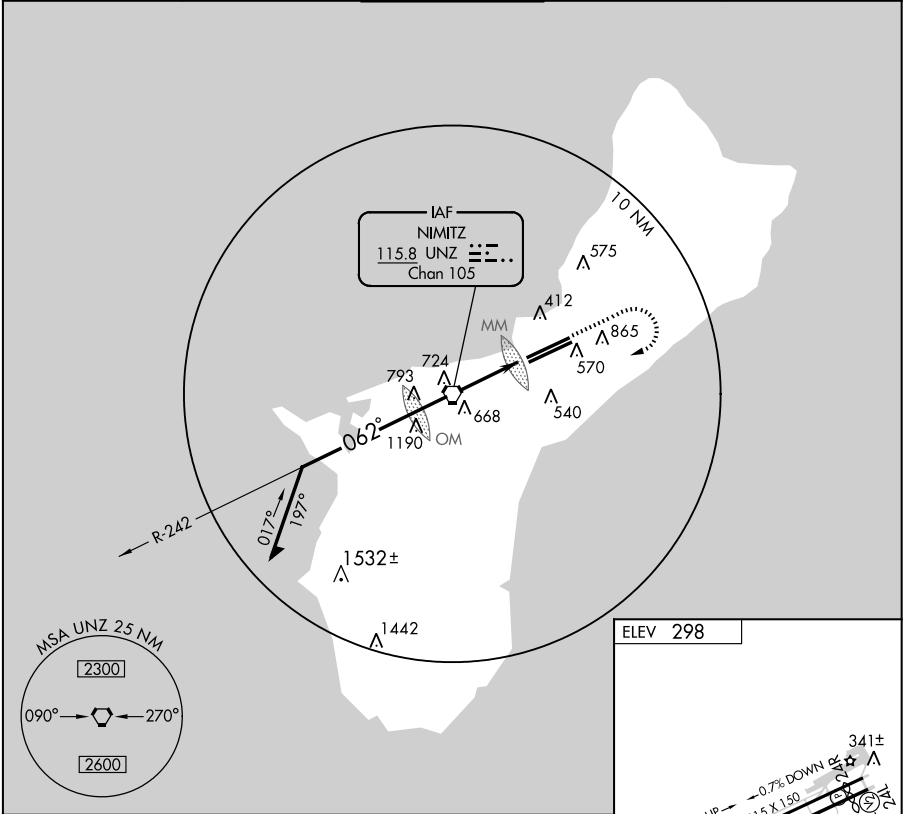

CATEGORY	A	B	C	D	FAF to MAP 3.3 NM					
CIRCLING	780-1	482 (500-1)	780-1½ 482 (500-1½)	860-2 562 (600-2)	Knots	60	90	120	150	180
					Min:Sec	3:18	2:12	1:39	1:19	1:06

GUAM, GQ  
Orig-D 10042

13°29'N-144°48'E

GUAM INTL(GUM)(PGUM)  
**VOR-A**



GUAM, GG

AL-2146 (FAA)

NDB AJA <b>385</b>	APP CRS <b>241°</b>	Rwy Idg <b>10015</b> TDZE <b>297</b> Apt Elev <b>298</b>
-----------------------	------------------------	--

# NDB/DME RWY 24R

GUAM INTL (GUM)(PGUM)

**NA** Circling NA southeast of Rwy 6R-24L.  
DME from UNZ VORTAC.

MISSED APPROACH: Climb to 2300 direct AJA NDB, then left turn via 061° bearing from AJA NDB to ADAYI/UNZ 15 DME and hold.

ATIS <b>119.0</b>	GUAM CERAP <b>119.8 269.0</b>	AGANA TOWER <b>118.1 340.2</b>	GND CON <b>121.9 336.4</b>	CLNC DEL <b>121.9</b>
----------------------	----------------------------------	-----------------------------------	-------------------------------	--------------------------

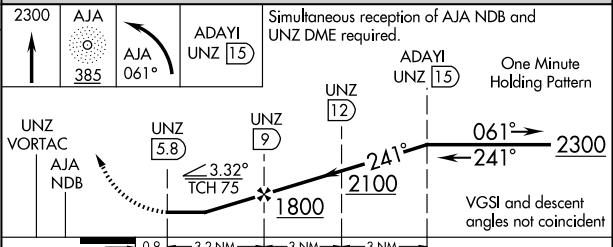
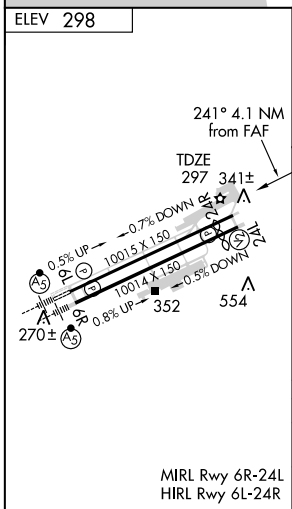
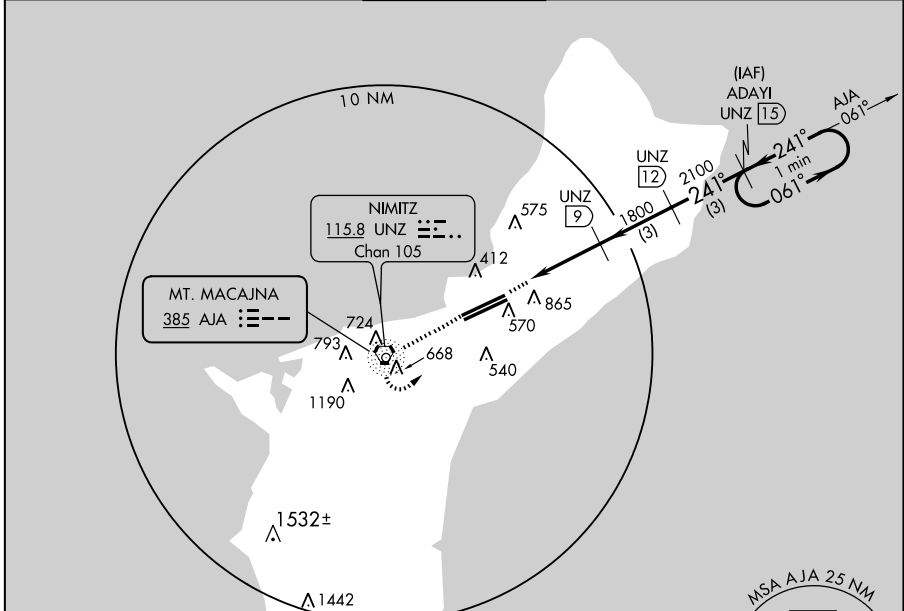

CATEGORY	A	B	C	D
S-24R	1220-1¼ 923 (1000-1¼)		1220-2¾ 923 (1000-2¾)	1220-3 923 (1000-3)
CIRCLING	1220-1¼ 922 (1000-1¼)		1220-2¾ 922 (1000-2¾)	1220-3 922 (1000-3)

GUAM, GG  
Orig-B 10042

13° 29'N-144° 48'E

# GUAM INTL (GUM)(PGUM) NDB/DME RWY 24R

10042

AIRPORT DIAGRAM

AI-2146 (FAA)

GUAM INTL (GUM)(PGUM)  
GUAM, GQ

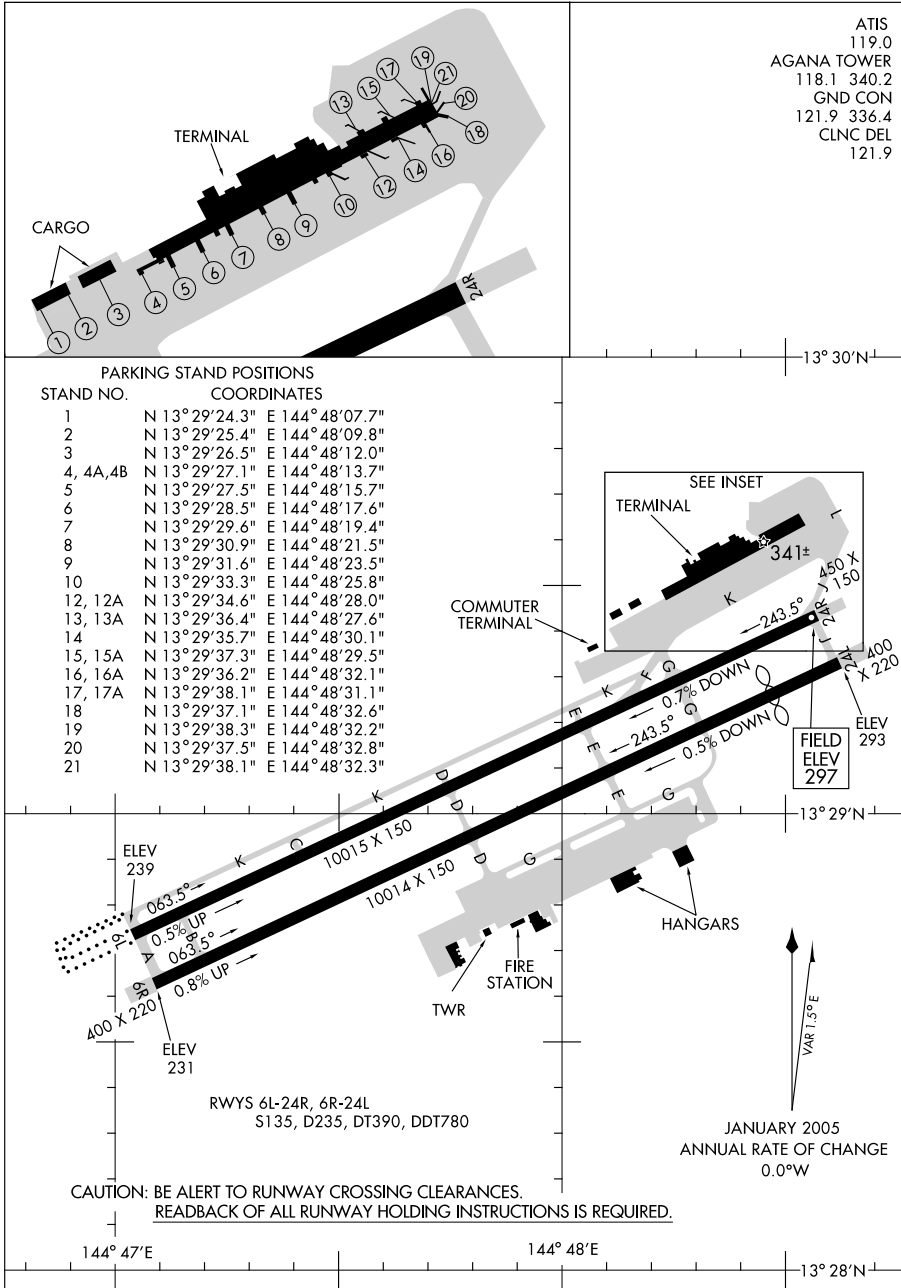

AIRPORT DIAGRAM

10042

GUAM, GQ  
GUAM INTL (GUM)(PGUM)

HANA, HAWAII

AL-5156 (FAA)

APP CRS	Rwy Idg	<b>3606</b>
<b>259°</b>	TDZE	<b>70</b>
	Apt Elev	<b>78</b>

# RNAV (GPS) RWY 26

HANA(HNM)(PHHN)

Circling NA S of Rwy 8-26. DME/DME RNP-0.3 NA. Procedure NA at night.		MISSED APPROACH: Climbing right turn to 2500 direct GPYLE and hold.	
AWOS-3 <b>118.325</b>	HCF APPROACH <b>126.0 278.3</b>	CLNC DEL <b>122.3</b>	CTAF <b>122.9</b>

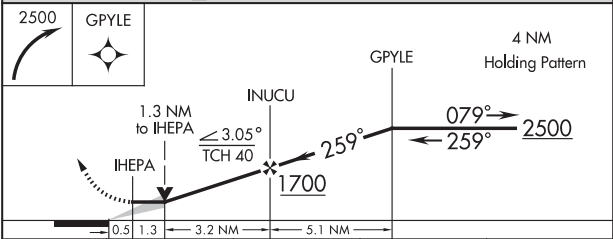
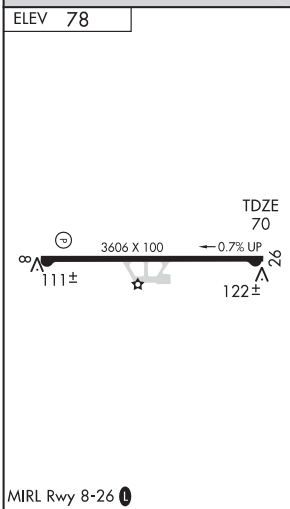
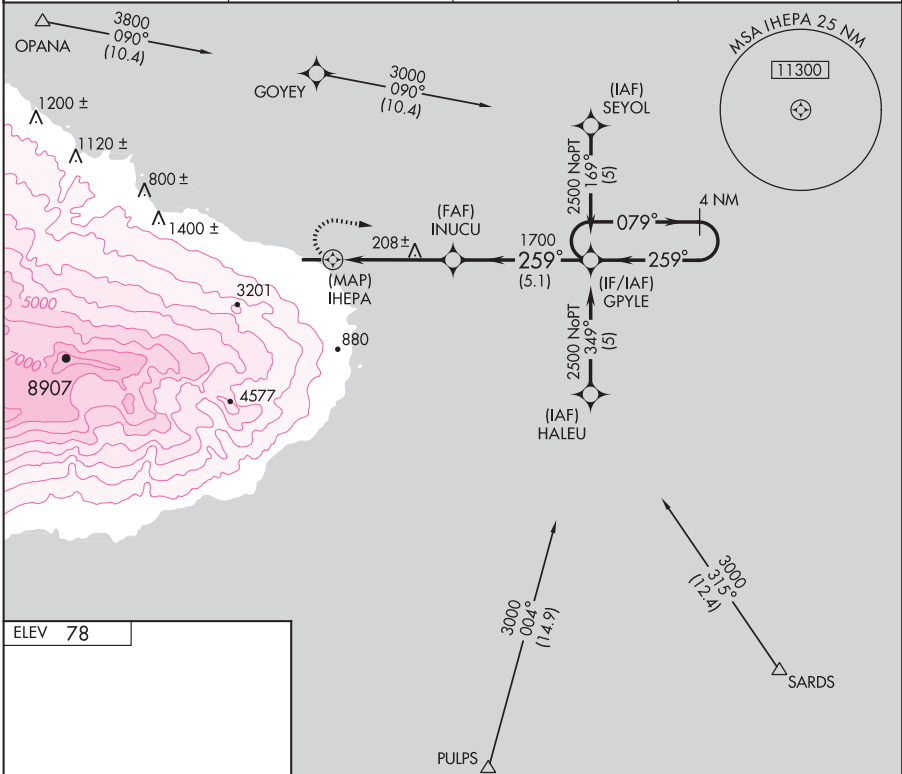

CATEGORY	A	B	C	D
LNAV MDA	660-1	590 (600-1)	NA	NA
CIRCLING	660-1 582 (600-1)	760-1 682 (700-1)	NA	NA

HANA, HAWAII  
Orig 07074

20° 48'N - 156° 01'W

# RNAV (GPS) RWY 26

(LNBR1.LNBR) 09295 SL-5156 (FAA)  
**LINDBERG ONE DEPARTURE (OBSTACLE) (RNAV)**

HANA (HNM)(PHHN)  
 HANA, HAWAII

HCF APPROACH  
 126.0 278.3  
 CLNC DEL 122.3  
 CTAF 122.9

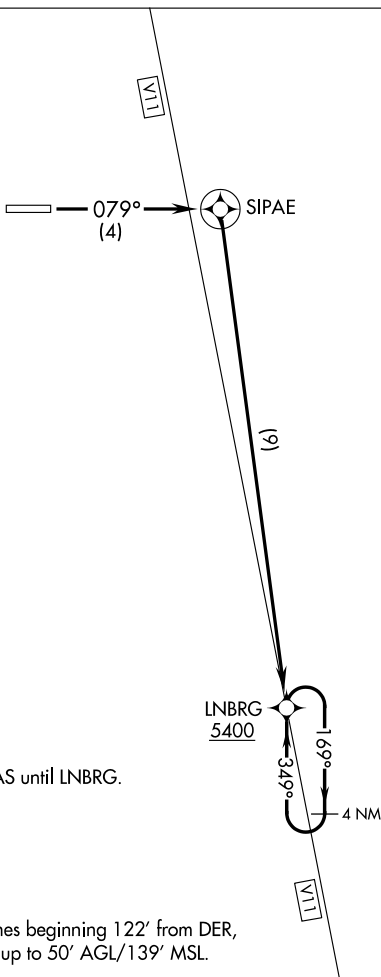

NOTE: RNAV 1.  
 NOTE: GPS required.  
 NOTE: Do not exceed 200 KIAS until LNBRG.

TAKE-OFF MINIMUMS  
 Rwy 26: NA.  
 Rwy 8: Standard.

TAKE-OFF OBSTACLE NOTE  
 Rwy 8: Multiple trees and bushes beginning 122' from DER,  
 75' right of centerline, up to 50' AGL/139' MSL.

NOTE: Chart not to scale



**DEPARTURE ROUTE DESCRIPTION**

TAKE-OFF RUNWAY 8: Climb via 079° course to SIPAE, then right turn direct LNBRG, thence. . . .

. . . .climb in holding (if required) to cross LNBRG at or above 5400 before proceeding via assigned route.

**LINDBERG ONE DEPARTURE (OBSTACLE) (RNAV)**  
 (LNBR1.LNBR) 09295

HANA, HAWAII  
 HANA (HNM)(PHHN)

HILO, HAWAII

AL-756 (FAA)

LOC/DME I-TO	APP CRS	Rwy Idg	9800
110.7	259°	TDZE	38
Chan 44		Apt Elev	38

ILS or LOC RWY 26  
HILO INTL (ITO) (PHTO)

**⚠** Circling not authorized south of Rwy 8-26. For inoperative MALSRL increase S-LOC 26 vis to 1 mile all Cats. Inoperative table does not apply to S-ILS 26. ADF or DME required.

**MALSRL**  MISSED APPROACH: Climb to 450 then climbing right turn to 3000 via ITO R-002 then direct ITO VORTAC and hold.

ATIS <b>126.4</b>	HILO APP CON <b>119.7 269.2</b>	HILO TOWER* <b>118.1(CTAF) 263.1</b>	GND CON <b>121.9</b>
----------------------	------------------------------------	---	-------------------------

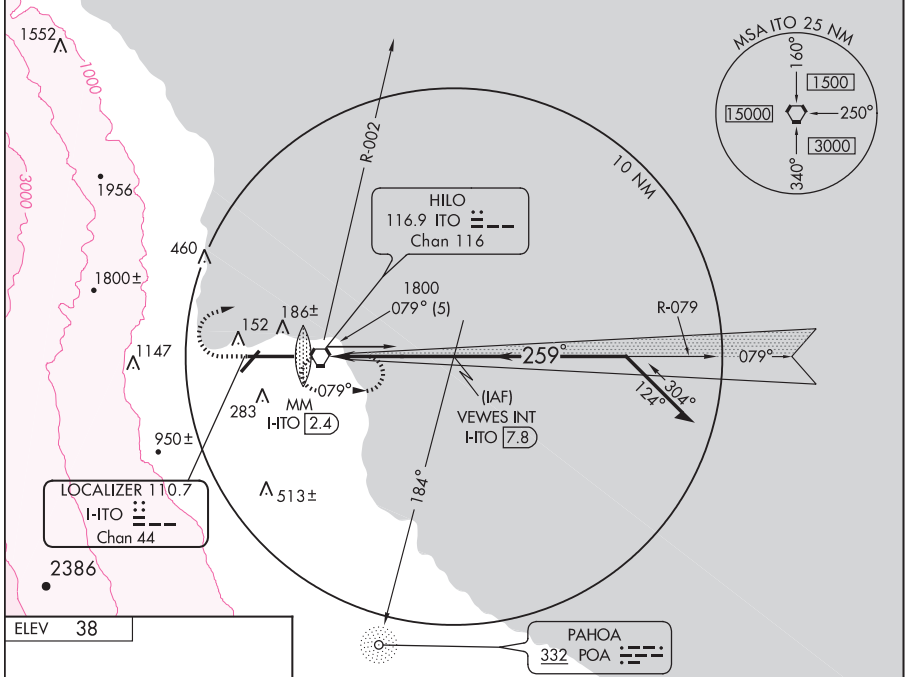

ADF or DME REQUIRED

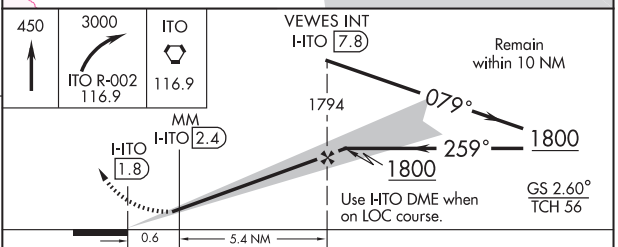
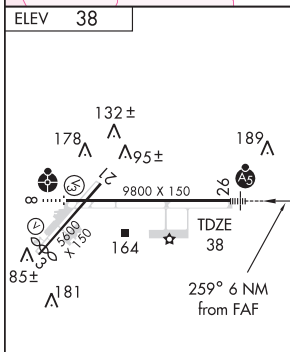

REIL Rwy 3  
MIRL Rwy 3-21  
HIRL Rwy 8-26

FAF to MAP 6 NM

Knots	60	90	120	150	180
Min:Sec	6:00	4:00	3:00	2:24	2:00

CATEGORY	A	B	C	D
S-ILS 26		288-1	250 (300-1)	
S-LOC 26		420-¾	382 (400-¾)	
CIRCLING	500-1	462 (500-1)	500-1½ 462 (500-1½)	700-2 662 (700-2)

HILO, HAWAII

Amdt 12B 09071

19°43'N-155°03'W

HILO INTL (ITO) (PHTO)  
ILS or LOC RWY 26

HILO, HAWAII

AL-756 (FAA)

# RNAV (GPS) RWY 21

HILO INTL (ITO) (PHTO)

APP CRS	Rwy Idg	<b>5600</b>
<b>210°</b>	TDZE	<b>31</b>
	Apt Elev	<b>38</b>

<p><b>⚠</b> Circling not authorized south of Rwy 8-26.</p> <p><b>⚠ NA</b></p>	<p>MISSED APPROACH: Climbing left turn to 5000 direct POA NDB and hold.</p>		
<p>ATIS</p> <p><b>126.4</b></p>	<p>HILO APP CON</p> <p><b>119.7 269.2</b></p>	<p>HILO TOWER ★</p> <p><b>118.1 (CTAF) 0 263.1</b></p>	<p>GND CON</p> <p><b>121.9</b></p>

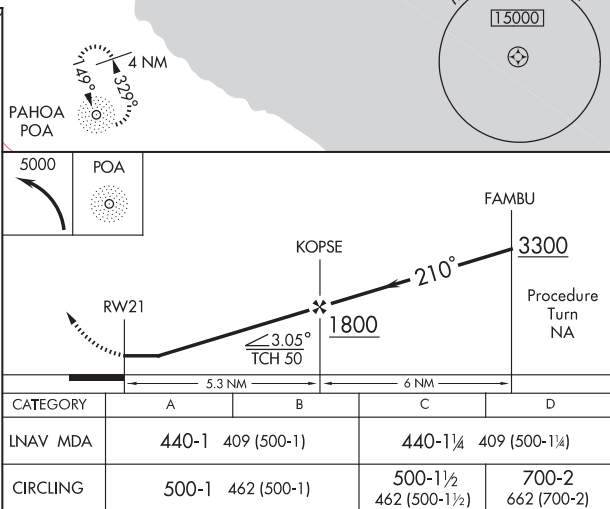
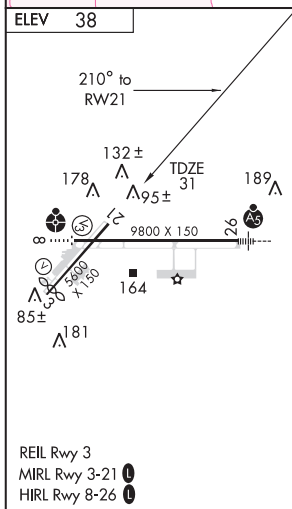
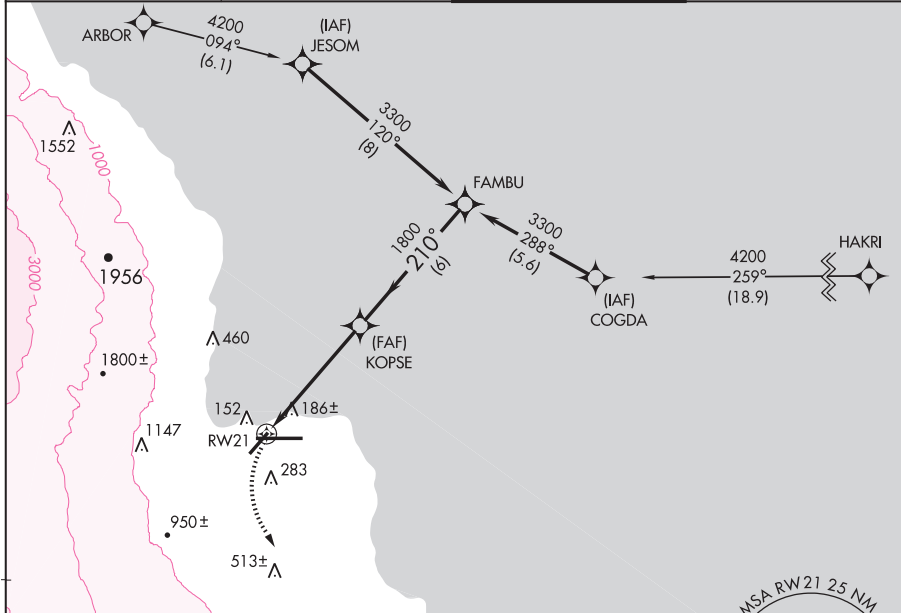

HILO, HAWAII  
Orig 09071

19°43'N-155°03'W

# HILO INTL (ITO) (PHTO)

## RNAV (GPS) RWY 21

HILO, HAWAII

AL-756 (FAA)

# RNAV (GPS) RWY 26

HILO INTL (ITO) (PHTO)

APP CRS <b>259°</b>	Rwy Idg <b>9800</b> TDZE <b>38</b> Apt Elev <b>38</b>
------------------------	---

⚠ Circling not authorized south of Rwy 8-26.  
 For inoperative MALS R increase LNAV Cat A, B & D ¼ mile.  
 Baro-VNAV NA below -5°C (23°F).  
 GPS or RNP-0.3 Required. DME/DME RNP-0.3 NA.  
 WAAS VNAV NA.

MALS R  
  
 MISSED APPROACH: Climb to 5000  
 direct EKAGE WP then right turn  
 direct ARBOR WP and hold.

ATIS <b>126.4</b>	HILO APP CON <b>119.7 269.2</b>	HILO TOWER ★ <b>118.1 (CTAF) 263.1</b>	GND CON <b>121.9</b>
----------------------	------------------------------------	---	-------------------------

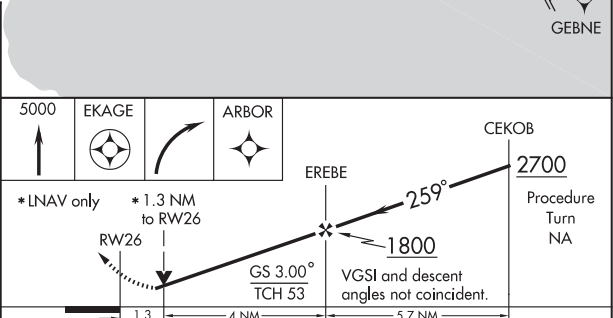
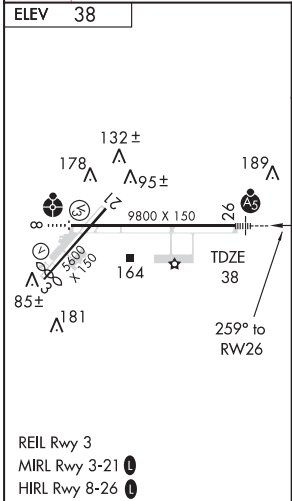
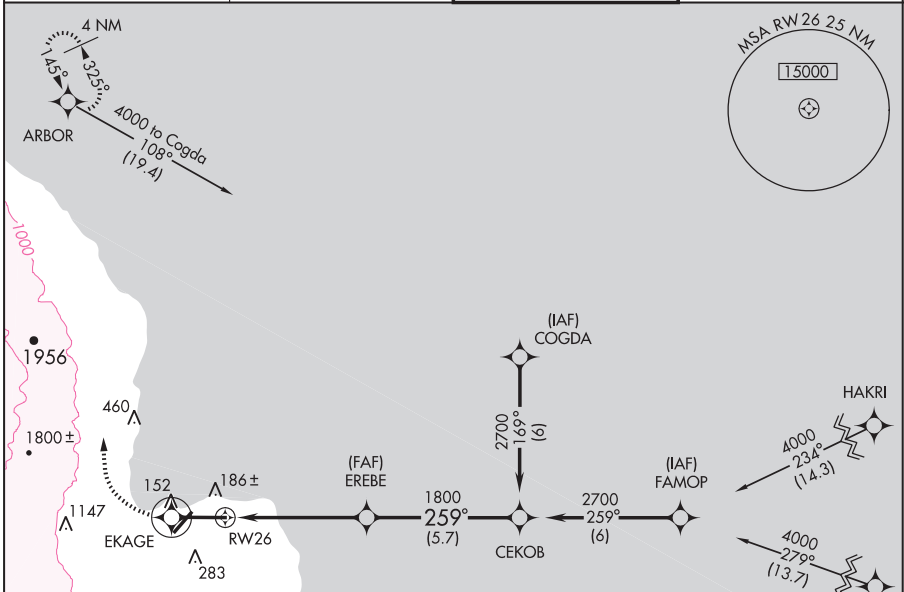

CATEGORY	A	B	C	D
GLS PA DA	NA			
LNAV/ VNAV	440-1 402 (500-1)			
LNAV MDA	440-¾ 402 (500-¾)		440-1 402 (500-1)	
CIRCLING	500-1½ 462 (500-1½)		700-2 662 (700-2)	

HILO, HAWAII  
 Orig-B 09071

19° 43'N-155° 03'W

# HILO INTL (ITO) (PHTO)

## RNAV (GPS) RWY 26

HILO, HAWAII

AL-756 (FAA)

# VOR/DME or TACAN RWY 26

HILO INTL (ITO) (PHTO)

VORTAC ITO <b>116.9</b> Chan <b>116</b>	APP CRS <b>259°</b>	Rwy Idg TDZE Apt Elev	<b>9800</b> <b>38</b> <b>38</b>
---	------------------------	-----------------------------	---------------------------------------

Circling not authorized south of Rwy 8-26. Visibility reduction for helicopters NA. For inoperative MALSR increase S-26 Cat. A/B and D visibility 1/2 mile.

MALSR

MISSED APPROACH: Climbing right turn to 3000 via ITO R-079 to VEWES/5 DME and hold.

ATIS <b>126.4</b>	HILO APP CON <b>119.7 269.2</b>	HILO TOWER ★ <b>118.1</b> (CTAF) <b>0 263.1</b>	GND CON <b>121.9</b>
----------------------	------------------------------------	--	-------------------------

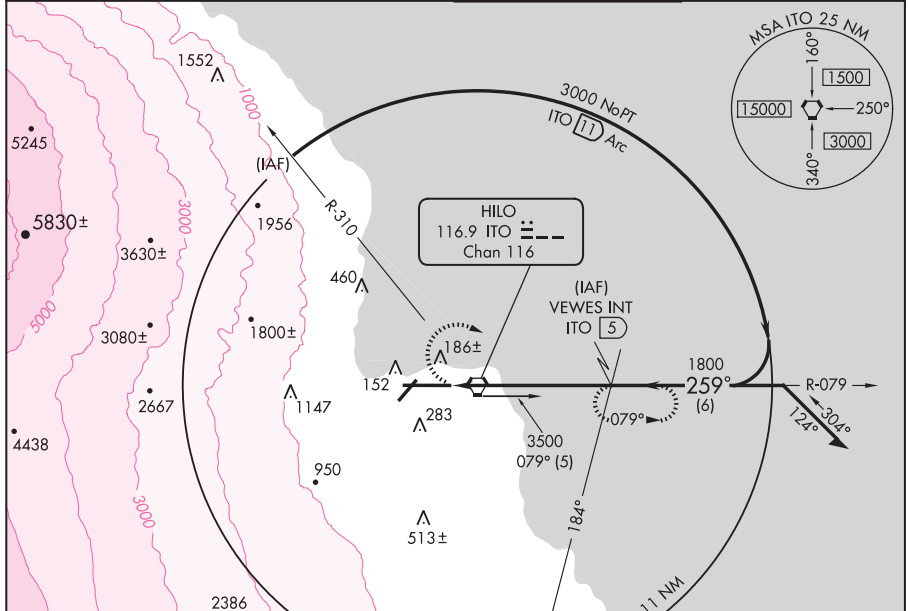

ELEV 38

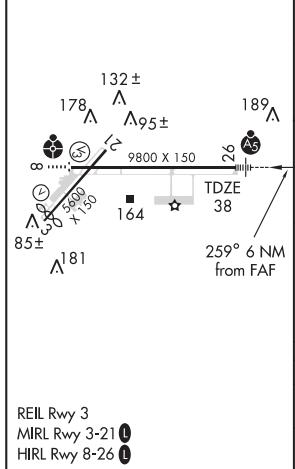

	3000	VEWES INT	VEWES INT ITO (5)	Remain within 10 NM
	ITO R-079 116.9			
	VORTAC ITO (1)	VORTAC ITO (0.2)		
	1.0	0.2	4.8 NM	
CATEGORY	A	B	C	D
S-26	460-3/4	422 (500-3/4)		460-1 422 (500-1)
CIRCLING	500-1 1/2	462 (500-1 1/2)		700-2 662 (700-2)

HILO, HAWAII  
Amdt 5C 09071

19°43'N-155°03'W

HILO INTL (ITO) (PHTO)

# VOR/DME or TACAN RWY 26



HILO, HAWAII

AL-756 (FAA)

VORTAC ITO <b>116.9</b> Chan <b>116</b>	APP CRS <b>145°</b>	Rwy Idg TDZE Apt Elev <b>38</b>	<b>N/A</b> <b>N/A</b> <b>38</b>
---	------------------------	--	---------------------------------------

# VOR/DME or TACAN-A

HILO INTL (ITO) (PHTO)

<p><b>▼</b> Circling not authorized south of Rwy 8-26.</p>		<p>MISSED APPROACH: Climbing left turn to 3000 via ITO R-079 to VEWES/5 DME and hold.</p>	
<p>ATIS <b>126.4</b></p>	<p>HILO APP CON <b>119.7 269.2</b></p>	<p>HILO TOWER * <b>118.1 (CTAF) 0 263.1</b></p>	<p>GND CON <b>121.9</b></p>

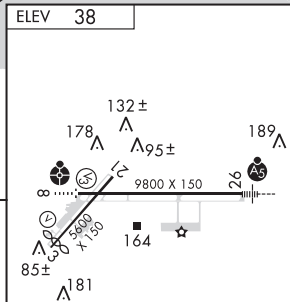
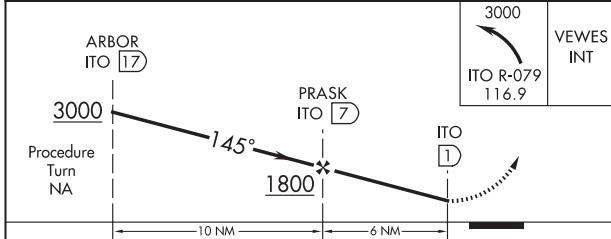
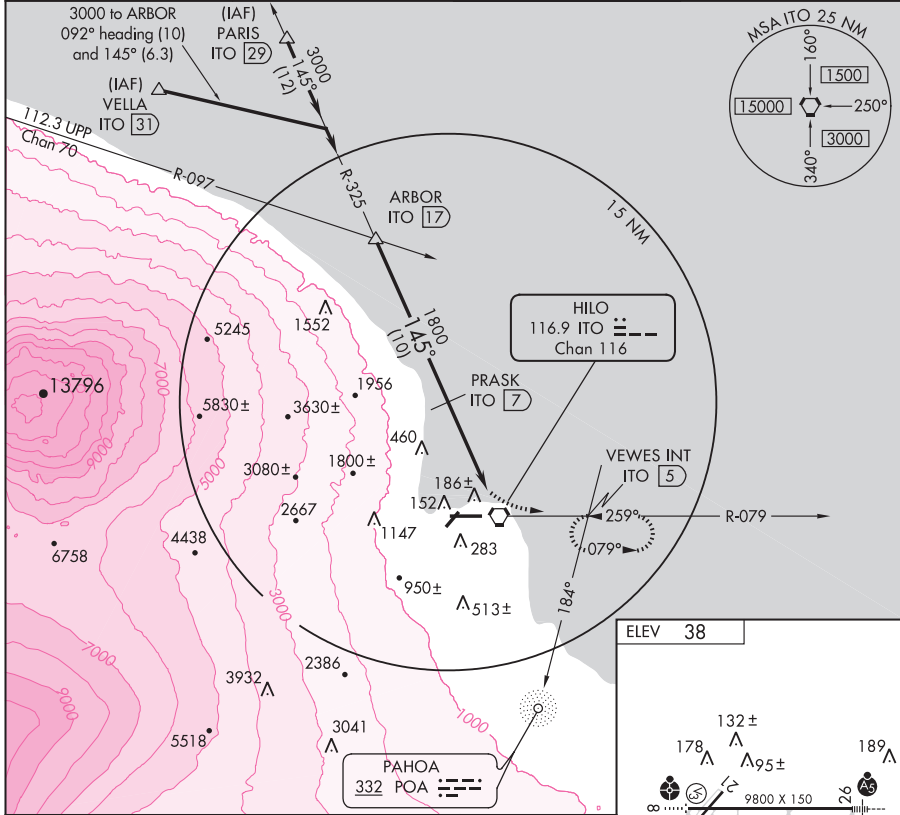

CATEGORY	A	B	C	D
CIRCLING	500-1½	462 (500-1½)		700-2 662 (700-2)

REIL Rwy 3  
MIRL Rwy 3-21  
HIRL Rwy 8-26

HILO, HAWAII  
Amdt 7B 09071

19°43'N-155°03'W

# HILO INTL (ITO) (PHTO)

## VOR/DME or TACAN-A

HILO, HAWAII

AL-756 (FAA)

VORTAC ITO <b>116.9</b> Chan <b>116</b>	APP CRS <b>259°</b>	Rwy Idg TDZE Apt Elev <b>N/A</b> <b>N/A</b> <b>38</b>
---	------------------------	--

**VOR-B**  
HILO INTL (ITO) (PHTO)

<p>▼ Circling not authorized south of Rwy 8-26.</p>		<p>MISSED APPROACH: Climbing right turn to 3000 via ITO R-002 then direct to ITO VORTAC and hold.</p>	
<p>ATIS <b>126.4</b></p>	<p>HILO APP CON <b>119.7 269.2</b></p>	<p>HILO TOWER * <b>118.1 (CTAF) 263.1</b></p>	<p>GND CON <b>121.9</b></p>

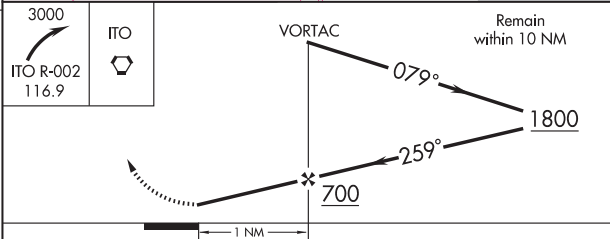
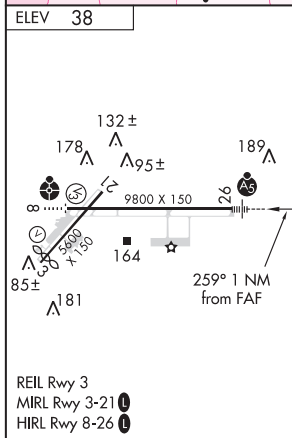
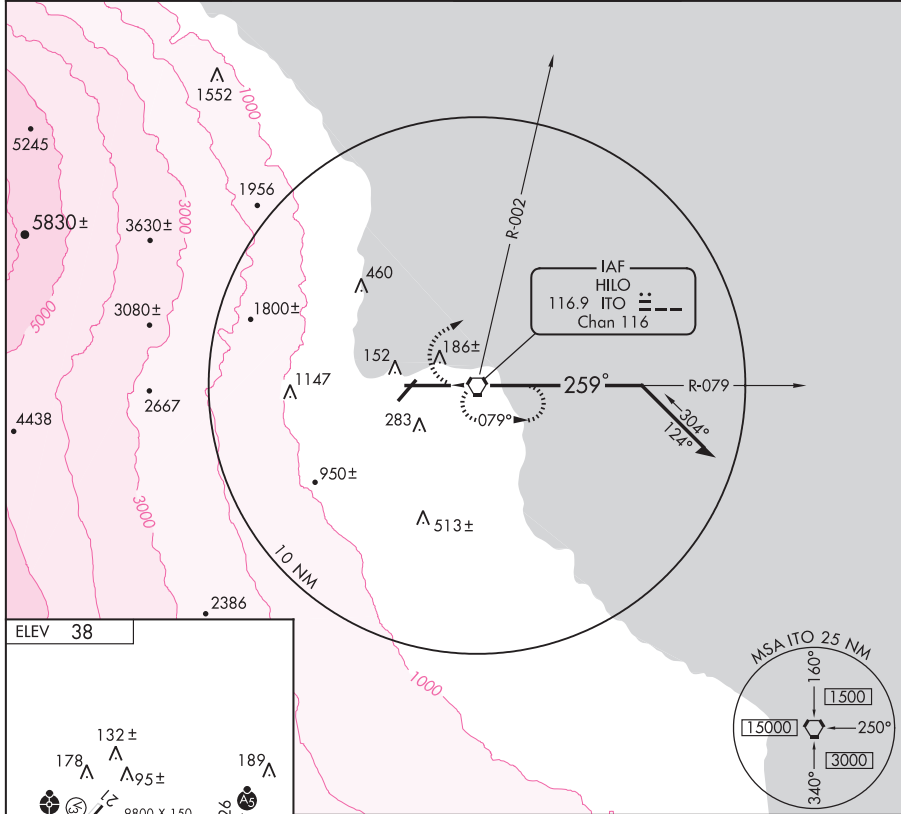

FAF to MAP 1 NM					
Knots	60	90	120	150	180
Min:Sec	1:00	0:40	0:30	0:24	0:20

CATEGORY	A	B	C	D
CIRCLING	500-1	462 (500-1)	500-1½ 462 (500-1½)	700-2 662 (700-2)

HILO, HAWAII  
Orig-B 09071

19°43'N-155°03'W

HILO INTL (ITO) (PHTO)  
**VOR-B**

09071

# AIRPORT DIAGRAM

AL-756 (FAA)

HILO INTL (ITO)(PHTO)  
HILO, HAWAII

ATIS  
126.4  
HILO TOWER\*  
118.1 263.1  
GND CON  
121.9



JANUARY 2005  
ANNUAL RATE OF CHANGE  
0.0° W

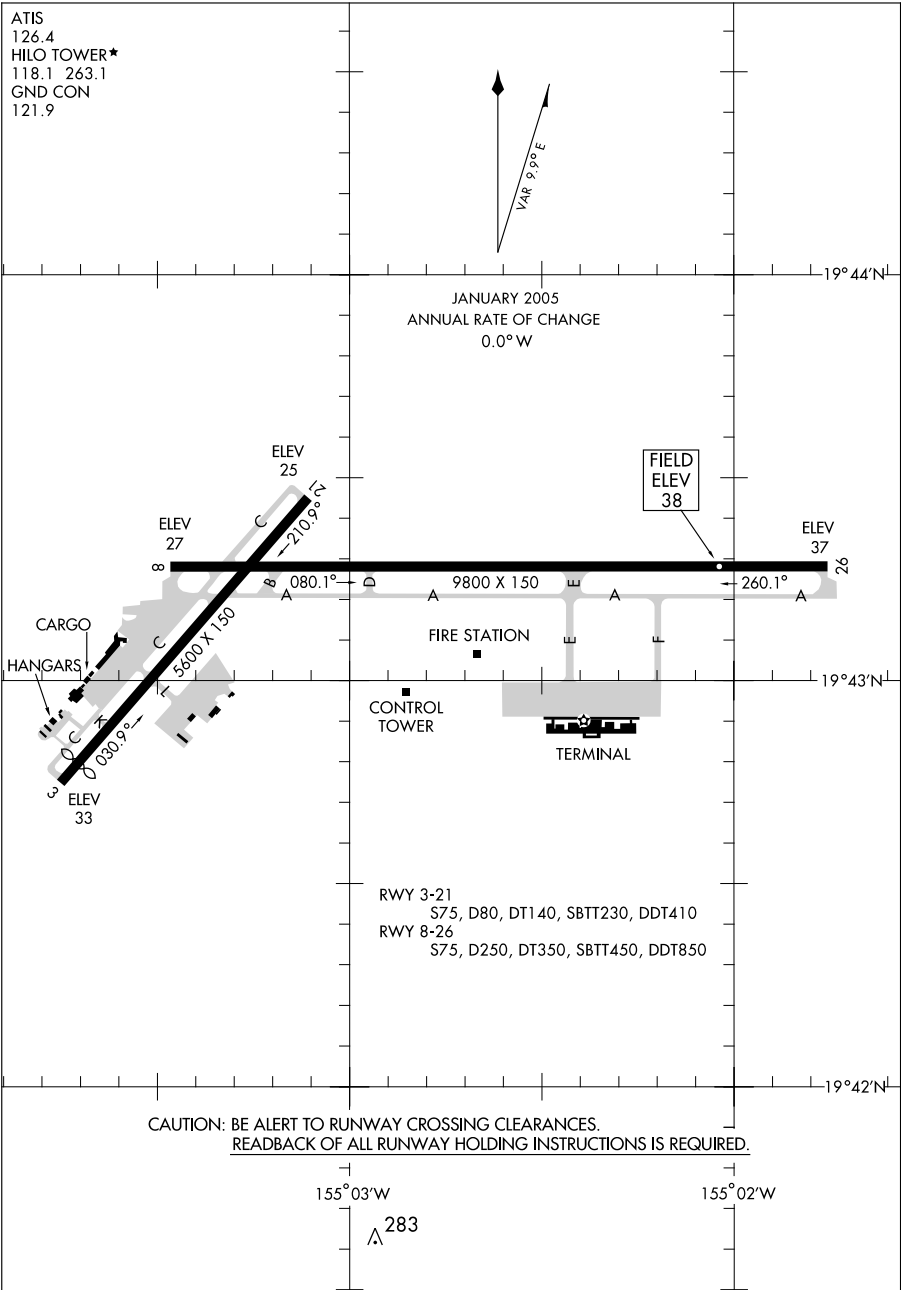

CAUTION: BE ALERT TO RUNWAY CROSSING CLEARANCES.  
READEBACK OF ALL RUNWAY HOLDING INSTRUCTIONS IS REQUIRED.

155° 03' W

△ 283

155° 02' W

# AIRPORT DIAGRAM

09071

HILO, HAWAII  
HILO INTL (ITO)(PHTO)

(PARIS4.PARIS) 10042

SL-756 (FAA)

HILO INTL (ITO)(PHTO)  
HILO, HAWAII

**PARIS FOUR DEPARTURE (OBSTACLE)**

ATIS 126.4  
GND CON  
121.9  
HILO TOWER \*  
118.1 (CTAF) 263.1  
HILO DEP CON  
119.7 269.2

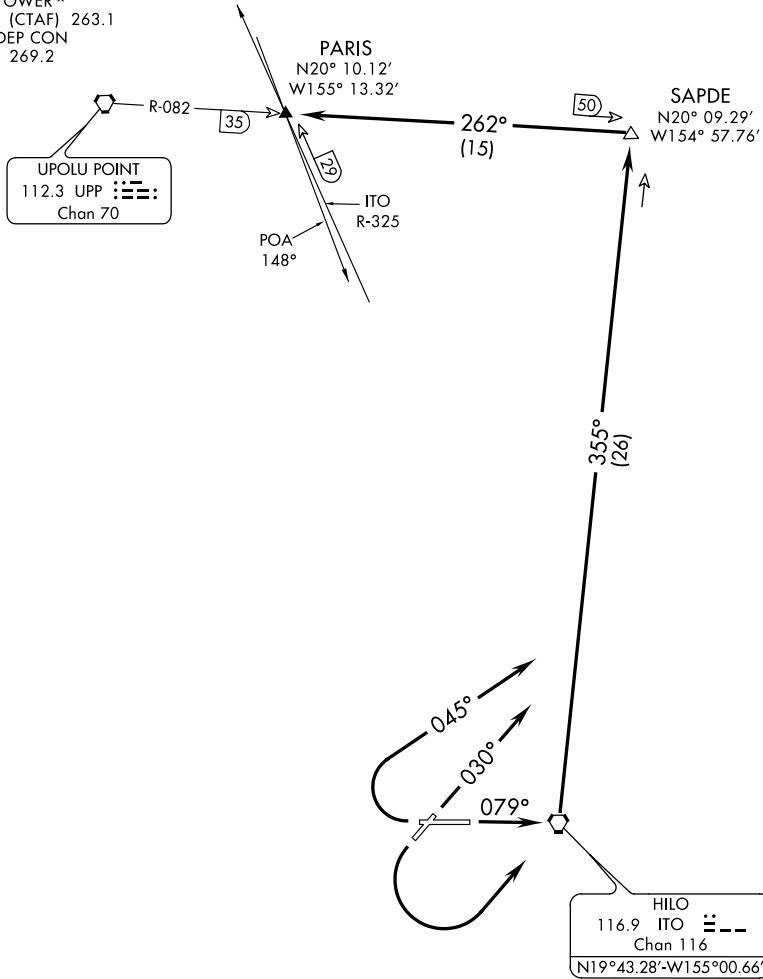

**TAKE OFF MINIMUMS:**

- Rwy 3, 8: STANDARD
- Rwy 21: Standard with minimum climb of 310' per NM to 1100 or 1300-2½ for climb in visual conditions.
- Rwy 26: Standard with minimum climb of 385' per NM to 2900 or 1300-2½ for climb in visual conditions.

NOTE: Chart not to scale.

(NARRATIVE ON FOLLOWING PAGE)

**PARIS FOUR DEPARTURE (OBSTACLE)**

(PARIS4.PARIS) 10042

HILO, HAWAII  
HILO INTL (ITO)(PHTO)

**PARIS FOUR DEPARTURE (OBSTACLE)****DEPARTURE ROUTE DESCRIPTION**

TAKE-OFF RUNWAY 3: Climb heading 030° and ITO R-355 to SAPDE INT, thence....

TAKE-OFF RUNWAY 8: Climb heading 079° to ITO VORTAC and ITO R-355 to SAPDE INT, thence....

TAKE-OFF RUNWAY 21: Climbing left turn direct ITO VORTAC and ITO R-355 to SAPDE INT, or climb in visual conditions to cross ITO VORTAC northbound at or above 1200 MSL, then via R-355 to SAPDE INT, thence....

TAKE-OFF RUNWAY 26: Climbing right turn via heading 045° and ITO R-355 to SAPDE INT, or climb in visual conditions to cross ITO VORTAC northbound at or above 1200 MSL, then via R-355 to SAPDE INT, thence....

....proceed via UPP R-082 to PARIS INT.

TAKE OFF OBSTACLE NOTES

Rwy 3: Numerous trees and WSK beginning 395' from DER, 68' left of centerline, up to 86' AGL/115' MSL.

Numerous trees beginning 325' from DER, 137' right of centerline, up to 66' AGL/95' MSL.

Rwy 8: Tree 1198' from DER, 480' left of centerline, 37' AGL/70' MSL.

Numerous trees beginning 414' from DER, 328' right of centerline, up to 46' AGL/79' MSL.

Rwy 21: Numerous trees and poles beginning 1077' from DER, 272' left of centerline, up to 70' AGL/490' MSL.

Numerous trees and poles beginning 236' from DER, 43' right of centerline, up to 83' AGL/362' MSL.

Vehicles on road beginning 234' from DER, 260' left of centerline, 15' AGL/58' MSL.

Rwy 26: Numerous vehicles beginning 6' from DER, 452' right of centerline, up to 15' AGL/39' MSL.

Numerous trees and light poles beginning 542' from DER, 471' left of centerline, up to 86' AGL/92' MSL.

Numerous trees beginning 1645' from DER, 266' right of centerline, up to 93' AGL/119' MSL.

Windsock 3' from DER, 269' right of centerline, 19' AGL/46' MSL.

Radar reflector 373' from DER, 346' right of centerline, 10' AGL/37' MSL.

HONOLULU, HAWAII

AL-754 (FAA)

LOC/DME IUM <b>110.5</b> Chan 42	APP CRS <b>042°</b>	Rwy Idg TDZE Apt Elev <b>9000</b> <b>9</b> <b>13</b>
--	------------------------	---

# ILS RWY 4R

HONOLULU INTL (HNL) (PHNL)

▼ Cat. A, B, C circling not authorized northwest of airport between Rwys 8L-26R and 4L- 22R. Cat. D, E circling not authorized north of Rwy 8L-26R. For inoperative MALSR, increase S-ILS-4R Cat. E visibility to 1/4 and S-LOC-4R visibility to 1/2.

▲ MALSR  
MISSED APPROACH: Climb to 500 then climbing right turn to 3000 via HNL R-171 to ALANA Int/HNL 13.9 DME and hold.

ATIS <b>127.9 251.15</b>	HCF APPROACH <b>118.3 269.0</b>	HONOLULU TOWER <b>118.1 257.8</b>	GND CON <b>121.9 348.6</b>	CLNC DEL <b>121.4 281.4</b>	RAMP CONTROL <b>121.8</b>
-----------------------------	------------------------------------	--------------------------------------	-------------------------------	--------------------------------	------------------------------

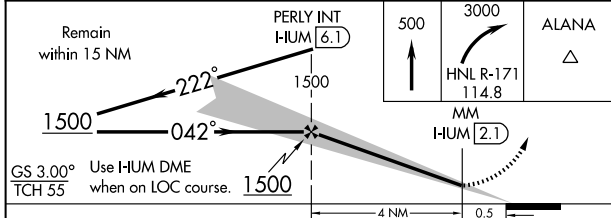
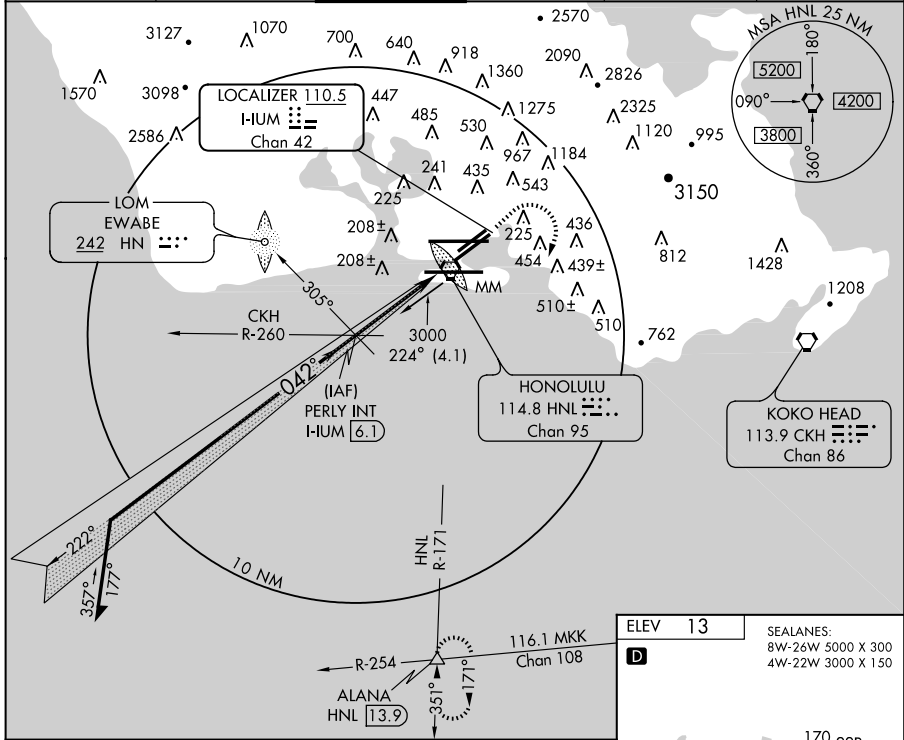

ELEV 13	SEALANES: 8W-26W 5000 X 300 4W-22W 3000 X 150
---------	---

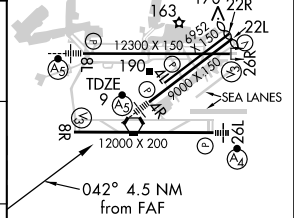

CATEGORY	A	B	C	D	E
S-ILS 4R	209-1/2		200 (200-1/2)		359-1 350 (400-1)
S-LOC 4R	460-1/2	451 (500-1/2)	460-3/4 451 (500-3/4)	460-1 451 (500-1)	
CIRCLING	620-1 607 (700-1)		620-1 3/4 607 (700-1 3/4)	760-2 1/2 747 (800-2 1/2)	1500-3 1487 (1500-3)

MIRL Rwy 4L-22R REIL Rwys 4L, 8R, 22L, 22R and 26R HIRL Rwys 4R-22L, 8L-26R and 8R-26L					
FAF to MAP 4 NM					
Knots	60	90	120	150	180
Min:Sec	4:00	2:40	2:00	1:36	1:20

HONOLULU, HAWAII  
Amdt 11B 09295

21° 19'N-157° 55'W

# HONOLULU INTL (HNL) (PHNL) ILS RWY 4R

HONOLULU, HAWAII

AL-754 (FAA)

LOC HNL	APP CRS	Rwy Idg	<b>12300</b>
<b>111.7</b>	<b>079°</b>	TDZE	<b>13</b>
		Apt Elev	<b>13</b>

# ILS RWY 8L

HONOLULU INTL (HNL) (PHNL)

▼ Cat. A, B, C circling not authorized northwest of airport between Rwys 8L-26R and 4L- 22R; Cat. D circling not authorized north of Rwy 8L-26R.



MISSED APPROACH: Climb to 500 then climbing right turn to 3000 via HNL R-171 to ALANA Int/HNL 13.9 DME and hold.

ATIS	HCF APPROACH	HONOLULU TOWER	GND CON	CLNC DEL	RAMP CONTROL
<b>127.9 251.15</b>	<b>118,3 269,0</b>	<b>118,1 257,8</b>	<b>121.9 348.6</b>	<b>121.4 281.4</b>	<b>121.8</b>

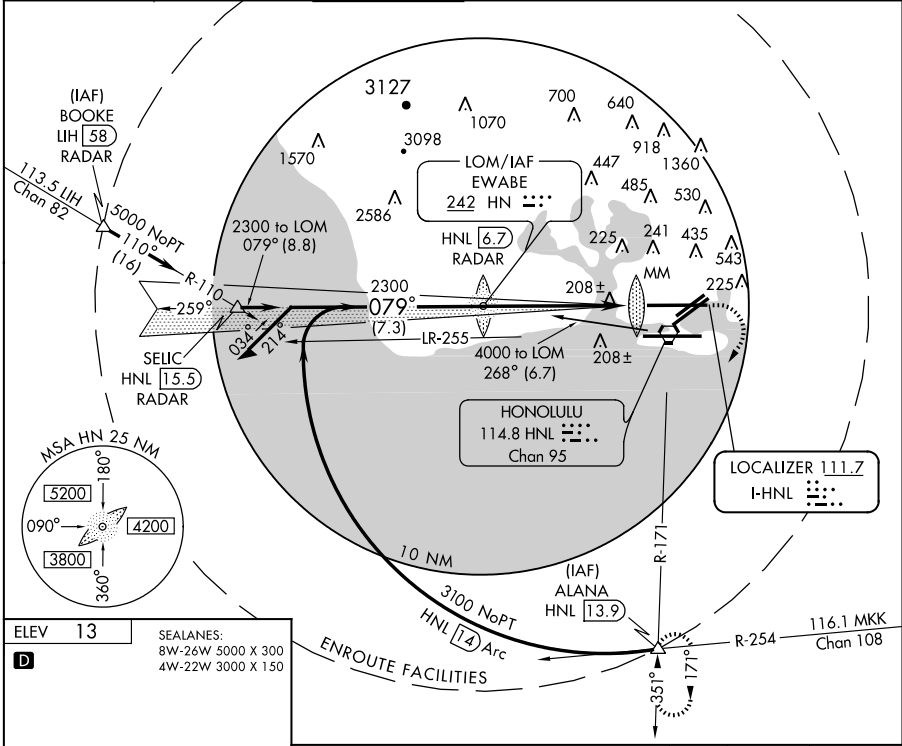

ELEV	13	SEALANES:
		8W-26W 5000 X 300
		4W-22W 3000 X 150

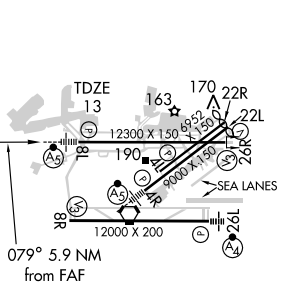

MIRL Rwy 4L-22R  
REIL Rwys 4L, 8R, 22L, 22R and 26R  
HIRL Rwys 4R-22L, 8L-26R and 8R-26L

FAF to MAP 5.9 NM

Knots	60	90	120	150	180
Min:Sec	5:54	3:56	2:57	2:22	1:58

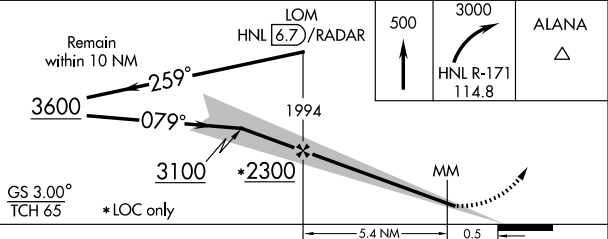

CATEGORY	A	B	C	D
S-ILS 8L	213-1/2 200 (200-1/2)			
S-LOC 8L	460-1/2	447 (500-1/2)	460-3/4 447 (500-3/4)	460-1 447 (500-1)
CIRCLING	620-1	607 (700-1)	620-13/4 607 (700-13/4)	760-2 1/2 747 (800-2 1/2)

HONOLULU, HAWAII  
Amdt 21A 0929S

21° 19'N-157° 55'W

# HONOLULU INTL (HNL) (PHNL)

## ILS RWY 8L

HONOLULU, HAWAII

AL-754 (FAA)

# RNAV (GPS) RWY 4L

HONOLULU INTL (HNL) (PHNL)

APP CRS	Rwy Idg	<b>6398</b>
<b>042°</b>	TDZE	<b>10</b>
	Apt Elev	<b>13</b>

GPS or RNP-0.3 Required. DME/DME RNP-0.3 NA. Cats. A, B, C circling not authorized northwest of airport between Rwy 8L-26R and 4L-22R. Cats. D, E circling not authorized north of Rwy 4L-22R.

MISSED APPROACH: Climb to 500 then climbing right turn to 3000 direct to ALANA WP and hold.

ATIS	HCF APPROACH	HONOLULU TOWER	GND CON	CLNC DEL	RAMP CONTROL
<b>127.9 251.15</b>	<b>118.3 269.0</b>	<b>118.1 257.8</b>	<b>121.9 348.6</b>	<b>121.4 281.4</b>	<b>121.8</b>

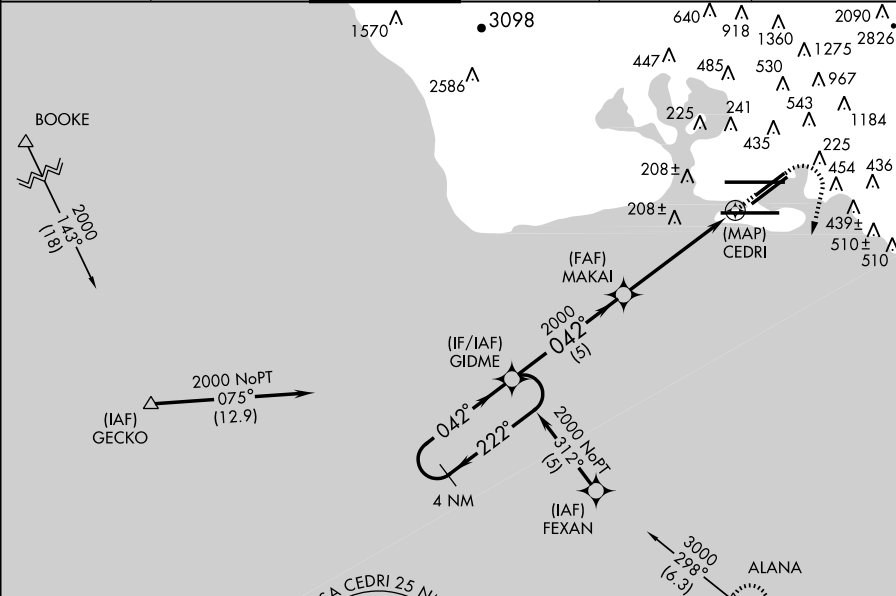

ELEV	13	SEALANES:
<b>D</b>		8W-26W 5000 X 300
		4W-22W 3000 X 150

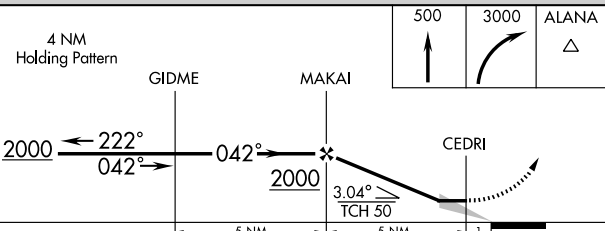
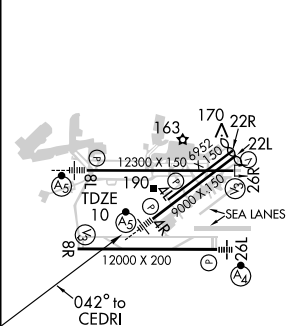
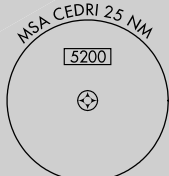

CATEGORY	A	B	C	D	E
LNVA MDA	460-1¼		450 (500-1¼)		460-1½ 450 (500-1½)
CIRCLING	620-1¼	607 (700-1¼)	620-1¾ 607 (700-1¾)	820-2½ 807 (900-2½)	1500-3 1487 (1500-3)

MIRL Rwy 4L-22R  
REIL Rwy 4L, 8R, 22L, 22R and 26R  
HIRL Rwy 4R-22L, 8L-26R and 8R-26L

HONOLULU, HAWAII  
Orig 09295

21° 19'N-157°55'W

HONOLULU INTL (HNL) (PHNL)  
**RNAV (GPS) RWY 4L**



HONOLULU, HAWAII

AL-754 (FAA)

APP CRS	Rwy Idg	<b>12000</b>
<b>079°</b>	TDZE	<b>10</b>
	Apt Elev	<b>13</b>

# RNAV (GPS) RWY 8R

HONOLULU INTL (HNL) (PHNL)

▼ Cat. A, B, C circling NA northwest of airport between Rwys 8L-26R and 4L-22R. Cat. D, E circling NA north of Rwy 4L-22R.  
 ▲ NA GPS or RNP-0.3 Required. DME/DME RNP-0.3 NA.

MISSED APPROACH: Climb to 500 then climbing right turn to 3100 direct ALANA WP and hold.

ATIS	HCF APPROACH	<b>HONOLULU TOWER</b>	GND CON	CLNC DEL	RAMP CONTROL
<b>127.9 251.15</b>	<b>118.3 269.0</b>	<b>118.1 257.8</b>	<b>121.9 348.6</b>	<b>121.4 281.4</b>	<b>121.8</b>

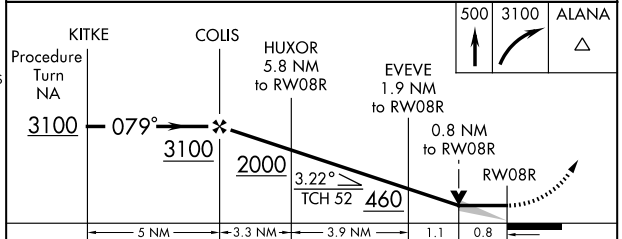
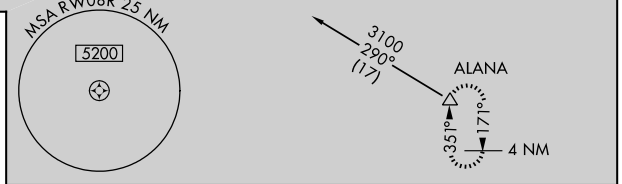
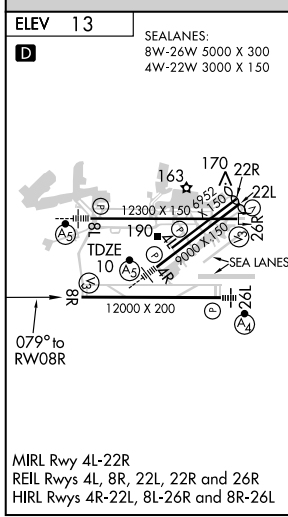

CATEGORY	A	B	C	D	E
LNVA MDA	320-1 310 (400-1)				
CIRCLING	620-1	607 (700-1)	620-1 <sup>3</sup> / <sub>4</sub> 607 (700-1 <sup>3</sup> / <sub>4</sub> )	820-2 <sup>1</sup> / <sub>2</sub> 807 (900-2 <sup>1</sup> / <sub>2</sub> )	1500-3 1487 (1500-3)

HONOLULU, HAWAII  
 Orig 09295

21° 19'N-157° 55'W

# HONOLULU INTL (HNL) (PHNL)

## RNAV (GPS) RWY 8R



HONOLULU, HAWAII

AL-754 (FAA)

# RNAV (GPS) Y RWY 8L

HONOLULU INTL (HNL) (PHNL)

APP CRS	Rwy Idg	<b>12300</b>
<b>079°</b>	TDZE	<b>13</b>
	Apt Elev	<b>13</b>

**▼** DME/DME RNP-0.3 NA Cat. A, B, C circling NA northwest of airport between Rwys 8L-26R and 4L-22R. Cat. D, E circling NA north of Rwy 8L-26R.



**MISSED APPROACH:** Climbing right turn to 3600 direct GECKO and hold.

ATIS	HCF APPROACH	HONOLULU TOWER	GND CON	CLNC DEL	RAMP CONTROL
<b>127.9 251.15</b>	<b>118.3 269.0</b>	<b>118.1 257.8</b>	<b>121.9 348.6</b>	<b>121.4 281.4</b>	<b>121.8</b>

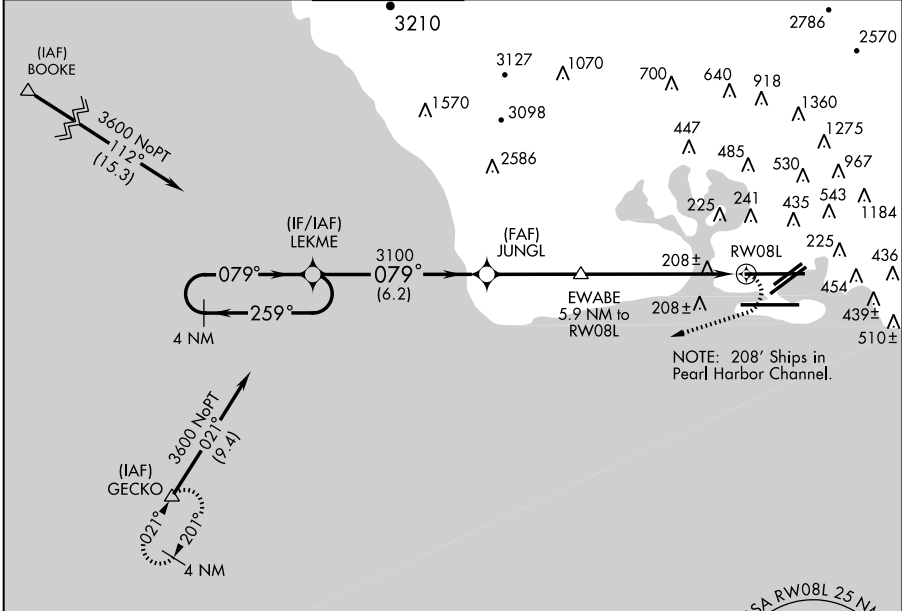

NOTE: 208' Ships in Pearl Harbor Channel.

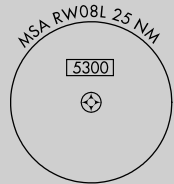

ELEV	<b>13</b>	SEALANES:
<b>D</b>		8W-26W 5000 X 300
		4W-22W 3000 X 150

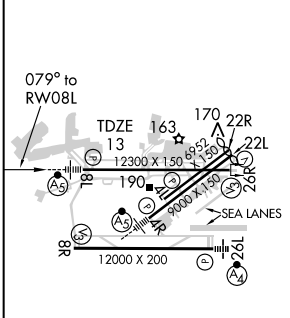

MIRL Rwy 4L-22R  
 REIL Rwys 4L, 8R, 22L, 22R and 26R  
 HIRL Rwys 4R-22L, 8L-26R and 8R-26L

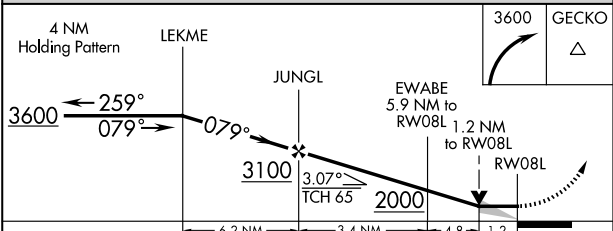

CATEGORY	A	B	C	D	E
LNAV MDA	460-1/2	447 (500-1/2)	460-3/4 447 (500-3/4)	460-1	447 (500-1)
CIRCLING	620-1	607 (700-1)	620-1 3/4 607 (700-1 3/4)	820-2 1/2 807 (900-2 1/2)	1660-3 1647 (1700-3)

HONOLULU, HAWAII  
 Amdt 1 09295

21° 19'N-157° 55'W

# HONOLULU INTL (HNL) (PHNL) RNAV (GPS) Y RWY 8L

HONOLULU, HAWAII

AL-754 (FAA)

# RNAV (RNP) RWY 26L

HONOLULU INTL (HNL) (PHNL)

APP CRS	Rwy Idg	<b>12000</b>
<b>259°</b>	TDZE	<b>10</b>
	Apt Elev	<b>13</b>

**RF and GPS REQUIRED.** For uncompensated Baro-VNAV systems, procedure NA below 15°C (58°F) or above 49°C (121°F).  
**NA** For inoperative MALSF, increase RNP 0.15 visibility to 1 all Cats.  
 \* Missed approach requires a minimum climb of 234' per NM to 300.

**MALSF** MISSED APPROACH: Climb to 3000 via 259° track to KABTE, left turn via 4.9 radius to LAYIG, 133° track to ALANA and hold.

ATIS	HCF APPROACH	<b>HONOLULU TOWER</b>	GND CON	CLNC DEL	RAMP CONTROL
<b>127.9 251.15</b>	<b>118.3 269.0</b>	<b>118.1 257.8</b>	<b>121.9 348.6</b>	<b>121.4 281.4</b>	<b>121.8</b>

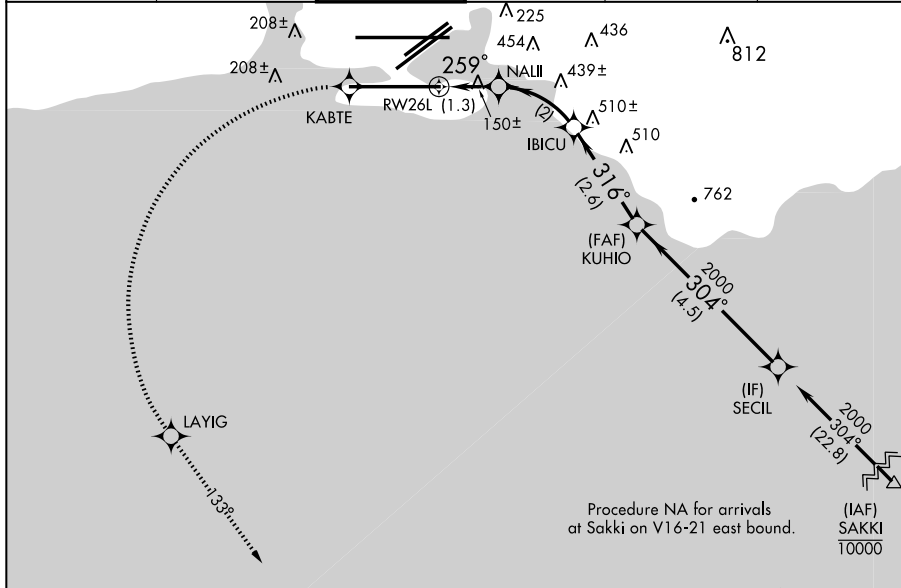

ELEV	<b>13</b>	SEALANES:
		8W-26W 5000 X 300
		4W-22W 3000 X 150

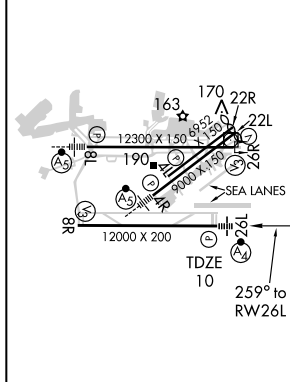

MIRL Rwy 4L-22R  
 REIL Rwys 4L, 8R, 22L, 22R and 26R  
 HIRL Rwys 4R-22L, 8L-26R and 8R-26L

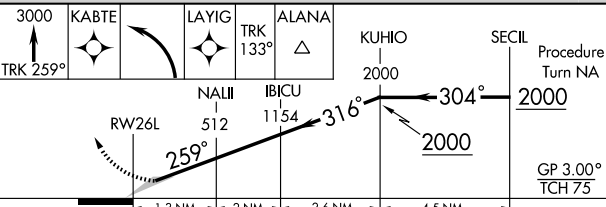

CATEGORY	A	B	C	D
RNP 0.15 DA*	260-1/2	250 (300-1/2)		

**SPECIAL AIRCRAFT & AIRCREW AUTHORIZATION REQUIRED**

HONOLULU, HAWAII  
 Orig-A 09295

21° 19'N-157° 55'W

HONOLULU INTL (HNL) (PHNL)  
**RNAV (RNP) RWY 26L**

HONOLULU, HAWAII

AL-754 (FAA)

# RNAV (RNP) Z RWY 4R HONOLULU INTL (HNL) (PHNL)

APP CRS	Rwy Idg	<b>9000</b>
<b>042°</b>	TDZE	<b>9</b>
	Apt Elev	<b>13</b>

**GPS Required.** For uncompensated Baro-VNAV systems, procedure NA below 16°C (60°F) or above 48°C (119°F). For inoperative MALSR, increase RNP 0.30 visibility to 2¼.

**MALSR**  

**MISSED APPROACH:** Climbing right turn to 5000 direct LUYEV and hold.

ATIS	HCF APPROACH	<b>HONOLULU TOWER</b>	GND CON	CLNC DEL	RAMP CONTROL
<b>127.9 251.15</b>	<b>118.3 269.0</b>	<b>118.1 257.8</b>	<b>121.9 348.6</b>	<b>121.4 281.4</b>	<b>121.8</b>

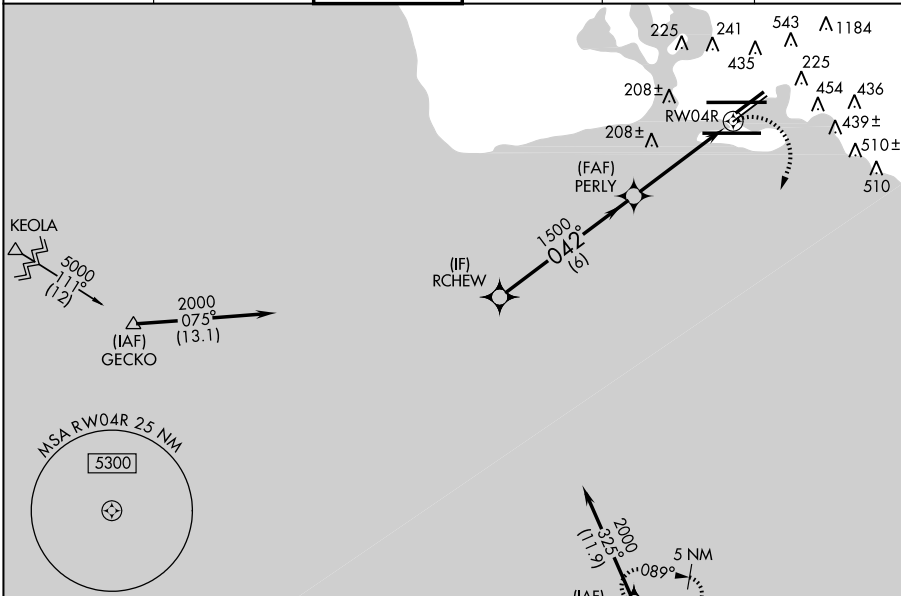

ELEV	13	SEALANES:
<b>D</b>		8W-26W 5000 X 300
		4W-22W 3000 X 150

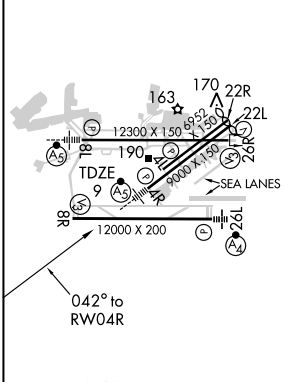

MIRL Rwy 4L-22R  
 REIL Rwys 4L, 8R, 22L, 22R and 26R  
 HIRL Rwys 4R-22L, 8L-26R and 8R-26L

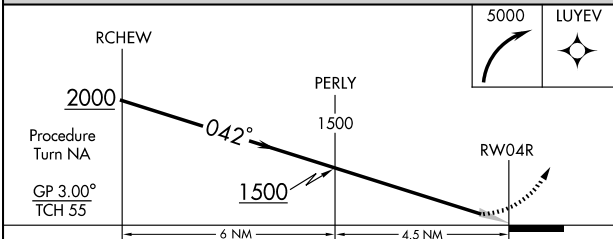

CATEGORY	A	B	C	D
RNP 0.30 DA		658-1¾	649 (700-1¾)	

**SPECIAL AIRCRAFT & AIRCREW  
 AUTHORIZATION REQUIRED**

HONOLULU, HAWAII  
 Orig 09295

HONOLULU INTL (HNL) (PHNL)  
**RNAV (RNP) Z RWY 4R**  
 21° 19'N-157° 55'W

HONOLULU, HAWAII

AL-754 (FAA)

# RNAV (RNP) Z RWY 8L

HONOLULU INTL (HNL) (PHNL)

APP CRS	Rwy Idg	<b>12300</b>
<b>079°</b>	TDZE	<b>13</b>
	Apt Elev	<b>13</b>

**GPS REQUIRED.** For uncompensated Baro-VNAV systems, procedure NA below 15°C (58°F) or above 49°C (121°F). For inoperative MALSRS increase RNP 0.30 visibility to 1/4 all Cats.

**MALSRS** MISSED APPROACH: Climb to 700 then climbing right turn to 3000 direct ALANA and hold.

ATIS	HCF APPROACH	HONOLULU TOWER	GND CON	CLNC DEL	RAMP CONTROL
<b>127.9 251.15</b>	<b>118.3 269.0</b>	<b>118.1 257.8</b>	<b>121.9 348.6</b>	<b>121.4 281.4</b>	<b>121.8</b>

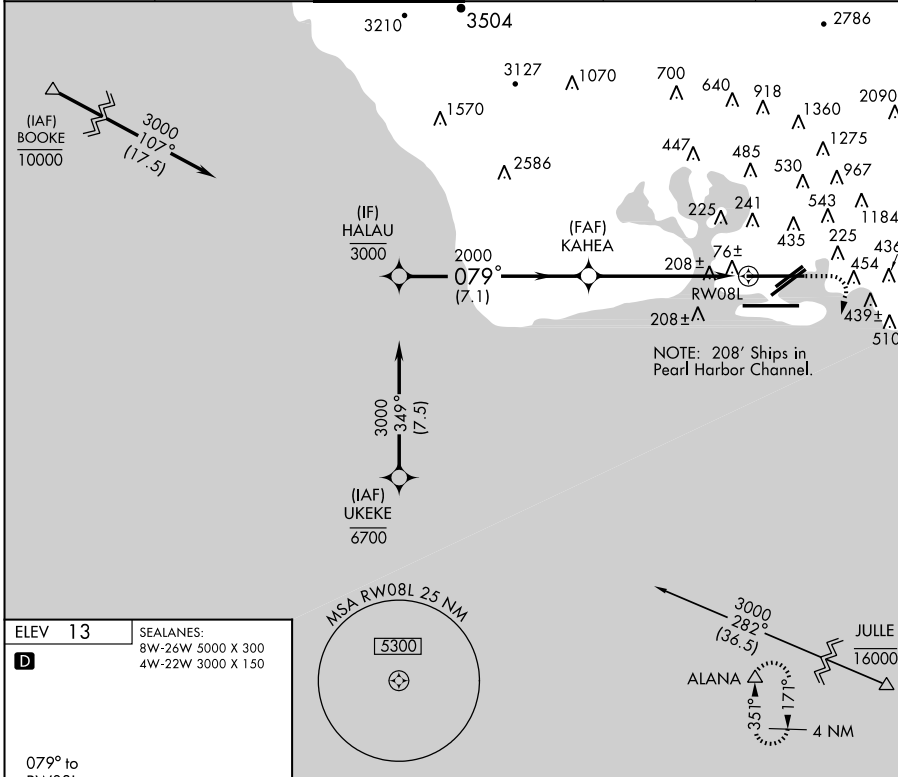

ELEV 13	SEALANES:
<b>D</b>	8W-26W 5000 X 300
	4W-22W 3000 X 150

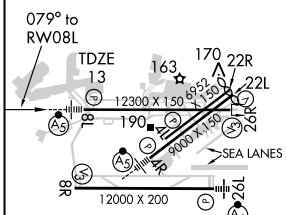

MIRL Rwy 4L-22R  
REIL Rwy 4L, 8R, 22L, 22R and 26R  
HIRL Rwy 4R-22L, 8L-26R and 8R-26L

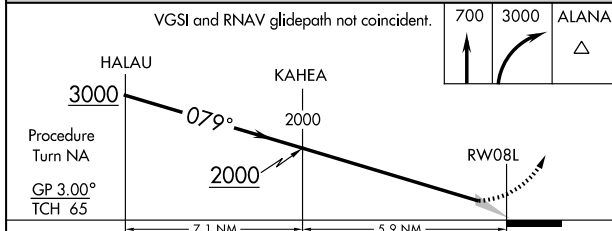

CATEGORY	A	B	C	D
RNP 0.30 DA		344-3/4	331 (400-3/4)	

**SPECIAL AIRCRAFT & AIRCREW AUTHORIZATION REQUIRED**

HONOLULU, HAWAII  
Orig 09295

HONOLULU INTL (HNL) (PHNL)  
RNAV (RNP) Z RWY 8L  
21° 19'N-157° 55'W

HONOLULU, HAWAII

AL-754 (FAA)

LOC/DME I-EPC <b>109.1</b> Chan 28	APP CRS <b>304°</b>	Rwy Idg TDZE Apt Elev <b>12000</b> <b>10</b> <b>13</b>
--	------------------------	---

**LDA/DME RWY 26L**  
HONOLULU INTL (HNL) (PHNL)

<p>▼ Cat. A, B, C circling not authorized northwest of airport between Rwy 8L/26R and 4L/22R. Cat. D, E circling not authorized north of Rwy 8L/26R.</p> <p>▲ Inoperative table does not apply to MALSF. Follow flasher lights to Rwy 26L. Procedure not authorized at night when MALSF inoperative.</p>	<p>MALSF</p> <p>Ⓜ</p> <p>MISSED APPROACH: Climbing left turn to 3000 via HNL R-171 to ALANA Int/HNL 13.9 DME and hold.</p>
--	--

ATIS <b>127.9 251.15</b>	HCF APPROACH <b>118.3 269.0</b>	HONOLULU TOWER <b>118.1 257.8</b>	GND CON <b>121.9 348.6</b>	CLNC DEL <b>121.4 281.4</b>	RAMP CONTROL <b>121.8</b>
-----------------------------	------------------------------------	--------------------------------------	-------------------------------	--------------------------------	------------------------------

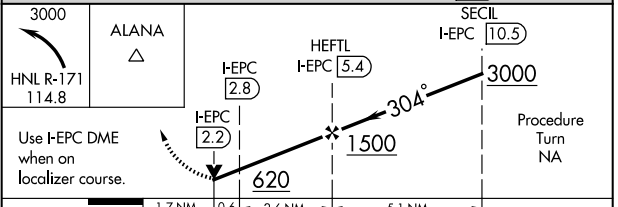
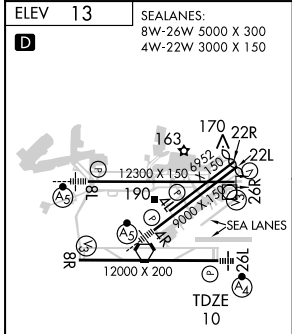
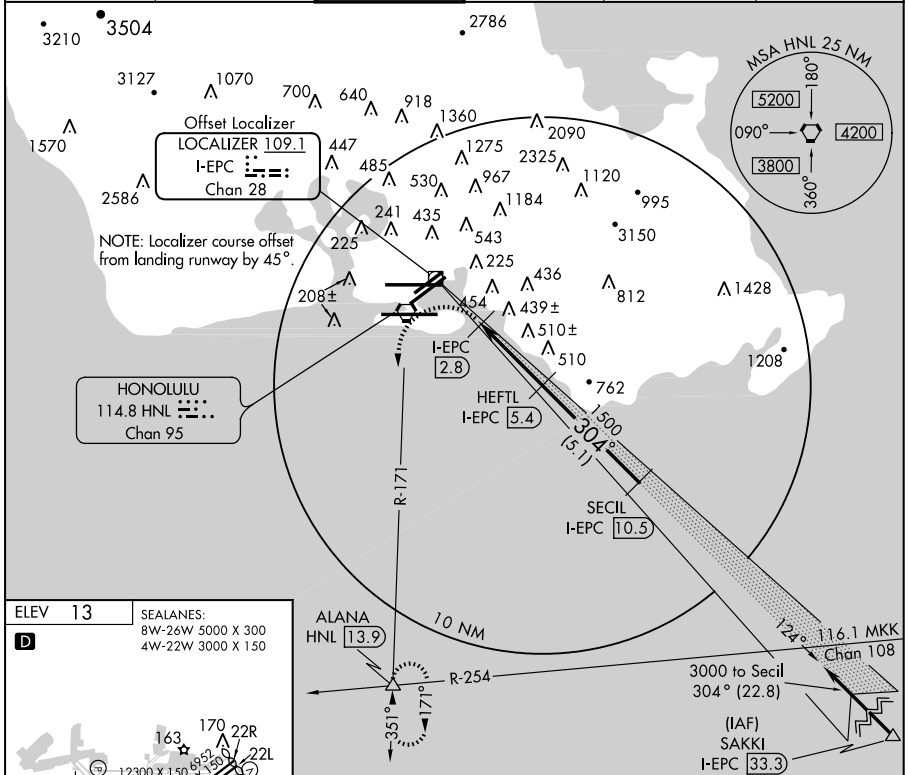

CATEGORY	A	B	C	D	E
S-26L	560-2 550 (600-2)				
CIRCLING	620-2	607 (700-2)	760-2½	1500-3	747 (800-2½) 1487 (1500-3)

HONOLULU, HAWAII  
Amdt 5A 09295

21° 19'N-157° 55'W

HONOLULU INTL (HNL) (PHNL)  
**LDA/DME RWY 26L**

HONOLULU, HAWAII

AL-754 (FAA)

VORTAC HNL <b>114.8</b> Chan <b>95</b>	APP CRS <b>037°</b>	Rwy Idg TDZE Apt Elev	<b>N/A</b> <b>N/A</b> <b>13</b>
--	------------------------	-----------------------------	---------------------------------------

# VOR/DME or TACAN or GPS-B

HONOLULU INTL (HNL) (PHNL)

**⚠** Cat. A, B, C circling not authorized northwest of airport between Rwys 8L-26R and 4L-22R. Cat. D circling not authorized north of Rwy 8L-26R. Cat. E circling not authorized north of Rwy 8R-26L.

MISSED APPROACH: Climbing right turn to 3000 via HNL R-171 to ALANA/HNL 13.9 DME and hold.

ATIS <b>127.9 251.15</b>	HCF APPROACH <b>118.3 269.0</b>	HONOLULU TOWER <b>118.1 257.8</b>	GND CON <b>121.9 348.6</b>	CLNC DEL <b>121.4 281.4</b>	RAMP CONTROL <b>121.8</b>
-----------------------------	------------------------------------	--------------------------------------	-------------------------------	--------------------------------	------------------------------

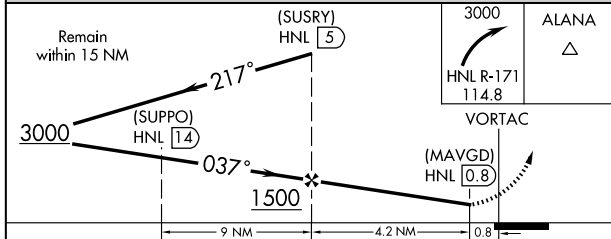
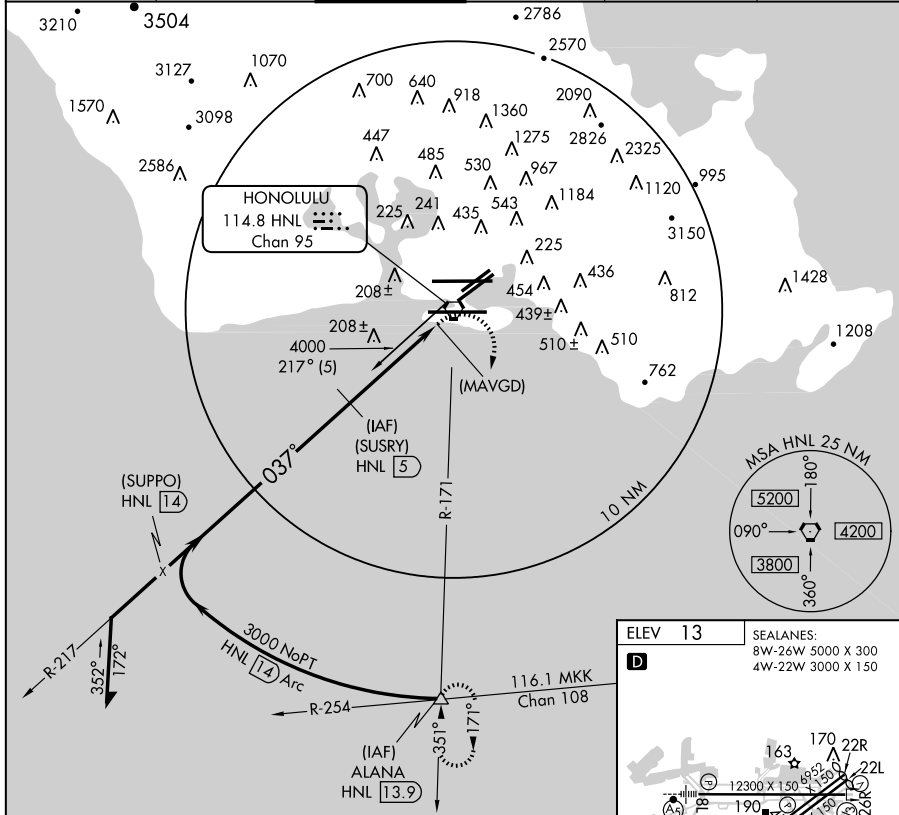

ELEV 13	SEALANES: 8W-26W 5000 X 300 4W-22W 3000 X 150
---------	---



HONOLULU, HAWAII

AL-754 (FAA)

VORTAC HNL <b>114.8</b> Chan 95	APP CRS <b>305°</b>	Rwy Idg TDZE Apt Elev	<b>N/A</b> <b>N/A</b> <b>13</b>
---------------------------------------	------------------------	-----------------------------	---------------------------------------

# VOR or TACAN or GPS-A

HONOLULU INTL (HNL) (PHNL)

**⚠** Cat. A, B, C circling not authorized northwest of airport between Rwys 8L-26R and 4L-22R; Cat. D, E circling not authorized north of Rwy 8L-26R.

MISSED APPROACH: Climbing left turn to 3000 via HNL R-171 to ALANA Int/HNL 13.9 DME and hold.

ATIS <b>127.9 251.15</b>	HCF APPROACH <b>118.3 269.0</b>	HONOLULU TOWER <b>118.1 257.8</b>	GND CON <b>121.9 348.6</b>	CLNC DEL <b>121.4 281.4</b>	RAMP CONTROL <b>121.8</b>
-----------------------------	------------------------------------	--------------------------------------	-------------------------------	--------------------------------	------------------------------

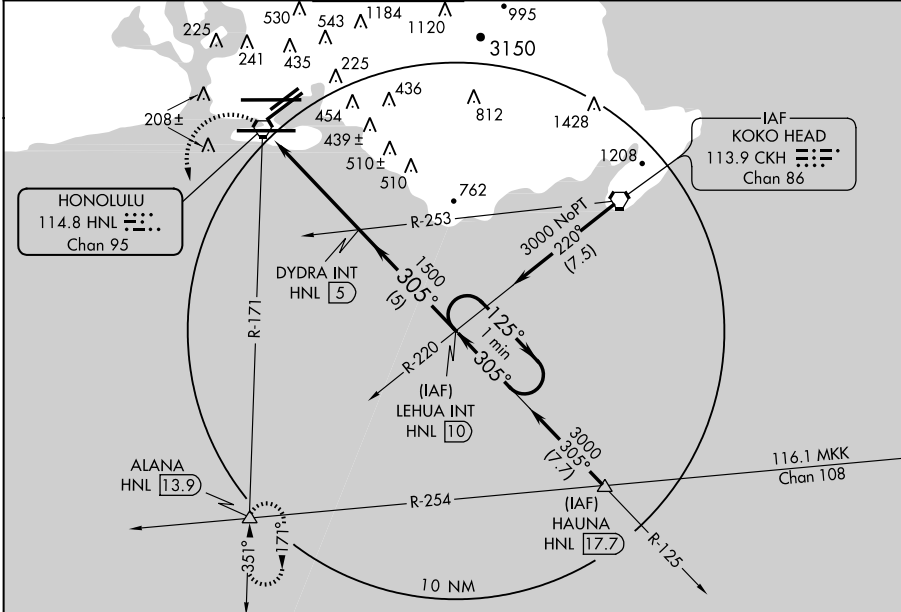

ELEV 13	SEALANES: 8W-26W 5000 X 300 4W-22W 3000 X 150
---------	---

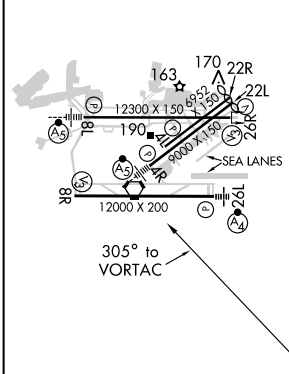

MIRL Rwy 4L-22R  
REIL Rwys 4L, 8R, 22L, 22R and 26R  
HIRL Rwys 4R-22L, 8L-26R and 8R-26L

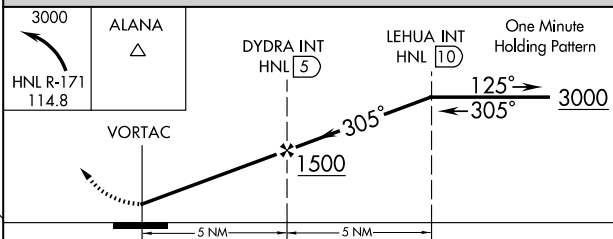

CATEGORY	A	B	C	D	E
CIRCLING	620-1	607 (700-1)	620-1¾ 607 (700-1¾)	760-2½ 747 (800-2½)	1500-3 1487 (1500-3)

HONOLULU, HAWAII  
Amdt 1A 09295

21° 19'N-157° 55'W

HONOLULU INTL (HNL) (PHNL)

# VOR or TACAN or GPS-A

HONOLULU, HAWAII

AL-754 (FAA)

VORTAC HNL <b>114.8</b> Chan <b>95</b>	APP CRS <b>018°</b>	Rwy Idg TDZE Apt Elev <b>9000</b> <b>9</b> <b>13</b>
--	------------------------	---

# VOR or TACAN RWY 4R

HONOLULU INTL (HNL) (PHNL)

**⚠** Cat. A, B, C circling not authorized northwest of airport between Rwys 8L-26R and 4L-22R. Cat. D circling not authorized north of Rwy 8L-26R. Inoperative table does not apply.

**MALS R** 

**MISSED APPROACH:** Climbing right turn to 3000 via HNL R-171 to ALANA Int/HNL 13.9 DME and hold.

ATIS <b>127.9 251.15</b>	HCF APPROACH <b>118.3 269.0</b>	HONOLULU TOWER <b>118.1 257.8</b>	GND CON <b>121.9 348.6</b>	CLNC DEL <b>121.4 281.4</b>	RAMP CONTROL <b>121.8</b>
-----------------------------	------------------------------------	--------------------------------------	-------------------------------	--------------------------------	------------------------------

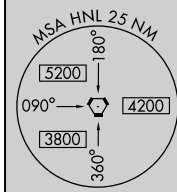
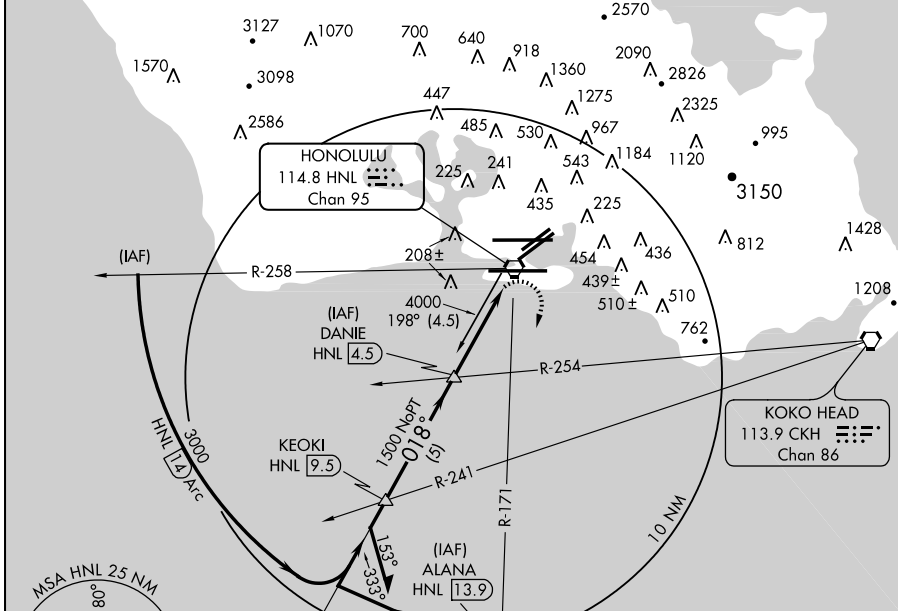

ELEV 13	SEALANES: 8W-26W 5000 X 300 4W-22W 3000 X 150
---------	---

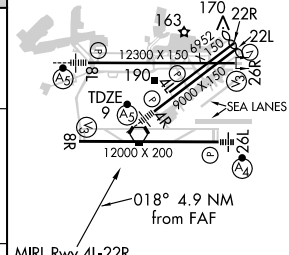
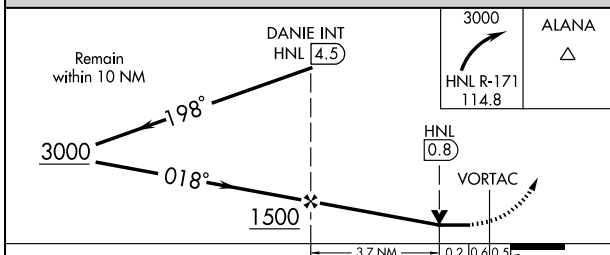

CATEGORY	A	B	C	D
S-4R	460-1	451 (500-1)	460-1¼ 451 (500-1¼)	460-1½ 451 (500-1½)
CIRCLING	620-1	607 (700-1)	620-1¾ 607 (700-1¾)	760-2½ 747 (800-2½)

FAF to MAP 3.9 NM

Knots	60	90	120	150	180
Min:Sec	3:54	2:36	1:57	1:34	1:18

HONOLULU, HAWAII  
Orig-B 09295

HONOLULU INTL (HNL) (PHNL)  
21° 19'N-157° 55'W **VOR or TACAN RWY 4R**



(HNL1.HNL) 09071

SL-754 (FAA)

HONOLULU ONE DEPARTURE (OBSTACLE)

HONOLULU INTL (HNL) (PHNL)  
HONOLULU, HAWAII

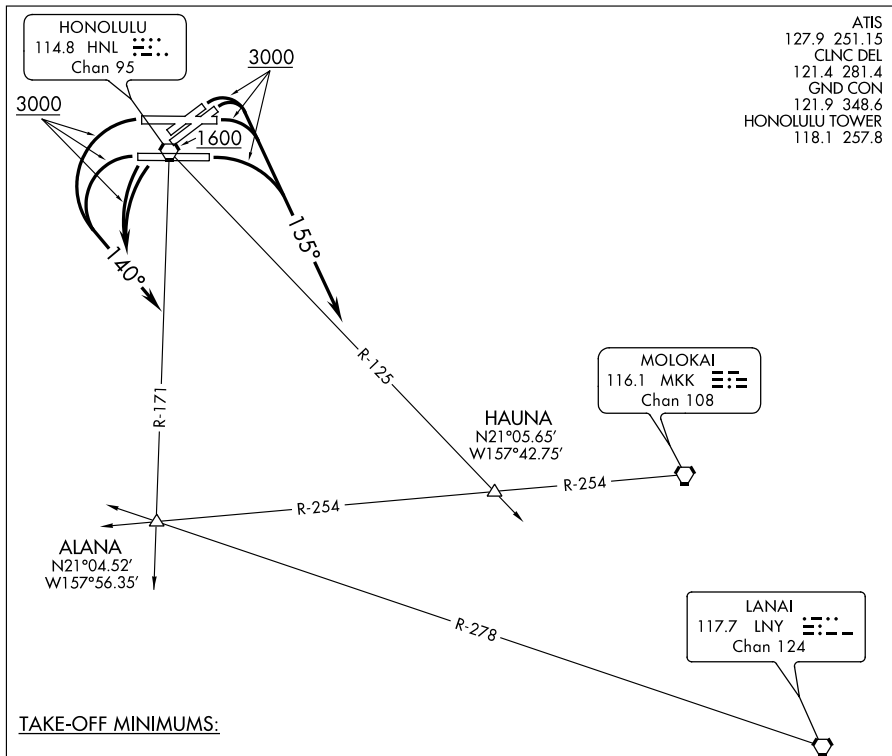

TAKE-OFF MINIMUMS:

- RWYS 22L/R, 26R: Standard.
- RWYS 4L/R: Standard with minimum climb of 425 feet per NM to 1900, do not exceed 180 KIAS until southeast bound on 155° heading, or 1700-2½ for climb in visual conditions.
- RWY 8L: Standard with minimum climb of 310 feet per NM to 1000, or 1700-2½ for climb in visual conditions.
- RWY 8R: Standard with minimum climb of 270 feet per NM to 1000, or 1700-2½ for climb in visual conditions.
- RWY 26L: Standard with minimum climb of 237 feet per NM to 300, or 1700-2½ for climb in visual conditions.

(NARRATIVE ON FOLLOWING PAGE)

NOTE: Chart not to scale.



DEPARTURE ROUTE DESCRIPTION

TAKE-OFF RUNWAYS 4L/R, 8L/R: Climbing right turn to 3000 via heading 155° to intercept HNL R-125 to HAUNA INT before proceeding on course, or....

TAKE-OFF RUNWAYS 22L/R, 26L/R: Climbing left turn to 3000 via heading 140° to intercept HNL R-171 to ALANA INT before proceeding on course, or....

....For climb in visual conditions to cross HNL VORTAC southbound at 1600, continue climb to 3000 via HNL R-171 to ALANA INT before proceeding on course.

HONOLULU ONE DEPARTURE (OBSTACLE)

(HNL1.HNL) 09071

HONOLULU, HAWAII  
HONOLULU INTL (HNL) (PHNL)

(HNL1.HNL) 09071

SL-754 (FAA)

HONOLULU INTL (HNL) (PHNL)  
HONOLULU, HAWAII**HONOLULU ONE DEPARTURE (OBSTACLE)****TAKE-OFF OBSTACLE NOTES:**

RWY 4L: Multiple lights beginning 630 feet from DER, 236 feet left of centerline, 102 feet right of centerline, up to 84 feet AGL/92 feet MSL. Light on bldg 669 feet from DER, 394 feet left of centerline, 29 feet AGL/37 feet MSL. Stack on bldg 2,488 feet from DER, 219 feet right of centerline, 72 feet AGL/80 feet MSL. Multiple trees beginning 1,253 feet from DER, 209 feet left of centerline, 935 feet right of centerline, up to 64 feet AGL/72 feet MSL. Bush 450 feet from DER, 234 feet left of centerline, 14 feet AGL/22 feet MSL.

RWY 4R: Stack on bldg, 2,442 feet from DER, 283 feet left of centerline, 72 feet AGL/80 feet MSL. Multiple trees beginning 1,206 feet from DER, 711 feet left of centerline, 433 feet right of centerline, up to 64 feet AGL/72 feet MSL. Multiple lights beginning 1,072 feet from DER, 399 feet left of centerline, 504 feet right of centerline, up to 36 feet AGL/44 feet MSL. Pole 2,110 feet from DER, 951 feet left of centerline, 59 feet AGL/67 feet MSL.

RWY 22L: Multiple bushes beginning 265 feet from DER, 396 feet right of centerline, 17 feet AGL/31 feet MSL. Tree 1,065 feet from DER, 499 feet right of centerline, 30 feet AGL/38 feet MSL.

RWY 22R: Rod on OL ASR 1,451 feet from DER, 827 feet right of centerline, 76 feet AGL/84 feet MSL. Tree 853 feet from DER, 308 feet right of centerline, 43 feet AGL/51 feet MSL.

RWY 26L: Ship 6,683 feet from DER, on centerline, 208 feet AGL/208 feet MSL.

**HONOLULU ONE DEPARTURE (OBSTACLE)**

(HNL1.HNL) 09071

HONOLULU, HAWAII  
HONOLULU INTL (HNL) (PHNL)

07074

SL-754 (FAA)

HONOLULU INTL (HNL) (PHNL)  
HONOLULU, HAWAII

**KEAHI THREE DEPARTURE (KEAHI3.KEAHI)**

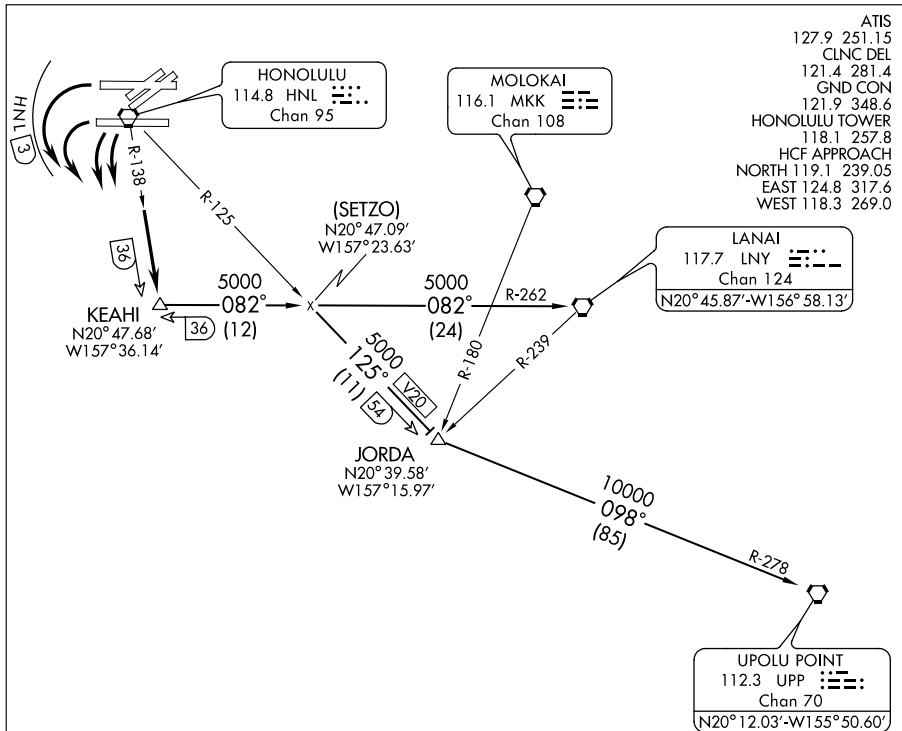

NOTE: Departures from Runways 26L/R must complete left turn to assigned heading within 2 NM of runway departure end (HNL 3 DME).

NOTE: Chart not to scale.



**DEPARTURE ROUTE DESCRIPTION**

**TAKE-OFF RUNWAYS 22/26 ONLY:** Turn left to heading assigned by tower, expect radar vectors to intercept HNL R-138; then via HNL R-138 to KEAHI INT, maintain 5000'; then via (transition). Expect clearance to enroute altitude/flight level at JORDA INT or LNY VORTAC.

**JORDA TRANSITION (KEAHI3.JORDA):** From over KEAHI INT via LNY R-262 and HNL R-125 to JORDA INT.

**LANAI TRANSITION (KEAHI3.LNY):** From over KEAHI INT via LNY R-262 to LNY VORTAC.

**UPOLU TRANSITION (KEAHI3.UPP):** From over KEAHI INT via LNY R-262 and HNL R-125 to JORDA INT, thence via UPP R-278 to UPP VORTAC.

**KEAHI THREE DEPARTURE (KEAHI3.KEAHI)**

HONOLULU, HAWAII  
HONOLULU INTL (HNL) (PHNL)

07074

# KEOLA TWO DEPARTURE (KEOLA2.KEOLA)

HONOLULU INTL (HNL) (PHNL)  
HONOLULU, HAWAII

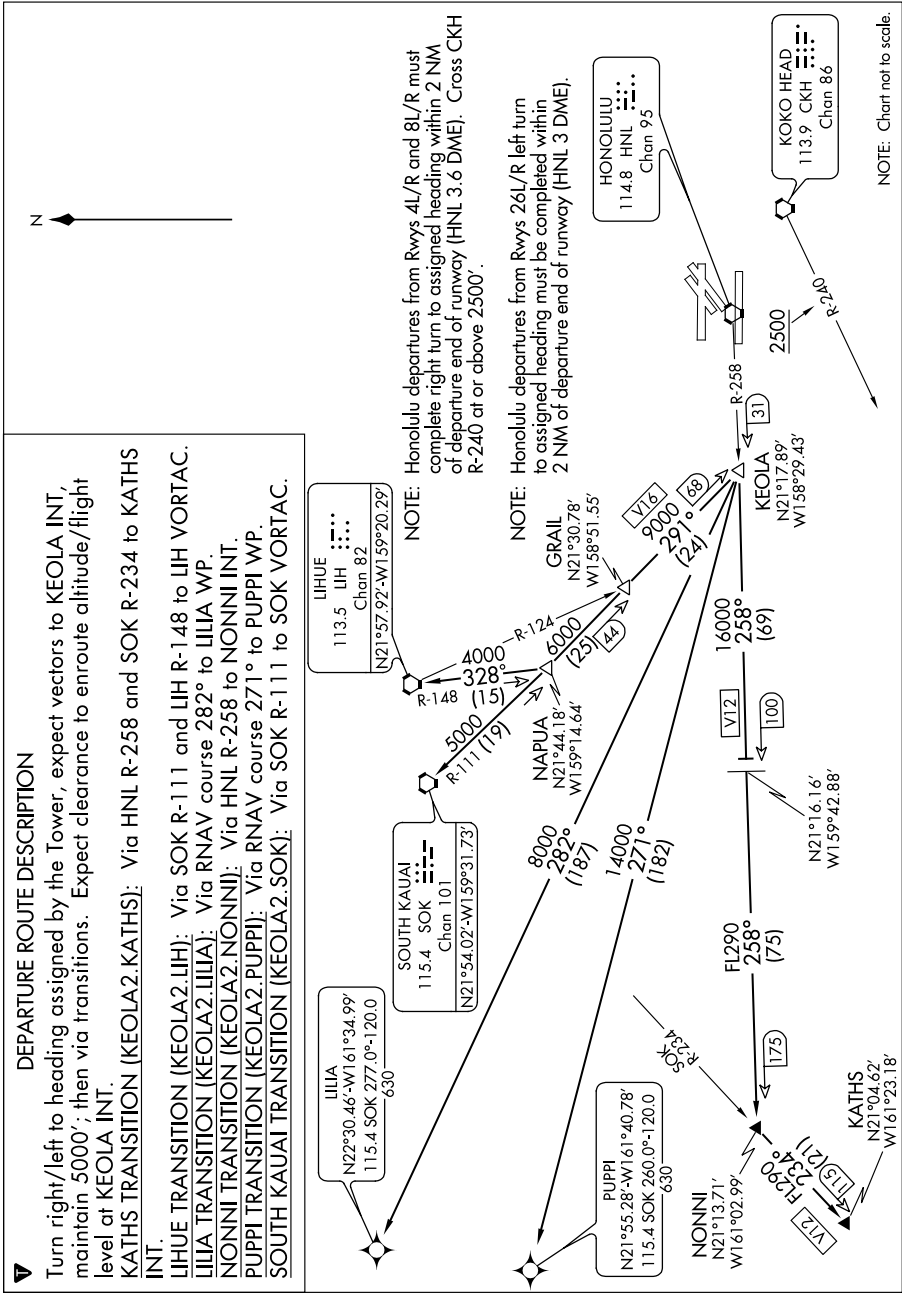

NOTE: Chart not to scale.

# KEOLA TWO DEPARTURE (KEOLA2.KEOLA)

HONOLULU, HAWAII  
HONOLULU INTL (HNL) (PHNL)

07018

SL-754 (FAA)

HONOLULU INTL (HNL) (PHNL)  
HONOLULU, HAWAII

# MOLOKAI FOUR DEPARTURE (MKK4.MKK)

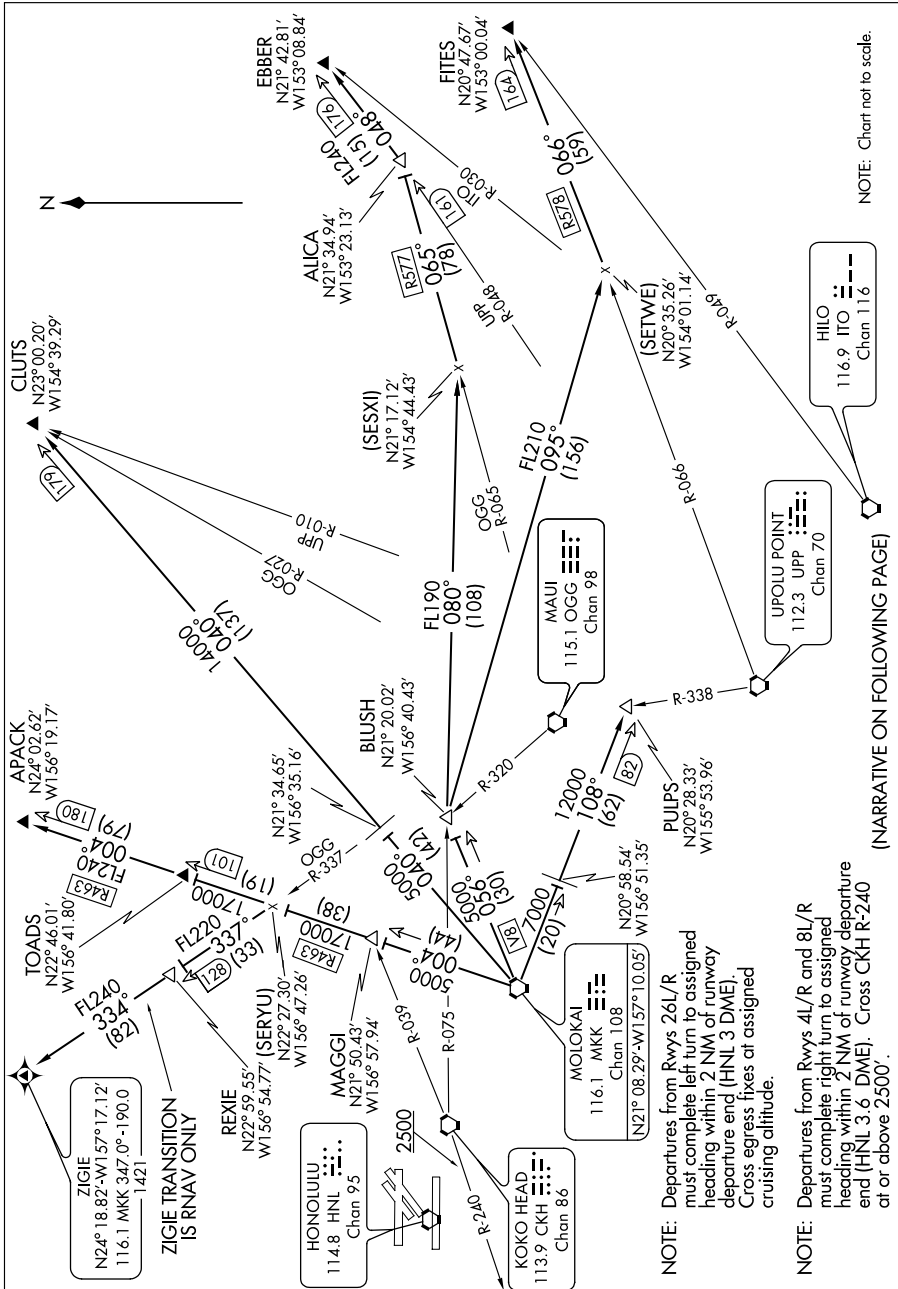

# MOLOKAI FOUR DEPARTURE (MKK4.MKK)

HONOLULU, HAWAII  
HONOLULU INTL (HNL) (PHNL)

07018





## DEPARTURE ROUTE DESCRIPTION

Turn right/left to heading as assigned by Tower, expect vectors to MKK VORTAC, maintain 5000'; then via (transition). Expect clearance to enroute altitude/flight level at MKK VORTAC. Cross egress fixes ZIGIE, APACK, CLUTS, EBBER, and FITES at assigned cruising altitude, unless otherwise advised by ATC.

APACK TRANSITION (MKK4.APACK): From over MKK VORTAC via MKK R-004 to APACK INT.

CLUTS TRANSITION (MKK4.CLUTS): From over MKK VORTAC via MKK R-040 to CLUTS INT.

EBBER TRANSITION (MKK4.EBBER): From over MKK VORTAC via MKK R-056 to BLUSH INT then via 080° heading and R577 to EBBER INT.

FITES TRANSITION (MKK4.FITES): From over MKK VORTAC via MKK R-056 to BLUSH INT then via 095° heading and R578 to FITES INT.

PULPS TRANSITION (MKK4.PULPS): From over MKK VORTAC via MKK R-108 to PULPS INT.

ZIGIE TRANSITION (MKK4.ZIGIE): From over MKK VORTAC via MKK R-004 to intercept and proceed via OGG R-337 to REXIE DME. Then via RNAV heading 334° to ZIGIE WP.

07018

SL-754 (FAA)

# OPIHI TWO DEPARTURE (OPIHI2.OPIHI)

HONOLULU INTL (HNL) (PHNL)  
HONOLULU, HAWAII

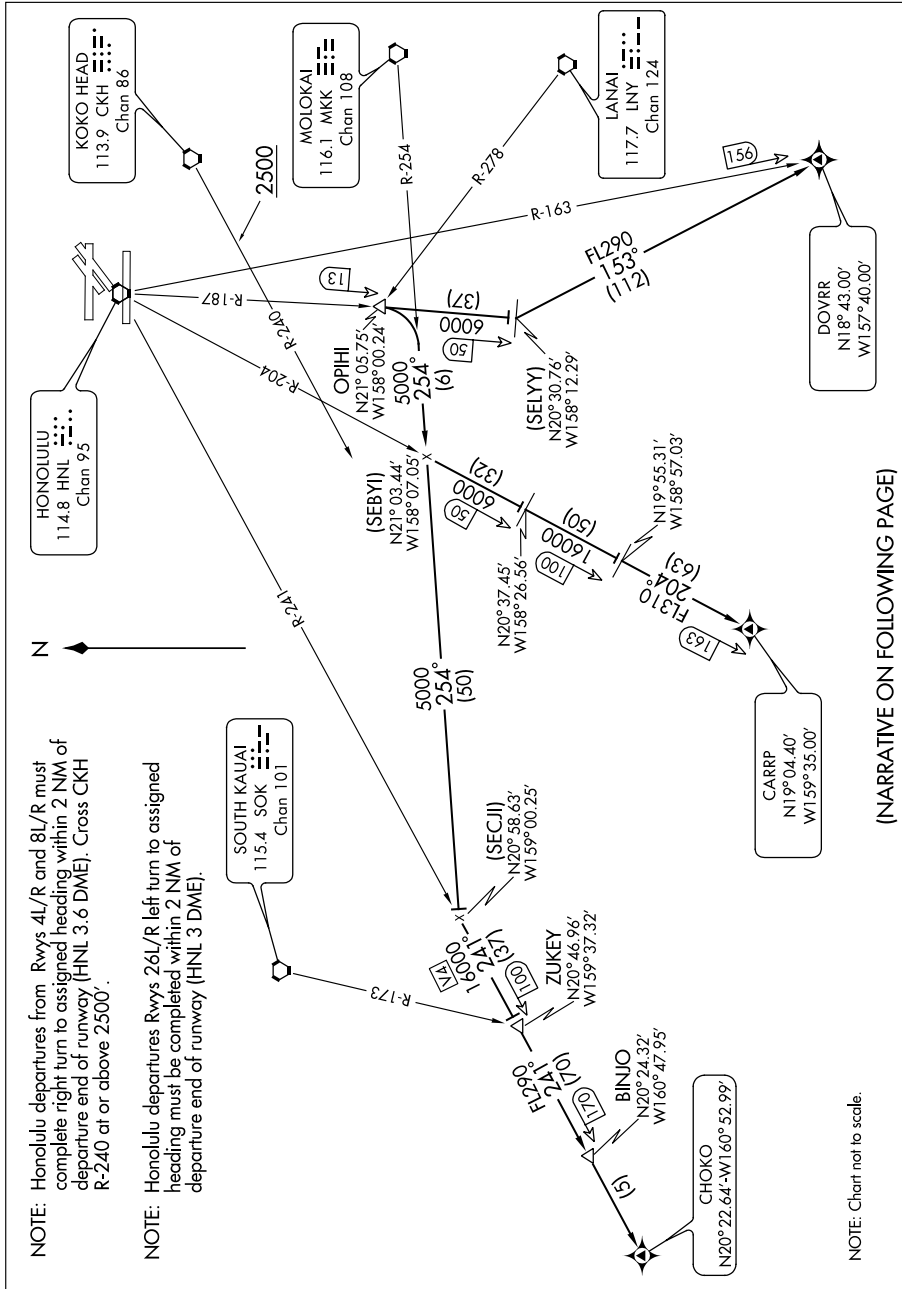

# OPIHI TWO DEPARTURE (OPIHI2.OPIHI)

HONOLULU, HAWAII  
HONOLULU INTL (HNL) (PHNL)

07018



## DEPARTURE ROUTE DESCRIPTION

Turn right/left to heading assigned by tower, expect vectors to OPIHI INT, maintain 5000'; then via (transition). Expect clearance to enroute altitude/flight level at OPIHI INT.

CARRP TRANSITION (OPIHI2.CARRP): From over OPIHI INT via right turn to intercept MKK R-254 to HNL R-204, then via HNL R-204 to HNL 100 DME, then via course 204° to CARRP WP.

CHOKO TRANSITION (OPIHI2.CHOKO): From over OPIHI INT via right turn to intercept MKK R-254 to HNL R-241 to BINJO DME, then via course 241° to CHOKO WP.

DOVRR TRANSITION (OPIHI2.DOVRR): From over OPIHI INT via HNL R-187 to HNL 50 DME, then via left turn heading 153° RNAV course to DOVRR WP.

07074

SL-754 (FAA)

**PALAY TWO DEPARTURE (PALAY2.PALAY)**

HONOLULU INTL (HNL) (PHNL)  
HONOLULU, HAWAII

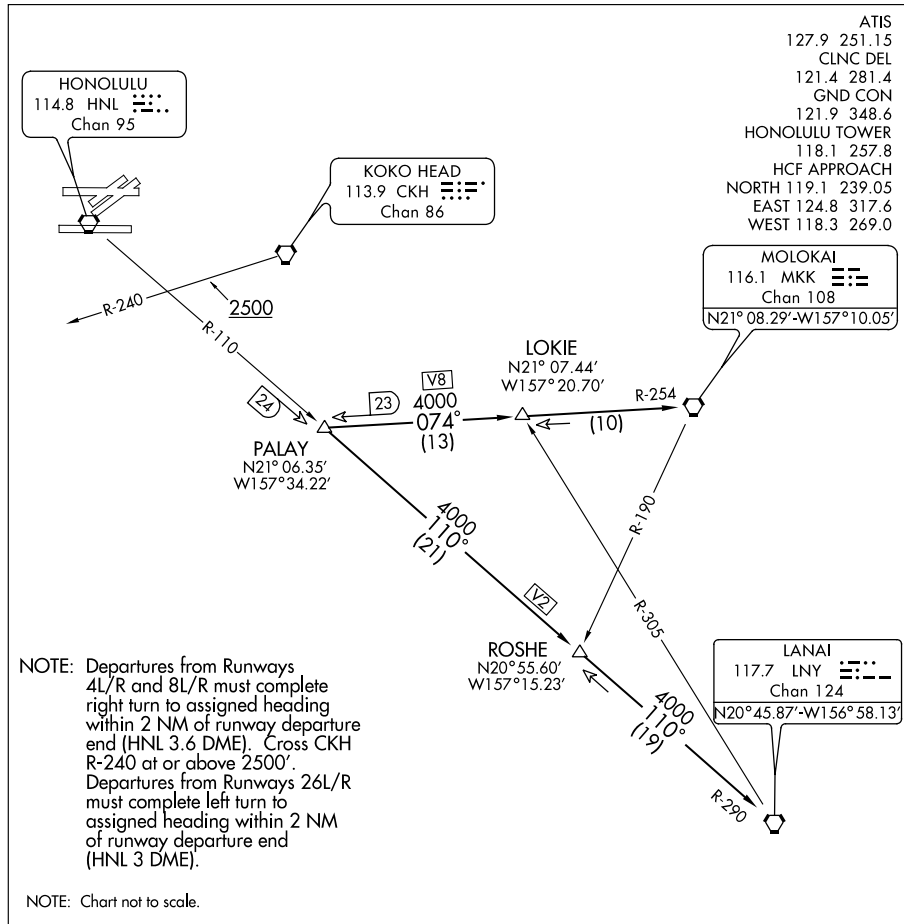

ATIS  
127.9 251.15  
CLNC DEL  
121.4 281.4  
GND CON  
121.9 348.6  
HONOLULU TOWER  
118.1 257.8  
HCF APPROACH  
NORTH 119.1 239.05  
EAST 124.8 317.6  
WEST 118.3 269.0

MOLOKAI  
116.1 MKK  
Chan 108  
N21°08.29'-W157°10.05'

LANAI  
117.7 LNY  
Chan 124  
N20°45.87'-W156°58.13'

**DEPARTURE ROUTE DESCRIPTION**

Turn right/left to heading as assigned by tower, expect vectors to PALAY INT, maintain 5000'; then via (transition). Expect clearance to enroute altitude/flight level at LNY VORTAC.

**LANAI TRANSITION (PALAY2.LNY):** From over PALAY INT via HNL R-110 and LNY R-290 to LNY VORTAC.

**MOLOKAI TRANSITION (PALAY2.MKK):** From over PALAY INT via MKK R-254 to MKK VORTAC.

**PALAY TWO DEPARTURE (PALAY2.PALAY)**

HONOLULU, HAWAII  
HONOLULU INTL (HNL) (PHNL)

07074

KAHULUI, HAWAII

AL-762 (FAA)

09351

LOC/DME I-OGG	APP CRS	Rwy Idg	6995
<b>110.1</b>	<b>024°</b>	TDZE	<b>54</b>
Chan 38		Apt Elev	<b>54</b>

# ILS or LOC Rwy 2

KAHULUI (OGG)(PHOG)

**⚠** Inoperative table does not apply to ILS all Cats, LOC Cat A and B. DME or RADAR required. Visibility reduction by helicopters NA. For inoperative MALSR, increase NOWAK fix minimums LOC Cat A and B visibility 1/2 mile, increase Cat E 1/2 mile.

**MALSR**  
  
**MISSED APPROACH:** Climb to 3000 via OGG R-024 then climbing right turn to 5000 direct OGG-VORTAC, then via OGG R-190 and LNY R-095 to CAMPS and hold.

ATIS <b>128.6</b>	HCF APPROACH <b>120.2 322.4 (NORTH)</b> <b>119.5 225.4 (SOUTH)</b>	MAUI TOWER * <b>118.7 (CTAF) 0 279.6</b>	GND CON <b>121.9 279.6</b>	CLNC DEL <b>120.6 290.5</b>	UNICOM <b>122.95</b>
----------------------	--	---	-------------------------------	--------------------------------	-------------------------

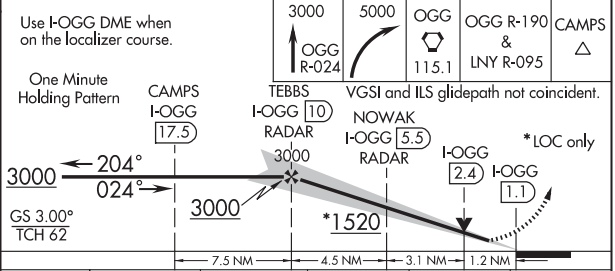
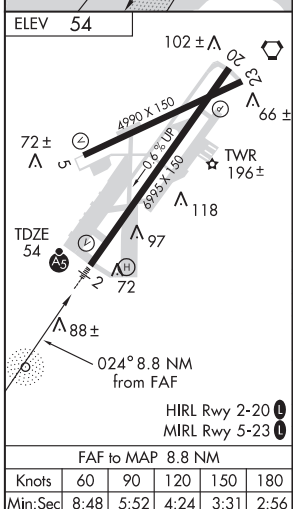
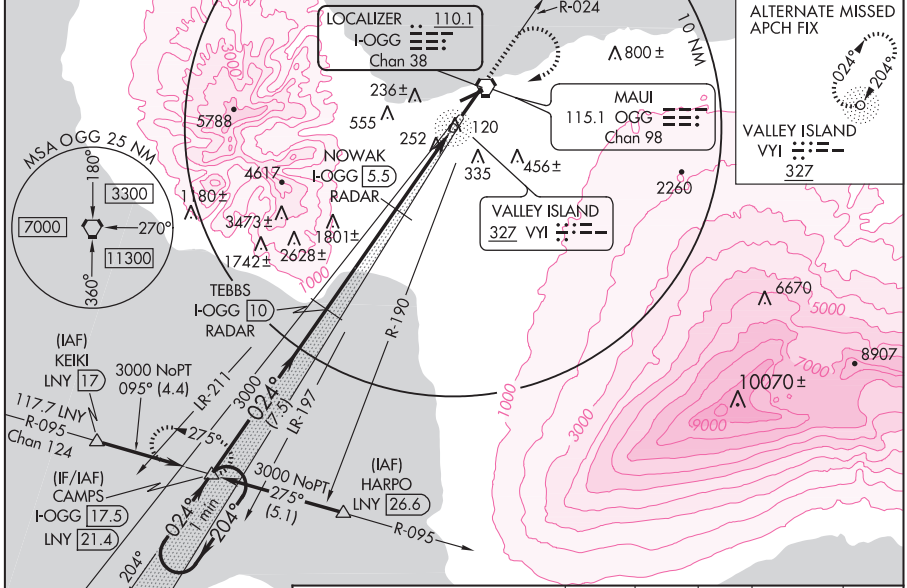

CATEGORY	A	B	C	D	E
S-ILS 2	304-3/4 250 (300-3/4)				
S-LOC 2	1520-1 1/4 1466 (1500-1 1/4)	1520-1 1/2 1466 (1500-1 1/2)	1520-2 1/2 1466 (1500-2 1/2)		
CIRCLING	1520-1 1/4 1466 (1500-1 1/4)	1520-1 1/2 1466 (1500-1 1/2)	1520-3 1466 (1500-3)		
NOWAK FIX MINIMUMS					
S-LOC 2	520-3/4 466 (500-3/4)		520-1 466 (500-1)	520-1 1/4 466 (500-1 1/4)	
CIRCLING	520-1 466 (500-1)	560-1 506 (600-1)	620-1 1/2 566 (600-1 1/2)	660-2 606 (700-2)	1400-3 1346 (1400-3)

KAHULUI, HAWAII  
 Amdt 24 22OCT09

20° 54' N-156° 26' W

# ILS or LOC Rwy 2

KAHULUI, HAWAII

AL-762 (FAA)

APP CRS	Rwy Idg	<b>6995</b>
<b>021°</b>	TDZE	<b>54</b>
	Apt Elev	<b>54</b>

# RNAV (GPS) RWY 2

KAHULUI (OGG)(PHOG)

**⚠** Circling NA at night to Rwy 5.  
**⚠** GPS or RNP-0.3 Required. DME/DME RNP-0.3 NA.  
 For inoperative MALS R increase LNAV visibility 1/4 mile.



**MISSED APPROACH:** Climb to 2700 then climbing right turn to 6000 direct HARPO WP and hold.

ATIS	HCF APPROACH	MAUI TOWER ★	GND CON	CLNC DEL	UNICOM
<b>128.6</b>	<b>120.2 322.4 (NORTH)</b> <b>119.5 225.4 (SOUTH)</b>	<b>118.7 (CTAF) 0 279.6</b>	<b>121.9 279.6</b>	<b>120.6 290.5</b>	<b>122.95</b>

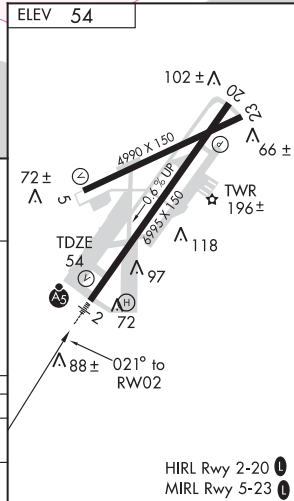
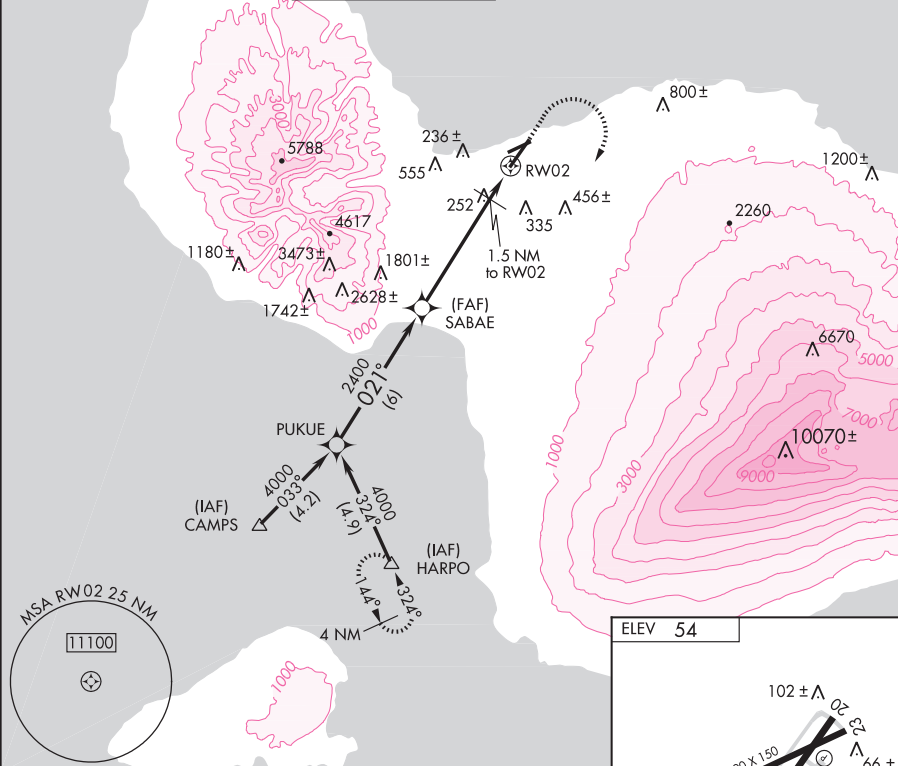

PUKUE	SABAE	2700	6000	HARPO
4000	2400	1.5 NM to RWY 2	0.9 NM to RWY 2	
Procedure Turn NA	021°			
VGSI and descent angles not coincident.	3.45°			
	TCH 65			
	6 NM	4.7 NM	0.6	0.9
CATEGORY	A	B	C	D
LNAV MDA	400-3/4	346 (400-3/4)		400-1 346 (400-1)
CIRCLING	500-1 446 (500-1)	560-1 506 (600-1)	620-1 1/2 566 (600-1 1/2)	640-2 586 (600-2)

KAHULUI, HAWAII  
 Orig 09015

20°54'N-156°26'W

# KAHULUI (OGG)(PHOG)

## RNAV (GPS) RWY 2

KAHULUI, HAWAII

AL-762 (FAA)

# RNAV (GPS) RWY 20

KAHULUI (OGG)(PHOG)

APP CRS	Rwy Idg	<b>6995</b>
<b>204°</b>	TDZE	<b>25</b>
	Apt Elev	<b>54</b>

<b>▽</b>	GPS or RNP-0.3 Required.	MISSED APPROACH: Climbing left turn to 6000 direct HARPO WP and hold.			
<b>△</b> NA	DME/DME RNP-0.3 NA.				
ATIS	HCF APPROACH	MAUI TOWER *	GND CON	CLNC DEL	UNICOM
<b>128.6</b>	<b>120.2 322.4 (NORTH)</b> <b>119.5 225.4 (SOUTH)</b>	<b>118.7 (CTAF) 0 279.6</b>	<b>121.9 279.6</b>	<b>120.6 290.5</b>	<b>122.95</b>

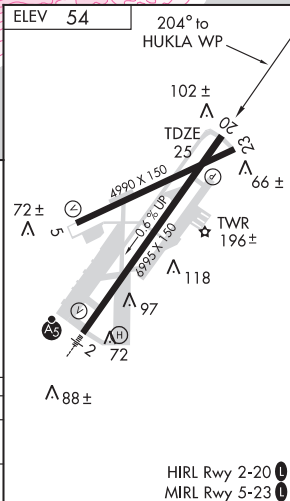
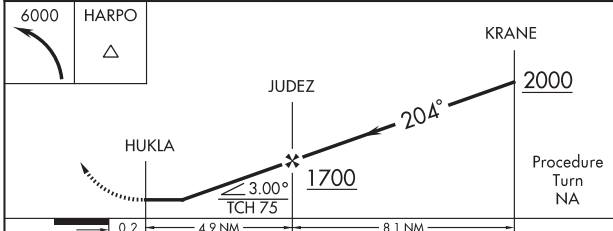
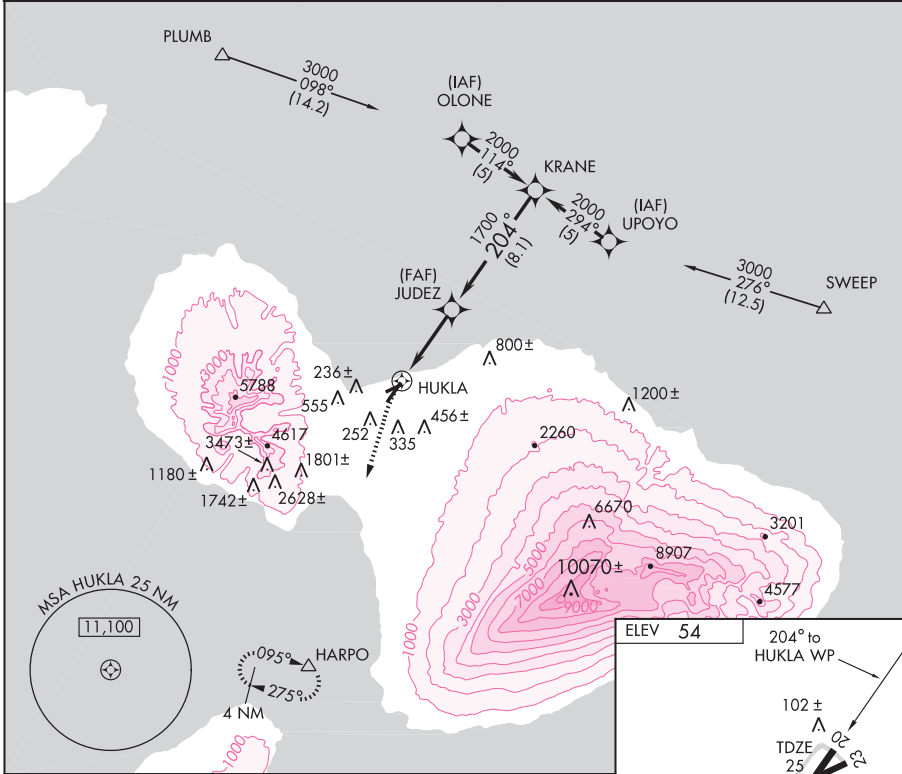

CATEGORY	A	B	C	D
LNVA MDA	400-1 375 (400-1)			400-1¼ 375 (400-1¼)
CIRCLING	660-1 606 (700-1)	720-1 666 (700-1)	780-2 726 (800-2)	800-2½ 746 (800-2½)

HIRL Rwy 2-20 **①**  
MIRL Rwy 5-23 **②**

KAHULUI, HAWAII  
Orig 09015

20° 54'N-156° 26'W

# RNAV (GPS) RWY 20

KAHALUI, HAWAII

AL-762 (FAA)

# RNAV (GPS) RWY 23

KAHALUI (OGG)(PHOG)

APP CRS	Rwy Idg	<b>4990</b>
<b>234°</b>	TDZE	<b>17</b>
	Apt Elev	<b>54</b>

**⚠** DME/DME RNP-0.3 NA. Visibility reduction by helicopters NA. When local altimeter setting not received, procedure NA. **⚠** Straight-in minimums NA at night.

MISSED APPROACH: Climbing right turn to 4000 direct ZULUD and hold, continue climb-in-hold to 4000.

ATIS	HCF APPROACH	MAUI TOWER*	GND CON	CLNC DEL	UNICOM
<b>128.6</b>	<b>120.2 322.4 (NORTH)</b> <b>119.5 225.4 (SOUTH)</b>	<b>118.7 (CTAF) 0 279.6</b>	<b>121.9 279.6</b>	<b>120.6 290.5</b>	<b>122.95</b>

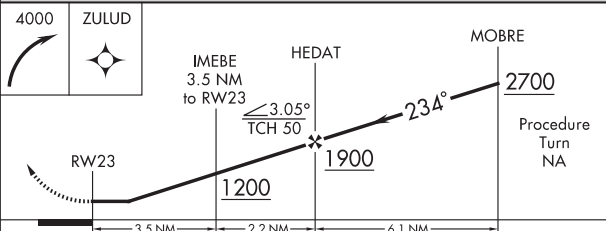
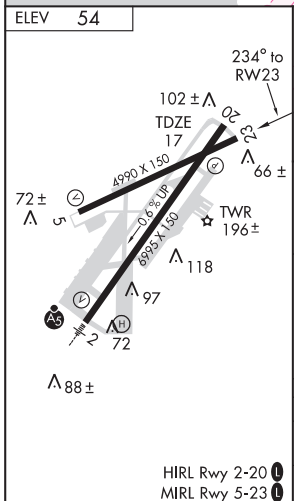
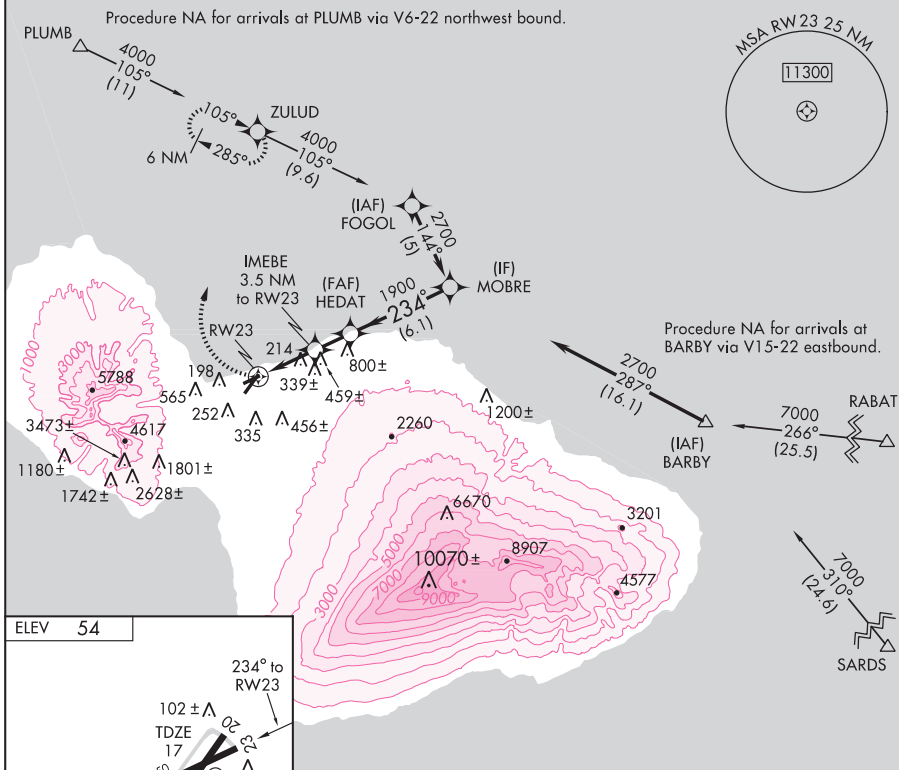

CATEGORY	A	B	C	D
LNNAV MDA	460-1	443 (500-1)	460-1¼ 443 (500-1¼)	460-1½ 443 (500-1½)
CIRCLING	520-1 466 (500-1)	560-1 506 (600-1)	620-1½ 566 (600-1½)	640-2 586 (600-2)

KAHALUI, HAWAII  
Amdt 1 09015

20° 54'N - 156° 26'W

# RNAV (GPS) RWY 23

PAC, 08 APR 2010 to 03 JUN 2010



KAHULUI, HAWAII

AL-762 (FAA)

09295

LOC/DME I-OGG <b>110.1</b> Chan 38	APP CRS <b>204°</b>	Rwy Idg TDZE Apt Elev	<b>6995</b> <b>25</b> <b>54</b>
--	------------------------	-----------------------------	---------------------------------------

**LOC/DME BC RWY 20**  
KAHULUI (OGG)(PHOG)

**DME required.**

MISSED APPROACH: Climb to 6000 via OGG R-190 and LNY VORTAC R-090 to DIPPS INT and hold.

ATIS <b>128.6</b>	HCF APPROACH <b>120.2 322.4</b> (NORTH) <b>119.5 225.4</b> (SOUTH)	MAUI TOWER ★ <b>118.7</b> (CTAF) <b>279.6</b>	GND CON <b>121.9 279.6</b>	CLNC DEL <b>120.6 290.5</b>	UNICOM <b>122.95</b>
----------------------	--	--	-------------------------------	--------------------------------	-------------------------

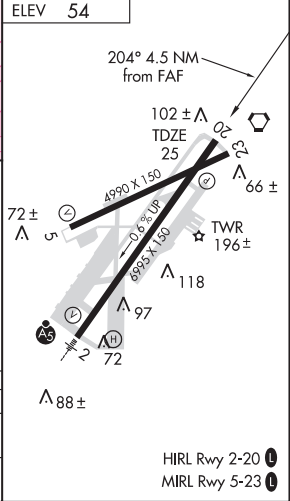
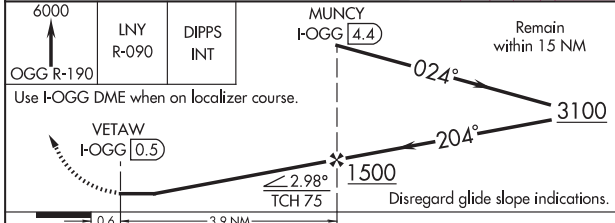
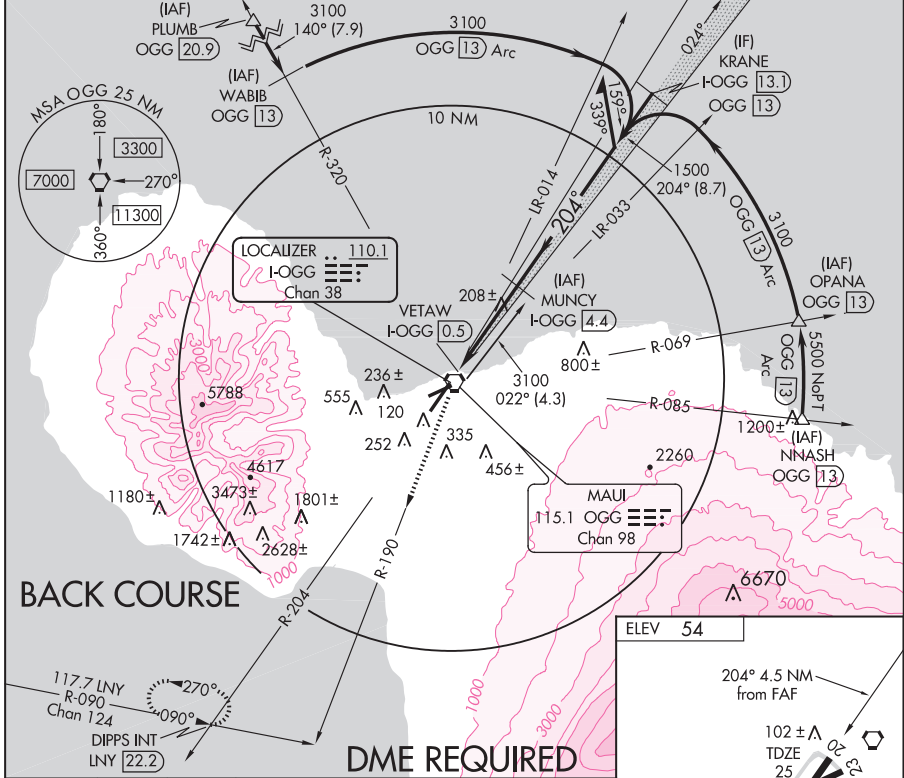

CATEGORY	A	B	C	D	E
S-20	460-1	435 (500-1)	460-1¼ 435 (500-1¼)	460-1½	435 (500-1½)
CIRCLING	500-1 446 (500-1)	560-1 506 (600-1)	620-1½ 566 (600-1½)	660-2 606 (700-2)	1400-3 1346 (1400-3)

KAHULUI, HAWAII  
Amdt 14 22OCT09

20° 54'N-156° 26'W

KAHULUI (OGG)(PHOG)  
**LOC/DME BC RWY 20**

KAHALUI, HAWAII

AL-762 (FAA)

VORTAC OGG <b>115.1</b> Chan <b>98</b>	APP CRS <b>194°</b>	Rwy Idg TDZE Apt Elev	<b>6995</b> <b>25</b> <b>54</b>
--	------------------------	-----------------------------	---------------------------------------

# VOR/DME or TACAN RWY 20

KAHALUI (OGG)(PHOG)

**⚠** When tower closed, procedure not authorized except for operators with approved weather reporting service. **MISSED APPROACH:** Climb to 6000 via OGG VORTAC R-187 to intercept LNY R-090, then climbing right turn direct DIPPS Int and hold.

ATIS <b>128.6</b>	HCF APPROACH <b>120.2 322.4 (NORTH)</b> <b>119.5 225.4 (SOUTH)</b>	MAUI TOWER★ <b>118.7 (CTAF) 279.6</b>	GND CON <b>121.9 279.6</b>	CLNC DEL <b>120.6 290.5</b>	UNICOM <b>122.95</b>
----------------------	--	--	-------------------------------	--------------------------------	-------------------------

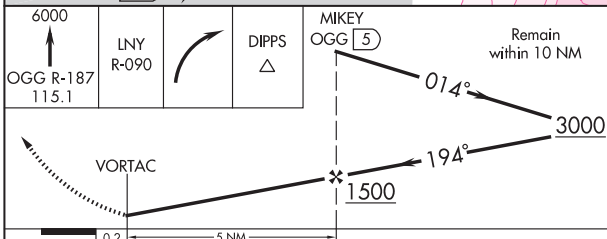
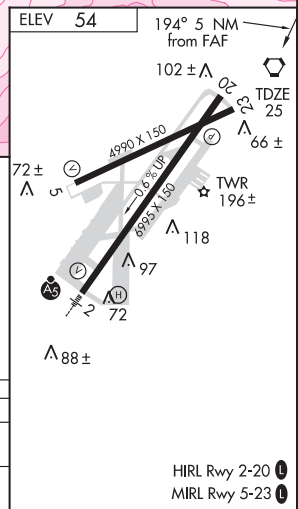
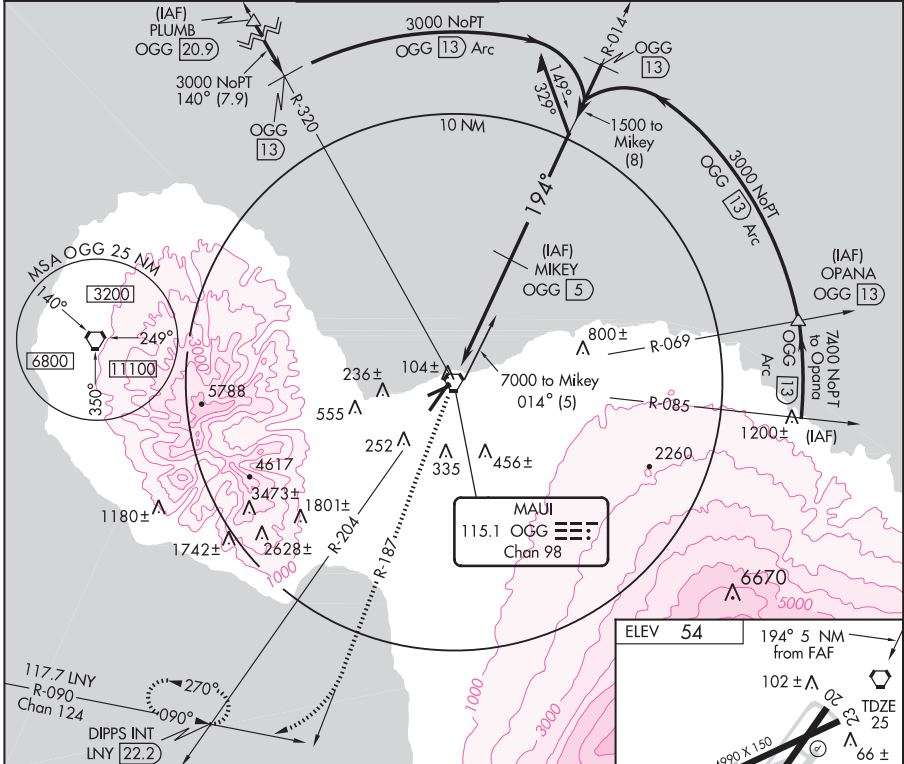

CATEGORY	A	B	C	D
S-20	400-1 375 (400-1)			400-1¼ 375 (400-1¼)
CIRCLING	520-1 466 (500-1)	560-1 506 (600-1)	620-1½ 566 (600-1½)	640-2 586 (600-2)

KAHALUI, HAWAII  
Orig-A 09015

20° 54'N-156° 26'W

# VOR/DME or TACAN RWY 20

KAHALUI (OGG)(PHOG)

KAHULUI, HAWAII

AL-762 (FAA)

VORTAC OGG	APP CRS	Rwy Idg	6995
115.1	194°	TDZE	25
Chan 98		Apt Elev	54

**VOR RWY 20**  
KAHULUI (OGG)(PHOG)

**MISSED APPROACH:** Climb to 6000 via OGG R-187 to intercept LNY R-090, then climbing right turn direct DIPP'S Int and hold.

ATIS	HCF APPROACH	MAUI TOWER*	GND CON	CLNC DEL	UNICOM
128.6	120.2 322.4 (NORTH) 119.5 225.4 (SOUTH)	118.7 (CTAF) 279.6	121.9 279.6	120.6 290.5	122.95

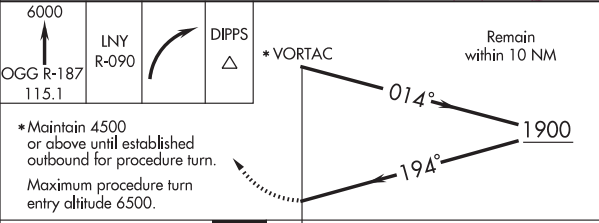
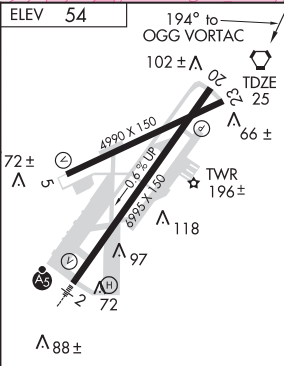
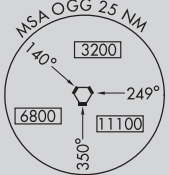
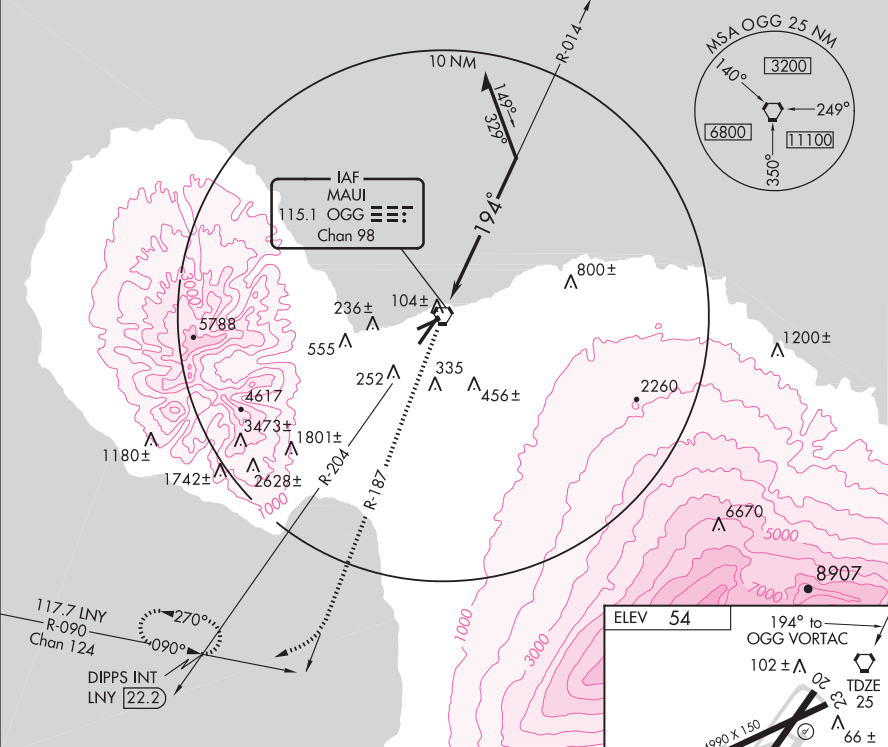

\*Maintain 4500 or above until established outbound for procedure turn.  
Maximum procedure turn entry altitude 6500.

CATEGORY	A	B	C	D
S-20		420-1 395 (400-1)		420-1½ 395 (400-1½)
CIRCLING	520-1 466 (500-1)	560-1 506 (600-1)	620-1½ 566 (600-1½)	640-2 586 (700-2)

HIRL Rwy 2-20  
MIRL Rwy 5-23

KAHULUI, HAWAII  
Orig-B 09015

20° 54'N-156° 26'W

KAHULUI (OGG)(PHOG)  
**VOR RWY 20**

KAHULUI, HAWAII

AL-762 (FAA)

NDB VYI	APP CRS	Rwy Idg	6995
327	005°	TDZE	54
		Apt Elev	54

# NDB/DME RWY 2

KAHULUI (OGG)(PHOG)

		MISSED APPROACH: Climb to 4000 via 005° bearing from VYI NDB then climb to 7000 direct VYI NDB and hold.			
		ATIS <b>128.6</b>	HCF APPROACH <b>120.2 322.4 (NORTH)</b> <b>119.5 225.4 (SOUTH)</b>	MAUI TOWER ★ <b>118.7 (CTAF) 0 279.6</b>	GND CON <b>121.9 279.6</b>

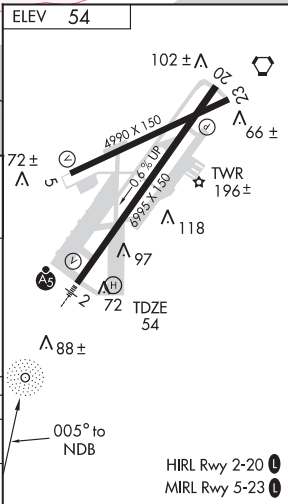
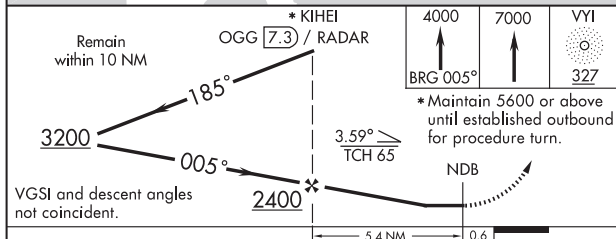
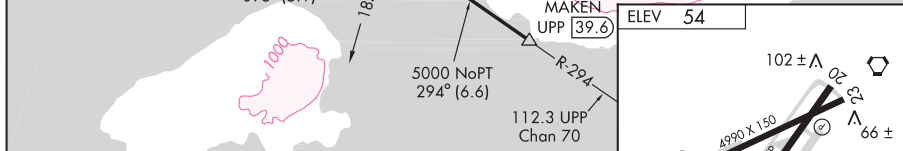
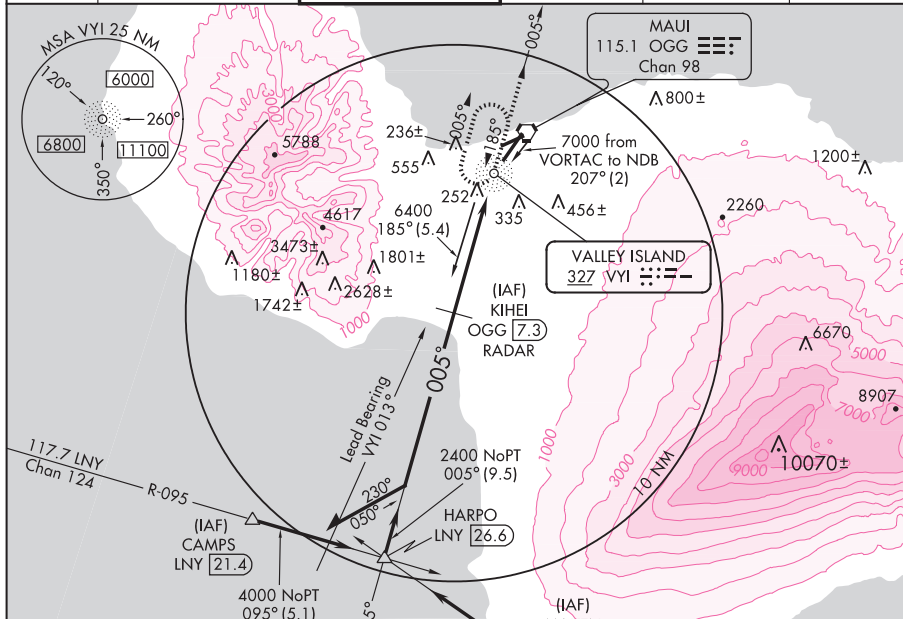

	5.4 NM		0.6	
CATEGORY	A	B	C	D
S-2	640-3/4	586 (600-3/4)	640-1 1/2 586 (600-1 1/2)	640-1 3/4 586 (600-1 3/4)
CIRCLING	640-1	586 (600-1)	640-1 1/2 586 (600-1 1/2)	640-2 586 (600-2)

KAHULUI, HAWAII  
Amdt 2A 09015

20° 54' N-156° 26' W

# KAHULUI (OGG)(PHOG)

## NDB/DME RWY 2

# SMOKE STACK VISUAL RWY 2

KAHULUI (OGG)(PHOG)  
KAHULUI, HAWAII

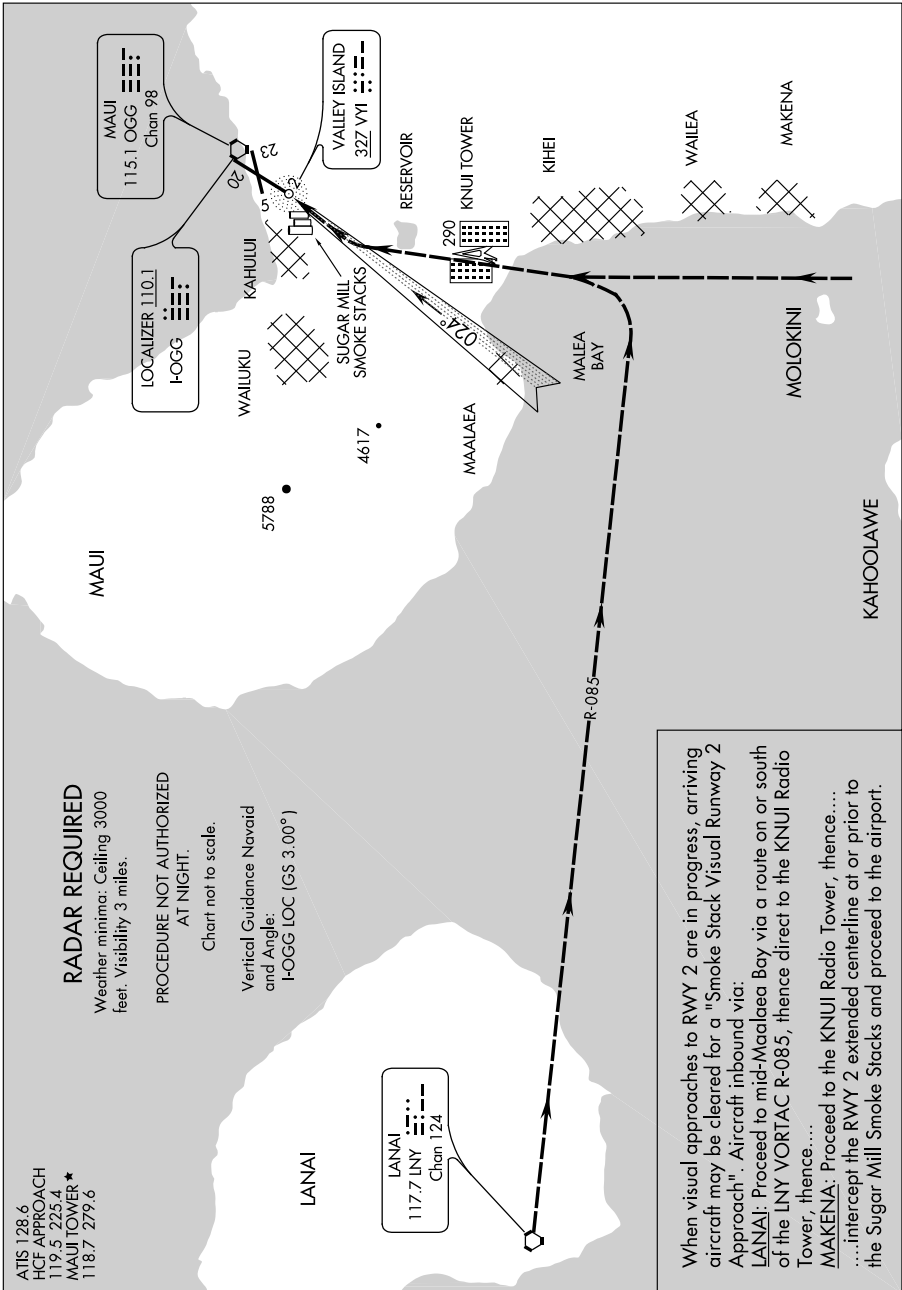

# SMOKE STACK VISUAL RWY 2

20°54'N-156°26'W

KAHULUI, HAWAII  
KAHULUI (OGG)(PHOG)

09295

# AIRPORT DIAGRAM

AL-762 (FAA)

KAHULUI (OGG)(PHOG)

KAHULUI, HAWAII

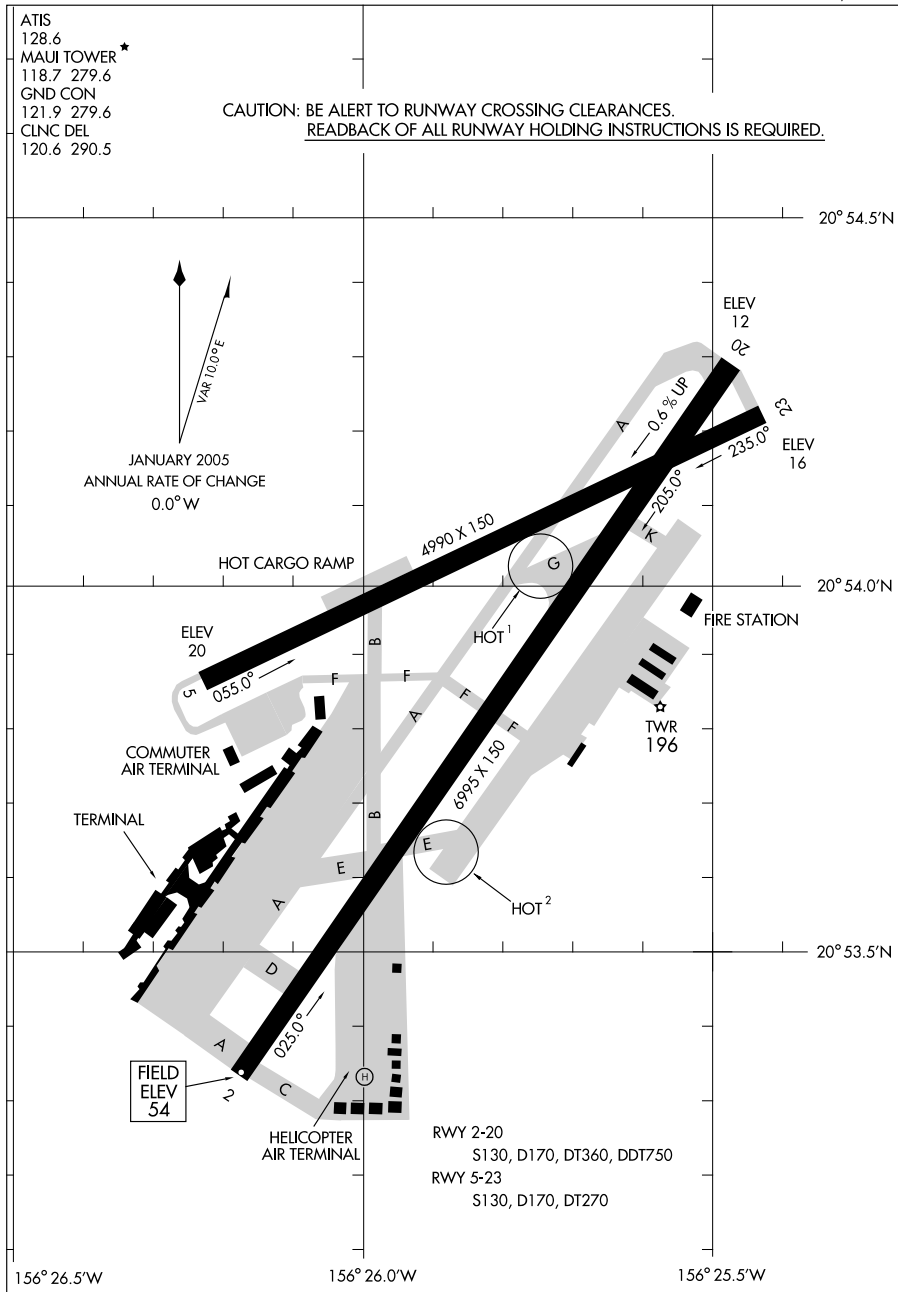

# AIRPORT DIAGRAM

09295

KAHULUI, HAWAII

KAHULUI (OGG)(PHOG)

# BARBY ONE DEPARTURE

ATIS 128.6  
 CLNC DEL  
 120.6 290.5  
 GND CON  
 121.9 279.6  
 MAUI TOWER \*  
 118.7 (CTAF) 279.6  
 MAUI DEP CON  
 NORTH 120.2 322.4  
 SOUTH 119.5 225.4  
 HCF APPROACH  
 NORTH 120.2 322.4  
 SOUTH 119.5 225.4

### TAKE-OFF MINIMUMS:

Rwy 23: NA Obstacle and ATC.  
 Rwy 2: Standard with ATC climb of 480 feet per NM to 2200.  
 Rwy 5: Standard with ATC climb of 480 feet per NM to 2900.  
 Rwy 20: Standard with minimum climb of 480 feet per NM to 2100.

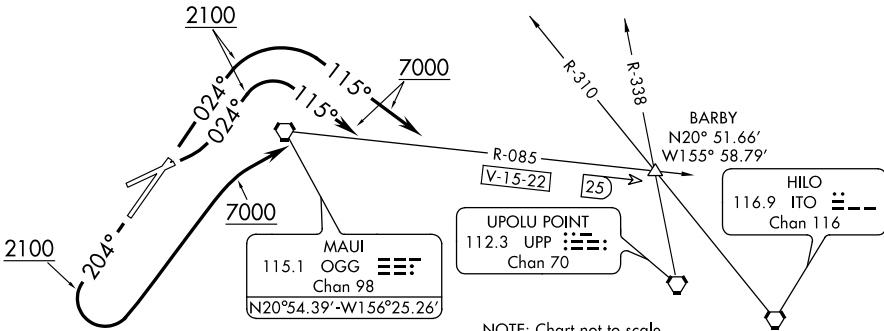

NOTE: Chart not to scale.



## DEPARTURE ROUTE DESCRIPTION

**TAKEOFF RUNWAY 2:** Climb heading 024° to 2100 then climbing right turn to 7000 via heading 115° to intercept OGG VORTAC R-085 (V15-22) to BARBY INT/OGG 25 DME.

**TAKEOFF RUNWAY 5:** Climbing left turn heading 024° to 2100 then climbing right turn to 7000 via heading 115° to intercept OGG VORTAC R-085 (V15-22) to BARBY INT/OGG 25 DME.

**TAKEOFF RUNWAY 20:** Climb heading 204° to 2100 then climbing left turn to 7000 direct OGG VORTAC then via OGG R-085 (V15-22) to BARBY INT OGG 25 DME.

### TAKEOFF OBSTACLE NOTES:

Rwy 2: Bush/trees beginning 190 feet from DER, 362 feet left of centerline, up to 60 feet AGL/79 feet MSL. Pipe on building 339 feet from DER, 289 feet right of centerline, 20 feet AGL/25 feet MSL. Bush beginning 902 feet from DER, 637 feet right of centerline, up to 20 feet AGL/39 feet MSL.

Rwy 5: Trees 2,359 feet from DER, 512 feet left of centerline, 56 feet AGL/75 feet MSL. Fence beginning 20 feet from DER, 299 feet right of centerline, up to 7 feet AGL/31 feet MSL. Bush/trees beginning 291 feet from DER, 300 feet right of centerline, up to 76 feet AGL/95 feet MSL.

Rwy 20: Bush 22 feet from DER, 236 feet right of centerline, 2 feet AGL/55 feet MSL. Bush/trees beginning 24 feet from DER, 173 feet left of centerline, up to 29 feet AGL/68 feet MSL.

# BARBY ONE DEPARTURE

(BEACH2.BEACH) 07074

SL-762 (FAA)

KAHULUI (OGG)(PHOG)  
KAHULUI, HAWAII

## BEACH TWO DEPARTURE

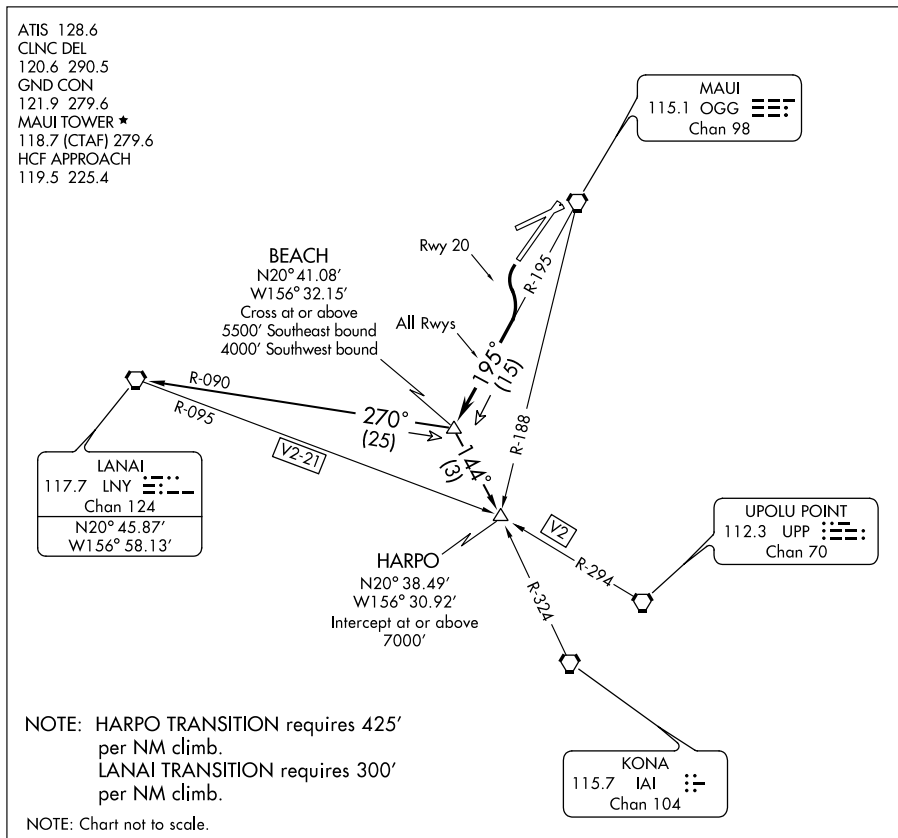

## DEPARTURE ROUTE DESCRIPTION

**TAKE-OFF RUNWAYS 2, 5, AND 23:** Maintain flight in visual conditions until intercepting the OGG R-195, then climb southbound via the OGG R-195 to BEACH INT.

**TAKE-OFF RUNWAY 20:** Turn left to intercept the OGG R-195, then climb southbound via the OGG R-195 to BEACH INT.

**HARPO TRANSITION (BEACH2.HARPO):** Cross BEACH INT at or above 5500', turn left, continue to climb southbound via IAI R-324 to intercept V2 at or above 7000'.

**LANAI TRANSITION (BEACH2.LNY):** Cross BEACH INT at or above 4000', turn right, continue climb to 5000' or above via LNY R-090 to LNY VORTAC.

BEACH TWO DEPARTURE  
(BEACH2.BEACH) 07074KAHULUI, HAWAII  
KAHULUI (OGG)(PHOG)

PAC, 08 APR 2010 to 03 JUN 2010



(MAUI5.OGG) 07074

SL-762 (FAA)

KAHULUI (OGG)(PHOG)  
KAHULUI, HAWAII

MAUI FIVE DEPARTURE

ATIS 128.6  
CLNC DEL  
120.6 290.5  
GND CON  
121.9 279.6  
MAUI TOWER \*  
118.7 (CTAF) 279.6  
HCF APPROACH  
120.2 322.4

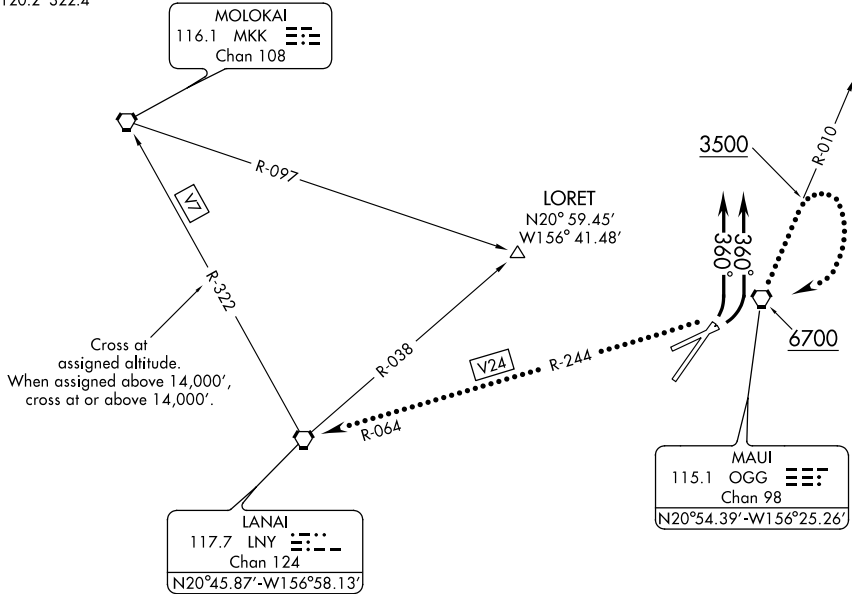

NOTE: Take-off requires minimum climb of 420' per NM until reaching 8000'.

NOTE: Chart not to scale.



DEPARTURE ROUTE DESCRIPTION

**TAKE-OFF RUNWAYS 2 AND 5 ONLY:** After take-off, all aircraft fly heading 360°, expect radar vectors west of Maui Island to assigned fix/route. Cross the LNY R-322 at assigned altitude. When assigned above 14,000', cross at or above 14,000'.

**LOST COMMUNICATIONS:** If not in contact with Departure Control 1 minute after crossing the shoreline, climb northbound via the OGG R-010 until reaching at least 3500'. Then reverse course to the right direct OGG VORTAC. Then via V24 to LNY VORTAC. Cross OGG VORTAC at or above 6700'.

MAUI FIVE DEPARTURE  
(MAUI5.OGG) 07074

KAHULUI, HAWAII  
KAHULUI (OGG)(PHOG)

(SWEEP1.SWEEP) 09015

SL-762 (FAA)

KAHALUI (OGG)(PHOG)  
KAHALUI, HAWAII

## SWEEP ONE DEPARTURE

ATIS 128.6  
CLNC DEL  
120.6 290.5  
GND CON  
121.9 279.6  
MAUI TOWER \*  
118.7 (CTAF) 279.6  
MAUI DEP CON  
NORTH 120.2 322.4  
SOUTH 119.5 225.4  
HCF APPROACH  
NORTH 120.2 322.4  
SOUTH 119.5 225.4

## TAKE-OFF MINIMUMS:

Rwy 23: NA Obstacle and ATC.

Rwy 2,5: Standard with ATC climb of 480 feet per NM to 2100.

Rwy 20: Standard with minimum climb of 480 feet per NM to 2100.

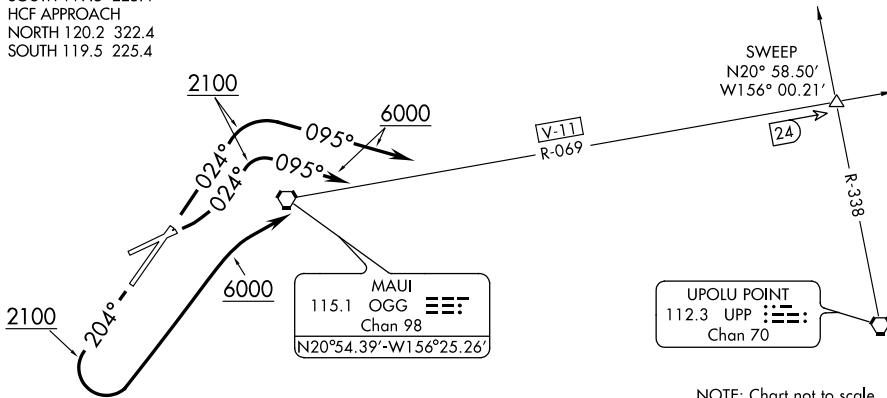

NOTE: Chart not to scale.



## DEPARTURE ROUTE DESCRIPTION

**TAKEOFF RUNWAY 2:** Climb heading 024° to 2100 then climbing right turn to 6000 via heading 095° to intercept OGG VORTAC R-069 (V11) to SWEEP INT/OGG 24 DME.

**TAKEOFF RUNWAY 5:** Climbing left turn heading 024° to 2100 then right turn to 6000 via heading 095° to intercept OGG VORTAC R-069 (V11) to SWEEP INT/OGG 24 DME.

**TAKEOFF RUNWAY 20:** Climb heading 204° to 2100 then climbing left turn to 6000 direct OGG VORTAC then via OGG R-069 (V11) to SWEEP INT/OGG 24 DME.

## TAKEOFF OBSTACLE NOTES:

Rwy 2: Bush/trees beginning 190 feet from DER, 362 feet left of centerline, up to 60 feet AGL/79 feet MSL. Pipe on building 339 feet from DER, 289 feet right of centerline, 20 feet AGL/25 feet MSL. Bush beginning 902 feet from DER, 637 feet right of centerline, up to 20 feet AGL/39 feet MSL.

Rwy 5: Trees 2,359 feet from DER, 512 feet left of centerline, 56 feet AGL/75 feet MSL. Fence beginning 20 feet from DER, 299 feet right of centerline, up to 7 feet AGL/31 feet MSL. Bush/trees beginning 291 feet from DER, 300 feet right of centerline, up to 76 feet AGL/95 feet MSL.

Rwy 20: Bush 22 feet from DER, 236 feet right of centerline, 2 feet AGL/55 feet MSL. Bush/trees beginning 24 feet from DER, 173 feet left of centerline, up to 29 feet AGL/68 feet MSL.

## SWEEP ONE DEPARTURE

KAHALUI, HAWAII

(SWEEP1.SWEEP) 09015

KAHALUI (OGG)(PHOG)



KAILUA-KONA, HAWAII

AI-5761 (FAA)

APP CRS	Rwy Idg <b>11000</b>
<b>174°</b>	TDZE <b>47</b>
	Apt Elev <b>47</b>

# RNAV (GPS) RWY 17

KAILUA-KONA/ KONA INTL AT KEAHOLE (KOA) (PHKO)

<p><b>▼</b> Baro-VNAV NA below -5°C (23°F).  <b>▲</b> NA GPS or RNP-0.3 required. DME/DME RNP-0.3 NA.          Circling NA east of Rwy 17-35.          WAAS VNAV NA.</p>	<p>MALSRL</p> 	<p>MISSED APPROACH: Climb to 5000 direct HOXLY WP and via 264° track to HELUT WP and via 354° track to ANDES WP and hold.</p>
--	---	---

ATIS <b>127.4</b>	HCF APPROACH <b>126.0 278.3</b>	KONA TOWER * <b>120.3 (CTAF) 0 254.3</b>	CLNC DEL <b>121.9</b>
----------------------	------------------------------------	---	--------------------------

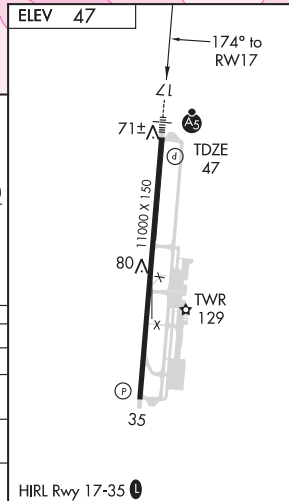
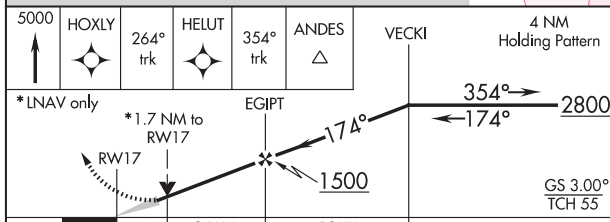
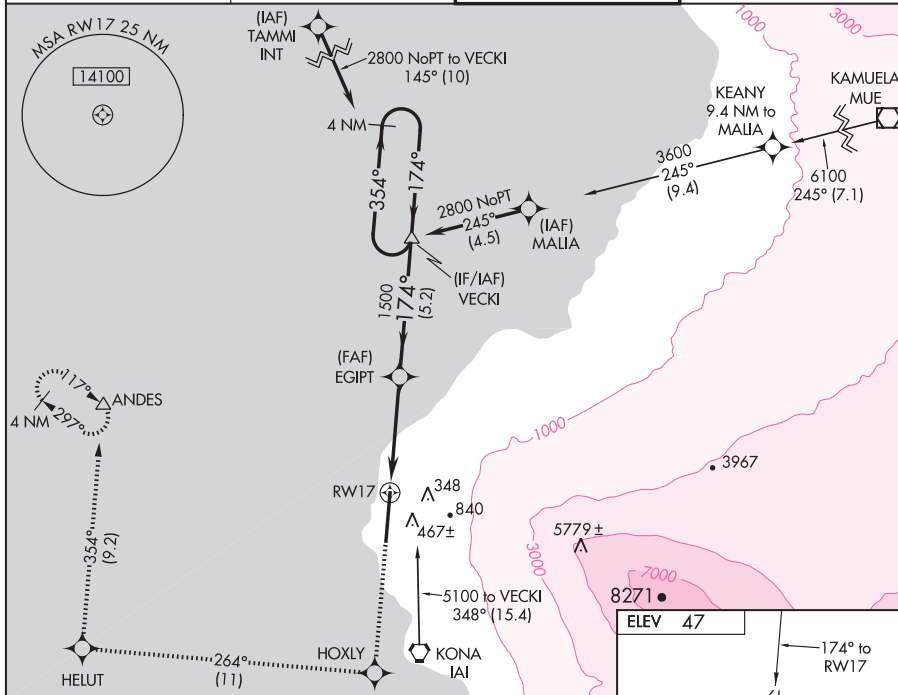

CATEGORY	A	B	C	D
GLS PA DA	NA			
LNAV/VNAV DA	540-1¼		493 (500-1¼)	
LNAV MDA	640-½	593 (600-½)	640-1 593 (600-1)	640-1¼ 593 (600-1¼)
CIRCLING	640-1¾ 593 (600-1¾)		640-2 593 (600-2)	

KAILUA-KONA, HAWAII  
 Orig-B 10042

KAILUA-KONA/ KONA INTL AT KEAHOLE (KOA) (PHKO)  
 19°44'N-156°03'W  
**RNAV (GPS) RWY 17**

KAILUA-KONA, HAWAII

AL-5761 (FAA)

# RNAV (GPS) Y RWY 35

KAILUA-KONA/ KONA INTL AT KEAHOLE (KOA) (PHKO)

APP CRS <b>354°</b>	Rwy Idg <b>11000</b> TDZE <b>37</b> Apt Elev <b>47</b>
------------------------	--

**NA** Circling NA east of Rwy 17-35.  
GPS or RNP-0.3 required.  
DME/DME RNP-0.3 NA.

MISSED APPROACH: Climbing left turn to 5000  
direct ANDES WP and hold.

ATIS <b>127.4</b>	HCF APPROACH <b>126.0 278.3</b>	KONA TOWER* <b>120.3 (CTAF) 0 254.3</b>	CLNC DEL <b>121.9</b>
----------------------	------------------------------------	--	--------------------------

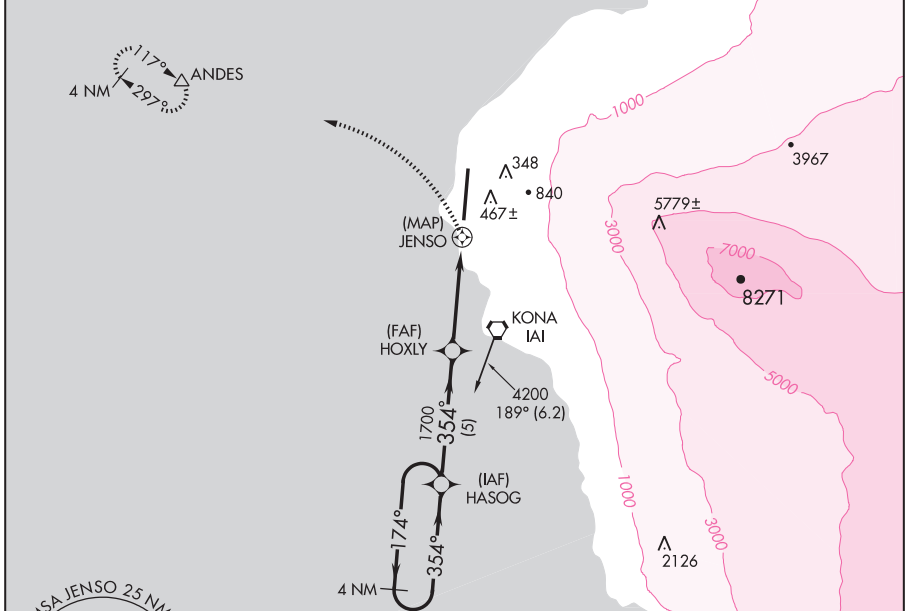

ELEV 47	HIRL Rwy 17-35
---------	----------------

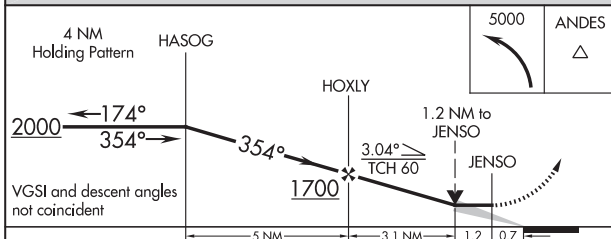
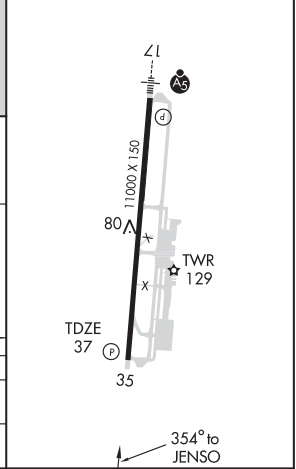

CATEGORY	A	B	C	D	E
LNVA MDA	400-1	363 (400-1)		400-1¼	363 (400-1¼)
CIRCLING	460-1 413 (500-1)	500-1 453 (500-1)	500-1½ 453 (500-1½)	600-2	553 (600-2)

KAILUA-KONA, HAWAII  
Orig-A 10042

KAILUA-KONA/ KONA INTL AT KEAHOLE (KOA) (PHKO)  
19°44'N-156°03'W  
**RNAV (GPS) Y RWY 35**

KAILUA-KONA, HAWAII

AL-5761 (FAA)

# RNAV (GPS) Z RWY 35

KAILUA-KONA/KONA INTL AT KEAHOLE (KOA) (PHKO)

APP CRS	Rwy Idg <b>11000</b>
<b>354°</b>	TDZE <b>37</b>
	Apt Elev <b>47</b>

<p><b>⚠</b> NA</p> <p>Circling NA east of Rwy 17-35. Baro-VNAV NA below -5°C (23°F). GPS or RNP-0.3 required. DME/DME RNP-0.3 NA. WAAS VNAV NA.</p>	<p>MISSED APPROACH: Climb to 5000 direct EGIPT WP and left turn via 254° track to ANDES WP and hold.</p>
---	--

ATIS <b>127.4</b>	HCF APPROACH <b>126.0 278.3</b>	KONA TOWER * <b>120.3</b> (CTAF) <b>0 254.3</b>	CLNC DEL <b>121.9</b>
----------------------	------------------------------------	--	--------------------------

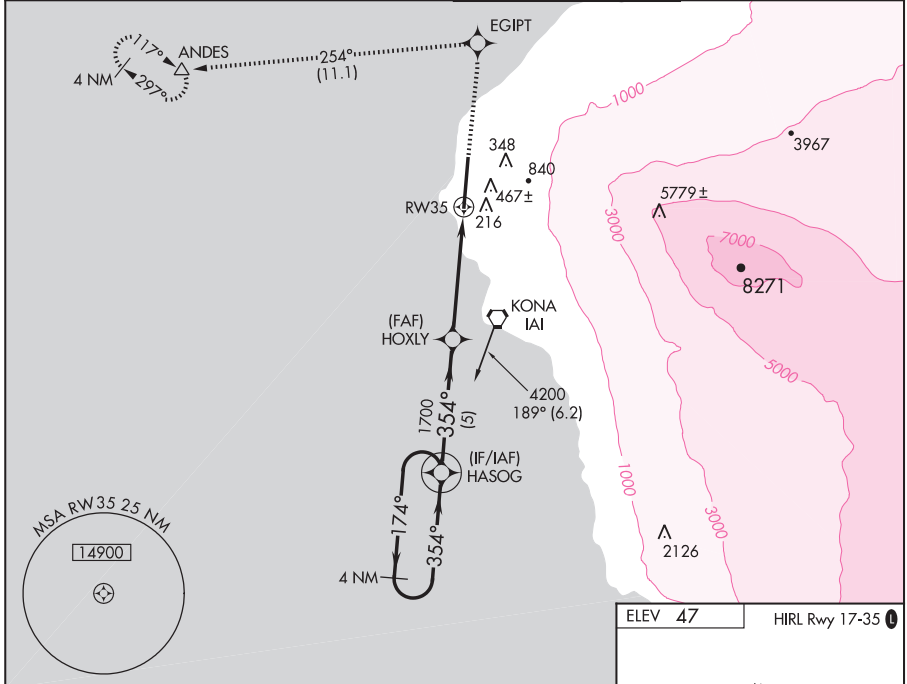

ELEV 47 HIRL Rwy 17-35 **Ⓛ**

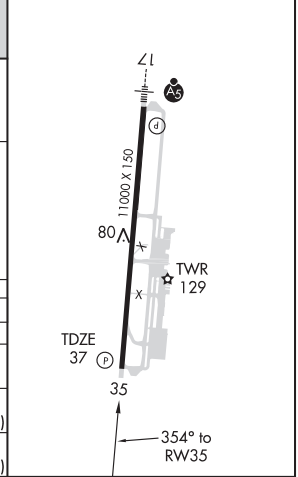
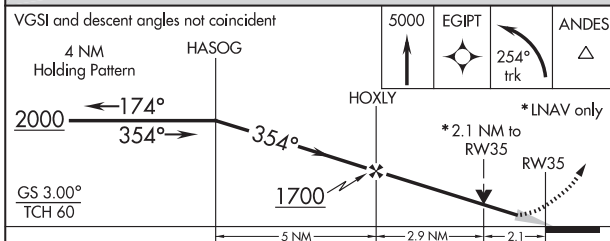

CATEGORY	A	B	C	D	E
GLS PA DA	NA				
LNAV/VNAV DA	540-1¾ 503 (500-1¾)				
LNAV MDA	640-1 603 (600-1)	640-1¾ 603 (600-1¾)	640-2 603 (600-2)	640-2½ 603 (600-2½)	
CIRCLING	640-1¾ 593 (600-1¾)		640-2 593 (600-2)		640-2½ 593 (600-2½)

KAILUA-KONA, HAWAII  
Orig-B 10042

KAILUA-KONA/KONA INTL AT KEAHOLE (KOA) (PHKO)  
19°44'N-156°03'W  
**RNAV (GPS) Z RWY 35**

KAILUA-KONA, HAWAII

AL-5761 (FAA)

LOC/DME I-KOA <b>109.7</b> Chan 34	APP CRS <b>354°</b>	Rwy Idg <b>11000</b> TDZE <b>37</b> Apt Elev <b>47</b>
--	------------------------	--

# LOC BC RWY 35

KAILUA-KONA/KONA INTL AT KEAHOLE (KOA) (PHKO)

<p>⚠ Circling NA east of Rwy 17-35.</p>		<p>MISSED APPROACH: Climbing left turn to 5000 via IAI R-297 to ANDES INT/IAI 1.5 DME and hold, continue climb-in-hold to 5000.</p>	
ATIS <b>127.4</b>	HCF APPROACH <b>126.0 278.3</b>	KONA TOWER* <b>120.3 (CTAF) 254.3</b>	CLNC DEL <b>121.9</b>

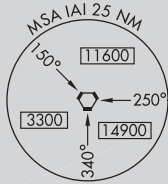
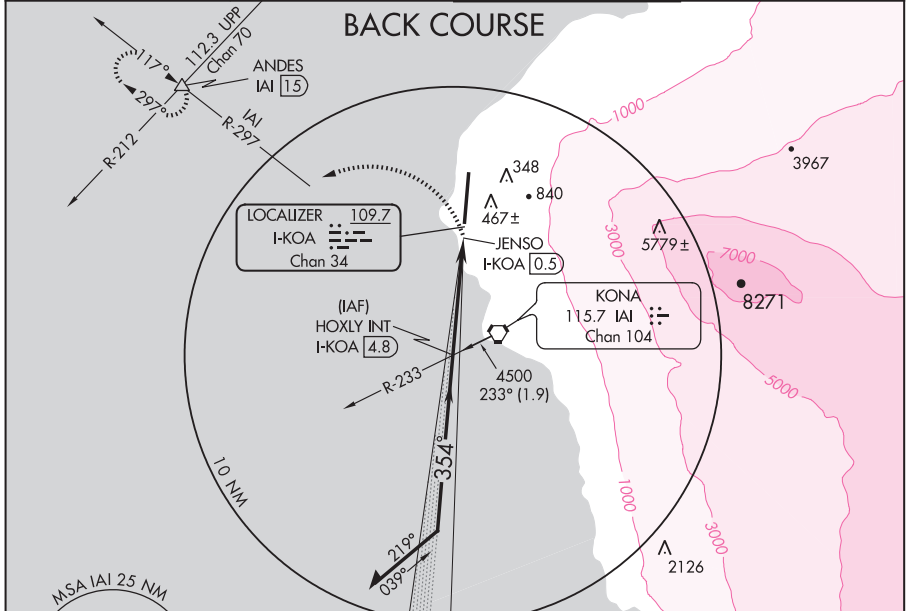

Use I-KOA DME when on LOC course.  
Remain within 10 NM

\*HOXLY INT I-KOA 4.8

5000 ANDES  
IAI R-297

VGSI and descent angles not coincident. Disregard glide slope indications.

JENSO I-KOA 0.5

3.05° TCH 55

174° 354° 1700

\*Maintain 4500 feet or above until established outbound for procedure turn.

4.3 NM 0.7

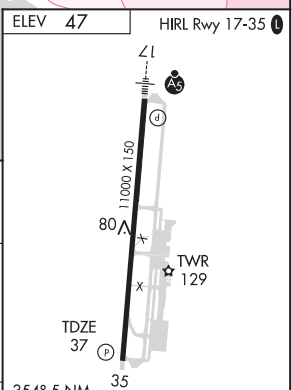

CATEGORY	A	B	C	D
S-35	400-1 363 (400-1)			400-1¼ 363 (400-1¼)
CIRCLING	460-1 413 (500-1)	500-1 453 (500-1)	500-1½ 453 (500-1½)	600-2 553 (600-2)
FAF to MAP 4.3 NM				
Knots 60 90 120 150 180				
Min:Sec 4:18 2:52 2:09 1:43 1:26				

KAILUA-KONA, HAWAII  
Amdt 9 10042

KAILUA-KONA/KONA INTL AT KEAHOLE (KOA) (PHKO)  
19°44'N-156°03'W

# LOC BC RWY 35





KAILUA-KONA, HAWAII

AL-5761 (FAA)

# VOR or TACAN RWY 35

KAILUA-KONA/ KONA INTL AT KEAHOLE (KOA) (PHKO)

VORTAC IAI <b>115.7</b> Chan <b>104</b>	APP CRS <b>330°</b>	Rwy Idg <b>11000</b> TDZE <b>37</b> Apt Elev <b>47</b>
---	------------------------	--

<p>⚠ Circling NA east of Rwy 17-35. Procedure turn NA for Cat E aircraft.</p>		<p>MISSED APPROACH: Climbing left turn to 1500 via IAI R-297 to ANDES INT/IAI 15 DME and hold.</p>	
ATIS <b>127.4</b>	HCF APPROACH <b>126.0 278.3</b>	KONA TOWER* <b>120.3</b> (CTAF) <b>254.3</b>	CLNC DEL <b>121.9</b>

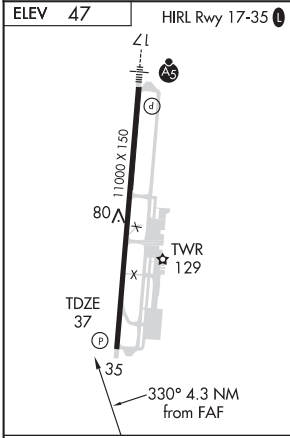
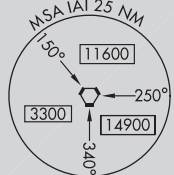
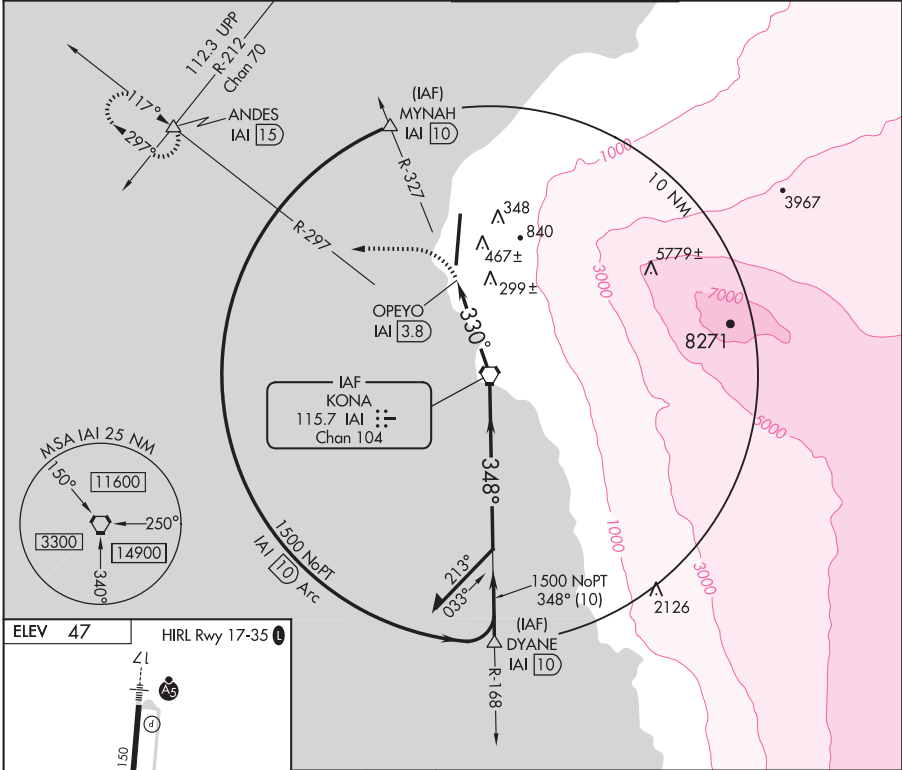

FAF to MAP 3.8 NM					
Knots	60	90	120	150	180
Min:Sec	3:48	2:32	1:54	1:31	1:16

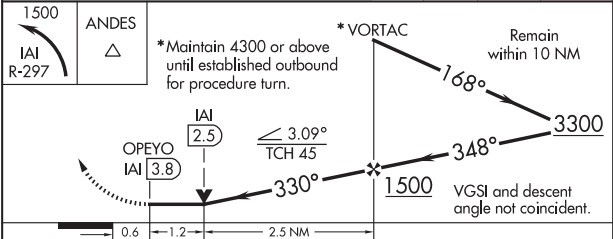

CATEGORY	A	B	C	D	E
S-35	560-1	523 (600-1)	560-1½ 523 (600-1½)	560-1¾	523 (600-1¾)
CIRCLING	560-1	513 (600-1)	560-1½ 513 (600-1½)	600-2	553 (600-2)

KAILUA-KONA, HAWAII  
Amdt 7 10042

KAILUA-KONA/ KONA INTL AT KEAHOLE (KOA) (PHKO)

19°44'N - 156°03'W

# VOR or TACAN RWY 35

08213

# AIRPORT DIAGRAM

KAILUA-KONA/ KONA INTL AT KEAHOLE (KOA) (PHKO)  
AL-5761 (FAA) KAILUA-KONA, HAWAII

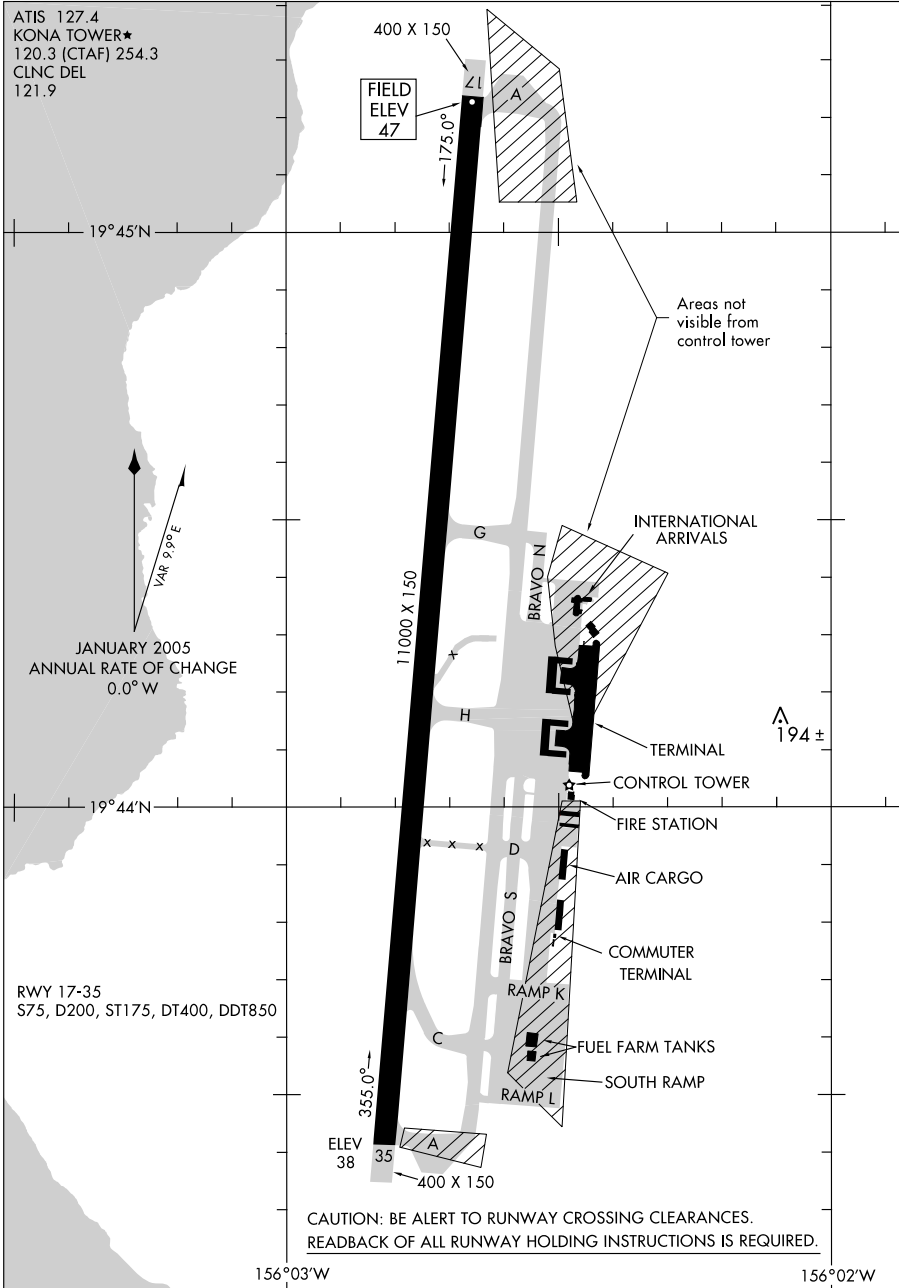

# AIRPORT DIAGRAM

KAILUA-KONA, HAWAII  
KAILUA-KONA/ KONA INTL AT KEAHOLE (KOA) (PHKO)

08213

(AMERY2.AMERY) 07074

KAILUA-KONA/ KONA INTL AT KEAHOLE (KOA) (PHKO)

AMERY TWO DEPARTURE

SL-5761 (FAA)

KAILUA-KONA, HAWAII

ATIS 127.4  
 CLNC DEL  
 121.9  
 KONA TOWER ★  
 120.3 (CTAF) 254.3  
 HCF APPROACH  
 126.0 278.3

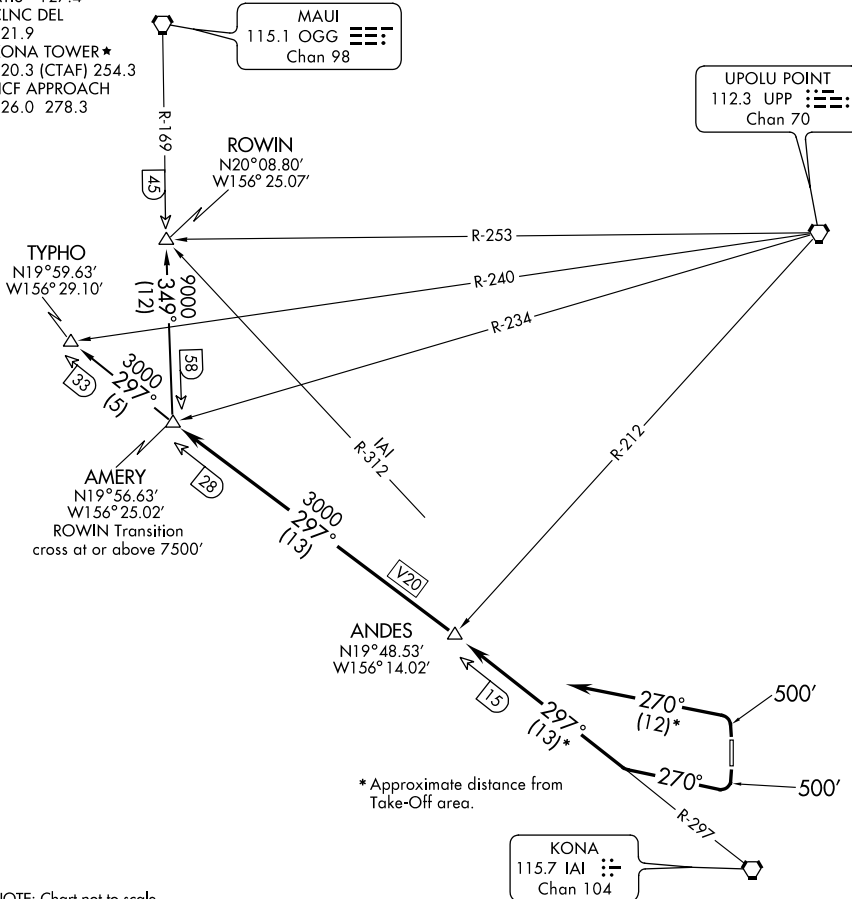

NOTE: Chart not to scale.

DEPARTURE ROUTE DESCRIPTION

**TAKE-OFF RUNWAY 17:** Climb on runway heading to 500 ft., then climbing right turn to heading 270°, intercept IAI R-297 to AMERY INT. Thence via (transition).

**TAKE-OFF RUNWAY 35:** Climb on runway heading to 500 ft., then climbing left turn to heading 270°, intercept IAI R-297 to AMERY INT. Thence via (transition).

**ROWIN TRANSITION (AMERY2.ROWIN):** From AMERY INT via OGG R-169 to ROWIN INT.

**TYPHO TRANSITION (AMERY2.TYPHO):** From AMERY INT via IAI R-297 to TYPHO INT.

AMERY TWO DEPARTURE

KAILUA-KONA, HAWAII

(AMERY2.AMERY) 07074

KAILUA-KONA/ KONA INTL AT KEAHOLE (KOA) (PHKO)

KAMUELA, HAWAII

AL-5306 (FAA)

APP CRS <b>055°</b>	Rwy Idg <b>5197</b>
	TDZE <b>2671</b>
	Apt Elev <b>2671</b>

# RNAV (GPS) RWY 4

KAMUELA/ WAIMEA-KOHALA (MUE)(PHMU)

**NA** Circling not authorized NW of Rwy 04-22.  
GPS or RNP-0.3 Required.  
DME/DME RNP-0.3 NA.

MISSED APPROACH: Climb to 5000  
direct TIGAH WP and hold.

AWOS-3 <b>120.0</b>	HCF APPROACH <b>126.0 278.3</b>	CTAF <b>122.9 0</b>
------------------------	------------------------------------	------------------------

Procedure NA for arrivals on UPP VORTAC Airway radials 149 CW 268.  
Procedure NA for arrivals at HEFTI on V5 northwest bound.

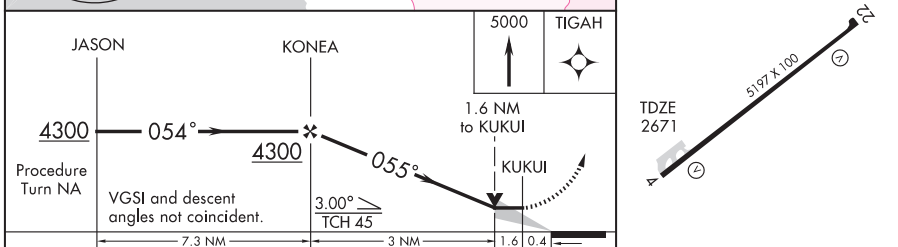
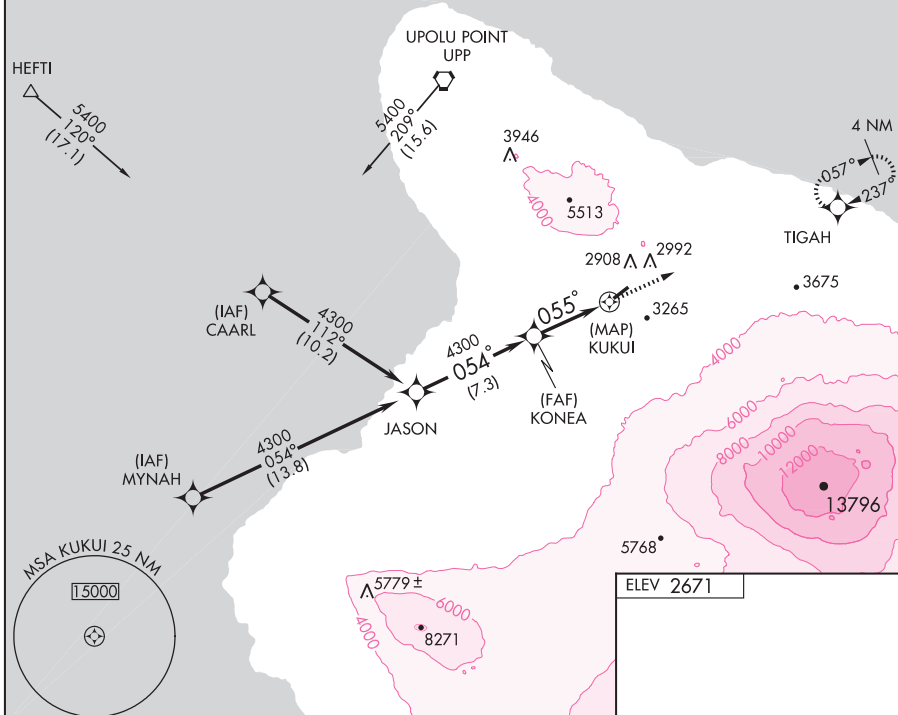

CATEGORY	A	B	C	D
LNVA MDA	3220-1	549 (600-1)	3220-1½ 549 (600-1½)	3220-1¾ 549 (600-1¾)
CIRCLING	3520-1 849 (900-1)	3520-1¼ 849 (900-1¼)	3520-2½ 849 (900-2½)	3880-3 1209 (1300-3)

KAMUELA, HAWAII  
Orig-A 07242

KAMUELA/ WAIMEA-KOHALA (MUE)(PHMU)  
20° 00' N-155° 40' W

# RNAV (GPS) RWY 4

KAMUELA, HAWAII

AL-5306 (FAA)

APP CRS <b>235°</b>	Rwy Idg <b>5197</b>
	TDZE <b>2671</b>
	Apt Elev <b>2671</b>

# RNAV (GPS) RWY 22

KAMUELA/ WAIMEA-KOHALA(MUE)(PHMU)

**⚠** NA GPS or RNP-0.3 Required. DME/DME RNP-0.3 NA. Circling not authorized NW of Rwy 04-22. Straight-in minimums NA at night.

MISSED APPROACH: Climb to 5000 direct JASON WP and hold.

AWOS-3 <b>120.0</b>	HCF APPROACH <b>126.0 278.3</b>	CTAF <b>122.9 0</b>
------------------------	------------------------------------	------------------------

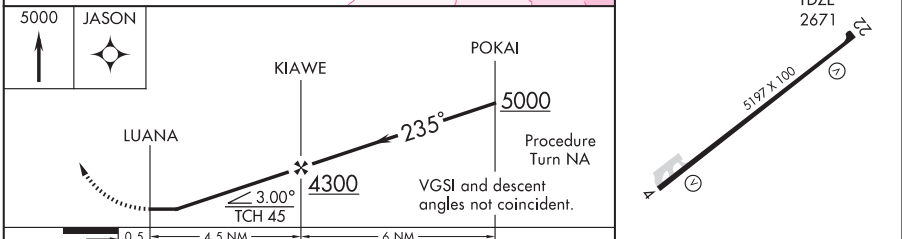
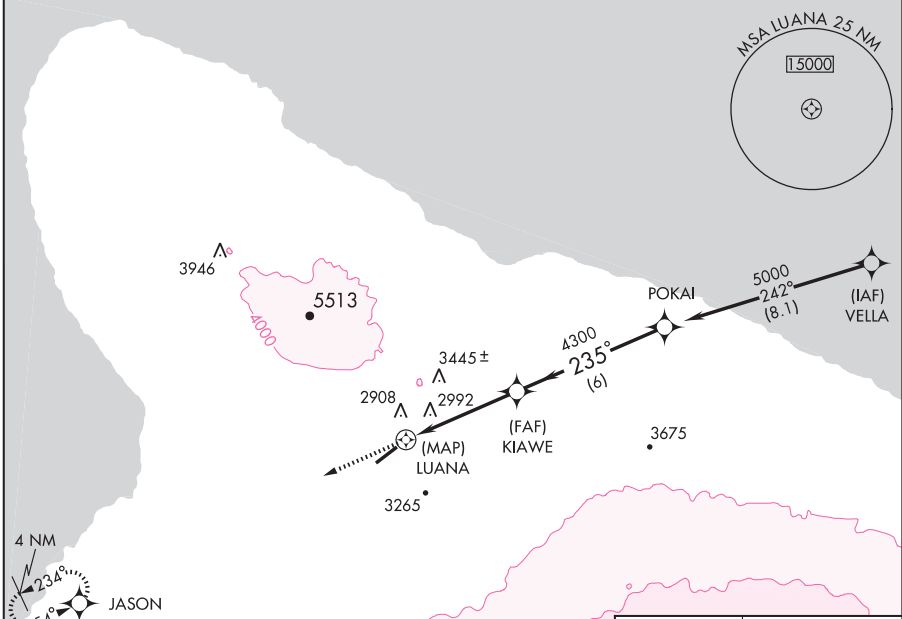

CATEGORY	A	B	C	D
LNAV MDA	3660-1¼ 989 (1000-1¼)	3660-1½ 989 (1000-1½)	3660-3	989 (1000-3)
CIRCLING	3660-1¼ 989 (1000-1¼)	3660-1½ 989 (1000-1½)	3660-3 989 (1000-3)	3880-3 1209 (1300-3)

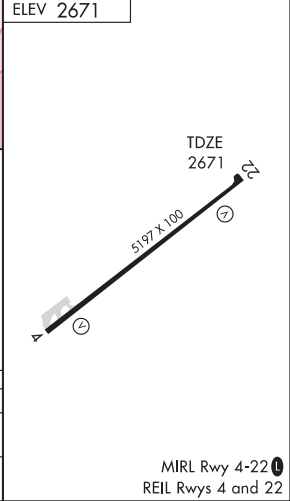

KAMUELA, HAWAII  
Orig-A 07074

KAMUELA/ WAIMEA-KOHALA(MUE)(PHMU)  
20° 00' N-155° 40' W  
**RNAV (GPS) RWY 22**

MIRL Rwy 4-22 0  
REIL Rws 4 and 22

KAMUELA, HAWAII

AL-5306 (FAA)

VOR/DME MUE <b>113.3</b> Chan <b>80</b>	APP CRS <b>054°</b>	Rwy Idg TDZE Apt Elev	<b>5197</b> <b>2671</b> <b>2671</b>
---	------------------------	-----------------------------	---

**VOR/DME RWY 4**  
KAMUELA/ WAIMEA-KOHALA (MUE) (PHMU)

**V** Circling NA NW of Rwy 4-22. **MISSED APPROACH:** Climb to 5000 via MUE R-057 to TIGAH Int/ 13.2 DME and hold.

AWOS-3 <b>120.0</b>	HCF APPROACH <b>126.0 278.3</b>	CTAF <b>122.9 0</b>
------------------------	------------------------------------	------------------------

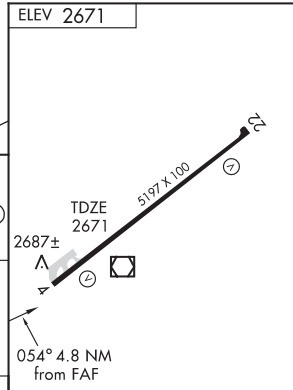
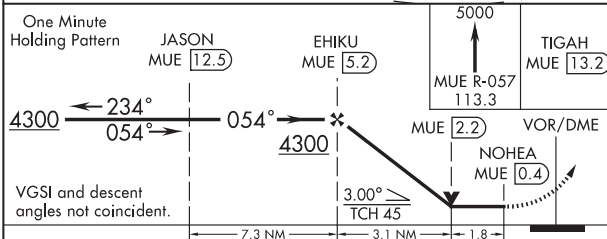
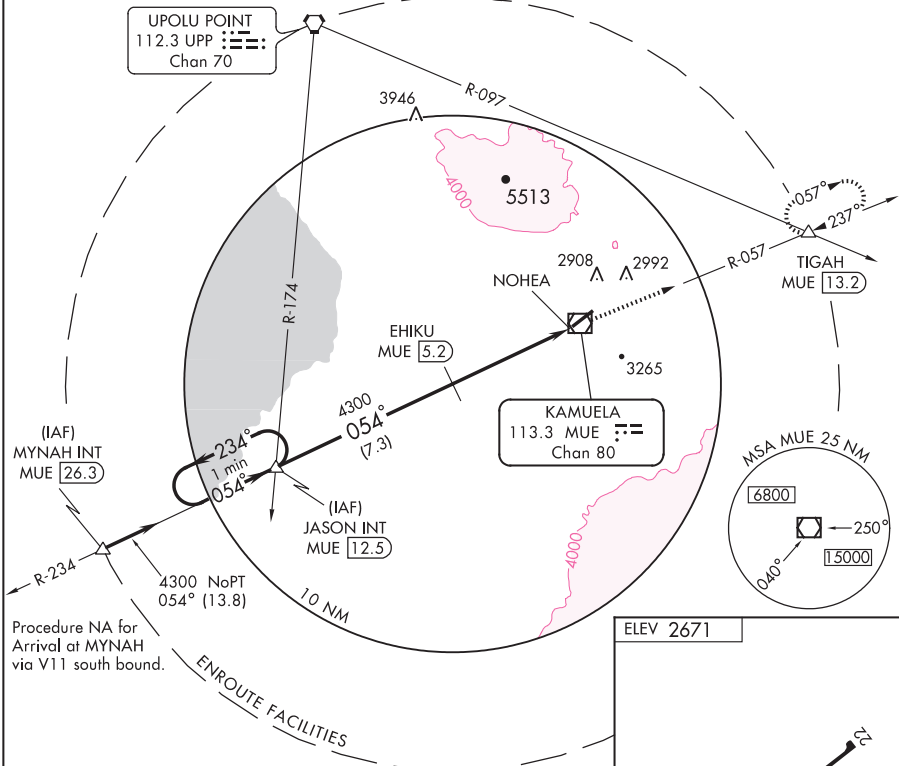

CATEGORY	A	B	C	D
S-4	3220-1	549 (600-1)	3220-1½ 549 (600-1½)	3220-1¾ 549 (600-1¾)
CIRCLING	3520-1 849 (900-1)	3520-1¼ 849 (900-1¼)	3520-2½ 849 (900-2½)	3880-3 1209 (1300-3)

Knots	60	90	120	150	180
Min:Sec					

KAMUELA, HAWAII  
Orig 07074

KAMUELA/ WAIMEA-KOHALA (MUE) (PHMU)  
20° 00' N-155° 40' W  
**VOR/DME RWY 4**

KAMUELA, HAWAII

AL-5306 (FAA)

VOR/DME MUE <b>113.3</b> Chan <b>80</b>	APP CRS <b>237°</b>	Rwy Idg TDZE Apt Elev <b>N/A</b> <b>N/A</b> <b>2671</b>
---	------------------------	--

**VOR/DME-A**  
KAMUELA/ WAIMEA-KOHALA(MUE)(PHMU)

**⚠** Circling NA NW of Rwy 4-22. MISSED APPROACH: Climb to 5000 via MUE R-234 to JASON Int/ 12.5 DME and hold.

AWOS-3 <b>120.0</b>	HCF APPROACH <b>126.0 278.3</b>	CTAF <b>122.9</b> <b>⓪</b>
------------------------	------------------------------------	-------------------------------

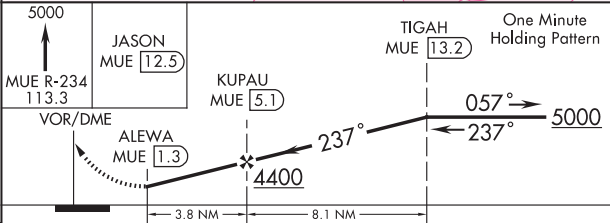
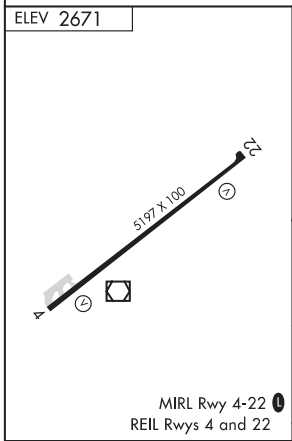
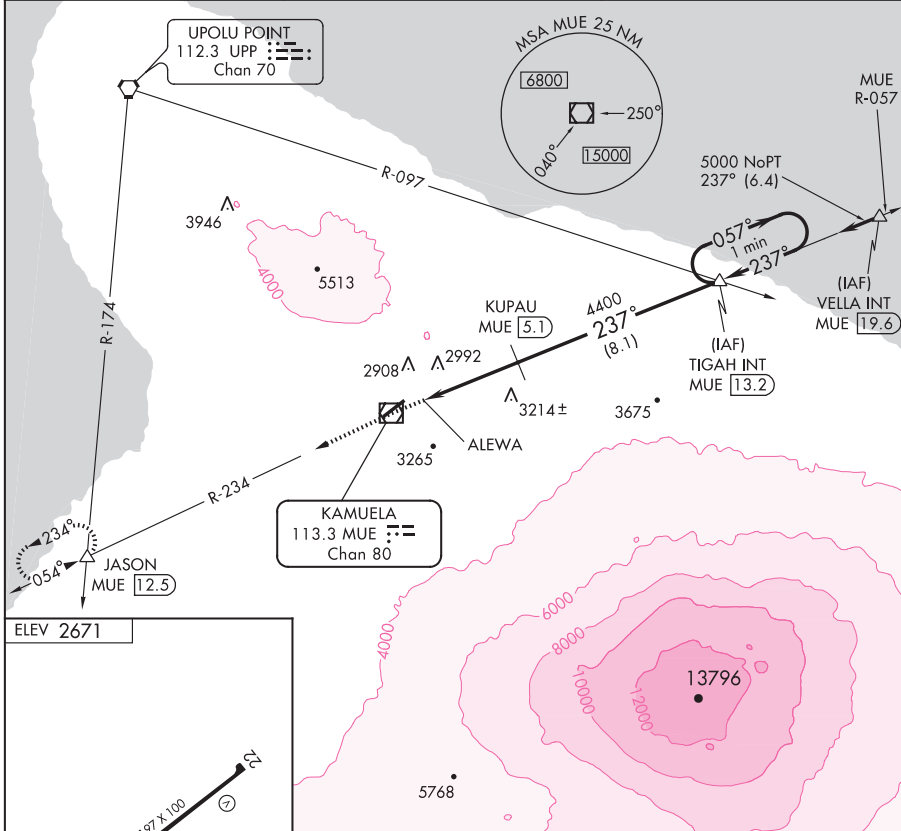

Knots	60	90	120	150	180			
Min:Sec								
CATEGORY	A		B		C		D	
CIRCLING	3680-1¼ 1009 (1100-1¼)		3680-1½ 1009 (1100-1½)		3680-3 1009 (1100-3)		3880-3 1209 (1300-3)	

KAMUELA, HAWAII  
Orig 07074

KAMUELA/ WAIMEA-KOHALA(MUE)(PHMU)  
20° 00' N-155° 40' W  
**VOR/DME-A**

KAPOLEI, HAWAII

AL-761 (FAA)

09295

VORTAC HNL <b>114.8</b> Chan <b>95</b>	APP CRS <b>074°</b>	Rwy Idg TDZE Apt Elev	<b>8000</b> <b>17</b> <b>30</b>
--	------------------------	-----------------------------	---------------------------------------

KAPOLEI / KALAELOA (JOHN RODGERS FIELD) (JRF)(PHJR)

# VOR/DME RWY 4R

<b>⚠</b> Circling NA north of Rws 11 and 22R. Inoperative table does not apply.	MALSF 	MISSED APPROACH: Climbing right turn to 3000 via heading 248° and HNL VORTAC R-241 to GECKO/HNL 22.37 DME and hold.
--	-----------	---

ATIS <b>119.8</b>	HCF APPROACH <b>118.3 269.0</b>	KALAELOA TOWER ★ <b>132.6 (CTAF) 0 340.2</b>	GND CON <b>123.8 336.4</b>	CLNC DEL <b>121.7 380.5</b>
----------------------	------------------------------------	---	-------------------------------	--------------------------------

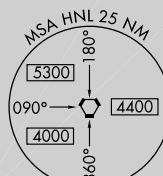
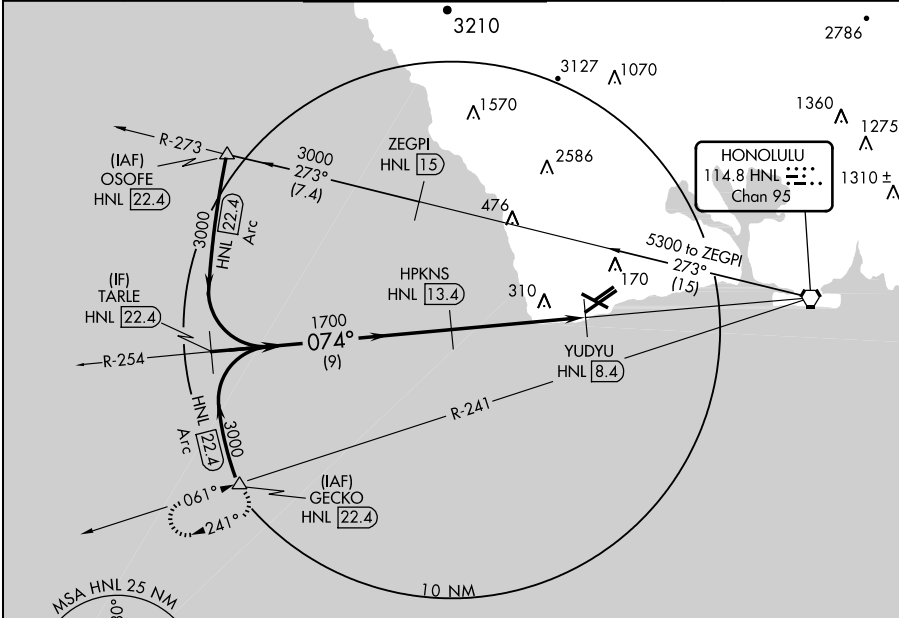

Procedure NA for arrivals at GECKO via V16 southeast bound.

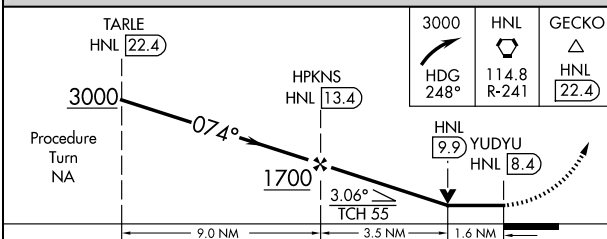
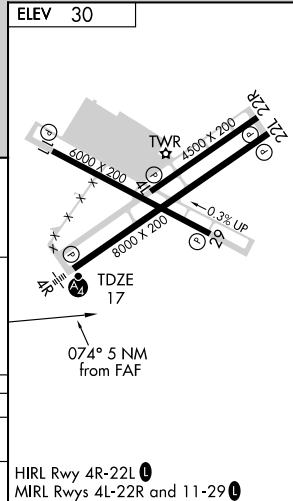

CATEGORY	A	B	C	D
S-4R	560-1 543 (600-1)		560-1½ 543 (600-1½)	560-1¾ 543 (600-1¾)
CIRCLING	560-1 530 (600-1)	620-1 590 (600-1)	620-1½ 590 (600-1½)	620-2 590 (600-2)

KAPOLEI, HAWAII  
Amdt 1 22OCT09

KAPOLEI / KALAELOA (JOHN RODGERS FIELD) (JRF)(PHJR)  
21°18'N - 158°04'W

# VOR/DME RWY 4R



KAPOLEI, HAWAII

AL-761 (FAA)

HN LOM <b>242</b>	APP CRS <b>037°</b>	Rwy Idg <b>8000</b>
		TDZE <b>17</b>
		Apt Elev <b>30</b>

KAPOLEI/ KALAELOA (JOHN RODGERS FIELD) (JRF)(PHJR)

# NDB RWY 4R

	Circling not authorized north of Rwys 11 and 22R.	MALSF 	MISSED APPROACH: Climbing right turn to 2600 via 175° bearing from HN LOM, then climbing right turn to 4900 direct HN LOM and hold.
--	---	-----------	---

ATIS <b>119.8</b>	HCF APPROACH <b>118.3 269.0</b>	KALAELOA TOWER ★ <b>132.6(CTAF) 0 340.2</b>	GND CON <b>123.8 336.4</b>	CLNC DEL <b>121.7 380.5</b>
----------------------	------------------------------------	--	-------------------------------	--------------------------------

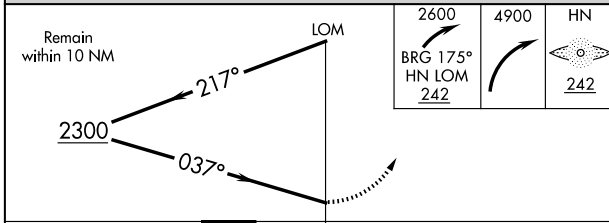
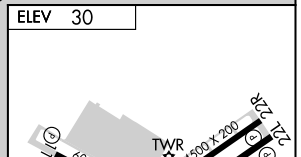
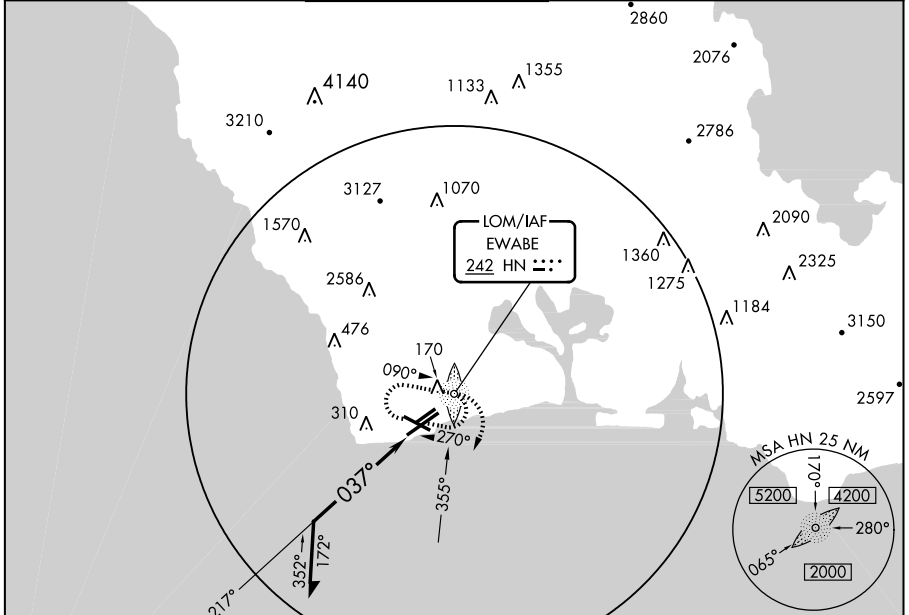

CATEGORY	A	B	C	D
S-4R	800-1 783 (800-1)	800-1¼ 783 (800-1¼)	800-2¼ 783 (800-2¼)	800-2½ 783 (800-2½)
CIRCLING	800-1 770 (800-1)	800-1¼ 770 (800-1¼)	800-2¼ 770 (800-2¼)	800-2½ 770 (800-2½)

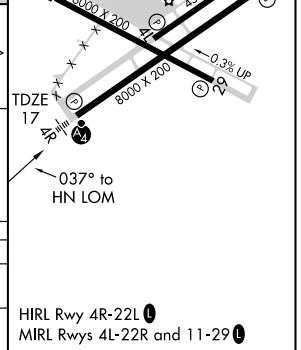

KAPOLEI, HAWAII  
Orig 09295

KAPOLEI/ KALAELOA (JOHN RODGERS FIELD) (JRF)(PHJR)  
21°18'N - 158°04'W

# NDB RWY 4R

07018

# AIRPORT DIAGRAM

KAPOLEI/ KALAELOA (JOHN RODGERS FIELD) (JRF)(PHJR)  
AL-761 (FAA)  
KAPOLEI, HAWAII

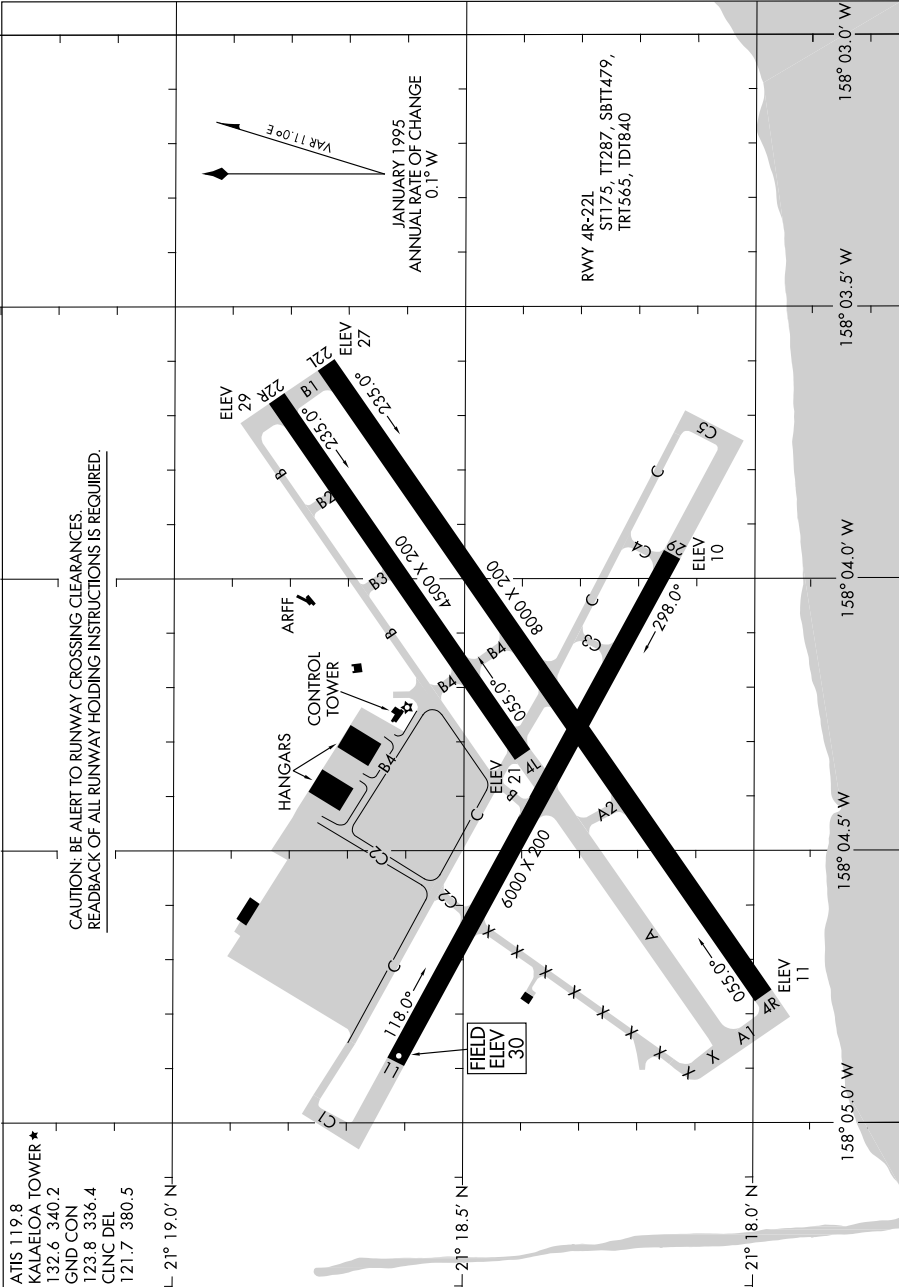

# AIRPORT DIAGRAM

07018

KAPOLEI, HAWAII  
KAPOLEI/ KALAELOA (JOHN RODGERS FIELD) (JRF)(PHJR)

KAUNAKAKAI, HAWAII

AL-759 (FAA)

APP CRS <b>043°</b>	Rwy Idg TDZE Apt Elev	<b>N/A</b> <b>N/A</b> <b>454</b>
------------------------	-----------------------------	--

**RNAV (GPS)-B**  
KAUNAKAKAI/MOLOKAI (MKK) (PHMK)

<b>NA</b>	GPS or RNP-0.3 Required. DME/DME RNP-0.3 NA.	MISSED APPROACH: Climb to 1400 then climbing left turn to 5000 direct MKK VORTAC and hold.	
ATIS <b>128.2</b>	HCF APPROACH <b>124.1 317.5</b>	MOLOKAI TOWER ★ <b>125.7 (CTAF) 0 306.2</b>	GND CON <b>121.9</b>

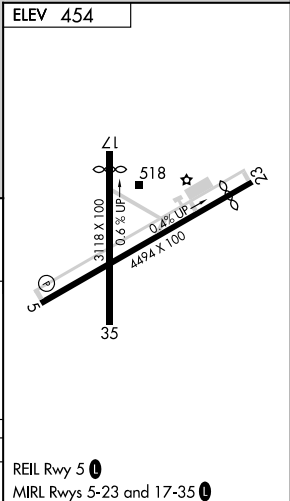
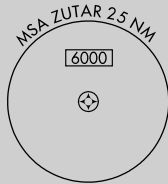
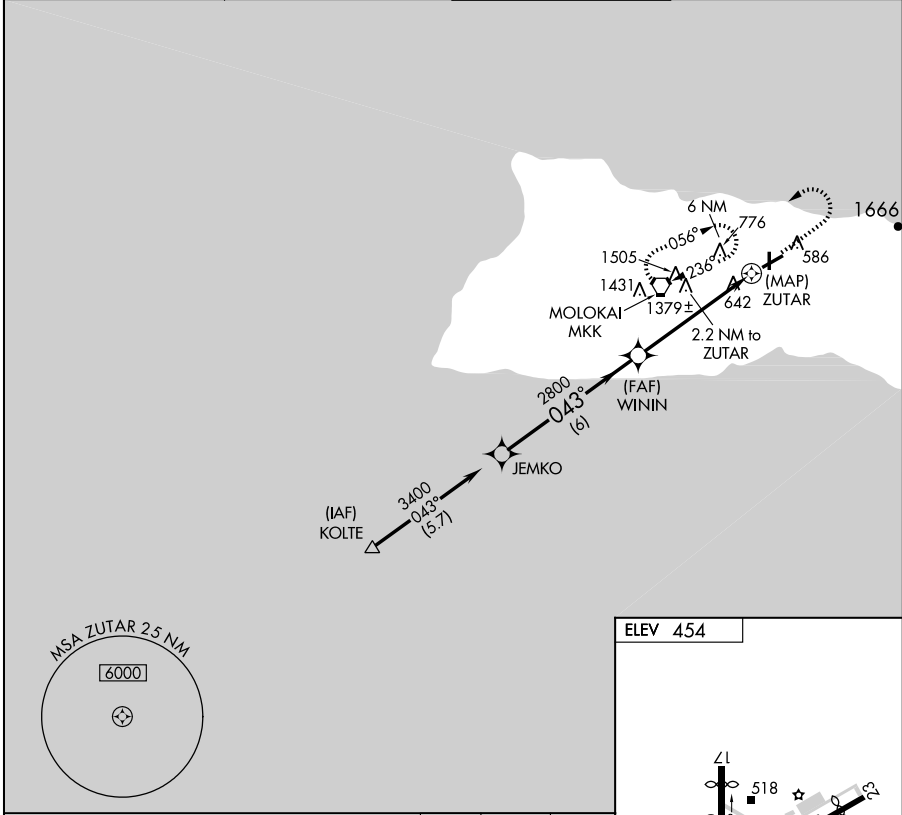

Procedure Turn NA	JEMKO		WININ		1400	5000	MKK
	3400		2800		↑	↶	⬡
	043°		2.2 NM to ZUTAR				
	6 NM		2.8 NM		2.2 NM		0.5
CATEGORY	A		B		C		D
CIRCLING	980-1 526 (600-1)		1080-1 3/4 626 (700-1 3/4)		1460-3		1006 (1100-3)

KAUNAKAKAI, HAWAII  
Orig 09183

21° 09'N - 157° 06'W

KAUNAKAKAI/MOLOKAI (MKK) (PHMK)  
**RNAV (GPS)-B**

KAUNAKAKAI, HAWAII

AL-759 (FAA)

VORTAC MKK <b>116.1</b> Chan <b>108</b>	APP CRS <b>070°</b>	Rwy Idg TDZE Apt Elev <b>N/A</b> <b>N/A</b> <b>454</b>
---	------------------------	---

# VOR or TACAN or GPS-A

KAUNAKAKAI/MOLOKAI (MKK) (PHMK)

**⚠** MISSED APPROACH: Climbing left turn via heading 360° to join the MKK R-030 northeast to 3500. Then left turn direct MKK VORTAC and hold.

ATIS <b>128.2</b>	HCF APPROACH <b>124.1 317.5</b>	MOLOKAI TOWER * <b>125.7 (CTAF) 306.2</b>	GND CON <b>121.9</b>
----------------------	------------------------------------	--	-------------------------

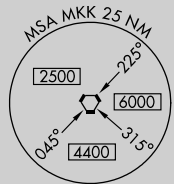
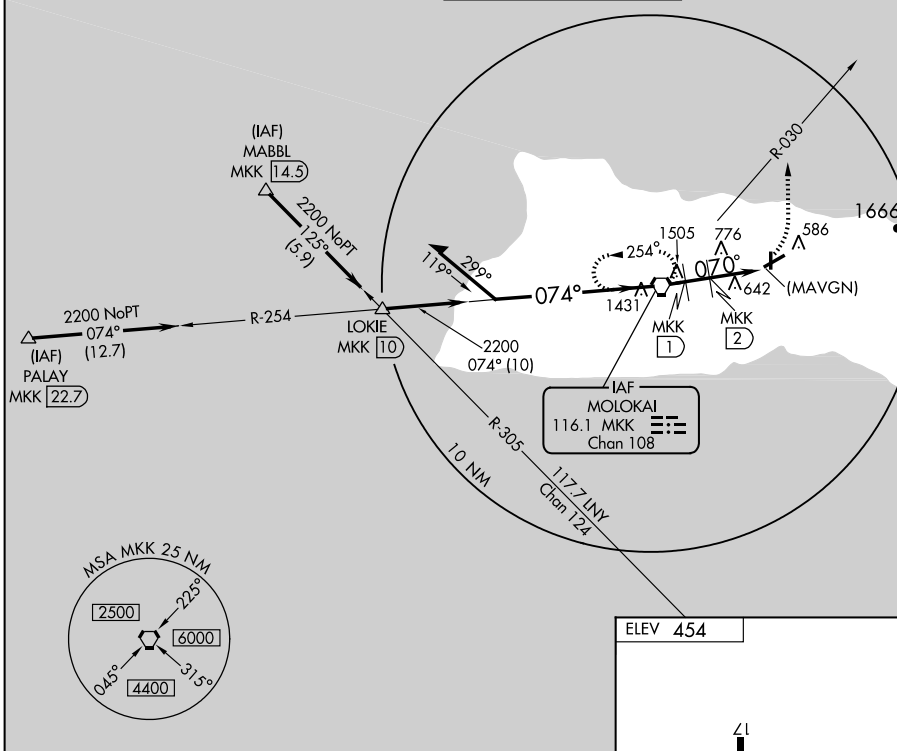

ELEV 454

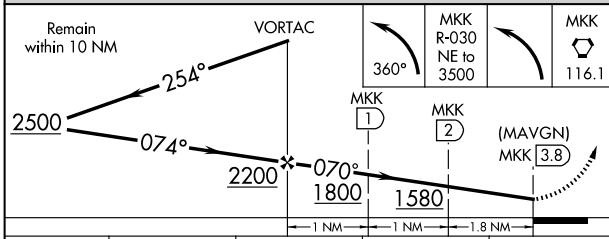
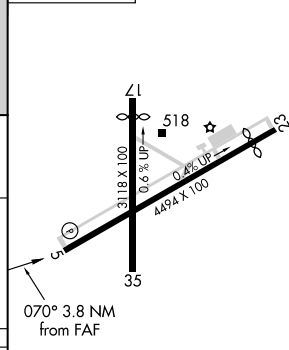

CATEGORY	A	B	C	D
CIRCLING	1800-1¼ 1346 (1400-1¼)	1800-1½ 1346 (1400-1½)	1800-3	1346 (1400-3)
DME MINIMUMS				
CIRCLING	1040-1 586 (600-1)		1080-1¾ 626 (700-1¾)	1460-3 1006 (1100-3)

REIL Rwy 5	MIRL Rwy 5-23 and 17-35				
FAF to MAP 3.8 NM					
Knots	60	90	120	150	180
Min:Sec	3:48	2:32	1:54	1:31	1:16

KAUNAKAKAI, HAWAII  
Amdt 15B 09183

21°09'N-157°06'W

# VOR or TACAN or GPS-A

09071

# AIRPORT DIAGRAM

KAUNAKAKAI/ MOLOKAI (MKK) (PHMK)  
KAUNAKAKAI, HAWAII

AL-759 (FAA)

ATIS  
128.2  
MOLOKAI TOWER ★  
125.7 306.2  
GND CON  
121.9

↑  
VAR 100°E  
JANUARY 2005  
ANNUAL RATE OF CHANGE  
0.0°W

21°09.5'N

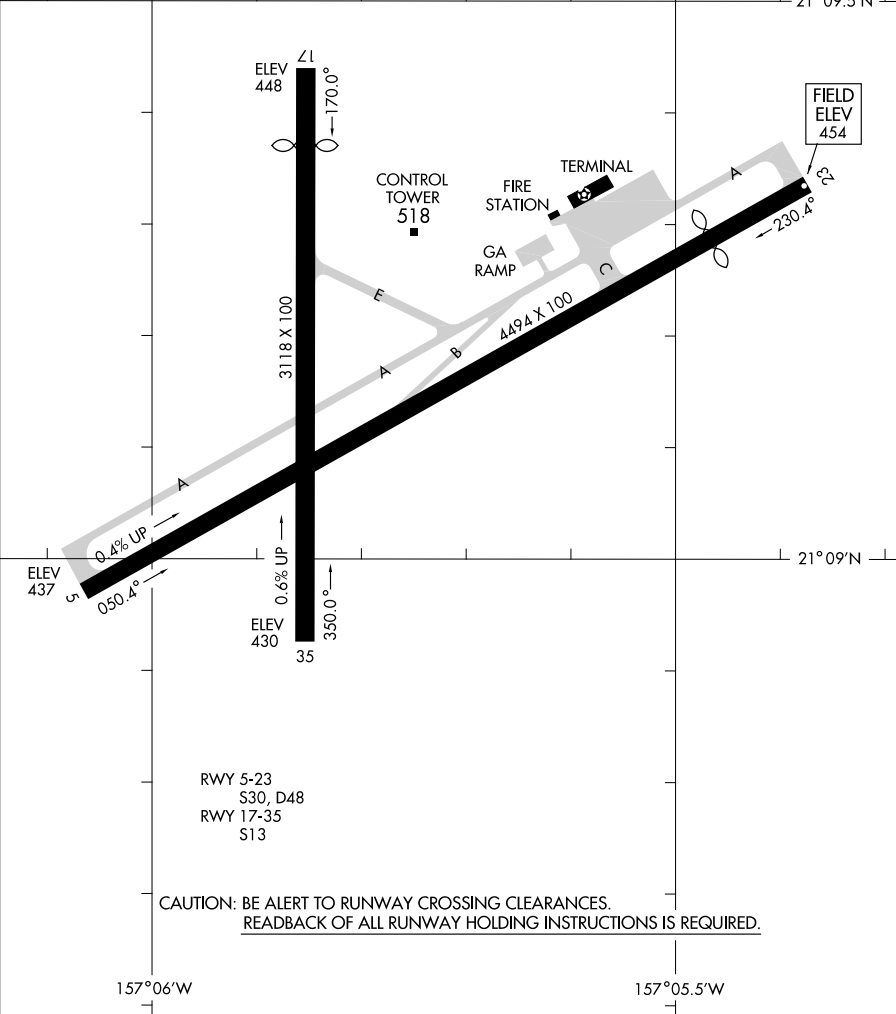

CAUTION: BE ALERT TO RUNWAY CROSSING CLEARANCES.  
READBACK OF ALL RUNWAY HOLDING INSTRUCTIONS IS REQUIRED.

# AIRPORT DIAGRAM

09071

KAUNAKAKAI, HAWAII  
KAUNAKAKAI/ MOLOKAI (MKK) (PHMK)

(BLUSH1.BLUSH) 07074  
**BLUSH ONE DEPARTURE**

SL-759 (FAA)

KAUNAKAKAI/MOLOKAI (MKK) (PHMK)  
 KAUNAKAKAI, HAWAII

ATIS  
 128.2  
 GND CON  
 121.9  
 MOLOKAI TOWER ★  
 125.7 (CTAF) 306.2  
 HCF APPROACH  
 124.1 317.5

TAKE-OFF OBSTACLES:

Rwy 5: Pole 2254' from DER, 222' right of centerline, 45' AGL/565' MSL.  
 Tree 1.12 NM from DER, 720' right of centerline, 50' AGL/675' MSL.  
 Fenceline beginning 147' from DER, 177' left of centerline, up to 12' AGL/471' MSL.  
 Multiple trees and bushes beginning 50' from DER, 273' left of centerline, up to 50' AGL/551' MSL.  
 Obstruction light 1366' from DER, 79' right of centerline, 30' AGL/528' MSL.  
 Multiple poles beginning 3065' from DER, 644' left of centerline, up to 45' AGL/623' MSL.  
 Multiple trees beginning 4155' from DER, 184' right of centerline, up to 50' AGL/714' MSL.

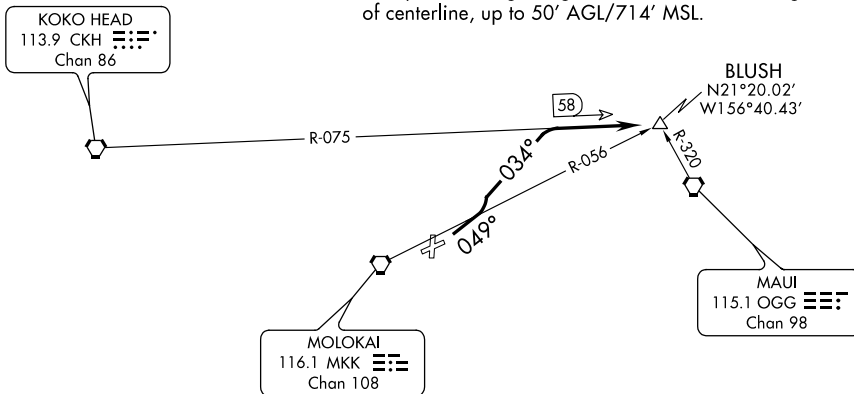

TAKE-OFF MINIMUMS:

Rwy 17, 35, 23: NA, ATC.

Rwy 5: STANDARD with minimum obstacle climb of 395' per NM to 1600'.

NOTE: Chart not to scale.



**DEPARTURE ROUTE DESCRIPTION**

TAKE-OFF RUNWAY 5: Climb via 049° heading to 860, then climbing left turn to 5000 via 034° heading and CKH R-075 to BLUSH INT.

**BLUSH ONE DEPARTURE**  
 (BLUSH1.BLUSH) 07074

KAUNAKAKAI, HAWAII  
 KAUNAKAKAI/MOLOKAI (MKK) (PHMK)

(HAPAI2.HAPAI) 07074  
**HAPAI TWO DEPARTURE**

SL-759 (FAA) KAUNAKAKAI/ MOLOKAI (MKK) (PHMK)  
 KAUNAKAKAI, HAWAII

ATIS  
 128.2  
 GND CON  
 121.9  
 MOLOKAI TOWER \*  
 125.7 (CTAF) 306.2  
 HCF APPROACH  
 124.1 317.5

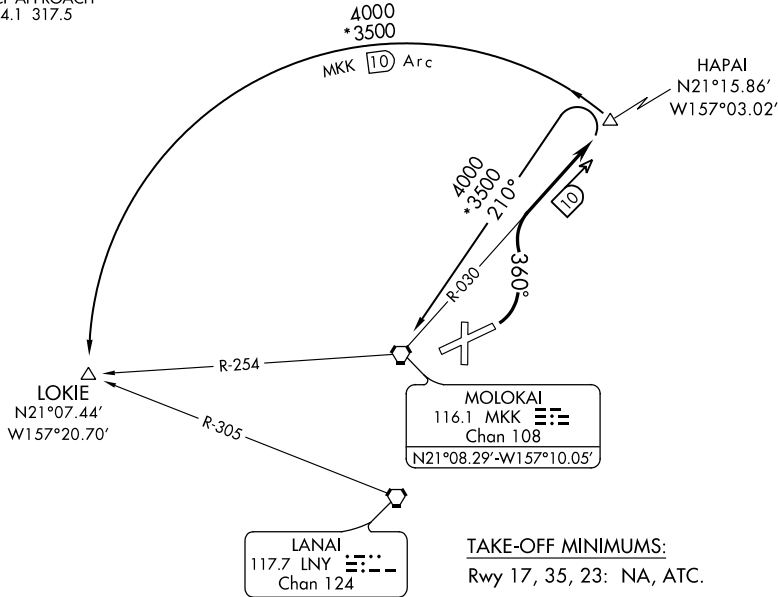

NOTE: DME Required.

**TAKE-OFF OBSTACLES:**

- Rwy 5: Pole 2254' from DER, 222' right of centerline, 45' AGL/565' MSL.
- Tree 1.12 NM from DER, 720' right of centerline, 50' AGL/675' MSL.
- Fenceline beginning 147' from DER, 177' left of centerline, up to 12' AGL/471' MSL.
- Multiple trees and bushes beginning 50' from DER, 273' left of centerline, up to 50' AGL/551' MSL.
- Obstruction light 1366' from DER, 79' right of centerline, 30' AGL/528' MSL.
- Multiple poles beginning 3065' from DER, 644' left of centerline, up to 45' AGL/623' MSL.
- Multiple trees beginning 4155' from DER, 184' right of centerline, up to 50' AGL/714' MSL.

NOTE: Chart not to scale

**TAKE-OFF MINIMUMS:**

Rwy 17, 35, 23: NA, ATC.

Rwy 5: STANDARD with minimum obstacle climb of 395' per NM to 1600'.

**DEPARTURE ROUTE DESCRIPTION**

**TAKE-OFF RUNWAY 5:** Climbing left turn via 360° heading and MKK VORTAC R-030 to HAPAI/10 DME. Thence. . . .  
 . . . . via (Transition). Maintain 4,000.

**LOKIE TRANSITION (HAPAI2.LOKIE):** From over HAPAI via MKK VORTAC 10 DME Arc CCW to LOKIE.

**MOLOKAI TRANSITION (HAPAI2.MKK):** From over HAPAI via 210° heading and MKK R-030 to MKK VORTAC.

**HAPAI TWO DEPARTURE**  
 (HAPAI2.HAPAI) 07074

KAUNAKAKAI, HAWAII  
 KAUNAKAKAI/ MOLOKAI (MKK) (PHMK)

KOSRAE, FM

AL-6887 (FAA)

APP CRS	Rwy Idg	<b>5751</b>
<b>058°</b>	TDZE	<b>10</b>
	Apt Elev	<b>11</b>

# RNAV (GPS) RWY 5

KOSRAE (TTK)(PTSA)



Circling not authorized southeast of Rwy 5-23.  
 Obtain local altimeter setting on CTAF; when not received, procedure not authorized. DME/DME RNP-0.3 NA.  
 No controlled airspace below 5500.

MISSED APPROACH: Climbing left turn to 2000 direct WAVKI WP and hold.

KOSRAE RADIO  
**123.6 (CTAF)**

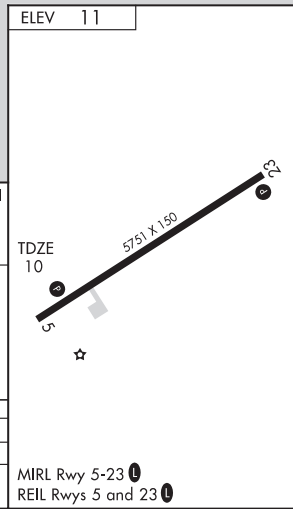
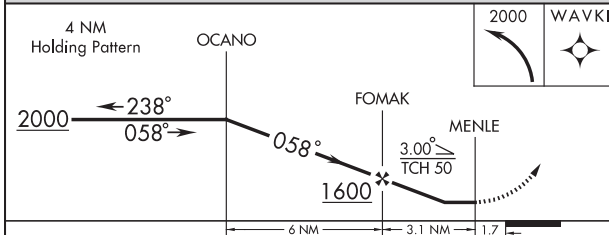
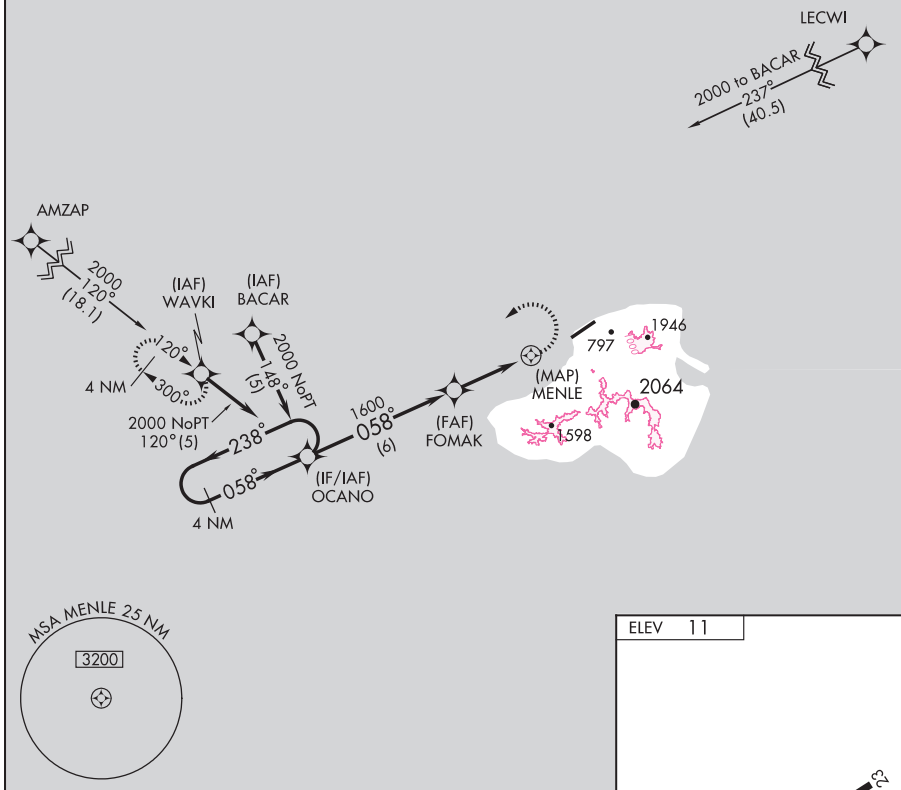

CATEGORY	A	B	C	D
LNAV MDA	460-2 450 (500-2)			
CIRCLING	520-2 509 (600-2)		580-2 569 (600-2)	

KOSRAE, FM  
 Orig-B 09071

05°21'N-162°58'E

# KOSRAE (TTK)(PTSA) RNAV (GPS) RWY 5



KOSRAE, FM

AL-6887 (FAA)

# RNAV (GPS) RWY 23

KOSRAE (TTK)(PTSA)

APP CRS	Rwy Idg	<b>5751</b>
<b>213°</b>	TDZE	<b>11</b>
	Apt Elev	<b>11</b>



Circling not authorized southeast of Rwy 5-23. Obtain local altimeter setting on CTAF; when not received, procedure not authorized. DME/DME RNP-0.3 NA. Fly visual to airport, 213°-1.85 nautical miles. No controlled airspace below 5500.

**MISSED APPROACH:**  
Climbing right turn to 1700 direct CANAY WP and hold.

**KOSRAE RADIO**  
**123.6 (CTAF) 0**

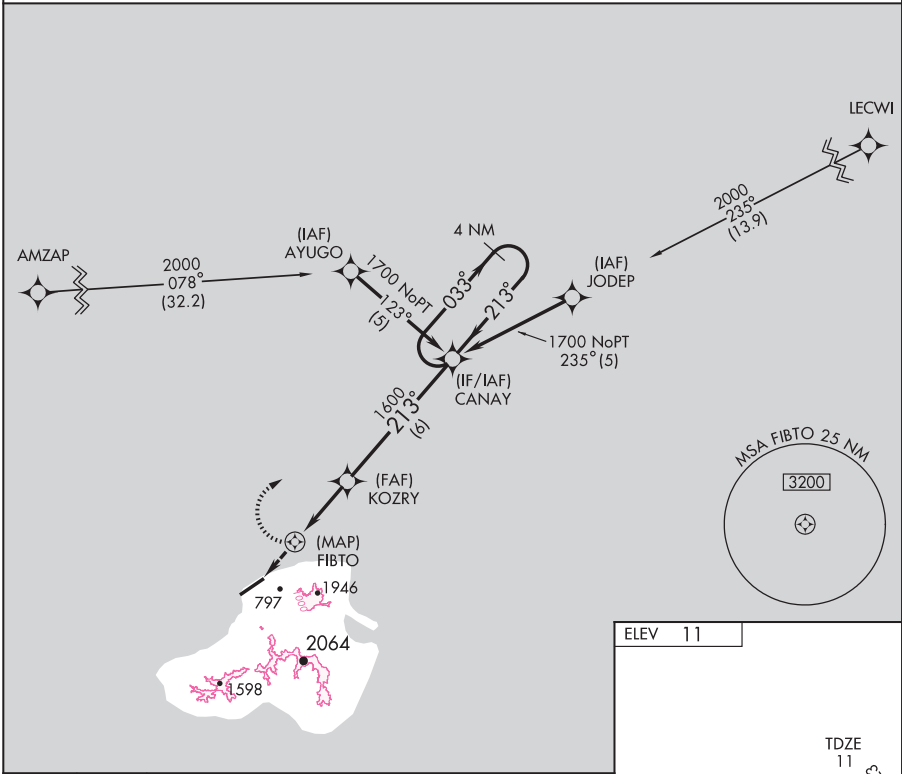

ELEV 11

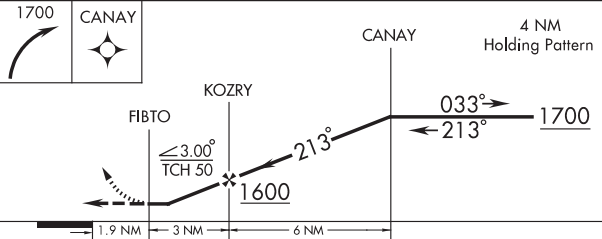
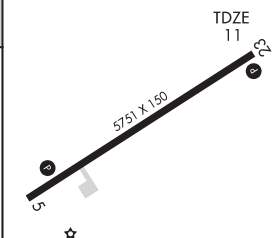

CATEGORY	A	B	C	D
LNVA MDA	800-2	789 (800-2)	800-2¼ 789 (800-2¼)	800-2½ 789 (800-2½)
CIRCLING	800-2	789 (800-2)	800-2¼ 789 (800-2¼)	800-2½ 789 (800-2½)

MIRL Rwy 5-23 0  
REIL Rws 5 and 23 0

KOSRAE, FM  
Orig-B 09071

05°21'N-162°58'E

# KOSRAE (TTK)(PTSA)

## RNAV (GPS) RWY 23

KOSRAE, FM

AL-6887 (FAA)

NDB/DME UKS <b>393</b>	APP CRS <b>084°</b>	Rwy Idg TDZE Apt Elev	<b>5751</b> <b>N/A</b> <b>11</b>
Chan <b>100 (115.3)</b>			

**NDB/DME-A**  
KOSRAE (TTK)(PTSA)

**⚠** Circling not authorized southeast of Rwy 5-23.

MISSED APPROACH: Climbing left turn to 3000 via UKS NDB/DME 300° bearing and 10 DME Arc to OBOTY/10 DME and hold.

KOSRAE RADIO  
**123.6 (CTAF) 0**

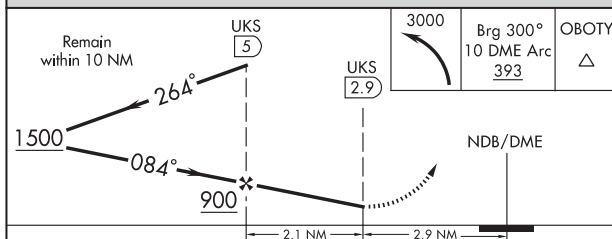
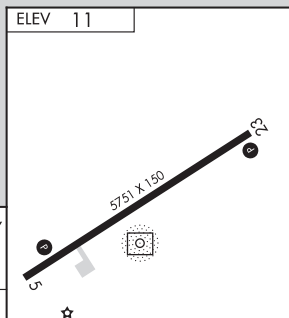
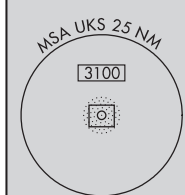
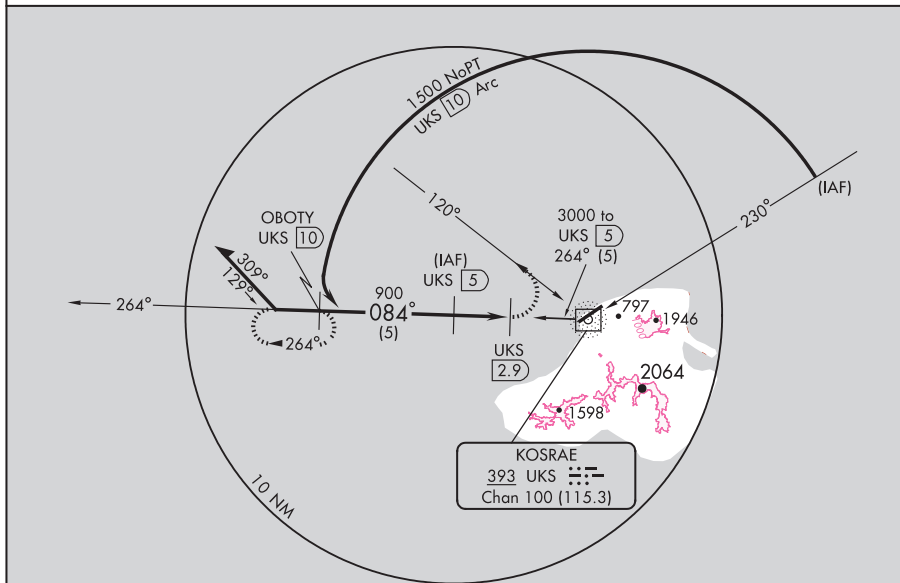

CATEGORY	A	B	C	D
CIRCLING		500-3	489 (500-3)	580-3 569 (600-3)

MIRL Rwy 5-23 0  
REIL Rws 5 and 23 0

KOSRAE, FM  
Orig-B 09071

05°21'N - 162°58'E

KOSRAE (TTK)(PTSA)  
**NDB/DME-A**

LANAI CITY, HAWAII

AL-777 (FAA)

# ILS RWY 3

LANAI CITY/LANAI (LNY)(PHNY)

LOC/DME I-LNY	APP CRS	Rwy Idg	5001
111.1	033°	TDZE	1305
Chan 48		Apt Elev	1308

- ▼ When local altimeter setting not received, procedure not authorized, except for operators with approved weather reporting service.
- ▲ Glide slope unusable for coupled approaches below 1505 MSL.
- Glide slope unusable beyond 5 degrees left of course.

MISSED APPROACH: Climb to 1700 when climbing left turn to 3000 via LNY R-278 to GRAMY Int/LNY 10 DME and hold.

ASOS  
**118.375**

HCF APPROACH  
**119.3 307.1**

CTAF  
**122.9**

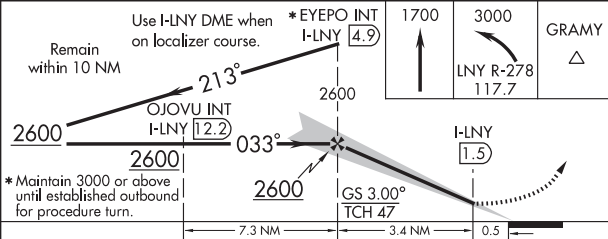
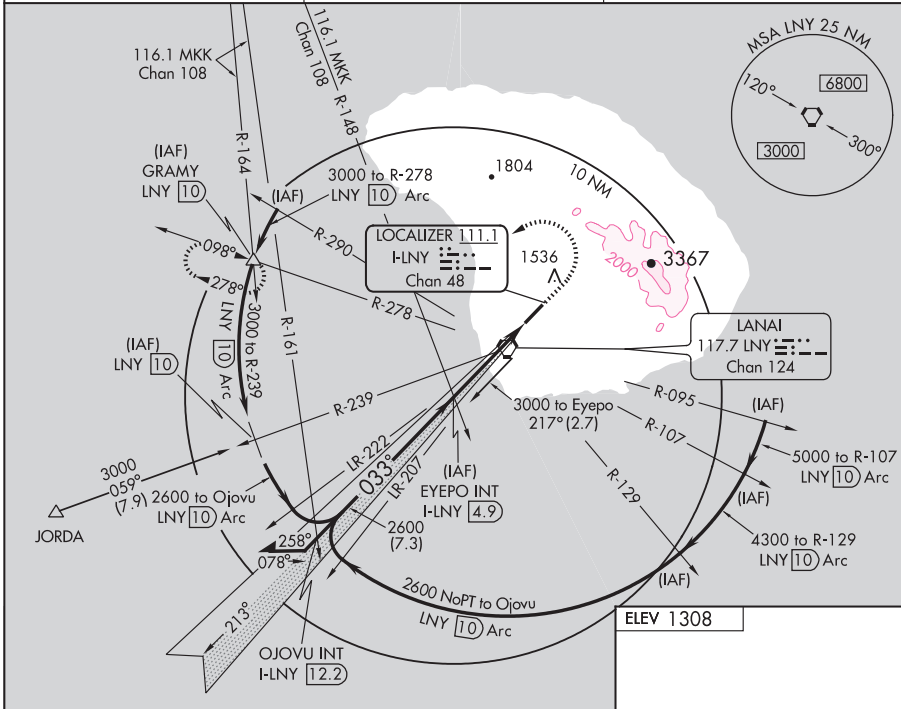

ELEV 1308	1346	1323	TDZE 1305																								
GRAMY	500' x 150'	MIRL Rwy 3-21	FAF to MAP 3.4 NM																								
033° 3.9 NM from FAF																											
<table border="1"> <thead> <tr> <th>CATEGORY</th> <th>A</th> <th>B</th> <th>C</th> <th>D</th> </tr> </thead> <tbody> <tr> <td>S-ILS 3</td> <td></td> <td>1505-¾</td> <td>200 (200-¾)</td> <td></td> </tr> <tr> <td>S-LOC 3</td> <td></td> <td>1580-1</td> <td>275 (300-1)</td> <td></td> </tr> <tr> <td rowspan="2">CIRCLING</td> <td>1840-1</td> <td>1880-1</td> <td>1900-1½</td> <td>1900-2</td> </tr> <tr> <td>532 (600-1)</td> <td>572 (600-1)</td> <td>592 (600-1½)</td> <td>592 (600-2)</td> </tr> </tbody> </table>				CATEGORY	A	B	C	D	S-ILS 3		1505-¾	200 (200-¾)		S-LOC 3		1580-1	275 (300-1)		CIRCLING	1840-1	1880-1	1900-1½	1900-2	532 (600-1)	572 (600-1)	592 (600-1½)	592 (600-2)
CATEGORY	A	B	C	D																							
S-ILS 3		1505-¾	200 (200-¾)																								
S-LOC 3		1580-1	275 (300-1)																								
CIRCLING	1840-1	1880-1	1900-1½	1900-2																							
	532 (600-1)	572 (600-1)	592 (600-1½)	592 (600-2)																							
<table border="1"> <thead> <tr> <th>Knots</th> <th>60</th> <th>90</th> <th>120</th> <th>150</th> <th>180</th> </tr> </thead> <tbody> <tr> <td>Min:Sec</td> <td>3:24</td> <td>2:16</td> <td>1:42</td> <td>1:21</td> <td>1:08</td> </tr> </tbody> </table>				Knots	60	90	120	150	180	Min:Sec	3:24	2:16	1:42	1:21	1:08												
Knots	60	90	120	150	180																						
Min:Sec	3:24	2:16	1:42	1:21	1:08																						

LANAI CITY, HAWAII  
Orig 07074

20°47'N - 156°57'W

LANAI CITY/LANAI (LNY)(PHNY)  
**ILS RWY 3**

LANAI CITY, HAWAII

AL-777 (FAA)

# RNAV (GPS) RWY 3

LANAI CITY / LANAI (LNY)(PHNY)

APP CRS <b>033°</b>	Rwy Idg <b>5001</b>
	TDZE <b>1305</b>
	Apt Elev <b>1308</b>

**DME/DME RNP-0.3 NA.** MISSED APPROACH: Climbing left turn to 3300 direct GRAMY and hold.

ASOS <b>118.375</b>	HCF APPROACH <b>119.3 307.1</b>	CTAF <b>122.9</b>
------------------------	------------------------------------	----------------------

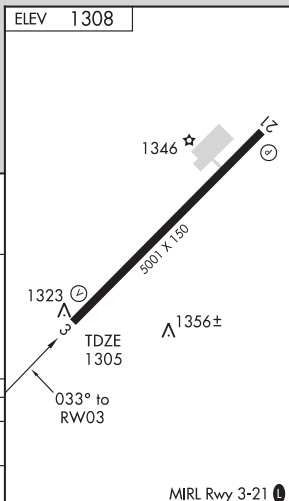
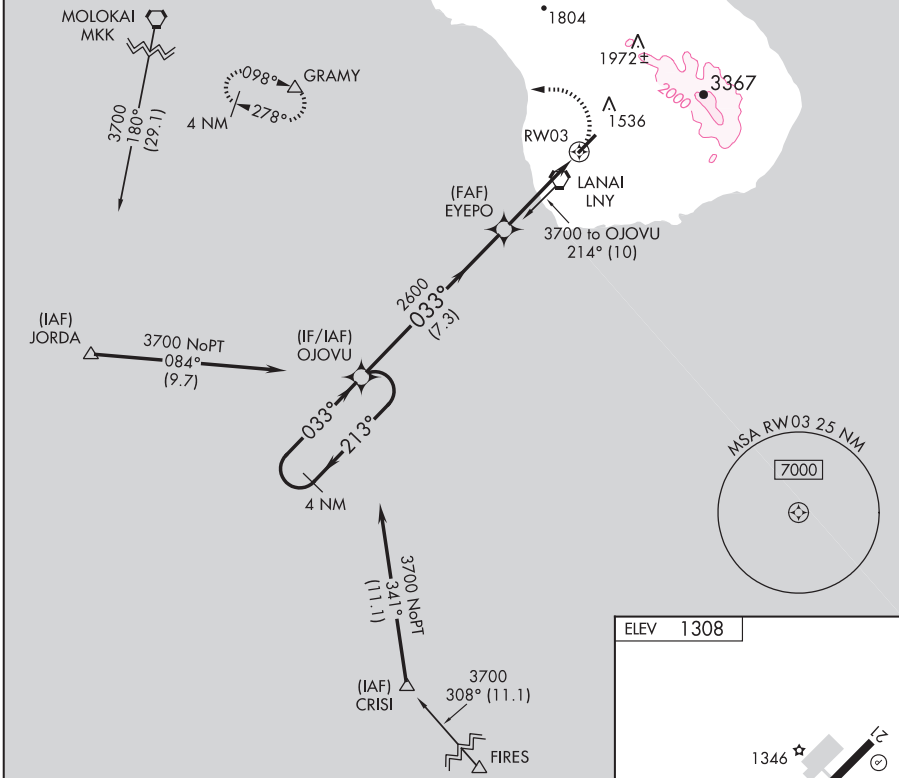

4 NM Holding Pattern	OJOVU	3300	GRAMY	
3700 ← 213°	→ 033°	→ 033°	→ 3.03° TCH 52	
VGSI and descent angles not coincident.				
7.3 NM		3.9 NM		
CATEGORY	A	B	C	D
LNAV MDA	1720-1	415 (500-1)	1720-1¼	415 (500-1¼)
CIRCLING	1840-1 532 (600-1)	1880-1 572 (600-1)	1900-1½ 592 (600-1½)	1900-2 592 (600-2)

LANAI CITY, HAWAII  
Orig 09239

20°47'N - 156°57'W

LANAI CITY / LANAI (LNY)(PHNY)  
**RNAV (GPS) RWY 3**

LANAI CITY, HAWAII

AL-777 (FAA)

VORTAC LNY <b>117.7</b> Chan <b>124</b>	APP CRS <b>098°</b>	Rwy Idg TDZE Apt Elev <b>1308</b>	N/A N/A
---	------------------------	--	------------

**VOR or TACAN or GPS-A**  
LANAI CITY/LANAI (LNY)(PHNY)

**⚠** When local altimeter not received, procedure not authorized, except for operators with approved weather reporting service.

**MISSED APPROACH:** Climbing right turn to 2000 via LNY R-278 to GRAMY Int/LNY 10 DME and hold.

ASOS <b>118.375</b>	HCF APPROACH <b>119.3 307.1</b>	CTAF <b>122.9</b>
------------------------	------------------------------------	----------------------

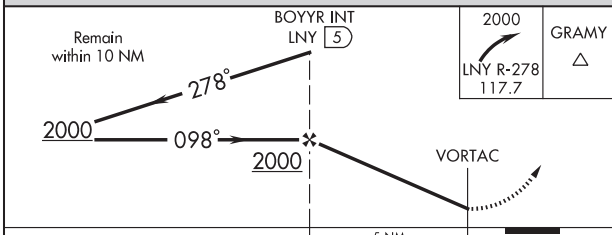
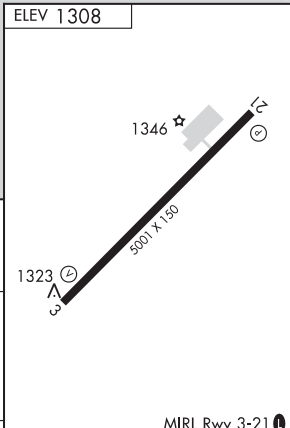
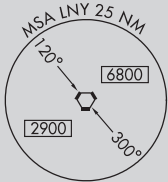
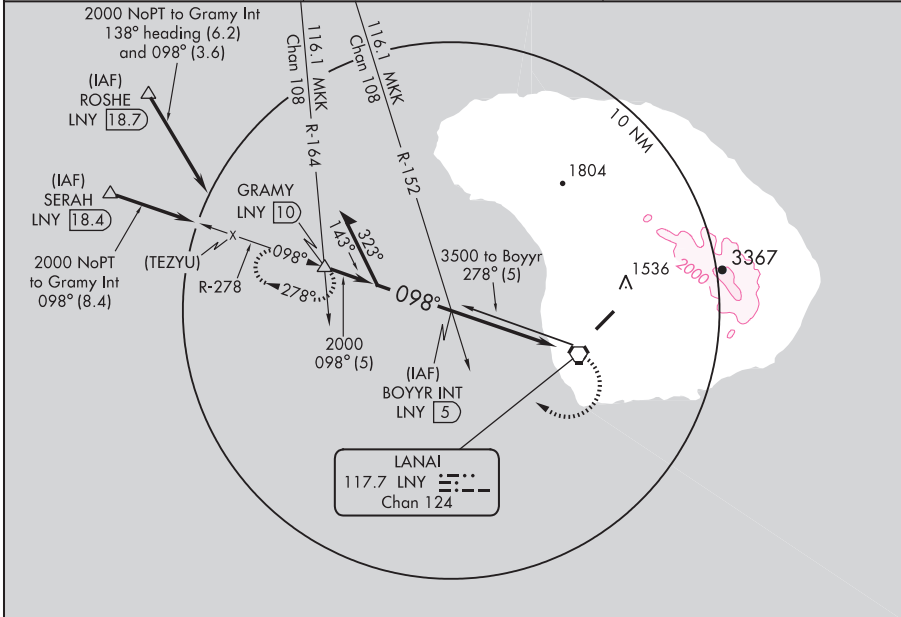

CATEGORY	A	B	C	D	Knots	60	90	120	150	180
CIRCLING	1840-1½ 532 (600-1½)	1880-1½ 572 (600-1½)	1900-1½ 592 (600-1½)	1900-2 592 (600-2)	Min:Sec					

LANAI CITY, HAWAII  
Amdt 8 07074

20° 47' N - 156° 57' W

LANAI CITY/LANAI (LNY)(PHNY)  
**VOR or TACAN or GPS-A**

LANAI CITY, HAWAII

AL-777 (FAA)

# VOR or TACAN RWY 3

LANAI CITY / LANAI (LNY)(PHNY)

VORTAC LNY <b>117.7</b> Chan <b>124</b>	APP CRS <b>025°</b>	Rwy Idg TDZE Apt Elev <b>5001</b> <b>1305</b> <b>1308</b>
---	------------------------	--

MISSED APPROACH: Climb to 1720 then climbing left turn to 3300 via heading 240° and LNY VORTAC R-278 to GRAMY Int/LNY 10 DME and hold.

ASOS <b>118.375</b>	HCF APPROACH <b>119.3 307.1</b>	CTAF <b>122.9</b>
------------------------	------------------------------------	----------------------

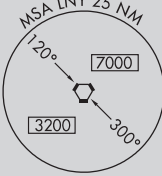
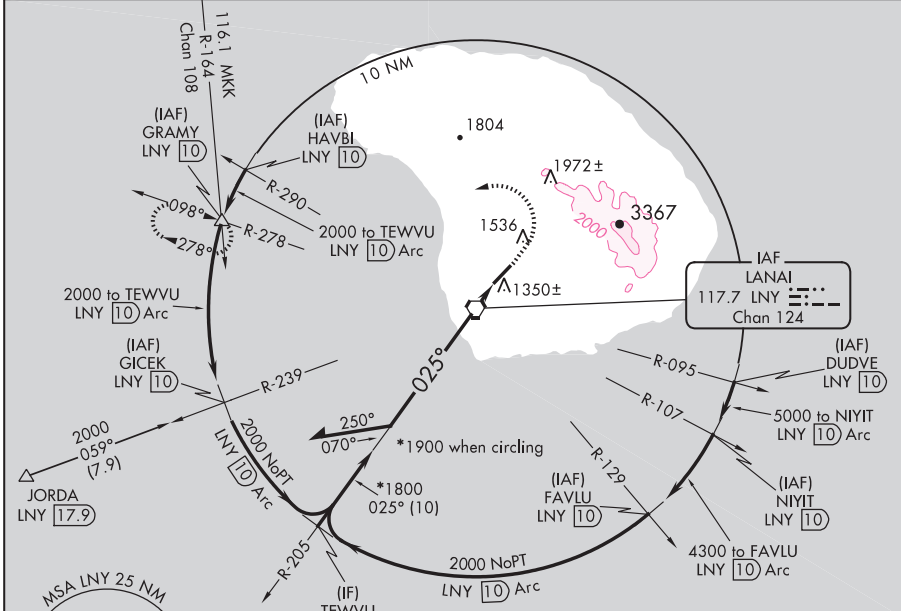

ELEV 1308
-----------

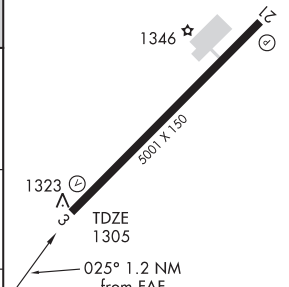
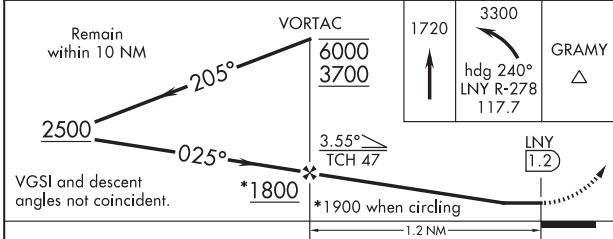

CATEGORY	A	B	C	D						
S-3	1660-1 355 (400-1)			1660-1¼ 355 (400-1¼)	MIRL Rwy 3-21					
					FAF to MAP 1.2 NM					
CIRCLING	1840-1 532 (600-1)	1880-1 572 (600-1)	1900-1½ 592 (600-1½)	1900-2 592 (600-2)	Knots	60	90	120	150	180
					Min:Sec	1:12	0:48	0:36	0:29	0:24

LANAI CITY, HAWAII  
Amdt 7 09239

20°47'N - 156°57'W

# LANAI CITY / LANAI (LNY)(PHNY)

## VOR or TACAN RWY 3



LIHUE, HAWAII

AL-776 (FAA)

# RNAV (GPS) RWY 17

LIHUE (LIH)(PHLI)

APP CRS	Rwy Idg	<b>6500</b>
<b>184°</b>	TDZE	<b>99</b>
	Apt Elev	<b>153</b>

<p><b>▼</b> Circling NA between Rwy 3 and 35.  <b>▲</b> DME/DME RNP-0.3 NA.                  Circling NA at night.</p>	<p>MISSED APPROACH: Climbing left turn to 3000 direct NAGAI and hold.</p>		
	<p>ATIS <b>127.2</b></p>	<p>HCF APPROACH <b>126.5 269.4</b></p>	<p>LIHUE TOWER* <b>118.9(CTAF) 0 263.1</b></p>

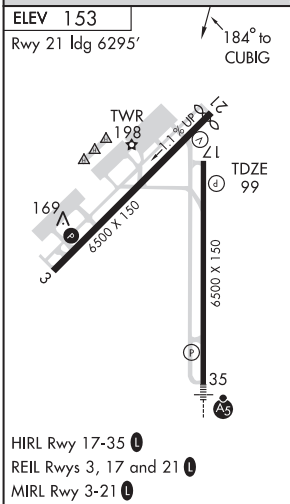
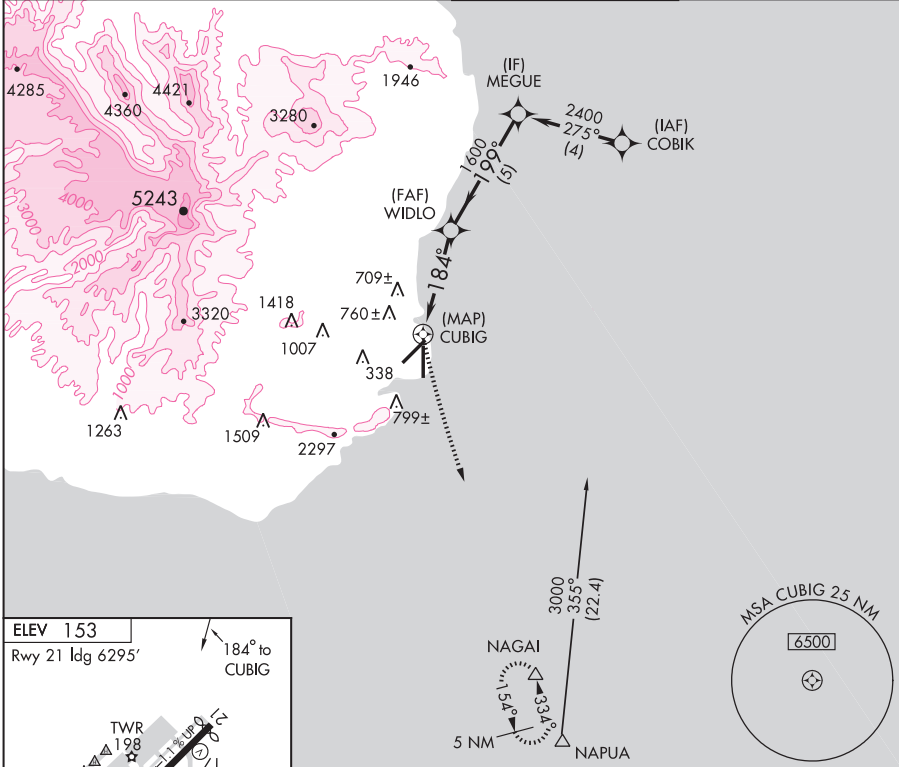

3000	NAGAI	WIDLO		MEGUE
△		1.4 NM to CUBIG	1600	2400
		CUBIG	184°	199°
			3.06°	Procedure Turn NA
		0.5 1.4 2.6 NM	5 NM	
CATEGORY	A	B	C	D
LNVA MDA	740-1	641 (600-1)	740-1¾ 641 (600-1¾)	740-2 641 (600-2)
CIRCLING	740-1 587 (600-1)	1000-1¼ 847 (900-1¼)	1060-2¾ 907 (1000-2¾)	1060-3 907 (1000-3)

LIHUE, HAWAII  
Orig-A 07186

21° 59'N-159° 20'W

# LIHUE (LIH)(PHLI) RNAV (GPS) RWY 17



LIHUE, HAWAII

AL-776 (FAA)

# RNAV (GPS) Y RWY 21

LIHUE (LIH)(PHLI)

APP CRS	Rwy Idg	<b>6295</b>
<b>214°</b>	TDZE	<b>118</b>
	Apt Elev	<b>153</b>

<p><b>▼</b> DME/DME RNP-0.3 NA.  <b>▲</b> Circling NA between Rwys 3 and 35.          Circling NA at night.</p>	<p>MISSED APPROACH: Climbing left turn to 3000 direct NAGAI and hold.</p>		
<p>ATIS <b>127.2</b></p>	<p>HCF APPROACH <b>126.5 269.4</b></p>	<p>LIHUE TOWER★ <b>118.9(CTAF) 263.1</b></p>	<p>GND CON <b>121.9</b></p>

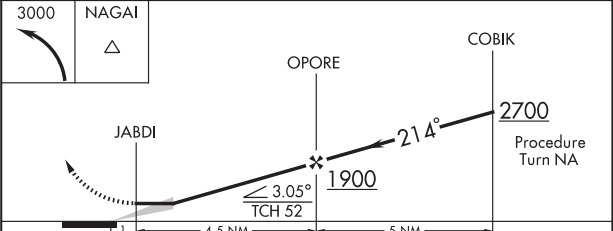
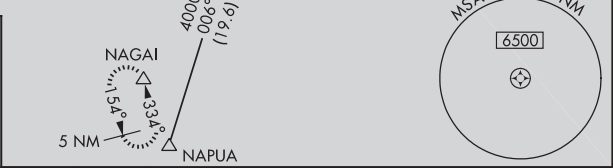
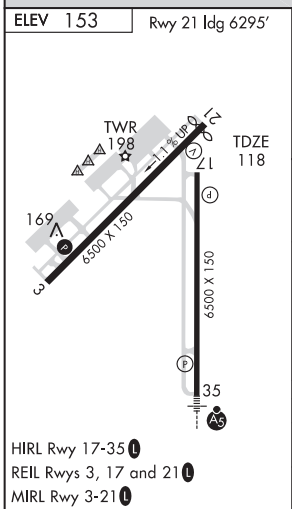
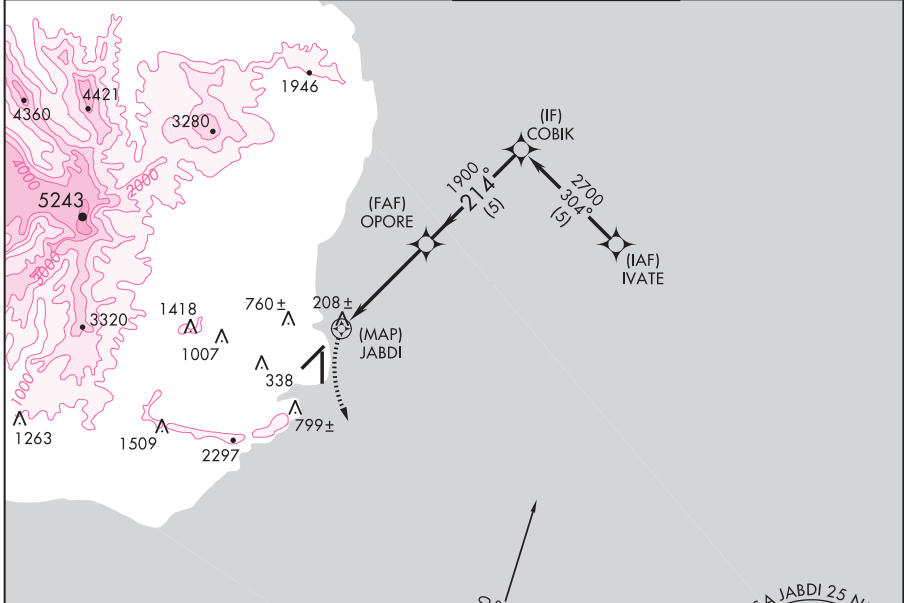

CATEGORY	A	B	C	D
LNAV MDA	580-1¼ 462 (500-1¼)			580-1½ 462 (500-1½)
CIRCLING	600-1¼ 447 (500-1¼)	1000-1¼ 847 (900-1¼)	1060-2¾ 907 (1000-2¾)	1060-3 907 (1000-3)

LIHUE, HAWAII  
Orig-B 07186

21° 59'N-159° 20'W

# LIHUE (LIH)(PHLI) RNAV (GPS) Y RWY 21

LIHUE, HAWAII

AL-776 (FAA)

# RNAV (GPS) Y RWY 35

LIHUE (LIH)(PHLI)

APP CRS	Rwy Idg	<b>6500</b>
<b>349°</b>	TDZE	<b>96</b>
	Apt Elev	<b>153</b>

**▲** For inoperative MALSR, increase LNAV Cat. A visibility to 1 mile and Cat. E to 3 miles. Circling NA west of Rwy 17-35.  
**▲** Circling NA at night. DME/DME RNP-0.3 NA.



**MISSED APPROACH:** Climbing right turn to 3000 direct KREEN WP and hold.

ATIS <b>127.2</b>	HCF APPROACH <b>126.5 269.4</b>	LIHUE TOWER* <b>118.9 (CTAF) 263.1</b>	GND CON <b>121.9</b>
----------------------	------------------------------------	---	-------------------------

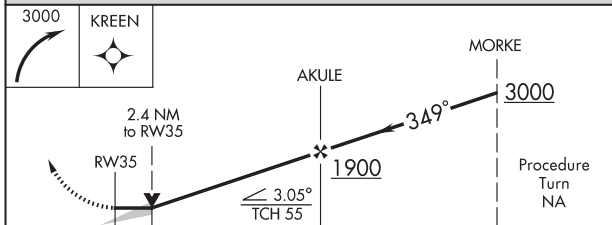
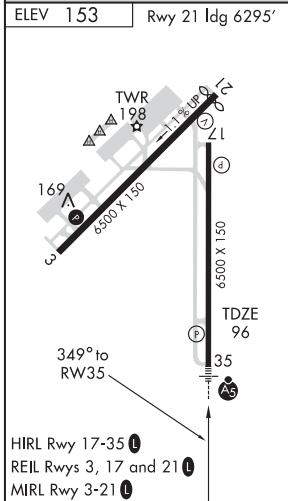
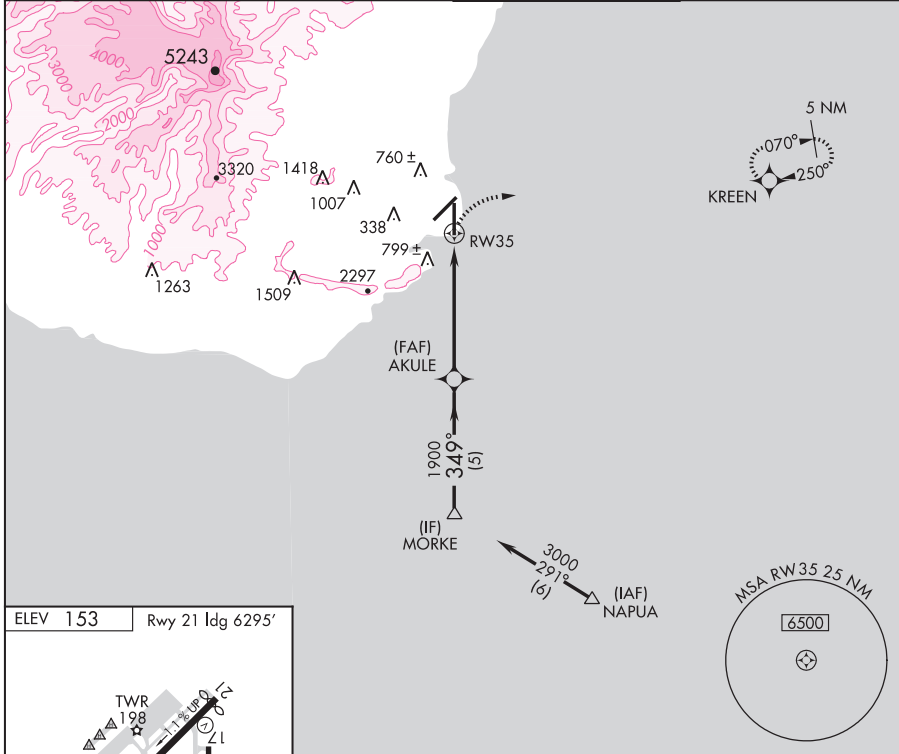

CATEGORY	A	B	C	D	E
LNAV MDA	920-3/4	824 (800-3/4)	920-2 824 (800-2)	920-2 1/4 824 (800-2 1/4)	920-2 1/2 824 (800-2 1/2)
CIRCLING	920-1 767 (800-1)	920-1 1/4 767 (800-1 1/4)	920-2 1/4 767 (800-2 1/4)	920-2 1/2 767 (800-2 1/2)	NA

LIHUE, HAWAII  
 Orig-D 07354

21° 59'N-159° 20'W

# RNAV (GPS) Y RWY 35

LIHUE (LIH)(PHLI)

LIHUE, HAWAII

AL-776 (FAA)

# RNAV (RNP) Z RWY 21

LIHUE (LIH)(PHLI)

APP CRS <b>214°</b>	Rwy Idg TDZE Apt Elev	<b>6295'</b> <b>118</b> <b>153</b>
------------------------	-----------------------------	--

**▽** \*Missed approach requires minimum climb rate of 350 feet per NM to 2500.  
**△** NA For uncompensated Baro-VNAV systems, procedure NA below 14°C (57°F) or above 48°C (119°F). GPS REQUIRED.

MISSED APPROACH: Climbing left turn to 3000 direct OLOYI and hold.

ATIS <b>127.2</b>	HCF APPROACH <b>126.5 269.4</b>	LIHUE TOWER* <b>118.9</b> (CTAF) <b>263.1</b>	GND CON <b>121.9</b>
----------------------	------------------------------------	--	-------------------------

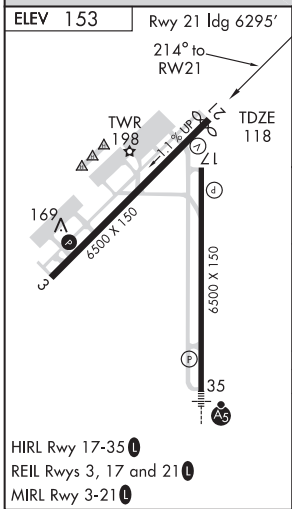
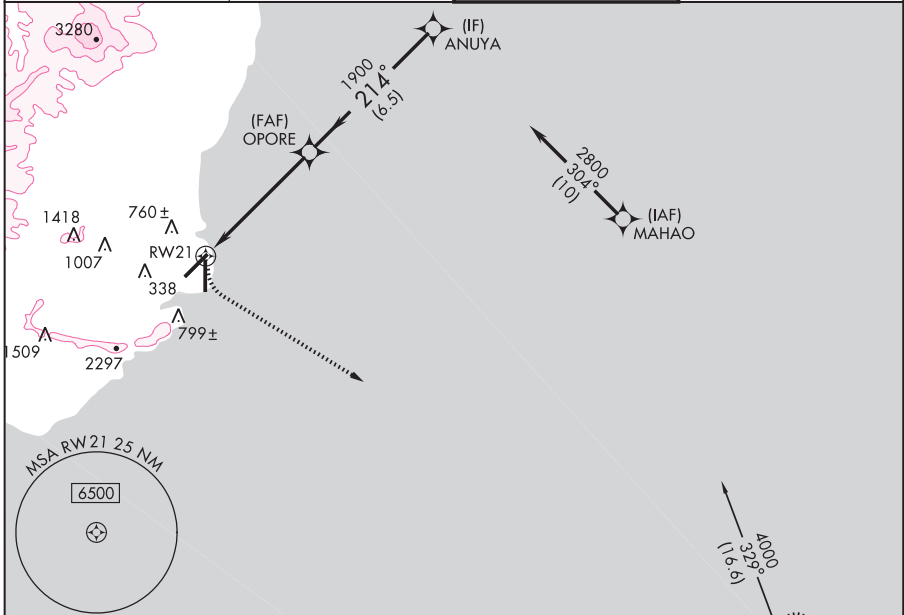

Procedure NA for arrivals at GRAIL via V16 southeast bound and at OLOYI via V15 southeast bound.

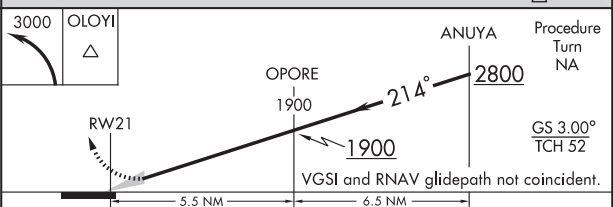

CATEGORY	A	B	C	D
RNP 0.30 DA *		663-2	545 (600-2)	
RNP 0.30 DA		1078-4	960 (1000-4)	

**SPECIAL AIRCRAFT & AIRCREW AUTHORIZATION REQUIRED**

LIHUE, HAWAII  
Orig 07186

LIHUE (LIH)(PHLI)  
21° 59'N-159° 20'W  
**RNAV (RNP) Z RWY 21**

LIHUE, HAWAII

AL-776 (FAA)

# RNAV (RNP) Z RWY 35

LIHUE (LIH)(PHLI)

APP CRS <b>349°</b>	Rwy Idg <b>6500</b>
	TDZE <b>96</b>
	Apt Elev <b>153</b>

**GPS REQUIRED.** For inoperative MALSRS, increase RNP 0.30 visibility to 1¾. For uncompensated Baro-VNAV systems, procedure NA below 14°C (57°F) or above 48°C (119°F).

**MALSRS**  
 MISSED APPROACH: Climbing right turn to 3000 direct KREEN and hold.

ATIS <b>127.2</b>	HCF APPROACH <b>126.5 269.4</b>	LIHUE TOWER* <b>118.9 (CTAF) 263.1</b>	GND CON <b>121.9</b>
----------------------	------------------------------------	---	-------------------------

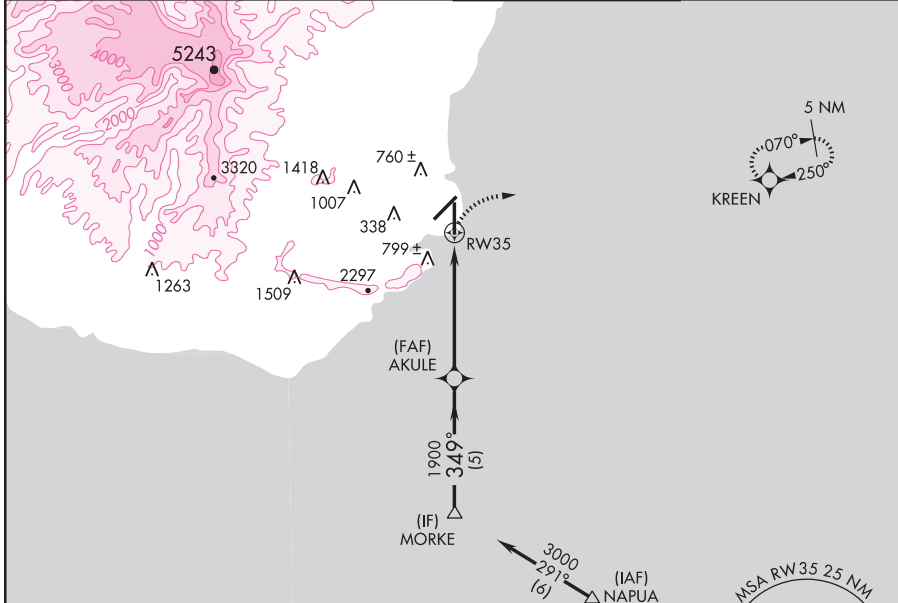

ELEV 153 Rwy 21 Idg 6295'

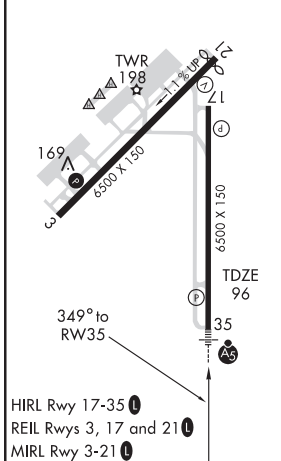

Procedure NA for arrivals at NAPUA via V16 southeast bound.

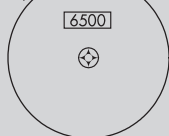
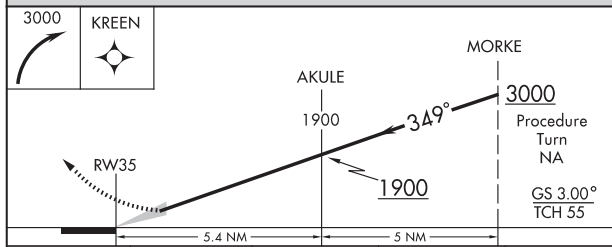
CATEGORY	A	B	C	D
RNP 0.30 DA		599-1¼	503 (500-1¼)	

**SPECIAL AIRCRAFT & AIRCREW AUTHORIZATION REQUIRED**

LIHUE, HAWAII  
Orig 07186

21° 59'N-159° 20'W

LIHUE (LIH)(PHLI)  
**RNAV (RNP) Z RWY 35**

LIHUE, HAWAII

AL-776 (FAA)

VORTAC LIH	APP CRS	Rwy Idg	6295
113.5	191°	TDZE	118
Chan 82		Apt Elev	153

# VOR/DME or TACAN RWY 21

LIHUE (LIH)(PHLI)



Circling NA west of Rwy 17-35.  
Circling NA at night.

MISSED APPROACH: Climbing left turn to 3000 via heading 152° and LIH VORTAC R-148 to NAGAI/12 DME and hold.

ATIS  
**127.2**

HCF APPROACH  
**126.5 269.4**

LIHUE TOWER★  
**118.9(CTAF) 263.1**

GND CON  
**121.9**

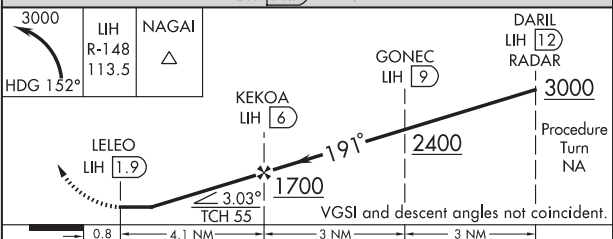
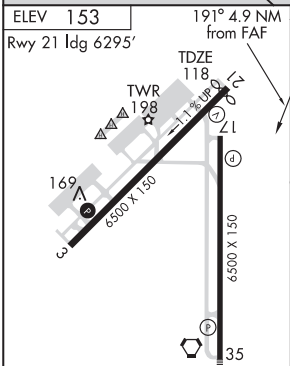
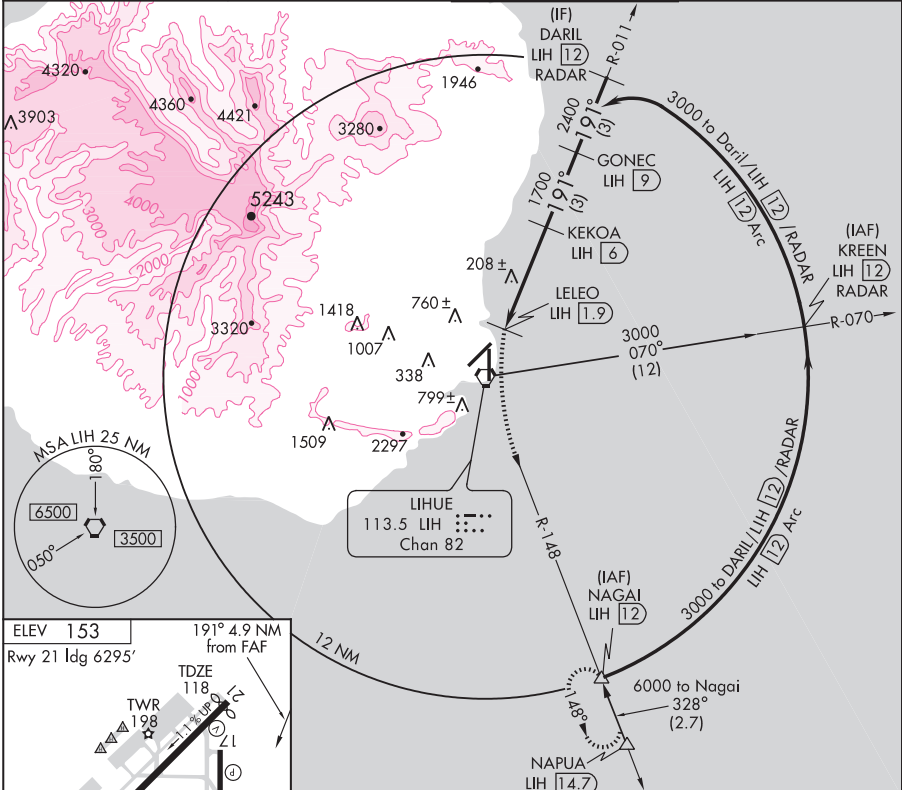

HIRL Rwy 17-35	REIL Rwy 3, 17 and 21	MIRL Rwy 3-21			
Knots	60	90	120	150	180
Min:Sec					

CATEGORY	A	B	C	D
S-21	520-1	402 (400-1)	520-1¼	402 (400-1¼)
CIRCLING	520-1	620-1	620-1½	720-2
	367 (400-1)	467 (500-1)	467 (500-1½)	567 (600-2)

LIHUE, HAWAII  
Amdt 4 07186

21° 59'N-159° 20'W

# LIHUE (LIH)(PHLI)

## VOR/DME or TACAN RWY 21

LIHUE, HAWAII

AL-776 (FAA)

VORTAC LIH <b>113.5</b> Chan <b>82</b>	APP CRS <b>328°</b>	Rwy Idg TDZE Apt Elev	<b>6500</b> <b>96</b> <b>153</b>
--	------------------------	-----------------------------	--

# VOR or TACAN RWY 35

LIHUE (LIH)(PHLI)

Circling NA at night. DME or RADAR REQUIRED Inoperative table does not apply. Circling NA west of Rwy 17-35.	MALS	MISSED APPROACH: Climbing right turn to 3000 via heading 100° and LIH VORTAC R-070 to KREEN/12 DME/RADAR and hold.	
		ATIS <b>127.2</b>	HONOLULU CENTER <b>126.5 269.4</b>

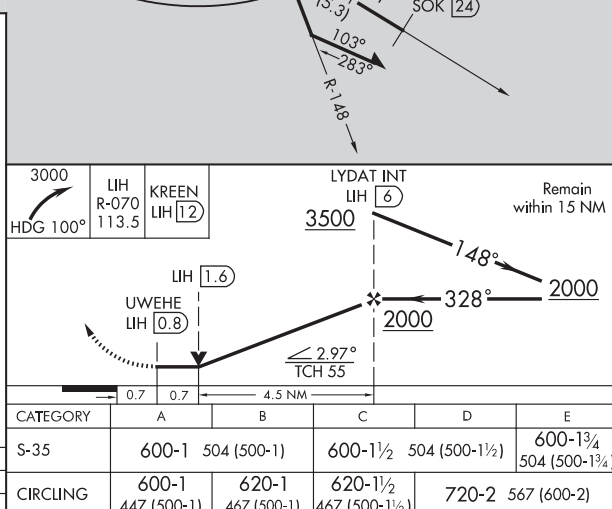
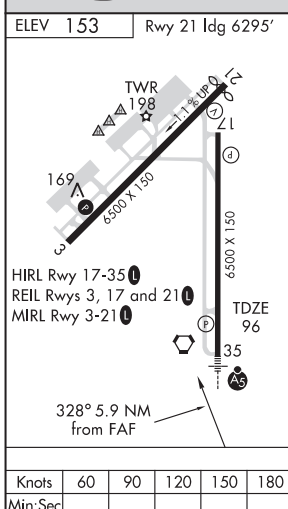
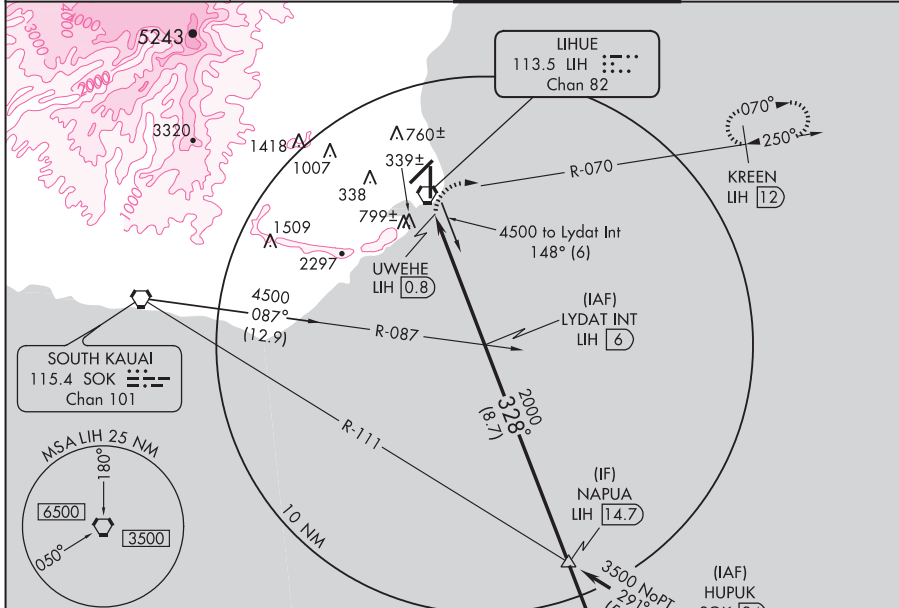

LIHUE, HAWAII  
Amdt 7 07186

21° 59'N-159° 20'W

# LIHUE (LIH)(PHLI) VOR or TACAN RWY 35

LIHUE, HAWAII

AL-776 (FAA)

VORTAC LIH <b>113.5</b> Chan <b>82</b>	APP CRS <b>300°</b>	Rwy Idg TDZE Apt Elev <b>153</b>	N/A N/A 153
--	------------------------	---	-------------------

**VOR-A**  
LIHUE (LIH)(PHLI)

Circling NA west of Rwy 17-35. Procedure NA at night.		MISSED APPROACH: Climbing right turn to 3000 via heading 100° and LIH VORTAC R-070 then climbing right turn to 4000 direct LIH VORTAC and hold.	
ATIS <b>127.2</b>	HCF APPROACH <b>126.5 269.4</b>	LIHUE TOWER★ <b>118.9</b> (CTAF) <b>263.1</b>	GND CON <b>121.9</b>

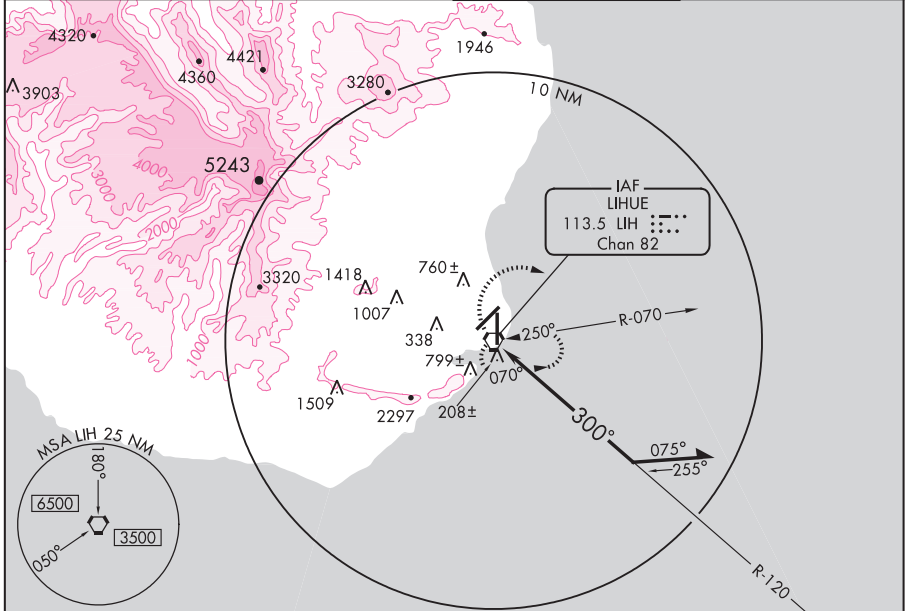

ELEV 153 Rwy 21 Idg 6295°

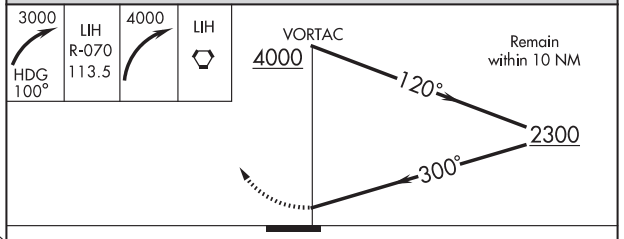
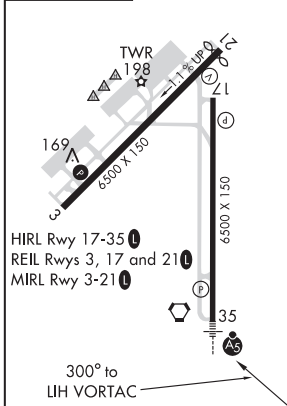

Knots	60	90	120	150	180		
Min:Sec							
CATEGORY	A		B		C		D
CIRCLING	800-1		647 (700-1)		800-1¾ 647 (700-1¾)		800-2 647 (700-2)

LIHUE, HAWAII  
Amdt 4 07186

21° 59'N-159° 20'W

LIHUE (LIH)(PHLI)  
**VOR-A**

09071

# AIRPORT DIAGRAM

AL-776 (FAA)

LIHUE (LIH)(PHLI)  
LIHUE, HAWAII

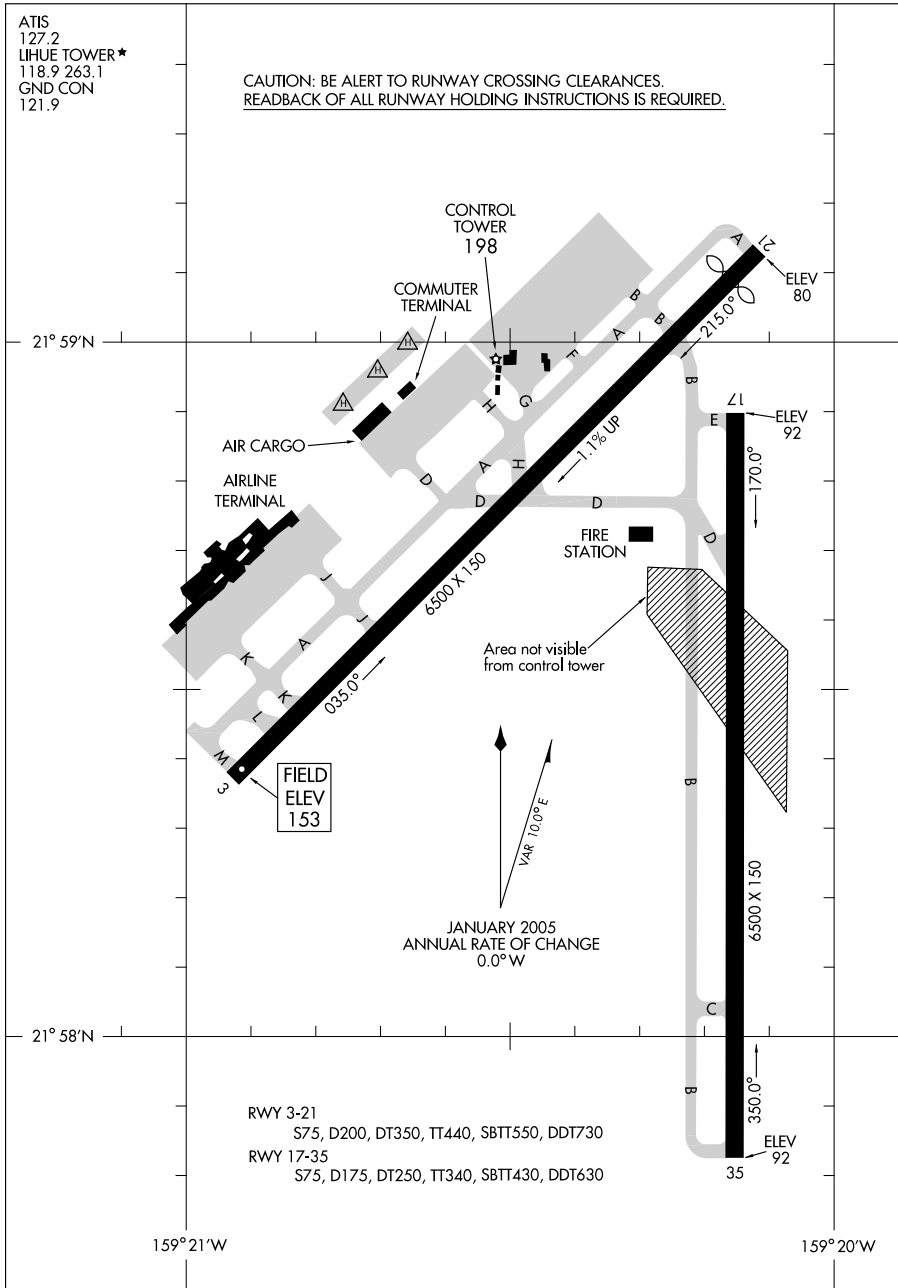

# AIRPORT DIAGRAM

09071

LIHUE, HAWAII  
LIHUE (LIH)(PHLI)



DIANE ONE DEPARTURE

ATIS  
127.2  
GND CON  
121.9  
LIHUE TOWER★  
118.9 (CTAF) 263.1  
HCF APPROACH  
126.5 269.4

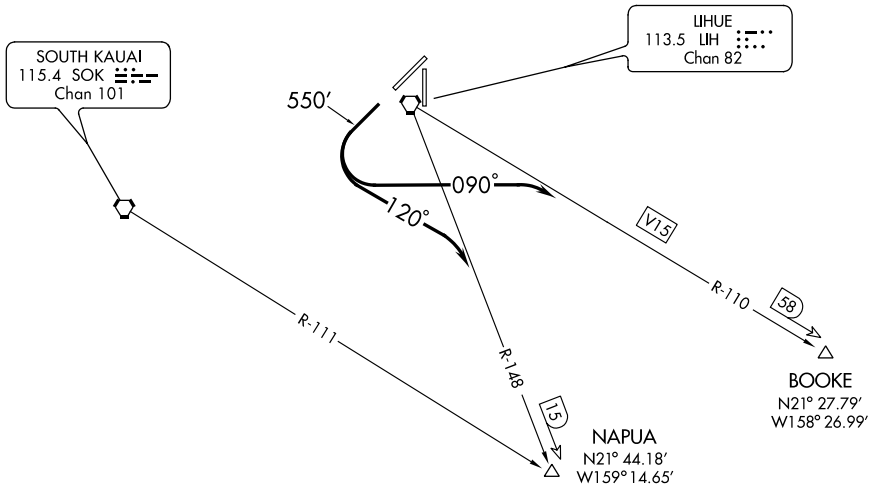

TAKE-OFF MINIMUMS: Rwy 21, 2400-3

NOTE: Honolulu CERAP radio call is "Honolulu Center".

NOTE: Ridgeline 1.5 NM south to 6 NM southwest, 900' to 2400' MSL.

NOTE: Terrain heights to 2297' MSL occur within 4.2 NM southwest of the airport.

NOTE: This Departure not authorized for Rwy 3, Rwy 17, Rwy 35.

NOTE: Chart not to scale.



DEPARTURE ROUTE DESCRIPTION

TAKE-OFF RUNWAY 21:

To V15: Climb runway heading to 550 then climbing left turn, heading 090°, to intercept LIH R-110 (V15), maintain 5000, direct BOOKE INT or as assigned.

To LIH R-148: Climb runway heading to 550, then climbing left turn, heading 120°, to intercept LIH R-148, maintain 3000, direct NAPUA INT or as assigned.

(LIH5.BOOKE) 07130  
**LIHUE FIVE DEPARTURE**

SL-776 (FAA)

LIHUE (LIH)(PHLI)  
 LIHUE, HAWAII

ATIS  
 127.2  
 GND CON  
 121.9  
 LIHUE TOWER\*  
 118.9 (CTAF) 263.1  
 HCF APPROACH  
 126.5 269.4

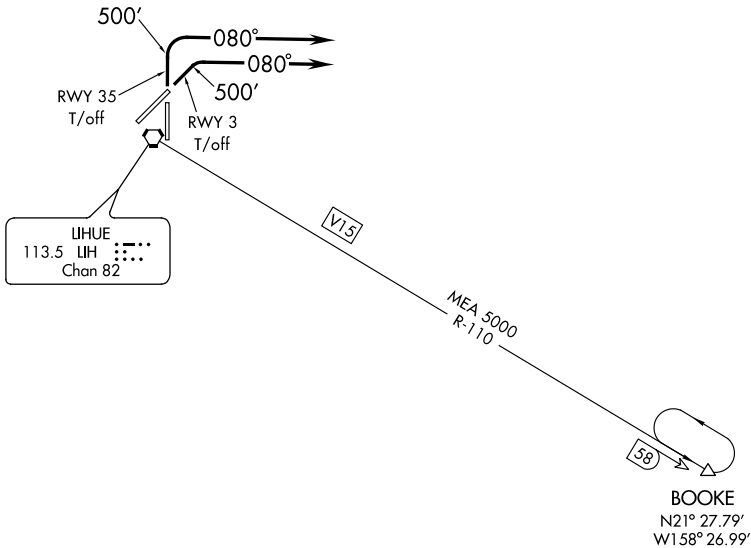

NOTE: DME Required.

NOTE: Honolulu CERAP radio call is "Honolulu Center".

NOTE: Chart not to scale.



### DEPARTURE ROUTE DESCRIPTION

TAKE-OFF RUNWAYS 3 and 35: Climb runway heading to 500, then climbing right turn to heading 080°, expect radar vectors to intercept LIH R-110 to BOOKE DME fix. MEA 5000.

LOST COMMUNICATIONS: If not in contact with Honolulu CERAP one minute after departure, maintain SID heading until 10 NM east of LIH VORTAC, then intercept LIH R-110 to BOOKE DME fix. MEA 5000.

**LIHUE FIVE DEPARTURE**  
 (LIH5.BOOKE) 07130

LIHUE, HAWAII  
 LIHUE (LIH)(PHLI)

(RICH2.BOOKE) 07130

SL-776 (FAA)

LIHUE (LIH)(PHLI)  
LIHUE, HAWAII

**RICHE TWO DEPARTURE**

ATIS  
127.2  
GND CON  
121.9  
LIHUE TOWER\*  
118.9 (CTAF) 263.1  
HCF APPROACH  
126.5 269.4

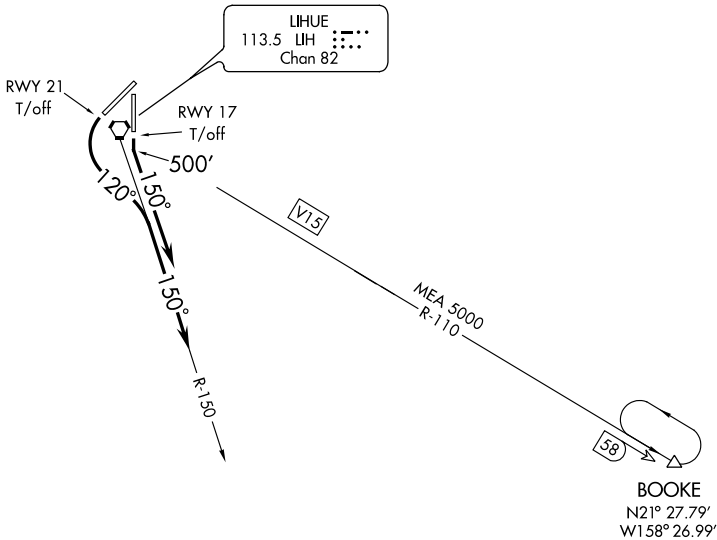

NOTE: DME Required.

NOTE: Honolulu CERAP radio call is "Honolulu Center".

NOTE: Terrain heights to 2297' occur within 4.5 NM southwest of the airport.

NOTE: Chart not to scale.



**DEPARTURE ROUTE DESCRIPTION**

**TAKE-OFF RUNWAY 17:** Climb runway heading to 500 feet , then climbing left turn to heading 150° , expect radar vectors to intercept LIH R-110 to BOOKE DME fix. MEA 5000.

**TAKE-OFF RUNWAY 21:** Immediate climbing left turn to heading 120 until crossing LIH R-150, thence fly heading 150° , expect radar vectors to intercept LIH R-110 to BOOKE DME fix. MEA 5000.

**LOST COMMUNICATIONS:** If not in contact with Honolulu CERAP one minute after departure, maintain SID heading until 10 NM southeast of LIH VORTAC, then intercept LIH R-110 to BOOKE DME fix. MEA 5000.

**RICHE TWO DEPARTURE**

(RICH2.BOOKE) 07130

LIHUE, HAWAII  
LIHUE (LIH)(PHLI)

MIDWAY ATOLL, MQ

AL-2154 (FAA)

APP CRS	Rwy Idg	<b>7800</b>
<b>059°</b>	TDZE	<b>13</b>
	Apt Elev	<b>13</b>

# RNAV (GPS) RWY 6

MIDWAY ATOLL / HENDERSON FIELD (MDY) (PMDY)

**▲** DME/DME RNP-0.3 NA.  
No controlled airspace below 5500.  
When local altimeter setting not received procedure NA.

MISSED APPROACH: Climb to 1700  
direct ESOVY WP and hold.

AWOS-3  
**118.325**

MIDWAY RADIO  
**126.20 257.8**

CTAF  
**122.9**

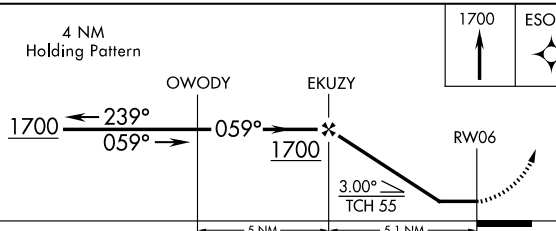
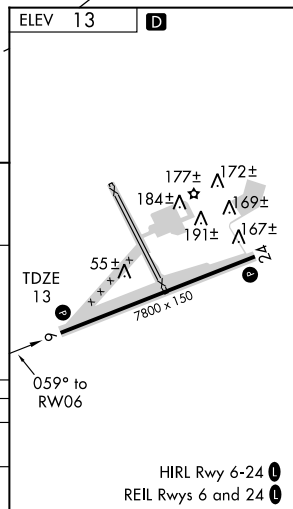
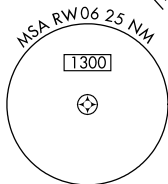
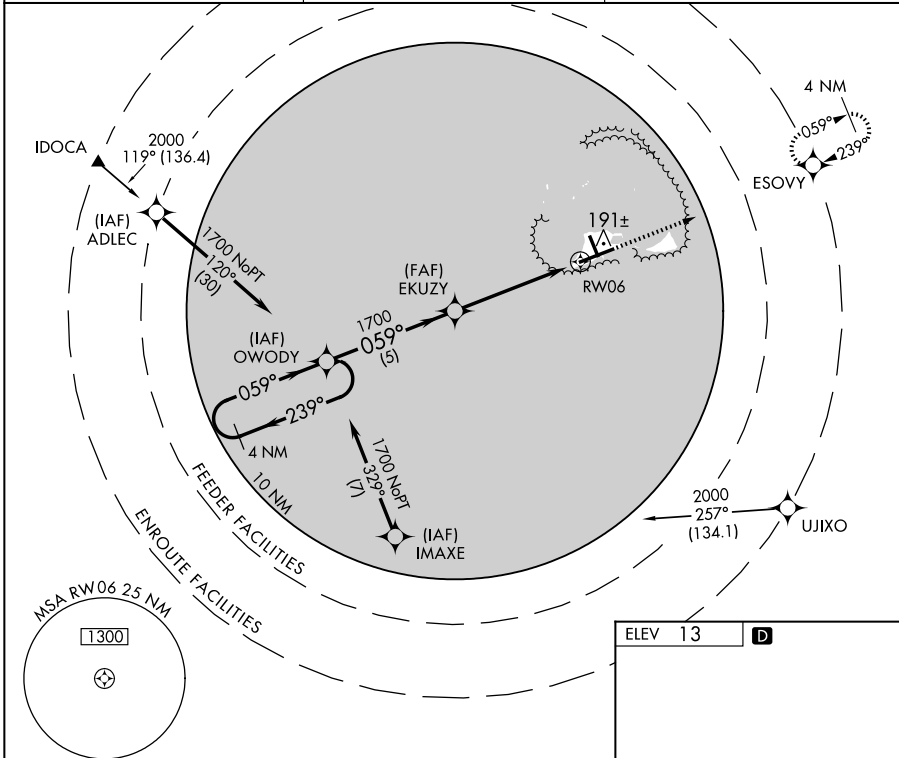

CATEGORY	A	B	C	D
INAV MDA	460-1	447 (500-1)	460-1¼ 447 (500-1¼)	460-1½ 447 (500-1½)
CIRCLING	520-1	507 (600-1)	520-1½ 507 (600-1½)	580-2 567 (600-2)

MIDWAY ATOLL, MQ  
Orig-B 09351

MIDWAY ATOLL / HENDERSON FIELD (MDY) (PMDY)  
28°12'N - 177°23'W

# RNAV (GPS) RWY 6

MIDWAY ATOLL, MQ

AI-2154 (FAA)

# RNAV (GPS) RWY 24

MIDWAY ATOLL / HENDERSON FIELD (MDY) (PMDY)

APP CRS <b>239°</b>	Rwy Idg <b>7400</b>
	TDZE <b>7</b>
	Apt Elev <b>13</b>

**⚠** DME/DME RNP-0.3 NA.  
No controlled airspace below 5500.  
When local altimeter setting not received procedure NA.

MISSED APPROACH: Climb to 1700  
direct OWODY WP and hold.

AWOS-3  
**118.325**

MIDWAY RADIO  
**126.2 257.8**

CTAF  
**122.9**

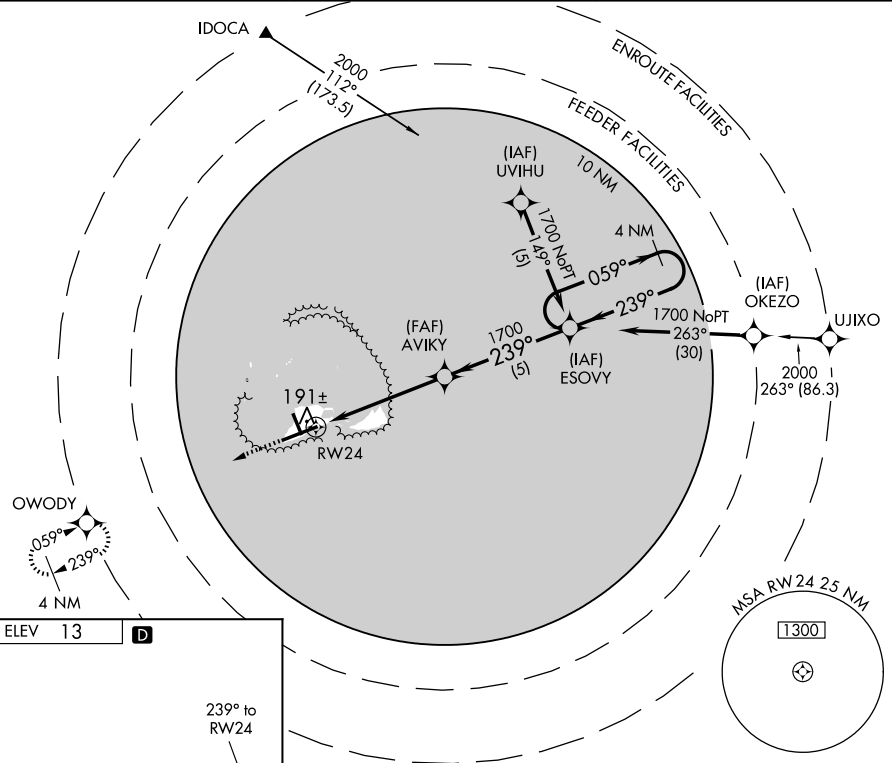

ELEV 13 **D**

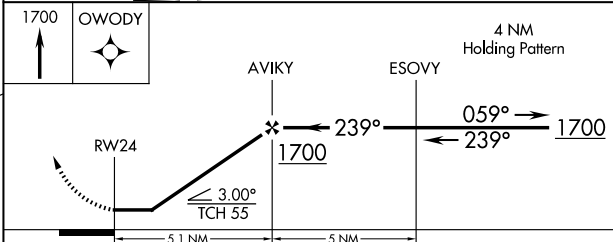
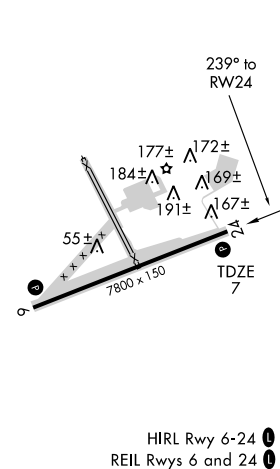

CATEGORY	A	B	C	D
LNAV MDA	460-1	453 (500-1)	460-1½ 453 (500-1½)	460-1½ 453 (500-1½)
CIRCLING	520-1	507 (600-1)	520-1½ 507 (600-1½)	580-2 567 (600-2)

MIDWAY ATOLL, MQ  
Orig-B 09351

MIDWAY ATOLL / HENDERSON FIELD (MDY) (PMDY)  
28°12'N - 177°23'W **RNAV (GPS) RWY 24**

MIDWAY ATOLL, MQ

AL-2154 (FAA)

NDB MDY <b>400</b>	APP CRS <b>055°</b>	Rwy Idg 7800
		TDZE 13
		Apt Elev 13

# NDB RWY 6

MIDWAY ATOLL / HENDERSON FIELD (MDY) (PMDY)

**⚠** No controlled airspace below 5500 feet.  
When local altimeter not received, procedure NA.

MISSED APPROACH: Climb to 2000, then left turn direct MDY NDB and hold.

AWOS-3 <b>118.325</b>	MIDWAY RADIO <b>126.20 257.8</b>	CTAF <b>122.9</b>
--------------------------	-------------------------------------	----------------------

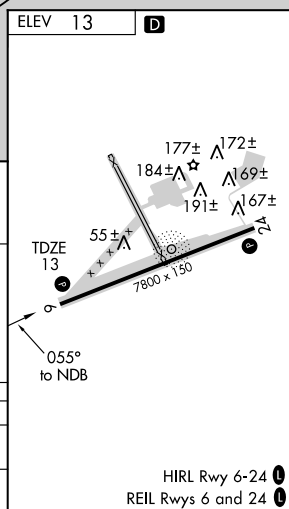
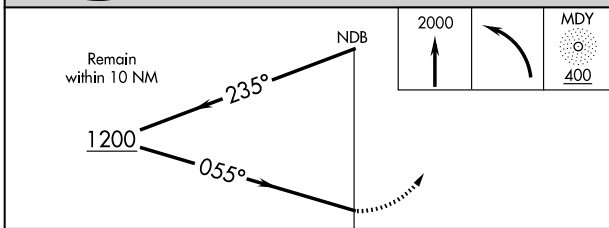
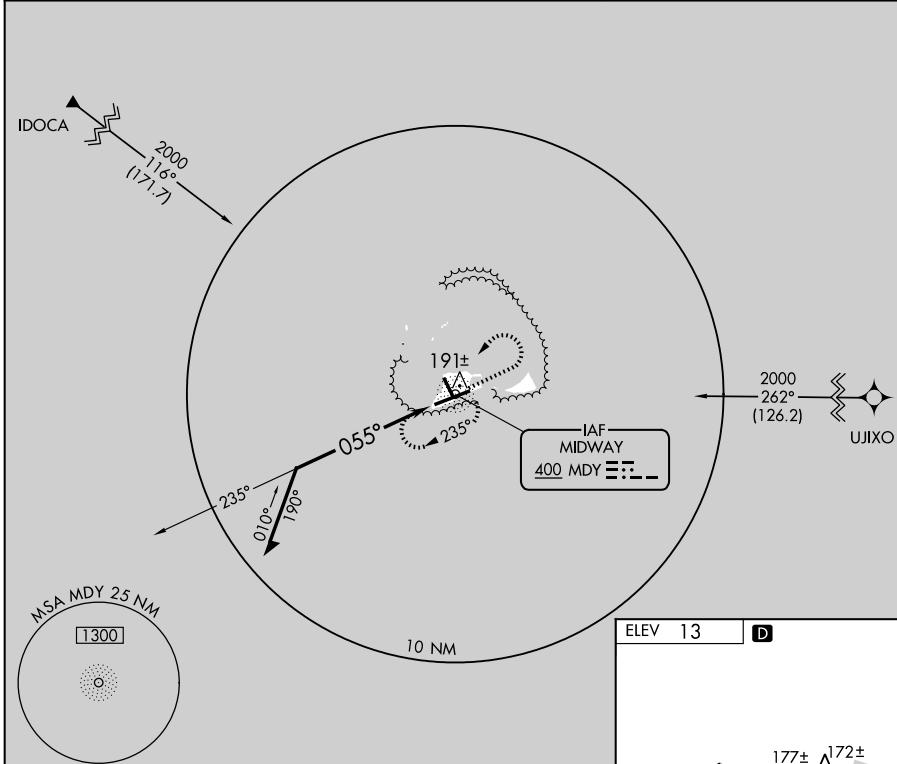

CATEGORY	A	B	C	D
S-6	560-1 547 (600-1)		560-1½ 547 (600-1½)	560-1¾ 547 (600-1¾)
CIRCLING	560-1 547 (600-1)		560-1½ 547 (600-1½)	580-2 567 (600-2)

MIDWAY ATOLL, MQ  
Orig-A 09351

MIDWAY ATOLL / HENDERSON FIELD (MDY) (PMDY)  
28°12'N - 177°23'W

# NDB RWY 6

MIDWAY ATOLL, MQ

AL-2154 (FAA)

NDB MDY <b>400</b>	APP CRS <b>243°</b>	Rwy Idg TDZE Apt Elev	<b>7400</b> <b>7</b> <b>13</b>
-----------------------	------------------------	-----------------------------	--------------------------------------

# NDB RWY 24

MIDWAY ATOLL / HENDERSON FIELD (MDY) (PMDY)

**⚠** No controlled airspace below 5500 feet.  
When local altimeter not received, procedure NA.

MISSED APPROACH: Climb to 2000, then left turn direct MDY NDB and hold.

AWOS-3 <b>118.325</b>	MIDWAY RADIO <b>126.2 257.8</b>	CTAF <b>122.9</b>
--------------------------	------------------------------------	----------------------

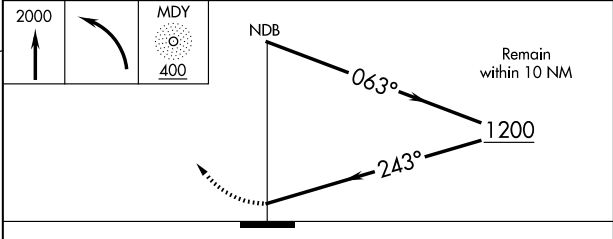
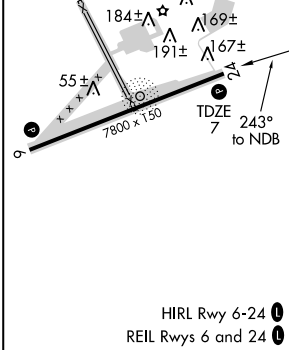
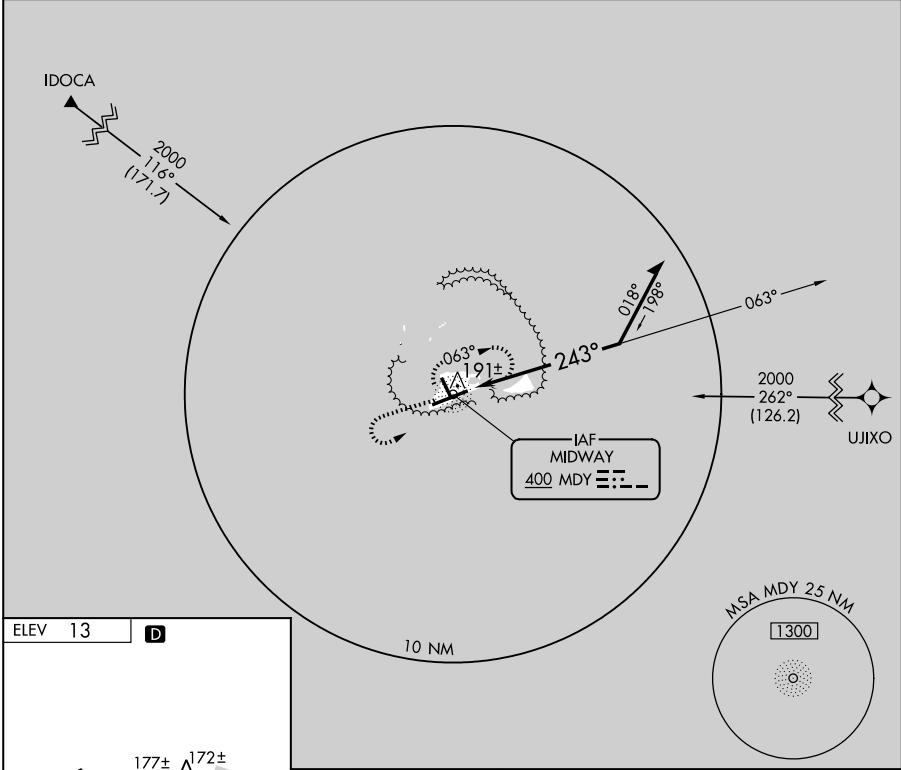

CATEGORY	A	B	C	D
5-24	560-1	553 (600-1)	560-1½ 553 (600-1½)	560-1¾ 553 (600-1¾)
CIRCLING	560-1	547 (600-1)	560-1½ 547 (600-1½)	580-2 567 (600-2)

MIDWAY ATOLL, MQ  
Orig-A 09351

MIDWAY ATOLL / HENDERSON FIELD (MDY) (PMDY)  
28°12'N - 177°23'W

# NDB RWY 24

POHNPEI ISLAND, FM

AL-6167 (FAA)

APP CRS	Rwy Idg	<b>6001</b>
<b>098°</b>	TDZE	<b>8</b>
	Apt Elev	<b>8</b>

# RNAV (GPS) RWY 9

POHNPEI INTL (PNI)(PTPN)

⚠ Circling not authorized south of Runway 9-27. DME/DME RNP-0.3 NA. Obtain local altimeter setting on CTAF; when not received, procedure not authorized except for operators with approved weather reporting service. Procedure not authorized at night except by prior arrangement for runway lights. No controlled airspace below 5500 feet.

⚠ MISSED APPROACH: Climbing left turn to 2000 direct OHAFU WP and hold.

POHNPEI RADIO  
**123.6 (CTAF)**

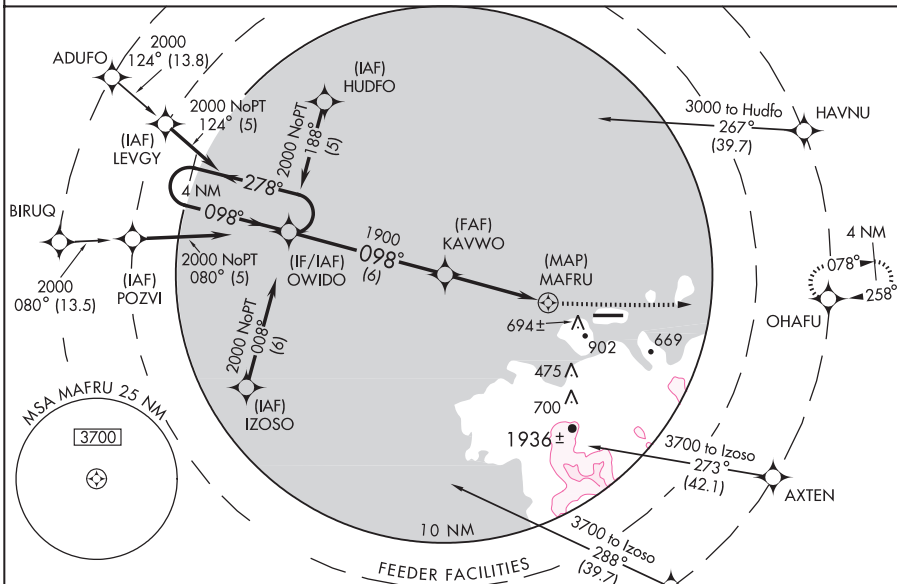

ELEV **8**

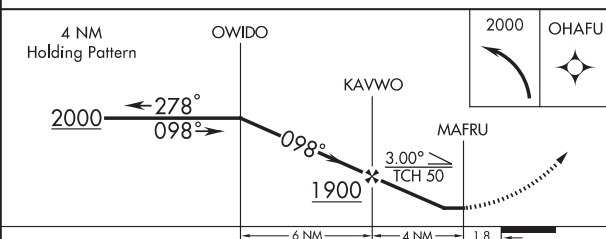
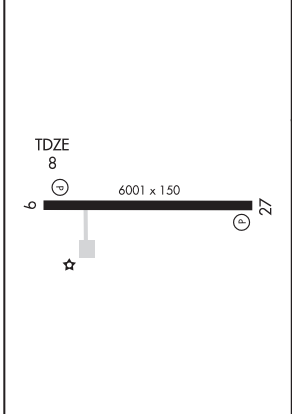

CATEGORY	A	B	C	D
LNAV MDA	920-2¼ 912 (1000-2¼)	920-2¾ 912 (1000-2¾)	920-3 912 (1000-3)	920-3 912 (1000-3)
CIRCLING	920-2¼ 912 (1000-2¼)	920-2¾ 912 (1000-2¾)	920-3 912 (1000-3)	920-3 912 (1000-3)

MIRL Rwy 9-27  
REIL Rws 9 and 27

POHNPEI ISLAND, FM  
Orig-A 08269

06°59'N-158°13'E

# POHNPEI INTL (PNI)(PTPN) RNAV (GPS) RWY 9



POHNPEI ISLAND, FM

AL-6167 (FAA)

APP CRS	Rwy Idg	<b>6001</b>
<b>258°</b>	TDZE	<b>8</b>
	Apt Elev	<b>8</b>

# RNAV (GPS) RWY 27

POHNPEI INTL (PNI)(PTPN)

◻ Circling not authorized south of Runway 9-27. DME/DME RNP-0.3 NA.  
 ▼ Obtain local altimeter setting on CTAF; when not received procedure not authorized except for operators with approved weather reporting service.  
 ▲ Procedure not authorized at night except by prior arrangement for runway lights.  
 No controlled airspace below 5500 feet.

MISSED APPROACH: Climbing right turn to 2000 direct ODOBO WP and hold.

POHNPEI RADIO  
**123.6 (CTAF)**

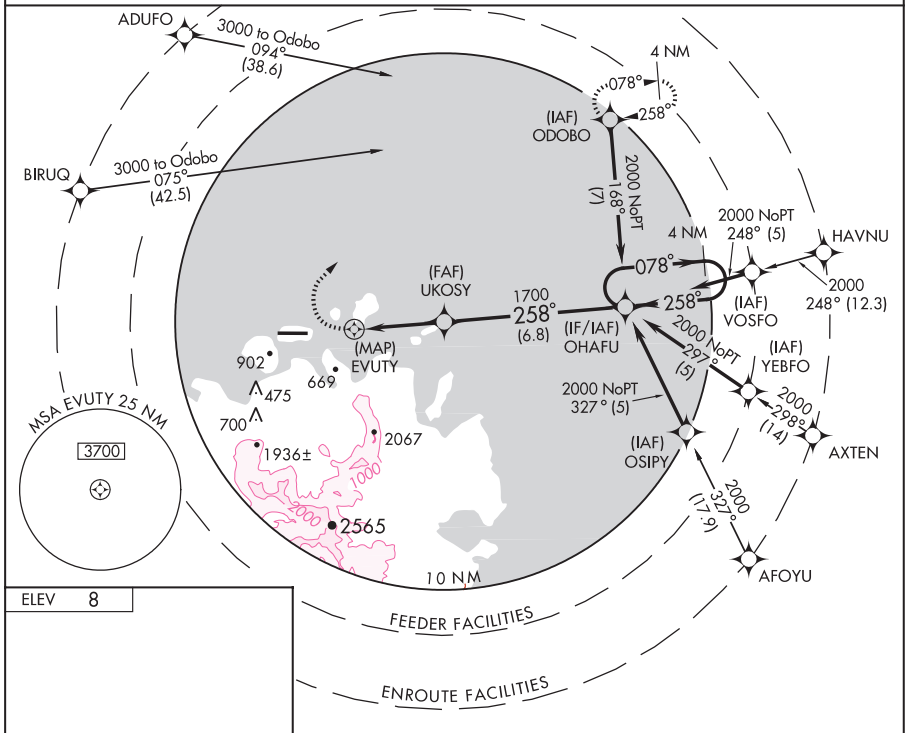

ELEV	<b>8</b>
------	----------

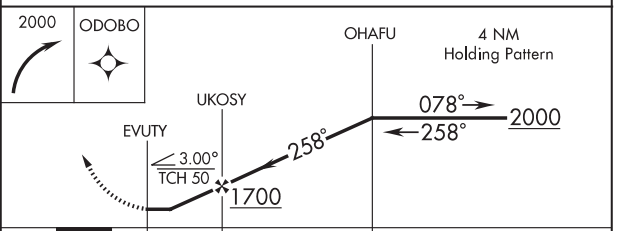
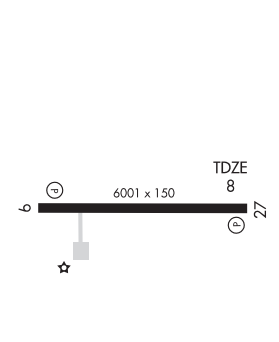

CATEGORY	A	B	C	D
LNAV MDA	580-2¼ 572 (600-2¼)			
CIRCLING	580-2¼ 572 (600-2¼)		660-2¼ 652 (700-2¼)	

MIRL Rwy 9-27   
 REIL Rwy 9 and 27  
 POHNPEI ISLAND, FM  
 Orig-A 08269

06° 59'N-158° 13'E

# POHNPEI INTL (PNI)(PTPN) RNAV (GPS) RWY 27

POHNPEI ISLAND, FM

AL-6167 (FAA)

NDB/DME PNI <b>366</b>	APP CRS <b>248°</b>	Rwy Idg TDZE Apt Elev	<b>N/A</b> <b>N/A</b> <b>8</b>
Chan <b>47 (111)</b>			

**NDB/DME or GPS-A**  
POHNPEI INTL (PNI)(PTPN)

⚠ Circling not authorized south of Rwy 9-27. Obtain local altimeter setting on CTAF; when not received, procedure not authorized except for operators with approved weather reporting service.  
⚠ Procedure not authorized at night except by prior arrangement for runway lights. No controlled airspace below 5500 feet.

MISSED APPROACH: Immediate climbing right turn to 2000 via heading 340° then climbing right turn to 3600 direct PNI NDB/DME and hold.

POHNPEI RADIO  
**123.6 (CTAF)**

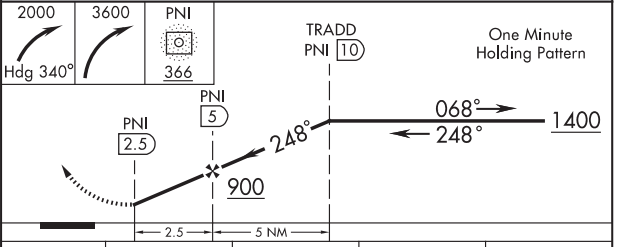
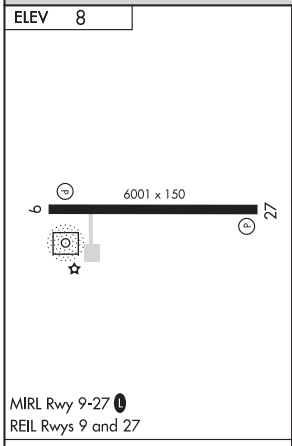
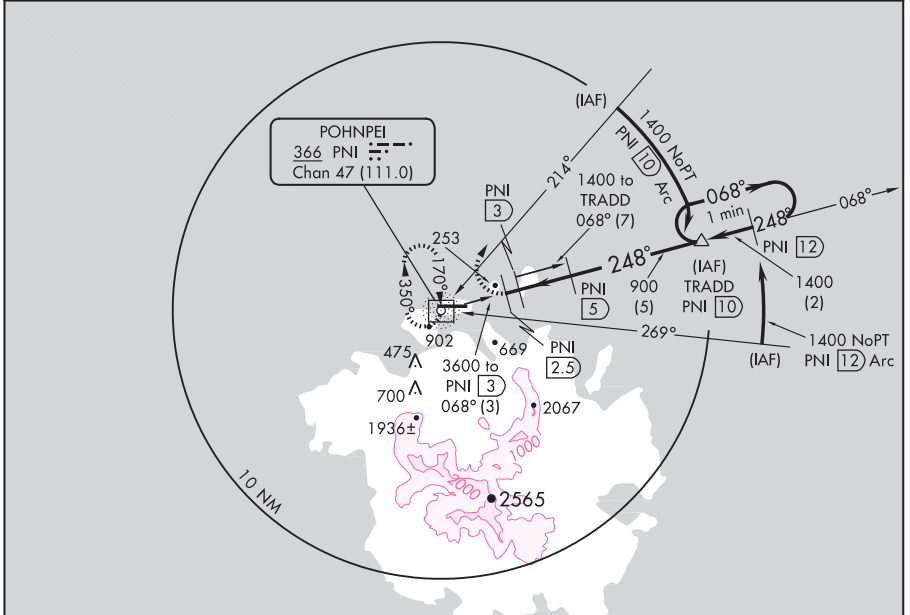

Knots	60	90	120	150	180
Min:Sec					

CATEGORY	A	B	C	D
CIRCLING	700-1¾	692 (700-1¾)	700-2 692 (700-2)	700-2¼ 692 (700-2¼)

POHNPEI ISLAND, FM  
Amdt 1B 08269

06° 59' N - 158° 13' E

POHNPEI INTL (PNI)(PTPN)  
**NDB/DME or GPS-A**

POHNPEI ISLAND, FM

AL-6167 (FAA)

NDB/DME PNI <b>366</b>	APP CRS <b>114°</b>	Rwy Idg <b>6001</b>
Chan <b>47 (111)</b>		TDZE <b>8</b>
		Apt Elev <b>8</b>

## NDB/DME RWY 9

POHNPEI INTL (PNI)(PTPN)

**⚠** Circling not authorized south of Rwy 9-27. Procedure not authorized at night except by prior arrangement for runway lights. Obtain local altimeter setting on CTAF; when not received procedure not authorized except for operators with approved weather reporting service. Fly visual from MAP to airport 112° 2.9 NM. No controlled airspace below 5500 feet.

**MISSED APPROACH:** Immediate climbing left turn to 1200 via heading 020°, then climbing left turn to 3600 direct PNI NDB/DME and hold.

POHNPEI RADIO  
**123.6 (CTAF) 0**

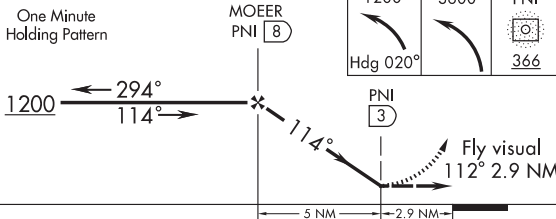
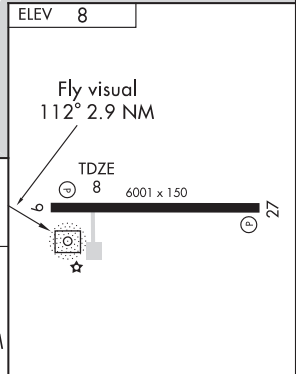
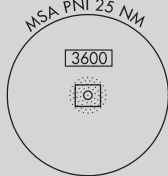
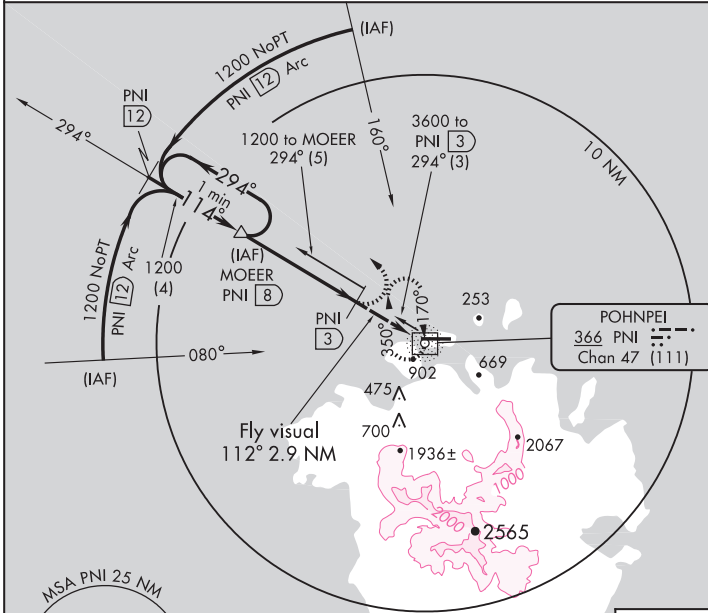

CATEGORY	A	B	C	D
S-9	560-3 552 (600-3)		700-3 692 (700-3)	
CIRCLING	560-3 552 (600-3)		700-3 692 (700-3)	

MIRL Rwy 9-27 0  
REIL Rwys 9 and 27

Knots	60	90	120	150	180
Min:Sec					

POHNPEI ISLAND, FM  
Amdt 4A 08269

06° 59'N - 158° 13'E

## POHNPEI INTL (PNI)(PTPN) NDB/DME RWY 9

POHNPEI ISLAND, FM

AL-6167 (FAA)

NDB/DME PNI <b>366</b>	APP CRS <b>100°</b>	Rwy Idg TDZE Apt Elev	<b>N/A</b> <b>N/A</b> <b>8</b>
Chan <b>47 (111)</b>			

**NDB or GPS-B**  
POHNPEI INTL (PNI)(PTPN)

⚠ Circling not authorized south of Rwy 9-27. Proceed outbound 5 NM on 280° bearing at 3600 before descending to procedure turn altitude. Descend to MDA immediately after completion of procedure turn. Obtain local altimeter setting on CTAF; when not received procedure not authorized except for operators with approved weather reporting service. Procedure not authorized at night except by prior arrangement for lights. No controlled airspace below 5500 feet. Fly visual to airport.

⚠ MISSED APPROACH: If not visual at MDA, climbing left turn to 2000 on 020° heading, then climbing left turn to 3600 direct PNI NDB/DME and hold.

POHNPEI RADIO  
**123.6 (CTAF)**

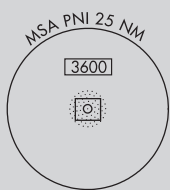
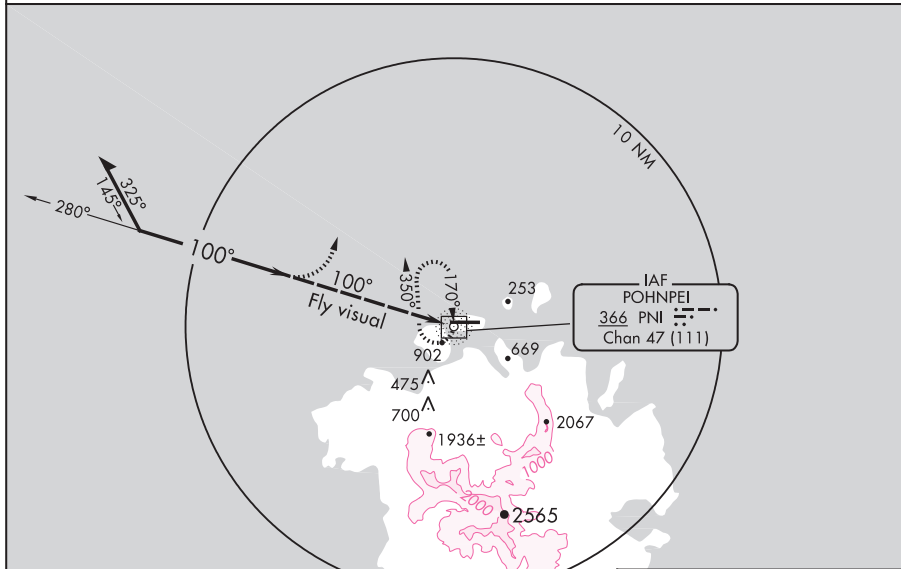

ELEV 8

MIRL Rwy 9-27  
REIL Rwys 9 and 27

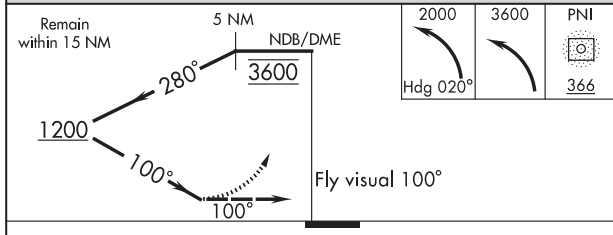

CATEGORY	A	B	C	D	Knots	60	90	120	150	180
CIRCLING		560-2	552 (600-2)	700-2¼ 692 (700-2¼)	Min:Sec					

POHNPEI ISLAND, FM  
Amdt 3A 08269

06° 59'N - 158° 13'E

POHNPEI INTL (PNI)(PTPN)  
**NDB or GPS-B**

POHNPEI ISLAND, FM

AL-6167 (FAA)

NDB/DME PNI <b>366</b>	APP CRS <b>257°</b>	Rwy Idg TDZE Apt Elev	<b>N/A</b> <b>N/A</b> <b>8</b>
Chan <b>47 (111)</b>			

**NDB or GPS-C**  
POHNPEI INTL (PNI)(PTPN)

◻ Circling not authorized south of Rwy 9-27. Proceed outbound 5 NM on 077° bearing at 3600 before descending to procedure turn altitude.  
 ▼ Descend to MDA immediately after completion of procedure turn.  
 ▲ Procedure not authorized at night except by prior arrangement for lights.  
 Obtain local altimeter setting on CTAF; when not received procedure not authorized except for operators with approved weather reporting service.  
 No controlled airspace below 5500 feet. Fly visual to airport.

MISSED APPROACH: If not visual at MDA, climbing right turn to 2000 on 020° heading, then climbing right turn to 3600 direct PNI NDB/DME and hold.

POHNPEI RADIO  
**123.6 (CTAF)**

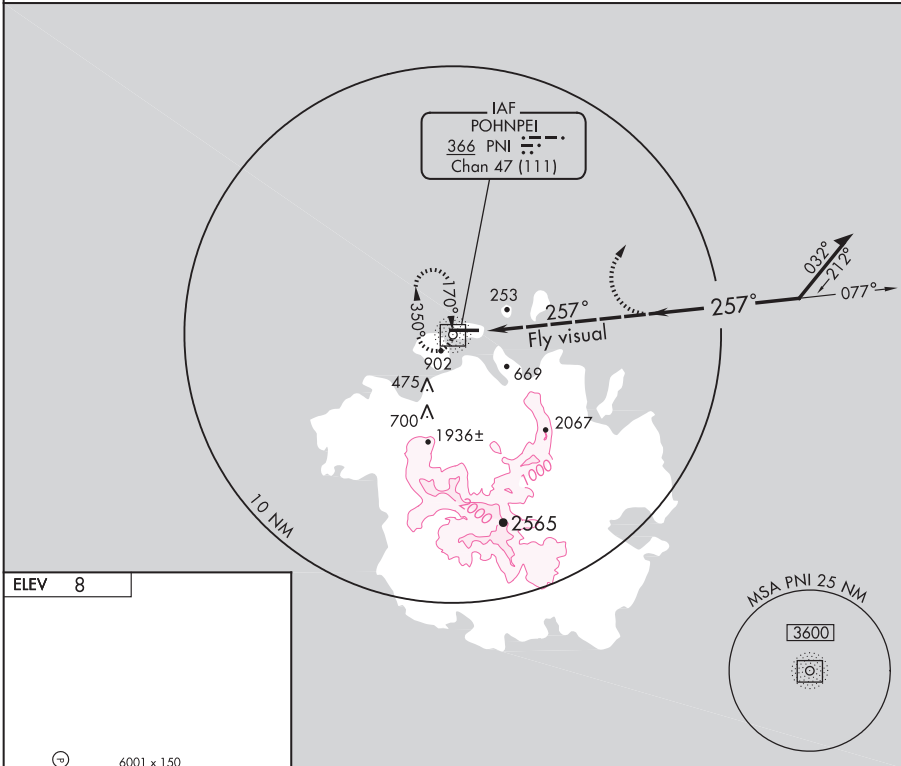

ELEV **8**

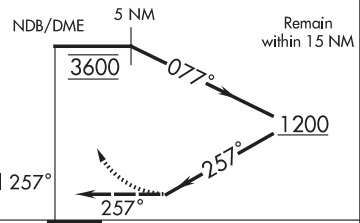
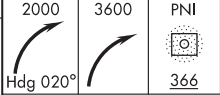
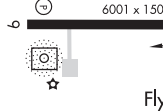

MIRL Rwy 9-27  
REIL Rwys 9 and 27

Knots	60	90	120	150	180
Min:Sec					

CATEGORY	A	B	C	D
CIRCLING	560-2 552 (600-2)			700-2¼ 692 (700-2¼)

POHNPEI ISLAND, FM  
Amdt 3A 08269

06° 59' N - 158° 13' E

POHNPEI INTL (PNI)(PTPN)  
**NDB or GPS-C**

SAIPAN, CQ

AL-6293 (FAA)

LOC/DME I-GSN <b>109.9</b> Chan <b>36</b>	APP CRS <b>066°</b>	Rwy Idg <b>8700</b> TDZE <b>215</b> Apt Elev <b>215</b>
---	------------------------	---

# ILS or LOC/DME RWY 7

FRANCISCO C. ADA/SAIPAN INTL (GSN)(PGSN)

Cat. C, D circling not authorized north of Rwy 7-25.  
 Cat. D S-LOC visibility increased 1/4 mile for inoperative MM or MALSR.
 

 MALSR
 

 MISSED APPROACH: Climb to 1600 heading 070° then climbing right turn to 2600 direct SN NDB and hold.

ATIS <b>127.2</b>	GUAM APP CON <b>118.4 290.5</b>	SAIPAN TOWER <b>125.7 256.9</b>	GND CON <b>121.8</b>
----------------------	------------------------------------	------------------------------------	-------------------------

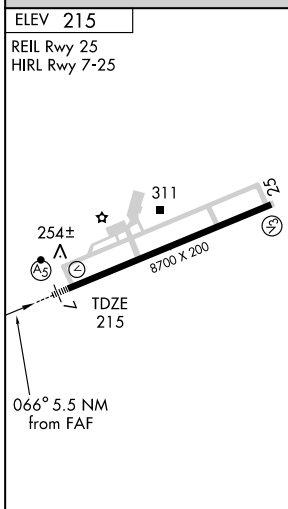
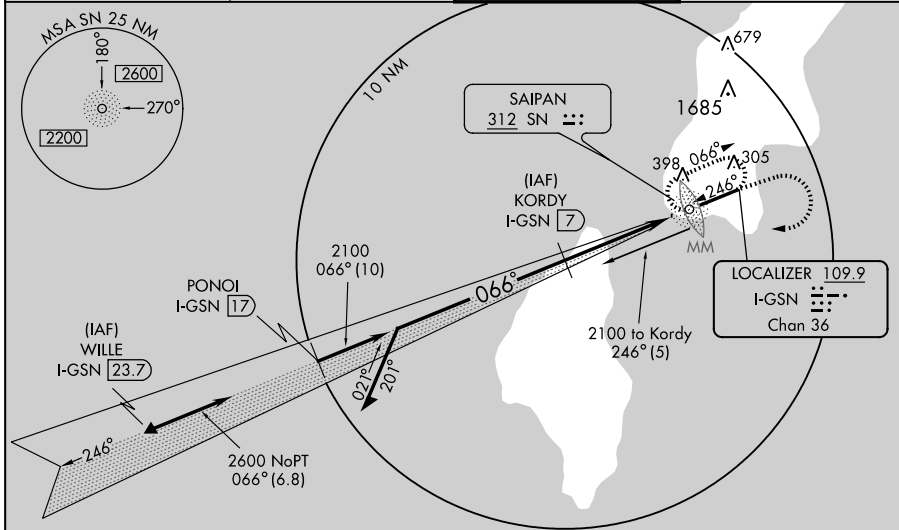

**DME REQUIRED**

HIRCH UNZ **100**

2600 to NDB (19.7)  
346°

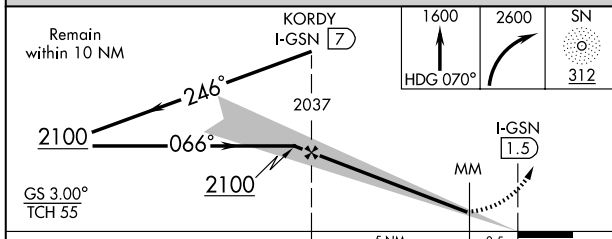

CATEGORY	A	B	C	D
S-ILS 7	415-1/2 200 (200-1/2)			
S-LOC 7	480-1/2 265 (300-1/2)			480-3/4 265 (300-3/4)
CIRCLING	720-1	505 (600-1)	720-1-1/2 505 (600-1-1/2)	780-2 565 (600-2)

SAIPAN, CQ  
Amdt 5A 09071

FRANCISCO C. ADA/SAIPAN INTL (GSN)(PGSN)  
15°07'N-145°44'E **ILS or LOC/DME RWY 7**

SAIPAN, CQ

AL-6293 (FAA)

# GPS RWY 7

FRANCISCO C. ADA/SAIPAN INTL (GSN)(PGSN)

APP CRS <b>066°</b>	Rwy Idg <b>8700</b>
	TDZE <b>215</b>
	Apt Elev <b>215</b>

	<b>IAF</b> ARM Approach mode prior to IAF. Cat. C, D circling not authorized north of Rwy 7-25. Inoperative table does not apply to Cat. D.		MISSED APPROACH: Climb to 2600 direct AGODY WP and hold.

ATIS <b>127.2</b>	GUAM APP CON <b>118.4 290.5</b>	SAIPAN TOWER <b>125.7 256.9</b>	GND CON <b>121.8</b>
----------------------	------------------------------------	------------------------------------	-------------------------

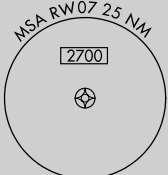
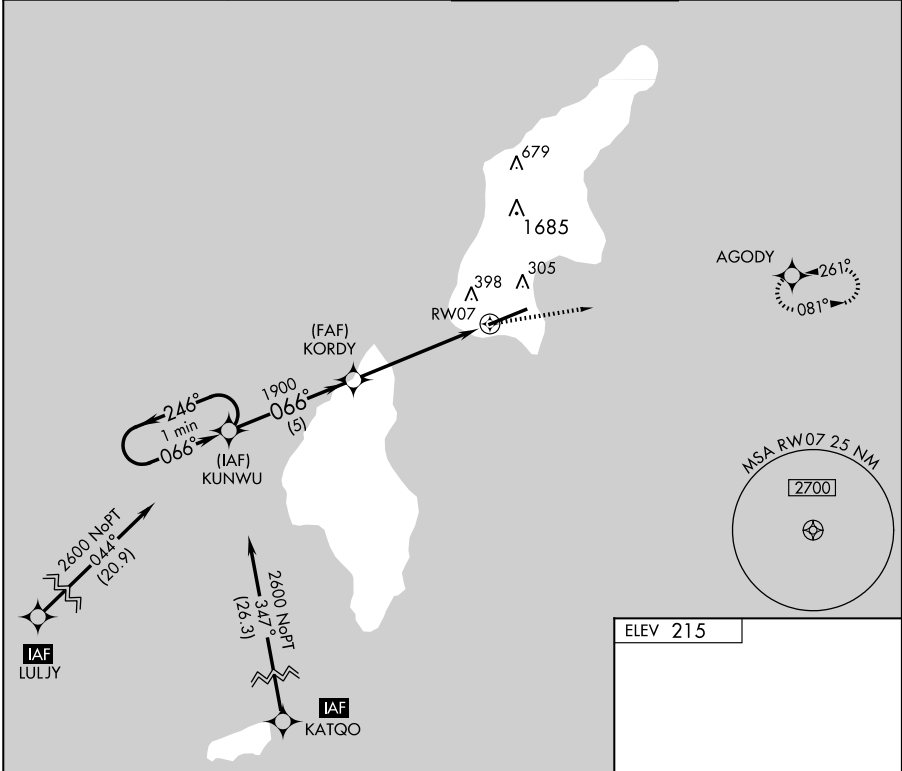

ELEV 215

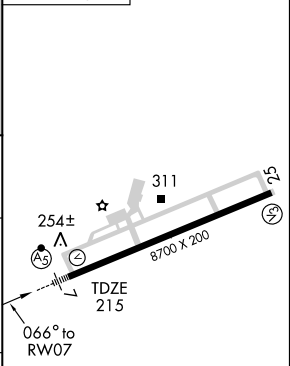
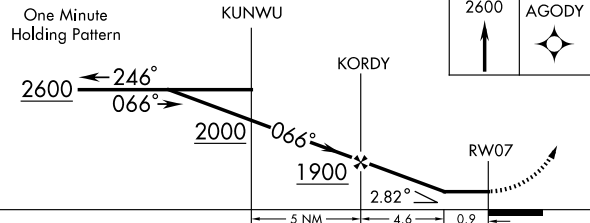

CATEGORY	A	B	C	D
S-7	520-1/2	305 (400-1/2)		520-1 305 (400-1)
CIRCLING	720-1	505 (600-1)	720-1 1/2 505 (600-1 1/2)	780-2 565 (600-2)

REIL Rwy 25  
HIRL Rwy 7-25

SAIPAN, CQ  
Orig-B 09071

FRANCISCO C. ADA/SAIPAN INTL (GSN)(PGSN)  
15°07'N-145°44'E

# GPS RWY 7

SAIPAN, CQ

AL-6293 (FAA)

# GPS RWY 25

FRANCISCO C. ADA/SAIPAN INTL (GSN)(PGSN)

APP CRS	Rwy Idg	<b>8700</b>
<b>261°</b>	TDZE	<b>210</b>
	Apt Elev	<b>215</b>

Cat. C, D circling not authorized north of Rwy 7-25.		MISSED APPROACH: Climb to 2600 direct KUNWU WP and hold.	
ATIS	GUAM APP CON	SAIPAN TOWER	GND CON
<b>127.2</b>	<b>118.4 290.5</b>	<b>125.7 256.9</b>	<b>121.8</b>

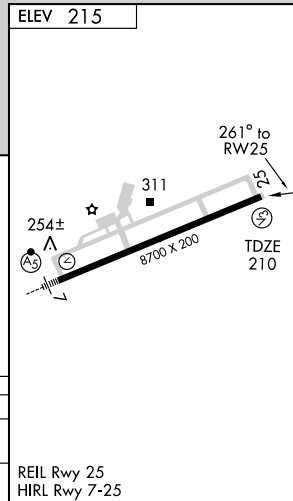
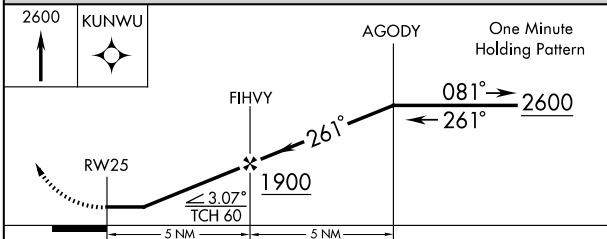
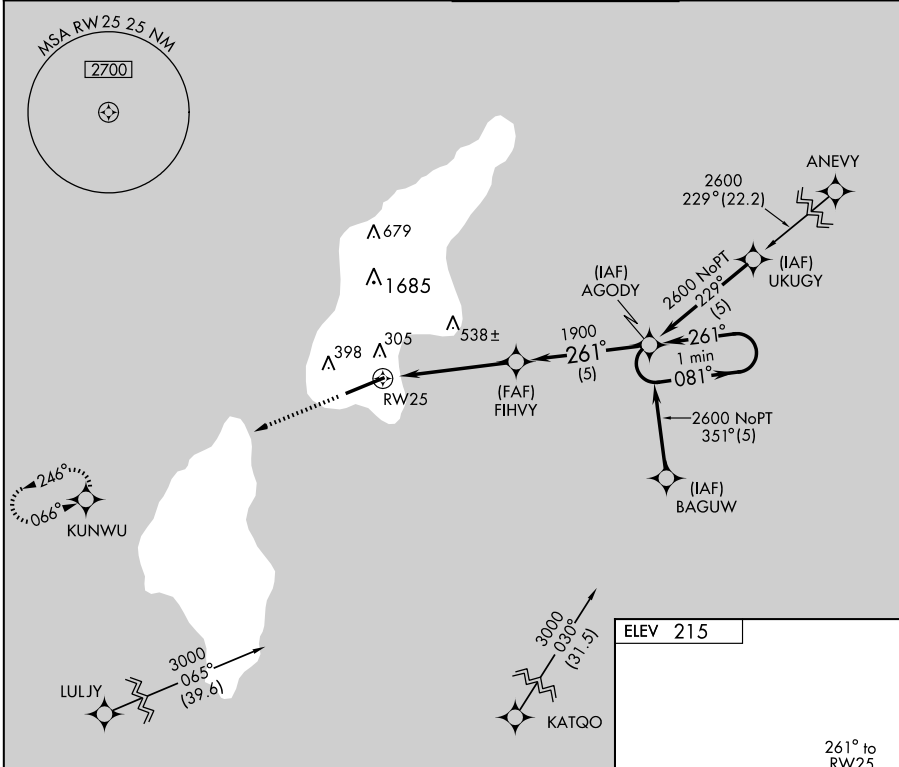

CATEGORY	A	B	C	D
S-25	580-1 370 (400-1)			580-1¼ 370 (400-1¼)
CIRCLING	720-1 505 (600-1)		720-1½ 505 (600-1½)	780-2 565 (600-2)

REIL Rwy 25  
HIRL Rwy 7-25

SAIPAN, CQ  
Amdt 1B 09071

FRANCISCO C. ADA/SAIPAN INTL (GSN)(PGSN)  
15°07'N-145°44'E

# GPS RWY 25



SAIPAN, CQ

AL-6293 (FAA)

NDB SN <b>312</b>	APP CRS <b>066°</b>	Rwy Idg TDZE Apt Elev	<b>8700</b> <b>215</b> <b>215</b>
----------------------	------------------------	-----------------------------	---

# NDB/DME RWY 7

FRANCISCO C. ADA/SAIPAN INTL (GSN)(PGSN)

**▼** Cat. C S-7 visibility increased ¼ mile for inoperative MALSR. Cat. C, D circling not authorized north of Rwy 7-25.

**MALSR** 

**MISSED APPROACH:** Climb to 1600 via 070° bearing from SN NDB then climbing right turn to 2600 direct SN NDB then 246° bearing from SN NDB to Shaka 5 DME and hold.

ATIS <b>127.2</b>	GUAM APP CON <b>118.4 290.5</b>	SAIPAN TOWER <b>125.7 256.9</b>	GND CON <b>121.8</b>
----------------------	------------------------------------	------------------------------------	-------------------------

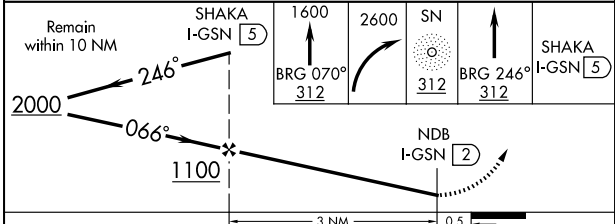
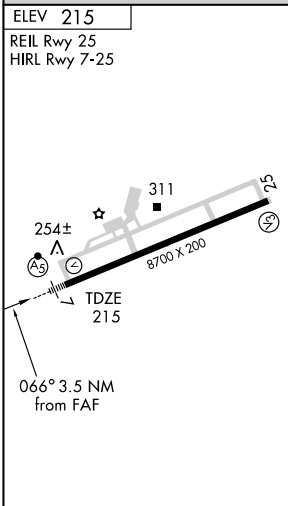
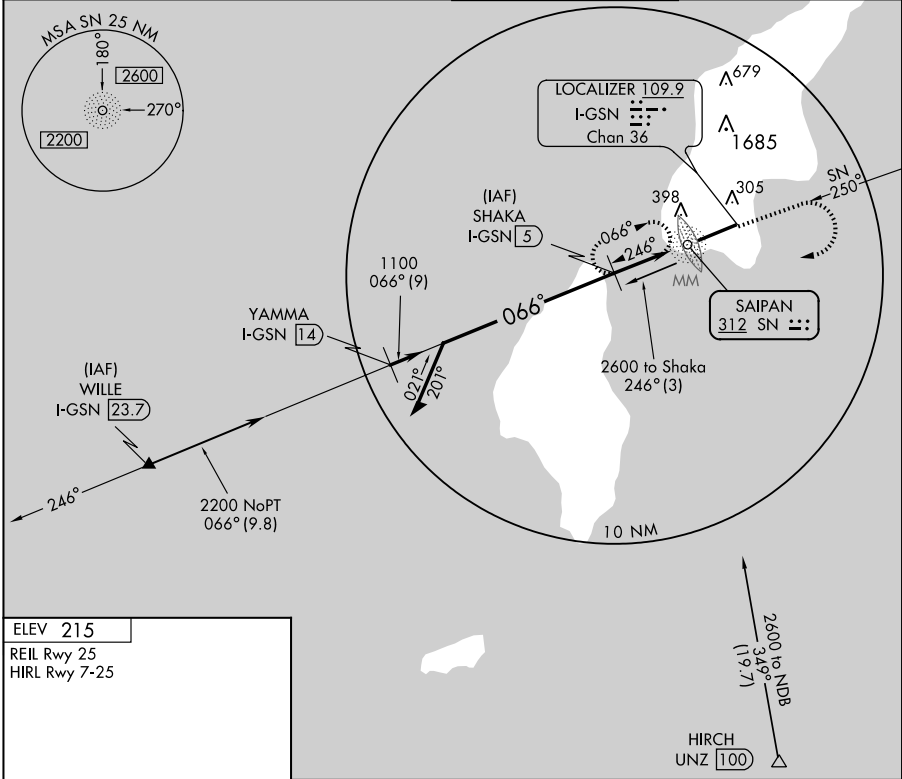

CATEGORY	A	B	C	D
S-7	560-¾	345 (400-¾)		560-1 345 (400-1)
CIRCLING	720-1	505 (600-1)	720-1½ 505 (600-½)	780-2 565 (600-2)

SAIPAN, CQ  
Amdt 3A 09071

FRANCISCO C. ADA/SAIPAN INTL (GSN)(PGSN)  
15°07'N-145°44'E  
**NDB/DME RWY 7**

SAIPAN, CQ

AL-6293 (FAA)

NDB SN <b>312</b>	APP CRS <b>246°</b>	Rwy Idg TDZE Apt Elev	<b>8700</b> <b>210</b> <b>215</b>
----------------------	------------------------	-----------------------------	---

# NDB/DME RWY 25

FRANCISCO C. ADA/SAIPAN INTL (GSN)(PGSN)

<p><b>▼</b> Cat. C, D circling not authorized north of Rwy 7-25. ACTIVATE MALSR Rwy 7-123.6.</p>		<p>MISSED APPROACH: Climb runway heading to 1500 then climbing left turn to 2600 direct SN NDB and hold.</p>	
ATIS <b>127.2</b>	GUAM APP CON <b>118.4 290.5</b>	SAIPAN TOWER <b>125.7 256.9</b>	GND CON <b>121.8</b>

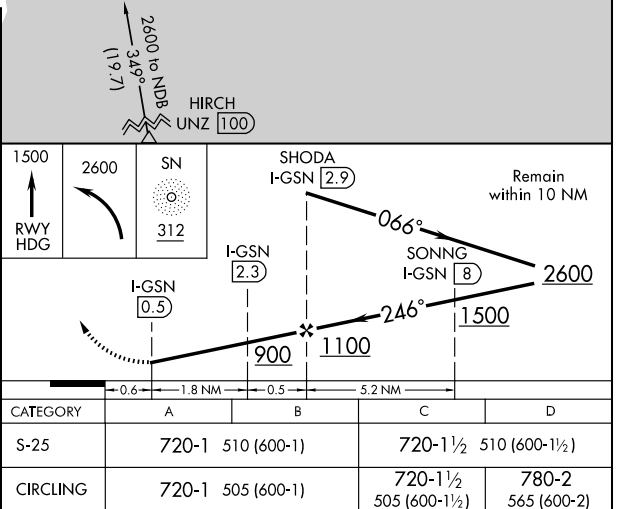
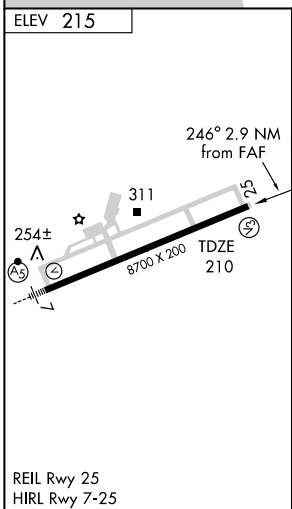
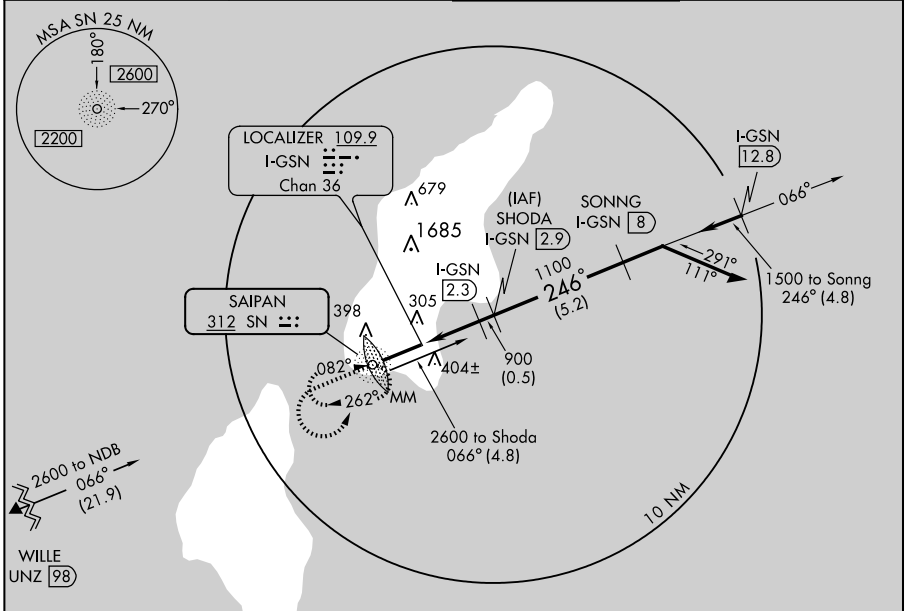

SAIPAN, CQ  
Amdt 2A 09071

FRANCISCO C. ADA/SAIPAN INTL (GSN)(PGSN)  
15°07'N-145°44'E

# NDB/DME RWY 25

SAIPAN, CQ

AL-6293 (FAA)

# NDB RWY 7

FRANCISCO C. ADA/SAIPAN INTL (GSN)(PGSN)

NDB SN <b>312</b>	APP CRS <b>082°</b>	Rwy Idg <b>8700</b>
		TDZE <b>215</b>
		Apt Elev <b>215</b>

▼ Cat. C, D circling not authorized north of Rwy 7-25.  
Inoperative table does not apply.  
ACTIVATE MALS Rwy 7-123.6.



MISSED APPROACH: Climb to 1600 via 082° bearing from SN NDB then climbing right turn to 2600 direct SN NDB and hold.

ATIS <b>127.2</b>	GUAM APP CON <b>118.4 290.5</b>	SAIPAN TOWER <b>125.7 256.9</b>	GND CON <b>121.8</b>
----------------------	------------------------------------	------------------------------------	-------------------------

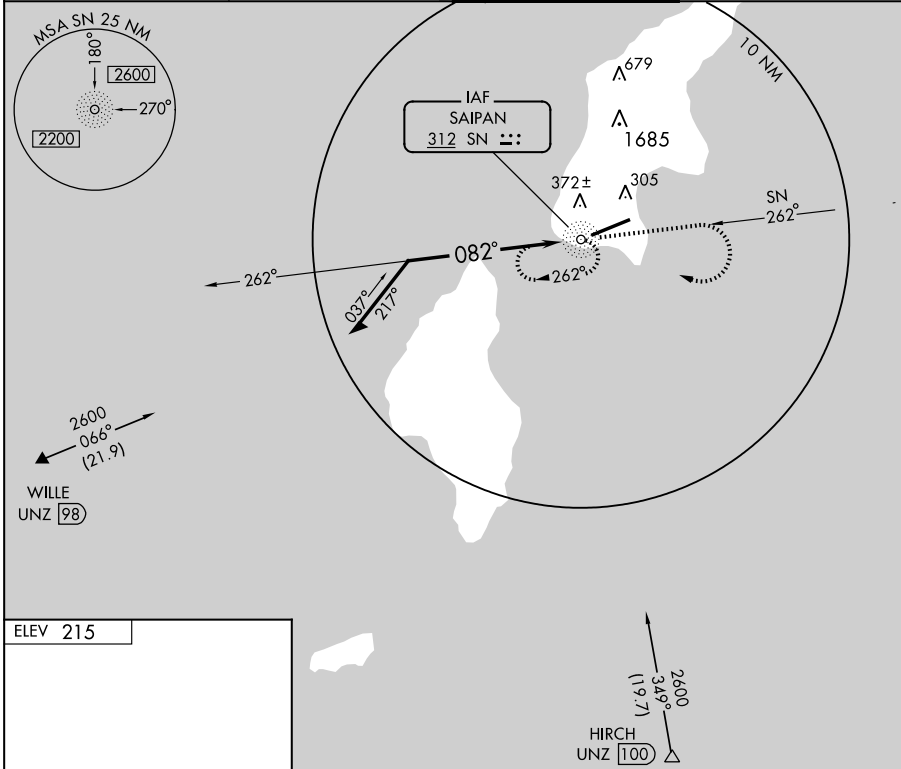

ELEV 215

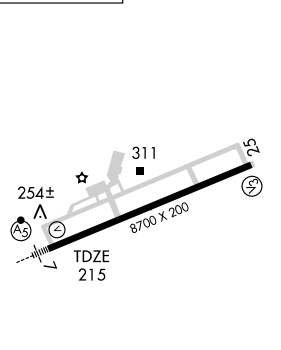

Remain within 10 NM

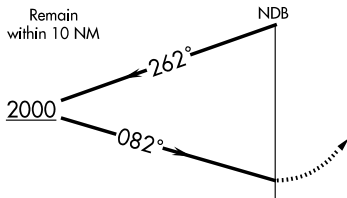

1600 ↑ BRG 082° 312	2600 ↷	SN ○ 312
------------------------------	-----------	----------------

CATEGORY	A	B	C	D
S-7	620-1	405 (500-1)	620-1¼	405 (500-1¼)
CIRCLING	720-1	505 (600-1)	720-1½ 505 (600-1½)	780-2 565 (600-2)

REIL Rwy 25  
HIRL Rwy 7-25

SAIPAN, CQ  
Amdt 4A 09071

FRANCISCO C. ADA/SAIPAN INTL (GSN)(PGSN)  
15°07'N-145°44'E  
**NDB RWY 7**

09295

# AIRPORT DIAGRAM

FRANCISCO C. ADA/SAIPAN INTL (GSN)(PGSN)  
AL-6293 (FAA) SAIPAN, CQ

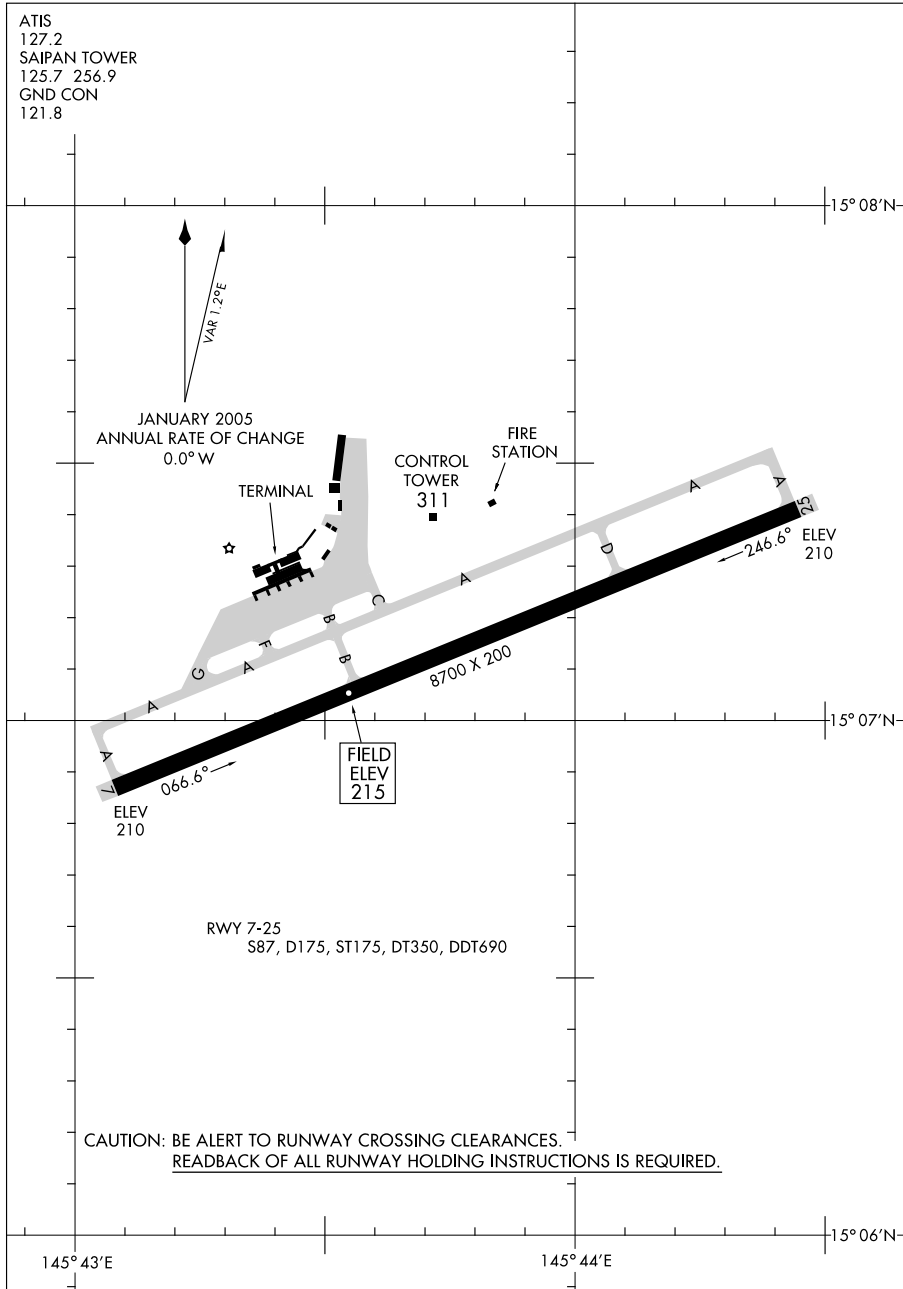

# AIRPORT DIAGRAM

FRANCISCO C. ADA/SAIPAN INTL (GSN)(PGSN)  
SAIPAN, CQ

09295

SAIPAN, CQ

AL-6596 (FAA)

**GPS RWY 9**  
ROTA INTL (GRO)(PGRO)

APP CRS <b>105°</b>	Rwy Idg <b>6000</b>
	TDZE <b>593</b>
	Apt Elev <b>607</b>

**⚠** Cat C, D circling not authorized south of Rwy 9-27.  
**⚠** When local altimeter setting not received, procedure not authorized.

MISSED APPROACH: Climb to 3000 via 090° course to TOXPA and hold.

GUAM CENTER  
**120.5 263.0**

CTAF  
**123.6**

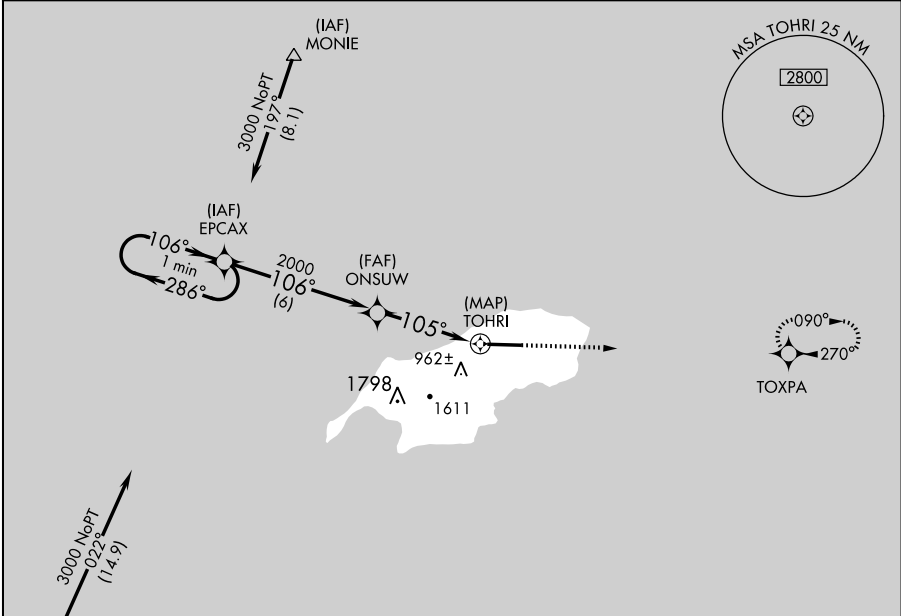

ELEV 607

One Minute Holding Pattern

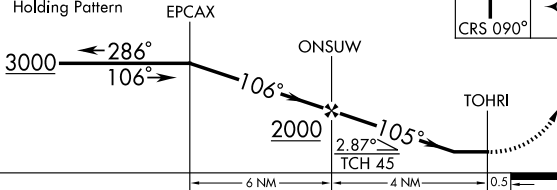

3000 TOXPA  
↑  
CRS 090°

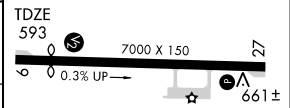

CATEGORY	A	B	C	D
S-9	940-1 347 (400-1)			940-1¼ 347 (400-1¼)
CIRCLING	1180-1 573 (600-1)	1220-1 613 (700-1)	1220-1¾ 613 (700-1¾)	1220-2 613 (700-2)

REIL Rwy 9 **⓪**  
MIRL Rwy 9-27 **⓪**

SAIPAN, CQ  
Orig-C 09295

14°10'N-145°14'E

ROTA INTL (GRO)(PGRO)  
**GPS RWY 9**

SAIPAN, CQ

AL-6596 (FAA)

APP CRS	Rwy Idg	<b>7000</b>
<b>270°</b>	TDZE	<b>607</b>
	Apt Elev	<b>607</b>

# GPS RWY 27

ROTA INTL (GRO)(PGRO)

**⚠** Cat C, D circling not authorized south of Rwy 9-27.  
**⚠** When local altimeter setting not received, procedure not authorized.

MISSED APPROACH: Climb to 3000 via 284° course to EPCAX WP and hold.

GUAM CENTER <b>120.5 263.0</b>	CTAF <b>123.6 0</b>
-----------------------------------	------------------------

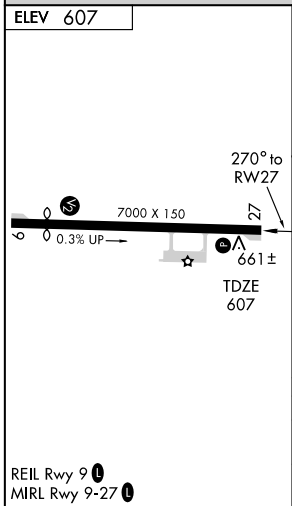
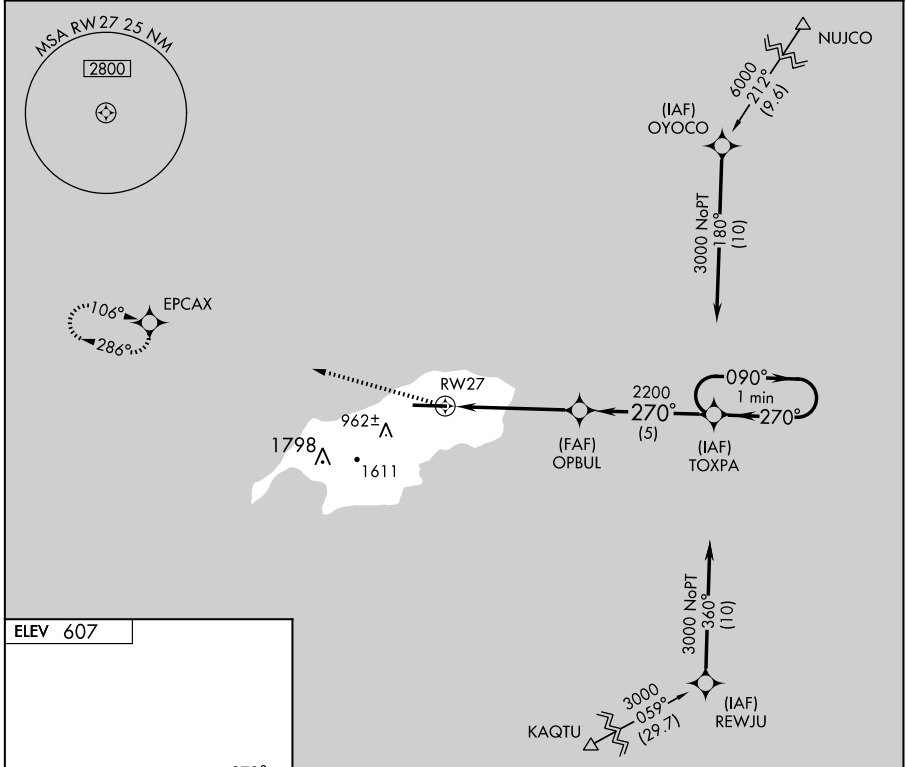

	OPBUL	TOXPA	One Minute Holding Pattern	
	RWY 27	2200	090° →	← 270°
	5 NM	5 NM	3000	3000
CATEGORY	A	B	C	D
S-27	920-1 313 (400-1)			
CIRCLING	1180-1 573 (600-1)	1220-1 613 (700-1)	1220-1½ 613 (700-1½)	1220-2 613 (700-2)

SAIPAN, CQ  
 Orig-C 09295

14°10'N-145°14'E

ROTA INTL (GRO)(PGRO)  
**GPS RWY 27**

SAIPAN, CQ

AL-6596 (FAA)

NDB GRO <b>332</b>	APP CRS <b>115°</b>	Rwy Idg <b>6000</b>
		TDZE <b>593</b>
		Apt Elev <b>607</b>

**NDB RWY 9**  
ROTA INTL (GRO)(PGRO)

▼ Procedure NA at night except by prior arrangement for runway lights.  
▲ Obtain local altimeter setting on 123.6; when not available, except for operators with approved weather reporting service, use Guam altimeter setting and increase all MDAs 225 feet.  
Cat C, D circling not authorized south of Rwy 9-27.

MISSED APPROACH: Climb to 2000 then climbing left turn to 3000 direct GRO NDB and hold.

GUAM CENTER  
**120.5 263.0**

CTAF  
**123.6**

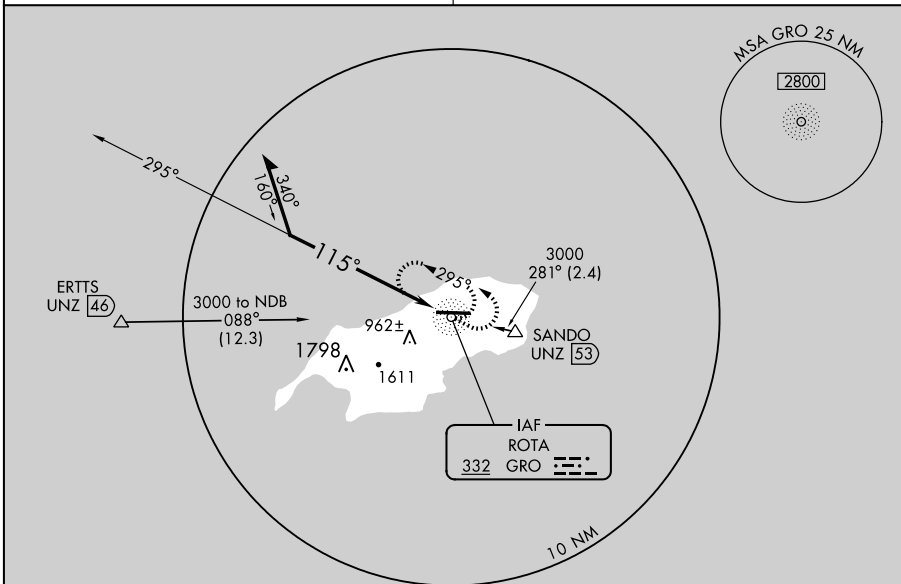

Remain within 10 NM

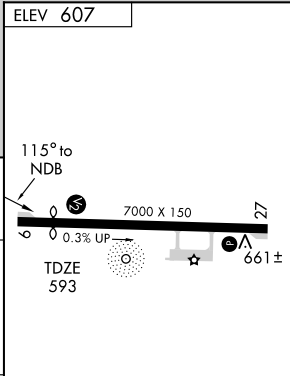
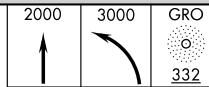
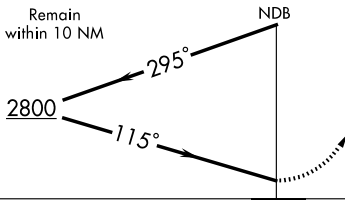

CATEGORY	A	B	C	D
S-9	1320-1	727 (800-1)	1320-2 727 (800-2)	1320-2¼ 727 (800-2¼)
CIRCLING	1320-1	713 (800-1)	1320-2 713 (800-2)	1320-2¼ 713 (800-2¼)

REIL Rwy 9  
MIRL Rwy 9-27

SAIPAN, CQ  
Amdt 3B 09295

14°10'N-145°14'E

ROTA INTL (GRO)(PGRO)  
**NDB RWY 9**

SAIPAN, CQ

AL-6596 (FAA)

NDB GRO <b>332</b>	APP CRS <b>260°</b>	Rwy Idg TDZE Apt Elev	<b>7000</b> <b>607</b> <b>607</b>
-----------------------	------------------------	-----------------------------	---

**NDB RWY 27**  
ROTA INTL (GRO)(PGRO)

**⚠** Procedure NA at night except by prior arrangement for runway lights.  
**⚠** Obtain local altimeter setting on 123.6; when not available, except for operators with approved weather reporting service, use Guam altimeter setting and increase all MDAs 225 feet.  
Cat C, D circling not authorized south of Rwy 9-27.

**MISSED APPROACH:** Climbing right turn to 2000 heading 360° continue climb to 3000 direct GRO NDB and hold.

GUAM CENTER  
**120.5 263.0**

CTAF  
**123.6**

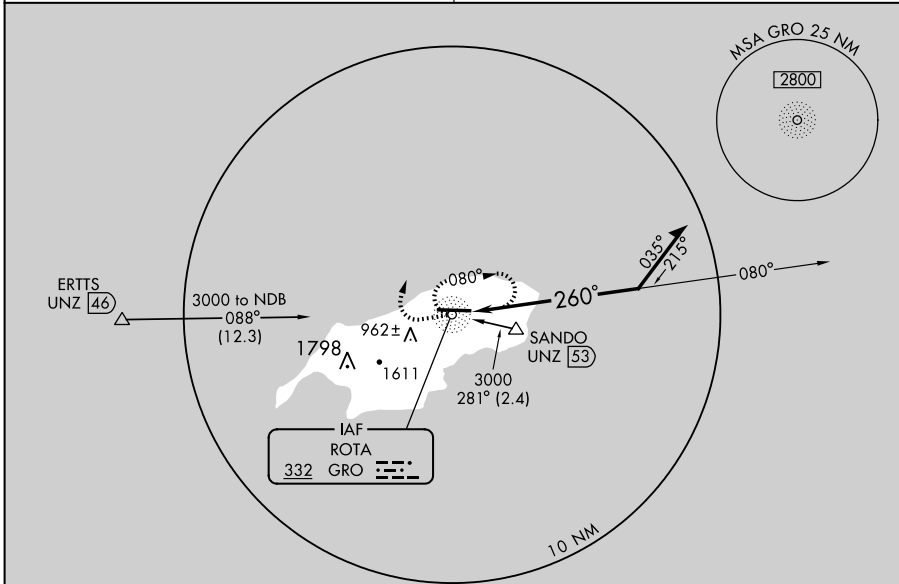

ELEV 607

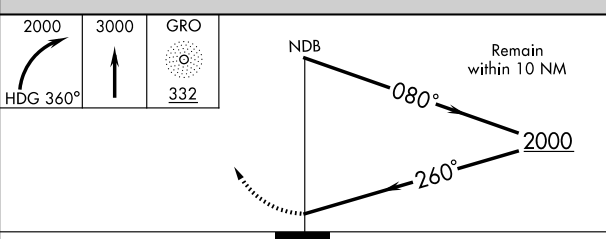
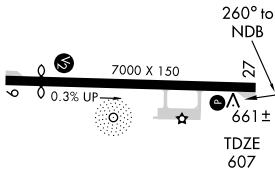

CATEGORY	A	B	C	D
S-27	1220-1 613 (700-1)		1220-1 <sup>3</sup> / <sub>4</sub> 613 (700-1 <sup>3</sup> / <sub>4</sub> )	1220-2 613 (700-2)
CIRCLING	1260-1 653 (700-1)	1280-1 673 (700-1)	1280-2 673 (700-2)	1280-2 <sup>1</sup> / <sub>4</sub> 673 (700-2 <sup>1</sup> / <sub>4</sub> )

REIL Rwy 9 **0**  
MIRL Rwy 9-27 **0**

SAIPAN, CQ  
Amdt 3C 09295

14°10'N-145°14'E

ROTA INTL (GRO)(PGRO)  
**NDB RWY 27**



TINIAN ISLAND, CQ

AL-6848 (FAA)

APP CRS	Rwy Idg	<b>8600</b>
<b>078°</b>	TDZE	<b>243</b>
	Apt Elev	<b>271</b>

# RNAV (GPS) RWY 8

TINIAN INTL (TNI)(PGWT)

**▼** DME/DME RNP-0.3 NA. Obtain local altimeter setting on CTAF;  
**▲** when not received, use Saipan altimeter setting.  
 VDP NA when using Saipan altimeter setting.

**MISSED APPROACH:** Climb to 2800 direct DUCFI and via 360° track to SN NDB and hold, continue climb-in-hold to 2800.

GUAM APP CON  
**118.4 290.5**

SAIPAN RADIO  
**123.6 (CTAF) 0**

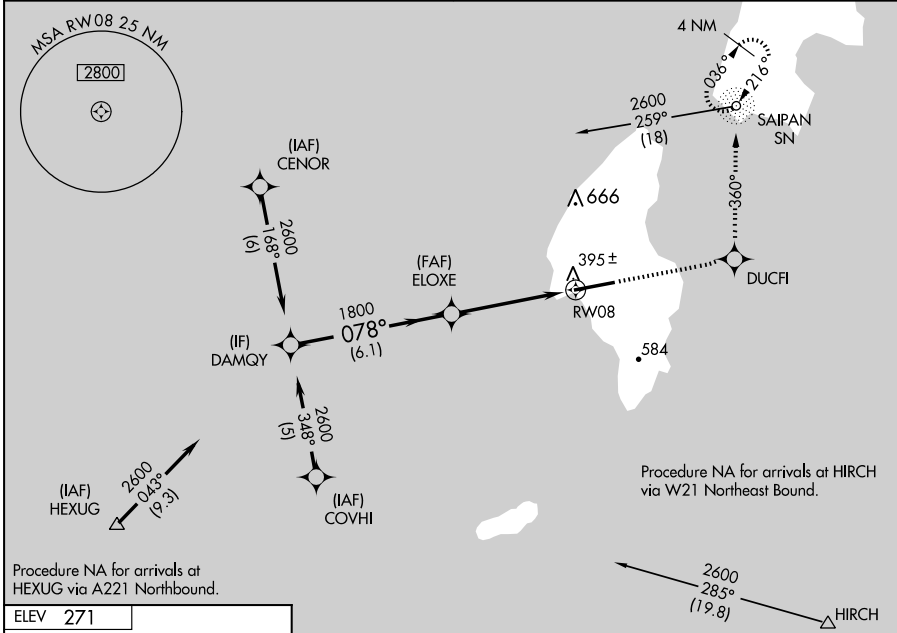

Procedure NA for arrivals at HEXUG via A221 Northbound.

ELEV 271

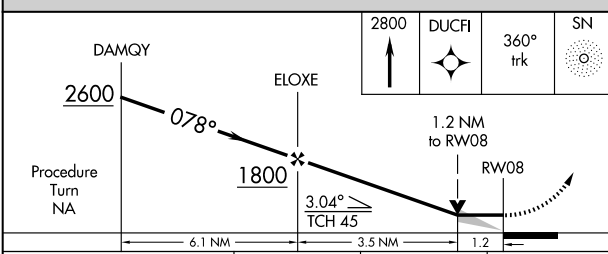
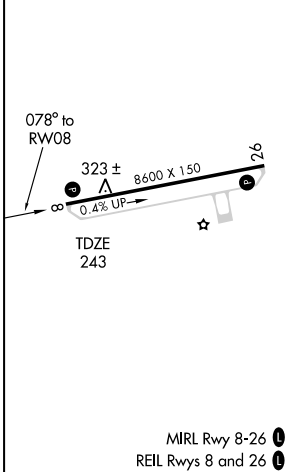

CATEGORY	A	B	C	D
RNAV MDA	660-1	417 (400-1)	660-1¼	417 (400-1¼)
CIRCLING	760-1	489 (500-1)	800-1½ 529 (600-1½)	960-2¼ 689 (700-2¼)
SAIPAN ALTIMETER SETTING MINIMUMS				
RNAV MDA	680-1	437 (500-1)	680-1¼ 437 (500-1¼)	680-1½ 437 (500-1½)
CIRCLING	800-1	529 (600-1)	840-1½ 569 (600-1½)	1000-2¼ 729 (800-2¼)

TINIAN ISLAND, CQ  
Amdt 1 09239

15° 00'N-145° 37'E

# TINIAN INTL (TNI)(PGWT)

## RNAV (GPS) RWY 8

TINIAN ISLAND, CQ

AL-6848 (FAA)

APP CRS	Rwy Idg	<b>8600</b>
<b>258°</b>	TDZE	<b>271</b>
	Apt Elev	<b>271</b>

# RNAV (GPS) RWY 26

TINIAN INTL (TNI)(PGWT)

**▼** DME/DME RNP-0.3 NA. Obtain local altimeter setting on CTAF; when not received, use Saipan altimeter setting.  
**▲** VDP NA when using Saipan altimeter setting.

MISSED APPROACH: Climbing right turn to 2800 direct SN NDB and hold, continue climb-in-hold to 2800.

GUAM APP CON **118.4 290.5** SAIPAN RADIO **123.6 (CTAF) 0**

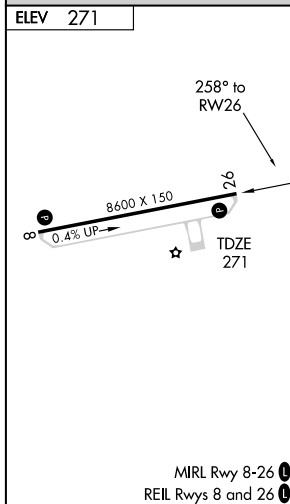
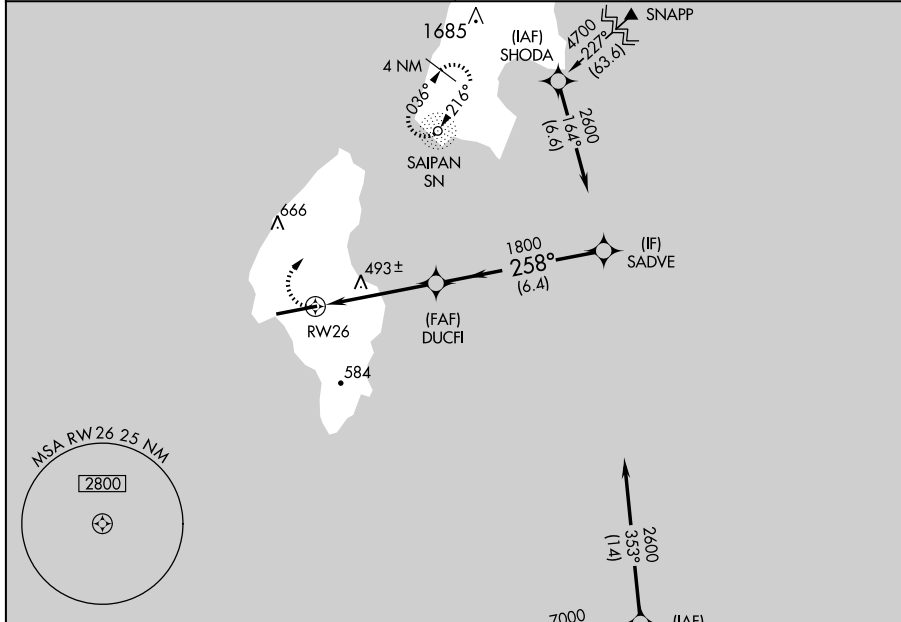

	2800	SN		
	1.4	3.2 NM	6.4 NM	
CATEGORY	A	B	C	D
LNAV MDA	760-1	489 (500-1)	760-1¼ 489 (500-1¼)	760-1½ 489 (500-1½)
CIRCLING	760-1	489 (500-1)	800-1½ 529 (600-1½)	960-2¼ 689 (700-2¼)
SAIPAN ALTIMETER SETTING MINIMUMS				
LNAV MDA	780-1	509 (600-1)	780-1½	509 (600-1½)
CIRCLING	800-1	529 (600-1)	840-1½ 569 (600-1½)	1000-2¼ 729 (800-2¼)

TINIAN ISLAND, CQ  
Amdt 1 09239

15° 00'N-145° 37'E

# TINIAN INTL (TNI)(PGWT)

## RNAV (GPS) RWY 26

TINIAN ISLAND, CG

AL-6848 (FAA)

NDB-A

TINIAN INTL (TNI)(PGWT)

SN NDB <b>312</b>	APP CRS <b>216°</b>	Rwy Idg TDZE Apt Elev	N/A N/A 271
----------------------	------------------------	-----------------------------	-------------------

	MISSED APPROACH: Climb to 1400 via 216° bearing from SN NDB then climbing right turn to 2600 direct SN NDB and hold.
GUAM APP CON <b>118.4 290.5</b>	SAIPAN RADIO <b>123.6 (CTAF) 0</b>

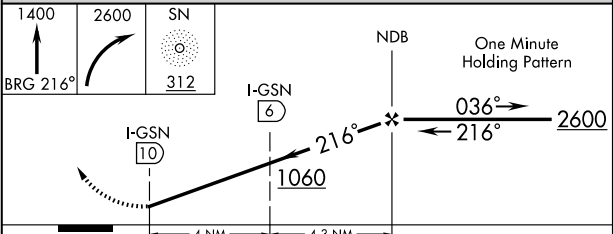
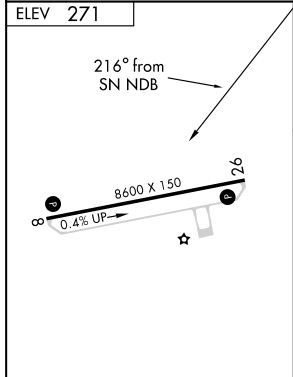
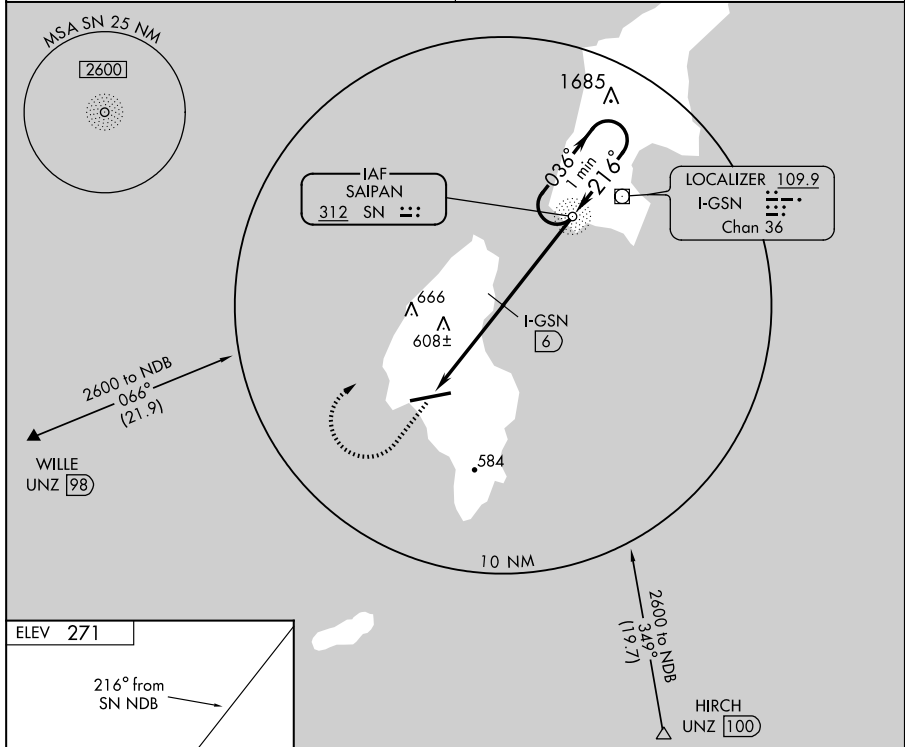

MIRL Rwy 8-26 **0**  
REIL Rwys 8 and 26 **0**

FAF to MAP 8.3 NM

Knots	60	90	120	150	180
Min:Sec	8:18	5:32	4:09	3:19	2:46

CATEGORY	A	B	C	D
CIRCLING	1060-1 789 (800-1)	1060-1¼ 789 (800-1¼)	1060-2¼ 789 (800-2¼)	1060-2½ 789 (800-2½)
DME MINIMUMS				
CIRCLING	940-1 669 (700-1)		940-2 669 (700-2)	940-2¼ 669 (700-2¼)

TINIAN ISLAND, CG  
Amdt 1C 09015

15°00'N-145°37'E

TINIAN INTL (TNI)(PGWT)  
NDB-A

TUTUILA, AQ

AL-5018 (FAA)

LOC/DME I-TUT <b>110.3</b> Chan <b>40</b>	APP CRS <b>046°</b>	Rwy Idg TDZE Apt Elev	<b>9000</b> <b>30</b> <b>32</b>
---	------------------------	-----------------------------	---------------------------------------

# ILS/DME RWY 5

TUTUILA/ PAGO PAGO INTL (PPG) (NSTU)

<p><b>⚠</b> Circling not authorized north of Rwy 5-23. No controlled airspace below 9500 feet. When local altimeter setting not received, procedure NA.</p>	<p><b>MALSR</b></p>	<p><b>MISSED APPROACH:</b> Climb to 500 then climbing right turn to 3000 via TUT R-080 and 10 DME Arc CCW to JONAS 10 DME and hold.</p>
---	---------------------	---

FALEOLO APP CON <b>126.9</b>	CTAF <b>122.9</b>	<b>118.30</b>
---------------------------------	-------------------	---------------

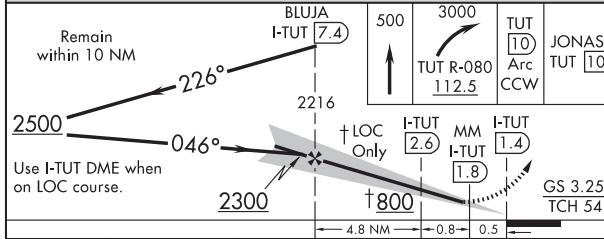
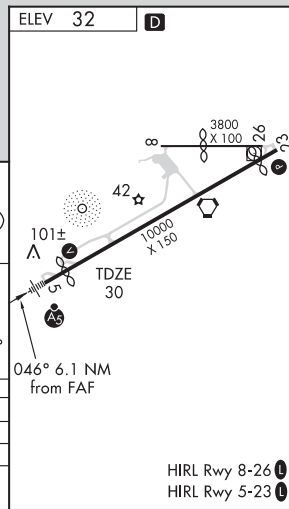
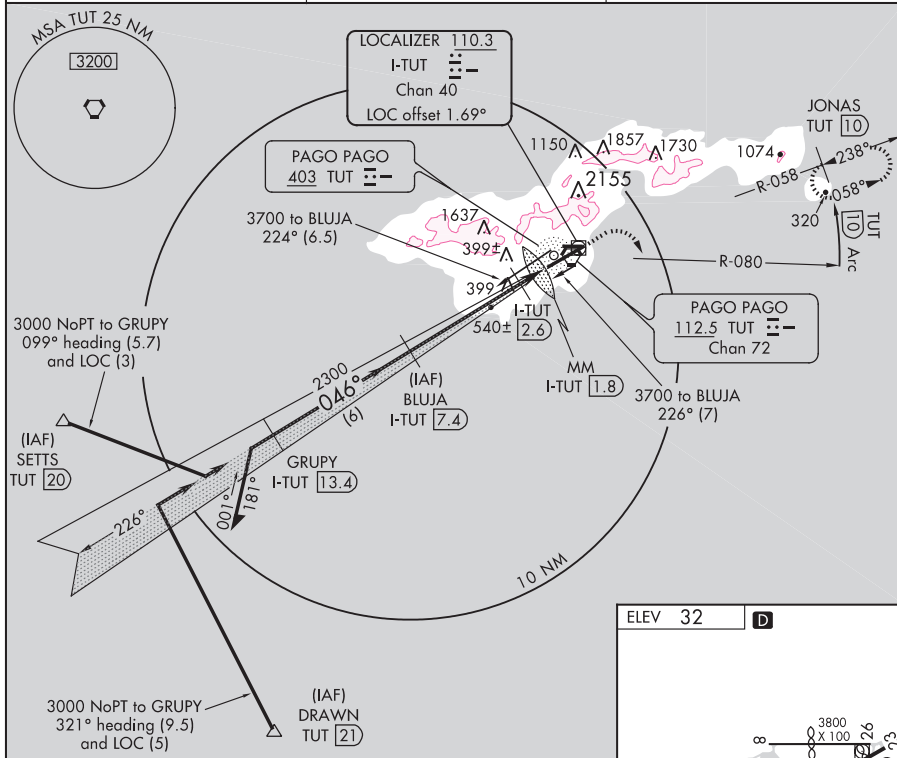

CATEGORY	A	B	C	D
S-ILS 5		281-1/2	250 (300-1/2)	
S-LOC 5	Straight-in minima NA, CIRCLING MINIMA APPLY			
CIRCLING	540-1	508 (600-1)	700-1 3/4 668 (700-1 3/4)	700-2 668 (700-2)

TUTUILA, AQ  
Amdt 13D 09071

TUTUILA/ PAGO PAGO INTL (PPG) (NSTU)  
14° 20' S-170° 43' W

# ILS/DME RWY 5

HIRL Rwy 8-26 **1**  
HIRL Rwy 5-23 **1**



TUTUILA, AQ

AL-5018 (FAA)

VORTAC TUT <b>112.5</b> Chan <b>72</b>	APP CRS <b>238°</b>	Rwy Idg TDZE Apt Elev	<b>N/A</b> <b>N/A</b> <b>32</b>
--	------------------------	-----------------------------	---------------------------------------

**VOR/DME or TACAN-B**  
TUTUILA/ PAGO PAGO INTL (PPG) (NSTU)

▼ Circling not authorized north of Rwy 5-23.  
No controlled airspace below 9500 feet.  
When local altimeter setting not received, procedure NA.

MISSED APPROACH: Climbing left turn to 3000  
via TUT R-180 to PITTI 10 DME and hold.

FALEOLO APP CON <b>126.9</b>	CTAF <b>122.9</b>	<b>118.3</b> <b>0</b>
---------------------------------	-------------------	-----------------------

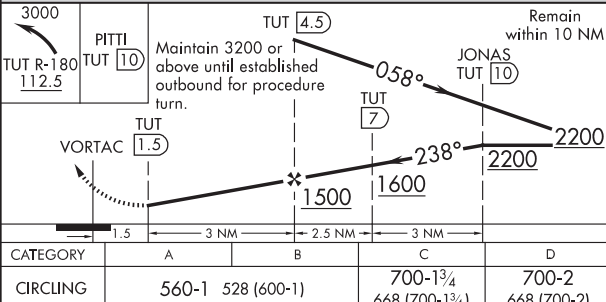
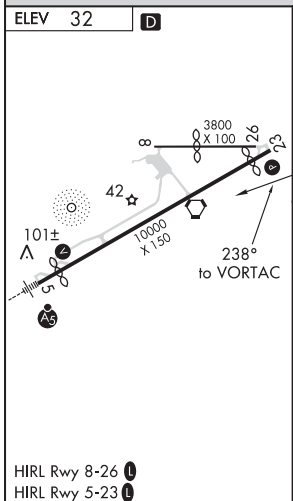
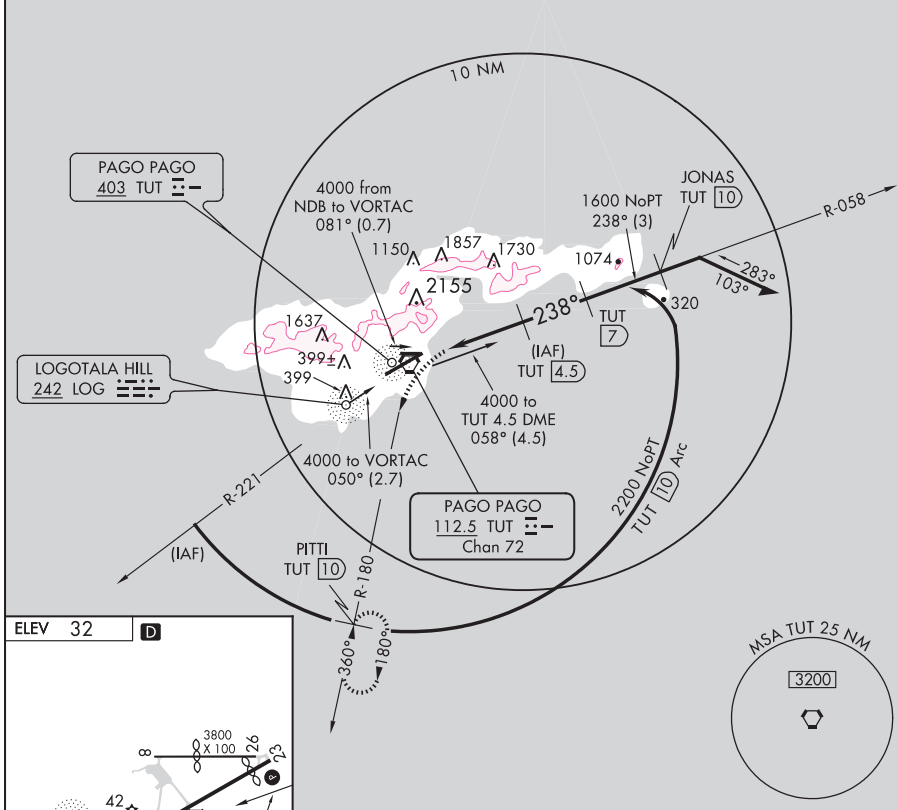

TUTUILA, AQ  
Amdt 5C 09071

TUTUILA/ PAGO PAGO INTL (PPG) (NSTU)  
14° 20'S-170° 43'W **VOR/DME or TACAN-B**

TUTUILA, AQ

AL-5018 (FAA)

VORTAC TUT <b>112.5</b> Chan 72	APP CRS <b>048°</b>	Rwy Idg TDZE Apt Elev	N/A N/A <b>32</b>
---------------------------------------	------------------------	-----------------------------	-------------------------

**VOR-D**

TUTUILA/ PAGO PAGO INTL (PPG) (NSTU)

**⚠** Circling not authorized north of Rwy 5-23.  
When control zone not in effect:  
1. No control airspace below 9500'.  
2. Contact NANDI ACC for traffic advisories.

**⚠** MISSED APPROACH: Climbing right turn to 4000 via R-080 then direct TUT VORTAC and hold.

FALEOLO APP CON <b>126.9</b>	CTAF <b>122.9</b>	<b>118.3</b> <b>0</b>
---------------------------------	-------------------	-----------------------

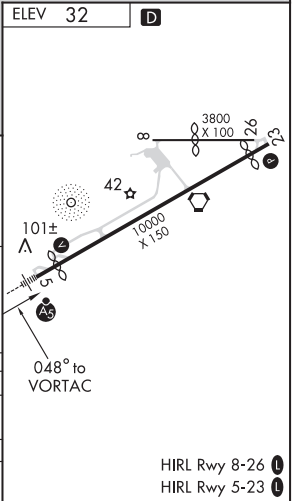
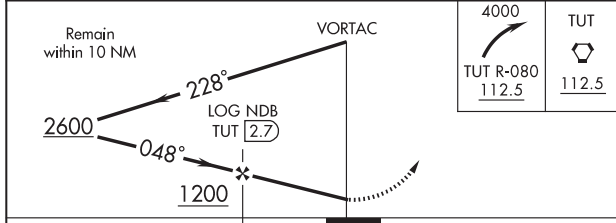
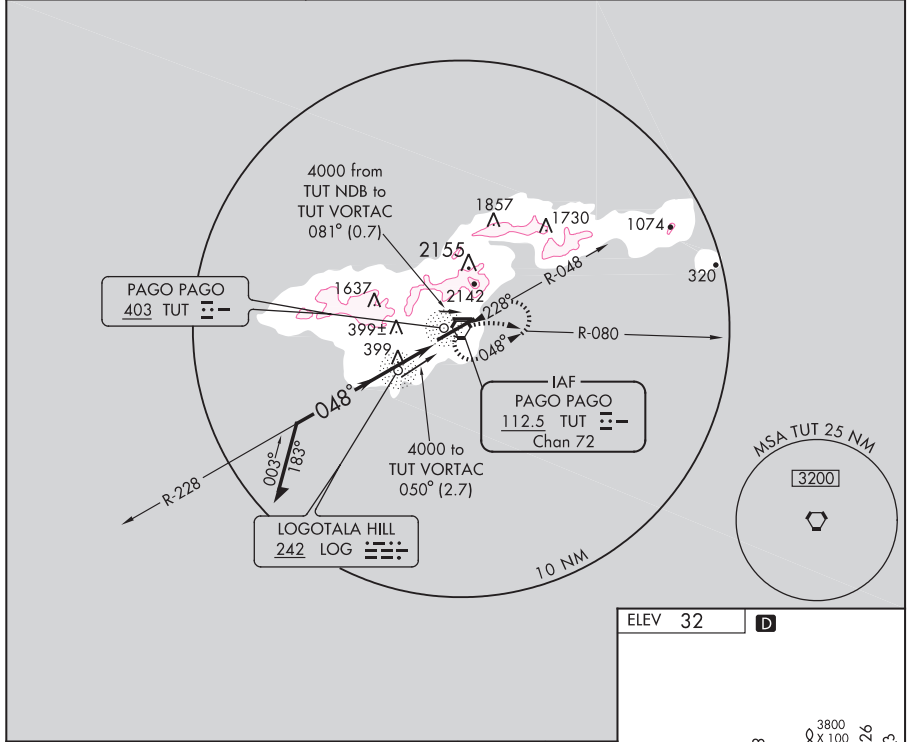

CATEGORY	A	B	C	D
CIRCLING	1100-1¼ 1069 (1100-1¼)	1100-1½ 1069 (1100-1½)	1100-3	1069 (1100-3)
ADF or DME MINIMUMS				
CIRCLING	660-1 628 (700-1)	700-1¾ 668 (700-1¾)	700-2 668 (700-2)	

HIRL Rwy 8-26 **0**  
HIRL Rwy 5-23 **0**

TUTUILA, AQ  
Amdt 5A 09071

TUTUILA/ PAGO PAGO INTL (PPG) (NSTU)  
14° 20' S-170° 43' W

**VOR-D**

TUTUILA, AQ

AL-5018 (FAA)

**NDB-C**

TUTUILA/ PAGO PAGO INTL (PPG) (NSTU)

NDB LOG <b>242</b>	APP CRS <b>048°</b>	Rwy Idg TDZE Apt Elev	<b>N/A</b> <b>N/A</b> <b>32</b>
-----------------------	------------------------	-----------------------------	---------------------------------------

<p><b>⚠</b> Circling not authorized north of Rwy 5-23. No controlled airspace below 9500 feet. When local altimeter setting not received, procedure NA.</p>	<p><b>MISSED APPROACH:</b> Climbing right turn to 4000 via 180° bearing from LOG NDB then direct LOG NDB and hold.</p>
---	--

FALEOLO APP CON <b>126.9</b>	CTAF <b>122.9</b>	<b>118.3</b> <b>Ⓛ</b>
---------------------------------	-------------------	-----------------------

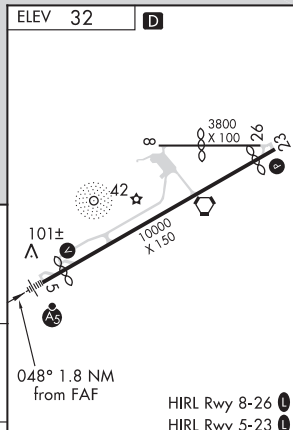
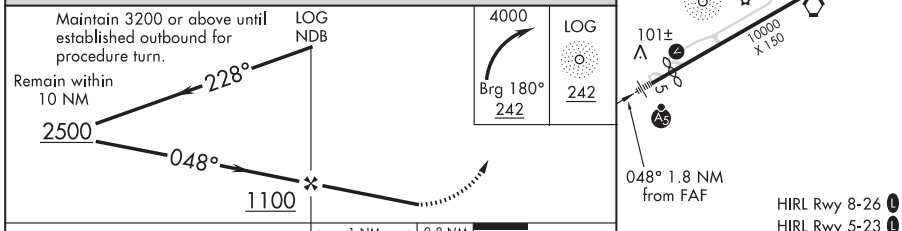
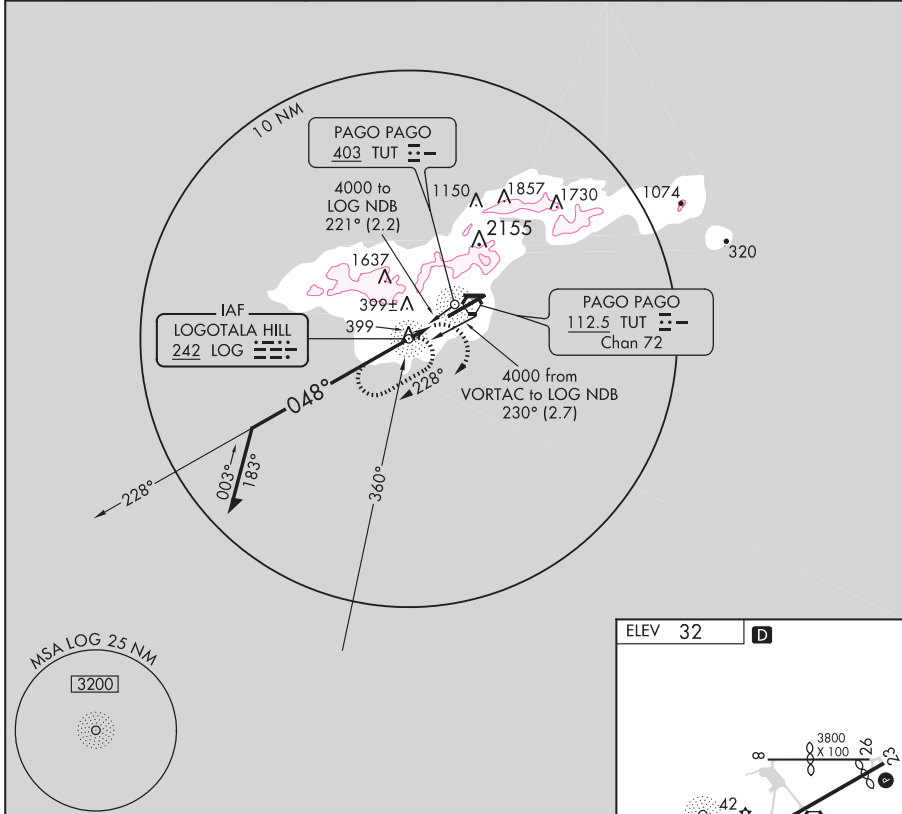

CATEGORY	A		C		D		FAF to MAP 1 NM					
	760-1	728 (800-1)	760-2	728 (800-2)	760-2¼	728 (800-2¼)	Knots	60	90	120	150	180
CIRCLING							Min:Sec	1:00	0:40	0:30	0:24	0:20

TUTUILA, AQ  
Amdt 6B 09071

TUTUILA/ PAGO PAGO INTL (PPG) (NSTU)  
14° 20' S - 170° 43' W

**NDB-C**



09071

# AIRPORT DIAGRAM

AL-5018 (FAA)

PAGO PAGO INTL (PPG) (NSTU)  
PAGO PAGO, AS

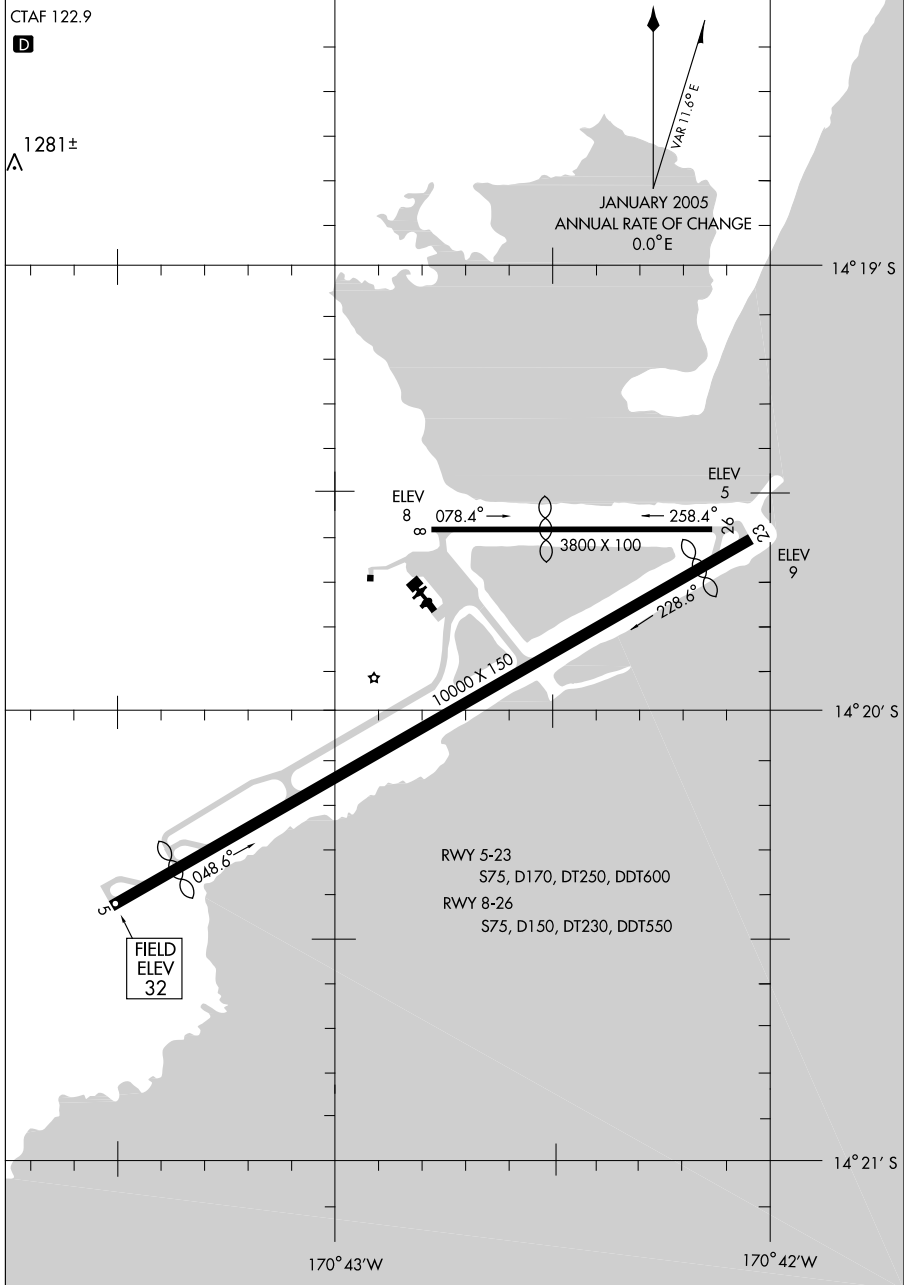

# AIRPORT DIAGRAM

09071

PAGO PAGO, AS  
PAGO PAGO INTL (PPG) (NSTU)

WENO ISLAND, FM

AL-2655 (FAA)

APP CRS	Rwy Idg	<b>6006</b>
<b>041°</b>	TDZE	<b>10</b>
	Apt Elev	<b>10</b>

# RNAV (GPS) RWY 4

WENO ISLAND/ CHUUK INTL (TKK) (PTKK)



Obtain local altimeter setting on CTAF; when not received procedure not authorized. No controlled airspace below 5500'. Circling not authorized southeast of runway 4-22. GPS or RNP-0.3 Required. DME/DME RNP-0.3 NA.

MISSED APPROACH: Climbing left turn to 2500 direct FIGBI WP and hold.

TRUK RADIO  
**123.60** (CTAF)

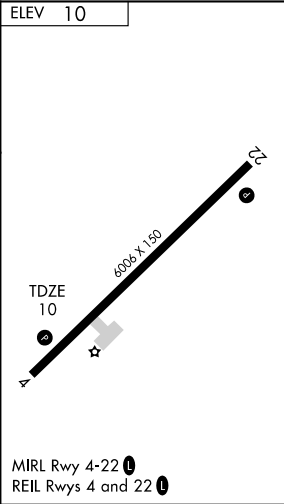
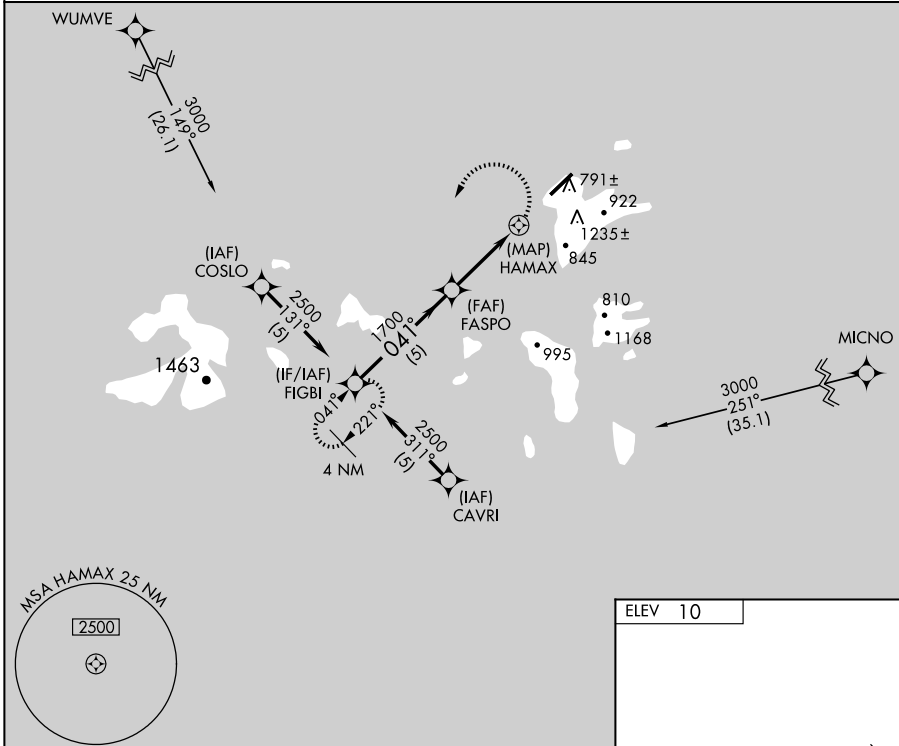

Procedure Turn NA

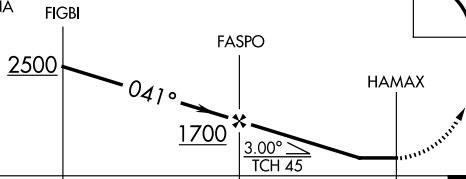

CATEGORY	A	B	C	D
LNAV MDA	400-2 390 (400-2)			
CIRCLING	460-2	450 (500-2)	560-2 550 (600-2)	

WENO ISLAND, FM  
Orig-A 07018

WENO ISLAND/ CHUUK INTL (TKK) (PTKK)  
07°28'N-151°51'E  
**RNAV (GPS) RWY 4**

WENO ISLAND, FM

AL-2655 (FAA)

# GPS RWY 22

WENO ISLAND/ CHUUK INTL (TKK) (PTKK)

APP CRS <b>226°</b>	Rwy Idg TDZE Apt Elev	<b>6006</b> <b>10</b> <b>10</b>
------------------------	-----------------------------	---------------------------------------



Circling not authorized southeast of Runway 4-22.

MISSED APPROACH: Climbing right turn to 3000 direct CEYJE WP and hold.

TRUK RADIO  
**123.6** (CTAF)

WUMVE

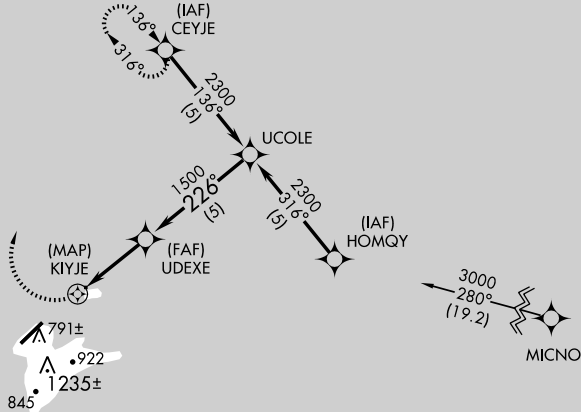
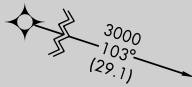

ELEV 10

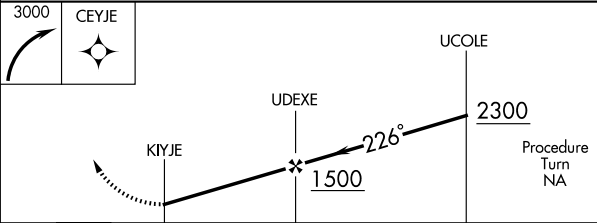
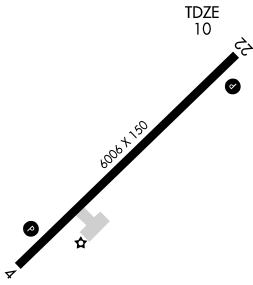

CATEGORY	A	B	C	D
S-22	700-1¾	690 (700-1¾)	700-2 690 (700-2)	700-2¼ 690 (700-2¼)
CIRCLING	700-1¾	690 (700-1¾)	700-2 690 (700-2)	700-2¼ 690 (700-2¼)

MIRL Rwy 4-22  
REIL Rws 4 and 22

WENO ISLAND, FM  
Orig 07018

WENO ISLAND/ CHUUK INTL (TKK) (PTKK)

07°28'N-151°51'E

# GPS RWY 22

WENO ISLAND, FM

AI-2655 (FAA)

NDB/DME TTK <b>375</b>	APP CRS <b>069°</b>	Rwy Idg TDZE Apt Elev	<b>6006</b> <b>11</b> <b>10</b>
Chan <b>111 (116.4)</b>			

# NDB/DME RWY 4

WENO ISLAND/ CHUUK INTL (TKK) (PTKK)

**⚠** Circling not authorized southeast of Rwy 4-22.  
**⚠** Fly visual to airport, 069°-2.8 NM.

**MISSED APPROACH:** Immediate climbing left turn to 2100 via bearing 308° to DAMAY 9 DME and hold.

TRUK RADIO  
**123.6** (CTAF)

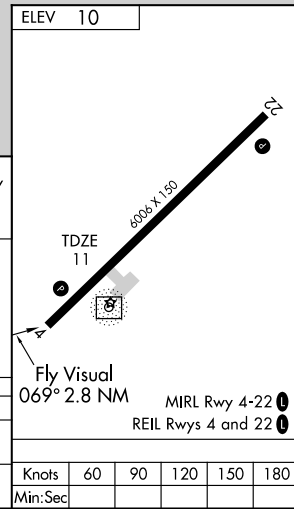
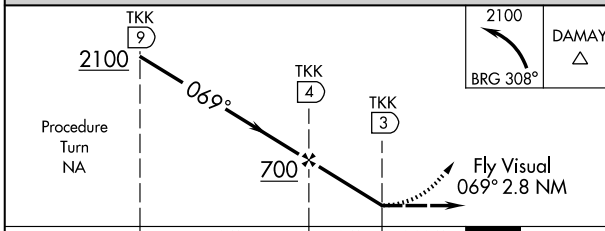
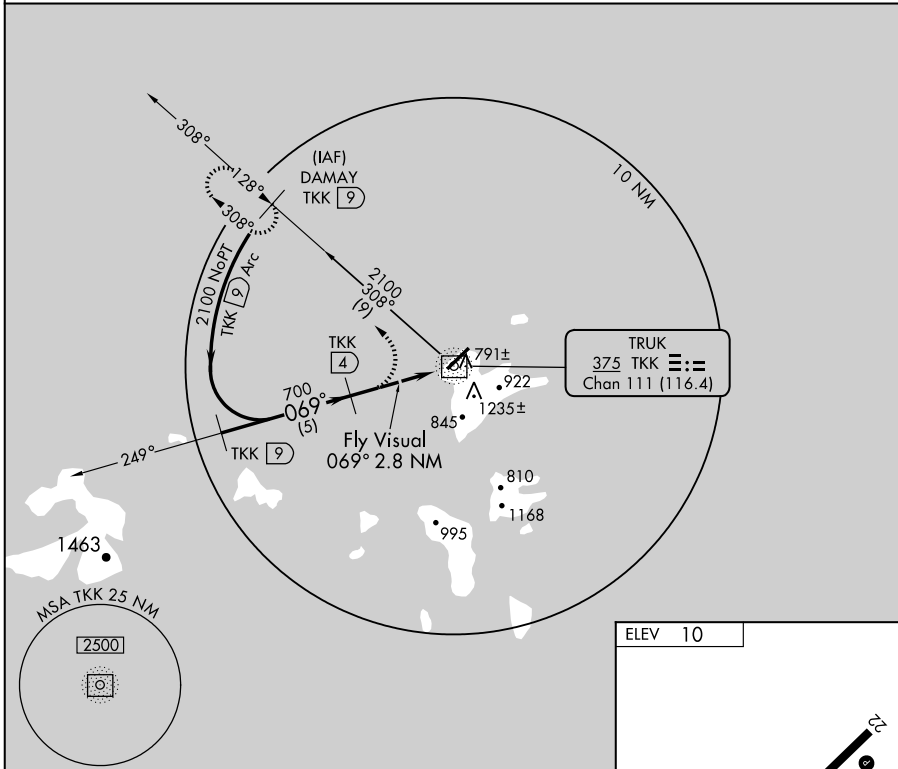

CATEGORY	A	B	C	D
S-4	460-3 449 (500-3)	480-3 469 (500-3)		580-3 569 (600-3)
CIRCLING	460-3 449 (500-3)	480-3 469 (500-3)		580-3 569 (600-3)

WENO ISLAND, FM  
Orig-A 07018

WENO ISLAND/ CHUUK INTL (TKK) (PTKK)  
07°28'N-151° 51' E

# NDB/DME RWY 4

WENO ISLAND, FM

AL-2655 (FAA)

NDB/DME TTK <b>375</b>	APP CRS <b>095°</b>	Rwy Idg TDZE Apt Elev	<b>N/A</b> <b>N/A</b> <b>10</b>
Chan <b>111 (116.4)</b>			

**NDB or GPS-A**

WENO ISLAND/ CHUUK INTL (TKK) (P'TKK)

**▼** Circling not authorized southeast of Runway 4-22.  
**▲** Descend to MDA immediately after completion of procedure turn. Fly visual to airport.

**MISSED APPROACH:** If not visual at MDA, climbing left turn to 2500 on 345° heading then direct TTK NDB/DME and hold.

TRUK RADIO  
**123.6** (CTAF)

**DME REQUIRED**

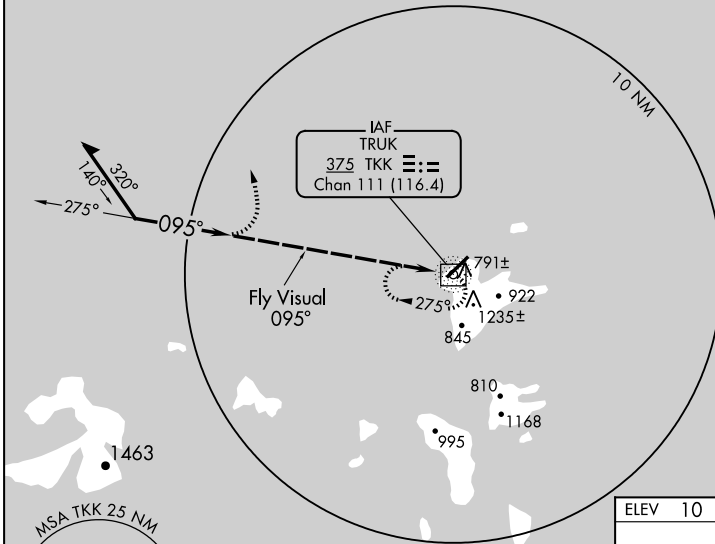

ELEV 10

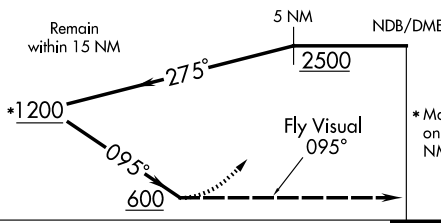

5 NM NDB/DME  
2500  
TKK  
HGD 345°  
375

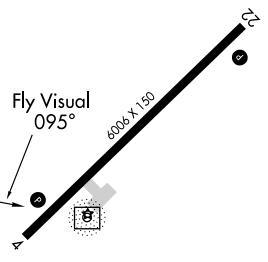

MIRL Rwy 4-22  
REIL Rws 4 and 22

CATEGORY	A	B	C	D	Knots	60	90	120	150	180
CIRCLING		600-3	589 (600-3)		Min:Sec					

WENO ISLAND, FM  
Orig-A 07018

WENO ISLAND/ CHUUK INTL (TKK) (P'TKK)  
07°28'N-151°51'E

**NDB or GPS-A**

WENO ISLAND, FM

AL-2655 (FAA)

NDB/DME TTK <b>375</b>	APP CRS <b>214°</b>	Rwy Idg TDZE Apt Elev	<b>N/A</b> <b>N/A</b> <b>10</b>
Chan <b>111 (116.4)</b>			

# NDB or GPS-B

WENO ISLAND/ CHUUK INTL (TKK) (PTKK)

**⚠** Circling not authorized southeast of Runway 4-22.  
**⚠** Descend to MDA immediately after completion of procedure turn. Fly visual to airport.

**MISSED APPROACH:** If not visual at MDA, climbing right turn to 2500 on 345° heading then direct TTK NDB/DME and hold.

TRUK RADIO  
**123.6** (CTAF)

**DME REQUIRED**

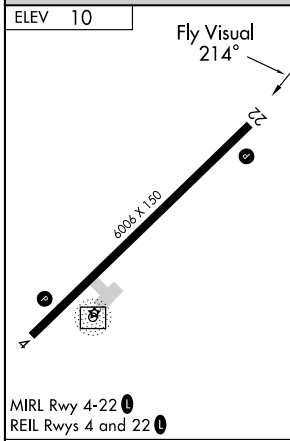
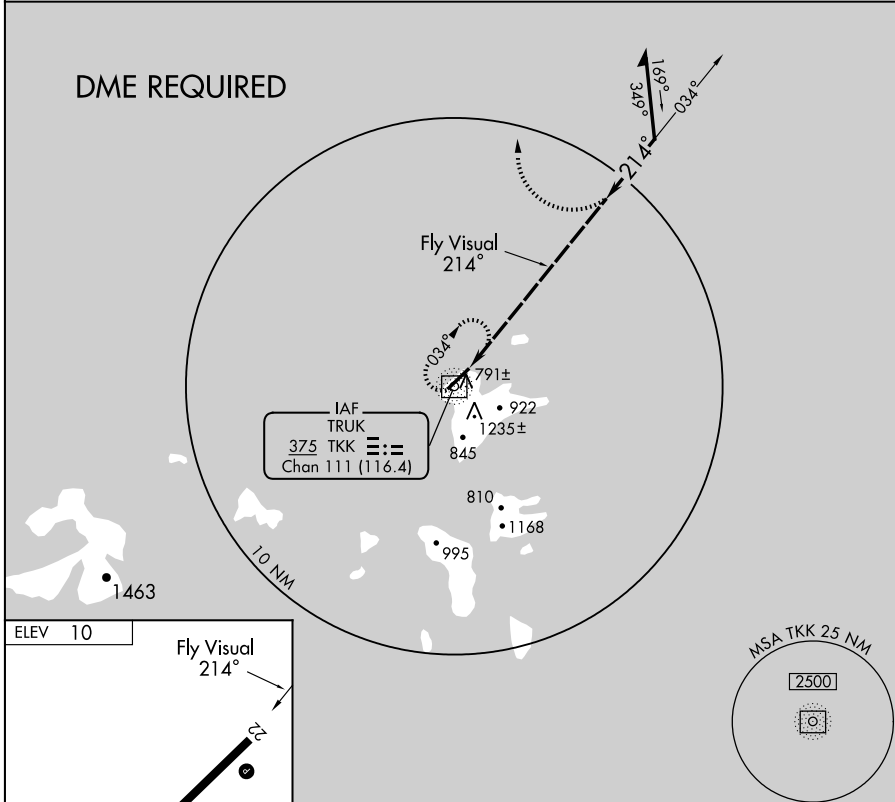

MIRL Rwy 4-22 **⓪**  
 REIL Rws 4 and 22 **⓪**

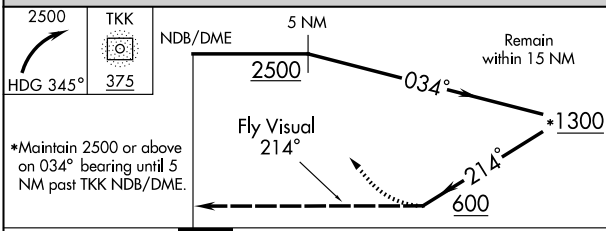

\*Maintain 2500 or above on 034° bearing until 5 NM past TTK NDB/DME.

Knots	60	90	120	150	180
Min:Sec					
CATEGORY	A	B	C	D	
CIRCLING	600-3 589 (600-3)				

WENO ISLAND, FM  
 Amdt 4A 07018

WENO ISLAND/ CHUUK INTL (TKK) (PTKK)  
 07°28N-151°51'E

# NDB or GPS-B

YAP ISLAND, FM

AL-6048 (FAA)

# RNAV (GPS) RWY 7

YAP INTL (T11)(PTYA)

APP CRS	Rwy Idg	<b>6000</b>
<b>071°</b>	TDZE	<b>91</b>
	Apt Elev	<b>91</b>

Obtain local altimeter setting on CTAF; when not received, procedure not authorized.  
 Circling NA North of Rwy 7-25. DME/DME RNP-0.3 NA.  
 No controlled airspace below 5500'.

MISSED APPROACH: Climb to 1700 direct OMOCO WP and hold.

YAP RADIO  
**123.6** (CTAF)

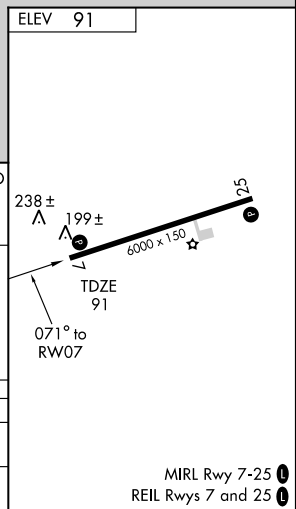
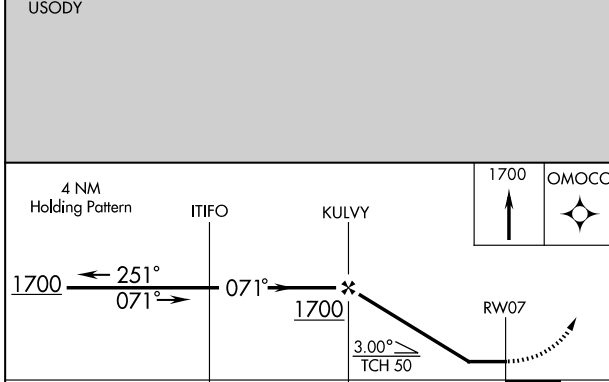
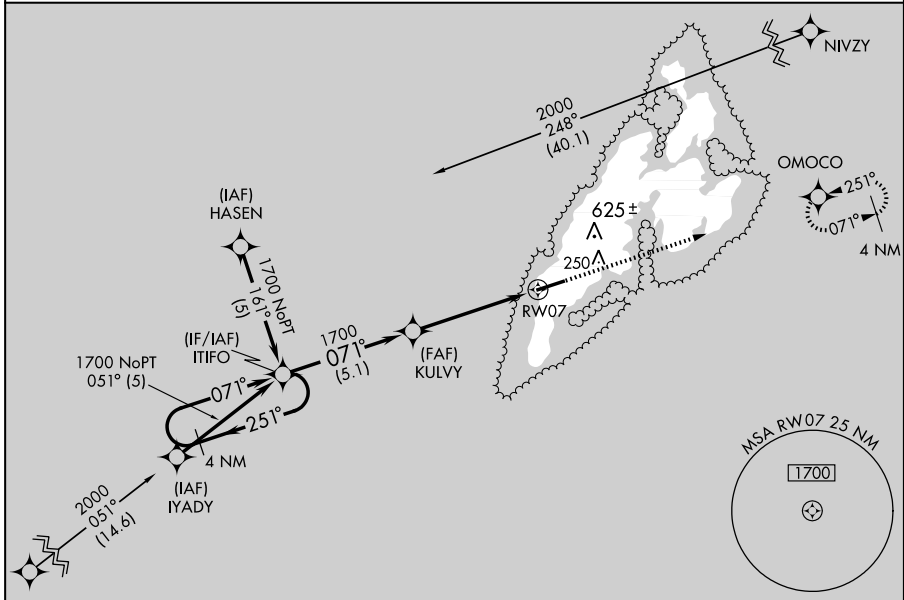

CATEGORY	A	B	C	D
LNVA MDA	600-1	509 (600-1)	600-1½	509 (600-1½)
CIRCLING	600-1	509 (600-1)	600-1½	660-2
			509 (600-1½)	569 (600-2)

YAP ISLAND, FM  
 Orig-A 07018

09° 30'N-138° 05'E

# RNAV (GPS) RWY 7

YAP ISLAND, FM

AL-6048 (FAA)

APP CRS	Rwy Idg	<b>6000</b>
<b>251°</b>	TDZE	<b>89</b>
	Apt Elev	<b>91</b>

# RNAV (GPS) RWY 25

YAP INTL (T11)(PTYA)

Obtain local altimeter setting on CTAF; when not received, procedure not authorized.  
 Circling NA North of Rwy 7-25. DME/DME RNP-0.3 NA.  
 No controlled airspace below 5500'.  
**MISSED APPROACH:** Climb to 1700 direct ITIFO WP and hold.

YAP RADIO  
**123.6** (CTAF)

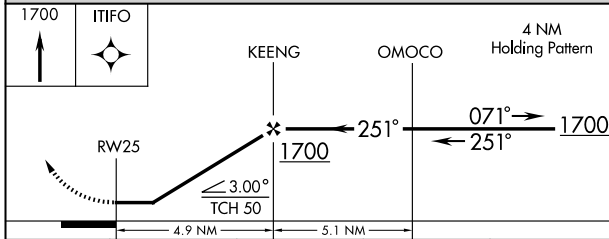
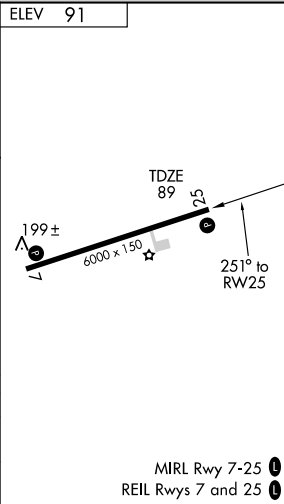
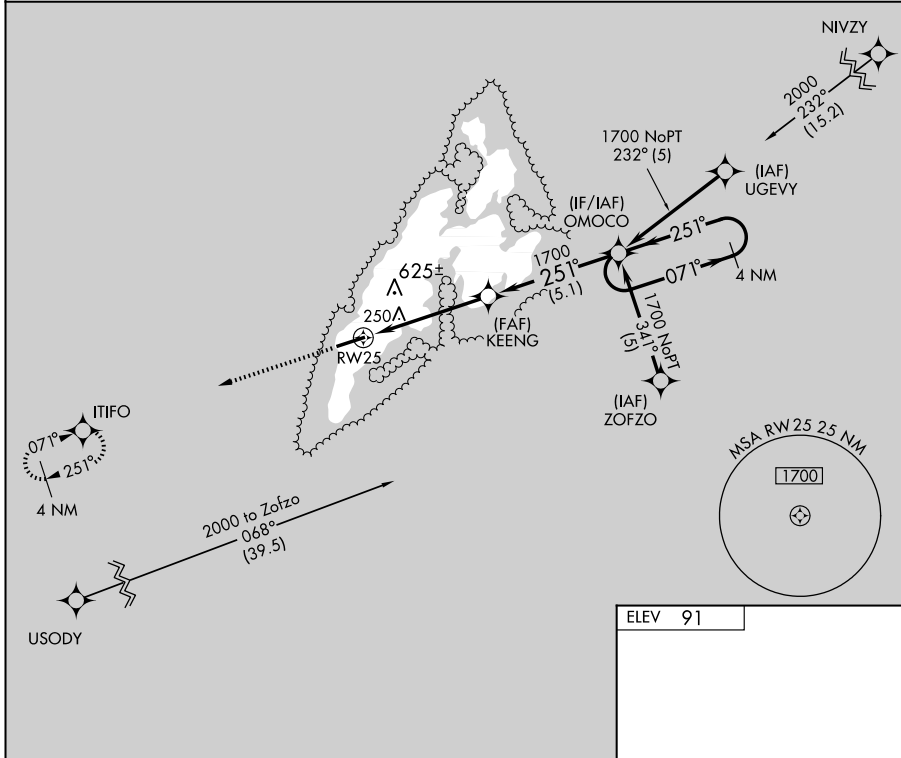

CATEGORY	A	B	C	D
LNAV MDA	700-1	611 (700-1)	700-1¾ 611 (700-1¾)	700-2 611 (700-2)
CIRCLING	700-1	609 (700-1)	700-1¾ 609 (700-1¾)	700-2 609 (700-2)

YAP ISLAND, FM  
 Orig-A 07018

09° 30'N-138° 05'E

YAP INTL (T11)(PTYA)  
**RNAV (GPS) RWY 25**

MIRL Rwy 7-25  
 REIL Rwy 7 and 25



YAP ISLAND, FM

AL-6048 (FAA)

NDB/DME YP <b>317</b>	APP CRS <b>074°</b>	Rwy Idg TDZE Apt Elev	<b>6000</b> <b>91</b> <b>91</b>
Chan <b>122 (117.5)</b>			

**NDB/DME RWY 7**  
YAP INTL (T11)(PTYA)

▼ Obtain local altimeter setting on CTAF; when not received, procedure NA.  
Circling NA North of Runway 7-25.  
No controlled airspace below 5500.

MISSED APPROACH: Climbing right turn to 1700 via 254° bearing from YP NDB/DME to RAZEL/12 DME and hold.

YAP RADIO  
**123.6** (CTAF)

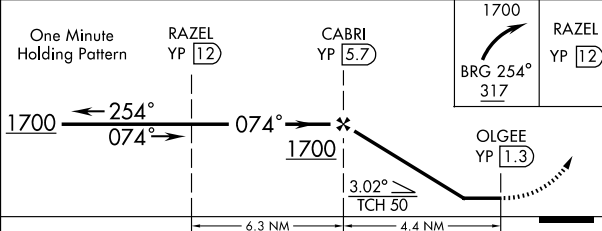
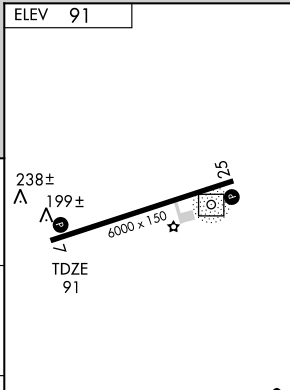
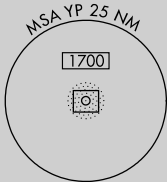
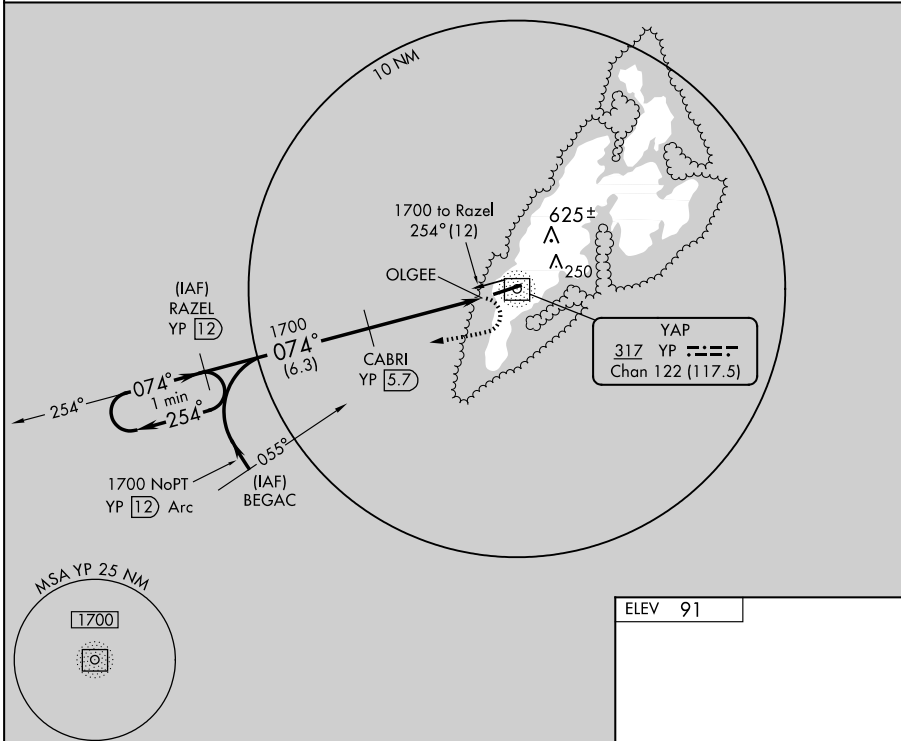

CATEGORY	A	B	C	D
S-7	640-1 549 (600-1)		640-1½ 549 (600-1½)	640-1¾ 549 (600-1¾)
CIRCLING	640-1 549 (600-1)		640-1½ 549 (600-1½)	660-2 569 (600-2)

ELEV	91				
Knots	60	90	120	150	180
Min:Sec					

MIRL Rwy 7-25  
REIL Rws 7 and 25

YAP ISLAND, FM  
Amdt 2A 07018

09° 30'N-138° 05'E

YAP INTL (T11)(PTYA)  
**NDB/DME RWY 7**

YAP ISLAND, FM

AL-6048 (FAA)

NDB/DME YP <b>317</b>	APP CRS <b>237°</b>	Rwy Idg <b>6000</b>
Chan <b>122 (117.5)</b>	TDZE <b>89</b>	Apt Elev <b>91</b>

# NDB/DME RWY 25

YAP INTL (T11)(PTYA)

- ▼ Obtain local altimeter setting on CTAF; when not received, procedure NA.
- ▲ Circling NA North of Runway 7-25. No controlled airspace below 5500.

MISSED APPROACH: Climbing left turn to 1700 via 057° bearing from YP NDB/DME to ADABE/11.1 DME and hold.

YAP RADIO  
**123.6** (CTAF)

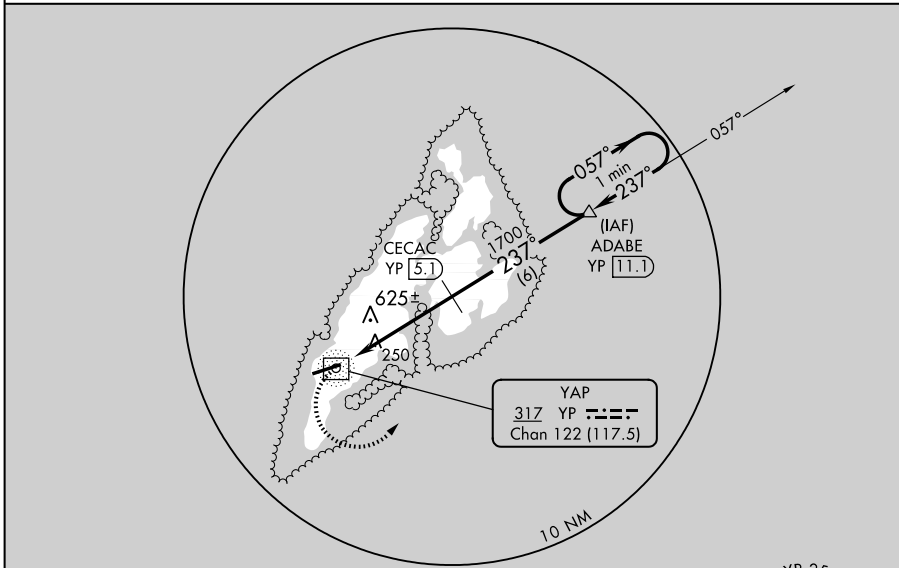

ELEV 91

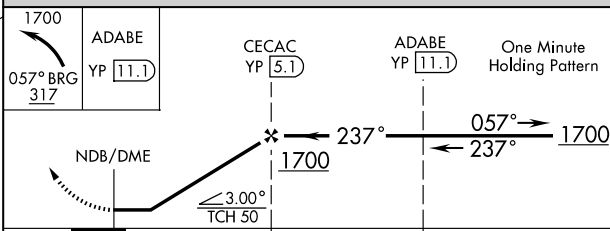
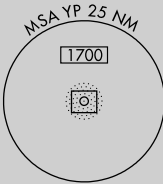
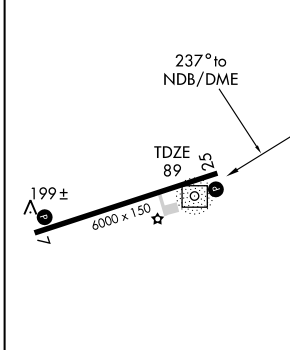

MIRL Rwy 7-25  
REIL Rwys 7 and 25

Knots	60	90	120	150	180
Min:Sec					

CATEGORY	A	B	C	D
S-25	940-1 851 (900-1)	940-1¼ 851 (900-1¼)	940-2½ 851 (900-2½)	940-2¾ 851 (900-2¾)
CIRCLING	940-1 849 (900-1)	940-1¼ 849 (900-1¼)	940-2½ 849 (900-2½)	940-2¾ 849 (900-2¾)

YAP ISLAND, FM  
Orig-A 07018

09° 30' N-138° 05' E

# YAP INTL (T11)(PTYA) NDB/DME RWY 25

YAP ISLAND, FM

AL-6048 (FAA)

NDB/DME YP <b>317</b>	APP CRS <b>074°</b>	Rwy ldg TDZE Apt Elev	<b>6000</b> <b>91</b> <b>91</b>
Chan <b>122 (117.5)</b>			

**NDB RWY 7**  
YAP INTL (T11)(PTYA)

▼ Obtain local altimeter setting on CTAF; when not received, procedure NA.  
Circling NA North of Runway 7-25.  
No controlled airspace below 5500 ft.

MISSED APPROACH: Climbing right turn to 1700 via 180° bearing from YP NDB/DME then right turn direct YP NDB/DME and hold.

YAP RADIO  
**123.6** (CTAF)

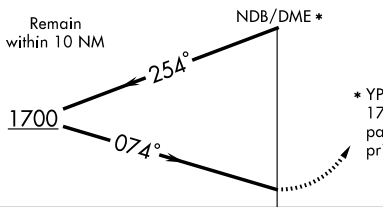
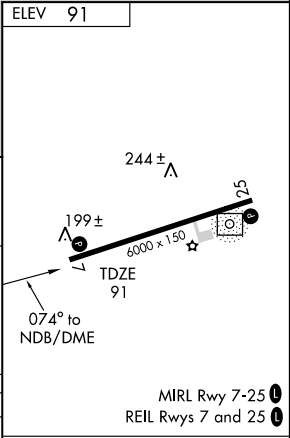
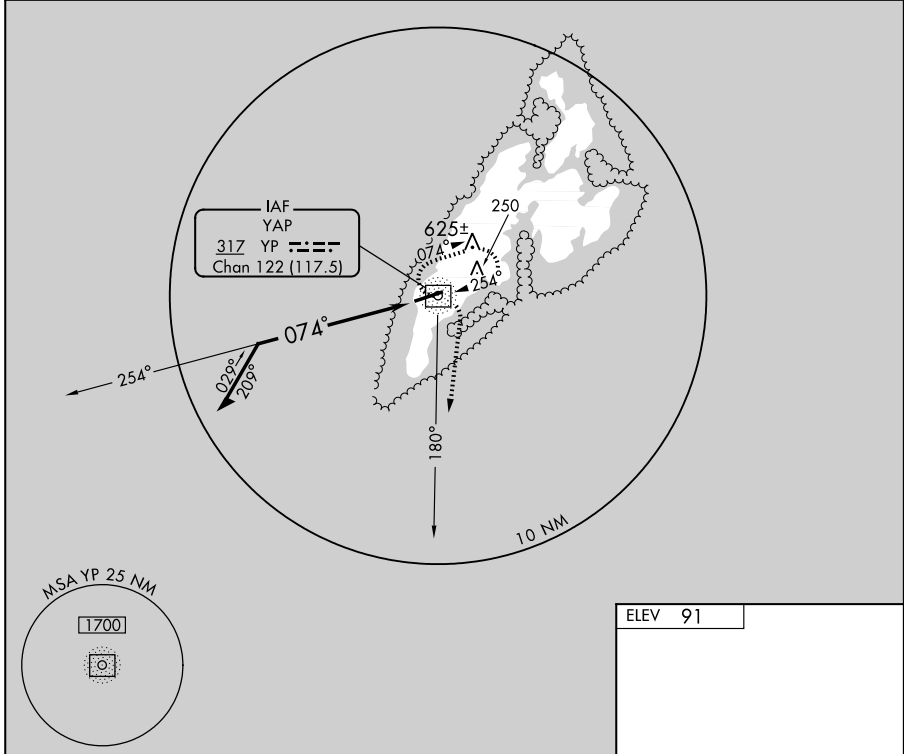

1700  
BRG 180°

YP  
317

\* YP NDB/DME arrivals descend to 1700 in YP NDB/DME holding pattern (E, RT, 254° inbound) prior to commencing approach.

CATEGORY	A	B	C	D
S-7	700-1	609 (700-1)	700-1¾ 609 (700-1¾)	700-2 609 (700-2)
CIRCLING	700-1	609 (700-1)	700-1¾ 609 (700-1¾)	700-2 609 (700-2)

Knots	60	90	120	150	180
Min:Sec					

YAP ISLAND, FM  
Amdt 2A 07018

09° 30'N-138° 05'E

YAP INTL (T11)(PTYA)  
**NDB RWY 7**

YAP ISLAND, FM

AL-6048 (FAA)

NDB/DME YP <b>317</b>	APP CRS <b>237°</b>	Rwy Idg <b>6000</b>
Chan <b>122 (117.5)</b>		TDZE <b>89</b>
		Apt Elev <b>91</b>

# NDB RWY 25

YAP INTL (T11)(PTYA)

**▼** Obtain local altimeter setting on CTAF; when not received, procedure NA.  
**▲** Circling NA North of Rwy 7-25.  
 No controlled airspace below 5500.

MISSED APPROACH: Climb to 1700 then left turn direct YP NDB/DME and hold.

YAP RADIO  
**123.6** (CTAF)

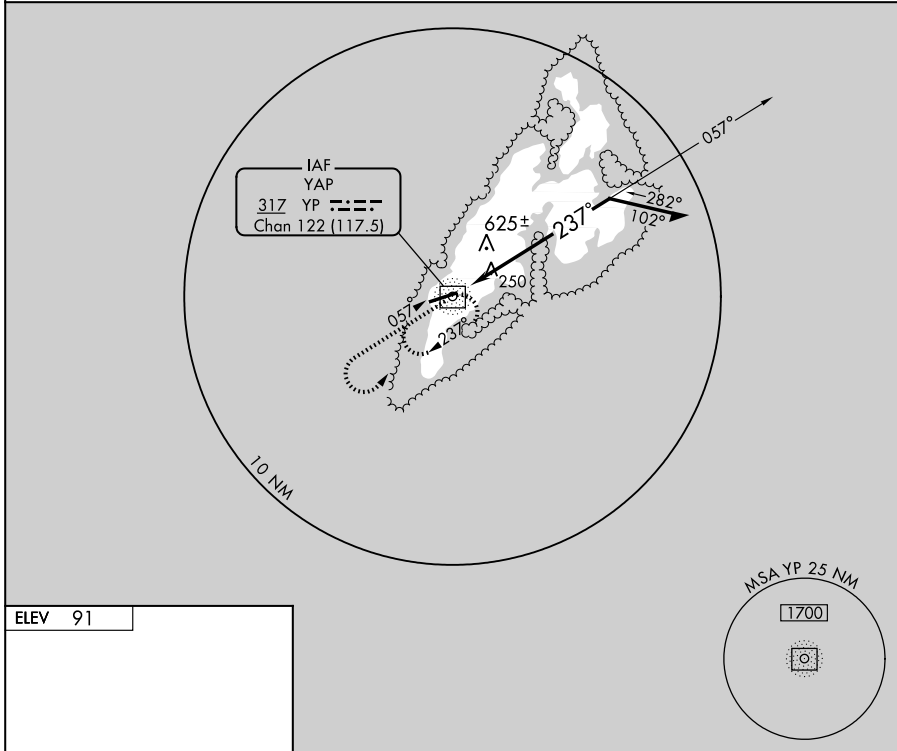

ELEV 91

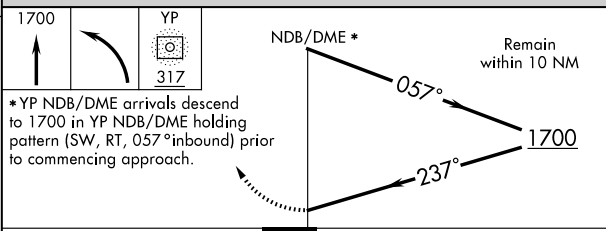
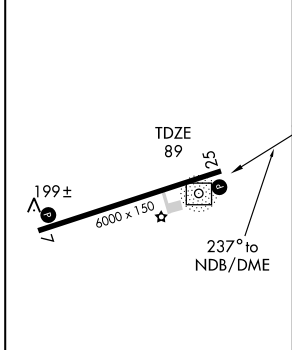

CATEGORY	A	B	C	D
S-25	980-1¼	891 (900-1¼)	980-2¾ 891 (900-2¾)	980-3 891 (900-3)
CIRCLING	980-1¼	889 (900-1¼)	980-2¾ 889 (900-2¾)	980-3 889 (900-3)

MIRL Rwy 7-25  
 REIL Rwys 7 and 25

Knots	60	90	120	150	180
Min:Sec					

YAP ISLAND, FM  
 Orig-A 07018

09° 30'N-138° 05'E

YAP INTL (T11)(PTYA)  
**NDB RWY 25**

**INTENTIONALLY  
LEFT  
BLANK**

CLIMB/DESCENT TABLE 10042

INSTRUMENT TAKEOFF OR APPROACH PROCEDURE CHARTS RATE OF CLIMB/DESCENT TABLE (ft. per min)													
A rate of climb/descent table is provided for use in planning and executing climbs or descents under known or approximate ground speed conditions. It will be especially useful for approaches when the localizer only is used for course guidance. A best speed, power, altitude combination can be programmed which will result in a stable glide rate and altitude favorable for executing a landing if minimums exist upon breakout. Care should always be exercised so that minimum descent altitude and missed approach point are not exceeded.													
CLIMB/ DESCENT ANGLE (degrees and tenths)	ft/NM	GROUND SPEED (knots)											
		60	90	120	150	180	210	240	270	300	330	360	
2.0	210	210	320	425	530	635	743	850	955	1060	1165	1275	
2.5	265	265	400	530	665	795	930	1060	1195	1325	1460	1590	
V E R T I C A L P A T H A N G L E	2.7	287	287	430	574	717	860	1003	1147	1290	1433	1576	1720
	2.8	297	297	446	595	743	892	1041	1189	1338	1486	1635	1783
	2.9	308	308	462	616	770	924	1078	1232	1386	1539	1693	1847
	3.0	318	318	478	637	797	956	1115	1274	1433	1593	1752	1911
	3.1	329	329	494	659	823	988	1152	1317	1481	1646	1810	1975
	3.2	340	340	510	680	850	1020	1189	1359	1529	1699	1869	2039
	3.3	350	350	526	701	876	1052	1227	1402	1577	1752	1927	2103
	3.4	361	361	542	722	903	1083	1264	1444	1625	1805	1986	2166
3.5	370	370	555	745	930	1115	1300	1485	1670	1860	2045	2230	
4.0	425	425	640	850	1065	1275	1490	1700	1915	2125	2340	2550	
4.5	480	480	715	955	1195	1435	1675	1915	2150	2390	2630	2870	
5.0	530	530	795	1065	1330	1595	1860	2125	2390	2660	2925	3190	
5.5	585	585	880	1170	1465	1755	2050	2340	2635	2925	3220	3510	
6.0	640	640	960	1275	1595	1915	2235	2555	2875	3195	3510	3830	
6.5	690	690	1040	1385	1730	2075	2425	2770	3115	3460	3805	4155	
7.0	745	745	1120	1490	1865	2240	2610	2985	3355	3730	4105	4475	
7.5	800	800	1200	1600	2000	2400	2800	3200	3600	4000	4400	4800	
8.0	855	855	1280	1710	2135	2560	2990	3415	3845	4270	4695	5125	
8.5	910	910	1360	1815	2270	2725	3180	3630	4085	4540	4995	5450	
9.0	960	960	1445	1925	2405	2885	3370	3850	4330	4810	5295	5775	
9.5	1015	1015	1525	2035	2540	3050	3560	4065	4575	5085	5590	6100	
10.0	1070	1070	1605	2145	2680	3215	3750	4285	4820	5355	5890	6430	

CLIMB/DESCENT TABLE 10042