

# **PORCE-NAMEL**

**Kitchen Furniture**

**MUTSCHLER BROS. CO. *Nappanee, Ind.***

# PORCE-NAMEL

TRADE-MARK REGISTERED

## KITCHEN FURNITURE

*Nationally Advertised and in Strong Demand*

COMPLETE PRICE LIST

**APRIL 1, 1929**

---

Prices Subject to Change Without Notice

### TERMS

2 per cent discount for cash in 30 days FROM DATE OF INVOICE or 60 days net. An extra 5 per cent trade discount is allowed on car loads. F. O. B. Factory.

### PACKING AND CRATING

On cabinets no extra charge. On tables no extra charge, except on K. D. tables listing under \$20.00 when crated singly, 50 cents extra, list price.

### DELIVERY

OUR RESPONSIBILITY CEASES WHEN THIS FURNITURE IS DELIVERED AND RECEIPTED FOR IN GOOD ORDER BY THE TRANSPORTATION COMPANY. We aim to make prompt shipments and will assist in hastening delivery. All of our Cabinets, Tables and Cupboards are packed in a most practical manner and if handled with ordinary care by the Transportation Companies will reach destination in first class condition. ALL CLAIMS FOR DELAY, LOSS OR DAMAGE MUST BE MADE AGAINST THE CARRIERS.

---

CATALOG OF SAMSON OFFICE AND DIRECTORS TABLES  
SENT UPON REQUEST

## Mutschler Brothers Co.

Nappanee, Indiana, U. S. A.

### EXHIBITS

American Furniture Mart—Chicago—Permanent, Daily  
206 Lexington Ave., New York City—Permanent, Daily  
75-87 Northampton Street, Boston—Permanent, Daily  
J. H. Moore Co., Inc., Tulsa, Okla.—Permanent, Daily

# PORCE-NAMEL

## KITCHEN FURNITURE

*Displayed Throughout the  
Year at*

**1017 American Furniture Mart**  
Chicago, Illinois

**The L. D. Waters Sales Co.**  
206 Lexington Avenue  
New York City, N. Y.

**The Casey-Foster Company**  
75-87 Northampton Street  
Boston, Massachusetts

**J. H. Moore Co., Inc.**  
Madison & Frisco R. R.  
Tulsa, Okla.

*Catalog E*

### MUTSCHLER BROTHERS Co.

➤ *Makers of Fine Furniture Since 1896* ◀

NAPPANEE, INDIANA

## *foreword*

**P**ORCE-NAMEL Kitchen Furniture includes the largest assortment of styles, sizes, and color combinations to be found in the field of quality kitchen merchandise today.

We want our dealers to come to us with full confidence that their needs will be taken care of, and in a way most satisfactory to themselves and to their customers.

A consistent policy of National Advertising in leading Women's publications—and the more important publicity received through recommendations by users and dealers, are daily increasing the popularity of Porce-Namel.

Aggressiveness in styles, maintenance of quality, and the practice of "fair dealing" enables the Mutschler Brothers Company to serve you advantageously in increasing profits in your Kitchen Furniture Department.

# PORCE-NAMEL

## Its Beauty and Construction

AS consumer demand grows and changes — so does the line of Porce-Namel Kitchen Furniture, with the result that now complete harmony is possible in all of the kitchen appointments. Drop Leaf Breakfast Sets, Kitchen Cabinets, Bases, Leg Tables and Auxiliary Units are finished and trimmed to match perfectly—even to the artistic and varied design on the porcelain tops. This influences your customers to buy a number of pieces of Porce-Namel Kitchen Furniture at one time and creates a desire to dispose of the old and unsightly—in favor of the new.

## Color Combinations

### Drop Leaf Breakfast Sets

| Color of Base—<br>Tops and Leaves | Edge of Top—<br>Leaves and Trim | Floral Decorations |
|-----------------------------------|---------------------------------|--------------------|
| Green                             | Orange                          | Ivory and Orange   |
| Green                             | White                           | Ivory and Orange   |
| Ivory                             | Green                           | Green and Red      |
| Ivory                             | Blue                            | Blue and Orange    |
| Ivory                             | Red                             | Green and Red      |
| Grey                              | Blue                            | Blue and Orange    |
| Grey                              | Green                           | Green and Orange   |
| White                             | Blue                            | Blue and Orange    |
| White                             | Green                           | Green and Red      |

The colors and designs of the floral decorations used with the four basic colors are each distinctly different, thereby meeting the demands of your trade for the plain and conservative or for the more elaborate — omitting all that might be classed extreme.

### Kitchen Cabinets, Bases, Tables and Cupboards

Porce-Namel Cabinets, Bases, Tables and Cupboards are finished and decorated to match the various color combinations of the Drop Leaf Tables. The 36 inch and 40 inch Cabinets, Bases and Tables may be had with the full colored and decorated porcelain tops if desired—the same as those used on the decorated Drop Leaf Tables. Any of the sizes of tops are furnished in the all white, or white with green, blue or orange edges. Please specify colors carefully. Do not ask us to supply special colored tops or interchange the colors or stencil designs.

## Special Construction Features

### New Original Shaped Drop Leaves

Your attention is especially directed to the new style 11 inch shaped porcelain drop leaves to be found exclusively on Porce-Namel Drop Leaf Tables. This full roomy leaf affords ample dining or working surface and adds greatly to the beauty of a table that has already met with enthusiastic consumer demand.

### New Linoleum Top Drop Leaf and Extension Tables

On pages from 23 to 29 inclusive see the complete Porce-Namel line of Linoleum Top Drop Leaf and

Extension Tables, with companion Leg Tables. Green or brown inlaid linoleum in jaspe finish is used on a heavy plywood under top. This new surface is quiet, serviceable, attractive, and is being used very effectively by those who do not care for porcelain or plain wood tops. Though recently introduced, sales of it are far beyond our most optimistic expectation. Without doubt it is a coming standard table in all Kitchen Furniture Departments.

## General Construction

### Drop Leaf Tables

On all Porce-Namel Decorated Drop Leaf Tables heavy metal leaf supports are used which are positive and easy to work. These supports break together or one may be broken at a time. Drawers are lip construction, dovetailed front and back with framed-in plywood bottoms. Porcelain tops are the genuine "Laflat" guaranteed never to buckle or bulge. The legs are slightly staggered, thus adding to the beauty and strength of the table, at the same time giving more room for the chairs between the legs.

### Laflat Porcelain Tops

Laflat porcelain tops are used on all Porce-Namel Bases, Cabinets, and Tables. This construction is patented and guaranteed to keep the top flat and free from buckle or bulge. The Laflat process has been worked out in our own factories and is, in our judgment, the best top construction known.

### Dovetailed Drawer Construction

Porce-Namel drawers are dovetailed front and back with framed-in plywood bottoms—like the finest living, dining room or office furniture. This feature will especially appeal to your trade for it insures the longest possible life obtainable in drawer construction.

### Double Extension Sliding Top

On Models 48, 42 and 36 Kitchen Cabinets, the "Laflat" sliding top pulls forward locking automatically for extra working surface. From that position, by a touch of the finger the top pulls forward, again locking in the extreme extended position, for dining table use. This is one of the many conveniences of Porce-Namel Kitchen Cabinets and adds greatly to their salability.

### Hardware

The polished nickel chromium plated hardware of highest quality is rust proof and insures a lasting brightness.

The sifter type metal flour bin used in all Porce-Namel Cabinets is of twenty-five pound capacity, finished to match the cabinet. In the base tables, the forty pound drawer type metal flour bins pull forward and tilt down bringing the flour to the front.

For other Porce-Namel features of construction and convenience we refer you to pages 62 and 63.



## Porce-Namel Decorated Drop Leaf Table

*Model 4090 and 3690*

*FINISHED* in green with orange edge top and orange trim on legs. The floral decorations are in ivory and orange. Laflat porcelain top, dovetailed drawer and other construction features are as described on page 3. Furnished in 25 x 40 or 25 x 36 inch sizes with 11 inch shaped drop leaves. Use Models 4-90, 6-90 or 8-90 chairs to match this table. (See page 21).

Model 4090 size 40 x 47 in. Leaves Extended.

Shipping weight 82 lbs.

Model 3690 size 36 x 47 in. Leaves Extended.

Shipping weight 75 lbs.



## Decorated Turned Leg Table

*Model 490 and 390*

*LAFLAT* porcelain top table with dovetailed drawer. Finished and decorated as a companion table to Model 4090 and 3690.

Model 490 size 25 x 40 in.  
Weight crated double 102 lbs.

Model 390 size 25 x 36 in.  
Weight crated double 98 lbs.



## Porce-Namel Decorated Drop Leaf Table

*Model 4097 and 3697*

*FINISHED* in green with white edge top and white trim on legs. The floral decorations are in ivory and orange. Laflat porcelain top, dovetailed drawer and other construction features are as described on page 3. Furnished in 25 x 40 or 25 x 36 inch sizes with 11 inch shaped drop leaves. Use Models 4-97, 6-97 or 8-97 chairs to match this table. (See page 21).

Model 4097 size 40 x 47 in. Leaves Extended. Shipping weight 82 lbs.

Model 3697 size 36 x 47 in. Leaves Extended. Shipping weight 75 lbs.

## Decorated Turned Leg Table

*Model 497 and 397*

*LAFLAT* porcelain top with dove-tailed drawer. Finished and decorated as a companion table to Model 4097 or 3697.

Model 497 size 25 x 40 in.  
Weight crated double 102 lbs.

Model 397 size 25 x 36 in.  
Weight crated double 98 lbs.





## Porce-NameL Decorated Drop Leaf Table

*Model 4039 and 3639*

*AS* illustrated—this model is finished in ivory with green edge top and green trim on legs. The floral decorations are in green and red. Laflat top, drawer construction and other notable features as described on page 3. Furnished in 25 x 40 or 25 x 36 inch sizes, with 11 inch shaped drop leaves. Use Model 4-39, 6-39 or 8-39 chairs to match this table. (See page 21).

Model 4039 size 40 x 47 in. Leaves Extended.  
Model 3639 size 36 x 47 in. Leaves Extended.

Shipping weight 82 lbs.  
Shipping weight 75 lbs.



## Decorated Turned Leg Table

*Model 439 and 339*

*LAFLAT* porcelain top table with dovetailed drawer. Finished and decorated as a companion table to Model 4039 and 3639.

Model 439 size 25 x 40 in.  
Weight crated double 102 lbs.

Model 339 size 25 x 36 in.  
Weight crated double 98 lbs.



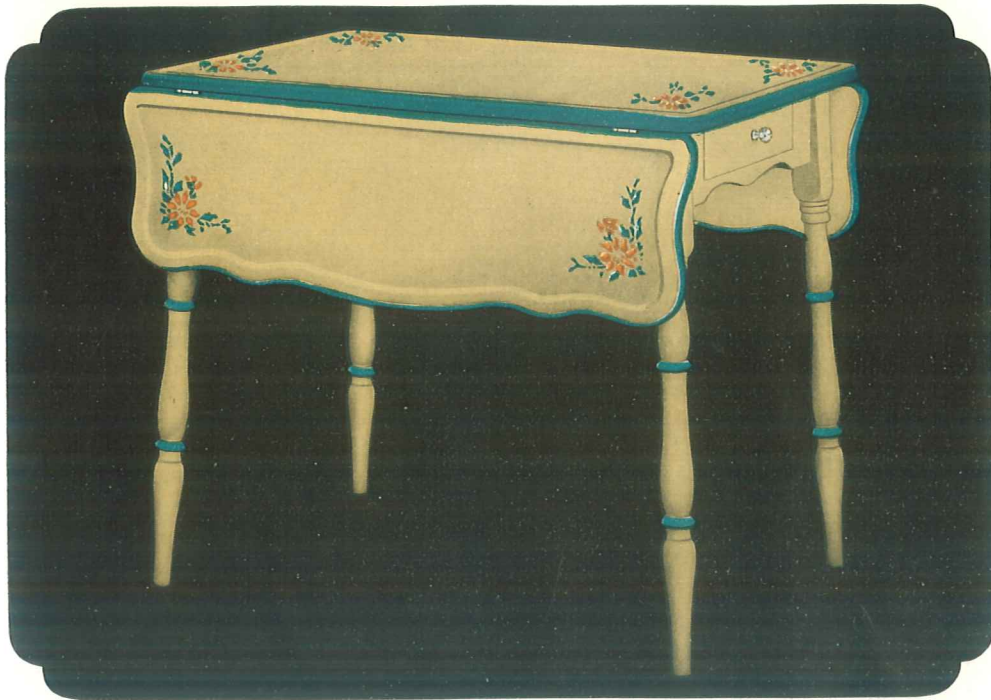

## Porce-Namel Decorated Drop Leaf Table

*Model 4036 and 3636*

*FINISHED* in ivory with blue edge top and blue trim on legs. The floral decorations are in blue and orange. Laflat porcelain top, dovetailed drawer and other construction features are as described on page 3. Furnished in 25 x 40 or 25 x 36 inch sizes, with 11 inch shaped drop leaves. Use Models 4-36, 6-36 or 8-36 chairs to match this table. (See page 21).

Model 4036 size 40 x 47 in. Leaves Extended.

Shipping weight 82 lbs.

Model 3636 size 36 x 47 in. Leaves Extended.

Shipping weight 75 lbs.

## Decorated Turned Leg Table

*Model 436 and 336*

*LAFLAT* porcelain top table with dovetailed drawer. Finished and decorated as a companion table to Model 4036 and 3636.

Model 436 size 25 x 40 in.  
Weight crated double 102 lbs.

Model 336 size 25 x 36 in.  
Weight crated double 98 lbs.





## Porce-Namel Decorated Drop Leaf Table

*Model 4032 and 3632*

*FINISHED* in ivory with red edge top and red trim on legs. The floral decorations are in red and green. Laflat porcelain top, strong metal leaf supports and other construction features as described on page 3. Furnished in 25 x 40 or 25 x 36 inch sizes, with 11 inch shaped drop leaves. Use Models 4-32, 6-32 or 8-32 chairs to match this table. (See page 21).

Model 4032 size 40 x 47 in. Leaves Extended.

Shipping weight 82 lbs.

Model 3632 size 36 x 47 in. Leaves Extended.

Shipping weight 75 lbs.



## Decorated

## Turned Leg Table

*Model 432 and 332*

*LAFLET* porcelain top table with dove-tailed drawer. Finished and decorated as a companion table to Model 4032 and 3632.

Model 432 size 25 x 40 in.  
Weight crated double 102 lbs.

Model 332 size 25 x 36 in.  
Weight crated double 98 lbs.



## Porce-NameL Decorated Drop Leaf Table

*Model 4089 and 3689*

*FINISHED* in grey with green edge top and green trim on legs. The floral decorations are in green and orange. Laflat porcelain top, dovetailed drawer and other construction features are as described on page 3. Furnished in 25 x 40 or 25 x 36 inch sizes with 11 inch shaped drop leaves. Use Models 4-89, 6-89 or 8-89 chairs to match this table. (See page 21).

Model 4089 size 40 x 47 in. Leaves Extended.

Shipping weight 82 lbs.

Model 3689 size 36 x 47 in. Leaves Extended.

Shipping weight 75 lbs.

## Decorated Turned Leg Table

*Model 489 and 389*

*LAFLAT* porcelain top table with dovetailed drawer. Finished and decorated as a companion table to Model 4089 and 3689.

Model 489 size 25 x 40 in.  
Weight crated double 102 lbs.

Model 389 size 25 x 36 in.  
Weight crated double 98 lbs.





## Porce-Namel Decorated Drop Leaf Table

*Model 4086 and 3686*

*FINISHED* in grey with blue edge top and blue trim on legs. The floral decorations are in blue and orange. Laflat porcelain top, dovetailed drawer and other construction features are as described on page 3. Furnished in 25 x 40 or 25 x 36 inch sizes with 11 inch shaped drop leaves. Use Models 4-86, 6-86 or 8-86 chair to match this table. (See page 21).

Model 4086 size 40 x 47 in. Leaves Extended.  
Model 3686 size 36 x 47 in. Leaves Extended.

Shipping weight 82 lbs.  
Shipping weight 75 lbs.



## Decorated Turned Leg Table

*Model 486 and 386*

*LAFLAT* porcelain top table with dovetailed drawer. Finished and decorated as a companion table to Model 4086 and 3686.

Model 486 size 25 x 40 in.  
Weight crated double 102 lbs.

Model 386 size 25 x 36 in.  
Weight crated double 98 lbs.



## Porce-Namel Decorated Drop Leaf Table

*Model 4079 and 3679*

*FINISHED* in white with green edge top and green trim on legs. The floral decorations are in green and red. Laflat porcelain top, dovetailed drawer and other construction features are as described on page 3. Furnished in 25 x 40 or 25 x 36 inch sizes with 11 inch shaped drop leaves. Use Models 4-79, 6-79 or 8-79 chairs to match this table. (See page 21).

Model 4079 size 40 x 47 in. Leaves Extended.

Shipping weight 82 lbs.

Model 3679 size 36 x 47 in. Leaves Extended.

Shipping weight 75 lbs.

## Decorated Turned Leg Table

*Model 479 and 379*

*LAFLAT* porcelain top table with dovetailed drawer. Finished and decorated as a companion table to Model 4079 and 3679.

Model 479 size 25 x 40 in.  
Weight crated double 102 lbs.

Model 379 size 25 x 36 in.  
Weight crated double 98 lbs.





## Porce-Namel Decorated Drop Leaf Table

*Model 4076 and 3676*

*FINISHED* in white with blue edge top and blue trim on legs. The floral decorations are in blue and orange. Laflat porcelain top, dovetailed drawers and other construction features are as described on page 3. Furnished in 25 x 40 or 25 x 36 inch sizes with 11 inch shaped drop leaves. Use Models 4-76, 6-76 or 8-76 chairs to match this table. (See page 21).

Model 4076 size 40 x 47 in. Leaves Extended.  
Model 3676 size 36 x 47 in. Leaves Extended.

Shipping weight 82 lbs.  
Shipping weight 75 lbs.



## Decorated Turned Leg Table

*Model 476 and 376*

*LAFLAT* porcelain top table with dovetailed drawer. Finished and decorated as a companion table to Model 4076 and 3676.

Model 476 size 25 x 40 in.  
Weight crated double 102 lbs.

Model 376 size 25 x 36 in.  
Weight crated double 98 lbs.

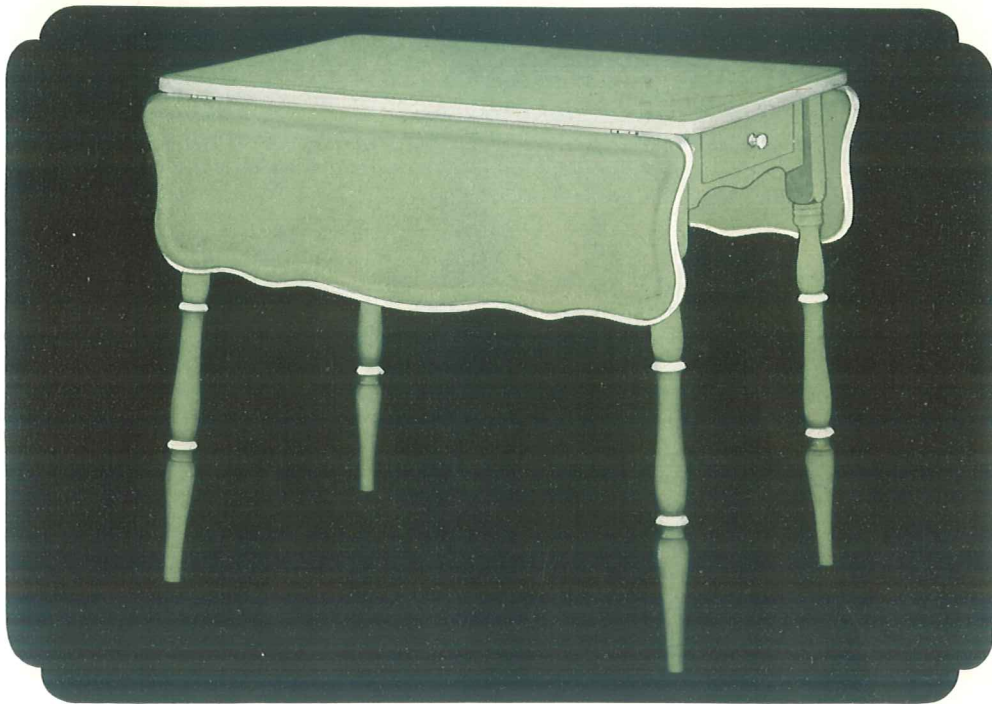

## Porce-NameL Decorated Drop Leaf Table

*Model 4097E and 3697E*

*FINISHED* in green with white edge top and white trim on legs. Laflat porcelain top, dovetailed drawer and other construction features as described on page 3. Furnished in 25 x 40 or 25 x 36 inch sizes with 11 inch shaped drop leaves. Use Models 4-97, 6-97 or 8-97 chairs to match this table. (See page 21).

Model 4097E size 40 x 47 in. Leaves Extended.

Shipping weight 82 lbs.

Model 3697E size 36 x 47 in. Leaves Extended.

Shipping weight 75 lbs.

## Decorated Turned Leg Table

*Model 497E and 397E*

*LAFLAT* porcelain top table with dove-tailed drawer. Finished and decorated as a companion table to Model 4097E and 3697E.

Model 497E size 25 x 40 in.  
Weight crated double 102 lbs.

Model 397E size 25 x 36 in.  
Weight crated double 98 lbs.



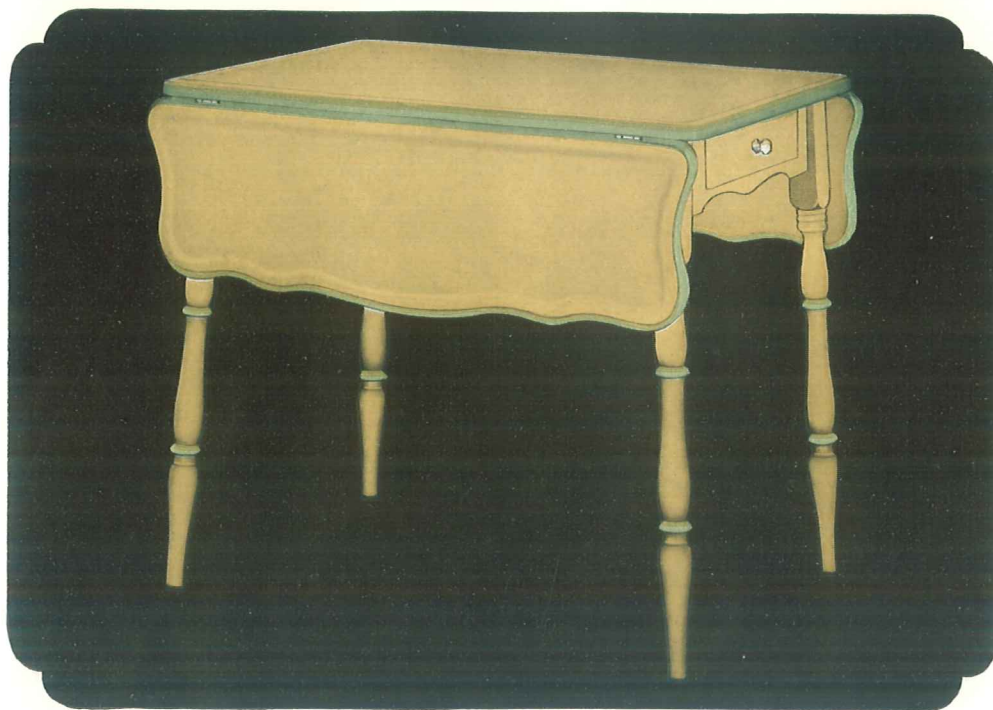

## Porce-Namel Decorated Drop Leaf Table

### Model 4039E and 3639E

*FINISHED* in ivory with green edge top and green trim on legs. Laflat porcelain top, dovetailed drawer and other construction features as described on page 3. Furnished in 25 x 40 or 25 x 36 inch sizes with 11 inch shaped drop leaves. Use Models 4-39, 6-39 or 8-39 chairs to match this table. (See page 21).

Model 4039E size 40 x 47 in. Leaves Extended.  
Model 3639E size 36 x 47 in. Leaves Extended.

Shipping weight 82 lbs.  
Shipping weight 75 lbs.



## Decorated Turned Leg Table

### Model 439E and 339E

*LAF* porcelain top table with dovetailed drawer. Finished and decorated as a companion table to Model 4039E and 3639E.

Model 439E size 25 x 40 in.  
Weight crated double 102 lbs.

Model 339E size 25 x 36 in.  
Weight crated double 98 lbs.



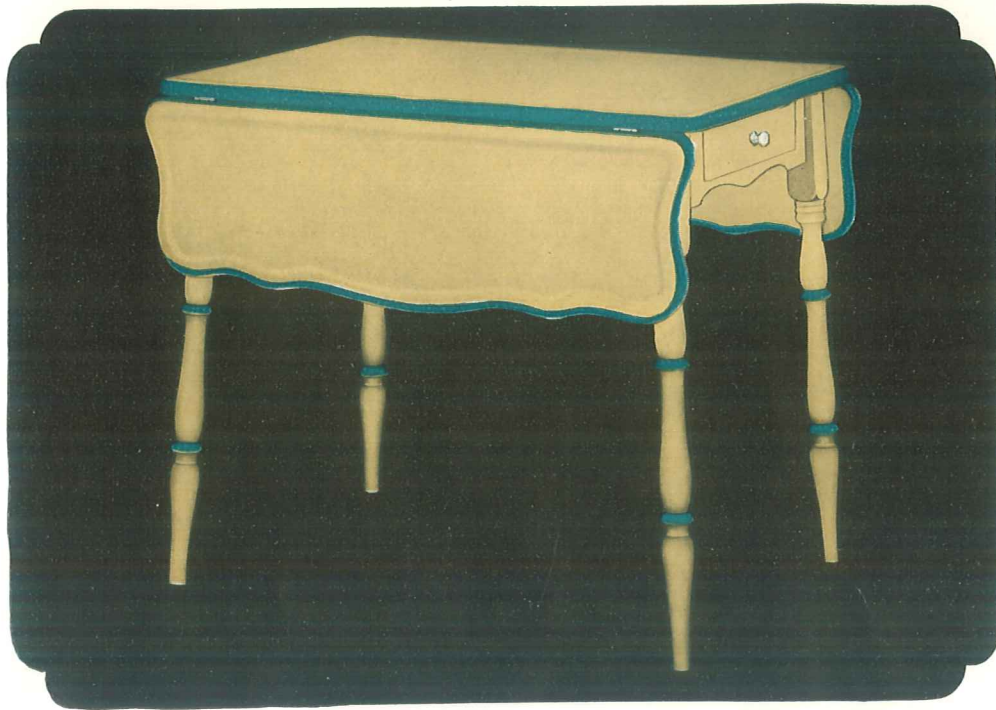

## Porce-Namel Decorated Drop Leaf Table

### Model 4036E and 3636E

*FINISHED* in ivory with blue edge top and blue trim on legs. Laflat porcelain top, dovetailed drawer and other construction features as described on page 3. Furnished in 25 x 40 or 25 x 36 inch sizes with 11 inch shaped drop leaves. Use Models 4-36, 6-36 or 8-36 chairs to match this table. (See page 21).

Model 4036E size 40 x 47 in. Leaves Extended. Shipping weight 82 lbs.  
 Model 3636E size 36 x 47 in. Leaves Extended. Shipping weight 75 lbs.

## Decorated Turned Leg Table

### Model 436E and 336E

*LAF* porcelain top table with dovetailed drawer. Finished and decorated as a companion table to Model 4036E and 3636E.

Model 436E size 25 x 40 in.  
 Weight crated double 102 lbs.  
 Model 336E size 25 x 36 in.  
 Weight crated double 98 lbs.



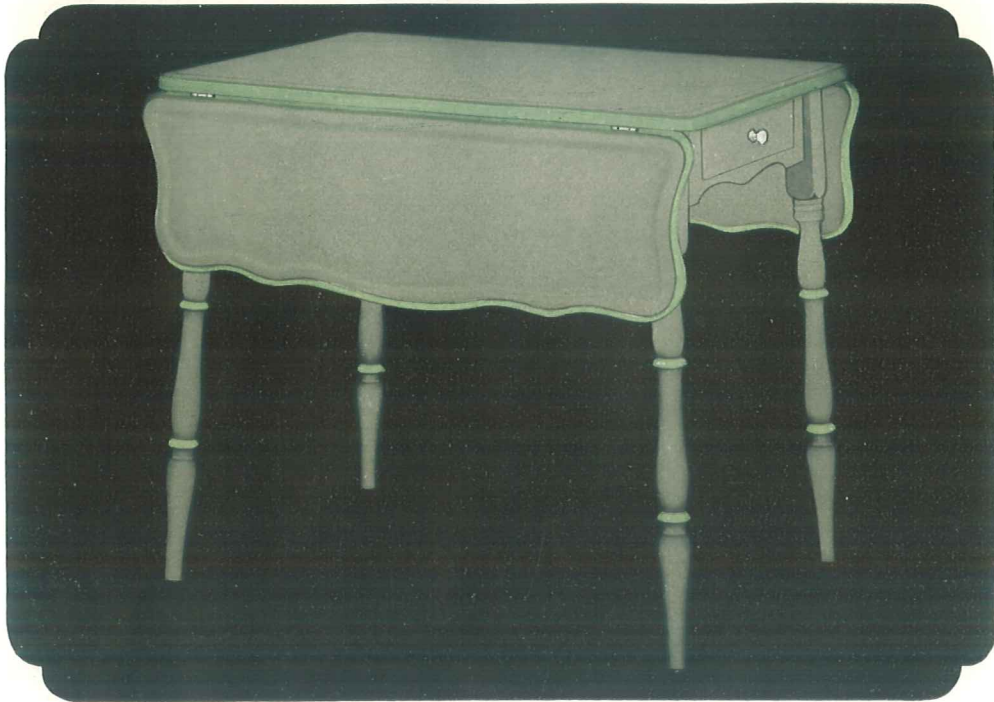

## Porce-Namel Decorated Drop Leaf Table

*Model 4089E and 3689E*

*FINISHED* in grey with green edge top and green trim on legs. Laflat porcelain top, dovetailed drawer and other construction features as described on page 3. Furnished in 25 x 40 or 25 x 36 inch sizes with 11 inch shaped drop leaves. Use Models 4-89, 6-89 or 8-89 chairs to match this table. (See page 21).

Model 4089E size 40 x 47 in. Leaves Extended.

Shipping weight 82 lbs.

Model 3689E size 36 x 47 in. Leaves Extended.

Shipping weight 75 lbs



## Decorated Turned Leg Table

*Model 489E and 389E*

*LAFLAT* porcelain top table with dovetailed drawer. Finished and decorated as a companion table to Model 4089E and 3689E.

Model 489E size 25 x 40 in.  
Weight crated double 102 lbs.

Model 389E size 25 x 36 in.  
Weight crated double 98 lbs.

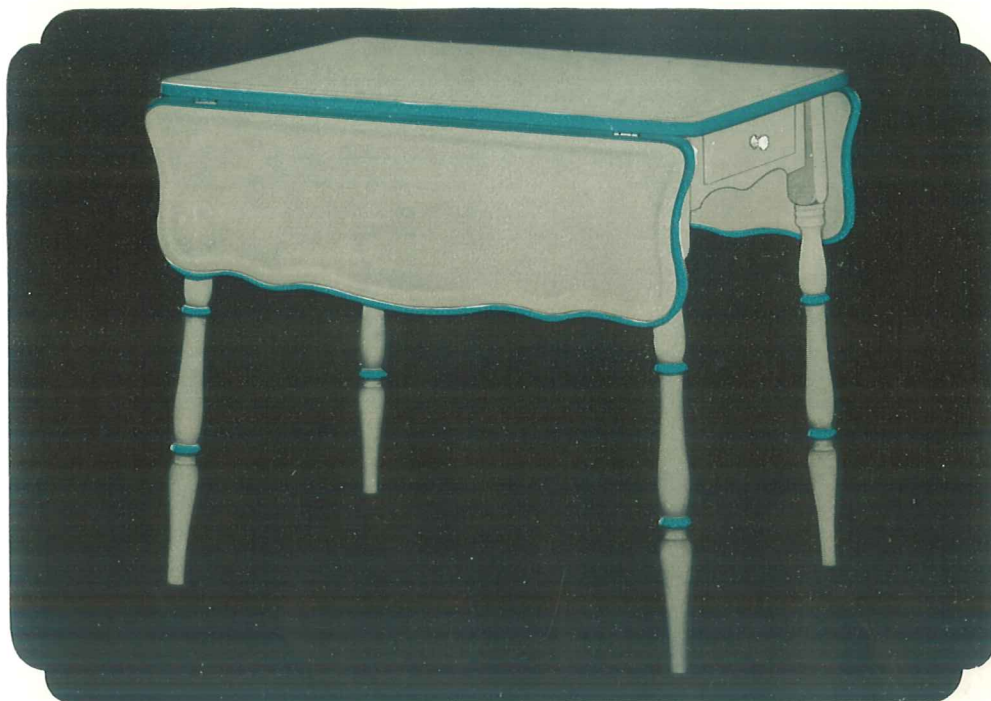

## Porce-Namel Decorated Drop Leaf Table

*Model 4086E and 3686E*

*FINISHED* in grey with blue edge top and blue trim on legs. Laflat porcelain top, dovetailed drawer and other construction features are as described on page 3. Furnished in 25 x 40 or 25 x 36 inch sizes with 11 inch shaped drop leaves. Use Models 4-86, 6-86 or 8-86 chairs to match this table. (See page 21).

Model 4086E size 40 x 47 in. Leaves Extended. Shipping weight 82 lbs.  
 Model 3686E size 36 x 47 in. Leaves Extended. Shipping weight 75 lbs.

## Decorated Turned Leg Table

*Model 486E and 386E*

*LAFLAT* porcelain top table with dove-tailed drawer. Finished and decorated as a companion table to Model 4086E and 3686E.

Model 486E size 25 x 40 in.  
 Weight crated double 102 lbs.

Model 386E size 25 x 36 in.  
 Weight crated double 98 lbs.



57



## Porce-Namel Decorated Drop Leaf Table

*Model 4079E and 3679E*

*FINISHED* in white with green edge top and green trim on legs. Laflat porcelain top, dovetailed drawer and other construction features as described on page 3. Furnished in 25 x 40 or 25 x 36 inch sizes with 11 inch shaped drop leaves. Use Models 4-79, 6-79 or 8-79 chairs to match this table. (See page 21).

Model 4079E size 40 x 47 in. Leaves Extended.

Shipping weight 82 lbs.

Model 3679E size 36 x 47 in. Leaves Extended.

Shipping weight 75 lbs.



## Decorated Turned Leg Table

*Model 479E and 379E*

*LAFLAT* porcelain top table with dovetailed drawer. Finished and decorated as a companion table to Model 4079E and 3679E.

Model 479E size 25 x 40 in.  
Weight crated double 102 lbs.

Model 379E size 25 x 36 in.  
Weight crated double 98 lbs.

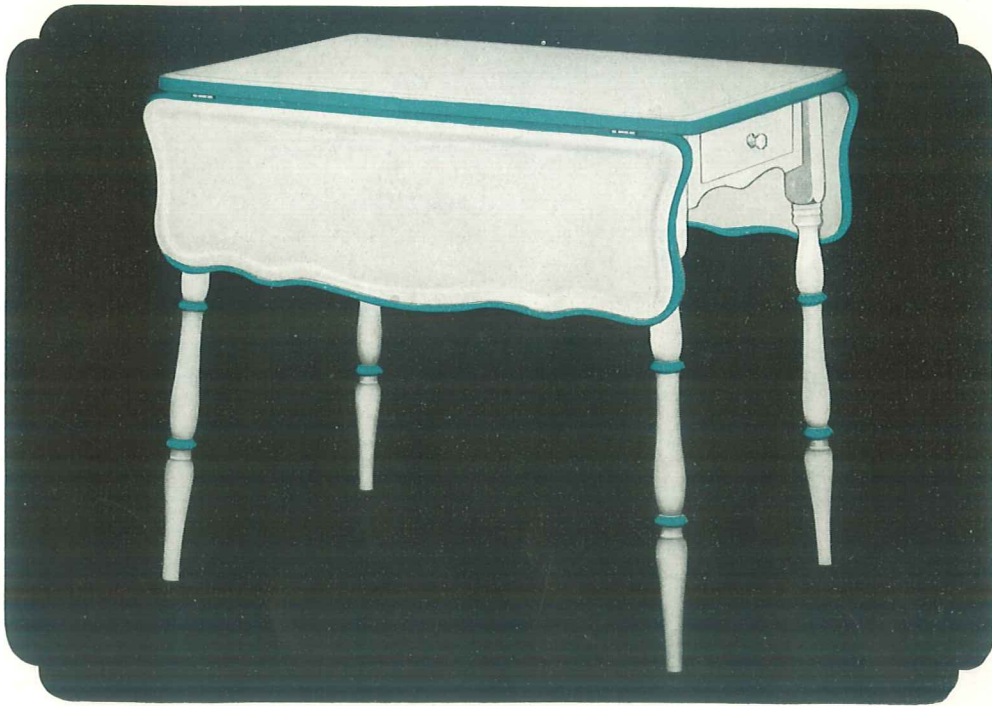

## Porce-Namel Decorated Drop Leaf Table

*Model 4076E and 3676E*

*FINISHED* in white with blue edge top and blue trim on legs. Laflat porcelain top, dovetailed drawer and other construction features as described on page 3. Furnished in 25 x 40 or 25 x 36 inch sizes with 11 inch shaped drop leaves. Use Models 4-76, 6-76 or 8-76 chairs to match this table. (See page 21).

Model 4076E size 40 x 47 in. Leaves Extended.

Shipping weight 82 lbs.

Model 3676E size 36 x 47 in. Leaves Extended.

Shipping weight 75 lbs.

## Decorated Turned Leg Table

*Model 476E and 376E*

*LAF* porcelain top table with dovetailed drawer. Finished and decorated as a companion table to Model 4076E and 3676E.

Model 476E size 25 x 40 in.  
Weight crated double 102 lbs.

Model 376E size 25 x 36 in.  
Weight crated double 98 lbs.



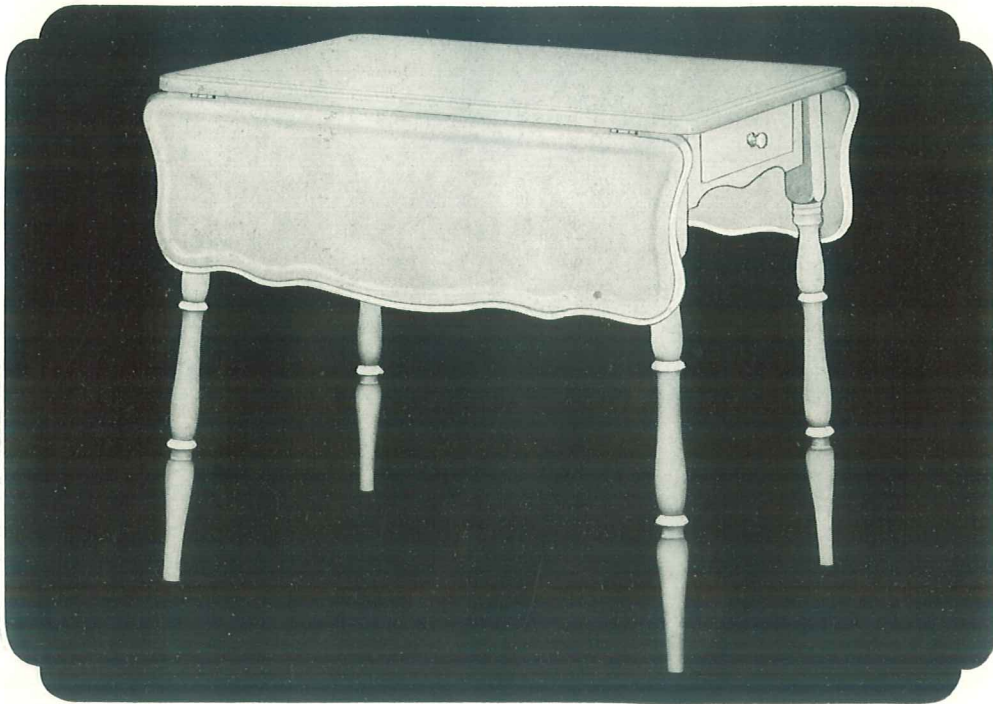

## Porce-Namel Drop Leaf Table

*Model 4077 and 3677*

*FINISHED* in white satin enamel with white Laflat porcelain top. Dovetailed drawer, heavy metal leaf supports and other construction features as described on page 3. Furnished in 25 x 40 or 25 x 36 inch sizes with 11 inch shaped drop leaves. See chairs on page 21.

Model 4077 size 40 x 47 inches, leaves extended. Shipping weight 82 pounds.

Model 3677 size 36 x 47 inches, leaves extended. Shipping weight 75 pounds.



## Linoleum Top Gate-Leg Table

*Model 66*

*THIS* new table is designed to be used in the kitchen or breakfast nook, and due to its compactness when leaves are down, it is very convenient for apartment use. The green inlaid linoleum (jaspe finish) is laid on a heavy plywood top which provides against any possibility of warping. The size is 10½ x 30 inches when leaves are down, or 36½ x 30 inches, leaves extended. Height 31 inches. Finished in ivory, green, grey or white, trimmed to match the other Porce-Namel color combinations.





Pinch Back  
Style 4

Bow Back  
Style 6

Fiddle Back  
Style 8

## Porce-Namel Chairs

*ILLUSTRATED* above are the three different styles of chairs furnished to match the various Porce-Namel drop leaf breakfast tables and decorated leg tables. All of these, with the exception of Model 4 oak, are high-grade solid birch chairs nicely sanded and finished. Shipping weight 50 pounds, four chairs packed in a carton.

| Pinch-Back<br>Chairs<br>Model | Bow-Back<br>Chairs<br>Model | Fiddle-Back<br>Chairs<br>Model | Color | Decorations      |
|-------------------------------|-----------------------------|--------------------------------|-------|------------------|
| 4-90                          | 6-90                        | 8-90                           | Green | Orange and Ivory |
| 4-97                          | 6-97                        | 8-97                           | Green | White and Orange |
| 4-39                          | 6-39                        | 8-39                           | Ivory | Green and Red    |
| 4-36                          | 6-36                        | 8-36                           | Ivory | Blue and Orange  |
| 4-32                          | 6-32                        | 8-32                           | Ivory | Red and Green    |
| 4-89                          | 6-89                        | 8-89                           | Grey  | Green and Orange |
| 4-86                          | 6-86                        | 8-86                           | Grey  | Blue and Orange  |
| 4-76                          | 6-76                        | 8-76                           | White | Blue and Orange  |
| 4-79                          | 6-79                        | 8-79                           | White | Green and Red    |
| 4- 7                          | 6- 7                        | 8- 7                           | White | Plain            |
| 4 Oak.                        | Shaded Oak.                 |                                |       |                  |



*Open Cupboard Style  
Model 739-1*



*Closed Cupboard Style  
Model 790-2*

## Porce-Namel Servers Model 739-1 and 790-2

*THESE* servers, with closed or open cupboards, are finished to accompany any of the Porce-Namel drop leaf breakfast sets. The Laflat porcelain top is 16 x 34 inches, height over all 58½ inches. Fitted with one dovetailed drawer for silverware. Weight: open style 75 pounds; closed style 80 pounds.

| Open Cupboard<br>Style | Closed Cupboard<br>Style | Color | Decorations      |
|------------------------|--------------------------|-------|------------------|
| 739-1                  | 739-2                    | Ivory | Green and Red    |
| 736-1                  | 736-2                    | Ivory | Blue and Orange  |
| 732-1                  | 732-2                    | Ivory | Red and Green    |
| 790-1                  | 790-2                    | Green | Orange and Ivory |
| 797-1                  | 797-2                    | Green | White and Orange |
| 789-1                  | 789-2                    | Grey  | Green and Orange |
| 786-1                  | 786-2                    | Grey  | Blue and Orange  |
| 779-1                  | 779-2                    | White | Green and Red    |
| 776-1                  | 776-2                    | White | Blue and Orange  |



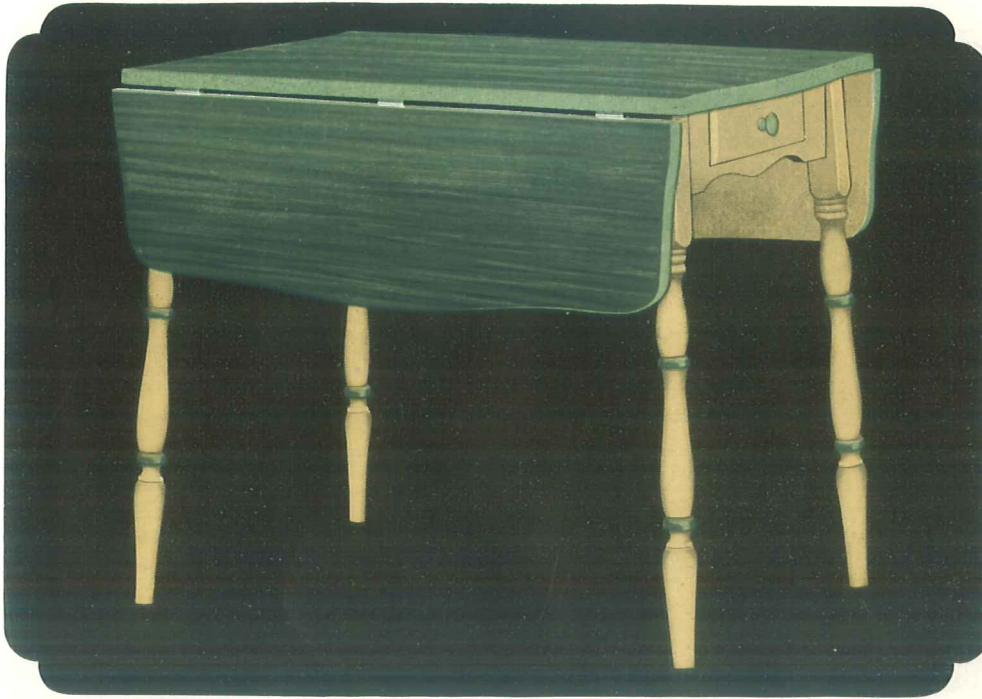

### Porce-Namel Drop Leaf Table with Linoleum Top Model 550

*THIS* is one of a complete line of linoleum top drop leaf tables recently added to the Porce-Namel Family. Model 550 is finished in ivory with green top and trim. Genuine Armstrong Inlaid Linoleum is used on the heavy plywood top and leaves; this linoleum is flush with the edges, which are nicely decorated. The new linoleum surface is attractive, quiet and has more warmth than porcelain or wood. In addition it is very durable and is not readily stained. Heavy metal braces support the drop leaves. Size 24 x 36 inches; with leaves extended 36 x 46 inches. Weight crated 75 pounds. Use Models 4-39, 6-39 or 8-39 chairs to match.

Model 550 Linoleum Top size 24 x 36 in.

### Porce-Namel Table With Linoleum Top Model 539

*MODEL 539* is an ivory table with a green inlaid linoleum top 24 x 36 inches in size. The decorations are also green. All construction features are in keeping with standard Porce-Namel quality. Height 31 inches. Shipping weight crated two to the crate K. D. 100 pounds. Models 4-39, 6-39 and 8-39 chairs are finished to match.

Model 539 Linoleum Top Size 24 x 36 in.



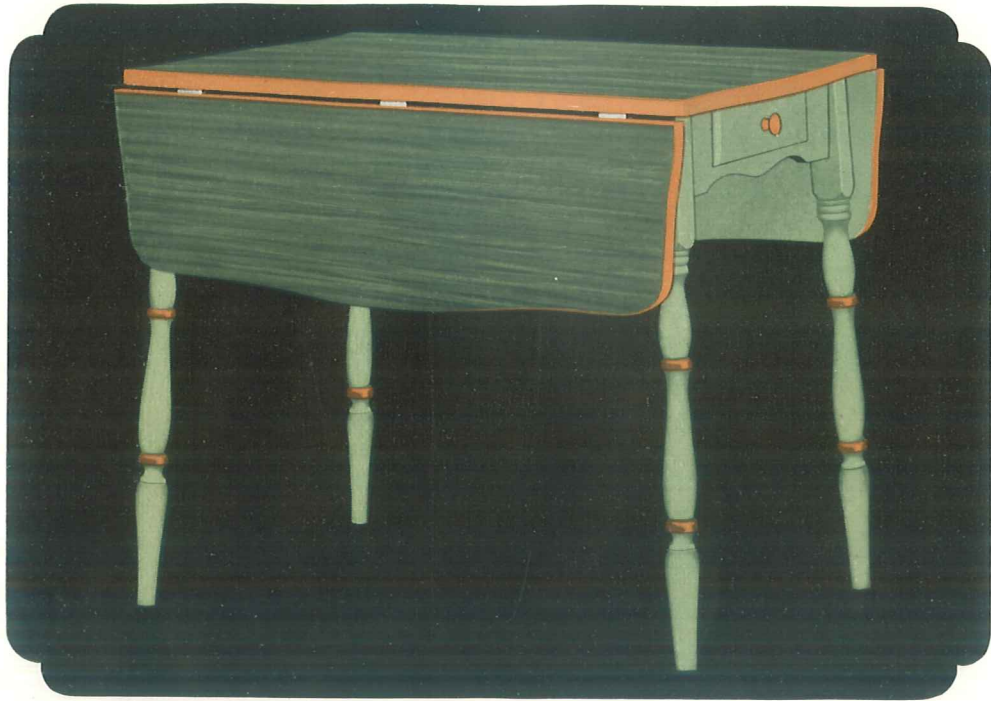

## Porce-Namel Drop Leaf Table *with* Linoleum Top

### Model 551

*MODEL 551* is finished in green satin enamel with green inlaid linoleum top and orange trim. The five-ply top construction, dovetailed drawer, strong metal drop leaf supports, and legs slightly staggered are important construction features. A durable table and easily kept clean. Size 24 x 36 inches; with leaves extended 36 x 46 inches. Shipping weight crated 75 pounds. Use Models 4-90, 6-90 or 8-90 chairs to match.

Model 551 Linoleum Top size 24 x 36 in.



## Porce-Namel Table

### With Linoleum Top

### Model 538

*MODEL 538* is finished in green with a 24 x 36 inch inlaid linoleum top trimmed with orange. The dovetailed drawer, plywood undertop construction and other features are of standard Porce-Namel quality. A smooth, quiet working surface—both serviceable and easily kept clean. Height 31 inches. Shipping weight crated two to the crate K. D. 100 pounds. Models 4-90, 6-90 and 8-90 chairs are finished to match.

Model 538 Linoleum Top size 24 x 36 in.



## Porce-Namel Drop Leaf Table *with* Linoleum Top

### *Model 554*

*MODEL 554* is a shaded oak table with brown jaspe, inlaid linoleum top and green trim. The under-construction for the linoleum is of heavy plywood; drawer is dovetailed; heavy metal leaf supports are used and the legs are slightly staggered. The smooth quiet surface is very desirable for kitchen or breakfast table use. Size 24 x 36 inches; with leaves extended 36 x 46 inches. Shipping weight 75 pounds. Use Model 4 oak chairs (pinch-back) to match this style.

Model 554 Linoleum Top size 24 x 36 in.

## Porce-Namel Table

With Linoleum Top

### *Model 541*

*MODEL 541* is an oak table in shaded oak finish. The brown jaspe finish top is genuine Armstrong Inlaid Linoleum laid on the heavy plywood undertop. The trim is of green enamel. Drawer is dovetailed. This table is a companion piece to Model 554 linoleum top drop leaf style. Height 31 inches. Shipping weight crated two to the crate K. D. 100 pounds. Model 4 oak chair is finished to match.

Model 541 Linoleum Top size 24 x 36 in.



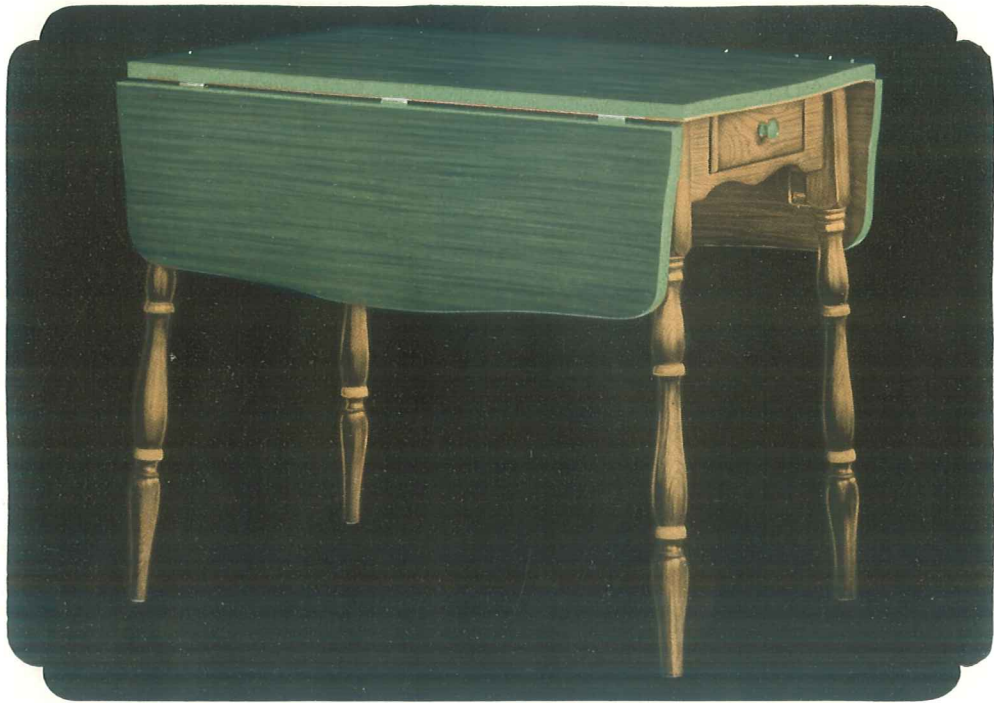

### Porce-Namel Drop Leaf Table *with* Linoleum Top *Model 555*

*MODEL 555* is another shaded oak style with green jaspe, inlaid linoleum top and green trim. Construction features are the same as Model 554. An attractive and practical model to be used as a breakfast table or for general kitchen use. Size 24 x 36 inches; with leaves extended 36 x 46 inches. Shipping weight 75 pounds. Use Model 4 oak chairs (pinch-back) to match this style.

Model 555 Linoleum Top size 24 x 36 in.



### Porce-Namel Table With Linoleum Top *Model 542*

*MODEL 542* is an oak table in shaded oak finish. The top is green inlaid linoleum and the decorations are in green enamel. The smooth, quiet linoleum surface, practical and easy to keep clean, makes this a desirable table for any kitchen. Height 31 inches. Shipping weight crated two to the crate 100 pounds. Model 4 oak chairs are finished to match.

Model 542 Linoleum Top size 24 x 36 in.

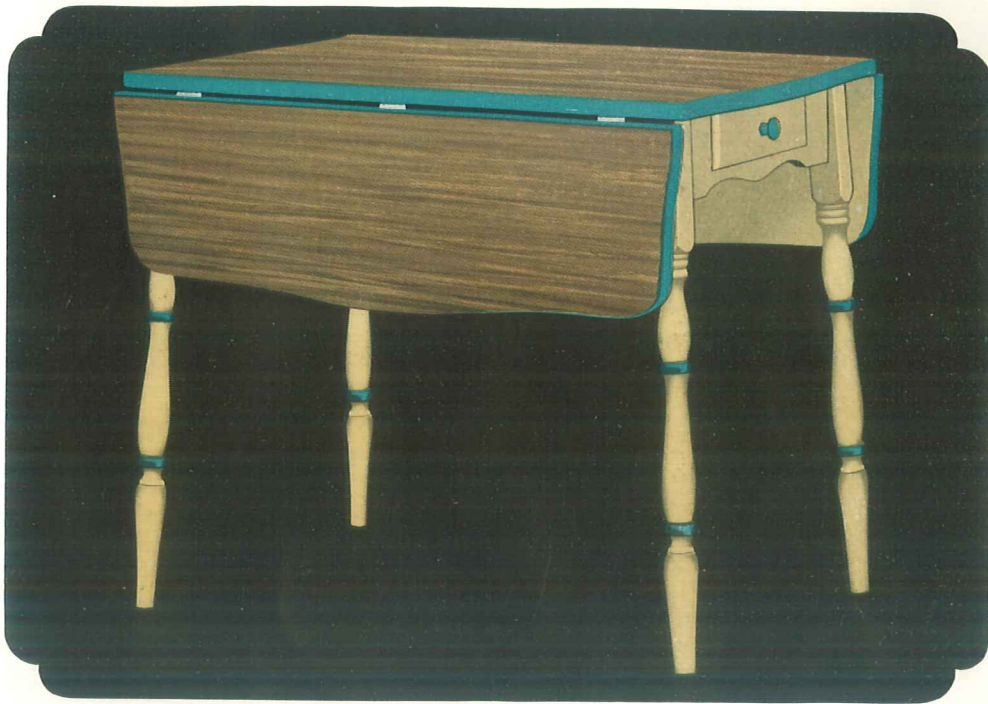

### Porce-Namel Drop Leaf Table *with* Linoleum Top *Model 552*

*MODEL 552* is finished in ivory satin enamel with brown jaspé, inlaid linoleum top and blue trim. The underconstruction for the linoleum is of heavy plywood; drawer is dovetailed; heavy metal drop leaf supports are used, and the legs are slightly staggered. This table is quiet,—not readily stained and is very easy to keep clean. Size 24 x 36 inches; with leaves extended 36 x 46 inches. Shipping weight 75 pounds. Use Model 4-36, 6-36 or 8-36 chairs to match.

Model 552 Linoleum Top size 24 x 36 in.

### Porce-Namel Table With Linoleum Top *Model 537*

*MODEL 537* is finished in ivory. The brown inlaid linoleum top—24 x 36 inches in size, is trimmed in blue. Dovetailed drawers, plywood undertop construction and other features are of regular Porce-Namel quality. A quiet, smooth working surface which is both serviceable and pleasant to use. Height 31 inches. Shipping weight crated two to the crate K. D. 100 pounds. Models 4-36, 6-36 and 8-36 chairs are finished to match.

Model 537 Linoleum Top size 24 x 36 in.



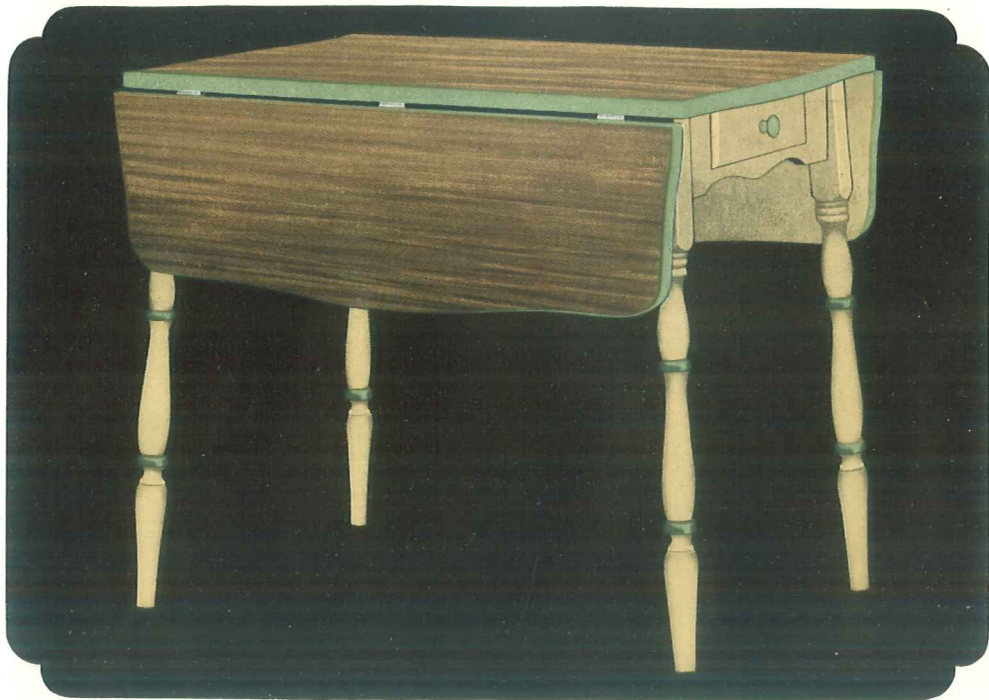

## Porce-Namel Drop Leaf Table *with* Linoleum Top

### *Model 553*

*MODEL 553* is finished in ivory satin enamel with brown jaspe, inlaid linoleum top and green trim. The undertop construction is of plywood, drawer is dovetailed, strong metal drop leaf supports are used and the legs are slightly staggered. The smooth, quiet surface of this linoleum top table makes it very desirable for kitchen or breakfast nook. Size 24 x 36 inches; with leaves extended 36 x 46 inches. Shipping weight 75 pounds. Use Models 4-39, 6-39 or 8-39 chairs to match.

Model 553 Linoleum Top size 24 x 36 in.



## Porce-Namel Table

With Linoleum Top

### *Model 536*

*MODEL 536* is finished in ivory with a 24 x 36 inch brown inlaid linoleum top—the trim is green. Drawer is dovetailed and partitioned. These new tops will not warp, they are quiet, easy to keep clean and make an ideal table for general kitchen use. Height 31 inches. Shipping weight two to the crate K. D. 100 pounds. Models 4-39, 6-39 and 8-39 chairs are finished to match.

Model 536 Linoleum Top size 24 x 36 in.

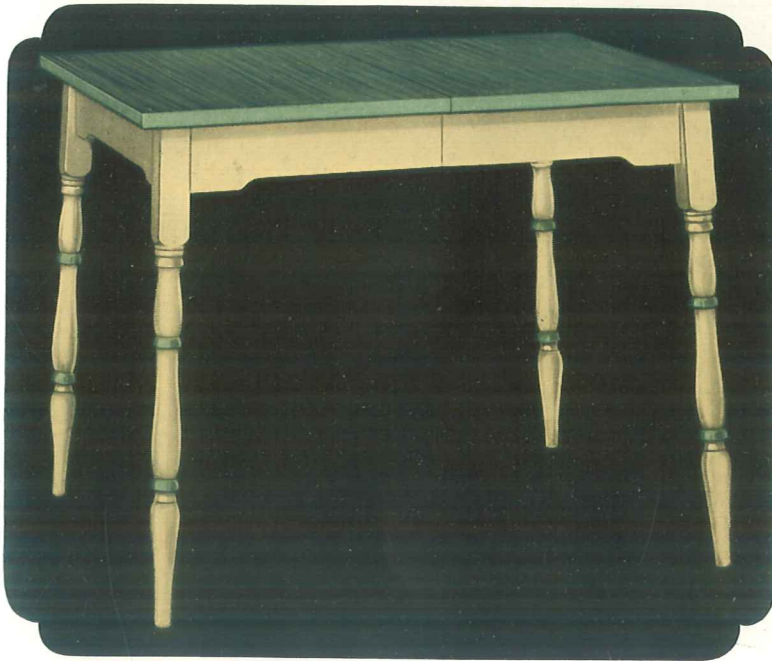

## Porce-Namel Extension Table

With Linoleum Top

### Model 650

*MODEL 650* is the new Porce-Namel extension table with 30 x 40 inch green inlaid linoleum top. With the two 10 inch leaves, which are carried under the top, the table is 30 x 60 inches. A smooth, quiet surface, durable and easily kept clean. Finished in ivory with green trim. Height 31 inches. Shipping weight 100 pounds. Models 4-39, 6-39 or 8-39 chairs finished to match.

## Porce-Namel Extension Table

With Linoleum Top

### Model 654

*MODEL 654* is a shaded oak table with brown inlaid linoleum top and green trim. In the closed position it is 30 x 40 inches; with the two 10 inch leaves 30 x 60 inches. A serviceable table for breakfast room or kitchen. The smooth quiet linoleum surface is very easily kept clean. Height 31 inches. Shipping weight 100 pounds. Model 4 oak chair is finished to match.





## Porce-Namel Kitchen Table

### *Model B*

*THE* arrangement of this roomy base is to give the utmost in convenience and beauty. It is a quality table for your better trade. The Laflat porcelain top is 27 x 56 inches in size. Metal pastry and flour bins, cupboard space, dovetailed drawers, etc., are within arm's reach. Finished on all sides in standard Porce-Namel white, green, ivory or grey satin enamel. Green, blue or orange edge top if desired, see list. Height 31 inches. Shipping weight 207 pounds.

Model B Laflat Porcelain Top size 27 x 56 inches.





## Porce-Namel Kitchen Table

### *Model P*

*A HANDY*, roomy base for the kitchen of moderate size. The Laflat porcelain top is 27 x 42 inches. Pastry drawer and flour bin are of metal, cutlery drawer is dovetailed. Cupboard is provided with sliding tray. Finished on all sides in standard Porce-Namel white, green, ivory or grey satin enamel. Colored edge top if desired (See list). Height 31 inches. Shipping weight 150 pounds.

Model P Laflat Porcelain Top size 27 x 42 inches.



## Porce-Namel Higirl Model D

*MODEL D* is the new Porce-Namel Higirl with green or brown inlaid linoleum top, size 24 x 36 inches. This model contains a great amount of drawer, bin and cupboard space, yet occupies very little room. Finished on all sides as specified by model numbers below. Height 38 inches. Furnished with porcelain top if desired. Shipping weight 170 pounds.

| Model | Color Base | Color Top | Color Trim | Model | Color Base | Color Top | Color Trim |
|-------|------------|-----------|------------|-------|------------|-----------|------------|
| D999  | Green      | Green     | Green      | D899  | Grey       | Green     | Green      |
| D990  | Green      | Green     | Orange     | D856  | Grey       | Brown     | Blue       |
| D399  | Ivory      | Green     | Green      | D799  | White      | Green     | Green      |
| D356  | Ivory      | Brown     | Blue       | D756  | White      | Brown     | Blue       |



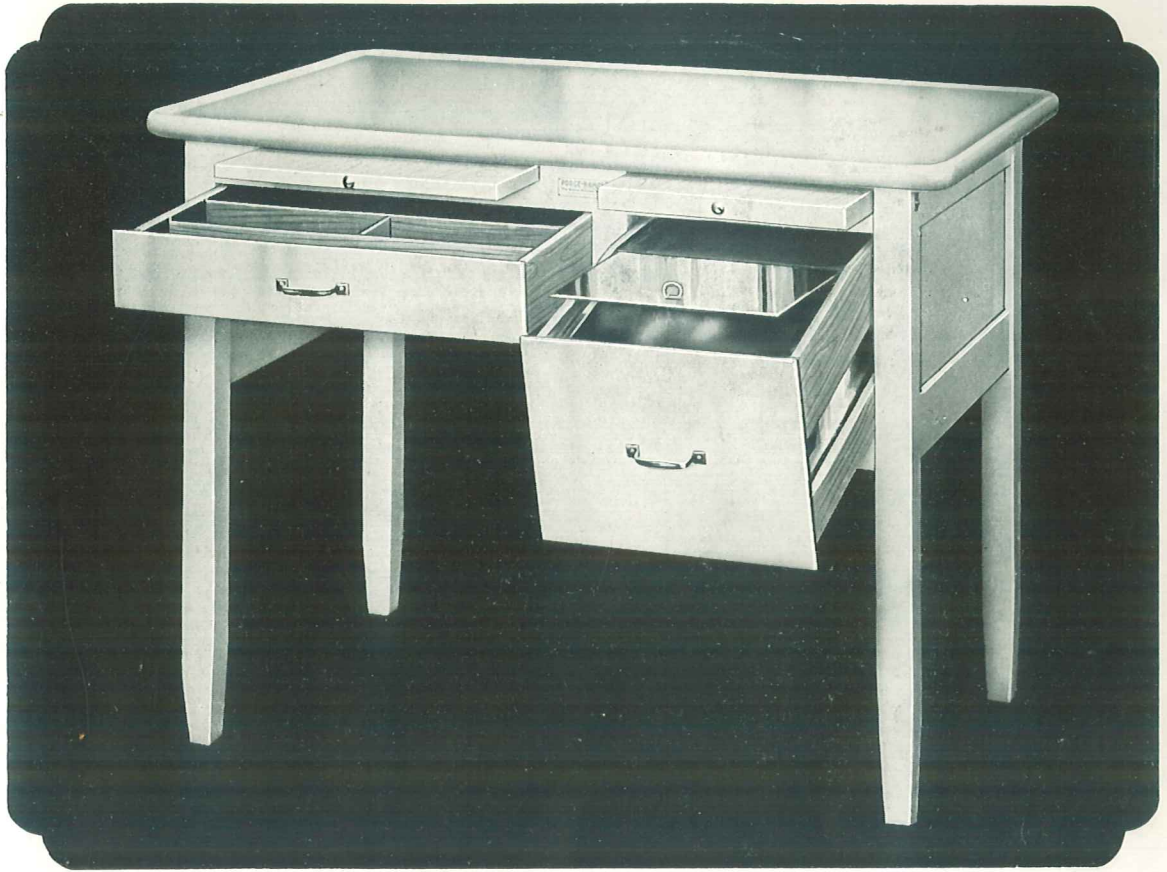

## Porce-Namel Kitchen Table

### *Model R*

*A*N attractive and conveniently arranged baking and general work table. Furnished in 42 or 36 inch sizes. The large size is provided with a tilting metal flour bin. In the small size a divided metal pastry drawer is used. Model R is equipped with dovetailed, partitioned cutlery drawer, kneading board and chopping block. Finished on all sides in white, green, ivory or grey satin enamel. Colored edge top if desired. Height 31 inches.

Model R-42 Top size 27 x 42 inches. Weight 122 lbs.

Model R-36 Top size 25 x 36 inches. Weight 108 lbs.



## Porce-Namel Kitchen Table

### *Model T*

*MODEL T* with Laflat porcelain top size 25 x 36 inches is suitable for kitchens of any size. Cutlery and linen drawers are dovetailed, metal bread and pastry drawer is fitted with sliding tray. Finished on all sides in white, green, grey or ivory satin enamel. Colored edge top if desired. (See list). Height 31 inches. Shipping weight 123 pounds.

Model T Laflat Porcelain Top size 25 x 36 inches.

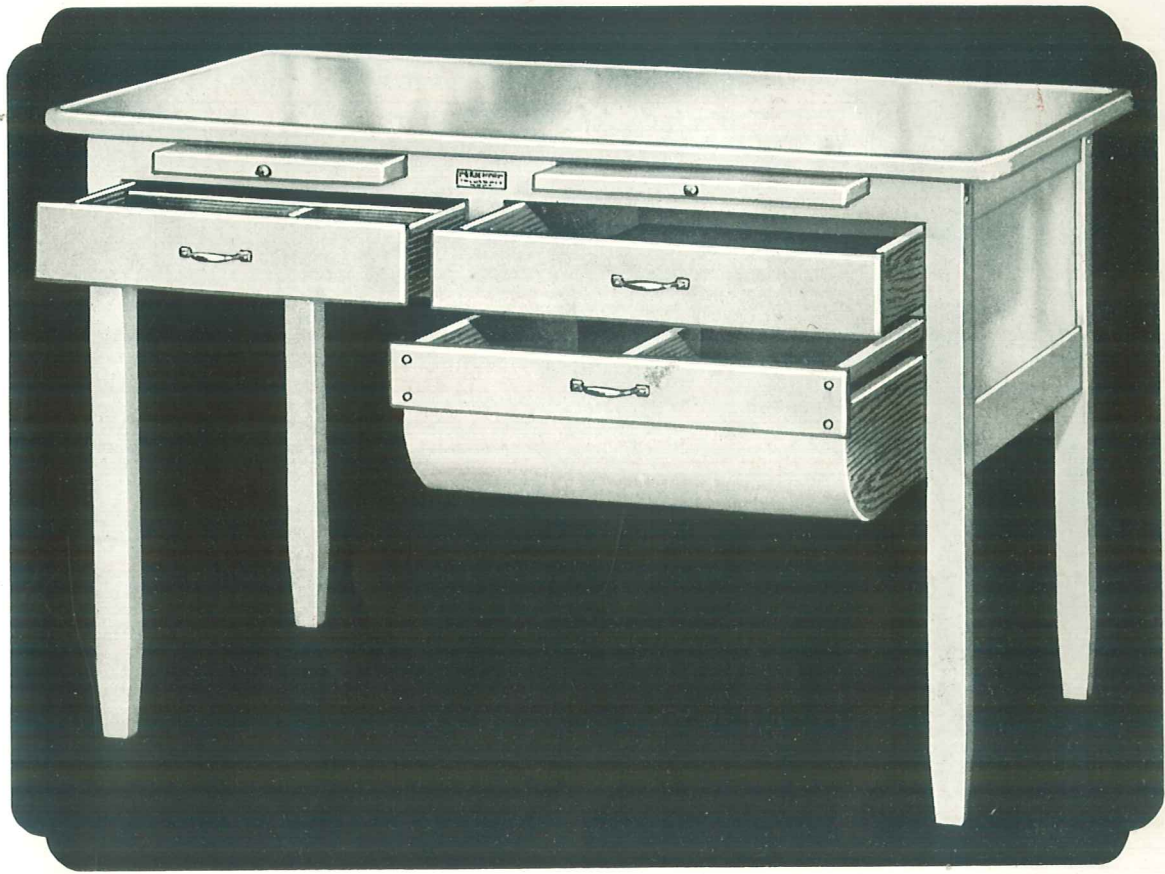

## Porce-Namel Kitchen Table

### *Model 56*

*MODEL 56* is a large roomy table conveniently arranged for general kitchen use. Laflat porcelain top 27 x 48 inches. Cutlery and linen drawers are dovetailed and the large metal bin is divided. Also, equipped with kneading board and chopping block. Finished on all sides in white, green, ivory or grey satin enamel. Colored edge top if desired. (See list). Height 31 inches. Shipping weight 142 pounds.

Model 56 Laflat Porcelain Top size 27 x 48 inches.



## Porce-Namel Kitchen Table

### *Model 20*

*MODEL 20* is especially suitable for apartment use or for the smaller kitchen. It has a 20 x 36 inch sliding Laflat porcelain top over which is fitted a convenient low back shelf. Other notable features are the roomy cupboard with sliding tray and kneading board; two dovetailed drawers for cutlery and linen; and the metal bin with sliding partition for pastry, etc. Finished on all sides in green, ivory, grey or white satin enamel. Colored edge top if desired. (See list). Height 31 inches. Shipping weight 120 pounds.

Model 20 Laflat Porcelain Top size 20 x 36 inches.

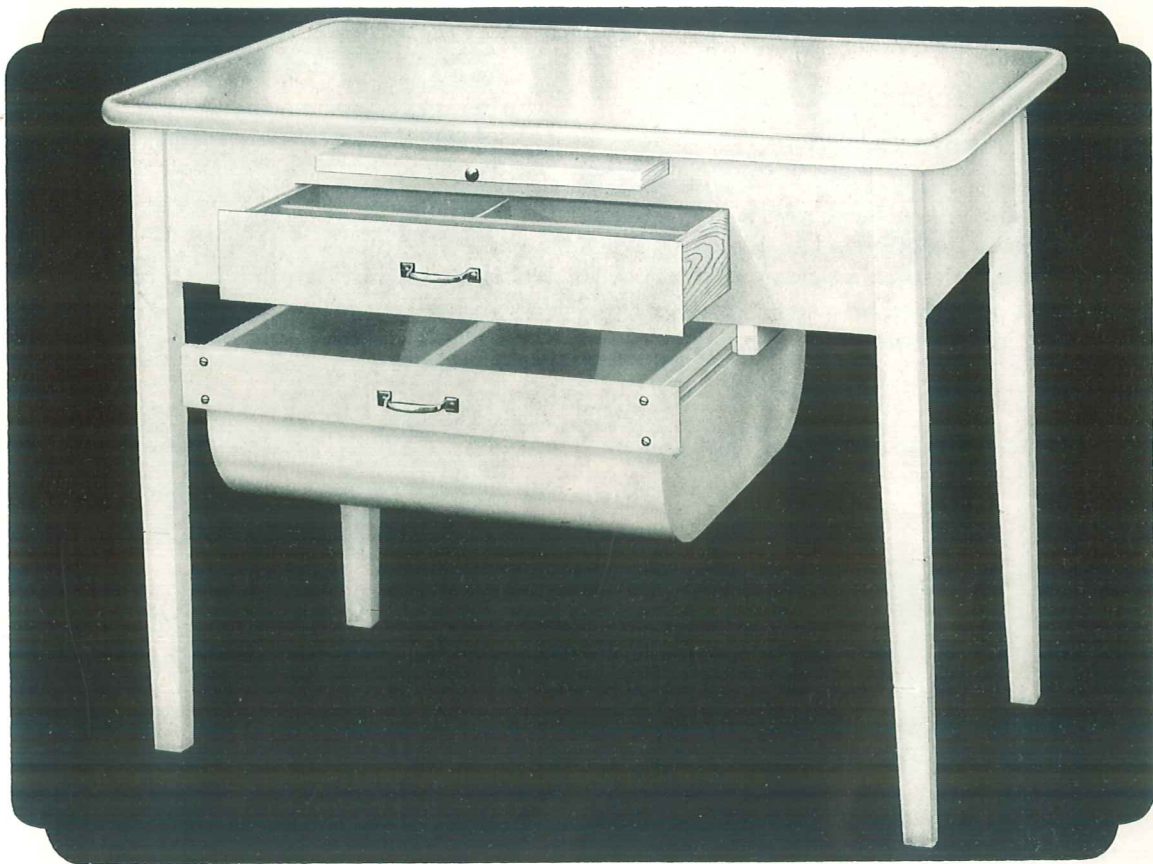

## Porce-Namel Kitchen Table

### *Model E*

*THIS* is another baking table of a different style. It is equipped with a Laffat porcelain top, large divided metal bin for sugar, flour, etc., dovetailed and partitioned cutlery drawer and kneading board. It is supplied in 40 and 36 inch sizes. Finished on all sides in white, green, ivory or grey satin enamel. Colored edge top if desired. (See list). Height 31 inches.

Model E-40 Laffat Porcelain Top size 25 x 40 inches. Shipping weight 100 lbs.  
Model E-36 Laffat Porcelain Top size 25 x 36 inches. Shipping weight 90 lbs.

## Porce-Namel Kitchen Table

### Model 55

*MODEL 55* is another small utility base for general kitchen use. Laffat porcelain top size 22 x 27 inches. The upper left-hand drawer is of metal for pastry, etc. Finished on all sides in white, green, ivory or grey satin enamel. Colored edge top if desired. (See list). Height 31 inches. Shipping weight 82 pounds.

Model 55 Laffat Porcelain Top size 22 x 27 inches.



## Porce-Namel Kitchen Table

### Model 55-LD

*MODEL 55-LD* is the same general style as 55 but is equipped with green inlaid linoleum top, and drop leaves, which are 10 x 22 inches in size. These leaves are fitted with strong metal supports. Finished on all sides in white, green, grey or ivory satin enamel. Shipping weight 92 pounds.

Model 55-LD Inlaid Linoleum Top 22x27 in.  
Model 55-WD Laffat Porcelain Top with Wood Drop Leaves.

## Porce-Namel Kitchen Table

### Model 55-PD

*THIS* style is similar in construction to Model 55 with 10 x 22 inch shaped porcelain drop leaves. Heavy metal braces which are positive and easy to work support these leaves. Finished on all sides in white, green, grey or ivory. Colored edge top if desired. (See list). Shipping weight 92 pounds.

Model 55-PD Laffat Porcelain Top 22x27 in.







### Porce-Namel Kitchen Table Model 54

*FOR* the small kitchen or where a lot of drawer space is desired, Model 54 applies perfectly. Laffat porcelain top size 22 x 27 inches. Drawers are dovetailed. Upper left-hand bin is of metal equipped with lid. Finished in white, green, ivory or grey satin enamel. Colored edge top if desired. (See list). Height 31 inches. Shipping weight 100 pounds.

Model 54 Laffat Porcelain Top size 22 x 27 inches.

### Porce-Namel Kitchen Table Model 54-PD

*MODEL 54-PD* is fitted with 10 inch shaped porcelain drop leaves. Otherwise this table is the same as Model 54. Heavy metal braces which are positive and easy to work, support the leaves. Finished in white, green, grey or ivory. Colored edge top if desired. (See list). Shipping weight 110 pounds.

Model 54-PD Laffat Porcelain Top 22x27 in.



### Porce-Namel Kitchen Table Model 54-WD

*MODEL 54-WD* is another table similar to Model 54, with 10 inch wood drop leaves, finished in enamel. Heavy metal braces support each of these drop leaves. Finished in white, green, grey or ivory. Colored edge top if desired. (See list). Shipping weight 110 pounds.

Model 54-WD Laffat Porcelain Top 22x27 in.  
Model 54-LD with Green Inlaid Linoleum Top and Drop Leaves.



## Porce-Namel Kitchen Table

### Model F

*A* TABLE for the small kitchen or to be used as an extra unit in a larger one. Laffat porcelain top size 18 x 24 inches. Heavy hardwood chopping block, two dovetailed drawers for cutlery and linens, and a metal partitioned pastry drawer. Finished on all sides in white, green, ivory or grey satin enamel. Colored edge top if desired. (See list). Height 31 inches. Shipping weight 80 pounds.

Model F Laffat Porcelain Top size 18 x 24 inches



## Porce-Namel Kitchen Table

### Model F-PD

*MODEL F-PD* is the same as Model F, provided with 10 x 24 inch shaped porcelain drop leaves. Strong metal braces, positive and easy to work, support these leaves. Finished in white, green, grey or ivory satin enamel. Colored edge top if desired. (See list). Shipping weight 88 pounds.

Model F-PD Laffat Porcelain Top 18 x 24 inches.

## Porce-Namel Kitchen Table

### Model F-WD

*MODEL F-WD* is equipped with 10 x 24 inch drop leaves of wood. Heavy metal braces which are positive and easy to work, support the leaves. Finished in white, green, grey or ivory satin enamel. Colored edge top if desired. (See list). Shipping weight 88 pounds.

Model F-WD Laffat Porcelain Top 18 x 24 inches.  
Model F-LD Green Inlaid Linoleum Top and Drop Leaves.



## Porce-Namel Kitchen Table

### Model 57

*MODEL 57* is a very convenient table for either kitchen or bathroom use. It is equipped with one large dovetailed drawer above and a roomy cupboard below with sliding tray. Finished on all sides in white, green, ivory or grey satin enamel. Colored edge top if desired. (See list). Height 31 inches. Shipping weight 63 pounds.

Model 57 Laflat Porcelain Top size 18 x 24 inches.



## Porce-Namel Kitchen Table

### Model 53

*A COMPACT* roll curtain base with lots of cupboard space. Equipped with wire rack for pots, pans, etc. Laflat porcelain top size 22 x 27 inches. Roomy dovetailed drawer for cutlery or linen. Finished on all sides in white, green, ivory or grey satin enamel. Colored edge top if desired. (See list). Height 31 inches. Shipping weight 80 pounds.

Model 53 Laflat Porcelain Top size 22 x 27 inches.



## Porce-Namel Utility Cabinet

### Model 59

*MODEL 59* is a general utility cabinet for kitchen or bathroom use. It is regularly constructed with wood top but Laflat porcelain top is furnished if desired, at a slight extra charge. The top drawer is fitted with six small partitions and three larger ones providing suitable compartments for hosiery—or the many small articles which tend to make a room disorderly. Roomy cupboard and drawer space below. Finished in green, grey, ivory or white, decorated to match our various color combinations. Please specify color. Shipping weight 72 pounds.

Model 59 size Top 24 inches wide, 18 inches deep. Height 31 inches.  
Model 59-P With White Laflat Porcelain Top.

## Porce-Namel Utility Cabinet

### Model 60

*THIS* is another general utility cabinet in 39 inch height. Equipped with either wood or Laflat porcelain top. The upper drawer is partitioned for hosiery, etc., the same as Model 59. Shelf and drawer spaces below are convenient for shoes, felt hats, etc., or for general kitchen use. Finished in ivory, green, grey or white, nicely trimmed to match the various Porce-Namel color combinations. Please specify color. Shipping weight 90 pounds.

Model 60 size Top 24 inches wide, 18 inches deep.  
Model 60-P with White Laflat Porcelain Top.  
Height 39 inches.



**Porce-Namel Table**  
**With Laflat Top**  
**Model N-C-S**

*A* **PORTABLE** Porce-Namel table fitted with small rubber wheels. This handy little table may be loaded with dishes, food, etc., and pushed about from table to stove or wherever desired. Drawer is dovetailed; equipped with good strong shelf underneath. Finish is white, green, grey or ivory satin enamel. Height 31 inches. Packed two to the crate.

Model NCS Laflat Porcelain Top, 22 x 27 inches.  
 Shipping weight 125 lbs.

Model XCS Laflat Porcelain Top 18 x 24 inches.  
 Shipping weight 88 lbs.



**Porce-Namel Table**  
**With Laflat Top and Drop Leaves**  
**Model N-P-D**

*WITH* the growing demand for small drop leaf tables these various Porce-Namel styles have recently been added. They are fitted with dovetailed drawers, tapered legs, and the porcelain drop leaves are 10 inches in width. Furnished in white, green, grey or ivory, in the following sizes:

|                          |                    |
|--------------------------|--------------------|
|                          | Double             |
| Model NPD Size 22x27 in. | Ship. wt. 125 lbs. |
| Model ZPD Size 20x36 in. | Ship. wt. 125 lbs. |
| Model VPD Size 20x30 in. | Ship. wt. 120 lbs. |
| Model XPD Size 18x24 in. | Ship. wt. 115 lbs. |



**Porce-Namel Table**  
**With Drop Leaves of Wood**  
**Model N-W-D**

*MODEL NWD* with Laflat porcelain top, dovetailed drawer, and tapered legs, is fitted with 10 inch drop leaves of wood. This table is furnished in white, green, grey or ivory, in the following sizes:

|                          |                    |
|--------------------------|--------------------|
|                          | Double             |
| Model NWD Size 22x27 in. | Ship. wt. 125 lbs. |
| Model ZWD Size 20x36 in. | Ship. wt. 125 lbs. |
| Model VWD Size 20x30 in. | Ship. wt. 120 lbs. |
| Model XWD Size 18x24 in. | Ship. wt. 115 lbs. |





## Porce-Namel Kitchen Table

### *Model K and L*

*THIS* table is furnished in several sizes. It is a well proportioned piece, of high quality and provides a clean, roomy, working surface especially well adapted to the larger kitchen. Genuine Laffat porcelain top, 2½ inch tapered legs, dovetailed drawers, kneading board and chopping block. Finished in green, ivory, grey or white satin enamel. Colored edge top if desired. (See list). Height 31 inches. See price list for K. D. shipping weights.

Model K Laffat Porcelain Top size 27 x 48 inches.

Model 63 Laffat Porcelain Top size 32 x 48 inches.

Model L Laffat Porcelain Top size 27 x 56 inches.

Model L 32 x 56 Laffat Porcelain Top size 32 x 56 inches.



## Porce-Namel Kitchen Table

### *Model H*

*A* **STURDY**, well arranged table for general kitchen use. The 27 x 42 inch top is a genuine "Lafiat." Drawers are dovetailed, and the 2½ inch legs are nicely tapered. Finished in white, green, grey or ivory satin enamel. Colored edge top if desired. (See list). Shipping weight, (crated double) 151 pounds.

Model H Lafiat Porcelain Top size 27 x 42 inches.



## Porce-Namel Kitchen Table

### Model G

*A WELL* proportioned and substantially built table furnished in the various sizes listed below. Legs are 2½ inch, tapered, cutlery or linen drawer is dovetailed, and the genuine Laflat porcelain top is guaranteed never to buckle or bulge. Finished in green, ivory, grey or white satin enamel. Height 31 inches. Shipped K. D. two in a crate.

Model G-42 Laflat Porcelain Top size 27 x 42 in. Shipping weight 120 lbs.

Model G-48 Laflat Porcelain Top size 27 x 48 in. Shipping weight 140 lbs.

Model 61 Laflat Porcelain Top size 32 x 48 in. Shipping weight 144 lbs.

Model G 32 x 56. Two drawers. Size 32 x 56 in. Weight 200 lbs.

## Porce-Namel Cafeteria Table

### Model C-G

*THIS* table is especially styled for restaurant or cafeteria use. The porcelain top is a genuine Laflat—guaranteed never to buckle or bulge. 2½ inch tapered legs are used, assuring sturdiness and rigidity. Finished in white, green, ivory or grey satin enamel. Height 31 inches. Table is without drawers. Shipped K. D. two in a crate.

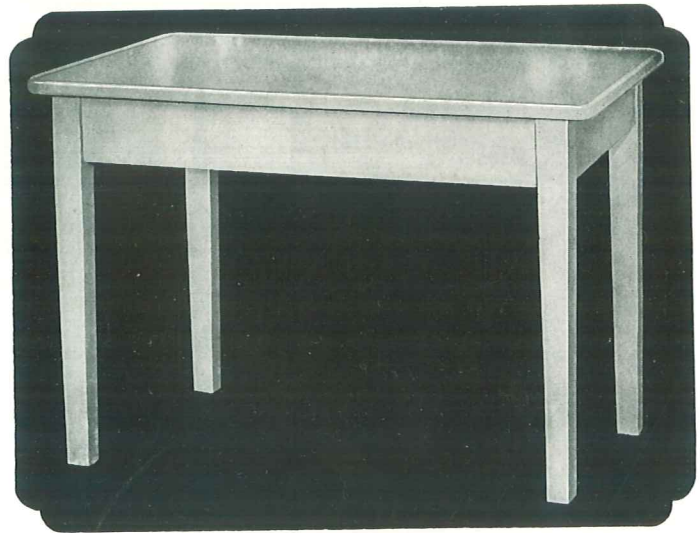

Model CG-42 Laflat Porcelain Top size 27 x 42 in. Shipping weight 105 lbs.

Model CG-48 Laflat Porcelain Top size 27 x 48 in. Shipping weight 123 lbs.

Model CG-32 x 56 Laflat Porcelain Top size 32x56 in. Shipping weight 177 lbs.

Model 65 Laflat Porcelain Top size 32 x 48 in. Shipping weight 156 lbs.





## Porce-Namel Kitchen Table

### *Model M-O-N-Z-V-X-Y*

**ONE** of the standard leg tables of the Porce-Namel line which is furnished in almost any desired size. The finish is white, green, grey or ivory. The cutlery or linen drawer is dovetailed, with framed-in plywood bottom; legs are nicely tapered. Equipped with genuine Laflat Porcelain Top. Height 31 inches. Furnished with colored edge top at extra cost if desired. Shipped K. D. two in crate.

Model M Laflat Porcelain Top size 25 x 40 in. Shipping weight 105 lbs.  
Model O Laflat Porcelain Top size 25 x 36 in. Shipping weight 100 lbs.  
Model N Laflat Porcelain Top size 22 x 27 in. Shipping weight 80 lbs.  
Model Z Laflat Porcelain Top size 20 x 36 in. Shipping weight 85 lbs.  
Model V Laflat Porcelain Top size 20 x 30 in. Shipping weight 80 lbs.  
Model X Laflat Porcelain Top size 18 x 24 in. Shipping weight 70 lbs.  
Model Y Laflat Porcelain Top size 16 x 34 in. Shipping weight 70 lbs.



## Porce-Namel Kitchen Table

*Model 136 and 140*

*THIS* is a very moderately priced yet attractive and serviceable table for general kitchen use. The porcelain top is a genuine "Lafat"; legs are  $1\frac{3}{4}$  inch with chamfered corners; drawer is full lip construction. Finished in white satin enamel. Height 31 inches. Approximate weight 2 in crate K. D.

Model 136 Lafat Porcelain Top 25 x 36 inches. Shipping weight 95 lbs.

Model 140 Lafat Porcelain Top 25 x 40 inches. Shipping weight 100 lbs.

## Porce-Namel Kitchen Table

*Model 148*

*MODEL 148* is a 27 x 48 inch table with two roomy drawers for cutlery, etc., and a kneading board. Top is a genuine "Lafat", legs are  $1\frac{3}{4}$  inch with chamfered corners; finished in white satin enamel. Height 31 inches. Shipping weight 144 pounds.

Model 148 Lafat Porcelain Top 27 x 48 in.





## Porce-Namel Kitchen Cabinets

*PORCE-NAMEL* cabinets are constructed to insure the maximum in convenience, service and beauty. They are furnished in a variety of sizes attractively finished in green, ivory, grey or white satin enamel, trimmed to match any of the regular Porce-Namel color combinations. Unless color preference is specified, white with blue trim will be shipped. Page 3 of this catalog describes Porce-Namel construction principles more fully. The following pages illustrate the various patterns. Model 42 is shown above.



## Porce-Namel Kitchen Cabinet

### *Model 48*

*MODEL 48* is the largest cabinet in the Porce-Namel line. The 27 x 48 inch sliding Laffat porcelain top, with drawers, pulls forward  $9\frac{1}{4}$  inches locking automatically for extra working surface. From this point there is a second extension of 8 inches for dining table use. Height with ant-proof casters 70 inches; depth of upper section 12 inches. For more detailed description see page 3. Unless order specifies otherwise, shipped in white with blue trim; green with orange trim; ivory with green trim; or grey with blue trim. Decorations to match our other color combinations furnished without extra charge. Please specify color. Shipping weight 303 pounds.



## Porce-Namel Kitchen Cabinet

### *Model 42*

*THE* 27 x 42 inch sliding Laflat porcelain top, with the drawers, pulls forward  $9\frac{1}{4}$  inches, locking automatically for extra working surface. From this point there is a second extension of 8 inches for dining table use. Height with ant proof casters 70 inches; depth of upper section 12 inches. For more detailed description see page 3. Unless order specifies otherwise, shipped in white with blue trim; green with orange trim; ivory with green trim; or grey with blue trim. Decorations to match our other color combinations furnished without extra charge. Please specify color. Shipping weight 265 pounds.



## Porce-Namel Kitchen Cabinet

### Model 36

**T**HE 25 x 36 inch sliding Laflat porcelain top with the drawers, pulls forward  $9\frac{1}{4}$  inches, locking automatically for extra working surface. From this point there is a second extension of 6 inches for dining table use. Height with ant proof casters 70 inches; depth of upper section 12 inches. For more detailed description see page 3. Unless order specifies otherwise, shipped in white with blue trim; green with orange trim; ivory with green trim; or grey with blue trim. Decorations to match our other color combinations furnished without extra charge. Please specify color. Shipping weight 225 pounds.



## Porce-Namel Kitchen Cabinet

### *Model 40*

*THE* sliding Laffat porcelain top of Model 40 is 25 x 40 inches and pulls forward easily for extra working surface. Height with ant-proof casters is 70 inches and depth of upper section 12 inches. Dovetailed drawers, easy working roll curtain and other construction features are as described on page 3. Unless order specifies otherwise, shipped in white enamel with blue trim; green with orange trim; ivory with green trim; or grey with blue trim. Decorations to match our other color combinations are furnished without extra charge. Please specify color. Shipping weight 231 pounds. Model 40 is also furnished in oak.



## Porce-Namel Kitchen Cabinet

### *Model 28*

*MODEL 28* provides a lot of cupboard and drawer space yet takes up a very small amount of room. The sliding Laflat porcelain top is 22 x 27 inches and pulls forward easily for extra working surface. Height with ant proof casters 70 inches; depth of upper section 12 inches. The smooth rolling curtain, dovetailed drawers and other construction features are as described on page 3. Unless order specifies otherwise, shipped in white enamel with blue trim; green with orange trim; ivory with green trim; or grey with blue trim. Decorations to match our other color combinations are furnished without extra charge. Please specify color. Shipping weight 175 pounds.





## Porce-Namel Kitchen Cabinet

### *Model 46*

*THIS* is a moderately priced roll curtain cabinet with stationary inlaid linoleum top in green or brown. Or it may be had with the 25 x 36 inch Laflat porcelain top. The fine satin enamel finish, 25 pound sifter flour bin, roomy cupboard and drawer compartments, and other noteworthy Porce-Namel features make this a very attractive style. Height with ant proof casters 70 inches, depth of upper section 12 inches. Unless order specifies otherwise, shipped in white enamel with blue trim; green with orange trim; ivory with green trim; or grey with blue trim. Decorations to match our other color combinations are furnished without extra charge. Please specify color. Shipping weight 185 pounds.



## Porce-Namel Dish Cupboard

### Model 14

*MODEL 14* — designed for dishes, canned goods, etc., is suitable for any kitchen, as well as a mighty convenient cupboard for the bathroom. It is a well built piece of full post construction, with five deep shelves. Finished in green, ivory, grey or white satin enamel, trimmed to match Porce-Namel kitchen cabinets. Shipping weight 83 pounds.

Model 14 size 16 x 22 x 70 inches.

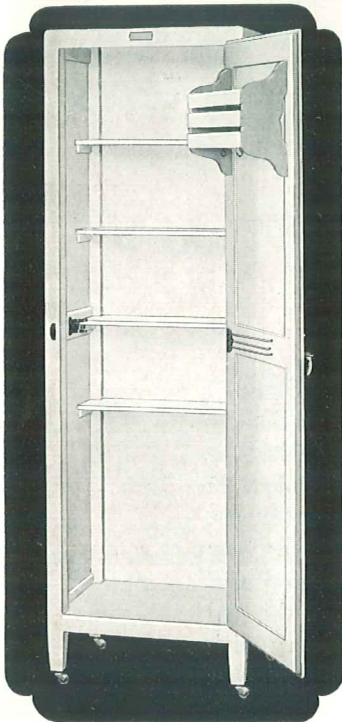
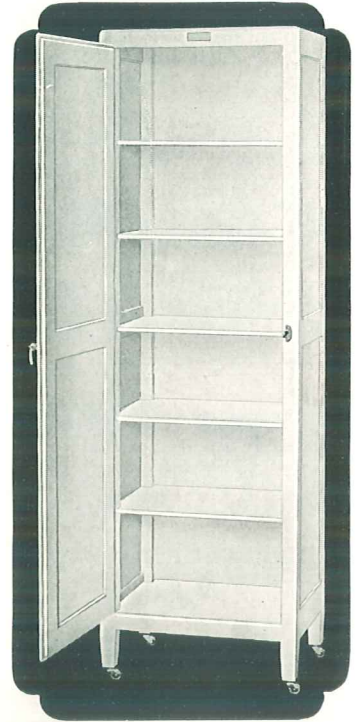

## Porce-Namel Broom Closet

### Model 15

*THIS* utility broom closet is the matched piece to be used with Model 14. It is a very useful closet for general kitchen use. Fitted with four half shelves, leaving ample room for vacuum sweeper, brooms, etc. Also equipped with package rack, towel racks and a broom holder. Full post construction with plywood panels. Finished in green, ivory, grey or white satin enamel, trimmed to match Porce-Namel kitchen cabinets. Shipping weight 75 pounds.

Model 15 size 16 x 22 x 70 inches.

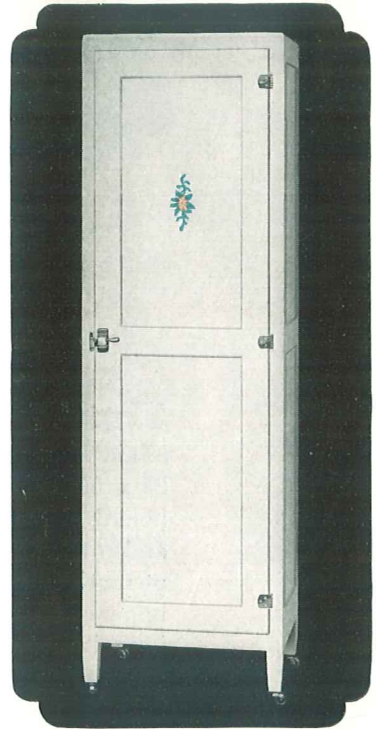

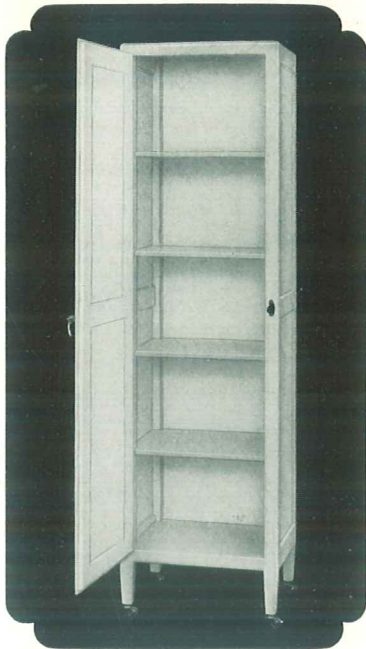

## Porce-Namel Dish Cupboard

### Model 10

*MODEL 10* is an ideal piece for either kitchen or bathroom use for the deep shelves provide ample space for general household necessities. It is, of course, especially adaptable for dishes and canned goods. Full post construction with plywood panels. Finished in green, ivory, grey or white satin enamel—trimmed to match Porce-Namel kitchen cabinets. Shipping weight 58 pounds.

Model 10 size 14 x 18 x 64 inches.

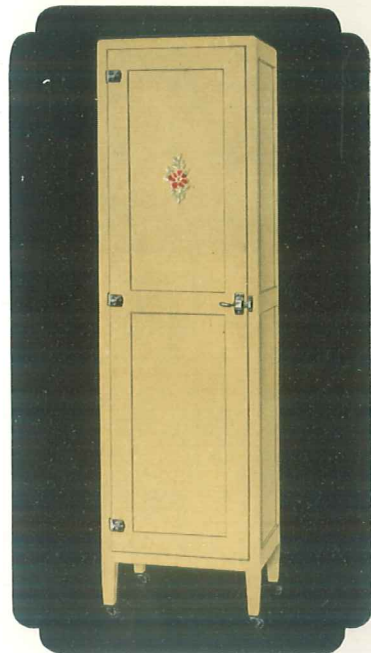

1/2  
2/2  
19  
27  
19

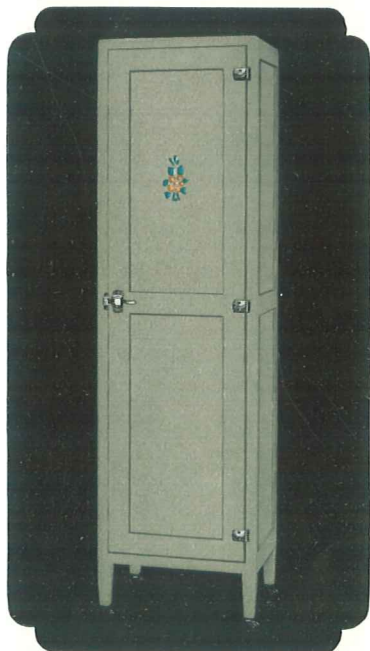

## Porce-Namel Broom Closet

### Model 9

*A STURDY* combination cupboard for brooms, vacuums, etc., and with half shelves for packages, cleaning materials and other kitchen necessities. Full post construction with plywood panels. Fitted with package rack, towel rods and broom holder. Finished in green, ivory, grey or white satin enamel, trimmed to match Porce-Namel kitchen cabinets. Shipping weight 52 pounds.

Model 9 size 14 x 18 x 64 inches.

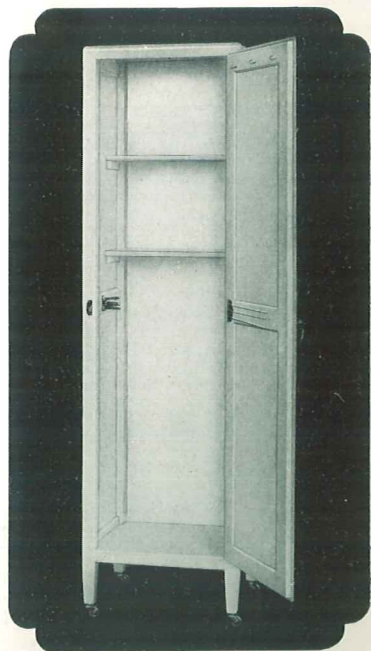

## Porce-Namel Bathroom Cupboard

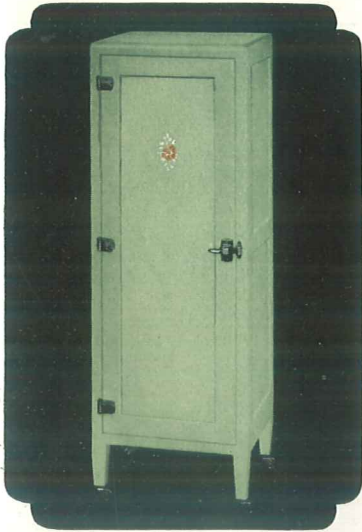

### Model 8

*MODEL 8* is the companion cupboard for Model 11. It is fitted with adjustable shelves to accommodate the many articles needed in the average bathroom yet is equally suitable for kitchen use. Full post construction with plywood panels. Finished in white, grey, green or ivory satin enamel, nicely trimmed to match Porce-Namel cabinets. Shipping weight 36 pounds.

Model 8 size 16 in. wide, 14 in. deep, 44 in. high.

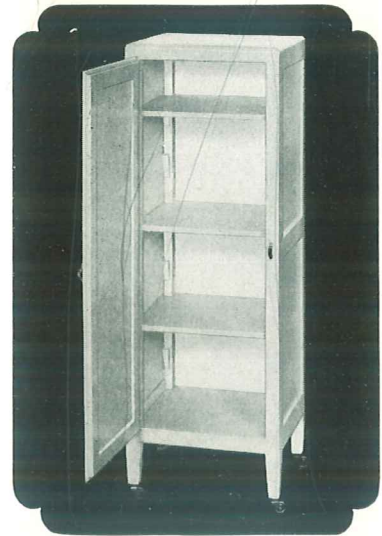

## Porce-Namel Bathroom Cupboard

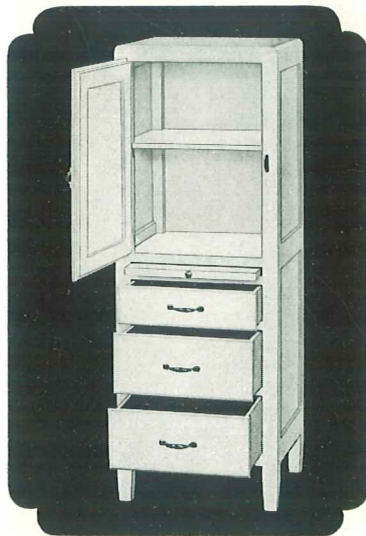

### Model 11

*THIS* neatly arranged cupboard is designed especially for bathroom use. It is just the right height so that the top may be used as well as the shelves. Fitted with a handy service board; drawers are dovetailed. Full post construction with plywood panels. Finished in white, grey, green or ivory satin enamel, nicely trimmed to match Porce-Namel cabinets. Shipping weight 50 pounds.

Model 11 size 16 in. wide, 14 in. deep, 44 in. high.



## Porce-Namel Auxiliary Cupboard

### Model 17

*MODEL 17* is another conveniently arranged auxiliary cupboard. This style is fitted with a handy service board and with drawer and cupboard space below. Construction is with full posts and plywood panels. This, too, is a very suitable cupboard for general kitchen or bathroom use. Finished in green, ivory, grey or white satin enamel. Trimmed to match Porce-Namel kitchen cabinets. Shipping weight 145 pounds.

Model 17 size 18 x 25 x 70 inches.



## Porce-Namel Auxiliary Cupboard

### Model 18

*MODEL 18* is a large auxiliary cupboard with a lot of drawer and cupboard space. Equipped with four dovetailed drawers in various sizes and with four deep shelves. Built with post construction and plywood panels. Finished in green, ivory, grey or white satin enamel, trimmed to match Porce-Namel kitchen cabinets. This style may be equipped with one or two Laffat porcelain drop shelves size 18 x 24 inches if desired; please specify. Shipping weight 139 pounds.

Model 18 size 18 x 25 x 70 inches.



## Porce-Namel Cafeteria or Breakfast Room Table

*Models 96, 97, 98*

*THIS* pattern is suitable for the breakfast nook or cafeteria where either benches or chairs are used. The pedestal base ends are of heavy construction sturdily supported and fastened to the underframe by long screws. The rail between the pedestal insures added strength. The Laflat porcelain top is white with blue, green or orange edge. Finish is green, ivory, grey or white satin enamel.

Model 96 Laflat Top 27 x 42 in. Shipping weight 100 lbs.

Model 97 Laflat Top 27 x 48 in. Shipping weight 110 lbs.

Model 98 Laflat Top 27 x 56 in. Shipping weight 125 lbs.

## Porce-Namel Sink Cupboard

*Model 19*

*WHERE* additional cupboard space is needed this style which hangs on the wall—or may be placed over a sink or table, answers nicely. The size is 10½ x 30 x 27 inches. Finished in green, ivory, grey or white satin enamel, trimmed to match Porce-Namel kitchen cabinets. Shipping weight 40 pounds.

Model 19 size 10½ x 30 x 27 inches.

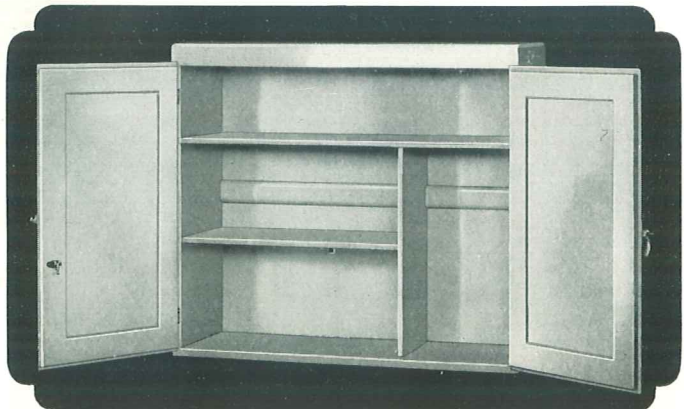

## Linoleum Top Cafeteria Table

### Model 500

*THIS* is one of the newer cafeteria tables which is proving especially popular. It is an attractive and serviceable table for cafeteria, restaurant or club dining room. Sturdily built of gum or solid oak with heavy five-ply top on which is laid the plain green or brown, or green or brown jaspe, battleship linoleum. Edge of top is substantially reinforced with 3/8 inch banding. This table will not stain or warp—and is easily kept clean by merely washing with a damp cloth. Finished in light golden oak, walnut or mahogany. Shipped 2 to the crate. The opportunity of quoting on your special color combinations and size requirements is solicited.



|                      |                          |
|----------------------|--------------------------|
| Size 30 x 30 inches. | Shipping weight 130 lbs. |
| Size 36 x 36 inches. | Shipping weight 150 lbs. |
| Size 42 x 42 inches. | Shipping weight 180 lbs. |
| Size 30 x 48 inches. | Shipping weight 180 lbs. |
| Size 30 x 60 inches. | Shipping weight 200 lbs. |
| Size 30 x 72 inches. | Shipping weight 240 lbs. |
| Size 30 x 96 inches. | Shipping weight 360 lbs. |

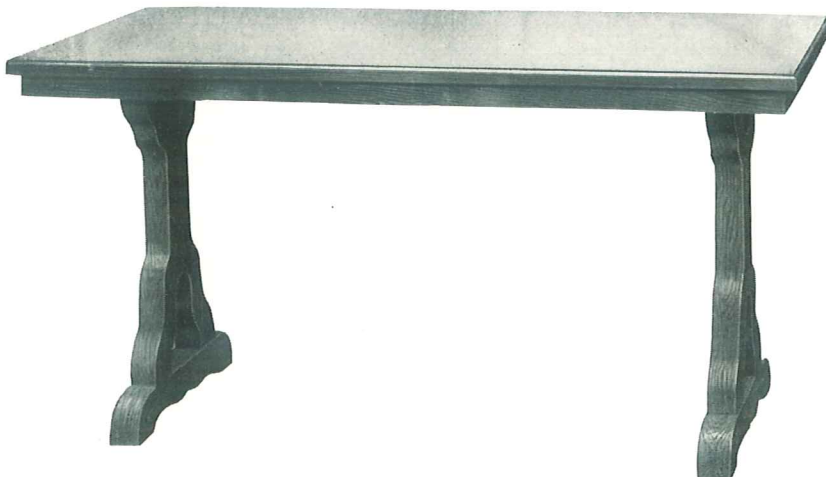

|                      |                          |
|----------------------|--------------------------|
| Size 30 x 48 inches. | Shipping weight 120 lbs. |
| Size 30 x 60 inches. | Shipping weight 160 lbs. |
| Size 30 x 72 inches. | Shipping weight 190 lbs. |
| Size 30 x 96 inches. | Shipping weight 280 lbs. |

## Linoleum Top Cafeteria Table

### Model 520

*AN* attractive pedestal style cafeteria table in light golden oak, walnut or mahogany finish. Construction is of oak or gum. The pedestal bases which may be placed at different distances from the ends are securely fastened to the heavy five-ply top by long screws. This genuine battleship linoleum top is furnished in either plain green or brown, or green or brown jaspe, and makes a wonderful surface for cafeteria or club dining room tables. It is quiet, has more warmth than most tables of its kind and is easily kept clean. Crated single.

# ▶ PORCE-NAMEL

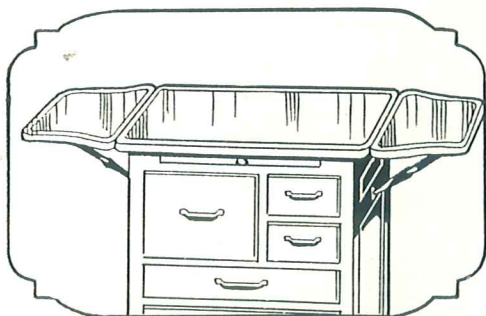

Flat porcelain top and shaped porcelain drop leaves are guaranteed not to buckle or bulge. Very easily cleaned.

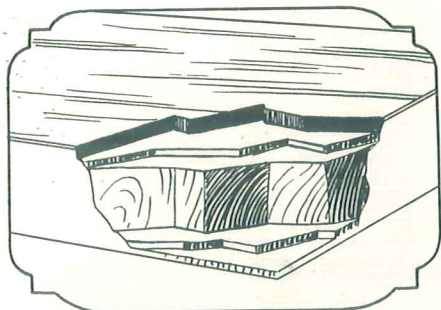

Armstrong inlaid linoleum, jasper finish, mounted on heavy plywood top prevents warping and insures long life of service.

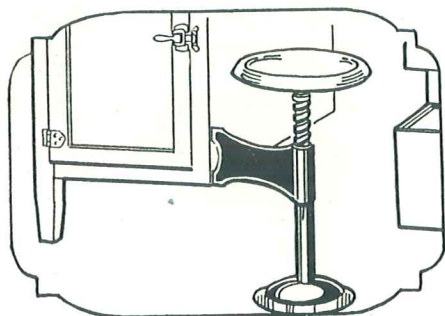

Comfortable swinging stool, easily adjusted to any height. Pushes back under table when not in use.

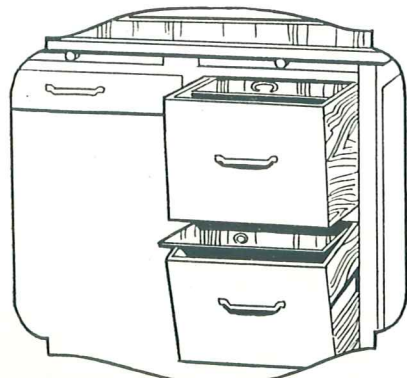

All-metal dust-proof flour bin pulls out smoothly, and the partitioned metal pastry drawer is dust-proof. Cleans easily.

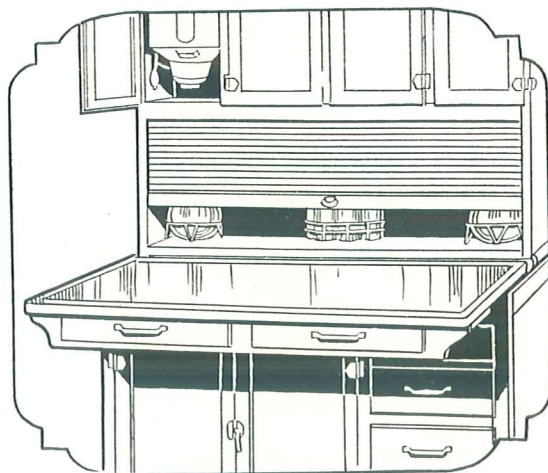

Double stop sliding top locks in either of two extended positions, for work or breakfast table. Roll curtains never stick or bind.

**WHEN** you buy kitchen furniture, look for these things. You pay for them in any piece of kitchen furniture—you actually get them in PORCE-NAMEL. It is this careful and painstaking attention to the things below the surface—the hidden things that you cannot see—that has made PORCE-NAMEL quality go all the way through. There is no skimping in PORCE-NAMEL—no attempt to take shortcuts—no cutting down of

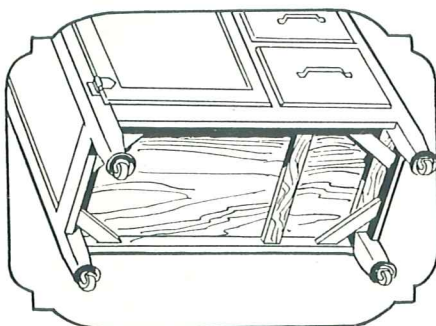

Note the strongly reinforced corner brace construction and dust proof plywood bottoms on cabinets and bases.

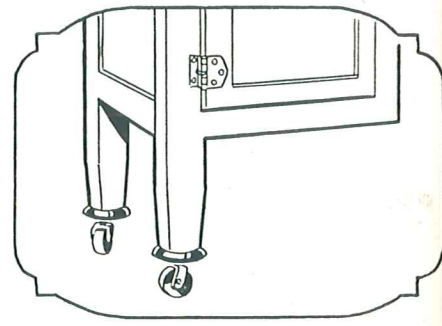

Ant-proof casters on all PORCE-NAMEL cabinets offer the housewife absolute protection from these kitchen pests.



# L FEATURES

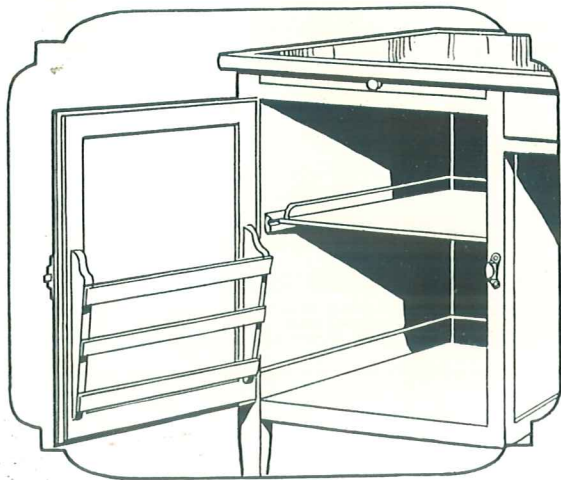

Roomy cupboard space—easy sliding shelves—lid rack on door, which is free-swinging. No sagging doors or loose hinges.

quality to make a price—each piece is built as well as it is possible to build it, and the integrity and reputation of the manufacturer goes into every operation necessary to produce it.

Look for the name PORCE-NAMEL when you buy kitchen furniture. It is your guarantee of honest dollar-for-dollar value, of fair price, and of years of the most convenient, comfortable service you will ever know.

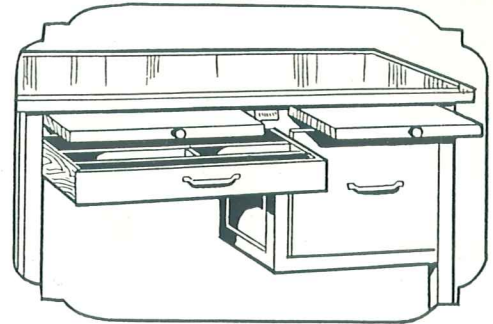

Convenient large drawer partitioned for cutlery. Kneading board and hardware chopping block where you need them most.

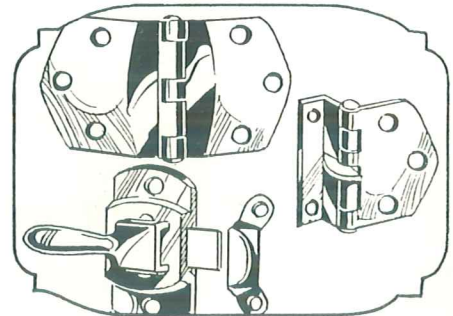

High grade, permanent lustre, rust-resisting hardware. No time wasted in polishing of knobs, handles, or hinges.

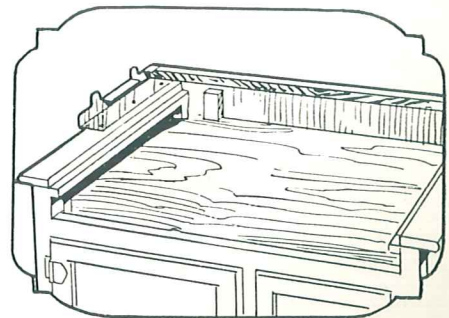

Under each of the sliding tops you will find a sturdy panel of plywood construction like the one shown here.

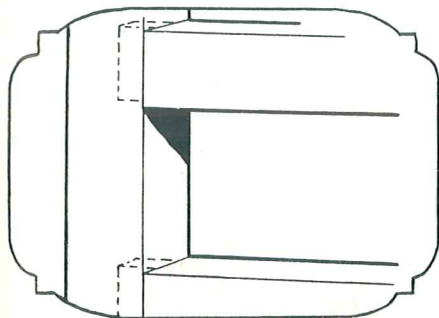

All joints mortise and tenon construction giving added life and greater strength to all PORCE-NAMEL kitchen furniture.

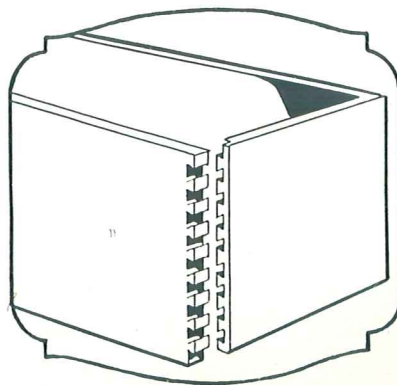

Drawers are dovetailed front and back with boxed-in three plywood bottoms. The best drawer construction in existence.

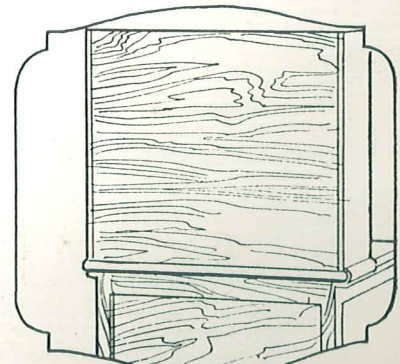

Notice the sturdy one-piece plywood back construction on all PORCE-NAMEL kitchen cabinets and bases.

# PORCE-NAMEL

## Advertising Materials and Selling Helps

### Porce-Namel Sales Aids

The manufacturers of Porce-Namel Kitchen Furniture are interested in helping you increase your profits through the sale of this merchandise. To assist you most efficiently the general merchandising pieces shown on this page have been prepared and are ready to be mailed to you without cost, at your request. Use this valuable service. Many merchants are doing business in a half-hearted way but the ones who are making money are the ones who are taking advantage of such opportunities as are presented here.



### National Advertising

In Good Housekeeping, Modern Priscilla and several other smaller national publications, reaches thousands of your prospects. Show Porce-Namel models on your sales floors and in your windows—"cash in" on this advantage.



### Beautiful Store or Window Card

This attractive card, showing merchandise in actual colors will lend life and appeal to your store or window display. Write for yours. Furnished without cost.

### General Merchandising and Mat Service

This manual consists of a complete newspaper mat service, a follow up letter and card service and valuable general information for your floor salesmen. It gives you an attractive assortment of advertisements already prepared, for your local newspaper advertising—avoiding trouble and expense for you, at the same time giving you efficiency. The possibilities for you through the use of this sales promotion service cannot be overestimated. It will increase your profits.

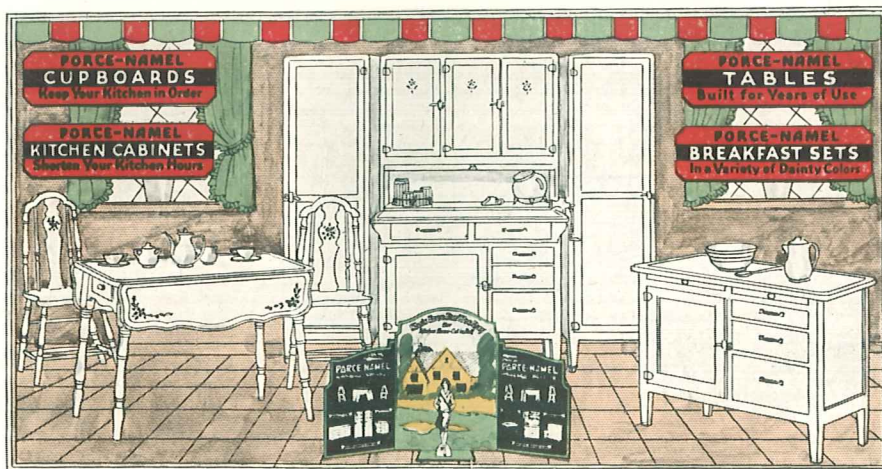

### Window Trims

This window trim nicely lettered in orange and black will fit in very nicely with your Porce-Namel window display. Gummed stickers are also included to assist in placing them.

### Window Display

Porce-Namel dealers everywhere are increasing their sales through the use of their windows. For this purpose, expensive display cards, window trims, etc., have been prepared and are furnished free. Select several Porce-Namel models and with this display material dress up your windows for a real campaign. You'll be more than pleased with the results.



### Porce-Namel Folders

These attractive little folders in bright colors, showing Porce-Namel Kitchen Cabinets, and Cupboards; Bases and Tables; and Drop Leaf Breakfast Sets and Decorated Leg Tables will be mailed to you in liberal quantities, imprinted—at your request. Write for them.

### Results Through Application

These selling helps have been prepared for your use with the definite knowledge that the results will be profitable. Use this service; run these advertisements, already prepared for you, trim your windows with this display material, use these sales helps imprinted with your firm name. Acquaint your floor salesmen with this really valuable merchandise manual on Porce-Namel. These selling helps will materially increase your volume.

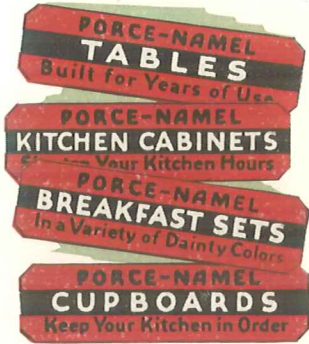

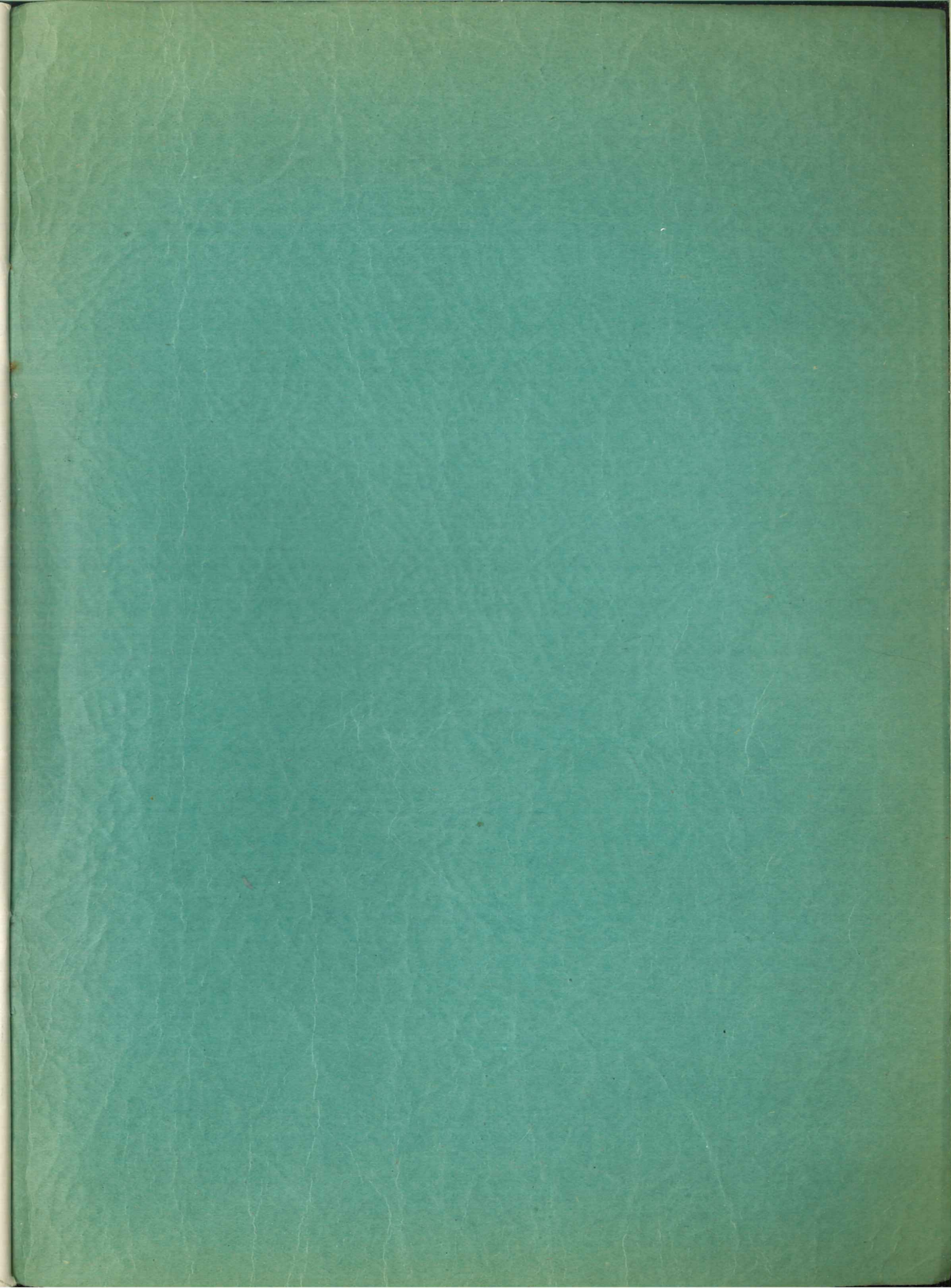

L. Kistner