







1934  
RECORDS

OF THE

AUSTRALIAN MUSEUM.

EDITED BY THE CURATOR.

---

Vol. V.

---

PRINTED BY ORDER OF THE TRUSTEES.

R. ETHERIDGE, JUNR., J.P.

Curator.

SYDNEY, 1903-1905.



# CONTENTS.

No. 1.

Published 14th April, 1903.

	Page
Notes on the Zoology of Paanopa or Ocean Island and Nauru or Pleasant Island, Gilbert Group ... ..	
The Birds. By Alfred J. North ... ..	1
The Reptiles. By Edgar R. Waite ... ..	2
The Fishes. By Edgar R. Waite ... ..	3
The Mollusca. By C. Hedley ... ..	4
The Arthropoda. By W. J. Rainbow ... ..	5
The Crustacea and Echinodermata. By T. Whitelegge ...	8
Notes and Analysis of Phosphatic Specimens. By C. Anderson	13
<i>Fossopora</i> , a New Genus of Palæozoic Perforate Corals. By R. Etheridge, Junr. ... ..	16
Additions to the Fish Fauna of Lord Howe Island. No. 3. By Edgar R. Waite ... ..	20
Further Observations on the Caudex of <i>Glossopteris</i> by R. Etheridge, Junr. ... ..	46
A Fresh-water Turtle ( <i>Pelochelys cantoris</i> , Gray), from New Guinea. By Edgar R. Waite ... ..	50
Notes on Fleas Parasitic on the Tiger Cat. By W. J. Rainbow ...	53
New Records or Recurrences of Rare Fishes from Eastern Australia, No. 2. By Edgar R. Waite ... ..	56
Studies in Australian Araneidæ, No. 1. By W. J. Rainbow... ..	62
On a Mineral Allied to Montmorillonite from Exeter, New South Wales. By C. Anderson ... ..	67
A New Species of <i>Dendrostoma</i> . By H. L. Kesteven ... ..	69
Occasional Notes—	
I. The Tavau, or Coil Feather Money of Santa Cruz. By R. Etheridge, Junr. ... ..	74
II. <i>Chersydrus granulatus</i> , Schneider. A Snake new to Australia, by Edgar R. Waite ... ..	74

## No. 2.

Published 28th January, 1904.

On the Occurrence of a Lituitean in the Upper Silurian Rocks of Bowning, New South Wales. By R. Etheridge, Junr. ...	75
A New "Bat Tick." By W. J. Rainbow ... ..	78
A Remarkable Rock-Shelter in the Milton District. New South Wales. By R. Etheridge, Junr. ... ..	80
Additions to the Marine Molluscan Fauna of New Zealand. By Charles Hedley ... ..	86
Trilobite Remains collected in the Florentine Valley, West Tasmania, by Mr. T. Stephens, M.A. By R. Etheridge, Junr. ...	98
Studies in Australian Araneidæ, No. 2. By W. J. Rainbow... ..	102
On the Occurrence of the Genus <i>Ptychoceras</i> (?) and other Additional Fossils in the Cretaceous beds of the Northern Territory of South Australia. By R. Etheridge, Junr.... ..	108
Australian Cicadidæ. The Mating of <i>Cyclochila australasia</i> , Don. and <i>Thopha saccata</i> , Amyot. By W. J. Rainbow... ..	116
Aboriginal Petroglyphs between Beaumont and Hamley Trigonometrical Stations, Kuringai. By R. Etheridge, Junr. ... ..	118
Description of a new <i>Phascogale</i> from North Western Australia. By Edgar R. Waite ... ..	122
Description of a New Species of <i>Pachycephala</i> . By Alfred J. North	125
An Association of Natrolite and Datolite at Pokolbin, New South Wales. By C. Anderson ... ..	127
Description of the Nest of the Guttated Bower-Bird ( <i>Chlamydodera guttata</i> , Gould). By Alfred J. North ... ..	131
Occasional Notes—	
III. The Tavau, or Coil Feather Money of Santa Cruz. By R. Etheridge, Junr. ... ..	133
IV. The Habitat of <i>Gomphina mærcchi</i> , Angas. By C. Hedley ... ..	134
V. The Genus <i>Dromicia</i> in New South Wales. By Edgar R. Waite ... ..	134

## No. 3.

Published 11th March, 1904.

Additions to the Fish Fauna of Lord Howe Island, No. 4. By Edgar R. Waite ... ..	135
Catalogue of the Fishes of Lord Howe Island. By Edgar R. Waite	187



## No. 4.

Published 16th June, 1904.

New Records or Recurrences of Rare Fishes from Eastern Australia, No. 3. By Edgar R. Waite ... ..	231
Note on <i>Cicindela jungi</i> , and descriptions of two new Beetles. By W. J. Rainbow ... ..	245
Notes on Australian Cretaceous Fossils. By R. Etheridge, Junr. ...	248
The Larvæ of <i>Doratifera casta</i> , Scott. By W. J. Rainbow ... ..	253
An Endophyte ( <i>Stichus mermisoides</i> ), occurring in the test of a Cretaceous Bivalve. By R. Etheridge, Junr. ... ..	255
The Occurrence of Monazite <i>in situ</i> at Blatherarm Creek, near Deep- water, N.S.W. By C. Anderson ... ..	258
Description of a New Species of <i>Paphila</i> . By Alfred J. North ...	263
On Heterochrosis in Australian <i>Psittaci</i> . By Alfred J. North ...	265
Descriptions of the Eggs of the White-Quilled Rock Pigeon ( <i>Petro- phassa albipennis</i> , Gould). By Alfred J. North ... ..	269
On the Bower of the Eastern Bower-Bird ( <i>Chlamydotera orientalis</i> , Gould). By Alfred J. North ... ..	270

— — —

## No. 5.

Published 22nd December, 1904.

Ethnological Notes made at Copmanhurst, Clarence River. By R. Etheridge, Junr. ... ..	271
A Review of the Eleotrids of New South Wales. By Edgar R. Waite	277
<i>Pisocrinus</i> in the Upper Silurian rocks of the Yass District. By R. Etheridge, Junr. ... ..	287
The Breeding Habits of the Fighting Fish ( <i>Betta pugnax</i> , Cantor) By Edgar R. Waite ... ..	293
Mineralogical Notes: No. 1.—Topaz, Beryl, Vesuvianite, Tourmaline, and Wolframite. By C. Anderson ... ..	296
A Second Sauropterygian converted into Opal, from the Upper Cretaceous of White Cliffs, New South Wales. By R. Etheridge, Junr. ... ..	306
Notes on the Architecture, Nesting Habits, and the Life Histories of Australian Araneidæ, based on specimens in the Australian Museum. By W. J. Rainbow ... ..	317
Studies in Australian Araneidæ, No. 3. By W. J. Rainbow ..	326
Ornithological Notes. By Alfred J. North ... ..	337



## LIST OF THE CONTRIBUTORS.

With References to the Articles contributed by each.

### Anderson, Chas.—

	Page
Notes and Analysis of Phosphatic Specimens from Ocean and Pleasant Islands ... ..	13
On a Mineral allied to Montmorillonite, from Exeter, New South Wales ... ..	67
An Association of Natrolite and Datolite, at Pokolbin, New South Wales ... ..	127
The Occurrence of Monazite <i>in situ</i> at Blatherarm Creek, near Deepwater, New South Wales ... ..	258
Mineralogical Notes : No. 1.—Topáz, Beryl, Vesuvianite, Tourmaline, and Wolframite ... ..	296

### Etheridge, R., Junr.—

<i>Fossopora</i> , a New Genus of Palæozoic Perforate Corals ... ..	16
Further Observations on the Caudex of <i>Glossopteris</i> ... ..	46
The Tavau, or Coil Feather Money of Santa Cruz ... ..	74, 133
On the Occurrence of a Lituitean in the Upper Silurian rocks of Bowning, New South Wales ... ..	75
A Remarkable Rock-Shelter in the Milton District, New South Wales ... ..	80
Trilohite Remains collected in the Florentine Valley, West Tasmania, by Mr. T. Stephens, M.A. ... ..	98
On the Occurrence of the Genus <i>Ptychoceras</i> (?) and other Additional Fossils in the Cretaceous Beds of the Northern Territory of South Australia ... ..	108
Aboriginal Petroglyphs between Beaumont and Hamley Trigonometrical Stations, Kuringai ... ..	119
Notes on Australian Cretaceous Fossils ... ..	248
An Endophyte ( <i>Stichus mermisoides</i> ), occurring in the test of a Cretaceous Bivalve ... ..	255
Ethnological Notes made at Copmanhurst, Clarence River ... ..	271
<i>Pisocrinus</i> in the Upper Silurian rocks of the Yass District ... ..	287
A Second Sauropterygian converted into Opal, from the Upper Cretaceous of White Cliffs, New South Wales ... ..	306

**Hedley, Charles—**

The Mollusca of Ocean and Pleasant Islands	...	...	...	4
Additions to the Marine Molluscan Fauna of New Zealand	...	...	...	86
The Habitat of <i>Gomphina mærcchi</i> , Angas	...	...	...	134

**Kesteven, H. L.—**

A New Species of <i>Dendrostoma</i>	...	...	...	69
-------------------------------------	-----	-----	-----	----

**North, Alfred J.—**

The Birds of Ocean and Pleasant Islands	...	...	...	1
Description of a New Species of <i>Pachycephala</i>	...	...	...	125
Description of the Nest of the Guttated Bower-Bird ( <i>Chlamydo-</i> <i>dera guttata</i> , Gould)	...	...	...	131
Description of a new Species of <i>Pæphila</i>	...	...	...	263
On Heterochrosis in Australian <i>Psittaci</i>	...	...	...	265
Description of the Eggs of the White-Quilled Rock Pigeon ( <i>Petrophassa albipennis</i> , Gould)	...	...	...	269
On the Bower of the Eastern Bower-Bird ( <i>Chlamydo-</i> <i>deralis</i> , Gould)	...	...	...	270
Ornithological Notes	...	..	...	337

**Rainbow, W. J.—**

The Arthropoda of Ocean and Pleasant Islands	...	...	...	5
Notes on Fleas Parasitic on the Tiger Cat	...	...	...	53
Studies in Australian Araneidæ, No. 1	...	...	...	62
"                    "          No. 2	...	...	...	102
"                    "          No. 3	...	...	...	326
A New "Bat Tick"	...	...	...	78
Australian Cicadidæ. The Mating of <i>Cyclochila australasie</i> , Don., and <i>Thopha saccata</i> , Amyot	...	...	...	116
Note on <i>Cicindela jungi</i> , and Descriptions of two new Beetles	...	...	...	245
The Larvæ of <i>Doratifera casta</i> , Scott	...	...	...	253
Notes on the Architecture, Nesting Habits, and Life Histories of Australian Araneidæ, based on specimens in the Aus- tralian Museum	...	...	...	317

**Waite, Edgar R.—**

The Reptiles of Ocean and Pleasant Islands	...	...	...	2
The Fishes of Ocean and Pleasant Islands	...	...	...	3
Additions to the Fish Fauna of Lord Howe Island. No. 3.	...	...	...	20
"                    "          "          "          "          "          No. 4.	...	...	...	135

Catalogue of the Fishes of Lord Howe Island	...	...	...	187
A Fresh-Water Turtle ( <i>Pelochelys cantoris</i> , Gray), from New Guinea	50			
New Records or Recurrences of Rare Fishes from Eastern Australia, No. 2	...	...	...	56
No. 3	...	...	...	231
<i>Chersydrus granulatus</i> , Schneider. A Snake new to Australia	74			
Description of a new <i>Phascogale</i> from North Western Australia	122			
The Genus <i>Dromicia</i> in New South Wales	...	...	...	134
A Review of the Eleotrids of New South Wales	...	...	...	277
The Breeding Habits of the Fighting Fish ( <i>Betta pugnax</i> , Cantor)	293			

### Whitelegge, T.—

The Crustacea and Echinodermata of Ocean and Pleasant Islands	8
---	---

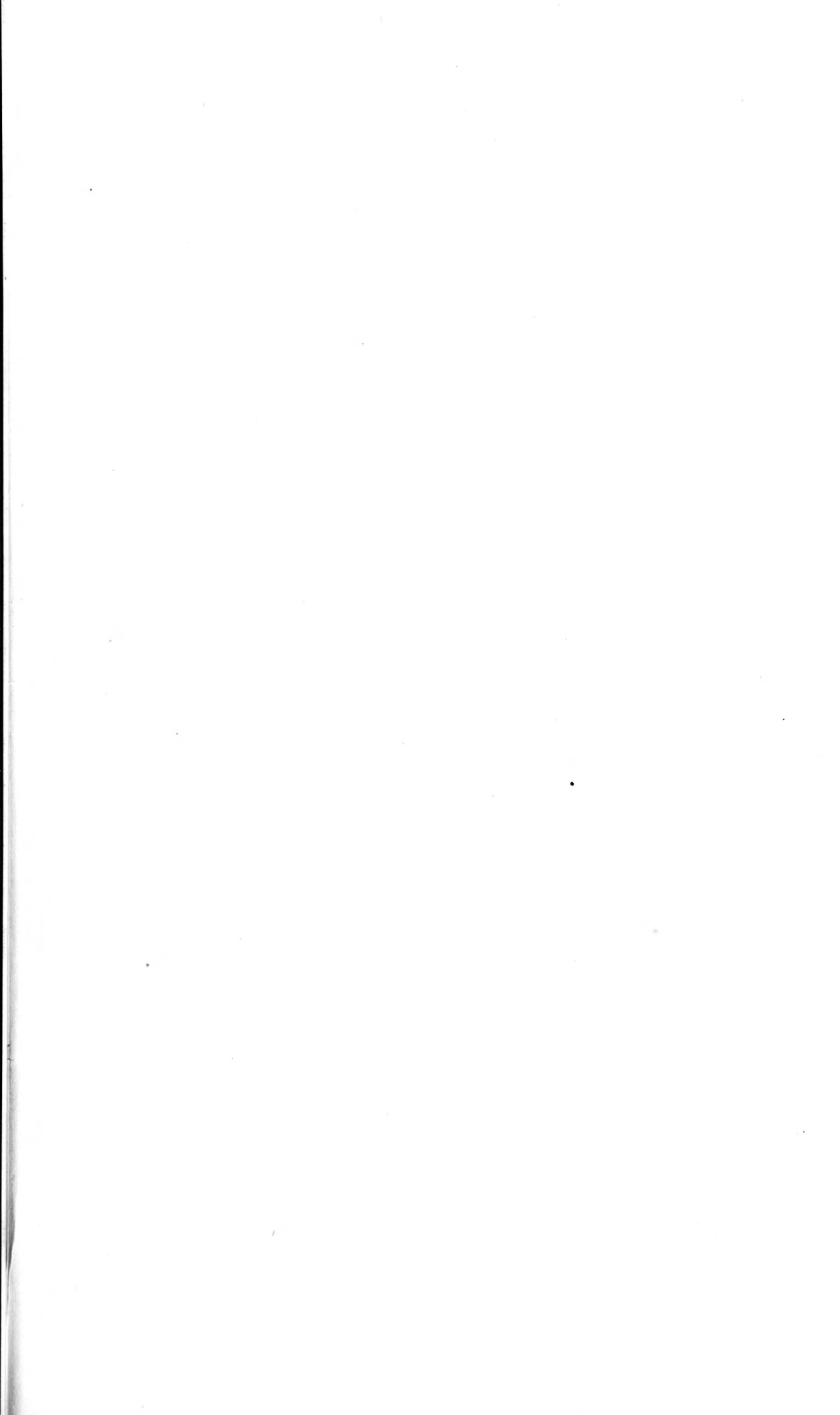

## LIST OF THE PLATES.

### PART I.

- I. *Fossopora wellingtonensis*.
- II.    "          "
- III. 1. *Ophichthus versicolor*.
- 2. *Brachaluteres haueri*.
- IV.  1. *Pseudolabrus luulentus*.
- 2. *Machærope latispinis*.
- V.   1. *Coris picta*.
- 2. *Cocotropus altipinnis*.
- VI. *Prosoplismus recurvirostris*.
- VII. *Dendrostoma dehamata*.

### PART II.

- VIII. *Cyclolituites bowringensis*.
- IX. *Nycteribia pteropus*.
- X.  1-3. *Niobe* ? sp. ind.
- 4. *Dikelocephalus florentinensis*
- 5-9. *Orthis lenticularis*.
- XI. 1, 2. *Cycklochila australasæ*.
- 3. *Thopha saccata*.
- XII. Locality Map, Kuringai Staff Station.
- XIII. Petroglyphs at Kuringai Staff Station.
- XIV. Coprolites, Nodules, and Cretaceous Shells.
- XV.  Nodules, and Cretaceous Shells.
- XVI. Nest of *Chlamydodera guttata*.

### PART III.

- XVII. 1. *Muraenichthys nicholsæ*,
- 2. *Gymnothorax chalazius*,
- 3. *Gonorrhynchus gonorrhynchus*.
- XVIII. 1. *Æthoprora perspicillata*,
- 2. *Notoscopelus ejectus*,
- 3. *Dasyscopelus naufragus*,
- 4. *Howella brodiei*.
- XIX.  1. *Xenogramma carinatum*,
- 2. *Bathystethus cultratus*.
- XX.   1. *Schedophilus maculatus*,
- 2. *Apogon chrysurus*,
- 3. *Girella cyanea*.
- XXI.   *Aplodactylus etheridgii*.
- XXII.  *Parma polylepsis*.
- XXIII. 1. *Glyphisodon polyacanthus*,
- 2. *Gobius æolosoma*,
- 3. *Allogobius viridis*,
- 4. *Limnichthys fasciatus*.
- XXIV. 1. *Diplocrepis costatus*,
- 2. *Lepadichthys frenatus*,
- 3. *Petroscirtes icelii*,
- 4. *Tripterygion rufopileum*,
- 5. *Dinematichthys longifilis*.

## PART IV.

- XXV. 1. *Trachinocephalus myops*.  
 2. *Tropidostethus rhotophilus*.  
 3. *Neopercis binivirgata*.  
 XXVI. 1. *Gnathagnus innotabilis*.  
 2. *Gnathypops jacksoniensis*.  
 3. *Schizochirus insolens*.  
 XXVII. 1, 2. *Rigonia* sp. ind.  
 3, 4. *Trigonia moorei*  
 5, 6, 7. *Acmaea* (?) *monswoodensis*.  
 XXVIII. *Isocrinus australis*, var. *albascopularis*.  
 XXIX. Spray of Eucalypt with leaves covered with larvæ of  
*Doratifera casta*.  
 XXX. *Stichus mermisoides*.  
 XXXI. *Stichus mermisoides*.  
 XXXII. Bower of *Chlamydodera orientalis*.

## PART V.

- XXXIII. Petroglyphs on a portion of the outer face of a Rock-shelter, Copmanhurst.  
 XXXIV. 1. *Carassiops compressus*.  
 2. " *galii*.  
 XXXV. 1. *Krefftius adpersus*.  
 2. " *australis*.  
 XXXVI. 1. *Krefftius covii*.  
 2. *Philipnodon grandiceps*.  
 XXXVII. 1-14. *Pisocrinus* (?) *yassensis*.  
 15. *Pisocrinus* (?) *yassensis*, var. *lobata*.  
 XXXVIII. 1. *Betta pugnax*.  
 2. Nest of *Betta pugnax*.  
 XXXIX. *Topaz*.  
 XL. 1. *Beryl*.  
 2. *Vesuvianite*.  
 3, 4, 5. *Tourmaline*.  
 XLI. *Wolframite*.  
 XLII. *Cimoliosaurus maccoyi*.  
 XLIII. *Cimoliosaurus maccoyi*.  
 XLIV. *Cimoliosaurus maccoyi*.  
 XLV. 1, 2. *Cimoliosaurus sutherlandi*.  
 3. *Ichthyosaurus*.  
 XLVI. 1-4. *Ectalostica troglodytes*.  
 5, 6. *Mimetus maculosus*.  
 7-9. *Pæcilipta venusta*.  
 10-12. *Corinnomma formiciforme*.



## CORRECTIONS.

---

- Page 58—for *Prosoplismus recurvirostris*, read *Pentaceropsis recurvirostris*:  
(see Ann. Mag. Nat. Hist. (7), xii., 1903, p. 288.)
- „ 170—further investigation, in conjunction with Mr. McCulloch,  
shows that examples recorded under the name *Glyphisodon*  
*antjerius*, and *G. brownriggii* are the young of *Parma poly-*  
*lepis*, specimens recorded from the mainland under these  
names are the young of *Parma squammpinnis*, *Parma micro-*  
*lepis*, the tenable name of the species, being the half-grown  
stage.
- „ 171—for D. xiii. 9; read D. xiii. 19.
- „ 190 No. 9—for figure none, read Kner, Reise Novara, Fische, 1867,  
pl. xiii., fig. 2.
- „ 195 No. 33—for p. 148, read 481.
- „ 206 No. 81 *Figure*—for 1869, read 1865.
- „ 209 No. 94—delete in favour of No. 92, and see note p. 170 above.
- „ 219 No. 147—read 147 TROPIDICHTHYS CAUDOFASCIATUS, Günther.  
*Tetrodon caudofasciatus*, Günther Cat. Fish. Brit. Mus., viii.,  
1870, p. 304, of which *T. callisternus* is a synonym.
- „ 234—for *Tropidostethus rhotophilus*, read *Iso rhotophilus*.
- „ 247—at third line from bottom for “elytra 24” read “elytra 2·4.”
- „ 298—line 4 from bottom, for abtuse read obtuse.
- „ 300 No. 30 for (0110) read (0110)

## CORRECTION TO EXPLANATION OF PLATE XIV

---

✓ For fig. 10 read fig. 9.

SCAPHITES ERUCIFORMIS, *Eth. fl.*

✓ Fig. 10. Back of limonite cast showing sutures and sculpture.—×2.



NOTES ON THE ZOOLOGY OF PAANOPIA OR OCEAN ISLAND  
AND NAURU OR PLEASANT ISLAND, GILBERT  
GROUP.

---

The material described in the following pages was either collected for, or presented to the Trustees by Messrs. F. Danvers Power and A. E. Stephen, who visited Ocean and Pleasant Islands on behalf of the Pacific Islands Co., Ltd., of this City. R. E.

---

THE BIRDS.

By ALFRED J. NORTH, Ornithologist

---

Only five spirit specimens were obtained, referable to the following four species:—

ACROCEPHALUS REHSEI, *Finsch.*

*Rehse's Reed Warbler.*

*Calamoherpe syrixa* (*non* Kittl.), Finsch, *Ibis*, 1881, p. 246.

*Calamoherpe rehsei*, Finsch, *Ibis*, 1883, p. 143.

*Tatave rehsei*, Sharpe, *Brit. Mus. Cat., Bds., vii., 1883, p. 528.*

Two specimens. Dr. O. Finsch, who visited Pleasant Island on the 24th July, 1880, and was the first naturalist to land on its shores, gives an interesting account of this species in his "Letters from the Pacific," published in "The Ibis" in the following year. It is known in the Island by the Mauru native name of Tereet.

TOTANUS INCANUS, *Vieill.**Grey-rumped Sandpiper.*

*Totanus incanus*, Vieill., Nonv. Diet. Hist. Nat., vi., 1816, p. 400.  
*Heteractilis incanus*, Sharpe, Brit. Mus. Cat., Bds., xxiv., 1896,  
 p. 453.

A single specimen. Nauru native name Tekr (A) ret.

MICRANOUS LEUCOCAPILLUS, *Gould.**White-capped Noddy.*

*Anous leucocapillus*, Gould, Proc. Zool. Soc., 1845, p. 103.  
*Micranous leucocapillus*, Saunders, Brit. Mus. Cat., Bds., xxv.,  
 1896, p. 145.

One specimen. Nauru native name Teror.

GYGIS CANDIDA, *Gmelin.**White Tern.*

*Sterna candida*, Gmel., Syst. Nat., i., 1788, p. 607.  
*Gygis candida*, Saunders, Brit. Mus. Cat., Bds., xxv., 1896, p. 149.

One specimen. Nauru native name Te gigea.

---

 THE REPTILES.

By EDGAR R. WAITE, F.L.S., Zoologist.

Three species of Lizards were obtained, all known from neighbouring islands, they are:—

*Gehyra oceanica*, Lesson.—Ocean Island.

*Lygosoma cyanurum*, Lesson.—Pleasant and Ocean Islands.

*Lygosoma atrocostatum*, Lesson.—Pleasant Island.

---

 THE FISHES.

By EDGAR R. WAITE, F.L.S., Zoologist.

Gauged by the small number of species placed in our hands, no serious effort seems to have been made to collect the fishes of the islands. Those obtained, as would be expected, are common to many of the Polynesian Islands, and are interesting as extending the known habitats of the species, and being, as far as I am aware, the only specimens recorded from the islands.

As both Pleasant and Ocean Islands are purely oceanic, their fauna may not be so rich as those of a group, as, for example, the Marshall and the Gilbert Groups, to which, politically, the islands are respectively attached.

PLEASANT ISLAND, (*Nauru*.)

- Gymnothorax pictus*, Ahl.  
*Fistularia depressa*, Günther.  
*Mulloidés samoensis*, Günther.  
*Caranx hippos*, Linnæus. (Regarded as poisonous at times! )  
*Anthias pleurotania*, Bleeker.  
*Cirrhités maculatus*, Lacépède.  
*Glyphidodon brownriggii*, Bennett.  
*Thalassoma purpurea*, Forskal.  
*Thalassoma melanochir*, Bleeker.  
*Teuthis lineatus*, Linnæus.  
*Teuthis triostegus*, Linnæus.  
*Nasus unicornis*, Forskal.  
*Salarias periophthalmus*, Cuvier and Valenciennes.  
*Rhomboidichthys pantherinus*, Rüppell.

OCEAN ISLAND, (*Paanopia*.)

- Gymnothorax flavomarginatus*, Rüppell.  
*Gymnothorax tessellatus*, Richardson.  
*Tylosurus platyrus*, Rüppell (? = *Belen depressa* Günther).  
*Fistularia depressa*, Günther.  
*Holocentrus erythreus*, Günther. (Native name *Te breno*).  
*Promethichthys promethus*, Cuvier and Valenciennes.  
*Caranx hippos*, Linnæus.  
*Kuhlia taniura*, Cuvier and Valenciennes.  
*Epinephelus merra*, Bloch.  
*Teuthis triostegus*, Linnæus.  
*Gobius albopunctatus*, Cuvier and Valenciennes.  
*Salarias meleagris*, Cuvier and Valenciennes.

The following are given as native names at Ocean Island, as specimens were not obtained the species cannot be given.

- Hammer-headed Shark, *Te-pakoa te anoa*.  
Tiger Shark, *Emurr*.  
Flying Fish, *Te-nouti*.  
Palu, *Te-kauebek*.

The last-named, of which I have seen a photograph, is *Rucettus pretiosus*, Cocco, a species I first recorded from the South Pacific.<sup>1</sup>

<sup>1</sup> Waite—Aust. Mus. Mem., iii., 1899, p. 539.

## THE MOLLUSCA.

By C. HEDLEY, Conchologist.

The collection of shells brought from Pleasant Island includes no new or remarkable forms. All commonly occur in the Central Pacific. The species are as follows:—

- Acmea stellaeformis*, Reeve.  
*Trochus maculatus*, Linne.  
*Turbo argyrostomus*, Linne.  
*Nerita plicata*, Linne.  
*Helicina musiva*, Gould.  
*Vanikoro petitiana*, Recluz.  
*Ianthina ianthina*, Linne. .  
*Cerithium columna*, Sowerby.  
*Cypræa arenosa*, Gray.  
     " *arabica*, Linne.  
     " *carneola*, Linne.  
     " *caput-serpentis*, Linne.  
     " *cicercula*, Linne.  
     " *helvola*, Linne.  
     " *isabella*, Linne.  
     " *moneta*, Linne.  
     " *nucleus*, Linne.  
     " *reticulata*, Martyn.  
     " *scurra*, Chemnitz.  
     " *stolida*, Linne.  
     " *talpa*, Linne.  
     " *teres*, Gmelin.  
     " *tigris*, Linne.  
     " *ventricosa*, Linne.  
*Purpura hippocastaneum*, Lamk.  
     " *armigera*, Chemnitz.  
*Sistrum dumosum*, Conrad.  
     " *horridum*, Lamk.  
*Mitra pontificalis*, Lamk.  
*Conus auratus*, Hwass.  
     " *glans*, Hwass.  
     " *geographus*, Linne.  
     " *hebraeus*, Linn.  
     " *lividus*, Hwass.  
     " *miliaris*, Hwass.  
     " *rattus*, Hwass.

*Stenogyra gracilis*, Hutton.  
*Modiola australis*, Gray.  
*Melina perna*, Linn.  
*Libitina guinaica*, Lamk.  
*Circe pectinata*, Linne.  
*Venus reticulata*, Linne.  
*Tridacna elongata*, Linne.  
*Chama*, sp.

---

## THE ARTHROPODA.

By W. J. RAINBOW, F.L.S., Entomologist.

---

Very few specimens in this division were collected, and these, which are enumerated below, are well known Pacific forms. It is apparent, from the material obtained, that no serious effort at collection was made, otherwise the results would undoubtedly have been greater. Nevertheless, the collection, small as it is, is important and of interest, seeing that nothing has hitherto been published concerning the fauna of these small and out of the way Islands.

The following is a list of the specimens obtained:—

### ORDER ARANEIDÆ.

#### FAMILY ULOBORIDÆ.

#### GENUS ULOBORUS, Latr.

#### ULOBORUS GENICULATUS, Oliv.

This species is widely distributed, occurring in nearly all tropical regions.

*Loc.*—Pleasant Island.

### FAMILY ARGIOPIDÆ.

#### GENUS TETRAGNATHA, Latr.

#### TETRAGNATHA PANOPEA, L. Koch.

Previously recorded from the Islands of Tanna and Malekula, New Hebrides; Samoa; and Noumea, New Caledonia.

*Loc.*—Pleasant Island.

#### GENUS ARANEUS, Clerck (= *Epeira*, auct).

#### ARANEUS THEISHI, Walck.

This species is common in all tropical regions.

*Loc.*—Ocean Island.

## FAMILY CLUBIONIDÆ.

GENUS HETEROPODA, *Latr.*HETEROPODA VENAFORIA, *Linn.*

This species, like the preceding, is also common in all tropical regions.

*Loc.*—Ocean and Pleasant Islands.

## FAMILY ATTIDÆ.

GENUS PLEXIPPUS, *C. Koch.*PLEXIPPUS PAYKULLI, *Aud.*

Very widely distributed—in fact, cosmopolitan.

*Loc.*—Pleasant Island.

## ORDER MYRIAPODA.

Two specimens of the genus *Julus*, *Linn.*, were collected on Pleasant Island, but were too immature for specific determination. The native name for these creatures is Te tapoa.

## ORDER COLEOPTERA.

## FAMILY TROGOSITIDÆ.

GENUS LATOLEVA, *Reitt.*LATOLEVA INCENSA, *Olliff.*

Previously recorded from Apu ; Salwatty ; New Guinea.

*Loc.*—Pleasant Island.

## FAMILY CLERIDÆ.

GENUS CORYNETES, *Herbst.*CORYNETES CŒRULEUS, *De Geer.*

This species is cosmopolitan.

*Loc.*—Pleasant Island.

## FAMILY ELATERIDÆ.

GENUS MONOCREPIDIUS, *Fsch.*MONOCREPIDIUS UMBRACULATUS, *Cand.*

Previously recorded from New Guinea and Funafuti, Ellice Group.

*Loc.*—Ocean and Pleasant Islands.

## FAMILY BOSTRYCHIDÆ.

GENUS RHIZOPERTHA, *Steph.*RHIZOPERTHA RELIGIOSA, *Boisd.*

Previously recorded from New Britain and New Guinea.

*Loc.*—Pleasant Island.



FAMILY CEDEMERIDÆ.

GENUS NACERDES, *Schm.*

NACERDES TRANSMARINA, *Rainb.*

Previously recorded from New Guinea and Funafuti, Ellice Group.

*Loc.*—Ocean and Pleasant Islands.

ORDER ORTHOPTERA.

FAMILY CONOCEPHALIDÆ.

GENUS CONOCEPHALUS, *Thund.*

CONOCEPHALUS TROUDETI, *Le Guil.*

Previously recorded from Northern Australia and New Guinea.

*Loc.*—Pleasant Island.

FAMILY CEDIPODIDÆ.

GENUS PACHYTYLUS, *Fieb.*

PACHYTYLUS CINERASCEUS, *Schaff.*

This species which is widely distributed is very variable, both in size and colour. It has been recorded from Victoria River, N. Australia; New Zealand; New Hebrides; Sandwich Islands; Corea; Mauritius; South Africa; Teneriffe; Madeira.

*Loc.*—Pleasant Island.

ORDER LEPIDOPTERA.

No Butterflies were obtained, but several Moths were collected. These were, unfortunately, too worn to be of value. Amongst them there was one of the Sphingidæ, from Pleasant Island, probably a species of *Acosmeryx*, Butl., but it was too broken to permit one to speak with certainty. Other species were:—

FAMILY APAMIIDÆ.

GENUS AMYNA, *Guén.*

AMYNA OCTO, *Guén.*

Previously recorded from the Ellice and Gilbert Groups.

*Loc.*—Ocean Island.

FAMILY REMIGIIDÆ.

GENUS REMIGIA, *Guén.*

REMIGIA TRANSLATA, *Walk.*

This species has been recorded from Ceylon; Marshall Islands; and the Ellice Group.

*Loc.*—Pleasant Island.

## THE CRUSTACEA AND ECHINODERMATA.

By T. WHITELEGGE, Zoologist.

The collection consists of fifty-two specimens,—forty-two Crustaceans and ten Echinoderms. The species are as follows:—

## CRUSTACEA.

*Micippa philyra*, Herbst.  
*Daira perlata*, Herbst.  
*Eriphia scabricula*, Dana.  
*Cardisoma hirtipes*, Dana.  
*Gecarcinus lagostoma*?, Edwards.  
*Ocypoda cordimana*, Desmarest.  
*Geograpsus crinitipes*, Dana.  
*Cenobita spinosa*, Edwards.  
*C. rugosa*, Edwards.  
*Clibanarius taciatus*, Edwards.  
*Calcinus herbsti*, De Mann.  
*Atya bisulcata*, Randall.  
*Gonodactylus trispinosa*, White.

## ECHINODERMS.

*Echinothrix turcarum*, Schym.  
*Heterocentrotus manillatus*, Klein.  
*Echinometre lucinta*, Leske.  
*E. oblonga*, Blainville.  
*Ophiocoma brevipipes*, Peters,  
*Muelleria echinites*, Jaeger.  
*Holothuria atra*, Jaeger.

## CRUSTACEA.

MICIPPA PHILYRA, *Herbst.*

*Micippa philyra* (Herbst.), H. Milne Edwards, Hist. Nat. Crust., i., 1834, p. 330; A. Milne Edwards, Nouv. Arch. Mus., viii., 1834, p. 239, pl. xi., fig. 2.

Two small males of this species were obtained at Pleasant Island.

DAIRA PERLATA, *Herbst.*

*Daira Perlata* (Herbst.), Dana, Crust. U.S. Explor. Exped., i., p. 204, pl. x, fig. 14.

Two males and two females from Pleasant Island.

ERIPHIA SCABRICULA, *Dana*.

*Eriphia scabricula*, Dana, Crust. U.S. Explor. Exped., i., p. 247, pl. xiv., fig. 5a.

A single specimen is present in the collection.

CARDISOMA HIRTIPES, *Dana*.

*Discoplaea longipes*, A. Milne Edwards, Nouv. Arch. Mus., ix., 1873, p. 294, pl. xv.

A fine male specimen of this species was collected at Pleasant Island.

Length of carapace	...	...	...	68 mm.
Bredth of earapace	...	...	...	74 ,,
Total width with legs extended	...	...	...	355 ,,

GECARCINUS LAGOSTOMA, *H. Milne Edwards?*

*Gecarcinus lagostoma*, H. Milne Edwards?, Hist. Nat. Crust., ii., 1837, p. 27; Ann. Sci. Nat., (3), xx., 1853, p. 203; Ortmann, Zool. Jahrbüch., x, 1897, p. 337.

A single example of this genus is present in the collection from Ocean Island. A great deal of uncertainty exists in regard to the only species recorded from the Pacific, *Gecarcinus lagostoma*, Milne Edwards, which was supposed to have been collected in Australia by Quoy and Gaimard. Ortmann considers the locality as erroneous, and also that Mier's figure truly represented *G. lagostoma*, M. Edwards. The latter author has examined what he surmises is the type of the species, from M. Guérin's collection. The specimen under notice is apparently distinct from that figured by Miers, and may possibly be the original *G. lagostoma*, M. Edwards. Under these circumstances I propose to describe the species under this name, and trust to future investigators to determine the true position of it.

The carapace is 60 mm. long and 78 mm. wide, the frontal region is strongly convex and the lateral regions are broadly and evenly rounded. The orbits measure 11 mm. by 8 mm., and the frontal process is 12 mm. in length. The front has a slightly raised granular margin, which is continued on each side to the inferior orbital hiatus, the granules, as the latter is approached, gradually increase in size and in distance apart. The rudimentary antero-lateral line is represented by a very faint ridge, which commences at the external orbital border, and is continued for a distance equal to the length of the orbit. The apex of the basal joint of the second antennæ is almost in contact with the external angle of the front; immediately below its insertion, a well marked granular ridge arises and is con-

tinued to within a short distance of the end of the faint antero-lateral line; its total length is about 18 mm. The upper surface of the carapace is smooth, glossy and closely punctate. The post-orbital region is plain, and the post-frontal space has two low rounded elevations; in advance of the latter a pair of very faint transverse lines are present; they can only be seen with difficulty and at certain angles. A well defined median groove exists on the anterior third of the carapace, and a lateral pair extends from the orbits to the anterior border of the cardiac region. The course of the grooves is marked by four pairs of depressed yellow spots. The first pair are situated about their own diameter from the external orbital border, and mark the commencement of the grooves, the second are 15 mm. posterior to the first pair, and 33 mm. from each other, the third are 15 mm. apart and about the same distance from the two preceding, and 9 mm. from the last pair.

The pterygostomial region is quite glabrous; the inflected surfaces and the mesal joints of the legs are more or less covered with squamiform granulations; the inferior surface of the body is smooth and remotely punctate.

The external maxillipedes agree in shape and size with de Haan's figure of *Gecarcinus ruricola*.<sup>1</sup> In the figure given by Miers<sup>2</sup> the interno-distal angle of the third joint is depicted as being rounded and the outer border is about twice as long as the inner. In the specimen under notice the third joint has the lateral borders of equal length, and the internal angle is a little more prominent than the outer, with a moderately large emargination in the middle of the distal border, behind and below which the fourth joint is articulated, the upper two-thirds of the joint being exposed. The merus joints of the first pair of legs have a double row of large alternating granules along the anterior border, and a broader series confined to the proximal half of the posterior angle.

The upper surface of the carpus, the external surface of the palm and fingers are closely punctate, the extremities of the fingers are studded with horny granules, or rudimentary spines. The left hand is much the larger, it is 70 mm. in length and 30 mm. in depth at the base of the fingers; the latter are widely separated and meet only at their tips. The fingers of the right hand are almost in contact throughout when closed; their inner edges are armed like the left with a series of about five tubercles on the lower, and three closely placed denticles on the proximal portion of the upper border. The last three joints of the ambulatory legs are armed with

---

<sup>1</sup> De Haan—Fauna Japon., Crust., 1833, pl. C.

<sup>2</sup> Miers—Chall. Rep., Zool., xvii, pl. xviii., figs. 2, b and c

horny spinules, the fifth joint has two rows seated on the angles of the upper border, the sixth has four and the seventh six rows, all of which are confined to the prominent angles of the joints. Between the bases of the fourth and fifth legs there is a series of long hairs, which are probably similar in function to those occurring at the bases of the third and fourth legs in the genus *Ocypoda* and also in *Geograpsus crinipes*, Dana.

OCYPODA CORDIMANA, *Desmarest*.

*Ocypoda cordimana*, Desmarest, Consid. sur le Crustacés, 1803, p. 121; Miers, Ann. Mag. Nat. Hist., (5), x., 1882, p. 387, pl. xvii, fig. 9.

A single half grown male example is present in the collection.

GEOGRAPSUS CRINIPES, *Dana*.

*Geograpsus crinipes*, Dana, Crust. U. S. Explor. Exped., i., p. 341, pl. xxi., fig. 6; Whitelegge, Aust. Mus. Mem., iii., 2, p. 139.

A fine male example of this species was obtained at Pleasant Island.

CENOBITA SPINOSUS, *H. Milne Edwards*.

*Cenobita spinosus*, H. Milne Edwards, Hist. Nat. Crust., ii., 1837, p. 242.

*Cenobita olivieri*, Owen, Voy. "Blossom," 1839, p. 84.

*Cenobita brunnea*, Dana, Crust. U.S. Explor. Exped., i., 1852, p. 420, pl. xxix., fig. 10.

*Birgus hirsutus*, Hess, Decap-krebs. Ost. Austral., 1865, p. 36, pl. vii., fig. 16.

*Cenobita olivieri* and *C. brunnea* (Dana), Haswell, Aust. Mus. Cat., v., Crust., 1882, p. 160-161.

Two specimens of this species were obtained at Pleasant Island in the shells of *Turbo argyrostoma*, Linné.

CENOBITA RUGOSA, *H. Milne Edwards*.

*Cenobita rugosa*, H. Milne Edwards, Hist. Nat. Crust., ii., 1837, p. 241; Dana, Crust. U.S. Explor. Exped., i., 1852, pl. xxx, figs. 1-2.

Three specimens are present in the collection.

CLIBANARIUS TENIATUS, *H. Milne Edwards*.

*Clibanarius tæniatus*, H. Milne Edwards, Ann. Sci. Nat., Zool. (3), x., 1848, p. 62.

*Pagurus clibanarius*, Quoy and Gaimard, Voy. "Uranie," Zool., Crust., pl. lxxviii., fig. 1.

A single example of this beautifully marked species was obtained at Pleasant Island.

CALCINUS HERBSTI, *De Mann.*

*Calcinus tibicen*, H. Milne Edwards, *Hist. Nat. Crust.*, ii., 1837, p. 229; *Atlas, Cuv. Regn. Anim., Crust.*, 1849, pl. xlvi., fig. 3.  
*Calcinus herbsti*, De Mann, *Arch. Naturg.*, liii., 1, fig., 1887, p. 437.

There are four examples of this common species from Pleasant Island.

ATYA BISULCATA, *Randall.*

*Atya bisulcata*, Randall, *Journ. Acad. Nat. Sci. Phil.*, viii., p. 140, pl. v, fig. 5.

About twenty young examples which are with some hesitation referred to this species. The specimens are too immature to determine satisfactorily.

GONODACTYLUS TRISPINOSUS, *White.*

*Gonodactylus trispinosus*, White, Miers, *Ann. Mag. Nat. Hist.*, (5), v., 1880, p. 121, pl. iii., fig. 10.

One specimen of this species from Pleasant Island.

## ECHINODERMS.

ECHINOTHRIX TURCARUM, *Schym.*

*Echinothrix turcarum* (Schym.), Agassiz, *Rev. Echini*, *Mem. Mus. Comp. Zool.*, iii., p. 416, pl. iiiia, fig. 3.

One specimen from Pleasant or Ocean Island.

HETEROCENTROTUS MAMILLATUS, *Klein.*

*Heterocentrotus mamillatus* (Klein), Agassiz, *Rev. Echini*, iii., p. 428.

Two specimens from Ocean or Pleasant Island. The spines are dark purple with one or two subterminal whitish rings.

ECHINOMETRA LUCUNTER, *Leske.*

*Echinometra lucunter* (Leske), Agassiz, *Rev. Echini*, iii., p. 341.

A single example from Ocean or Pleasant Island.

ECHINOMETRA OBLONGA, *Blainville.*

*Echinometra oblonga* (Blainville), Agassiz, *Rev. Echini*, iii., p. 433.

A solitary specimen was obtained at Ocean or Pleasant Island,

OPHIOCOMA BREVIPES, *Peters.*

*Ophiocoma brevipes*, Peters, *Arch. Naturg.*, xviii., 1852, p. 85.

A small immature example is referred to this species. Ocean or Pleasant Island.

MUELLERIA ECHINITES, *Jaeger*.

*Muelleria echinites*, Jaeger, De Holoth., 1833, p. 17-18, pl. iii., fig. 6; Semper, Reisen. Arch. Phil., Holoth., i., 1868, p. 76, pl. xxx., fig. 8.

One specimen from Pleasant Island.

HOLOTHURIA ATRA, *Jaeger*.

*Holothuria atra*, Jaeger, De Holoth., 1833, p. 22; Théel, Chall. Rep., Zool., xiv., p. 181, pl. vii., fig. 4.

Three specimens from Ocean or Pleasant Island.

---

NOTES AND ANALYSES OF PHOSPHATIC SPECIMENS

By CHARLES ANDERSON, M.A., B.Sc., Mineralogist.

---

Most of these specimens were presented by Mr. F. Danvers Power, two being the gift of Mr. J. T. Arundel.

1. This specimen is stalactitic in structure and has an outside layer, brownish in colour and about an eighth of an inch in thickness, while the interior shows coral structure. The outer layer is fairly hard and compact, carries warty, stalactitic growths, and in parts the surface is slightly mammillated.—Ocean Island.

2. Consists of a single stalactite about four inches long, solid throughout, with internal coralline structure. Like the preceding it shows an outer more compact skin, slightly darker in colour. Here, however, the contrast is not so striking, the whole being more homogenous in grain and of a fairly uniform dirty white. In this specimen the external surface is rough.

*Loc.*—Ocean Island.

3. This is an alluvial specimen consisting of rounded and subangular fragments of a prevailing white colour, set in a matrix of finer-grained, buff-coloured material. These fragments have the characteristic darker outer layer, and some shew a concentric structure (pisolitic). A bulk analysis of this specimen yielded the following result:—

Moisture at 100° C.	...	...	...	1·69 %
Loss at 180° C.	...	...	...	·39
Carbonic Anhydride (CO <sub>2</sub> )	...	...	...	3·12
Organic Matter (by Difference)	...	...	...	1·34
Lime (CaO)	...	...	...	52·80
Phosphoric Anhydride (P <sub>2</sub> O <sub>5</sub> )	...	...	...	39·85

---

99·19

*Loc.*—Ocean Island.

4. This specimen is marked by a stratified arrangement. It consists of two different kinds of phosphate, one white and friable, the other buff-coloured and compact, and these are arranged in irregular layers. At the junction there is in places a commingling of the two, the darker shedding blocks into the other, while it is itself intruded by the latter. An attempt was made to get a sample of the darker coloured material for analysis, and a fairly homogeneous piece gave the following figures:—

Carbonic Anhydride ( $\text{CO}_2$ )	...	...	2.22 %
Loss on ignition (less $\text{CO}_2$ )	...	...	3.84
Lime ( $\text{CaO}$ )	...	...	53.61
Phosphoric Anhydride ( $\text{P}_2\text{O}_5$ )	...	...	39.72
			<hr/>
			99.39

*Loc.*—Ocean Island.

5. Of an almost uniform white, and varies in hardness between 1 and 3. It shews a few shell remains. On analysis it was found to have the following composition:—

Moisture at 100° C.	...	...	...	1.48 %
Loss at 180° C.	...	...	...	1.29
Carbonic Anhydride ( $\text{CO}_2$ )	...	...	...	2.15
Organic Matter (by Diff.)	...	...	...	5.13
Lime ( $\text{CaO}$ )	...	...	...	52.78
Phosphoric Anhydride ( $\text{P}_2\text{O}_5$ )	...	...	...	36.72
				<hr/>
				99.55

*Loc.*—Ocean Island.

6. This specimen is from an upraised coral formation. It is hard and compact, of a prevailing white, and is characterised by the presence of numerous shells and casts of molluscs. An analysis showed the composition to be as follows:—

Moisture at 100° C.	...	...	...	1.09 %
Loss at 180° C.	...	...	...	.52
Carbonic Anhydride ( $\text{CO}_2$ )	...	...	...	3.12
Organic Matter (by Difference)	...	...	...	2.27
Lime ( $\text{CaO}$ )	...	...	...	53.21
Phosphoric Anhydride ( $\text{P}_2\text{O}_5$ )	...	...	...	39.08
				<hr/>
				99.29

*Loc.*—Ocean Island.

7. Has a ferruginous interior, which appears where the specimen was broken off from the main mass; outside is a layer of white phosphate. The surface is covered with numerous excrescences, which may be described as botryoidal in character.

*Loc.*—Pleasant Island.



8. Shows a thin external layer, which is smooth, mammillated and brownish. The remainder of the specimen is apparently of coralline nature.

*Loc.*—Pleasant Island.

9. This is a hollow stalactite, about two inches long. It is smooth and hard (about 4) and greyish in colour.

*Loc.*—Ocean Island.

10. A phosphatic nodule, roughly spherical, about six-eighths of an inch in diameter, and has a fairly good enamel on some parts of the surface.—

*Loc.*—Ocean Island.

---

FOSSOPORA, A NEW GENUS OF PALÆOZOIC PERFORATE  
CORALS.

By R. ETHERIDGE, Junr., Curator.

---

(Plates i., ii.)

The compound corallum is in the form of lobate masses of medium size, and is composed of very small prismatic and polygonal corallites, firmly united by their walls, divided into well-defined peripheral and axial portions, the corallites in the former being more or less vertical, and in the latter gradually bent or inclined outwards to the surface. In consequence of the specimen being wholly included in matrix the appearance of the corallites at the surface of the corallum, or terminal period of growth, has not been studied, nor is the method of attachment known.

It is proposed to term this coral *Fossopora*<sup>1</sup> *wellingtonensis*<sup>2</sup>.

The firmly united polygonal corallites are long, and chiefly hexagonal and pentagonal, but their regularity of outline, from causes to be described later, frequently becomes lost. The average diameter is as near as possible half a millimetre, or two calices in the space of one millimetre. The firmly united, or rather indistinguishably amalgamated walls in the axial region are sufficiently thickened to sometimes obliterate the prismatic form, but in the peripheral area stereoplasmic matter has been added to such an extent as to almost conceal all other points of structure.

In a transverse section prepared for the microscope the small size of the corallites is at once seen, and the polygonal outline generally so. It also becomes evident that neighbouring tubes are placed in communication by large mural pores. In places this perforation predominates to such an extent that the structure practically becomes cribriform, and through this the outline of the corallites is also sensibly interfered with.

The septa are very apparent, invariably six in number, projecting inwards towards the centres of the visceral cham-

---

<sup>1</sup> *Fossa*, a channel or trench.

<sup>2</sup> In allusion to the locality.

bers, but never meeting, revolving, or departing from the straight in the slightest degree. As seen in transverse section each septum has a trabecular or spine-like appearance, terminating distally in a club-shaped, or somewhat pyriform end, this, however, is not wholly their entire structure, as will be shown later. The septa are primary only, no trace of intermediate projections having presented itself, nor has a single instance of departure from the number six been verified. There is no coenenchyma, nor a columella.

In a transverse section (tangential) of the peripheral area the sclerenchymatous thickening in a very great measure obliterates the essential features of the coral, still the sex-radiate septa and perforate walls are more or less distinguishable. In a longitudinal section of the axial region some very instructive features are brought to light. The perfectly amalgamated walls are, at once apparent, the true structure of the septa, after a little consideration grasped, and the characters of the tabulae displayed. The corallite walls are detected by their darker and thicker appearance, but in many, if not in most of the visceral chambers are finer vertical lines passing in and out of the plane of the section. In the same alignment with any given one of these lines are also visible circular dark dots, resembling the cut ends of spiniform septa in some *Favosites*. I believe the explanation of these structures is as follows:—The septa are at first in the form of vertical lamellae extending the whole length of the visceral chambers of a corallite, from top to bottom, and represented in a transverse section by the straight proximal portions of the radii; the inner or free ends of these lamellae then become divided or broken up into free spines having distal more or less club-shaped ends. I conceive that this explanation is to all intents and purposes proved by the break in the continuity of the lamellae when viewed longitudinally, and in the same alignment occupied by the dark spots, the cut ends of the free, spine-like portions of the septa. Indeed, it is even possible to here and there detect a faint vertical line uniting a series of these dots.

The pores of communication are visible under two aspects as usual, either as direct breaks in the continuity of the amalgamated walls, or as openings in the latter, where the section has passed vertically through a visceral chamber out of the centre; they are uniserial and usually in the centre of a wall. These mural pores are large, oval, and with their longest diameters parallel to the direction or growth of the coral.

The tabulae, like the lamellar portions of the septa, are not thickened to the same extent as the walls. They are horizontal, oblique, concave, and occasionally anastomosing, very numerous, close, although at variable distances apart,

sometimes on the same level in contiguous corallites, but not necessarily so. The old visceral chambers are wider than long, *i.e.*, their greatest diameter is transverse to the direction of the growth of the coral.

A longitudinal section of the peripheral area, or that portion of the corallum in which the corallites diverge from the vertical (more or less) to pass out to the surface, is rendered obscure by the large amount of the stereoplasmic matter deposited, greatly thickening the walls and filling up the visceral chambers. This deposit is of a lighter colour than the other tissues.

The absence of any trace of spongy coenenchyma, or reticulated sclerenchyma, the presence of regular mural pores, instead of highly and irregularly porous or lattice-like walls removes *Possopora wellingtonensis* from the Poritidæ proper. On the other hand, the occurrence of these pores of communication, and the fact that the walls of neighbouring corallites are indistinguishably fused, appear to point to the Favositidæ, but the bistructural form of the septa seems to mark it as peculiar in this family. The septa in the Favositidæ may be obsolete (some *Favosites*), rudimentary (*Fletcheria*), in the form of ridge-like marginal lamellæ (*Laceripora*, *Calapavicia* and *Nyetopora*), tooth-like projections of limited number (*Cænites*), squamose (*Cladopora*), or more commonly as simple vertically disposed rows of spinelets (other *Favosites*, *Pachypora*, *Alveolites*, *Chonostegites*, *Trachypora*, etc.). The first and last conditions, typically represented by *Favosites* itself, are by far the most common.

It may be advantageous to refer more in detail to the structure of three of the more highly perforate genera, as compared with that of *Possopora*.

1. *Calapavicia*, Billings (*Columnopora*, Nicholson). — The mural pores in this genus are so numerous as to reduce the walls to a mere lattice-work. The septa, according to Nicholson, consist of "longitudinal ridges," or "marginal ridges," generally about twenty in each corallite<sup>3</sup>. Lambie, on the other hand, speaks of them as "spiniform septal ridges"<sup>4</sup>; his figure apparently representing them as separate septal spines<sup>5</sup>. Nicholson also describes the walls as longitudinally traversed by "intra-mural canals," but Lambie does not refer to them. It is difficult to reconcile the two authors' statements. Are the septa simply longitudinal lamellæ, or are they primarily the latter, secondarily giving support to spines on their free edges? If in the last-named condition, a resemblance to the septa of *Possopora* is manifest, although the number of septa in a cycle

<sup>3</sup> Nicholson—*Tab. Corals Pal. Period*, 1879, pp. 159 and 161.

<sup>4</sup> Lambie—*Contrib. Canadian Pal.*, iv., 1, 1899, p. 42.

<sup>5</sup> Lambie—*Loc. cit.*, pl. i, fig. 6.

is largely increased. On the other hand, I have seen no trace of intra-mural canals in my genus, and the arrangement of the pores of communication is very different.

2. *Laceripora*. — In Eichwald's genus the corallum is ramose, and the walls of the corallites, like those of *Fossopora*, are firmly united, but so numerous are the mural pores that the unequal visceral chambers appear in cross sections as if confluent. The septa are either rudimentary or lamellar, and when in the latter condition vary in number from two to many, but there are usually five or six, as I find from a specimen of *Laceripora cribrosa*, Eichw., very kindly supplied to me by Mr. H. Pietz, Curator of the Geological Museum of the Imperial University of St. Petersburg.<sup>6</sup>

The tabulæ, unlike those of *Fossopora* are said by Eichwald to be on the same level in contiguous corallites throughout the corallum, so as to form superimposed stages or strata, one above the other.<sup>7</sup> The abundance of the mural pores renders the walls highly cribriform.

3. *Somphopora*. — In general appearance and structure *Somphopora*, Lindström, is closely allied to *Laceripora*, for Nicholson says:—"Very closely allied to *Laceripora*, Eichw., if indeed really generically distinct from it, is *Somphopora*, Lindstr."<sup>8</sup> On the other hand, Lindström<sup>9</sup> points out that in his genus the septa are constantly six, and spiniform only, and the tabulæ few. Furthermore, one of his figures renders it perfectly clear that the tabulæ were comparatively far apart, and were not so regularly placed on the same level as to break the corallum up into a series of superimposed strata.

It would appear, therefore, that in *Laceripora*, *Somphopora*, and *Fossopora*, we have three closely allied genera, but with structural details sufficiently varied to separate one from the other.

*Fossopora wellingtonensis* occurs in Siluro-Devonian beds of the Wellington District in this State, but whether on a horizon referable to the former formation, or on one forming a portion of the latter, I am not at present able to say.

<sup>6</sup> Etheridge & Foord, Ann. Mag. Nat. Hist., (5), xiv., 1884, p. 314.—It is now quite clear to me that Mr. A. H. Foord and myself committed a very grave error when we referred Eichwald's *Laceripora cribrosa* to *Chaetetes*. Our mistake evidently arose (1) from a misconception of the interrupted structure of the walls seen in transverse section; and (2) from the accidental non-appearance of mural pores in the longitudinal.

<sup>7</sup> Eichwald—Lethæa Rossica, i., 1860 (?), p. 490.

<sup>8</sup> Nicholson—Geol. Mag., (3), iii., 1886, p. 291.

<sup>9</sup> Lindström—Beiträge Pal. China, (Richthofen's China), iv., 4, 1883, p. 51.

ADDITIONS TO THE FISH-FAUNA OF LORD HOWE  
ISLAND, No. 3. \*

By EDGAR R. WAITE, F.L.S., Zoologist.

(Plates iii.—v. and figs 1, 2.)

Towards the end of the year I hope to spend two or three weeks on Lord Howe Island, for the purpose of studying the fishes, and in a more thorough manner than was possible on the occasion of my short and unprepared visit in 1898.

In order, therefore, to clear the way, I have prepared the present paper, and believe that it contains notice of all species which may be identified without fresh material; in other words, there are now four fishes recorded from the island by genera only (in addition to an "unrecognisable scopelid"), and it is not yet possible to recover the species thus represented. The genera represented, each by an undetermined species, are as follows:—

*Atopichthys*,  
*Hyporhamphus*,  
*Canthidermis*,  
*Plagusia*†

Three species, hitherto undetermined, I have been able to identify as follows:—

*Ophisurus* sp. = *Ophichthus versicolor*, Richardson.  
*Balistes* sp. = *Pachynathus capistratus*, Shaw.  
*Gobioides* sp. = *Xiphasia setifer*, Swainson.

In addition to these, eleven known species are recorded as new to the fauna, namely:—

*Callichelys melanotænia*, Bleeker.  
*Bascanichthys pinguis*, Günther.  
*Euleptorhamphus longirostris*, Cuvier.  
*Trachinotus baillonii*, Lacépède.  
*Thalassoma janseni*, Bleeker.  
*Thalassoma dorsale*, Quoy and Gaimard.  
*Pseudolabrus nigromarginatus*, Macleay.  
*Chætodon trifasciatus*, Park.  
*Brachaluteres baueri*, Richardson.  
*Ostracion cornutus*, Linnæus.  
*Tetraodon hypselogeneion*, Bleeker.

---

\* The MS. of this paper was handed in on 8th November, 1902, before Mr. Waite went on an expedition to Lord Howe Island, from which he has now returned. [ED.]

Three new species are described:—

- Zenopsis scopus*,  
*Chætodon howensis*,  
*Cocotropus altipinnis*.

In addition to these, the following are figured for the first time:—

- Ophichthus versicolor*, Richardson.  
*Machærope latispinis*, Ogilby.  
*Pseudolabrus luculentus*, Richardson.  
*Brachaluteres baueri*, Richardson, and  
*Coris picta*, Bloch and Schneider is refigured.

The following known species are redescribed:—

- Ophichthus versicolor*, Richardson.  
*Coris picta* Bloch and Schneider.  
*Brachaluteres baueri*, Richardson.

Further notes are published of the species below named:—

- Chætodon tricinctus*, Waite.  
*Iniistius cacatua*, Waite.  
*Holacanthus conspicillatus*, Waite.  
*Holacanthus semicinctus*, Waite.  
*Monacanthus howensis*, Ogilby.

The material on which the paper is based was obtained as below, all species worthy of note, with the exception of those here included, having been previously dealt with.

1. Old collection.
2. Mr. W. E. Langley, Mareh, 1891.
- 3-4. Mr. T. R. Icely, September, 1889; August, 1894.
- 5-9. Mrs. T. Nichols, November, 1898; January, 1900; January, February, and March, 1902.
- 10-11. Mr. W. S. Thompson, September, 1901; October, 1902.
12. Mr. F. Farnell, July, 1902.

CALLECHELYS MELANOTENIA, *Bleeker*.

*Callechelys melanotenia*, Bleeker, Atl. Ichth., iv., 1864, p. 66, pl. cxciii., fig. 2.

But two specimens of this species appear to be previously known; the type, from Amboyna, and an example recorded by Klunzinger<sup>1</sup> from the Red Sea.

Though apparently very rare the species has a wide distribution, extending to Lord Howe Island, whence I now record it.

<sup>1</sup> Klunzinger—Verh. k.k. Zool.-bot. Ges. Wien., xxi., 1871, p. 612.

example. This is quite similar to the type and was obtained in January 1902 by Mrs. Nichols. The length of the three known specimens is about 480 mm.

BASCANICHTHYS PINGUIS, *Günther*.

*Ophichthys pinguis*, Günther, Cruise "Curagoa," 1873, p. 430, pl. xxxv.

Five examples of this species are known to me, namely:—the type from the Solomon Islands, two from Port Jackson, one from Lady Robinson's Beach, south of Port Jackson, and one from Lord Howe Island, this latter was obtained in March 1902 and forwarded by Mrs. Nichols.

OPHICHTHUS VERSICOLOR, *Richardson*.

*Ophisurus versicolor*, Richardson, Voy. "Ereb. and Terr.," Fish., 1848, p. 103.

(Plate iii., fig. 1).

Writing on the fishes of Lord Howe Island, Mr. J. D. Ogilby<sup>2</sup> observes:—"I have also a note of an undetermined species of *Ophisurus*." The specimen referred to, was, I find, brought from the island by Mr. T. R. Icely in September 1889, and forms the subject of the present note.

It enters the genus *Ophichthus*, Thunberg and Ahl, as understood of modern writers; characterised by having sharp teeth, no pronounced canines, the dorsal fin not arising on the head, the pectoral fin comparatively well-developed, and the end of the tail free. The following is a description of the specimen:—

The head is 13.6 times in the total length; the snout, measured to the centre of the eye, one-fourth that of the head; it is pointed and greatly depressed; the anterior nostril is tubular, the posterior simple, placed beneath the anterior margin of the eye: the latter lies near the border and a diameter in advance of the angle of the mouth. There are six teeth on the premaxillary, three on each side. The palatine teeth are arranged on each side, in a single row of six followed by a smaller series of about seven pairs continued as a single row to the angle of the mouth. The vomerine teeth form a single series, of which the anterior six are much larger and less regularly arranged than those that follow.

The lower jaw is much shorter than the upper, its tip not reaching the premaxillary teeth. The mandibular teeth are arranged uniserially, twenty or thereabouts in each ramus, separated at the symphysis. All the teeth are strongly recurved and differ little in length. The throat is distensible.

<sup>2</sup> Ogilby—Proc. Linn. Soc. N.S.W., xxiii., 1899, p. 731.



The dorsal fin arises above the anterior edge of the gill-opening and runs to within three-fourths of an inch of the end of the tail, it is low and can be completely contained in a groove running its entire length. The anal fin originates a quarter of an inch behind the vent and passes to within half an inch of the end of the tail, it is somewhat higher than the dorsal and is received into a similar groove, both fins expand slightly near their termination. The pectoral fin is twice the diameter of the eye in length.

The body is sub-circular in section, its depth one-third the length of the head, and slightly flattened below, while the tail posteriorly is a little compressed: it is one-sixth longer than the head and body together. A series of pores below and behind the eye is continued along a lateral line the entire length of the body and tail.

*Colours.*— After preservation for thirteen years the ground-colour is cream, possibly white during life: it is crossed by twenty-three dark brown bands, of which two occupy the head and thirteen the tail; on the body these bands are interrupted beneath. The end of the snout is white and the first band extends to beyond the angle of the mouth, it is varied by three white spots, one above each eye and one in the median line. The dark bands are very much wider—from five to seven times—than the interspaces, and each may be regarded as formed of two bands with lateral connections: the bands are further varied with two large white spots on each side: these are, however, absent from the last six bands. The dorsal fin is coloured throughout according to the portion of the body whence it arises, but the ventral is so marked only in correspondence with the last two body bands, otherwise it is colourless. The correct disposition of the markings will be better understood by reference to the accompanying plate.

*Dimensions*

Length of head	...	...	53 mm.
Depth of body	...	...	18 „
Length of head and body	...	...	330 „
Length of tail	...	...	390 „
Total length	...	...	720 „

Of described species, this eel is most nearly allied to *Ophichthus versicolor*, Richardson, and I am so regarding it, as only comparison with the type can definitely determine the question, from my standpoint. I venture to think, however, that with the above description and accompanying figure, those in a position to examine the type will have small difficulty in deciding the matter.

Richardson's description is not in his usually exhaustive style, but as far as dealt with, the structural details appear to represent our specimen very nearly. The teeth well coincide. The colour description reads as follows:—"The body is varied by twenty-seven purplish-brown rings, considerably broader than the intervals between them: most of the rings are further divided more or less completely by narrower white lines or imperfect circles. Tips of the snout and tail white." In the Lord Howe Island example there are twenty-three rings and the subdivision is much more regular and decided than appears to be the case with Richardson's specimen, now in the British Museum.

In making it the type of a new genus, *Elapsopsis*, Kaup<sup>3</sup> added to the original description:—"A white spot is placed on the forehead." and gave the "French Museum" as repository of a second example. Kaup's further reference<sup>4</sup> contains no additional information. Bleeker,<sup>5</sup> who had not seen a specimen, transcribes Richardson's description, and suggests that the eel resembles *Ophichthys bonapartei*. Günther,<sup>6</sup> on examination of the type specimen, gives some additional measurements and remarks that the dorsal fin is "coloured as the body underneath."

I fail to find any further reference to the specimen in the (presumably) Paris Museum: the habitat of both examples is the Moluccas. The type measures nearly twenty-one inches, the Lord Howe Island specimen over twenty-eight inches in total length.

*EULEPTORHAMPHUS LONGIROSTRIS*, Cuvier.

*Hemirhamphus longirostris*, Cuvier, Règne Anim., Ed. 2, ii., 1829, p. 286; Valenciennes in Cuvier, Règne Anim. Ill. Poiss., 1849, pl. xcvi., fig. 2.

A fine representative of this monotypic genus, (unless indeed *E. velox*, Poey, be different) we owe to Mr. Farnell, who numbered it among his collection of July 16th last.

*MACHÆROPE LATISPINIS*, Ogilby.

*Machærope latispinis*, Ogilby, Proc. Linn. Soc. N.S.W., xxii., 1899, p. 737.

(Plate iv., fig. 2).

This member of the Gempylidæ was described in 1898 from a single specimen 155 mm. in length. Since that time the Trus-

<sup>3</sup> Kaup.—Cat. Apodal Fish Brit. Mus., 1856, p. 10.

<sup>4</sup> Kaup.—Arch. f. Naturg., xxii., 1856, p. 45.

<sup>5</sup> Bleeker.—Atl. Ichth., iv., 1864, p. 50.

<sup>6</sup> Günther.—Brit. Mus., Cat. Fish, viii., 1870, p. 68.

tees have received five examples, the largest of which measures 263 mm. All these were collected by Mrs. Nichols, and on the following dates, three in November 1898, one each in January 1900 and January 1902. The following alterations and additions to the original description are to be noted:—The ventral profile is rounded, not sub-cultrate as stated, and instead of being obsolete, the lateral line is particularly well marked: it rises high above the opercle, under the origin of the dorsal fin, and, making a slightly sinuous diagonal course, passes downwards across the body to just above the anal finlets, thence upwards to the centre of the caudal peduncle and to within a short distance of the tail; the scales number about ninety. Body wholly scaled; there are about sixty-five scales in the horizontal series, and five plus fifteen vertically: the head also is scaly, but the space between the frontal crests, and the area in advance of the eyes is naked. The number of anal rays should be extended from fourteen to sixteen: a specimen exhibiting this feature is illustrated on the accompanying plate.

TRACHINOTUS BAILLONI, *Lacépède*.

*Cæsiomorus bailloni*, Lacépède, Hist. Nat. Poiss., iii., 1802, p. 93, pl. iii, fig. 1.

Included in the latest collection from Mr. W. S. Thompson is a nice example of *Trachinotus bailloni*. It measures 430 mm.<sup>7</sup> to the central caudal rays, and is the second member of the genus recorded for the island. *T. russellii* was identified there from by Ogilby<sup>8</sup> who refers to the characters noticed by Day by which it may be distinguished from *T. bailloni*. Judged by the shortness of the ventral fins (not more than one and a fourth the diameter of the eye) and by the position and decided character of the lateral body spots, Mr. Thompson's example must unquestionably be identified with *T. bailloni*. The species is known from the mainland, southward to Port Jackson.

THALASSOMA JANSENI, *Bleeker*.

*Julis janseni*, Bleeker, Act. Soc. Reg. Sci. Ind. Nedrl., i., 1856, p. 56, and Atl. Ichth., i., 1862, p. 91, pl. xxxiv, fig. 5.

This species, not uncommon in Malaysia and the Western Pacific Islands, is to be added to the fauna of Lord Howe Island. The only example known therefrom was obtained in March 1891 by Mr. W. E. Langley, and registered as *Julis* sp. Its length is 190 mm.

<sup>7</sup> = 17 inches. Day gives the length as 20 inches but possibly includes the caudal lobes, if so measured our specimen totals 22 inches.

<sup>8</sup> Ogilby—Edib. Fish. N.S.W., 1893, p. 89.

THALASSOMA DORSALE, Quoy and Gaimard.

*Julia dorsalis*, Quoy and Gaimard, Voy. "Astrolabe", Poiss., 1834  
p. 713, pl. xv, fig. 5.

To Mr. Farnell belongs the credit of first securing this species from the island, an example having been forwarded in July last.

? *CORIS PICTA*, Bloch and Schneider.

? *Labrus pictus*, Bloch and Schneider, Systema Ichthyologiae,  
1801, p. 251, pl. lv.

*Coris semicineta*, Ramsay, Proc. Linn.Soc. N.S.W., vii., 1882,  
p. 301.

(Plate v., fig. 1).

In 1801 Schneider described a labroid, under the name *Labrus pictus*, and gave a coloured figure of the same. This seems to have been overlooked by Günther, though he refers to other species, occurring on the same page. I do not find it noticed by Cuvier and Valenciennes, and indeed it does not appear to have been referred to since first described. The former author<sup>9</sup> places under *PlatyGLOSSUS*, *Labrus pictus*, Gronovius, an ill-defined form from the East Indies, while the latter<sup>10</sup> mention as a synonym of *Labrus micotus* Linnaeus, Willughby's *Turdus perbelle pictus*.

The original description by Schneider, published in the Systema Ichthyologiae, reads as follows:—

"38. *PICRUS lab.* 55. L. capite nudo, fascia nigra ab occipite ad branchias, vertice pinnisque cinnabarinis, squamis magnis, dorso cœruleo, striis transversalibus brevibus, pinna ani longitudinali, ano pinnis ventralibus vicino.

P. 14. V. 4. A. 2<sup>3</sup>. C. 18. D. 2<sup>8</sup>.

Habitat in America australi ad Novam Hollandiam, a Dr. Latham missus."

*Coris semicineta*, Ramsay, described in 1882, as above noted, bears such a strong resemblance to Schneider's figure and description, with certain differences, that I am inclined to regard it as the same species. The differences are to be found in the radial formula and the size of the scales. Owing to Schneider's practise of placing as the denominator, the total number of spines and rays in the vertical fins, his figures according to modern usage may be read thus:—

D. viii. 15; A. iii. 17; V. i. 5; P. 14; C. 18.

The plate distinctly shows nine dorsal spines and fourteen rays, but on the other hand four anal rays are illustrated more than described. These figures may be compared with those furnished below by myself.

<sup>9</sup> Günther—Brit. Mus., Cat. Fish iv., 1862, p. 143.

<sup>10</sup> Cuvier and Valenciennes—Hist. Nat. Poiss., xiii., 1839, p. 152.

The description and illustration are in agreement as to the size of the scales, which are large, and this is the only serious obstacle to my definitely placing the species as identical. Nevertheless I feel prompted to so regard them, and consider that if Ramsay had seen Schneider's work, *Coris semicincta*, as a name, would not have existed.

As to habitat, though South America is mentioned, it was only under the belief that New Holland was in that country, while the mention of Dr. Latham's name is sufficient guarantee that the fish came from Australia, and, in all probability, from New South Wales.

The first recent specimen known, was taken by Captain Armstrong in February, 1882, but this is not the type of *Coris semicincta* as stated in the Museum Memoir<sup>11</sup>; the type was obtained two months later near Broken Bay. Although not taken by the Museum collecting party in 1887, nor by myself in 1898, the species has been well represented in the several consignments since received.

On the mainland, since first recorded, it has been secured at Port Jackson, Maroubra Bay and Manly, from the latter locality we have the specimen which I now figure and describe. In Ramsay's notice of the species, the description is mainly of colour and markings. By a misprint the number of scales in the transverse series appear as 4-5, this should read 45. The length of the snout is stated to be "more than twice the long diameter of the eye." In all examples I have seen the eye is more than half the length of the snout.

D. ix. 12; A. iii. 12; V. i.5; P. 13; C. 7 + 6; L. lat. 83; L. tr. 7 + 35.

Length of head 4.1, of caudal 5.7, height of body 4.0 in the length. The eye is 6.6 in the length of the head, slightly more than half the length of the snout, to which the interorbital space is equal. The latter is strongly convex: the body and tail are strongly compressed: the upper profile of the head is low passing with a regular sweep into the very low curve of the dorsal profile: the ventral profile is similar. The jaws are equal and the lips not very fleshy, the cleft of the mouth extends a little more than half the distance to the anterior margin of the eye. The nostrils lie on a level with the upper edge of the eye, the posterior midway between its front edge and the anterior one. Scattered pores are found on the snout, above behind and below the eye, and also within the lower limit of the preopercle.

<sup>11</sup> Ogilby—Aust. Mus. Mem., ii., 1889, p. 70.

*Teeth.*—In the upper jaw a pair of large curved canines is followed by a smaller one on each side, also curved, then eleven conical teeth much smaller and regularly decreasing in size: a strong posterior canine is also present: within the anterior teeth is another series formed of four teeth on each side. The mandibular teeth are similar with a double series anteriorly but the lateral series is formed only of twelve pairs and there is no posterior canine.

*Fins.*—The dorsal fin commences in advance of the opercular flap, it is low, the first spine one-third longer than the diameter of the eye, the last and longest rather more than twice the same; the rays also regularly increase in length and form a sharp angle posteriorly. The anal fin commences beneath the first dorsal ray but its spines are shorter than the corresponding ones of that fin: it forms a similar posterior angle and its base is carried a little further back. The ventral is situated beneath the base of the pectoral to which it is equal, 1.4 in the length of the head, its spine is slender, its length 2.5 in the head. The caudal also equals the pectoral in length and has a slightly rounded margin; the least height of the peduncle is 1.8 in the head. The lateral line runs with a low curve along fifty-nine scales to beneath the ninth dorsal ray, thence descends suddenly by seven scales to the centre line of the tail.

*Colours.*—In a fresh specimen the colouration is as follows:—The upper part of the snout is grey followed by a scarlet patch extending from above the eye to below the first dorsal spine, thence the back is salmon coloured to the tail. Commencing on the snout, passing through the upper half of the eye and continued to the tail is a lilac band, below this, embracing the lower half of the eye, which is scarlet, and widening to one-third the depth of the fish, is a deep brown band running likewise to the tail; from its lower edge it gives off a number of short vertical bars, the first on the operculum; towards the tail they are less pronounced. The remainder of the head and body is violet, the chest excepted, which, as far as the anal fin, is lemon yellow. The dorsal fin bears three colour bands, the upper yellow, the median lilac and the lower salmon-coloured; this last carries along its centre a dark-brown line, which, expanding anteriorly, occupies nearly the whole membrane of the first three or four spines; the fin is also narrowly edged with blue. The anal is lemon yellow without markings, the pectoral ventral and caudal orange, the former with a brown triangular patch on its upper lobe, the latter narrowly edged, above and below, with blue.

Length of specimen described 223 mm.

In a small example, 135 mm. in length, the short cross bars are merely indicated, giving the lower edge of the band a wavy aspect. It thus much reminds one of *Labroides*?

PSEUDOLABRUS LUCULENTUS, *Richardson*.

*Labrus luculentus*, Richardson, Voy. "Ereb. and Terr.", Fish, 1848 p. 130.

(Plate iv., fig. 1.)

This species is subject to much variation in colour pattern, expressed mainly in the presence or absence of certain markings.

In the simplest phase I have seen, the only mark is a black blotch embracing the first two dorsal spines, though in more fully adorned examples this may be absent. For the purpose of description I have selected the best marked specimen I have seen; it must, however, be borne in mind that few exhibit all the markings here noted.

The head bears three horizontal dark purple lines, one on the temporal region with irregular marks on the occiput, another behind the eye and continued on to the body scales below the lateral line, and a third from the snout, below the eye to the opercular margin, whereon it bifurcates. On each body scale is a vertical purple mark, large below the lateral line, smaller above it. The soft dorsal fin bears a brown line along its base, some irregular marks above and has a dark margin. The anal fin is similar but the marks are more pronounced and posteriorly run parallel to the rays. Base of pectoral fin black, otherwise without markings, the ventral and caudal also are immaculate.

PSEUDOLABRUS NIGROMARGINATUS, *Macleay*.

*Labrichthys nigromarginatus*, Macleay, Proc. Linn. Soc. N.S.W., iii., 1878, p. 35, pl. iii., fig. 3.

Included in Mrs. Nichols's collection of February last is an example of this common New South Wales species, the first record of its occurrence off the island.

INIISTIUS CACATUA, *Waite*.

*Iniistius cacatua*, Waite, Rec. Aust. Mus., iv., 1901, p. 41, pl. vii.

Since this species was described, the Trustees have received two further specimens from the island, one in September 1901 obtained by Mr. Thompson and the other in February 1902 forwarded by Mrs. Nichols. An examination of these shows that the first dorsal fin has a slightly more anterior position than described and figured, the first spine being inserted above the posterior margin of the orbit. Some distortion of the head of the type renders the exact position of the fin in that specimen uncertain. None of the specimens show the black marks on the second dorsal fin found in *I. leucozonus*, Jenkins,<sup>12</sup> which, on the other hand, lacks the decided fin markings of *I. cacatua*.

<sup>12</sup> Jenkins—Bull. U.S. Fish Com., xix., 1901, p. 54, fig. 11.

*ZENOPSIS SCOPUS*, *sp. nov.*

(Fig. 1.)

The genus *Zenopsis* was founded by Gill<sup>13</sup>, on *Zeus nebulosus* Temminck and Schlegel<sup>14</sup>, from Japan; it differs from *Zeus* mainly in having three instead of four anal spines, and by the

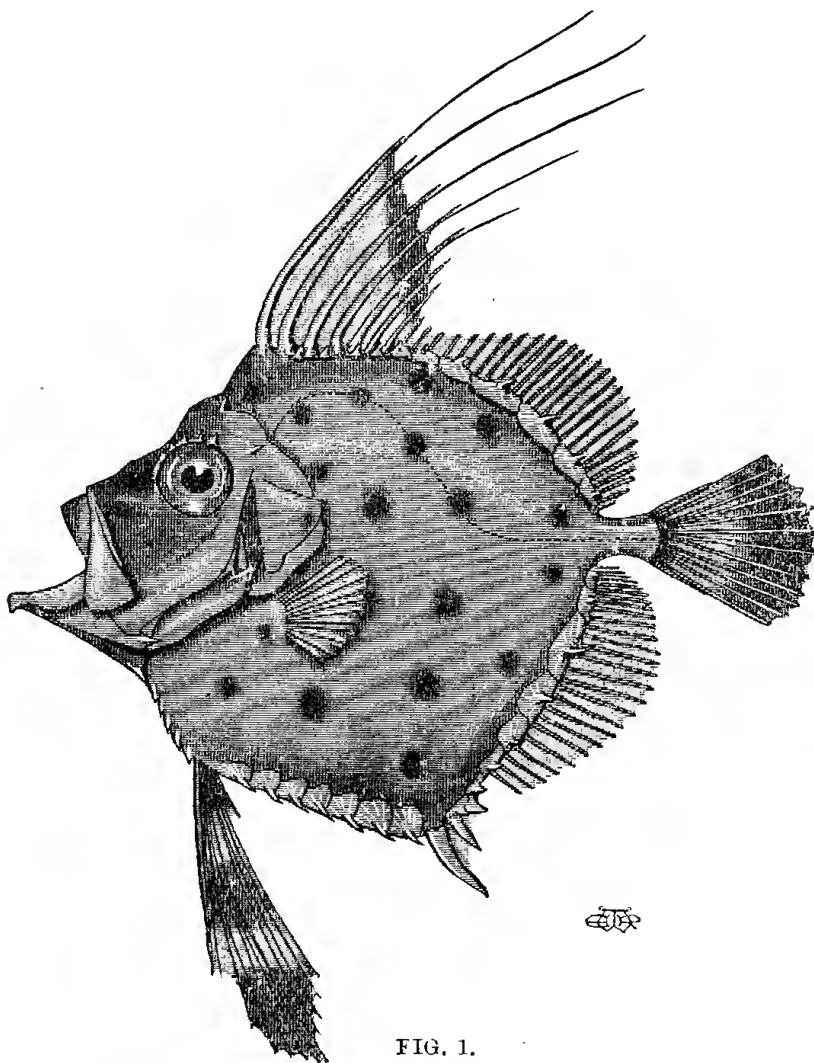

FIG. 1.

base of the spinous dorsal being armed with bony plates in addition to those of the soft dorsal and anal. Three other known species enter the genus, namely *Z. conchifer*, Lowe<sup>15</sup>, from

<sup>13</sup> Gill—Proc. Acad. Nat. Sci. Phil., 1862, p. 126.

<sup>14</sup> Temminck and Schlegel.—Fauna Japonica, Pisces, 1845, p. 123, pl. LXVI.

<sup>15</sup> Lowe—Proc. Zool. Soc., 1850, p. 247.



Madeira, *Z. ocellatus*, Storer<sup>16</sup>, from Massachusetts, and *Z. fiquirai*, Berg<sup>17</sup> from Montevideo. I now add a fifth, a small example having been obtained in October last by Mr. W. S. Thompson of Lord Howe Island.

The species of the family *Zeidae* are known to undergo considerable changes. My example is, I think, sufficiently large to have assumed the principal adult characters, though the spinous nature of its armature indicates that it may not have wholly lost the features of the young.

The scattered black spots, recalling the appearance of a rifle-target marked by bullets, suggest the specific name *scopus*.

D. viii. 26; A. iii. 26; V. i. 7; P. 13; C. 12 + 2.

Length of head 2.3, depth of head 2.0, height of body (behind ventral fins) 1.36, length of caudal 3.57 in the total length. The eye is midway between the snout and gill opening, and though near to, does not enter the profile, it is 3.25 in the head; interorbital space slightly less, with a median ridge. The snout is one-fourth longer than the diameter of the eye, close in front of which the nostrils are situated, near together. The maxilla has a nearly vertical position, and reaches to beneath the front edge of the eye; its length is one half greater than the orbit; gill rakers short. Teeth small, on jaws and vomer only. The head and body are strongly compressed, the profile of the former forms an angle of 45 degrees, that of the dorsal is at first straight, then evenly curved. The ventral profile is formed of two angles marked by the insertion of the ventral and first anal spine respectively, the connecting lines being nearly straight.

There are five spines on the supraorbital margin, one on the temporal, and one on the occipital region on each side. Eleven spinous bucklers at the base of the dorsal fin, of which the eighth and ninth are largest; five pairs in front of the ventrals, the fifth largest; one median and seven pairs between the ventral and anal, and eight pairs along the base of the anal.

The first dorsal spine is equal in length to the head, the next two but slightly less, the produced filament of the first is a little shorter, those of the two following somewhat longer than their respective spines. From the fourth to the eighth spines the decrease in length is rapid and the last three spines are without filaments; the middle rays are the longest, the eleventh being equal to the first anal spine. The origin of the anal fin marks the lowest point of the body; the first spine is much the longest, more than twice the second or one-eighth greater than the

<sup>16</sup> Storer—Proc. Bost. Soc. Nat. Hist., vi., 1858, p. 386.

<sup>17</sup> Berg—Anal. Mus. Nac. Buenos Ayres, (2), iv., 1895, p. 43.

diameter of the eye; the third spine is small and tubercular: the rays are quite similar to those of the dorsal. The pectoral is small and rounded, its length equal to the first anal spine. The ventral spine is slightly shorter than the head, the rays are very long, the fourth being one quarter longer than the head and reaching far beyond the origin of the anal. The caudal is rounded, the peduncle small; its height equal to half the diameter of the eye, the rays of all the fins, except the ventral, are simple.

Excepting where armed, the head and body are naked. Lateral line strongly arched in front, but straight from a point midway between the opercular border and the base of the caudal rays; it is formed of about seventy-five pores.

*Colours*.—Silvery, upper part of head and back smoky brown. Body, with few large black spots. Fins, colourless, marked as follows:—filaments and upper part of membrane of spinous dorsal black, three black bars across the ventrals and one across the base of the caudal, the distal half of this fin and some of the spines of the dorsal and anal bucklers are also black.

Length, 38 mm.

*CHETODON TRIFASCIATUS, Park.*

*Chætodon trifasciatus*, Park, Trans. Linn. Soc., iii., 1797, p. 34.

*Tetragonopterus trifasciatus*, Bleeker, Atl. Ichth., ix., 1878, pl. cccclxxvii., fig. 1.

Apparently not recorded off the mainland, south of Cape York, we have received an example of this fish from the island, by favour of Mr. W. S. Thompson.

*CHETODON TRICINCTUS, Waite.*

*Chætodon tricinctus*, Waite, Rec. Aust. Mus., iv., 1901, p. 45, fig. 12.

From Mr. W. S. Thompson, in his last collection, we have a fine example of this species: it is nearly twice the size of the type being 185 mm. in length. Its colour is well preserved, and enables me to correct and supplement the original description.

The ground colour is pale yellow. The front of the head from the snout to above the eyes is brilliant orange; this also is the colour of the upper and lower terminations of the ocular band, of the skinny margin of the opercle, the adjoining part of the body and the upper base of the pectoral fin; the inner base of this fin is wholly orange. The membranes of the dorsal and anal fins, excepting where coloured like the body bands, are

of the brightest orange colour, which tint also broadly margins the dorsal and anal rays, the colour being separated from the paler basal portion by a narrow white line, more pronounced posteriorly. The caudal rays, with the exception of a grey hinder margin, are also bright orange.

The pectoral has the upper angle pointed, and is not, therefore, of the shape shown in the figure.

CHÆTODON HOWENSIS, *sp. nov.*

(Fig. 2).

Under the genus *Chætodon*, Linnæus, in his "Systema Naturæ," included all the Chætodontidæ. In 1817 Cuvier<sup>18</sup> removed therefrom *C. rostratus* as the type of his genus *Chelmon*. To this species are allied *Ch. marginalis*, Richardson<sup>19</sup> *Ch. mülleri* Klunzinger<sup>20</sup> and *Ch. tricoloratus*, Castelnau<sup>21</sup>. In 1862 Gill<sup>22</sup> proposed the name *Prognathodes* for *Ch. pelta*, Günther (= *Ch. aculeatus*, Poey). Bleeker used the name for *Ch. longirostris*, but Jordan and McGregor<sup>23</sup> regard the latter as the type of a new genus *Forcipiger*, and add a species *F. flavissimus*.

Other species have been placed in the genus *Chelmon*, but they are still more entitled to generic rank. In epitomising *Chætodon truncatus*, Kner<sup>24</sup>, Günther placed it in the genus *Chelmo* (*Chelmon*) and in 1874 added another species, *C. trochilus*<sup>25</sup>, both Australian forms. Later writers have followed Günther, with the exception of Bleeker, who recognised generic separation of the former species under the name *Chelmonops*<sup>26</sup>. I regard this genus as valid, characterised by the graduated dorsal spines regularly increasing in length followed in similar sequence by the anterior rays. Some of the rays form a pointed lobe, whence the profile is vertical to the caudal pedicle. The anal is similar, but without pointed lobe. Snout, moderately produced. Scales in regular series, about forty-five in the horizontal line. Lateral line strongly curved and continued to the base of the caudal fin.

All Australian writers have agreed in regarding our not uncommon species as *C. truncatus*, though possibly, as in my own case, without being able to consult the original description.

<sup>18</sup> Cuvier—Règne Anim., Ed. i., ii., 1817, p. 334.

<sup>19</sup> Richardson—Ann. Mag. Nat. Hist., (1), x., 1842, p. 29.

<sup>20</sup> Klunzinger—Sitzb. Akad. Wiss. Wien., lxxx., 1879, p. 361.

<sup>21</sup> Castelnau—Research Fish, Austr., 1875, p. 14.

<sup>22</sup> Gill—Proc. Acad. Nat. Sci. Phil., 1862, p. 238.

<sup>23</sup> Jordan and McGregor—Bull. U.S. Nat. Mus., No. 47, ii., 1898, p. 1671.

<sup>24</sup> Kner—Sitzb. Akad. Wiss. Wien, xxxiv, 1859, p. 442, pl. ii.

<sup>25</sup> Günther—Ann. Mag. Nat. Hist., (4), xiv., 1874, p. 368.

<sup>26</sup> Bleeker—Revis. Chætodontoides, 1877, p. 30.

The description of *C. trochilus* exactly applies to our fish but rather than consider *C. truncatus* as rare, I am inclined to regard *C. trochilus* as a synonym, more especially as Günther does not mention the former species and, seeing that it occurs only in the Appendix of the British Museum Catalogue, may indeed have overlooked it. I am not, however, in a position to determine this matter, nor can I, for similar reasons, discuss the position of *Ch. pulcher*, Steindachner, which Bleeker doubtfully places in his genus *Chaetodontops*.

Not having access to Gill's paper on the Chaetodontidæ, I refer to Jordan and Evermann's diagnosis of the family.<sup>27</sup> The sub-family *Chaetodontinæ* is in part characterised as having "the dorsal spines not graduated, some of the median spines longer than the last spines." Such diagnosis excludes *Chelmonops* from the sub-family.

Though we may not subscribe to the great subdivision of *Chaetodon* proposed by Bleeker, those species in which the lateral line is continued to the base of the caudal rays may be recognised as at least sub-generically distinct from those in which it ceases under the soft dorsal; this latter condition is a character of *C. striatus*, the type of *Chaetodon*, unless *C. capistratus* be so regarded, in which I believe the lateral line also has the same character. In the work quoted, Jordan and Evermann regard *C. capistratus* as the type of the sub-genus *Chaetodon*, while *C. striatus* is placed under *Chaetodontops*, though in their synopsis of species both are arrayed under *Chaetodon*. For the forms in which the lateral line is extended to the caudal peduncle we have *Coradion*, Kaup, and *Hemitaurichthys*, Bleeker; in the former the scales are larger, fifty in the transverse series and eight to ten dorsal spines: in *Hemitaurichthys* the scales are smaller, seventy to ninety, and the dorsal spines number ten to twelve. These differences can scarcely command full generic rank, and for present purposes I admit *Coradion* only.

Without considering the Chaetodontidæ as a whole, a restatement of the characters above mentioned may be useful.

- a. Dorsal spines not graduated.
  - b. Snout produced, beak-like, lateral line ceasing under soft dorsal.
    - c. Dorsal spines nine. *Chelmon.*
    - cc. Dorsal spines twelve or thirteen.
    - d. Scales large. *Prognathodes.*
    - dd. Scales small. *Forcipiger.*
  - bb. Snout moderate or short. *Chaetodon.*

<sup>27</sup> Jordan and Evermann—Bull. U.S. Nat. Mus., No. 47, ii., 1898, p. 1670.

c. Lateral line ceasing under soft dorsal.

Sub. gen.

*Chaetodon*.

cc. Lateral line continued to caudal.

Sub. gen. *Coradion*.

aa. Dorsal spines graduated, snout long, lateral line continued to base of caudal.

*Chelmonops*.

In a previous paper<sup>28</sup> I recorded *Chelmo truncatus*, from Lord Howe Island on the evidence of a beach-dried example. This was much worn and I attributed the rounding of the vertical fins to damaging agencies, the spines were dried down so that I failed to recognise their true condition. Mention was also made of an example in spirits from the old collection; this though not seen at that time, has since been recovered. The Trustees have also received specimens of the same species collected by Mrs. Nichols and I find it to be generically different from *Chelmonops* but with a colour-pattern strikingly similar to *C. truncatus*. It belongs to the sub-genus *Coradion*, as above restricted and bears resemblance to the two typical species in the markings, these consisting of broad vertical bars.

*Description*—D. xii. 25; A. iii. 13; V. i. 5; P. 16; C. 17 + 6; L. lat. 48; L. tr. 10 + 24.

Length of head 3.1, of caudal fin 5.5, height of body 1.7 in the total length. Diameter of eye 3.0, and length of snout 2.7 in that of the head. Interocular space slightly convex and nearly equal to the diameter of the eye. Preoperculum denticulated, its angle somewhat produced. Body not markedly short but strongly compressed. Upper profile of head oblique, with the snout moderately produced. Ventral profile low. Outline of dorsal spines together, much rounded, the first spine short 1.6 in the diameter of the eye; fifth the longest, more than three times the same, or 1.2 in the length of the head. The two last spines are equal, 1.9 in the same. The anterior rays are rather higher than the posterior spines, the third highest 1.6 in the head. The hinder margin of the fin is but little rounded, and the last ray is a little longer than half the diameter of the eye. The first anal spine is stouter and longer than the first dorsal: the second is the strongest, a little shorter than the third, which is equal to the dorsal or 1.6 in the head. The rayed portion is similar to, but much shorter than the soft dorsal.

The ventral spine is longer than the third anal, 1.4 in the head; the first ray one-fifth longer than the spine, extending to the vent and equal in length to the pectoral or 1.2 in the head.

<sup>28</sup> Waite—Rec. Aust. Mus., iii., 1900, p. 203.

The caudal is feebly rounded, its peduncle very short, its least height twice the diameter of the eye. Scales in regular series, not in contrary directions. The lateral line follows the high curvature of the back and is continued along the middle of the caudal peduncle to the base of the rays.

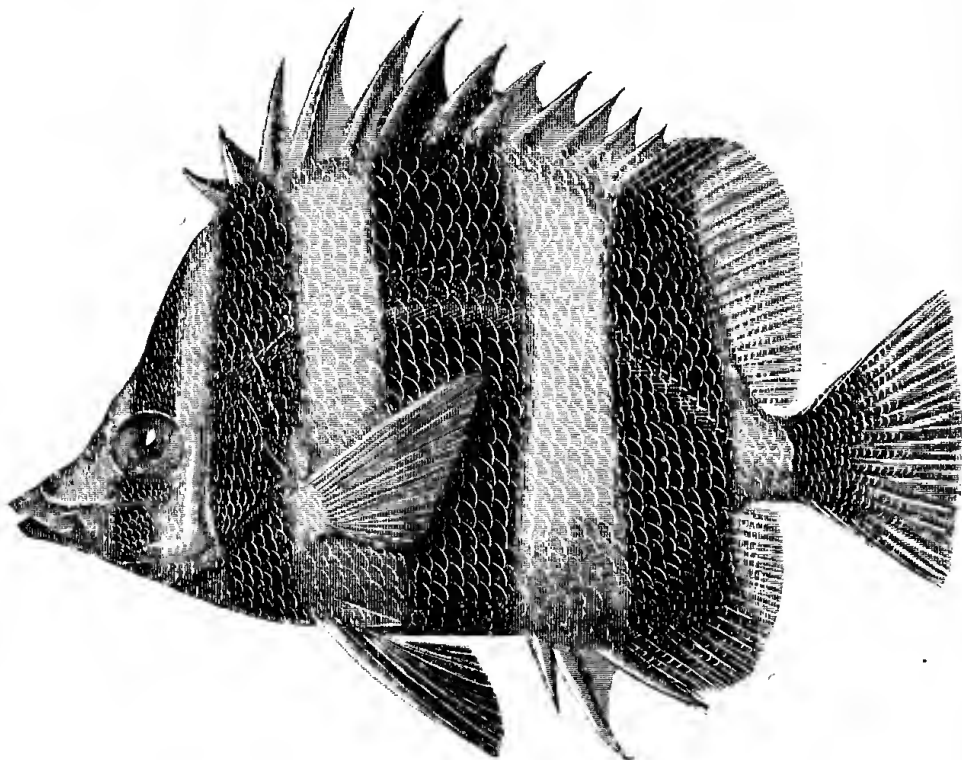

FIG. 2.

*Colours*.—Ground colour white, all the spines yellow; markings dark brown or black. A broad median line commences on the upper lip, passes between the nostrils, narrows and is lost in a point above the eyes. A broad ocular band, narrower than the eye, commences behind this point, and passes obliquely forwards and downwards to the interoperculum. Of three body bands the first arises from the base of the anterior three dorsal spines, passes across the opercle in advance of the pectoral and ventral fins: the next band, the broadest, passes from the vi.-viii. dorsal spines to the space between the ventrals and the anal fin: the third body-band connects the anterior portions of the dorsal and anal rays. The caudal band is partly on the peduncle and includes the basal portion of the rays.

The dorsal and anal fins are coloured in consonance with the body markings, the pectorals colourless, the ventrals black.

Length of specimen 157 mm.

Of four other species recorded from the Island *C. trifasciatus*,

Mungo Park, *C. aphrodite*, Ogilby, and *C. tricinatus*, Waite, satisfy the characters of *Chatodon*, but *C. strigatus*, Langsdorf, does not. If another sub-genus be considered necessary, *Microcanthus*, Swainson, should be used for this species.<sup>29</sup>

HOLACANTHUS SEMICINCTUS, *Waite*.

*Holacanthus semicinctus*, Waite, Rec. Aust. Mus., iii., 1900, p. 204, pl. xxxvi.

Included in the old collection previously mentioned, I was especially pleased to find an example of this species. It is somewhat larger than the type, measuring 205 mm. in length, and the caudal filaments are more than twice the length of those shown in my figure. The proportions and markings are in every way similar.

HOLACANTHUS CONSPICILLATUS, *Waite*.

*Holacanthus conspicillatus*, Waite, Rec. Aust. Mus., iii., 1900, p. 203, pl. xxxv.

Associated with *H. semicinctus*, was a specimen of this species, being the fourth known; this also is larger than those described, measuring 277 mm. in length. A beach-worn example obtained by Mr. T. R. Iccly in 1894 is also recognised as of this species.

MONACANTHUS HOWENSIS, *Ogilby*.

*Monacanthus howensis*, Ogilby, Aust. Mus. Mem., ii., 1889, p. 25  
Waite, Rec. Aust. Mus., iv., 1901, p. 46, pl. viii.

The known distribution of the species is extended to the Sandwich Islands by Seale, who describes and figures a specimen under the name *Monacanthus albopunctatus*.<sup>30</sup>

OSTRACION CORNUTUS, *Linnaeus*.

*Ostracion cornutus*, Linnaeus, Syst. Nat., Ed x., i., 1758, p. 409,  
Bleeker, Atl. Ichth., v., 1865, p. 33, pl. ccii., fig. 3.

This addition to the fauna is made by Mr. W. S. Thompson, who has just (October, 1902), forwarded a large and peculiarly distorted example. *O. cubicus*, Linnaeus, and *O. forasini*, Bianconi, are the species previously known from the island.

<sup>29</sup> Swainson—Nat. Hist. Fish, ii., 1839, p. 215.

<sup>30</sup> Seale—Ber. Pa. Bishop Museum, Occ. Papers i., 1901, p. 13, fig. 6.

TETRAODON HYPSELOGENEION, *Bleeker*.

*Tetraodon, hypselogencion*, Bleeker, Nat. Tyds. Ned. Ind., iii., 1852, p. 300; Atl. Ichth., v., 1865, p. 61, pl. cxxiii., fig 5.

In September 1901 Mr. W. S. Thompson forwarded us two examples of this familiar species.

PACHYNATHUS CAPISTRATUS, *Shaw*.

*Balistes capistratus*, Shaw, Gen. Zool., v., 1804, p. 417.

The only notice of a species of the genus *Balistes* having been obtained from the island is that contained in the Museum Memoir. It is there recorded that the upper jaw of a member of the genus was picked up on the beach. There is, however, in the old collection an entire but unnamed example from Lord Howe Island. It has lost all colour markings, but is otherwise in fair condition. It belongs to the restricted genus *Pachynathus*, Swainson, and to the species *capistratus*, Shaw (= *Balistes mitis*, Bennett), as determined by the following characters, which distinguish it from its near ally *P. niger*, Mungo Park.

D. iii. 30; A. 27.

Body scales in thirty-five transverse rows.

Scales on middle of cheek rectangular.

Length of specimen, 245 mm.

BRACHALUTERES BAUERI, *Richardson*.

*Aleuterius baueri*, Richardson, Voy. "Ereb. and Terr.," Fish., 1846, p. 68.

(Plate iii., fig. 2.)

Few authors have described fishes with more care and attention to detail than Richardson, and few again so systematically figured their types. On the other hand, he was prone to accept a drawing as a type.

I strongly condemn this practice, though well aware it is followed by other writers and in other branches of Zoology and sanctioned by the American Ornithologists' Union. In its code of nomenclature the union declares<sup>31</sup> (Canon xlii.):—"The basis of a generic or subgeneric name is . . . . . a designated recognisable plate or figure," and, again (Canon xliii.):—"The basis of a specific or subspecific name is . . . . . a recognizable published figure or plate." A slight redeeming feature of this last canon is the insertion of the word "published," but in the absence of a specimen, which a description

<sup>31</sup>Cole of Nomenclature, Amer. Ornithologists' Union, 1892, p. 52.



from a figure or plate implies, who is to know whether such figure be recognisable or not, and the publication of the original figure cannot remove the uncertainty.

Günther has expressed a similar sentiment as follows:—"It may be questioned whether it is desirable to utilize drawings, the types of which are lost, in any other way but as a help to supplement the insufficient published descriptions."<sup>32</sup>

No one but an Ichthyologist, or an artist working under his eye, can represent a fish so as to include all essential details. It is not, therefore, reasonable to produce a description from a drawing, and such description should scarcely be recognised.

Though such tenet cannot well be made retrospective, I make the suggestion for present and future workers.

Reverting to Richardson, I would also remark on descriptions made from drawings by Lieut. Emery, because they were executed from Australian fishes, and, as Richardson himself says, were unavoidably deficient in the expression of certain generic characters. The descriptions were published in the "Magazine of Natural History,"<sup>33</sup> and the author explains omissions, etc., thus:—"Lieut. Emery not being an Ichthyologist omitted to portray the minute serratures of the opercular pieces, and has not always distinguished the spinous from the articulated rays." In the following year (1843) the author published some of the drawings from which descriptions were made, remarking<sup>34</sup>:—"Verbal descriptions of them may mislead the naturalist, but the plate enables him to judge for himself." As, however, only the first fasciculus of the "Icones Piscium" was ever published, there are many fishes described from drawings which Richardson never reproduced.

This preamble is suggested by the attempt to identify with one of Richardson's species, a fish received from Lord Howe Island. It is a Monacanth, and as far as one may judge, is to be identified with *Aleuterius baueri*.<sup>35</sup>

The claims of *A. baueri* rest upon the description of a drawing which Richardson introduces as follows:—"This species is named in honour of Mr. Ferdinand Bauer, being founded on one of his admirable drawings in Dr. Brown's possession." Lest my strictures on this practice appear rather uncalled for, I quote further:—"Looking to his known scrupulous accuracy in details (Mr. Bauer's figure) may be considered as the representation of a generic form not yet described, in which the characters of several groups of *Plectognathi* are combined. It

<sup>32</sup>Günther—Zool. Record, vi., 1869, p. 127.

<sup>33</sup>Richardson—Mag. Nat. Hist., (i), ix., 1842, pp. 15, 120, 207, 384.

<sup>34</sup>Richardson—Icones Piscium, 1843.

<sup>35</sup>Richardson—Voy. "Ereb. & Terr.," Fishes, 1846, p. 68.

exhibits the undivided dental plate of *Diodon*, the inflated body and dermal spines of *Tetrodon*, and the fins of *Aluterius*. We shall not venture upon the formation of a new generic name without having seen a specimen of the fish."

From this figure-description Günther<sup>36</sup> inclined to the belief that the species was very closely allied to his *M. oculatus*. If my conclusions as to the identity of the Lord Howe Island example with *A. baueri* are correct, it is a distinct species, while I can confidently pronounce *M. oculatus* to be a synonym of *A. trossulus*, Richardson, having a large collection showing perfect intermediate grades. It is in fact the ocellated colour-pattern of *M. oculatus*, which is described and figured by Hollard.<sup>37</sup> Günther also appears to have had very grave doubts as to correct representation of the teeth of *A. baueri*, for, though, unlike Emery, Bauer was a skilled draughtsman, he was not an Ichthyologist, and would fail to appreciate the necessary characters.

*Aluterius*, or, as Richardson also used it, *Aluterus* and its forms *Alutarius* and *Aluterus* is a synonym of *Alutera* Cuvier, of which the type is *A. monoceros*, Osbeck. From this, *A. trossulus* and *A. baueri* differ in having less than thirty rays each in the dorsal and anal fins, instead of forty or more, but agree in the absence of a pelvic spine. For *A. trossulus* Bleeker proposed the genus *Brachaluterus*, and I add *A. baueri* as a second member.

*Description*.—D. 29; A. 26; P. 11; C. 12.

Length of head, 3.3; height of body, 1.2; length of caudal fin 3.1 in the total. The eye, which lies nearer to the snout than to the dorsal fin is 3.0 in the head, the convex inter-orbital space one-half more. The gill opening is small and lies beneath the posterior margin of the eye. The nostrils are inconspicuous, and placed close to the front edge of the eye.

The teeth do not differ from those of the typical monacanth.

Upper profile of head slightly concave, from the spine to the commencement of the rays the contour is straight, thence curved to the caudal peduncle. The lower profile is very convex, its regularity broken by the distensible abdomen.

The dorsal spine arises above the middle of the eye, and reaches two-thirds of the distance to the first ray, its surface is granular, but without spines or barbs. The dorsal and anal fins are similar in character, the former the longer, both are highest anterior to their centres. Pelvic bone without spine or external indication, the pectoral fin is one-fourth longer than the diameter of the eye and inserted beneath its hinder margin. The caudal peduncle is compressed but thick, its

<sup>36</sup>Günther—Cat. Fish. Brit. Mus., viii., 1870, p. 235.

<sup>37</sup>Hollard—Ann. Sci. Nat., Zool., (4), iv., 1855, p. 6, pl. i., fig. 1.

height one-half more than the diameter of the eye. The fin, which is long and rounded, has its insertion narrower than the peduncle.

The skin, which is rather rough to the finger is beset with needle-like spines, smaller on the head and below, larger posteriorly especially on the caudal peduncle where they are one-third of an eye diameter in length and strongly recurved.

*Colours.*—In formaline, greenish-yellow, green at the bases of the fins, also the dorsal spine and caudal rays. The markings are longitudinal brown stripes: two pass from the base of the dorsal fin, three from the posterior border of the eye and two above the pectoral fin, all these run horizontally and parallel. Two others pass from below the eye downward and forward, then backward; they separate, and, another stripe arising between them, all run to form horizontal lines below those above described. Most of the spaces between the streaks carry short interrupted lines, which below break up into spots. There are also three or four streaks in front of the eye, the upper ones pass over the profile and unite with their fellows. One runs down to the angle of the mouth, while another behind it is continued downward, and, parallel to the profile, forms a linear series of dots, which, at the base of the anal fin, are lost in a mass of dots forming the ornamentation on this part. Similar dots exist on the caudal peduncle. The membranes of the dorsal and anal fins are damaged but show traces of spots. The caudal is spotted with brown, forming transverse bars.

Total length, 65 mm.

Collected by Mr. W. S. Thompson, September, 1901.

Since the foregoing was in type, I have received from Dr Jordan, his joint paper (issued in advance of the volume), on the Trigger-fishes of Japan<sup>38</sup>. The authors describe and figure a new species, *Brachaluteres ultrarum*, which is a close ally of *B. baueri*.

#### COCOTROPUS ALTIPIXNIS, *sp. nov.*

(Plate v, fig. 2).

The known range of the genus *Cocotropus*, expressed as Japan, Andaman Isles, South-east coast of India, Pinang, Celebes and Ceram, is now extended to Lord Howe Island. In September, 1901, the Trustees received a single example collected by Mr. W. S. Thompson. This appears to be an undescribed species. The following is a description of the specimen:—

D. xiii. 10; A. ii. 8; V. i. 3; P. 13; C. 11; L.lat. 11.

Length of head 3.0; of caudal 3.0; height of body 2.7 in

<sup>38</sup>Jordan and Fowler—Proc. U.S. Nat. Mus., xxv., 1902, p. 271, fig. 5.

the length. The diameter of the eye is one-fifth less than the interorbital space and 3.7 in the length of the head; its lower margin bisects the vertical line. The snout is one-half longer than the eye.

The head and body are strongly compressed, the profile of the head very steep, and the dorsal profile of the body much more convex than the ventral. The jaws are equal, but the lower is advanced when the mouth is open: the maxilla extends to beneath the front margin of the eye. The head is strongly armed, the profile is formed of two bony ridges which terminate each in a small boss in front of the dorsal fin. A knob exists on the anterior edge of the orbital ring and another above the eye, which is continued backwards as a temporal ridge. Below this, from the hinder edge of the eye is a second ridge; both end in blunt spines, which are in vertical line with the similar preopercular spines, five in number, of which the upper is the largest, its length two-thirds the diameter of the eye. A ridge passing from the preorbital below the eye bears three small blunt spines. The preorbital carries two large spines; an upper and longer runs to beneath the centre of the eye and has its tip inclined upwards; the lower spine is directed downwards over the maxilla. On the front edge also there is a prominent knob. Two weak, flat, but sharp spines are found on the opercle; height of caudal peduncle 2.8 in the length of the head.

*Fins.*—The continuous dorsal fin has a sinuous margin, and commences a little in advance of the front edge of the eye. The first spine is strongly curved, the second less so, to which it is equal, 1.1 in the head. Having a more elevated origin, the second spine appears to be the longer; a decrease to the fifth is followed by a longer series to the eighth, whence the remainder are sub-equal and half the length of the head. The first ray is slightly longer, and the third the longest, 1.5 in the head; the last ray is half the length of the first. The anal commences beneath the twelfth dorsal spine; both fins are connected to the caudal peduncle by membrane. The pectoral has a deep base and is evenly rounded, the sixth ray equals the length of the head; the tips are free. The ventral is inserted in advance of the pectoral, and its second ray is 1.6 in the length of the head. The rays of all the fins are undivided.

*Scales.*—Top of the head, cheeks, opercles, and the whole of the body closely covered with small spinous granules, continued on to the basal portion of the pectoral and vertical fins. The lateral line follows the dorsal curvature and does not descend to the middle of the caudal peduncle; it is formed of eleven very long tubes, the first three almost in contact, the others widely spaced; the last is at the base of the caudal rays.

*Colours*.—Head and body brilliant red, the latter with a pale spot below the v.-vii. dorsal spines; eye and vertical fins red; pectoral, orange, with the lower edge lighter and crossed by some red bars.

Length of specimen, 43 mm.

The genus *Cocotropus* was formed by Kaup<sup>39</sup> in 1858 on *Corythobatus echinatus*, Cantor.<sup>40</sup> The name *Corythobatus* was proposed by Cantor as a substitute for *Minois*, Cuvier and Valenciennes ("preoccupied by *Minois*, Hübner"), with *C. noora*, Cuvier and Valenciennes, as the type. This species is not congeneric with *C. echinatus*, which Günther places in his genus *Tetraroge*.<sup>41</sup> In this he also places *Apistus dermacanthus*, Bleeker.<sup>42</sup> In 1878 Bleeker figured this species under the name *Cocotropus dermacanthus*.<sup>43</sup> The text to accompany the plate was never issued and I am unaware if Bleeker referred to the species elsewhere. Day records two species from Indian seas,<sup>44</sup> namely, *C. echinatus*, above referred to, and a new species, *C. roseus*.

Another species, *C. pottii*, is described by Steindachner<sup>45</sup> from Japan, and to these I add a fifth, *C. altipinnis* (*ante*), from Lord Howe Island.

For comparative purposes the leading characteristics of these five species may be expressed as follows:—

1. *Cocotropus echinatus*, Cantor.

D. xiii. 11; A. ii. 8; P. 11; V. i.5 (? i.3).

Length of head 3.7; height of body 2.9. Dorsal fin commences above anterior half of eye. First spine longest, 1.3 in height of body. Pectoral equal to the head in length.

*Hab.*—Andamans and Pinang.

2. *Cocotropus dermacanthus*, Bleeker.

D. xii. 9; A. iii-ii. 7-8; P. 11; V. i.3.

Length of head 2.8; height of body 2.8. Dorsal fin commences over middle of eye. First and second spines longest and equal, 2.0 in height of body. Pectoral shorter than the head.

*Hab.*—Sea of Waihai, North Ceram.

<sup>39</sup> Kaup—Arch. Naturg., 1858, p. 333.

<sup>40</sup> Cantor—Cat. Malay Fish, 1850, p. 45.

<sup>41</sup> Günther—Cat. Fish. Brit. Mus., ii., 1860, p. 136.

<sup>42</sup> Bleeker—Nat. Tijdschr. Ned. Ind., iii., 1852, p. 268.

<sup>43</sup> Bleeker—Atl. Ichth., ix., 1878, pl. cccexi., fig. 2.

<sup>44</sup> Day—Fishes India, 1875, pp. 159 and 160.

<sup>45</sup> Steindachner—Ann. K. K. Nat. Hofmus. Wien, xi., 1896, p. 203.

3. *Cocotropus roseus*, Day.

D. xiv-xv. 9-10; A. ii. 7-8; P. 14; V. i. 3.

Length of head 2.9; height of body 3.2. Dorsal fin commences over middle of eye. Second spine longest, 2.0 in height of body. Pectoral equal to the head in length.

*Hab.*—Coromandel Coast of India.

4. *Cocotropus pottii*, Steindachner.

D. xi-xii, 13-12; A. i-ii., 10-11; P. 12; V. i. 2.

Length of head 4.0; height of body, 3.5. Dorsal fin commences behind centre of eye. First spine longest, 2.3 in height of body. Pectoral equal to the head in length.

*Hab.* Japan and Celebes.

5. *Cocotropus altipinnis*, Waite.

D. xiii. 10; A. ii. 8; P. 13; V. i. 3.

Length of head 3.0; height of body 2.7. Dorsal fin commences in advance of the eye. First and second spine longest and equal 1.1 in height of body. Pectoral equal to the head in length.

I have tried to reconcile this last species with the first-named, to which it is undoubtedly most nearly allied: its differences however, as far as one may judge, outweigh its points of similarity. From Cantor's description it differs in having the margin of the dorsal fin sinuous, though it must be noted that the account is scarcely intelligible. The author writes:—"The anterior spine. . . . . is the longest and strongest of all, its length being about  $\frac{3}{4}$  of that of the head. The succeeding spines and rays gradually decrease to the seventh ray, which is about  $\frac{3}{4}$  of the length of the head." In *C. altipinnis* the first two spines are equal in length; the pectoral has thirteen rays and the ventral three, of which the second is noticeably the longest. *C. echinatus* has eleven pectoral rays and five ventral ones, the first being described and figured as the longest. In describing an example from the Andaman Isles, Day counts but three ventral rays. This latter species appears to have a smaller head, and, as no mention is made of the large postorbital spines, a simpler armature. These spines in *C. altipinnis* are larger than those of the preopercle, which bears five spines, none of which can be said to be minute, as described of *C. echinatus*, which has but four. Cantor distinctly states that "the axilla and the space covered by the pectorals is naked;" also that "on the back, the sides of the head and body the tubercles are fewer, more distant than on the throat and

abdomen, where they are crowded." In our species the whole body is evenly covered with tubercles. Lastly, the colour markings, as recorded by both Cantor and Day, are conspicuous features, whereas in *C. altipinnis*, described from a recent example, the only markings are a light area on the back and dark bars on the lower pectoral rays.

*Hab.* Lord Howe Island.

XIPHASIA SETIFER, *Swainson*.

*Xiphasia setifer*, Swainson, Nat. Hist. Fish., ii., 1839, pp. 179 and 259; Day, Fish. India, 1876, p. 337, pl. lxxiii., fig. 1.

Though not previously recorded from the island, an example obtained by Mr. Farnell, in July, 1902, is the second known. By the kindness of the Committee of the Macleay Museum, I have had the opportunity of examining the fish referred to in the Museum Memoir as *Gobioides* sp.,<sup>46</sup> and noticed as follows:—"A single example, which has evidently been washed ashore, was presented by Dr. James Cox to the Hon. Wm. Macleay, in whose collection it now is." This is undoubtedly a *Xiphasia*, and the discovery removes one more uncertain species from the island list. *X. setifer* was first recorded from the mainland by Ramsay and Ogilby, who described specimens taken in Port Jackson, in 1886.<sup>47</sup>

---

<sup>46</sup> Ogilby—Aust. Mus. Mem., ii., 1889, p. 14.

<sup>47</sup> Ramsay and Ogilby—Proc. Linn. Soc. N.S.W., (2), i., 1886, p. 582.

---

FURTHER OBSERVATIONS ON THE CAUDEX OF  
GLOSSOPTERIS.

By R. ETHERIDGE, Junr., Curator.

(Fig. 3.)

In 1894 I described a specimen of a *Glossopteris*, found by Mr. C. J. Horsley, in the Upper Coal Measures on the Woller Road, about seventeen miles from Mudgee, "showing the attachment of the fronds to the caudex."<sup>1</sup> This is now supplemented by the equally fortunate discovery by Mr. John Mitchell, Resident Teacher, Technical College, Newcastle, of part of a much larger caudex, with large leaf-scars, associated in the same bed of shale with, although not actually attached to, immense leaves of *Glossopteris*. The shale in question is above the Victoria Tunnel Coal Seam of the Upper Coal Measures at Shepherd's Hill, Newcastle.

The specimen approximately represents half the caudex split longitudinally, and is three and a half inches long, by two inches wide in its present more or less compressed condition; it is a matrix cast with adherent fragments of a black carbonaceous pellicle. This stem fragment is covered with transversely oval leaf scars, which have a longitudinal diameter of from three-eighths of an inch to half an inch, and a transverse measurement varying from half to one inch. The scars are placed alternately or in oblique rows forming a spiral arrangement; thirteen scars are visible, more or less perfect. They are separated from one another above and below by narrow interstitial spaces, with the upper and lower margins raised above the general level of the specimen. The leaf-scar surface is vertically wrinkled, and slightly concave, but there are no traces of vascular bundle openings. The opposite surface of the stem is hidden by matrix, except at one spot of limited extent, from which the latter has been removed.

The leaves associated with this stem, are of very large size, but as the remains are matted together in layers in the shale, it is impossible to obtain an absolutely perfect frond, and in consequence difficult to estimate the size to which they attained. One leaf, however, has been exposed over a very considerable portion of its surface, and even in this imperfect state, measures eleven inches in length by eight inches in breadth. By continuing the outlines I estimate this leaf to

---

<sup>1</sup> Etheridge—Proc. Linn. Soc. N.S.W., (2), ix., 1894, p. 228.



have been, when perfect, at least two feet in length by one foot wide. The mid-rib is very stout and strong; the veins coarser



FIG. 3.

at their point of issue from the former, and arising at an acute angle, proceed to the margins in open curves. The reticula-

tion is close, and the meshes long, narrow and apically pointed. Over a wide inter-marginal area the veins break up into closely crowded, very numerous veinlets, giving to the leaf over this portion a totally different appearance to that presented along the mid-rib. These veinlets are certainly less reticulate than the veins proper.

It is only reasonable to surmise from the plentitude of this leaf in the shale of the Victoria Tunnel Seam, to the almost total exclusion of the other leaves, that they and the stem belong to one and the same form. The only species of *Glossopteris* occurring in our Coal Measures, the leaves of which agree with the above, is *Glossopteris ampla*, Dana,<sup>2</sup> and with the latter's description our fossils agree very closely. Dana remarked:—"The full size of this species we cannot ascertain from our specimens, as the frond was evidently quite thin and tender, and is much broken. The breadth could not have been less than six inches, and the length probably exceeded considerably a foot."

One of Dana's figures<sup>3</sup> of *G. ampla* is very suggestive. It represents the basal portion of one of these large fronds, with a petiole expanding proximally to such a size, one inch in breadth, as would adapt it to any of these leaf scars; the rachis in the figure is nearly three-quarters of an inch wide. In all probability the fronds known as *G. ampla* represent one of the largest, if not actually the largest fern in our Coal Measures, and is a worthy rival to the huge *Gangamopteris cyclopteroides*, Feistmantel, from the Talcher Shales of India.

In 1878 Dr. O. Feistmantel described a fern trunk from the Newcastle Coal Measures as *Caulopteris adamsi*<sup>4</sup>, showing the presence of large spirally arranged transversely-oval leaf scars, and on the whole by no means unlike that now under description. The interspaces between the leaf scars are, however, very much greater in *C. adamsi*, and the scars show a number of transverse cicatrices. The community of characters, and similarity of horizon raises a suspicion that the two stems may be one and the same, and also the caudex of *Glossopteris ampla*, Dana. Feistmantel remarked of his specimen:—"The specimen is hardly sufficiently complete to decide its nature and systematical position with absolute certainty; but supposing it to be, what it most probably is, a fragment of a fern trunk and, taking the disposition of the scars to be quincuncial, I

<sup>2</sup> Dana—Wilkes' U.S. Explor. Exped., x., Geol., 1849, p. 717, pl. 13 f. 1 a and b.

<sup>3</sup> Dana—*Loc. cit.*, pl. 13, f. 1a.

<sup>4</sup> Feistmantel—*Palaeontographica*, 1878, Suppl. Bd. iii., 3, p. 93, pl. xii., f. 1 and 2; *Mem. Geol. Survey N.S.W., Pal.*, 3, 1890, p. 135, pl. xii., f. 1 and 2.

thought it would be more correct to place this specimen with the genus *Caulopteris*, as there are not sufficient characters for placing it anywhere else, or for making it the type of a new genus."

Neither the precise locality at Newcastle, nor the horizon in the measures of *C. adamsi* were recorded, but, now that we have a portion of a second fern trunk associated with leaves which cannot be distinguished from *Glossopteris ampla*, I think we may tentatively conclude that—(1.) The portion now described is the caudex of the species known under Dana's name; and (2) that Feistmantel's *C. adamsi* is the same thing, and hence the latter will become a synonym of *G. ampla*, Dana.

The following section of the Upper Coal Measures, kindly furnished by Mr. Mitchell, approximately shows the position of the bed yielding the stem and leaves of *G. ampla*, at Shepherd's Hill:—

HORIZON.	STRATA.	THICKNESS.
		Ft.
Shepherd's Hill	Conglomerate ...	80
	Thick bedded Sandstone...	40
<i>Glossopteris ampla</i> , stem ...	and { Conglomerate or argil- laceous sandstone ... Shale ...	20 10
	Coal (Victorian Tunnel Seam) with parting	20
Nobby's	Cherts ...	70
	Coal (Pipe-clay Seam)	10
<i>Phyllothea ramosa</i> , <i>Glos-</i> <i>sopteris browniana</i> and <i>G. linearis</i> ...	} Sandstones and Shales ...	80
	Coal (Dirty Seam) with partings ...	10
<i>Cingularia</i> in lower part	} Sandstones and Shales ...	70
	Coal (Yard Seam) ...	5
	Sandstones and Shales ...	75
	Coal (No. 5 Seam) with partings ...	7
<i>Phyllothea</i> and <i>Verte-</i> <i>braria</i> in lower part ...	} Sandstones and Shales ...	80
	Coal (Borehole Seam) ...	10
	Thick-bedded Grey Sand- stones ...	—

The thicknesses are approximate only.

A FRESH-WATER TURTLE (*Pelochelys cantoris*, Gray,)  
FROM NEW GUINEA.

By EDGAR R. WAITE, F.L.S., Zoologist.

(Fig. 4.)

By the kindness and forethought of the Hon. Anthony Musgrave, C.M.G., Government Secretary of British New Guinea, our knowledge of the distribution of the fresh-water turtles (Trionychoidea) has been considerably extended. This gentleman forwarded to the Trustees a large example accompanied by the following particulars:—"The fresh-water Tortoise was brought to the camp of a road-making party, on the third of September, by some natives, who had speared it in the Laloki River, one of the outfalls of the Astrolabe Range, forty miles from its entry into Redscar Bay. I reached the camp myself late on the following day and was shown the tortoise alive and active, in the small pool of a creek flowing into the above river. It seemed to me of interest to science, and I proposed to send it alive to Sydney and had it brought to Port Moresby, but it died on the tenth September of wounds, the carapace showing three or four punctures with a hunting spear. Mr. A. C. English kindly preserved the skin. The tortoise being a gravid female, I superintended the preservation of all the contents of the ovary. All the fleshy parts of the body were readily received by the natives for food. I may mention that Mr. John MacDonald, Head Gaoler for British New Guinea, first drew my attention to the tortoise. It seems to be little known to the natives, or it may be that they seldom attain such large size, as the river whence it was taken is frequented also by a large-sized species of crocodile."

When received at the Museum it was seen that, though the external parts were in good condition, the cervical, pelvic, caudal and limb bones had been removed; the skull had fortunately been preserved. I am thus definitely able to identify the turtle as of the genus *Pelochelys*, Gray,<sup>1</sup> and I do not see sufficient grounds for regarding it as distinct from the only admitted species, *P. cantoris*, Gray. It is recorded from India, Burma, Malaysia, Borneo, the Philippines and South-east China (*P. poliakowii*, Strauch<sup>2</sup>), and, as before mentioned, it is now added to the fauna of New Guinea.

---

<sup>1</sup> Gray—Proc. Zool. Soc., 1864, p. 89.

<sup>2</sup> Strauch—Mém. Acad. Imp. Sci. St. Pétersb., (7), xxxviii., 1890, p. 118, pl. iv., figs. 1-3.

From a geographical aspect, this record is of particular interest. When "Wallace's Line," separating the Oriental from the Austro-Malayan Region, was first traced, little was known of the Zoology of the Moluccas or New Guinea. Since then workers on particular groups have frequently announced that the limits of Wallace's Line did not harmonise with the results of their studies. An excellent summary of this subject has been published by Meyer and Wigglesworth.<sup>3</sup>

To the transgressors of this celebrated boundary, *Pelochelys*, hitherto known only from the Asiatic side of the "line," is now added. If the New Guinea fauna be regarded as balancing between the Oriental and Australian affinities, the present addition will help to weight the Oriental scale.

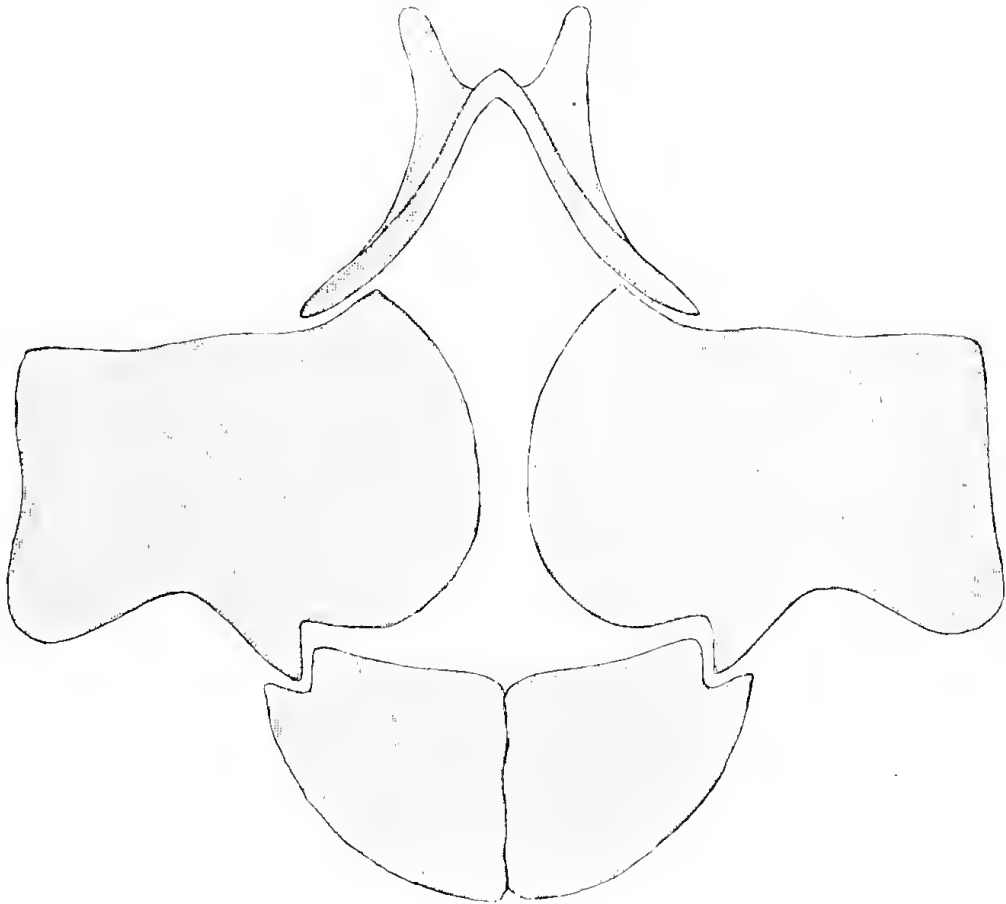

FIG. 4.

The accompanying illustration of the plastron renders the appearance in "the flesh," removal of the soft parts not being practicable. The callosities on the hyo-hypo- and xiphiplastra are, however, so largely developed as to almost conceal the underlying structures.

<sup>3</sup> Meyer & Wigglesworth—Birds of Celebes, i., 1898, pp. 80-89.

The sculpturing of each hyo-and hypo-plastron together forms a regular concentric series but each xiphiplastron has its own concentric ornamentation.

Three genera of the Trionyhydæ, namely:—*Cycloderma*, Peters, *Emyda*, Gray, and *Cyclanorbis*, Gray, are separated from the other three: namely:—*Trionyx*, Geoffroy, *Pelochelys*, Gray, and *Chitra*, Gray, by the presence of a pair of posterior cutaneous flaps, under which the hind limbs may be concealed. *Pelochelys* has an anterior flap, forming a complete bow, beneath which the head and anterior limbs may be concealed. I am unable to examine this condition in examples of the other genera and we do not possess further specimens of *Pelochelys*.

Of the carapace, the first four neural shields have the posterolateral sides shortest, the last four have these sides longest. A similar condition is figured by Günther and Strauch. If wide enough, the outer extremities of the nuchal plate would possibly overlie the second dorsal rib. The notched ends are simply embedded in the fleshy tissue.

On the lower surface of each hind foot a flat tubercle may be noted; it lies to the outer edge of the mid-line and is truncate anteriorly, but shelving behind. Its breadth is 18 mm.

Mr. Musgrave informs us that the weight of the Turtle, when alive, was 68 lbs. The principal measurements are:—

Total length of back	...	650 mm.
„ breadth „	... ..	520 „
Length of carapace	... ..	420 „
Breadth „	... ..	425 „
Length of Plastron	... ..	420 „
Breadth „	... ..	500 „
„ Bridge	... ..	165 „
Length of Skull	... ..	180 „
Breadth „	... ..	108 „

The ovaries contain eggs in all stages of development while the uteri held twenty-seven completely shelled eggs. These are almost spherical, the dimensions averaging 34.5 x 33.3 mm., and the weight 30.9 grammes. The shells are white and perfectly smooth.

## NOTES ON FLEAS PARASITIC ON THE TIGER CAT.

By W. J. RAINBOW, F.L.S., Entomologist.

In a former number of the "Records of the Australian Museum,"<sup>1</sup> the late Mr. F. A. A. Skuse described what he supposed to be the male and female of a flea parasitic on the Australian Tiger Cat, *Dasyurus maculatus*, Kerr, and for the reception of the species founded a new genus, *Stephanocircus* (*S. dasyuri*, Sk.). Later, Mr. Carl F. Baker, of Fort Collins, Colorado, published a monographic list under the title of "Preliminary Studies in Siphonaptera,"<sup>2</sup> and in this work, not only questioned the validity of Skuse's genus, but also suggested<sup>3</sup> that the latter writer had probably confused two species, and that both were referable to known genera. For this reason Mr. Baker, whilst reprinting the description, declined to incorporate the genus and species as defined by Skuse in his table of the Pulicidæ. In answer to this Mr. Skuse published a short paper under the heading of "*Stephanocircus*, Sk.: A Rejoinder,"<sup>4</sup> in which he maintained the accuracy of his determination.

Fortunately the types of Skuse's species are in the collection of the Australian Museum, and a study of these has convinced me that two distinct forms were confused, and that each are referable to separate genera, but, having also carefully studied Taschenberg's descriptions and figures<sup>5</sup> together with Baker's Key to the genera, I am of opinion that Skuse's genus should stand, and that it should be amended so as to include not only *S. dasyuri*, Sk., but also *S. mars*, N. C. Rothsch.<sup>6</sup>

In order to assist the student in working out the systematic position of these insects, I reprint Baker's Key of the Pulicidæ,<sup>7</sup> adding thereto the characters of Skuse's genus, as I think they should be understood.

- a. Eyes well developed; antennæ with circular incisions or cleft only on one side; head and thorax usually stout and compact; head rarely angulated in front;

---

<sup>1</sup> Skuse—Rec. Aust. Mus., ii., 5, 1893, p. 78, pl. xvii.

<sup>2</sup> Baker—Canadian Entomologist, xxvii., 1895, pp. 19-22, 63-66, 108-111, 130-132, 162-165, 186-191, and 221-2.

<sup>3</sup> Baker—loc. cit., p. 63.

<sup>4</sup> Skuse—Rec. Aust. Mus., ii., 7, 1896, p. 5.

<sup>5</sup> Taschenberg—Die Flöhe, 1880.

<sup>6</sup> N. C. Rothschild—Nov. Zool., v., 1898, p. 544, pl. xvi, fig. 11.

<sup>7</sup> Baker—loc. cit., p. 63.

lower edge of head and pronotum behind sometimes with combs, abdominal segments and discs of cheeks without. . . . . *Pulex*.

- aa. Eyes wanting, or very rudimentary; antennæ with circular incisions.
- b. Eyes entirely wanting; head and thorax stout and compact; head angulated in front, truncate; discs of cheeks, pronotum, and several abdominal segments with combs of numerous spines, the whole body heavily bristled. . . . . *Hystrihopsylla*.
- c. Eyes entirely wanting; head flattened in front, or sharply truncated, posterior margin pectinated; discs of cheeks and pronotum armed with tooth-like spines similar to those encircling the head; the whole body thickly bristled. . . . . *Stephanocircus*.

It is remarkable, too, when we consider how careful Mr. Skuse usually was, that not only should he have confused two genera so well marked, and so easily distinguishable, but that he should have failed to distinguish the female form of the male he described as *Stephanocircus*. Yet such is the case. There are four microscope slides in the Museum collection, the specimens upon which are registered as types of *Stephanocircus*. One contains three specimens—two females of *Stephanocircus*, and one male *Pulex*, and this slide is labelled “*Stephanocircus dasyuri*, Sk., from *D. maculatus*, N.S.W. (TYPES) 1 male, 2 female Tiger Cat Flea;” the second has two specimens of *Pulex*—one male and one female, and it is labelled “Tiger Cat Flea, 2 males, (TYPE);” the third and fourth contain dissected portions of females of *Stephanocircus dasyuri*, and are labelled “Tiger Cat Flea, female.” It is singular to note, that, whilst specimens of both sexes of a *Pulex* were collected from the body of a Tiger Cat, only one sex (female) of *Stephanocircus* was obtained. Probably the males were overlooked.

As to the identity of the *Pulex*: It appears to me that the form collected from the Tiger Cat is *Pulex fasciatus*, Bosc. It certainly agrees with the brief description given by Baker in his Key to that species of the genus *Pulex*,<sup>8</sup> and is similar to many examples taken from plague-infested and other rats by Dr. F. Tidswell, of the Department of Public Health of New South Wales, to whom I am indebted for the privilege of examining his long series of specimens, and who has also kindly presented some examples to the Trustees of the Australian Museum. That *P. fasciatus* should be found parasitic on the Tiger Cat

<sup>8</sup> Baker—*loc. cit.*, pp. 109-110.



does not, to me, appear strange, seeing that it has been recorded from time to time as occurring upon various mammals. It has been found upon the Garden Dormouse, *Myomys nitedula*, Pall. (= *P. nitela*, Curv.); the Mole, *Talpa europea*, Linn.; the Hampster, *Cricetus cricetus* Linn. (= *C. frumentarius*, Pall.); the House Mouse, *Mus musculus*, Linn.; the Brown Rat, *Mus decumanus*, Pall.; and the White Fox, *Canis lagopus*, Linn.

It has been stated that it is not usual for two species of fleas to be found living together upon a single wild animal, and it was a belief in this theory, doubtless, that led Mr. Skuse into the mistaken assumption that the two species found upon the Tiger Cat were merely the male and female forms of what he described as *Stephanocircus dasyuri*. Indeed, in his "Rejoinder" (already quoted) he endeavoured to make a strong point of this, for he wrote: "It is at least remarkable that one supposed species should be all males, and the others all females. Were such the case they might produce a hybrid in consonance with Mr. Baker's classification." Unhappily for this argument, as I have already shown, *two species were taken from one animal*, and although no males of one form were found, both sexes of the other were represented. Again, in reference to the fleas found upon rats by the authorities of the Department of Public Health, I may point out that it was not at all an uncommon experience to find two species upon a single animal—indeed, such was frequently the case. Dr. Tidswell showed me a number of examples. From this it will be seen how careful a collector should be when collecting these parasites for study and observation, and how important it is to bear this in mind when dealing with animals—parasitic or otherwise—that have the power of spreading disease.

---

NEW RECORDS OR RECURRENCES OF RARE FISHES  
FROM EASTERN AUSTRALIA.

No. 2.

By EDGAR R. WAITE, F.L.S., Zoologist.

(Plate vi.).

The principal species dealt with is *Histiopterus recurvirostris*, Richardson, which is regarded as the type of a new genus, *Prosoplismus*. This species, together with *Thyrsites atun*, Euphrasen, has not previously been recorded from New South Wales. *Cyttus australis*, Richardson, is readmitted as an inhabitant of our waters, a previous record having been overlooked. Additional specimens of *Callanthias platei*, Steindachner, are chronicled, while the identity of *Creedia clathrisquamis*, Ogilby, with *Heimerocetes haswelli*, Ramsay, is made known.

THYRSITES ATUN, *Euphrasen*.

*Scomber atun*, Euphrasen, Vetensk. Acad. Nya. Handl., xii., 1791, p. 315.

Though this southern species is known to occur occasionally off our shores, no definite record appears to have been made. It is not included in the published catalogues of our fauna and I therefore chronicle the following occurrence. By the kind offices of Mr. R. Eastway it became known to me that on 11th August the Amateur Fishermen's Association obtained a Barracouta eight miles off Coogee. On my expressing the desire that the specimen might be obtained for the National Collection, the Association kindly presented it to the Trustees.

CALLANTHIAS PLATEI, *Steindachner*.

*Callanthias platei*, Steindachner, Zool. Jahrb., Supp., iv., 2, 1898, p. 284, pl. xv.

Of this species, first recorded for New South Wales in 1898, additional specimens have been obtained by Mr. J. A. Boyd, who forwarded them from Twofold Bay in September, 1901.

CYTTUS AUSTRALIS, *Richardson*.

*Cyprus australis*, Richardson, Trans. Zool. Soc., iii., 1849, p. 72; Voy. "Ereb. and Terr.", 1848, p. 137, pl. lix, figs. 1-5.

Considering the extreme rarity of this species in our waters, it is noteworthy that although the description was made from

a drawing executed in Tasmania, the actual type was taken at Sydney. This fact has been overlooked by Australian authors and consequently the species has been omitted from the New South Wales lists. This may be accounted for by a misreading of Richardson's habitat, "Coasts of Tasmania and southern parts of Australia." Macleay renders it "Tasmania, South Coasts of Australia."

As far as I am aware the second known occurrence of this southern species in New South Wales is an example obtained on 5th August last. On that date Mr. R. East obtained a specimen at Bondi and forwarded it to the Trustees.

Richardson mentions that, owing to mutilation the representation of the dorsal, anal, and pectoral rays may not be quite exact. Of these the pectoral only is incorrectly shown. This fin is not rounded, its upper rays being the longer, the third is the longest, to which the second and fourth are almost equal, 2.5 in the length of the head.

The general colouration of the body is iridescent on a silvery ground. The lips are pink, the upper one is a very broad reflexed flap not mentioned nor illustrated by Richardson. The snout to the origin of the dorsal fin is also pink. The first dorsal and ventral fins are ruby-coloured, the soft dorsal, anal and caudal salmon-pink and the pectoral colourless, with a pink base. The eye is most brilliant, having a golden iris shot with green.

The type specimen measured only five inches in length. The Bondi example is larger, while representatives in the Museum collection from South Australia reach 290 mm. = nearly eleven and a half inches.

*CREEDIA HASWELLI*, Ramsay.

*Hemerocætes haswelli*, Ramsay, Proc. Linn. Soc. N. S. W., vi., 1881, p. 575.

Though this species appears under the genus *Hemerocætes*, it is due to its author to make the following transcription:—"I have placed this fish provisionally in the genus *Hemerocætes*, to which it comes nearest. It is not, however, identical with that genus."

I next refer to *Creedia clathrisquamis*, Ogilby.<sup>1</sup> This species was described in 1898, and made the type of a new genus; in the following year I more fully described the peculiar scales and illustrated the fish.<sup>2</sup> It but remains for me to point out that *Hemerocætes haswelli* and *Creedia clathrisquamis* are identical. As was first noted by Ramsay, the genus *Hemero-*

<sup>1</sup> Ogilby—Proc. Linn. Soc. N. S. W., xxiii., 1898, p. 299.

<sup>2</sup> Waite—Aust. Mus. Mem., iv., 1899, p. 63, fig. 6.

*cetes* cannot contain the fish: and its correct designation should therefore be *Credia haswelli*, Ramsay.

PROSOPLISMUS RECURVIROSTRIS, *Richardson*.

*Histiopterus recurvirostris*, Richardson, Voy. "Ereb. and Terr.", 1845, p. 34, pl. xxii, figs. 5 and 6.

(Plate vi.).

The genus *Histiopterus* has had a rather unfortunate history. It was first instituted by Temminck and Schlegel<sup>3</sup> in 1844, two species being included, namely, *H. typus* and *H. acutirostris*. I have suggested that the latter may be the young of the former, though without further justification than a perusal of the respective descriptions.<sup>4</sup>

In 1845 Richardson added a Tasmanian species to the genus, though as I shall show, *H. recurvirostris* should not be included. The genus was entirely overlooked by Günther in his Catalogue of the British Museum Fishes, but in 1871 he described an Australian form, *H. labiosus*.<sup>5</sup> Two further species have been made known, *H. elevatus*, Ramsay and Ogilby,<sup>6</sup> and *H. farnelli*, Waite.<sup>7</sup> The genus further suffered neglect at the hands of Agassiz and Marschall who omitted it from their respective "Nomenclatores." Seudder includes it in his work but erroneously ascribes it to Richardson.

In reviewing the history of *H. recurvirostris*, we find it first named from a head only, from Tasmania. It was more fully described and figured by Canestrini,<sup>8</sup> whose paper has been overlooked by Australian authors; I am not aware of the locality whence Canestrini's specimens were obtained. In 1872 Castelnau,<sup>9</sup> published a description from specimens taken in the Melbourne markets, where, he states, it is not rare, and reaches twenty inches in length.

On 24th June last, the Trustees received from the Amateur Fisherman's Association of New South Wales, a fresh specimen obtained in our waters; a new record for the fauna of the State. An examination of this specimen suggests the advisability of redescribing the species,

<sup>3</sup> Temminck and Schlegel—Fauna Japon, Pisces, 1844, p. 86, pl. xlv.

<sup>4</sup> Waite—Aust. Mus. Mem., iv., 1899, p. 115.

<sup>5</sup> Günther—Proc. Zool. Soc., 1871, p. 658, pl. lix.

<sup>6</sup> Ramsay and Ogilby—Proc. Linn. Soc. N.S.W., (2), iii., 1888, p. 1311.

<sup>7</sup> Waite—*loc. cit.*, p. 116, pl. xxvii.

<sup>8</sup> Canestrini—Arch. per la Zool., 1869, p. 152, pl. ii.

<sup>9</sup> Castelnau—Proc. Zool. Soc. Viet., i., 1872, p. 109.

while a comparison with Canestrini's figure shows this to be incorrect. I therefore supply an illustration and in justification draw attention to the most glaring defects of the previous figure; it is to be remarked that Canestrini's specimen was dry and possibly distorted, but even this could not account for the erroneous position accorded to the anal fin. It is shown as commencing beneath the penultimate dorsal spine, whereas its true origin is beneath the first ray; this defect is not so obvious as its point of termination, shown beneath the base of the 5-6 rays, or far in advance of the end of the dorsal; the anal really terminates almost evenly with that fin. Of course, if the figure is accurate, another species is indicated, but as I have also an example from Tasmania, the type locality, and two from Victoria, all of which exactly agree with the New South Wales specimen in this particular, I consider that I am warranted in condemning Canestrini's illustration.

Richardson had only a head, but in assigning this to *Histiopterus* he made a very shrewd conjecture as to its relationship. Canestrini does not refer to the type of the genus, Castelnau recognised generic difference, but, not possessing the Fauna Japonica, presumed *H. recurvirostris* to be congeneric with *H. typus* and proposed a new name *Richardsonia* (preoccupied), for his *R. insignis* (? *H. labiosus*, Günther).<sup>10</sup>

With the following characters I submit for *H. recurvirostris* the name:—

PROSOPLISMUS, gen. nov.

Body strongly compressed, the length greater than the depth. Two dorsal fins (connected), the first of nine or ten spines depressible in a groove, the second of one spine and about fourteen rays, anal fin with three spines and about eleven rays. Head partly armoured, partly scaled. Snout narrow and greatly produced; mouth small, terminal; teeth in the jaws in an outer conical series, and an inner setaceous one. Vomer, palatines, and tongue without teeth. Scales small, finely ctenoid.

*Description*—B. vi; D. x. i. 14; A. iii. 11; V. i. 5; P. 17; C. 17; L. lat. 95.

Length of head 3.1; height of body behind ventral fin 2.6; length of caudal, 6.5 in the total length. Diameter of eye 4.2; length of snout 1.8; and interorbital space 4.9 in the length of the head.

The upper profile of the snout is very concave, that of the head rounded. The interorbital space is slightly convex. From the base of the third dorsal spine to that of the second

<sup>10</sup>Castelnau—*loc. cit.*, p. 112.

anal ray the profile is quite straight, thence declivous to the caudal peduncle. The ventral profile, from the jaws to the anal spines, is very slightly convex, thence rising to the caudal peduncle. The mouth is small, terminal and horizontal, with the jaws equal. The teeth, present only in the jaws, are moveable and consist of an outer conical series in a single row and an inner setiform patch; in the upper jaw these are continued in band-form towards the angle of the jaw. In the mandible the lateral band is very narrow; the maxilla extends half-way to the anterior margin of the eye; the width of its distal extremity is one-third the orbital diameter; the nostrils are placed nearer the eye than the end of the snout.

The dorsal fin arises above the middle of the opercle. The first spine is short, two-thirds the diameter of the eye, to which the second is nearly equal. The third is three times the same, while the fourth and longest is one-fifth longer than the head. The next spine is a little longer than the third, the following gradually decrease to the tenth which is 2.7 in the head. The eleventh spine is twice the length of the second and the first ray the longest, twice the length of the spine. The remainder regularly decrease to the last, forming a slightly sinuous margin. The membrane of all the spines arises behind the tip and in the five first is continued as a mere strip, the connection with each succeeding spine being at the base only.

The anal commences beneath the last dorsal spine, and terminates evenly with that fin. The first spine is slightly longer than the first dorsal; the second is nearly as long as the third, which slightly exceeds the tenth dorsal in length. The second anal ray is the longest, 1.52 in the length of the head, the rest regularly decrease, forming a truncate margin. The ventral spine is flat and broad, its length equal to the third dorsal. The first ray is more than a third longer or nearly equal to the length of the head; when depressed it reaches to the hind margin of the vent. The upper pectoral rays are long, the first two excepted, the fourth being 1.22 in the head: the margin is slightly rounded and the lower rays short. The caudal is emarginate, the upper lobe the longer. The least height of the pedicel is equal to its length or one-third the length of the head.

*Scales.*—On the head, a broad patch extending from behind the eye to the angle of the mouth, one above the opercle and another patch on the temporal region, remainder of head naked or armoured. The scales on the body are small, finely etenid and irregularly disposed. Castelnau counted over 130 horizontally. I find 95 on the lateral line. This forms a sinuous arch, concurrent with the dorsal profile, and runs

straight along the middle of the caudal pedicel. The sheaths of the soft dorsal and anal fins are clothed with very small scales.

*Colours*.—Silvery on the opercles, plumbeous-grey on the body. A brown mark from the snout to the eye, thence to the occiput. Three brown streaks on the body, one from the base of the first three dorsal spines towards, but failing to reach the anal; a second from below the fifth and sixth spines to between the posterior dorsal and anal rays and a third from the ninth spine at the base of the scaly sheath to the end of the fin. The fin membranes are grey, the upper lobe of the dorsal and anal, and the distal third of the ventral being clouded with smoke-grey.

Total length, 388 mm.

The Tasmanian example, previously referred to, is larger, 415 mm., and the two Victorian ones 490 and 285 mm. respectively. All these have but ten dorsal spines. In the Tasmanian specimen the odd spines (i. iii. v., etc.), are dextral, whereas in the Australian specimens they are sinistral. Castelnau describes the shape of the body as conical, with the base at the insertion of the head. Such a term by no means fits our specimens and if the ray-sheaths be included, the upper and lower profiles approach the parallel.

This writer gives eight as the number of dorsal spines, but afterwards mentions a ninth and next a spine prefaceing the second dorsal, so that ten appears to be the correct number. His remarks as to the absence or non-connection of the membrane are incorrect. The irregular contour of the longer spines appears to be a constant condition, and is especially marked in one of the Victorian examples.

The principal characters of all the species may be tabulated as follows:—

**HISTIOPTERUS.** One dorsal fin; four to seven spines.

*a.* Three anal spines.

*b.* Four dorsal spines.

*c.* 1. Third longest,

*typus.*

*cc.* 2. Fourth longest,

*acutirostris.*

*bb.* Six dorsal spines, sixth longest,

*elevatus.*

*aa.* Two anal spines.

*d.* Dorsal spines low,

*labiosus.*

*dd.* Dorsal spines high,

*farnelli.*

**PROSOPLISMUS.** Two dorsal fins; ten or eleven spines.

*recurvirostris*

## STUDIES IN AUSTRALIAN ARANEIDÆ.

No. 1.

By W. J. RAINBOW, F.L.S., Entomologist.

(Figs. 5 and 6.).

ERIODON OCCATORIUM, *Walck.*

Mr. H. R. Hogg, M.A., in his monographic list of the "Spiders of the Sub-order Mygalomorphae,"<sup>1</sup> when dealing with this species, reviews briefly the history of the type and other specimens in Europe,<sup>2</sup> from which it would appear that Walckenaer's specimen (type) came, in all probability from Port Jackson, N.S.W. Later, M. H. Lucas obtained a specimen from "les environs de Melbourne," and this was purchased by the Paris Museum in 1859.

In his paper, Mr. Hogg points out that Walckenaer "gives two drawings of the eyes, in one of which the front middle pair are quite small, about three diameters apart; in the other somewhat larger, one-and-a-half diameters apart. In the former, also, the rear side eyes are nearer together than the front side, and in the other drawing both distances are the same. The first is from above, the second from in front." Walckenaer described this species as *Missulena occatoria*.<sup>3</sup>

Lucas, in a paper dealing with the genus, says<sup>4</sup> that the front middle eyes of *occatorium* are close together, and gives a figure in which they are delineated as small, and about a diameter apart; he was able to compare his specimen with the type, so, as Mr. Hogg remarks, "his identification should be correct." Lucas gave the measurements as 20 mm. long, but does not say whether the palces are included or not. According to the author of "Spiders of the Sub-order Mygalomorphae"<sup>5</sup> there are in the British Museum two female specimens from the Hunter River, N. S. W., and West Australia, labelled *E. occatorium*; these are old and dried, different from one another, and do not agree with Lucas's description. In order to assist the student, Hogg

---

<sup>1</sup> Hogg—Proc. Zool. Soc., 1901, p. 218 *et seq.*

<sup>2</sup> Hogg—*loc. cit.*, pp. 220-221.

<sup>3</sup> Walckenaer—Tableau des Araneides, 1805, p. 8, pl. ii., figs. 11-14; *id.*, Ins. Apt., 1837, i, p. 252.

<sup>4</sup> Lucas—Ann. Soc. Ent. Fr. (4), v., 1865, p. 309, pl. 8; also, Hogg—Proc. Zool. Soc., 1901, p. 221.

<sup>5</sup> Hogg—*loc. cit.*, p. 221.



gives a brief description of these, together with measurements of the largest specimen,<sup>6</sup> and adds:—"These two are more likely the female (unknown) of *E. rubrocapitatum*, Auss., and of *E. crassum*, Cambr., respectively."

Whatever these forms may be, I do not think that either of them is referable to *E. rubrocapitatum*, and this I will endeavour to demonstrate later on.

A short time ago, my colleague, Mr. E. R. Waite, presented to the Trustees of the Museum a specimen of *Eriolon* found by him at Mosman's Bay, and which, after careful examination, leaves no doubt in my mind as to its specific position—namely, *E. occatorium*. This, for the benefit of students is herewith described.

FEMALE: *Cephalothorax* (from base to *clypeus*) 6·5 mm., or (including *falces*) 10·5 mm. long; breadth, 7·8 mm.; *abdomen* 12·2 mm. long, 10·3 mm. broad.

*Cephalothorax*.—Black-brown, glossy. *Pars cephalica* rising abruptly, high, strongly arched; a few long, stiff bristles form a fringe in front of anterior row of eyes, and at the sides; there are also a few long bristles scattered over the surface behind the median and rear eyes; from the median pair of eyes to junction of the cephalic and thoracic segments, there is a faintly discernible ridge; the junction of the cephalic and thoracic segments is deeply grooved. *Pars thoracica* moderately arched, depressed at centre; radial grooves faintly distinct. *Clypeus* of a pale, somewhat fleshy tint. *Marginal band* concolorous, broad, and fringed with fine, pale yellowish hairs.



FIG. 5.

*Eyes*.—Arranged in three series of 3, 2, 3 each; median pair separated from each other by a space equal to about once their individual diameter; lateral eyes protuberant, and of these each outer anterior eye is decidedly the largest of the group, and the inner one much the smallest (Fig. 5.)

<sup>6</sup> Hogg—*loc. cit.*, p. 221.

*Legs.* — Short and strong, dark brown, glossy, spined, and clothed with long coarse hairs or bristles. Their measurements (in millimeters), are as follows:—

Leg.	Coxa.	Trochanter and femur.	Patella and tibia.	Metatarsus and tarsus.	Total.
1	3·0	5·8	4·5	4·0	17·3
2	3·0	5·8	4·3	3·5	16·6
3	3·5	5·8	4·5	4·0	17·8
4	3·5	7·5	5·5	4·5	21·0

*Palpi.*—Similar in colour, clothing, and armature to legs. measurements (in millimeters): Coxa, 2·1; trochanter and femur, 4·5; patella and tibia, 3·1; tarsus, 2·1; total, 11·8.

*Falces.*—Concolorous with cephalothorax, porrected, powerful, arched, apices and inner margins clothed with long, coarse bristles; falx sheath armed on the inner margin with a row of eleven small, strong teeth, and on the outer with nine; in addition to these there are two intermediate rows of about a dozen smaller teeth.

*Maxillæ.*—Dark brown, strong, broad, arched, tapering outwards to a point, surface hairy, inner and apical margins fringed with long reddish bristles.

*Labium.*—Similar to maxillæ in colour and clothing, longer than broad, arched, conical.

*Sternum.*—Rather longer than broad, glossy, narrowest in front, where it is deeply indented; surface depressed in places, and moderately hairy; margins fringed (not thickly) with long hairs.

*Abdomen.*—Obovate, projecting over base of cephalothorax, strongly arched, hairy, chocolate brown above, rather paler below.

*Obs.*— Since the above description was drawn up, the Trustees have received, through the courtesy of Mr. S. J. Johnston, B.A., of the Technological Museum, Sydney, and Mr. George Blake, of the Government Savings Bank, Sydney, two additional specimens (female) both of which were collected in the neighbourhood of Sydney. Unfortunately Mr. Johnston's specimen was dry when he obtained it, but that presented by Mr. Blake was in good condition. Both specimens are rather larger than the one described above, and their leg and palpi measurements are, therefore, relatively longer.

#### ERIODON RUBROCAPITATUM, *Auss.*

This is a widely distributed species, specimens having been collected in Northern and Southern Queensland, N. S. Wales, Victoria, S. Australia and W. Australia. The male

example is by far the best known, and is, as a rule, the only one found in collections. It differs somewhat in the intensity of its colouration, some examples having the head and falcæ a brilliant scarlet, whilst in others these parts are merely reddish-brown. The female has never been described.

Mr. Hogg, in addition to a brief description of a male in the Keyserling Collection (British Museum) gives the measurements of a specimen—which he regards as the female form of this species; this specimen is also in the British Museum Collection. The characters, however, with exception of the colour of the eyes, are not enumerated.<sup>7</sup> *E. rubrocapitatum* is the form recorded by Simon under the specific name of *E. semicoccineum*,<sup>8</sup> and by myself as *Actinopus formosus*.<sup>9</sup>

A short time ago Mr. W. W. Froggatt, Government Entomologist of New South Wales, presented to the Trustees two specimens from Kalgoorlie, Western Australia, a male and female; the latter is described hereunder.

The fact that this specimen is the first female recorded having red head and falcæ, makes it particularly interesting. Hogg, in commenting upon the question of colour, says:—"No scarlet coloured females have been found; probably they are of the normal black-brown or chocolate colour and may not differ even so much as the males."<sup>10</sup>

FEMALE: *Cephalothorax* (from base to *clypeus*) 7·5 mm. or (including *falcæ*) 14·5 mm long; breadth, 12 mm.; *abdomen*, (shrunken) 5·7 mm. long, 5 mm. broad.

*Cephalothorax*.—Broadest in front. *Pars cephalica* rising abruptly, high, strongly arched, smooth, shining red, darkest at base; immediately at rear of median eyes there are two distinct circular depressions or pits, from near which to the junction of the thoracic segment there is also a faintly discernible ridge. *Pars thoracica* smooth, shining, chocolate brown, broad, moderately convex, deeply depressed at centre, radial grooves distinct,

<sup>7</sup> Hogg—*loc. cit.*, pp. 226-227.

<sup>8</sup> Rainbow—*Proc. Lin. Soc., N. S. W.*, xxi., 1896, p. 328, pl. xx. *loc. cit.*, xxii., p. 253.

<sup>9</sup> Simon in Semon—*Zool. Forsch. Austr. Malay. Archipel.*, 1896 Lief. 8, p. 343.

<sup>10</sup> Hogg—*loc. cit.*, p. 223.

lateral and posterior angles reflexed. *Marginal band*, pale yellowish.



FIG. 6.

*Eyes*.—In three series of 3, 2, 3; median and outer lateral pairs moderately large and of equal size, but the inner lateral eyes are exceedingly minute; median eyes opalescent, surrounded by black rings, and separated from each other by a space equal to about once their individual diameter; outer lateral eyes protuberant, oval, colourless, and separated from each other by a space equal to three times their individual diameter; inner angles black; each inner lateral eye is seated midway between outer lateral and median eyes; they are also colourless (Fig. 6.)

*Legs*.—Short, robust, glossy, reddish brown above, and clothed with long coarse hairs and bristles; under surfaces of a somewhat lighter hue. Measurements (in millimeters):—

Leg.	Coxa.	Trochanter and Femur.	Patella and Tibia.	Metatarsus and Tarsus.	Total.
1	3.7	7.4	7.5	5.5	24.1
2	3.7	7.0	7.5	5.5	23.7
3	3.7	8.0	6.5	6.0	24.2
4	4.5	8.5	8.5	6.5	28.0

*Palpi*—Similar in colour and clothing to legs. Measurements (in millimeters): Coxa, 2; trochanter and femur, 7; patella and tibia, 7; tarsus, 4; total, 20

*Palces*.—Smooth, red, powerful, porrected, arched, apices and inner margins clothed with long, coarse hairs or bristles; falx sheath armed on inner margin with nine small strong teeth, and on the outer with six; in addition to these there are two inner rows of about a dozen smaller teeth.

*Maxilla*.—Concolorous, strong, broad, clothed with long, coarse ferruginous and golden red hairs or bristles; inner apical angles thickly set with short coniform tubercles.

*Labium*.—Concolorous also, rather longer than broad, narrowest in front, the surface generally smooth, but depressed in places, and moderately hairy; outer angles fringed with long, reddish hairs.

*Sternum*.—Rather longer than broad, glossy, narrowest in front, where it is deeply depressed; there are also two deep depressions or pits near the posterior angle; surface smooth, red, and fringed with reddish hairs.

*Abdomen*.—Obovate, overhanging base of cephalothorax, hairy, black-brown, both above and below.

ON A MINERAL ALLIED TO MONTMORILLONITE  
FROM EXETER, NEW SOUTH WALES.

By C. ANDERSON, M.A., B.Sc., Mineralogist.

This specimen was acquired by exchange with the Technical College, Goulburn, and, from information supplied by, Mr. A. J. Sach, the Resident Master, we learn that it was obtained from a railway deviation cutting at Exeter, on the Sydney to Goulburn line. Mr. Sach informs us that, when found, the mineral was of a pronounced pink colour and very gelatinous. Presumably the colour has since faded and the mineral lost water.

The specimen is amorphous, clay-like and very soft, being easily marked by the thumb nail. Fracture subconchoidal to uneven. Lustre rather waxy. Colour white to delicate rose pink. Rather translucent. Soapy feel and earthy smell. Non plastic; adheres slightly to the tongue. Rapidly disintegrates in water, with slight evolution of air bubbles. Before the blowpipe it whitens, decrepitates slightly and fuses on the edges. With cobalt nitrate yields a blue colour. Gives much water in the closed tube. Slightly soluble in acids.

From its general characters the specimen is seen to belong to the kaolin division of minerals, agreeing pretty closely with *Montmorillonite*,<sup>1</sup> and this agreement is confirmed by the chemical analysis, the result of which is given below.

After twenty hours exposure over sulphuric acid the mineral lost 10.68 per cent, and after forty-six hours the loss increased to 10.74 per cent. At 100° C. a further loss of 1.16 was suffered. The weight was restored after eighteen hours in the balance case. It is difficult to decide with certainty whether this large loss is due to hygroscopic or to combined water, but, as certain hydrous silicates are known to lose water of combination in dry air, I

---

<sup>1</sup> Dana—System of Mineralogy, 6th Edit., 1892, p. 690.

think it advisable to enter this loosely held water in the analysis (1), whilst calculating the percentages on the basis of material dried at 100°C (2).

	(1)	(2)
H <sub>2</sub> O at 100°C — ... ..	11·90	
H <sub>2</sub> O at 100°C + (ignition)...	12·54	14·24
SiO <sub>2</sub> ... ..	52·72	59·84
Al <sub>2</sub> O <sub>3</sub> ... ..	21·28	} 25·14
Fe <sub>2</sub> O <sub>3</sub> ... ..	·87	
MgO ... ..	trace	
CaO ... ..	1·44	1·63
Alkalies ... ..	traces	
	100·75	100·85

A direct determination of the total water by Penfield's method gave 24·44 per cent.

The formula corresponding to (1) is Al<sub>2</sub>O<sub>3</sub> · 4 SiO<sub>2</sub> + 6H<sub>2</sub>O, three molecules of water being lost at 100°C, but, seeing that the material is amorphous and doubtless impure, too much reliance cannot be placed on the formula.

## A NEW SPECIES OF DENDROSTOMA.

By H. LEIGHTON KESTEVEN.

(Plate vii., and fig. 7).

The specimens from which the following description and figures are drawn, were collected by Mr. T. Whitelegge on the beach at Balmoral, Port Jackson, in July of 1901. At the time there had been much rain and heavy storms on the coast and it is probable that the rain washing down the wooded hills carried with it a large quantity of tanin and other deleterious matters derived from vegetable refuse, and thereby poisoned the marine invertebrate fauna generally. It is to this cause that Mr. Hedley assigned the occurrence of *Solen sloanii*, in numbers on the same beach.<sup>1</sup> It may, therefore, be concluded that the present species lives in three or four fathoms of water.

I am indebted to Mr. Whitelegge, not only for his kindness in placing the material at my disposal, but also for assistance in working it out.

The specimens when collected were placed in spirits, and most of them exerted the whole of the introvert and extended the trunk to its fullest extent. It is such a specimen that is here described.

### DENDROSTOMA DEHAMATA, sp. nov.

*External characters.*—Length over all 230 mm.; of introvert, 60 mm. Diameter of trunk; at anus 5 mm., a few millimetres behind the anus, 8 mm.; thence it tapers slowly to about 6 mm. in diameter just anterior to the obtuse posterior point. Diameter of introvert, 3 mm. The trunk is cylindrical, of nearly uniform diameter throughout, but tapering slightly towards the obtusely pointed extremity. Colour white, inclined to wax yellow, especially on the introvert. The length of the introvert is slightly less than a third that of the trunk, the anterior quarter of it is quite smooth, the rest bears papillæ which, anteriorly, are rather long and slender, but become shorter, stouter, and more crowded as the posterior end is reached (Pl. vii., f. 5). There are *no* hooks on the introvert (hence the name), both young and old, introverted and exerted specimens have been examined. Tentacles plumed (Pl. vii., figs. 2, 3); their arrangement is variable; there are four main stems, two of two, and two of three primary branches. In some specimens, however, the divisions between these branches ex-

---

<sup>1</sup> Hedley—Proc. Linn. Soc. N.S.W., xxiv., 1899, p. 432.

tend right down to the circum-oral muscular ridge, in which case there are eight branches arranged in groups as above. The stems are connected by a narrow filamentous flap. On the median dorsal line there is a rather broader gap between the stems than elsewhere, the flap is here inflected slightly towards the mouth, and bears longer filaments than between the other stems. The tentacles are blotched with dark brown. The mouth is not directly in the centre, but is placed somewhat towards the dorsal edge. It appears as an arcuate depression, the long axis of which is at right angles to the dorso-ventral axis of the worm; there are several papillae radiating from it. The dorsal lip, if it may be so termed, is slightly more elevated than the ventral. On the anterior end of the introvert, in the median dorsal line, and forming the posterior boundary to the sinus made by the inflection of the filamentous flap, there is a brown pigmented, elevated cap, which, although it shows no depressions or orifices on its surface, is probably the cerebral organ. (Pl. vii., fig. 4, e.g.) The anus (Pl. vii., fig. 6) is situated a little way behind the base of the introvert, the nephridial apertures being a little further back. All are of the same appearance, except that the latter are slightly the smaller. The cuticle being slightly pigmented round the orifices they are plainly discernible. The wall of the introvert is thinner and more flexible than that of the body. The cuticle of the body exhibits a slight tendency to be raised into squares, the longitudinal furrows being the most conspicuous, and is marked with semi-translucent pores. When the cuticle is stripped off these pores are seen to correspond to pelucid tubercles. These latter are doubtless the glandular bodies of unknown function, which have been described as occurring in the body walls of other *Gephyrea*. At the extreme posterior end of the trunk there is a small, smooth, yellow button.

*Internal Characters.*—Internally the body wall is light yellow smooth, and glistening. The brain and circumoesophageal nerve ring are buried in the integument of the circumoral muscular sheath, the brain being directly beneath the pigmented cap previously mentioned. The ventral nerve cord is of the usual type, its retaining muscles are not appreciably longer in the introvert than in the body. The two retractor muscles (Pl. vii., fig. 1, r.m.), are inserted in the body wall about one-third from the posterior end. For the posterior one-sixth of their length they are separate, thence to the oesophageal sheath they are joined by a thin elastic membrane. The anterior fused portion or oesophageal sheath is about 5 mm. long. Where they are joined by the membrane, they are divided from one another ventrally by a deep groove the sides of which are in contact; dorsally they form a rather broad gutter, down the middle of which,



with slightly undulating course, the oesophagus or foregut runs. In the sheath this latter is contracted so as to be X shaped in transverse section. The fore-gut (Pl. vii., fig. 1, oes.), after leaving the abovementioned gutter proceeds down to about half-way between the insertion of the retractor muscles and the end of the trunk, thence it turns suddenly forward, reaches the spiral on about a level with the insertion of the muscles, and passes forward to the anterior end of the spiral, along the dorsal face thereof. The anterior end of the mid-gut or intestinal spiral (Pl. vii., fig. 1, int. sp.) is placed a little in advance of the insertion of the retractor muscles, the posterior end, almost at the base of the body cavity. Anteriorly the spiral is tightly wound, posteriorly only loosely so. The rectum (Pl. vii., fig. 1, rect.) proceeds in a straight course from the anterior end of the spiral to the anus, the position of which has already been described. The rectum and spiral are of about equal length, and together they are equal to about five-sixths of the length of the body cavity. The digestive canal is kept in position by the following muscles. For the whole length of the gutter it is firmly attached to the membrane connecting the retractor muscles. The loop of the fore-gut extending towards the posterior end of the cavity is kept in position by two fine thread-like muscles (Pl. vii., fig. 1, mes. mes.); these arise from the body wall half-way between the end of the loop and the end of the body cavity, one of them is inserted into the descending arm of the loop a little in advance of the end, where the second is inserted. The anterior end of the spiral is prevented from moving forward by two spindle-shaped muscles (Pl. vii., fig. 1, sp. m. sp. m.). The first of these arises from the base of the left retractor muscle, and proceeding round the left side of the spiral, giving some fine threads thereto in its course, it is inserted in the dorsal side of the rectum just anterior to the spiral. The second arises a little anterior to, and underneath the right retractor, and passing round the right side of the spiral, is inserted in the rectum beside the first. These muscles cannot be traced along the rectum, but it is probable that they are scattered through its wall, and that the fine muscular membrane which with the body wall forms an elongate triangular pocket (Pl. vii., fig. 1, mus. poc.) at the anterior end of the rectum, is really their segregation and amplification. The spiral is bound together by very fine muscular threads. The posterior spindle muscle is absent, and the spiral is entirely free. The contractile vessel is slender, its diverticula short, clustered on the dorsal side of the descending arm of the oesophageal loop. The two brown segmental organs are long; rather more than one-third the length of the body cavity; slender and free. They are provided with thick, muscular walls just inside the orifices.

*Comparative.* — The present is the sixth and much the largest species of the genus. The only two with which it need be compared are *D. blandum*, Sel. and de Man, and *D. signifer*, Sel. and de Man.<sup>2</sup> From them it differs to a greater or lesser extent in the following particulars:—They are smaller, possessed of introvert hooks, their spirals are retained in position by muscles differently arranged and placed. The rectum and “brown-tubes” in the new species are proportionately longer, also its retractor muscles are not separate for so large a proportion of their length. Finally, if the descriptions given are complete, neither of the two species mentioned have the muscular pocket at the anterior end of the rectum nor the peculiar cerebral organ (?) which occurs in *D. dehamata*.

Type to be presented to the Australian Museum.

Some of the specimens are swollen and club-shaped posteriorly. This leads me to suggest that they bury themselves by the same mechanism as do some bivalve Molluscs; e.g., *Solen* that is, by swelling the posterior end, already slightly buried, and then sending the swelling forward. I have attempted to explain my meaning diagrammatically by the accompanying text figure.

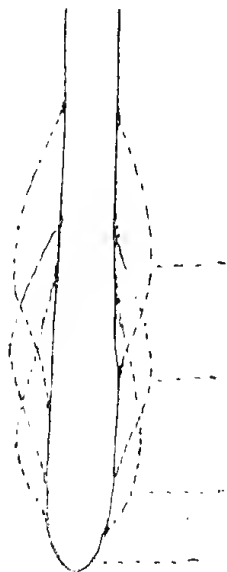

FIG. 7.

In his “List of the Invertebrate Fauna of Port Jackson” Mr Whitelegge enumerated six species of Gephyrea; the work which has been done since that has rendered the list incomplete. I therefore give the following:—

<sup>2</sup> Selenka and de Man in Semper—Reisen. Arch. Philip., iv., 1883, Sipunculiden, pp. 85-86.

<sup>3</sup> Whitelegge—Proc. Roy. Soc. N.S.W., xxiii., 1889, pp. 211-212.

## GEPHYREA.

## ORDER, SIPUNCULOIDEA.

PHYSCOSOMA JAPONICA, *Grube*.

*P. japonica*, Grube, Schles. Ges. Vaterlandische Cultur. Breslau, 54 Jahr. 1877, p. 73; Selenka, Chall. Rep., Zool., xiii., 1885, p. 21; Selenka in Semper, Reis. Arch. Philip., iv., 1883, Sipunculiden, p. 76, pl. ii., f. 18, 19, pl. x., f. 145-46.

SIPUNCULUS AUSTRALIS, *Kieferstein*.

*S. australis*, Kef., Nach. K. Ges. Wiss. Gottingen; 1865, p. 197-98; Selenka, *loc. cit.*, p. 90, pl. xiii., f. 180-82.

SIPUNCULUS MUNDANUS, *Sel. & Bulow*.

*S. mundanus*, Sel. & Bul., Selenka, *Loc. cit.*, p. 108, pl. xiii, f. 174.

The locality, "Sow and Pigs Bank (1 exemplars aus dem Britischen Museum)" seems to have puzzled the authors of this species, for it was omitted from their table of Geographical Distribution. I have not seen the species, but the locality in full is doubtless Sow and Pigs Reef, Port Jackson, New South Wales.

## SIPUNCULUS, sp.

*Sipunculus*, sp., Whitelegge, Proc. Roy. Soc. N.S.W., xxiii., 1889, p. 212.

DENDROSTOMA SIGNIFER, *Sel. and de Man*.

*D. signifer*, Sel. and de Man, Selenka *Loc. cit.*, p. 86, pl. ii., f. 21, pl. xi., f. 163-169.

DENDROSTOMA DEHAMATA, *Kesteven*.

*D. dehamata*, Kestv. *ante*.

## ORDER ECHIUROIDEA.

## THALASSEMA, sp.

*Thalassema* sp., Whitelegge, *Loc. cit.*, p. 211.

BONELLIA VIRIDIS, *Roland. ?*

*B. viridis*, Roland, Mem. R. Acad. Sci. Torino, 1821, p. 539  
Laeaz-Duthiers, Ann. Sci. Nat. (4), x., 1858, p. 49-110  
Haswell, Proc. Linn. Soc. N.S.W., x., 1886, p. 331.

Since it has become usual to include *Phoronis* in works on Gephyrea, the two following references may not be out of place.

PHORONIS AUSTRALIS, *Haswell*.

*P. australis*, Haswell, *Loc. cit.*, vii., 1883, p. 606; Benham, Quart. Journ. Micro. Sci., xxx., 1889, pp. 125-158.

PHORONIS PSAMMOPHYLA, *Cori. ?*

*P. psammophyla*, Cori., Zeits. Wiss. Zool., li., 1891, pp. 480-568; Haswell, *Loc. cit.*, (2), vii., 1892, p. 341.

## OCCASIONAL NOTES.

### I.—THE *TAVAU*—OR COIL FEATHER MONEY OF SANTA CRUZ.

In connection with this interesting object lately described,<sup>1</sup> Prof. H. H. Giglioli writes me as follows—"Firenzi, 31st July, 1902—We have in the Museum here a sample of the interesting feather-money of Santa Cruz, Indengi, or Nitendi Island. It is a sort of ribbon of plaited vegetable flat stripes (mat work) covered on outside with the red feathers of *Trichoglossus massena*. On the label received was written St. Bartholomew Island, and it was described as a woman's ornament, which I think are both mistakes. There is, however, a query; Edge-Partington describes the specimen he figures in his "Ethnological Album" as a "strip of wood," this our specimen certainly is not. The specimen we have is the only one I have seen, and I have visited nearly all the Ethnological Museums in Europe." The example in the Florence Zoological Museum of Vertebrata will thus form the fourth I am able to record, and like that in this Museum does not seem to consist of a "strip of wood."

R. ETHERIDGE.

### II—*CHERSYDRUS GRANULATUS*, SCHNEIDER,

#### A SNAKE NEW TO AUSTRALIA.

By the kindness of Mr. P. G. Black the Trustees have received an example of *Chersydrus granulatus* Schneider, a marine and estuarine Aglyphous Snake, not before recorded for the continent. It was obtained in the Cooktown district, Northern Queensland and was previously known from Southern India, Burma, the Malay Peninsula and Archipelago, and New Guinea.

EDGAR R. WAITE.

<sup>1</sup> Etheridge—Rec. Aust. Mus., iv., 7, 1902, p. 289.

ON THE OCCURRENCE OF A LITUITEAN IN THE UPPER  
SILURIAN ROCKS OF BOWNING, NEW SOUTH  
WALES.

By R. ETHERIDGE, Junr., Curator.

(Plate viii.)

Mr. John Mitchell, Resident Teacher of the Technical College, Newcastle, brought under my notice two specimens of a Cephalopod. from the Upper Silurian of Bowning, that appear to possess characters relegating them to the Lituitidæ. One of these is more or less wholly compressed, the other is partly so and partly still preserved in the round, the latter portion being about one half the youngest remaining whorl. The wholly compressed example Mr. Mitchell has been good enough to present to the Trustees of the Australian Museum.

The late Prof. A. Hyatt included<sup>1</sup> in the Lituitidæ the following genera :—*Cyclolituities*, Remelé; *Lituities*, Breynius; *Angelinoceras*, Hyatt; *Ancistroceras*, Boll; *Rhyncorthoceras*<sup>2</sup>, Remelé; and *Holmiceras*, Hyatt.

As Hyatt's paper is not readily accessible, and with a view of showing how these genera differ from one another, the following abbreviated characters, taken from his descriptions, are appended :—

1. *Cyclolituities*, Remelé.—Whorls touching until a late ephebic stage; living chamber free only in part; section round or a compressed oval ellipse; hyponomic sinus deep and narrow; abdominal crests blunt; lateral sinuses present; dorsum occupied by a crest (?), and with an impressed zone.

2. *Lituities*, Breynius.—Whorls in contact for between three and four volutions; living chamber more or less straight; hyponomic sinus deep; lateral sinuses two, shallow; dorsum with a deep sinus; crests and sinuses well pronounced; coiled whorls costate.

3. *Angelinoceras*, Hyatt<sup>3</sup>.—Whorls open and coiled for about three volutions, attenuated and compressed; outstretched free

---

<sup>1</sup> Hyatt—Proc. Amer. Phil. Soc., xxxii., 143, 3 L, 1894, p. 505.

<sup>2</sup> Hyatt spelt this name in two ways—*Rhyncorthoceras* and *Rhynchorthoceras*, (*loc. cit.*, p.p. 511 and 512.)

<sup>3</sup> Hyatt—Proc. Amer. Phil. Soc., xxxii., 143, 3 L., 1894, p. 508.

whorls present in the older stages; ventral sinuses deep more or less; lateral sinuses near the dorsum deep more or less; crests at the abdominal angles and on the dorsum.

4. *Ancistroceras*, Boll. (= *Strombolituites*, Remelé<sup>4</sup>).—Spiral closed for from one to one and a half, or two whorls; section compressed elliptical to more or less quadrangular; outstretched free whorl circular; a ventral and two lateral sinuses present; dorsum occupied by a broad low crest.

5. *Rhyncorthoceras*, Remelé (= *Rhyncoceras*, Remelé).—Completely uncoiled in the young stage, the apex simply curved, not coiled; ventral and dorsal crests and lateral lobes low and broad.

6. *Holmiceras*, Hyatt<sup>5</sup>.—Whorls enrolled, open and discoidal. There are four major sinuses as in *Lituites*, but no median dorsal crest; ventral sinus shallow; ventro-lateral crests two, narrow; lateral sinuses shallow; dorsal sinus slight.

In referring the fossils now under description to *Cyclolituites*, I have been forced to rely on Prof. Hyatt's paper, the other memoirs dealing with the Lituitidæ being inaccessible to me, with the exception of two of Mr. Remelé's.

The Bowring petrifications consist of coiled portions in one plane (Pl. viii., figs. 1 and 2) with the whorls in close contact, but without a gerontic free termination; one specimen displays four whorls, the other five. The former is entirely compressed, but there are still visible faint costæ on a portion of the last whorl preserved; these are obliquely concave forwards. On the latter of the two specimens the whorls are also compressed, with the exception of about half the last volution, and this is fortunately retained in the round. The cross section of this portion is reniform with a rather shallow contact furrow<sup>6</sup>; the venter and lateral portions are rounded, and the siphuncle is large and practically central.

On the venter the costæ describe deep, narrow and acute hyponomic angles, thence passing forwards laterally in gentle convex curves to the sub-acute edges of the contact furrow, but in the latter the course of the lines of growth are quite hidden by a crust of irremovable matrix. The intercostal spaces have a width of approximately three millimetres, and bear delicate striæ having the same direction of curvature.

The curvature of the costæ and lines of growth is so very regular and continuous that it is difficult to differentiate between sinuses and lobes, but there does appear to be a slight inflection of the curvature immediately before reaching the subacute edges of the impressed zone of the dorsum; on crossing these angles

<sup>4</sup> Remelé—Zeit. Deuts. Geol. Gesellsch., xxxii., 1881, p. 190; *ibid.*, xxxiv., 1882, p. 116.

<sup>5</sup> Hyatt—Proc. Amer. Phil. Soc., xxxii., 143, 3 L, 1894, p. 512.

<sup>6</sup> Hyatt—*Loc. cit.*, diagram pl., f. B".

they become lost as already explained. The wholly compressed specimen shows distinct traces of numerous regular septal sutures, one millimetre apart.

The acute angle formed by the costæ and lines of growth on the venter, representing the hyponomic sinus, except that the former are much stronger, closely resemble those on a shell termed by Mr. E. de Verneuil and Comte A. de Keyserling *Lituites cornuarietis*, J. Sby<sup>7</sup>, from the Lower Silurian limestones of the neighbourhood of Reval, Russia.

This hyponomic sinus is far more acute than that of Mr. F. Noetling's figure<sup>8</sup> of *L. lituus*, De Montfort. The inflections of the lines of growth certainly indicate a less number of crests and sinuses than that seen in *Ancistroceras*, Boll, irrespective of the different direction and angles of the latter<sup>9</sup>.

Hyatt says<sup>10</sup> that the "crest and sinuses are very much more pronounced in *Lituites*<sup>11</sup>, and the enrolled portion of the whorl is continued longer and is more closely coiled, the whorls being in contact for between three and four volutions." One sinus in the Bowning fossils, the hyponomic, is very pronounced, and the whorls numerous, at least five and in close contact; hence an approach to *Lituites*, but the free and straight portion of the living chamber is not preserved in either example.

Two of the, at first sight, more important characters of *Cyclolituities*, are the "whorls touching until a late ephebic stage," and no "genus of this family except *Cyclolituities* has an impressed zone<sup>12</sup>." Both of these conditions are fulfilled by our specimens. They are quite unlike the Rhyncorthoceran forms with uncoiled whorls.

The evident resemblance of Mr. Mitchell's fossils to *Cyclolituities*, particularly the two last characters referred to, and the absence of other features to the contrary emboldens me to refer them to that genus under the name of *C. bowningensis*. *Cyclolituities* is an Ordovician genus, but if my determination stands the test of further discoveries, we now find it occurring in the Upper Silurian, to which we have been in the habit of referring the Bowning beds.

<sup>7</sup> De Verneuil & Keyserling—Murchison's Geol. Russia in Europe, ii., 1845, pl. xxv., f. 7b.

<sup>8</sup> Noetling—Zeit. Deuts. Geol. Gesellsch., xxxiv., 1882, pl. xi.

<sup>9</sup> Remelé—Zeit. Deuts. Geol. Gesellsch., xxxiv., 1882, pl. v, f. 1-5.

<sup>10</sup> Hyatt—Proc. Amer. Phil. Soc., xxxii., 143, 3 L., 1894, p. 507.

<sup>11</sup> Than in the other genera of the family.

<sup>12</sup> Hyatt—Proc. Amer. Phil. Soc., xxxii., 143, 3 L., 1894, p. 504.

## A NEW "BAT TICK."

By W. J. RAINBOW, F.L.S., F.E.S., Entomologist.

(Plate ix.)

During his recent visit to the Gulf of Carpentaria, my Colleague, Mr. C. Hedley, collected some Flying Foxes. These were duly handed to Mr. Edgar R. Waite, who identified them as *Pteropus gouldi*, Peters, and in the cloths in which they were packed, discovered a specimen of *Nycteribia*, Latr. Subsequently I made careful examination of all the flying foxes obtained, with the result that three other specimens of the parasite were brought to light.

In a former number of the "Records of the Australian Museum," the late Mr. F. A. A. Skuse published a paper entitled "Description of a New Flea (*Stephanocircus dasypuri*) from New South Wales; with Notes on some other Insect Parasites known in Australia,"<sup>1</sup> in which he said in respect of the family Nycteribidæ (Wingless "Bat Ticks")—"Some species known, but none yet described from Australia."<sup>2</sup> In the interval that has elapsed since the publication of Skuse's paper, two or three genera and a number of species have been described from different parts of the world, but none from this continent. The most elaborate paper yet published on the genus *Nycteribia* is that by J. O. Westwood—"On *Nycteribia*, a Genus of Wingless Insects,"<sup>3</sup> and to this memoir the reader is referred.

The specimens collected are described below.

### Family NYCTERIBIDÆ.

#### NYCTERIBIA PTEROPUS,<sup>4</sup> *sp. nov.*

Male 4.7 mm. long.

*Thorax*.—Above: pale, nearly white; the groove in which the head rests when thrown back, dark brown; ventral surface mahogany brown, shining, finely granulated, flat; in front and between anterior and intermediate legs, the pectinated process peculiar to these insects, is prominent and dark brown; each pectino has fourteen teeth.

<sup>1</sup> Skuse—Rec. Aust. Mus., ii., 5, 1893, p. 77.

<sup>2</sup> Skuse—*Loc. cit.*, p. 80.

<sup>3</sup> Westwood—Trans. Zool. Soc., i., 1835, pp. 275-294, pl. 36.

<sup>4</sup> So named in reference to its host.



*Caput.*—Dark brown; the lateral elongated organs strongly setose; antennæ minute; upper margin of head furnished with setæ, the remainder smooth and depressed.

*Legs.*—Long, bristly. *Coxæ* and *trochanters* yellowish; each *femur* concolorous as far as the transverse impressions near the middle, thence dark brown; *tibiæ* dark brown with three oblique white bands; *metatarsi* long, dark brown, annulated; first three *tarsal joints* short, the terminal one long, and furnished with a pair of large *pulvilli*, and two strong curved claws.

*Abdomen.*—Dark brown, with six articulations, nearly black, oblong, finely and sparingly granulated, and moderately clothed with long bristles; on the underside the first abdominal articulation is armed with a row of obtusely pointed teeth or spines.

One specimen.

Female gravid forms 4·7 mm.; normal 3·6 mm.

*Thorax, caput* and *legs* similar to the male.

*Abdomen.*—In gravid forms oval, convex, and very slightly contracted behind the basal articulation; integument of upper surface yellowish-brown, granulated and naked, except at posterior extremity where there are lateral and apical tufts of long coarse bristles; there are also four rather large tubercles at the middle, arranged in pairs, and again on each side, equally as large, but wide apart, three more; the underside is similar in colour and granulation, but is clothed with short scale-like, adpressed hairs; there is also an anal pectinated process present; the first abdominal articulation as in the male form. In the unimpregnated female the abdomen is smaller than that of gravid examples, and also owing to not being distended, is apparently much darker.

Three specimens—two gravid, and one normal.

*Obs.*—There are in the Museum Collection some specimens of *Nycteribia* taken from *Pteropus*, and these were collected many years ago by Mr. G. Masters, at King George's Sound, W. Australia. They have, however, been mounted on card, and are much shrunken, and therefore unsuitable for accurate determination or description. They are much smaller than the form described above, much lighter in colour, and apparently otherwise distinct.

*Loc.*—Mapoon Mission Station, mouth of Batavia River, Gulf of Carpentaria.

A REMARKABLE ROCK-SHELTER IN THE MILTON  
DISTRICT, NEW SOUTH WALES.

---

By R. ETHERIDGE, Junr., Curator.

---

(Figs. 8-13.)

---

The geographical distribution of the once frequented Rock-Shelters, with their pictographs, the petroglyphs or Rock-Carvings, so plentifully scattered throughout our metropolitan coastal area, and the more widely distributed arborglyphs, or Carved-trees, are amongst the few remaining subjects of investigation relating to our almost totally extinct Aborigines, left to us.

Through the interest taken in the study of these remains by Inspector E. Milne, of the Railway Department, Goulburn, and Capt. James Cork, J.P., of Milton, and under their guidance, I was able, by instruction of the Trustees, during February last, to pay a visit to a fine example of a Cave-Shelter situated on a branch of Coal Creek, in the parish of Little Forest, Co. St. Vincent. Coal Creek flows into Lake Conjola, a salt water sea lagoon, a short distance to the north of Milton.

There are three Shelters on this branch creek, within a short distance of one another. The principal opening is situated near its head, at a point where the scarp of Hawkesbury Sandstone is but a few feet above the level of the water course, and on its west bank. On the east bank, but somewhat lower down, are two smaller cavities, also containing pictographs.

The principal Shelter has been known for twenty-two years, and was discovered by Messrs. A. Cork and F. White when on a shooting excursion. After a lapse of fifteen years, a search was again made for it by Messrs. Milne and White, without success, but subsequently Capt. J. Cork, Inspector Milne and Mr. J. Higgins succeeded in locating it. The difficulty in fixing the exact spot arose from the extremely rugged and scrubby nature of the locality, typical coast brush country. There is still living in the Uladulla Aborigines Camp an old full-blooded black, known as "Berrima Jim," who was "made a man" at the last

Bora ceremony held in the Milton District, about forty years ago, and when questioned about this Shelter and its pictographs, he knew nothing of them, or professed not to, as the case may be.

The opening is one hundred and thirty feet long, fourteen feet in depth from the overhanging hrow to the innermost recess, and at about the entrance is nine feet from floor to ceiling, shelving inwards. The floor is formed by a wide sandstone bench, extending nearly the whole length of the Shelter, and on this there is a widely-spread fire refuse heap, consisting of very fine greyish coloured dust, containing fragments of burnt bones and a few stone chips; at the point we excavated this bed was one foot in thickness. Outside the Shelter, at the upper end, is a block of stone with several good examples of tomahawk-head rubbing grooves.

The back of the Shelter is broken up into a series of retiring narrow vertical faces, and on these the pictographs are delineated, but now all are faint, and, excepting a few, are decipherable with difficulty. The principal group seems, so far as we could decipher it, to represent a corroboree, and extends for a distance of twenty-six feet. The figures are small compared with some I have seen in shelters on other parts of our coast.

The more important objects delineated are numerous conventional outlines of the human form, some (males) in the position known as the "corroboree jump" (fig. 8.), the arms elevated above the head and the legs drawn up, and a particularly good outline of a female figure, with the characteristically attenuated lower limbs. There is a good representation of a dog, the three-pointed figure usually ascribed to that of an Emu foot, and numerous outlines of conventional animals that it is impossible to suggest names for. In all, the drawings extend over a length of sixty feet, the corroboree group, or the assemblage we took to represent such, alone reaching a length of twenty-six feet. The wide geographical

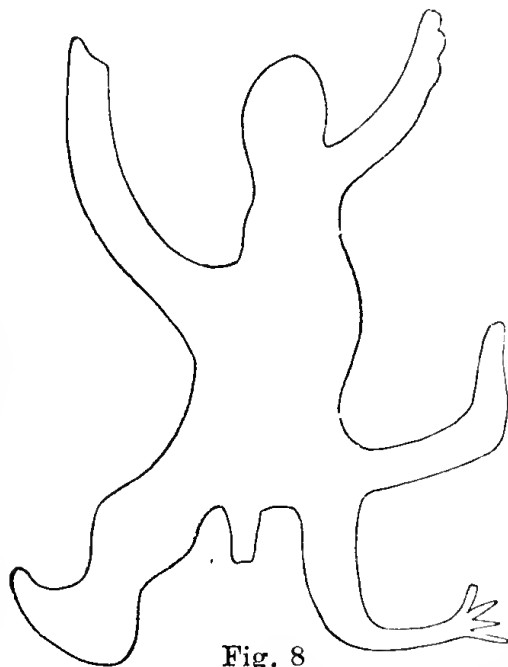

Fig. 8

distribution of the Emu foot design is shown by the fact of its discovery, amongst many other instances, by Mr. R. Helms,

during the progress of the Elder Exploring Expedition in 1891, at Arcolillinna Wells, eighty miles east of the Everard Ranges. It is there delineated in red on the walls of a Rock-Shelter.<sup>1</sup> Again, it is a frequent petroglyph on the so-called phallic conical stones met with throughout the sandy wastes of Western New South Wales.<sup>2</sup>

Prominent amongst the representations is an elongated worm or eel-like object (fig. 9.), with a long body and sagittate head, or a

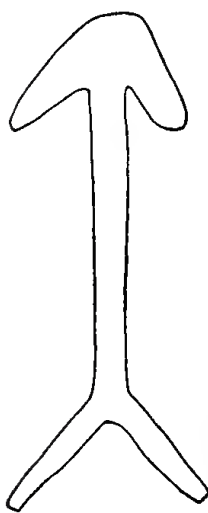

Fig. 9.

double sagittate head (fig. 10.). One of the latter is nine inches long and five inches across the barbed head. Another figure appears to represent a double more or less heart-shaped body, fifteen inches in height by sixteen inches in breadth (fig. 11.). I think this is intended for a very highly conventionalised human male figure, for at the top of the central double line is an oval outline, possibly intended for a head, and from it proceed two v-shaped prolongations that may be arms conjoined to two other upwardly curved outlines from the base representing legs. Another figure, certainly a male, is provided with a remarkably slender body, the arms

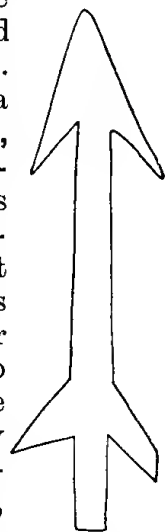

Fig. 10.

upwardly spread, one with three finger-like terminations, the other with only one, and the legs spread horizontally at right angles to the body (fig. 12.); this figure is eleven inches in height and ten inches across the spread legs. Fig. 13 represents another object depicted in this shelter; I am not able to offer any solution of it.

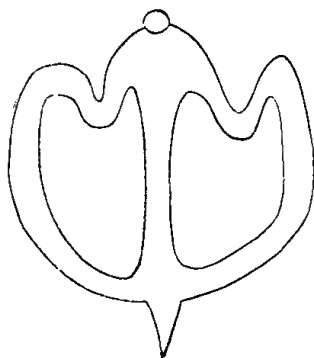

Fig. 11.

Some of the pictographs are in black outline only, others similarly delineated but infilled with white, and others again in red only, such as the Emu feet. Here and there one of the red figures is defined by a black outline, but none, so far as my observation went, in black splash work alone. Strange to say, no trace of the open hand, either black or red, nor of foot imprints could be found.

<sup>1</sup> Helms—Trans. Roy. Soc. S. Austr., xvi., 3, 1896, p. 261, pl. ix.

<sup>2</sup> Harper—Proc. Linn. Soc. N.S. Wales, xxiii., 3, 1898, p. 420 ; Williams—*Ibid*, xxvi., 4, 1901, p. 515.

The representation of the human foot is met with both in our pictographs and petroglyphs. The former was excellently figured by Mr. P. T. Hammond amongst the drawings

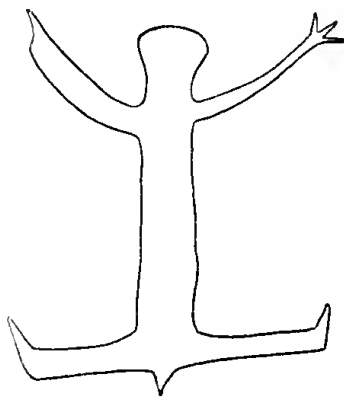

Fig. 12.

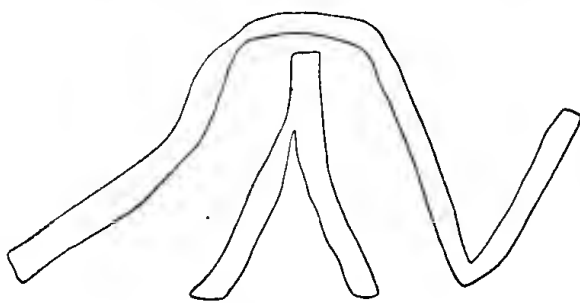

Fig. 13.

taken in a large Rock-Shelter on Wollombi Creek, Hunter River District,<sup>3</sup> and the latter was recorded by myself from the Cockle Creek group of petroglyphs, Cowan Creek, a branch of the lower Hawkesbury River.<sup>4</sup>

The first smaller Shelter down the creek and on its east side, discovered some years ago by Inspector Milne and Capt. Cork, is very much higher up on the steep creek bank. The size of this recess is limited, and the drawings are again on the narrow vertical rock faces at the back of the opening. There is a remarkably well drawn "Iguana," three feet long, two well executed, although small, boomerangs of the "come-back" type, and a large object on the roof, possibly representing a whale. The mouth of the latter is open and heavily toothed, with a large flipper protruding from one side. It is not to be overlooked that the sable artist who drew these pictographs formed one of a community of Coast Blacks, so there is nothing improbable in this figure being meant for that of a whale, and from the presence of teeth in the mouth, it is not unlikely that the Sperm Whale (*Physeter macrocephalus*, Shaw) is intended. This giant is at times met with on our coast, the Museum containing the skeleton, fifty feet long, of one stranded on the not far distant shore of Wollongong. The Iguana is black banded, and may be intended to represent *Varanus varius*, Shaw. Not the least interesting amongst this set of figures, is the outline of a very small shield of the same type as that figured by Professor T. W. E.

<sup>3</sup> Hammond—Rec. Geol. Surv. N.S. Wales, ii., 4, 1892, pl. xv.

<sup>4</sup> Etheridge—Rec. Geol. Surv. N.S. Wales, iv., 2, 1894, pl. ix., f. 13 *a* and *b*. Other petroglyphic representations of the human foot will be found throughout Mr. W. D. Campbell's "Aboriginal Carvings of Port Jackson and Broken Bay" (*Mem. Geol. Survey N.S. Wales, Ethnol. Series, No. 1, 1899.*) To those interested in this subject, I cannot do better than recommend a perusal of this exhaustive work.

David and myself, found on a promontory of Hawkesbury Sandstone, near Forty Baskets Bay, North Harbour, Port Jackson,<sup>5</sup> and again by Mr. G. H. Barrow and myself at the head of Bantry Bay, Middle Harbour, Port Jackson.<sup>6</sup> A similar type of shield was also met with in the group of petroglyphs at Flat Rocks, near Manly.<sup>7</sup> On the roof is also delineated an undoubtedly phallic object—a rudely executed penis and scrotum. The superior execution of the drawings in this Shelter suggests that the draftsman was not identical with the depicter of the figures in the larger Shelter. The drawings are all in black outline.

The second smaller Shelter, found by Inspector Milne during our visit, is still lower down the creek, but in a similar position to the last. The figures in this instance are either in black outline, infilled with white, or in white or red alone, of the last colour is again the Emu foot.

Not the slightest doubt exists that the pictographs in these Shelters are the work of Aboriginal artists. No trace whatever of "touching up" is visible, similar to that seen in the large recess on Harris' Creek, a tributary of George River, near Liverpool, explored by Dr. J. C. Cox and myself some years ago.<sup>8</sup>

A more primitive form of the eel-like figure, already referred to, was observed in the group at Flat Rocks, near Manly,<sup>9</sup> and regarded by Dr. A. Carrol as a Catfish.<sup>10</sup> In the latter instance, the petroglyphs were very much larger, without either the fish-tail end or double barbed appendages.<sup>11</sup>

Whales are often represented in rock carving groups throughout the metropolitan area, and several illustrations will be found in Mr. Campbell's Monograph already mentioned, but I had not previously seen a representation of a toothed whale.

I did not notice in the Coal Creek pictographs of the human form the peculiar angulation of the knee and elbow joints that

<sup>5</sup> David & Etheridge—*Rec. Geol. Surv. N.S. Wales*, i., 2, 1889, p. 144 pl. xxi.

<sup>6</sup> Etheridge—*Ibid*, ii., 1, 1890, p. 29, pl. ii., f. 8 and 9.

<sup>7</sup> Etheridge—*Ibid*, ii., 4, 1892, pl. xvi., f. 4.

<sup>8</sup> Etheridge—*Ibid*, i., 2, 1889, p. 146.

<sup>9</sup> Etheridge—*Ibid*, ii., 4, 1892, pl. xvi., f. 9 *b-e*.

<sup>10</sup> Carrol—*Centennial Mag.*, i, No. 3, p. 193, f. 7.

<sup>11</sup> In a very interesting Cave-Shelter on Pigeon Creek, between Tenthill and Pilton, Queensland, Mr. Henry Tryon found many petroglyphs closely resembling this "cat-fish" (?), both single and double barbed; this shelter contains a very remarkable series of petroglyphs. (*Proc. Roy. Soc. Q'land*, i., 2, 1884, pl. xi., f. 2).

## A REMARKABLE ROCK SHELTER IN THE MILTON DISTRICT—ETHERIDGE. 11

forms so conspicuous a feature on some of the petroglyphic figures around Port Jackson, for instance those forming a portion of the group above Bantry Bay, at Flat Rocks, or on the low headland east of Point Piper. Nor is there any trace of eyes as represented in the human figure at the last-named locality,<sup>12</sup> or above Cockle Creek, Cowan.<sup>13</sup>

Possible explanations of some of the pictographs and petroglyphs have been given by Dr. Carrol<sup>14</sup> and myself,<sup>15</sup> and by inference the same may be applied to the drawings at Coal Creek and other similar localities.

---

<sup>12</sup> Etheridge—*Rec. Geol. Surv. N.S. Wales*, iii., 3, 1893, pl. xv., f. 11.

<sup>13</sup> Etheridge—*Loc. cit.*, iv., 2, 1894, pl. ix., f. 15.

<sup>14</sup> Carrol—*Centennial Mag.*, i., Nos. 1 and 2, pp. 53 and 89.

<sup>15</sup> Etheridge—*Rec. Geol. Surv. N.S. Wales*, ii., 1, 1890, p. 34; iii., 3, 1893, pp. 82-85; iv., 2, 1894, p. 59.

ADDITIONS TO THE MARINE MOLLUSCAN FAUNA  
OF NEW ZEALAND.

---

By CHARLES HEDLEY, Conchologist.

---

(Figs. 14-25.)

An interesting parcel of raw dredgings and beach gatherings from the coast of New Zealand was received from Mr. Augustus Hamilton, Registrar of the University of Otago.

In presenting this material to the Trustees of the Australian Museum, Mr Hamilton expressed a wish that any novelties contained should be published. Hence the present article.

The Mollusca of New Zealand are difficult to identify because many species are still unfigured, of many the published definitions are insufficient for recognition and some appear to have been assigned to wrong genera. The collection here discussed contains several shells which I have been unable to place among named species, but which I refrain from publishing, lest by doing so existing names should be duplicated.

In the discovery of genera, either new to science or to New Zealand, I have felt on firmer ground.

On surveying the whole series it is evident that the fauna of the continental shelf of New Zealand is practically unknown. It also appears that the element common to New Zealand and Australia, hitherto calculated on the beach fauna, will be dis-



proportionately increased when the fauna of the continental shelf is taken into consideration.

I have to gratefully acknowledge valuable advice received from Mr. Henry Suter in relation to this subject.

PLEURODON MAORIANUS,<sup>1</sup> *sp. nov.*

(Fig. 14.)

Shell rather large for the genus, inflated, oval, very oblique, smooth or with a few incremental striae, umbo submedian.

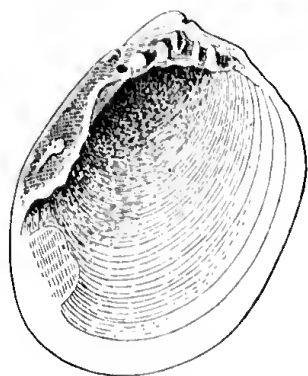
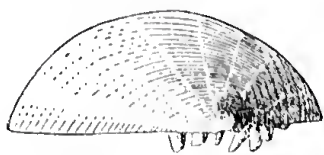

Cardinal teeth, six; the first of the anterior series slender, the others erect and stout. The cardinal plate broad, undulate below, posteriorly produced in a long and broad lateral tooth, having distally a subsidiary tubercle. Length 2.5; height 3.25; diameter 1 mm.

The present is the first record of the genus in Australasia; the species nearest approaches the African shell figured and described by Smith under the name of *Nuculina oralis*.<sup>2</sup>

Two valves (one presented to the Trustees) from 5 fathoms off Anchor Island, Dusky Sound, New Zealand

Fig. 14.

CYCLOPECTEN AVICULOIDES, *Smith*.

*Pecten aviculoides*, Smith, Chall. Rep., Zool., xiii., 1885, p. 305, pl. xxiii., f. 5, 5a.

A single specimen from Foveaux Straits answers exactly to the figure and description of Prince Edward Island examples. It adds a genus as well as a species to the New Zealand fauna.

CUNA DELTA, *Tate and May*, *sp.*

*Carditella delta*, Tate and May, Proc. Linn. Soc. N.S. Wales, xxvi., 1901, p. 434, pl. xxvii., f. 100, 101.

A series from Foveaux Straits and a couple from Dusky Sound are rather larger than Australian examples.<sup>3</sup> This record adds a genus as well as a species to New Zealand.

<sup>1</sup> Native of New Zealand.

<sup>2</sup> Smith—Chall. Rep., Zool., xiii., 1885, p. 230, pl. xix., f. 1-1b.

<sup>3</sup> Dr. J. G. Jeffreys stated (*Ann. Mag. Nat. Hist.* (3), v., 1860, p. 200.) that some British shells diminish in size when they range into the Mediterranean.

VERTICIPRONUS,<sup>4</sup> *gen. nov.*

A genus of the Carditidæ; valve small, smooth, capped by a flat prodissoconch; in each valve a single prominent cardinal and two distant posterior teeth.

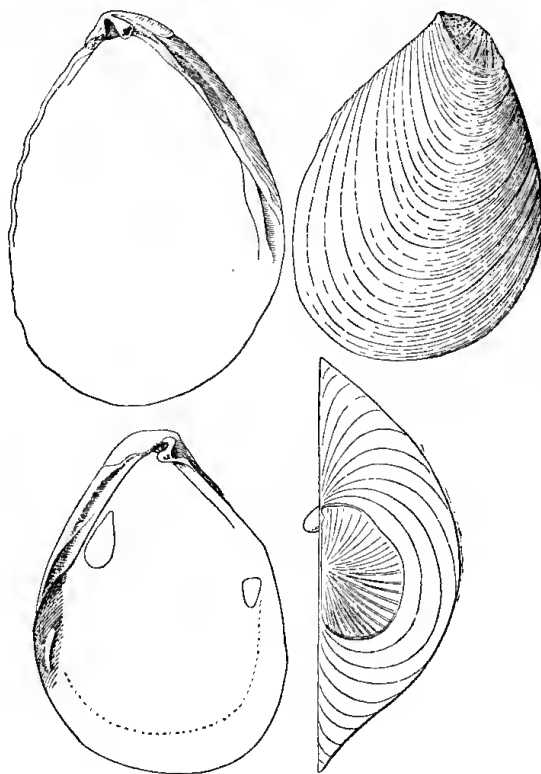

*Type.*—*V. mytilus.*

It is with much doubt that this strange little shell is referred to the Carditidæ, from the other members of which the prodissoconch, dentition and lack of radial sculpture distinguish it. The prodissoconch alone suggested such genera as *Condylocardia* or *Philobrya*. From either the relation of the ligament to the hinge effectually sever it.

Fig. 15.

VERTICIPRONUS MYTILUS,<sup>5</sup> *sp. nov.*

(Fig. 15.)

Shell small, rather solid, mytili-form equivalent, inequilateral, the anterior side longest, non-nacreous, smooth, except for faint growth lines, polished. Colour russet to fawn. Beak terminal, obliquely truncate, capped by a flat, subtrigonal, radially wrinkled, prodissoconch whose edges do not project. Lunule minute, indistinct. In each valve under the umbo, a single prominent cardinal tooth and deep socket, and at the posterior angle two oblique successive lamelliform lateral teeth. Interior ventral margin not crenulated. Pallial line entire, posterior adductor muscle high up, anterior small at about half the height of the shell.

<sup>4</sup> *Vertex-pronus*—Prone-topped.

<sup>5</sup> *Mytilus*—a mussel.

ADDITIONS TO THE MARINE MOLLUSCAN FAUNA OF N.Z.—HEDLEY. 15

Height, 2.3 mm.; length, 1.6 mm.; depth of single valve, 0.7 mm.

*Hab*—Lyall Bay, near Wellington.

HOCHSTETTERIA TRAPEZINA, *Bernard*.

*Hochstetteria trapezina*, Bernard, Journ. de Conch., xlv., 1897,  
p. 18, pl. i., f. 7.

*Myrina minuta*, Smith, Proc. Malacol. Soc., iii., 1898, p. 24, f. 4.

A good series from Lyall Bay and one valve from Foveaux Straits answer in every way to Bernard's admirable description. An authentic specimen of *M. minuta*, Smith, from Lyttleton received from Mr. Suter, proves that name to be a synonym. It is curious that so complete a description as Bernard gave, does not insure a species against immediate renomination.

TAPES FABAGELLA, *Deshayes*.

*Tapes fabagella*, Desh., Conch. Icon., xiv., 1864, pl. xxx., f. 66.

Though originally described<sup>6</sup> from New Zealand, this species has not been locally recognised and has finally been rejected<sup>7</sup> as exotic. It is therefore important to note that a gathering from Island Bay, Cooks Straits, contains a series inseparable specifically from Australian examples.

CADULUS SPRETUS, *Tate and May*.

*Cadulus spretus*, Tate and May, Proc. Linn. Soc. N.S. Wales,  
xxvi., 1901, p. 420, pl. xxv., f. 52.

Two specimens from five fathoms off Anchor Island, Dusky Sound, add a species and a genus to the New Zealand fauna.

SCHISMOPE BEDDOMEI, *Petterd*.

*Schismope beddomei*, Tate and May, Proc. Linn. Soc. N.S. Wales,  
xxvi., 1901, p. 407, pl. xxiv., f. 24.

A specimen from Foveaux Straits appears to be indistinguishable from Australian examples. This species and genus have not been previously recorded from New Zealand.

<sup>6</sup> Deshayes—Proc. Zool. Soc., 1853, (1854), p. 10.

<sup>7</sup> Suter—Trans. N.Z. Inst., xxxiv., 1901, (1902), p. 222.

SCHISMOPE BREVIS,<sup>8</sup> *sp. nov.*

(Fig. 16.)

Shell turbinate, openly perforate, solid. Colour white. Whorls three, tabulate above, rounded below, last rapidly descending.

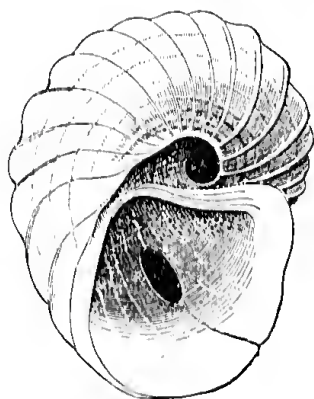
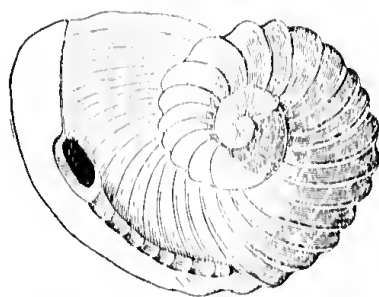
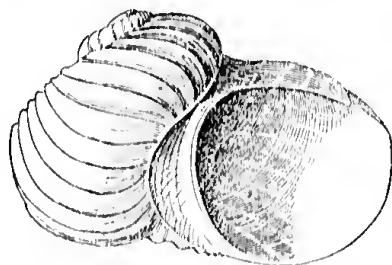

Protoconch of a whorl and a half, concluding with a prominent varix. Sculpture: distant longitudinal lamellate ribs cross the whorl from the suture to the umbilicus, their interstices contain raised spiral threads which grow coarser on approaching the umbilicus. Foramen large, distant from the margin, to which a furrow joins it. Fasciole extremity short, terminating half a whorl behind the aperture, bordered by keels and traversed by lamellæ, which correspond to the longitudinal ribs. Umbilicus narrow, deep, bordered with a raised edge. Aperture subquadrate, peristome entire, simple. Height, 0.94 mm.; major diam. 1.14 mm.; minor diam. 0.9 mm.

*Hab.*—Lyll Bay, near Wellington.

Fig. 16.

SCISSURELLA ROSEA,<sup>9</sup> *sp. nov.*

(Fig. 17.)

Shell auriform, small, thin, translucent, narrowly perforate, spire slightly elevate. Colour, white with apex rose. Whorls

<sup>8</sup> *Brevis*—Short.

<sup>9</sup> *Roseus*—Rosy.

three, last spreading and flattened above, earlier rounded.

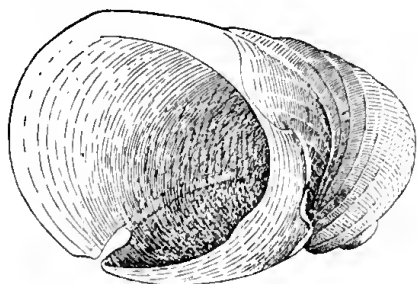

Fig. 17.

Protoconch delicately longitudinally ribbed. Slit deep, situated well above the periphery and leading to a fasciole which is not crossed by lamellae, but edged with low smooth keels and tapers to the termination half a whorl back. Sculpture: above close fine spiral threads, below sharp distant spiral keels, both crossed by faint growth lines.

Aperture large, oblique, oval; columella concave, broad, extending a median lobe over the steep and narrow umbilicus. Height, 1.2; major diam. 1.35; minor diam. 0.7 mm.

This species is associated with *Incisura lyttletonensis*, to which it has a deceitful resemblance, but from which it is separable by being smaller, less solid, with elevated and coloured apex. None of a considerable series of *Incisura lyttletonensis* before me present any trace of colour. The character "rosea vel albida" attributed to that species in the original description was, perhaps, derived from examples of *S. rosea*.

*Hab.*—Lyall Bay, New Zealand.

INCISURA,<sup>10</sup> *gen. nov.*

(Fig. 18.)

A genus of the Fissurellidæ, minute, spiral, smooth, with a slit on the right side. Type—*Scissurella lyttletonensis*, Smith.

When introducing this species Smith<sup>11</sup> laid stress on various eccentric characters, particularly the brevity of the slit and the

<sup>10</sup> *Incisura*—A cutting into, a slit.

<sup>11</sup> Smith—Proc. Malacol. Soc., i., 1894, p. 57, pl. vii, f. 1-2.

absence of keels on either side of it. Not merely *Scissurella* but

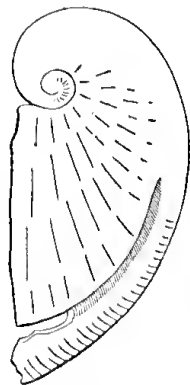
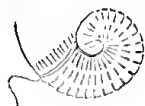
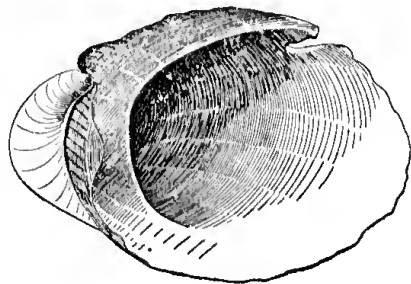

Fig. 18.

all its relations as distant as *Pleurotomaria*, have the slit fasciole edged on either side by an upturned rim. The absence of this is alone fatal to the ascription of the species in question to *Scissurella*. Other characters incompatible with *Scissurella* are the subterminal apex, the absence of spiral sculpture and the remarkable solidity of the shell. Judging from *Schismope* (which I have kept in captivity for weeks), *Scissurella* is as active a mollusc as any of the Trochidæ are. From the shell characters of *Incisura* I deduce it to be if not sessile, yet of sluggish habits. The broad hollow columella calls to mind that of *Naricella*, *Gundlachia* or *Zeidora* and indicates similar mode of life. The margins of the aperture are in one plane and present slight irregularities conformable to a base used as a constant perch.

If it be demonstrated that *l. lyttletonensis* cannot be included in *Scissurella*, the necessity arises of finding for it a more suitable place in classification.

I now advance the hypothesis that *Incisura* is a member of the Fissurellidæ, in which development has been arrested, the usual subsequent metamorphoses have not been enacted and the larval characters have persisted in adult life.

Boutan<sup>12</sup> has traced the development of *Fissurella reticulata* and found that the apical fissure has resorbed the young shell, and that in the part so lost the growing shell passes in succession through an "emarginuliform" and a "rimuliform" stage before reaching maturity. Of the former he writes—"Les larves de la Fissurelle, parvenues, en effet, à cette période de leur développements, présentent tous les caractères d'une Emarginule mais d'une Emarginule asymétrique." By virtue of its asymmetry,

<sup>12</sup> Boutan—Arch. Zool. Exper., 2) iii, bis, 1., 1885, p. 102, pl. xlii, f. 5.

*Incisura* exactly represents the stage which, for want of a better analogue, Boutan has figured and described as "Emarginuliform."

For proof of the above hypothesis I rely on the following facts. Those features in which *Incisura* disagrees with *Scissurella* are characters which knit it to the Fissurellidæ; namely the short slit, the absence of fringes to the slit, the solidity of the shell, the subterminal apex and the perching habit. In aged examples of *Incisura* the slit is interuallally margined with callus, a strikingly fissurelloid feature. Amongst the adult Fissurellidæ the lack of sculpture and the asymmetrical slit appear at first incongruous characters. The asymmetrical condition of the slit occurs, however in the fossil shell *Locotoma neocomiensis*, D'Orbigny,<sup>13</sup> sp.

I find the protoconch to be delicately radiately ribbed.

*Hab.*—This species is fairly common in shell sand from Lyall Bay.

PUNCTURELLA DEMISSA,<sup>14</sup> sp. nov.

(Fig. 19.)

Shell small, thin, but opaque, low arched, summit posterior, within the margin. Anterior slope gentle arched, posterior steep, straight. Nucleus persistent, set obliquely, exposing part of two spiral whorls. Colour white. Sculpture fine incremental threads, scarcely undulated by obsolete radial ribs. Aperture oblong, rather broader in front. Slit on the summit linear-lanceolate, more than three times longer than broad. The septum drawn down to a third of the length of the shell, completely screening the interior from the slit, thickened at the margin. Length 1·8, height 1·0, breadth 1·2 mm.

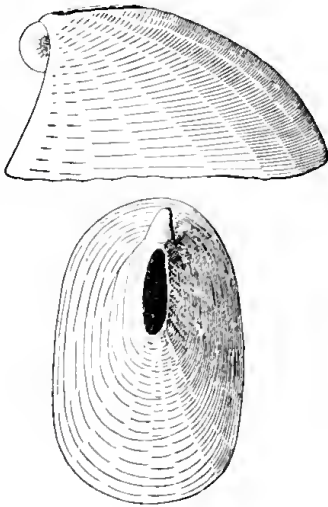

Fig. 19.

The comparative smoothness, persistent apex, narrow fissure and long septum, sufficiently characterise this minute species, which is the first of the genus to be recorded from New Zealand.<sup>15</sup>

*Hab.*—Foveaux Straits.

LIOTIA POLYPLEURA,<sup>16</sup> sp. nov.

(Fig. 20.)

Shell minute, thin, turbinate, widely umbilicate, spire slightly

<sup>13</sup> D'Orbigny—Pal. franç. Terr. Crét. ii., Gast., 1842. p. 392, pl. 234 f. 4.

<sup>14</sup> *Demissus*—Hanging down.

<sup>15</sup> Pilsbry conjectures (*Man. Conch.*, xii., 1890, p. 216) that *Fissurella rubiginosa*, Hutton, may prove to be a *Puncturella*.

<sup>16</sup> Πλεῖρον—A rib, and πολυς—many.

elevate. Colour white. Whorls three, loosely coiled. Sculpture: on the last whorl about sixteen thick, prominent ribs cross the whorl, slender on leaving the suture, they slant forward thickening rapidly, but turning they descend the periphery perpendicularly, on the base they again bend and tapering rapidly curve into the umbilicus, the margin of which they crenulate. The interstices are smooth. On the penultimate the ribs gradually vanish, the first whorl and a half is smooth. Aperture subquadrate, almost free, peristome formed by one of the ribs. Height 0.6 mm.; major diam. 0.9 mm.; minor diam. 0.7 mm.

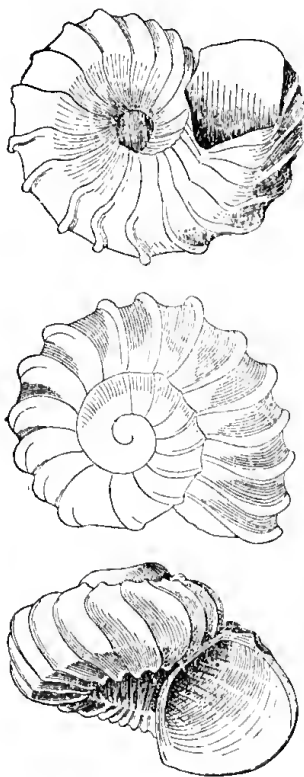

This species appears to be related to such Australian forms as *L. annulata*, Ten. Woods. The genus has not hitherto been known in New Zealand.

*Hab.*—Lyall Bay, near Wellington.

Fig. 20.

*CÆCUM DIGITULUM*,<sup>17</sup> *sp. nov.*

(Fig. 21.)

Shell small, smooth save for very slight growth lines, thin, opaque, dull, white, slightly curved, tapering rapidly. Aperture circular, slightly everted. Septum subnngulate. Length, 2.3; major diam., 0.5; minor diam., 0.3 mm.



The rapidity with which this species tapers is an unusual feature. The genus is an addition to the New Zealand fauna.

*Hab.*—Lyall Bay, near Wellington (type) and Foveaux Straits, (*A. Hamilton*); fossil in the Pliocene sands of Wanganni (*R. Murdoch*).

Fig. 21.

<sup>17</sup> *Digitulus*—A little finger.



COUTHOUYIA CORRUGATA,<sup>18</sup> *sp. nov.*

(Fig. 22.)

Shell fusiform, thin. Whorls four and a half, rounded, constricted at the sutures, last whorl finally free. Sculpture: numerous growth lines cross the whorl irregularly and assume the aspect of varices, the whorls are crossed by faint, shallow, close, spiral grooves. Aperture elliptical; peristome separated from the body whorl by a deep groove, thickened and reflected; columella broad and excavate. Length 2.58; breadth 1.55 mm.

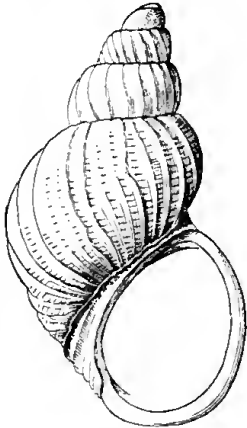

Fig. 22.

I submitted some specimens of this species to Mr. R. Murdoch of Wanganui, asking him to compare them with the fossil he described<sup>19</sup> as *Lacuna exilis*. His answer (6. v. 1903) is as follows:—"I have carefully compared them with my *L. exilis*. I consider them a distinct species. *L. exilis* has the aperture much more broadly ovate, the anterior end

of aperture not produced to any appreciable extent, the posterior angle of the aperture much more widely separated from the adjoining whorl, also the angle of the aperture is rather more oblique to the axis of the shell. The body whorl has an almost uniform course to the anterior end of the aperture, this and its considerable more inflated form gives to the shell quite a distinct appearance, more strongly marked when viewed from above. The whorls are also a little more rounded. I took micrometer-eyepiece measurements of the apertures of—

*Lacuna exilis.*    *Couthouyia gracilis.*    *New. sp.*

Greatest length	34	58	25
Breadth	26	37	16

The above are proportional figures. This does not include the thickness of the wall or the produced anterior end of the Foveaux Straits species, that is the small portion which is flatly expanded. The number of whorls and sculpture is practically the same in the new species as in *L. exilis*. It is much more indistinct in the fossil, and can only be seen with careful oblique illumination, which is due to its condition as a fossil and it escaped my notice when describing it. I have no doubt whatever that it belongs to *Couthouyia*."

*Hab.*—Foveaux Straits.

<sup>18</sup> *Corruogo*—To wrinkle up, corrugated.

<sup>19</sup> Murdoch—Trans. N.Z. Inst., xxxii., 1899, p. 220, pl. xx., f. 3.

## RISSEA SUTERI, sp. nov.

(Fig. 23.)

Shell small, ovate, imperforate, very solid, gradate. Colour white. Whorls four. Sculpture: the first and second whorls are smooth and rounded; the third is belted with two, the fourth with five broad spiral flat-topped bands, separated by deep sharp and equally broad interstices. The uppermost band of each whorl is the largest, thence to the base the others gradually diminish. Above the shoulder the concave surface slopes upwards to the suture, and a single small spiral thread interrupts this slope. Aperture oval, peristome much thickened, externally polygonal from the junction of the spiral ribs, internally duplicated by a small raised rim. Length, 1.78 mm.; breadth, 1.4 mm.

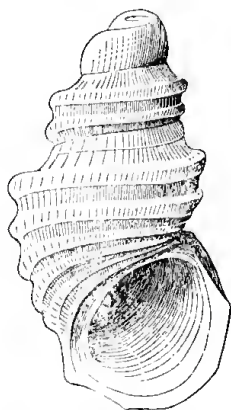

Fig. 23.

The heavy spiral sculpture sufficiently distinguishes this from the other New Zealand *Rissoea*. It is named in honour of Mr. Henry Suter, the well known New Zealand Conchologist.

*Hab.*—Foveaux Straits.

EULIMA PAXILLUS,<sup>20</sup> sp. nov.

(Fig. 24.)

Shell small, short, straight, sub-cylindrical with a blunt apex, thin, colourless, semi-transparent, smooth and glossy. Whorls six, flattened, impressed at the sutures. The base of each whorl, seen indistinctly through the substance of the next, appears as an impressed line beneath the sutures. Aperture pyriform, columella broad, right insertion of the peristome far back. Length, 2.9 mm.; breadth, 0.86 mm.

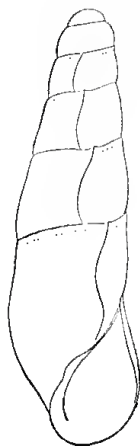

Fig. 24.

Mr. H. Suter informed me that this species is not known to him. None of the genus has before been reported from New Zealand.

<sup>20</sup> *Paxillus*—A little peg.

*LEIOSTRACA MURDOCHI*, *sp. nov.*

(Fig. 25.)

Shell small, sub-cylindrical, with blunt ends, thin, translucent, glossy. Whorls five, slightly tapering, last exceeding the rest. Colour: pale brown below, darkening to chocolate above; on the last whorl is a broad peripheral and a narrow subsutural colourless band, the latter of which also re-appears on the penultimate, and is overlined by a chocolate thread; the peristome and a patch on the centre of the base are also chocolate. The apex is colourless. Sculpture: none, and no varices are apparent. The umbilical region is impressed but not perforate. Aperture oval, everted anteriorly; peristome a little thickened and expanded, ends united by a curved callus on the body whorl. Length, 2.6 mm.; breadth, 0.9 mm.

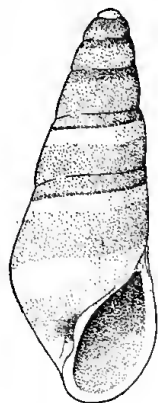

Fig. 25.

Mr. H. Suter informs me that he considers this species new. It is named in honour of Mr. R. Murdoch, of Wanganui, author of many valuable papers on the New Zealand Mollusca. *L. murdochi* is apparently the smallest of the genus and the first to be recorded from New Zealand.

*Hab.*—Foveaux Straits and Lyall Bay.

*MITROMORPHA SUBSTRIATA*, *Suter, sp.*

*Daphnella substriata*, Suter, Trans. N.Z. Inst., xxxi., 1899, p. 76, pl. iii., f. 6, 6a.

Specimens from the type locality, Foveaux Straits, and perhaps from the same parcel as the type, conform well to the figure and description. The transference of the species, which is indisputable, from *Daphnella* to *Mitromorpha*, adds a genus to the New Zealand fauna.

TRILOBITE REMAINS COLLECTED IN THE FLORENTINE VALLEY, WEST TASMANIA, BY MR. T. STEPHENS, M.A.

By R. ETHERIDGE, Junr., Curator.

(Plate x.)

Mr. T. Stephens, M.A., late Chief Inspector of Schools for Tasmania, recently presented to the Trustees some fragmentary fossils, chiefly Trilobite remains, from a new locality in that island. He informed me by letter that "the locality is the Florentine Valley. The river of that name is a tributary of the Derwent, the course of which is entirely through Permo-Carboniferous formations, but the Florentine itself runs through the eastern fringe of the Silurian country of West Tasmania, with its ancient limestones, conglomerates, quartzites, etc., the true relative position of which is still a matter of conjecture. While accompanying an exploring party last year towards the River Gordon, I noticed shales and sandstone likely to yield fossils, and you see the result."

The matrix is a yellow, slightly micaceous, somewhat fissile mudstone, and the organic remains are all preserved either as casts, or external impressions; in no instance is there any preservation of test. The remains are those of Trilobites and *Mellusca*, all fragmentary and badly preserved.

Amongst the former are a peculiar pygidium and an indistinct cephalon that seem to be referable to the genus *Dikelocephalus*. The pygidium is broad oval in outline, with a narrow tapering axis, consisting of seven segments and a terminal appendage, which does not reach the ventral border. The side lobes are flattened and each bears seven or eight pleural segments, which gradually curve downwards, more and more towards the posterior, until the last one is practically parallel to the axis, and the two above it nearly so. The ventral margin supports two caudal spines, lateral in position, opposite the outward terminations of the second pleural segments. The length of these spines cannot be accurately defined, but I believe them to have been short. Beneath the outer preserved layer is a wide and imbricately striate limb.

The resemblance of this pygidium to that of *Dikelocephalus minnesotensis*, D. D. Owen,<sup>1</sup> is very strong, but if the pleural

---

<sup>1</sup> D. D. Owen—Report Geol. Survey Wisconsin, Iowa and Minnesota, 1852, p. 574, atlas, pl. i., f. 1 and 2; Whitfield—Geol. Wisconsin, Survey of 1873-79, iv., 1882, pl. iii., f. 1.

segments in our fossil are in no way misplaced by distortion, they are decidedly more parallel to the axis than in the illustrations of the above species quoted below. A similar likeness may be noticed between the Tasmanian fossil and the British *D. furca*, Salter,<sup>2</sup> even to the short caudal spines. In *Dikelocephalus* the caudal margin is not always produced into spines, although in possessing these organs our fossil resembles the already described form from Tasmania *D. tasmanicus*, Eth. fil.,<sup>3</sup> but the characters of the axis and pleural segments are quite different in the two tails.

In passing, the close affinity borne by Mr. Stephens' fossil to a pygidium of a Norwegian Trilobite described by Angelin<sup>4</sup> as *Centropleura? dicæura* may be noted; the resemblance is even stronger than to *D. minnesotensis*. *Centropleura* was reduced to a synonym of *Dikelocephalus* by Salter,<sup>5</sup> and this step was acknowledged by Zittel,<sup>6</sup> but to whatever genus Angelin's species may ultimately be referred (in all probability to *Dikelocephalus*), there also will be the genus of the Tasmanian pygidium under discussion.

Another genus possessing a very similarly segmented pygidium is *Nesouretus*, Hicks,<sup>7</sup> from the Menavian beds of St. David's in South Wales. In this fossil, however, the caudal margin is entire, and not produced into spines. It is also worthy of remark that Mr. R. Etheridge has suggested<sup>8</sup> the transference of all Salter's British *Dikelocephali* to *Nesouretus*.

It is unfortunate that we do not possess the perfect cephalon of this Trilobite. There is one crushed head amongst the specimens, which, so far as it can be deciphered, has the appearance of that of *Dikelocephalus*. There are traces of a wide frontal border, with a small central nuero; certainly one, if not two, continuous furrows at the base of the crushed glabella, and traces of the ocular lobes, but the eyes are not preserved.

Poor as the material is, I feel sure in my own mind that we have here a second Tasmanian species of *Dikelocephalus*, and propose for it the name of *D. florentinensis*.<sup>9</sup>

Four other pygidiums are visible on some of the shale fragments differing very widely from that just described. They vary in outline from semi-circular (one specimen) to deltoid-triangular

<sup>2</sup> Salter—Mem. Geol. Surv. Gt. Brit., iii., 2nd Edit., 1881, pl. vi., f. 4, pl. viii., f. 10.

<sup>3</sup> Etheridge Junr.—Proc. Roy. Soc. Tas. for 1882 (1883), p. 155, pl. 1., f. 4.

<sup>4</sup> Angelin—Pal. Scandinavica, 1878, p. 88, pl. xli., f. 9.

<sup>5</sup> Salter—Mem. Geol. Surv. Gt. Brit., iii., 2nd Edit., 1881, p. 497.

<sup>6</sup> Zittel—Handb. Pal., i. Abth., ii. Bd., 1881-85, p. 596.

<sup>7</sup> Hicks—Quart. Journ. Geol. Soc., 1873, xxix., p. 44.

<sup>8</sup> Etheridge—Foss. Brit. Islands, i., 1888, p. 51.

<sup>9</sup> In allusion to the locality.

(three specimens), with a narrow and long axis extending to the inner limb margin, and consisting of at least nine segments. The lateral lobes are broad and apparently flat, with indistinct traces of pleural segmentation, and the limb is broad and continuous with numerous imbricating striæ. The probability is that the single tail displays the true outline, whilst the three deltoid-triangular pygidiums are distorted. Were it not for the uncertainty of the pleural segments these tails might represent an Asaphid of the *Basilicus tyrannus*, Murchison, group. On the other hand, the segmentation of the axis removes the specimens from the genus *Isotelus*. We may also dismiss *Ogygia* from consideration, and all Asaphids with a short axis in the pygidium. Could it be shown that the deltoid-triangular outline of the three specimens was a true feature in contra-distinction to the semi-circular outline of the single example, then a reference might be made, perhaps, to *Stygina* (e. g. *S. murchisonia*, Murchison), as this particular outline and condition of parts is sometimes met with in that genus—or even to *Megalaspis*, Angelin. I think, however, that all four are one species, and in consequence this line of argument is inadmissible.

In his paper on the St. David's fossils already quoted, Dr. H. Hicks described a *Niobe* from the Tremadoc beds of that neighbourhood as *N. menapiensis*,<sup>10</sup> in which the normal form of the pygidium is broadly semi-circular, and the distorted outline deltoid-triangular, as surmised in the present case. This particular species of *Niobe* has a more highly segmented pygidium than the typical British *N. homfrayi*, Salter, but not more so than some of the Scandinavian species described by Angelin.

If my surmise be correct that the deltoid-triangular pygidiums represent distorted tails of a *Niobe*, then in the fourth, or single pygidium, we see the more or less correct outline, and this will accord with the perfect condition of the caudal portion of *N. menapiensis*, Hicks. The only other satisfactory alternative would be to regard the three specimens as referable to *Megalaspis*, but under the circumstances, I do not think this tenable. One may even go a step further and suggest that the pygidiums from the Caroline Creek beds referred by me to *Asaphus*,<sup>11</sup> may really be referable to *Niobe* also.

The other organic remains from the Florentine Valley are in an unsatisfactory state of preservation. They comprise two impressions of a small Univalve, a *Tentaculites*, and numerous casts and external impressions of an *Orthis*. The small shell has

<sup>10</sup> Hicks—Quart. Journ. Geol. Soc., xxix., 1873, p. 46, pl. iv., f. 7-9.

<sup>11</sup> Etheridge Junr.—Proc. Roy. Soc. Tas. for 1882 (1883), pl. ii., f. 5-6.

the appearance of a *Bellerophon*, with for its size a large body whorl, and a deep telescopic umbilicus, but there is no evidence of a keel, and in its present state is indeterminable. The *Tentaculites* is also an impression, with close concentric sculpture.

The remains of the *Orthis* are plentiful, but always in the condition of casts or impressions. I have not been able to satisfactorily determine it, but I believe it is related to that form referred by Salter<sup>12</sup> and Davidson<sup>13</sup> to *O. lenticularis*, Wahl., of the Upper Lingula Flags. It is larger than the latter, and although more highly costate, the costæ still vary greatly in number. At the same time the outline closely resembles that of *O. lenticularis*, there is the same rather triangular sinus in the dorsal valve, bounded by prominent ribs, and this contains other well defined costæ; secondary ribs are also present between the primary. Our specimens are not allied to the Arenig *O. menapicæ*, Hicks, or the Menevian *O. hicksi*, Salter. The condition of preservation renders it most difficult to determine the species accurately, especially in so variable a genus as *Orthis*, and it is even possible that more than one form is present.

With regard to the important question of the age of the Florentine Valley mudstones, I shall confine my remarks simply to the Trilobite remains. In North America *Dikelocephalus* appears to be both an Upper Cambrian and a Lower Silurian (Quebec Group) genus,<sup>14</sup> but typically the former; in Britain it is essentially Upper Cambrian (Lingula Flags and Tremadoc).<sup>15</sup> *Nesouretus*, according to Hicks is an Upper Cambrian (Tremadoc) form, and *Niobe* is both an Upper Cambrian and Lower Silurian (Arenig) genus.<sup>16</sup>

Without expressing a decided opinion on the subject, there is the possibility that in these Florentine Valley beds we have another Tasmanian Cambrian locality, Upper Cambrian in fact, or at the least an horizon *very* low in the Silurian.

<sup>12</sup> Salter—Mem. Geol. Surv. Gt. Brit., iii., 2nd Edit., 1881, p. 544.

<sup>13</sup> Davidson—Geol. Mag., v., 1868, p. 314, pl. xvi., f. 20-22; Mon. Brit. Sil. Brach., pt. 3, p. 230, pl. xxxiii., f. 22-28.

<sup>14</sup> Miller—N. American Geol. and Pal., 1889, p.p. 543-44; Vogdes—Bib. Pal. Crustacea (*Bull. U.S. Geol. Survey, No. 63*), 1890, p.p. 112-114.

<sup>15</sup> Etheridge—Foss. Brit. Islands, i., 1888, p. 51.

<sup>16</sup> Etheridge—Foss. Brit. Islands, i., 1888, p. 59.

STUDIES IN AUSTRALIAN ARANEIDÆ.

No. 2.

By W. J. RAINBOW, F.L.S., F.E.S., Entomologist.

(Figures 26-31.)

The present paper contains descriptions of three interesting spiders, two of which were presented to the Trustees of the Australian Museum by Mr. J. J. Walker, R.N., and one by my colleague, Mr. Chas. Hedley. Those collected by the first-named gentleman are from Western Australia, and that by Mr. Hedley from Mornington Island, the largest island of the Wellesley Group, Gulf of Carpentaria.

Family ARGIOPIDÆ.

Genus *Araneus*, Walck.

(= *Epeira*, auct.)

ARANEUS, EXSERTUS<sup>1</sup>, sp. nov.

(Figs. 26, 27.)

Female: *Cephalothorax*, 3.2 mm. long, 2.6 mm. broad; *abdomen*, 6.7 mm. long, 4.2 mm. broad.

*Cephalothorax* longer than broad, arched, sides and caput dark brown, median area grey; the whole clothed with grey hairs.

*Pars cephalica* arched, terminating in front with a tubercular ocular eminence. *Pars thoracica* strongly arched, deeply furrowed at centre, radial grooves partially hidden by grey hairs. *Marginal band* broad.

*Eyes*.—Black. The four comprising the median group are elevated on a prominent tubercular eminence, and form a square or nearly so; of these the anterior pair are slightly the largest, and are separated from each other by a space equal to nearly twice their individual diameter; the posterior pair are separated from their anterior neighbours by a space equal to one and a half their individual diameter, and again from each



Fig. 26.  
*Araneus exsertus*.

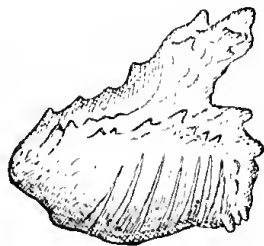

Fig. 27.  
*A. exsertus*.  
Abdomen, profile.

<sup>1</sup> *Exsertus*—Stretched out. So named in reference to the large abdominal tubercle.



other by about two diameters; lateral eyes minute, contiguous and elevated obliquely upon small tubercles.

*Legs.*—Long, spined, clothed with grey hairs; coxæ and trochanters yellowish-green; femora concolorous for rather more than half their length, thence dark brown; patellæ yellowish green above, orange yellow beneath, lateral ridges dark brown; tibiæ yellowish-green with dark green annulations, the latter much the darkest underneath; meta-tarsi and tarsi concolorous. Relative lengths: 1, 2, 4, 3.

*Palpi.*—Yellowish-green, similar in clothing and armature to legs.

*Falces.*—Strong, arched, apices divergent, shining, dark brown except at base of inner margins where they are pale yellowish; upper margin of furrow of each falx armed with four teeth, and the lower with three.

*Maxillæ.*—Arched, apices truncated, dark brown, inner margins whitish.

*Labium.*—Short, broad, arched, base dark brown, apex whitish.

*Sternum.*—Shield-shaped, dark brown, clothed with grey hairs.

*Abdomen.*—Ovate, overhanging base of cephalothorax, dark grey down the middle, light grey laterally, and dark grey underneath; superior surface rather rough and uneven, ornamented with a leaf-like design, and strongly tuberculated; from near the posterior extremity of the dorsal surface, a long, strong, rugose tubercle is directed backwards and upwards; beneath the latter there are two pairs of coniform tubercles, and of these the lower pair are much the shortest; in addition to these there are eight large lateral tubercles—four on each side, and each series form a slightly curved line, with the curvature directed outwards; there are also several smaller tubercles beneath the latter.

*Epigyne.*—A short, somewhat coniform process directed backwards.

*Loc.*—Mornington Island, Wellesley Group, Gulf of Carpentaria.

Genus *Poltys*, C. Koch.

*POLTYS SALEBROSUS*,<sup>2</sup> *sp. nov.*

(Figs. 28, 29.)

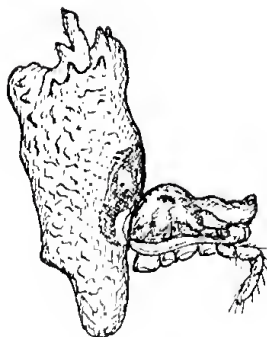

Fig. 28.  
*Poltys salebrosus*.

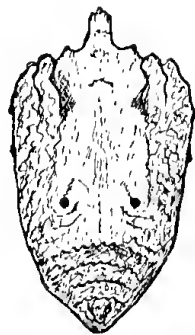

Fig. 29.  
*P. salebrosus*,  
Abdomen from  
the rear.

Female: *Cephalothorax* 2.6 mm. long; 1.8 mm. broad; abdomen 2.2 mm. long, 3.5 mm. broad, 6.8 mm. high.

*Cephalothorax*.—Longer than broad, arched, dark mahogany brown, smooth, glossy. *Pars cephalica* arched, terminating in front with a tubercular ocular eminence, furnished with a thick median brush of grey bristles. *Clypeus* broad, pitchy black and clothed with long grey hairs. *Pars thoracica* smooth, shining, strongly arched, median depression deep, radial grooves faintly distinct. *Marginal band* broad.

*Eyes*.—Normal.

*Legs*.—Long, hairy and spined; coxæ yellowish-grey; trochanters of first and second pairs yellow, with patches of black near the base on the underside, and ringed with black at the lower extremity; patellæ, tibiæ, meta-tarsi, and tarsi yellowish-grey; posterior pairs yellowish-grey. Relative lengths: 1. = 2, 4, 3.

*Palpi*.—Yellowish-grey; similar in clothing and armature to legs.

*Palces*.—Long, arched, glossy, dark brown, inner margin hairy, apices divergent.

*Maxilla*.—Broad, arched, moderately long, divergent, glossy, dark brown, lateral margins clothed with tawny hairs.

*Sternum*.—Shield-shaped, convex, densely clothed with tawny hairs.

<sup>2</sup> *Salebrosus*—Rough, rugged. Named in reference to the abdomen.

*Abdomen*.—Short, broad, rugged, tuberculated, densely hairy, vertical, not overhanging base of cephalothorax; in front the base is naked, pitchy black; above this, and towards apex, the surface is densely clothed with yellowish-grey hairs; the summit is convex, tuberculated, and densely clothed with tawny hairs, the tubercles of varying size and coniform; laterally, the surface is wrinkled, densely clothed with short greyish hairs, and furnished with a few small, obtuse tubercles; behind, from spinnerets to apex the surface is clothed laterally with greyish hairs, and in the median line with a large leaf-like patch of yellowish pubescence; at the summit of the posterior elevation there are two large lateral vertical protuberances composed of small coniform tubercles; between the latter there are two small but distinct depressions or punctures, and a little in front of these, two others rather more widely separated; a little more than midway between the lateral tubercular protuberances and spinnerets, the surface is somewhat depressed, and there are in addition two widely separated but distinct punctures; the lower extremity of the posterior elevation is wrinkled transversely and obtusely pointed.

*Obs.*—I am indebted to Mr. J. J. Walker who collected the specimen, for the following interesting field note:—

“While beating a withered bush near Fremantle for beetles, I noticed a small and active spider in the umbrella. It ran rapidly up to a broken twig, which it clasped closely with all its legs bunched up as it were beneath the cephalothorax; then elevating the rather elongate abdomen at right angles to the twig, the resemblance to a dry bud was complete. To such a degree of perfection was this resemblance carried, that I am sure no one could have detected the spider when at rest in this position.”

*Loc.*—Fremantle, W. Australia.

*Family* THOMISIDÆ.

*Genus* Diæa, *Thor*.

DIÆA MULTIMACULATA,<sup>3</sup> *sp. nov.*

(Figs. 30, 31.)

Female: Cephalothorax 2·9 mm. long, 2·9 mm. broad; abdomen 5·8 mm. long, 5·8 mm. broad.

<sup>3</sup> *Multus*—Much or many, and *maculata*, stained, spotted. So named in reference to the colouration.

*Cephalothorax*.—As long as broad, arched, truncated in front, pale yellowish, ornamented by two dark brown longitudinal lateral bars, which are uneven in outline, broadest posteriorly, gradually tapering towards the front, where they are united by a transverse bar of a somewhat paler hue and which covers the ocular area. *Pars cephalica* slightly elevated in front, truncated, sloping posteriorly, rounded off at sides; segmental groove distinct. *Clypeus* broad, arched. *Pars thoracica* broad, convex, radial grooves faintly distinct. *Marginalband* broad.

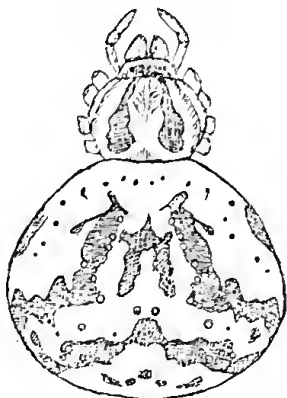

Fig 30.  
*Dica multimaculata*.

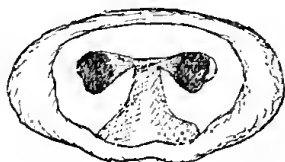

Fig. 31.  
*D. multimaculata*,  
Epigyne.

*Eyes*.—Black; each mounted upon a small tubercle, and surrounded by an opalescent ring; the tubercles carrying the four lateral eyes (especially those of the second row) are much the largest; of the two rows, the anterior is the shortest and the most strongly recurved; each row has four eyes; those comprising the second row are small, and each lateral eye is separated from its inner neighbour by a space equal to about six times its individual diameter, and the median pair by a space equal to about four diameters; of the anterior row each eye is separated from its neighbour by a space equal to about two diameters; of these each lateral eye is slightly larger than those of the posterior row, and the median pair, again, are somewhat larger than the lateral eyes.

*Legs*.—Yellowish, moderately pubescent and armed with the usual spines; the first and second pairs are much the longest, and each of these have a few pitchy black spots on the femur and patella, whilst the tibia has a broad concolorous band at its lower extremity; third and fourth pairs immaculate. Relative lengths: 1 = 2, 4, 3.

*Palpi*.—Short, pale yellowish.

*Falces*.—Short, strong, concolorous.

*Maxilla*.—Short, widest at base, apices inclining inwards; the base and inner and outer side of each maxilla pale yellowish; the median area dark brown.

*Labium*.—Long, arched, apex obtusely pointed; base pale yellow; apex dark brown.

*Sternum*.—Shield-shaped, glossy, sparingly clothed with long hairs or bristles, arched, pale yellowish except in front, where there is a broad slightly recurved transverse bar of dark brown; this bar, however, does not quite reach the sides.

*Abdomen*.—Broadly ovate projecting over base of cephalothorax, strongly arched, straw yellow, relieved by a series of large black and brownish patches, and large and small concolorous spots, both above and laterally; ventrally the surface is straw yellow, with two moderately large brownish spots immediately in front of the spinnerets.

*Epigyne*.—As in figure.

*Hab*.—Perth, W. Australia.

ON THE OCCURRENCE OF THE GENUS *PTYCHOCERAS* (?)  
AND OTHER ADDITIONAL FOSSILS IN THE CRETACEOUS  
BEDS OF THE NORTHERN TERRITORY OF  
SOUTH AUSTRALIA.

---

By R. ETHERIDGE, Junr., Curator.

---

(Plates xiv. and xv.)

---

Since the completion of my study of the Cretaceous fossils of South Australia and the Northern Territory,<sup>1</sup> a few additional forms have been collected by Messrs. Christie and Godfrey from the latter beds, near the Point Charles Lighthouse, and presented by them to the Trustees. The most important of the series is a small *Ptychoceras*, a genus not hitherto recorded as Australian. The other specimens comprise amongst them the phragmocone of a small Belemnite, fourteen millimetres long by eight millimetres in diameter, several specimens of a small *Nucula*, two admirably preserved *Scaphites cruciformis*, mihi, exhibiting the sculpture and sutures, an *Avellana*-like univalve, possibly an *Alaria*, a peculiar dermal tubercle, and a number of curious concretions and coprolite-like bodies.

The whole of these fossils are in the condition of limonite casts, highly glazed.

I have selected the following as worthy of description:—

*Genus Nucula*, Lamarck, 1799.

(Prodrome—Mém. Soc. Hist. Nat. Paris, 1799, p. 87.)

*NUCULA SEJUGATA*, *sp. nov.*

(Plate xiv., fig. 9; Plate xv., fig. 5).

*Sp. Char.*—Shell (cast) oval, compressed; cardinal margin oblique anteriorly, and straight posteriorly; anterior ends somewhat produced, and all three margins—anterior, posterior and ventral—regularly rounded, the posterior obliquely so below; anterior and posterior slopes small and narrow. Lunule fairly deep; esutcheon long and narrow. Posterior teeth exceeding twelve in number.

---

<sup>1</sup> Etheridge—Mem. Roy. Soc. S. Austr., ii., 1, 1892, p. 1.

*Obs.*—The casts of this *Nucula*, although common, in their present condition present few distinctive characters, at the same time I am not able to refer it to any of the already known Australian species. The posterior teeth are visible in several specimens, and although it is impossible to be sure of their exact number, it can safely be asserted that they exceed twelve in a series in each valve. There are no appreciable diagonal ridges, and the posterior slopes, both anterior and posterior, were small and narrow. No traces of the adductor scars or pallial impressions remain. As it will only be by the merest chance that specimens like these or further features will be obtained, I purpose calling this form *Nucula sejugata*,<sup>2</sup> in allusion to the isolated position of the beds in which it occurs.

*Genus Avellana, D'Orbigny, 1842.*<sup>3</sup>

(Pal. Franç. Terr. Crét., Gastropodes, ii., Livr. 43-48, 1842, pl. 168-69; Livr. 49-60, 1843, p. 131).

AVELLANA CAROLENSIS,<sup>4</sup> *sp. nov.*

(Plate xv., figs. 3, 4 and 11.)

*Obs.*—This is a small globose shell of four or perhaps five convex whorls, with a short moderately acute spire. The body-whorl is globose and comparatively large, and displays traces of very numerous spiral punctate lines. The mouth is unfortunately filled with a plug of limonite, and the characters of the inner lip quite effaced. The revolving punctate lines, however, indicate the Tornatellidæ, and in this family the genus *Avellana* seems to advance the strongest claim for its reception. On the other hand, the spire is too elevated and distinct from the body-whorl for a true *Avellana*, and much more so for *Euptycha*, Meek. Such as it is, the fossil is certainly distinct from any other Australian Cretaceous univalve with which I am acquainted, the only possible ally being Moore's *Cinulia depressa*,<sup>5</sup> from Wollumbilla, in Queensland.

<sup>2</sup> *Sejugatus*—Separated, isolated.

<sup>3</sup> See note by Stoliczka—Cret. Fauna S. India, Gasteropoda (Pal. Ind.), ii., pts. 7-10, p. 406.

<sup>4</sup> In allusion to the locality.

<sup>5</sup> Moore—Quart. Journ. Geol. Soc., xxvi., 1870, p. 256, pl. x., f. 20.

*Genus Ptychoceras, D'Orbigny, 1842.*

(Pal. Franç. Terr. Crét., Cephalopodes, i., Livr. 33-42, 1842,  
p. 554).

PTYCHOCERAS (?) CLOSTEROIDES,<sup>6</sup> *sp. nov.*

(Plate xv., figs. 6-9.)

*Sp. char.*—Shell small, composed (at least) of three subcylindrical limbs, variable in section. Neonie (or youngest limb) small, delicate, round, and pipe-like; ephebie (or second) limb transversely oval, enlarging slowly, convex on the venter, slightly flattened laterally, and somewhat concave on the dorsal aspect; gerontic (or third) limb stouter than the other two combined, convex on the venter, very little compressed laterally, but swelling slightly at its union with the second limb, and the dorsum concave, with a well marked contact furrow, in which reposes the first limb. Ephebie-gerontic umbilical depression shallow and somewhat pyriform in outline. Surface smooth, sculpture unknown.

*Obs.*—The largest specimen in the collection is twenty millimetres long by seven millimetres wide, but none of them are perfect. The three limbs are very apparent in all, the youngest limb in several specimens projecting beyond the broken ends of the second and third limbs, and looking like a miniature siphuncle. The youngest limb is unquestionably circular in outline, the second transversely oval with a concave face, and the third limb round-oval in section with a concave emarginate face. The ventral siphuncle and sutures are visible only on one specimen, but the latter, in consequence of the mode of preservation, are not sufficiently distinct for description; the camerae were very shallow. Viewing the specimens longitudinally there appears to be a certain degree of curvature. For instance, in the direction stated the gerontic outline is faintly convex, whilst the ephebie is rather concave. In Pl. xv., fig. 9, representing a transverse section of the whole, the relation of the three limbs to one another is distinctly visible.

In a majority of instances *Ptychoceras* is described as possessing a once reflected shell, but some authors—for instance, D'Orbigny, Ooster, Stoliezka, Gabb, and Whitfield—have described twice reflected individuals. Whether or no the perfect state of *Ptychoceras* consists of two, three, or more limbs is, I believe, still an open question; at any rate Gabb has proposed for the twice reflected shells the generic name *Diptychoceras*.<sup>7</sup> He

<sup>6</sup> κλωστήρ, ἦρος, ὁ—A hank, and *oides*—resemblance.

<sup>7</sup> Gabb—Pal. California, ii., Sect. 2, 1869, p. 143.



remarked as follows:—"In the present (1869) state of our knowledge it seems that there is a well-defined group of species characterized by two straight parallel limbs, the larger, or newer of which never develops beyond a certain point on the length of the smaller: while another group . . . . has this larger limb continued and again reflected. Should it be ascertained that there is a gradation between the two, or that other species have more than two reflections, then there will be good grounds for doubting the validity of my genus; until then, I believe we have sufficient reasons for maintaining it."

Meek rejected<sup>8</sup> *Diptychoceras*, but Zittel admitted<sup>9</sup> it. Had our Australian form simply possessed the three limbs it would unquestionably be referred to Gabb's genus, for whatever the name may be worth, but the deeply excavated contact furrow on the ephebic and gerontic limbs, particularly the latter, immediately calls to mind the much debated *Solenoceras*, Conrad. This author described his genus as differing "from *Ptychoceras*, D'Orbigny, in the smaller tube lying in a furrow of the larger one, which is straight only for a short distance from the junctions and then suddenly recurved."<sup>10</sup> Both Meek and Whitfield have touched on this question. The former remarks as follows of the type, *Ptychoceras annulifer*, Morton, sp.—"A small species that not only had its limbs in contact, but the smaller limb received into a deep furrow along the inner side of the larger. It shows no positive evidence of more than one folding upon itself; but then the specimen is broken off at both ends, so that we can hardly be sure as to the exact form of the mature unbroken shell. At the larger of the broken ends, there is, in the type specimen, some slight appearance of the commencement of another bend *outward* or *away from* the inner limb. Unfortunately, however, the specimen is hardly in a condition to be altogether satisfactory on this point. . . . . If, however, it *did* make a bend there in the direction supposed, *Solenoceras* would certainly be a good genus. If not, I should think the more deeply embracing characters of the large limb could hardly alone form a sufficient generic distinction."<sup>11</sup>

In his "Palæontology of the Black Hills of Dakatoa," Mr. R. P. Whitfield refers to the bending of the shell in the three genera *Ptychoceras*, *Diptychoceras*, and *Solenoceras*, and states that in two new species described by him (*P. meekianum* and *P. crassum*), some of the specimens exhibit a "prolonged curved

<sup>8</sup> Meek—Report U.S. Geol. Survey Territories (Hayden's), ix., 1876, p. 410.

<sup>9</sup> Zittel—Handb. Pal., i. Abth., 2, p. 445.

<sup>10</sup> Whitfield—Mon. U.S. Geol. Surv., xviii., 1892, p. 272.

<sup>11</sup> Meek—Report U.S. Geol. Surv. Territories (Haydens's), ix., 1876, p. 411.

portion of the smaller limb."<sup>12</sup> The same author enters more fully into the structure of *Solenoceras* in his "Gasteropoda and Cephalopoda of the Raritan Clays and Greensand Marls of New Jersey." He says—"Mr. Gabb, although admitting the genus as a valid one, is inclined to dispute the deflection of the outer part of the tube. This would leave the genus to stand entirely upon the feature of the smaller tube lying in a groove of the larger one . . . . . On examining Dr. Morton's specimen [*i.e.* the type] I think there is every evidence that can be derived from an internal cast by such a shell that the supposed deflection of the tube at the outer end of the fragment is only the thickening and rounding out of the completed or adult aperture of the shell."<sup>13</sup>

The Australian specimens are, as I have already said, only portions of individuals, yet they conclusively show a three-limbed shell with sharp and well-marked contact furrows in both what I have termed the ephebic and gerontic limbs. It follows from this that my *P. ? closteroides* unites more or less the characters of all three genera, *Ptychoceras*, *Diptychoceras*, and *Solenoceras*. It has fundamentally two limbs as in *Ptychoceras*, acquires three limbs as in *Diptychoceras*, and displays embracing features by the two younger limbs similar to that described in *Solenoceras*. At the same time the fossils are too imperfect to display any free deflection such as is said to exist in the third genus.

*P. ? closteroides* is closely allied to *P. ? forbesianus*, Stoliczka,<sup>14</sup> from the Ootatoor Group of India, which exhibits precisely the same peculiarities of a three-limbed shell, with the youngest limb strongly embraced by the two others.

*Genus Scaphites*, Parkinson, 1811.

(Organic Remains Former World, 1811, p. 145.)

SCAPHITES ERUCIFORMIS, *Eth. fil.*

(Plate xiv., fig. 10; Plate xv., fig. 10.)

*Scaphites eruciformis* *Eth. fil.*, Mem. R. Soc. S. Austr., ii., Pt. 1, 1892, p. 45, pl. vii., f. 10 and 11.

*Obs.*—Two excellent specimens of the inrolled position of the shell are in the collection, both exhibiting the sculpture, and one

<sup>12</sup> U.S. Geogr. and Geol. Surv. Rocky Mt. Region (Powell's).

<sup>13</sup> Whitfield—Mon. U.S. Geol. Surv., xviii., 1892, pp. 271-272.

<sup>14</sup> Stoliczka—Foss. Cephalopoda Cretaceous Rocks S. India (Pal. Ind.), Ser. 3, pts. 10-13, 1866, p. 195, pl. lxxx., f. 11.

the sutures. The sharp transverse sculpture threads start from the umbilicus as a single line, but immediately bifurcate, and branches then passing over the venter singly; here and there, however, a single tread is interpolated amongst the others. At a point on one of the flanks is a peculiar anastomosis of three threads, but whether an occasional character, or the result of injury during life, I am unable to say. I figure the sutures as exposed on the shell (Pl. xiv., fig. 10.) but from a rounding off of the edges the finer details are lost, and description is impossible. The siphonal line on the centre of the venter is also plainly visible as a faint groove.

## TUBERCLE

(Plate xiv., figs. 6-8.)

*Obs.*—In my Preliminary Report<sup>15</sup> on the fossils of this deposit I recorded the occurrence of bony scute-tubercles believed to be reptilian. A third has now reached my hands, and is figured for future elucidation. It is conical in outline with an obtuse apex, and a rather broad base, nine millimetres in fore and aft measurement, ten millimetres in a transverse direction, and eight millimetres in height. The anterior outline is gently convex, and the posterior concave. With the means at my disposal I was not able to suggest an affinity for this object, but more than one alternative suggested itself, each to be rejected in its turn—for instance: (1). It may be allied to the dermal neck tubercles of a Crocodile, although in our *Crocodylus porosus*, the apices are much more laterally compressed; (2) a general resemblance in miniature to some of the tubercle-cores of *Meiolania*; (3) abandoning the tubercle theory, it may be compared to the claws or terminal phalanges of *Agrosaurus macgillivrayi*, Seeley,<sup>16</sup> but the latter are too long and laterally compressed, and there is no trace of an articular face in the Port Darwin fossil.

An exact reproduction of this tubercle was subsequently forwarded to Dr. A. Smith Woodward for the benefit of his opinion. He has very kindly replied as follows:—"It seems to me to be entirely new. I do not think it belongs to a fish, and should regard it as a dermal scute of a reptile, perhaps one of the Stegosauria. In general shape it much resembles some of the dermal tubercles from the Purbeck beds provisionally referred by Owen to *Nuthetes destructor*, but these scutes are tuberculated."

<sup>15</sup> Etheridge—S. Austr. Parl. Papers, No. 82, 1895, p. 34.

<sup>16</sup> Seeley—Quart. Journ. Geol. Soc., xlvii., 1891, pl. opp. p. 168, f. 6.

## NODULES AND COPROLITES

(Plate xiv., figs. 1-5; Plate xv., figs. 1 and 2.)

The Point Charles deposit has yielded a very large number of small irregularly shaped nodules and shapeless pieces of limonite (Pl. xiv., fig. 4; Pl. xv., fig. 1.); none of them are more than two inches long by half to one inch wide. With these are other small, more or less spherical or oblong bodies perfectly smooth and shining (Pl. xiv., fig. 5; Pl. xv., fig. 2.) The irregularly shaped nodules on the contrary are of a darker colour than the preceding, with a rough, pimpled, and often minutely cavernous or pitted surface, and exhibiting also shrinkage cracks; both are darker externally than internally. Still a fourth form is present in considerable quantity, in my opinion coprolitic, and having within a certain compass, a definite form—an irregular fusiform outline (Pl. xiv., figs. 1-3.) These are enlarged in the middle and taper towards the ends, which are blunt, or they may be slightly bent. The largest is two inches long by six-eighths of an inch diameter in the centre, and all of them exhibit ill-defined transverse or oblique stricture marks.

The shells, nodules, spherical bodies, and coprolites are either of a black or dark red-brown colour, but the degree of lustre is very variable, the shells and spherical bodies possessing the highest. The colour of the nodules and coprolites is, generally speaking, darker than the others. Most of the shells are a good deal worn, nearly all broken, and their angles rounded. The spherical bodies are undoubtedly concretionary, formed of concentric layers that peel off; the nodules, on the other hand, are seen on fracture to be cavernous or vesicular.

The coprolites exhibit traces of oblique constrictions representing the structure of the inner surface of the intestine of the animal voiding them; they may either be those of Reptiles or Fish. Our knowledge of these forms of life in the Australian Cretaceous is at present very limited. Amongst the former class we possess evidence of the existence of the Ichthyopterygia and Sauropterygia, with a Chelonian, *Notocheles costata*, Owen, sp. As members of the second class we have *Belonostomus*, an Aspidorhynchian Teleostomatous fish; a shark—*Lamna*; *Porthetus*, a Saurodontidian Teleostomatous fish, and *Cladocyclus*, a Sphyrænidian Teleostomoid. Lastly the remains of a Saurischian Reptile—*Agrosaurus macgillivrayi*, Seeley,<sup>17</sup> have been described from North-east Australia, but the precise geological horizon is unknown.

The coprolites, or "bezoar stones,"<sup>18</sup> of the Port Darwin deposit do not display the same regular spiral as those of the

<sup>17</sup> Seeley—Quart. Journ. Geol. Soc., xlvii., 1891, p. 164, pl., opp. p. 164.

<sup>18</sup> Mantell—Petrifactions and their Teachings, 1851, p. 375.

Ichthyopterygia,<sup>19</sup> and perhaps also the Sauropterygia. The interior of the intestine in Selachians (Sharks, Dog-fish and Rays) is also spirally coiled. Mantell figured the coprolites of *Squalus* from the Chalk Marl, which exhibited a closely imbricated series of convolutions.<sup>20</sup> Another coprolite is that of the genus *Macropoma*, a Cœlocanthidian Ganoid from the Chalk, in which the gyrations are less numerous than in that of a shark.<sup>21</sup> On the whole I think it will be better to regard these coprolites, in the meantime, as those of fish; possibly further collecting may bring to light some organism to which they can be referred with greater certainty.

My colleague, Mr. Charles Anderson, M.A., B.Sc., has made analyses of the shells, nodules, and coprolites, with the result that the composition is substantially that of limonite carrying a little phosphoric acid. The following are his detailed analyses:—

	Nodules.	Shells.	Coprolites.
Loss on ignition	12·71	12·66	12·64
Insoluble Silica (SiO <sub>2</sub> )	3·16	3·04	4·92
Ferric-Oxide (Fe <sub>2</sub> O <sub>3</sub> )	80·69	81·10	79·93
Lime (CaO)	2·25	1·88	2·07
Phosphoric Anhydride (P <sub>2</sub> O <sub>5</sub> )	0·44	0·42	1·12
Carbonic Oxide (CO <sub>2</sub> )	traces	traces	—
	99·25	99·10	100·68

The very low percentage of Phosphoric Anhydride notwithstanding, the mere occurrence of this in connection with animal remains on this Continent, is interesting, particularly the slight increase in the coprolites proper. I am not aware that it has been previously noticed in connection with our Cretaceous deposits. As compared with phosphatic nodules from other world-wide localities, the percentage of Phosphoric Anhydride is, of course, absurdly low, still it indicates that there possibly exist other deposits in Australia of economic importance.

<sup>19</sup> Owen—Palæontology, 2nd Edit., 1861, p. 221, f. 89 (*Ichthyosaurus*.)

<sup>20</sup> Mantell—Medals of Creation, i., 1844, p. 432, lign. 99, f. 2; *loc cit*, ii., p. 656.

<sup>21</sup> Mantell—*Ibid.*, i., 1844, p. 432, lign. 99, f. 1; *Id.* ii., p. 656. For further information on this subject and excellent illustrations see Buckland—Geology and Mineralogy (*Bridgewater Treatise*), new edit., 1858, p. 190, *et seq.*, pl. xvii.

## AUSTRALIAN CICADIDÆ.

### THE MATING OF *CYCLOCHILA AUSTRALASIÆ*, Don. AND *THOPHA SACCATA*, Amyot.

By W. J. RAINBOW, F.L.S., F.E.S., Entomologist.

(Plate xi.)

A short time ago, Mr. T. M. McGregor, of Rockdale, presented to the Trustees, a green male of *Cyclochila australasiæ*, Don, ("Green Monday"), and a female of the "Double-drummer," *Thopha saccata*, Amyot, which he had taken *in cop.* last summer, when collecting around Sydney. Numerous instances of insects of distinct species and genera taken in the act of coition, have, from time to time been recorded in the Old World, but this appears to be the first instance of the kind reported from Australia.

Mr. McGregor informs me that when his attention was attracted to these insects, he at first thought he had discovered an unusually large Cicada, and it was not until he had captured them, that he discovered he had secured two Cicadas of distinct genera in the act of coition. These when taken were placed in the cyanide bottle. When captured the female was suspended to a branch, which she had firmly grasped with her legs, whilst the male was hanging head downwards, but grasping his partner round her abdomen. Fig. 1, in the accompanying plate gives a side view of the insects *in cop.*; fig. 2 illustrates the male *Cyclochila australasiæ*, and fig. 3, the female, *Thopha saccata*.

The following is a brief list of references bearing on the subject:

- Low (F.)—Records two fertile copulations of distinct species of Zyganidæ: *Z. carniolica*, Scop., male, with *Z. ephidles*, Linn. *Verh. Zool.-bot. Ges. Wien*, xvi., 1866, p. 951.
- Andrews (W. V.)—On the Copulation of Distinct Species of Lepidoptera. *Canadian Entomologist*, iv., 1872, pp. 78 and 79.
- Frey and Wulschlegel.—Hybrids occurring naturally between *Deilephila resperilio*, Esp., and *D. hippophaes*, Esp.; *D. elpenor*, Linn., and *D. porcellus*, Linn.; and *Smerinthus ocellatus*, Linn., and *S. populi*, Linn. *Mittheil. Schw. ent. Ges.*, iv., 1874, pp. 206-210.

- Reuter (O. M.)—Sur l'hybridisation chez les Insectes. *Ent. Tidskr.*, i., 1880, pp. 174-177. On Abnormal Pairing in Insects, and the questions arising therefrom. *Öfv. Finsk. Soc.*, xxiii., 1881, pp. 1-30. The writer discusses the various instances which have occurred in various orders of Insects of different species, or even different genera, pairing; and also copulation "inter mares."
- Suchelet (A.)—L'hybridité dans la Nature. *Rev. Quest. Sci.*, xxiv., 1888, pp. 180-187.
- Rodgers (J. T.)—Results of Copula between two different varieties. *Entomologist*, xxii., 1889, pp. 49-50.
- Heyden (L. V.)—Ueber copula verschiedenartigcr Coleopteren. *Deutsche ent. Zeitsch.*, 1889, p. 212. Six cases, some between species of different genera.
- Weed (C. M.)—Copula between Aphididæ of Different Genera. *Insect Life*, iii., 1891, p. 290.
- Fletcher (W. H. B.)—Hybridism of *Zygania lonicera*, Esp., and *Z. filipendulæ*, Linn. *Trans. Ent. Soc.*, 1891, p. ix.
- Tutt (J. W.)—Hybrid between *Amphidasis prodromaria*, W. V., and *A. betularia*, Linn. *Trans. Ent. Soc.* 1891, p. xvi.
- Escherich (C.)—Die biologische Bedeutung der "Genitalanhänge der Insekten" (Ein Beitrag zur Bastard frage.) *Verh. Zool.-bot. Ges. Wien.*, xlii., 1892, pp. 225-240, pl. iv.
- Standfuss (M.)—Ueber die Hybridation bei den Insekten. *Mittheil. Schw. ent. Ges.*, viii., 1892, pp. 386-396.
- Rudow (F.)—Hybrid of *Libellula quadrimaculata*, Linn., and *L. fulva*, Müll. *Soc. Ent. Zurich.*, viii., 1893, p. 84.
- Rocquigny (G. de)—Copulation of *Satyrus* and *Vanessa*. *Feuille Nat.*, xxiv., 1894, p. 174.
- Graves (S.)—Copulation of *Argynnis paphia*, Linn., and *Thecla quercus*, Linn. *Entomologist*, 1894, p. 269.
- Shepherd-Walwyn (H. W.)—Pairing of distinct species and genera of Lepidoptera. *Entomologist*, 1896, p. 166. Copulation between Lepidoptera of Different Genera. *Berl. ent. Zeitsch.*, 1896, S.B., p. 8.
- Jacobson (G.)—Ueber anormale Kopulation bei der Insekten. *Horæ Soc. Ross.*, xxxi., 1898, pp. cxxv-cxxxii.
- Schulz (O.)—Copula between males of *Bombyx quercus*, Linn. *Berl. ent. Zeitsch.*, xlv., 1899, S.B., p. 27.

ABORIGINAL PETROGLYPHS BETWEEN BEAUMONT AND  
HAMLEY TRIGNOMETRICAL STATIONS, KURINGAI.

---

By R. ETHERIDGE, Junr., Curator.

---

(Plates xii. and xiii.)

My attention was recently drawn by Mr. W. S. O'Brien, Electrician to the Railway Commissioners at Hornsby Junction, on the Northern line, to an interesting group of aboriginal rock carvings at Kuringai Staff Station, about four-and-a-half miles north of the Junction. This group is not recorded by Mr. W. D. Campbell in his excellent "Aboriginal Carvings of Port Jackson and Broken Bay."<sup>1</sup> Mr. O'Brien was good enough to guide me to the spot and assist in noting the following particulars:—

The petroglyphs are immediately contiguous to the railway line, on its west side, opposite the Staff Station, and between the railway line and the Peat's Ferry Road. There are three prominent figures, a man, woman, and smaller figure of doubtful sex. They are lying in an east and west direction, side by side; the man's outline in the centre, the woman's on the left or north, and the nondescript's on the right or south. At right angles to this group, extending beyond the female outline, in a general direction of slightly east of north, is a series of huge foot outlines; these we traced for one hundred and seventy-six yards. Above the male outline, inclined in an oblique direction over the head, is a large boomerang, the lower point almost touching the outspread left hand. A few feet above the woman's head, but a little further to the left, are five fish outlines,<sup>2</sup> four in a line close together, and the fifth slightly removed from the others, all pointing in an easterly direction.

*The Man.*—This is a huge figure, ten feet two inches in height. The arms are outstretched above the head and the fingers expanded. The legs are normally placed, but with the view of displaying the toes, the dorsal surfaces of the feet are represented "full face," the figure standing on the inner edge of the right foot, and the outer edge of the left foot. The hands and feet are

---

<sup>1</sup> Mem. Geol. Surv. N.S. Wales, Eth. Series, i, 1899.

<sup>2</sup> These are not represented in the plate.



remarkable in that the former are six-fingered, and the latter seven-toed. No features are represented. The trunk is girt with the belt of manhood, and above it extending from axilla to axilla is a band with a series of more or less lanceolate incisions, nine on one side and five on the other, the centre being plain.

*The Woman.*—This outline is placed at a distance of three feet four inches from that of the man, on the left side. It is six feet high, and also with the arms outstretched and curved above the head. The fingers and toes, in this instance, are not represented, but the feet are normally placed; the mammæ are large, pendulous, and laterally situated.

*The Nondescript Human Figure.*—Immediately at the man's right side is the smaller human figure, without indication of sex; it is about four feet high. One arm, the right, is passed beneath the man's trunk, the other is extended on the opposite side, and the hand is four-fingered; again no features are visible. The legs are very indistinctly portrayed, curving away from the man, and the feet are ill-formed.

*The Boomerang.*—This is two feet eleven inches across the bend, and although not grasped in the man's left hand, extends from above it obliquely over the head.

*The Feet Impressions.*—We now come to one of the most interesting features in this group of petroglyphs, a line of huge feet impressions extending in a northerly to an east-north-east direction for a distance of one hundred and seventy-six yards, following round the Hawkesbury Sandstone escarpment. The two first form a pair, at ten feet seven inches from the female figure. Beyond the pair the impressions are single, thirty-six in all, more or less. Between the twentieth and twenty-first there seems to be a gap, and at one point a small fish-like figure is introduced, and at another is an oval incision of no particular meaning. The largest foot impression is two feet four inches long by one foot seven inches wide, and all are seven-toed. They are variable distances apart, but as a rule from four to ten feet. Immediately opposite the Staff Station, and on a sloping surface of rock within the westerly railway fence, is a single footmark at right angles to the long line already described, as if approaching the latter.

The all important points in this group of petroglyphs are the long line of tracks, the peculiar presentation of the man's feet, and the increase in number of the man's fingers and toes.

A long line of tracks accompanying other figures has already been recorded by Mr. W. D. Campbell in a few instances. In a group off the Manly to Pittwater Road, on Portion 64, Parish of Narrabeen, twenty-two impressions are visible, leading up to a

coroneted figure.<sup>3</sup> One of the finest petroglyphs known is on a saddle between Wheeler and Middle Creeks, on Portion 906, Parish of Manly Cove. "The western part of the group represents two hunters; the foot-marks represent their tracks. The central portion appears to represent a combat between two natives, who exhibit plenty of energy in their attitudes; each has a boomerang in the right hand; the foot-marks show, apparently, the flight of the smaller individual and his chase;"<sup>4</sup> there are an immense number of tracks here, and two of them exhibiting the toes are supplied with the correct number. On a ridge between Gunson Trigonometrical Station and Sugar Loaf Hill, in Portion 81, Parish of Narrabeen, is a large petroglyph, almost entirely composed of foot-imprints.<sup>5</sup> Another fine exhibition of picture story work may be seen on a high ridge, forming the watershed between Middle and Narrabeen Creeks, on the road line, south side of Portions 107 and 110, Parish of Manly Cove.<sup>6</sup> Here numerous foot-prints, with other well executed figures, are to be seen. These illustrations are sufficient to show how frequent and important an element the foot-imprint is in our East Coast petroglyphs.

The position of the feet in the male figure is almost unique. Feet are often represented as an integral portion of a figure, turned in opposite directions, right and left, but only in one instance<sup>7</sup> am I acquainted with a similar representation approaching that of the Kuringai man. This occurs on the upper ledge of a large extent of rock on the northern side of a high flat-topped hill, north of Smith's Creek, Parish of Broken Bay. Another occurs in a group on the west side of Roach Trigonometrical Station, on a ledge of rock skirting the hill-side overlooking the south-west branch of Smith's Creek, Cowan, Parish of Broken Bay. Here is a male figure with the right foot turned in the proper direction, and the left half turned to correspond with it.<sup>8</sup>

Fingers and toes are occasionally depicted, either normal or less in number than there should be. A good illustration of the former is that of an elaborate male figure<sup>9</sup> on the summit of a

<sup>3</sup> Campbell—Mem. Geol. Surv. N.S. Wales, Eth. Series, i., 1899, pl. viii., f. 16.

<sup>4</sup> Campbell—*Loc. cit.*, p. 22, pl. x., f. 1.

<sup>5</sup> Campbell—*Loc. cit.*, pl. xiii., f. 1.

<sup>6</sup> Campbell—*Loc. cit.*, pl. xv., f. 2.

<sup>7</sup> Campbell—*Loc. cit.*, pl. xii., f. 12.

<sup>8</sup> Campbell—*Loc. cit.*, pl. xxi., f. 2.

<sup>9</sup> Campbell—*Loc. cit.*, pl. xii., f. 16.

ridge on the south side of Smith's Creek, near a rock pinnacle, Parish of Broken Bay. A similarly good representation of the latter is that already referred to as having the feet facing both in the same direction.<sup>10</sup>

The combined male and female figures are sometimes met with also. On the east side of French's Forest Road, near the crossing of the boundary of Manly Cove and Narrabeen Parishes, a decidedly erotic group occurs.<sup>11</sup> Again at the top of the ridge at Coal and Candle Creek, near Arden Trigonometrical Station, Parish of Broken Bay;<sup>12</sup> and on the west side of the road from Turramurra to Bobbin Head, near the Bobbin Trigonometrical Station, Parish of Gordon.<sup>13</sup> In all three instances the female figure, and in the two first, those of the men have the arms upraised, as in the Staff Station Group, but that of the man in the third series exhibits the legs drawn up in the position known as the "corroboree jump," and is accompanied by five large *mundoe* foot-prints, as Mr. Campbell calls them.

An attempt to explain the meaning of many of these petroglyphs will be found in two papers by myself,<sup>14</sup> in which the views of some of our best authorities are quoted.

It is questionable whether the less distinct figure at Kuringai is intended for that of a male or female. If the latter, I offer the following explanation. In the *Kuringai (Bora)* of the five tribal groups forming the Murring association, extending in southern New South Wales from Twofold Bay to Port Jackson, and west to the Lachlan River, about Hay, are performed two magic dances, those of *Daramulan* and *Njalalbal*.<sup>15</sup> The latter mythical being is a duality, the wives of *Daramulan*, and in the dance they are seen to glide from the forest and disappear in the gloom beyond.<sup>16</sup> It is, therefore, possible that the Kuringai petroglyph may be intended to represent the dread spirit who presided over the initiation ceremonies, accompanied by his wives.

<sup>10</sup> Campbell—*Loc. cit.*, pl. xii., f. 12.

<sup>11</sup> Campbell—*Loc. cit.*, pl. viii., f. 15.

<sup>12</sup> Campbell—*Loc. cit.*, pl. xix., f. 9.

<sup>13</sup> Campbell—*Lic. cit.*, pl. xxi., f. 4.

<sup>14</sup> Etheridge—*Rec. Geol. Surv. N.S. Wales*, ii., 1, 1890, p. 34; iii., 3, 1893, p. 82.

<sup>15</sup> Howitt—*Journ. Anthropol. Inst.*, xiii., 1884, p. 433.

<sup>16</sup> Howitt—*Journ. Anthropol. Inst.*, xiii., 1884, p. 450.

DESCRIPTION OF A NEW *PHASCOGALE* FROM NORTH  
WESTERN AUSTRALIA.

By EDGAR R. WAITE, F.L.S., Zoologist.

In January 1902, Mr. A. C. Blyth, of this city, invited me to see three small mammals which he had just brought alive from the Pilharra District, North Western Australia.

I found them to be an adult pair and a half-grown example of a species of *Phascogale*. Mr. Blyth told me that on passing through Western Australia he had also left two examples with the Director of the Western Australian Museum and Art Gallery. In April, Mr. Blyth kindly placed his animals in my charge for observation, but as I was at that time unable to give them the necessary study, they were returned, to await a more favorable opportunity. This proved a disastrous proceeding, for within a week the animals escaped and were not again seen.

Two months later Mr. B. H. Woodward, Director of the Western Australian Museum and Art Gallery, asked me to examine the examples which he still had alive. In due course they were sent to me and form the subjects of the following descriptions. As they had unfortunately been prepared as dry skins, the descriptions are not so satisfactory as though examination in the flesh had been possible.

During the two or three days I had Mr. Blyth's animals in my possession, I found them to be very tolerant of the hand, having been accustomed thereto by their owner, though he told me that at first he had received some sharp bites from them.

I several times liberated them in a closed room but by approaching gently had small difficulty in securing them again. When startled, say by clapping the hands, they would make a spasmodic spring of two feet or more.

In response to any inquiries regarding the behaviour of the animals in captivity, Mr. Woodward writes:—"The only habits I noticed were the wonderful quickness and skill in catching beetles, of which they were very fond. They always avoided the light as much as possible."

When sending the specimens to me, Mr. Woodward expressed the wish that if new, Mr. Blyth's name might be associated with them. I have much pleasure in acceding to his request, and desire to thank both Mr. Woodward and Mr. Blyth for the facilities afforded me.

PHASCOGALE BLYTHI, *sp. nov.*

Size large, form delicate, fur close and soft with longer scattered hairs.

The colour of the upper parts is sandy, speckled with brown, the basal portion of the fur being dark-grey; top of snout pale yellow, eye surrounded with a ring of light hairs, upper whiskers black, the lower ones white.

The whole of the under parts, together with the inner side of the limbs and the lining of the pouch is pure white. No grey at the base of the fur; the fore limbs are pale yellow above, the hands thinly clothed above with white hairs. Palms with granulated pads each with raised striated area. Outside of thighs coloured like the body above; upper side of feet thickly covered with white hairs, the under surface, the heel excepted, is naked but partly concealed by the hairs on the sides, which are bent underneath: there are three pads, striated and similar to those of the palms, and a small hallux which does not nearly reach the pads, it has no pad and is clawless. Tail of moderate length, shorter than the body, incrassated; the proximal two-fifths above, covered with short stiff yellow hairs, the remainder with gradually lengthening black hairs, which do not however form a crest. The whole of the lower surface is black, with the exception of a small proximal portion, which is yellow.

*Dimensions.*

	Male, <i>ad.</i>	Female, <i>juv.</i>
Head and body ...	150·0	132·0 mm.
Hind foot ...	27·8	26·5 "
Tail ...	102·0	95·0 "

*Skull.*—Short and broad, the bones of the nasal region so thin as to enable the tooth-roots to be seen through them; muzzle short and broad, its lateral profile swollen by the roots of the canines which render its breadth more than a third the basal length. Nasals rather long and noticeably expanded behind, their greatest more than once and a half their least breadth. Interorbital space moderate, its edges at the constriction rounded, in front of which they are acute and form two prominences on each side, a larger long posterior one, and a small tooth-like anterior one. Anterior palatine foramen extending to between the canines. Posterior palate with a pair of large vacuities opposite  $M^2$  and  $M^3$ , and a pair of minute ones behind them. Bullæ large and evenly rounded, their mastoid portion much swollen.

*Teeth.*—Of the upper incisors, the first pair are cylindrical, curved and separated from each other and from the second incisors, which are smallest. The lateral incisors are flattened, sub-equal

in height, but graduated in length, the posterior ones being longest; they are well separated from the canines which are long and slender.  $P^4$  not developed,  $P^3$  slightly larger than  $P^1$ . Lower incisors as large as the upper ones, spatulate, the anterior pair larger than the others. Canine without posterior basal ledge  $P^1$  and  $P^3$  large, subequal, touching each other, in contact with the canine and  $M^1$  respectively.  $M^1$  narrowed in front without antero-internal secondary cusp.

*Dimensions.*

Basal length ... ..	35.0	...	33.0
Greatest breadth ... ..	24.1	...	22.9
Nasals, length ... ..	12.2	...	10.7
,, breadth greatest ... ..	4.8	...	4.4
,,     ,, least ... ..	2.9	...	2.5
Constriction ... ..	7.0	...	6.7
Palate length ... ..	18.0	...	17.9
,, outside $M^3$ ... ..	13.3	...	12.3
Palatal foramen ... ..	3.0	...	—
Basi-cranial axis ... ..	14.0	...	13.0
Basi-facial axis ... ..	21.0	...	20.0
Facial index ... ..	150	...	154
Teeth, length of $M^{1-3}$ ... ..	8.2	...	8.0
,, breadth of $M^4$ ... ..	2.2	...	2.1

DESCRIPTION OF A NEW SPECIES OF *PACHYCEPHALA*.

By ALFRED J. NORTH, C.M.B.O.U., C.M.Z.S., Ornithologist.

*Pachycephala howensis*, sp. nov.

*Adult Male*.—General colour above olive-green; band on the hind neck rich yellow slightly washed with olive-green; lesser wing-coverts like the back, the median and greater coverts black margined with olive-yellow; quills black, the primaries externally edged with olive-green which passes into ashy-olive on the outermost series, the secondaries externally margined with olive-green; rump and upper tail-coverts olive-green; tail olive-green with an indistinct subterminal blackish-brown band which is almost lost on the outermost feathers; crown of the head, nape, a line of feathers below the eye and the ear-coverts black; throat white, followed by a black crescentic band on the fore neck which meets the black feathers on each side of the nape; remainder of the under surface and the under tail-coverts rich gamboge-yellow; bill black; legs and feet dark slaty-grey; iris dark brown. Total length 6.6 inches, wing 3.6, tail 3, bill 0.45, tarsus 0.9.

*Adult Female?*—Similar to the adult female of *Pachycephala gutturalis*, but having deeper yellow under tail-coverts.

*Hab.*—Lord Howe Island.

*Type.*—In the Australian Museum.

*Remarks.*—This species is closely allied to *Pachycephala gutturalis*, Latham, of the Australian continent, but from which the adult male may be distinguished by the olive-green tail and the smaller and less distinct subterminal blackish-brown band. In some specimens the band is formed by a large oval spot in the centre of the web only, and which is entirely lost on the outermost feathers. Eight specimens in the collection were procured by Messrs. Etheridge and party in 1887. Another adult male was obtained by Mr. E. R. Waite in April, 1898.

In the "Catalogue of Birds in the British Museum,"<sup>1</sup> Dr. Gadow in describing *Pachycephala gutturalis*, remarks:—"The amount of grey on the tail varies much, and is sometimes replaced by olive-yellow. This is especially the case in examples from

<sup>1</sup> Gadow—Cat. Bds. Brit. Mus., viii., 1888, p. 198.

Lord Howe Island and Tasmania." Evidently the specimens in the British Museum labelled from the latter island are not properly localized, for the only yellow-breasted species of *Pachycephala* inhabiting Tasmania is *P. glaucura*, which has the tail feathers uniformly grey and entirely devoid of any olive-yellow wash. Moreover Dr. Gadow's description of the adult male of *P. gutturalis*, "basal two-thirds of the tail grey, apical third blackish-brown, tipped with grey" is not applicable to that species but to the western form *P. occidentalis*. Latham's diagnosis of *P. gutturalis*, is founded on his description of the Guttural Thrush,<sup>2</sup> which he states is "not infrequently seen at Port Jackson in the winter months." Adult males of *P. gutturalis*, from New South Wales have the basal portion of the tail-feathers olive-green, or grey with a more or less olive-green wash especially on the outer webs. Specimens from South Australia received on loan from the Trustees of the South Australian Museum, also one in the collection obtained by Mr. J. A. Thorpe in the hills near Adelaide, are like the western form *P. occidentalis*, but have the basal portion of the tail-feathers of a slightly darker grey and the blackish-brown apical band darker and broader. Some specimens from western Victoria are similar to those from South Australia. A specimen in Mr. Edwin Ashby's collection procured at Lal Lal is like *P. occidentalis*, but having the faintest trace of an olive-green wash on the basal portion of the tail-feathers and the apical band much broader. Should it be necessary to distinguish this darker grey tailed form from South Australia and western Victoria I would propose for it the name of *Pachycephala meridionalis*. This forms a connecting link between the species inhabiting New South Wales and its extreme western representative *P. occidentalis*. The adult male in the Australian Museum collection, obtained by Mr. Thorpe in the hills near Adelaide in June, 1887, measures—Total length 6.5 inches, wing 3.75, tail 3.2, bill 0.45, tarsus 0.88.

Another collection of birds made by Mr. Waite on Lord Howe Island in December, 1902, contained two species that have not been previously recorded from that island, viz., *Tringa subarquata*, Gldenst. and *Puffinus carneipes*, Gould. A specimen of the latter was also obtained by Mr. E. H. Saunders on the same island so far back as 1887.

---

<sup>2</sup> Latham—Gen. Syn. Bds. Suppl., ii., p. 182.



AN ASSOCIATION OF NATROLITE AND DATOLITE AT  
POKOLBIN, NEW SOUTH WALES.

By C. ANDERSON, M.A., B.Sc., Mineralogist.

In September, 1901, the Trustees of the Australian Museum acquired by exchange with the University of Sydney, through Professor T. W. E. David, Trustee, three specimens of a white, fibrous, radiating mineral, believed to be natrolite. It occurs in veins and cavities in an amygdaloidal hypersthene-andesite (*vide* Prof. David) at Kangaroo Grounds, Millfield, Pokolbin, Co. Northumberland. One specimen, of which an analysis (No. IV.) is given, is undoubtedly typical natrolite, but a preliminary examination showed that the others contain a notable amount of boric acid, and detailed chemical and microscopical investigation left little doubt that we have here an intimate mixture of the two minerals natrolite and datolite. This result is of some interest, as datolite, so far as I am aware, has not hitherto been recorded from the mainland of Australia, though occurring in Tasmania.

*Physical Characters.*—The mixture is white, almost opaque, the fibres radiate from several centres and appear bladed on fracture. It fuses between 2 and 3, with slight intumescence, to a clear glass. Specific gravity determinations gave values varying from 2.27 to 2.54, suggesting a mixture, not a definite mineral. The natrolite does not differ materially in appearance and habit save that it seems less compact. The habit of the two is that which is typical of natrolite, thomsonite and pectolite. The specimens which react for boron look perfectly homogeneous to the eye and, on a superficial examination, might easily be mistaken for a single mineral.

*Microscopic Characters.*—Two sections were prepared, one parallel to the direction of the fibres, the other transverse. The former plainly revealed the presence of two minerals, one of which has a low refractive index and weak birefringence, depolarising in colours of the first order. It is fibrous and striated parallel to its direction of elongation. Extinction is straight and compensation takes place perpendicular to the length of the fibres. The other occupies the interspaces between the fibres of the first, is not striated, has a higher refractive index and stronger birefringence, depolarising in second order colours. The extinction has no constant relation to the borders of the

stripes, shewing that the mineral has no definite orientation. The transverse section is even more conclusive. The field is studded with nearly square cross-sections of a mineral with weak double refraction. It shews well-marked zonal growth, appears rather cloudy, perhaps from inclusions, and extinguishes diagonally. It is biaxial, shewing emergence of a bisectrix, and therefore, the extinction being straight, as already observed in the other section, belongs to the orthorhombic system. The axial plane is parallel to *b*, and the optical sign positive. These are the optical properties of natrolite, and, taking this in conjunction with the occurrence of pure natrolite alongside, we may fairly conclude that one component in the mixture is natrolite. The rest of the section is occupied by an interstitial mineral of rather high double refraction. As to the relations of the two minerals, it is apparent that the one with definite crystal outlines is generally of prior formation to the other, though in some parts of the section portions of the latter are included by the former. This may possibly be explained by solution and intrusion subsequent to the formation of the earlier mineral.

*Chemical Characters.*—The mixture easily decomposes with hydrochloric acid, yielding gelatinous silica. The analytical methods employed call for no particular mention, except as regards the direct determination of boric acid, a somewhat difficult operation, and one involving a considerable expenditure of time. With the exception of the natrolite analysis No. IV, all the determinations were made on the same specimen. Several lumps were broken off, the cleanest selected and broken successively into smaller and smaller pieces, of which the most homogeneous and purest-looking only were taken. The final selection was made under a lens. Two samples A and B were thus procured, and, as might have been expected, were found to differ slightly in composition. In sample A boric acid was estimated directly, in sample B by difference. For the direct estimation 1.3320 grams were taken. The method employed was substantially that of Gooch.<sup>1</sup> A 150 c.c. pipette, suitably bent, was utilised as a retort, and heated up to 160°C in a bath of paraffin melting about 78°C. In a preliminary trial the fine powder was introduced into the retort, and nitric acid and alcohol added, but it was difficult to judge when the mineral was completely decomposed, and also to limit the quantity of acid to a minimum, success in which greatly facilitates the future operations. Subsequently the material was, as recommended by Penfield, fused with sodium carbonate, exhausted with water, carbonate of ammonia added, and the residue and precipitate filtered off and washed. The solution was rendered just acid by

---

<sup>1</sup> Gooch—Bull. U.S. Geol. Surv., No. 42, 1888, p. 64.

nitric acid, using methyl orange as indicator. The retort was charged with about 40 c.c. of solution, made up of 20 c.c. of filtrate, 2 c.c. nitric acid and the rest alcohol. The distillate was caught in a flask containing strong ammonia solution,<sup>2</sup> then transferred to a porcelain basin (platinum not being available) and evaporated to dryness over lime. The lime was prepared from pure calcium carbonate, ignited in a platinum crucible until of constant weight, when the bulk of it was transferred to the porcelain basin, the distillate added and evaporated on the water bath, the basin being supported on a porcelain ring inside a somewhat larger basin. By this means the evaporation proceeded with perfect safety, if rather slowly. When dry the contents were removed to the platinum crucible containing the residue of the lime, and heated cautiously at first, and finally ignited over the blast until of constant weight. The residue in the retort was tested unsuccessfully for boron, also the residue from the fusion with sodium carbonate. This proves that all the boric acid was secured in the distillate.

To prevent contamination of silica and the bases by small quantities of boric acid, recourse was had to repeated evaporation with alcohol and a little hydrochloric acid.

For analysis III a quantity of sample B was thrown into methylene iodide diluted with benzene to a specific gravity 2.6, intermediate between the specific gravities of natrolite and datolite. A partial separation took place, and the analysis was made on the lighter portion. A complete separation is unattainable owing to the intimate nature of the mixture.

	A		B		IV	V
	I	II	III	IV		
H <sub>2</sub> O @ 100°C—	} 6.87	.26	} 7.56	.34	} 2.95	
H <sub>2</sub> O @ 100°C+		6.89		9.38		
SiO <sub>2</sub> ... ..	43.47	43.44	44.25	46.91	38.72	
Al <sub>2</sub> O <sub>3</sub> ... ..	16.07	18.67	23.47	27.10	—	
CaO ... ..	14.54	13.06	8.42	.63	33.83	
K <sub>2</sub> O ... ..	} 8.96	.39	} 11.57	.14	—	
Na <sub>2</sub> O ... ..		9.23		15.65		
B <sub>2</sub> O <sub>3</sub> ... ..	9.93	(8.06)	(4.76)	—	23.66	
	99.84	100.00	100.00	100.15	99.16	

I, II, III. Mixture of natrolite and datolite.

IV. Natrolite.

V. Calculated composition of datolite.

<sup>2</sup> Penfield and Sperry—Am. Journ. Sci., (3), xxxiv., 1887, p. 222.

*Discussion of Analyses.*—Analysis I, in which the boric acid was determined directly, gives us the ratios  $\text{H}_2\text{O} : \text{SiO}_2 : \text{Al}_2\text{O}_3 : \text{CaO} : \text{Na}_2\text{O} : \text{B}_2\text{O}_3 = 269 : 507 : 110 : 183 : 101 : 100$ . From this we deduce the empirical formula  $\text{Al}_2\text{O}_3 \cdot 2 \text{CaO} \cdot \text{Na}_2\text{O} \cdot \text{B}_2\text{O}_3 \cdot 5 \text{SiO}_2 \cdot 3 \text{H}_2\text{O}$ , which corresponds to

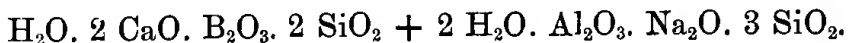

Datolite.

Natrolite.

Therefore we must assume that sample A contains natrolite and datolite in molecular proportions. Analysis II does not yield a simple formula but it is noticeable that lime and boric acid retain the ratio of 2:1 and that they vary in the opposite direction to the alumina and soda, which on the other hand retain their ratio of 1:1. The same holds with analysis III; therefore it is a fair assumption to conclude that we are dealing with two silicates, one of which contains lime and boric acid, the other alumina and soda. Further relying on the microscopic determination of natrolite in the mixture, and taking analysis IV as representing its composition, we can, by assuming all the alumina and soda in the mixture to belong to natrolite molecules, calculate the composition of the other component. The calculated result is given in analysis V, and is sufficiently near to the published analyses of datolite to warrant the conclusion that datolite does actually exist in the mixture.

DESCRIPTION OF THE NEST OF THE GUTTATED BOWER-  
BIRD, *CHLAMYDODERA GUTTATA*, GOULD.

By ALFRED J. NORTH, C.M.B.O.U., C.M.Z.S., Ornithologist.

(Plate xvi.)

The Trustees of the Australian Museum have received from Mr. C. Ernest Cowle, through Mr. G. A. Kearland, a nest of *Chlamydodera guttata*. Up to the present time only two nests of this species have been recorded, and both were also found in Central Australia. One discovered by Mr. Cowle on the 28th October, 1898, in a mulga growing in a valley south of Mareena Bluff, contained minute fragments of eggshell and dried up yolk, a young Bower-bird just able to fly being caught in the same tree. Another nest with two fresh eggs was found by Mr. James F. Field during the first week in February, 1899, near Alice Springs Telegraph Station. Both of these nests are referred to in "Nests and Eggs of Birds found breeding in Australia and Tasmania"<sup>1</sup>. The present nest, which contained three young ones, was found by one of Mr. Cowle's black boys near Illamurta about the 18th January, 1903. It is a nearly flat, oval structure, built at the junction of a horizontal forked stem of a *Capparis spinosa*, the foundation being irregularly formed of long, thin twigs and thorny stems interlaced together, and the inside, which is slightly cupped, is lined with finer twigs, and some curly tendrils and dried grass stems. With the exception of a few straggling twigs, it measures externally twelve inches in length along the fork, eight inches in breadth, and four inches in depth, the inner cup averaging four inches in diameter by one inch and a quarter in depth. Relative to this nest, which is figured on Plate xvi., Mr. Cowle, writing from Illamurta, Central Australia, under date 21st January, 1903, has kindly supplied me with the following notes:—"One of the black boys told me a few days ago there was a Bower-bird's nest, with three young in it, about a mile from here, and I have just come back from having a look at it. The nest was built in a "Native Orange" (*Capparis spinosa*), the fruit of which is a favourite food of these

---

<sup>1</sup> North—Aus. Mus. Spec. Cat., i., 2, 1902, p.p. 50, 51.

birds. We found that two of the young ones had left the nest, but managed to secure the other after some time, which was just able to flutter about. One of the parents was very daring, flying repeatedly at the boy, at the same time ruffling up its feathers like a rooster and making most peculiar noises in its throat. I got the boy to take the young one to the nest and make it cry out, and while the parent was peering at him he grabbed it also, and I am going to see if I can rear them in a cage. The nest is very similar to the one I previously described to you, and has that 'last season' appearance about it. I will cut it carefully down when I am better, and will send it to you. What surprised me most was the viciousness and daring of the bird the boy caught. Usually they are shy and cunning when one is about, caeckling and screeching until you appear, and then one cannot hear or find them although you may be quite close to them." Mr. Cowle subsequently informed me that the young bird did not live long, and that the old one died after it had been kept in captivity for about ten months.

With the above nest Mr. Keartland kindly forwarded me on loan for description the fellow egg of the set taken by Mr. Field, near Alice Springs Station, the first egg being fully described and figured in Part ii. of "Nests and Eggs of Birds found breeding in Australia and Tasmania."<sup>2</sup> It is of a greenish-grey ground colour, which is overlaid with splashes, long blurred streaks, and angular, curved, or zig-zag markings of different shades of umber-brown, most of them being broader in the middle and tapering out towards each end; one somewhat resembles a man's head, another consists of a broad black streak, which joins a similar coloured scroll. Length, 1.52 x 1 inch. So far as is known the remarkably handsome set of eggs of the Guttated Bower-bird in Mr. Keartland's collection are the only specimens yet taken.

---

<sup>2</sup> North—Loc. cit., p. 51, pl. ii., fig. 7.

## OCCASIONAL NOTES.

1.—THE *TAVAU*—OR COIL FEATHER MONEY OF  
SANTA CRUZ.

In response to my enquiry as to the whereabouts of examples of this interesting form of currency, Prof. W. T. Brigham, M.A., has briefly described a specimen in the Bernice Pauahi Bishop Museum<sup>1</sup>, and Prof. F. W. Hutton has forwarded me a description of an old coil in the Canterbury Museum, at Christchurch, bringing the number of recorded coils at least up to six. The Honolulu example is twenty-three feet long, and a trifle over an inch wide, and like our specimen is coiled on wooden hoops, with Job's Tears (*Coix lachryma*) seeds on the edges near the ends, but no other decorations.

The Canterbury coil is thus described by Prof. Hutton:—  
“The feather part of the belt is twenty-two feet, nine inches long and three-quarters of an inch wide. At each end it tapers off into a piece of plaited sennet, to which is attached a ring of wood, six inches in diameter. The wooden rings are made of split liana, and are double, or two turns. The belt is formed of bundles of vegetable fibre rolled transversely, pressed flat, and held in their places by narrow, longitudinal strips of fibre blackened on the outside with some kind of varnish; there are from two to four of these longitudinal bands. This internal structure shows on only one place on the belt where it is very much worn, for outside this mat-work there is another layer of string, like what sailors call ‘serving.’ It is in this binding that the feathers are inserted with a black varnish which stieks them all together. In our specimen most of the red feathers are worn down to blackened stumps. The belt is ornamented at the two ends, and at two places in the middle, with little strings of beads made of white seeds, and each string has an obsidian bead in the centre, and a fish cut out of *Haliotis* shell at the end.”

The wooden hoop support is evidently a favourite form of core in these coils, for it is present in the Australian Museum specimen, in Prof. Brigham's, and again in that described by Prof. Hutton. I suspect the white seeds mentioned by the latter are Job's Tears, similar to those on the Honolulu coil.

Still later Baron A. von Hügel has informed me of the existence of a fine specimen in the Cambridge Archæological and Ethnological Museum<sup>2</sup>, formerly in the possession of the late Bishop Selwyn, thus raising the number to seven.

R. ETHERIDGE.

<sup>1</sup> Brigham—Mem. Bernice Pauahi Bishop Mus., i., 5, 1903, p. 18, f. 20.

<sup>2</sup> 17th Ann. Report Antiq. Committee Mus. General and Local Archæol. and Ethnol. Cambridge, 1902, p. 14, No. 1316.

## II.—THE HABITAT OF *GOMPHINA MOERCHI*, ANGAS.

Mr. E. A. Smith writes<sup>1</sup>, in references to this species:—"The locality of *G. moerhi* was unknown at the time it was described, but examples received from the late M. Robillard show that it occurs at the Mauritius." In the "Hargraves Collection," now in the Australian Museum, there is an example of this species from the New Hebrides. As it was referred to Mr. E. A. Smith some years ago, and is labelled in his handwriting, the identification is beyond dispute.

C. HEDLEY.

## III.—THE GENUS *DROMICIA* IN NEW SOUTH WALES.

Commenting on the distribution of *Dromicia*, Mr. Oldfield Thomas<sup>2</sup> remarks that "the genus is isolated in the three places most conspicuous for their retention of ancient forms—New Guinea, Western Australia, and Tasmania, while no species appears now to live in the temperate parts of Eastern Australia."

Under the name *Dromicia unicolor*, Krefft recorded two examples, one taken at St. Leonards, the other at Sydney. Assigning these to *D. nana*, Thomas<sup>3</sup> further writes:—"The two specimens of '*D. unicolor*' mentioned by Krefft came from the near neighbourhood of Sydney, and I have no doubt that both escaped from captivity, as the species has otherwise never been recorded from the mainland, while it is at the same time to be found in the collection of almost every dealer in live animals."

On the sixth of October last, the Trustees of the Australian Museum received from Mr. T. Goldby, of Grosse's Plains, Jindabyne, an example, which I also identify with *D. nana*. It differs from typical specimens, however, in having in each side a very pronounced dark band from the nose to beyond the eye. The little animal was taken from a log near the Snowy River, in the midst of the country where the Tasmanian fauna is most richly represented on the continent. Though I cannot claim this occurrence as grounds for definitely including *Dromicia* in our fauna, it is not at all improbable that representatives may still exist in the Tasmanian-like climate of the Australian Alps.

EDGAR R. WAITE.

<sup>1</sup> E. A. Smith—Journ. of Malac., ix., pt. 4, 1902, p. 110.

<sup>2</sup> Thomas—Brit. Mus., Cat. Marsup. and Monotr., 1888, p. 141.

<sup>3</sup> Thomas—*Loc. cit.*, p. 146, footnote.



ADDITIONS TO THE FISH-FAUNA OF LORD HOWE  
ISLAND, No. 4.

By EDGAR R. WAITE, F.L.S., Zoologist.

(Plates xvii.-xxiv., and fig. 32.)

In my last contribution I wrote<sup>1</sup>:—"Towards the end of the year I hope to spend two or three weeks on Lord Howe Island, for the purpose of studying the fishes, and in a more thorough manner than was possible on the occasion of my short and unprepared visit in 1898."

After two days steaming from Sydney, I arrived at the island on 3rd December, 1902, by the S.S. "Tambo," together with Mr. A. R. McCulloch, who accompanied me as an assistant. It was our intention to return by the S.S. "Titus," due at the island about December 20th, but she did not put in an appearance until Christmas Day, and was then seen about nine miles outside the reef in a lumpy sea. Owing to the entire absence of any shelter, landing is difficult and dangerous in heavy weather, we were not therefore surprised when the vessel hoisted a signal and turning westward made for Sydney. I was thus, for the second time, left, contrary to my intentions. We finally got away by the "Tambo" on her return from the New Hebrides, arriving in Sydney on January 21st. What had thus been organised as a private holiday, in which my wife and son participated, encroached upon, and terminated in official time. Our enforced stay was not however a matter for regret as the general conditions proved much more propitious during the second period, and we were in consequence able to work more satisfactorily and with much better results.

Unfortunately at no time were the tides wholly favourable, we were thus unable to work the outermost portion of the reef, and it so fell that when the tides were lower, heavy weather interfered with collecting.

In addition to the usual fishing gear, nets, lines, traps, etc., we had an ample supply of explosives and poisons, and for permission to use these otherwise illegal methods, I wish to express my thanks to the Fishery Commissioners of New South Wales. I have also to thank Messrs. Keele and Cameron of the

---

<sup>1</sup> Waite—Rec. Aust. Mus., v., 1903, p. 20,

Harbour and Rivers Branch of the Works Department for the loan of an electric sparking machine. This obviated the use of a time-fuse in firing explosives, and rendered their use comfortable and harmless in comparatively inexperienced hands. In the South Sea Islands the natives are constantly using dynamite and frequently come to grief by their economy in firing with dangerously short fuses. A collector there may always rely on ready assistance. At Lord Howe Island, on the contrary, where there are no natives, a collector must manipulate his own explosives and thus finds an electric discharger, possibly cumbersome, but certainly, as I have said, comfortable.

In the matter of poisons I have to thank my esteemed correspondent, Dr. David S. Jordan, President of the Leland Stanford Jr. University, California, for valuable advice in their selection and method of application. In the rock pools their use was invaluable and, as the following pages will indicate, responsible for many of the novelties obtained.

In this connection also, a fine meshed net (prawn net) was of great service. The pools on the east side of the island frequently so communicate with one another as to form a chain, consisting of a series of deep pools connected by shallow passages. On selecting a pool for work, it was first necessary to close the passages, a net proving the best medium.

Fishes found in rock pools are broadly divisible into two classes, namely accidental and permanent. The former comprise those free swimming species which happen to be in the pool as the water recedes, and are thus imprisoned until the rise of the next tide. The pools always contained a fair number of these accidental denizens: when disturbed such fishes rush wildly about seeking some outlet they know not where, a characteristic I have elsewhere detailed.<sup>2</sup>

The rock-pool fishes proper, pass a very different existence, when surprised or incommoded by the poison, they at once hide themselves in a crevice, under a rock or among seaweed, or if the pool be one of a chain they may rush straight for a passage, and finding this barred make for a smaller one which perchance escaped our eye. They are so obviously at home and know every stone and angle in the pool that possibly numbers never leave the identical pool in which they were bred.

Although apparently of frail structure, these little fishes have wonderful powers of stemming the force of an inrushing wave. This was especially noticeable in the case of *Glyphisodon* and *Parma*, easily watched by means of the water telescope: they certainly revelled in the tumbling waters, and though perhaps

---

<sup>2</sup> Waite—Proc. Linn. Soc. N.S. Wales, (2), ix., 1894, p. 217.

temporarily swept back, speedily regained their position. To the uninitiated I may mention that the water telescope or water glass, as it is also called, is simply a vessel with a glass bottom, which, when placed on the surface of the water, instantly stops the ripple and enables one to see clearly to considerable depths. A ripple on the water prevents the fishes from seeing upwards beyond the surface, just as it does our seeing below it. Similarly the water-glass provides a window for the fishes, a circumstance which was readily availed of; the beautiful Pomacentrids in especial, thrusting their snouts against the glass.

The introduction of poison into a pool produces a different behaviour among the various inhabitants. What I have previously called the accidental denizens such as *Mugil*, *Atherina*, *Kuhlia*, etc., died in the open. Rock fishes such as *Epinephelus*, *Girella*, etc., sought hiding places, vacated echinoderm-holes being favourites, for it may be mentioned that these Invertebrates are very sensitive to poison and leave their retreats with surprising alacrity, exceeded however by the crabs. Anemones close-up, loosen their hold and fall off the rock or weed. Bleunnies (*Salaria*, *Petroscirtes*) promptly left the water where possible, and skipping over the rocks attempted to reach other pools. Eels gave us the most trouble; so openly is the coral rock massed together that it abounds in holes and crevices, which furnish hiding places or the means of escape for the sinuous eels. By breaking away the rock with a crowbar we secured a few examples, these being however but a small proportion of those seen.

The principal bait used by the islanders for line fishing is the larva of a large longicorn beetle, (*Agrianome gemella*, Pascoe) and no one would think of fishing without first obtaining a supply. These larvæ are found in dead, though still hard wood, and an axe is necessary for their extraction. They are extremely common and appeared to particularly infest the banyan trees. The grub when full grown is nearly as large as one's thumb and the skin only is used on the hook, the juicy contents being squeezed out, and used as "berley," (an Australian term for ground bait). Crabs also furnish bait and in consequence of its habit of running over the rocks above water mark, *Grapsus variegatus*, Fabricius, is the species usually obtained; the legs and shell are torn off and the body only placed on the hook.

In writing on the Flying Fish (*Exonastes roundletii*) I mention the presence of sea birds on the Admiralty Islets. On the occasion of our visit, which was fortunately in the breeding season, the birds were present on and around the islets in countless myriads.

Though fishes teem in the waters, the amount consumed per day, and every day, must be measured by tons.

I should be extremely loth to advocate any wanton destruction, yet if Lord Howe Island is to become a fishing ground for New South Wales, the question of bird-life will be one to seriously engage attention. The date of our visit to the islets was December 10th, at which time the following species were breeding:—

Wide-Awake	...	<i>Sterna fuliginosa</i> , Gmelin.
Noddy	...	<i>Anous stolidus</i> , Linnæus.
Blue Billy	...	<i>Anous cinereus</i> , Gould.
Small Mutton Bird...		<i>Puffinus chlororhynchus</i> , Lesson.
Gannet	...	<i>Sula cyanops</i> , Sundevall.

The large Mutton Bird, *Puffinus carneipes*, Gould, and the Bo's'n Bird, *Phaeton rubricauda*, Boddaert, were also breeding on the main island. The determinations are made by Mr. A. J. North and the vernacular names are those employed by the islanders.

This contribution does not include notices of all the fishes obtained during our visit to the island, but those only which prove to be new to the fauna or upon which some observations were made. On the other hand, several species not obtained are mentioned mainly for the purpose of delineation. As a result it will be seen that nearly all the species known from the island are now figured.

A few of the accompanying illustrations are, as on previous occasions, my own productions, the greater number were however prepared by my assistant, Mr. A. R. McCulloch, whom I have specially trained for the work. The drawings were made under my immediate supervision and may therefore be relied upon for accuracy of detail and general proportion.

On October 20th, 1903, nine months after our return, the fine steamer "Ovalau," while proceeding from Norfolk Island to Lord Howe Island took fire, and following an explosion sunk off the latter island, in twelve fathoms. During the present month (January, 1904) certain salvage was effected by Captain J. Weston, dynamite being largely used for the work. The explosives killed many fishes, a selection of which was placed in the hands of Mrs. T. Nichols, who kindly preserved them for transmittal to the Trustees.

One known species is thus added to the fauna, and several specimens of other species, larger and finer than previously received, are included. The thanks of the Trustees are due to Mr. Weston for his kindness in thus collecting the fishes and bringing them to Sydney.

The following is an epitome of the contents of this contribution to the fauna.

The following seventeen known species have not been previously recorded from the island:—

- Carcharhinus menisorrh*, Valenciennes.  
 \**Gymnothorax thyrsoides*, Richardson.  
     ,,       *nubilus*, Richardson.  
     ,,       *flavimarginatus*, Rüppell.  
*Trachinocephalus myops*, Forster.  
*Myctophum phengodes*, Lütken.  
     ,,       *opalinum*, Goode and Bean.  
     ,,       *hygomi*, Lütken.  
     ,,       *reinhardtii*, Lütken.  
 \**Exonastes rondeleti*, Cuvier and Valenciennes.  
*Bathystethus cultratus*, Forster.  
*Cubiceps gracilis*, Lowe.  
*Epinephelus rhyncholepis*, Blecker.  
*Genyoroge bengalensis*, Bloch.  
*Anampses diadematus*, Rüppell.  
*Sebastes guamensis*, Quoy and Gaimard.  
*Tripterygion nigripinne*, Cuvier and Valenciennes.

The species marked with an asterisk respectively replace *Murena afra*, Bloch, and *Exocetus dovii*, Gill, incorrectly identified from the island.

Ten species are described as new, those marked with an asterisk being regarded as types of new genera:—

- Muraenichthys nicholse*,  
*Gymnothorax chalazius*,  
*Notoscopelus ejectus*,  
*Dasyscopelus naufragus*,  
 \**Xenogramma carinatum*,  
*Pseudomonacanthus analis*,  
 \**Allogobius viridis*,  
 \**Limnichthys fasciatus*,  
 \**Lepadichthys frenatus*,  
*Tripterygion rufopileum*,

In addition to the above the following are figured for the first time:—

- Æthoprora perspicillata*, Ogilby.  
*Howella brodiei*, Ogilby.  
*Bathystethus cultratus*, Forster.  
*Schedophilus maculatus*, Günther.  
*Apogon chrysurus*, Ogilby.  
*Girella cyanea*, Macleay.  
*Aplodactylus etheridgii*, Ogilby.

*Parma polylepis*, Günther.  
*Glyphisodon polyacanthus*, Ogilby.  
*Gobius aelosoma*, Ogilby.  
*Diplocrepis costatus*, Ogilby.  
*Petroscirtes icelii*, Ogilby.  
*Dinematichthys longifilis*, Ogilby.

CARCHARHINUS MENISORRAH, Valenciennes.

*Carcharias menisorrah*, Valenciennes, in Müller and Henle, *Plagiostomen*, 1838, p. 46, pl. xvii.

Sharks, up to four feet in length, are by no means uncommon in the lagoon, but no one has been known to be attacked. While indulging in our early morning and occasional evening swim they were never seen nor thought of, but their presence was occasionally indicated at night by a long phosphorescent glow, when two examples about three feet in length were caught. Angling from the jetty for salmon (*Arripis trutta*, Bloch and Schneider), which afforded good sport, the whole shoal would suddenly disappear, and the presence of a shark would supply the reason, or if not actually seen, its proximity was sufficiently suggested. Outside the reef, sharks were very commonly seen and of much larger size than those within. One school, in attendance on the steamer while at anchor, numbered about thirty, individuals of which must have measured twelve feet in length. We caught several which proved to be of the same species as those taken inside the lagoon. They were pale ashy-grey above and lighter beneath, appearing most conspicuous in the deep blue water and visible when several fathoms below the surface.

With the exception of the next-named, *Carcharhinus menisorrah* was the only shark met with, though the inhabitants report an occasional Tiger Shark. Ogilby<sup>3</sup> writes:—"I am convinced that *Galeocerdo rayneri* and *Carcharodon rondeletii* will prove to be the most abundant of the large sharks." The first-named, as I have indicated, very probably occurs off the island, but the latter should be removed from the list (until authenticated) in favour of the abundant species I now record.

*C. menisorrah* was recognised from Australia (Newholland) by Müller and Henle. The locality was however not included in the British Museum Catalogue, which probably accounts for its omission from Australian lists.

The islanders told me that, two or three miles outside the reef,

---

<sup>3</sup> Ogilby—Aust. Mus. Mem., ii, 1889, p. 52.

sharks are to be found "in thousands." If so there should be opening for a good industry in sharks' fins. At present there is no boat on the island large enough to engage in such work except in the calmest weather, and as sudden squalls are not infrequent, it is not safe, at any time, to venture far from the shelter of the lagoon, in the small boats available.

ISISTIUS BRASILIENSIS, *Quoy and Gaimard.*

*Scymnus brasiliensis*, Quoy and Gaimard, Voy. "Uranie.," Zool., 1824, p. 198.

In 1900 I first recorded this species for the island<sup>4</sup> and now chronicle a second example: this was caught by Mr. Robert Thompson, with hook and line, and handed to us by Mrs. Nichols. It is a female and somewhat smaller than the previous specimen, a male, measuring 342 mm. in length; it is similarly coloured and likewise possesses thirty-one teeth in the lower jaw.

I have followed authors in assigning the name to Quoy and Gaimard, though these writers credit it to Cuvier. Of the "Règne Animal" the only edition available to Quoy and Gaimard in 1824 was the first (1817), this does not contain the species and I have been unable to find it described in any other of Cuvier's writings. It is possibly an unpublished museum or manuscript name and should therefore be attributed to the authors who first described the species.

DASYATIS, *sp.*

Pulling across the lagoon one day, I noticed a large Sting Ray lying on the bottom in about a fathom of water. By means of the water-telescope I was able to see the ray very clearly. Some weeks later Mr. George Nichols while fishing in the lagoon, discovered a ray and by means of an oar, drove it beachwards for a considerable distance. After landing and returning with a harpoon, he was unfortunately not able to again locate the monster; in common with others he tells me that similar rays are not infrequently seen in the lagoon.

PLOTOSUS ANGUILLARIS, *Bloch.*

*Platystacus anguillaris*, Bloch, Nat. ausl. Fische, viii., 1794, p. 61.

When originally recorded from the island, this species was described as being abundant, a statement I can fully confirm.

At the north end of the lagoon are small masses of seaweed

<sup>4</sup> Waite—Rec. Aust. Mus., iii., 1900, p. 195, figs. 1-2.

three or four feet in diameter, their fronds oscillate in the wash of the waves and at low tide are barely covered. Occasionally when wading through the water one such apparent mass of seaweed will be noticed to become active and pass slowly over the sand. After the first investigation of such phenomenon this moving mass is known to consist entirely of the striped cat-fish. Though the water telescope reveals the striking markings of the species, the unaided eye perceives the regular yellow stripes only as disconnected patches rendered irregular by the ever-present ripple on the water. The resemblance to the seaweed becomes thus so complete that I imagine great protection is obtained from the attacks of Gannets and other birds to whom the fish would fall an easy prey in such shallow water. The wavelet-broken lines on the fish, supply the reflections of light cast by the crinkled seaweed and render the illusion complete.

It may be that, in the water, the conspicuous markings are of "warning" import: such would secure immunity from the attacks of other fishes, but would scarcely apply to birds to whose eyes they would lose the warning appearance.

By wading behind one of these fish-masses they may easily be driven into very shallow water and caught with hand nets. They move slowly and keep in a compact mass separating only when the net is dashed against them, soon to re-unite. In large shallow pools, left by the receding tide, congregations of small individuals are common; when much harassed they hide in the seaweed, or scattering, conceal themselves under stones, shelters not provided on the sandy shores of the lagoon.

This fish is usually quoted as *Plotosus arab*, Forskal,<sup>5</sup> but it may be noted that Forskal did not name it, the word "Arab," being merely a form of "Arabia" in reference to the native name *Boa* or *Buja*. Bleeker in 1863 first used the word *Arab* as a specific name, crediting it to Forskal, but Bloch had already named the fish *Platystacus anguillaris*, which should therefore be used; it is not jeopardised by *Silurus anguillaris*, Linnæus.

MURÆNICHTHYS NICHOLSE, *sp. nov.*

(Plate xvii, fig. 1.)

Head pointed, one eighth of the total length, a sac on the throat; anterior nostril in a tube close to the lip; owing to the presence of a number of large pores the position of the posterior nostril cannot be defined. Cleft of mouth one fourth the length of the head; eye situated above its posterior fourth, its diameter 2.5 in the length of the snout. Gill opening very small, round,

<sup>5</sup> Forskal—Descr. Anim., 1775, p. xvi., no. 36.



situated in the lower half of the head but widely separated from its fellow. Teeth of both jaws stout, those of the upper in a double series. Upper jaw much the longer, a row of large distant pores along the margin of each lip and others on the top of the head; head and trunk together three-fourths the length of the tail. Body worm-like, tail somewhat compressed, its depth one-thirtieth of the total length. Lateral line median, running the whole length of the body and tail. Dorsal fin very low arising well in advance of the vent, but nearer to it than to the end of the snout, anal scarcely higher than the dorsal, uniting with that fin around the end of the tail.

*Colours.*—Very pale green when alive, colourless in formaline. Upper half of head and body and the whole tail, the lower part excepted, covered with small black dots, producing a grey appearance. Clusters of larger dots occur at intervals near the lateral line more pronounced on the tail and tending to form transverse bands.

Length of specimen 63 mm.

It was obtained from a poisoned rock-pool on the western side of the island.

Four species of the genus *Muraenichthys* have been recorded from Australian waters, *M. australis*, Macleay,<sup>6</sup> *M. breviceps*, Günther,<sup>7</sup> *M. macropterus*, Bleeker,<sup>8</sup> and *M. gymnotus*, Bleeker.<sup>9</sup> For the first named, Ogilby<sup>10</sup> proposed a new genus *Scolecenchelys* in reference to its slender proportions: this species is known only from Port Jackson. In *M. breviceps* from Tasmania and *M. macropterus* from Amboyna and Victoria (*vide* Klunzinger) the dorsal fin arises nearer the head than the vent, while in *M. gymnotus* from Amboyna and Port Jackson it arises opposite to the vent. In *M. nicholsæ* the origin of the dorsal fin is nearer the vent than the head. Of all described species it most nearly approaches *M. gymnopterus*, Bleeker,<sup>11</sup> the fins are however, much lower, and in none do I find mention of the sac under the throat.

In grateful recognition of the many kindnesses received, I have pleasure in associating with this fish, the names of Mrs. T. Nichols and her daughters.

<sup>6</sup> Macleay—Proc. Linn. Soc. N.S. Wales, vi., 1881, p. 272.

<sup>7</sup> Günther—Ann. Mag. Nat. Hist., (4), xvii., 1876, p. 401.

<sup>8</sup> Bleeker—Act. Soc. Sci. Indo. Neerl., ii., 1857, (Amboina ii.), p. 91.

<sup>9</sup> Bleeker—*Loc. cit.*, p. 90.

<sup>10</sup> Ogilby—Proc. Linn. Soc. N.S. Wales, xxii., 1897, p. 246.

<sup>11</sup> Bleeker—Verh. Bat. Gen., xxv., 1852, Muraen. and Symbr., p. 52.

GYMNOTHORAX THYRSOIDEA, *Richardson*.

*Muraena thyrsoidea*, Richardson, Voy. "Sulphur," Ichth., 1844, p. 111.

This is the commonest eel of the island and was originally recorded<sup>12</sup> as *Muraena afra*, Bloch. Being unable to reconcile it with that species, and not having an authentic example for comparison with the island form, I forwarded a specimen of the latter to Dr. G. A. Boulenger, who kindly writes:—"The fish you sent me differs much from *Gymnothorax afer* (specimens from the Niger, and others), which has a much longer snout, and longer sharper teeth. I refer it to *G. thyrsoidea*."

Günther associates the figure published by Richardson as *Muraena thyrsoidea*, with *Gymnothorax makassariensis*, Bleeker, and considers that Bleeker's *G. prosopeion* is a synonym of *G. thyrsoidea*. I may mention that the mucous which clothes the body of this eel is transparent, and no great colour change takes place during preservation.

As *Gymnothorax afer* has appeared in the literature of the island, and is also recorded from New South Wales, a few remarks on the mainland species, so identified, may not be out of place.

*Gymnothorax afer* was first recorded from Sydney by Günther,<sup>13</sup> and subsequent writers have applied the name to our common green eel. I have never recognised *G. afer* on our coast, and refer the common species to *G. prasina*, Richardson.<sup>14</sup> When first removed from the water it is always (as recorded by Richardson, and noted by others) of bright green colour, and, in tint, exactly resembles a common green seaweed (*Phyllospora comosa*, Agardh), found among the rocks which the eel frequents.

This green colour is entirely due to the mucous which covers the body, an interesting fact discovered by my assistant, Mr. A. R. McCulloch, when preserving a recent example. When the mucous is scraped away the brown colour so characteristic of preserved examples is revealed. The colour is produced by pigment and not by the presence of algæ in the slime, a fact ascertained by microscopical examination. The origin of the colour is not therefore comparable with that found on the sloth and discovered by Dr. H. C. Sorby to be due to the growth of parasitic algæ among the hairs.

The mimetic colour of the green eel can scarcely be regarded as protective, and should rather be considered as of aggressive import. I do not remember to have read of an aualogous instance

<sup>12</sup> Ogilby—Aust. Mus. Mem., ii., 1889, p. 72.

<sup>13</sup> Günther—Cat. Fish Brit. Mus., viii., 1870, p. 124.

<sup>14</sup> Richardson—Voy. "Ereb. and Terr.," Fish., 1847, p. 93.

of colouration among fishes, and publish the interesting fact for the benefit of those collecting *data* on the subject of "Animal Coloration."

When the green mucous is removed, the body generally presents a brown colour, somewhat lighter on the head. An ill-defined dark streak passes from the snout on each side to behind the eye, the nostrils are margined with black and the angle of the mouth is dark. The longitudinal gular folds number four or five on each side. The body markings are confined to the lower half of the body and become obsolete behind the vent. They take the form of vertical dots which become deeper ventrally, the lower series form closely set transverse lines which extend across the abdomen.

GYMNOTHORAX NUBILUS, *Richardson*.

*Muraena nubila*, Richardson, Voy. "Ereb. and Terr.," Fish., 1847, p. 81, pl. xlvi., figs. 6-10.

One specimen only of this species was obtained. It is a new record for the island and was first described from Norfolk Island. Marine eels are generally spoken of as snakes by the islanders and are much dreaded on account of the fearful wounds they inflict.

GYMNOTHORAX FLAVIMARGINATUS, *Rüppell*.

*Muraena flavimarginata*, Rüppell, Atlas, Reise Nord. Afrika, Fische, 1828, p. 119, pl. xxx., fig. 3.

This eel is recognised from Norfolk Island by Günther and an example, which I also identify with the species, we owe to Mr. W. S. Thompson. It has not been previously recorded from Lord Howe Island.

GYMNOTHORAX CHALAZIUS, *sp. nov.*

(Plate xvii; fig. 2.)

Head compressed 8·3 in the total length. The gape is half the length of the head and the eye slightly less than half the snout. The teeth of the upper jaw are arranged in two series, an outer row of small sub-equal compressed teeth inclined backwards, there are twenty-eight in each ramus. Within these is a second row, those anterior to the front edge of the eye, nine in number on each side, are large, thrice the size of the outer teeth, stout and conical, their apices much bent backwards, they stand close to the outer row and are alternate with them. Posterior to the front edge of the eye, the inner series is widely separated from

the outer one, and consists of about nine spaced slender and almost straight teeth twice the length of those of the outer series. The anterior portion of the mouth is further provided with six long lance-like teeth, two in the mid line, of which the second is the largest tooth in the mouth, and two on each side alternate to the central ones. The vomerine series is not forked and comprises about twelve low conical teeth in a single series. The lower teeth are uniserial, similar to the outer row of the upper jaw, there are six large teeth (canines) anteriorly, corresponding to those of the upper jaw. With the exception of the vomerine teeth all are movable, the canines and inner upper teeth perfectly depressible. The converging extremities of the jaws prevent the mouth being closed at the sides.

The head and body are 2.2 in the total length, the tail 1.84 in the same. The dorsal fin begins in advance of the gill-opening and is not conspicuously elevated.

*Colours*.—Coffee brown all over except the under surface of the body which is yellowish. The dark parts, the fins included, are entirely ornamented with small white spots which anastomose somewhat on the cheeks, and are larger and more widely spaced on the tail. The posterior half of the head and the body, as far as the vent, bear about five rows of black spots, the upper ones as large as the eye, the lower ones much smaller.

Length of specimen 415 mm. A second example differs only in being somewhat smaller, 320 mm., and of rather lighter brown colour.

This species bears some resemblance to *Lycodontis parvibranchialis*, Fowler,<sup>15</sup> but differs in having the white spots much smaller and in eight or nine rows, instead of four only: the spots also extend over the fins. In *G. chalazius* the black spots are much larger than the white ones and are confined to the head and trunk. In this species also, the eye is very much smaller and the mandibular teeth are in a single series, the gape of the mouth is half the distance of the tip of the snout from the gill opening, but in the Hawaiian species it is a third of the distance only.

GONORHYNCHUS GONORHYNCHUS, *Linnaeus*.

*Cyprinus gonorynchus*, *Linnaeus*, *Syst. Nat.*, ed. xii., i., 1766, p. 528.

(Plate xvii; fig. 3.)

This fish is by no means uncommon, and has the habit of burying itself in the sand; it is, as far as I could learn, of some-

<sup>15</sup> Fowler—*Proc. Acad. Nat. Sci. Phil.*, 1900, p. 494, pl. xviii., fig 1.

what solitary habit, or at least is not found in large shoals. Of several specimens obtained, one is young and possesses an ornamentation different from the adult. It exactly resembles an unlocalised example found with New South Wales fishes in our store collection and also a young example which I identified for Mr. James S. Bray, of this city, and which I understood was taken at Narrabeen, off our coast, constituting a record for the State. These young fishes have the body of a pale sandy colour, with no trace of dark markings on the fins, so characteristic a feature of the adult. The lateral line is bounded immediately above and below by black spots, arranged in about sixty-five pairs, each spot is formed of an x-shaped figure. The lower row is continued forward to below the eye, but the upper row ceases far behind the head. There are also some small spots on the snout and a few large ones on the occipital region.

The umbilicus is found some little distance in front of the ventrals.

This is the fish *Gonorhynchus greyi* of Günther and authors generally. The generic name *Gonorynchus* was first given by Gronovius in 1763, but as his work is non-binomial the name cannot be used upon his authority. *Gonorhynchus* used in 1846 by both Cuvier and Valenciennes, and Temminck and Schlegel, is antedated by *Rhynchana*, Richardson, March, 1845. I find however that Cuvier republished the name in 1817, the reference to which has been omitted from Günther's and subsequent catalogues.

The first specific name, *gonorynchus*, is usually credited to Gmelin, but rejected on account of the *Scomber scomber* principle. Gmelin however but copied Linnæus who in 1766 fixed the name for all time, the synonymy therefore stands as follows:—

*Genus* GONORHYNCHUS, Cuvier, 1817.

*Gonorynchus*, Gronovius, Zoophyl., i., 1763, p. 55 (*non-binomial*).

*Gonorhynchus*, Cuvier, Règ. Anim., ed. i., 1817, p. 196.

*Rhynchana*, Richardson, Voy. "Ereb. and Terr.," Fish. 1845, p. 44.

*Gonorhynchus*, Cuvier and Valenciennes, Hist. Nat. Poiss., xix., 1846, p. 207; Temminck and Schlegel, Fauna Japon. Pisces, 1846, p. 217.

*Species* GONORHYNCHUS, Linnæus.

*Cyprinus gonorynchus*, Linnæus, Syst. Nat., ed. xii., i., 1766, p. 528.

Gmelin, in Linnæus, Syst. Nat., ed. xiii., 1788, p. 1422. Bloch and Schneider, Syst. Ichth., 1801, p. 443, pl. lxxviii., fig. 1 (*errore Conorynchus*).

*Cobitis gonorhynchus*, Gronovius (ed. Gray), 1841, p. 41.

*Rhynchana greyi*, Richardson, *loc. cit.*; pl. xxix., figs. 1-6.

*Gonorhynchus abbreviatus*, Temminck and Schlegel, *loc. cit.*, pl. ciii., fig. 5.

*Gonorhynchus gronovii*, Cuvier and Valenciennes, *loc. cit.* p. 207, pl. dlxviii.

*Gonorhynchus greyi*, Cuvier and Valenciennes, *loc. cit.*, p. 212. Günther, *Cat. Fish. Brit. Mus.*, vii., 1868, p. 373.

*Gonorhynchus brevis*, Kner, *Reise Novara, Fische*, 1867, p. 342, pl. xvi., fig. 1.

TRACHINOCEPHALUS MYOPS, *Forster*.

*Salmo myops*, Forster, in Bloch and Schneider, *Syst. Ichth.*, 1801, p. 421.

Though not previously recorded from the island we were fortunate in securing two examples of this species; they were washed on to Blenkiuthorpe Beach during heavy weather.

Family MYCTOPHIDÆ.

Working the lagoon beach in the early morning of 2nd January, we gathered a number of representatives of this family. They had been thrown up during the night, whether as a result of the stormy weather of the previous few days, or driven ashore by predaceous fish we were unable to ascertain. We visited the beach again at night in the hope of seeing examples alive, their presence revealed by their luminous organs, but were disappointed. On the following morning however we obtained a further supply; on both occasions the fishes came ashore in a very restricted space about the middle of the beach, and although we traversed the whole strand, we found none of the Myctophids very far from the main body. The Gempelids, as noted under *Machærope*, were, on the other hand, found scattered along nearly the whole beach. A large number of the fishes obtained were more or less mutilated by the attacks of Isopods (*Sphæroma*) which were present in thousands. Needless to say we collected all the fishes seen, in whatever condition.

With two exceptions, all the species are identified with described forms. Though large ocean tracts sunder the known habitats of some of the species, it is not to be forgotten that the continents set no bounds to the wanderings of pelagic forms.

My comparisons have been made with the utmost care and, in addition, I have had independent drawings made from the island material, and have compared them with those furnished respectively by Raffaele, Lütken, Goode and Bean, and others who have studied the members of the family.

In the case of one species, (*M. hygomii*) Prof. Dr. H. F. E. Jungersen, of Copenhagen, has obligingly compared one of our specimens with the type, and has not only verified the determination, but has also discovered that the figure is not quite accurate in features I indicated.

To Prof. Leon Vaillant, of Paris, I am indebted for some notes on *Dasyscopelus cuvieri*, Castelnau, resulting from an examination of the type specimen preserved in the Paris Museum. The information thus kindly supplied induces me to consider our specimen of *Dasyscopelus* as distinct from *D. cuvieri* with which I was at first inclined to identify it.

*ÆTHOPRORA PERSPICILLATA*, Ogilby.

*Æthoprora perspicillata*, Ogilby, Proc. Linn. Soc. N. S. Wales, xxiii., 1898, p. 36.

(Plate xviii., fig. 1.)

The type specimen was "badly mutilated, being almost broken in two just behind the termination of the anal fin, and also injured along the ventral surface." Under these circumstances a partial redescription is advisable, and the following remarks are based upon six examples in our collection.

The author's definition of the photophore groups does not coincide with my reading of them, I therefore enumerate them as follows:—

*Mandibular*.—Three.

*Opercular*.—Two, one behind the extremity of the gape; the other, larger, above.

*Pectoral*.—Three, an upper one on a scale below the lateral line, a median one at the base of the fin, and a lower one in advance of the latter.

*Anterolateral*.—Three, one low, in advance of the end of the pectoral fin, one above the front edge of the ventral fin, and the third slightly or much lower, its vertical position being variable.

*Mediolateral*.—Three, in a straight sub-vertical line, the upper one close to the lateral line.

*Posterolateral*.—One, close to the lateral line below the soft dorsal.

*Thoracic*.—Four, the first two well separated.

*Ventral*.—Four, the second and third well separated.

*Anal*.—6 + 5, the first and sixth raised above the line of the others, the posterior series in an even line.

*Caudal*.—Four, the first three equidistant the third being higher than the others, the fourth is further spaced and nearer to the lateral line.

In the original description the two lower mediolaterals are stated to be on nearly the same "horizontal" plane. This is possibly an error, for which vertical should be read.

Sundry discrepancies in the respective descriptions would favour the idea that our examples represent a species distinct from *Æ. perspicillata*; for example, no mention is made of the upper pectoral photophore and but two caudal pores are described. It must be remembered however that the type example is in poor condition and may not have exhibited all necessary features; in the absence of a figure, only a direct comparison with the type (in the author's possession) could determine these points.

I have therefore referred our examples to *Æ. perspicillata* and furnished a figure for the benefit of future workers.

Our largest specimen measures 88 mm. in length and is thus larger than the type, (62 mm.)

NOTOSCOPELUS<sup>16</sup> EJECTUS, *sp. nov.*

(Plate xviii., fig. 2.)

D. 22; A. 19; V.i. 8; P. 12; C. 19; L. lat. 39; L.tr. 3 + 5.

Length of head 3·4, height of body 5·2 in the total length, eye 4·4 in the head, one half more than the length of the snout, and less than the interorbital space.

Preopercle very oblique, mouth large, slightly oblique, the cleft extending to far beyond the eye, almost to the margin of the preopercle. The origin of the dorsal is nearly one-third nearer the end of the snout than the base of the caudal; the length of its base is nearly equal to that of the head. The fifth ray is the longest and is a little more than the height of the body.

The anal commences beneath the seventeenth dorsal ray and terminates below the soft dorsal, its base is equal to the length of the longest dorsal rays and its longest rays one-fourth less. The ventral is situated beneath the anterior rays of the dorsal and is longer than the pectoral, the latter measuring but half the height of the body. The caudal is rather deeply forked, its length 2·6 and the least depth of the peduncle 3·0 in the length of the head.

*Scales.*—The body scales are entire but with radiate striæ, the margins irregular, those of the lateral line appear smaller, being more encroached upon than the ordinary series, they are medially indented.

<sup>16</sup> *Notoscopelus*, Günther = *Macrostoma*, Risso, antedated by *Macrostomus* Wied.



The Photophores are arranged as follows :—

*Opercular*.—One, just behind the preopercular border and above the level of the maxilla.

*Pectoral*.—Three, two above and one at the lower base of the fin, these form a sub-vertical line.

*Anterolateral*.—One, posterior to the insertion of the dorsal fin.

*Mediolateral*.—Three, forming an obtuse angle.

*Posterolateral*.—Two, placed horizontally close together, beneath the adipose fin.

*Thoracic*.—Five, a very long interspace between the first and second.

*Ventral*.—Four, close together and occupying a median position between the ventral and anal fins.

*Anal*—8 + 5. The first below and the eighth above the line; the second portion posterior to the anal fin.

*Caudal*.—Three, one beneath the termination of the lateral line and two, close together, near the lower profile.

Length of specimen 40.5 mm.

Goode and Bean write<sup>17</sup>:—"Steindachner, Vinciguerra, Raffaele, and Collett seem all disposed to recognise but one species of *Notoscopelus*. We think we have distinguished four, but possibly our series is not sufficiently complete to justify us in positive opinions." Still less am I in a position to discuss the question. The example above described possesses characters which appear to warrant specific recognition. It finds its nearest ally in *N. quercinus*, Goode and Bean, but differs therefrom in the following particulars:—the mediolateral photophores form a very obtuse angle instead of a "curved subvertical line," a difference at once apparent on comparing the two figures. In *N. quercinus* the anals are 8 + 8 and form an even series with a slight break only; in *N. ejectus*, the break is large, the first and last pore of the anterior series deflected out of line and the second series formed of five pores only. The statement that one of the pre-caudals is very high up and between the flap of the operculum and the lateral line, occurs both in the generic and specific descriptions and some confusion is apparent; though one of the caudal pores is high the upper pore of the pectoral series is evidently intended.

It may be noted that in the description of *N. castaneus*, Goode and Bean count the mediolateral pores as three, but figure one only.

<sup>17</sup> Goode and Bean—U.S. Nat. Mus., Sp. Bull. 2, Oceanic Ichth., 1895, p. 84.

MYCTOPHUM PHENGODES, *Lütken*.

*Scopelus phengodes*, Lütken, *Spolia Atlantica*, ii., 1892, p. 253, fig. 11.

D. 13; A. 20; V. i. 8; P. 16; C. 19; L. lat. 38; L. tr. 2+3.

Length of head 3.4, height of body 1.4 in the total length. Eye 2.6 in the head, and one half more than the interorbital space. Snout less than half the diameter of the eye, obtusely pointed: preopercle quite vertical. Mouth slightly oblique, the lower jaw the longer, the maxilla reaches to below the hinder edge of the eye, Origin of dorsal nearer the end of the snout than base of the caudal, the length of its base one-seventh the total length. The fifth ray is the longest a little less than the height of the body. The anal commences in advance of the end of the dorsal and terminates behind the soft dorsal, its base is twice that of the dorsal, the fourth ray is the longest, an eighth shorter than the fifth dorsal. The ventral is situated vertically in front of the dorsal. The length of the pectoral is equal to the height of the body and reaches to below the ninth dorsal ray. The caudal is well forked and is one-third shorter than the head, the height of the peduncle is 3.6 in the length of the head.

*Scales*.—Cycloid, those of lateral line vertically enlarged.

The arrangement of the Photophores is as below:—

*Mandibular*.—Three.

*Opercular*.—Two, the upper on the lower level of the eye, the lower, which is in advance, below the level of the maxilla.

*Anterolateral*.—One, above hinder insertion of ventral.

*Mediolateral*.—Three, in straight oblique line directed forwards below.

*Posterolateral*.—One, above last pore of anterior anals.

*Thoracic*.—Five.

*Ventral*.—Four.

*Anal*.—7 + 8 (in all examples).

*Caudal*.—Two, somewhat apart.

*Supercaudal* (present in three examples only).—Large, occupying seven scales.

*Infracaudal* (present in one example only).—Small, occupying two scales.

Four examples sub-equal in length and measuring 105 mm.

As far as known this is a southern species ranging from 5° 30' W. Long. to 98° E. Long. and reappearing at Lord Howe Island.

MYCTOPHUM OPALINUM, *Goode and Bean.*

*Myctophum opalinum*, Goode and Bean, *Oceanic Ichth.* 1895, p. 72, fig. 81.

A single example, 95 mm. in length, so very nearly agrees with this species, known from the Western Atlantic, that I cannot regard it as distinct. The following points however call for remark. The origin of the dorsal is stated to be midway between the snout and the adipose fin, in our example the extremity of that fin is the point attained, and it is so figured by the authors. Though correctly described, but two mediolateral photophores are figured; the omission is rectified by Jordan and Evermann in their more recent work.<sup>18</sup> Six supercaudal scales are luminous in our specimen.

*M. aurolaterdatum*, Garman,<sup>19</sup> though much resembling this species, differs by having smaller scales, which though stated to be larger on the lateral line are figured smaller than those of the ordinary series.

MYCTOPHUM HYGOMII, *Lütken.*

*Scopelus hygomii*, Lütken, *Spolia Atlantica*, ii., 1892, p. 256, fig. 15.

Of this species we obtained over fifty examples, many of which are however in but indifferent condition. The only feature in which they at all differ from Lütken's figure is in respect to the hinder anterolateral photophore which is somewhat more ventral in position and thus agrees with *M. remiger*, Goode and Bean,<sup>20</sup> regarded as probably identical with *M. hygomii*.

The vertebræ number  $15 + 21 = 36$ , and 72 mm. is the maximum length attained.

A small number of our specimens have the last supercaudal scale luminous and in one or two examples the last infracaudal scale also, but the two conditions do not occur in the same specimen.

In consequence of the differences above noted, I sent an example to the Copenhagen Museum for comparison with the type, and Prof. Hector F. E. Jungersen has kindly written to me as follows:—"I have compared your specimen with the original type specimen of *Scopelus hygomii*, Lütk., and I have not been able to find the least difference between them: there can be no doubt about their identity. As to figure 15 of Lütken's work

<sup>18</sup> Jordan and Evermann—*Bull. U.S. Nat. Mus.*, 47, iv., 1900, pl. xcii., fig. 247.

<sup>19</sup> Garman—*Mem. Mus. Comp. Zool. Harvard*, xxiv., 1899, p. 267, pl. lv., fig. 3.

<sup>20</sup> Goode and Bean—*U.S. Nat. Mus., Sp. Bull.*, 2, *Oceanic Ichth.*, 1895, p. 74, fig 84.

there is some slight incorrectness in the position of some of the photophores compared with the type specimen itself, which may have caused your doubt."

The previously recorded range of the species was from 22° 20' W. Long. to 81° E. Long.

MYCTOPHUM REINHARDTII, *Lütken*.

*Scopelus reinhardtii*, Lütken, *Spolia Atlantica*, ii., 1892, p. 257, fig. 16.

Two examples are identified with this species, measuring 45 mm. and 35 mm. respectively; the larger specimen has a luminous plate, composed of three scales, on the lower side of the caudal peduncle and the smaller, a similar plate above. The two examples studied by Lütken were similarly adorned.

The following slight difference is observable, in the arrangement of the photophores, between our specimens and the figure. Of the mediolateral series, the anterior pore is below the level of the median one and not on the same horizontal as in the type. Of the two posterolaterals the lower is not nearer to an anal pore than to the upper one as figured by Lütken.

The radial formulæ is:—

D. 14; A. 22; P. 14; V.i. 8; C. 19.

The rays in the dorsal and anal are therefore in greater number than in the Atlantic specimens. The general proportions are the same and I cannot consider that the slight differences indicated, merit specific recognition. It is to be noted however that *M. reinhardtii* has not previously been identified south of the equator, nor in the Eastern Hemisphere. It is possible therefore that direct comparison might reveal differences not indicated in the description.

DASYSCOPELUS NAUFRAGUS, *sp. nov.*

(Plate xviii, fig. 3.)

D. 13; A. 18; V.i. 8; P. 14; C. 19; L. lat. 38; L. tr. 2 + 3.

Length of head 4.0, height of body 4.7 in the total length. Eye 2.6 in the head and a little more than the interorbital width; snout short, two-fifths the width of the eye; preopercle subvertical. Mouth slightly oblique the cleft extending to beyond the hinder edge of the eye. Origin of dorsal much nearer tip of snout than base of caudal, the length of its base less than one-seventh the length of the fish. The fifth ray is the longest, a little less than the height of the body; the anal commences behind the dorsal and terminates beneath the soft dorsal,

its base more than one-half longer than the dorsal, the fourth ray is the longest, one-fourth shorter than the fifth dorsal. The ventral is placed in front of the dorsal. The length of the pectoral is equal to the height of the dorsal fin, and reaches to below its eighth ray, it is narrow and sub-median in position. The caudal is one fourth shorter than the head, and is well forked, the peduncle is slender, its depth three and a half times in the length of the head.

*Scales* of head large and thin, scales of the body ctenoid, those of the lateral line less so and slightly enlarged.

The Photophores are as follows:—

*Opercular*.—One, just behind the preopercular border and slightly below the level of the lower edge of the eye.

*Pectoral*.—Three, one at the lower base of the fin, one mid-way between its upper base and the lateral line immediately behind the operculum, and an inferior one in advance of the others.

*Anterolateral*.—One, above the hinder insertion of the ventral fin.

*Mediolateral*.—Three, forming an obtuse angle.

*Posterolateral*.—One, above the last pore of the anterior anals and close to the lateral line.

*Thoracic*.—Five, the fifth immediately in front of the ventral fin.

*Ventral*.—Four, the first immediately behind the fin.

*Anal*.—Normally 7 + 6, varying to 6-8 + 5-7.

*Caudal*.—Two, approximate, below the lateral line.

Twenty-five specimens, the largest of which measures 62 mm. in length.

This species is closely allied to *D. asper*, Richardson,<sup>21</sup> but differs by having three scales between the anterolateral and the lower mediolateral photophores, instead of one only: by having the anals differently divided, the posterolateral situated over the last instead of the third last anterior anals and by not having the upper caudal photophore placed at the end of the lateral line. In *D. naufragus* the adipose fin is low with a very broad base. Goode and Bean<sup>22</sup> represent *D. asper* as having the fin long and narrow, the condition also of *D. pristilepis*, Gilbert and Cramer,<sup>23</sup> to which our species is also nearly allied, but differs in having the scales of the lateral line ctenoid, in a more forward position of the ventral fin and by a difference in the

<sup>21</sup> Richardson—Voy. "Ereb. and Terr.," Fish., 1845, p. 41, pl. xxvii.

<sup>22</sup> Goode and Bean—U.S. Nat. Mus., Sp. Bull., 2, Oceanic Ichth., 1895, p. 92, pl. xxviii., fig. 106.

<sup>23</sup> Gilbert and Cramer—Proc. U.S. Nat. Mus., xix., 1897, p. 412, pl. xxxix., fig. 1.

arrangement of the pectoral, thoracic, and anal photophores. Judging by the illustration, the Hawaiian species has a differently shaped head in which the eye cuts the profile.

In respect to *Scopelus curvieri*, Castelnau,<sup>24</sup> which Lütken recognised as of the genus *Dasyseopelus* I sought the assistance of Prof. Leon Vaillant who kindly examined the type in the Paris Museum. The reply to my questions, seriatim, enables me to publish the following particulars additional to the original description.

The mediolateral photophores form a straight line, the central pore being further removed from the upper than from the lower one.

There are four ventral photophores on the right side of the fish and five on the left, though the absence of a scale on the former, where a pore would be situated, indicates five as the normal number. Lütken also counted five in the type, a circumstance which led to his writing:—"It thus comes close to *S. spinosus*, Std. but must be another species, provided the five ventrals as noted by me are not accidental abnormalities, or perchance a mistake on my part. I have otherwise never found that number outside the *Lampanyctus-Nyctophus* group."<sup>25</sup>

The tail is imperfect, the total length is about 90 mm.

EXONAUTES RONDELETHI, *Cuvier and Valenciennes.*

*Exocætus rondeletii*, Cuvier and Valenciennes, Hist. Nat. Poiss., xix., 1846, p. 115, pl. dlxii.

A flying fish has been recorded<sup>26</sup> from the island, under the name *Exocætus dovii*, Gill, (= *E. rufipinnis*, Cuvier and Valenciennes). An examination of the specimen thus determined, proves it to be of the same species as those obtained by myself.

*Exonautes rondeletii* is characterised by having the first two pectoral rays simple, the second about half longer than the first; the third ray divided and the fourth and fifth longest. In *E. rufipinnis* the first pectoral ray only, is simple, and the third and fourth are longest.

In the memoir quoted, it is mentioned that Flying Fishes occur occasionally in the nets, together with *Scombresox forsteri*, among the garfishes. We were not fortunate enough to secure examples in this way and though they were commonly seen around the island we did not obtain living specimens.

<sup>24</sup> Castelnau—Proc. Zool. Soc. Viet., ii., 1873, p. 106.

<sup>25</sup> Lütken—Spolia Atlantica., ii., 1892, p. 242.

<sup>26</sup> Ogilby—Aust. Mus. Mem., ii., 1889, p. 71.

The way in which we obtained the Flying Fishes was no less unexpected than interesting. The Admiralty Islets which lie within a twenty minutes pull of the main island, and on the north-east side, are the breeding grounds of myriads of sea birds.

Though I do not now propose to describe the habits of the birds, I may mention that whereas the Terns left their nests when we were within an arm's length of them, the Gannets sat close upon their eggs or young.

In defence of their charge they attempted to drive off visitors with vicious blows of their powerful beaks. Failing this they offered ransom by depositing their latest catch at the intruder's feet. In such instances, and they were many, large flying-fish were voided, and one accommodating Gannet presented me with a couple.

HOWELLA BRODIEI, *Ogilby*.

*Howella brodiei*, *Ogilby*, Proc. Linn. Soc. N.S. Wales, xxiii., 1899, p. 735.

(Plate xviii., fig. 4.)

The type specimen is the only example so far known, and for the opportunity of figuring it I have to thank the author, on whose recommendation it was lent to me by the Curator of the Queensland Museum.

Some ambiguity in the original description of the position of the anal fin, would be more clearly expressed as:—Anal originating very slightly behind the anterior insertion of the second dorsal fin.

XENOGRAMMA CARINATUM, *gen. et sp. nov.*

To Mr. Campbell Stevens, Postmaster at Lord Howe Island, I owe the opportunity of making known this remarkable and interesting fish. Mr. Stevens noticed it alive and awash on the lagoon beach, and threw it out of reach of the waves: it was thus secured in almost perfect condition, and handed to me as a curiosity.

This fish proves to be the type of a new genus, which may be thus defined:—

XENOGRAMMA, *gen. nov.*

Family GEMPYLIDÆ.

Body fusiform, moderately elongate, somewhat compressed, rounded below. Head conical, compressed behind, preopercle unarmed, branchiostegals seven, gill rakers rudimentary, jaws nearly equal with strong sharp teeth, much larger and fang-like in the mandible: vomer and palatines toothed, tongue smooth. The first dorsal fin low, uniform with about nine weak spines, not widely separated from the soft portion, the anterior lobe of which is well developed; six finlets. Anal fin with two spines

and five finlets. Ventrals moderate, thoracic, no detached spine behind the vent; pectorals sub-median. Tail well-developed, strongly keeled. Scales small thin cycloid adherent, with scalelets, no corselet. Lateral line remarkably tortuous; vertebrae about thirty.

XENOGRAMMA CARINATUM, *sp. nov.*

(Plate xix., fig. 1.)

D. ix. 18 + 16; A. ii. 12 + 5; V. i. 5; P. 15; C. 17 + 4.

Head 3.6, height of body 4.1, in the total length. Horizontal diameter of eye 5.2 in the head, and less than the vertical diameter which is one-third greater; interocular (bony) width, one-seventh more than the horizontal diameter of the eye, slightly convex. Snout broad, depressed, its length 2.7 in the head. Nostrils separated, the posterior a vertical slit midway between the edge of the eye and the anterior one, which is small and vertically oval, lying a little nearer the end of the snout than the middle of the eye. The maxilla is slightly broadened and rounded behind, and extends to just below the anterior margin of the eye.

*Teeth.*—The edge of the premaxillary is beset with short strong teeth, the anterior ones slightly larger, those behind smaller; four, larger, fang-like teeth on the roof of the mouth anteriorly. The teeth on the vomer and palatines are each in a single row, similar to those of the premaxillary; those of the former arranged crescentrically. The mandible is deep and powerful, the teeth large and fang-like, there are ten on each side, of which the first and last are smallest. The opercles are thin, flexible, and unarmed. Pseudobranchiæ well developed, gill rakers represented by a few short, weak spines near the angle.

*Fins.*—The first dorsal fin arises over the base of the pectoral, and consists of nine weak, short, sub-equal spines, of which the central three are longest, half the diameter of the eye in length; they may be completely concealed in a narrow groove. The soft dorsal is highest in front, the fifth ray being longest and 2.3 in the head. The anal spines are not separate from the soft portion which resembles the soft dorsal, but is shorter and lower. The dorsal is followed by six finlets, the anal by five. The ventral spine is placed a little in front of the pectoral, its length 3.4 in the head, the first ray 2.4 in the same; the greater part of the fin can be received by a broad groove. The pectoral fin is a little longer than the ventral, and has a rounded lower margin; its upper rays are the longest, the third being 2.2 in the head. Caudal fin deeply forked with a slender peduncle, the



least height of which is 1.4 in the eye, it is flattened above and below; the lateral keel is large and prominent and there are also two small oblique ridges near the base of the rays.

*Scales.*—The snout, upper part of head, maxilla, and mandible are naked; the rest of the head furnished with small smooth cycloid scales. The scales on the body are similar, but each carries a row of small scalelets which give it a rough appearance; the scales are irregularly arranged. The lateral line is at first straight and near to the dorsal profile, with which it is concurrent to below the seventh and eighth spines, it then descends vertically to within a similar distance of the ventral surface which it follows for a short distance; it next rises to a point above the mid line beneath the lobe of the dorsal, whence it immediately again descends to a corresponding position in respect to the anal; it again rises, less abruptly to above the mid line, which it finally attains slightly in advance of the caudal keel.

*Colours.*—Head dark brown, with silvery patches on the lower opercles, inside of mouth black. Body brown, but appearing of a much lighter tint, owing to the presence of the scalelets, which form a rivulate pattern: on the lower surface the scalelets quite hide the ground colour, giving a yellow appearance to these parts. All the fins dusky, the outer base of the pectoral yellow.

Length, 575 mm.

The normal condition of the ventral fins, the complete sealing of the body, the small number of dorsal spines and the presence of more than two finlets each in the dorsal and anal fins; together with the single and strangely tortuous lateral line and the keeled caudal, render this fish an unmistakable form.

The only species which may be discussed in connection with *X. carinatum* appears to be *Thyrsites niger*, Poey,<sup>27</sup> whose work, however, is not accessible to me. Of this species Goode and Bean<sup>28</sup> write:—"Jordan and Evermann propose the new generic name *Escolar* for *Thyrsitops violaceus*, Bean. They also are of the opinion that *Thyrsites niger*, Poey, is of the same species. Since this was described from a fragment, we have not taken it into consideration in our studies." In passing, it may be noted that Jordan and Evermann,<sup>29</sup> use *Bipinnula* for *T. violaceus*, and respecting *T. niger* write:—"Known only from a fragment of the tail of a specimen weighing about 100 pounds. Caudal peduncle with a distinct keel. Scales thin, smooth, and

<sup>27</sup> Poey—Enumeratio Pisc. Cubens, 1875. p. 74.

<sup>28</sup> Goode and Bean—U.S. Nat. Mus., Sp. Bull., 2, Oceanic Ichth., 1895. p. 519.

<sup>29</sup> Jordan and Evermann—Bull. U.S. Nat. Mus. 47, i., 1876, p. 879. (footnote.)

roundish, not spinose. Color everywhere intense black. Last rays of dorsal apparently detached. Flesh white, exquisite in flavor, as in *Ruvettus pretiosus*. Havana. (Poey). Thrown on shore by a storm. This is probably not a *Thyrsites*, nor a *Bipinnula*, as the caudal peduncle has no keel in either genus."\*

The question arises:—Can a species described from a mere fragment be admitted, or resuscitated in case a second example, apparently of the same species, be obtained? Though a portion of the tail may coincide, how are we to know that the remainder of the fish does so? Goode and Bean, as before indicated, decline to recognise Poey's species, and I argue they had good reasons for so doing. As far as may be ascertained from the description, the fragment of *T. niger* is very similar to the caudal portion of *X. carinatum*.

I desire to express my thanks to Dr. F. P. Sandes, Demonstrator in Anatomy at the Sydney University, for radiographs of the fish, enabling me to ascertain the number and condition of the vertebræ, without mutilating the unique specimen.

MACHÆROPE LATISPINIS, *Ogilby*.

*Machærope latispinis*, *Ogilby*, Proc. Linn. Soc. N.S. Wales, xxiii., 1899, p. 737.

Many examples of this species in breeding condition were cast on to the lagoon beach on January 2nd and 3rd, in company with members of the Myctophidæ as already noted. To the published descriptions I may add that the vertebræ number  $10 + 25 = 35$ .

CARANX GEORGIANUS, *Cuvier and Valenciennes*.

*Caranx georgianus*, *Cuvier and Valenciennes*, Hist. Nat. Poiss., ix., 1833, p. 85.

The Trevally is a common island species, young examples being freely taken with a seine net in the lagoon. Larger specimens up to thirty inches in length are caught outside the reef while we had an interesting experience of them on the reef itself. On one occasion while wading knee-deep during a receding tide we were considerably scared by the presence, within a dozen yards of us, of what appeared to be two or three sharks, indicated by the fins being out of water. After cautiously reconnoitring with a large fish spear, in hand, we discovered the supposed sharks to be a small school of Trevally. They were feeding on the reef in a sub-vertical position, the depth of water not being sufficient to submerge the whole of the tail, the upper lobe of which showed above the surface.

BATHYSTETHUS CULTRATUS, *Forster*.

- Sciæna cultrata*, Forster, MS., 1774.  
*Cichla cultrata*, Bloch and Schneider, Syst. Ichth., 1801, p. 343.  
*Seriola cultrata*, Richardson, Ann. Mag. Nat. Hist., (i.), xi., 1843,  
 p. 169, fig. (front view of head); Bleeker, Verh. Kon.  
 Akad. Wetens., ii., 1855, p. 10.<sup>30</sup>  
*Platystethus cultratum*, Günther, Cat. Fish. Brit. Mus., ii., 1860,  
 p. 391; Ogilby, Aust. Mus. Mem., ii., 1889, p. 61.  
*Platystethus guentheri*, Ogilby, Proc. Zool. Soc., 1889, p. 157.  
*Bathystethus cultratus*, Gill, Mem. Nat. Acad. Sci. Washington,  
 vi., 1893, pp. 95, 123.

(Plate xix., fig. 2.)

Though several species of "Plathystethus" (invalid for fishes) have been described none are congeneric with *B. cultratus*. This fish was originally described from Norfolk Island and has since been recorded from Lord Howe Island.

We found it to be comparatively common there, and well-known to the natives who call it "The Herring." It was always to be found in the large and deep rock pools on the north end of the island, and was especially noticeable on account of its deep blue colour. The islanders tell me that it sometimes occurs off the coasts in large schools.

As above noted, Richardson figured a front view of the head of this fish, the illustration being a copy of a drawing by Forster. As this is of small practical value, I supply the accompanying illustration made from a Norfolk Island example, the type locality.

In addition to Forster's short description, and Schneider's augmentation thereof, we have that by Richardson made from Forster's drawing, and next an independent description by Günther together with generic diagnosis.

In 1889 Ogilby examined three specimens from Lord Howe Island, and on account of certain disagreements from Günther's description, suggested *Platystethus guentheri* as a name to embrace them. Having examples from both islands I have made a careful comparison, and find them to be identical; with the exception of the ocular diameter the discrepancies noted are un-

<sup>30</sup> I am indebted to Dr. F. A. Jentink, of Leyden, for the list of Norfolk Island fishes contained in Bleeker's paper.

important, but upon this special stress is laid. In fresh specimens and also in those carefully prepared, notably in formaline, the eye is surrounded with fleshy tissue, which makes it appear much smaller than those placed in strong alcohol. Ogilby's fishes were treated in the latter manner, and the tissues have contracted back almost to the bone; in all examples the bony orbit is of the same relative size. To the same agency may be traced the differences noted in the width of the inter-orbital space.

In assigning the fish to the genus *Seriola*, Richardson and Bleeker referred it to the Carangidæ. It was removed therefrom by Günther when formulating the genus *Platystethus* and placed with the Scombridæ, apparently because its vertebræ, counted as twenty-five, were one in excess of the number he allowed in the Carangidæ. As however he identified it with his group *Nomeina*, modern writers would probably regard it as a member of the Stromateidæ.

One of the characters of this latter family is the presence of teeth in the cesophagus, a feature which I have ascertained is not found in *Bathystethus*. The vertebræ number  $10 + 14 = 24$  so that I reinstate it in the family Carangidæ.

BRAMA RAI, Bloch.

*Sparus rai*, Bloch, Nat. australiane Fische., v., 1791, p. 95.

I recorded this species for the island from a single example obtained in 1889, and though I cannot add anything to our knowledge of this pelagic form, it is pleasing to be able to report that we obtained three additional specimens in perfect condition.

CUBICEPS GRACILIS, Lowe.

*Seriola (Cubiceps) gracilis*, Lowe, Proc. Zool. Soc., xi., 1843, p. 82.

The subject of this notice is an example four inches in length; it was washed on to the beach and, with the exception of slight damage to some of the dorsal spines and the loss of most of the scales, is in good condition. I cannot dissociate it from *C. gracilis*, Lowe, and in the case of a pelagic species do not consider distribution alone sufficient warranty for the creation of a species.

Our specimen is fairly represented by Günther's figure (A)<sup>31</sup> but is of more even depth, not tapering so gradually towards the tail. In fig. C a median depression, present in our example, is possibly rendered as a lateral line, the line itself probably occupying a normal position.

<sup>31</sup> Günther—Chall. Rep., Zool., xxxi., Pelagic Fishes, 1889, p. 11, pl. ii., figs. A-C.

The species was previously known from the Mediterranean, Madeira, and the Azores; in identifying it from Lord Howe Island I considerably extend the known distribution of the genus. In addition to the before-named localities representatives are recorded from The Cape, the Red Sea and the Moluccas.

The following is a description of the specimen.

D. xi. i. 21; A. iii. 21; V. i. 5; P. 20; C. 17 + 12; L. lat. 52.

Length of head 3·6, height of body 3·1, in the total length. The snout is five-sevenths the diameter of the eye, which is 3·2 in the length of the head and equalled by the interorbital space. The nostrils of each side are close together and nearer to the end of the snout than the eye. The jaws are equal and bear a single row of small teeth; similar teeth occur on the vomer, and a minute series on the tongue. The maxilla barely extends to below the front edge of the eye and may be concealed for its entire length by the preorbital.

The dorsal commences considerably behind the head, the sixth (?) spine is the longest and one-half the head in length; the anterior rays are longest, slightly shorter than the longest spine. The anal is similar to the soft dorsal but has a more posterior insertion. The pectorals are long, equal to the height of the body or one-fifth longer than the head. The ventrals are inserted behind the pectorals, their length half that of the head. The height of the caudal peduncle is equal to the diameter of the eye, the caudal is deeply forked and shorter than the head.

The scales are deciduous and for the greater part lost, there are five rows above the lateral line, this runs high and concurrently with the dorsal contour.

*Colours*.—Generally deep brown above and silvery beneath, the throat barred with brown, dorsal fin dusky, the others colourless.

Length 99 mm.

SCHEDOPHILUS MACULATUS, *Günther*.

*Schedophilus maculatus*, Günther, Cat. Fish. Brit. Mus., ii., 1860, p. 412.

(Plate xx. fig. 1.)

I first recorded this species for the island in 1894 and have little further to add. I however embrace the opportunity of illustrating the species as it has not been previously figured. The example selected is 110 mm. in length.

In 1889 Günther recognised the identity of his genus *Hyperoglyphe* with the previously described *Leirus*, Lowe, and wrote :<sup>32</sup>—“*Hyperoglyphe*, therefore, should be eliminated from the

<sup>32</sup> Günther—Chall. Rep., Zool., xxxi., Pelagic Fishes, 1889, p. 10.

Perch-like fishes, and placed as a synonym of *Lirus* immediately after *Schedophilus*." Regan<sup>33</sup> goes further, and unites *Schedophilus*, Cocco, with *Leirus*, but follows Günther in spelling the word "*Lirus*." *Leirus*, Lowe, in 1833 is antedated in Coleoptera by Megerle v. Mühlfeld, 1823. *Mupus*, Cocco, appears, as far as I know, only on the authority of Bonaparte, 1841, and if so is quite out of date. *Schedophilus*, Cocco, 1834, therefore seems to be the correct name of the genus. Regan removes from the Stromateidæ, *Teosteus*, Lockington, and *Leichthys*, Jordan and Gilbert, remarking on the obscurity of their affinities. The presence of ventral fins is one of the characters of these two genera, yet Goode and Bean<sup>34</sup> figure a fish purporting to be *Leichthys lockingtoni* without ventral fins, this figure is reproduced by Jordan and Evermann<sup>35</sup> under the same name without comment. The latter authors also figure, on the same page, an example of *Schedophilus medusophagus*, Cocco, which differs widely from the adult of this species. As is well-known pelagic fishes often undergo considerable metamorphoses and though the adult is described, the figure may represent an immature stage, though this is not indicated by the usual "inch-mark." It is to be further noted that the spines on the interoperculum described and figured, as present in the young, by Lütken,<sup>36</sup> and retained in the adult, are not shown, and the head is represented as wholly scaly.

KUHLLIA TÆNIURA, Cuvier and Valenciennes.

*Dules tæniurus*, Cuvier and Valenciennes, Hist. Nat. Poiss., iii., 1829, p. 114.

We found the young of this little fish to be very common in all the rock pools of the island. It is very quick in its movements and difficult to catch with a hand net. The older fish are plentiful in the open waters and frequent the sandy shores in shoals. They take the hook readily and are known to the islanders under the appropriate name of "Flagtail."

APOGON NORFOLCENSIS, Ogilby.

*Apogon norfolcensis*, Ogilby, Proc. Linn. Soc. N.S. Wales, (2.), ii., 1868, p. 990.

The Big-eye is the commonest fish in the lagoon, and proves

<sup>33</sup> Regan—Ann. Mag. Nat. Hist., (7), x., 1902, p. 195.

<sup>34</sup> Goode and Bean—U.S. Nat. Mus., Sp. Bull., 2, Oceanic Ichth., 1895, p. 216, fig. 226.

<sup>35</sup> Jordan and Evermann—Bull. U.S. Nat. Mus. 47, i., 1896, p. 969, pl. cli., fig. 406.

<sup>36</sup> Lütken—Spolia Atlantica, Videns. Sel. Skr. xii., 1880, p. 118, pl. ii., fig. 9.

of great annoyance, taking the bait intended for larger fish. The water telescope revealed this species in great numbers, it was immediately distinguishable by a conspicuous white stripe in the upper half of the eye. This disappears in preserved examples and is thus not represented in my figure.<sup>37</sup> The pectoral fin is coloured red in a small proportion of specimens only.

APOGON CHRYSURUS, *Ogilby*.

*Apogon chrysurus*, Ogilby, Aust. Mus. Mem., ii., 1889, p. 54.

(Plate xx., fig. 2.)

This species was not obtained, and the original specimens are still the only ones known. The type example is here figured.

EPINEPHELUS RHYNCHOLEPIS, *Bleeker*.

*Serranus rhyncholepis*, Bleeker, Nat. Tijdschr. Ned. Ind., iii., 1852, p. 749.

While line fishing in the lagoon, we obtained a fish which, though stated to be extremely rare, was recognised by the islanders. It is to be identified with *E. rhyncholepis*, previously known only from Celebes and Timor. As originally described, the ground colour is uniform brown, each scale with a white (pale blue) spot. In a second and smaller example, since forwarded by Mrs. Nichols, the ground colour is pale brown with darker markings disposed as follows:—The fore part of the head is dark and an irregular bar passes from behind the eye to above the opercle and a broader one from beneath the eye obliquely backwards across the angle of the opercle, where a few irregular blotches also occur. The lower part of the head is dark, with three large white spots along each ramus of the lower jaw. The body bears five bars directed obliquely forward, the first immediately in front of the dorsal fin; this unites with the post-ocular band and is preceded by two large blotches on the occipital region. The second body band arises at the base of the iv-vi dorsal spines, passes behind the opercle and broadens below, there uniting with the third band which originates at the base of the last three dorsal spines. The next band is less regular, arises beneath the middle of the soft dorsal and ventrally extends from the vent to the end of the anal: the last band is across the caudal peduncle. The lower surface of the fish is generally dark coloured (owing to the width of the bands) the chest especially; there is a large black spot on the isthmus, preceded by one and followed by two paired large white spots, and one or two smaller

---

<sup>37</sup> Waite—Rec. Aust. Mus., iv., 1901, p. 41, pl. vi.

ones: there is also a large oblong spot on each side of the chest, a smaller one at the base of, and others below, the pectoral. The dorsal fin is formed with lobules as described, but is blotched in some agreement with the body bands; the soft dorsal has two rows of sub-marginal white spots and the anal has a yellow margin: the pectoral has a broad sub-basal and a narrow marginal brown bar; the ventrals are black; the caudal is also marked, two irregular bars being traceable.

The specimens measure 250 mm. and 200 mm. respectively.

EPINEPHELUS FASCIATUS, *Forsk.*

*Perca fasciata*, Forskal, Descr. Anim., 1775, p. 40.

Of this species, previously known from the island by a single example, we obtained two specimens on the line, the larger of which was in roe. When first taken from the water the body is a delicate salmon colour, and the transverse semi-bands are pink. The pectoral fin is lemon yellow, the ventral, soft dorsal and anal are orange, the two latter margined with white. The dark colour on the dorsal spines does not extend to the end of the membrane, the extreme tip being pink.

GENYORGE BENGALENSIS, *Bloch.*

*Holocentrus bengalensis*, Bloch, Nat. ausl. Fische, iv., 1790, p. 102.

This species is represented by a single specimen, 225 mm. in length, obtained during operations at the wreck of the "Ovalau." It is known from Port Jackson but has not previously been received from the island.

LETHRINUS OPERCULARIS, *Cuvier and Valenciennes.*

*Lethrinus opercularis*, Cuvier and Valenciennes, Hist. Nat. Poiss., vi., 1830, p. 289.

This species is the Schnapper of the island and can always be obtained by lines in the deeper water. The Schnapper of the mainland *Pagrosomus auratus*, Forster,<sup>38</sup> is rare and is in fact almost unknown at Lord Howe Island.

<sup>38</sup> *Sparosomus*, Gill, (*Mem. Nat. Acad. Sci. Washington*, vi., 1893, p. 123) may be regarded as preoccupied by *Sparosoma*, Sauvage, 1883, and is duly noted in the "Zoological Record" (1893, p. 22.) *Pagrosoma*, Gill, defined on p. 98 of the above mentioned work and overlooked by its author on p. 123 has therefore precedence, but is omitted from the "Zoological Record." If however *Sparosomus* and *Sparosoma* are accounted distinct names, the former should be used for our fish in preference to *Pagrosoma* as I have already published it (*Aust. Mus. Mem.*, iv., 1899, p. 82).



*Lethrinus opercularis* is said to be common and much prized at Norfolk Island where it is called "The Oo-oo Trumpeter."

GIRELLA CYANEA, *Macleay*.

*Girella cyanea*, Macleay, Proc. Linn. Soc. N. S. Wales, v., 1881, p. 409.

(Plate xx., fig. 3.)

The Blue-fish is the staple food fish of the island and is generally caught with hand lines off the rocks; a shoal of perhaps fifty individuals or more may be seen in a deep gulch, the colour of those in the deeper water appearing of the most intense blue, while those near the surface or just drawn from the water are the colour of the sky, but the beautiful tint fades before the fish is dead. The young abound in all the rock pools but all are dusky in colour, the characteristic blue not appearing until the fish is five or six inches in length. The Blue-fish is a good species for smoking and curing, and recent consignments realised twenty-eight shillings net per hundredweight in the Sydney market.

The inhabitants told me of some large yellow fishes occasionally seen and named Guinea-fish. One specimen only is known to have been taken, with crab for bait. This may be a variety of the Blue-fish, but I have at present no means of knowing.

This species has not been previously figured.

CESIOSOMA EQUIPINNIS, *Richardson*.

*Scorpiæ equipinnis*, Richardson, Voy. "Ereb. and Terr.," Fish., 1848, p. 121.

The Sweep of New South Wales is known as the Hard-bellied Blue Fish on the island, and its colouration is even more striking than that of *Girella cyanea* owing to its being of a lighter and brighter hue. It is very common and easily caught.

CIRRHITICHTHYS SPLENDENS, *Ogilby*.

*Cirrhitichthys splendens*, Ogilby, Aust. Mus. Mem., ii., 1889, p. 58, pl. ii.

We brought away two examples of this marvellously arrayed fish, caught among rocks with hook and line. Though we may, at different times, have received a dozen examples from the island, it is accounted rare, and scarcely known to the colonists.

APLODACTYLUS ETHERIDGII, *Ogilby*.

*Haplodaetylus etheridgii*, Ogilby, Aust. Mus. Mem., ii., 1889, p. 57.

(Plate xxi)

Two or three specimens only have been received since the

species was first described. We obtained a nice example in a poisoned rock-pool and from this the accompanying illustration is prepared (See Note, p. 186).

AMPHIPRION MELANOPUS, *Bleeker*.

*Amphiprion melanopus*, Bleeker, Nat. Tijdschr. Ned. Ind., iii., 1852 (Amboina ii.), p. 561.

Among numerous other fishes, a large rock-pool contained several examples of an *Amphiprion*. These were extremely conspicuous, being apparently of deep black colour with pure white tail. On obtaining specimens this was indeed seen to be the case, one example only showing a limited streak on the opercle, not nearly so extensive as figured by Bleeker.<sup>39</sup> This species has been already recorded from the island and I have examined the specimens thus identified; they absolutely agree with those since obtained.

POMACENTRUS FASCIOLATUS, *Ogilby*.

*Pomacentrus nigricans*, Quoy and Gaimard, Voy. "Uranie," Zool., 1825, p. 399 (not *Holocentrus nigricans*, Lacépède).

*Pomacentrus fasciolatus*, Ogilby, Aust. Mus. Mem., ii., 1889, p. 64.

*Eupomacentrus marginatus*, Jenkins, Bull. U.S. Fish Comm., xix., 1901, (1899,) p. 391, fig. 5.

The author of the name indicated the similarity of the species to *P. scolopseus* (*P. scolopsis*) Quoy and Gaimard, but remarked upon the constancy in the number of dorsal spines as constituting specific distinction. The identity of the Lord Howe Island examples with *P. nigricans*, Quoy and Gaimard, is here suggested, the name being, however, preoccupied by Lacépède. Jenkins has also identified specimens from Honolulu, with *P. nigricans* and if my conclusions are correct the name *E. marginatus* must be sunk in favour of the prior *P. fasciolatus*. The respective descriptions do not differ materially: the length of the head in that of the body is given as 4.50 to 4.75 in *P. fasciolatus*, the caudal being included. In *E. marginatus* it is rendered as 2.66 exclusive of the caudal; this is obviously a misprint, possibly for 3.66 the illustration exhibiting the latter proportion.

The invariable number of dorsal spines is thirteen, and over fifty examples have been examined.

Many young of this species have the membrane of the first six dorsal spines tipped with orange, a most conspicuous feature during life; nearly all the young possess a large black spot on the ii-vi dorsal spines, but in none have I seen a spot on the rays.

<sup>39</sup> Bleeker—Atl. Ichth., ix., 1877, pl. cccci., fig. 7.

The teeth being in a single series dissociates the species from typical members of *Pomacentrus*, while the incompletely scaled snout and lower jaw seem to indicate affinity with *Amblypomacentrus*, Bleeker, which is possibly synonymous with *Parapomacentrus*, Bleeker, into which *Eupomacentrus*, Bleeker, may also have to be merged.

This, the only "Pomacentrus" recorded from the island, is the commonest member of the family met with, and was found in great numbers in every suitable rock-pool.

PARMA POLYLEPIS, *Günther*.

*Parma polylepis*, Günther, Brit. Mus. Cat. Fish., iv., 1862, p. 59.

(Plate xxii.)

I use the name *Parma*, Günther, on the supposition that its members are generically distinct from the type of *Hypsypops*, Gill. The latter genus was instituted in 1861 for *Glyphisodon rubicundus*, Girard, but in 1862, Günther proposed the new name *Parma* and placed *G. rubicundus* in the genus, although already assigned by Gill to *Hypsypops*. The reasons for so doing are expressed as follows:—"This genus (*Hypsypops*) is founded on characters entirely different from those of *Parma*, and its limits agree so little with those of the latter, that it would cause only confusion if I were to adopt the name."

The Sailor Fish is common in all the rock-pools, adult examples frequenting the larger and deeper pools and hiding beneath the overhanging ledges.

Ogilby<sup>40</sup> describes it as being a variable species in colouration. Of a large number of specimens examined the variations detected are due to age. In the young the snout is somewhat pointed and the head is without rugosities. As age advances the snout becomes more and more vertical until, in old specimens, the profile is little removed from the perpendicular, the snout is then very rugose roughly forming two low vertical ridges which terminate above the level of the eyes, each in a rugose boss; a similar but larger pair of bosses is developed at the upper anterior angle of each eye.

The colouration in the young (of 35 mm.) is a creamy ground with three vertical cross bands; the first from the occiput and first dorsal spine, to the base of the pectoral; the second across the middle of the body, and the third from the viii-xiii dorsal spines to the anal, fading towards the tail. A dark line, blue in life, arises on each side of the snout, and passes above the eye to the first dorsal spine; another from the upper hinder angle of

<sup>40</sup> Ogilby—Aust. Mus. Mem., ii., 1889, p. 66.

the eye to the origin of the lateral line, and another below the eye, breaking into spots on the opercles. A jet black spot as large as the eye and surrounded by a blue line occurs at the base of the four last dorsal spines, encroaching on the body as far as the lateral line. The fins are dusky, the first, and elongate ventral ray, black. In larger examples (of 90 mm.) the ground colour becomes darker and the bands intensified, the lines on the head have disappeared though the black spot on the dorsal fin is still apparent. An indication of the bosses in front of the eyes is discernable. In adult specimens (250 mm.) the ground colour becomes so dark as to render the cross bands and black spot almost indistinguishable: the fins are correspondingly darkened, the colour of the whole fish appearing a nearly uniform brownish-black. In some cases the head and fore part of the body remain yellowish-brown.

GLYPHISODON SAXATILIS, *Linnaeus*.

*Chaetodon saxatilis*, Linnæus, Syst. Nat. (ed. x.), 1758, p. 276.

Once only was this species met with; in a rock-pool at Middle Beach we encountered a shoal of small individuals some of which were secured. They measure but 20 mm. in length and when alive were of vivid green colour: in some the tail is of uniform tint, in others the upper and lower rays are brown. All have the characteristic five cross bands. The species has been recorded under the name *Glyphidodon caelestinus*, Cuvier and Valenciennes.

GLYPHISODON POLYACANTHUS, *Ogilby*.

*Glyphidodon polyacanthus*, Ogilby, Aust. Mus. Mem., ii., 1889, p. 65.

(Plate xxiii., fig. 1.)

Both young and adult examples were freely obtained in rock-pools, the former being perhaps one of the most strikingly coloured fishes met with. When alive the ground colour is brilliant orange and the naso-dorsal blue line is very broad, as is also that surrounding the dorsal ocellus; these lines narrow with age, become broken into dots and finally disappear, while the ground colour turns uniformly dark brown. The figure represents a half-grown individual.

GLYPHISODON ANTJERIUS, *Cuvier and Valenciennes*.

*Glyphisodon antjerius*, Cuvier and Valenciennes, Hist. Nat. Poiss., v., 1830, p. 481.

In recording *G. brownriggii*, Bennett, from the island in 1894,<sup>41</sup>

<sup>41</sup> Waite—Proc. Linn. Soc. N.S. Wales, (2), ix., 1894, p. 219.

I followed Bleeker, Günther, and Day in regarding this species and *G. antjerius* as synonymous. I now prefer to recognise them as distinct, and assign the island form to the latter species, characterised by having only one dorsal ocellus, and that situated at the base of the posterior dorsal spines. This species differs from *G. polyacanthus*, Ogilby, by having the normal number of thirteen dorsal spines.

From a study, in conjunction with Mr. McCulloch, of many members of the family, received mainly from the New Hebrides, I cannot subscribe to Day's statement<sup>42</sup> that colour variations "are not merely due to age." Further needful investigation into the genus *Glyphisodon* will probably show that many of the so-called varieties of *G. brownriggii* are in reality valid species, undergoing changes with age, but otherwise constant.

Cuvier and Valenciennes' short description was based only upon a drawing sent from Java by Kuhl and Von Hasselt, to whom they credit the specific name. It may be noted that the radial formula is not given and subsequent writers have apparently considered it to be the same as in *G. brownriggii*. If I am correct in assigning our examples to *G. antjerius*, the species is certainly distinct. They yield the following characters:—

D. xiii. 9; A. ii. 15; V. i. 5; P. 22; C. 15.

and have thus nine more dorsal rays than counted by Bennett, or six more than rendered by other writers.

#### THALASSOMA TRILOBATUM, Lacépède.

*Labrus trilobatus*, Lacépède, Hist. Nat. Poiss., iii., 1802, p. 454.

*Julis umbrostygma*, Rüppell, Neue Wirbelt., Fische, 1837, p. 11, pl. iii., fig. 2.

An examination of the nice series collected, enables me to identify Rüppell's species as a younger stage of *T. trilobatum*. To the already long synonymy, *T. berendti*, Seale,<sup>43</sup> from Honolulu, should be added. In small specimens the longitudinal colour lines appear only as clusters of dark vertical marks, there being six clusters in each row, of which there are three; one at the base of the dorsal, one along the centre of the body, and a third from the base of the pectoral to the lower part of the tail. The dorsal and anal fins each bear three bands, one basal, one median and one marginal, the marginal bands disappear with age and the median one becomes

<sup>42</sup> Day—Fishes India, 1877, p. 387.

<sup>43</sup> Seale—Occ. Papers Bernice Pauahi Bishop Mus., i., 1901, p. 15, fig. 7.

sub-marginal. The opercular lines are not at first apparent, and when developed are not so wide as they ultimately become. The tail is, in the younger stages, rounded, and assumes a truncate shape before reaching the trilobed condition of the adult.

The behaviour of this fish renders it liable to be caught by hand. The reefs at the northern and southern extremities of the lagoon are very even and level, and are consequently quickly exposed and covered at the ebb and flow of the tide. So loth does the fish seem to leave the reef, that it becomes half exposed by the receding tide, and then exhibits much commotion when disturbed. As we waded along the reef every few steps was marked by the flonndering action and subsequent rush of one of these fishes. They are also among the first fishes to appear with the incoming tide. Numbers remain in the larger pools between tide marks, while on the eastern side of the island we obtained young examples in the rock-pools.

*CORIS PICTA*, Bloch and Schneider.

*Labrus pictus*, Bloch and Schneider, Syst. Ichth., 1801, p. 251, pl. lv.

The water telescope showed this beautiful fish to be common immediately outside the reef, where, by dropping a bait, a dozen would be in view within a few minutes.

*ANAMPSES DIADEMATUS*, Rüppell.

*Anampses diadematus*, Rüppell, Neue Wirbelt., Fische, 1835, p. 21, pl. vi., fig. 3.

With this species I associate an example obtained while wading on the South Reef. When alive it was of dark green colour, with vertical pearl-coloured marks on each scale. It bears the characteristic blue lines on the head but the interocular band is absent, in which respect it agrees with Günther's figure "A."<sup>44</sup> The specimen measures 270 mm. in length, and constitutes a record for the island.

*ANAMPSES ELEGANS*, Ogilby.

*Anampses elegans*, Ogilby, Aust. Mus. Mem., ii., 1889, p. 67.  
*Anampses variolatus*, Ogilby, loc. cit.

In our examples, of which we have two, preserved in formaline, the ground colour is green with the upper half of the head and body darker and greyer; a deep grey band passes across the front of the snout and through the eye on to the oper-

---

<sup>44</sup> Günther—Fische Südsee, vii., 1881, pl. cxxxix.

culum, where it descends and forms a large blotch of purplish hue; rather widely spaced dark-green spots occur on the upper part of the head and opercle and behind the eye. Scales on the body with longitudinal lines, fainter, but distinct, on the lower parts, a blue spot on each scale. Both dorsal and anal fins spotted with green, each with a black yellow-edged spot at the base of the hinder rays; the caudal is yellow with green markings and a clear margin; the pectoral is yellow basally, otherwise colourless, it has a blue line across the muscular base. In the smaller example the markings on the upper part of the back form transverse bands and in this specimen only, is an anal spot present: both the spots and bands are possibly indications of immaturity. I have examined the type specimens and in the smaller examples can still see indications of the spot on the dorsal fin. Though much colour has now disappeared from the type of *A. variolatus*, of the same author, I regard it as a younger stage of the same species, the rows of scales though rendered as 4/10 and 6/11 respectively do not differ in number, the first-named figures being correct.

*PACHYNATHUS CAPISTRATUS*, Shaw.

*Balistes capistratus*, Shaw, Gen. Zool., v., 1804, p. 417.

I previously identified this species from the island from the examination of an old and discoloured specimen. In the consignment just received from Mrs. Nichols, I am pleased to find a large and well preserved example. It was obtained by dynamite, exploded at the wreck of the "Ovalau."

In "Nature" (10th Dec., 1903, p. 126), Prof. W. A. Herdman reports that Mr. James Hornell has discovered that a species of *Balistes* is a host of the endoparasitic worm, the larva of which is the nucleus of the pearl of the Cingalese oyster. The final host of the worm is *Trygon (Dasjatis)* which feeds upon *Balistes*.

*PSEUDOMONACANTHUS ANALIS*, *sp. nov.*

(Fig. 32.)

D. ii. 34; A. 31; P. 12; C. 12.

Length of head 3.5, height of body at the vent 2.7, length of caudal 4.5 in the total. The eye is moderate, 3.3 in the length of the head and less than the interorbital space: it lies midway between the dorsal rays and the snout.

The gill opening is oblique, placed under the anterior half of the eye; it is longer than the eye and is separated therefrom by a space less than an eye-diameter. The nostrils are close together, separated from the eye by a third of its diameter: they are simple pores with skinny margins.

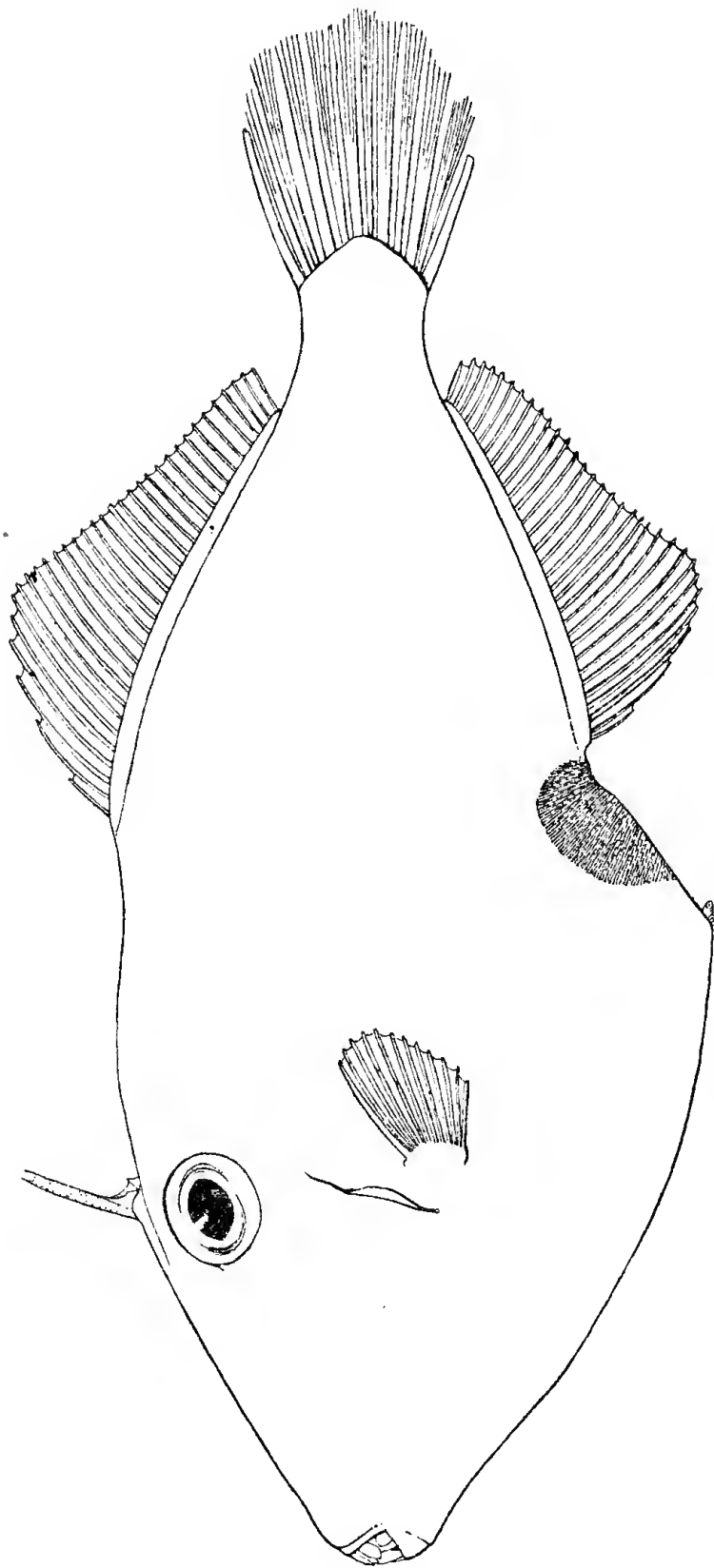

Fig. 32.—*Pseudomonacanthus analis*, Waite. Three-fourths natural size.



Head deeper than long, its upper profile scarcely convex, as is also its continuation to the dorsal rays. The body is elongate, strongly compressed and the ventral process is not greatly extensible. The dorsal spine is without barbs and is broken, it stands above the middle of the eye and midway between the end of the snout and the soft dorsal fin: the rays are similar to those of the anal, they commence in advance of that fin. The vertical from the ventral process lies nearer to the dorsal rays than to the spine. The ventral spine is simply roughened without distinct points. The pectoral is inserted in advance of the hinder edge of the eye. The caudal is short and rounded, the peduncle bears neither spines nor bristles, and its height is rather more than the diameter of the eye.

Skin everywhere rough, with distinct scales, each bearing a number of fine points on its edge.

*Colours.*—Head and body umber brown, end of snout blackish; a large black well-defined area surrounds the vent. All the fins blue, the pectoral and caudal intensely and uniformly so.

Total length 220 mm.

Since writing the above, I have received from Mr. C. T. Regan, his paper on the classification of the Plectognathi, wherein he describes a species from Melbourne, under the name *P. degeni*,<sup>45</sup> which is closely allied to *Pseudomonacanthus modestus*, Günther, *P. ayraudi*, Günther, and *P. septentrionalis*, Günther, but differs from all by the absence of barbs on the dorsal spine.

SEBASTOPSIS GUAMENSIS, *Quoy and Gaimard.*

*Scorpaena guamensis*, Quoy and Gaimard, Voy. "Uranie," Zool., 1824 p. 326.

One example was taken of this species, not previously known from the island, it measures 107 mm. in length. *Sebastes scaber*, Ramsay and Ogilby,<sup>46</sup> also belongs to the genus *Sebastes* and is a species distinct from *S. guamensis*.

COCOTROPUS ALTIPINNIS, *Waite.*

*Cocotropus altipinnis*, Waite, Rec. Aust. Mus., v., 1903, p. 41, pl. v., fig. 2.

At the time of writing upon *Cocotropus*, I had not seen the works of Klunzinger,<sup>47</sup> nor of Kossmann and Räuber,<sup>48</sup> both of

<sup>45</sup> Regan—Proc. Zool. Soc., 1902, p. 299, pl. xxiv., fig. 1.

<sup>46</sup> Ramsay and Ogilby.—Proc. Linn. Soc. N.S. Wales, x., 1886, p. 577.

<sup>47</sup> Klunzinger—Fische roth. Meer., i., 1884, p. 74

<sup>48</sup> Kossmann and Räuber—Reise roth. Meer., Fische., 1876, p. 395, pl. ii., fig. 6.

which have since become available. The author first-named places *Tetraroge gallus*, Kossmann and Räuber, in the genus *Cocotropus*; the species is not included in my synopsis of the species, and I therefore furnish the following points for comparison, as deduced from the authors' description.

*Cocotropus gallus*, Kossmann and Räuber.

D. xiii. 9; A. ii. 6.

Length of head 3, height of body 3·8. Dorsal fin commences over middle of eye. Second spine longest, 1·25 in height of body? (plate ii. is absent in my copy).

*Hab.*—Red Sea.

GObIUS EOLOSOMA, *Ogilby*.

*Gobius aeolosoma*, Ogilby, Aust. Mus. Mem., ii., 1889, p. 61.

(Plate xxiii., fig. 2.)

This goby was found to be quite common in the rock-pools, and was the only member of the genus taken. The largest examples measure 72 mm. in length. With a good series in hand, it is possible to augment the original description somewhat.

D. vi. i. 9-10; A. i. 8; V. i. 5; P. 18-20.

The snout is a little shorter than the eye. The pectoral fin is shorter than the head and has the upper three to five rays split to their bases and "silk-like." The ventrals vary in length, reaching to the vent in their greatest development. In the male the anal papilla is pointed, in the female slightly bifid. Though the middle rays of the caudal are the longest they are not sufficiently produced to give a wedge-shaped contour to the fin as described.

Examples taken were in full breeding condition, the eggs being bright orange in colour. A male is selected for the accompanying illustration.

ALLOGOBIUS, *gen. nov.*

*Family* GOBIDÆ.

Body oblong and compressed with large imbricate minutely ctenoid scales. Head large, broad, and slightly compressed, naked, without barbels. Eyes large, anterior, not approximate, opercles unarmed. Mouth oblique, rather large. A row of conical teeth in both jaws with canines. A large patch of canines within the symphysis of the lower jaw. Tongue entire. Branchiostegals five. Gill opening small, lateral, the membranes broadly attached to the isthmus. Dorsal fin with six plus one

slender spines and about ten rays. Anal short. Ventral fins not united, with one spine and four separate rays. Pectoral without free rays. Caudal fin rounded. Skull without distinct median keel. Vertebrae  $10 + 15 = 25$ .

This genus differs from the typical members of the family by having but four ventral rays.

From those with the same character, namely, *Oxymetopon*, *Trypauchen* and their allies, it may be distinguished by the short vertical fins and the smaller number of vertebrae.

ALLOGOBIUS VIRIDIS, *sp. nov.*

(Plate xxiii., fig. 3)

B. v; D. vi. i. 10; A. i. 8; V. i. 4; P. 17-18; C. 13; Se. 25; Sc. tr. 8.

The head is large, slightly compressed, and 3.7 in the total length. The height of the body is 4.4 in the same, and equal to the length of the caudal. Eyes large, anterior, lateral, one-third of a diameter apart; they just attain the profile of the head and are one-fourth its length. Snout obtuse equal to two-thirds the diameter of the eye. Body oblong, compressed, covered with large minutely ctenoid scales, with the exception of the portions in front of the dorsal and ventral fins. Head naked.

The first dorsal spine is filamentous in the male, of twice and a third the length of the second which is 1.7 in that of the head; the remaining spines successively decrease and the membrane of the last reaches the origin of the second fin. The soft dorsal is higher posteriorly, the ninth ray being equal to the second spine. The anal arises beneath the second dorsal ray and the last ray is beneath the penultimate ray of the dorsal. The ventrals are well separated, the inner rays longest and more than the height of the body, reaching the vent: they are unconnected and feather-like, the vanes being developed only on the anterior aspect of each ray. The pectorals are pointed. The nine upper rays are simple, the first divided ray is the longest, being slightly longer or shorter than the head, and attaining to about the first dorsal ray. The caudal fin is rounded. The peduncle is deep and strongly compressed, its depth less than its length.

The anal papilla, in the male, forms an incomplete cup, open in front, its margins extremely digitate; in the female it is simpler, conical in shape, with two digitate processes only.

*Colours.*—The ground tint is green, the body crossed with seven somewhat darker bands less than an eye-diameter in width: the anterior band commences at the first dorsal spine, the second between the fifth and sixth, two below the second dorsal, and three on the caudal peduncle, the last of which bears

a large black spot: the five last bands are darkest beneath. The head markings are brown, bright red in life, and consist of large spots extending over the whole head, smaller on the snout and below, and forming bars across the occiput. The first dorsal is dusky, especially towards the margin, the second dorsal and caudal bear brown spots which on the latter tend to form bars, the colouration of the fins however is subject to variation. Most of the scales bear a vertical row of small brown spots.

Length, 40 mm.

This small species was very common in the rock-pools and in breeding condition when obtained. The eggs are large and green in colour.

*LIMNICHTHYS, gen. nov.*

*Family* TRICHONOTIDÆ.

Head depressed, pointed, body sub-cylindrical anteriorly, tail compressed, cleft of mouth wide, nearly horizontal, jaws equal; eyes directed upwards; scales moderate, cycloid, lateral line continuous. One dorsal fin shorter than the anal; ventrals jugular with one spine and five rays, the rays of all the fins, the caudal excepted, are simple. Gill openings very wide. Branchiostegals seven. Villiform teeth in the jaws and on the palatines. None on the vomer. Vertebrae  $13 + 27 = 40$ .

This genus is sufficiently distinguished from other members of the family by the dorsal fin being inserted behind the origin of the anal. In *Creedia*, which should perhaps also be referred to the family, the dorsal fin is short and situated above the middle of the anal, the lateral line is ventral in position and of peculiar formation.

*LIMNICHTHYS FASCIATUS, sp. nov.*

(Plate xxiii., fig. 4.)

B. vii; D. 25-26; A. 27-29; V. i. 5; P. 13; C. 12 + 4; L. lat. 40; L. tr. 3 + 5.

The head is depressed and triangular, 4.8; height of the body, at the first anal ray, 7.2; and the caudal 5.0 in the length of the body. Eyes half a diameter apart, directed upwards, interrupting the profile of the head, 5.5 in its length, and equal to that of the snout: anterior nostril in a tube near the end of the snout, posterior nostril simple, close in front of the eye. The upper lip is pointed and produced into a skinny process nearly as long as the eye (illustrated in the figure.)

Body elongate, subcylindrical in front, passing into the compressed tail. Head naked; body with rather large adherent cycloid scales, lateral line sub-median in position, but running

posteriorly lower on the body; it is very conspicuous, and each scale, to the thirteenth, has an entire margin and bears a large simple tube, thence the free margin of each scale is trilobed, the centre lobe being much longer than the lateral ones.

The dorsal fin arises its own length behind the tip of the snout, and extends nearly to the base of the caudal. The first ray is one-third longer than the diameter of the eye and the following successively increase in length to the seventh, which is half the length of the head. Thence they gradually decrease in length, the last being once and a half the diameter of the eye. The anal fin arises three rays in advance of the dorsal, and extends a little further backward, it is similar to the dorsal, though its posterior rays are longer. The ventrals are short and are inserted in advance of the pectorals; the latter are pointed and do not reach to the first anal ray; the caudal is rounded, its peduncle less than half the height of the body; the rays are divided, those of all the other fins simple.

*Colours.*—Ground colour creamy with black markings, a black band connects the eyes and passes towards the angle of the mouth, though this is sometimes absent. The body bears eight transverse bars; they are placed at equal intervals, the first is above the opercle, the last at the base of the caudal: the four anterior bands are broadened above and form each a triangular figure, the following bands are widened below and, uniting, produce a broad longitudinal line which constitutes the most striking colour feature of the fish. Fins colourless.

Length, 43 mm.

Though small, our examples are fully adult many being in full roe, the ova are large and of yellow colour.

These little fishes are common in the rock-pools, but owing to their secretive habits were not observed until driven from their retreats by poison.

*DIPLOCREPIS COSTATUS, Ogilby.*

*Diplocrepis costatus*, Ogilby, Proc. Linn. Soc. N. S. Wales, x., 1885, p. 270.

(Plate xxiv., fig. 1.)

Two examples of this species were originally recorded from New South Wales and other two were subsequently recognised from Lord Howe Island. By means of poison we collected a nice series from the rock-pools, and at the time noted that they were of brown colour with darker cross markings on the dorsal surface. All markings have disappeared under preservation of the specimens, so that I am unable to describe the ornamentation.

The accompanying illustration represents the type specimen much enlarged.

LEPADICHTHYS, *gen. nov.*

Family GOBIESOCIDÆ.

Head moderately broad and depressed; body, anteriorly slightly depressed, posteriorly deep and strongly compressed, naked; opercle without apparent spine. Gills, three. Gill membranes united and attached to the isthmus. Incisor teeth in both jaws in a single series, no teeth on the vomer or palatines. Sucking disc of moderate size, the posterior portion without free margin. Dorsal and anal fins long, the former with about sixteen, the latter with about thirteen rays. Vertebrae  $14 + 20 = 34$ .

Of the two main divisions of the family, founded on the character of the sucking disc, this new genus agrees with *Gobiesox* and its allies, rather than with the *Lepadogaster* group. Fundamentally it more nearly approaches the latter, the number of vertebrae being identical. The long vertical fins are also well in agreement, but the gills are fewer in number. It differs from *Gobiesox* by having the gill membranes attached to the isthmus, and also from other genera of the group by its longer vertical fins.

LEPADICHTHYS FRENATUS, *sp. nov.*

(Plate xxiv., fig. 2.)

D. 16; A. 13; P. 29; V. i. 4; C.  $17 + 8 = 10$ .

Length of head 3.4, width 5.6; height of body 6.5, width 6.8 in the total length. The snout is broad and depressed 3.4 in the length of the head; the mouth is small and terminal, its cleft less than two-thirds the distance from the tip of the snout to the eye. Teeth in the jaws very small, in a single series, closely set and incisor-like, with entire edges. A velum behind the teeth in both jaws, broader in the lower jaw. The nostrils on each side are close together at the upper anterior angle of the orbit. The eye is longer than deep, 5.4 in the length of the head and equal to the interocular space, which is quite flat.

Adhesive apparatus longer than broad, its length equal to the width of the head.

The length of the dorsal is equal to that of the head, and its point of origin to the front edge of the eye is twice its length. The anal commences beneath the fifth dorsal ray and terminates in the same vertical; both fins are higher behind than in front, and are attached to the base of the caudal rays.

Pectorals broad and rounded, nearly half the length of the head and without distinct fold at the base. The ventrals are

attached to the eighteenth pectoral rays. Vent midway between the posterior edge of the sucking disc and the first anal ray. Anal papilla small. Caudal rounded, its length half that of the head, the pedicle very strongly compressed, its depth more than half the length of the caudal.

*Colours.*—When preserved the general colour is pinkish yellow. The edge of the upper lip is bright scarlet, the colour continued as a streak which passes backward through the eye, towards the upper margin of the opercle. Fins colourless.

We possess two examples which measure 53 mm. and 52.3 mm. respectively in length.

PETROSCIRTES ICELII, *Ogilby.*

*Petroscirtes icelii*, Ogilby, Proc. Linn. Soc. N. S. Wales, (2), ix., 1894, p. 370.

(Plate xxiv., fig. 3.)

One example only of this species was taken. When first discovered it was basking on a rock, quite out of the water, but hopped into a rock-pool on our nearer approach. Members of the genus *Salarias* indulged in a similar habit. Of these we obtained the following three species:—*S. alboapicalis*, Ogilby; *S. marmoratus*, Bennett; and *S. quadricornis*, Cuvier and Valenciennes, all previously known from the island.

PETRAITES ROSEUS, Günther.

*Cristiceps roseus*, Günther, Cat. Fish. Brit. Mus., iii., 1861, p. 274.

In the Australian Museum Memoir on Lord Howe Island, Ogilby<sup>49</sup> tentatively identified "a small *Cristiceps* in bad condition" with *C. roseus*. We obtained three examples of that species. They were taken in rock-pools and when alive were of green colour with darker markings; after preservation in formaline the colour became orange, and it may be noted that most of the species known are described as of yellowish or reddish hues, and several names applied, have such significance notably:—*C. aurantiacus*, *C. roseus*, *C. splendens*, *C. pallidus*. Judging by the Lord Howe Island examples and the number of species of *Cristiceps*, etc., with which I am acquainted in New South Wales waters, I should say that green is the life colour of nearly all. These little fishes habitually live in the green ulvæ of our coasts and bays, and may be readily obtained by means of a sweep net. So characteristic are they of the seaweed that they are known to boys as "weed-fishes."

<sup>49</sup> Ogilby—Aust. Mus. Mem., ii., 1889, p. 63.

TRIPTERYGION NIGRIPENNE, *Cuvier and Valenciennes.*

*Tripterygion nigripenne*, Cuvier and Valenciennes, Hist. Nat. Poiss., xi., 1836, p. 413, pl. cccxxxix.

I provisionally associate with this species two examples, the larger of which measures 56 mm. in length. The radial formula is:—

D. iv. xv. 11-12; A. i. 21; V. 2; P. 16-17; C. 13;

and is thus noticeably different from the original description. Hutton<sup>50</sup> remarks that in his opinion *T. forsteri*, *T. fenestratum*, and *T. varium* are only accidental varieties of *T. nigripenne*, in which case our examples may be justly included. In some respects they nearly approach *T. medium*, but differ from that species by having a large orbital tentacle, though this is possibly a doubtful specific character.

In the absence of New Zealand examples for comparison, I am unable to offer any opinion on the validity of the various described species.

TRIPTERYGION RUFOPILEUM, *sp. nov.*

(Plate xxiv., fig. 4.)

D. iii. xii.-xiii. 10-11; A. 18-20; P. 15-17; V. 2; C. 13; L. lat. 17-18 + 19; L. tr. 3 + 7.

Length of head 3·7, height of body 4·1, length of caudal 4·8 in the total. Diameter of eye 3·2 in the head and slightly more than the length of the snout. Head a little depressed, body subcylindrical, deepest at origin of the second dorsal; eyes close together, directed obliquely upwards; upper jaw a little the longer, teeth small, in bands in the jaws and on the vomer. A bifurcate tentacle on the anterior nostril, and a simple one above the hinder part of the eye.

Head, throat and lower part of body as far as the origin of the anal fin, naked. All the scales minutely ctenoid. The lateral line extends to below the second dorsal, whence two rows lower it *apparently* reaches to the base of the caudal: the lower row is without tubes and the effect of a line is produced by a deep and narrow notch in each scale.

The spines of the first dorsal fin are graduated, the first being longest and 2·4 in the length of the head, the anterior portion of the second dorsal is higher than the preceding fin, the first spine being a little shorter than the second and longest, which is a trifle longer than half the length of the head; the remaining spines decrease gradually to the ninth, thence suddenly. The

<sup>50</sup> Hutton—Trans. N.Z. Inst., v., 1873, p. 263.



rays of the third dorsal are graduated, the first and longest being a fifth more than the first spine of the anterior fin.

The anal rays successively increase in length to the second last, which equals the first spine of the dorsal fin. The membrane of the first dorsal is slightly and of the anal deeply incised. Pectoral pointed, the tenth ray is the longest and less than its distance from the snout, it extends to the base of the seventh anal ray, the seven or eight lowermost rays are simple and have their tips free and thickened. The ventral rays are united for one-fourth their length, the inner is the longer and less than the height of the body. Caudal rounded, the rays bifurcated only.

*Colours.*—The general ground colour is yellow, reddish or brownish, body markings being invariably present in the form of more or less regularly transverse bands, eleven in number: one at the base of the first dorsal fin, another between the bases of the first and second fin, three below the second dorsal, one between the second and third fin, three below the third dorsal, and two on the caudal peduncle. These markings, in examples with light ground colour, are more pronounced dorsally, in dark varieties they are darker and broader below.

With the exception of a scarlet patch on the occiput, which is always present, the head may be with or without markings, such consist of a jet black area which embraces the snout, throat, lower part of the opercles and base of the pectoral fin; the hinder part of the upper and the whole of the lower lip are colourless, an iridescent blue spot on the preopercle. The spinous dorsals are margined with black and have also a broad sub-basal black line. In pale examples the other fins are colourless: in the dark varieties, that is, those with ventral markings, the dorsal fins are colourless, while the anal and caudal are deep black, the latter with or without a white margin. The dark patch at the base of the pectoral extends somewhat on to the rays.

Length 42 mm. Over one hundred examples collected.

These little fishes swarmed in every rock-pool, and it was observed that the colouration is correlated to their surroundings. Examples taken in the coral rock are of reddish hue, those from sandy bottoms yellow, while the specimens obtained in the dark volcanic troughs are the dark variety above referred to. It is especially interesting to note that in these the ventral surface is quite dark in colour, whereas the upper surface is light, markings on the dorsal fin even being absent. So constantly were

these correlated peculiarities noted that the establishment of well marked varieties becomes a certainty.

This fact supports the remarks as to the non-roving habit of rock-pool fishes mentioned in the introductory paragraph.

They spend their lives and breed in the pool in which they find themselves, and when stormy waters rush through, they cling to the rocky walls of their home. Occasional examples may be swept into other pools, the species being thus dispersed and varieties produced and propagated by change of environment.

The species above described has been identified with *T. atrogulare*, Günther,<sup>48</sup> known from a single specimen taken at Bowen, Queensland. As far as one may judge from the short description, it differs from Günther's species by constantly having an increased number of both dorsal and anal rays and also in the persistent body markings. The dark ornamentation of the head is a feature found in other members of the genus, the type *T. nasus*, Cuvier and Valenciennes, included. This colour peculiarity has not been noted in *T. etheostoma*, Jordan and Snyder,<sup>49</sup> recently described from Japan and to which our species bears considerable resemblance.

#### ACANTHOCLINUS LITOREUS, Forster.

*Blennius litoreus*, Forster in Bloch and Schneider, Syst. Ichth., 1801, p. 177.

*Acanthoclinus fasciolatus*, Ogilby, Aust. Mus. Mem., ii., 1889, p. 63, pl. iii., fig. 3.

A small, though interesting collection of this species was made from rock-pools, the individuals of which exhibit considerable variation.

The following appear to be constant characters, a white stripe from the upper lip along the middle of the head to the origin of the dorsal fin; a round black spot, as large as the eye, on the upper angle of the operculum; the tips of the dorsal and anal spines white. In examples in which the body is wholly dark-brown there is a white or grey streak from the upper lip, to below the eye and opercular spot. In other specimens the body is of lighter hue and the eye and opercular spot are connected by a narrow black line, below this, the whole

<sup>48</sup> Günther—Journ. Mus. Godeffroy, i., 1873, p. 267.

<sup>49</sup> Jordan & Snyder—Proc. U.S. Nat. Mus., xxv., 1902, p. 444, fig. 1.

head, with the exception of the tip of the lower jaw, is white, which colour also extends to the base of and includes the pectoral fin, throat and chest. The banded variety (*A. fasciolatus*) is in every way similar to this, with the exception that the body is marked with twelve or more narrow vertical black bars, which do not however quite attain to the dorsal and ventral profiles. With the exceptions above mentioned all the fins are black in every variety.

The largest example measures 55 mm. in length. None exhibit signs of breeding.

*DINEMATICTHYS LONGIFILIS*, *Ogilby*.

*Diancistrus longifilis*, *Ogilby*, Proc. Linn. Soc. N. S. Wales, xxiii., 1899, p. 744.

(Plate xxiv., fig. 5.)

The type of this species, the only example known, is in the Queensland Museum and was lent to me, for the purpose of illustration, by the Curator on the application of Mr. *Ogilby*.

The scales are described as cycloid, striated and deciduous; the few remaining on the body are indicated in the figure. No mention is made, in the original description, of a maxillary spine present on the inferior aspect, in advance of the angle; and the dorsal and anal rays are said to be simple; the rays of all the fins, with the exception of the ventrals, are certainly bifid, the latter are composed each of a single ray which is enclosed in a membrane for its proximal half. The author has erroneously interpreted the condition as:—"Each (ventral) developed as a long filament of two distally coalescent rays." The "strong dentition" is therefore the only feature distinguishing *Diancistrus* from *Dinematichthys*, and one which scarcely entitles it to generic rank.

---

Note, page 141.

*PLOTOSUS ANGUILLARIS*, *Bloch*.

As the foregoing was passing through the press, I received, by the courtesy of Drs. *Jordan* & *Fowler*, an advance copy of their "Review of the Siluroid Fishes of Japan."<sup>50</sup>

---

<sup>50</sup> *Jordan* & *Fowler*—Proc. U.S. Nat. Mus., xxvi., 1903.

I notice that these authors also reject the word *arab* as a specific name for the striped catfish. In adopting *anguillaris* they assign it to Lacépède, 1803; I have credited it to Bloch, 1794, and do not see why the earlier writer should not be quoted.

Under the peculiar system of nomenclature which Bleeker adopted, Lacépède's name was naturally used; but Bleeker's practices are not endorsed by modern writers.

---

Note, page 167.

APLODACTYLUS ETHERIDGII, *Ogilby*.

*Parhaplodactylus* is a genus formed by Thominot<sup>51</sup> for *Aplodactylus lophodon*, Günther, *A. arctidens*, Richardson, and *A. marmoratus*, Thominot. As I cannot refer to this author's work I am unable to say if *Aplodactylus etheridgii*, should also enter the genus.

---

<sup>51</sup> Thominot—Bull. Soc. Philom., (7), vii., p. 140.

## CATALOGUE OF THE FISHES OF LORD HOWE ISLAND.

By EDGAR R. WAITE, F.L.S., Zoologist.

My intention of publishing a Catalogue of the Fish Fauna of Lord Howe Island was, as already mentioned,<sup>1</sup> relinquished when Mr. J. D. Ogilby announced that he had the preparation of such a catalogue in view.<sup>2</sup> When leaving the State, however, he intimated to me that, in consequence thereof, he had abandoned the project, and suggested that I should undertake the work as previously contemplated.

It has been thought advisable to make the Catalogue more useful than a mere list of species; to this end I have given, under the heading of each species, the original name and reference; indicated where a figure may be found, and recorded the first mention of it as a member of the island fauna.

The names Foulis and Hill,<sup>3</sup> in brackets, refer to two papers on the island, in which certain fishes are mentioned by their vernacular names; not being authoritative as regards the subject, these references are merely indicated.

As some species are mentioned in the Proceedings of the Zoological Society of London, and also in the Australian Museum Memoir No. II., for the same year, I may state that the published date of the latter, though not specifically indicated, is 1st May, 1889. The fish catalogue, which was complete to date, contains eighty-eight species.

The list, as it now stands, numbers one hundred and eighty. The following are not included as their claims at present rest upon, the one circumstantial, the other, doubtful evidence.

*Dasyatis*, sp.

*Epinephelus punctatus*, Linnæus.

*Hippocampus hippocampus* Linnæus, is also withdrawn.

Representatives of the following genera have not been specifically determined.

*Atopichthys*.

*Hyporhamphus*.

*Canthidermis*.

*Symphurus*.

---

<sup>1</sup> Waite—Rec. Aust. Mus., iii., 1900, p. 193.

<sup>2</sup> Ogilby—Proc. Linn. Soc. N.S. Wales, xxiii., 1898, p. 731.

<sup>3</sup> Foulis and Hill—See Bibliography.

An "unrecognisable Scopelid" may be considered as a representative of one of the within named species of Myctophidæ, and so removed from the undetermined list.

*Family GALEIDÆ.*

PRIONACE, *Cantor*, 1850.

1. PRIONACE GLAUCA, *Linncæus*,  
*Blue Shark.*

*Squalus glaucus*, *Linncæus*, *Syst. Nat.*, (ed. x.), 1758, p. 235.

*Figure*—*Müller & Henle*, *Plagiostomen*, 1838, pl. xi.

*Recorded*—*Ogilby*, *Proc. Linn. Soc. N. S. Wales*, xxiii., 1899, p. 732.

CARCHARHINUS, *Blainville*, 1828.

2. CARCHARHINUS MENISORRAH, *Valenciennes*.  
*School Shark.*

*Carcharias menisorrah*, *Valenciennes*, in *Müller & Henle*, *Plagiostomen*. 1838, p. 46.

*Figure*—*Müller & Henle*, *loc. cit.*, pl. xvii.

*Recorded*—(? *Hill*); *Waite*, *Rec. Aust. Mus.*, v., 1904, p. 140.

*Family ISISTIIDÆ.*

ISISTIUS, *Gill*, 1864.

3. ISISTIUS BRASILIENSIS, *Quoy & Gaimard*.

*Scymnus brasiliensis*, *Quoy & Gaimard*, *Voy. "Uranie," Zool.*, 1824, p. 198.

*Figure*—*Garman*, *Mem. Mus. Comp. Zool. Harvard*, xxiv., 1899, pl. i., fig. 1, pls. ii. iii. and lxix., fig. 2.

*Recorded*—*Waite*, *Rec. Aust. Mus.*, iii., 1900, p. 195.

*Family SILURIDÆ.*

PLOTOSUS, *Lacépède*, 1803.

- 4 PLOTOSUS ANGUILLARIS, *Bloch*.  
*Striped Cat-Fish.*

*Platystacus anguillaris*, *Bloch*, *Nat. ausl. Fische.*, viii., 1794, p. 61.

*Figure*—*Bleeker*, *Atl. Ichth.*, ii., 1863, pl. xcv., fig. 2.

*Recorded*—*Ogilby*, *Aust. Mus. Mem.*, ii., 1889, p. 71.

Family ANGUILLIDÆ.

ANGUILLA, *Shaw*, 1804.

5. ANGUILLA AUSTRALIS, *Richardson*.

*Fresh-water Eel.*

*Anguilla australis*, *Richardson*, Proc. Zool. Soc., ix., 1841, p. 27.

*Figure*—*Richardson*, Voy. "Ereb. and Terr.", Fish., 1847, pl. xlv., figs. 1-6.

*Recorded*—*Ogilby*, Aust. Mus. Mem., ii., 1889, p. 72.

6. ANGUILLA REINHARDTII, *Steindachner*.

*Long-finned Eel.*

*Anguilla reinhardtii*, *Steindachner*, Sitzb. Akad. Wiss. Wien, iv., 1867, p. 15.

*Figure*—*Tenison Woods*, Fish. N.S. Wales, 1882, pl. xxxix., (as *A. australis*).

*Recorded*—*Waite*, Rec. Aust. Mus., iv., 1901, p. 36.

Family LEPTOCEPHALIDÆ.

LEPTOCEPHALUS, *Scopoli*, 1777.

7. LEPTOCEPHALUS CINEREUS, *Rüppell*.

*Conger Eel.*

*Conger cinereus*, *Rüppell*, Atlas Reise nord. Afrika, Fische, 1828, p. 115.

*Figure*—*Eydoux & Souleyet*, Voy. "Bonite," Poiss., 1841, pl. ix., fig. 1.

*Recorded*—*Waite*, Rec. Aust. Mus., iii., 1900, p. 197.

CONGRELLUS, *Ogilby*, 1898.

8. CONGRELLUS GILBERTI, *Ogilby*.

*Congrellus gilberti*, *Ogilby*, Proc. Linn. Soc. N.S. Wales, xxiii., 1898, p. 288.

*Figure*—None.

*Recorded*—*Ogilby*, Aust. Mus. Mem., ii., 1889, p. 72, (as *Congromuræna mellissii*).

CONGERMURÆNA, *Kaup*, 1856.9. CONGERMURÆNA LONGICAUDA, *Ramsay & Ogilby*.

*Congromuræna longicauda*, *Ramsay & Ogilby*, Proc. Linn. Soc. N.S. Wales, (2), ii., 1888, p. 1022.

*Figure*—None.

*Recorded*—*Waite*, Rec. Aust. Mus., iii., 1900, p. 196.

*Family* MYRIDÆ.MURÆNICHTHYS, *Bleeker*, 1853.10. MURÆNICHTHYS NICHOLSÆ, *Waite*.

*Murænichthys nicholsæ*, *Waite*, Rec. Aust. Mus., v., 1904, p. 142.

*Figure*—*Waite*, *loc. cit.*, pl. xvii., fig. 1.

*Recorded*—*Waite*, *loc. cit.*

*Family* OPHICHTHYIDÆ.CALLECHELYS, *Kaup*, 1856.11. CALLECHELYS MELANOTÆNIA, *Bleeker*.

*Callechelys melanotaenia*, *Bleeker*, Atl. Ichth., iv., 1864, p. 66.

*Figure*—*Bleeker*, *loc. cit.*, pl. cxiii., fig. 2.

*Recorded*—*Waite*, Rec. Aust. Mus., v., 1903, p. 21.

BASCANICHTHYS, *Jordan & Davis*, 1892.12. BASCANICHTHYS PINGUIS, *Günther*.

*Ophichthys pinguis*, *Günther*, Cruise "Curaçoa," 1873, p. 430.

*Figure*—*Günther*, *loc. cit.*, pl. xxxv.

*Recorded*—*Waite*, Rec. Aust. Mus., v., 1903, p. 22.

OPHICHTHUS, *Thunberg & Ahl*, 1789.13. OPHICHTHUS VERSICOLOR, *Richardson*.

*Ophisurus versicolor*, *Richardson*, Voy. "Ereb. and Terr.," Fish., 1848, p. 103.

*Figure*—*Waite*, Rec. Aust. Mus., v., 1903, pl. iii., fig. 1.

*Recorded*—*Waite*, *loc. cit.*, p. 22.



Family MURÆNIDÆ.

GYMNOTHORAX, *Bloch*, 1795.

14. GYMNOTHORAX THYRSOIDEA, *Richardson*.

*Muræna thyrsoidea*, *Richardson*, *Voy. "Sulphur," Ichth.*, (1844), p. 111.

*Figure*—*Bleeker*, *Atl. Ichth.*, iv., 1864, pl. clxxxiii., fig. 3.

*Recorded*—*Ogilby*, *Aust. Mus. Mem.*, ii., 1889, p. 72 (as *Muræna afra*); *Waite*, *Rec. Aust. Mus.*, v., 1904, p. 144.

15. GYMNOTHORAX NUBILUS, *Richardson*.

*Muræna nubila*, *Richardson*, *Voy. "Ereb. and Terr.," Fish*, 1847, p. 81.

*Figure*—*Richardson*, *loc. cit.*, pl. xlvi., figs. 6-10.

*Recorded*—*Waite*, *Rec. Aust. Mus.*, v., 1904, p. 145.

16. GYMNOTHORAX FLAVIMARGINATUS, *Rüppell*.

*Muræna flavimarginata*, *Rüppell*, *Atlas Reise nord. Afrika, Fische*, 1828, p. 119.

*Figure*—*Rüppell*, *loc. cit.*, pl. xxx., fig. 3.

*Recorded*—*Waite*, *Rec. Aust. Mus.*, v., 1904, p. 145.

17. GYMNOTHORAX CHALAZIUS, *Waite*.

*Gymnothorax chalazius*, *Waite*, *Rec. Aust. Mus.*, v., 1904, p. 145.

*Figure*—*Waite*, *loc. cit.*, pl. xvii., fig. 2.

*Recorded*—*Waite*, *loc. cit.*

ECHIDNA, *Forster*, 1788.

18. ECHIDNA NEBULOSA, *Thunberg & Ahl*.

*Painted Eel.*

*Muræna nebulosa*, *Thunberg & Ahl*, *De Muræna*, 1789, p. 7.

*Figure*—*Bleeker*, *Atl. Ichth.*, iv., 1864, pl. clxviii. fig. 2.

*Recorded*—*Ogilby*, *Aust. Mus. Mem.*, ii., 1889, p. 72.

*Family* CLUPEIDÆ.SPRATELLOIDES, *Bleeker*, 1852.19. SPRATELLOIDES GRACILIS, *Temminck & Schlegel*.*Sandy Sprat.**Clupea gracilis*, *Temminck & Schlegel*, *Fauna Japon.*, Pisces, 1846, p. 238.*Figure*—*Temminck & Schlegel*, *loc. cit.*, pl. cviii., fig. 2.*Recorded*—*Ogilby*, *Aust. Mus. Mem.*, ii., 1889, p. 72.*Family* GONORHYNCHIDÆ.GONORHYNCHUS, *Cuvier*, 1817.20. GONORHYNCHUS GONORYNCHUS, *Linnaeus*.*Sand Shark.**Cyprinus gonorynchus*, *Linnaeus*, *Syst. Nat.*, (ed. xii.), i., 1766, p. 528.*Figure*—*Richardson*, *Voy. "Ereb. and Terr."*, *Fish.*, 1848, pl. xxix., figs. 1-6.*Recorded*—*Ogilby*, *Aust. Mus. Mem.* ii., 1889, p. 72.*Family* SYNODONTIDÆ.SYNODUS, *Bloch & Schneider*, 1801.21. SYNODUS VARIUS, *Lacépède*.*Salmo varius*, *Lacépède*, *Hist. Nat. Poiss.*, v., 1803, p. 224.*Figure*—*Temminck & Schlegel*, *Fauna Japon.*, Pisces, 1846, pl. cvi., fig. 1.*Recorded*.—*Ogilby*, *Aust. Mus. Mem.*, ii., 1889, p. 71.TRACHINOCEPHALUS, *Gill*, 1851.22. TRACHINOCEPHALUS MYOPS, *Forster*.*Salmo myops*, *Forster*, in *Bloch & Schneider*, *Syst. Ichth.*, 1801, p. 421.*Figure*—*Temminck & Schlegel*, *Fauna Japon.*, Pisces, 1846, pl. cvi., fig. 2.*Recorded*—*Waite*, *Rec. Aust. Mus.*, v., 1904, p. 148.

Family MYCTOPHIDÆ.

ÆTHOPRORA, *Goode & Bean*, 1895.

23. ÆTHOPRORA PERSPICILLATA, *Ogilby*.

*Æthoprora perspicillata*, *Ogilby*, Proc. Linn. Soc. N.S. Wales, xxiii., 1898, p. 36.

*Figure*—*Waite*, Rec. Aust. Mus., v., 1904, pl. xviii., fig. 1.

*Recorded*—*Ogilby*, *loc. cit.*

NOTOSCOPELUS, *Günther*, 1864.

24. NOTOSCOPELUS EJECTUS, *Waite*.

*Notoscopelus ejectus*, *Waite*, Rec. Aust. Mus., v., 1904, p. 150.

*Figure*—*Waite*, *loc. cit.*, pl. xviii., fig. 2.

*Recorded*—*Waite*, *loc. cit.*

MYCTOPHUM, *Rafinesque*, 1810.

25. MYCTOPHUM PHENGODES, *Lütken*.

*Scopelus phengodes*, *Lütken*, Spolia Atlantica, ii., 1892, p. 253.

*Figure*—*Lütken*, *loc. cit.*, fig. 11.

*Recorded*—*Waite*, Rec. Aust. Mus., v., 1904, p. 152.

26 MYCTOPHUM OPALINUM, *Goode & Bean*.

*Myctophum opalinum*, *Goode & Bean*, Oceanic Ichth., 1895, p. 72.

*Figure*—*Goode & Bean*, *loc. cit.*, fig. 81.

*Recorded*—*Waite*, Rec. Aust. Mus., v., 1904, p. 153.

27. MYCTOPHUM HYGOMII, *Lütken*.

*Scopelus hygomii*, *Lütken*, Spolia Atlantica, ii., 1892, p. 256.

*Figure*—*Lütken*, *loc. cit.*, fig. 15.

*Recorded*—*Waite*, Rec. Aust. Mus., v., 1904, p. 153.

28. MYCTOPHUM REINHARDTII, *Lütken*.

*Scopelus reinhardtii*, Lütken, *Spolia Atlantica*, ii., 1892, p. 257.

*Figure*—Lütken, *loc. cit.*, fig. 16.

*Recorded*—Waite, *Rec. Aust. Mus.*, v., 1904, p. 154.

DASYSCOPELUS, *Günther*, 186429. DASYSCOPELUS NAUFRAGUS, *Waite*.

*Dasyscopelus naufragus*, Waite, *Rec. Aust. Mus.*, v., 1904, p. 154.

*Figure*—Waite, *loc. cit.* pl. xviii., fig. 3.

*Recorded*—Waite, *loc. cit.*

*Family* STERNOPTYCHIDÆ.STERNOPTYCHIDES, *Ogilby*, 1888.30. STERNOPTYCHIDES AMABILIS, *Ogilby*.

*Sternoptychides amabilis*, Ogilby, *Proc. Linn. Soc. N.S. Wales*, (2), iii., 1888, p. 1313.

*Figure*—None.

*Recorded*—Ogilby, *loc. cit.*

*Family* HEMIRAMPHIDÆ.HYPORHAMPHUS, *Gill*, 1859.31. HYPORHAMPHUS INTERMEDIUS, *Cantor*.

*Gar-fish.*

*Hemiramphus intermedius*, Cantor, *Ann. Nat. Hist.* ix., 1842, p. 485.

*Figure*—McCoy, *Prod. Zool. Vict.*, dec. xiv., 1887, pl. cxxxv., fig. 1.

*Recorded*—(Foulis); Ogilby, *Aust. Mus. Mem.*, ii, 1889, p. 71.

EULEPTORHAMPHUS, *Gill*, 1859.32. EULEPTORHAMPHUS LONGIROSTRIS, *Cuvier*.

*Hemiramphus longirostris*, Cuvier, *Règne Anim.*, (ed. 2), ii., 1829, p. 286.

*Figure*—Valenciennes in Cuvier, *Règne Anim.*, Ill. Poiss., 1850, pl. xcvi., fig. 2.

*Recorded*—Waite, *Rec. Aust. Mus.*, v., 1903, p. 24.

Family SCOMBRESOCIDÆ.

SCOMBRESOX, *Lacépède*, 1803.

33. SCOMBRESOX FORSTERI, *Cuvier & Valenciennes*.

*Bill-fish.*

*Scombresox forsteri*, *Cuvier & Valenciennes*, *Hist. Nat. Poiss.*, xviii., 1846, p. 148.

*Figure*—McCoy, *Prod. Zool. Vict.*, dec. xiv, 1887, pl. cxxxv., fig. 2.

*Recorded*—Ogilby, *Aust. Mus. Mem.*, ii., 1889, p. 71.

Family EXOCÆTIDÆ.

EXONAUTES, *Jordan & Evermann*, 1896.

34. EXONAUTES RONDELETHI, *Cuvier & Valenciennes*.

*Flying Fish.*

*Exocætus rondeletii*, *Cuvier & Valenciennes*, *Hist. Nat. Poiss.*, xix., 1846, p. 115.

*Figure*—*Cuvier & Valenciennes*, *loc. cit.*, pl. dlxii.

*Recorded*—Ogilby, *Aust. Mus. Mem.*, ii., 1889, p. 71 (as *Exocætus dovii*); *Waite*, *Rec. Aust. Mus.*, v., 1904, p. 156.

Family AULOSTOMIDÆ.

AULOSTOMUS, *Lacépède*, 1803.

35. AULOSTOMUS CHINENSIS, *Linnaeus*.

*Trumpet Fish.*

*Fistularia chinensis*, *Linnaeus*, *Syst. Nat.*, (ed. xii.), i., 1766, p. 515.

*Figure*—*Günther*, *Fische Südsee*, vii., 1881, pl. cxxiii., figs. B and C.

*Recorded*—*Waite*, *Rec. Aust. Mus.*, iii., 1900, p. 198.

Family FISTULARIIDÆ.

FISTULARIA, *Linnaeus*, 1758.

36. FISTULARIA DEPRESSA, *Günther*,

*Flute Mouth.*

*Fistularia depressa*, *Günther*, *Chall. Rep. Zool.*, i., 1880, *Shore Fishes*, p. 69.

*Figure*—*Günther*, *loc. cit.*, pl. xxxii, fig. D.

*Recorded*—*Waite*, "Thetis" *Prelim. Report*, 1898, p. 61.

*Family* MACRORHAMPHOSIDÆ.MACRORHAMPHOSUS, *Lacépède*, 1803.37. MACRORHAMPHOSUS GRACILIS, *Lowe*.*Little Bellows Fish.**Centriscus gracilis*, *Lowe*, Proc. Zool. Soc., vii., 1839, p. 86.*Figure*—*Waite*, Aust. Mus. Mem., iv., 1899, pl. vii., fig. 2.*Recorded*—*Waite*, Rec. Aust. Mus., iii., 1900, p. 199.*Family* SYNGNATHIDÆ.SOLEGNATHUS, *Swainson*, 1839.38. SOLEGNATHUS SPINOSISSIMUS, *Günther*.*Spiny Sea-Horse.**Solenognathus spinosissimus*, *Günther*, Brit. Mus. Cat. Fish, viii., 1870, p. 195.*Figure*—*Waite*, Proc. Linn. Soc. N.S. Wales, (2), ix., 1894, p. 222, pl. xvii., figs. 5 and 8.*Recorded*—*Ogilby*, Aust. Mus. Mem., ii., 1889, p. 72.HIPPOCAMPUS, *Rafinesque*, 1810.39. HIPPOCAMPUS PUNCTULATUS, *Guichenot*.*Sea-Horse.**Hippocampus punctulatus*, *Guichenot*, in R. de la Sagra, Hist. Cuba, Poiss., 1853, p. 174.*Figure*—*Guichenot*, *loc. cit.*, pl. v, fig. 2.*Recorded*—*Ogilby*, Proc. Linn. Soc. N.S. Wales, (2), xxiii., 1899, p. 732.40. HIPPOCAMPUS ABDOMINALIS, *Lesson*.*Sea-Horse.**Hippocampus abdominalis*, *Lesson*, in Férussac, Bull. Sci. Nat. et Géol., xi., 1827, p. 127.*Figure*—*Lesson*, Voy. "Coquille," Zool., ii., 1829, p. 125, fig. 4.*Recorded*—*Ogilby*, Aust. Mus. Mem., ii., 1889, p. 72.

*Family* ATHERINIDÆ.

ATHERINA, *Linnaeus*, 1758.

41. ATHERINA LACUNOSA, *Forster*.

*Hardyhead.*

*Atherina lacunosa*, *Forster*, in *Bloch & Schneider*, *Syst. Ichth.*, 1801, p. 112.

*Figure*—*Günther*, *Fische Südsee*, vi., 1877, pl. cxviii., fig. E.

*Recorded*—*Waite*, "Thetis" *Prelim. Report*, 1898, p. 60.

*Family* MUGILIDÆ.

MUGIL, *Linnaeus*, 1758,

42. MUGIL DOBULA, *Günther*.

*Mullet.*

*Mugil dobula*, *Günther*, *Cat. Fish. Brit. Mus.*, iii., 1861, p. 420.

*Figure*—*Günther*, *Fische Südsee*, vi., 1877, pl. cxx., fig. A.

*Recorded*—*Waite*, "Thetis" *Prelim. Report*, 1898, p. 60.

MYXUS, *Günther*, 1861.

43. MYXUS ELONGATUS, *Günther*.

*Sand Mullet.*

*Myxus elongatus*, *Günther*, *Cat. Fish. Brit. Mus.*, iii., 1861, p. 466.

*Figure*—*Waite*, "Thetis" *Prelim. Report* 1898, pl. xii.

*Recorded*—(*Foulis*) ; *Ogilby*, *Aust. Mus. Mem.*, ii., 1889, p. 63.

*Family* HOWELLIDÆ.

HOWELLA, *Ogilby*, 1899

44. HOWELLA BRODIEI, *Ogilby*.

*Howella brodiei*, *Ogilby*, *Proc. Linn. Soc. N.S. Wales*, xxiii., 1899, p. 735.

*Figure*—*Waite*, *Rec. Aust. Mus.*, v., 1904, pl. xviii., fig. 4.

*Recorded*—*Ogilby*, *loc. cit.*

*Family* MULLIDÆ.UPENEUS, *Cuvier*, 1829.45. UPENEUS SIGNATUS, *Günther*.*Red Mullet.**Upeneus signatus*, *Günther*, *Ann. Nat. Hist.*, (3), 1867, xx., p. 59.*Figure*—*Ogilby*, *Edib. Fish. N.S. Wales*, 1893, pl. xi.*Recorded*—*Ogilby*, *Aust. Mus. Mem.*, ii., 1889, p. 56.46. UPENEUS PLEUROSTIGMA, *Bennett*.*Upeneus pleurostigma*, *Bennett*, *Proc. Zool. Soc.*, i., 1830, p. 59.*Figure*—*Waite*, *Rec. Aust. Mus.*, iv., 1901, pl. v.*Recorded*—*Waite*, *loc. cit.*, p. 37.*Family* GEMPYLIDÆ.XENOGRAMMA, *Waite*, 1904.47. XENOGRAMMA CARINATUM, *Waite*.*Xenogramma carinatum*, *Waite*, *Rec. Aust. Mus.*, v., 1904, p. 158.*Figure*—*Waite*, *loc. cit.*, pl. xix., fig. 1.*Recorded*—*Waite*, *loc. cit.*MACHÆROPE, *Ogilby*, 1899.48. MACHÆROPE LATISPINIS, *Ogilby*.*Dagger Fish.**Machærope latispinis*, *Ogilby*, *Proc. Linn. Soc. N.S. Wales*, xxiii., 1899, p. 737.*Figure*—*Waite*, *Rec. Aust. Mus.*, v., 1903, pl. iv., fig. 2.*Recorded*—*Ogilby*, *loc. cit.*GEMPYLUS, *Cuvier*, 1829.49. GEMPYLUS SERPENS, *Cuvier & Valenciennes*.*Gempylus serpens*, *Cuvier & Valenciennes*, *Hist. Nat. Poiss.*, viii, 1831, p. 207.*Figure*—*Valenciennes*, in *Cuvier Règne Anim.*, *Ill. Poiss.*, 1850, pl. xlix., fig. 2.*Recorded*—*Waite*, *Rec. Aust. Mus.*, iii., 1900, p. 199.



Family CARANGIDÆ.

SERIOLA, Cuvier, 1817.

50. SERIOLA LALANDI, Cuvier & Valenciennes.

*King Fish.*

*Seriola lalandi*, Cuvier & Valenciennes, Hist. Nat. Poiss., ix., 1833, p. 208.

*Figure*—McCoy, Prod. Zool. Vict., dec. xviii., 1889, pl. clxxii.

*Recorded*—(Foulis); Ogilby, Aust. Mus. Mem., ii., 1889, p. 61.

DECAPTERUS, Bleeker, 1855.

51. DECAPTERUS SANCTÆ-HELENÆ, Cuvier & Valenciennes.

*Caranx sanctæ-helenæ*, Cuvier & Valenciennes, Hist. Nat. Poiss., ix., 1833, p. 37.

*Figure*—Steindachner & Döderlein, Fische Japans, iii., 1884, pl. iv., fig. 1.

*Recorded*—Waite, Rec Aust. Mus., iii., 1900, p. 200.

CARANX, Lacépède, 1802.

52. CARANX GEORGIANUS, Cuvier & Valenciennes.

*Trevally.*

*Caranx georgianus*, Cuvier & Valenciennes, Hist. Nat. Poiss., ix., 1833, p. 85.

*Figure*—Richardson, Voy. "Ereb. and Terr.," Fish, 1848, pl. lviii., figs. 1-3.

*Recorded*—(Hill); Ogilby, Aust. Mus. Mem., ii., 1889, p. 61.

TRACHINOTUS, Lacépède, 1802.

53. TRACHINOTUS RUSSELLII, Cuvier & Valenciennes.

*Dart.*

*Trachinotus russelii*, Cuvier & Valenciennes, Hist. Nat. Poiss., viii., 1831, p. 436.

*Figure*—Day, Fish. India, 1876, pl. li. B, fig. 3.

*Recorded*—Ogilby, Edib. Fish. N.S. Wales, 1893, p. 90.

54. TRACHINOTUS BAILLONII, *Lacépède*.

*Casiomorus baillonii*, Lacépède, Hist. Nat. Poiss., iii., 1802, p. 93.

*Figure*—Day, Fish. India, 1876, pl. li. A, fig. 4.

*Recorded*—Waite, Rec. Aust. Mus., v., 1903, p. 25.

BATHYSTETHUS, *Gill*, 1893.55. BATHYSTETHUS CULTRATUS, *Forster*.

*Herring*.

*Sciæna cultrata*, Forster in Bloch & Schneider, Syst. Ichth., 1801, p. 343.

*Figure*—Waite, Rec. Aust. Mus., v., 1904, pl. xix, fig. 2.

*Recorded*—Ogilby, Proc. Zool. Soc., 1889, p. 157.

## Family BRAMIDÆ.

BRAMA, *Bloch & Schneider*, 1801.

56. BRAMA RAI, *Bloch*.

*Sparus raii*, Bloch, Nat. ausl. Fische, v., 1791, p. 95.

*Figure*—Day, Fish. Gt. Brit. & Irel., i., 1881, pl. xli.

*Recorded*—Waite, Rec. Aust. Mus., iii., 1900, p. 200.

## Family STROMATEIDÆ.

NOMEUS, *Cuvier*, 1817.

57. NOMEUS GRONOVII, *Gmelin*.

*Portuguese Man-of-War Fish*.

*Gobius gronovii*, Gmelin, Syst. Nat., ed. xiii., i., 1788, p. 1205.

*Figure*—Valenciennes in Cuvier, Ill. Poiss., 1850, pl. lvi., fig. 2.

*Recorded*—Waite, Rec. Aust. Mus., iv., 1901, p. 39.

CUBICEPS, *Lowe*, 1843.

58. CUBICEPS GRACILIS, *Lowe*.

*Seriola gracilis*, Lowe, Proc. Zool. Soc., xi., 1843, p. 82.

*Figure*—Günther, Chall. Rep., Zool., xxxi., 1889, Pelagic Fishes, pl. ii., figs. A-C.

*Recorded*—Waite, Rec. Aust. Mus., v., 1904, p. 162.

SCHEDOPHILUS, *Cocco*, 1834.

59. SCHEDOPHILUS MACULATUS. *Günther*.

*Raft Fish.*

*Schedophilus maculatus*, *Günther*, *Cat. Fish. Brit. Mus.*, ii., 1860, p. 412.

*Figure*—*Waite*, *Rec. Aust. Mus.*, v., 1904, pl. xx, fig. 1.

*Recorded*—*Waite*, *Proc. Linn. Soc. N.S. Wales*, (2), ix., 1894, p. 219.

*Family* TETRAGONURIDÆ.

TETRAGONURUS, *Risso*, 1810.

60. TETRAGONURUS CUVIERI, *Risso*.

*Square-tail.*

*Tetragonurus cuvieri*, *Risso*, *Ichth. Nice*, 1810, p. 347.

*Figure*—*Lowe*, *Fish. Madeira*, 1860, pl. xix.

*Recorded*—*Macleay*, *Proc. Linn. Soc. N.S. Wales*, x., 1886, p. 718.

*Family* PEMPHERIDÆ.

PARAPRIACANTHUS, *Steindachner*, 1870.

61. PARAPRIACANTHUS UNWINI, *Ogilby*.

*Unwini.*

*Pempheris unwini*, *Ogilby*, *Mem. Aust. Mus.*, ii., 1889, p. 60.

*Figure*—*Ogilby*, *loc. cit.*, pl. iii., fig. 1.

*Recorded*—*Ogilby*, *loc. cit.*

*Family* KUHLIIDÆ.

KUHLIA, *Gill*, 1861.

62. KUHLIA TENIURA, *Cuvier & Valenciennes*.

*Flaytail.*

*Dules teniurus*, *Cuvier & Valenciennes*, *Hist. Nat. Poiss.*, iii., 1829, p. 114.

*Figure*—*Günther*, *Fische Südsee*, i., 1873, pl. xix., fig. C.

*Recorded*—*Waite*, *Proc. Linn. Soc. N.S. Wales*, (2), ix., 1894, p. 217.

*Family* CHEILODIPTERIDÆ.APOGON, *Lacépède*, 1802.63. APOGON NORFOLCENSIS, *Ogilby*,*Big-Eye*.*Apogon norfolcensis*, *Ogilby*, Proc. Linn. Soc. N.S. Wales, (2), ii, 1888, p. 990.*Figure*—*Waite*, Rec. Aust. Mus., iv., 1901, pl. vi.*Recorded*—*Ogilby*, *loc. cit.*, p. 992.64. APOGON CHRYSURUS, *Ogilby*.*Apogon chrysurus*, *Ogilby*, Aust. Mus. Mem., ii., 1889, p. 54.*Figure*—*Waite*, Rec. Aust. Mus., v., 1904, pl. xx., fig. 2.*Recorded*—*Ogilby*, *loc. cit.**Family* SERRANIDÆ.ACANTHISTIUS, *Gill*, 1862.65. ACANTHISTIUS CINCTUS, *Günther*.*Banded Sea Perch*.*Plectropoma cinctum*, *Günther*, Cat. Fish. Brit. Mus., i., 1859, p. 162.*Figure*—*Boulenger*, Cat. Fish. Brit. Mus., (ed. 2), i., 1895, pl. i.*Recorded*—*Ogilby*, Aust. Mus. Mem., ii., 1889, p. 53.TRACHYPOMA, *Günther*, 1859.66. TRACHYPOMA MACRACANTHUS, *Günther*.*Red Rock Cod*.*Trachypoma macracanthus*, *Günther*, Cat. Fish. Brit. Mus., i., 1859, p. 167.*Figure*—*Boulenger*, Cat. Fish. Brit. Mus., (ed. 2), i., 1895, pl. ii.*Recorded*—*Ogilby*, Aust. Mus. Mem., ii., 1889, p. 54.

EPINEPHELUS, *Bloch*, 1793.

67. EPINEPHELUS DÆMELII, *Günther*.

*Black Rock Cod.*

*Serranus dæmelii*, *Günther*, *Ann. Mag. Nat. Hist.*, (4), xvii., 1876, p. 391.

*Figure*—*Boulenger*, *Cat. Fish. Brit. Mus.*, (ed. 2), i., 1895, pl. vii.

*Recorded*—(Foulis); *Ogilby*, *Aust. Mus. Mem.*, ii., 1889, p. 53.

68. EPINEPHELUS RHYNCHOLEPIS, *Bleeker*.

*Serranus rhyncholepis*, *Bleeker*, *Nat. Tijd. Ned. Ind.*, iii., 1852, p. 749.

*Figure*—*Bleeker*, *Atl. Ichth.*, vii., 1875, pl. cclxxxvi., fig. 2, (1872).

*Recorded*—*Waite*, *Rec. Aust. Mus.*, v., 1904, p. 165.

69. EPINEPHELUS FASCIATUS, *Forsk.*

*Perca fasciata*, *Forsk.*, *Desc. Anim.*, 1775, p. 40.

*Figure*—*Bleeker*, *Atl. Ichth.*, vii., 1875, pl. cccxxvi., fig. 3.

*Recorded*—*Waite*, *Rec. Aust. Mus.*, iii., 1900, p. 200.

70. EPINEPHELUS MERRA, *Bloch*.

*Rock Cod.*

*Epinephelus merra*, *Bloch*, *Nat. ansl. Fische*, vii., 1793, p. 17.

*Figure*—*Günther*, *Fische Südsee*, i., 1873, pl. vii.

*Recorded*—*Ogilby*, *Proc. Linn. Soc. N.S. Wales*, xxiii., 1899, p. 730.

71. EPINEPHELUS FUSCOGUTTATUS, *Rüppell*.

*Serranus fuscoguttatus*, *Rüppell*, *Atl. Reise nord. Afrika, Fische*, 1828, p. 108.

*Figure*—*Rüppell*, *loc. cit.*, pl. xxvii., fig. 2.

*Recorded*—*Ogilby*, *Aust. Mus. Mem.*, ii., 1889, p. 53.

PSEUDANTHIAS, *Bleeker*, 1872.72. PSEUDANTHIAS HYPSELOSOMA, *Bleeker*.

*Pseudanthias hypselosoma*, *Bleeker*, Arch. Neerl., xiii., 1878, p. 58.

*Figure*—*Bleeker*, *loc. cit.*, pl. ii., fig. 2.

*Recorded*—*Ogilby*, Proc. Zool. Soc., 1889, p. 151 (*Anthias cichlops*)

PLESIOPS, *Cuvier*, 1817.73. PLESIOPS NIGRICANS, *Rüppell*.

*Pharopteryx nigricans*, *Rüppell*, Atl. Reise nord. Afrika, Fische, 1828, p. 15.

*Figure*—*Günther*, Fische Südsee, iii., 1874, pl. lviii., fig. B.

*Recorded*—*Ogilby*, Aust. Mus. Mem., ii., 1889, p. 60.

## Family MALACANTHIDÆ.

MALACANTHUS, *Cuvier*, 1829.74. MALACANTHUS HOEDTII, *Bleeker*.

*Malacanthus hoedtii*, *Bleeker*, Act. Soc. Sci. Indo. Neerl., vi., 1859, p. 18.

*Figure*—*Günther*, Fische Südsee, v., 1876, pl. xcvi., fig. B.

*Recorded*—*Ogilby*, Proc. Linn. Soc. N.S. Wales, xxiii., 1899, p. 741.

## Family ARRIPIDIDÆ.

ARRIPIS, *Jenyns*, 1840.75. ARRIPIS TRUTTA, *Forster*.*Salmon*.

*Sciæna trutta*, *Forster* in *Bloch & Schneider*, Syst. Ichth., 1801, p. 542.

*Figure*—*McCoy*, Prod. Zool. Vict., dec. ii., 1878, pls. xvi. xvii.

*Recorded*—(*Foulis*); *Ogilby*, Aust. Mus. Mem., ii., 1889, p. 54.

*Family* LUTIANIDÆ.

GENYOROGE, *Cantor*, 1850.

76. GENYOROGE BENGALENSIS, *Bloch*.

*Holocentrus bengalensis*, *Bloch*, *Nat. ausl. Fische*, iv., 1790, p. 102.

*Figure*—*Bleeker*, *Atl. Ichth.*, viii., 1877, pl. cccxxxiii., fig. 4, (1875).

*Recorded*—*Waite*, *Rec. Aust. Mus.*, v., 1904, p. 166.

*Family* HÆMULIDÆ.

TERAPON, *Cuvier*, 1817.

77. TERAPON JARBUA, *Forsk.*

*Scicena jarbua*, *Forsk.*, *Descr. Anim.*, 1775, p. 50.

*Figure*—*Bleeker*, *Atl. Ichth.*, vii., 1876, pl. cccxii., fig. 2, (1872).

*Recorded*—*Waite*, *Rec. Aust. Mus.*, iii., 1900, p. 200.

*Family* SPARIDÆ.

PAGROSOMUS, *Gill*, 1893.

78. PAGROSOMUS AURATUS, *Forster*.

*Sydney Schnapper*.

*Scicena aurata*, *Forster* in *Bloch & Schneider*, *Syst. Ichth.*, 1801, p. 266.

*Figure*—*Tenison Woods*, *Fish. N. S. Wales*, 1882, Frontispiece.

*Recorded*—*Ogilby*, *Aust. Mus. Mem.*, ii., 1889, p. 58.

LETHRINUS, *Cuvier*, 1829.

79. LETHRINUS OPERCULARIS, *Cuvier & Valenciennes*.

*Schnapper*.

*Lethrinus opercularis*, *Cuvier & Valenciennes*, *Hist. Nat. Poiss.*, vi, 1830, p. 289.

*Figure*—*Bleeker*, *Atl. Ichth.*, viii., 1877, pl. cccxxxv., fig. 5, (1875).

*Recorded*.—*Ogilby*, *Aust. Mus. Mem.*, ii., 1889, p. 58.

*Family* KYPHOSIDÆ.GIRELLA, *Gray*, 1835 (?).80. GIRELLA CYANEA, *Macleay*.*Blue Fish.**Girella cyanea*, *Macleay*, Proc. Linn. Soc. N. S. Wales, v., 1881, p. 409.*Figure*—*Waite*, Rec. Aust. Mus., v., 1904, pl. xx., fig. 3.*Recorded*—(*Foulis*); *Ogilby*, Aust. Mus. Mem., ii., 1889, p. 56:CÆSIOSOMA, *Kaup*, 1863.81. CÆSIOSOMA ÆQUIPINNIS, *Richardson*.*Hard-bellied Blue Fish.**Scorpiæ æquipinnis*, *Richardson*, Voy. "Ereb. and Terr.", Fish., 1848, p. 121.*Figure*—*Kner*, Reise Novara, Fische, 1869, pl. v., fig. 3.*Recorded*—*Ogilby*, Aust. Mus. Mem., ii., 1889, p. 56.ATYPICHTHYS, *Günther*, 1862.82. ATYPICHTHYS STRIGATUS, *Günther*.*Leather Jacket.**Atypus strigatus*, *Günther*, Cat. Fish. Brit. Mus., ii., 1860, p. 64.*Figure*—*Steindachner*, Sitzb. Akad. Wiss. Wien, liii., 1866, pl. iv., fig. 2.*Recorded*—*Ogilby*, Aust. Mus. Mem., ii., 1889, p. 56.*Family* SILLAGINIDÆ.SILLAGO, *Cuvier*, 1817.83. SILLAGO CILIATA, *Cuvier & Valenciennes*.*Whiting.**Sillago ciliata*, *Cuvier & Valenciennes*, Hist. Nat. Poiss., iii., 1829, p. 415.*Figure*—*McCoy*, Prod. Zool. Vict., dec. xix., 1889, pl. clxxxii.*Recorded*—*Waite*, Rec. Aust. Mus., iv., 1901, p. 47.



Family CIRRHITIDÆ.

CIRRHITICHTHYS, *Bleeker*, 1857.

84. CIRRHITICHTHYS SPLENDENS, *Ogilby*.

*Cirrhitichthys splendens*, *Ogilby*, *Aust. Mus. Mem.*, ii., 1889, p. 58.

*Figure*—*Ogilby*, *loc. cit.*, pl. ii.

*Recorded*—*Ogilby*, *loc. cit.*

Family APLODACTYLIDÆ.

APLODACTYLUS, *Curier & Valenciennes*, 1831.

85. APLODACTYLUS ETHERIDGII, *Ogilby*.

*Turtle Head.*

*Haplodactylus etheridgii*, *Ogilby*, *Mem. Aust. Mus.*, ii., 1889, p. 57.

*Figure*—*Waite*, *Rec. Aust. Mus.*, v., 1904, pl. xxi.

*Recorded*—*Ogilby*, *loc. cit.*

CHIRONEMUS, *Curier*, 1829.

86. CHIRONEMUS MARMORATUS, *Günther*.

*Kelp Fish.*

*Chironemus marmoratus*, *Günther*, *Cat. Fish. Brit. Mus.*, ii., 1860, p. 76.

*Figure*—*Ogilby*, *Edib. Fish. N. S. Wales*, 1893, pl. xvii.

*Recorded*—*Ogilby*, *loc. cit.*, p. 55.

GONISTIUS, *Gill*, 1862.

87. GONISTIUS GIBBOSUS, *Richardson*.

*Banded Morwong.*

*Cheilodactylus gibbosus*, *Richardson*, *Trans. Zool. Soc.*, iii., 1849, p. 102.

*Figure*—*Günther*, *Fische Südsee*, iii., 1874, pl. li., fig. B.

*Recorded*—*Ogilby*, *Aust. Mus. Mem.*, ii., 1889, p. 59.

## Family POMACENTRIDÆ.

AMPHIPRION, *Bloch & Schneider*, 1801.88. AMPHIPRION MELANOPUS, *Bleeker*.

*Amphiprion melanopus*, *Bleeker*, *Nat. Tijds.*, iii., 1852, p. 561,  
(Amboina ii.).

*Figure*—*Bleeker*, *Atl. Ichth.*, ix., 1877, pl. cccci., fig. 7.

*Recorded*—*Ogilby*, *Aust. Mus. Mem.*, ii., 1889, p. 64.

89. AMPHIPRION LATEZONATUS, *Waite*.

*Amphiprion latezonatus*, *Waite*, *Rec. Aust. Mus.*, iii., 1900,  
p. 201.

*Figure*—*Waite*, *loc. cit.*, pl. xxxiv.

*Recorded*—*Waite*, *loc. cit.*

CHROMIS, *Cuvier*, 1815.90. CHROMIS HYSILEPIS, *Günther*.

*Heliastes hysilepis*, *Günther*, *Ann. Mag. Nat. Hist.*, (3),  
xx., 1867, p. 66.

*Figure*—(?) *Waite*, *Aust. Mus. Mem.*, iv., 1899, pl. xiv.  
(*Heliastes immaculatus*).

*Recorded*—*Ogilby*, *Aust. Mus. Mem.*, ii., 1889, p. 66.

POMACENTRUS, *Lacépède*, 1802.91. POMACENTRUS FASCIOLATUS, *Ogilby*.

*Pomacentrus fasciolatus*, *Ogilby*, *Aust. Mus. Mem.*, ii., 1889,  
p. 64.

*Figure*—*Jenkins*, *Bull. U.S. Fish. Comm.*, xix., 1901, p. 392,  
fig. 5.

*Recorded*—*Ogilby*, *loc. cit.*

PARMA, *Günther*, 1862.92. PARMA POLYLEPIS, *Günther*.*Sailor Fish.*

*Parma polylepsis*, *Günther*, *Cat. Fish. Brit. Mus.*, iv., 1862,  
p. 59.

*Figure*—*Waite*, *Rec. Aust. Mus.*, v., 1904, pl. xxii.

*Recorded*—*Ogilby*, *Aust. Mus. Mem.*, ii., 1889, p. 66.

GLYPHISODON, *Lacépède*, 1802.

93. GLYPHISODON SAXATILIS, *Linnæus*.

*Chaetodon saxatilis*, Linnæus, Syst. Nat., (ed. x.), 1758, p. 276.

*Figure*—Bleeker, Atl. Ichth., ix., 1877, pl. ccccviii., fig. 5.

*Recorded*—Ogilby, Aust. Mus. Mem., ii., 1889, p. 64.

94. GLYPHISODON ANTJERIUS, *Cuvier & Valenciennes*.

*Glyphisodon antjerius*, Cuvier & Valenciennes, Hist. Nat. Poiss., v., 1830, p. 481.

*Figure*—Some of the figures of Schlegel or Kner, whose writings I am unable to consult, may represent this form.

*Recorded*—Waite, Proc. Linn. Soc. N.S. Wales, (2), ix., 1894, p. 219 (*G. brownriggii*).

95. GLYPHISODON POLYACANTHUS, *Ogilby*.

*Glyphisodon polyacanthus*, Ogilby, Aust. Mus. Mem., ii., 1889, p. 65.

*Figure*—Waite, Rec. Aust. Mus., v., 1904, pl. xxiii., fig. 1.

*Recorded*—Ogilby, *loc. cit.*

Family LABRIDÆ.

THALASSOMA, *Swainson*, 1839.

96. THALASSOMA TRILOBATUM, *Lacépède*.

*Parrot Fish.*

*Labrus trilobatus*, Lacépède, Hist. Nat. Poiss., iii., 1802, p. 454.

*Figure*—Lesson & Garnot, Voy. "Coquille," Zool., pl. xxxv., 1827, fig. 1.

*Recorded*—Ogilby, Aust. Mus. Mem., ii., 1889, p. 68.

97. THALASSOMA ANEITENSE, *Günther*.

*Julis aneitensis*, Günther, Cat. Fish. Brit. Mus., iv., 1862, p. 183.

*Figure*—Waite, Rec. Aust. Mus., iv., 1902, pl. xxix.

*Recorded*—Waite, Rec. Aust. Mus., iii., 1900, p. 202.

98. THALASSOMA JANSENI, *Bleeker*.

*Julis janseni*, Bleeker, Act. Soc. Sci. Indo. Neerl., i., 1856, p. 56 (Manado & Makassar).

*Figure*—Bleeker, Atl. Ichth., i., 1862, pl. xxxiv., fig. 5.

*Recorded*—Waite, Rec. Aust. Mus., v., 1903, p. 25.

99. THALASSOMA LUNARE, *Linnaeus*.

*Labrus lunaris*, Linnaeus, Syst. Nat., (ed. x.), 1758, p. 283.

*Figure*—Bleeker, Atl. Ichth., i., 1862, pl. xxxiii., fig. 5.

*Recorded*—Ogilby, Aust. Mus. Mem., ii., 1889, p. 68.

100. THALASSOMA DORSALE, *Quoy & Gaimard*.

*Julis dorsalis*, Quoy and Gaimard, Voy. "Astrolabe," Zool., iii., Poiss., 1835, p. 713.

*Figure*—Quoy and Gaimard, *loc. cit.*, pl. xv., fig. 5.

*Recorded*—Waite, Rec. Aust. Mus., v., 1903, p. 26.

CORIS, *Lacépède*, 1802.101. CORIS AYGULA, *Lacépède*.

*Double-head.*

*Coris aygula*, Lacépède, Hist. Nat. Poiss., iii., 1802, p. 96.

*Figure*—Jordan & Snyder, Proc. U.S. Nat. Mus., xxiv., 1902, p. 642, fig. 9.

*Recorded*—Ogilby, Aust. Mus. Mem., ii., 1889, p. 68.

102. CORIS PICTA, *Bloch & Schneider*.

*Comb Fish.*

*Labrus pictus*, Bloch & Schneider, Syst. Ichth., 1801, p. 251.

*Figure*—Waite, Rec. Aust. Mus., v., 1903, pl. v., fig. 1.

*Recorded*—Ramsay, Proc. Linn. Soc. N.S. Wales, vii., 1882, p. 301.

ANAMPSES, *Cuvier*, 1829.

103. ANAMPSES TWISTII, *Bleeker*.

*Anampses twistii*, Bleeker, Act. Soc. Sci. Indo. Neerl., i., 1856, p. 56 (Amboina).  
*Figure*—Bleeker, Atl. Ichth., i., 1862, pl. xxv., fig. 4.  
*Recorded*—Ogilby, Aust. Mus. Mem., ii., 1889, p. 67.

104. ANAMPSES DIADEMATUS, *Rüppell*.

*Anampses diadematus*, Rüppell, Neue Wirb., Fische, 1835, p. 21.  
*Figure*—Günther, Fische Südsee, vii. 1881, pl. cxxxix.  
*Recorded*—Waite, Rec. Aust. Mus., v., 1904, p. 172.

105. ANAMPSES ELEGANS, *Ogilby*.

*Anampses elegans*, Ogilby, Aust. Mus. Mem., ii., 1889, p. 67.  
*Figure*—None.  
*Recorded*—Ogilby, *loc. cit.*

GÜNTHERIA, *Bleeker*, 1861.

106. GÜNTHERIA TRIMACULATA, *Quoy & Gaimard*.

*Julis trimaculata*, Quoy & Gaimard, Voy. "Astrolabe," Zool., iii., 1835, p. 705.  
*Figure*—Bleeker, Atl. Ichth., i., 1862, pl. xxxii., fig. 1.  
*Recorded*—Ogilby, Aust. Mus. Mem., ii., 1889, p. 68.

HALICHERES, *Rüppell*, 1835.

107. HALICHERES PSEUDOMINIATUS, *Bleeker*.

*Julis pseudominiatus*, Bleeker, Act. Soc. Sci. Indo. Neerl., i., 1856, p. 62 (Amboina).  
*Figure*—Bleeker, Atl. Ichth., i., 1862, pl. xl., fig. 5.  
*Recorded*—Ogilby, Aust. Mus. Mem., ii., 1889, p. 68.

108. HALICHERES OPERCULARIS, *Günther*.

*PlatyGLOSSUS opercularis*, Günther, Cat. Fish. Brit. Mus., iv., 1862, p. 148.

*Figure*—Günther, Fish. Zanzibar, 1866, pl. xii., fig. 1.

*Recorded*—Waite, Rec. Aust. Mus., iii., 1900, p. 202.

STETHOJULIS, *Günther*, 1861.109. STETHOJULIS AXILLARIS, *Quoy & Gaimard*.

*Julis axillaris*, Quoy & Gaimard, Voy. "Uranie," Zool., 1824, p. 272.

*Figure*—Bleeker, Atl. Ichth., i., 1862, pl. xliv., fig. 3.

*Recorded*—Ogilby, Aust. Mus. Mem., ii., 1889, p. 68.

PSEUDOLABRUS, *Bleeker*, 1861.110. PSEUDOLABRUS INSCRIPTUS, *Richardson*.*Parrot Fish.*

*Labrus inscriptus*, Richardson, Voy. "Ereb. and Terr.," Fish., 1848, p. 134.

*Figure*—Richardson, *loc. cit.*, pl. lvi., figs. 1-2.

*Recorded*—Ogilby, Aust. Mus. Mem., ii., 1889, p. 66.

111. PSEUDOLABRUS LUCULENTUS, *Richardson*.*Parrot Fish.*

*Labrus luculentus*, Richardson, Voy. "Ereb. and Terr.," Fish., 1848, p. 130.

*Figure*—Waite, Rec. Aust. Mus., v., 1903, pl. iv., fig. 1.

*Recorded*—Ogilby, Aust. Mus. Mem., ii., 1889, p. 67.

112. PSEUDOLABRUS NIGROMARGINATUS, *Macleay*.

*Labrichthys nigromarginatus*, Macleay, Proc. Linn. Soc. N.S. Wales, iii., 1878, p. 35.

*Figure*—Macleay, *loc. cit.*, pl. iii., fig. 3.

*Recorded*—Waite, Rec. Aust. Mus., v., 1903, p. 29.

INIISTIUS, *Gill*, 1862.

113 INIISTIUS CACATUA, *Waite*.

*Cockatoo Fish*,

*Iniistius cacatua*, *Waite*, *Rec. Aust. Mus.*, iv., 1901, p. 41.

*Figure*—*Waite*, *loc. cit.*, pl. vii.

*Recorded*—*Waite*, *loc. cit.*

NOVACULICHTHYS, *Bleeker*, 1861.

114. NOVACULICHTHYS JACKSONENSIS, *Ramsay*.

*Novacula jacksonensis*, *Ramsay*, *Proc. Linn. Soc. N.S. Wales*, vi., 1881, p. 198.

*Figure*—*Waite*, *Aust. Mus. Mem.*, iv., 1899, pl. xv.

*Recorded*—*Waite*, *Rec. Aust. Mus.*, iii., 1900, p. 202.

LABROIDES, *Bleeker*, 1851.

115. LABROIDES PARADISEUS, *Bleeker*.

*Labroides paradiseus*, *Bleeker*, *Nat. Tijd. Ned. Ind.*, ii., 1851, p. 249 (Banda).

*Figure*—*Bleeker*, *Atl. Ichth.*, i., 1862, pl. xlv., fig. 2.

*Recorded*—*Ogilby*, *Aust. Mus. Mem.*, ii., 1889, p. 67.

LEPIDAPLOIS, *Gill*, 1862.

116. LEPIDAPLOIS PERDITIO, *Quoy & Gaimard*.

*Labrus perditio*, *Quoy & Gaimard*, *Voy. "Astrolabe"*, *Zool.*, iii., 1835, p. 702.

*Figure*—*Jordan & Snyder*, *Proc. U.S. Nat. Mus.*, xxiv., 1902, p. 618, fig. 2.

*Recorded*—*Ogilby*, *Aust. Mus. Mem.*, ii., 1889, p. 66.

Family SCARIDÆ.

SCARICHTHYS, *Bleeker*, 1861.

117. SCARICHTHYS AURITUS, *Kuhl & Van Hasselt*.

*Scarus auritus*, *Kuhl & Van Hasselt* in *Cuvier & Valenciennes*, *Hist. Nat. Poiss.*, xiv., 1839, p. 218.

*Figure*—*Bleeker*, *Atl. Ichth.*, i., 1862, pl. i., fig. 3.

*Recorded*—*Ogilby*, *Aust. Mus. Mem.*, ii., 1889, p. 70.

SCARUS, *Forskål*, 1775.118. SCARUS PYRRHOSTETHUS, *Richardson*.

*Scarus pyrrhostethus*, Richardson, Rep. Ichth. China & Japan, Brit. Ass. Rep., 1845, p. 262.

*Figure*—Bleeker, Atl. Ichth., i., 1862, pl. ix., fig. 1.

*Recorded*—(Ogilby, Aust. Mus. Mem., ii., 1889, p. 70, *Scarus* sp.); Waite, Rec. Aust. Mus., iv., 1901, p. 44.

*Family* ZEIDÆ.ZENOPSIS, *Gill*, 1862.119. ZENOPSIS SCOPUS, *Waite*.*Target Fish.*

*Zenopsis scopus*, Waite, Rec. Aust. Mus., v., 1903, p. 30.

*Figure*—Waite, *loc. cit.*, fig. 1.

*Recorded*—Waite, *loc. cit.*

*Family* CHÆTODONTIDÆ.CHÆTODON, *Linnaeus*, 1758.120. CHÆTODON TRIFASCIATUS, *Mungo Park*.

*Chatodon trifasciatus*, Mungo Park, Trans. Linn. Soc., iii., 1797, p. 34.

*Figure*—Bleeker, Atl. Ichth., ix., 1877, pl. cccclxxvii. (1876), fig. 1.

*Recorded*—Waite, Rec. Aust. Mus., v., 1903, p. 32.

121. CHÆTODON APHRODITE, *Ogilby*.

*Chatodon aphrodite*, Ogilby, Aust. Mus. Mem., ii., 1889, p. 55.

*Figure*—Ogilby, *loc. cit.*, pl. iii., fig. 2.

*Recorded*—Ogilby, *loc. cit.*

122. CHÆTODON TRICINCTUS, *Waite*.

*Chatodon tricinctus*, Waite, Rec. Aust. Mus. iv., 1901, p. 45.

*Figure*—Waite, *loc. cit.*, fig. 12.

*Recorded*—Waite, *loc. cit.*



123. *CHÆTODON HOWENSIS*, *Waite*.

*Chætodon howensis*, Waite, Rec. Aust. Mus., v., 1903, p. 33.

*Figure*—Waite, *loc. cit.*, p. 36, fig. 2

*Recorded*—Waite, *loc. cit.*

MICROCANTHUS, *Swainson*, 1839.

124. *MICROCANTHUS STRIGATUS*, *Langsdorf*.

*Chætodon strigatus*, Langsdorf in Cuvier & Valenciennes, Hist. Nat. Poiss., vii., 1831, p. 25.

*Figure*—Cuvier & Valenciennes, *loc. cit.*, pl. clxx.

*Recorded*—Ogilby, Aust. Mus. Mem., ii, 1889, p. 55.

HOLACANTHUS, *Lacépède*, 1802.

125. *HOLACANTHUS TIBICEN*, *Cuvier & Valenciennes*.

*Holacanthus tibicen*, Cuvier & Valenciennes, Hist. Nat. Poiss., vii., 1831, p. 173.

*Figure*—Blecker, Atl. Ichth., ix., 1878, pl. cccclxx. (1876), fig. 4.

*Recorded*—Waite, Rec. Aust. Mus., iii., 1900, p. 203.

126. *HOLACANTHUS CONSPICILLATUS*, *Waite*.

*Holacanthus conspicillatus*, Waite, Rec. Aust. Mus., iii., 1900, p. 203.

*Figure*—Waite, *loc. cit.*, pl. xxxv.

*Recorded*—Waite, *loc. cit.*

127. *HOLACANTHUS SEMICINCTUS*, *Waite*.

*Holacanthus semicinctus*, Waite, Rec. Aust. Mus., iii., 1900, p. 204.

*Figure*—Waite, *loc. cit.*, pl. xxxvi.

*Recorded*—Waite, *loc. cit.*

*Family ACANTHURIDÆ.*XESURUS, *Jordan & Evermann*, 1896.128. XESURUS MACULATUS, *Ogilby*.*Prionurus maculatus*, *Ogilby*, *Proc. Zool. Soc.*, 1887, p. 395.*Figure*—None.*Recorded*—*Waite*, *Rec. Aust. Mus.*, iii., 1900, p. 207.ACANTHURUS, *Forskal*, 1775.129. ACANTHURUS UNICORNIS, *Forskal*.*Chætodon unieornis*, *Forskal*, *Descr. Anim.*, 1775, p. 63.*Figure*—*Günther*, *Fische Südsee*, iv., 1875, pl. lxxviii.*Recorded*—*Waite*, *Rec. Aust. Mus.*, iii., 1900, p. 207.*Family BALISTIDÆ.*PACHYNATHUS, *Swainson*, 1839.130. PACHYNATHUS CAPISTRATUS, *Shaw*.*Balistes capistratus*, *Shaw*, *Gen. Zool.*, v., 1804, p. 417.*Figure*—*Bleeker*, *Atl. Ichth.*, v., 1869, pl. ccxxiii. (1865),  
fig. 2.*Recorded*—*Waite*, *Rec. Aust. Mus.*, v., 1903, p. 38.*Family MONACANTHIDÆ.*STEPHANOLEPIS, *Gill*, 1861.131. STEPHANOLEPIS NITENS, *Hollard*.*Monacanthus nitens*, *Hollard*, *Ann. Sci. Nat.*, (4), ii., 1854,  
p. 364.*Figure*—*Hollard*, *loc. cit.*, pl. xiv., fig. 12.*Recorded*—*Waite*, "Thetis" *Prelim. Rep.*, 1898, p. 62.PSEUDOMONACANTHUS, *Bleeker*, 1866.132. PSEUDOMONACANTHUS HOWENSIS, *Ogilby*.*Monacanthus howensis*, *Ogilby*, *Aust. Mus. Mem.*, ii., 1889, p. 73.*Figure*—*Waite*, *Rec. Aust. Mus.*, iv., 1901, pl. viii.*Recorded*—*Ogilby*, *loc. cit.*

133. PSEUDOMONACANTHUS ANALIS, *Waite*.

*Pseudomonacanthus analis*, Waite, Rec. Aust. Mus., v., 1904, p. 173.

*Figure*—Waite, *loc. cit.*, p. 174, fig. 32.

*Recorded*—Waite, *loc. cit.*

BRACHALUTERES, *Bleeker*, 1866.

134. BRACHALUTERES BAUERI, *Richardson*.

*Alcuterius baueri*, Richardson, Voy. "Ereb. and Terr.," Fish., 1846, p. 68.

*Figure*—Waite, Rec. Aust. Mus., v., 1903, pl. iii., fig. 2.

*Recorded*—Waite, *loc. cit.*, p. 38.

ALUTERA, *Cuvier*, 1817.

135. ALUTERA MONOCEROS, *Linnaeus*.

*Balistes monoceros*, Linnaeus, Syst. Nat., (ed. x.), 1758, p. 327.

*Figure*—Bleeker, Atl. Ichth., v., 1869, pl. ccxxvi. (1865), fig. 2.

*Recorded*—Waite, Rec. Aust. Mus., iii., 1900, p. 207.

Family OSTRACIIDÆ.

LACTOPHRYS, *Swainson*, 1839.

136. LACTOPHRYS CONCATENATUS, *Bloch*.

*Ostracion concatenatus*, Bloch, Nat. ausl. Fische, i., 1785, p. 101.

*Figure*—Bloch, *loc. cit.*, pl. cxxxi.

*Recorded*—Ogilby, Aust. Mus. Mem., ii., 1889, p. 73.

OSTRACION, *Linnaeus*, 1758.

137. OSTRACION FORNASINI, *Bianconi*.

*Ostracion fornasini*, Bianconi., Spec. Zool. Mosamb., i., 1850, p. 7.

*Figure*—Bleeker, Atl. Ichth., v., 1865, pl. cciii., fig. 4.

*Recorded*—Ogilby, Aust. Mus. Mem., ii., 1889, p. 73.

138. OSTRACION TUBERCULATUM, *Linnaeus*.*Box Fish.*

*Ostracion tuberculatus*, Linnæus, Syst. Nat., (ed. x.), 1758, p. 331.

*Figure*—Bleeker, Atl. Ichth., v., 1865, pl. cci., fig. 2.

*Recorded*—Waite, Rec. Aust. Mus., iii., 1900, p. 207.

139. OSTRACION CORNUTUM, *Linnaeus*.

*Ostracion cornutus*, Linnæus, Syst. Nat., (ed. x.), 1758, p. 331.

*Figure*—Bleeker, Atl. Ichth., v., 1865, pl. ccii., fig. 3.

*Recorded*—Waite, Rec. Aust. Mus., v., 1903, p. 37.

*Family* TETRAODONTIDÆ.SPHEROIDES, *Lacépède*, 1800.140. SPHEROIDES OBLONGUS, *Bloch*.

*Tetraodon oblongus*, Bloch, Nat. ausl. Fische, ii., 1786, p. 6.

*Figure*—Bleeker, Atl. Ichth., v., 1864, pl. ccviii. (1865), fig. 4.

*Recorded*—Waite, Rec. Aust. Mus., iii., 1900, p. 207.

141. SPHEROIDES HYPSELOGENEION, *Bleeker*.

*Tetraodon hypselogeneion*, Bleeker, Nat. Tijds. Ned. Ind., iii., 1852, p. 300.

*Figure*—Bleeker, Atl. Ichth., v., 1865, pl. ccxiii., fig. 5.

*Recorded*—Waite, Rec. Aust. Mus., v., 1903, p. 38.

142. SPHEROIDES ALTIPINNIS, *Ogilby*.

*Tetrodon altipinnis*, Ogilby, Rec. Aust. Mus., i., 1891, p. 110.

*Figure*—None.

*Recorded*—Ogilby, *loc. cit.*

TETRAODON, *Linnaeus*, 1758.

143. TETRAODON HISPIDUS, *Linnaeus*.

*Tetraodon hispidus*, *Linnaeus*, *Syst. Nat.*, (ed. x.), 1758, p. 333.

*Figure*—*Bleeker*, *Atl. Ichth.*, v., 1865, pl. ccv., fig. 3.

*Recorded*—*Ogilby*, *Aust. Mus. Mem.*, ii., 1889, p. 74.

144. TETRAODON STELLATUS, *Bloch & Schneider*.

*Toado*.

*Tetrodon lagocephalus*, var *stellatus*, *Bloch & Schneider*, *Syst. Ichth.*, 1801, p. 503.

*Figure*—*Bleeker*, *Atl. Ichth.*, v., 1865, pl. ccxii., fig. 1.

*Recorded*—*Waite*, "Thetis" *Prelim. Rep.*, 1898, p. 62.

145. TETRAODON MELEAGRIS, *Lacépède*.

*Tetrodon meleagris*, *Lacépède*, *Hist. Nat. Poiss.*, i., 1798, p. 505.

*Figure*—*Bleeker*, *Atl. Ichth.*, v., 1865, pl. ccx., fig. 1.

*Recorded*—*Waite*, *Rec. Aust. Mus.*, iii., 1900, p. 207.

*Family* TROPIDICHTHYIDÆ.

TROPIDICHTHYS, *Bleeker*, 1854.

146. TROPIDICHTHYS VALENTINI, *Bleeker*.

*Tetraodon valentini*, *Bleeker*, *Nat. Tijds. Ned. Ind.*, iv., 1853, p. 130.

*Figure*—*Bleeker*, *Atl. Ichth.*, v., 1865, pl. ccviii., fig. 1.

*Recorded*—*Ogilby*, *Aust. Mus. Mem.*, ii., 1889, p. 74.

147. TROPIDICHTHYS CALLISTERNUS, *Ogilby*.

*Tetrodon callisternus*, *Ogilby*, *Aust. Mus. Mem.*, ii., 1889, p. 74.

*Figure*—*Ogilby*, *loc. cit.*, pl. iii., fig. 5.

*Recorded*—*Ogilby*, *loc. cit.*

## Family DIODONTIDÆ.

DIODON, *Linnaeus*, 1758.148. DIODON HYSTRIX, *Linnaeus*.*Porcupine Fish.**Diodon hystrix*, *Linnaeus*, *Syst. Nat.*, (ed. x.), 1758, p. 335.*Figure*—*Bleeker*, *Atl. Ichth.*, v., 1865, pl. ccvii., fig. 2.*Recorded*—*Ogilby*, *Aust. Mus. Mem.*, ii., 1889, p. 74.EUCHILOMYCTERUS, *Waite*, 1900.149. EUCHILOMYCTERUS QUADRATICATUS, *Waite*.*Euchilomycterus quadraticatus*, *Waite*, *Rec. Aust. Mus.*, iii., 1900, p. 208.*Figure*—None.*Recorded*—*Waite*, *loc. cit.*

## Family SCORPÆNIDÆ.

SEBASTOPSIS, *Gill*, 1862.150. SEBASTOPSIS GUAMENSIS, *Quoy & Gaimard*.*Scorpena guamensis*, *Quoy & Gaimard*, *Voy. "Uranie," Zool.*, 1824, p. 326.*Figure*—*Günther*, *Fische Südsee*, iii., 1874, pl. lvi., fig. B.*Recorded*—*Waite*, *Rec. Aust. Mus.*, v., 1904, p. 175.151. SEBASTOPSIS SCABER, *Ramsay & Ogilby*.*Sebastes scaber*, *Ramsay & Ogilby*, *Proc. Linn. Soc. N.S. Wales*, x., 1886, p. 577.*Figure*—None.*Recorded*—*Ogilby*, *Aust. Mus. Mem.*, ii., 1889, p. 60.SCORPÆNA, *Linnaeus*, 1758.152. SCORPÆNA COOKII, *Günther*.*Sandy-Bay Cod.**Scorpena cookii*, *Günther*, *Fische Südsee*, iii., 1874, p. 78.*Figure*—*Günther*, *loc. cit.*, pl. lv.*Recorded*—*Ogilby*, *Proc. Zool. Soc.*, 1889, p. 155.

COCOTROPUS, *Kaup*, 1858.

153. COCOTROPUS ALTIPINNIS, *Waite*.

*Cocotropus altipinnis*, *Waite*, *Rec. Aust. Mus.*, v., 1903, p. 41.

*Figure*—*Waite*, *loc. cit.*, pl. v., fig. 2.

*Recorded*—*Waite*, *loc. cit.*

PTEROIS, *Cuvier*, 1817.

154. PTEROIS VOLITANS, *Linnaeus*.

*Red Fire Fish*

*Gasterosteus volitans*, *Linnaeus*, *Syst. Nat.*, (ed. x.), 1758, p. 296.

*Figure*—*Bleeker*, *Atl. Ichth.*, ix., 1878, pl. ccccxii., fig. 3.

*Recorded*—*Ogilby*, *Aust. Mus. Mem.*, ii., 1889, p. 60.

155. PTEROIS ZEBRA, *Cuvier & Valenciennes*.

*Fire Fish.*

*Pterois zebra*, *Cuvier & Valenciennes*, *Hist. Nat. Poiss.*, iv., 1829, p. 367.

*Figure*—*Bleeker*, *Atl. Ichth.*, ix., 1878, pl. ccccxii., fig. 1.

*Recorded*—*Waite*, *Rec. Aust. Mus.*, iii., 1900, p. 209.

*Family* NOTOTHENIIDÆ.

PARAPERCIS, *Bleeker*, 1872.

156. PARAPERCIS CYLINDRICA, *Bloch*.

*Sciæna cylindrica*, *Bloch*, *Nat. ansl. Fische*, vi., 1792, p. 42.

*Figure*—*Bloch*, *loc. cit.*, pl. cccxcix, fig. 1.

*Recorded*—*Waite*, *Rec. Aust. Mus.*, iii., 1900, p. 209.

*Family* CALLIONYMIDÆ.

CALLIONYMUS, *Linnaeus*, 1758.

157. CALLIONYMUS JAPONICUS, *Houttuyn*.

*Stink-Fish.*

*Callionymus japonicus*, *Houttuyn*, *Verh. Holl. Maatsch. Wet. Harlem*, xx., 1782, p. 311.

*Figure*—*Temminck & Schlegel*, *Fauna Japon.*, *Pisces*, 1845, pl. lxxix. A., fig. 1.

*Recorded*—*Waite*, "Thetis" *Prelim. Report*, 1898, p. 60.

*Family* TRICHONOTIDÆ.LIMNICHTHYS, *Waite*, 1904.158. LIMNICHTHYS FASCIATUS, *Waite*.*Limnichthys fasciatus*, *Waite*, *Rec. Aust. Mus.*, v., 1904, p. 178.*Figure*—*Waite*, *loc. cit.*, pl. xxiii., fig. 4.*Recorded*—*Waite*, *loc. cit.**Family* GOBIIDÆ.GOBIUS, *Linnaeus*, 1758.159. GOBIUS ÆOLOSOMA, *Ogilby*.*Gobius æolosoma*, *Ogilby*, *Aust. Mus. Mem.*, ii., 1889, p. 61.*Figure*—*Waite*, *Rec. Aust. Mus.*, v., 1904, pl. xxiii., fig. 2.*Recorded*—*Ogilby*, *loc. cit.*ALLOGOBIUS, *Waite*, 1904.160. ALLOGOBIUS VIRIDIS, *Waite*.*Allogobius viridis*, *Waite*, *Rec. Aust. Mus.*, v., 1904, p. 177.*Figure*—*Waite*, *loc. cit.*, pl. xxiii., fig. 3.*Recorded*—*Waite*, *loc. cit.**Family* GOBIESOCIDÆ.DIPLOCREPIS, *Günther*, 1861.161. DIPLOCREPIS COSTATUS, *Ogilby*.*Cling Fish.**Diplocrepis costatus*, *Ogilby*, *Proc. Linn. Soc. N.S. Wales*, x., 1885, p. 270.*Figure*—*Waite*, *Rec. Aust. Mus.*, v., 1904, pl. xxiv., fig. 1.*Recorded*—*Ogilby*, *Aust. Mus. Mem.*, ii., 1889, p. 63.LEPADICHTHYS, *Waite*, 1904.162. LEPADICHTHYS FRENATUS, *Waite*.*Lepadichthys frenatus*, *Waite*, *Rec. Aust. Mus.*, v., 1904, p. 180.*Figure*—*Waite*, *loc. cit.*, pl. xxiv., fig. 2.*Recorded*—*Waite*, *loc. cit.*



Family BLENNIIDÆ.

PETROSCIRTES, Rüppell, 1828.

163. PETROSCIRTES ICELII, Ogilby.

*Petroscirtes icelii*, Ogilby, Proc. Linn. Soc. N.S. Wales, (2), ix., 1894, p. 370.

Figure—Waite, Rec. Aust. Mus. v., 1904, pl. xxiv., fig. 3.

Recorded—Ogilby, *loc. cit.*

XIPHASIA, Swainson, 1839.

164. XIPHASIA SETIFER, Swainson.

*Xiphasia setifer*, Swainson, Fishes, ii., 1839, p. 259.

Figure—Day, Fish. India, 1876, pl. lxxiii, fig. 1.

Recorded—Ogilby, Aust. Mus. Mem., ii., 1889, p. 62 (*Gobioides sp.*); Waite, Rec. Aust. Mus., v., 1903, p. 45.

SALARIAS, Cuvier, 1817.

165. SALARIAS QUADRICORNIS, Cuvier & Valenciennes.

*Salarias quadricornis*, Cuvier & Valenciennes, Hist. Nat. Poiss., xi., 1836, p. 329.

Figure—Cuvier & Valenciennes, *loc. cit.*, pl. cccxxix.

Recorded—Ogilby, Aust. Mus. Mem., ii., 1889, p. 63.

166. SALARIAS MARMORATUS, Bennett.

*Blennius marmoratus*, Bennett, Zool. Journ., iv., 1829, p. 35.

Figure—Günther, Fische Südsee, vi., 1877, pl. cxvi., fig. B.

Recorded—Ogilby, Aust. Mus. Mem., ii., 1889, p. 62.

167. SALARIAS INSULÆ, Ogilby.

*Salarias insulæ*, Ogilby, Proc. Linn. Soc. N.S. Wales, xxiii., 1899, p. 741.

Figure—None.

Recorded—Ogilby, *loc. cit.*

168. SALARIAS ALBOAPICALIS, *Ogilby*.*Jumping Fish.**Salarias alboapicalis*, Ogilby, Proc. Linn. Soc. N.S. Wales, xxiii., 1899, p. 742.*Figure*—Günther, Fische Südsee, vi., 1877, pl. cxvi., fig. A., (*S. variolosus*).*Recorded*—Ogilby, Aust. Mus. Mem., ii., 1889, p. 62 (*S. variolosus*).PETRÄITES, *Ogilby*, 1885.169. PETRÄITES ROSEUS, *Günther*.*Cristiceps roseus*, Günther, Cat. Fish. Brit. Mus., iii., 1861, p. 274.*Figure*—None.*Recorded*—Ogilby, Aust. Mus. Mem., ii., 1889, p. 63CRISTICEPS, *Cuvier & Valenciennes*, 1836.170. CRISTICEPS AUSTRALIS, *Günther*.*Weed Fish.**Cristiceps australis*, Günther, Cat. Fish. Brit. Mus., iii., 1861, p. 275.*Figure*—None.*Recorded*—Waite, Rec. Aust. Mus., iii., 1900, p. 209.171. CRISTICEPS AURANTIACUS, *Castelnau*.*Cristiceps aurantiacus*, Castelnau, Proc. Linn. Soc. N.S. Wales, iii., 1879, p. 386.*Figure*—None.*Recorded*—Ogilby, Aust. Mus. Mem., ii, 1889, p. 63.TRIPTYRGION, *Risso*, 1826.172. TRIPTYRGION NIGRIPENNE, *Cuvier & Valenciennes*.*Triptyrgion nigripenne*, Cuvier & Valenciennes, Hist. Nat. Poiss., xi., 1836, p. 413.*Figure*—Cuvier & Valenciennes, *loc. cit.*, pl. cccxxxix.*Recorded*—Waite, Rec. Aust. Mus., v., 1904, p. 182.

173. TRIPTERYGION RUFOPILEUM, *Waite*.

*Tripterygion rufopileum*, Waite, Rec. Aust. Mus., v., 1904, p. 182.

*Figure*—Waite, *loc. cit.*, pl. xxiv., fig. 4.

*Recorded*—Ogilby, Aust. Mus. Mem., ii., 1889, p. 63 (*T. atrogulare*).

*Family* ACANTHOCLINIDÆ.

ACANTHOCLINUS, *Jenyns*, 1842.

174. ACANTHOCLINUS LITOREUS, *Forster*.

*Blennius litoreus*, Forster in Bloch & Schneider, Syst. Ichth., 1801, p. 177.

*Figure*—Ogilby, Aust. Mus. Mem., ii., 1889, pl. iii., fig. 3.

*Recorded*—Ogilby, *loc. cit.*, p. 63.

*Family* BROTULIDÆ.

DINEMATICHTHYS, *Bleeker*, 1854.

175. DINEMATICHTHYS LONGIFILES, *Ogilby*.

*Diancistrus longifiles*, Ogilby, Proc. Linn. Soc. N.S. Wales, xxiii., 1899, p. 744.

*Figure*—Waite, Rec. Aust. Mus., v., 1904, pl. xxiv., fig. 5.

*Recorded*—Ogilby, *loc. cit.*

*Family* GADIDÆ.

LOTELLA, *Kaup*, 1858.

176. LOTELLA CALLARIAS, *Günther*.

*Beardie*.

*Lotella callarias*, Günther, Ann. Mag. Nat. Hist., (3), xi., 1863, p. 116.

*Figure*—McCoy, Prod. Zool. Vict., dec. ii., 1878, pl. xix.

*Recorded*—Ogilby, Aust. Mus. Mem., ii., 1889, p. 70, and Proc. Linn. Soc. N.S. Wales, xxiii., 1899, p. 745.

*Family* PLEURONECTIDÆ.PLATOPHRYS, *Swainson*, 1839177. PLATOPHRYS PANTHERINUS, *Rüppell*.*Panther Flounder.**Rhombus pantherinus*, *Rüppell*, Atlas Reise nörd Afrika, Fische, 1825, p. 121.*Figure*—*Bleeker*, Atl. Ichth., vi., 1870, pl. cxxxiii., 1865, fig. 3.*Recorded*—*Waite*, "Thetis" Prelim. Rep., 1898, p. 61.*Family* SOLEIDÆ.ASERAGGODES, *Kaup*, 1858178. ASERAGGODES RAMSAYI, *Ogilby*.*Solea ramsayi*, *Ogilby*, Aust. Mus. Mem., ii., 1889, p. 70.*Figure*—*Ogilby*, *loc. cit.*, pl. iii., fig. 4.*Recorded*—*Ogilby*, *loc. cit.**Family* ANTENNARIIDÆ.ANTENNARIUS, *Lacépède*, 1798.179. ANTENNARIUS COCCINEUS, *Lesson & Garnot*.*Angler Fish.**Chironectes coccineus*, *Lesson & Garnot*, Voy. "Coquille," Poiss., 1827, p. 143.*Figure*—*Lesson & Garnot*, *loc. cit.*, pl. xvi., fig. 1.*Recorded*—*Ogilby*, Aust. Mus. Mem., ii., 1889, p. 61.180. ANTENNARIUS COMMERSIONII, *Cuvier*.*Chironectes commersonii*, *Cuvier*, Mem. Mus. Hist. Nat., iii., 1817, p. 431 (after *Lacépède*, 1798).*Figure*—*Günther*, Fische Südsee, v., 1876-7, pl. c-cvi.*Recorded*—*Waite*, Rec. Aust. Mus., iv., 1901, p. 47.

## BIBLIOGRAPHY.

---

### FOULIS—DR.

Votes and Proceedings Legislative Council. New South Wales, 1853.

[Enumerates six fishes.]

### GÜNTHER—ALBERT.

Catalogue of the Fishes in the British Museum, i., 1859, p. 120.

[*Serranus ouatabili*, Cuvier & Valenciennes, (not admitted in catalogue.)]

### HILL—E. S.

Lord Howe Island.—Official visit of the Water Police Magistrate, and the Director of the Botanic Gardens. Sydney, 1870.

[Enumerates nine fishes.]

### MACLEAY—WM.

A remarkable Fish from Lord Howe Island.—*Proc. Linn. Soc. N. S. Wales*, x., 1885, p. 718, pl. xlvii.

[*Ctenodax wilkinsoni*, sp. nov.]

---

Note on *Ctenodax wilkinsoni*, Maccl.—*Proc. Linn. Soc. N.S. Wales*, (2), i., 1886, p. 511.

### OGILBY—J. DOUGLAS.

Description of a new Genus and Species of Deep-sea Fish from Lord Howe Island.—*Proc. Linn. Soc. N.S. Wales*, (2), iii., 1888, p. 1313.

[*Sternoptychides amabilis*.]

## OGILBY—J. DOUGLAS.

Notes on some Fishes new to the Australian Fauna.—*Proc. Zool. Soc.*, 1889, p. 151.

[*Anthias cichlops*, Bleeker, *Scorpena cooki*, Günther, and *Platystethus guentheri*, sp. nov.]

---

Lord Howe Island—Fishes.—*Mem. Aust. Mus.*, ii., 1889, pp. 52-74, pls. ii.-iii.

[A complete catalogue to date. Eighty-eight species, fourteen new species, and six species figured.]

---

Description of a new Fish from Lord Howe Island.—*Rec. Aust. Mus.*, i., 1891, p. 110.

[*Tetrodon altipinnis*, sp. nov.]

---

Edible Fishes of New South Wales, 1893, pp. 55, 90.

[*Chironemus marmoratus*, Günther. *Trachynotus russelli*, Cuvier & Valenciennes.]

---

Description of five new Fishes from the Australasian Region.—*Proc. Linn. Soc. N.S. Wales*, (2), ix., 1894, p. 370.

[*Petroscirtes icelii*, sp. nov.]

---

New Genera and Species of Fishes.—*Proc. Linn. Soc. N.S. Wales*, xxiii., 1898, p. 36.

[*Ethoprora perspicillata*, sp. nov.]

OGILBY—J. DOUGLAS.

New Genera and Species of Fishes.—*Proc. Linn. Soc. N.S. Wales*, xxiii., 1898, p. 288.

[*Congrellus gilberti*, nom. nov.]

---

Additions to the Fauna of Lord Howe Island.—*Proc. Linn. Soc. N.S. Wales*, xxiii., 1899, pp. 730-745.

[Nine species added, three new genera and five new species.]

RAMSAY—EDWARD P.

Description of a new Species of *Coris* from Lord Howe's Island and New South Wales.—*Proc. Linn. Soc. N.S. Wales*, vii., 1882, p. 301.

[*Coris picta*, sp. nov.]

RAMSAY—EDW. P. & J. DOUGLAS OGILBY.

On the genus *Tetragonurus* of Risso.—*Proc. Linn. Soc. N.S. Wales*, (2), iii., 1888, p. 9.

WAITE—EDGAR R.

New or rare Fishes from Maroubra, New South Wales.—*Proc. Linn. Soc. N. S. Wales*, (2), ix., 1894, pp. 217, 219.

[Three species added.]

---

“Thetis” Preliminary Report, 1898, pp. 58-62, pl. xii.

[Seven species added, *Myxus elongatus*, Günther, figured.]

## WAITE—EDGAR R.

Additions to the Fish Fauna of Lord Howe Island.—*Rec. Aust. Mus.*, iii., 1900, pp. 193-209, pls. xxxiv.-xxxvi.

[Thirty-one species added, four new species, three species figured.]

---

Additions to the Fish Fauna of Lord Howe Island, No. 2.—*Rec. Aust. Mus.*, iv., 1901, pp. 36-47, pls. v.-viii., and fig. 12.

[Eight species added, two new species, five species figured.]

---

New Records or Recurrences of rare Fishes from Eastern Australia.—*Rec. Aust. Mus.*, iv., 1902, p. 267.

[*Tetragonurus wilkinsoni*, Macleay=*T. cuvieri*, Risso.]

---

Additions to the Fish Fauna of Lord Howe Island, No. 3.—*Rec. Aust. Mus.*, v., 1903, pp. 20-45, pls. iii.-v., and figs. 1-2.

[Seventeen species added, three new species, eight species figured.]

---

Additions to the Fish Fauna of Lord Howe Island, No. 4.—*Rec. Aust. Mus.*, v., 1904, pp. 135-186, pls. xvii.-xxiv., and fig. 32.

[Twenty-seven species added, four new genera, ten new species, twenty-four species figured.]

---

Catalogue of the Fishes of Lord Howe Island.—*Rec. Aust. Mus.*, v., 1904, pp. 187-226.

[One hundred and eighty species.]



NEW RECORDS OR RECURRENCES OF RARE FISHES  
FROM EASTERN AUSTRALIA.

No. 3.

By EDGAR R. WAITE, F.L.S., Zoologist.

(Plates xxv. and xxvi., and figures 33-34.)

Ten species are dealt with in this paper, of which three are described as new, namely:—*Neopercis binivirgata*, *Gnathagnus innotabilis* and *Schizochirus insolens*, the last named being regarded as the type of a new genus. *Glyphisodon savatilis*, Linnæus, *G. leucozona*, Bleeker, and *Limnichthys fasciatus*, Waite, are known species, now first recorded for New South Wales. *Gnathypops jacksoniensis*, Macleay, is redescribed, and it is suggested that the genus *Goodella*, Ogilby, is founded on young examples of *Trachinocephalus myops*, Forster. The occurrence of *Mordacia mordax*, Richardson, is recorded from the Murrumbidgee River, and notes upon *Tropidostethus rhotophilus*, Ogilby, are published.

With the exception of *Mordacia*, *Glyphisodon*, and *Limnichthys*, elsewhere illustrated, all the species are figured, the plates being reproduced from drawings by Mr. A. R. McCulloch.

MORDACIA MORDAX, *Richardson*.

*Petromyzon mordax*, Richardson, Voy. "Ereb. and Terr.," Ichth., 1846, p. 62, pl. xxxviii., figs. 3-6.

This Lamprey was first recorded from Australia by Klunzinger<sup>1</sup> from near the mouth of the Murray River, and I identify examples from a New South Wales tributary of that river as also belonging to the species.

Two ammocoetal individuals were forwarded by Mr. H. G. Donaldson for identification, and were obtained from a submerged boat on the Murrumbidgee River at Hay. This appears to be the first record of a Lamprey in New South Wales, west of the dividing range; the species is known from the Hawkesbury River watershed and is apparently not uncommon.

---

<sup>1</sup> Klunzinger—Arch. für Naturg., 1872, p. 45.

In his "Monograph of the Australian Marsipobranchii," Ogilby<sup>2</sup> used the name *Mordacia* instead of *Caragola*, only in deference to the opinions of Drs. A. Günther and G. A. Boulenger, holding that the latter, occurring prior to the other, though on the same page, is entitled to be used. I also hold similar views but admit *Mordacia* under the rules indicated by Dr. L. Plate<sup>3</sup> as governing such conditions.

"Other things being equal, the name is to be preferred which stands first in the book or article.

But in all cases, the name adopted by the first reviser of the group shall stand, even if such adoption is contrary to these conditions."<sup>4</sup>

Having made known<sup>5</sup> the recurrence of a Lamprey from West Australia, under the name *Velasia stenostoma*, Ogilby,<sup>6</sup> I may be permitted to mention that Plate<sup>7</sup> regards the genus *Velasia*, Gray, as but an immature form of *Geotria*, but admits the species under the name *Geotria stenostomus*. Dendy and Margaret Olliver<sup>8</sup> arrive at the same conclusion and would recognise three stages, *Ammocetes*, *Velasia*, and *Geotria*, the gular pouch being developed only in the adult, *Geotria*. Previously *Geotria australis*, Gray,<sup>9</sup> was known in New Zealand only from Stewart Island, as recorded by Hutton, but these writers received it from the mainland, examples being taken in the Matoura River, South Island, which flows into Foveaux Strait, opposite to Stewart Island.

#### TRACHINOCEPHALUS MYOPS, Forster.

*Salmo myops*, Forster in Bloch and Schneider, Syst. Ichth., 1801, p. 421.

*Goodella hypozona*, Ogilby, Proc. Linn. Soc. N.S. Wales, xxii., 1897, p. 250.

(Plate xxv., fig. 1.)

The following notes are based upon an examination of specimens I recently collected, together with others placed in my hands by Mr. Thomas Whitelegge, who was the first to observe this form upon our coast, more than ten years ago.

<sup>2</sup> Ogilby—Proc. Linn. Soc. N.S. Wales, xxi., 1896, p. 398.

<sup>3</sup> Plate—Zool. Jahrb. Supp., ii., 1902, p. 653.

<sup>4</sup> Verh. v. Internat. Zool. Cong. Berlin, 1901, p. 968, par. 4, c. and d.

<sup>5</sup> Waite—Rec. Aust. Mus., iv., 1902, p. 179.

<sup>6</sup> Ogilby—*Loc. cit.*, p. 409.

<sup>7</sup> Plate—*Loc. cit.*

<sup>8</sup> Dendy and Olliver—Trans. N. Z. Inst., xxxiv., 1896, p. 147.

<sup>9</sup> Gray—Proc. Zool. Sec., 1851, p. 238.

The author of *Goodella hypozona* concludes his paper with the following paragraph:—

“That the specimens from which the above description is taken are immature is apparent from the soft state of the bones, even the vertebral column being incompletely ossified; but the complete absence of a scaly covering\* is a character of such importance that I have no hesitation in describing and naming the species and genus as new, the more so that there is no synodont fish known from our coast of which it could be the fry.

\*In *Harpodon*, a partially scaleless synodont from the tropical Indo-Pacific, the ventral fin is inserted below the dorsal, not well in advance of it as in *Goodella*.”

I can fully confirm the conclusions as to the immaturity of the specimens, one example, but a trifle smaller than the others, had the yolk sac incompletely absorbed when obtained.

The statement as to the entire absence of a scaly covering is one which cannot be maintained. The scales of the lateral line are well developed but are not, at this stage, imbricate; they number fifty-six. I have not the opportunity of examining the type specimen and it is necessary to mention that it is not in the Australian Museum as stated, though it was evidently the author's intention to place it there; the matter was doubtless overlooked and the number quoted (I. 3670, 24th June, 1897) is allotted to another fish.

The ordinary series of scales are being developed on the caudal peduncle and posteriorly are well formed, though as in the case of those of the lateral line, not imbricated; more anteriorly the scales are less developed while still more in advance their position is merely indicated by pits; there can, however, be little doubt that at a later stage the body would be normally clothed.

With these facts in view one may be in a position to reconsider the question of the affinities of the species. Though I cannot, of course, be dogmatic on the matter, I have very little hesitation in pronouncing *Goodella* to be the fry of *Trachinocephalus myops*.

In the *Goodella* stage the eye is larger, the body more elongate and the bases of the vertical fins shorter than in the adult. In some examples, the type included, the base of the anal is longer than, in others equal to, or even shorter than that of the dorsal. An example exhibiting the latter character is figured, this has thirteen dorsal spines as in Schlegel's examples from Japan. Thirteen is also the normal number of rays in the pectoral.

The largest example examined measures 48 mm. in length.

TROPIDOSTETHUS RHOTHOPHILUS, *Ogilby*.

*Tropidostethus rhotophilus*, Ogilby, Proc. Linn. Soc. N.S. Wales, (2), x., 1895, p. 323.

(Plate xxv., fig. 2.)

As recorded by its author, this little fish was first noticed in March 1893, and was next observed from March to July of the following year. Since that time Mr. Whitelegge has made a point of watching for it during his weekly visits to Maroubra Bay with the result that he finds it to be a permanent resident, occurring at all times throughout the year.

In addition to the lateral band, the whole of the body cavity has a silvery lining. In company with Mr. Whitelegge I have watched these fishes disporting in the surf where they appear as thin grey lines which, as the fishes turn in the water, change to silvery streaks.

The original description may be augmented as follows:—

D. iv. i. 14-16; A. i. 23-27; V. i. 5; P. 15; C. 17; L. lat. 49. Vert. 15 + 28 = 43.

The ventrals are said to be situated "far behind the pectorals," this may be a little misleading, their exact position is shown in the accompanying figure.

The scales are described as being deciduous, they are in reality firmly adherent, but as they are developed on portion of the body only, the author doubtless concluded that they had fallen from the naked area.

The head and anterior part of the body are devoid of scales, the naked portion extending above, to the dorsal fin, and below, to the anal fin. Medially the scales extend forward to within the extremity of the pectoral fin, and occur over the whole posterior half of the body.

The height of the body, rendered as "five in the total length" was taken, it would appear, at the origin of the anal fin, the greatest height, three and a half, occurs at the ventral fin.

The genus *Iso*, Jordan and Starks,<sup>10</sup> very closely approaches *Tropidostethus*, which has priority. Direct comparison of *I. flosmaris*, Jordan and Starks, with *T. rhotophilus* will, however, be advisable, for which purpose I am forwarding examples of the local species to my American *confrères*. The Japanese fish appears to be more elongate and lower in the thoracic region though it must be noted that the dimensions rendered by the respective authors agree exactly. The scales as described and figured are certainly smaller than in the Australian form, and in the latter I fail to find vomerine teeth.

<sup>10</sup> Jordan and Starks—Proc. U.S. Nat. Mus., xxiv., 1901, p. 204.

One very important point must be referred to. Ogilby counted the vertebræ as  $15 + 29$ : as above indicated my figures are  $15 + 28 = 43$ . The Japanese fish also has forty three vertebræ but the thoracic and abdominal portions are differently divided,  $18 + 25 = 43$ : so significant are these numbers that one is tempted to ask if some mistake has not been made. If there is really this difference the two genera are valid, though such would never be guessed from an external examination alone. The habits of the two fishes are identical, our species has been named Surf-fish, while the Japanese form is known as the Surf-sardine, or in the poetical language of the country, "Flower of the Wave."

GLYPHISODON SAXATILIS, *Linnaeus*.

*Chaetodon saxatilis*, Linnaeus, Syst. Nat., (ed. x.), 1758, p. 276.

This species, new to the fauna of the State, is added by the efforts of Mr. Allan R. McCulloch, who obtained examples at Long Bay, where he found them to be not uncommon in rock-pools.

Colours in life creamy with five dark bands, spot on pectoral blue, outer ventral ray pure white, caudal without the outer rays dark.

In their "Fishes from Formosa," Jordan & Evermann<sup>11</sup> write of an apparently identical form—"This is *Glyphisodon celestinus* (the variety with plain caudal) of Günther and Bleeker, and corresponds fairly to Bleeker's fig. 5 in Pl. ix, in Bleeker's Atlas of the Pomacentridæ. But the true *Glyphisodon celestinus* has the caudal edged above and below with blackish. Whether this character is of a distinctive value we have not the material to decide."

I recently published<sup>12</sup> a note on this species from Lord Howe Island, and recorded the fact that both varieties were taken together from the same pool. This clearly indicates that the name *celestinus* has no status above that of a variety.

GLYPHISODON LEUCOZONA, *Bleeker*.

*Glyphisodon leucozona*, Bleeker, Natuurk. Tijdschr. Nederl. Ind., xix., 1859, p. 338, and Atl. Ichth., ix., 1877, pl. ccccvii., fig. 2.

This addition to the fauna we also owe to Mr. McCulloch, who obtained a single example at Long Bay. It agrees in every way with Bleeker's description, with the exception that it possesses the dark ocellus at the base of the posterior dorsal spines, shown

<sup>11</sup> Jordan and Evermann—Proc. U.S. Nat. Mus., xxv., 1902, p. 352.

<sup>12</sup> Waite—Rec. Aust. Mus., v., 1904, p. 170.

in the figure. This is doubtless an indication of immaturity, the example figured being smaller than the type, while ours is smaller still, being but 35 mm. in length. The black spot behind the last dorsal rays described, and present in our specimen, is not indicated in the figure and the sub-vertical white band is shown to pass from the base of the second and third dorsal spines, whereas in our example it originates as described by both Bleeker and Günther.

The types were from Karangbollong, in Java, and the largest examples were 77 mm. in length.

NEOPERCIS BINIVIRGATA, *sp. nov.*

(Plate xxv., fig. 3.)

D. v. 23; A.i. 20; V.i. 5; P. 21; C. 17; L. lat. 68; L.tr. 5 + 20.

Length of head 4.0, height of body slightly less than the width of the head and equal to the length of the caudal 5.3; length of pectoral 4.8; of ventral 4.5 in the total length, exclusive of the caudal fin. Eye 3.4, interorbital space 9.2, snout 3.7, and height of caudal peduncle 2.5 in the length of the head.

Cleft of mouth slightly oblique, jaws equal, the maxilla reaches to beyond the centre of the eye and is not concealed. Anterior nostril a little nearer the eye than the snout, the posterior one midway between it and the eye.

Opercle with a flat spine above the root of the pectoral, and a few denticulations at the angle, preopercular border smooth.

*Teeth.*—An outer row of rather large spaced curved teeth, somewhat larger in the mandible, and an inner band of very small teeth in both jaws, a patch of low conical teeth on the vomer and a row on each palatine.

*Fins.*—Fifth dorsal spine longest and nearly equal to the length of the snout; length of highest rays 1.6 in the head. Anal fin slightly lower; it arises below the fifth dorsal ray and terminates evenly with that fin; both are longer posteriorly and extend beyond the base of the caudal. Pectoral evenly rounded, extending to beyond the second anal ray. Fourth ventral ray longest reaching to the second ray of the anal. Caudal slightly rounded.

*Scales.*—The top of the head, snout and a space around the eyes are naked, but with numerous round pores; cheeks and opercles scaly. All the scales are minutely ctenoid.

*Colours*.—Generally yellowish-red, lighter and yellower beneath. Upper half of head and body with fourteen bars of brown colour, arranged in pairs; the first pair occupies the head behind the eyes, the second pair is placed beneath the dorsal spines; the others are evenly arranged beneath the rays; the last bar is on the caudal peduncle and there is also a faint mark at the base of the upper caudal rays; this fin also bears about eight oblique vertical brown bars which are inclined forward below and do not traverse the lower four rays. The dorsal rays are similarly marked but the bands are inclined backwards below. Pectoral yellow with a red mark at its upper base; ventral yellow, the median part of the inner rays black; the anal is without markings.

The foregoing description, and the accompanying figure are based on the larger of two examples taken on the coast of New South Wales, one in May, 1895, the other, which measures 180 mm. in length, obtained at Coogee by Mr. H. Newcombe in April, 1902.

The genus *Neopercis* was founded by Steindachner and Döderlein<sup>13</sup> on an example from St. Vincent's Gulf, which the former author<sup>14</sup> had previously named *Parapercis ramsayi*. I have not access to the description of the species, and cannot, therefore, say that *N. binivirgata* is distinct from *N. ramsayi*. The genus is founded on the presence of teeth on the palatines and a probable though lesser character is suggested, namely the posterior spines of the dorsal fin being highest, whereas in *Percis* (= *Parapercis*), the middle spines are highest. Jordan and Snyder,<sup>15</sup> in their "Trachinoid Fishes of Japan," accept these two characters, but I find that the latter cannot be maintained. In my *Parapercis ocellaris*<sup>16</sup> which I have re-examined, the palatines are without teeth (*Parapercis*), but the middle spines are not highest (*Neopercis*), and I may add the two fins are connected.

*Neopercis* can, therefore, be maintained only on the condition of the palatines.

I have also examined *Percis novæ-cambriæ*, Ogilby,<sup>17</sup> which I figured<sup>18</sup> under the generic name *Parapercis*. Though not mentioned by the author, small teeth are present on the palatines, this species is therefore a true *Neopercis*.

<sup>13</sup> Steindachner and Döderlein—Fische Japan's, iii, 1884, p. 212 (foot-note).

<sup>14</sup> Steindachner—Ichth. Beitr., xiii., 1883, p. 1072.

<sup>15</sup> Jordan and Snyder—Proc. U.S. Nat. Mus., xxiv., 1902, p. 463.

<sup>16</sup> Waite—Aust. Mus. Mem., iv., 1899, p. 109.

<sup>17</sup> Ogilby—Proc. Linn. Soc. N.S. Wales, x., 1885, p. 228.

<sup>18</sup> Waite—*Loc. cit.*, pl. xxv.

All local species in the collection of the Australian Museum have been examined, they stand as follows:—

*Parapercis nebulosus*, Quoy and Gaimard.

„ *ocularis*, Waite.

*Neopercis nove-cambrice*, Ogilby.

„ *binivirgata*, Waite.

*Percis allporti*, Günther,<sup>19</sup> which I have not seen, may also belong to *Neopercis*; the dorsal spines being described as of sub-equal length. *Percis stricticeps*, De Vis,<sup>20</sup> and *P. concinna*, De Vis,<sup>21</sup> are insufficiently described to enable one to form an opinion as to their generic relations.

GNATHAGNUS INNOTABILIS, *sp. nov.*

(Plate xxvi., fig. 1.)

D. 12; A. 16; V. i. 5; P. 21; C. 11 + 6.

Length of head 3·0, depth 4·4 in the total length, the width of the head is one-fourth more than its length. The eye is directed outwards and upwards, its diameter 4·3 in the head, interorbital space broad 2·2, and the snout 6·5 in the head; the depth of the caudal peduncle is 3·5 in the same.

The head is broader than the body which tapers rapidly to the tail, it is armed with bony plates, the most noticeable being a pair on the occiput, each of which bears a longitudinal ridge passing from its middle backwards, a longer broken ridge runs from above each eye and is continued towards a short ridge on the body which terminates in the humeral spine. The cheeks and opercles are rugose, the latter with a ridge which ends in a blunt prominence at the angle. The opercle has a series of ridges which extend fan-like from its articulation to the margin, and the preorbital bears three sub-imbricate curved ridges. Anterior nostril tubular with a short tentacle, posterior nostril with a skinny rim. Lower jaw with a small spine directed forwards, situated on its lower edge, nearer the posterior angle than the summit of dilatation. The humeral spine is of moderate size, fully exposed and directed upwards and backwards. Pseudobranchiæ present.

*Teeth.*—The teeth in both jaws are each in two rows, the inner alternate with the outer. All the teeth are strongly curved and depressible, bands of scattered villiform teeth on the vomer, those of the pharangeals in a close cluster.

<sup>19</sup> Günther—Ann. Mag. Nat. Hist., (4), xvii., 1876, p. 394.

<sup>20</sup> De Vis—Proc. Linn. Soc. N.S. Wales, x., 1885, p. 545.

<sup>21</sup> De Vis—*Loc. cit.*, p. 546.



*Scales.*—Body covered with minute scales which lie in depressions resembling the pits of a thimble, breast and belly naked. The lateral line arises above the humeral spine and runs an undulated course to the middle of the caudal fin.

*Fins.*—No spinous dorsal fin: the base of the soft dorsal is three-fourths the length of the head, the extreme tips of the rays free. The anal is much longer, slightly more than the length of the head, the rays are shorter than those of the dorsal and the fin extends, anteriorly and posteriorly, beyond the limits of the dorsal. Pectoral rounded, its length 4.0 in the total. Ventral shorter, 5.2 in the same. The anterior rays of the dorsal and all but the last anal are undivided. Caudal sub-truncate, its length 4.3 in the body.

*Colours.*—Chin and upper parts of head and body brown, the latter with indistinct brown spots, under parts colourless with sand-coloured areas, below the head, at the base of the ventral fins and on the belly. Dorsal fin dusky, anal, pectoral and caudal brown, all with white margins. The anal has a median longitudinal brown band and the ventrals are without colour or markings.

Three examples are known, the largest of which measures 152 mm. in length; they were taken off Narrabeen, New South Wales.

The genus *Gnathagnus* was instituted by Gill<sup>22</sup> in 1861 with

NOTE, page 239.—Writing on April 27th, 1904, Dr. Jordan informs me that Australia was included in the habitat of *Gnathagnus*, on unpublished information only.

E.R.W. 27/5/04.

are much closer together than in the Australian species, in which the space is contained  $2\frac{1}{2}$  times in length of the head.

<sup>22</sup> Gill—Proc. Acad. Nat. Sci. Philad., 1861, p. 115.

<sup>23</sup> Temminck and Schlegel—Fauna Japon., Pisces, 1846, p. 27, pl. ix., fig. 2.

<sup>24</sup> Jordan and Snyder—Proc. U.S. Nat. Mus., xxiv., 1902, p. 478.

GNATHYPOPS JACKSONIENSIS, *Macleay*.

*Opisthognathus jacksoniensis*, Macleay, Proc. Linn. Soc. N. S. Wales, v., 1881, p. 570.

(Plate xxvi., fig. 2.)

D. x. 17; A. i. 16; V. i. 5; P. 20; C. 13; Sc. lat. 50; Sc. tr. 19.

Length of head 3·5; height of body and length of caudal equal, 4·9 in the total. Diameter of eye 3·0, and snout 7·0 in the length of the head.

Head large, wider than the body, its profile rounded in front, the eyes are large, close together, the interorbital space being about one-fifth their diameter, they are directed forwards and upwards. The snout is short, the nostrils being situated rather close together, the posterior one immediately in front of the eye, the anterior one is bordered behind with a short skinny flap. The mouth is large and the maxilla extends far beyond the eye, its length 1·6 in the head, it is greatly dilated behind, its depth approaching one-third its length; a small supplemental bone on its upper edge: the premaxilla is much shorter and does not extend to below the hinder margin of the eye. Body strongly compressed.

*Teeth*.—Conical, sub-equal in size, none fang-like, they are in a narrow band anteriorly, uniserial behind. Two (or three) teeth at the head of the vomer, palatines and tongue edentulous.

*Scales*.—Head naked, the scales on the body are small and cycloid and are developed only on the posterior half; they extend forward, in the mid-line, as far as the vent, but above and below only to about the middle of the anal fin. The lateral line commences on the head, vertically above the end of the maxilla and traverses the body, near to its dorsal margin, to below the fifth or sixth last dorsal ray. With the exception of a slight wave near its termination it is quite straight.

*Fins*.—Dorsal fins continuous, the spinous portion lower than the rayed one; the latter increases in height to the fifth last, which is 1·8 in the length of the head. The anal commences below the second dorsal ray, its longest ray corresponds to that of the dorsal and is of the same height. When depressed both extend to nearly the same point, beyond the base of the caudal. The pectoral and ventral are equal, their length being half that of the head, the former is rounded, the two first rays of the latter are undivided.

*Colours.*—General colour lemon yellow, the ground tint of the head largely hidden by chocolate coloured markings, the yellow appearing as rivulate or aborescent figures. Lower posterior border of maxilla deep brown, its extremity white, branchiostegals dark brown. Naked portions of body marbled with warm brown colour, usually a bold and striking figure on the middle of the side. The scaly portion bears an irregular longitudinal median line with one to three large blotches below it, all markings brown. The dorsal fin is dark brown, posteriorly, in its upper portion, it bears about two rows of light dots and irregular light markings in its basal part which correspond more or less with those on the adjoining portions of the body; basal portion of anal fin clear, the remaining part dark brown with a median row of large clear spots; pectoral yellow, a brown band at its base and some dots along its rays; distal half of ventrals black; caudal with about three vertical brown bars, or some irregular dark marks.

Attention may be drawn to the fact that some of the proportionate measurements in the description do not agree with those of the figure; the eye may be cited as an extreme instance; the head is so rounded and the eye placed so far forward, that it must necessarily be illustrated in perspective, and therefore appears to be smaller, longitudinally, than the proportionate measurement given in the description.

Though by no means common, several examples of the species are preserved in the Museum collection, the maximum length is about 250 mm.

In connection with the suggestion that *Gnathypops* is a designation of the females, and that *Opistognathus*<sup>25</sup> is the male, I may mention that representatives of the latter genus are, so far, unknown here.

SCHIZOCHIRUS, *gen. nov.*

*Family* TRICHONOTIDÆ.

Head and body compressed, cleft of mouth sub-horizontal, upper jaw the longer. Eyes small, close together, directed obliquely upwards. Scales large, cycloid on head and body, lateral line continuous, one dorsal fin shorter than the anal, the latter with modified rays. Ventrals jugular with one spine and five rays which are also modified. Pectoral formed of two parts, a short upper one of divided rays, and a longer lower one of modified thickened rays, the two portions sharply contrasted. Gill openings very wide not attached to the isthmus. Branchiostegals seven. Villiform teeth in the jaws, on the vomer and palatines.

<sup>25</sup> So spelled by Cuvier—Règne. Anim. (ed. 2), ii., 1829, p. 240.

This genus is nearest allied to *Lamnichthy*, srecently described from Lord Howe Island, but differs principally by the compressed head in which the cheeks and opercles are scaly, by the peculiar structure of the pectoral, the modified anal, pectoral and ventral rays, and by the presence of teeth on the vomer.

SCHIZOCHIRUS INSOLENS, *sp. nov.*

(Plate xxvi., fig. 3, and figs. 33-34.)

B. vii. ; D. 19 ; A. 29 ; V. i. 5 ; P. 8 + 9 ; C. 12 + 5 ; L. lat. 37 ; L. tr. 3 + 3.

Length of head 4.3, height of body at the first dorsal ray 6.3, caudal 6.0 in the length. Eyes very close together, less than half a diameter apart, prominent and directed upwards 7.8 in the length of the head. Snout one-half longer than the eye. One nostril on each side only discernable, surrounded by a fleshy rim and situated midway between the end of the snout and the eye. The jaws equal and protractile, the maxilla is dilated and notched behind and extends to below the hinder edge of the eye. The head is compressed, the body is moderately elongate and compressed throughout, it is highest at the insertion of the dorsal fin.

*Teeth.*—The teeth extend along the entire edge of the jaws and are in a single row, with four enlarged teeth within the front margin of the upper jaw. There is a patch of teeth on the vomer and the palatines also are toothed.

*Scales.*—Upper part of head and snout naked, large scales on the cheeks smaller ones on the opercles. Body with large adherent cycloid scales, portion at base of pectorals and ventrals naked. The lateral line arises one scale in advance of the upper base of the pectoral and passes gradually towards the lower edge of the caudal fin. The anterior thirteen or fourteen scales are of usual conformation and each bears a simple pore in its proximal half. The following scales are trilobed, the condition being accentuated posteriorly, where the central lobe increases in length until it projects considerably beyond the limit of the scale proper. The marginal diagram (fig. 33.) illustrates the thirty-second scale, magnified eight times.

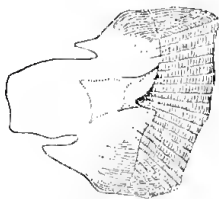

Fig. 33.

*Fins.*—The dorsal fin arises a little nearer the base of the caudal than the end of the snout and terminates the depth of the

peduncle in advance of the caudal; the third ray is longest and 2·3 in the length of the head, thence the rays decrease in length, the margin of the fin being sinuous. The anal fin arises seven rays in advance of the dorsal and is continued almost to the base of the caudal. Its rays are peculiarly modified and consist of an anterior shaft with branches on its posterior edge, the whole ray is enclosed in membrane and being broadened at its extremity is sub-spatulate in shape. The accompanying illustration (fig. 34.) shows the condition of the rays and is eight times natural size. The vent lies immediately in front of the first ray, it is normally concealed by the free edge of a longitudinal ridge or papilla which lies in the midline of the body between the ventrals and the anal, it has a length of three scales. The ventral fins are placed close together in advance of the pectorals and are very short, being 3·5 in the head. The rays are modified similar to but in a lesser degree than those of the anal. The pectoral, which forms a very striking feature of the fish, is composed of two distinct portions; the upper part, comprising eight rays is constituted in the usual way, and is much shorter than the upper rays of the lower part; the latter consists of nine rays all of which are similar in character to those of the anal, above described. The upper spatulate ray, which is the longest, extends to beyond the second anal ray.

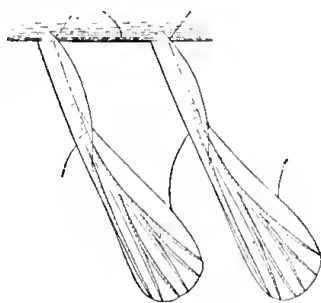

Fig. 34.

The caudal is sub-truncate, the height of its peduncle being less than half that of the body.

*Colours.*—Sandy coloured throughout, no trace of markings anywhere after preservation in formalin.

Two specimens 62 mm. and 53 mm. in length respectively.

These examples were picked up together, by my colleague, Mr. Thomas Whitelegge, who obtained them on the wave-line during stormy weather at Maroubra Bay. The gullet and stomach were crowded with small crustaceans which Mr. Whitelegge identifies as Amphipods, Copepods, and Isopods.

#### LIMNICHTHYS FASCIATUS, *Waite*.

*Limnichthys fasciatus*, Waite, Rec. Aust. Mus., v., 1904, p. 178, pl. xxiii., fig. 4.

Though first described from examples taken at Lord Howe Island, this species proves to be a continental form also. During April, 1904, Mr. A. R. McCulloch obtained specimens from a

rock pool at Long Bay, near Sydney. Some of them are in breeding condition though the ova are not yet ripe, and not of the bright yellow colour found in the island examples wherein the roe were fully mature.

The colour is greenish-white with the upper parts pink ; in some cases only are the markings black, in others they are brown. The dark longitudinal line also is not ventral in position, but follows the course of the lateral line, otherwise the markings are as in the typical examples.

NOTE ON CICINDELA JUNGI AND DESCRIPTIONS OF  
TWO NEW BEETLES.

By W. J. RAINBOW, F.L.S., F.E.S., Entomologist.

(Figures 35-37.)

Family CICINDELIDÆ.

CICINDELA JUNGI, *Blackburn.*

The present paper contains descriptions of two apparently undescribed beetles collected by myself at Botany, some time ago.

In addition to these, which are figured herewith, I include a figure of *Cicindela jungi*, Blackburn, a form not common in collections. This species was described by Blackburn from material collected by Mr. Jung, on Yorke Peninsula, South Australia. The specimen (fig. 35) in our cabinets was also collected in South Australia, but the exact locality is not given. In reference to this species Blackburn says:—"The female examples before me have the apex of the suture distinctly spiniform, but in the unique male there is no trace of a spine; perhaps this is an abnormal specimen."<sup>1</sup> The example in our collection, which is also a female, bears out Blackburn's description in this respect, but differs in the huge conspicuous blotch decorating the elytra, which

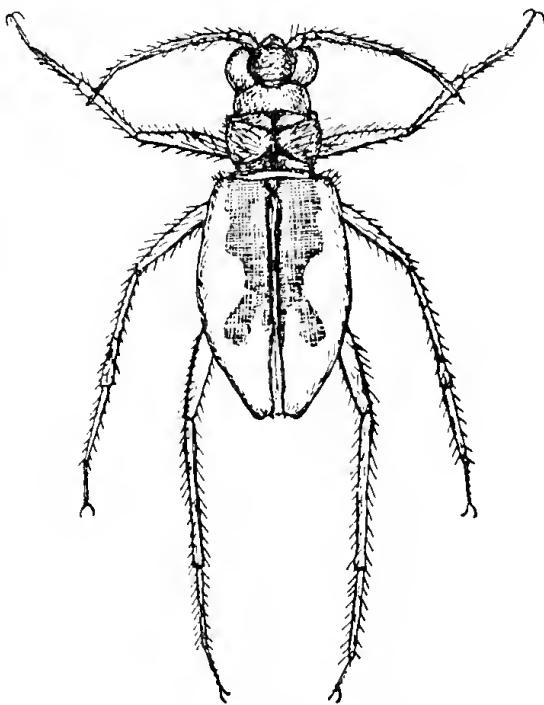

Fig. 35, *Cicindella jungi*, Blackburn.

in our specimen is of a brilliant coppery-tint, and not green as in those from Yorke Peninsula; the lateral elytral margins in the former are also coppery, a point not mentioned by Blackburn in respect of his species. Probably his specimens were not so marked.

<sup>1</sup> Blackburn—Trans. Roy. Soc. S.A., xxv., 1901, p. 15.

## Family BUPRESTIDÆ.

Genus *Stigmodera*, *Eschs.*STIGMODERA CYDISTA,<sup>2</sup> *sp. nov.*

(Fig. 36.)

*Caput.*—Metallic green, punctate, gently sloping from eyes inwards to the centre, where it is longitudinally furrowed.

*Prothorax.*—When viewed from above, green, from the sides, coppery; wider than body, punctate, distinctly impressed laterally near posterior angle, anterior margin sinuous, posterior margin strongly sinuous, impressed at centre; sides rounded.

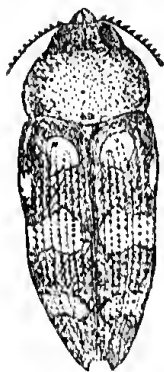

*Scutellum.*—Green, punctate.

*Elytra.*—Bright green with yellow markings, striate-punctate, the punctures deep and close, sides sinuous in outline, deeply impressed at shoulders, outer and inner angle of each elytron terminating with a blunt tooth.

Fig. 36, *Stigmodera cydista*,  
Rainbow.

*Underside.*—Bright green, closely and deeply punctured.

*Legs.*—Green, finely punctured.

*Measurements.*—Prothorax 1.7 mm. long, 2.4 mm. wide; elytra 6.7 mm. long, 3.2 mm. wide.

*Hab.*—Botany, near Sydney.

## Family ELATERIDÆ.

Genus *Horistonotus*, *Cand.*HORISTONOTUS BICOLOR,<sup>3</sup> *sp. nov.*

(Fig. 37.)

*Caput.*—Black, finely punctated, sparingly clothed with cinerous pile; antennæ yellowish.

*Prothorax.*—Black, shining, longer than broad, finely punctated, sparingly clothed with cinerous pile, strongly arched, narrowest

<sup>2</sup> Greek—κῦδιστος—Most glorious.

<sup>3</sup> In reference to its colour.



in front, sides bulging out towards the middle, from whence they dip inwards, but curve outwards again to lateral extremities of posterior angle, which are thereby obtusely pointed; a shallow median groove extends from anterior to posterior angle; anterior angle straight, posterior angle sinuous, lateral angles slightly reflexed.

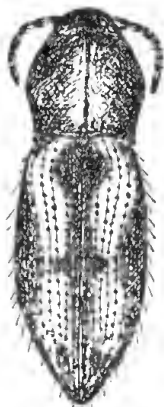

Fig. 37, *Horistonotus bicolor*,  
Rainbow.

*Scutellum*.—Black, shining, finely punctated.

*Elytra*.—Long, convex, shining black and yellow, conspicuously marked both laterally, apically, and down the median area, strongly punctate-striate, punctures deep and black, sides nearly parallel, apex obtusely pointed, the surface sparingly clothed with cinerous pile.

*Underside*.—Pitchy, punctated.

*Legs*.—Yellowish.

*Measurements*.—Prothorax 0.8 long, 1 mm. wide; elytra .24 mm. long, 1.1 mm. wide.

*Hab.*—Botany, near Sydney.

## NOTES ON AUSTRALIAN CRETACEOUS FOSSILS.

By R. ETHERIDGE, Junr., Curator.

(Plates xxvii. and xxviii.)

### OPALIZED TRIGONIA.

In 1901 Mr. G. Gürich figured<sup>1</sup> a portion of an opalized *Trigonia* left valve from the Upper Cretaceous of White Cliffs, near Wilcannia, and suggested its reference to *T. moorei*, Lycett,<sup>2</sup> a species found in the Oolitic rocks of the Greenough District in Western Australia.

The Trustees have lately received the gift of an opalized *Trigonia* from Messrs. M. Keough and A. Eberli. It is also a fragmentary left valve (Pl. xxvii., figs. 1-2), and differs from Mr. Gürich's to some extent. The crucial points displayed in the latter are externally fourteen or more wide flat concentric liræ, separated by very much narrower grooves. On the small portion of the posterior slope preserved are traces of radiating denticulated costæ. Internally we notice the socket of the anterior cardinal tooth, bearing eleven denticles on its anterior side, and eight or nine on the posterior; also the socket of the posterior cardinal tooth distinctly denticulated on its anterior side. The dental support or pillar of the anterior socket is widely lanceolate and flattened, with between it and the anterior margin a deep muscle scar.

The specimen presented by Messrs. Keough and Eberli, although much worn exteriorly, is more perfect than Mr. Gürich's, in that more of the posterior end and slope are preserved but only faint, although definite traces, of similar wide, smooth liræ and narrow grooves are extant; there are no costæ on the posterior slope, and this character alone renders identification with Mr. Gürich's shell doubtful.

The following are the general characters of our opalized *Trigonia*:—The valve is small, more or less deltoid-scapoid, produced posteriorly, convex, and unprovided with a cincture. The cardinal margin is arched, but the respective limbs are very disproportionate in length, the angle formed by their union being an obtuse one. The posterior slope immediately behind the

---

<sup>1</sup> Gürich—Neues Jahrb. Min., Beil.-Bd. xiv., 1901, p. 485, pl. xix., f. 1 *a* and *b*.

<sup>2</sup> Lycett—Mon. Brit. Foss. Trigoniæ, No. 4, 1878, p. 151, fig.

rounded diagonal ridge is concave, but is thickened immediately below the cardinal margin; neither radiating costæ nor concentric liræ are present. The umbonal region is depressed and obtuse, and the umbo is small and inconspicuous. The anterior cardinal socket is deep and unusually strong for the size of the valve, and although denticles are visible, it is not possible to count them; the posterior socket seems to have been long and narrow, and here again traces of denticles are preserved.

This fragmentary valve appears to represent a more transversely elongated shell than that delineated in Mr. Gürich's figure, and to possess a much more obtusely-angled hinge. If the non-costate condition of the posterior slope be a true feature, as I believe it to be, the two shells cannot be identical; at the same time the dental characters, so far as they can be deciphered, are very similar in both. I cannot venture to identify either shell with any of our known *Trigonia*. The least known is *T. lineata*, Moore,<sup>3</sup> but judging from Moore's figure, the limbs of the hinge form a far more acute angle than in either of the opalized specimens. The concentric liræ are described by Moore as fine, and terminating anteriorly in depressed tubercles; in neither of the opalized shells is there any trace of this whatever. If our shell and Mr. Gürich's prove to be distinct it is interesting to find two forms of *Trigonia* in the White Cliffs beds.

TRIGONIA, *sp. ind.* (*Gürich*).

*Trigonia sp. cf. Moorei* (Lycett), Gürich, Neues Jahrb. Min., Beil.-Bd. xiv., p. 485, pl. xix., f. 1 *a* and *b*.

*Obs.*—I have already expressed the opinion that this is not *T. moorei*, Lycett,<sup>4</sup> and remarked that it might be either *T. lineata*, Moore, or a new form; now I do not think it is the last-named shell.

Although the posterior slope in Mr. Gürich's specimen exhibits granulated costæ near the umbo, as in *T. moorei*, there is not, unfortunately, sufficient of the slope remaining to determine whether the granules become subordinate to the sharp concentric liræ towards the posterior ventral part of the valve as they do in *T. moorei*. On the other hand there is this manifest difference, that whilst the surface of the valve anterior to the diagonal ridge in the White Cliffs form is covered with flat liræ separated by very narrow interspaces, the corresponding portion of the shell in *T. moorei* is traversed by

<sup>3</sup> Moore—Quart. Journ. Geol. Soc., xxvi., 1870, p. 254, pl. xiv., f. 9 and 10.

<sup>4</sup> Moore—Quart. Journ. Geol. Soc., xxvi., 1870, p. 255, pl. xiii., f. 12.

sharp upstanding liræ separated by wide, flat, or slightly concave valleys. Internally the structure of the articulus differs in the two shells in a very marked manner. Selecting a left valve of *T. moorei*, (Pl. xxvii., fig. 4), first compare the height of the respective umbos, low in the Cretaceous form, high in the Oolitic. The thickened arched hinge plate of the latter between the sockets, is far more highly developed than that seen in Mr. Gürich's figure; the upstanding anterior crest of the anterior dental socket of *T. moorei* is most marked when compared with the rounded outline of the former; these points are sufficient in my opinion to clearly separate the two fossils. That the depressed umbo in Gürich's figure is a true feature, and not one due to any physical cause is borne out by the appearance of the same part in the opalized specimen in this Museum (Pl. xxvii., fig. 1).

#### CRETACEOUS PATELLIFORM SHELLS.

Only one shell possessing a patelliform outline has so far been described as such from our Cretaceous beds—*Siphonaria samwelli*, Eth. fil.,<sup>5</sup> of the Upper Cretaceous of Croydon, North Queensland. Whether or no this is correctly referred to the Siphonariidæ, or is a true Scutibranc, time alone can show. One other may exist, the so-called *Discina apicalis*, Moore,<sup>6</sup> from Wollumbilla. I have for some time entertained the suspicion that this fossil would be more appropriately placed in the Patellidæ, possibly under *Aemæa*, Esch. (= *Tectura*, Aud.). Species referred to the latter genus have at least been met with in the Cretaceous rocks of North America, India, and England. Compare Moore's figure with *A. (Tectura?) elevata*, Forbes,<sup>7</sup> of the Arrialoor Group of India; or *A. (Tectura) tenuistriata*, Seeley,<sup>8</sup> from the English Gault. Again, *D. apicalis* is equally like some forms of the supposed Pulmonate *Anisomyon*, Meek and Hayden, but unfortunately we know nothing of the apex in Moore's shell.

Quite recently Mr. H. Y. L. Brown, Government Geologist of South Australia, forwarded to me a few Cretaceous marine shells from a new locality in that State. Amongst these are two very small patelliform shells that are certainly undescribed with us. The smaller of the two appears to be an internal cast, and the larger a more or less exfoliated individual. Both Mr. C Hedley and myself think we can detect a faint horse-shoe-shaped scar on

<sup>5</sup> Etheridge, Junr.—Geol. Pal. Q'land, etc., 1892, p. 573, pl. xlii., f. 9.

<sup>6</sup> Moore—Quart. Journ. Geol. Soc., xxvi., 1870, p. 244, pl. x., f. 13.

<sup>7</sup> Stoliczka—Gastropoda Cret. Rocks S. India (Pal. Ind.), pts. 7-10, 1868, p. 322, pl. xxviii., f. 6.

<sup>8</sup> Seeley—Quart. Journ. Geol. Soc., xxxiii., 1877, p. 194, pl. vii., f. 18.

the surface of the former; if such be the case, it necessarily indicates the genus *Capulus* as the most appropriate resting place, but as there is an element of doubt on this point I think it better to provisionally place these little fossils in *Acmea*, with the following characters.

ACMÆA (?) MONSWOODENSIS,<sup>9</sup> *sp. nov.*

(Pl. xxvii., figs. 5-7.)

*Sp. Char.*—Small, depressed, unsymmetrical in outline, irregularly orbicular; apex subcentral, simple, obtuse, not recurved. Sculpture ill-defined, but concentric, apparently without radii of any kind.

*Obs.*—The larger of the two specimens appears to be exfoliated, little therefore can be said about the sculpture, beyond the fact that there are no radii. The marginal outline is unsymmetrically orbicular, but neither definitely sinuous nor crumpled as in some *Platyneri*; it presents the same form of irregularity as seen in *Capulus neocomiensis*, Seeley, *sp.*<sup>10</sup>

The larger specimen is seven millimetres in its longest diameter, and the smaller five millimetres.

The chief point of interest lies in the fact that it indicates the existence in our Cretaceous Series of an additional genus, and possibly family.

*Loc.*—Country around Mount Woods, north-west of Coward Springs, Lake Eyre Basin, South Australia, associated with *Pseudavicula anomala*, Moore, *sp.*

ISOCRINUS AUSTRALIS, *Moore, sp., var.*

ALBASCOPULARIS, *var nov.*

(Pl. xxviii.)

*Isocrinus australis*, Eth. fil., Mem. Geol. Surv. N.S. Wales, Pal., No. 11, 1902, p. 10, pl. iv., f. 7-10 (exclude synonymy).

*Obs.*—Two examples of an opalized Crinoid were presented to the Trustees by Messrs. Keough and Eberli after the publication of the above work. Neither of them is perfect, although both surpass the fragmentary specimens in the Geological Survey Collection. It is very difficult to distinguish the various plates

<sup>9</sup> In allusion to the locality.

<sup>10</sup> Seeley—Quart. Journ. Geol. Soc., xxxiii., 1877, p. 203, pl. vii., f. 1.

and pieces from the almost identical colour of the fossils and the matrix, and from the obstinate manner in which the kaolinised clay adheres to the various parts, notwithstanding the apparent success in mechanical development. The adhesion of matrix particles renders the sutures of the different plates and pieces obscure in places, and I found that any further attempt at cleaning would cause the collapse of such otherwise beautiful examples of the conversion of a Crinoid into precious opal.

The acquisition of these specimens, taken in conjunction with the partial cups and arms already figured indicates that the White Cliffs Crinoid is uniformly smaller than the Queensland *Isocrinus*. After careful examination I have failed to detect any difference in the structure of the dorsal cup proper from that of the species in chief; the number of rays is the same—five, and the arrangement and form of the various pieces appears to be identical. The only departure from the structure of the typical Crinoid I am able to detect is in the number of the component ossicles of the arms. Thus, in *I. australis* there are thirteen primibrachs (I Br),<sup>11</sup> the thirteenth being primaxil (I ax); in the present form, on the other hand, there are ten, the tenth being primaxil. In the former there are fifteen secundibrachs (II Br), the fifteenth being secundaxil (II ax), here the number is thirteen, the thirteenth being secundaxil. It was not possible to count the tertioibrachs in the Sweet specimen, although sufficient were seen to indicate that these ossicles were numerous; in the opalized Crinoid these pieces are very numerous, certainly more than thirty, without any indication of an axil.

In consideration of our still imperfect knowledge of this Crinoid, and with the view of emphasising the difference in the number of arm plates between the Queensland *Isocrinus* and that from White Cliffs, I purpose distinguishing the latter by the varietal name of *albascopularis*.

---

<sup>11</sup> I wish to correct a typographical error in my previous notice of this opalized Crinoid. In the Monograph referred to (p. 10) the primibrachs are expressed by the symbol  $\bar{i}$  Br, and the primaxils by  $\bar{i}$  ax; the symbols should simply be I Br and I ax respectively.

THE LARVÆ OF *DORATIFERA CASTA*, SCOTT.

By W. J. RAINBOW, F.L.S., F.E.S., Entomologist.

(Plate xxix.)

During a visit to Bathurst in February last, Mr. J. A. Thorpe collected, together with other material, a large quantity of the larvæ of a "Cup" Moth—*Doratifera casta*, Scott. These creatures were in thousands upon the leaves of various Eucalypts, some being minute, some half-grown, and some mature or nearly so.

This species was described and figured by Scott.<sup>1</sup> In the work referred to the author says:—"The larvæ are of frequent occurrence in March, and widely distributed, as we ourselves have procured them at the Turon, and in our own immediate vicinity on the Lower Hunter, the distance between the two places being fully 130 miles. They feed upon the leaves of various Eucalypts, principally confining themselves to the upper surfaces, which they speedily consume, leaving untouched the inferior epidermis and nervures, so that from their congregated numbers, the boughs of the trees which they infest appear as if scorched by a hot wind, the leaves becoming shrivelled or rolled up."

Mr. Thorpe informs me that in the district around Bathurst, the bush was being devastated by these larvæ, and that the further one drove out from the settlements, the worse they were, both saplings and trees being covered by them. The foliage of the trees affected appeared quite bleached.

In the accompanying illustration (Pl. xxix.), photographed from material collected by Mr. Thorpe, the half-grown larvæ will be seen congregated upon leaves and feeding upon the epidermis as described by Scott. Many of the leaves collected at Bathurst had had the epidermis eaten off on both sides, and some of them had been almost completely demolished. In captivity the younger larvæ appeared to content themselves with the epidermis merely, whilst those fully grown ate right through the leaves.

The fully grown larva is about 23 mm. long, thick, anterior and posterior extremities obtuse, velvety-black, and provided with four longitudinal rows of thick, yellow, spine-like protuber-

---

<sup>1</sup> Scott—Australian Lepidoptera, i., 1864, p. 18, pl. vi.

ances, all of which are furnished with short, stiff bristles and rather long hairs; of these protuberances, those constituting the two lateral rows, and the anterior and posterior pairs of the dorsal series, are much the largest; upon the thoracic segments there are, as is usual with *Doratifera* larvæ, four tubercular projections each of which is armed with urticating spines, and these can be thrust out for defensive purposes when the creature is irritated or annoyed; between the rows of spines there are numerous pale coloured spots; the larvæ are somewhat flattish or depressed along the dorsal line.

The cocoon is shining brown, about 11 mm. long, ovate, brittle, and attached to the food plant by threads.



AN ENDOPHYTE (*STICHIUS MERMISOIDES*) OCCUR-  
RING IN THE TEST OF A CRETACEOUS BIVALVE.

By R. ETHERIDGE, Junr., Curator.

(Plates xxx. and xxxi.)

In a very unlooked for host, another Endophyte has appeared, and quite a different type to any of the previously described Australian forms. Microscopic sections of the shell of *Fissilunula clarkei*, Moore, sp.,<sup>1</sup> were prepared for the purpose of examining its structure, when it became at once apparent, even with a good pocket lens, that the test was permeated by some foreign body.

A section taken parallel to the growth layers of the shell, under a one inch objective, revealed the presence of innumerable black specks and small masses of irregular outline, and variable diameter. A few of these little objects are cut obliquely, when hair-like black lines are observed to pass from them into the deeper recesses of the shell test. The diameter of these specks varies between .002 and .004 mm.

It is, however, in a section taken transversely to the growth, and under a two inch objective that the explanation of these remarkable small objects becomes apparent, as long, inequidistant, and generally parallel chains of black spheres or monillæ penetrating the shell substance at right angles to its plane of growth; the straight and direct course, curving neither to the right nor left is very marked. The continuity of the monillæ is at times broken for short distances, but at these points the line is maintained as a faint transparent tube or sheath, to be again shortly occupied in a similar manner. If these breaks, in the continuity of the chain, are carried to any extent, as they are in some instances, the latter appears broken up into a series of disconnected black spheres, but still following one another at intervals in the same straight linear series. In other portions of the section the tubes or sheaths may be seen empty, without any infilling of monillæ or pigment matter, pursuing the same straight and parallel course as the chains do.

The monillæ in a given chain are of variable size, from .002 to .006 mm. diameter, but this irregularity is here and there

---

<sup>1</sup> Etheridge, Junr.—Mem. Geol. Surv. N.S. Wales, Pal. No. 11, 1902, pp. 31 and 36.

interrupted either by the interpolation of much larger spheres, small patches of black amorphous pigment matter, or small clusters of the ordinary monillæ. When out of focus in the further thickness of the shell the chains of monillæ look like so many parallel hairs, but taking a section of this nature as a whole, when viewed through a low power, I cannot do better than compare the parallel lines to a series of black stalactites dropping from the roof of a cave.

As before said the moniliform chains are straight and parallel, without inosculation or bifurcation, not returning on themselves, nor is there any dipping-out-of and coming-into the focus of the microscope of a given chain. At times the parallel lines are widely separated, at others close together, but there is no intermingling. The monillæ are wholly of one colour—black, and there are no refractive centres. The larger round spheres, already mentioned, similar to the heterocysts in *Palæopede whiteleggei*,<sup>2</sup> are usually single, or seldom more than two together, are perfectly opaque, and have a diameter of from  $\cdot 01$  to  $\cdot 015$  mm. They may or may not occur at the commencement and termination of a chain, as well as appearing in its course. No terminal locus has been observed on any chain, nor any trace of pulverulent matter issuing from the monillæ, but here and there a few of the latter are distributed free in the shell substance.

The small amorphous masses of black pigment matter seen in the courses of some of the chains are probably agglomerated monillæ, in a few instances they are certainly so, as traces of the moniliform outline of the component spheres can be distinguished. At the same time there is another feature present not hitherto observed, so far as I remember, in any of the previously described Australian penetrating organisms. It is visible more particularly in the transverse section, and is a stellate condition of the pigment masses, or, the latter with a few protruding acicular points; these have a diameter of from  $\cdot 01$  to  $\cdot 02$  mm. inclusive of the rays. In some of these irregular stars there is a marked resemblance to the skeletal-spicules of some Heteractinellid Sponges. The monillæ are sometimes so closely packed in serial order along a chain that their individual outline is in a measure lost, and the chain assumes a rope-like appearance.

Of the described Endophytes this form seems to approach nearest to *Palæopede whiteleggei*, but is distinguished by sufficiently obvious characters. The tubes or sheaths, when empty, bear some resemblance to those (mycelium) of *Peronosporites minutus*, Loomis.<sup>3</sup>

<sup>2</sup> Etheridge, Junr.—Rec. Aust Mus., iii., 5, 1899, p. 121, pl. xxiii.

<sup>3</sup> Loomis—Bull. N. Y. State Mus., viii., 39, 1900, p. 225, pl. xvi., f. 5 and 6.

Referring to his three species of *Peronosporites*, Mr. F. B. Loomis says:—"Such fungi as those above described are common through Mesozoic and Cenozoic time, but have been found at least once in Siluric beds." In Australia we now know these Endophytic Fungi from Devonian (or possibly Silurian), Permo-Carboniferous, and Cretaceous rocks.

The penetrating body now described I purpose calling *Stichus mermisoides*.<sup>4</sup>

I am indebted for the excellent microphotographs represented in Pls. xxx.-xxxi., to my colleague Mr. T. Whitelegge, and for the two enlargements on Pl. xxxi. to Mr. Allan R. McCulloch.

---

<sup>4</sup>στίχος, a row; μέρμις, ἴθος, a rope, and οἶδες, signifying resemblance.

THE OCCURRENCE OF MONAZITE *in situ*  
AT BLATHERARM CREEK, NEAR DEEPWATER,  
NEW SOUTH WALES.

By C. ANDERSON, M.A., B.Sc., Mineralogist.

The first reference to the occurrence of Monazite in New South Wales was made by Mr. W. A. Dixon, F.I.C., who in 1881 analysed a specimen from Vegetable Creek, Co. Gough.<sup>1</sup> No description of its mode of occurrence is given, but we may presume that it was found in alluvial drift. In 1898 Mr. J. C. H. Mingaye, F.I.C., F.C.S., Analyst and Assayer to the Department of Mines of New South Wales, contributed a note on an occurrence of Monazite in a gem sand from the Tooloom Alluvial Gold-fields.<sup>2</sup> More recently the same author detected it in the beach sands at Ballina, Richmond River.<sup>3</sup>

Towards the end of 1903 Mr. D. A. Porter, of Tamworth, a zealous collector of minerals in the northern districts of New South Wales, brought to the Museum for identification, some small fragments of a mineral found embedded in a decomposed felspathic rock near Deepwater, which he believed to contain some of the rare earths. This was identified as Monazite, and Mr. Porter having kindly presented a larger quantity, also specimens of the matrix and country-rock, it is now possible to supply some account of the occurrence *in situ* and mineral associates of this comparatively rare mineral in New South Wales.

The locality is given as Blatherarm Creek, about twenty-one miles N.W. of Deepwater, and twenty-five miles, approximately N.E. by N., from Emmaville. Of the mode of occurrence Mr. Porter says:—"It occurs in a mineral vein of six to eight inches wide, which exists in a small gap in a granite (?) or felsite (?) formation . . . and strikes about N. 20° E." The matrix consists of felspar (apparently orthoclase), much decomposed and kaolinised; quartz, slightly dark in colour, rarely shewing hexagonal outlines, but chiefly irregular and blebby; also wolfram which occurs in irregular masses. These are accompanied by a mineral consisting of small crumbling scales, bronzy in colour,

---

<sup>1</sup> Dixon—Ann. Rept. Dept. Mines N.S. Wales for 1881 (1882), p. 26; Liversidge—Min. N.S. Wales, 1888, p. 114.

<sup>2</sup> Mingaye—Proc. Austr. Ass. Adv. Sci., vii., 1898, p. 333; Rec. Geol. Surv. N.S. Wales, vi., 1899, p. 118.

<sup>3</sup> Mingaye—Rec. Geol. Surv. N.S. Wales, vii., 1903, p. 222.

probably derived from the decomposition and oxidation of biotite. The monazite occurs in small crystals and irregular grains, embedded both in the quartz and in the felspar, hence we may conclude that it is at least not later in origin than these. The country-rock, from the specimens supplied by Mr. Porter, appears to be an ordinary biotite granite, rather coarsely crystalline in texture and much decomposed, the quartz bearing a general resemblance to that of the vein. I have not been able to detect monazite or wolfram in the country-rock itself.

With regard to the general mode of occurrence of monazite geologically, Mr. H. B. C. Nitze, says<sup>4</sup>:—"Monazite is an accessory constituent of the granitic eruptives and their derived gneisses." Prof. O. A. Derby makes the further statement<sup>5</sup>:—"There is thus a reasonable probability that zircon, and to a less degree monazite may prove to be guide minerals by which eruptives and their derivatives can be certainly identified no matter what degree of alteration they may have suffered." No doubt at Blatherarm Creek the mineral occurs in minute quantity in the granite of the district, and careful microscopic examination, or a "pan" test, may reveal its presence.<sup>6</sup> But from Mr. Porter's notes we learn that the larger masses of monazite are found in a "vein" enclosed in granite, which, as the result of erosion, now occupies a depression in the granite, and it is of importance to determine the relation of this vein to the enclosing rock. Either it is a segregation-vein, when it would probably be called pegmatite, or its contents have been leached out from the surrounding rock and redeposited in a fissure to form a mineral-vein in the ordinary sense of the term. I am of opinion that it is a pegmatitic vein, as quartz, felspar and mica (if the decomposed scales mentioned above represent mica), are normal constituents of pegmatite, and form an unusual association of veinstones. Careful examination of the ground is necessary to settle the question.

The mineral occurs in small crystals (too minute for accurate determination), in cleavage fragments, or in irregular grains. Its colour is reddish—or yellowish-brown, and the lustre is resinous. The specific gravity, determined by the pyknometer is 5.119 at 18° C. Under the microscope it is seen to be slightly pleochroic. By focussing a strong light from below on a cleavage fragment upon the stage of the microscope and replacing the eye-piece by a direct vision spectroscope, a broad absorption band appears in

---

<sup>4</sup> Nitze—16th Ann. Rep. U.S. Geol. Surv., iv., 1894-5, p. 682.

<sup>5</sup> Derby—Proc. Rochester Acad. Sci., i., 1891, p. 204.

<sup>6</sup> Derby—*loc. cit.*, pp. 198-206; Am. Jour. Sci., (3), xxxvii., 1889, p. 109; Min. Mag., xi., 1897, p. 304.

the yellow (didymium), and a faint dark line in the green (erbium ?)<sup>7</sup>

For analysis a collection of small crystalline fragments, which Mr. Porter obtained on his visit to the locality by panning the debris in a miner's dish, was utilised. The material was carefully selected under a lens and any shewing impurities rejected.

For the method of analysis the chief authorities followed are Baskerville,<sup>8</sup> Penfield<sup>9</sup> and Mingaye.<sup>10</sup>

For phosphoric acid the fine powder was fused with sodium and potassium carbonates, exhausted with water, filtered and washed. The filtrate was evaporated to dryness with nitric acid, and phosphoric acid precipitated with ammonium molybdate in the usual way. The mean of two closely agreeing results (28.17 and 28.24) gave 28.20 per cent. The residue was ignited in a platinum crucible, transferred to a porcelain basin, covered with concentrated sulphuric acid and heated for some time on a sand bath, the acid being renewed from time to time. The excess of acid was finally evaporated off, the residue dissolved in cold water and largely diluted. From the slightly acid solution, the rare earths were precipitated in the heat as oxalates by an excess of oxalic acid, warmed for some time, and allowed to stand. The precipitate was ignited and weighed, then redissolved with sulphuric acid as before, transferred to a small flask, excess of caustic potash added, and the whole submitted to a current of chlorine gas to saturation.<sup>11</sup> The flask was then corked and allowed to stand for twenty-four hours with frequent agitation. The undissolved oxides of cerium and thorium were filtered off, washed, dissolved in hydrochloric acid, and the treatment with potash and chlorine repeated. By this means the cerium and thorium (residue) were separated from the lanthanum and didymium (filtrate). The residue of cerium and thorium oxides was dissolved in hydrochloric acid, evaporated to expel excess of acid, and the earths precipitated as oxalates, ignited and weighed as sesquioxides, yielding 37.33 per cent. Thorium was determined by dissolving in sulphuric acid and adding sodium thiosulphate to the nearly neutral solution, warming for some time, igniting and weighing the precipitate as oxide ( $\text{ThO}_2$ ). The crude oxide was redissolved in sulphuric acid, the excess of acid removed, dissolved in water and ammonium acetate and ammonium oxalate

---

<sup>7</sup> Scharizer—Zeits. für Kryst., xii., 1887, p. 264, quoted by Nitze, *loc. cit.*, p. 679.

<sup>8</sup> Baskerville—Quoted by Nitze, *loc. cit.*, p. 677.

<sup>9</sup> Penfield—Am. Jour. Sci., (3), xxiv., 1882, p. 253.

<sup>10</sup> Mingaye—Rec. Geol. Survey N.S. Wales, vii., 1903, pp. 224-225.

<sup>11</sup> Damour and St. Claire Deville—Compt. Rend., 1864, 59, p. 272.

added. As thorium oxalate is soluble in this menstruum while cerium oxalate is precipitated, by this treatment the thoria was freed from traces of ceria. The slight precipitate was filtered off and to the filtrate hydrochloric acid was added, reprecipitating thorium oxalate, which was washed, ignited and weighed. The result was 1.63 per cent.; therefore the percentage of cerium oxide is by difference 35.70.

Similarly lanthanum and didymium were precipitated as oxalates by ammonium oxalate, ignited, redissolved in sulphuric acid, and again precipitated by oxalic acid. They yielded 30.73 per cent. The weighed oxides were redissolved by sulphuric acid, diluted, and excess of tartaric acid and ammonia added. After standing for two days, a very slight precipitate came down, which is entered in the analysis as a trace of yttrium and erbium oxides.

As the quantity taken for the general analysis was rather small (.6687 grams) it was deemed advisable to make separate determinations of thoria and yttria on larger quantities. Accordingly, for yttria, a fresh portion was taken, weighing 1.3802 grams, decomposed by sulphuric acid, converted into oxalates, ignited and redissolved as sulphates. To the clear solution tartaric acid and ammonia were added. After standing for three days the precipitate was filtered off and weighed, yielding .12 per cent. Similarly for thoria .9577 grams were taken, decomposed, precipitated by oxalic acid, ignited, dissolved in sulphuric acid and evaporated to a nearly neutral aqueous solution. Thoria was precipitated by sodium thiosulphate and purified from traces of the cerium group as above. The result was 2.10 per cent.

Iron and alumina were estimated in the filtrate from the first precipitation by oxalic acid. The solution was evaporated to dryness, the oxalic acid decomposed by sulphuric acid and the oxides precipitated by ammonia.

Silica was determined by decomposing the finely powdered mineral with sulphuric acid as above, evaporating to dryness, adding water, filtering off the insoluble residue, which was ignited and weighed, then evaporated with hydrofluoric and sulphuric acids. Silica was estimated as the loss. Two determinations gave percentages of .59 and .35, yielding a mean result of .47 per cent.

I ought to state that I am far from regarding the results of the analysis as complete or altogether trustworthy. For example I have not looked specially for zirconium, which may be present in small amount. Again, manganese, lime, magnesia, and perhaps other elements may constitute fractional percentages. On the other hand, anyone who has attempted the

analysis of a mineral containing the elements of the cerium and yttrium groups must feel that the methods of separation are not ideally perfect.

Composition of Monazite (per cent.).

	I	II	III	IV	V
P <sub>2</sub> O <sub>5</sub> ... ..	29.92	29.32	26.86	25.09	28.20
Ce <sub>2</sub> O <sub>3</sub> ... ..	28.82	37.26	24.80	36.64	35.70
La <sub>2</sub> O <sub>3</sub> ... ..	} 40.79	} 31.60	} 26.41	} 30.21	} 30.73
Di <sub>2</sub> O <sub>3</sub> ... ..					
Y <sub>2</sub> O <sub>3</sub> + Er <sub>2</sub> O <sub>3</sub> ...	—	—	4.76	—	tr.
ThO <sub>2</sub> ... ..	—	1.48	12.60	1.23	1.63
SiO <sub>2</sub> ... ..	—	0.32	0.91	3.21	0.49
Al <sub>2</sub> O <sub>3</sub> ... ..	—	—	—	3.11	} 2.23
Fe <sub>2</sub> O <sub>3</sub> ... ..	—	—	1.07	—	
MnO ... ..	—	—	—	tr.	—
CaO ... ..	—	—	1.54	—	—
MgO ... ..	—	—	0.04	tr.	—
H <sub>2</sub> O ... ..	—	0.17	0.78	—	0.34
	99.53	100.15	99.77	99.49	99.32

I. Arendal, Rammelsberg—Mineral Chemie, Zweites Auflage, Ergänzungsheft, 1886, p. 169.

II. Alexander Co., N. Carolina, Penfield and Sperry—Am. Jour. Sci., (3), xxxvi., 1888, p. 322.

III. Ottawa Co., Quebec, Genth—Am. Jour. Sci., (3), xxxviii., 1889, p. 203.

IV. Vegetable Creek, Co. Gough N.S. Wales, Dixon—Ann. Rep. Dept. Mines N.S. Wales for 1881 (1882), p. 26.

V. Blatherarm Creek, N.S. Wales.

There is a general correspondence between analyses Nos. IV and V and considering that the two localities in question are roughly in the same area this may be taken to mean that the occurrences are also essentially similar geologically.

The most noticeable feature about the composition of the New South Wales monazite hitherto analysed is the low percentage of thoria, which is the constituent commercially valuable for the manufacture of incandescent mantles, but as the amount of thoria fluctuates considerably even in specimens from the same locality, it is possible that marketable monazite may yet be discovered in New South Wales.

Thus it may be worth while to look for it in the sands and gravels in the beds of rivers which flow through granite country.



## DESCRIPTION OF A NEW SPECIES OF *PŒPHILA*.

By ALFRED J. NORTH, C.M.B.O.U., C.M.Z.S., Ornithologist.

### *PŒPHILA NEGLECTA*, *sp. nov.*

*Adult male.*—General colour above rich cinnamon-brown, slightly darker on the lower back; rump black; upper tail-coverts black, some of the longer feathers margined with white at the tips; upper wing-coverts brown, the lesser and median series washed with cinnamon-brown, the greater series indistinctly edged with cinnamon-brown; quills brown with a dusky wash which is more distinct towards the tips of the primaries, and on the innermost secondaries; tail black; head ashy-grey; lores black; cheeks and ear-coverts pearl grey, the plumes of the latter of a silky texture; throat velvety-black, remainder of the under surface rich cinnamon-brown; lower portion of the abdomen black; lower flank feathers black tipped with white; under tail-coverts dull white; bill black. Total length 3·8 inches, wing 2·4, tail 1·5, bill 0·4, tarsus 0·6.

*Hab.*—Queensland?

*Type.*—In the Australian Museum.

*Remarks.*—The distinctly darker under surface of *Pæphila neglecta*, is sufficient to distinguish it from any other cinnamon-coloured ally of the genus. Its nearest ally is *Pæphila atropygialis* (Diggles), Castlenau and Ramsay. From that species, however, it may be distinguished by its darker upper and under parts, and by having the longer black upper tail-coverts margined with white at the tips. Vernacularly it may be known as the Cinnamon-coloured Grass-Finch.

The above description is taken from a specimen received by the Trustees in June, 1877, from Mr. J. A. Thorpe. In the Old Register, the locality is recorded as Macquarie River, New South Wales. Unless an escaped cage-bird, which it does not appear to be, as it is in perfect plumage, the locality given is undoubtedly an error.

*Pæphila atropygialis*, was described as a new species by the late Comte de Castlenau and Dr. E. P. Ramsay in the Proceedings of the Linnean Society of New South Wales in 1877.<sup>1</sup> The type

---

<sup>1</sup> Castlenau & Ramsay—Proc. Linn. Soc. N.S.Wales, i., 4, 1877, p. 382.

measures: total length 4·2 inches, wing 2·35, tail 1·6, bill 0·4, tarsus 0·6. There are three specimens in the Reference Collection; all were obtained by Mr. T. A. Gulliver at the mouth of the Norman River, Gulf of Carpentaria. In a footnote to their description of *Pæphila atropygialis*, Comte de Castlenau and Dr. Ramsay make the following remarks:—"Diggles, *Queenslander* newspaper, 1876. We have adopted the name proposed by Mr. Diggles, of Queensland, for this new species, but more out of compliment to that gentleman than in accordance with the strict rules of nomenclature, as it will be evident to all ornithologists that the merely proposing a name and pointing out a difference in a newspaper can scarcely be looked upon as *describing the species*. We trust our friend will take this hint in the kindly spirit it is meant, and when he again favours us with the announcement of any new species, we hope they will be *fully described*."

Mr. E. Hartert in describing *Pæphila nigrotecta*<sup>2</sup> from Cape York compares it with *P. cineta*, which has white upper tail-coverts, instead of *P. atropygialis*. Judging by the description, it does not differ from the latter species.

---

<sup>2</sup> Hartert—Bull. Brit. Orn. Club, (*Ibis*, 1899, p. 647.)

## ON HETEROCHROSIS IN AUSTRALIAN *PSITTACI*.

By ALFRED J. NORTH, C.M.B.O.U., C.M.Z.S., Ornithologist.

Instances of xanthochroism, partial in most, total in some, are many in the specimens of Australian *Psittaci* in the Australian Museum. Among them may be mentioned a remarkably fine Black Cockatoo (*Calyptorhynchus funereus*), presented by Mr. G. M. Pitt, and obtained by him at Wiseman's Ferry, on the Hawkesbury River, New South Wales. This specimen differs from the typical form in having the upper and under surface, upper and under wing-coverts, scapulars, innermost secondaries and under tail coverts yellow, with which are intermingled a number of the usual brownish-black feathers, giving it a distinctly mottled appearance. A Pennant Parrakeet (*Platycercus elegans*), presented by Mr. W. E. Secombe, has the hind-neck, scapulars, back, breast and abdomen rich yellow; wings white with a faint bluish wash on the lesser and median wing-coverts, tail feathers white with a faint bluish wash, the central pair indistinctly margined with light scarlet. Another specimen of the same species obtained in Victoria has the upper and under parts entirely greenish-yellow except a frontal cap, and broad tips to the feathers on the foreneck, lower flanks and under tail-coverts which are scarlet; cheeks pale blue, quills white, upper wing-coverts like the back except the outer series of the lesser and median coverts which are pale blue, central pair of tail feathers faint greenish yellow washed with light scarlet on their margins, the remainder pale blue. Of Rose-hill Parrakeets (*Platycercus eximius*), there is a beautiful example presented by Mr. Henry Foster, and obtained by him at Young, New South Wales. It has the hind neck, rump, upper tail-coverts, sides of the breast, abdomen and flanks rich canary-yellow, scapulars and back white with canary-yellow margins to all the feathers, wings white with a faint bluish wash, tail feathers white the central pair tinged with yellow. A tendency to xanthochroism is exhibited in a female King Lory (*Aprosmictus cyanopygius*), procured in the Clarence River District, New South Wales. It is entirely yellowish-green with the exception of the lower breast, abdomen

and broad margins to the tips of the under tail-coverts, these parts being scarlet. Instances of almost total, and of partial xanthochroism are shown in three examples of the Red-rumped Parrakeet (*Psephotus haematonotus*), procured respectively by Mr. S. Hosie at Dubbo, by the late Mr. J. H. McCooey at Warren, and by Mr. J. A. Daley at Wagga, the former specimen exhibiting traces of the normal colouring in some of the quills and tail feathers, and having all the under surface white with a faint yellowish wash. Most of the specimens referred to above were obtained on dry plains.

When these birds were alive, their abnormal plumage rendered them conspicuous objects in the bush. Consequently they were much sought after, the Black Cockatoo being followed by Mr. Pitt at various times for three months before he shot it. However numerous these singularly plumaged specimens may be in cabinet or exhibit collections, it is seldom one sees these birds in captivity.

For an opportunity of examining an instance of xanthochroism in a living example of the "Buln-Buln" or Barnard's Parrakeet (*Platyercus barnardi*), I am indebted to Mr. H. B. Bradley, a Trustee of the Australian Museum. This bird which I saw at Mr. Bradley's office on the 18th April, 1904, was he informed me the property of Mr. A. L. Vivers of North Sydney. It was remarkably tame, and had the entire plumage canary-yellow except a dark scarlet band on the forehead and some scarlet feathers behind the eye and on the nape; primaries and under surface of wing white; tail yellowish-white.

Mr. Vivers subsequently informed me that it was one of three taken by a shearer in September, 1901, from a nesting-place in a tree on Burrawang Station, near Forbes, New South Wales. The other young ones were of the normal plumage, and one of these birds is at present in the possession of Mrs. Batty, of Strathfield, near Sydney.

Melanism, as represented by the specimens of Australian *Psittaci* in the collection, is confined to a single species, and all from the same district. It is a smaller and darker plumaged form of *Platyercus elegans*, inhabiting the Bellenden Ker Range, and the contiguous coastal districts of North-eastern Queensland, described by Dr. Ramsay<sup>1</sup> as *Platyercus pennantii* var *nigrescens*.

---

<sup>1</sup> Ramsay—Tab. List Austr. Bds., 1883, p. 31.

Several specimens collected by Mr. Robt. Grant in open forest lands, near Lake Eicham, are in the normal plumage; others he procured in dense brush at Boar Pocket, only four miles away, exhibit traces less or more of melanism from a few scattered black feathers among the crimson ones on the back, to others having most of the feathers on the head, back, checks, and breast black. Traces of melanism I have also seen pervading the quills of young *Cacatua galerita*. There is an adult male of this species in the collection obtained by Mr. Robt. Grant at Fernmount, on the Bellingen River, New South Wales, with a faint blackish wash on the quills and outer series of greater wing-coverts, the shafts, too, of some of the quills being brownish-black.

Erythrism in the Australian *Psittaci* in the Australian Museum collection is represented by a single abnormally plumaged specimen of *Platycercus eximius*, Shaw (the so-called *Platycercus ignitus*, Leadbeater), that was found dead in Victoria Park, Newtown, near the University of Sydney. The lengthened upper mandible, the much worn quills, and tail-feathers bear evidence that it was an escaped cage-bird. It has the upper and under parts red, feathers on the upper portion of the back and scapulars black with narrow reddish margins; lesser series of the upper wing-coverts black; quills and tail feathers worn, abraded, imperfect, and having a washed out appearance; cheeks white; vent and under tail-coverts white, the latter having a faint reddish subterminal cross-bar.

Partial albinism in the Australian *Psittaci* is rare, and is generally confined to the quills and tail-feathers, although there are specimens of *Psephotus haematonotus* in the collection with the upper parts white washed with yellow, and the under parts white. I have never seen a pure albino of any species of Australian *Psittaci*.

Hybrids or abnormally plumaged specimens are not uncommon, of which *Platycercus mastersianus*, Ramsay, the type of which I have before me, is an instance. In the collection are also specimens of *Platycercus elegans*  $\times$  *P. eximius*, and an adult male and female of *Platycercus barnardi*  $\times$  *P. flaveolus*. The latter specimens were presented by Dr. A. M. Morgan, of Adelaide, who wrote me:—"I am sending you a male and a female, hybrids of *Platycercus barnardi* and *P. flaveolus*, shot near Wirrabara, one hundred and fifty miles north of Adelaide. The female was mated with a male of *P. flaveolus*, and the eggs contained embryos." There are numerous instances of abnormally plumaged individuals. Among the latter is a specimen of *Neophema bourkei* with some of the

quills, the greater wing-coverts and lateral tail-feathers white. M. Octave Le Bon informed me that he netted eight living examples of *Neophema bourkeri* at a soak near Melville on the Murchison Gold-field, Western Australia. I believe this species has not been previously recorded from Western Australia.

DESCRIPTION OF THE EGGS OF THE WHITE-QUILLED  
ROCK PIGEON, *PETROPHASSA ALBIPENNIS*, GOULD.

By ALFRED J. NORTH, C.M.B.O.U., C.M.Z.S., Ornithologist.

The White-quilled Rock Pigeon is the rarest of the *Australian Columba*. The only specimens recorded are those sent by one of the officers of "H.M.S. Beagle" to Gould. Others were procured by the late Mr. M. Elsey, and by the late Sir George Grey in North-western Australia. For an opportunity of describing the eggs of this species I am indebted to Mr. C. G. Gibson, who took two sets of eggs and forwarded them to me together with the following interesting notes:—"While in the West Kimberley District, North-western Australia, in 1901, with the Brockman exploration expedition, to which party I was attached as Assistant-Geologist, we noticed numbers of *Petrophassa albipennis*. They were invariably restricted to the sandstone region, and although fairly numerous, they were never anywhere abundant. As a rule they were rather shy birds, and hard to flush, relying on their protective colour to hide them. When flushed they would rise with a loud whirr, fly a short distance, alighting usually on bare rocks, over which they would run rapidly for a few yards, finally crouching down on a rock harmonising with their own colour so much that it was difficult to detect them. During the month of July, 1901, while in about Lat.  $16^{\circ} 17'$  S. and Long.  $125^{\circ} 21'$  E. I found two nests of this Pigeon, one on the 3rd July, the other on the 4th, each containing two fresh eggs, but unfortunately broke one egg of the last set taken. The nests were slight hollows about two inches in depth scooped in the ground, and lined with dead soft grass. One was sheltered beside a small tuft of soft spinifex, the other beside a stone. These nests and eggs are very similar to those of *Geophaps smithi*, of which I found two nests with eggs in the same locality on the 3rd and 4th of July."

The eggs of *Petrophassa albipennis* are oval in form, the shell being close-grained, smooth, and lustrous. One set is of a light cream colour, and measures:—Length (A)  $1.16 \times 0.86$  inches; (B)  $1.07 \times 0.83$  inches. The remaining egg of the second set taken is creamy white in colour, and measures:—Length  $1.11 \times 0.84$  inches.

ON THE BOWER OF THE EASTERN BOWER-BIRD,  
*CHLAMYDODERA ORIENTALIS*, GOULD.

By ALFRED J. NORTH, C.M.B.O.U., C.M.Z.S., Ornithologist.

(Plate xxxii.)

In Part II of "Nests and Eggs of Birds found Breeding in Australia and Tasmania"<sup>1</sup> the bower and nest of this species are fully described, but I was unable to give a figure of the former. This want has now been supplied by Mr. A. Forsyth Smith, who has kindly lent the negative of a photograph of one of these structures, which he had taken in North-eastern Queensland, and has also supplied the following notes.

"This bower, or playground of *Chlamydodera orientalis*, I photographed on the 22nd December, 1901. It was built about eighty yards from the front of the homestead of Mungulla Station, about a mile from the sea-beach and opposite the Palm Islands, lying between Townsville and Lucinda Point. The land about here is very sandy and although there is a thick patch of forest country between the bower and the sea-beach it was built among a few straggling *Acacias*. Judging from memory, the walls of the structure which were formed of twigs, would be about three feet long and eighteen inches high. The decorations consisted of a collection of bones and land shells at each end, a few land shells also being placed in the centre of the floor of the structure. The place was much frequented by the black servants of the station, also by numbers of domestic fowls and turkeys, which eventually destroyed the bower. The drought, which may have caused this species to visit the coast, set in about September, 1901, and with the exception of some good rain in February, 1902, the drought did not thoroughly break up until after the visitation of the cyclone 'Leonta' in March, 1903, which wrecked Townsville and Bowen."

---

<sup>1</sup> North—Nests and Eggs Bds. Aust. Tas., Austr. Mus. Spec. Cat. i., 2, 1902, p. 56.



ETHNOLOGICAL NOTES MADE AT COPMANHURST,  
CLARENCE RIVER.

I. AN ABORIGINAL ROCK-SHELTER WITH AN  
INSCRIBED ROCKFACE; II. DISARTICU-  
LATION OF ONE OF THE LITTLE  
FINGER JOINTS.

By R. ETHERIDGE, Junr., Curator.

(Plate xxxiii.).

I.—ABORIGINAL ROCK-SHELTER.

The Rock-shelter partially represented in Pl. xxxiii. was brought to my notice by Mr. George Savidge, of Copmanhurst, a valued correspondent of the Australian Museum. In May last I had the pleasure of accompanying him to make an examination of the interesting petroglyphs scattered over the outer face of the shelter. In these lies the chief interest attached to the latter, from their peculiar and uncommon characters.

The shelter is situated in a low scarp of sandstone of the Clarence Group (Hawkesbury-Wianamatta Series), sixty-four feet long, running E.S.E. and W.N.W., at the head of a small gully, joining Nobby's Creek, a south branch of the Clarence River, immediately opposite Copmanhurst.

The scarp is between eight and ten feet high, overhanging above, and with a vertical face of two feet six inches (in its widest part) below, on which the petroglyphs occur, extending over a length of twenty-four feet. Immediately under this is the shelter, thirty-two feet long, nine feet six inches deep, two feet six inches high at the entrance, and three feet inside. The upper or overhanging part of the scarp is devoid of carvings, these being confined to the narrow vertical face as aforesaid. The floor inside is composed of hearth-refuse material of no great depth, consisting of ashes, charcoal, bone fragments, and pieces of calcined shell of the "fresh-water mussel" (*Unio*); the roof is well blackened by smoke. The whole aspect of the shelter clearly indicates that at one time it was a place of residence, and from its contiguity to the river—where a plentiful supply of shells and fish could be obtained—well adapted for habitation.

The petroglyphs on the vertical rock-face above the opening consist of parallel superimposed lines of vertical incisions, two to six inches long, and crown-like outlines about six inches in height by four inches in breadth. The vertical incisions follow one another in lateral series with some regularity along the entire face, and in places become confluent, forming vertical or longitudinal lines; this is noticeable on the right of Pl. xxxiii., and in their simpler form are conspicuous along the upper portion of the rock in Pl. xxxiii. The depth of the incisions varies from five-eighths to half-an-inch, but allowance must be made for weathering.

Interspersed with these simple gravings are the semicircular, crown-shaped, or horse-shoe-shaped petroglyphs. Two of these are very apparent along the lower edge of the rock face in Pl. xxxiii., the left hand one divided in the middle line by a vertical division. The same figures are again particularly noticeable at the extreme right hand of the rock face in Pl. xxxiii., both large and small, and close together. The rock surface circumscribed by these curved lines may be plain (*a*, Pl. xxxiii.), or with a subsidiary, smaller, and similar curved figure within the larger (*b*, Pl. xxxiii.); or, again, the within contained surface may be divided up by vertical incisions (*c*, Pl. xxxiii.).

Mr. Savidge believed he could detect an ill-preserved outline of a kangaroo or wallaby in the centre of the group, but although there did seem to be a faint representation of some kind, I could not, I must confess, satisfy myself of its nature. There are no hand imprints, white, black, or red on this rock face.

Petroglyphs of this nature are by no means common, as already stated, indeed, I know of no other instance of such a combination of markings. As a group the nearest akin is one described and figured by Mr. H. Tryon, on Pigeon Creek, between Tent Hill and Pilton,<sup>1</sup> Queensland, but many of the figures there are more complicated. Similarly these figures are petroglyphs, and not pictographs, and are on a rock face forming the face wall of a rock-shelter.

In Mr. Tryon's illustration we observe, without the slightest question, figures identical with *a* and *b*, Pl. xxxiii, repeated more than once, as well as simple linear incisions, although not arranged in regular lateral series, like those on the Copmanhurst rock-shelter. It is, at the same time singular, that semi-circular outlines similar to those of Pigeon Creek and Copmanhurst, do not occur, so far as I know, in any of the Port Jackson-Hawkesbury groups of petroglyphs.

---

<sup>1</sup> Tryon—Proc. Roy. Soc. Q'land, i., 3, 1884, p. 45, pl. xi.

The meaning of the Copmanhurst carvings is quite lost. No information can be obtained, notwithstanding there are several full-blooded Blacks still living there, indeed, it was one of these who first pointed out the shelter to Mr. Savidge; either they cannot, or will not disclose anything, probably the latter.

In North America petroglyphic gravings similar to *a* and *b*, Pl. xxxiii, occasionally occur. Thus, they are represented by Mr. G. Mallery in one of the Owen Groups, in Owen Valley, California,<sup>2</sup> and in another near the San Marcos Pass<sup>3</sup> in the same State. "They are not understood by the inhabitants of the vicinity who generally hold them in superstitious regard."<sup>4</sup>

Speaking of petroglyphs in general the same author remarks:—"It must be admitted that no hermenutic key has been discovered applicable to American pictographs, whether ancient on stone, or modern on bark, skins, linen, or paper. Nor has any such key been found which unlocks the petroglyphs of any other people. Symbolism was of individual origin and was soon variously obscured by conventionalizing; therefore it requires separate study in every region. No interpreting laws of general application to petroglyphs so far appear, although types and tendencies can be classified."<sup>5</sup>

I am indebted to Mr. G. Savidge for the loan of the negatives from which the plate is reproduced.

## II. DISARTICULATION OF ONE OF THE LITTLE FINGER JOINTS.

This is a very wide spread practice throughout Australia on the part of the women, and has been commented on by many writers.

There is a Blacks' camp at Copmanhurst, and I noticed that one at least, of the old gins, known as "Eliza," had lost the first joint of the left little finger. As I was anxious to ascertain the reason for this mutilation, if not accidental, Mr. William Campbell, of Copmanhurst, a *grata persona* amongst the resident Blacks, kindly undertook the necessary enquiries, when he obtained the following details from some of the oldest gins:—

On a young gin, or girl, becoming promised or betrothed, say between the ages of twelve to fourteen years, to a lad, through the parents, or tribal head-man, a feast was given by the parents or

<sup>2</sup> Mallery—10th Ann. Rept. U.S. Bureau Ethnol. for 1888-89 (1893), pl. i., f. l., pl. ii., f. m.

<sup>3</sup> Mallery—*Loc. cit.*, p. 63, f. 22.

<sup>4</sup> " " p. 31.

<sup>5</sup> " " p. 35.

guardians, when the oldest gin present took the girl and tied cobwebs round the finger in question. The girl was kept isolated for a month—from full moon to full moon—by which time the finger joint had dropped off. From thence onward all other young Blacks knew that the girl was allotted, or “engaged,” and on no account to be tampered with, under severe penalties to be inflicted by members of the tribe.

It will be apparent from this that in this part of the country, at any rate, disarticulation of a little finger joint was a sign of betrothal. Mr. Campbell added that the custom is now nearly extinct.

From accounts that have come down to us from the early colonists, the practice of disarticulating a little finger joint appears to have been common amongst tribes living on or near the sea coast. In the Port Jackson District, the operation was called *malgun*.<sup>6</sup> The first writers to comment on this custom were Surgeon J. White,<sup>7</sup> and the historian of Governor Phillip’s Voyage.<sup>8</sup> The former mentions its occurrence both in Port Jackson and north to Broken Bay, and says that both old and young women were so operated on. Captain John Hunter not only confirmed the above, but also stated that infants were similarly treated,<sup>9</sup> although not all females of the tribe in either case.

Lieutenant-Colonel D. Collins informs us that the two first joints of the left little finger were removed, the removal being accomplished by ligature,<sup>10</sup> confirmatory of Mr. Campbell’s statement, and gives as a reason for the mutilation “the idea that these joints of the little finger are in the way when they wind their fishing lines over the hand.”

Sir T. L. Mitchell suggested<sup>11</sup> that in common with the ceremony of knocking out one or more incisor teeth,<sup>12</sup> little finger joint forfeiture was a remnant of early sacrificial rites.

On returning to the sea coast it may be noticed that Captain J. Lort Stokes, R.N., described<sup>13</sup> a similar custom existing at

<sup>6</sup> The Hebrew word *malgun*, says G. F. Angas, signifies a cutting off in order to protection (Savage Life and Scenes in Austr. and N. Zealand, ii., 1847, p. 225, *f. n.*)

<sup>7</sup> White—Journ. Voy. to N. S. Wales, 1790, pp. 132 and 204.

<sup>8</sup> Voyage of Gov. Phillip to Botany Bay, 2nd Ed., 1790, p. 67.

<sup>9</sup> Hunter—Historical Journ. Trans. Port Jackson and Norfolk Isd., 1793, pp. 59, 205.

<sup>10</sup> Collins—Acc. English Colony in N. S. Wales, 1788-1801, 2nd Ed., 1804, p. 359.

<sup>11</sup> Mitchell—Three Expeditions E. Austr., ii., 1838, p. 339.

<sup>12</sup> This we now know to be a portion of the youth’s initiation ceremony, or in some tribes the whole of it—“the making of young men.”

<sup>13</sup> Stokes—Discoveries in Australia, 1837-43, i., 1846, p. 92.

Baskerville and Beagle Bays. At the latter several natives had lost one finger joint, but Stokes does not say of which hand, nor whether those so deprived were males or females.

At Halifax Bay, on the contrary, according to E. M. Curr,<sup>14</sup> the females lose a joint of the first finger of the right hand, and amongst the Larrakia of Port Darwin, and the Woolna of the Adelaide River, North Australia, "some of the finger joints" are amputated, according to Inspector Paul Foelsche.<sup>15</sup>

Confirmation of Mr. Campbell's information is found in the statement of Mr. J. F. Mann,<sup>16</sup> who says that in the coastal districts of New South Wales, the betrothal of a young woman to a man, who followed the occupation of a fisherman, compelled her to lose the first joint of the little finger of the left hand.

The only tribe referred to by Dr. W. E. Roth, performing this mutilation in Queensland, is the Kalkadoon: "female infants are said to have the top joint of the little finger amputated."<sup>17</sup>

Mr. R. J. Flanagan<sup>18</sup> likens the custom to a practice described by Catlin amongst some of the North American Indians, the men removing a finger as an act of sacrifice to the Great Spirit. It is not only in North America we find traces of this peculiar disarticulation, as the following instances will show. The historian of Governor Phillip's Voyage remarks<sup>19</sup> on its occurrence amongst a tribe of Hottentots at the Orange River, South Africa. Here, says Mr. O. Peschel,<sup>20</sup> amputation of finger joints is effected during youth and "seems to be superstitiously regarded as a charm." The same custom is known to exist amongst certain of the Kaffirs,<sup>21</sup> whilst the Bushmen sacrifice the ends of their fingers on occasion of illness.

In the Friendly Islands Captain James Cook, R.N., observed the severance of finger joints "designed as a propitiatory sacrifice to the *Natooa* to avert any danger or mischief to which they might be exposed."<sup>22</sup> On the other hand Captain J. Lort Stokes says<sup>23</sup> that this mutilation at the Friendly Islands was

<sup>14</sup> Curr—*Australian Race*, i., 1886, p. 74.

<sup>15</sup> Foelsche in Curr—*Loc. cit.*, p. 252.

<sup>16</sup> Mann—*Proc. Geogr. Soc. Austr. (N.S. Wales and Vict. Br.)*, i., 1885, p. 39.

<sup>17</sup> Roth—*Ethnological Studies*, 1897, p. 184.

<sup>18</sup> Flanagan—*Aborigines of Australia*, 1888, p. 126; Tylor—*Primitive Culture*, 2nd Ed., ii., 1873, p. 401.

<sup>19</sup> *Voyage of Gov. Phillip to Botany Bay*, 2nd Ed., 1790, p. 68, *f. n.*

<sup>20</sup> Peschel—*Races of Man*, 1876, p. 462.

<sup>21</sup> Peschel—*Loc. cit.*, p. 462, *f. n.*

<sup>22</sup> King—*Voyage to the Pacific Ocean, &c.*, 1776-1780, iii., 1804, p. 162.

<sup>23</sup> Stokes—*Discoveries in Australia, 1837-41*, i., 1846, p. 93, *f. n.*

intended as an expression of grief for the loss of a friend. Amongst the Feejians a similar operation was a mark of mourning for the dead.<sup>24</sup> Interesting remarks and further references will be found in Dr. E. B. Tylor's "Primitive Culture,"<sup>25</sup> especially on the Nicobar Islanders, Tonganese, and Dravidians.

---

<sup>24</sup> Pritchard—Mem. Anthropol. Soc. for 1863-4, i., 1865, p. 203.

<sup>25</sup> Tylor—Primitive Culture, 2nd Ed., ii, 1873, pp. 400-401.

A REVIEW OF THE *ELEOTRIDS* OF NEW SOUTH WALES.

By EDGAR R. WAITE, F.L.S., Zoologist, Australian Museum.

(Plates xxxiv.-xxxvi.)

In 1897 Mr. J. D. Ogilby published a paper "On some Australian Eleotrinæ"<sup>1</sup> and in the succeeding year made a further contribution to the same subject.<sup>2</sup> In the following pages these will be referred to as Nos. I. and II. respectively.

As the outcome of the first paper the author admits as members of the fauna of New South Wales, seven good and two doubtful species. In the second paper three other species are added so that the list stands as below:—

*Carassiops compressus*, Krefft.

*Carassiops longi*, Ogilby.

*Carassiops galii*, Ogilby.

*Krefftius australis*, Krefft.

*Krefftius adspersus*, Castelnau.

*Mulgoa coxii*, Krefft.

*Ophiorrhinus grandiceps*, Krefft.

*Ophiorrhinus angustifrons*, Ogilby.

*Gymnobutis gymnocephalus*, Steindachner.

? *striatus*, Steindachner.

? *Mogurnda mogurnda*, Richardson.

? *Gobiomorphus gobioides*, Cuvier and Valenciennes.

The author writes (I., p. 750):—"It is one of the most remarkable problems connected with Australian fish literature how the continental naturalists, receiving small collections from such well worked localities as Port Jackson and Hobson's Bay, invariably succeed in obtaining fishes, which we, despite our local knowledge, and despite that having once been recorded they are more carefully sought for, are unable to find."

It seems to me that as a first step instead of searching for forms new to us, which may be identified with species described by continental naturalists, we should rather seek to recognise in their description, some form with which we may be familiar under an earlier name.

---

<sup>1</sup> Ogilby—Proc. Linn. Soc. N.S. Wales, xxi., 1897, pp. 725-757.

<sup>2</sup> Ogilby—*Loc. cit.*, xxii, 1898, pp. 783-793.

Dr. Günther has, I find, made a similar suggestion: "Dr. Steindachner describes as new from New South Wales, *E. striata*, *E. gymnocephalus* and *E. richardsonii*. The types of these species being from the same source as the species described by Mr. Krefft in 1864, a further comparison will be necessary."<sup>3</sup>

Mr. Ogilby states (L., p. 757) that he had so far failed in his special endeavours to obtain examples of *E. gymnocephalus* and *E. striatus*.

In attempting to identify the descriptions of these species with known forms I have been only partially successful, but certain comparisons made, led me to a more extended examination of the group; this results in the present contribution to the subject. I have confined my attention to the New South Wales representatives because Mr. Ogilby tentatively promises to deal with the hitherto unnoticed forms of the Australian fauna (II., p. 785).

My efforts therefore may be regarded as a review of Mr. Ogilby's two papers and will mark another step towards our better knowledge of the group. The figures, of most of our species, will be of distinct value, and are reproduced from the work of Mr. A. R. McCulloch.

Under the name of *Carassiops longi*, Mr. Ogilby distinguished our local race of *C. compressus*, Krefft: I am not disposed however to accord it more than varietal rank; the genus is well characterised and includes the small species *C. galii*, Ogilby, whose original habitat is still unknown.

In *Krefftius*, Ogilby, with two species, *K. adpersus*, Castelnau, and *K. australis*, Krefft, I have placed *Eleotris coxii*, Krefft, the type of *Mulgoa*, Ogilby. It seems to me that these two latter species are allied, while the former approaches *E. mogurnda*, Richardson,<sup>4</sup> the type of *Mogurnda*, Gill, the diagnosis of which I have so far been unable to consult. Smaller scales, though not described, may exclude the other three species.

For the flat-headed gudgeons I have reverted to the genus *Philypnodon*, Bleeker, and regarded as synonyms *Gymnobutis*, Bleeker, and *Ophiorrhinus*, Ogilby. I am brought to this conclusion by the identification of *E. gymnocephalus*, Steindachner, with *E. grandiceps*, Krefft, with which I also associate *O. angustifrons*, Ogilby.

Mr. Ogilby failed to obtain examples of *E. striatus*, Steindachner,<sup>5</sup> and I have been unsuccessful in satisfactorily identifying it with any described species. Some confusion in terms is

<sup>3</sup> Günther—Zool. Rec., xxiii., 1866, p. 146.

<sup>4</sup> Richardson—Voy. "Ereb. and Terr.," Ichth., 1844, p. 4, pl. ii., fig. 1-2.

<sup>5</sup> Steindachner—Sitzb. Akad. Wiss. Wien, liii., 1866, p. 452.



evident between the epitomised and extended descriptions; in the former, I read that the interorbital breadth equals half the length of the eye, in the latter, that the diameter of the eye equals half the interorbital breadth.

I have nothing to add to Mr. Ogilby's remarks respecting *Eleotris gobioides*, Cuvier and Valenciennes<sup>6</sup>—"This is a New Zealand species, and its occurrence here requires confirmation."

Dr. Steindachner's "Fischfauna von Port Jackson" was written nearly forty years ago, and he would materially assist us by re-examining his specimens and deciding such problems as are left in doubt by Mr. Ogilby and myself.

As Mr. Ogilby has given such lengthy descriptions, both generic and specific, I have done little more than make necessary additions or corrections: the broad features in which the species differ are noted, while some few observations made on the forms in my aquaria are added. It may be mentioned that Mr. Ogilby's enumeration of the vertebræ does not always agree with mine, probably explainable, in part, by a different method of computation. I have not included the hypural in counting the caudal vertebræ.

#### CARASSIOPS, *Ogilby*.

*Carassiops*, Ogilby, Proc. Linn. Soc. N. S. Wales, xxi., 1897, p. 732.

Under this genus the author includes *Eleotris cyanostigma*<sup>7</sup>, but Bleeker had, in 1874, made it the type of *Brachyteleotris*<sup>8</sup> which should apparently be used instead of *Carassiops*. An examination of specimens collected by Mr. W. T. Quaipe at Vila in the New Hebrides, however, and which I determine as *B. cyanostigma*, indicates that the genus *Carassiops* may be retained for our forms. The number of vertebræ in *C. compressus*, the type of the genus, is  $14+10=24$ . In *B. cyanostigma* the caudal vertebræ are more numerous than the abdominal, the formula being  $10+15=25$ .

Ogilby compares his genus with *Asterropteryx* (so spelled), Rüppell<sup>9</sup> and under *C. guentheri* writes<sup>10</sup> (II., p. 787): "Bleeker has placed this fish in the genus *Asterropteryx* from which I have found it necessary to remove it to my genus *Carassiops*, because in *Asterropteryx* . . . the teeth are in a single series and there is no genital papilla."

<sup>6</sup> Cuvier and Valenciennes—Hist. Nat. Poiss., xii., 1837, p. 247.

<sup>7</sup> Bleeker—Nat. Tijds. Ned. Ind., viii., 1855, p. 452.

<sup>8</sup> Bleeker—Arch. Neerl. Sci. Nat., ix., 1874, p. 306.

<sup>9</sup> Rüppell—Atlas Reise nord. Afrika, Fische, 1828, p. 138.

<sup>10</sup> Bleeker—Versl. Kon. Akad. Wet., xi., 1876.

The last character, if valid, renders the genus unique, but as Rüppell had but a single example too much stress must not be placed upon this statement. Jordan and Snyder evidently do not regard it seriously, for they describe and figure a species, *Asterropteryx abax*<sup>11</sup>, from Japan, in which the anal papilla is conspicuous.

Apart from the stated structural characters, which Bleeker regards as of considerable import, *Asterropteryx semipunctatus* and *Brachyleotris cyanostigma* are very similar.

CARASSIOPS COMPRESSUS, *Kreffft.*

*Eleotris compressus*, Krefft, Proc. Zool. Soc., 1864, p. 184.

*Eleotris humilis*, De Vis, Proc. Linn. Soc. N. S. Wales, ix., 1884, p. 690.

*Eleotris cavifrons*, De Vis, *loc cit.*, p. 693.

*Carassiops longi*, Ogilby, Proc. Linn. Soc. N. S. Wales, xxi., 1897, p. 733.

(Plate xxxiv., fig. 1.)

D. vi.-vii. i. 9-10; A. i. 9-10; P. 13-15; Sc. 27-29/8; Vert. 14+10=24.

The form under examination is that described by Ogilby as *C. longi*, which designates what I am disposed, at most, to regard as a varietal form. Stress is laid on the comparative height of the body and the depth of the head, also upon the colouration, especially of the males, as distinguishing features from *C. compressus*.

The comparative measurements depend greatly upon age and other conditions, and we possess examples from Cook River and water-holes adjacent, which exhibit a depth of body almost equal to any from the northern rivers.

I can fully support the encomia with regard to colouration, the males, in aquaria, during the breeding season, being most handsome little fishes. At the time of writing, Mr. Ogilby had not, I believe, seen living typical examples of *C. compressus*. His deductions were made from old preserved examples, from which all colour, even had they been taken in breeding garb, had vanished. In order to show the extreme form of this species a slender example, *i.e.*, a typical *C. longi*, has been selected for the purpose of the accompanying illustration. An examination of specimens received from Brisbane under the name *E. humilis*, De Vis, shows that they are absolutely identical with our form. I have not found specimens with so small a number of dorsal spines as five, but have on the other hand counted

<sup>11</sup> Jordan and Snyder—Proc. U.S. Nat. Mus., xxiv., 1901, p. 40, fig. 2.

seven in one individual. The extended distribution of this form supports my conclusions as to its identity with *C. compressus*. Those who still prefer to regard it as distinct, will note that the name *C. humilis* takes precedence of *C. longi*. Reading De Vis' description of *E. cavifrons* with the Brisbane and Sydney specimens in hand, it is not possible to find any character which warrants the recognition of the species.

CARASSIOPS GALII, *Ogilby*.

*Carassiops galii*, Ogilby, Proc. Linn. Soc. N. S. Wales, xxii., 1898, p. 788.

(Plate xxxiv., fig. 2.)

D. vii.-viii. i. 10-12; A. i. 11-14; P. 15; Sc. 29-31/8; Vert. 16+14-15=30-31.

By the kindness of Mr. J. H. Maiden, Director of the Botanical Gardens, Sydney, I have kept examples of these little fishes for the past four years. They were taken from the same tank whence Mr. Albert Gale obtained his specimens, and have bred in my fish ponds, but not in the smaller aquaria where they are more readily observable. On the approach of cool weather they burrow in the mud and debris at the bottom of the water and so remain until spring, when breeding takes place. They become remarkably tame and jostle one another in their efforts to obtain a morsel of food held between the fingers.

The anal fin has a slightly more anterior insertion than in *C. compressus*, hence the generic description "anal fin originating behind the second dorsal" requires amending. Also in regard to the fin formula, number of vertebræ, etc. For this species Ogilby proposes the sub-genus *Austrogobio*, but of the features enumerated, the number of vertebræ is the only one at all distinctive.

KREFFTIUS, *Ogilby*.

*Krefftius*, Ogilby, Proc. Linn. Soc. N. S. Wales, xxi., 1897, p. 736.  
*Mulgoa*, Ogilby, *loc. cit.*, p. 740.

The characters of the genus were derived from its type *K. australis*, Krefft, but were not amended on the inclusion of *K. adspersus*, Castelnau. I cannot admit *Mulgoa* as a genus distinct from *Krefftius*. The author gives the following as distinguishing characters of the two:—

*Krefftius*.—First dorsal with seven rays (= spines); fourth ventral ray produced and filiform; pectoral with not more than sixteen rays; scales large, cheeks and interorbital space scaly.

*Mulgoa*.—First dorsal with six rays (= spines); fourth ventral ray not produced; pectoral with not less than eighteen rays; scales moderate; cheeks mostly, interorbital region entirely naked.

In *K. adpersus* the dorsal spines number eight and the fourth ventral ray is not filiform, in fact I should scarcely apply the term to *K. australis*; in this latter species the number of vertebræ agree with those of *M. coxi*, namely twenty-eight, whereas in *K. adpersus* there are thirty-one. Another feature noted is the size of the scales, large in *Krefftius*, moderate in *Mulgoa*; the size of the scales is surely determined by their relative depth and in the transverse series there are eleven rows in both *K. adpersus* and *Mulgoa*, whereas in *K. australis* they number eight to nine. A difference of two rays in the pectoral fin can scarcely be reckoned as of generic import, so that the only important character mentioned in the synopsis is in the degree of squamation of the head, possibly a less important factor than the number of vertebræ. In the diagnosis of *Krefftius* the ventral fins are stated to be inserted a little behind the root of the pectorals; in all the species the insertion is below the pectorals.

I have so far been unable to find Gill's diagnosis of *Mogurnda*, apparently founded on *Eleotris mogurnda*, Richardson. Judging however from the description of the species *Krefftius* must be very close to it and *K. adpersus* is scarcely dissimilar from the species, unless the scales are larger, as they would appear from comparison with Richardson's figure though they are not referred to by the author.

Ogilby includes *Mogurnda mogurnda* in his list as a doubtful record for New South Wales, remarking that its claim rests upon its inclusion by Steindachner<sup>12</sup> in his Fishes of Port Jackson and the authority of a single specimen now in the Australian Museum, and said to have come from the Clarence River. This latter example is nothing more than *K. adpersus*, and we may perhaps consider Steindachner's fish as of the same species also and so remove *Mogurnda* from the list. Further research will be needed to show the differences between *Krefftius* and *Mogurnda* unless such are expressed in Gill's diagnosis which, as above stated, I am at present unable to consult.

KREFFTIUS ADSPERSUS, *Castelnau*.

*Eleotris adpersa*, Castelnau, Proc. Linn. Soc. N. S. Wales, iii., 1878, p. 142.

*Eleotris minus*, De Vis, Proc. Linn. Soc. N. S. Wales, ix., 1884, p. 690.

*Krefftius adpersus*, Ogilby, Proc. Linn. Soc. N. S. Wales, xxii., 1898, p. 789.

(Plate xxxv., fig. 1.)

D. viii-ix. i. 10-12; A. i. 11-12; P. 15; Sc. 31-33/11-13;  
Vert. 15+16=31.

<sup>12</sup> Steindachner—Sitzb. Akad. Wiss. Wien, lvi., i., 1867, p. 328.

This species may be distinguished by its low spinous dorsal fin, the longest spine, the sixth, being but one-third the length of the head; by its long second dorsal and anal in which the hinder rays form an acute angle, also by the short stout caudal peduncle and rounded tail. Interorbital space scaly, cheeks partly naked.

KREFFTIUS AUSTRALIS, *Kreffft.*

*Eleotris australis*, Krefft, Proc. Zool. Soc., 1864, p. 183.

*Kreffftius australis*, Ogilby, Proc. Linn. Soc. N. S. Wales, xxi., 1897, p. 737.

(Plate xxxv., fig. 2.)

D. vii. i.8; A. i.8; P. 15; Sc. 31-33/8-9; Vert. 13 + 15 = 28.

The distinguishing characters of this species are the rounded spinous dorsal, in which the third spine is longest, and nearly half the length of the head; the short and high second dorsal, and the long and comparatively slender caudal peduncle and rounded tail. Interorbital space scaly, cheeks partly naked.

This common gudgeon has spawned in my possession, but the ova were devoured by a rapacious *Galaxias* which was unfortunately in the same aquarium.

KREFFTIUS COXII, *Kreffft.*

*Eleotris coxii*, Krefft, Proc. Zool. Soc., 1864, p. 183.

*Eleotris richardsonii*, Steindachner, Sitzb. Akad. Wiss. Wien, liii., 1866, p. 455, pl. ii., fig. 4.

*Eleotris mastersii*, Macleay, Proc. Linn. Soc. N.S. Wales, v., 1881, p. 622.

*Mulgoa coxii*, Ogilby, Proc. Linn. Soc. N. S. Wales, xxi., 1897, p. 741.

(Plate xxxvi., fig. 1.)

D. vi. i. 8-9; A. i. 8-9; P. 18-19; Sc. 37-40/11; Vert. 12 + 16 = 28.

In some respects this species is intermediate between the last two, the spinous dorsal fin is similar to that of *K. adspersus* but higher, the iii.-v. spines sub-equal in length and a little shorter than half the length of the head. The second dorsal and anal are longer than in *K. australis*, shorter than in *K. adspersus* and the posterior angles are rounded, the caudal peduncle is likewise intermediate, but the tail is subtruncate. Interorbital space naked, cheeks mostly so. In referring to Steindachner's figure, Ogilby characterises it as unnamed and unnumbered. In my

copy it is numbered as above quoted though omitted from the "explanation of plates." For the purpose of direct comparison I also supply a figure of this species, it represents a female of natural size and the pectoral fin is fully expanded to draw attention to the increased number of its rays.

PHILYPNODON, *Bleeker*.

*Philypnodon*, Bleeker, Arch. Neerl. Sci. Nat., ix., 1874, p. 301.

*Gymnobotis*, Bleeker, *loc. cit.*, p. 304.

*Ophiorrhinus*, Ogilby, Proc. Linn. Soc. N. S. Wales, xxi., 1897, p. 745.

This genus was instituted to receive *Eleotris nudiceps*, Castelnau<sup>13</sup> in which the teeth are described as extending on to the vomer and palatines, the posterior part of the tongue being also covered with them. After an examination of sixteen specimens, identified with this species, Ogilby stated that there are no teeth on any part of the mouth except those on the jaws. (I., p. 757.)

He further writes: "I have been for some time past making special endeavours to obtain examples of *Gymnocephalus* . . . but have failed so far in doing so." There can be no doubt that *E. grandiceps*, Krefft, and *E. gymnocephalus*, Steindachner, are two names for the same fish: this had not occurred to Ogilby who makes the former name the type of his genus *Ophiorrhinus*, but Bleeker had in 1874, proposed the genus *Gymnobotis* for Steindachner's species. Now Ogilby admits the generic relation of *E. nudiceps* with *E. grandiceps* so that we have choice of three names for the genus. This author writes (I., p. 751): "The want of Bleeker's paper prevents me from ascertaining whether his genus *Philypnodon* is founded on Castelnau's description of *nudiceps*; if this be the case, Bleeker's genus, being specially formed on account of a character which it does not possess must if monotypic be suppressed. And this raises another question to which I am unable to find a satisfactory answer, namely—if a genus be founded on a character which is purely mythical, should the name so proposed stand in preference to another correctly characterised from the same species but at a later date?"

I am not in accord with Mr. Ogilby's sentiments and so use the name *Philypnodon*. If this be rejected on the grounds advanced, *Ophiorrhinus* can still have no standing, the genus *Gymnobotis* being of earlier date.

---

<sup>13</sup> Castelnau—Proc. Zool. Soc. Viot., i., 1872, p. 126.

PHILYPNODON GRANDICEPS, *Kreffft.*

*Eleotris grandiceps*, Krefft, Proc. Zool. Soc., 1864, p. 183.

*Eleotris gymnocephalus*, Steindachner, Sitzb. Akad. Wiss. Wien, liii., 1866, p. 453, pl. ii., fig. 3.

*Gymnobotis gymnocephalus*, Bleeker, Arch. Neerl. Sci. Nat., ix., 1874, p. 304.

*Ophiorrhinus grandiceps*, Ogilby, Proc. Linn. Soc. N. S. Wales, xxi., 1897, p. 746.

*Ophiorrhinus angustifrons*, Ogilby, Proc. Linn. Soc. N. S. Wales, xxii., 1898, p. 793.

(Plate xxxvi., fig. 2.)

D. vii. i. 9-10; A. i. 9-10; P. 19; Sc. 38-44/12-13; Vert. 13+16=29.

In comparing the description of *E. gymnocephalus* with our examples the only real difference I can find is contained in Steindachner's statement that the height of the anal is more than the length of the head: this is obviously an error, the phrase becomes applicable if "half the length of the head" is read, and this approximates the proportion shown in the author's figure.

Writing of *Ophiorrhinus angustifrons* Ogilby remarks (II., p. 793):—"Compared with an example of *Ophiorrhinus grandiceps* of the same size, the narrowness of the head and especially of the interorbital region is at once noticeable, as also is the greater concavity of the cephalic profile; also the ventral fins are elongate and filamentous even in the fry, while in the adult male of *O. grandiceps* they are short, even in the breeding season."

I am unable to discriminate between the two forms and find examples which exhibit characters quite intermediate between the extremes described, the greater interorbital width of the typical *P. grandiceps* is due to a greater fleshy development, the bony width being the same in both. Age seems to be a factor in the variation, and it may be noted that Ogilby had but three small specimens, one of which, at least, must have been very small as he describes the ventral fins as elongate and filamentous "even in the fry." The number of vertebræ is not given, it is the same in both extremes as is also the number of pectoral rays. I may mention that the Museum possesses, by donation from Mr. A. R. McCulloch, an example identified by Mr. Ogilby with *O. angustifrons*, but whether one of the ex-

amples originally taken or obtained by him subsequently I am unaware. It is in this example that the vertebræ were counted, and in this also, the dorsal and anal rays are each but nine in number.

Though described from specimens taken in pure salt water it must not be inferred that it is a marine form. Towree or Towra Point is at the mouth of George River in which typical examples are common. Though half-grown specimens may be taken with either the broad or narrow head I have not seen adult examples with the latter character, and therefore presume it is an indication, to some extent, of immaturity.



THE OCCURENCE OF *PISOOCRINUS* OR AN ALLIED  
GENUS, IN THE UPPER SILURIAN ROCKS  
OF THE YASS DISTRICT.

By R. ETHERIDGE, Junr., Curator.

(Plate xxxvii.)

Some months since Mr. A. J. Shearsby, a valued correspondent, and contributor to the Museum collections, forwarded a large number of small Crinoid calyces, etc., collected from a bed of shale at two localities in the Yass District. These calyces I believe to be referable to De Koninck's genus *Pisocrinus*, and purpose describing them as *P. (?) yassensis*.

Our knowledge of the Lower Palæozoic Crinoidea, not only of New South Wales, but indeed of Australia generally is very limited. It may be summed up in the descriptions of three species; and some indefinite references to stem ossicles by Blandowski, Selwyn, and Smyth, which need only be mentioned as a matter of history. The latter may be referred to first:—

Mr. W. von Blandowski, at one time Curator of the National (or, as it was then called, the Museum of Natural History) Museum, Melbourne, briefly recorded "Fossii Animalculæ in the Primitive Rocks from the Upper Yarra District."<sup>1</sup> The specimens were collected by Mr. F. Acheson on the left bank of Anderson's Creek, about one mile from its junction with the Yarra, and consisted of Crinoid stem-joints, Polyzoa, and Molluscan casts. The stem-joints were referred to "*Cyatocrinites* probably *pinnatus*" but the figures given on an accompanying plate,<sup>2</sup> lead to the belief that two distinct forms were found. On the same plate other crinoidal fragments are represented<sup>3</sup> from the quartzose sandstone of the Heathcote, (McIvor) gold-field. Subsequently Dr. (then Mr.) A. R. C. Selwyn, in a list of Victorian Palæozoic fossils, mentioned<sup>4</sup> the occurrence of *Actinocrinus* and *Cyathocrinus* at Watson's Creek, Upper Yarra District. Selwyn's records were repeated by Dr. J. J. Bigsby in his *Thesaurus Siluricus*,<sup>5</sup> and *Actinocrinus* stems

---

<sup>1</sup> Blandowski—Trans. Phil. Soc. Vict., i., 1855, p. 122, plate; Personal Observations in Victoria, 1855, p. 27.

<sup>2</sup> Blandowski—Trans. Phil. Soc. Vict., i., 1855, pl. figs. 309, 310.

<sup>3</sup> Blandowski—*loc. cit.*, pl. figs. 311, &c.,

<sup>4</sup> Selwyn—Quart. Journ. Geol. Soc., xiv., 1858, p. 538.

<sup>5</sup> Bigsby—*Thesaurus Siluricus*, 1868, pp. 18 and 19.

from the same prolific district by Mr. R. Brough Smyth, in a list of Victorian fossils prepared by Prof. Sir F. McCoy.<sup>6</sup>

The only early record from New South Wales that occurs to my mind is one by the Rev. W. B. Clarke of "crinoidal columns" in Devonian or Passage Beds,<sup>7</sup> but without locality.

Not until 1897 was a Crinoid definitely described from Australian Lower Palæozoic rocks by Dr. F. A. Bather, who figured<sup>8</sup> a very imperfect impression from the Upper Silurian shales, near Prince's Bridge, Melbourne, as *Haplocrinus victoriae*. This was supplemented in 1903 by the description of two species, referable to distinct genera, by Mr. F. Chapman. For the first a new genus was proposed—*Helicocrinus*, and the species named *H. plumosus*;<sup>9</sup> the second was referred to *Botryocrinus* as *B. longibrachiatus*, Chapman.<sup>10</sup> Both are from the Upper Silurian rocks of the Melbourne suburbs.

The specimens of *Pisocrinus* (?) *yassensis* were collected by Mr. Shearsby at two localities—viz., Limestone Creek, Parish of Derrengullen, Co. King, and Hatton's Corner, Yass River, near the town of Yass; the two localities are at no great distance from one another. The Crinoid, according to Mr. Shearsby's notes, occurs at Limestone Creek, near Limestone Church, in a bed of olive-grey shale, about fifty yards below the Bowning to Wargeila crossing place. The bed is at least twenty feet thick, dips 15° W. S. W., and is overlaid by a limestone containing a copious coral fauna. The Crinoid is plentifully distributed through the lower five feet of the exposed shales, and is accompanied by casts of *Mucophyllum crateroides*, Eth. fil., numbers of a very characteristic *Cyathophyllum*,<sup>11</sup> *Rhizophyllum interpunctatum*, De Kon., and other corals.

At Hatton's Corner, a single specimen only was found in the thick shale below the wonderfully well defined limestone exposed there.<sup>12</sup> When I last visited this instructive locality, I

<sup>6</sup> Smyth—[First] Progress Report, [Second] Geol. Survey Vict., 1874, p. 34.

<sup>7</sup> Clarke—Researches S. Goldfields N. S. Wales, 2nd Ed., 1860, p. 286.

<sup>8</sup> Bather—Geol. Mag., (4), iv., 1897, p. 337, pl. xv.

<sup>9</sup> Chapman—Proc. R. Soc. Vict., n. s., xv., 2., 1903, pp. 107-108.

<sup>10</sup> Chapman—*Loc. cit.*, p. 108.

<sup>11</sup> To be described later as *Cyathophyllum shearsbyi*.

<sup>12</sup> Both the limestone and shale were described by Mr. C. Jenkins (Proc. Linn. Soc. N. S. Wales, iii., 1, 1878, p. 26), as members of his "Hume beds," and the *Calceola* mentioned by him in *Rhizophyllum interpunctatum*. In addition to this paper the geology of the district will be found treated in the two following papers:—  
David (T.W.E.)—Report on the Fossiliferous Beds, Yass. Ann. Rept. Dept. Mines N.S. Wales for 1882 (1883), p. 148, 3 plates.  
Mitchell (J.)—Notes on the Geology of Bowning, N. S. Wales. Proc. Linn. Soc. N. S. Wales, (2), i., 4, 1887, p. 1193, pl. xxi.

did not meet with *Pisocrinus*, but Mr. Shearsby's notes on a collection from the Limestone Creek shale, strongly support the view that it, and the bed referred to at Hatton's Corner are one and the same.<sup>13</sup> The *Cyathophyllum* is plentiful there, and so is *Rhizophyllum interpunctatum*; this bed of shale is also the horizon of *Barrandella linguifera*, Sby., var. *wilkinsoni*, Eth. fil. So characteristic of the Hatton's Corner shale are all three fossils that the name of either may be selected as a designation for the bed in question. I prefer the name of "Barrandella Shale," as the *Rhizophyllum* is also found in a lower bed of the section at this locality.<sup>14</sup>

Genus *Pisocrinus*, *De Koninck*, 1858.

(Bull. Acad. R. Belg., (2), iv., 1858, p. 104; Geologist, i., 1858, p. 182.)<sup>15</sup>

PISOCRINUS (?) YASSENSIS, *sp. nov.*

(Plate xxxvii., figs. 1—14.)

*Sp. Char.*—Dorsal cup small, rather variable in form, ob-conical to bowl-shaped, and in transverse section circular to sub-pentagonal. Base circular; BB entirely concealed in the deep stem depression, and entirely covered by the uppermost ossicle; sutures too faint to be perceptible, even in the best preserved specimens. RR5, the larger radials only curving sufficiently round to form the margin of the circular stem depression; l. ant. R<sup>16</sup> triangular, not reaching to the basals, with its lower sides equal to one another; l. post. R hexagonal, being bounded by the l. ant. R, ant. R, R', r. post R, and facet; r. post. R and r. ant. R. four-sided, the adjoining sides above the apex of R' well marked whilst the sides abutting against the same plate are longer than the outer sides; ant. R six-sided only, being bounded by r. and l. ant. Rs, R', certain basals, and facet; radial articular facets with a triangular ground plan, curved on the outer, or wall side of the cup, and excavated on the inner or calycinal side; radial processes well developed, halberd head-shaped when conjoined.; R' pentagonal, and its apex not produced into a process separating the r. ant. and post. Rs, nor does the plate curve inwards to form part of the basal cavity, but its apical margins are longer than those between the

<sup>13</sup> David previously suggested this, *loc. cit.*, p. 148, vert. section, bed C.-D.

<sup>14</sup> David—*Loc. cit.*, vert. section, bed I'.

<sup>15</sup> Emended Bather—1893.

<sup>16</sup> Omitting from consideration the radial processes.

l. post. and ant. Rs respectively. Anal  $x$  and tube unknown. Calicinal cavity hour-glass-shaped, constricted at about the centre. Arms and tegmen unknown; stem not known with certainty.

*Obs.*—I have quite failed to distinguish the very minute and somewhat deeply-sunk basal plates (BB). I believe there are five, but I cannot assert it as an ascertained fact. I think five basals must exist from the otherwise general agreement of this Crinoid in its structure with Dr. Bather's emended description<sup>17</sup> of the genus *Pisocrinus*. If three basals are present, and not five, there is only one other genus in the Pisocrinidæ in which these little fossils can be placed—*Triacrinus*, but all other features point to the former genus as the proper one.

Dr. Bather's remarks that in the type, *P. pilula*, De Kon., the dorsal cup varies much in shape. "So much so indeed that one is tempted to make more than one species,"<sup>18</sup> applies to a great extent in the present instance. In *P.(?) yassensis* three principal varieties can be distinguished:—

- a. Bowl-shaped dorsal cup, the diameter exceeding the height.
- b. More or less conical dorsal cup, the height exceeding or equal to the diameter.
- c. Pentalobate dorsal cup.<sup>19</sup>

The following table shows the respective measurements of seven examples of vars. *a* and *b*; var. *a* is by far the most common.

Example.	Var. <i>a</i> .		Example.	Var. <i>b</i> .	
	Height.	Diam.		Height.	Diam.
A.	5 mm.	6 mm.	B.	6 mm.	5 mm.
C.	4 "	5 "	G.	5 "	5 "
D.	6 "	6½ "	—	—	—
E.	4 "	5 "	—	—	—
F.	5 "	6 "	—	—	—

The basal cavity for the reception of the stem ossicles is hollow, there is no rim as in *P. pilula*, and the basals within the

<sup>17</sup> Bather—Crinoidea of Gotland, pt. 1, 1893, p. 22.

<sup>18</sup> Bather—*Ibid*, p. 28.

<sup>19</sup> This variety will be treated separately.

depression are flat. The inter-basal sutures are too faint to be discernable, and even in some examples the inter-radial sutures are seen with difficulty.

The radial processes are from one and a half to two millimetres long, and when those of contiguous radials are united the outline is more or less halberd-shaped, and they seemed to resemble more those of *P. pilula* than those of *P. ollula*.

The constriction of the calicinal centre is excellently shown on several specimens, some internal casts pure and simple, others in which the plates have been partially broken away; the constricted outline is distinctly hour-glass shaped.

I have succeeded in isolating the following plates:—The right and left anterior radials (Pl. xxxvii., fig. 9 and 11.), left posterior radial (Pl. xxxvii., fig. 8.), and the radianal (Pl. xxxvii., fig. 10).

Hand specimens of shale from the bed yielding the remains of *P. (?) yassensis* are full of stem ossicles of more than one crinoid, but those I believe to appertain to this species are very small, short, and oblong, unsculptured, with plain sutures, and a small apparently circular axial canal. They closely resemble the stem joints of *P. pilula*, as figured by Bather.<sup>20</sup>

The surface of the plates, when well preserved and unweathered, is fine-granulated or frosted. I believe this to be true sculpture as it is present on all the better preserved specimens. In this instance it certainly is not produced by weathering as suggested by Dr. Bather in the case of *P. pilula*.<sup>21</sup> The late Mr. S. A. Miller said that in perfectly preserved specimens of his *P. campana*<sup>22</sup> the surface was probably granular.

*Pisocrinus (?) yassensis* in no way resembles *P. pocillum*, Angelin,<sup>23</sup> specifically, and of the two other European species, *P. pilula*, De Kon.,<sup>24</sup> and *P. ollula*, Angelin,<sup>25</sup> it is certainly most nearly akin to the latter, for the basal plates do not show in a side view, or elevation of the calyx, as they do not only in *P. pilula*, but in the following American forms:—*P. gemmiformis*, S. A. Miller,<sup>26</sup> *P. pyriformis*, Ringueberg,<sup>27</sup> *P. globosus*,

<sup>20</sup> Bather—*Loc. cit.*, pl. i. f. 1.

<sup>21</sup> Bather—*Loc. cit.*, p. 28.

<sup>22</sup> Miller—Indiana. 17th Ann. Report Geol. and Nat. Resources for 1891 (1892), p. 642.

<sup>23</sup> Bather—*Loc. cit.*, pl. i., f. 20-23.

<sup>24</sup> Bather—*Loc. cit.*, pl. i., f. 1-11.

<sup>25</sup> Bather—*Loc. cit.*, pl. i., f. 12-19.

<sup>26</sup> Miller—Journ. Cincin. Soc. Nat. Hist., ii., 2, 1879, pl. ix. f. 6, 6 a-c.

<sup>27</sup> Ringueberg—*Triacrinus*, Proc. Acad. Nat. Sci. Philad. for 1884 (1885), pl. iii., f. 1, 1 a-e. Bather cannot distinguish this from the more conical vars. of *P. pilula*; probably a synonym.

Ringueberg,<sup>28</sup> *P. campana*, S. A. Miller,<sup>29</sup> and *P. benedicti*, S. A. Miller.<sup>30</sup> In addition to the same character separating the Australian Crinoid proper from *P. gorbyi*, S. A. Miller,<sup>31</sup> another American species, the projection of the five regular radials in this latter, which Mr. Miller described as "strongly lobed towards the tenons of the arm blades" will tend further to distinguish it. At the same time, this projection producing a sub-pentalobate outline indicates a transition towards our var. *c.* *Pisocrinus tennesseensis*, Roemer<sup>32</sup> was described from a specimen not sufficiently perfect to enable a comparison to be made.

It will be apparent from these comparisons that *P. (?) yassensis* need only be considered in its relations to *P. ollula*, Angelin. The difference between the two species lies chiefly in the form of the radials, which in *P. ollula* are said by Bather to be of the "same general shape as in *P. pilula*. That being the case we find as follows:—In *P. (?) yassensis* the l. post. R is hexagonal instead of heptagonal; the ant. R is six-sided only instead of eight-sided; R' is pentagonal and not heptagonal or "seven sided," and the apex of the plate is never produced into a process more or less separating the two smaller radials.

*P. (?) yassensis* has been found, as already explained, both at Limestone Creek, and at Hatton's Corner, near Yass.

*P. (?) YASSENSIS, var. LOBATA, var. nov.*

(Plate xxxvii., fig. 15.)

*Obs.*—I have separated a few specimens from the typical form on account of the greater convexity of the radials, and the projection of their outer ventral edges, giving rise to a pentalobate outline to the calyx, whether viewed from the dorsal or ventral aspects. This lobation is itself even open to variation, as it is much more pronounced in some than in others, and in one specimen may be said to be exaggerated. With this character there is a more or less corresponding transverse narrowing and longitudinal lengthening of the radial facets.

The variety has only been met with at Limestone Creek.

<sup>28</sup> Ringueberg—*Loc. cit.*, pl. iii., f. 2. 2 *a-d*. Bather says this is a mere var. or synonym of *P. gemmiformis*, S. A. Miller.

<sup>29</sup> Miller—Indiana. 17th, Ann. Rept. Geol. and Nat. Resources for 1891 (1892), pl. xi, f. 4 and 5.

<sup>30</sup> Miller—*Loc. cit.*, pl. vi., f. 13-16.

<sup>31</sup> Miller—*Loc. cit.*, pl. vi., f. 17-23.

<sup>32</sup> Roemer—Silurische Fauna W. Tennessee, 1860, pl. iv., f. 6 *a* and *b*.

## THE BREEDING HABITS OF THE FIGHTING FISH

(*Betta pugnax*, Cantor).

By EDGAR R. WAITE, F.L.S., Zoologist.

(Plate xxxviii.)

The life histories of several members of the Anabantidæ, have been investigated and the results of the observations made known. Special mention may be made of *Osphronemus*, *Polyacanthus* and *Trichogaster (Colisa)*. For our knowledge of the breeding habits of these interesting fishes we are mainly indebted to French naturalists, chief among whom stands M. Pierre Carbonnier.

Not having access to the whole of the literature of the subject I am unable to know if the life history of *Betta pugnax*, Cantor<sup>1</sup> has been described. A list of Carbonnier's papers will be found in the Royal Society's Catalogue of Scientific Papers.<sup>2</sup> Of these, one of the two following may contain some account of *Betta*:—

14. Importation de poissons exotiques, anabas, poissons combattants, gouramis. Soc. Acclim. Bull., i., 1874, pp. 526-529.

17. Reproductions de poissons exotiques. *Ibid*, viii., 1881, pp. 103-112.

The work cited does not appear to be in Australia, so that I may perhaps be excused if I publish matter already known. The term "poissons combattants" doubtless applies to *Betta*, but it may be noted that the name occurs under "Importation" and not under "Reproductions." The photograph of the nest of *Betta* here published will be of interest and is possibly unique.

The fishes, which I had under observation, were kindly obtained at my request by my friend Captain H. de C. Wethercrall, who procured them from Pinang during a voyage to the Strait Settlements. They reached my hands on April 5th. last, and on the following day the male commenced to blow the bubbles characteristic of the family. Rising to the surface a mouthful of air was taken and retained for two or three seconds, during which time it received a coating of mucous.

---

<sup>1</sup> Cantor—Cat. Malay. Fishes, 1850, p. 84, pl. ii. figs. 1-3.

<sup>2</sup> Cat. Sci. Papers, xii., 1902, p. 142.

The bubble thus formed was blown at the surface and the operation repeated until a circular mass was produced 75 mm. (= 3 inches) in diameter. Another layer of bubbles was next blown which had the effect of raising the first out of the water. Seven or eight layers were formed in all, but as the later bubbles were blown only under the central portion, a dome-shaped structure resulted. Leaves of duckweed and other small objects which happened to float over the area selected, were raised on the dome, but were there as the result of accident and not of design; they will be seen in the plate. So viscid is the secretion enclosing the bubble, that though exposed to the air for ten or twelve days it still fulfilled its function.

On the third day the nest was completed and breeding commenced. The period is apparently determined by the female; when the ova are ripe and possibly occasioning some discomfort she ascends to beneath the nest. Then takes place that marvellous display comparable to the actions of gallinaceous birds. The fins of the male are extended to the utmost, the gill membranes protruded and the blood-red gills exhibited beneath. The body and fins become resplendent with iridescent colours and quiver with intense excitement. The female thereupon approaches her mate and is turned upon her side. As he tightens his body round her, she becomes upside down. In three or four seconds the pressure is relaxed and the male assumes a position below.

The eggs are then extruded and caught by the pectoral and ventral fins where they remain for a few seconds, to ensure fecundation. They are next allowed to fall, being slightly heavier than water, when they are collected by the male waiting below. If the time is prolonged he will suck them in from the fins possibly to prevent their being taken by the female who promptly devours them. The male having given the eggs a coating of mucous, places them beneath the bubbles to which they adhere. From three to seven eggs are extruded each time, and the operation is repeated until from one hundred and fifty to two hundred are produced. The female is not allowed in the vicinity of the nest when laying is completed, and the male is untiring in his care of the eggs, constantly moving their position and recoating them with mucous.

On the third day the eggs hatched; the larvæ remained beneath the bubbles for some time but occasionally showed a tendency to sink; they were immediately taken in charge by the watchful father and replaced. In a day or two the numbers disposed to leave the shelter of the nest increased to such an extent that the



male could not possibly secure them all, though he frequently had seven or eight in his mouth at once. He would search for them at the bottom of the vessel and securing some, carry them to the surface and blow out a little mud with the larvæ. Many, however, were eaten by the female, and though the fishes bred on three occasions, at the end of a fortnight following, all the fry had disappeared. Possibly the weather proved too cold for the young, as it subsequently became for the adults, for they died also during the winter.

MINERALOGICAL NOTES: No. I.—TOPAZ, BERYL,  
VESUVIANITE, TOURMALINE, AND WOLFRAMITE.

By C. ANDERSON, M.A., B.Sc., Mineralogist.

(Plates xxxix.-xli.)

TOPAZ.

Topaz from New South Wales has been previously described by Hahn<sup>1</sup>, but I am unable to refer to his paper, and, as I am ignorant as to the localities and development of his specimens, it may be that this paper simply duplicates or falls short of his work. Nevertheless it is hoped that, besides being a description of specimens actually on view in the Australian Museum, the present paper will perhaps be useful to Australian Mineralogists to whom, as to the writer, the earlier work may not be available.

EMMAVILLE, NEW SOUTH WALES.

The collection of minerals lately purchased by the Trustees from Mr. D. A. Porter contains a large assortment of topaz, mainly small crystals, from an emerald mine at this well-known locality, which may be given more exactly as Glen Creek, seven miles N. by E. from Emmaville. It is associated with tinstone, beryl, and fluorspar in pegmatite, the occurrence having been already described by various observers<sup>2</sup>. The crystals are almost invariably clear and colourless, but do not seem to attain a large size, six of the better developed specimens averaging 7 mm. × 6 mm. × 5 mm. Two larger, doubly-terminated crystals, measured 13 mm. × 10 mm. × 8 mm., and 18 mm. × 9 mm. × 7 mm. respectively. The larger specimens are much less perfectly developed but show a greater proportion of doubly terminated crystals, which are rarely found in this species. Thus a collection of nineteen crystals specially picked on account of their suitability for goniometric measurement contained only one doubly terminated specimen, while no less than twelve were found in a collection of forty-four larger and less perfect crystals. The base, which is a constant feature in all the crystals I have examined though sometimes very small, is often pitted and dull. The faces in the prismatic zone are sometimes striated, but usually give good reflections; the unit prism, *m*

---

<sup>1</sup> Hahn—Zeits. Kryst., xxi., 1893, p. 337 (quoted 1st Appendix to the sixth edition of Dana's System of Mineralogy, 1899, p. 69).

<sup>2</sup> David—Anu. Rep. Dept. Mines for N.S. Wales for 1891 (1892), pp. 229-234; Curran—Journ. Roy. Soc. N.S. Wales, xxx., 1897, pp. 244-247, pl. xiv.

(110) generally predominates. One crystal showed a well-developed brachypinacoid (010), which on two others appeared as a very narrow plane. The rare macropinacoid (100) was not recognised. The brachydome  $f$  (021) seems to be invariably present. In all fifteen forms were identified:— $b$  (010),  $c$  (001);  $m$  (110),  $M$  (230),  $l$  (120),  $\pi$  (250),  $g$  (130);  $d$  (201),  $h$  (203),  $f$  (021),  $y$  (041);  $o$  (221),  $u$  (111),  $i$  (223),  $x$  (243) (in this as in the other species the lettering and axial ratios are according to Dana.); Pl. xxxix., fig. 3 shows all the forms except  $b$ . Five of the best and most typical crystals were measured on the Goldschmidt two-circle goniometer at the University of Sydney.

*Crystal I.*—(Pl. xxxix., fig. 1.) This crystal measures 9 mm.  $\times$  6 mm.  $\times$  5 mm. and may be described shortly as stout prismatic. The five forms in the prismatic zone are present in their full complement of four faces, excepting  $\pi$  which has only two. The prism  $m$  is the largest but the others are also well developed. The brachydome  $f$  is large,  $y$  is absent. The two faces of the macrodome  $d$  are present as small planes giving poor reflections. The base, relatively small owing to the large size of the brachydome, is rough and almost non-reflecting. Of the pyramids  $o$  and  $u$  have the full quota of faces, while  $i$  has only two.

The appended table shows the mean co-ordinate angles obtained, the crystal being placed in the conventional position with the zone-circle [021,001] as "prime meridian."

Form.		Measured.				Calculated.				Error.	
		$\phi$		$\rho$		$\phi$		$\rho$		$\phi$	$\rho$
		o	l	o	l	o	l	o	l	l	l
$c$	001	—	—	—	—	—	—	—	—	—	—
$m$	110	62	6 $\frac{1}{2}$	90	2	62	8	90	0	1 $\frac{1}{2}$	2
$M$	230	51	34	90	2	51	35	90	0	1	2
$l$	120	43	24	90	0	43	25	90	0	1	0
$\pi$	250	37	10	89	58	37	7	90	0	3	2
$g$	130	32	14	90	$\frac{1}{2}$	32	14	90	0	0	$\frac{1}{2}$
$d$	201	89	6	60	1	90	0	61	0	54	59
$f$	021		3 $\frac{1}{2}$	43	37	0	0	43	39	3 $\frac{1}{2}$	2
$o$	221	62	12	63	50	62	8	63	54	4	4
$u$	111	62	12	45	41	62	8	45	35	4	6
$i$	223	62	10	34	8	62	8	34	14	2	6

*Crystal II.*—(Pl. xxxix., fig. 2).—This specimen illustrates another common type. The dimensions of the crystal are 5 mm.  $\times$  7 mm.  $\times$  6 mm. Only three prisms are represented  $m$  (110)  $M$  (230) and  $l$  (120), of which  $m$  and  $l$  are the largest. The two brachydomes  $f$  and  $y$  are small as are the three pyramids, and the basal pinacoid is proportionately large. The brachypinacoid  $b$  (010) is present as a very small plane. There are also indications of one, or perhaps two, macrodomes, but they do not give images. The faces as a rule give good reflections, and the measured angles agree well with the calculated values.

*Crystal III.*—(Pl. xxxix., fig. 3).—This is the best crystal in the Museum collection, and shows a somewhat different habit. It measures 7 mm.  $\times$  4 mm.  $\times$   $2\frac{1}{2}$  mm. Fourteen forms were recognised. Of the prisms  $m$  (110) greatly predominates, and it has two parallel faces much larger than the others, so that the crystal might be described as tabular on these faces. The domes  $f$  and  $y$  are about equally developed and small, while the base, which is unusually smooth and brilliant, is large. The pyramids  $o$ ,  $u$ , and  $i$  are comparatively narrow, while in addition there are two small faces of the brachypyramid  $x$  (243). The macrodomes  $d$  and  $h$  are very small, and are each represented by one plane.

Crystal III. and another of similar habit were selected for the determination of the refractive indices and optic axial angle; as the values obtained were practically equal for the two, the results from both are combined in order to find the means. The indices  $\gamma$  and  $\beta$  were measured on a Fuess vertical axis goniometer, using the faces of  $m$  as a refracting prism, and fitting the telescope with a nicol prism. By viewing the signal successively through  $m$  and  $m'$ , and  $m''$  and  $m'''$ , making several determinations, and taking the mean of the best results, values which are at least reasonably correct were obtained. The three indices were also determined by the method of total reflection; sodium light was employed in all cases.

The optic axial angle for sodium light was measured in the usual apparatus on the universal stand carrying the vertical axis goniometer. The mean values of the indices having been found, a liquid was prepared consisting of cinnamic aldehyde, index 1.619, and bromoform, index 1.600, in such proportions as to have a refractive index equal to the value found for  $\beta$ . The crystals were immersed in this in a small glass tank with parallel walls. In this way the acute and obtuse angles  $2V_a$  and  $2V_o$  could be successively measured. In order to correct errors of observation and adjustment, successive readings were taken by revolving the crystal several times in one direction, and

determining the position of axial emergence from each end, and both sides of the crystal. The temperature was 17°-20° C. Subsequently the refractive index of the liquid was re-determined and found to be the same as before. The result for refractive indices and axial angles are combined in the table below

Refractive Indices.			Axial Angles.			
<i>a</i>	<i>β</i>	<i>γ</i>	2 <i>V</i> <sub>a</sub>		2 <i>V</i> <sub>o</sub>	
			°	'	°	'
1·6125	1·6163	1·6244	63	37	116	21
1·6143	1·6146	1·6212	63	33	116	29
1·6137	1·6166	1·6227	63	29	116	31
	1·6163	1·6229	63	21	116	27
		1·6229	63	32	116	38
Mean 1·6135	1·6160	1·6228	63	30	116	29

Thus the birefringence is ·0093.

From the mean refractive indices found the value of 2*V*<sub>a</sub> was calculated by the usual formula. The calculated value is found to be 62° 42' which agrees tolerably with the measured angle.

#### OBAN, NEW SOUTH WALES.<sup>3</sup>

At Oban topaz usually occurs as waterworn pebbles of rather large size; they are generally colourless but some have a bluish tint and when cut make handsome gems. When crystals are found, the faces are seldom good, being worn and dull; they sometimes show natural etch-figures, and what seem to be pre-erosion faces are occasionally developed. The basal plane is apparently rare, so that the crystals have either pointed terminations, or the large brachydomes meet in an edge.

*Crystal I.*—(Pl. xxxix., fig. 4).—The drawing shows the crystal in approximately its natural development; this is the best crystal from Oban in the Museum collection. Its colour is faintly bluish. The prism *l* is much larger than *m*, as can be seen on the unbroken side. There are indications of another prism between *m* and *l*, probably *M*, but, owing to striation, the measurement was unsatisfactory and the form is not figured. The dimensions

<sup>3</sup> Porter—Journ. Roy. Soc. N.S. Wales, xviii., 1885, p. 77; Curran—*Loc. cit.*, p. 245, pl. xiii., figs. 1, 2, 3.

are: 3 cm.  $\times$  3 cm.  $\times$   $2\frac{1}{2}$  cm. approximately. The brachydome  $y$ , which is only seen on one side, is very small;  $f$  is large, and its two faces meet in a long edge. The three pyramids  $o$ ,  $u$ , and  $i$  are present,  $u$  being the largest. Etch-figures are well seen especially on the domes. They seem to take the form on the dome faces of little rounded ridges, with a blunt termination towards the apex of the crystal, and tapering off, towards the other end. The forms were identified by the contact goniometer, the angles determined being as under:—

Angle.		Measured.		Calculated.		Error.	
		o	'	o	'	o	'
$m \wedge m'''$	$110 \wedge \bar{1}\bar{1}0$	56	30	55	43		47
$l \wedge l'''$	$120 \wedge \bar{1}\bar{2}0$	92	0	93	10	1	10
$f \wedge f'$	$021 \wedge 0\bar{2}\bar{1}$	86	0	87	18	1	18
$f \wedge y$	$021 \wedge 041$	18	0	18	41		41
$m \wedge o$	$110 \wedge 2\bar{2}1$	27	0	26	6		54
$m \wedge u$	$110 \wedge 111$	45	0	44	25		35
$m \wedge i$	$110 \wedge 2\bar{2}3$	57	0	55	46	1	14

*Crystal II.*—(Pl. xxxix, fig. 5.).—It measures 4 cm.  $\times$  4 cm.  $\times$   $3\frac{1}{2}$  cm. and is essentially similar to Crystal I. save that it is of a more pronounced bluish tint, and wants  $y$ ,  $o$ , and  $i$ . The etch-figures are similar to those of the first.

Dr. A. S. Eakle refers to an Australian crystal of topaz in the collection of the U.S. National Museum which from his description probably came from Oban<sup>4</sup>.

#### BERYL.

The occurrence of beryl and emerald at Emmaville has been known since 1890,<sup>5</sup> and considerable quantities have been cut and polished as gems. A large proportion of the stones is rather green beryl than emerald, the colour not being sufficiently deep. The crystals are comparatively simple, that shown in Pl. xl., fig. 1 being the most complex that has come under my observation. It is 2 mm. long by  $1\frac{1}{4}$  mm. in diameter, and the

<sup>4</sup> Eakle—Proc. U.S. Nat. Mus., xxi., 1899, p. 364.

<sup>5</sup> David—Ann. Rep. Dept. Mines N.S. Wales for 1891 (1892), pp. 229-234; Curran—Jour. Roy. Soc. N.S. Wales, xxx., 1897, pp. 238-244, pl. xv., fig. 1.

faces are developed in almost ideal symmetry, their relative sizes being approximately as represented in the figure. It is a combination of the unit prism  $m$  ( $10\bar{1}0$ ) with the unit pyramid  $p$  ( $10\bar{1}1$ ) and the diagonal pyramid  $s$  ( $11\bar{2}1$ ), truncated by the base. The co-ordinate angles obtained by measurement and the calculated values are as follows:—

Form.		Measured.				Calculated.				Error.	
		$\phi$		$\rho$		$\phi$		$\rho$		$\phi$	$\rho$
		o	l	o	l	o	l	o	l	l	l
$m$	$10\bar{1}0$	0	1	90	2	0		90	0	1	2
$p$	$10\bar{1}1$	0	7	29	55	0	0	29	57	7	2
$s$	$11\bar{2}1$	29	59	44	51	30	0	44	56	1	5

Three crystals of slightly larger size from Glen Creek, Emma-ville,<sup>6</sup> show the unit prism, a fairly large basal plane, a well developed diagonal pyramid, and only one small triangular face of  $p$  ( $10\bar{1}1$ ); so that, apparently, the usual form is a combination of the prism  $m$ , the base, and the diagonal pyramid, and, less commonly, the unit pyramid.

### VESUVIANITE.

Small but brilliant crystals of vesuvianite are found at Bowling Alley Point, Nundle, New South Wales, lining cavities in veins of massive garnet traversing serpentine.<sup>7</sup> A few crystals were carefully detached from the matrix and examined under a lens. They are remarkably uniform in development, all showing apparently the same combination, which is represented in ideal symmetry in Pl. xl., fig. 2. Owing to the small size of the faces it is impossible to do more than indicate their relative dimensions. The specimens may be generally described as long prismatic in habit, and yellowish green in colour. The forms present are the prism of the first order,  $m$  ( $110$ ), the prism of the second order,  $a$  ( $100$ ), with the unit pyramid  $p$  ( $111$ ), the pyramid  $t$  ( $331$ ), and the ditetragonal pyramid  $s$  ( $311$ ). Save

<sup>6</sup> Porter—Journ. Roy. Soc. N.S. Wales, xxii., 1889, p. 82, pl. i., figs. 8 and 9.

<sup>7</sup> Porter—*Loc. cit.*, xviii., 1885, p. 80; Liversidge—Minerals N.S. Wales, 1888, p. 204.

that it wants the basal plane the habit is essentially similar to that of the crystal from Zermatt figured by Dana after Penfield.<sup>8</sup>

Below are the co-ordinate angles obtained :—

Form.		Measured.				Calculated.				Error.	
		$\phi$		$\rho$		$\phi$		$\rho$		$\phi$	$\rho$
		o	'	o	'	o	'	o	'	'	'
<i>m</i>	110	89	50	90	1	90	0	90	0	10	1
<i>a</i>	100	44	56	90	2	45	0	90	0	4	2
<i>p</i>	111	45	10	37	25	45	0	37	14	10	11
<i>t</i>	331	45	0	66	15	45	0	66	19	0	4
<i>s</i>	311	18	38	59	30	18	26	59	32	12	2

#### TOURMALINE.

Tourmaline of gem quality has recently been discovered in the Hundred of Dudley, Kangaroo Island, South Australia. Mr. H. Y. L. Brown, Government Geologist, South Australia, says<sup>9</sup>:—"The stones are remarkable for their size and beauty, and after passing through the lapidary's hands form very handsome gems. The prevailing color is green in various shades, although some of the crystals have centres of a delicate pink color. Sales made show that the stones have commercial value in the rough, and the discovery bids fair to be of importance."

By the kindness of Mr. E. F. Pittman, Under-Secretary for Mines and Agriculture, New South Wales, and the good offices of Mr. G. W. Card, Curator and Mineralogist to the Geological Survey, I have been enabled to examine and measure some crystals of tourmaline from this locality on view in the Mining and Geological Museum, Sydney.

The six crystals examined in detail had been attached by one end, consequently show only one termination. Apparently they are of the usual columnar habit. The colour varies from practically opaque black at the apex, to transparent green towards the broken end, but there is no definite line of demarcation in the tint as is sometimes observed in tourmaline.<sup>10</sup> The faces in the

<sup>8</sup> Dana—System of Mineralogy, 6th Ed., 1892, p. 479, fig. 10.

<sup>9</sup> Brown—A Short Review of Mining Operations in the State of South Australia during the year 1903 (1904), p. 12.

<sup>10</sup> Bowman—Min. Mag., xiii., 1903, pp. 108-9.



prismatic zone are as usual rounded and striated, and in the figured specimens only the forms which were definitely recognised are taken account of. The commonest termination is evidently a combination of  $r$  and  $o$  simply,  $o$  predominating.

*Crystal I.*—(Pl. xl., fig. 3.)—It measures 7 mm. x 3 mm. Only one prism was clearly identified, namely the diagonal prism  $a$  ( $11\bar{2}0$ ). The crystal is terminated by  $r$  ( $10\bar{1}1$ ) and  $o$  ( $02\bar{2}1$ ). The latter in large, roughly triangular faces predominates,  $r$  being represented by narrow planes. All the forms are present in the full complement of faces.

Form.		Measured.				Calculated.				Error.	
		$\phi$		$\rho$		$\phi$		$\rho$		$\phi$	$\rho$
		$o$	$r$	$o$	$r$	$o$	$r$	$o$	$r$	$r$	$r$
$a$	$11\bar{2}0$	30	1	90	1	30	0	90	0	1	1
$r$	$10\bar{1}0$		2	27	30	0	0	27	20	2	10
$o$	$02\bar{2}1$	60	1	45	51	60	0	45	57	1	6

*Crystal II.*—(Pl. xl., figs. 4 and 5.)—This specimen, which is approximately of the same size as the last, is somewhat more complicated. It shows the two trigonal prisms  $m$  ( $10\bar{1}0$ ) and  $m$  ( $01\bar{1}0$ ), the diagonal prism  $a$  ( $11\bar{2}0$ ) the positive rhombohedron (trigonal pyramid)  $r$  ( $10\bar{1}1$ ), the negative rhombohedron  $o$  ( $02\bar{2}1$ ), and the scalenohedron  $u$  ( $3\bar{2}51$ ). The two rhombohedra are about equally developed while  $u$  is small.

An apparatus was improvised to test the crystals for pyroelectricity by Kundt's method. The result was to prove that in all six crystals the end with terminations becomes positively electrified on cooling. Hence the terminated end is the antilogous pole. On examining the crystals for pleochroism, it was found that the ordinary ray, vibrating perpendicular to the vertical axis, is almost completely absorbed, while the extraordinary ray, vibrating parallel to the axis, has a tint of apple to glaucous-green.

### WOLFRAMITE.

Wolframite is of common occurrence in New South Wales, but it is almost invariably massive. In fact crystallised specimens are, so far as I am aware, obtained only at the Wild Kate

Mine, near Deepwater. Mr. C. A. Süssmilch, Lecturer in Geology, Technical College, Sydney, was good enough to lend three crystals for description, and, from the Mining and Geological Museum four others were kindly given on loan for the same purpose. In Pl. xli, figs. 2 and 4 are drawn from the Geological Survey specimens, the original of fig. 3 belongs to Mr. Süssmilch; fig. 1 represents a crystal from the Museum collection.

The forms identified are :— $a$  (100)  $c$  (001),  $l$  (210)  $m$  (110,)  $t$  (102)  $y$  (102)  $f$  (011)  $w$  (111)  $o$  ( $\bar{1}11$ )  $\sigma$  (121)  $s$  ( $\bar{1}21$ ).

*Crystal I.*—(Pl. xli., fig. 1.)—This crystal measures  $3\frac{1}{2}$  cm. x  $2\frac{3}{4}$  cm. x 1 cm. It is developed in almost ideal symmetry and is so represented in the figure. The orthopinacoid  $a$  (100) is large, the two prisms  $l$  and  $m$  are approximately equal in size. The  $\sigma$  and  $s$  faces are well developed while  $f$  is comparatively small. The faces were measured with the contact goniometer, values being obtained as under :—

Angles.		Measured.		Calculated.		Error.
		o	'	o	'	'
$l \wedge l'''$	$210 \wedge 2\bar{1}0$	46	0	45	$4\frac{1}{2}$	$55\frac{1}{2}$
$m \wedge m''''$	$110 \wedge \bar{1}10$	79	0	79	23	23
$f \wedge f'$	$011 \wedge 0\bar{1}1$	82	0	81	54	6
$\sigma \wedge \sigma'$	$121 \wedge \bar{1}21$	99	30	100	3	33
$s \wedge s'$	$\bar{1}21 \wedge \bar{1}21$	100	0	100	41	41

The other crystals are drawn as nearly as possible according to their natural development, and call for no particular verbal description.

*Crystal II.*—(Pl. xli., fig. 2.) measures 5 cm. x 3 cm. x  $1\frac{1}{4}$  cm. It is the only specimen with the two orthodomcs  $t$  and  $y$  present. The crystal is much broken and the prism faces striated.

*Crystal III.*—(Pl. xli., fig. 4.) is cleaved and  $m$  is absent. On the left side of the drawing is a large cleavage plane parallel to  $b$ . Behind, it shows only  $a$  (100).

*Crystal IV.*—(Pl. xli., fig. 3.)—The dimensions are 2 cm. x 3 cm. x  $1\frac{1}{4}$  cm. It has the base present and is broken irregularly at both ends of the ortho-axis.

In conclusion, I desire to express my indebtedness to Mr. H. Stanley Jevons, M.A., B.Sc., F.G.S., Lecturer in Mineralogy and Petrology, in the University, Sydney, for much cordial assistance and advice.

---

Note—Since the above was written I have been able to obtain the paper on New South Wales Topaz, by Hahn, previously referred to. No locality is given, save New South Wales, but if the crystals are all from the same place, that place is probably Emmaville. Hahn recognised all the forms I have enumerated on Topaz from this locality, except the base and the pyramid  $x$ , but his combinations were evidently much simpler. Two crystals are figured, one showing the faces  $m, l, f, y, o, u, i$ , the other, the forms  $m, l, f, y, d, h, o, u, i$ .

2 E was determined on a cleavage plate in sodium light, and found to be  $113^{\circ} 18'$ .

A SECOND SAUROPTERYGIAN CONVERTED INTO  
OPAL, FROM THE UPPER CRETACEOUS OF  
WHITE CLIFFS, NEW SOUTH WALES.

WITH INDICATIONS OF ICHTHYOPTERYGIANS

AT THE SAME LOCALITY.

By R. ETHERIDGE, Jun., Curator.

(Plates xlii.—xlv.)

The discovery of the remains of *Cimoliosaurus leucoscopelus*, Eth. fil.,<sup>1</sup> in the White Cliffs Opal deposit has been followed by that of another Sauropterygian referable to *Cimoliosaurus*, closely allied to *C. sutherlandi*, McCoy<sup>2</sup>. The remains of this reptile have passed into the possession of the Trustees, by purchase, and are now described. The skeleton consists of the following parts:—Thirty-six vertebral centra, a number of rib pieces, a tooth, the distal end of a humerus, two femora, one nearly complete, and other fragments.

The mode of preservation is similar to that of *C. leucoscopelus*, the bones being converted into opal of one variety or another. In most instances the conversion is complete, but in a few cases traces of bone tissue still remain. Most of the centra are converted either into white opaque opal, or colourless translucent opal with blue patches, passing into indifferent "magpie" opal; here and there traces of precious opal make their

---

<sup>1</sup> Etheridge—Rec. Austr. Mus., iii., 2, 1897, p. 19.

<sup>2</sup> McCoy—Ann. Mag. Nat. Hist., (3), xix., 1867, p. 356; Trans. R. Soc. Vict., viii., 1, 1868, p. 42

appearance. In fact, this description will hold good for nine-tenths of the bones, the small cervical pleurapophysis (Pl. xlv., fig. 6 and 7) containing more precious opal than any of the other fragments. For richness of colour these bones bear no comparison with those of *C. leucoscopebus*.

*Vertebral Centra.*—The whole of these are faintly amphicœlous, but in some cases the double cupping is so faintly marked that the anterior and posterior articular surfaces may be described as amphiplatamous, and many with a marked central boss, but without any trace of peripheral rugosity. In outline the articular surfaces vary from oval to ellipsoidal—the anterior cervical and dorsal oval, the posterior cervical (? pectoral) ellipsoidal—and the lateral surfaces, speaking broadly, are slightly concave longitudinally. The ventral surfaces of the anterior cervical are rather flattened, and those of the pectoral (?) and dorsal convex in varying degree; from all the neural arches and pleurapophyses have been removed. The venous foramina are well marked and large, both dorsally and ventrally, whilst the central boss of the articular surfaces in the pectoral (?) and dorsal centra is not only large, but possesses a central depression of its own. The floor of the neural canal in the cervical centra is shown as a biconate scar, and on the pectoral (?) and dorsal as an hour-glass-shaped scar. The neurapophysial facets are ellipsoidal, deep, and more or less horizontal excavations on the anterior cervical centra, becoming broader as the column is descended, and there confined strictly to the dorsal surfaces of the bones. On the pectoral (?) centra these scars are even wider transversely, oblique, and descend on to the lateral surfaces, but on the dorsal centra, they, to all intents and purposes, again assume the same characters as those of the anterior cervicals; none of the neurapophyses are preserved *in situ*.

The pleurapophysial facets, or costal pits, are in every case single, and on the more anterior cervical centra are faint, elongated (fore and aft) scars, and situated low down on the lateral surfaces. On several of the centra, immediately in front of those I assume to be pectorals, these facets take on a very definite and rounded outline, showing a fractured projecting surface. On the pectoral (?) centra the pleurapophysial facets are compressed longitudinally, and project laterally. I distinguish the dorsal centra by the absence of these scars. There are three much worn centra, shorter (*i.e.* fore and aft), that may be caudals, although I cannot satisfactorily detect facets for the attachment of chevron bones.

The following are measurements of typical centra from the five parts of the column as here distinguished:—

Centrum.	Height of Centrum.	Width of Centrum.	Length (fore and aft) of Centrum.	Width of neuropophysial facet. (Transverse.)	Length of pleuropophysial facet (fore and aft).	Height of pleuropophysial facet.	Width of neural canal at centre of floor.
Anterior cervical	18 mm.	24 mm.	21 mm.	8 mm.	12 mm.	5 mm.	—
Median ...	31 mm.	43 mm.	30 mm.	18 mm.	16 mm.	10 mm.	—
Pectoral (?)	34 mm.	46 mm.	27 mm.	22 mm.	10 mm.	—	11 mm.
Dorsal ...	35 mm.	45 mm.	28 mm.	15 mm.	—	—	10 mm.
Caudal ...	26 mm.	37 mm.	17 mm.	11 mm.	—	—	9 mm.

The articular surfaces in the posterior cervical centra are practically flat; in the pectorals (?) there is a faint degree of concavity, whilst in the dorsal centra, the surface from the periphery for about one-fourth of the centrum diameter (longitudinally) is flat, the remainder of the surface within this margin, being slightly concave.

The venous foramina are close together on the venters of the anterior cervical centra, and far apart on the posterior cervical, pectoral (?), and dorsal centra, separated in some instances by an interforaminal flat or gently convex surface of from ten to fifteen millimetres; there is no dividing ridge, and on the dorsal surface only one foramen exists throughout the entire series of centra.

It is possible that the centra I have termed pectoral should be included in the cervical series proper, at the same time they to some extent agree with Mr. R. Lydekker's definition<sup>3</sup> of these bones, in having the costal articulation partly on the arch and partly on the centrum. In the present case the costal pits, although not strictly on the arch form one with the neurapophysial facets, as in the centra of *C. planus*, Owen<sup>4</sup> and which Sir Richard placed amongst the posterior cervicals.

*Neural Spines.*—Only two portions of detached neural spines remain. One, a cervical, is minus its apex, and below is broken off across the ceiling of the neural canal, but retains the fractured zygapophysial facets; in its present condition it is forty-one millimetres long, with a maximum fore and aft measurement of twenty-two millimetres. The other specimen is a very much stouter bone, with less of the spine proper remaining, but a larger proportion of the neural arch (Pl. xliii., fig. 3) and from its lateral spread, I am inclined to regard it as the remains of a dorsal spine, with the zygapophyses broken off.

*Pleurapophysis.*—In Pl. xliv., figs. 6 and 7 is represented a small bone, with a flat and spreading oblique base, a short constricted neck, and an expanded distal portion which is a little curved, gently convex on one side, slightly concave on the other. This want of bilateral symmetry removes it from the category of a neural spine, and I can only conclude that it is part of a cervical pleurapophysis. The length over-all is twenty-two millimetres, the width of the expanded portion fourteen millimetres, and the greatest diameter of the head nine millimetres.

*Pralange.*—Only one of these bones is present in the collection. It is short and stout, strongly hour-glass-shaped, twenty-one

<sup>3</sup> Lydekker—Nicholson's *Man. Pal.*, 3rd. Ed., 1889, p. 1068.

<sup>4</sup> Owen—*Mon. Foss. Reptilia Cret. Formations*, Suppl. iv., 1864, p. 3, pl. i., f. 5-7.

millimetres long, and nine millimetres in diameter at the median constriction, It closely resembles some of the phalanges of *C. leucoscopelus*.

*Ribs*.—Numerous pieces of ribs are present, fractured portions similar to those of *C. leucoscopelus*; typical examples will be found represented in the description of that species.

*Humerus*.—One fragment may be that of a portion of the distal end of a humerus exhibiting the greater part of an articular surface, and measures seventeen millimetres at its widest point (Pl. xlv., figs. 2 and 3), the breadth of articular surface being twenty-seven millimetres.

*Femora*.—Two bones, neither actually complete, accompany the other portions of the skeleton, which I believe are femora. They correspond in general outline with Owen's figure of the femur of *Cimoliosaurus neocomiensis*, Cpche<sup>5</sup>. One lateral edge of this bone is nearly straight, the other is concave. The proximal ends in both instances are lost, but the distal are fairly complete. The more complete of the two measures eighty-five millimetres in length, and forty-one millimetres transversely across the articular surface (Pl. xlv., fig. 1.)

*Tooth*.—Bones of the head are entirely wanting. One tooth, beautifully converted into translucent white and blue opal is present. It is defective at the base, but still measures twenty-two millimetres along the curve, and has a diameter of five millimetres at its stoutest part. The crown, gracefully curved, is thirteen millimetres long, with twenty-five sharp flutings, but leaving a longitudinal space on the arched or convex side devoid of ridges, but showing them in the opal-substance of the tooth; the apex of the crown is fine and acute. A similar bare track to the above is also present in the teeth of *Cimoliosaurus leucoscopelus*.

The present cervical centra generally resemble in outline those of the Liassic *C. rostratus*, Owen<sup>6</sup>, but still more those of our Australian *C. sutherlandi*, McCoy<sup>7</sup> (Pl. xlv., fig. 1.), as already stated, although in the present instance there is not even the hardly perceptible concentric depression of the articular surface visible in McCoy's species.

The outlines of the centra I have termed pectoral closely

<sup>5</sup> Owen—Mon. Foss. Reptilia Cret. Formations, Supl. iv., 1864, pl. vi., f. 12.

<sup>6</sup> Owen—Mon. Foss. Reptilia Liassic Formations, Pt. i., 1865, pl. x., f. 4 and 5.

<sup>7</sup> Etheridge—Ann. Rept. Dept. Mines N.S. Wales for 1887 (1888), pl. i., f. 1-4.



accord with those of *C. planus*, Owen<sup>8</sup>, from the Cambridge Greensand, but are more strictly oval, the neural canal is much wider, judging by its floor, and the pleurapophysial facets rather lower in position.

The dorsal centra are by no means unlike the mid-dorsals of *C. planus*, Owen<sup>9</sup>, but the neurapophysial facets are proportionally longer (fore and aft) to their width. Like the cervical centra of *C. neocomiensis*, Cpche<sup>10</sup>, they possess a central mammilla. Speaking of this species Owen said:—"I am inclined to think that the mammillate character of the terminal articular surfaces shown in the cervical vertebræ may, like other characteristic modifications, be less strongly manifested in the dorsal vertebræ, or in some of the dorsal vertebræ of the same individual<sup>11</sup>." If I am correct in referring the whole series of centra now described to one individual, we find such a modification carried to an extreme, in that the mammillæ are confined to the dorsal centra.

The three centra separated as caudal in position also present some features in common with those of *C. planus*.<sup>12</sup> They possess the same short fore and aft measurement, and a generally similar outline, but the neural canal floor is wider, and below the venous foramina closer together.

The identity of this reptile is a point of some difficulty, although the previously described opalized form *C. leucoscopelus* may be dismissed with brief remarks. Throughout the series of thirty-six centra there is not one that corresponds with the deeply amphiœolous articular surfaces of that species. Not only are the present centra amphiplatamous, but the relative proportions of height to breadth are quite dissimilar. In fact the two reptiles belong to different groups of the genus as defined by Lydekker<sup>13</sup>, *C. leucoscopelus* to the Cœlospondyline Group, the present fossil to the Typical Group. The relation of the latter to those bones named *Plesiosaurus sutherlandi* by the late Sir F. McCoy is the point at issue; this belongs to the second group and is a typical Cimoliosaurian. I have already figured<sup>14</sup>

<sup>8</sup> Owen—Mon. Foss. Reptilia Cret. Formations, Sup. iv., 1864, pl. i., f. 5-7.

<sup>9</sup> Owen—*Loc. cit.*, pl. i., f. 12-15.

<sup>10</sup> Owen—Mon. Foss. Reptilia Cret. Formations, Sup. iv., 1864, pl. vi., f. 1-11.

<sup>11</sup> Owen—*Loc. cit.*, p. 12.

<sup>12</sup> Owen—*Loc. cit.*, pl. 1, f. 16-19.

<sup>13</sup> Lydekker—Cat. Foss. Reptilia and Amphibia Brit. Mus., Pt. ii. 1889, p. 182 and 211.

<sup>14</sup> Etheridge—Ann. Report Dept. Mines N. S. Wales for 1887 (1888), pl. i., f., 1-4.

a cervical centrum of this species, and now give (Pl. xlv., fig. 1) as a means of further comparison an illustration of a reproduction of a typical cervical vertebra of *C. sutherlandi*, with nearly flat articular surfaces, a portion of the neural arch, and pleurapophysial facets; this was supplied to me by Sir Frederick some years before his death. A glance will suffice to indicate how remarkably close is the resemblance between the latter and, in miniature, the corresponding bones of the present form. At the same time I may parenthetically remark that the degree of ellipsoidality is greater in the cervicals of *C. sutherlandi* than here. Either, therefore we are dealing with a small individual of McCoy's species, or a distinct although closely allied form.

McCoy believed his *C. sutherlandi* to be "most nearly allied" to *C. australis*, Owen,<sup>15</sup> from New Zealand. In this species the terminal articular surfaces of the caudal vertebræ are "nearly flat, with obtuse margins, and a distinct central pit;"<sup>16</sup> the dorsal centra are a full oval with sharp edges, and two pairs of small foramina.

In another New Zealand species, *C. crassicosatus*, Owen<sup>17</sup>, which Lydekker unites<sup>18</sup> with *C. australis*, Owen, the cervical centra are a constricted oval in outline and moderately concave; the dorsal are more circular in outline and possess a central mammilla.<sup>19</sup>

Although there are some points of resemblance between the centra from White Cliffs and those of the previously described Australian and New Zealand species, there are equally well marked differences. I hardly think the former can be regarded as portions of a small individual of *C. sutherlandi*, McCoy. In the face of this element of doubt, and as marking a certain well-known geological horizon in our Cretaceous formation, I propose to call this reptile *Cimoliosaurus maccoyi*, in honour of my deceased friend, Prof Sir F. McCoy, F.R.S., &c.

#### OTHER BONES.

With the remains already described occur certain other bones that appear to be too large for inclusion with the former as portions of one reptile. They are as follows:—

*Humerus and Femur.*—Pl. xliii., fig. 5 is probably a portion of the proximal end of a humerus. It represents the greater part of an articular surface and a part of

<sup>15</sup> Owen—Brit. Assoc. Rept. for 1861 (1862), Pt. 2, p. 122.

<sup>16</sup> Hector—Trans. N.Z. Inst., vi., 1874, p. 340

<sup>17</sup> Owen—Geol. Mag., vii., 1870, p. 50, pl. iii., f. 4-5.

<sup>18</sup> Lydekker—Cat. Foss. Reptilia and Amphibia Brit. Mus., Pt. ii., 1889 p. 220.

<sup>19</sup> Hector—Trans. N. Z. Inst., vi., 1874, p. 342.

the expanded surface of the bone, which is grooved and pitted; across the former it measures thirty-four millimetres at its widest part. If Pl. xliv., figs. 2-3, represent a part of the humerus of *C. maccoyi*, it not only differs very widely from that of *C. leucoscophylus*, but belongs to a smaller individual than that now figured (Pl. xliii., fig. 5) as the distal end of a humerus. Pl. xliii., fig. 6 seems to be the proximal end of a femur. It consists of a rounded and slightly constricted head, with a portion of the shaft. In all, the fragment is one hundred and eighteen millimetres long, the head fifty-two millimetres in longest diameter, and the shaft fifty-seven millimetres a short distance below the constricted head.

*Pleurapophyses*.—These are two in number, and are stout slightly curved bones, with rather large expanded articular surfaces and roughly rhomboidal section. One side is sub-angular and convex, the other sub-angular and concave; the concave sides bear shallow grooves. The lengths are fifty-three and forty-six millimetres respectively, with greatest diameters of the shafts at the middle, of seventeen and eighteen millimetres respectively. Unless these are pleurapophyses of middle or post-cervicals I am unable to place them, with the material at my disposal for comparison.

*Ribs*.—Some of the rib pieces appear to be too large in comparison to the other bones of this skeleton, and may belong to another reptile; such are represented in Pl. xliv., fig. 8.

*Teeth*.—Some months ago Mr. A. E. Goldstein, a jeweller, of this city, submitted to me a fine opalized Sauropterygian tooth, a very beautiful object. It is seventy-eight millimetres long, and must represent a Plesiosaur of large dimensions; the length of the crown, less the apex removed, is forty-eight millimetres. The enamel ridges extend all round the crown, alternately larger and smaller, and appear to be equally well developed on all parts. A cast is preserved in this museum (Pl. xlv., fig. 2).

Later, the opalized crown of an equally large tooth was purchased by the Trustees. This fragment, less the apex again, is forty-five millimetres long, with the enamel ridges beautifully preserved, and as in the first instance longer and shorter alternately. Both specimens are from White Cliffs.

#### ICHTHYOPTERYGIAN REMAINS FROM WHITE CLIFFS.

The collection of the Mining and Geological Museum contains two small opalized centra from the column of an *Ichthyosaurus*, casts of which are deposited here. The form and dimensions, position of the diapophysial tubercles, and presence of hemapophysial scars, lead me to regard these centra as caudal in position.

These bones (Pl. xlv., figs. 4-7) are faintly octagonal in outline, markedly amphicoelous, very much antero-posteriorly compressed, with the sinking of the terminal articular face commencing at the peripheries to small central pits; there is no marginal convexity nor flattening. On the dorsal or neural side the centra are truncate, the remainder of the outline being rounded, but with a faint tendency to form seven other faces, two dorso-lateral, two mid-lateral, two ventro-lateral, and a ventral or hæmal. The peripheries, or edges, of the terminal articular surfaces project, leaving the sides of the centra concave. The truncated dorsal surface is twelve millimetres long (fore and aft), and eighteen millimetres wide. The neurapophysial joint surfaces, or facets, are deep and pit-like, five millimetres wide, and the floor of the neural canal, or myelonal surface is flat and eight millimetres in width. The di-parapophysial facets are situated at the bottom of the ventro-lateral angles of the centra; they are not sessile processes, or buttons, but again depressions or pits. The hæmapophysial facets are faintly indicated as long somewhat thickened inflexions of the peripheral edges. The vertical and transverse measurements are the same, forty-three millimetres.

The Trustees have obtained by purchase a third opalized centrum and portions of a fourth. These are highly amphicoelous, and exhibit both dia- and pleurapophysial tubercles. The dorsal surfaces of both, and the ventral surface of the more complete specimen (Pl. xlv., fig. 3) are too crushed to afford any characters. The consequent distortion renders measurements of little value, but as an indication of size, the more perfect is thirty millimetres in length (fore and aft), and sixty-nine millimetres between the dorsal and ventral margins. The peripheries of the terminal articular faces are prominent and sharp, and the lateral surfaces more or less excavate. In the better preserved specimen of the two, one of the neurapophysial facets is faintly outlined, and in juxtaposition to it is a well marked diapophysial tubercle, and below well separated from it, at about the middle of the centrum, and as near as possible in the middle line of the lateral surface is a well marked pleurapophysial tubercle. In consequence of the position of these facets, I take these to be anterior vertebræ,<sup>20</sup> and as to species closely allied to the centrum I formerly described as that of *I. australis*, McCoy,<sup>21</sup> from the Lower Cretaceous of Queensland, but occupying a more advanced position in the vertebral column.

<sup>20</sup> See Owen—Mon. Foss. Reptilia Liassic Formations, Pt. iii., 1881, pl. xxii., f. 1.

<sup>21</sup> Etheridge—Rec. Austr. Mus., iii., 3, 1897, p. 66.

I believe this to be the first notice of Ichthyopterygian remains from the White Cliffs Opal deposits.

SAUROPTERYGIAN OPALIZED REMAINS SO FAR DESCRIBED FROM  
WHITE CLIFFS.

Exclusive of the fossils treated of in the present paper, the following are the opalized bones described from White Cliffs, so far as they are known to me: —

CIMOLIOSAURUS LEUCOSCOPELUS, *Eth. fil.*

*C. leucoscopelus*, *Eth. fil.*, *Rec. Austr. Mus.*, iii., 2, 1897, p. 24, Pls. v.-vii. Large portion of the skeleton.

CIMOLIOSAURUS, sp.

*Sauropterygian vertebra*, *Eth. fil.*, *loc. cit.*, p. 22.

Half a centrum.

A centrum split medianally in the direction of its length (fore and aft). Both the terminal articular surfaces are concave, and the lateral surfaces are excavate or hollow. None of the apophyses are preserved. It is sixty-four millemetres in length, by fifty-four in height (dorsal to ventral), and is evidently a portion of a large vertebra.

CIMOLIOSAURUS (?), sp.

*Humerus of a Plesiosaurian*, Seeley, *Quart. Journ. Geol. Soc.*, liv., 1898, p. cvi.

Humerus.

On the 6th April, 1898, Prof. H. G. Seeley exhibited at a meeting of the Geological Society of London the "humerus of a Plesiosaurian" replaced by opal, from the "opal mines of New South Wales," rather a wide locality. "So far as he was aware, it was the only example of a fossil bone in this condition." My description of *Cimoliosaurus leucoscopelus* was published on 5th August, 1897.

CIMOLIOSAURUS, sp.

Centrum.

*Plesiosaurus*, sp., Gürich, *Neues Jahrb., Beil.-Bd.*, xiv., 1901, p. 492, pl. xix., f. 8a-d.

A cervical centrum, the terminal articular surfaces roughly hexagonal or roundly deltoid in outline, apparently slightly amphicelus, and the sides rather excavate. On the dorsal surface are two longitudinally elongated venous foramina close together, and the two deep neurapophysial facets separated by

a very narrow neural canal floor. The ventral, or hæmal surface bears a central hour glass-shaped fore and aft ridge bounded by a deep depression on each side, and on the flanks of the ridge are the two large and rather wide-apart venous foramina. The pleurapophysial facets, or costal pits, are large, situated latero-ventrally, and adjoin the deep depressions already mentioned; the position of these costal pits indicates this bone as a cervical centrum. The terminal articular surfaces appear to be more or less flat peripherally graduating inwards to a central hollow.

This centrum has some features in common with the corresponding centra of both *C. leucoscopus* and *C. maccoyi*.

NOTES ON THE ARCHITECTURE, NESTING HABITS, AND  
LIFE HISTORIES OF AUSTRALIAN ARANEIDÆ, BASED  
ON SPECIMENS IN THE AUSTRALIAN MUSEUM.

By W. J. RAINBOW, F.L.S., F.E.S., Entomologist.

(Figs. 37-38-39.)

PART IV.—ENTELEGYNÆ.

This group, according to Simon's classification embraces twenty-four families, many of which are exceedingly numerous in species and widely distributed. Indeed, some are cosmopolitan. The families occurring in Australia, so far as is at present known to me, are as follows:—

Drassidæ	Thomisidæ
Zodariidæ	Clubionidæ
Hersiliidæ	Agelenidæ
Pholcidæ	Pisauridæ
Theridiidæ	Lycosidæ
Mimetidæ	Oxyopidæ
Argiopidæ	Salticidæ.

In addition to these, two other families occur so close at hand, that it is quite possible representatives may yet be found in Australia also. They are:—*Prodidomidæ* and *Palpimanidæ*,

In connection with the first of these, the genus *Prodidomus*. Hentz, is widely distributed, its range being, "Regio mediterranea calid.; Hispania merid., Barbaria, Ægyptus et Syria; Africa occid.; Africa austr.; Arabia merid.; India orient; Nova-Caledonia; America sept. et merid.: Venezuela."<sup>1</sup> A second genus, *Zimiris*, E. Simon, is recorded by that author to contain three species, one of which occurs in "Arabia merid.,"<sup>2</sup> and another in India<sup>2</sup>; the third is a Malaisian form, but its habitat is uncertain.

The *Palpimanidæ* is represented in Malaisia and the Phillipines by the genus *Colopea*, E. Simon<sup>3</sup>, and this also by a single species, *C. pusilla*, E. Simon. Another genus, *Huttonia*, Cambr.,<sup>4</sup> occurs in New Zealand, and this also contains, so far as is known, only one species—*H. palpimanoides*, Cambr.

<sup>1</sup> Simon—Hist. Nat. des Araignées, 2nd Ed., i., 1892, p. 337.

<sup>2</sup> Simon—*Loc. cit.*, pp. 337, 338.

<sup>3</sup> Simon—*Loc. cit.*, p. 397.

<sup>4</sup> Simon—*Loc. cit.*, p. 398; Cambridge—Proc. Zool. Soc., 1879, p. 685.

## FAMILY DRASSIDÆ.

Simon divides the Drassidæ into four sub-families, viz.;—Hemicleinæ, Drassodinæ, Cithærominæ, and Cybæodinæ, and of these the two first named occur in Australia.

*Sub-family* HEMICLEINÆ.

Seven genera, six of which are distinct and one doubtful, are included in this sub-family, and of these, five are almost exclusively Australian. Of the foreign genera *Platyoides*, Cambr., occurs in South Africa, and *Trochanteria*, Karsch, published by Simon<sup>5</sup> under the heading, "Genus Invisum et Inerte Sedis," is recorded from Central America.

The *Hemiclea* were included by L. Koch in the Sparassid group, but naturalists now regard them as being of Drassid origin, and they have been so classified by Simon. Koch in his work, "Die Arachniden Australiens" records sixteen species under the generic name *Hemiclea*, Thor., but these have been revised by Simon<sup>6</sup> and distributed over four genera.

The genus *Hemiclea* occurs in Australia and New Zealand. They are dull-coloured, flat spiders, with legs so modified as to enable them to run forwards or sideways. They delight to lurk in nooks and crannies of rocks, and under the loose exfoliating bark of our native trees. By bushmen they have a bad reputation, which arises rather from prejudice or ignorance of their habits, than from any power to inflict injury. Naturally shy and retiring, these "triantelopes" as they are called, scuttle away to any safe retreat at hand, if disturbed. The Hemicleinæ do not construct webs for the capture of prey, but rush forth and seize any intruder whose temerity or curiosity lead it to invade such localities as indicated above. At night, however, these spiders sally forth in quest of prey, which they take either by stealth or pursuit. They, however, are not immune from attack, but are themselves hunted for by predatory beetles, centipedes, lizards, and birds. Their cocoons or ova-sacs vary in size according to the species; all are discular or cushion-shaped. *H. sundevalli*, Thor., constructs an ova-sac about 15 mm. in circumference and 3 mm. thick; it is slightly convex above; white; the outer covering consists of a very close texture which is strong and hard to tear; within the sac there is a little flocculent silk; the eggs are yellowish. Empty ova-sacs which I have examined have always had a small hole at the outer edge, through which the spiderlings after hatching out escaped. The

<sup>5</sup> Simon—*Loc. cit.*, p. 348.

<sup>6</sup> Simon—*Loc. cit.*, pp. 346, 347.



ova-sacs of those spiders frequenting trees are secured under the bark, sometimes attached to the latter, and sometimes to the trunk of the tree. This species has been recorded from Rockhampton, Port Mackay, and Sydney. *H. major*, L. K., one of the the largest species of the genus, occurs around Sydney. It is frequently met with in rock-shelters, in the nooks and crannies of which it seeks shelter. Koch has a note at the foot of his description<sup>7</sup> of the species, in which he says that there are two dried specimens and a good spirit specimen in the Museum at Stuttgart, from Sydney; also, the Godeffroy Museum possessed another example from Sydney, and this accompanied with an ova-sac measuring 22 mm. in circumference and 3 mm. in thickness; it was according to Koch, plano-convex, flat and smooth beneath, slightly arched above, rough, covered with coarse grit; the whole surrounded with a fine membrane. The animal lives under flat stones in rocky districts.

I have seen at different times many of these ova-sacs, but have never observed one covered with coarse grit—they were all clean and white; indeed, the one before me as I write is so. Nevertheless it is quite possible for a specimen to exhibit the peculiarity mentioned by Koch; it would, I take it, largely depend upon surroundings. The sac is always placed in a protected position, so as to secure it as far as possible from the attacks of predatory foes. This, however, does not always secure it from the raids of ants, for the latter frequently break through the tough silky covering for the purpose of robbing the eggs.

For the reception of Koch's *Hemiclæa lugubris*, Simon established the genus *Rebilus*.<sup>8</sup> This species occurs around Sydney, but it has also been recorded from Bowen. The genus is remarkable for the form of its spinnerets, by which it may be easily distinguished. These organs were delineated by Simon in his work, and are here refigured to assist those students to whom the work quoted is inaccessible (Fig. 37.). These hairy creatures are also found under stones in rocky situations.

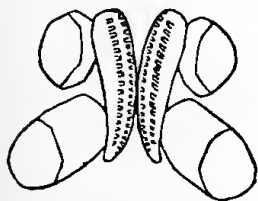

Fig. 37.  
Spinnerets, *Rebilus*  
*lugubris*.

The northern form described by Thorell under the name of *Hemiclæa somersetensis*<sup>9</sup> is unknown to me. This species also came in for revision by Simon, who founded the genus *Hemiclæcina*<sup>10</sup> for its reception, and of which it is the sole representative.

<sup>7</sup> Koch—Die Arach. Aust., i., 1871, p. 625.

<sup>8</sup> Simon—Hist. Nat. des Araignées, 2nd Ed., i., 1892, p. 346

<sup>9</sup> Thorell—Studi sui Rag. Mal. e Papuani, 1881, iii., p. 307.

<sup>10</sup> Simon—Hist. Nat. des Araignées, 2nd Ed., i., 1892, p. 346.

Thorell's specimen was collected at Somerset, Cape York, by D'Albertis, but nothing is said as to its life history.

*Prynus*<sup>11</sup>, Simon, was established for the reception of Koch's *Hemiclœa fulva* and *H. flavitarsus*, of which the former is indicated as the type of the genus. Koch gave no locality for *P. fulva*, but merely remarked: <sup>12</sup>“Ein Exemplar in Mr. Bradley's Sammlung.” Many of Mr. Bradley's specimens were collected around Sydney; probably this was one of them. The type of *P. flavitarsus* was collected at Sydney. Simon, in defining this

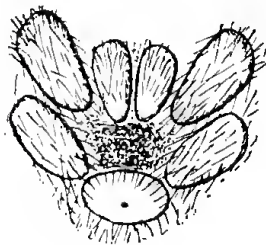

Fig. 38.  
Spinnerets, *Prynus flavitarsus*.

genus, wrote: <sup>13</sup>“Genus ignotum, a *Rebilo*, cui valde affine est, tantum differt, secundum L. Koch, cephalothorace paulo latiore quam longiore,” and added a footnote to the effect that Koch had not described the spinnerets. In the specimen before me—*P. flavitarsus* (Fig. 38)—the spinnerets are short, tubiform, and clothed with long, coarse hairs; the upper pair are slightly longer and stouter than the lower; the median pair are very

short, simple, and conical; the group occupies a somewhat quadrangular area. Koch's example of *P. flavitarsus* was an immature form, he was unable, therefore, to describe or figure the epigyne; this organ is now figured (Fig. 39.).

*Trachycosmus*,<sup>14</sup> Simon, is a Tasmanian form, and includes only one species, *T. sculptus*, Simon.

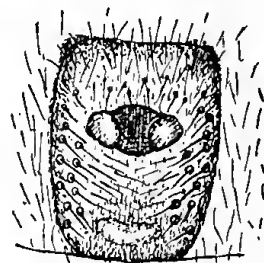

Fig. 39.  
Epigyne, *Prynus flavitarsus*.

#### *Sub-family* DRASSODINÆ.

This is an exceedingly difficult group, and will give much trouble before anything like order is established. A number of species described as *Drassus* certainly belong to other genera, and sometimes other families, and many of these errors have been unavoidable. Simon records five genera as occurring in Australia, three of which are widely distributed, whilst two are peculiar to this continent.

The range of the genus *Drassodes*, Westr., is given as<sup>15</sup> “Orbis utriusque reg. subtrop et frig.” It has been divided into several groups. Of these “Group D,” to which Simon is of

<sup>11</sup> Simon—*Loc. cit.*, p. 347.

<sup>12</sup> Koch—*Die Arach. Austr.*, i., 1871, p. 619.

<sup>13</sup> Simon—*Hist. Nat. des Araignées*. 2nd Ed., i., 1892, p. 347.

<sup>14</sup> Simon—*Loc. cit.*, p. 347.

<sup>15</sup> Simon—*Loc. cit.*, p. 359.

opinion the majority of our native forms belong, has for its type *D. perexiguus*, Simon, of New Caledonia. *D. invenustus*, L. K., and *D. silaceus*, L. K., occur in the vicinity of Sydney.

The *Drassodes* are variable in size and are usually of a yellow or reddish-brown colour, clothed with satiny pubescence. They are invariably found under stones. The habits of our native species have not been completely studied, but their ova-sacs are discular, with the upper and under surface slightly convex; the texture is strong, rather difficult to tear, and white. The female usually rests close by, guarding her cocoons.

*Obs.*—Mr. H. R. Hogg has described<sup>16</sup> an interesting form which he places provisionally in the genus *Drassus*, Walck. This species, *D. debilis*, Hogg, was collected at Macedon, Victoria, and the reader is referred to the description and comments.

The range of *Euchemus*, Simon,<sup>17</sup> is "Europa merid.; Africa sept., occid. et austr.; India; ins. Taprobane; Nova Hollandia; America antillana et andina." To this genus *Drassus dilutus*, L. K., recorded from Rockhampton, and *D. griseus*, L. K., "Neuholland," probably belong. Nothing has been recorded of their life histories.

*Melanophora*, C. Koch, has a wide range<sup>18</sup>: "Orbis utriusq. reg. temp. et calid." L. Koch's *Prothesima*<sup>19</sup> is a synonym. One species, *M. (Prothesima) flavens*, L. K., is described and figured by L. Koch in his standard work on Australian Araneidæ.<sup>20</sup> This species was recorded from the Swan River. The genus is rich both in species and individuals, about one hundred and fifty forms from different parts of the world having been described. It is quite possible that other species will hereafter be made known from Australia.

*Lampona*, Thor., is an exclusively Australian genus. Koch has described and figured eleven species.<sup>21</sup> I have taken these spiders from under stones and loose bark. They are not flat creatures like the *Hemichleina* group. The cephalothorax is longer than wide, somewhat ovate and either black or reddish-brown; legs short, robust, concolorous; abdomen oblong, convex, pubescent, dull-coloured, sometimes ornamented with large whitish spots, in addition to which there is frequently present a small whitish spot at the extremity—just above the spinnerets.

The *Lampona* are active spiders, and take their prey by pursuit. They construct cells in convenient nooks. The silk of

<sup>16</sup> Hogg—Proc. Roy. Soc. Vict., xiii., 1900, p. 90.

<sup>17</sup> Simon—Hist. Nat. des Araignées, 2nd Ed., i., 1892, p. 370.

<sup>18</sup> Simon—*Loc. cit.*, p. 373.

<sup>19</sup> Koch—Abhand. naturalist, Ges. Nürnberg, v., 1872, p. 139.

<sup>20</sup> Koch—Die Arach. Austr., i., 1871, p. 393, pl. xxx., figs. 9, 9a, 9b

<sup>21</sup> Koch—*Loc. cit.*, pp. 372-379, pls. xxviii. and xxix.

which these cells is constructed is opaque, white, gauzy, and of a close texture. The tissue is not very strong, and is easily torn. The female when about to deposit her eggs, which are of a yellowish colour, spins a sheet of web over the surface of the stone, timber, or bark, as the case may be, but always in a secluded place. Upon this sheet of silk the eggs are deposited. The latter, being sticky, readily adhere. When the task of ovipositing is complete a thin sheet of white transparent gauzy silk is spun over the whole. The eggs are further protected by the female constructing her dwelling cell over them, so that during the period of incubation they are never left unguarded, for the anxious parent will not desert them for an instant, even for food. Should prey come her way she will take it, but not at the risk of leaving her eggs unprotected. This I have proved by keeping them in captivity for observation purposes. *L. sordida* recorded by Koch from "Neuholland" constructs its cell or "retreat tube" under loose bark. I have collected it at Tempe, near Sydney. *L. fasciata*, L. K., was originally recorded from Port Mackay, but there are examples in our cabinets from Jenolan and Sydney. *L. obscura*, L. K., and *L. murina*, L. K., occur around Sydney. The former has been recorded from the Swan River and the latter by Koch from "Neuholland."

The last Australian genus of this family is *Gnaphosoides*, Hogg, and it is represented by a single species, *G. signatus*, Hogg. This is a Victorian form,<sup>22</sup> the species having been collected at Macedon.

#### FAMILY ZODARIIDÆ.

The family Zodariidæ is represented in Australia by two sub-families—Cryptothelinæ and Zodariinæ. Of these the first-named contains only one genus, whilst the second contains thirteen genera, as enumerated by Simon.

#### Sub-family CRYPTOHELINÆ.

The range of *Cryptothele*, L. K., was defined by Simon<sup>23</sup> as "Ins. Seychellæ; ins. Taprobane; penins. Malayana; Nova-Guinea; ins. Latronum; ins. Viti et Samoa." To this distribution I now add Fitzroy Is., Great Barrier Reef, N. Queensland, for there in 1901 my colleague, Mr. Charles Hedley, collected *C. doreyana*, Simon, a New Guinea species.

This genus, as will be noted from above, is a distinctly tropical one, so that the occurrence of *C. doreyana* on Fitzroy Island, considering how close it is to New Guinea, is only what one

<sup>22</sup> Hogg—Proc. Roy. Soc. Vict., xiii., 1900, p. 92.

<sup>23</sup> Simon—Hist. Nat. Araignées, 2nd Ed., i., 1892, p. 422.

might expect. The genus is a limited one in point of species, seven only having been recorded. Nothing is known of their habits.

Sub-family ZODARIINÆ.

The genus *Storena*, Walck., is widely distributed, its range being <sup>24</sup>“Regio mediterranea occid. et orient; Africa trop.; Indo-China; Malaisia; N. Guinea; N. Hollandia; N. Caledonia et Polynesia; Amer. septentr., æquator et australis.”

This genus is well represented in our native Arachnid fauna. Koch described<sup>25</sup> and figured a number of forms under the generic name of *Habronestes*, L. K., but this, however, has been sunk by Simon as a synonym.

The *Storena* are rather small spiders and bear some resemblance to the Lycosid group. The eyes of the species are very varied, no two forms being quite alike; they, therefore, present an admirable means for specific determination. The cephalothorax is strongly arched, black, and glossy; the legs are robust and moderately long; the abdomen ovate, arched, glossy and ornamented with white or yellow spots and markings.

Nothing is known of the life-history of these spiders. They are ground-running and very active. I have found that disturbing forest debris, such as accumulations of dead branches and leaves, is a good method of bringing these animals to light when collecting. They probably construct silken retreat tubes in secluded nooks. Our Australian species have been described chiefly by Koch<sup>26</sup> and Cambridge<sup>27</sup>; Walckenaer<sup>28</sup> described one; Hogg<sup>29</sup> described another; and I have described one.<sup>30</sup>

*Obs.*—Since the above was written, Mr. Frank Taylor, of Belmore, has presented to the Trustees a living specimen of *Storena albomaculata*, mihi, and this was kept alive for three or four days. During the interval it constructed its ova-sac and deposited its eggs. The sac is nearly round and measures 48 mm. in circumference. It consists of an upper and lower layer of closely-knitted, tough, shining papyraceous silk. Between these layers the eggs, of which there are about thirty, are deposited. The latter are grouped together, spherical, and orange-yellow.

*Obs.*—Mr. Hogg has described a Victorian species for which

<sup>24</sup> Simon—*Loc. cit.*, p. 429.

<sup>25</sup> Koch—*Die Arach. Austr.*, i., 1871, pp. 299-321, pl. xxv.

<sup>26</sup> Koch—*Loc. cit.*

<sup>27</sup> Cambridge—*Ann. Mag. Nat. Hist.*, (4), iii., 1869, pp. 52-59, pl. iv.

<sup>28</sup> Walckenaer—*Tabl. des Aranéides*, 1805, p. 83, pl. ix., figs. 85 and 86.

<sup>29</sup> Hogg—*Proc. Roy. Soc. Vict.*, xiii., 1900, pl. xiv., fig 4.

<sup>30</sup> Rainbow—*Proc. Linn. Soc. N.S. Wales*, xxvii., 1902, p. 485, pl. xviii., figs. 1, 1a.

he erected the genus *Storenosoma*,<sup>31</sup> and in the diagnosis he points out wherein it differs from the Egyptian and Syrian *Laches*, Thor., and *Storena*, Walck. Simon, however, contends that *Storenosoma* is a synonym of *Storena*,<sup>32</sup> but states no reason for regarding it as such. I have not had the good fortune to see a specimen of Hogg's *Storenosoma* but there appears from the author's description sufficient reason to justify at least sub-generic rank. The type of Hogg's genus is *S. lycosoides*. Five specimens were collected at Macedon.

#### FAMILY HERSILIIDÆ.

This is a very small family, embracing only four genera; of these one occurs in Australia, and that includes only three species, two of which were described by L. Koch<sup>33</sup> and one<sup>34</sup> by myself.

The Hersiliidæ are all striking forms, and may easily be distinguished by their spinnerets, which are characteristic. The superior spinners are very long; the basal joint is robust, cylindrical, and exceeds the entire length of the other spinnerets, whilst the terminal joint is tapering, and in the genera *Hersilia*, Aud. in Sav., and *Tama*, Simon, very long and attenuated.

The genus *Tama*, Simon, to which our Australian species belong, is distributed over "Africa septentr.; Asia occid.; Malaisia; N.-hollandia; America merid.: Venezuela, Paraguay."<sup>35</sup> The two forms described by Koch were assigned to the genus *Chalinura*, Dalm. Simon, in a footnote,<sup>36</sup> points out that *Chalinura* was proposed by Dalman for an Araneid (*C. longipes*) found in copal gum, and that it is contemporaneous with the genus *Hersilia*, Aud. in Sav., and further, that it is difficult to decide which name has priority.

Simon, in commenting upon their habits, says that the *Hersilia*<sup>37</sup> are found on trunks of trees and old walls, where their colouration, grey or whitish, is beneficial, by enabling them to conceal themselves; they do not make a web. *Tama*, Simon, and *Hersiliola*, Thor., are found under stones or in fissures of rocks, and construct an irregular web after the manner of spiders of the genus *Pholeus*, Walck.

<sup>31</sup> Hogg—Proc. Roy. Soc. Vict., xiii., 1900, p. 95, pl. xiv., fig. 3.

<sup>32</sup> Simon—Hist. Nat. des Araignées, ii. (Supp. Gén.), 1903, p. 987.

<sup>33</sup> Koch—Die Arach. Austr., ii., 1883, pp. 827-830, pl. lxxi, figs. 1 and 2.

<sup>34</sup> Rainbow—Proc. Linn. Soc. N. S. Wales, xxv., 1900, p. 485, pl. xxiii., figs. 1, 1a.

<sup>35</sup> Simon—Hist. Nat. des Araignées, i., 1892, p. 446.

<sup>36</sup> Simon—*Loc. cit.*, p. 440.

<sup>37</sup> Simon—*Loc. cit.*, pp. 444 and 445.

Simon's observation of the habits of *Tama* does not quite agree with mine so far as our Australian forms are concerned. Specimens collected by me at Balmoral, Sydney, were taken from the trunks of Eucalyptus trees, the grey bark of which they closely simulated. I have also collected them in other localities, and have always found them on trees; indeed I have never met with them on rocks, even in districts where the latter was plentiful, nor have I observed webs constructed by them. By their movements, which are exceedingly rapid, I should say that they relied upon their dexterity for food. At the foot of his description of *T. (Chalinura) nova-hollandiæ*, Koch added a short note<sup>38</sup> to the effect that that species was collected at Sydney by Mr. Bradley from shrubs and plants, but that no webs were found.

The native forms of this family are *Tama nova-hollandiæ*, L. K., Sydney; *T. fickerti*, L. K., Sydney; and *T. eucalypti*, mihl, Balmoral.

---

<sup>38</sup> Koch—Die Arach. Austr., ii., 1883, p. 830.

## STUDIES IN AUSTRALIAN ARANEIDÆ.

No. 3.

By W. J. RAINBOW, F.L.S., F.E.S., Entomologist.

(Plate xlv. ; text figs. 40, 41 and 42).

### Family HYPOCHILIDÆ.

#### Genus ECTATOSTICA, Simon.

The occurrence of this family and genus in the Australian region furnishes another interesting example in connection with our terrestrial fauna. The family is a very small one, comprising, so far as is known, only two genera, of which the above named is one, and *Hypochilus*, Marx, the other. Of these genera, the first contains two species, one of which (*E. davidi*, Simon) occurs in China, and the other (*E. troglodytes*, Higg. and Pett.) in Tasmania. Simon has briefly described an immature form, *E. australis*<sup>1</sup>, also from Tasmania, but this is, I doubt not, synonymous with the species described by Higgins and Petterd as *Theridion troglodytes*<sup>2</sup>. *Hypochilus* is a North American genus, and *H. thorelli*, Marx, the type.

The genus *Hypochilus* was founded by Marx<sup>3</sup> in 1888, and was included by that author in the family Pholcidae; but in the following year Hypochilidæ was erected for its reception,<sup>4</sup> Marx pointing out in two interesting papers, the importance of the structural characters of *Hypochilus* in the classification of the Araneidæ.

The interesting feature in connection with the Hypochilidæ is the presence of *four* pulmonary sacs similar to the Theraphosid group.

Simon had not, apparently, seen the "Proceedings of the Royal Society of Tasmania" for 1883, and even if he had it is questionable whether he would have detected in the form described by him in 1902, any affinity with that described by Higgins and Petterd in 1883. Indeed, it would have been surprising if he had, for the description of *Theridion troglodytes*

---

<sup>1</sup> Simon—Bull. Ent. Soc. France, 1902, p. 240.

<sup>2</sup> Higgins and Petterd—Proc. Roy. Soc. Tas., 1883, p. 191.

<sup>3</sup> Marx—Entom. Amer., iv., 1888, No. 8.

<sup>4</sup> Marx—Proc. Ent. Soc. Washington, i., 1889, pp. 166, 167 and 178, 179.



was, as was usual with old descriptions, so brief as to be little better than useless. The description contains no reference to the pulmonary sacs, the cribellum, chelicers, or eyes. Moreover, Higgins and Petterd's paper "Description of a New Cave-inhabiting Spider, together with Notes on Mammalian Remains from a Recently Discovered Cave in the Chudleigh District," was never listed in the "Zoological Record." In 1883 the Arachnid portion of that publication was vacant, and in 1884 the recorder had apparently overlooked it, or had, as is not unlikely, not seen the volume containing the description. In 1887 Morton published his "Register of Papers and Proceedings of the Royal Society of Tasmania from the year 1841 to 1885," and in that list on page 45 appears the record of Higgins and Petterd's paper, and this is apparently the only occasion on which it was referred to in print.

The armature of the chelicers in the Tasmanian form differs somewhat from the generic diagnosis laid down by Simon, which is as follows:—"Chelarum margo inferior dentibus minutissimus 5-6 remotis (spatio inter 2° et 3° latiore), margo superior dentibus subcontiguus 9 (7-8 exceptis) validis."<sup>5</sup> In the species under discussion the dentition on the inferior margin is very fine, and appears merely as though granulated, whilst the superior margin is armed with five strong teeth. In other respects, however, *E. troglodytes* agrees with Simon's generic definition, and I would therefore suggest that the diagnosis of *Ectatostica* be amended so as to include *E. troglodytes*, and with this object in view I would propose as follows:—

Inferior margin of falx granulated or armed with a series of minute teeth; superior margins armed with a series of from 5 to 9 strong teeth.

ECTATOSTICA TROGLODYTES, *Higg.* and *Pett.*

(Plate xlvi., fig. 1-4.)

*Theridion troglodytes*, Higgins and Petterd, Proc. Roy. Soc. Tas., 1883, p. 191.

*Ectatostica australis*, Simon, Bull. Ent. Soc. France, 1902, p. 240.

♀ Cephalothorax 8·8 mm. long, 5·4 mm. wide; abdomen, 11·3 mm. long, 8·7 mm. wide, 10 mm. high.

*Cephalothorax*.—Obovate, shining, moderately arched, fuscous. *Pars cephalica* arched, truncated in front, highest near the middle, sloping backwards towards junction of thoracic segment, normal

<sup>5</sup> Simon—Hist. Nat. des Araignées, i., 1892, p. 204.

grooves distinct, a few hairs scattered over the surface. *Pars thoracica* arched, very deeply depressed at centre, radial grooves present but not strongly marked; sides declivous; surface moderately hairy.

*Eyes*.—Eight, disposed in two transverse rows, nearly parallel, and constituting three series of 2, 4, 2; of these the medium series form a trapezium, the front pair being the smallest, diurnal, and nearly contiguous; the posterior pair are nocturnal and are separated from each other by a space which is equal to rather more than their individual diameter; the lateral pairs are also nocturnal and are as large as the posterior median eyes, or nearly so; they are contiguous and seated upon tubercles; each lateral eye is separated from its median neighbour by a space equal to about twice its individual diameter.

*Legs*.—Long, tapering, concolorous with cephalothorax; trochanters sparingly clothed with fine hairs on the underside and armed with rather long, fine, lateral spines, patellæ smooth, those of the first and fourth pairs have a rather long and deep longitudinal groove near their apex; femurs similar in clothing to trochanters, but armed with longer and stronger spines; metatarsi more densely hairy than preceding joints, and armed with long, strong spines; tarsi hairy, superior claws long, strong, curved, and armed with several teeth; inferior claw shorter, and armed at base with two teeth. Measurements (in millimetres):—

Leg.	Coxa.	Trochanter and Femur.	Tibia and Patella.	Metatarsus and Tarsus.	Total.
1	3·2	22·5	25·4	26·2	77·3
2	3·1	21·7	19·0	23·5	67·3
3	2·6	15·0	14·3	16·2	50·8
4	2·7	17·3	18·9	20·0	58·9

*Palpi*.—Similar in colour and armature to legs. Measurements: Coxa, trochanter, and femur, 5·7 mm.; patella and tibia, 4·8 mm.; tarsus, 3·7 mm.; total, 14·2 mm.

*Falces*.—Dark brown, shining, strong, arched, apices divergent, inner margins densely hairy; superior margin of the furrow of each falx armed with five strong teeth; inferior margin granulated.

*Maxillæ*.—Long, arched, concolorous, margins of inner angles yellowish and densely hairy.

*Labium*.—Concolorous also, rather longer than broad, widest at the base, apex truncated and hairy.

*Sternum*.—Reddish-brown, arched, elliptical, truncated in front, obtusely pointed at rear, thinly clothed with short black hairs.

*Abdomen*.—Ovate; overhanging base of cephalothorax, pubescent, strongly arched, of a tawny-olive tint; interior surface furnished with long hairs, concolorous, with the exception of the four pulmonary sacs which are yellowish. *Anal tubercle* large, obtusely triangular. *Cribellum* entire, transversely oval. *Spinnerets*.—Inferior cylindrical, widely separated at their base, apices truncated and rounded; superior conical, two-jointed, about same length as inferior, but not so stout; intermediate pair much smaller than their neighbours, contiguous.

*Hab.*—Mole Creek Caves, Tasmania.

Higgins and Petterd added an interesting note to their description to the effect that a "male was found on a stalactite, and the female on her globular nest, which hung from the roof, by a comparatively slender thread. The nest, which was about the size of a pigeon's egg, and contained a large number of young, as well as many unhatched eggs, was found on a white crystalline web, which scintillated when the light was placed near it, producing a strikingly beautiful effect. The nest was tightly surrounded by the legs of the female."<sup>6</sup>

In a letter Mr. Petterd informs me that the type specimens are in the Tasmanian Museum, Hobart; also that the species is fairly common in shallow sandstone caves on the banks of the Pieman River, Tasmania. The female constructs an egg-shaped casing for the eggs, and this cocoon is suspended from the roof of the cave by a thin web, the mother hanging over it for the protection of eggs and young.

#### *Family* MIMETIDÆ.

The species hereunder described constitutes the first record of this family from Australia. In his work, "Histoire Naturelle des Araignées,"<sup>7</sup> Simon has explained the affinities and characters of this small family, and to this work the student is referred. The genus *Mimetus*, Hentz, to which the species under discussion is attached, has a wide geographical range, Simon defining it

<sup>6</sup> Higgins and Petterd—Proc. Roy. Soc. Tas., 1883, p. 198.

<sup>7</sup> Simon—Hist. Nat. des Araignées, 2nd Ed., i., 1892, p. 940.

as:—"Regio mediterr.; Africa trop. et austr.; India; Nova Zealandia, Amer. sept. et austr.,"<sup>8</sup> and to this distribution I now add Jenolan Caves District, New South Wales.

*Genus* MIMETUS, *Hentz.*

MIMETUS MACULOSUS,<sup>9</sup> *sp. nov.*

(Plate xlvi., figs. 5 and 6; text figs. 40, 41, 42.)

♂ Cephalothorax, 3.5 mm. long, 2.6 mm. broad; abdomen, 3.6 mm. long, 2.9 mm. broad; falx, 2 mm. long.

*Cephalothorax*.—Obovate, arched, attenuated in front, pale yellow with a few dark brown spots. *Pars cephalica* arched, sloping forward, truncated in front, furnished with a few long, strong hairs, sides declivious, normal grooves distinct. *Pars thoracica* smooth, broad, strongly arched, medium depression deep; a few short hairs distributed over the surface.

*Eyes*.—Eight, arranged in three series of 2, 4, 2; of these the four comprising the median series form a trapezium, of which the anterior pair are diurnal and the largest of the group; the latter pair are separated from each other by a space scarcely equal to once their individual diameter; they are again separated from the posterior pair by a space which, whilst being still greater than that which separates them from each other is still not quite equal to their individual diameter; lateral eyes oblique, contiguous; anterior laterals separated from anterior medians by a space equal to rather more than the individual diameter of one of the latter, and the posterior laterals from the posterior medians by a space sensibly greater; anterior median eyes are elevated upon a rather large, tubercular eminence, and the laterals upon small tubercles.



Fig. 40. *Mimetus maculosus*, section of tibia of one of 1st pair.

*Legs*.—Long, tapering, sparingly hairy, armed with long, straight spines, yellow, with dark-brown spots; the lower half

<sup>8</sup> Simon—*Loc. cit.*, p 947.

<sup>9</sup> *Maculosus*, spotted, speckled, stained.

of the tibiæ, and the whole of the metatarsi of the first and second pairs have, on the inner side, a special armature (Fig. 40) which consists of a series of small, strong curved spines situated between the longer ones; of the curved spines the upper one is always the smallest, and each succeeding one is larger than its predecessor. Measurements (in millimetres):—

Leg.	Coxa.	Trochanter and Femur.	Patella and Tibia.	Metatarsus and Tarsus.	Total.
1	1·0	9·1	11·1	13·6	34·8
2	1·0	7·5	8·5	10·2	27·2
3	0·7	4·9	4·4	5·4	15·4
4	0·7	6·3	5·2	6·2	18·4

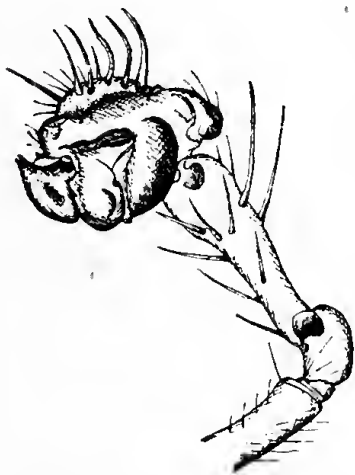

Fig. 41. *M. maculosus*.  
Palpus of ♂.

*Palpi*.—Pale yellow, femur sparingly clothed with a few short hairs, and the tibia with long strong bristles; at the base and apex of the latter there is, on the outer side, a deep cavity; bulb dark brown, complicated and furnished with hairs and long, strong bristles (Fig. 41.) Measurements:—Coxa, 0·1 mm.; trochanter and femur, 2·4 mm.; patella, tibia, and bulb, 2·2 mm.; total, 4·7 mm.

*Falces*.—Dark brown, shining, long, cylindrical, apices divergent (Fig. 42.).

*Maxillæ*.—Long, reddish-brown, except at inner angles and tips where they are whitish; they are furnished with a few long hairs or bristles; scopulæ at inner angles short, black.

*Labium*.—Long, broad at base, coniform, arched, concolorous.

*Sternum*.—Cordate, arched, furnished with a few long hairs or bristles, shining, yellow, marginal depressions brownish.

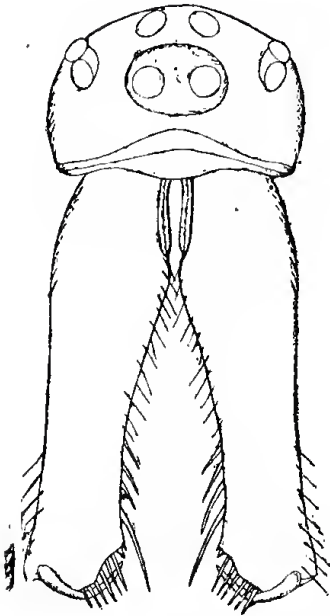

Fig. 42. *M. maculosus*.  
Eyes and Falces; front  
view.

*Abdomen*.—Ovate, strongly arched, overhanging base of cephalothorax, yellowish-grey with large dark brown markings and small yellowish spots, clothed with long coarse hairs.

One mature and two immature examples.

♀ Cephalothorax, 4·7 mm. long, 2·8 mm. wide; abdomen 4·7 mm. long, 3·5 mm. wide; falx 2·6 mm. long.

The female differs very immaterially from the male in general appearance; it is but very little larger than the latter, and the same scheme of colouration, clothing, and armature prevails. The *abdomen* is ovate, nearly globose, and the colouration is somewhat varied in the different examples. We have six specimens of this sex, all of which are mature, and each of these differ, some being much darker than others, so that the yellowish spots referred to in the description of the male stand out more prominently; the dark brown markings also differ both in number, size, and distribution. The *epigyne* is simple and seated on a tubercular eminence.

*Legs*.—These also vary in colouration in different individuals, some being more mottled than others. Measurements of largest specimen as follows:—

Leg.	Coxa.	Trochanter and Femur.	Patella and Tibia.	Metatarsus and Tarsus.	Total.
1	1·1	9·5	11·3	14·0	35·9
2	1·0	8·0	10·0	12·3	31·3
3	0·8	5·5	5·2	6·5	18·0
4	0·8	6·3	7·0	7·5	21·6

*Palpi*.—Yellow, clothed with long hairs. Measurements:—Coxa, 0·4 mm.; trochanter and femur, 1·6 mm.; patella and tibia, 2 mm.; tarsus, 2·2 mm.; total, 6·2 mm.

*Hab*.—Jenolan Caves District.

## Family CLUBIONIDÆ.

## Sub-family MICARIINÆ.

Two genera, namely *Pæcilipta* Simon, and *Corinnomma*, Karsch, are herein recorded from New South Wales for the first time. Of these, the former is, so far as is at present known, exclusively Australian, its recorded range being "Nova Hollandia septentrionalis;"<sup>10</sup> *Corinnomma* is distributed according to Simon as follows:—"Africa orient. æthiop. (*olivaceum*, E. Sim.); ins. Taprobane; Asia trop. orient.; Malaisia et Papuasias; ins. Philippinæ; N. Hollandia sept. (*suavcrubens*, E. Sim.)"<sup>11</sup>. To these localities I now add: *Pæcilipta venusta*, mihi, and *Corinnomma formiciforme*, mihi, Enfield, near Sydney, New South Wales. The species of both these genera are remarkable from the fact that they have a prominent *scutum* on the superior surface of the abdomen and this casts bright metallic reflections. The *Corinnomma* mimic ants.

## Genus PÆCILIPTA, Simon.

PÆCILIPTA VENUSTA<sup>12</sup>, sp. nov.

(Plate xlv., figs. 7, 8, 9.)

♀ Cephalothorax 2·7½ mm. long, 1·5 mm. wide; abdomen 4·3 mm. long, 2·3 mm. wide; petiole, 0·4 mm. long.

*Cephalothorax*.—Ovate, arched, smooth, ochraceous-rufus, caput with purple reflection; *marginal band* narrow, dark brown. *Pars cephalica* arched, truncated in front, sides declivous, retreating rearwards, normal grooves distinct. *Pars thoracica* strongly attenuated posteriorly, median and radial grooves distinct. *Petiole* ochraceous-rufus.

*Eyes*.—Eight, distributed over two rows, of which the anterior is straight or nearly so, and the posterior curved, the curvature directed backwards; anterior lateral eyes distinctly the smallest of the series, the others large and of equal size; the posterior median eyes are separated from their anterior neighbours by a space equal to one-and-a-half times their individual diameter, and from each other by a space equal to rather more than once their own individual diameter; the posterior lateral eyes are separated from the posterior medians by a space equal to once their own individual diameter; the anterior laterals are also separated from the anterior medians by a space equal to once

<sup>10</sup> Simon—Hist. Nat. des Araignées, 2nd Ed. ii., 1897, p. 173.

<sup>11</sup> Simon—*Loc. cit.*, pp. 173 and 174.

<sup>12</sup> *Venusta*, charming, beautiful, graceful.

their own individual diameter, and the latter from each other by a space equal to rather more than one-half their own individual diameter.

*Legs.*—Long, tapering, each clothed with short hairs and armed with long, straight spines; the femurs have, in addition, two long straight spines on the upper surface; the first and second pairs have the femurs concolorous with cephalothorax, and the patellæ, tibiæ, metatarsi, and tarsi pale yellowish; the third and fourth pairs of legs have dark brown femurs, patellæ yellowish, tibiæ and metatarsi yellowish at junction of preceding joint, but otherwise dark brown; tarsi yellowish. Measurements (in millimetres):—

Leg.	Coxa, Trochanter and Femur.	Patella and Tibia.	Metatarsus and Tarsus.	Total.
1	2.1	1.8	2.7	6.6
2	2.0	1.7	2.6	6.3
3	1.9	1.6	2.5	6.0
4	3.1	3.0	4.1	10.2

*Palpi.*—Pale yellowish, similar in clothing and armature to legs. Measurements:—Coxa, trochanter and femur, 0.8 mm.; patella and tibia, 0.9 mm.; tarsus, 1.2 mm.; total, 2.9 mm.

*Falces.*—Concolorous, long, arched, robust, pubescent, inner angles thickly clothed with long dark hairs.

*Maxillæ.*—Yellowish, inner angles white; long, robust, arched; inner angles thickly clothed with dark hairs.

*Labium.*—Concolorous, broad, arched, apex truncated, and furnished with rather long dark hairs.

*Sternum.*—Cordate, arched, orange-red, sparingly hairy.

*Abdomen.*—Elongate-ovate, pubescent, yellowish with a dark-brown lateral patch in front on each side of the scuta; just beyond the middle there is on each side a large triangular patch of dark brown, the upper points of which unite. *Scuta* situated in front, black with steel-blue reflections. Inferior surface dark brown above the epigastric fold, thence yellowish-grey to near posterior extremity where it becomes black; laterally the colour is yellowish grey for rather more than half its length from whence it becomes suddenly black, the black patches gradually broadening until they unite above the spinnerets. *Epigyne* a



simple structure elevated upon a small tubercular eminence as depicted in figure.

*Hab.*—Enfield, near Sydney; collected by Dr. E. P. Ramsay, October, 1904.

*Genus* CORINNOMMA, *Karsch.*

CORINNOMMA FORMICIFORME<sup>13</sup>, *sp. nov.*

(Plate xlvi., figs. 10, 11, 12.)

♀ Cephalothorax, 2.1 mm. long, 1.1 mm. broad; abdomen, 2.3 mm. long, 1.1 mm. broad; petiole, 0.4 mm. long.

*Cephalothorax.*—Oblong-ovate, arched, yellowish, caput with purple reflection. *Pars cephalica* arched, truncated in front, normal grooves distinct, ocular area black, hairy. *Pars thoracica* arched, attenuated at rear, median and radial grooves distinct. *Petiole* long, yellowish.

*Eyes.*—Eight, seated upon a slightly raised almost quadrangular eminence, distributed over two widely separated transverse rows; lateral eyes slightly smaller than their median neighbours, the two anterior eyes are separated from each other by a space equal to one-half their individual diameter, and each from their posterior neighbour by two-and-a-half times their individual diameter; anterior laterals separated from the anterior medians by rather more than once their individual diameter; posterior laterals separated from posterior medians by a space equal to once their individual diameter.

*Legs.*—Yellowish, long, pubescent, and armed with long, straight spines; each femur has also two long straight spines on the upper side. Measurements (in millimetres):—

Leg.	Coxa, Trochanter and Femur.	Patella and Tibia.	Metatarsus and Tarsus.	Total.
1	2.0	2.2	2.6	6.8
2	1.9	1.7	2.5	6.1
3	1.5	1.6	1.8	4.9
4	2.2	2.5	2.8	7.5

<sup>13</sup> So named in reference to its ant-like form.

*Palpi*.—Similar in colour and armature to legs. Measurements:—Coxa, trochanter and femur, 11 mm.; patella and tibia, 0·9 mm.; tarsus, 0·9 mm.; total, 2·9 mm.

*Falces*.—Robust, arched, hairy, apices divergent, pale yellowish.

*Maxillae*.—Concolorous, shining, long, arched, inner margins clothed with black hairs.

*Labium*.—Concolorous also, shining, broader than long, apex truncated.

*Sternum*.—Concolorous also, shining, elliptical, obtusely pointed behind, arched, lateral depressions distinct, sparingly pubescent.

*Abdomen*.—Oblong, constricted just beyond the middle, black, with a narrow grey transverse bar intercepted by the scuta in front, and a broad grey transverse bar at the constricted zone; there is also a large grey patch at posterior extremity. *Scuta* large, smooth, with steel-blue reflections. *Epigyne* as in figure.

*Hab*.—Enfield, near Sydney; collected by Dr. E. P. Ramsay, October, 1904.

## ORNITHOLOGICAL NOTES.

By ALFRED J. NORTH, C.M.Z.S.

Ornithologist, Australian Museum.

### I.

The Short-billed Honey-eater (*Melithreptus brevirostris*, Vig. and Horsf.), although not so uniformly distributed in the neighbourhood of Sydney as the Lunulated Honey-eater (*Melithreptus lunulatus*, Shaw), is fairly common in some localities. Except in the breeding season, it is usually met with in small flocks of about seven to twelve or more in number, and generally attracts one's attention by its peculiar grating or rasping notes as it passes from tree to tree.

During many years' observation I have noted a seasonal change in the colour of the bare space above and behind the eye. Adult specimens of both sexes obtained during July and August by the Curator, Mr. R. Etheridge, the Taxidermist, Mr. J. A. Thorpe, and myself, at Sutherland and Toongabbie, had the bill black, the legs and feet reddish-brown, the sides and soles of the feet ochreous yellow, and the bare space above and behind the eye pale greenish-blue. Adult examples obtained by me at Roseville from January to April inclusive, all had the bill, legs and feet of the same colour as specimens obtained in July and August, but the bare space above and behind the eye was dull yellow. The last example procured was an adult female, on the 7th January, 1904, shot together with a fledgeling Pallid Cuckoo (*Cuculus pallidus*, Lath.), that had only then recently left the nest of the foster-parent, in a tree close to my house. These specimens have been mounted together and placed in the Exhibit Collection. A similar seasonal change occurs in the colour of the bare space around the eye of the adult male of the Fig-bird (*Sphecothebes maxillaris*, Lath.); this part in the winter being pale buffy-yellow, and in the breeding season a uniform rich red. The comb too of the Lotus-bird or Comb-crested Parra (*Hydractator gallinaceus*, Temm.), Mr. G. Savidge informs me, in the autumn is yellow, but at the time of my visit to the Clarence River during the breeding season in November, all the birds I saw had the comb red.

## II.

Among several skins forming part of a collection made on Lord Howe Island and submitted to me for examination by Mr. J. B. Waterhouse, M.A., Head Master of the High School, Sydney, was a remarkably fine specimen of Latham's Snipe, (*Gallinago australis*, Lath.). It was obtained by Mr. Waterhouse's sons, during a stay on the island from August to October in 1903. This species breeds in Japan and winters in Australia and Tasmania; arriving in New South Wales, from which Lord Howe Island lies about four hundred miles due east, in the middle of August and departing again about the end of February or March. I can find no previous record of *Gallinago australis* being obtained on Lord Howe Island.

## III.

From Dr. P. Herbert Metcalfe, Resident Medical Officer at Norfolk Island, the Trustees have received from time to time the skins of avian visitors to that outlying insular dependency of New South Wales. Last mail brought a skin of the Silver-eye (*Zosterops lateralis*, Latham, = *Z. caerulea*, of Gould's Handbook of Australian Birds), with which Dr. Metcalfe sent me the following note:—"I am sending you the skin of a small bird for identification. Large flocks of the same visited the Island this year. It is a species of *Zosterops*, but it is much smaller than either of our two found here, *Z. tenuirostris* and *Z. albigularis*. It is a curious fact that almost always when we saw a flock of the bird like that we sent, especially when on the grass, there was what we call here a Sparrow, *Symphoricarpos leucopygius*, Gould, in the middle of it."

Previously Dr. Metcalfe forwarded skins of two birds procured on the island. One was the Goldfinch (*Carduelis elegans*, Stephens), and the other an immature example of the Starling (*Sturnus vulgaris*, Linn.) Both of these European species are acclimatised in Australia, and are common in the neighbourhood of Sydney. From the unusual prolificness of the latter it is almost certain to prove a pest. The same day that five fledgelings left a nest built under the roof of my house, towards the end of October, 1904, the parents commenced to carry in fresh nesting material, and four weeks later I saw them taking in food and heard the noise of young ones.



EXPLANATION OF PLATE I.

---

*Fossopora wellingtonensis*, Eth. fl.

- Fig. 1. Tangential section exhibiting the highly thickened and partially obliterated corallites. x 7.
- Fig. 2. Transverse section of the axial region showing the outlines of the corallites distinctly, and the six septa in each, etc. x 7.

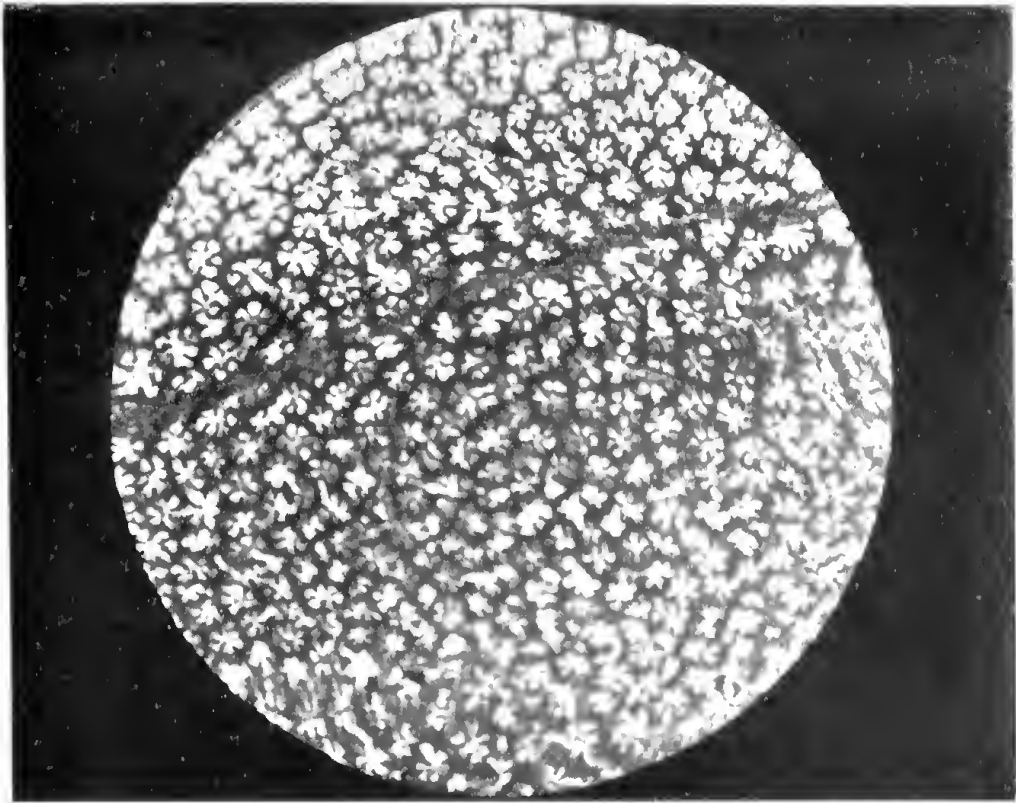

2

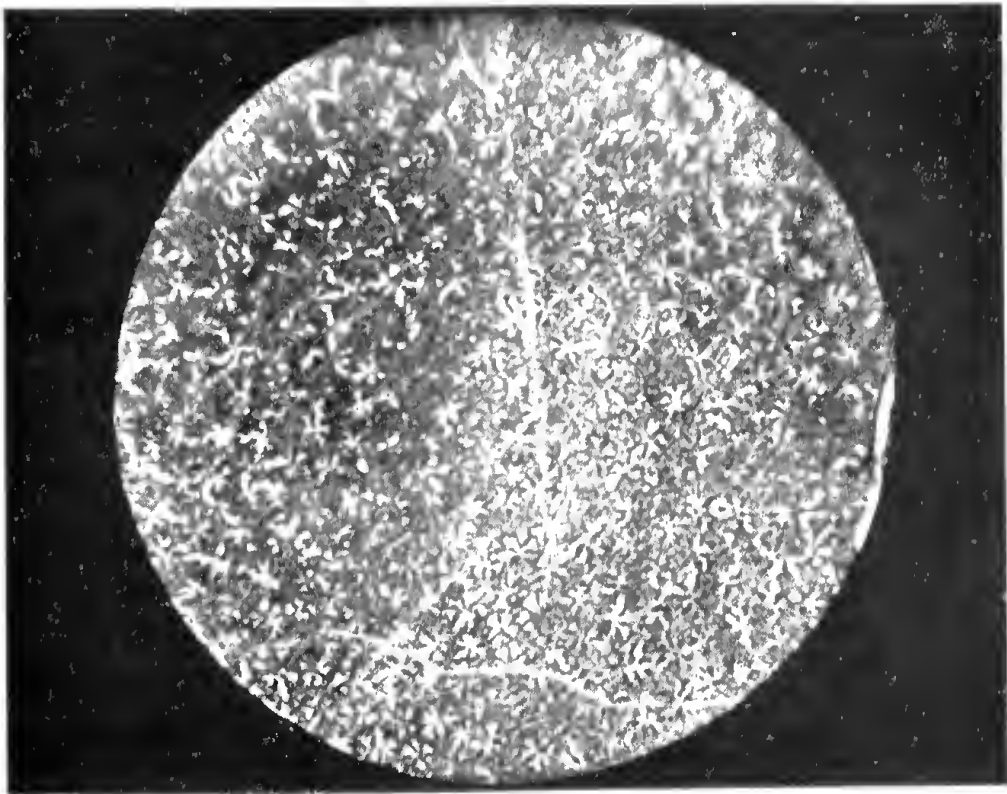

1







## EXPLANATION OF PLATE II.

---

*Fossopora wellingtonensis*, Eth. fil.

- Fig. 1. Longitudinal section exhibiting somewhat thickened tissues, but the walls, tabulæ, and mural pores distinctly visible. The bistructural nature of the septa is also apparent, sometimes as continuous vertical laminæ in the visceral chambers, at others as interrupted lines and dots. x 7.
- Fig. 2. A similar section with large and very distinct mural pores. x 7.

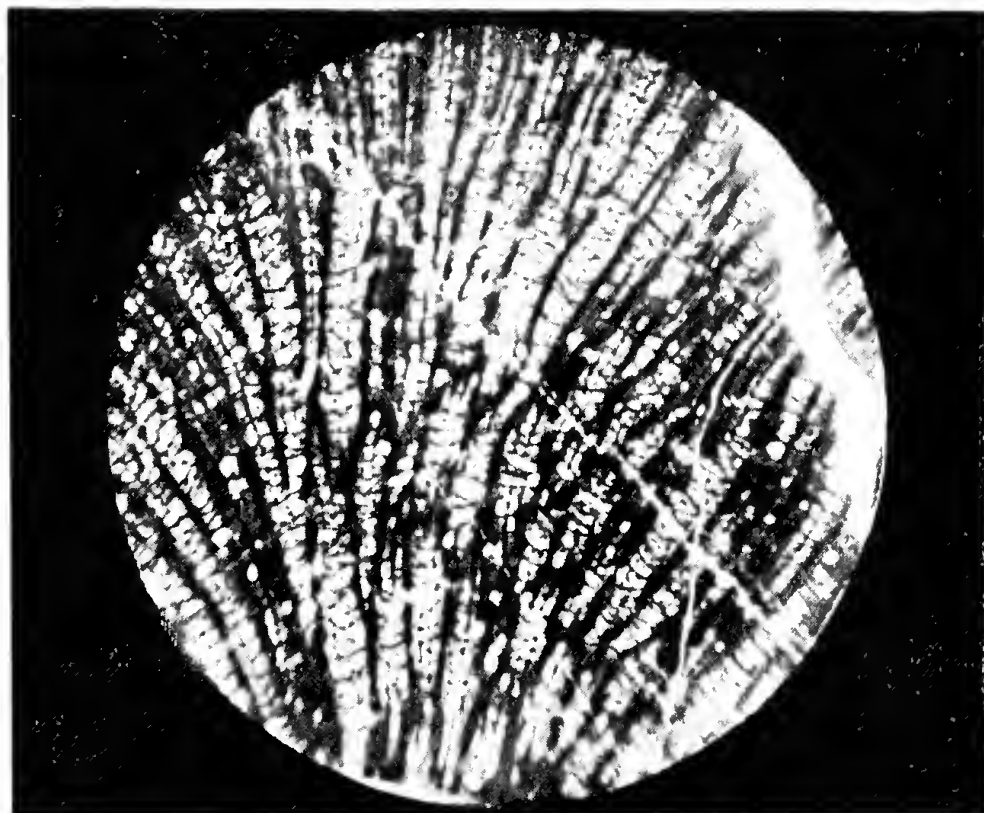

1

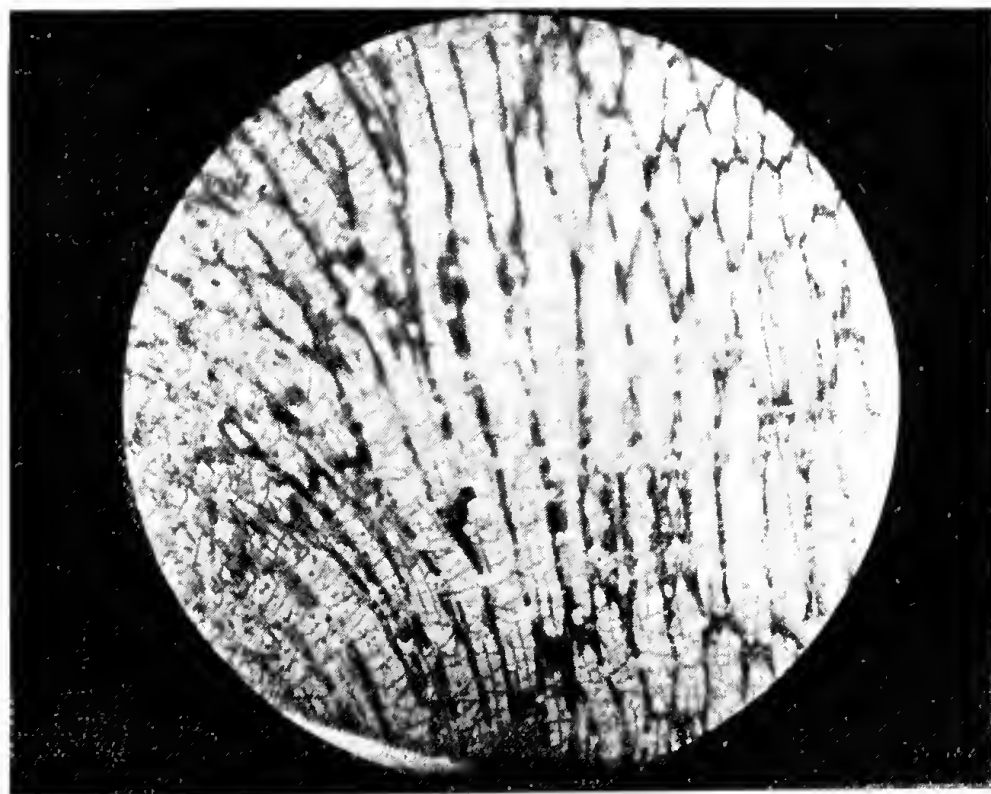

2





EXPLANATION OF PLATE III.

---

Fig. 1. *Ophichthus versicolor*, Richardson.  
(Reduced.)

Fig. 2. *Brachaluteres baueri*, Richardson.  
(Natural size.)

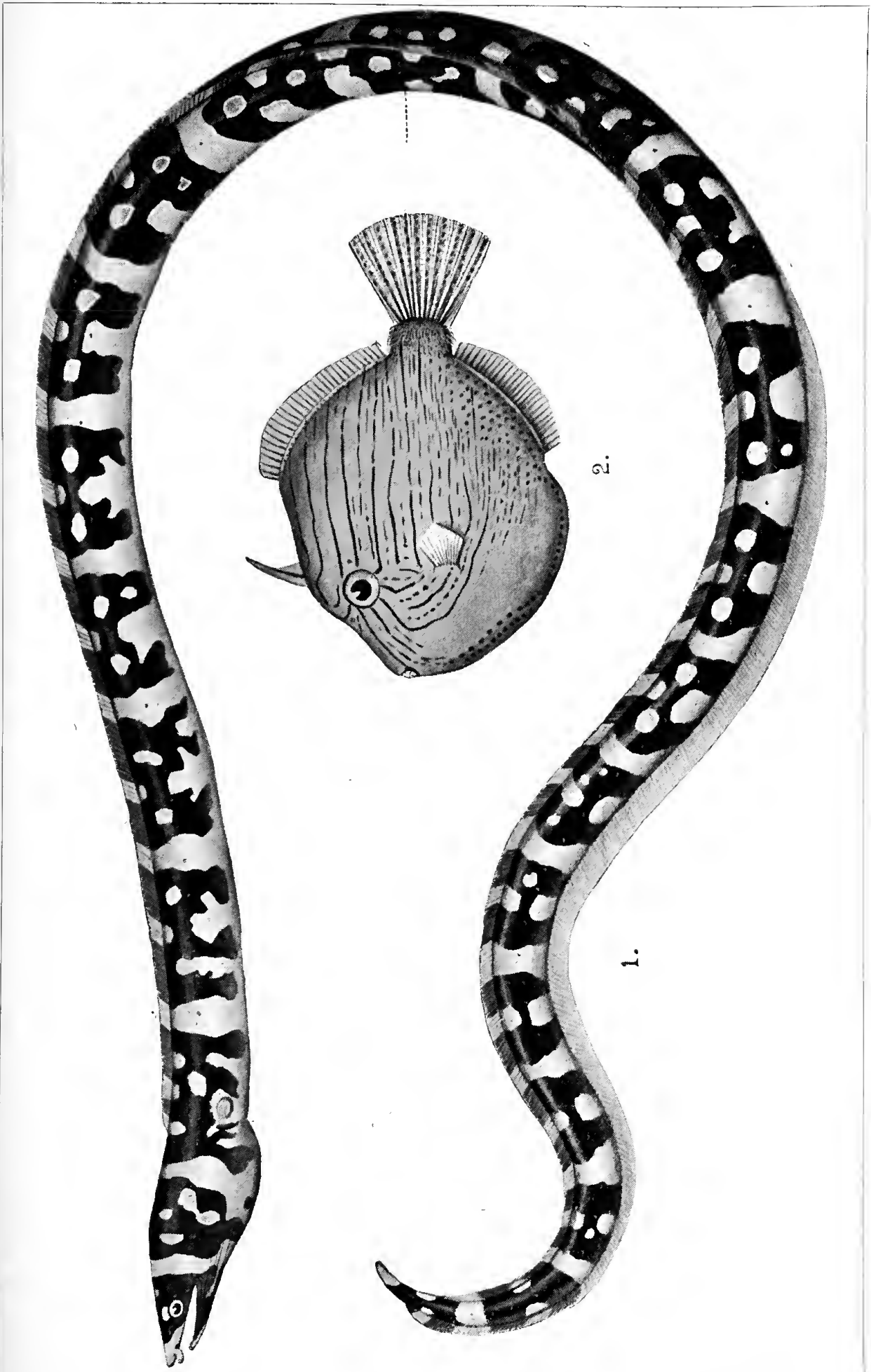







EXPLANATION OF PLATE IV.

---

- Fig. 1. *Pseudolabrus luculentus*, Richardson.  
(Natural size.)
- Fig. 2. *Machærope latispinis*, Ogilby.  
(Reduced.)

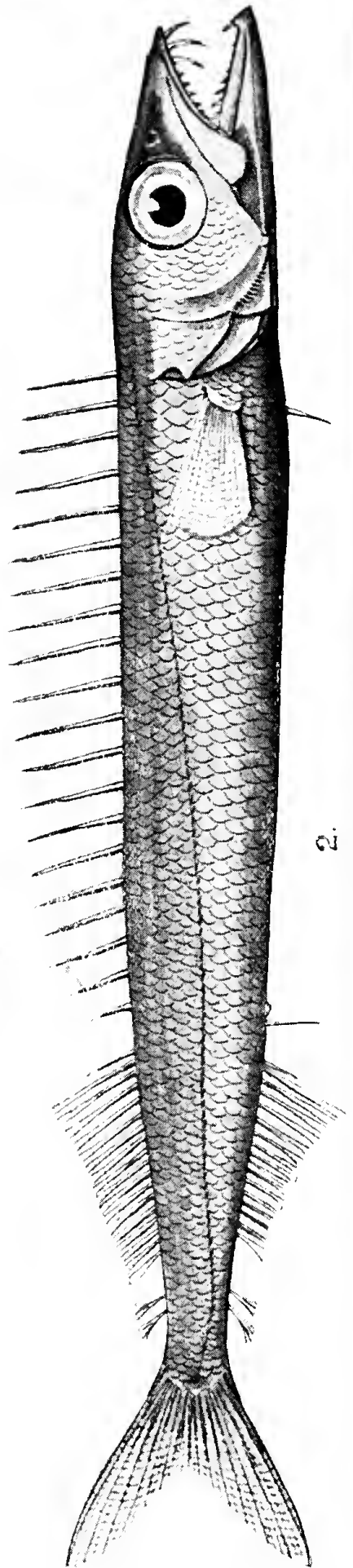
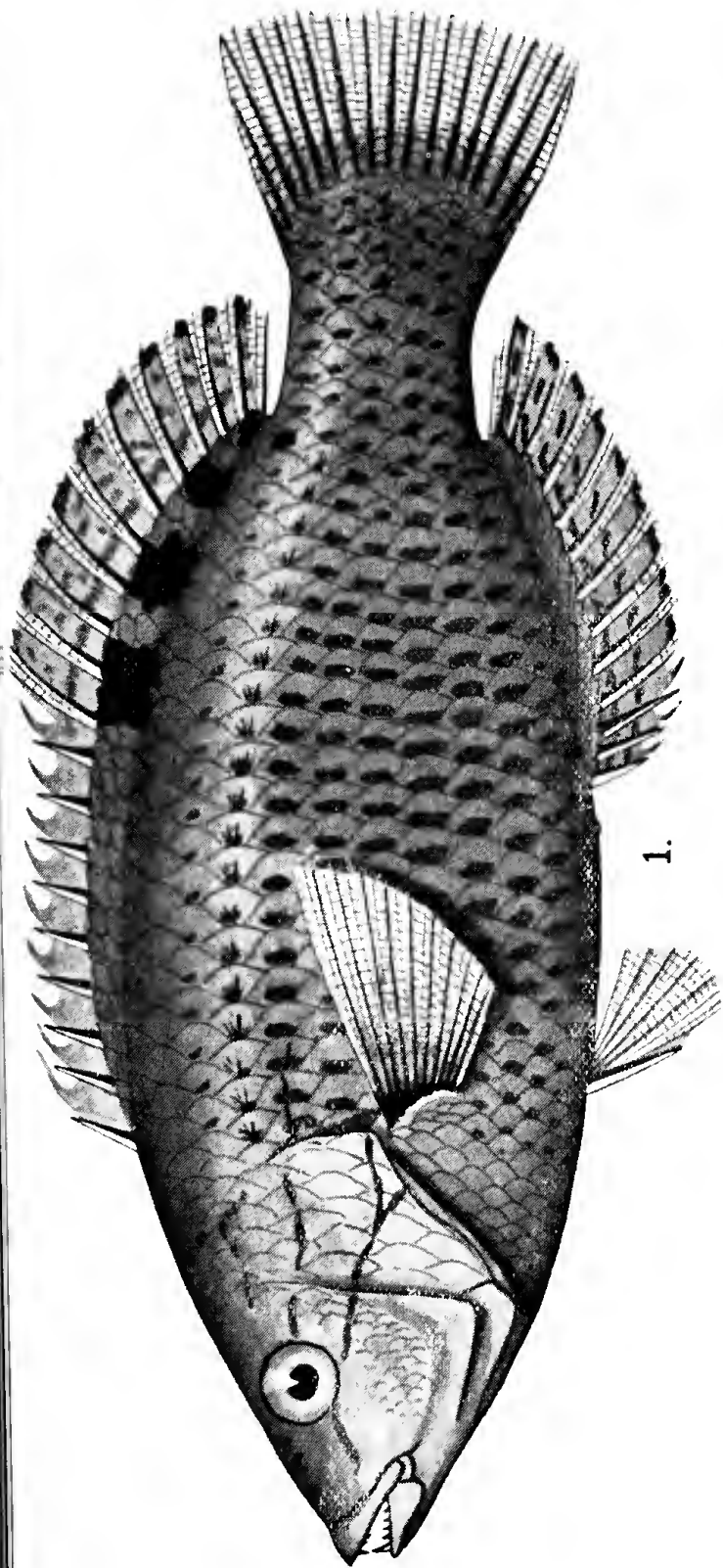





## EXPLANATION OF PLATE V.

---

- Fig. 1. *Coris picta*, Bloch and Schneider.  
(Reduced.)
- Fig. 2. *Cocotropus altipinnis*, Waite.  
(Enlarged.)

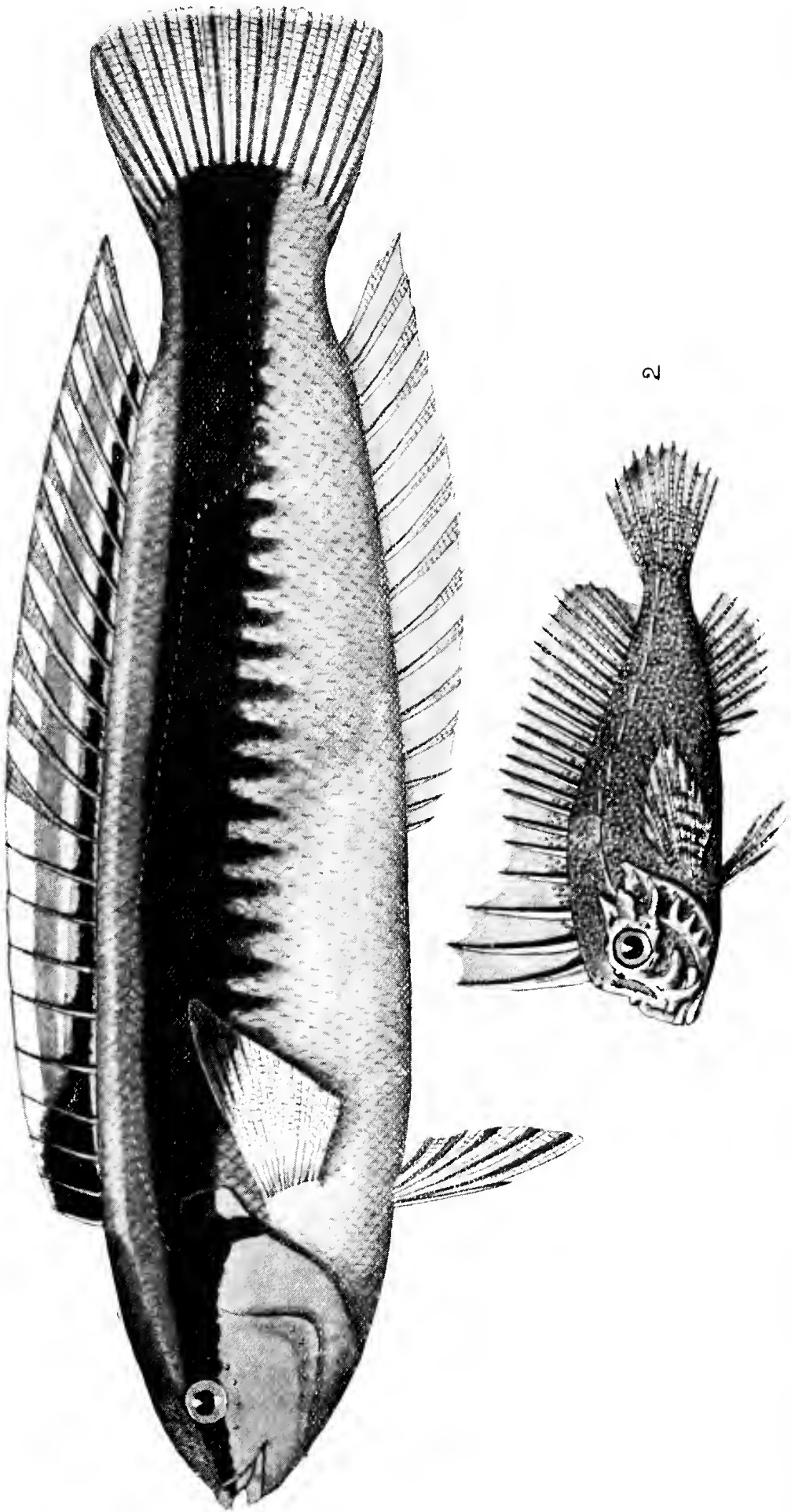

EDGAR R. WAITE, del.,  
Austr. Museum.

Electric Photo-Engr. Co. Austr. Ltd., Sydney  
Half-tone.







EXPLANATION OF PLATE VI.

---

*Prosoplismus recurvirostris*, Richardson.

(Half natural size.)

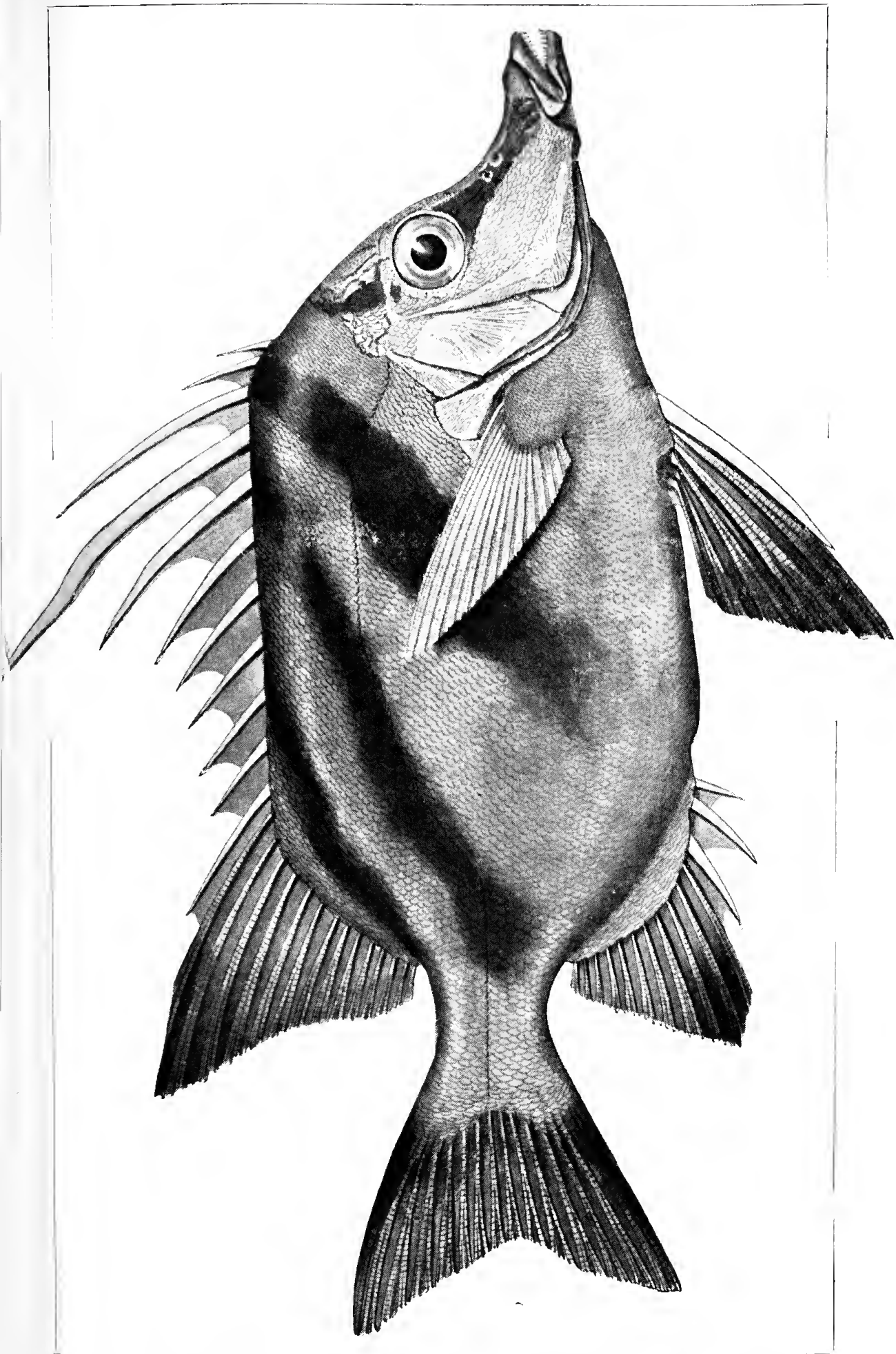





## EXPLANATION OF PLATE VII.

---

*Dendrostoma dehamata*, Kestv.

- Fig. 1. The organs in the body cavity. *Neph.* segmentle organs; *r. mus.* retractor muscles; *sp. m'. sp. m''.* left and right spindle muscles; *mes'. mes''.* muscles retaining oesophageal loop; *int. sp.* intestinal spiral; *oes.* oesophagus; *rect.* rectum; *mus. poc.* muscular pocket; *an.* anus. The nerve cord being of the usual type has been omitted.
- Fig. 2. One tentacular arm.
- Fig. 3. Anterior end showing mouth and arrangement of the tentacles.
- Fig. 4. Anterior dorsal end of introvert showing the cerebral organ [?] *c.g.*
- Fig. 5. Papillæ from base of introvert.
- Fig. 6. Anus.

(Figure 1 reduced; figures 2-6 enlarged.)

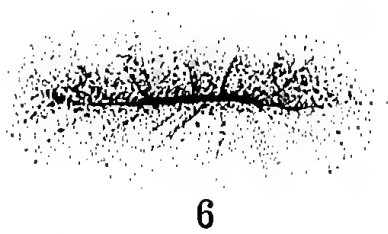
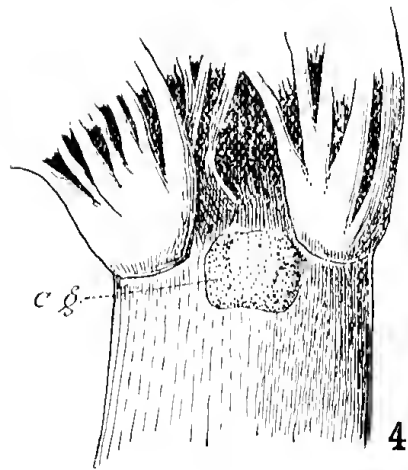
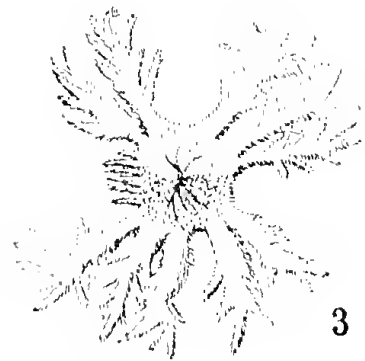
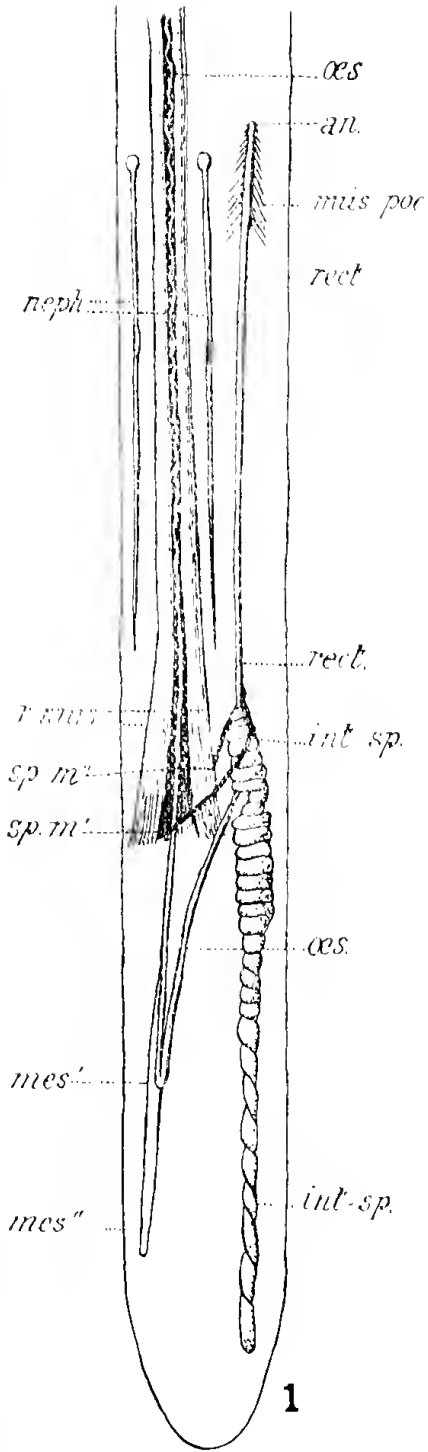







## EXPLANATION OF PLATE VIII.

---

### CYCLOLITUITES BOWNINGENSIS, *Eth. fil.*

- Fig. 1. Sub-compressed cast in mudstone showing the whorls in contact.
- „ 2. Specimen partly compressed, partly in the round; the former portion exhibits the whorls in contact, the latter the original convexity, and the costæ.
- „ 3. The convex portion of Fig. 2 detached, exhibiting the dorsal contact furrow.
- „ 4. Side view of Fig. 3.
- „ 5. Ventral view of one portion of Figs. 3 and 4.
- „ 6. Similar view of the other portion of Figs. 3 and 4. Both these figures (5 and 6) exhibit the strongly marked hyponomic sinus.
- „ 7. Section of Figs. 3 and 4.



1



3



4



2



7



5



6





## EXPLANATION OF PLATE IX.

---

### NYCTERIBIA PTEROPUS, *Rainbow*.

- Fig. 1. Male, from above.  
" 2. " profile.  
" 3. " abdomen, ventral view  
" 4. " 6th segment, profile.  
" 5. " head, from the side.  
" 6. " tarsus, profile.  
" 7. " tarsus, from beneath.  
" 8. Female, head from behind.  
" 9. " head from the front.  
" 10. " lateral thoracic pectinated process.  
" 11. " gravid, from beneath.  
" 12. " abdomen, normal from above.  
" 13. " abdomen, gravid from above.  
" 14. " extremity of abdomen, showing anal apparatus  
(All figures drawn by aid of an Abbé camera.)

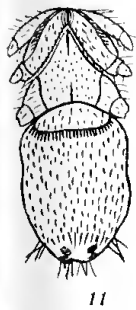

11

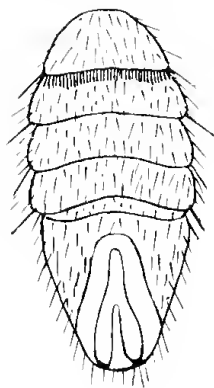

3

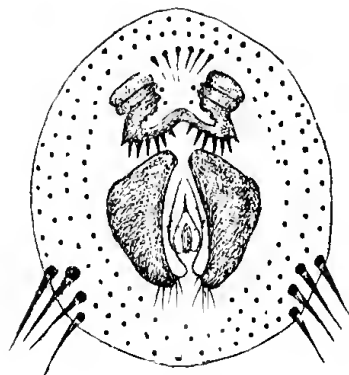

14

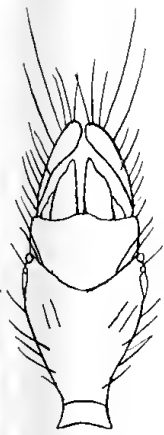

8

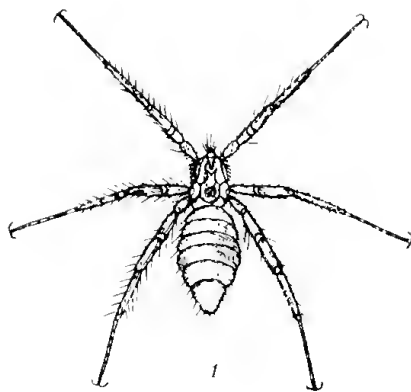

1

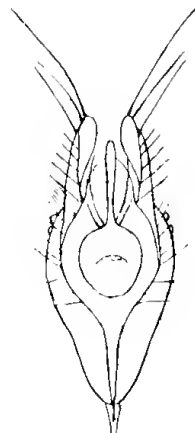

9



2

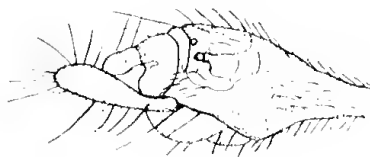

5

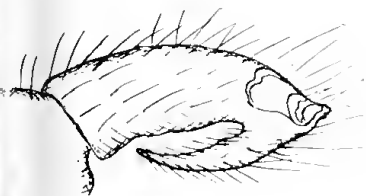

4



6



7

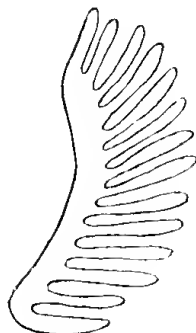

10



12

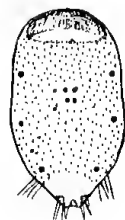

13







EXPLANATION OF PLATE X.

---

NIOBE? *sp. ind.*

- Fig. 1. Pygidium, laterally distorted.  
,, 2. A similar specimen.  
,, 3. Pygidium of the natural form.

DIKELOCEPHALUS FLORENTINENSIS, *Eth. fil.*

- ,, 4. Pygidium exhibiting segmentation and one caudal spine.

ORTHIS LENTICULARIS, *Wahlenberg?*

- ,, 5 )  
,, 7 } Casts in various states of preservation.  
,, 8 )  
,, 9 )  
,, 6 Costæ enlarged showing bifurcation.

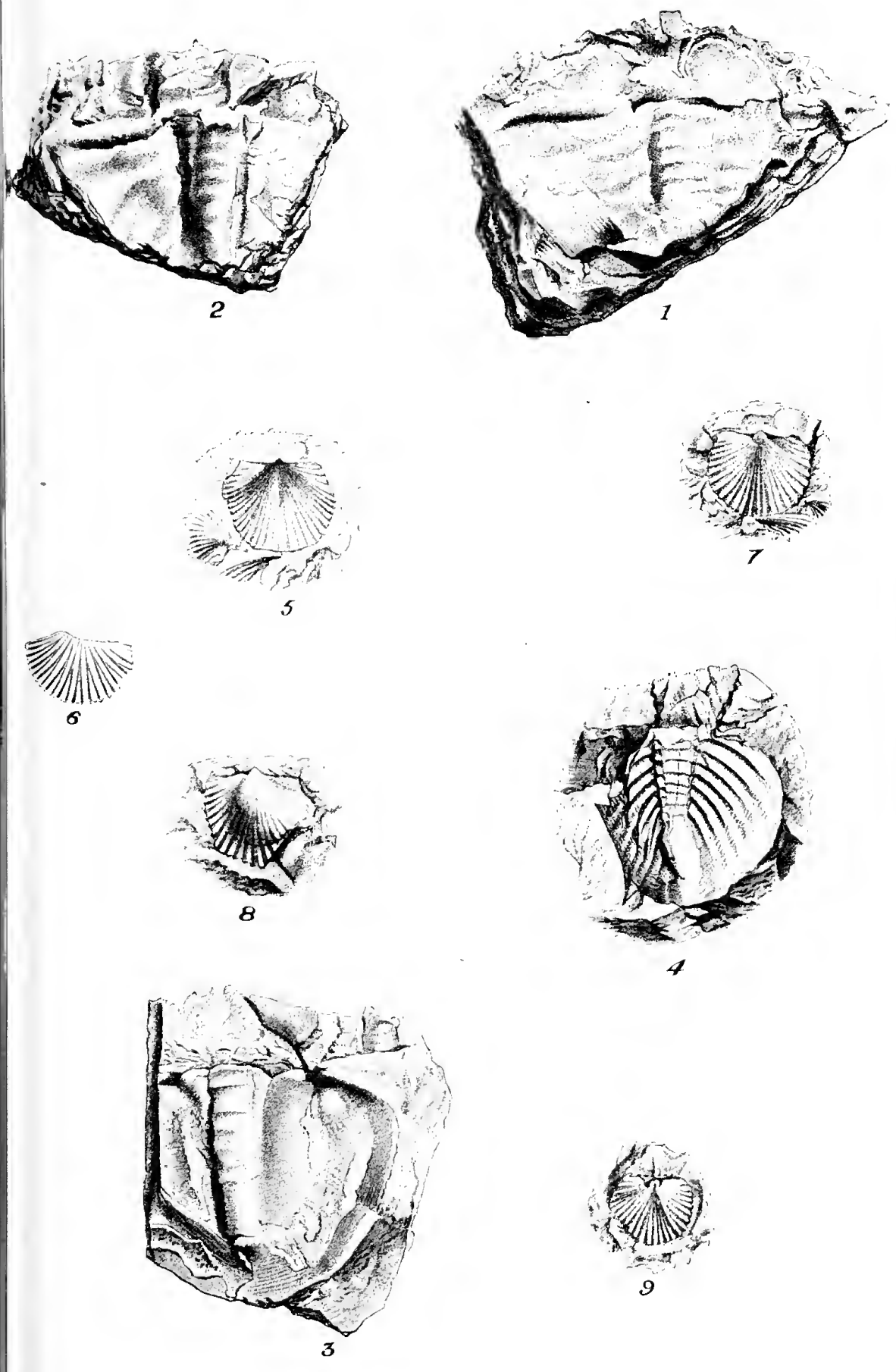

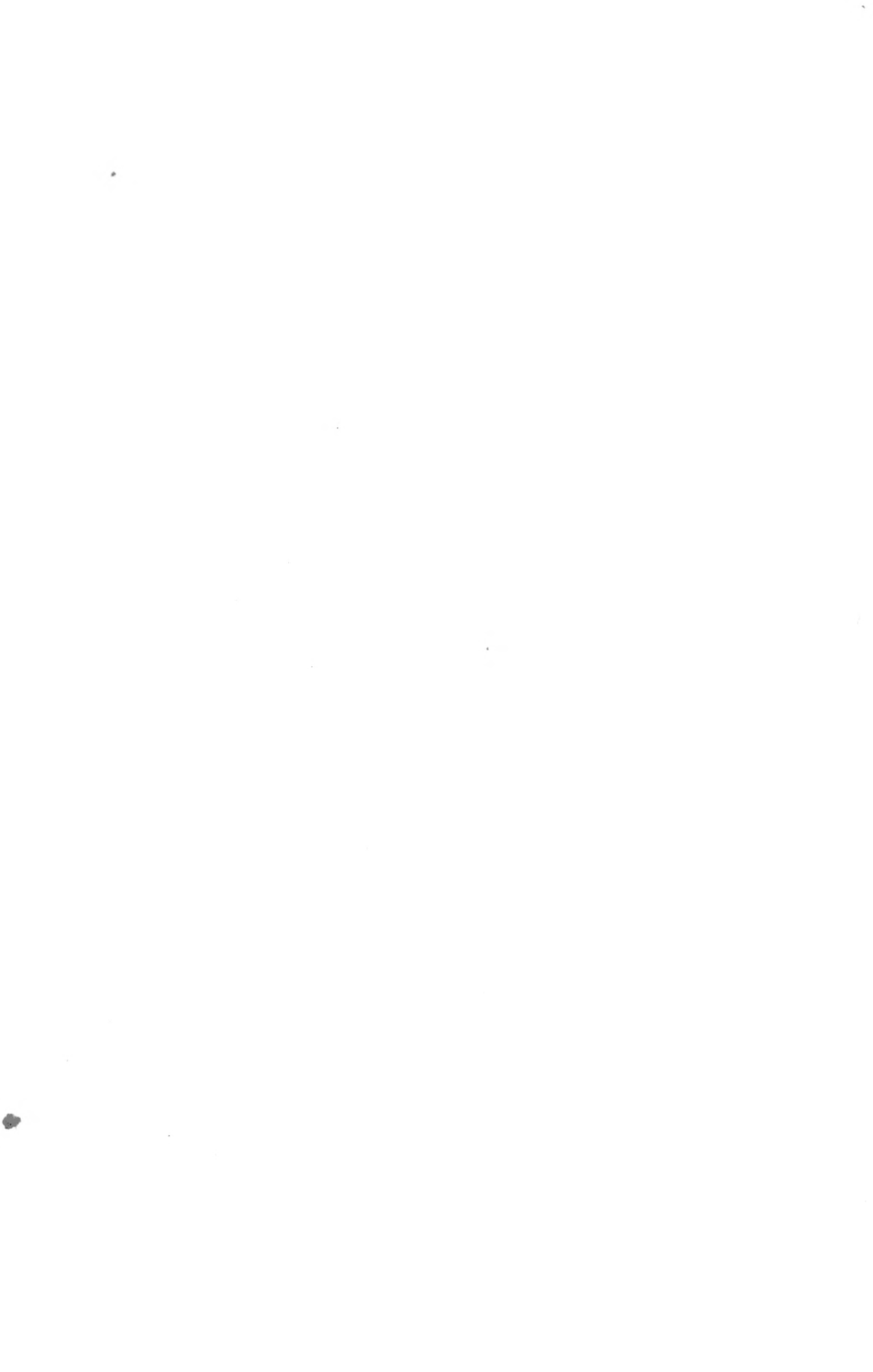



EXPLANATION OF PLATE XI.

---

CYCLOCHILA AUSTRALASIÆ, *Don.*, and THOPHA SACCATA, *Amyot.*  
Fig. 1. *In cop.*, side view.

CYCLOCHILA AUSTRALASIÆ, *Don.*  
,, 2. Male.

THOPHA SACCATA, *Amyot.*  
,, 3. Female.









**EXPLANATION OF PLATE XII.**

---

**Locality map showing position of Kuringai Staff Station.  
Scale :—One mile to one inch.**

S . . W . . R . .

NORTHERN LINE.

ing Line between Hornsby Junct & Kuring-gai.

Scale. 1 Mile to 1 inch.

T.F. 20 11.03.

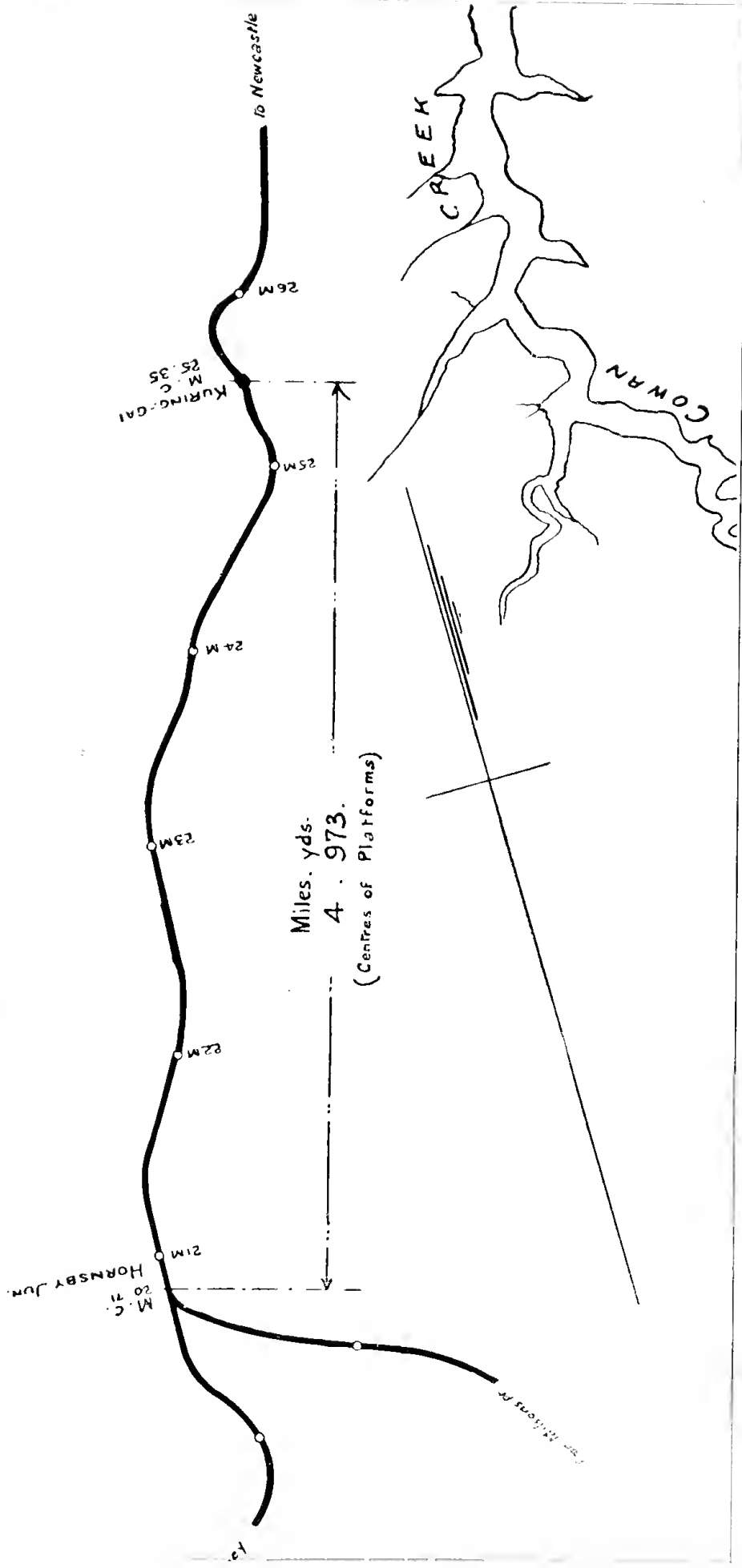
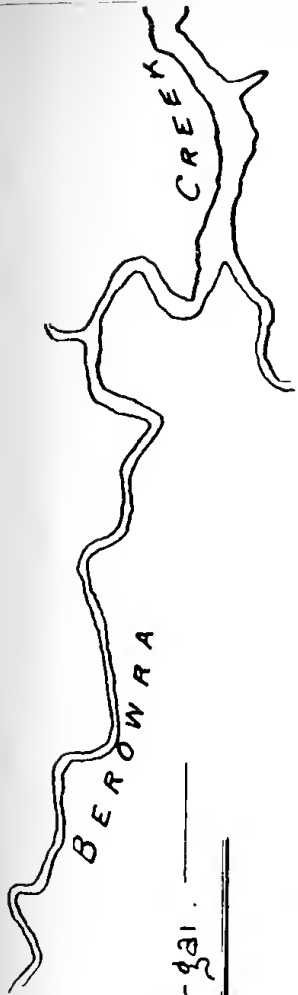

### EXPLANATION OF PLATE XIII.

---

The greater portion of a group of petroglyphs at Kuringai Staff Station, about four and a half miles from Hornsby Junction, Northern Railway line.

Scale:—About half-an-inch to one foot.

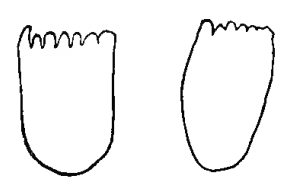
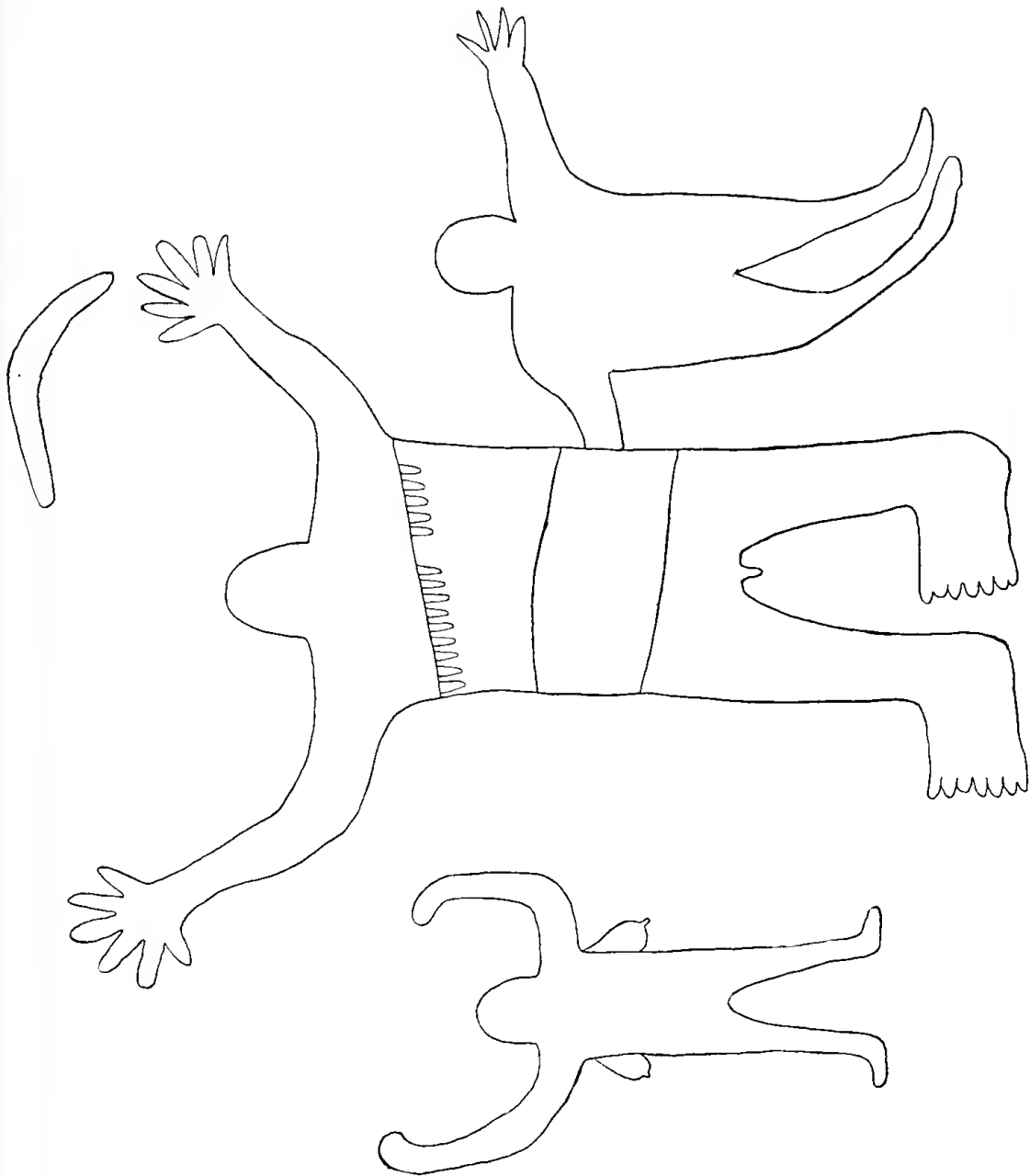





## EXPLANATION OF PLATE XIV.

### COPROLITES.

- Fig. 1. Sub-pyriform mass, showing traces of convolutions.  
" 2. More or less fusiform mass, with slight traces of convolutions.  
" 3. Oblong coprolite somewhat constricted.

### NODULES.

- Fig. 4. Irregularly shaped mass of limonite, with roughened and partially cavernous surface.  
" 5. Spherical, smooth and shining body.

### TUBERCLE.

- Fig. 6. Tubercle, side view.  
" 7. " posterior view.  
" 8. " anterior view.

### 9 NUCULA SEJUGATA, *Eth. fil.*

- Fig. 9. Cast in limonite, lateral view.  
" 10. Back of <sup>Scaliphites</sup> ~~limonite~~ <sup>eruciformis, Eth. Fil.</sup> cast, showing sutures and sculpture. — X2



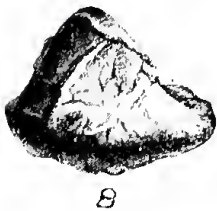
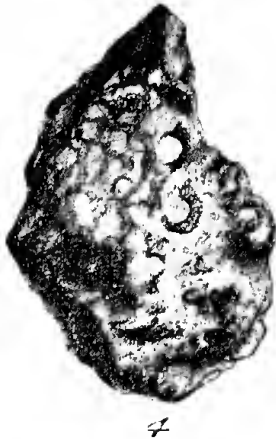
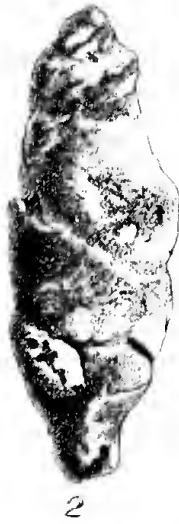





EXPLANATION OF PLATE XV.

NODULES.

- Fig. 1. Irregularly-shaped limonite nodule.  
„ 2. Bean-shaped, smooth and shining limonite nodule.

AVELLANA CAROLENSIS, *Eth. fil.*

- Fig. 3. Cast in limonite, dorsal view.—  $\times 2$ .  
„ 11. The same cast, ventral view.—  $\times 2$ .  
„ 4. Sculpture, highly enlarged.

NUCULA SEJUGATA, *Eth. fil.*

- „ 5. Limonite internal cast of united valves, with hinge-line and teeth.—  $\times 1\frac{1}{2}$ .

PTYCHOCERAS (?) CLOSTEROIDES, *Eth. fil.*

- Fig. 6. Limonite cast, lateral view, showing the three limbs—  $\times 2$ .  
„ 7. Similar specimen, with the youngest limb hidden.—  $\times 2$ .  
„ 8. Similar specimen, exhibiting the contact furrow on the dorsum of the second limb.—  $\times 2$ .  
„ 9. Similar specimen, showing the cross-section of the three limbs.—  $\times 1\frac{1}{2}$ .

e

SCAPHITES CRUCIFORMIS *Eth. fil.*

- Fig. 10. Sculpture, lightly enlarged.

~~Back of limonite cast showing sutures and sculpture~~

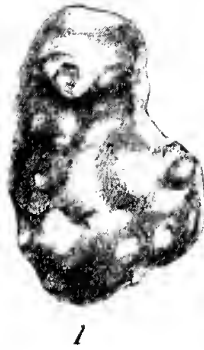





EXPLANATION OF PLATE XVI.

---

Nest of Guttated Bower Bird, *Chlamydodera guttata*, Gould.  
(About one-third natural size.)









## EXPLANATION OF PLATE XVII.

---

- Fig. 1. *Muraenichthys nicholsæ*, Waite.  
„ 2. *Gymnothorax chalazius*, Waite.  
„ 3. *Gonorhynchus gonorynchus*, Linnæus.

(Fig. 1, enlarged. Fig. 2, reduced. Fig. 3, young, natural size.)

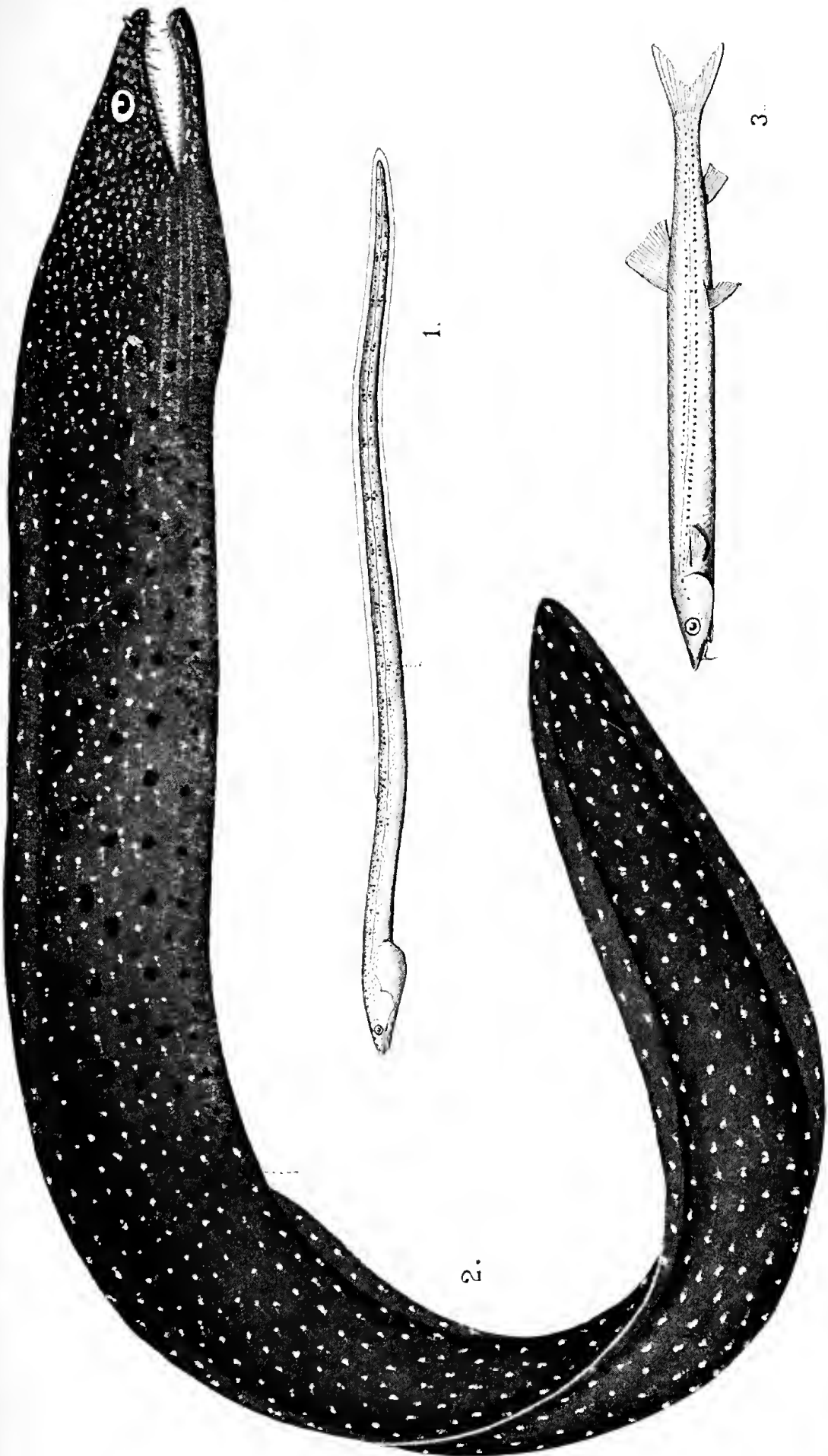





EXPLANATION OF PLATE XVIII.

---

- Fig. 1. *Æthoprora perspicillata*, Ogilby.  
„ 2. *Notoscopelus ejectus*, Waite.  
„ 3. *Dasyscopelus naufragus*, Waite.  
„ 4. *Howella brodiei*, Ogilby.  
(All the figures enlarged).



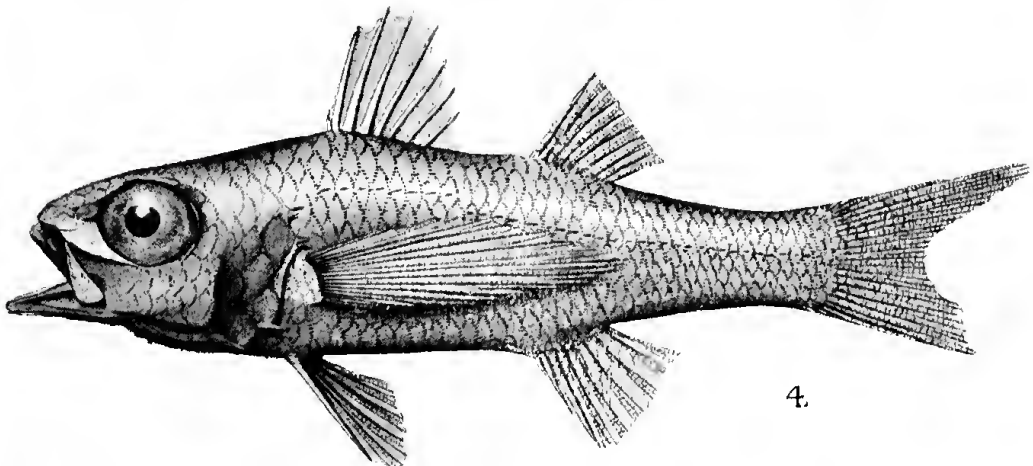
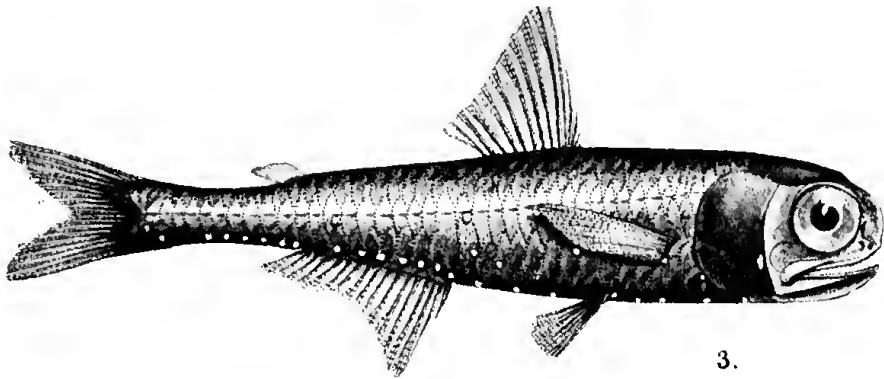
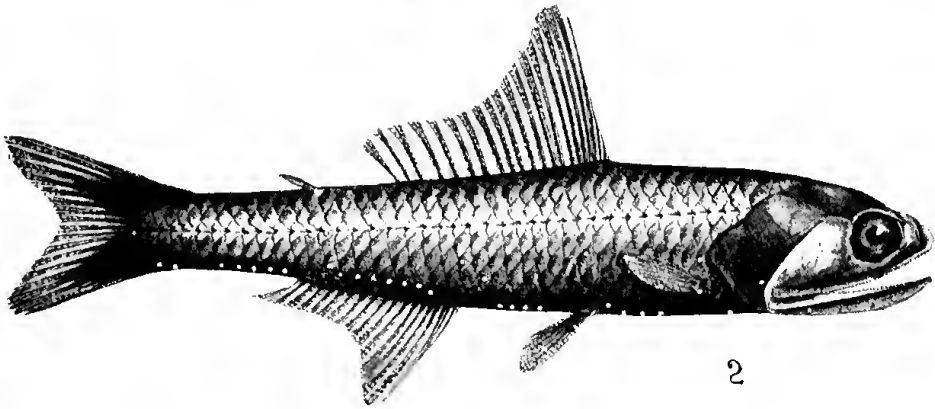
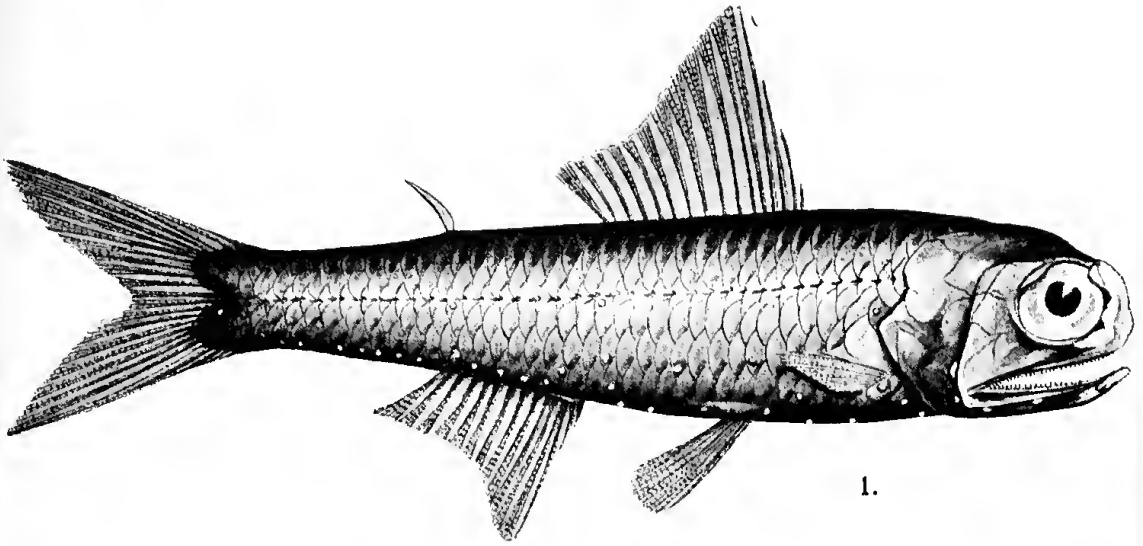





EXPLANATION OF PLATE XIX.

---

- Fig. 1. *Xenogramma carinatum*, Waite.  
,, 2. *Bathystethus cultratus*, Forster.  
(Both figures reduced).

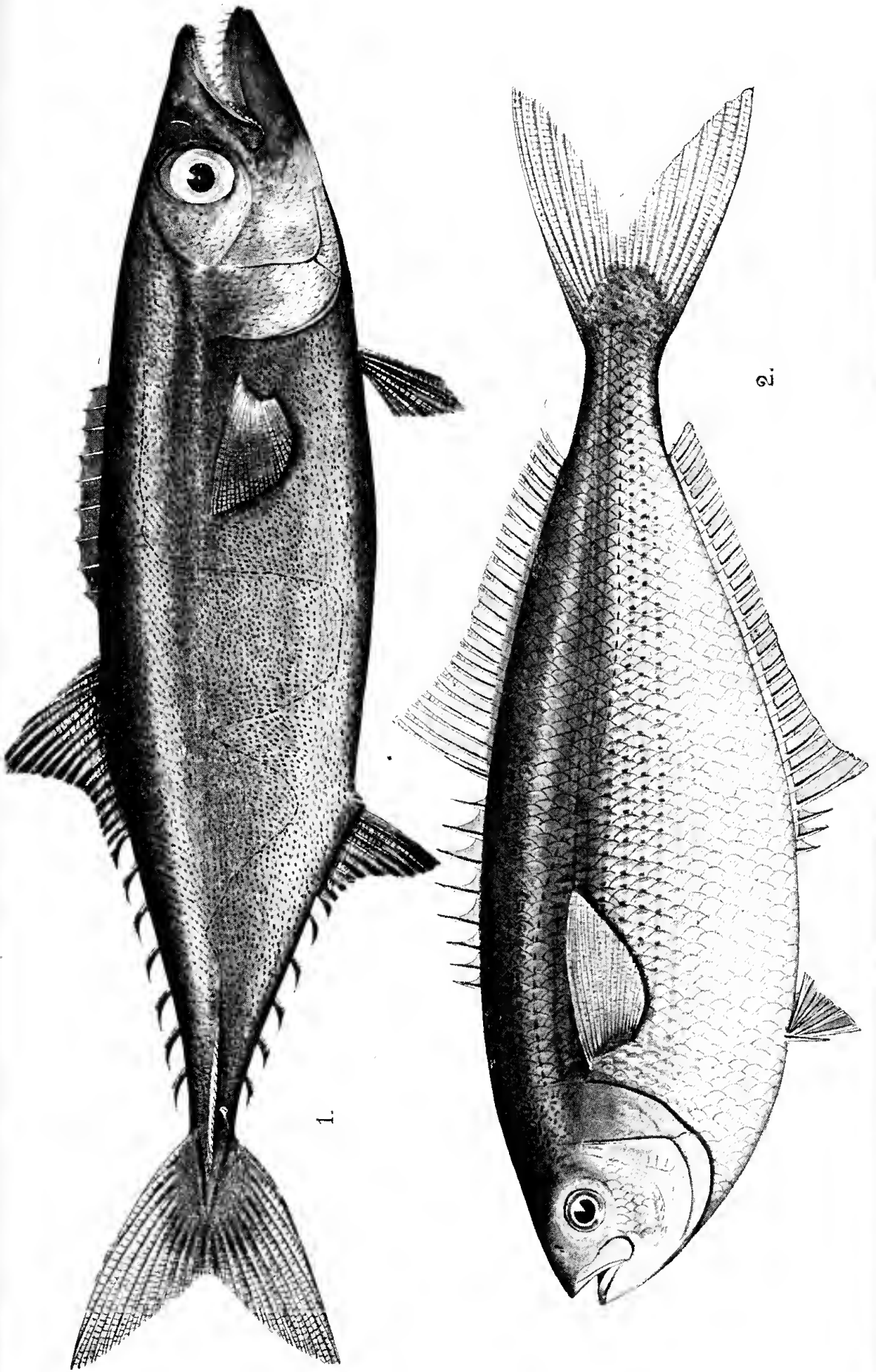





EXPLANATION OF PLATE XX.

---

- Fig. 1. *Schedophilus maculatus*, Günther.  
„ 2. *Apogon chrysurus*, Ogilby.  
„ 3. *Girella cyanea*, Macleay.  
(All the figures reduced).



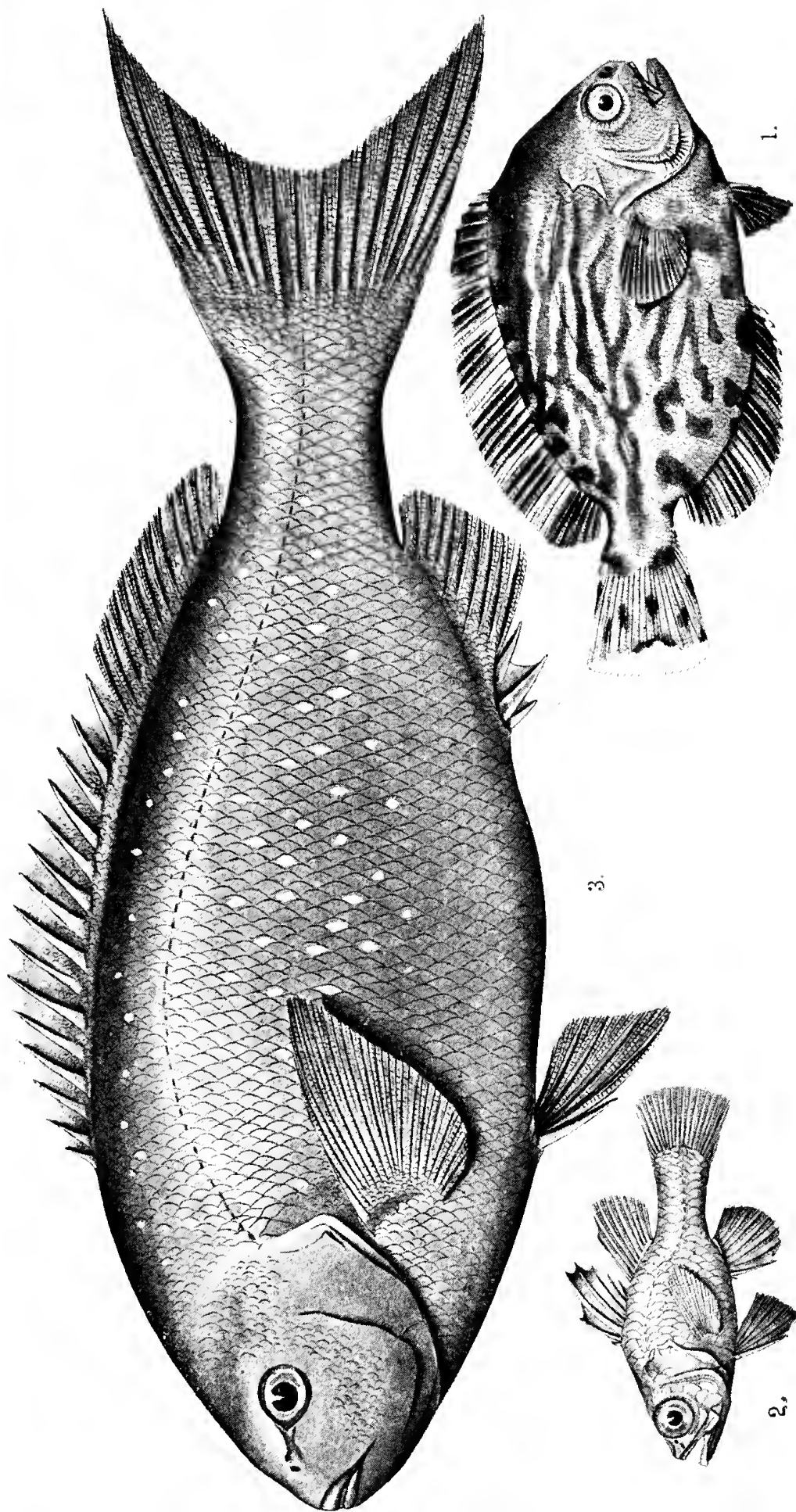





EXPLANATION OF PLATE XXI.

---

*Aplodactylus etheridgii*, Ogilby.  
(Reduced).

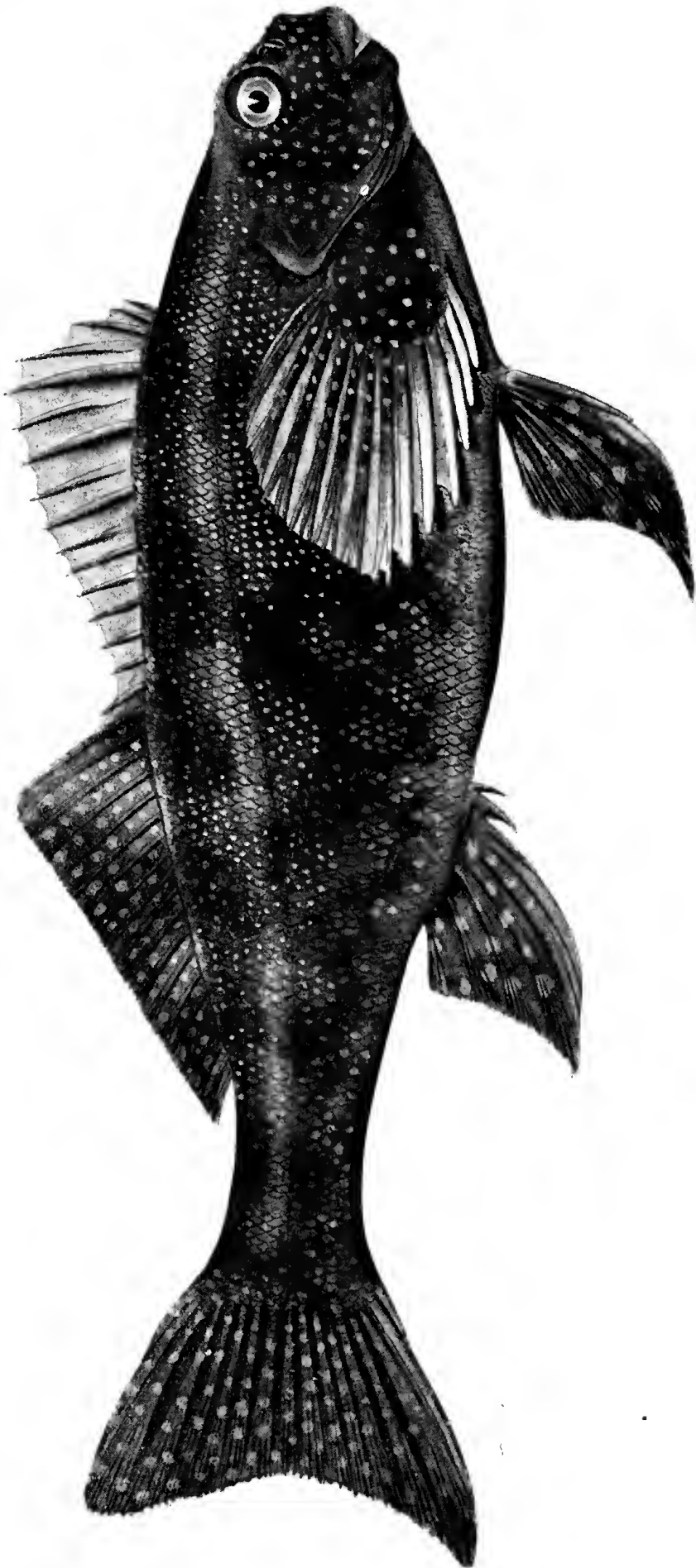





EXPLANATION OF PLATE XXII.

---

*Parma polylepis*, Günther.  
(Reduced).



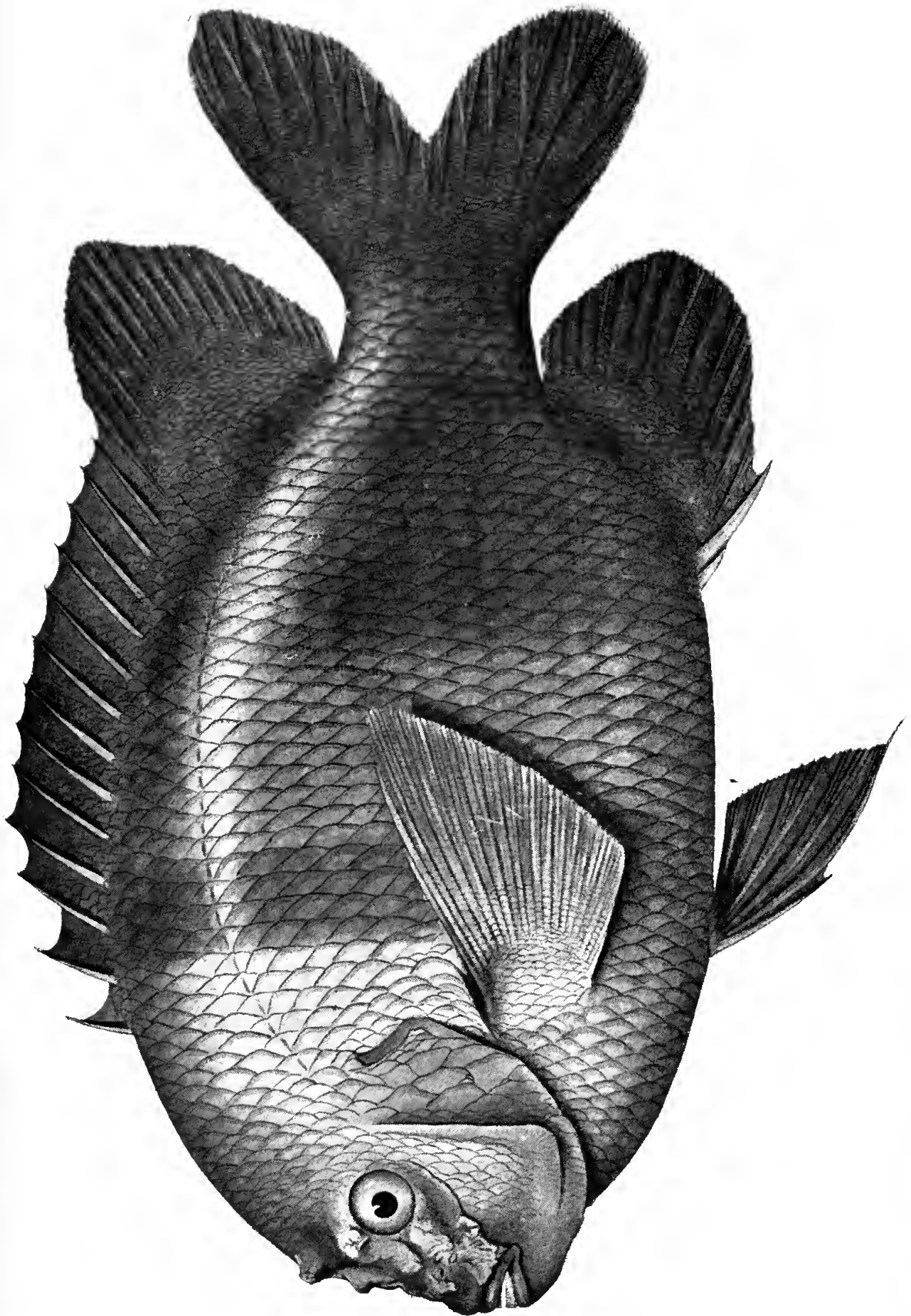





### EXPLANATION OF PLATE XXIII.

---

- Fig. 1. *Glyphisodon polyacanthus*, Ogilby.  
,, 2. *Gobius aelosoma*, Ogilby.  
,, 3. *Allogobius viridis*, Waite.  
,, 4. *Limnichthys fasciatus*, Waite.

(Fig. 1, natural size. Figs. 2-4, enlarged).

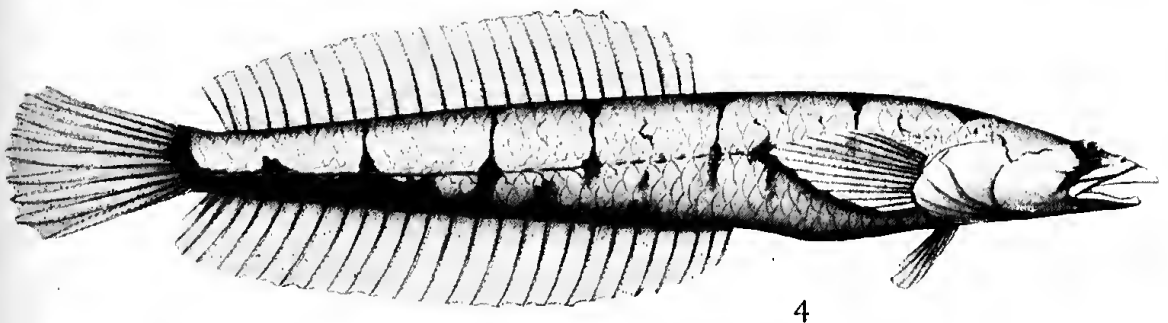
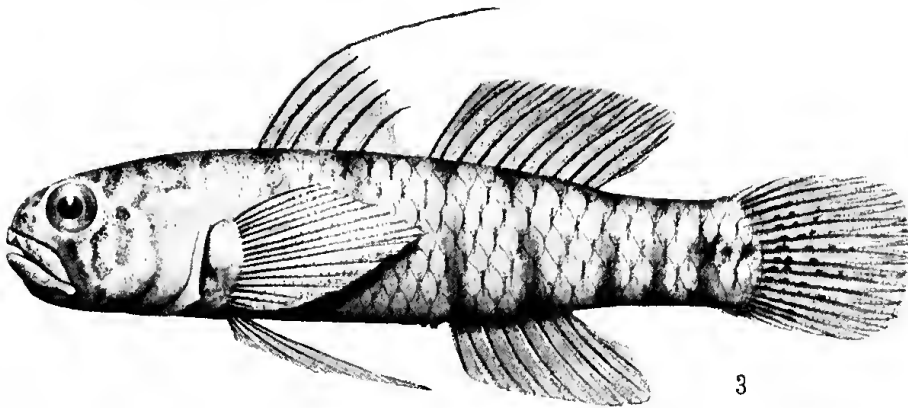
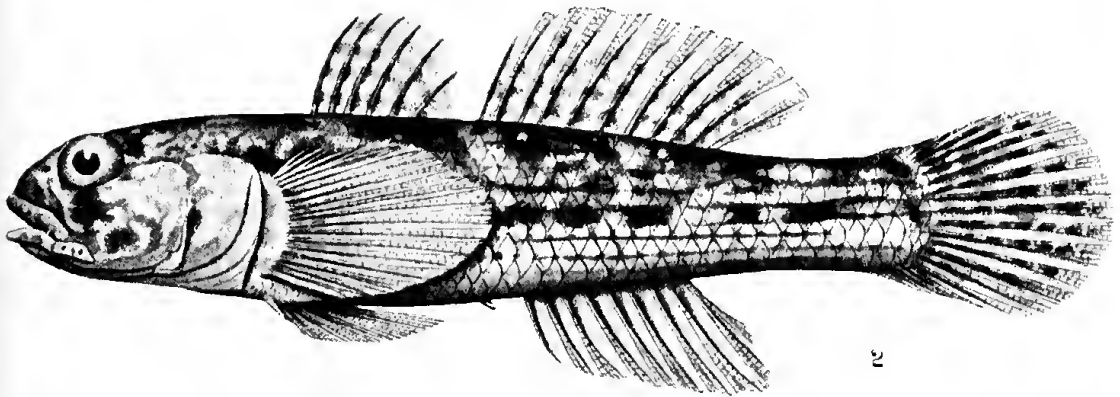
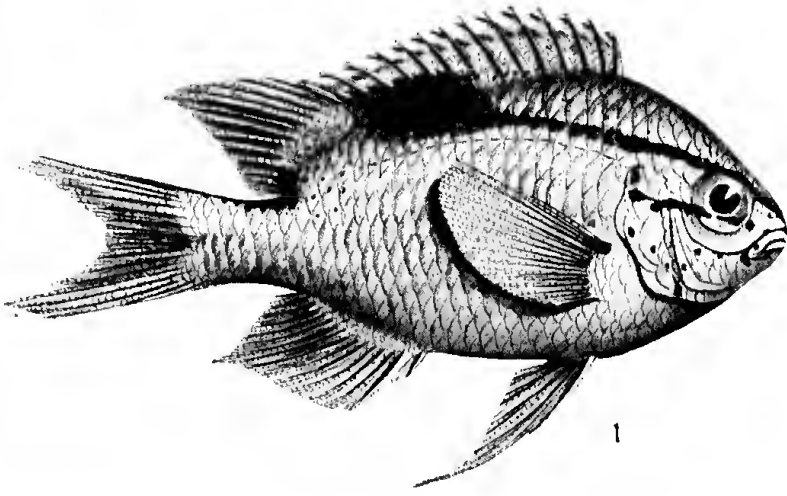





EXPLANATION OF PLATE XXIV.

---

- Fig. 1. *Diplocrepis costatus*, Ogilby.  
" 2. *Lepadichthys frenatus*, Waite.  
" 3. *Petroscirtes icelii*, Ogilby.  
" 4. *Tripterygion rufopileum*, Waite.  
" 5. *Dinematichthys longifilis*, Ogilby.  
(Fig. 3 natural size, the others enlarged).



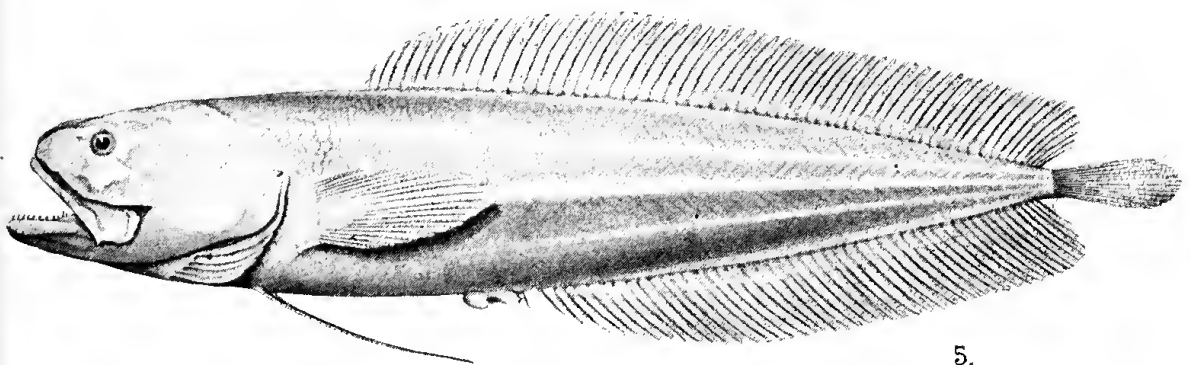
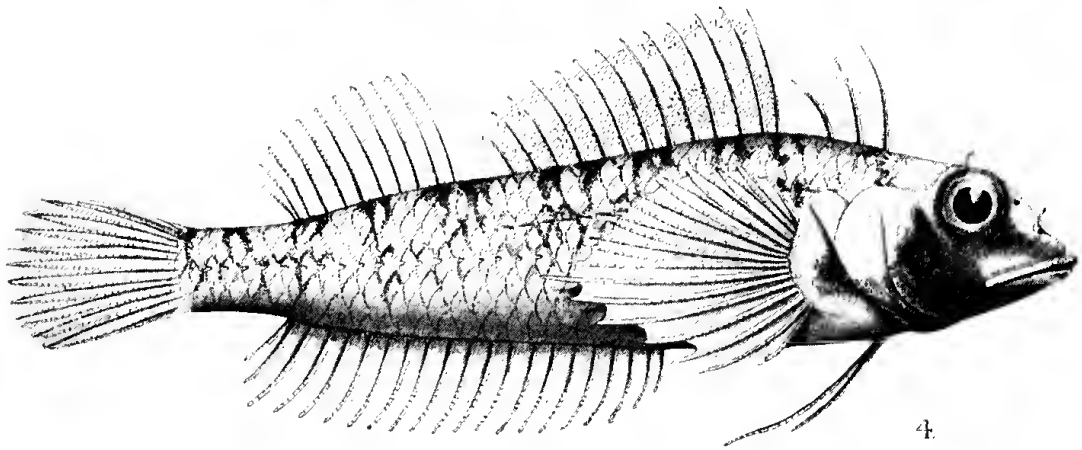
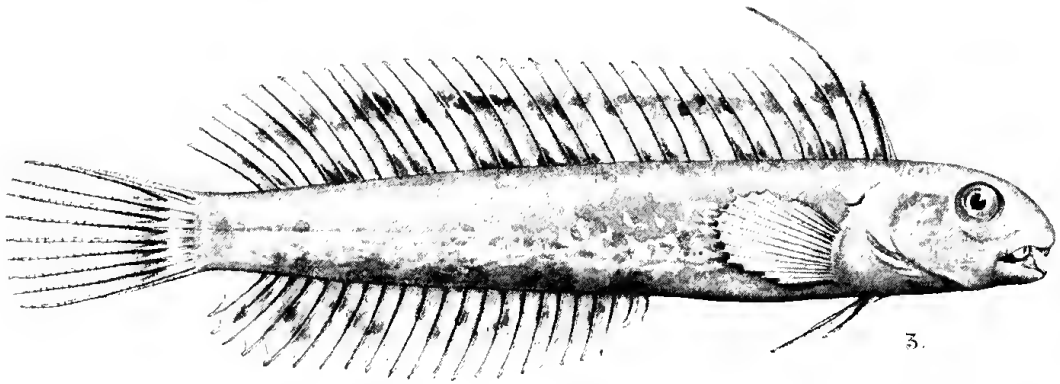





## EXPLANATION OF PLATE XXV.

---

- Fig 1. *Trachinocephalus myops*, Forster (young).  
„ 2. *Tropidostethus rhotophilus*, Ogilby.  
„ 3. *Neopercis binivirgata*, Waite.  
(Figs. 1 and 2, twice natural size. Fig. 3, natural size).

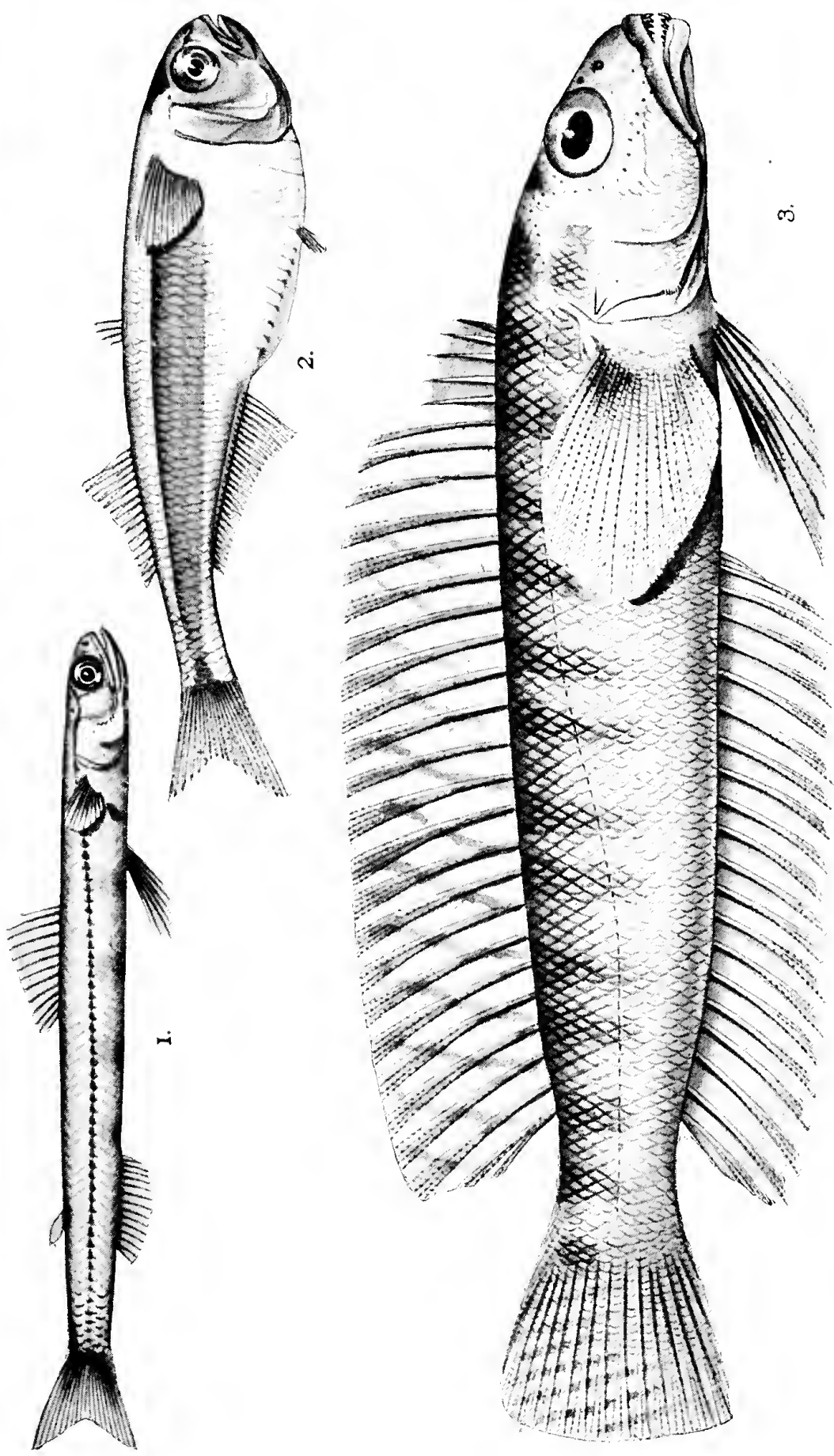



1911

## EXPLANATION OF PLATE XXVI.

---

- Fig. 1. *Gnathagnus innotabilis*. Waite.  
„ 2. *Gnathypops jacksoniensis*, Macleay.  
„ 3. *Schizochirus insolens*, Waite.  
(Figs. 1 and 2, natural size. Fig. 3, twice natural size.)



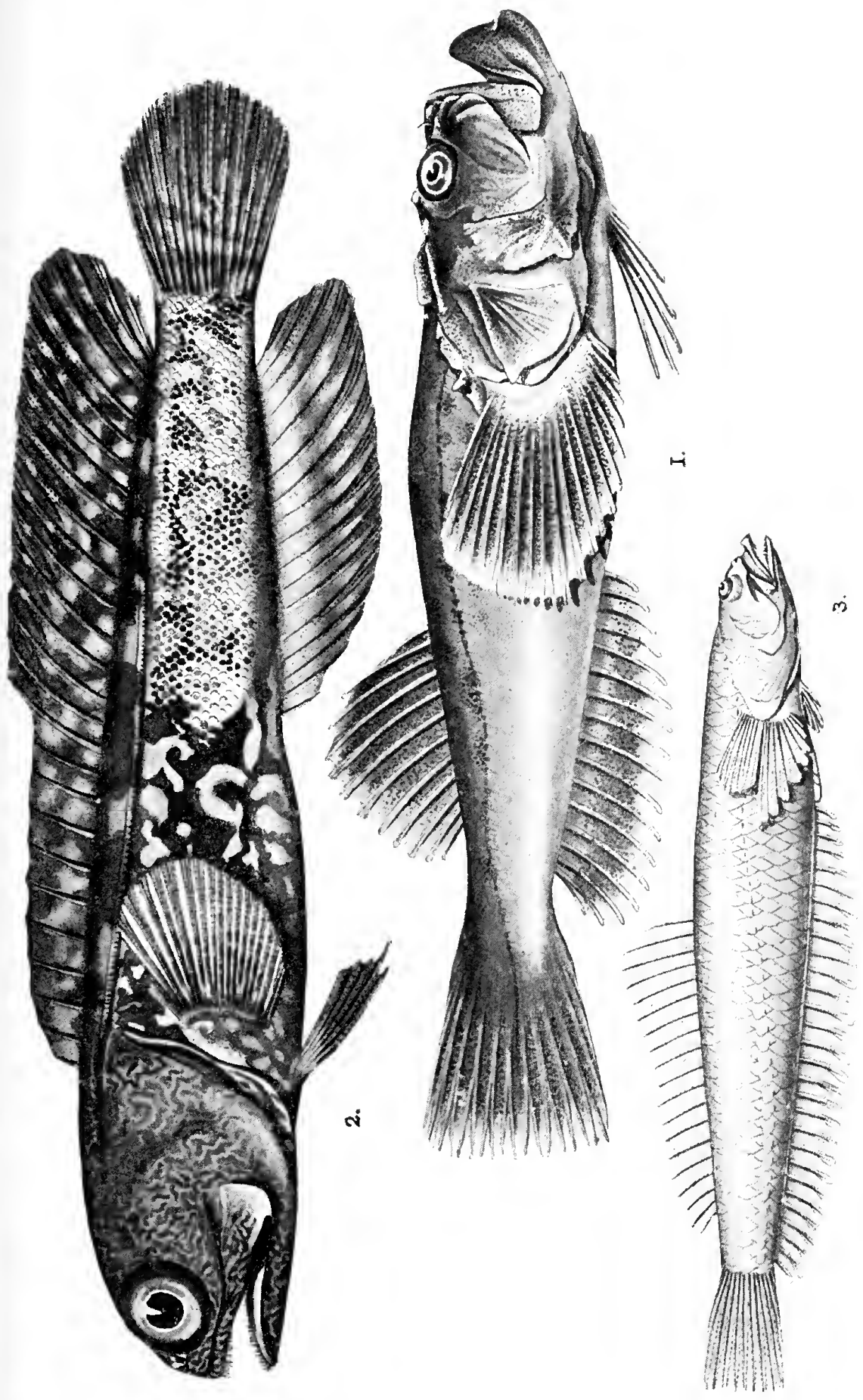

NATIONAL MUSEUM OF NATURE



EXPLANATION OF PLATE XXVII.

---

RIGONIA, *sp. ind.*

- Fig. 1. Exterior of an imperfect opalized left valve.  
,, 2. Interior of the same valve.

TRIGONIA MOOREI, *Lycett.*

- Fig. 3. Exterior of a nearly perfect left valve.  
,, 4. Partial interior of the same valve.

ACMÆA (?) MONSWOODENSIS, *Eth. fil.*

- Fig. 5. The larger of two examples of this species seen from above.—× 3.  
,, 6. The smaller specimen seen from above.—× 3.  
,, 7. Side view of fig. 6.—× 3.

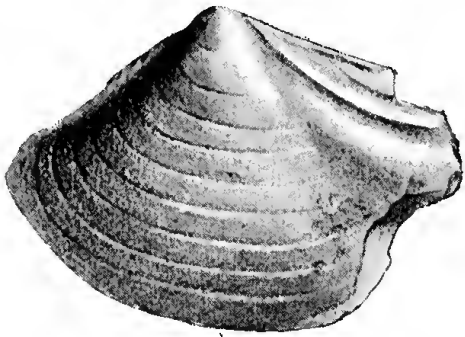

1

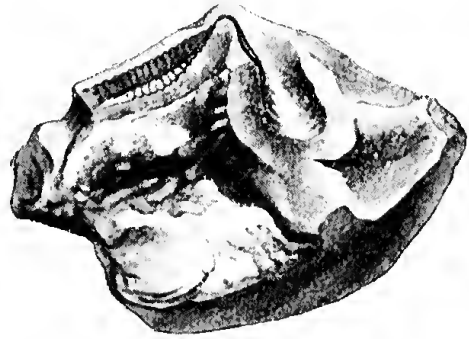

2



7

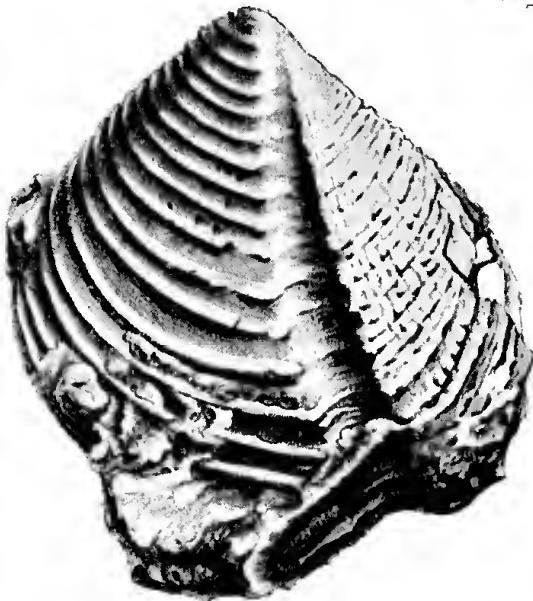

3

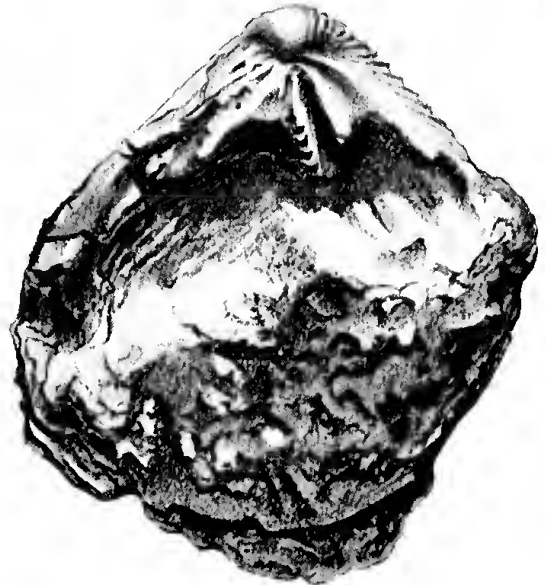

4



5

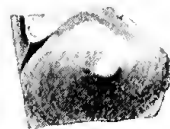

6





## EXPLANATION OF PLATE XXVIII

---

ISOCHRINUS AUSTRALIS, *Moore*, VAR. ALBASCOPULARIS, *Eth. fil.*

Fig. 1. Side view of the most complete specimen.

„ 2. Dorsal view of Fig. 1.

„ 3. and 4. Different views of a second and less complete example.





1



3

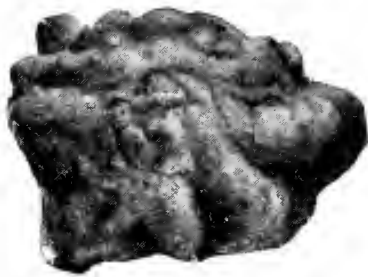

2



4

THE UNIVERSITY OF CHICAGO



## EXPLANATION OF PLATE XXIX.

---

### DORATIFERA CASTA, *Scott.*

Spray of Eucalypt with leaves covered with larvæ. The majority of these larvæ are about half-grown, but two examples upon a single leaf are fully grown, or nearly so. There are also two bleached leaves from which the epidermis has been eaten.

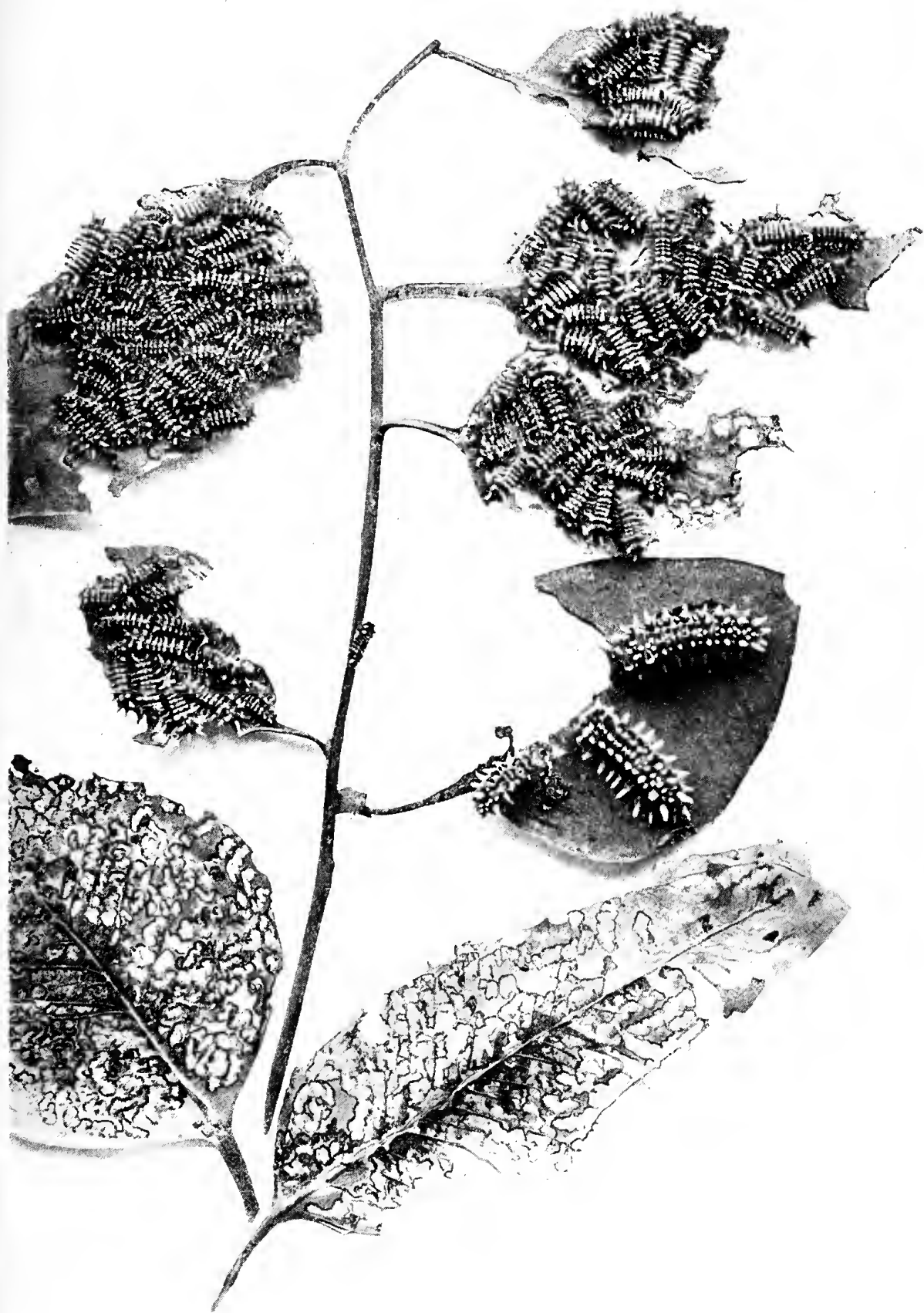





EXPLANATION OF PLATE XXX.

---

STICHUS MERMISOIDES, *Eth. fil.*

- Fig. 1. Section taken parallel to the growth layer of the shell of *Fissilunula clarkei*, Moore, viewed under a quarter inch objective.  
„ 2. Section taken at right angles to the growth layers.



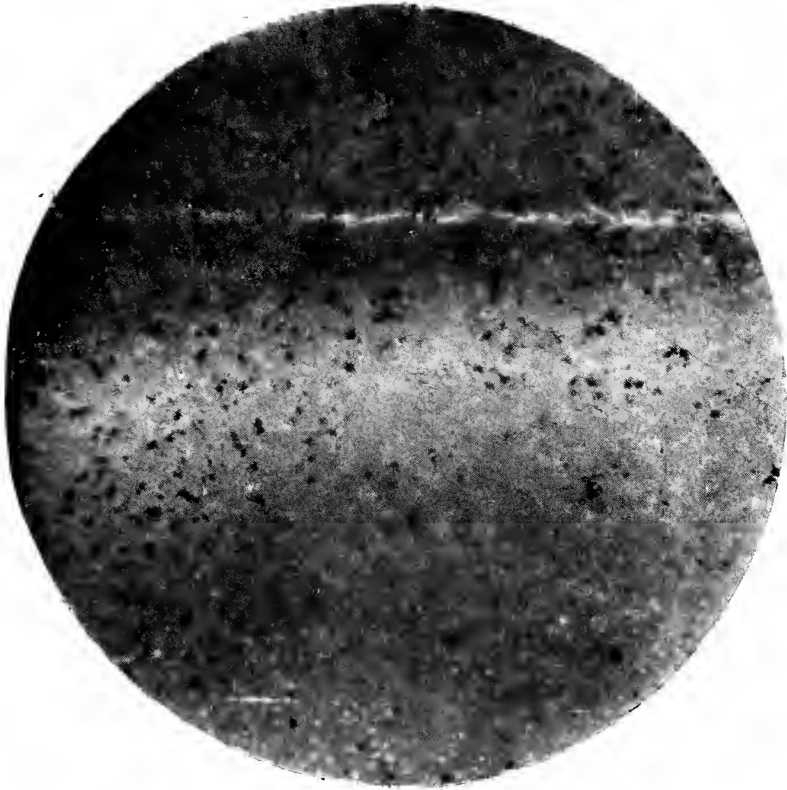

1

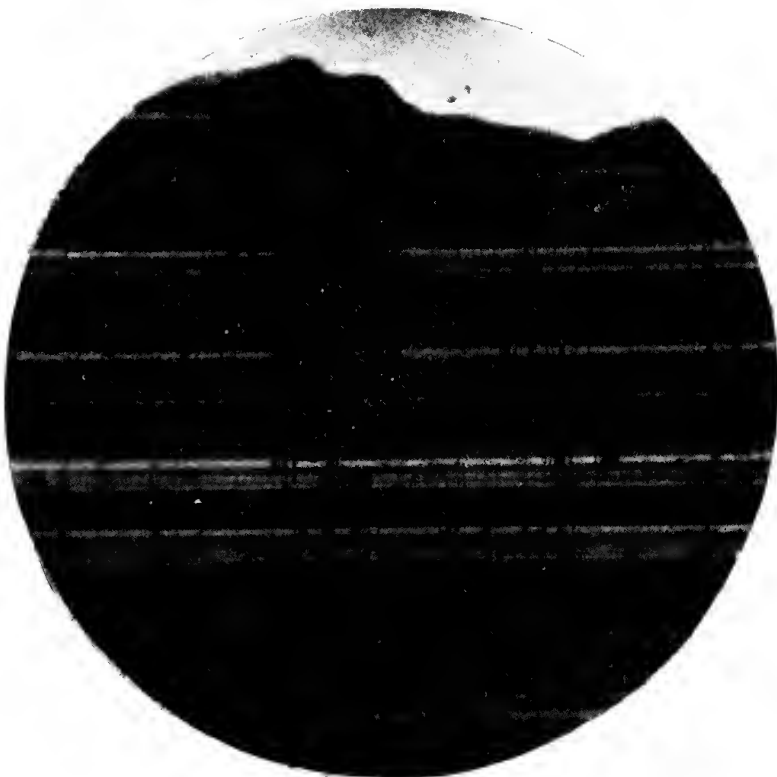

2





## EXPLANATION OF PLATE XXXI.

---

### TICHUS MERMISOIDES, *Eth. fl.*

- Fig. 1. Section taken at right angles to the growth layers of the shell of *Fissilunula clarkei*, Moore, viewed under a quarter inch objective.
- „ 2. Portion of a similar section highly enlarged to show details.
- „ 3. Portion of a section taken parallel to the growth layers, highly enlarged to show details.

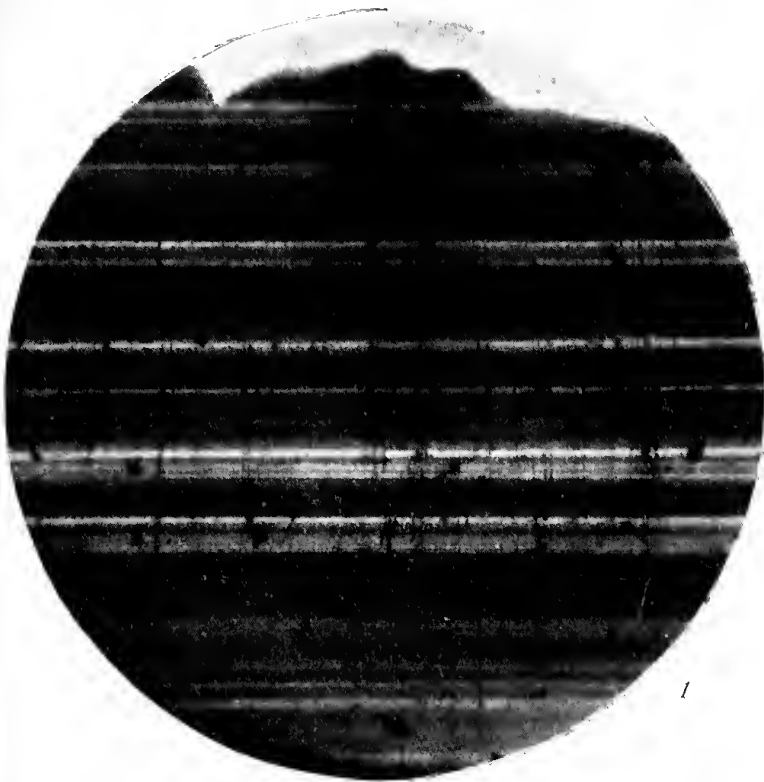

1

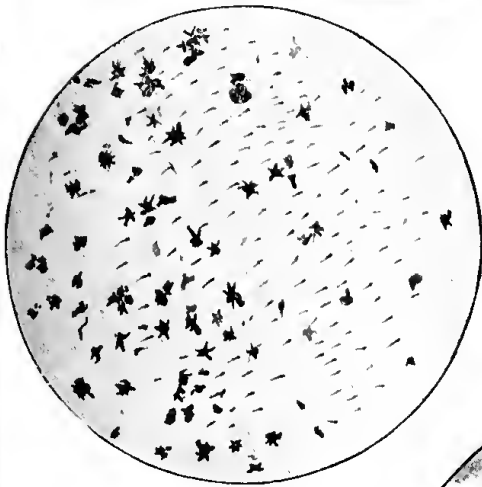

2

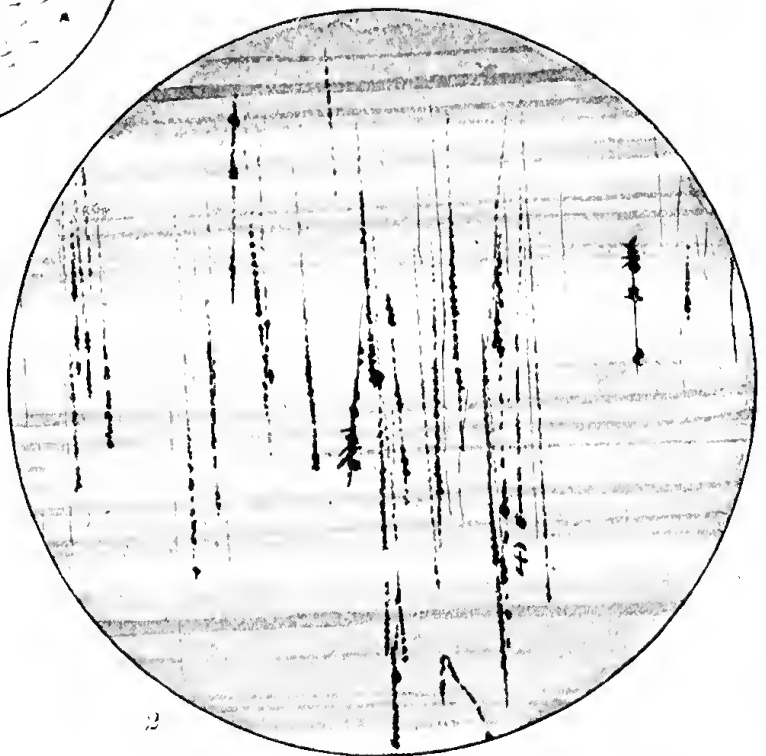

3





EXPLANATION OF PLATE XXXII.

---

Bower of the Eastern Bower-bird,  
*Chlamydodera orientalis*, GOULD.











EXPLANATION OF PLATE XXXIII.

---

Petroglyphs on a portion of the outer face of a Rock-shelter, Nobby's Creek, Clarence River, Copmanhurst, N. S. Wales.



11









EXPLANATION OF PLATE XXXIV.

---

Fig. 1. *Carassiops compressus*, Krefft,  
(male, twice natural size).

Fig 2. *Carassiops galii*, Ogilby,  
(male, thrice natural size).

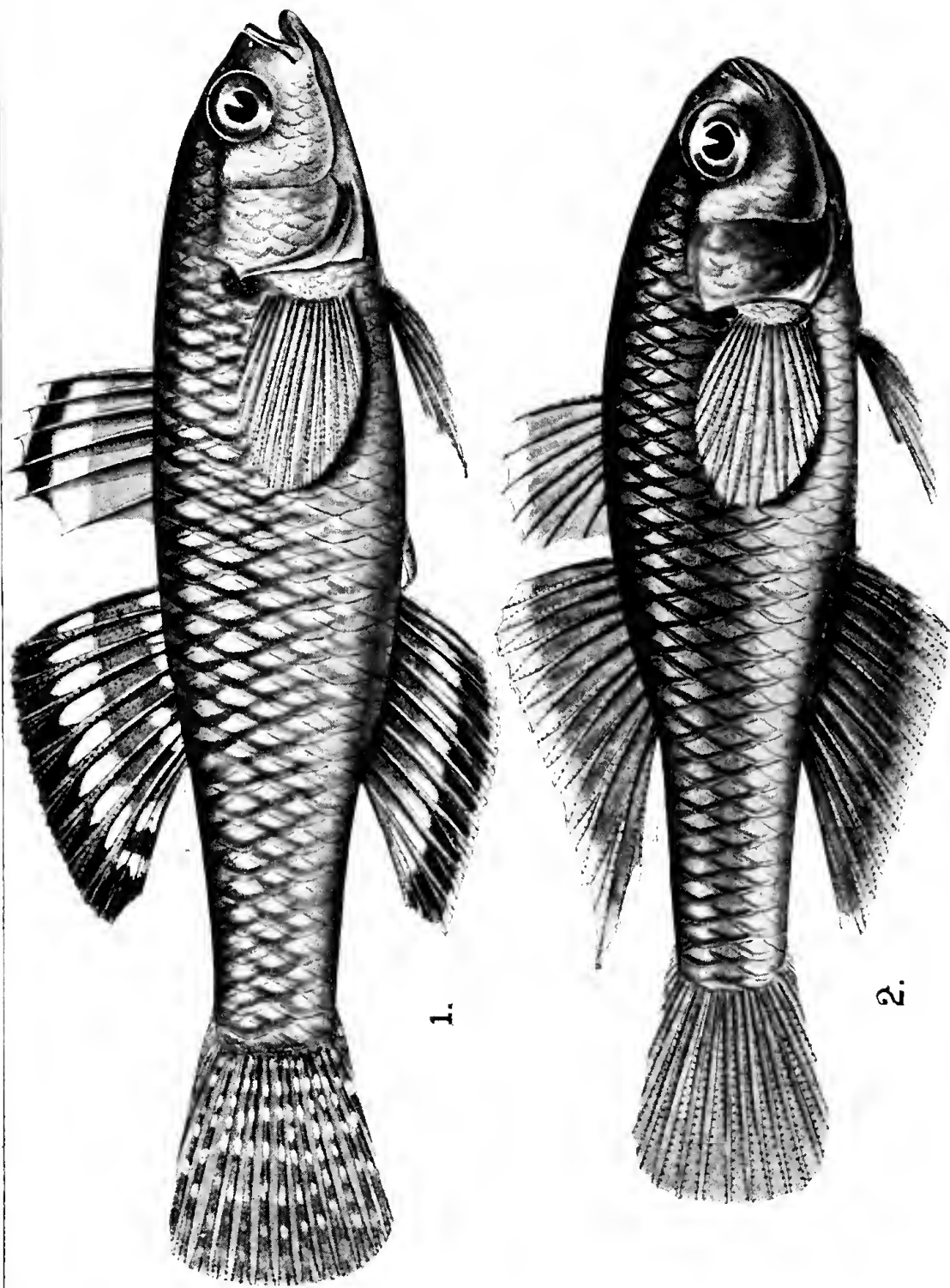

1.

2.





## EXPLANATION OF PLATE XXXV.

---

- Fig. 1. *Krefftius adspersus*, Castelnau,  
(male, one and a half times natural size).
- Fig. 2. *Krefftius australis*, Krefft,  
(male, one and a half times natural size).

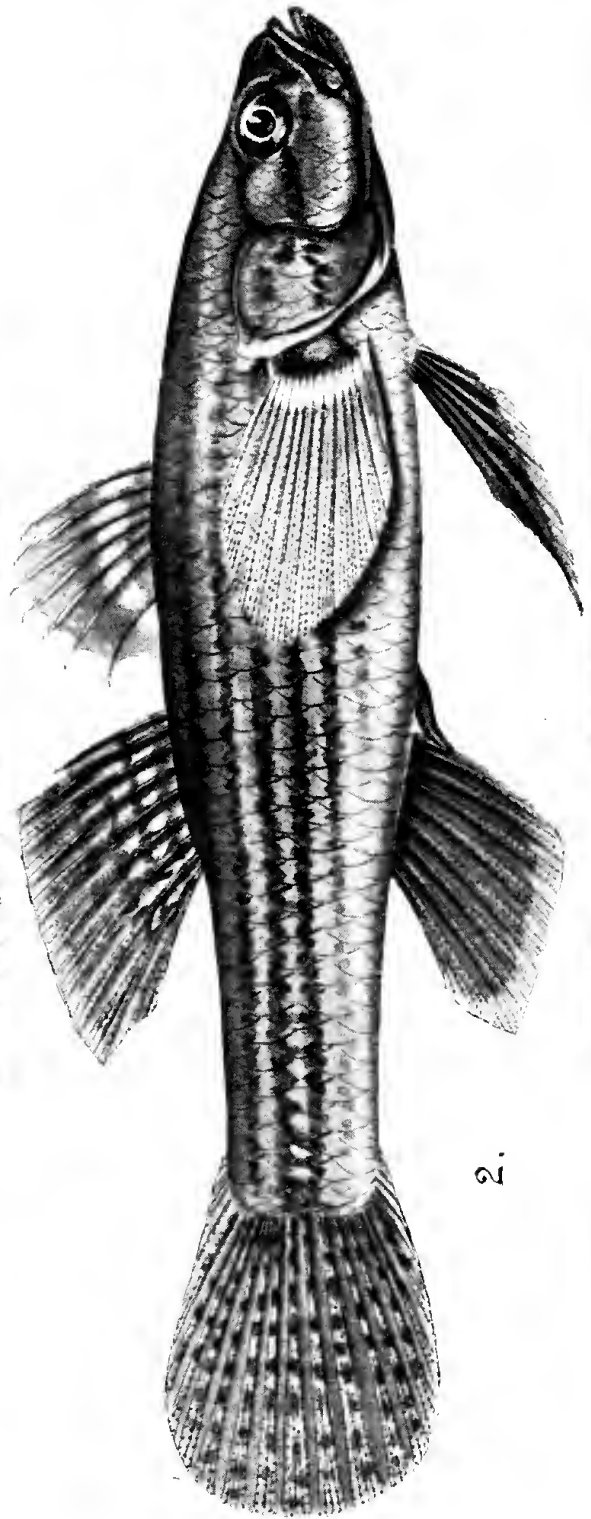
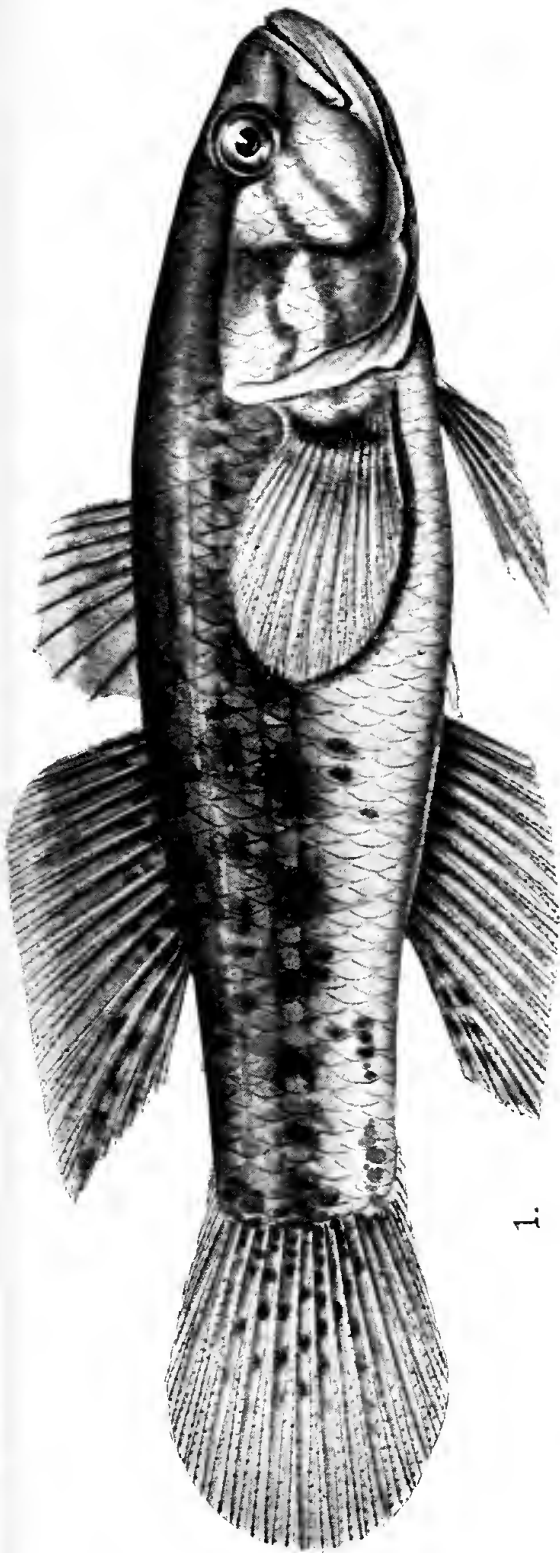

THE UNIVERSITY OF CHICAGO PRESS





EXPLANATION OF PLATE XXXVI.

---

Fig. 1. *Krefftius covii*, Krefft,  
(female, natural size).

Fig. 2. *Philipnodon grandiceps*, Krefft,  
(male, twice natural size).

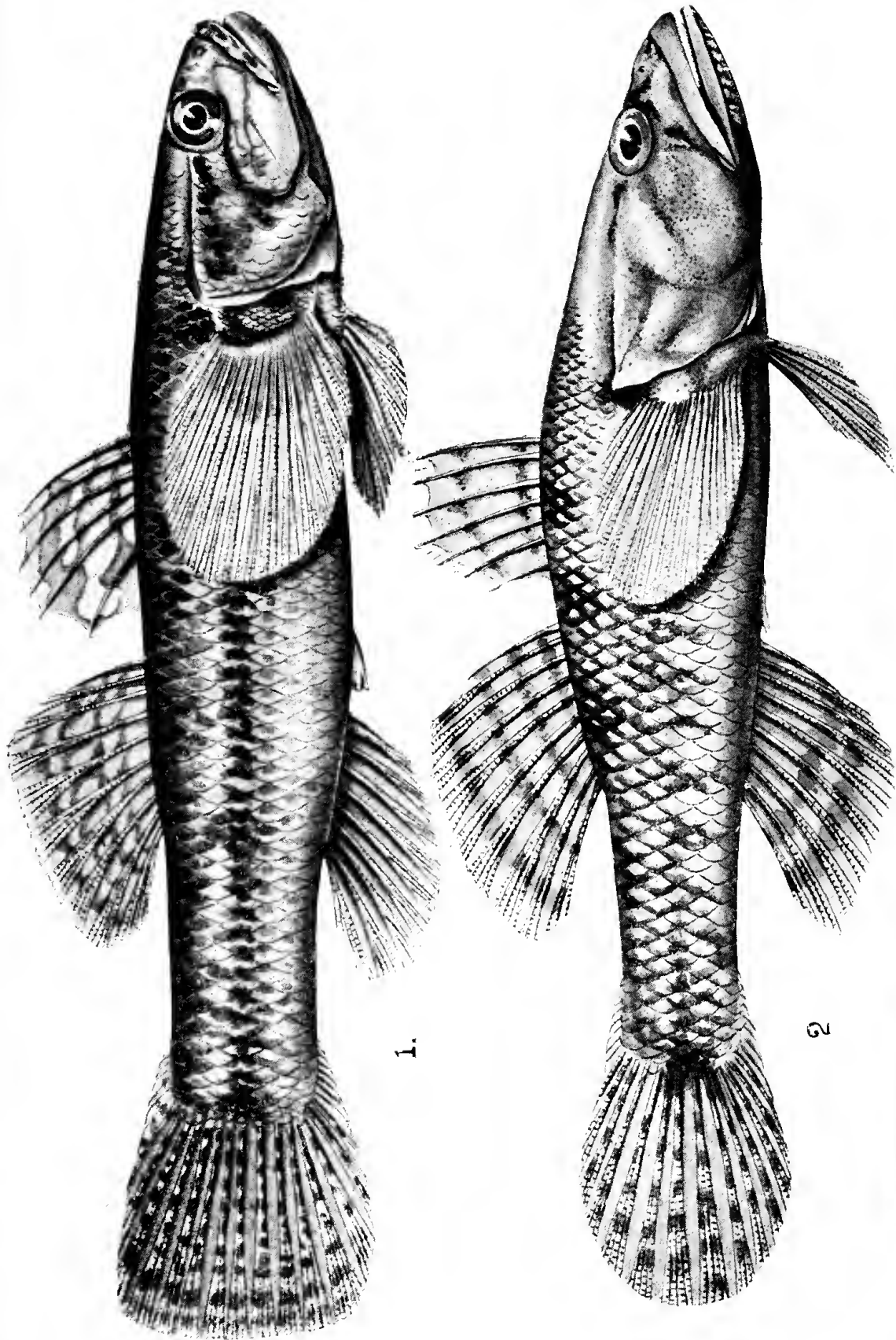

NATIONAL MUSEUM RESEARCH



EXPLANATION OF PLATE XXXVII.

---

PISOCRINUS (?) YASSENSIS, *Eth. fil.*

- Fig. 1. Side view of calyx, showing l. ant. R, ant. and l. post. Rs.  
—× 3.
- „ 2. Ventral or summit view of calyx, exhibiting the radial processes.  
—× 3.
- „ 3. Side view of calyx with the radianal (R'), the r. ant. and r. post.  
Rs.—× 3.
- „ 4. View of the dorsal surface, with the basal concavity, basals  
(united), and axial canal.—× 3.
- „ 5. Longitudinal natural section, exhibiting the internal cast, and  
basals *in situ*.—× 3.
- „ 6. Internal matrix cast.—× 3.
- „ 7. Ventral or summit view of calyx, with the radial processes and a  
facet.—× 3.
- „ 8. Left posterior radial (l. post. R), adhering to a fragment of mat-  
rix.—× 3.
- „ 9. Right anterior radial (r. ant. R).—× 3.
- „ 10. Radianal (R').—× 3.
- „ 11. Left anterior radial (l. ant. R).—× 3.
- „ 12. Side view of more or less bowl-shaped calyx.—× 3.
- „ 13. Side view of a similar specimen to fig. 12, showing sculpture.  
—× 3.
- „ 14. Three stem ossicles, believed to be those of this species.—× 3.

P. (?) YASSENSIS, VAR. LOBATA, *Eth. fil.*

- „ 15. Dorsal or basal view of a strongly pentalobate specimen.—× 3.



1

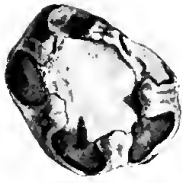

2



3



5



6



4



7

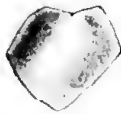

10



8



11



9



12



13

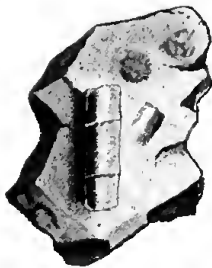

14

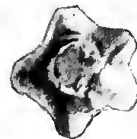

15







EXPLANATION OF PLATE XXXVIII.

---

Fig. 1. *Betta pugnax*, Cantor, male,  
(twice natural size).

Fig. 2. Nest of *Betta pugnax*, Cantor,  
(natural size).

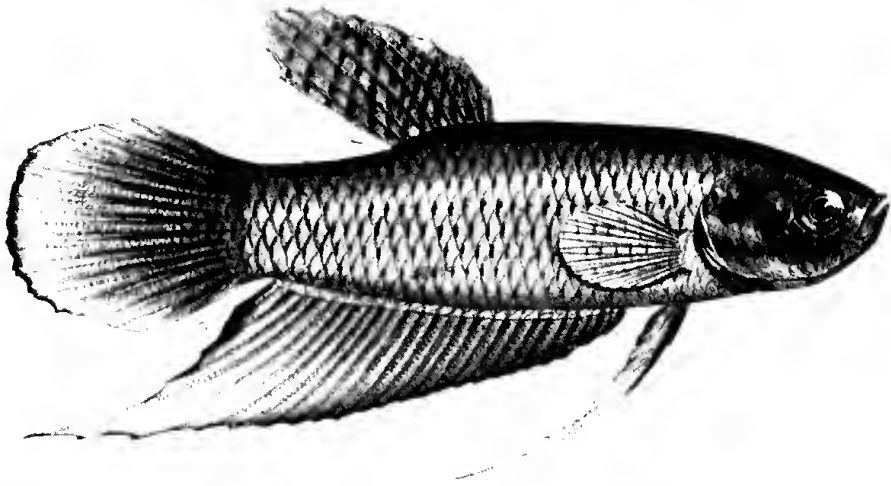

1

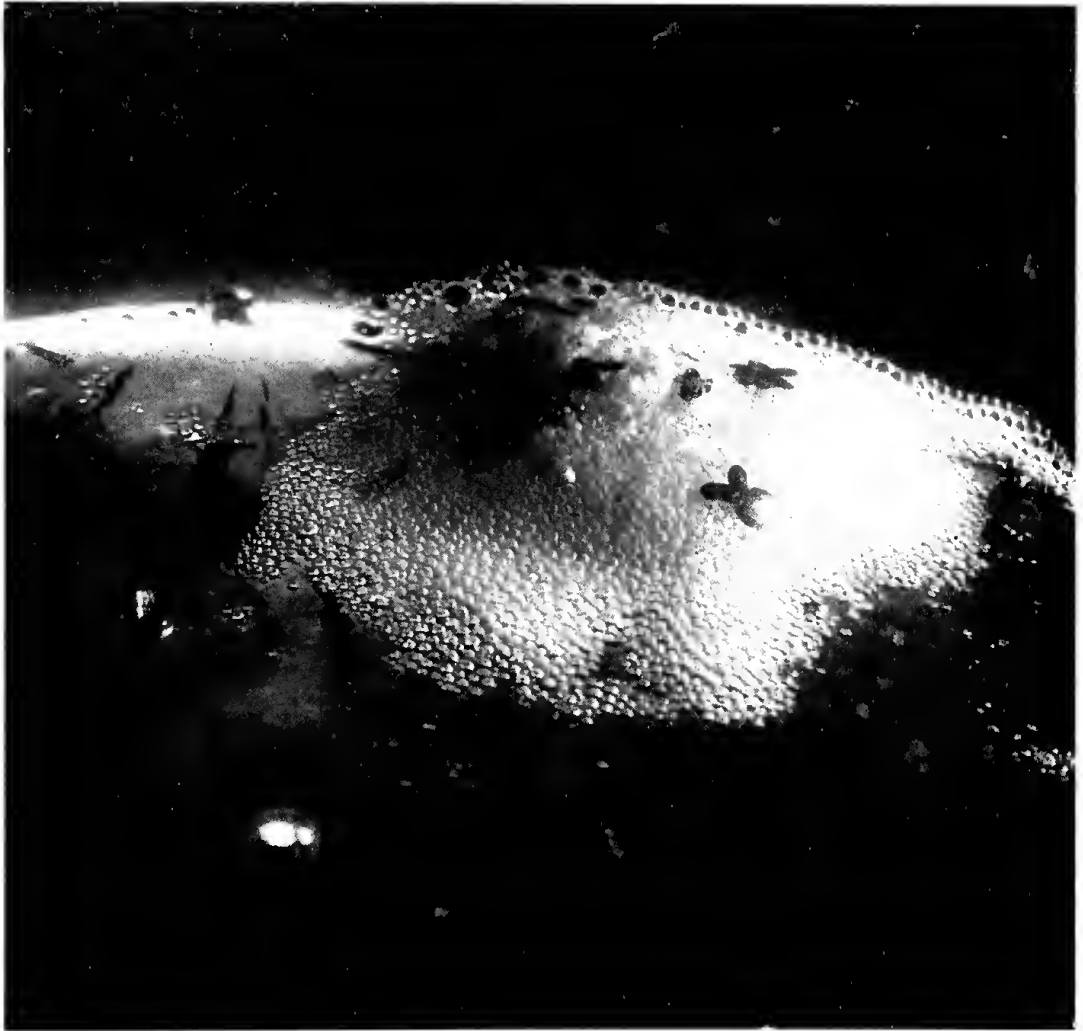

2

THE NATIONAL BUREAU OF STANDARDS



EXPLANATION OF PLATE XXXIX.

---

TOPAZ.

Figs. 1, 2, 3. Emmaville, New South Wales.

Figs. 4, 5. Oban, New South Wales.

Faces:—*b* (010), *c* (001), *m* (110), *M* (230), *l* (120),  $\pi$  (250),  
*g* (130), *d* (201), *h* (203), *f* (021), *y* (041), *o* (221), *u*  
(111), *i* (223), *x* (243).

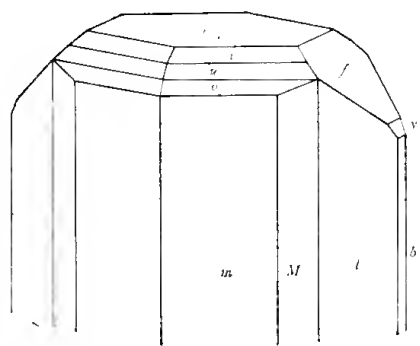

2

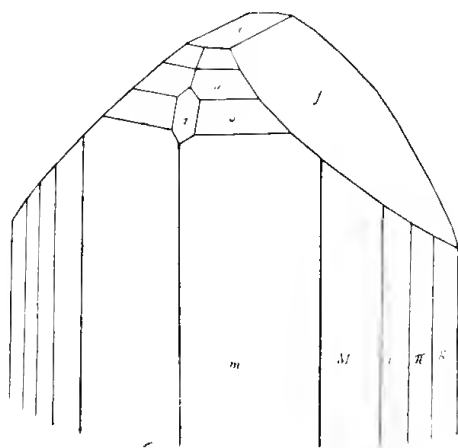

1

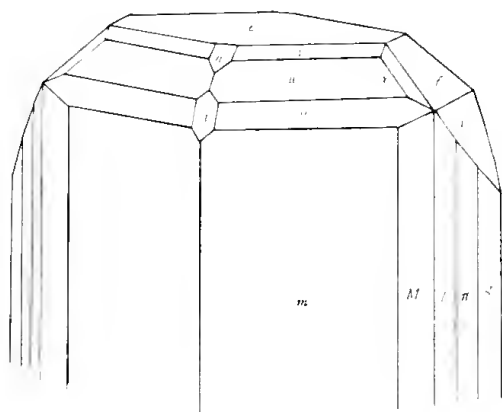

3

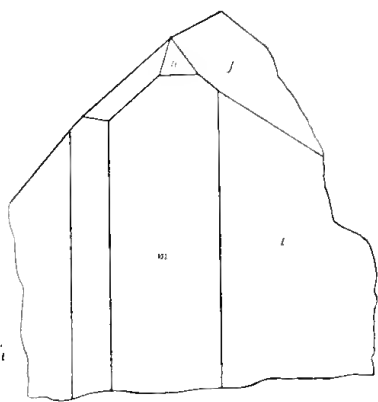

5

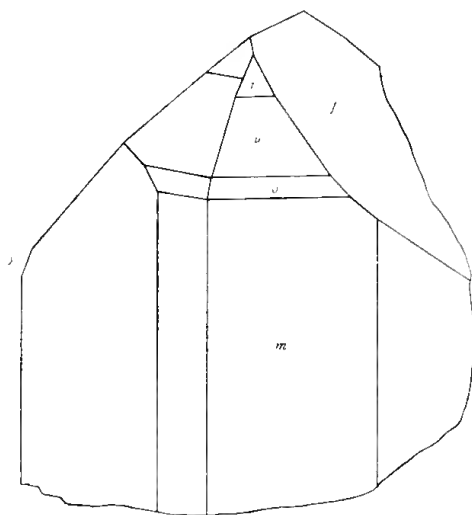

4







EXPLANATION OF PLATE XL,

---

BERYL.

Fig. 1. Emmaville, New South Wales. Faces:— $c$  (0001),  $m$  ( $10\bar{1}0$ ),  $p$  ( $10\bar{1}1$ ),  $s$  ( $11\bar{2}1$ ).

VESUVIANITE.

Fig. 2. Bowling Alley Point, Nundle, New South Wales. Faces:— $m$  ( $110$ ),  $a$  ( $100$ ),  $p$  ( $111$ ),  $t$  ( $331$ ),  $s$  ( $311$ ).

TOURMALINE.

Figs. 3, 4. Kangaroo Island, South Australia. Faces:— $m$  ( $10\bar{1}0$ ),  $m$  ( $01\bar{1}0$ ),  $a$  ( $11\bar{2}0$ ),  $r$  ( $10\bar{1}1$ ),  $o$  ( $02\bar{2}1$ ),  $u$  ( $32\bar{5}1$ ).

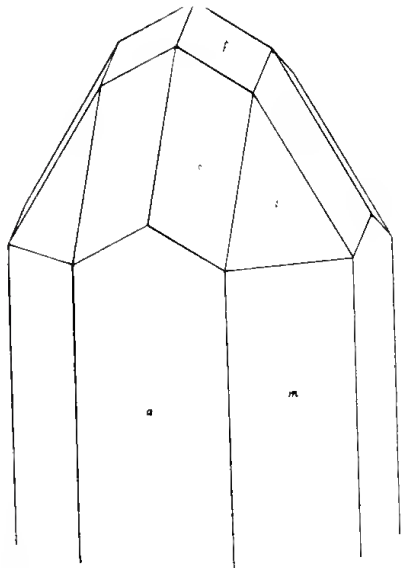

2

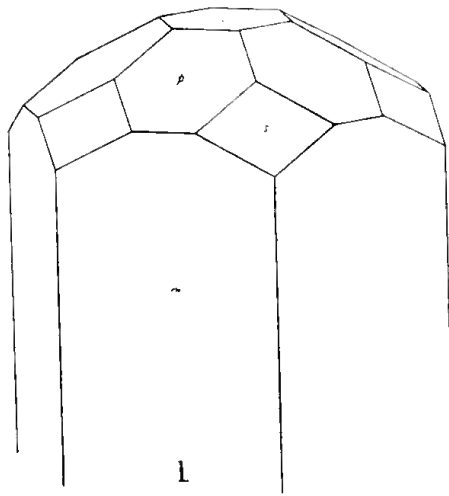

1

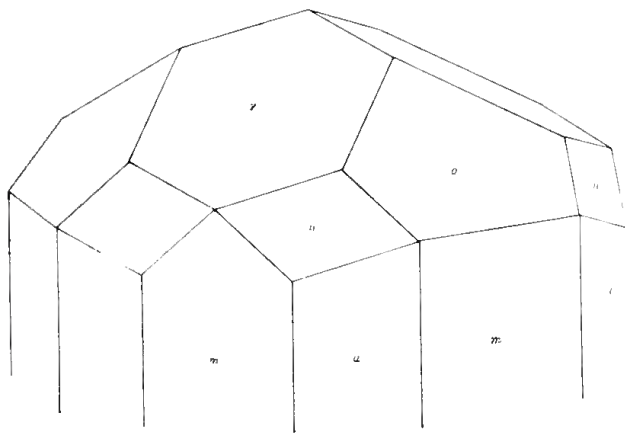

4

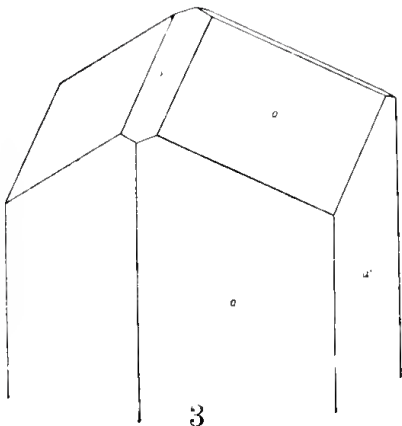

3

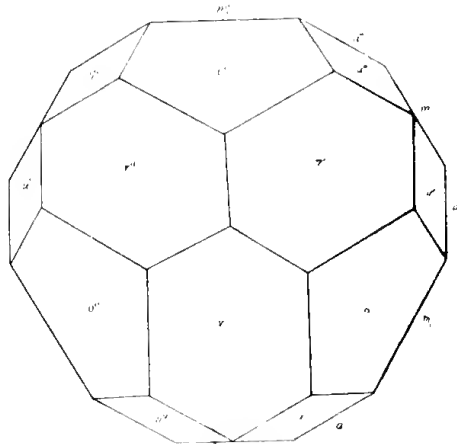

5





## EXPLANATION OF PLATE XLI.

---

### WOLFRAMITE.

Figs. 1, 2, 3, 4. Wild Kate Mine, near Deepwater, New South Wales.  
Faces :— $a$  (100),  $c$  (001),  $l$  (210),  $m$  (110),  $t$  (102),  $y$  ( $\bar{1}02$ ),  $f$  (011),  $\omega$  (111),  $o$  ( $\bar{1}11$ ),  $\sigma$  (121),  $s$  ( $\bar{1}21$ ).

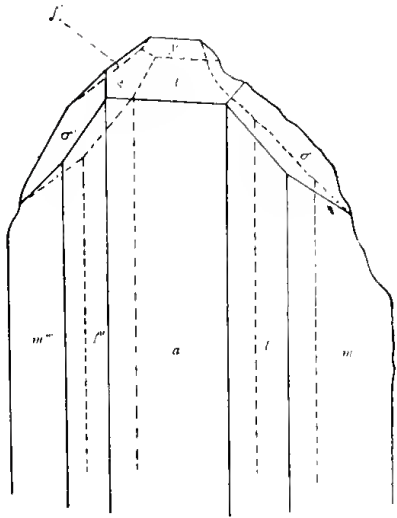

2

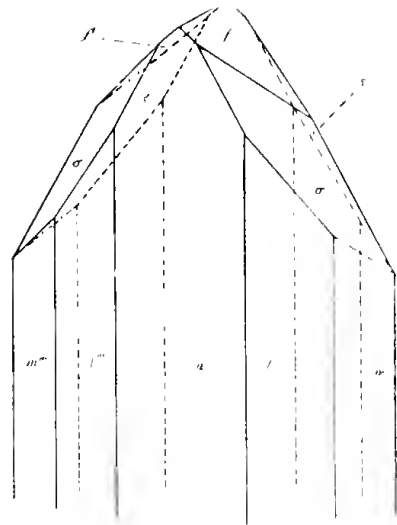

1

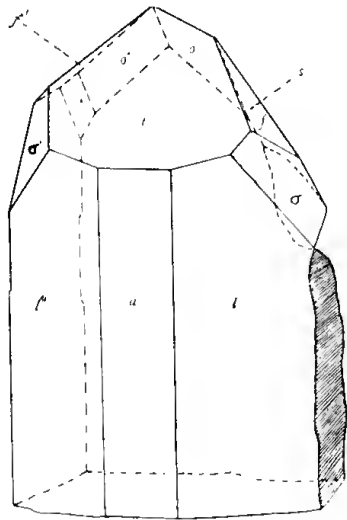

4

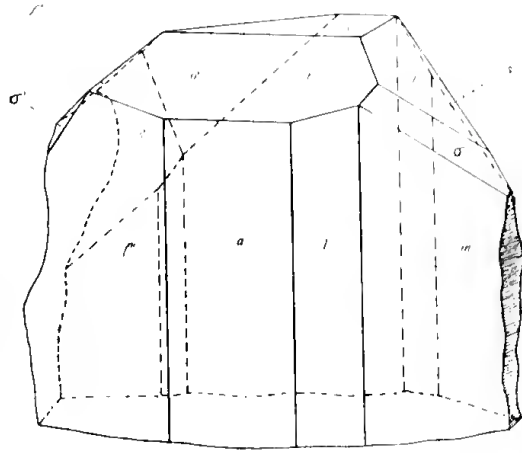

3







EXPLANATION OF PLATE XLII.

---

CIMOLIOSAURUS MACCOYI, *Eth. fil.*

- Fig. 1. Posterior cervical centrum, dorsal view.  
,, 2. Lateral view of the same.  
,, 3. Ventral view of the same.  
,, 4. Pectoral (?) centrum, dorsal view.  
,, 5. Lateral view of the same.  
,, 6. Ventral view of the same.  
,, 7. Terminal articular surface of the same.  
,, 8. Median cervical centrum, dorsal view.  
,, 9. Ventral view of the same.  
,, 10. Lateral view of the same.

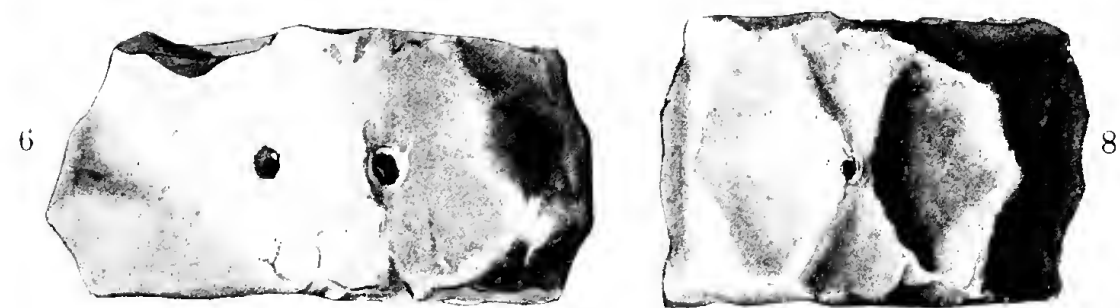
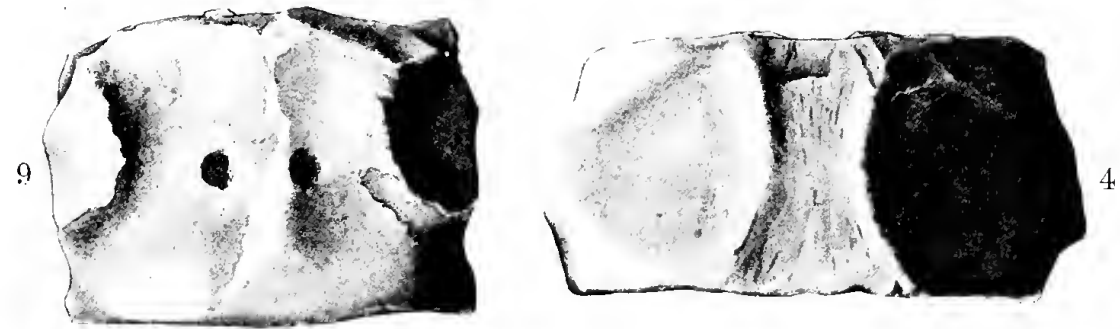





EXPLANATION OF PLATE XLIII.

---

CIMOLIOSAURUS MACCOYI, *Eth. fil.*

- Fig. 1. Cervical neural spine in part, side view.  
,, 2. The same fragment, anterior view.  
,, 3. Dorsal (?) neural spine with broken zygopophyses, anterior view.  
,, 4. Phalange.

HUMERUS.

- Fig. 5. Distal end in part of a larger humerus than that represented in Pl. xlv, figs. 2 and 3.

FEMUS.

- Fig. 6. Proximal end and portion of shaft of a large bone supposed to be a femur.

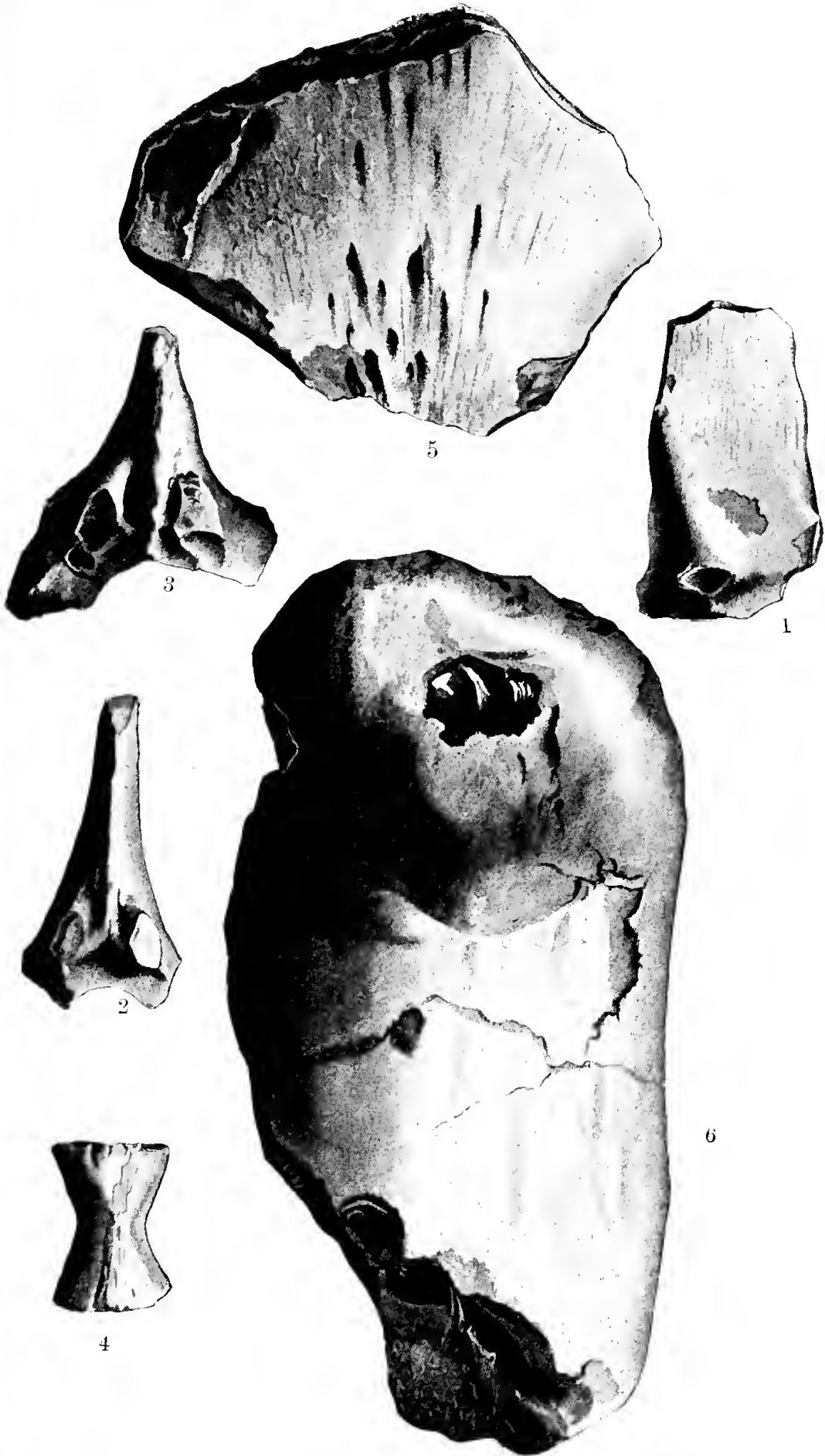







## EXPLANATION OF PLATE XLIV.

---

### CIMOLIOSAURUS MACCOYI, *Eth. fl.*

- Fig 1. Femur.  
,, 2. Humerus, portion of the distal end.  
,, 3. Humerus, distal articular surface.  
,, 4. Dorsal centrum, terminal articular surface and central tubercle.  
,, 5. Median cervical centrum, terminal articular surface, &c.  
,, 6. Cervical pleurapophysis.  
,, 7. Cervical pleurapophysis.

### RIB PORTION.

- ,, 8. Portion of a large rib, possibly belonging to a larger reptile than *C. maccoyi*.

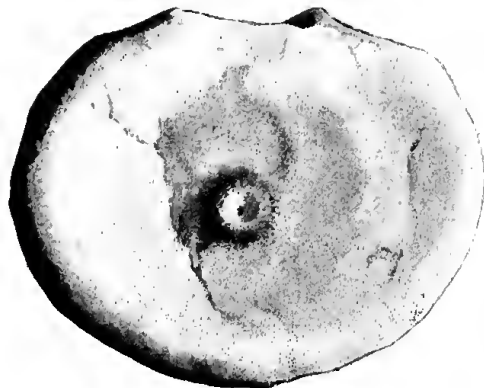
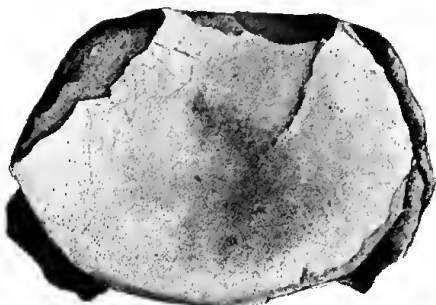





EXPLANATION OF PLATE XLV.

---

CIMOLIOSAURUS SUTHERLANDI, *McCoy*, sp.

Fig. 1. Cast of a cervical vertebra with a portion of the neural arch and pleurapophyses— $\frac{1}{2}$  nat.

TOOTH.

Fig. 2. Cast of a large tooth, probably *Cimoliosaurus*.

ICHTHYOSAURUS, Sp.

- Fig. 3. Trunk vertebra, side view.  
,, 4. Caudal vertebra, articular surface.  
,, 5. Caudal vertebra, dorsal surface.  
,, 6. Caudal vertebra, ventral surface.  
,, 7. Caudal vertebra, lateral surface.

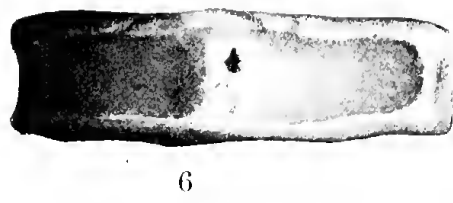
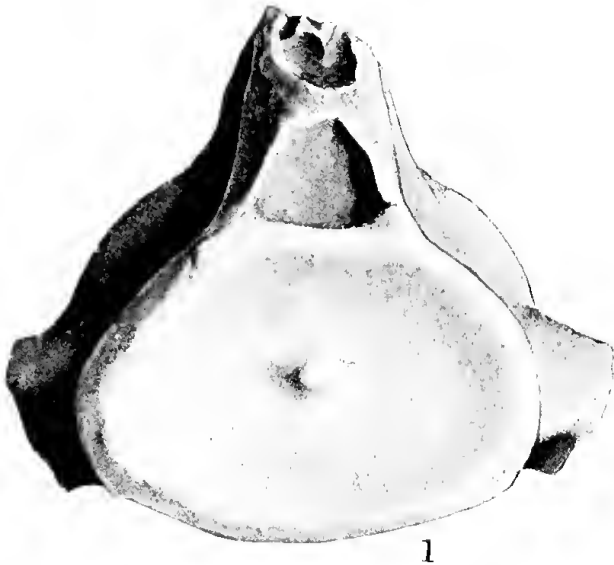







## EXPLANATION OF PLATE XLVI.

---

- Fig. 1. *Ectatostica troglodytes*, Higg. and Pett., cephalothorax.  
 " 2. " " " " falx.  
 " 3. " " " " sternum and maxillæ.  
 " 4. " " " " abdomen, underside.  
 " 5. *Mimetus maculosus*, Rainb., cephalothorax in profile.  
 " 6. " " " " epigyne.  
 " 7. *Pœcilipta venusta*, Rainb., female.  
 " 8. " " " " eyes.  
 " 9. " " " " epigyne.  
 " 10. *Corinnomma formiciforme*, Rainb., female.  
 " 11. " " " " eyes.  
 " 12. " " " " epigyne.

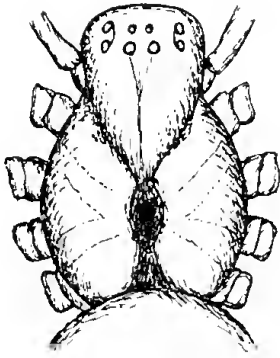

1



7

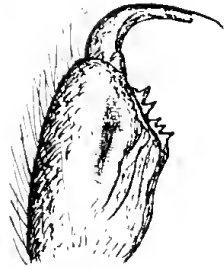

2

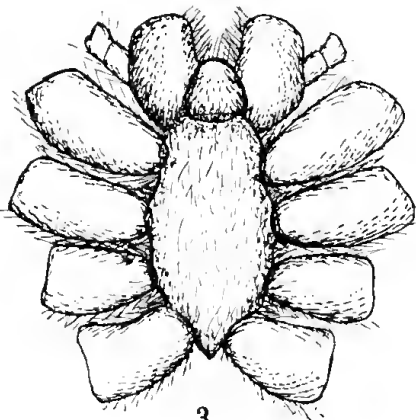

3



10

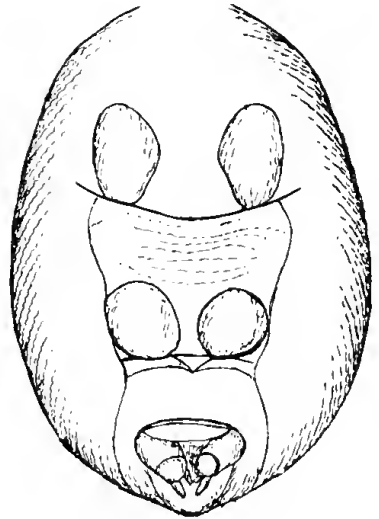

4

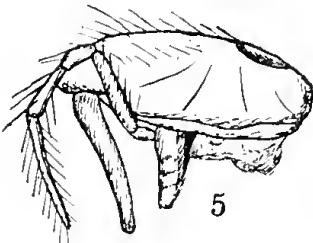

5



9

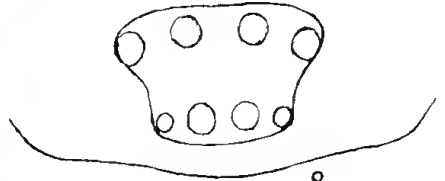

8

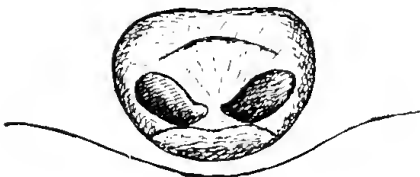

6

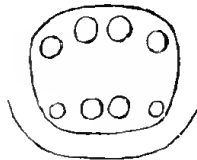

11

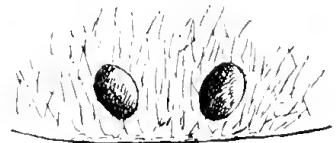

12



# INDEX.

A.	PAGE
<i>abbreviatus</i> , GONORHYNCHUS	147
<i>abdominalis</i> , HIPPOCAMPUS	196
Aboriginal rock-shelter	271
<i>ACANTHISTIUS cinctus</i>	202
<i>ACANTHOCLINUS fasciolatus</i>	184
<i>litoreus</i>	184, 225
<i>ACANTHURUS unicornis</i>	216
<i>ACMÆA monswoodensis</i>	251
<i>stellaeformis</i>	4
<i>ACOSMERYX</i> , sp.	7
<i>ACROCEPHALUS rehsei</i>	1
<i>ACTINOPUS formosus</i>	65
<i>acutirostris</i> , HISTIOPTERUS	61
<i>adamsi</i> , CAULOPTERIS	48
<i>adspersa</i> , ELEOTRIS	282
<i>adspersus</i> , KREFFTIUS	282
<i>æolosoma</i> , GOBIUS	176, 222
<i>æquipinnis</i> , CÆSIOSOMA	167, 206
<i>æquipinnis</i> , SCORPIS	167, 206
<i>ÆTHOPROBA perspicilla</i> a	149, 193
<i>afra</i> , GYMNOTHORAX	144
<i>afra</i> , MURÆNA	144, 191
<i>albascopularis</i> , (var.) ISOCRI- NUS <i>australis</i>	251
<i>albipennis</i> , PETROPHASSA, eggs of	269
<i>alboapicalis</i> , SALARIAS	181, 224
<i>albomaculata</i> , STORENA	323
<i>albopunctatus</i> , GOBIUS	3
<i>albopunctatus</i> , MONACANTHUS	37
<i>ALEUTERIUS haueri</i>	38, 217
<i>ALLOGOBIUS</i>	176
<i>viridis</i>	177, 222
<i>altipinnis</i> , COCOTROPUS	41,
	44, 175, 221
<i>altipinnis</i> SPHEROIDES	218
<i>altipinnis</i> , TETRODON	218
<i>ALUTERA monoceros</i>	217
<i>amabilis</i> , STERNOPTYCHIDES	194
<i>AMPHIPRION latezonatus</i>	208
<i>melanopus</i>	168, 208
<i>ampla</i> , GLOSSOPTERIS	48
<i>AMYNA octo</i>	7
<i>analis</i> , PSEUDOMONACANTHUS	173, 217
Analyses, Phosphatic Speci- mens	13
<i>ANAMPSES diadematus</i>	172, 211
<i>elegans</i>	172, 211
<i>twistii</i>	211
<i>variolatus</i>	172

	PAGE
<i>ANCISTROCERAS</i>	67
<i>aneitense</i> , THALASSOMA	209
<i>aneitensis</i> , JULIS	209
<i>ANGELINOCERAS</i>	75
<i>ANGUILLA australis</i>	189
<i>reinhardtii</i>	189
<i>anguillaris</i> , PLATYSTACUS	141, 188
<i>anguillaris</i> , PLOTOSUS	141, 185, 188
<i>angustifrons</i> , OPHIORRHINUS	285
<i>ANOUS cinereus</i>	138
<i>leucocapillus</i>	2
<i>stolidus</i>	138
<i>ANTENNARIUS coccineus</i>	226
<i>commersonii</i>	226
<i>ANTHIAS pleurotenia</i>	3
<i>antjerius</i> , GLYPHISODON	170, 209
<i>aphrodite</i> , CHÆTODON	214
<i>apicalis</i> , DISCINA	250
<i>APLODACTYLUS etheridgii</i>	167, 186, 207
<i>APOGON chrysurus</i>	165, 202
<i>norfolcensis</i>	164, 202
<i>APROSMYCTUS cyanopygius</i>	265
<i>arabica</i> , CYPRÆA	4
<i>arab</i> , PLOTOSUS	142
<i>ARANEUS exertus</i>	102
<i>theisii</i>	5
<i>arenosa</i> , CYPRÆA	4
<i>argyrostomus</i> , TURBO	4
<i>armigera</i> , PURPURA	4
<i>ARRIPIS trutta</i>	204
<i>ASERAGGODES ramsayi</i>	226
<i>ASTERROPTERIX semipunctatus</i>	280
<i>ATHERINA lacunosa</i>	197
<i>ATOPICHTHYS</i> , sp.	187
<i>atra</i> , HOLOTHURIA	13
<i>atrocostatum</i> , LYGOSOMA	2
<i>atrogulare</i> , TRIPTERYGION	184, 225
<i>atropygialis</i> , PEPHILA	263
<i>atun</i> , SCOMBER	56
<i>atun</i> , THYRSITES	56
<i>ATYA bisulcata</i>	12
<i>ATYPICHTHYS strigatus</i>	206
<i>ATYPUS strigatus</i>	206
<i>AULOSTOMUS chinensis</i>	195
<i>aurantiacus</i> , CRISTICEPS	224
<i>aurata</i> , SCIÆNA	205
<i>auratus</i> , CONUS	4
<i>auratus</i> , PAGROSOMUS	205
<i>auritus</i> , SCARICHTHYS	213
<i>auritus</i> , SCARUS	213



	PAGE		PAGE
<i>carolensis</i> , AVELLANA ...	109	CIRRHITES <i>maculatus</i> ...	3
<i>casta</i> , DORATIFERA, larvæ ...	253	CIRRHITICHTHYS <i>splendens</i>	167, 207
<i>caudofasciatus</i> , PETRODON ...	xiii	<i>clathrisquammis</i> , CREEDIA ...	57
<i>caudofasciatus</i> , TROPIDICHTHYS ...	xiii	<i>clibanarius</i> , PAGURUS ...	11
CAULOPTERIS <i>adamsi</i> ...	48	CLIBANARIUS <i>teniatus</i> ...	11
<i>cavifrons</i> , ELEOTRIS ...	280	<i>elosterooides</i> , PTYCHOCERAS ..	110
CENOBITA <i>brunnea</i> ...	11	CLUPEA <i>gracilis</i> ...	192
CENOBITA <i>olivieri</i> ...	11	COBITIS <i>gonorhynchus</i> ...	147
<i>rugosa</i> ...	11	<i>coccineus</i> , ANTENNARIUS ...	226
<i>spinus</i> ...	11	<i>coccineus</i> , CHIRONECTES ...	226
CENTRISCUS <i>gracilis</i> ..	196	COCOTROPUS <i>altipinnis</i> 41, 44,	175, 221
CERITHIUM <i>columna</i> ...	4	<i>dermacanthus</i> ...	43
CHÆTETES ...	19	<i>echinatus</i> ...	43
CHÆTODON ...	34, 5	<i>gallus</i> ...	176
<i>aphrodite</i> ...	214	<i>potlii</i> ...	44
<i>howensis</i> ...	33, 215	<i>roseus</i> ...	44
<i>saxatilis</i> 170, 209, 235		<i>caelestinus</i> , GLYPHISODON 170, 235	
<i>strigatus</i> ...	215	<i>cæruleus</i> , CORYNETES ...	6
<i>tricinatus</i> ...	32, 214	Coil-feather Money 74, 133	
<i>trifasciatus</i> ...	32, 214	<i>columna</i> , CERITHIUM ...	4
<i>unicornis</i> ...	216	COLUMNOPORA ...	18
<i>chalazius</i> , GYMNOTHORAX 145, 191		<i>commersonii</i> , ANTENNARIUS 226	
CHALINURA ...	324	<i>commersonii</i> , CHIRONECTES 226	
<i>novæ-hollandiæ</i> ...	325	<i>compressus</i> , CARASSIOPS ...	280
CHAMA, sp. ...	5	<i>compressus</i> , ELEOTRIS ...	280
CHEILODACTYLUS <i>gibbosus</i> ...	207	<i>concatenatus</i> , LACTOPHREYS... 217	
CHELMON ...	34	<i>concatenatus</i> , OSTRACION ...	217
CHELMONOPS ...	35	CONGER <i>cinerus</i> ...	189
CHELMO <i>truncatus</i> ...	35	CONGERMURÆNA <i>longicauda</i> 190	
CHERSYDRUS <i>granulatus</i> ...	74	CONGRELLUS <i>gilberti</i> ...	189
<i>chinensis</i> , AULOSTOMUS ...	195	CONGROMURÆNA <i>longicauda</i> 190	
<i>chinensis</i> , FISTULARIA ...	195	<i>mellissii</i> ...	189
CHIRONECTES <i>coccineus</i> ...	226	CONOCEPHALUS <i>trouletii</i> ...	7
<i>commersonii</i> ...	226	<i>conspicillatus</i> , HOLACANTHUS	37, 215
CHIRONEMUS <i>marmoratus</i> ...	207	CONUS <i>auratus</i> ...	4
CHLAMYDODERA <i>guttata</i> , nest 131		<i>geographus</i> ...	4
<i>orientalis</i> , Bower ...	270	<i>glans</i> ...	4
<i>chlororhynchus</i> , PUFFINUS... 138		<i>hebraeus</i> ...	4
CHROMIS <i>hypsilepis</i> ... 208		<i>lividus</i> ...	4
<i>chrysurus</i> , APOGON .. 165, 202		<i>miliaris</i> ...	4
<i>cicercula</i> , CYPRÆA ...	4	<i>rattus</i> ...	4
CICHLA <i>cultrata</i> ...	161	<i>cooki</i> , SCORPÆNA ...	220
CICINDELA <i>jungi</i> ...	245	Coprolites and Nodules ...	114
<i>viliata</i> , SILLAGO ...	206	CORADION ...	35
CIMOLIOSAURUS <i>leucoscopelus</i> 315		<i>cordimana</i> , OCYPODA ...	11
<i>maccoyi</i> ...	312	CORINNOMMA <i>formiciforme</i> 335	
<i>sutherlandi</i> ...	312	CORIS <i>aygula</i> ...	210
sp. ...	315	<i>picta</i> ...	26, 172, 210
<i>cinctum</i> , PLECTROPOMA ...	202	<i>semicincta</i> ...	26
<i>cinctus</i> , ACANTHISTIUS ...	202	<i>cornutum</i> , OSTRACION 37, 218	
<i>cinerasceus</i> , PACHYTYLUS ...	7	<i>corrugata</i> , COUTHOUYIA ...	95
<i>cinerus</i> , ANOUS ...	138	CORYNETES <i>cæruleus</i> ...	6
<i>cinerus</i> , CONGER ...	189	<i>costatus</i> , DIPLOCREPIS 179, 222	
<i>cinerus</i> , LEPTOCEPHALUS ...	189		
CIRCE <i>pectinata</i> ...	5		

	PAGE
COUTHOUYIA <i>corrugata</i> ...	95
<i>corii</i> , ELEOTRIS ...	283
<i>corii</i> , KREFFTIUS ...	283
<i>corii</i> , MULGOA ...	283
CREEDIA <i>clathrisquammis</i> ...	57
<i>haswelli</i> ...	57
<i>cribrosa</i> , LACERIPORA ...	19
<i>crinipes</i> , GEOGRAPSUS ...	11
CRISTICEPS <i>aurantiacus</i> ...	224
<i>australis</i> ...	224
<i>roseus</i> ...	181, 224
CRYPTOTHELE ...	322
CRYPTOTHELE <i>doreyana</i> ...	322
CUBICEPS <i>gracilis</i> ...	162, 200
CUCULUS <i>pallidus</i> ...	337
<i>cultrata</i> , CICHLA ...	161
<i>cultrata</i> , SCIÆNA ...	161, 200
<i>cultrata</i> , SERIOLA ...	161
<i>cultratum</i> , PLATYSTETHUS ...	161
<i>cultratus</i> , BATHYSTETHUS ...	161, 200
CUNA <i>delta</i> ...	87
<i>cuvieri</i> , SCOPELUS ...	156
<i>cuvieri</i> , TETRAGONURUS ...	201
<i>cyanea</i> , GIRELLA ...	167, 206
<i>cyanops</i> , SULA ...	138
<i>cyanopygius</i> , APROSMICTUS ...	265
<i>cyanostigma</i> , BRACHYELEOTRIS ...	279
<i>cyanostigma</i> , ELEOTRIS ...	279
<i>cyanurum</i> , LYGOSOMA ...	2
CYCLOCHILA <i>australasiae</i> ...	116
CYCOLLITUITES ...	75
<i>bowningensis</i> ...	77
CYCLOPECTEN <i>aviculoides</i> ...	87
<i>cydista</i> , STIGMODERA ...	246
<i>cylindrica</i> , PARAPERCEIS ...	221
<i>cylindrica</i> , SCIÆNA ...	221
CYPRÆA <i>arabica</i> ...	4
<i>arenosa</i> ...	4
<i>caput-serpentis</i> ...	4
<i>carneola</i> ...	4
<i>cicercula</i> ...	4
<i>helvola</i> ...	4
<i>isabella</i> ...	4
<i>moneta</i> ...	4
<i>nucleus</i> ...	4
<i>reticulata</i> ...	4
<i>scurra</i> ...	4
<i>stolida</i> ...	4
<i>talpa</i> ...	4
<i>teres</i> ...	4
<i>tigris</i> ...	4
<i>ventricosa</i> ...	4
CYPRINUS <i>gonorynchus</i> ...	146, 147, 192
CITTUS <i>australis</i> ...	56

D.	PAGE
<i>dæmelii</i> , EPINEPHELUS ...	203
DAIRA <i>perlata</i> ...	8
<i>dæmelii</i> , SERRANUS ...	203
DAPHNELLA <i>substriata</i> ...	97
DASYATIS, sp. ...	141, 187
DASYSCOPELUS <i>naufragus</i> ...	154, 194
<i>dasyuri</i> , STEPHANOCIRCUS ...	53
Datolite and Natrolite ...	127
<i>debilis</i> , DRASSUS ...	321
DECAPTERUS <i>sanctæ-helene</i> ...	199
<i>dehamata</i> , DENDROSTOMA ...	69, 73
<i>delta</i> , CARDITELLA ...	87
<i>delta</i> , CUNA ...	87
<i>demissa</i> , PUNCTURELLA ...	93
DENDROSTOMA <i>dehamata</i> ...	69, 73
<i>signifer</i> ...	73
<i>depressa</i> , BELONE ...	3
<i>depressa</i> , FISTULARIA ...	3, 195
<i>dermacanthus</i> , COCOTROPUS ...	43
<i>diadematus</i> , ANAMPSES ...	172, 211
DIÆA <i>multimaculata</i> ...	105
DIANCISTRUS <i>longifilis</i> ...	185, 225
<i>digitulum</i> , CÆCUM ...	94
DIKELOCEPHALUS <i>florentinensis</i> ...	99
<i>dilutus</i> , DRASSUS ...	321
DINEMATICTHYS <i>longifilis</i> ...	185, 225
DIODON <i>hystrix</i> ...	220
DIPLOCREPIS <i>costatus</i> ...	179, 222
Disarticulation of Finger Joints ...	273
DISCINA <i>apicalis</i> ...	250
DISCOPLAX <i>longipes</i> ...	9
<i>dobula</i> , MUGIL ...	197
DORATIFERA <i>casta</i> , larvæ ...	253
<i>doreyana</i> , CRYPTOTHELE ...	322
<i>dorsale</i> , THALASSOMA ...	26, 210
<i>dorsalis</i> , JULIS ...	26, 210
<i>dovii</i> , EXOCÆTUS ...	156, 195
DRASSODES ...	320
<i>invenustus</i> ...	321
<i>perexiguus</i> ...	321
<i>silaceus</i> ...	321
DRASSUS ...	320
<i>debilis</i> ...	321
<i>dilutus</i> ...	321
<i>griseus</i> ...	321
DROMICIA <i>nana</i> ...	134
DULES <i>tæniurus</i> ...	164, 201
<i>dumosum</i> , SISTRUM ...	4

E.	
ECHIDNA <i>nebulosa</i> ...	191
<i>echinatus</i> , COCOTROPUS ...	43
<i>echinites</i> , MUELLERIA ...	13
ECHINOMETRA <i>lucunter</i> ...	12
<i>oblonga</i> ...	12



	PAGE		PAGE
ECHINOTHRYX <i>turcarum</i> ...	12	<i>farnelli</i> , HISTIOPTERUS ...	61
<b>Echiuroidea</b> .. ...	<b>73</b>	<i>fasciata</i> , LAMPONA ...	322
ECTATOSTICA ...	326	<i>fasciata</i> , PERCA ...	166, 203
<i>australis</i> ...	327	<i>fasciatus</i> , EPINEPHELUS ...	166, 203
<i>troglodytes</i> ...	327	<i>fasciatus</i> , LIMNICHTHYS ...	178, 222, 243
<i>ejectus</i> , NOTOSCOPELUS ...	150, 193	<i>fasciatus</i> , PULEX ...	54
<i>elegans</i> , ANAMPSES ...	172, 211	<i>fasciolatus</i> , ACANTHOCLINUS ...	184
<i>elegans</i> , CARDUELIS ...	338	<i>fasciolatus</i> , POMACENTRUS ...	168, 208
<i>elegans</i> , PLATYCERCUS, 265, 266, 267		feather money, COIL ...	74, 133
ELEOTRIS <i>adspersa</i> ...	282	<i>fickerti</i> , TAMA ...	325
<i>australis</i> ...	283	Finger Joints, Disarticulation of ...	273
<i>carifrons</i> ...	280	FISTULARIA <i>chinensis</i> ...	195
<i>compressus</i> ...	280	<i>depressa</i> ...	3, 195
<i>coxii</i> ...	283	<i>flavens</i> , MELANOPHORA ...	321
<i>cyanostigma</i> ...	279	<i>flavens</i> , PROSTHESINA ...	321
<i>grandiceps</i> ...	285	<i>flavimarginata</i> , MUREENA ...	145, 191
<i>gymnocephalus</i> ...	285	<i>flavimarginatus</i> , GYMNOTHORAX ...	3, 145, 191
<i>humilis</i> ...	280	<i>flaveolus</i> , PLATYCERCUS ...	267
<i>mastersii</i> ...	283	<i>flavitarus</i> , HEMICLŒA ...	326
<i>mimus</i> ...	282	<i>flavitarus</i> , PRYNUS ...	320
<i>mogurnda</i> ...	282	<i>florentinensis</i> , DIKELOCEPHALUS ...	99
<i>richardsonii</i> ...	283	FORCIPIGER ...	34
<i>elevatus</i> , HISTIOPTERUS ...	61	<i>formiciforme</i> , CORINNOMMA ...	335
<i>elongata</i> , TRIDACNA ...	5	<i>formosus</i> , ACTINOPUS ...	66
<i>elongatus</i> , MYXUS ...	197	<i>fornasini</i> , OSTRACION ...	215
EPINEPHELUS <i>dæmelii</i> ...	203	<i>forsteri</i> , SCOMBRESOX ...	197
<i>fasciatus</i> ...	166, 203	FOSSOPORA <i>wellingtonensis</i> ...	15
<i>fuscoguttatus</i> ...	203	<i>frenatus</i> , LEPADICHTHYS ...	180, 222
<i>merra</i> ...	3, 203	<i>fuliginosa</i> , STERNA ...	138
<i>punctatus</i> ...	187	<i>fulva</i> , HEMICLŒA ...	320
<i>rhyncholepis</i> ...	165, 203	<i>fulva</i> , PRYNUS ...	320
ERIODON <i>occatorium</i> ...	62	<i>funereus</i> , CALYPTORHYNCHUS ...	265
<i>rubrocapitatum</i> ...	64	<i>fuscoguttatus</i> , EPINEPHELUS ...	203
<i>semicochinneum</i> ...	65	<i>fuscoguttatus</i> , SERRANUS ...	203
ERIPHA <i>scabricula</i> ...	9		
<i>eruciformis</i> , SCAPHITES ...	112	<b>G.</b>	
<i>erythræus</i> , HOLOCENTRUS ...	3	<i>galerita</i> , CACATUA ...	267
<i>etheridgii</i> , APLODACTYLUS ...	167, 186, 207	<i>galii</i> , CARASSIOPS ...	281
<i>etheridgii</i> , HAPLODACTYLUS ...	167, 207	<i>gallinaceus</i> , HYDRALECTOR ...	337
<i>eucalypti</i> , TAMA ...	325	GALLINAGO <i>australis</i> ...	338
EUCHEMUS ...	321	<i>gallus</i> , COCOTROPUS ...	176
EUCHILOMYCTERUS <i>quadraticatus</i> ...	220	<i>gallus</i> , TETRAROGA ...	176
EULEPTORHAMPHUS <i>longirostris</i> ...	24, 194	GASTEROSTEUS <i>rolitans</i> ...	221
EULIMA <i>parvillus</i> ...	96	GECARCINUS <i>lagostoma</i> ...	9
EUPOMACENTRUS <i>marginatus</i> ...	168	GEHYRA <i>oceanica</i> ...	2
<i>eximius</i> , PLATYCERCUS ...	265, 267	GEMPYLUS <i>serpens</i> ...	198
EXOCETUS <i>dovii</i> ...	156, 195	<i>geniculatus</i> , ULOBORUS ...	5
<i>rondeletii</i> ...	156, 195	GENYOROGA <i>bengalensis</i> ...	166, 205
EXONAUTES <i>rondeletii</i> ...	156, 195	<i>geographus</i> , CONUS ...	4
<i>æsertus</i> , ARANEUS ...	102	GEOGRAPSUS <i>erinipes</i> ...	11
<b>F.</b>		<i>georgianus</i> , CARANX ...	160, 197
<i>fabagella</i> , TAPES ...	89	<b>Gephyrea</b> ...	<b>73</b>

	PAGE		PAGE
<i>gibbosus</i> , CHEILODACTYLUS...	207	<i>guamensis</i> , SEBASTOPSIS	175, 220
<i>gibbosus</i> , GONIISTIUS ...	207	<i>guentheri</i> , PLATYSTETHUS ...	161
<i>gilberti</i> , CONGRELLUS ...	189	<i>guinaica</i> , LIBITINA ...	5
<i>GIRELLA cyanea</i> ...	167, 206	<i>GÜNTHERIA trimaculata</i> ...	211
<i>glans</i> , CONUS ...	4	<i>guttata</i> , CHLAMYDODERA, nest	131
<i>glauca</i> , PRIONACE ...	188	<i>gutturalis</i> , PACHYCEPHALA...	125
<i>glaucus</i> , SQUALUS ...	188	<i>GYGIS candida</i> ...	2
<i>GLOSSOPTERIS</i> ...	46	<i>GYMNOBUTIS</i> ...	284
<i>ampla</i> ...	48	<i>gymnocephalus</i> ...	285
<i>GLYPHISODON antjerius</i> xiii.		<i>gymnocephalus</i> , ELEOTRIS ...	285
	170, 209	<i>gymnocephalus</i> , GYMNOBUTIS	285
<i>brownriggii</i> , xiii. 3,	171, 209	<i>GYMNOTHORAX afer</i> ...	144
<i>cælestinus</i> ...	170, 235	<i>chalazius</i> ...	145, 191
<i>leucozona</i> ...	235	<i>flavimarginatus</i> 3,	145, 191
<i>polyacanthus</i> ...	170, 209	<i>nubilus</i> ...	145, 191
<i>saxatilis</i> 170,	209, 235	<i>pictus</i> ...	3
<i>GNAPHOSOIDES</i> ...	322	<i>prasina</i> ...	144
<i>GNATHAGNUS innotabilis</i> ...	238	<i>tessellatus</i> ...	3
<i>GNATHYPOPS jacksoniensis</i>	240	<i>thyrsoides</i> ...	144, 191
<i>GOBIOIDES</i> , sp. ...	45, 223		
<i>GOBIOUS æolosoma</i> ...	176, 222	H.	
<i>albopunctatus</i> ...	3	<i>HABRONESTES</i> ...	323
<i>gronovii</i> ...	200	<i>hamatonotus</i> , PSEPHOTUS	266, 267
<i>GOMPHINA moerchi</i> ...	134	<i>HALICHÆRES opercularis</i> ...	212
<i>GONIISTIUS gibbosus</i> ...	207	<i>pseudominiatus</i> ...	211
<i>GONODACTYLUS trispinosus</i>	12	<i>HAPLODACTYLUS etheridgii</i>	167,
<i>GONORHYNCHUS</i> ...	147		207
<i>abbreviatus</i> ...	147	<i>haswelli</i> , CREEDIA ...	57
<i>brevis</i> ...	148	<i>haswelli</i> , HEMEROCÆTES ...	57
<i>gonorynchus</i> 146,	192	<i>hebraeus</i> , CONUS ...	4
<i>greyi</i> ...	148	<i>HELIASES immaculatus</i> ...	208
<i>gronovii</i> ...	148	<i>HELIASTES hypsilepis</i> ...	208
<i>gonorhynchus</i> , COBITIS ...	147	<i>HELICINA musiva</i> ...	4
<i>gonorynchus</i> , CYPRINUS	146, 147,	<i>helvola</i> , CYPRÆA ...	4
	192	<i>HEMEROCÆTES haswelli</i> ...	57
<i>gonorynchus</i> , GONORHYNCHUS	146,	<i>HEMICLÆA</i> ...	318
	192	<i>flavitarisus</i> ...	320
<i>GOODELLA hypozona</i> ...	232	<i>fulva</i> ...	320
<i>gracilis</i> , CENTRISCUS ...	196	<i>lugubris</i> ...	319
<i>gracilis</i> , CLUPEA ...	192	<i>major</i> ...	319
<i>gracilis</i> , CUBICEPS ...	162, 200	<i>somersetensis</i> ...	319
<i>gracilis</i> , MACRORHAMPHOSUS	196	<i>sundevalli</i> ...	318
<i>gracilis</i> , SERIOLA ...	162, 200	<i>HEMICLÆINA</i> ...	319
<i>gracilis</i> , SPRATELLOIDES ...	192	<i>somersetensis</i> ...	319
<i>gracilis</i> , STENOGYRA ...	5	<i>HEMIRAMPHUS intermedius</i>	194
<i>grandiceps</i> , ELEOTRIS ...	285	<i>longirostris</i> ...	24, 194
<i>grandiceps</i> , OPHIORRHINUS	285	<i>herbsti</i> , CALCINUS ...	12
<i>grandiceps</i> , PHILYPNODON...	285	<i>HERSILIA</i> ...	324
<i>granulatus</i> , CHERSYDREUS ...	74	<i>HETERACTITIS incanus</i> ...	2
<i>greyi</i> , GONORHYNCHUS ...	148	<i>HETEROCENTROTUS mamil-</i>	
<i>greyi</i> , RHYNCHANA ...	147	<i>latus</i> ...	12
<i>griseus</i> , DRASSUS ...	321	<i>HETEROPODA venatoria</i> ...	6
<i>gronovii</i> , GOBIUS ...	200	<i>HIPPOCAMPUS abdominalis</i>	196
<i>gronovii</i> , GONORHYNCHUS ...	148	<i>hippocampus</i> ...	187
<i>gronovii</i> , NOMEUS ...	200	<i>punctulatus</i> ...	196
<i>guamensis</i> , SCORPÆNA	175, 220	<i>hippocastaneum</i> , PURPURA...	4

- |                                    | PAGE     |                                     | PAGE         |
|------------------------------------|----------|-------------------------------------|--------------|
| <i>hippos</i> , CARANX ...         | 3        | <i>innotabilis</i> , GNATHAGNUS ... | 238          |
| <i>hirsutus</i> , BIRGUS ...       | 11       | <i>inscriptus</i> , LABRUS ...      | 212          |
| <i>hirtipes</i> , CARDISOMA ...    | 9        | <i>inscriptus</i> , PSEUDOLABRUS .. | 212          |
| <i>hispidus</i> , TETRAODON ...    | 219      | <i>insolens</i> , SCHIZOCHIRUS ...  | 242          |
| HISTIOPTERUS <i>acutirostris</i>   | 61       | <i>insulæ</i> , SALARIAS ...        | 223          |
| <i>elevatus</i> ...                | 61       | <i>intermedius</i> , HEMIRAMPHUS    | 194          |
| <i>farnelli</i> ...                | 61       | <i>intermedius</i> , HYPORHAMPHUS   | 194          |
| <i>labiosus</i> ...                | 61       | <i>invenustus</i> , DRASSODES ...   | 321          |
| <i>recurvirostris</i> ...          | 58       | <i>isabella</i> , CYPRÆA ...        | 4            |
| <i>typus</i> ...                   | 61       | ISISTIUS <i>brasiliensis</i>        | 141, 188     |
| HOCHSTETTERIA <i>trapezina</i>     | 89       | Iso ...                             | 234          |
| <i>hoedtii</i> , MALACANTHUS ...   | 204      | <i>rhothophilus</i> ...             | xiii.        |
| HOLACANTHUS <i>conspicillatus</i>  | 37,      | ISOCRINUS <i>australis</i> ...      | 251          |
|                                    | 215      | var. <i>albascopularis</i> ...      | 251          |
| <i>semicinctus</i> ...             | 37, 215  |                                     |              |
| <i>tibicen</i> ...                 | 215      | J.                                  |              |
| HOLMICERAS ...                     | 76       | <i>jacksonensis</i> , NOVACULA ...  | 213          |
| HOLOCENTRUS <i>bengalensis</i>     | 166, 205 | <i>jacksonensis</i> , NOVACULICH-   |              |
| <i>erythroxus</i> ...              | 3        | THYS ...                            | 213          |
| HOLOTHURIA <i>atra</i> ...         | 13       | <i>jacksoniensis</i> , GNATHYPOPS   | 240          |
| HORISTONOTUS <i>bicolor</i> ...    | 246      | <i>jacksoniensis</i> , OPISTHO-GNA- |              |
| <i>horridum</i> , SISTRUM ...      | 4        | THUS ...                            | 240          |
| HOWELLA <i>brodiei</i> ...         | 157, 197 | <i>janseni</i> , JULIS ...          | 25, 210      |
| <i>howensis</i> , CHETODON         | 33, 215  | <i>janseni</i> , THALASSOMA         | 25, 210      |
| <i>howensis</i> , MONACANTHUS      | 37, 216  | <i>japonica</i> , PHYSCOSOMA ...    | 73           |
| <i>howensis</i> , PACHYCEPHALA ... | 125      | <i>japonicus</i> , CALLIONYMUS ...  | 221          |
| <i>howensis</i> , PSEUDOMONACAN-   |          | <i>jarbua</i> , SCIÆNA ...          | 205          |
| THUS ...                           | 216      | <i>jarbua</i> , TERAPON ...         | 205          |
| <i>humilis</i> , ELEOTRIS ...      | 280      | JULIS <i>aneitensis</i> ...         | 209          |
| HYDRALECTOR <i>gallinaceus</i> ... | 337      | <i>axillaris</i> ...                | 212          |
| <i>hygonii</i> , MYCTOPHUM         | 153, 193 | <i>dorsalis</i> ...                 | 26, 210      |
| <i>hygonii</i> , SCOPELUS ...      | 153, 193 | <i>janseni</i> ...                  | 25, 210      |
| HYPORHAMPHUS <i>intermedius</i>    | 194      | <i>pseudominiatus</i> ...           | 211          |
| sp. ...                            | 187      | <i>trimaculata</i> ...              | 211          |
| <i>hypozaona</i> , GOODELLA ...    | 232      | <i>umbrostyigma</i> ...             | 171          |
| <i>hypselogeneion</i> , SPHEROIDES | 218      | JULUS sp. ...                       | 6            |
| <i>hypselogeneion</i> , TETRAODON  | 38,      | <i>jungi</i> , CICINDELA ...        | 245          |
|                                    | 218      |                                     |              |
| <i>hypselosoma</i> , PSEUDANTHIAS  | 204      | K.                                  |              |
| <i>hypstilepis</i> , CHROMIS ...   | 208      | KREFFTIUS ...                       | 281          |
| <i>hypstilepis</i> , HELIASTES ... | 208      | <i>adspersus</i> ...                | 282          |
| HYSTRICHOPSYLLA ...                | 54       | <i>australis</i> ...                | 283          |
| <i>hystrix</i> , DIODON ...        | 220      | <i>coxi</i> ...                     | 283          |
|                                    |          | KUHLIA <i>taniura</i> ...           | 3, 164, 201  |
| I.                                 |          |                                     |              |
| IANTHINA <i>ianthina</i> ...       | 4        | L.                                  |              |
| <i>icelii</i> , PETROSCIRTES       | 181, 223 | <i>labiosus</i> , HISTIOPTERUS ...  | 61           |
| ICHTHYOPTERYGIAN remains           | 313      | LABRICHTHYS <i>nigromargina-</i>    |              |
| <i>ignitus</i> , PLATYCERCUS ..    | 267      | <i>tus</i> ...                      | 29, 212      |
| <i>immaculatus</i> , HELIASSES ... | 208      | LABROIDES <i>paradiseus</i> ...     | 213          |
| <i>incanus</i> , HETERACTITIS ...  | 2        | LABRUS <i>inscriptus</i> ...        | 212          |
| <i>incanus</i> , TOTANUS ...       | 2        | <i>luculentus</i> ...               | 29, 212      |
| <i>incensa</i> , LATOLÆVA ...      | 6        | <i>lunaris</i> ...                  | 210          |
| INCISURA ...                       | 91       | <i>perditio</i> ...                 | 213          |
| <i>lyttletonensis</i> ...          | 92       | <i>pictus</i> ...                   | 26, 172, 210 |
| INIISTIUS <i>cacatua</i> ...       | 29, 213  | <i>trilobatus</i> ...               | 171, 209     |

	PAGE
LACERIPORA ... ..	19
<i>cribrosa</i> ... ..	19
LACTOPHRYS <i>concatenatus</i> ...	217
<i>lacunosa</i> , ATHERINA ... ..	197
<i>lagocephalus</i> , var. <i>stellatus</i> , TETRODON ... ..	219
<i>lagostoma</i> GECARCINUS ... ..	9
<i>lalandi</i> , SERIOLA ... ..	199
LAMPONA ... ..	321
<i>fasciata</i> ... ..	322
<i>murina</i> ... ..	322
<i>obsœna</i> ... ..	322
<i>sordida</i> ... ..	322
<i>lateralis</i> , ZOSTEROPS ... ..	338
<i>latezonatus</i> , AMPHIPRION ... ..	208
<i>latispinis</i> , MACHÆROPE 24, 160, 198	198
LATOLEVA <i>incensa</i> ... ..	6
LEIOSTRACA <i>murdochi</i> ... ..	97
<i>lenticularis</i> , ORTHIS ... ..	101
LEPADICHTHYS ... ..	180
<i>frenatus</i> ... ..	180, 222
LEPIDAPLOIS <i>perditio</i> ... ..	213
LEPTOCEPHALUS <i>cinereus</i> ... ..	189
LETHRINUS <i>opercularis</i> 166, 205	205
<i>leucocapillus</i> , ANOUS ... ..	2
<i>leucocapillus</i> , MICRANOUS ... ..	2
<i>leucopygius</i> , SYMMORPHUS ... ..	338
<i>leucoscopelus</i> , CIMOLIOSAU- RUS ... ..	315
<i>leucozona</i> , GLYPHISODON ... ..	235
LIBITINA <i>guineaica</i> ... ..	5
LIMNICTHYS ... ..	178
<i>fasciatus</i> 178, 222, 243	178, 222, 243
<i>tineatus</i> , TEUTHIS ... ..	3
LIOTIA <i>polypleura</i> ... ..	93
<i>litoreus</i> , ACANTHOCLINUS 184, 225	184, 225
<i>litoreus</i> , BLENNIUS ... ..	184, 225
LITUITES ... ..	75
<i>lividus</i> , CONUS ... ..	4
<i>lobata</i> (var.) PISOCRINUS	
<i>yassensis</i> ... ..	292
<i>longi</i> , CARASSIOPS ... ..	280
<i>longicauda</i> , CONGERMURÆNA 190	190
<i>longicauda</i> , CONGROMURÆNA 190	190
<i>longifilis</i> , DIANCISTRUS 185, 225	185, 225
<i>longifilis</i> , DINEMATICTHYS 185, 225	185, 225
<i>longipes</i> , DISCOPLAX ... ..	9
<i>longirostris</i> , EULEPTORHAM- PHUS ... ..	24, 194
<i>longirostris</i> , HEMIRAMPHUS 24, 194	24, 194
LOTELLA <i>callarias</i> ... ..	225
<i>luculentus</i> , LABRUS ... ..	29, 212
<i>luculentus</i> , PSEUDOLABRUS 29, 212	29, 212
<i>lucunter</i> , ECHINOMETRA ... ..	12

	PAGE
<i>lugubris</i> , HEMICLŒA ... ..	319
<i>lugubris</i> , REBILUS ... ..	319
<i>lunare</i> , THALASSOMA ... ..	210
<i>lunaris</i> , LABRUS ... ..	210
<i>lunulatus</i> , MELITHREPTUS ... ..	337
<i>lycosoides</i> , STORENOSOMA ... ..	324
LYGOSOMA <i>atrocostatum</i> ... ..	2
<i>cyanurum</i> ... ..	2
<i>lyttletonensis</i> , INCISURA ... ..	92
<i>lyttletonensis</i> , SCISSURELLA ... ..	91

## M.

<i>maccoyi</i> , CIMOLIOSAURUS ... ..	312
MACHÆROPE <i>latispinis</i> 24, 160, 198	198
<i>macracanthus</i> , TRACHYPOMA ... ..	202
MACRORHAMPHOSUS <i>gracilis</i> ... ..	196
<i>maculatus</i> , CIERRHITES ... ..	3
<i>maculatus</i> , PRIONURUS ... ..	216
<i>maculatus</i> , SCHIEDOPHILUS 163, 201	163, 201
<i>maculatus</i> , TROCHUS ... ..	4
<i>maculatus</i> , XESURUS ... ..	216
<i>maculosus</i> , MIMETUS ... ..	330
<i>major</i> , HEMICLŒA ... ..	319
MALACANTHUS <i>hoedtii</i> ... ..	204
<i>mamillatus</i> HETEROCENTRO- TUS ... ..	12
<i>maorianus</i> , PLEURODON ... ..	87
<i>marginatus</i> , EUPOMACENTRUS ... ..	168
<i>marmoratus</i> , BLENNIUS ... ..	223
<i>marmoratus</i> , CHIRONEMUS ... ..	207
<i>marmoratus</i> , SALARIAS 181, 223	181, 223
<i>mars</i> , STEPHANOCIRCUS ... ..	53
<i>mastersianus</i> , PLATYCERCUS ... ..	267
<i>mastersii</i> , ELEOTRIS ... ..	283
<i>maxillaris</i> , SPHECOTHERES ... ..	337
<i>melanochir</i> , THALASSOMA ... ..	3
MELANOPHORA ... ..	321
<i>flavens</i> ... ..	321
<i>melaenopus</i> , AMPHIPRION 168, 208	168, 208
<i>melaenotœnia</i> , CALLECHELYS 21, 190	21, 190
<i>meleagris</i> , SALARIAS ... ..	3
<i>meleagris</i> , TETRAODON ... ..	219
MELINA <i>perna</i> ... ..	5
MELITHREPTUS <i>brevirostris</i> ... ..	337
<i>lunulatus</i> ... ..	337
<i>mellissii</i> , CONGROMURÆNA ... ..	189
<i>menisorrah</i> , CARCHARIAS 140, 188	140, 188
<i>menisorrah</i> , CARCHARHINUS 140, 188	140, 188
<i>meridionalis</i> , PACHYCEPHALA ... ..	126
<i>mermisoides</i> , STICHUS ... ..	255
<i>merri</i> , EPINEPHELUS ... ..	3, 203
MICIPPA <i>philyra</i> ... ..	2
MICRANOUS <i>leucocapillus</i> ... ..	8
MICROCANTHUS <i>strigatus</i> ... ..	215
<i>microlepis</i> , PARMA ... ..	xiii.

	PAGE		PAGE
<i>miliaris</i> , CONUS ...	4	<i>mytilus</i> , VERTICIPRONUS ...	88
MILTON rock-shelter ...	80	MYXUS <i>elongatus</i> ...	197
MIMETUS <i>maculosus</i> ...	330	N.	
<i>mimus</i> , ELEOTRIS ...	282	NACERDES <i>transmarina</i> ...	7
<i>minuta</i> , MYRINA ...	89	<i>nana</i> , DROMICIA ...	134
MISSULENA <i>occatoria</i> ...	62	NASEUS <i>unicornis</i> ...	3
MITRA <i>pontificalis</i> ...	4	Natrolite and Datolite ...	127
MITROMORPHA <i>substriata</i> ...	97	<i>naufragus</i> , DASYSCOPELUS ...	154, 194
MODIOLA <i>australis</i> ...	5	<i>nebulosa</i> , ECHIDNA ...	191
MOGURNDA ...	282	<i>nebulosa</i> , MURÆNA ...	191
<i>mogurnda</i> ...	282	<i>nebulosa</i> , PARAPERCIS ...	238
<i>mogurnda</i> , ELEOTRIS ...	282	<i>neglecta</i> , PŒPHILA ...	263
<i>moerchi</i> , GOMPHINA... ..	134	NEOPERCIS <i>binivirgata</i> ...	236, 238
MONACANTHUS <i>albopunctatus</i> ...	37	<i>novæ-cambriæ</i> ...	238
<i>howensis</i> ...	37, 216	NEOPHEMA <i>bourkei</i> ...	267
<i>nitens</i> ...	216	NERITA <i>plicata</i> ...	4
<i>oculatus</i> ...	40	<i>nicholsæ</i> , MURÆNICHTHYS ...	142, 190
<i>trossulus</i> ...	40	<i>niger</i> , THYRSITES ...	159
MONAZITE ...	258	<i>nigrescens</i> (var.) PLATYCER- CUS <i>pennantii</i> ...	266
<i>moneta</i> , CYPRÆA ...	4	<i>nigricans</i> , PHAROPTERYX ...	204
MONEY, coil feather... ..	74, 133	<i>nigricans</i> , PLESIOPS ...	204
<i>monoceros</i> , ALUTERA ...	217	<i>nigricans</i> , POMACENTRUS ...	168
<i>monoceros</i> , BALISTES ...	217	<i>nigripenne</i> , TRIPTERYGION ...	182, 224
MONOCREPIDIUS <i>umbracula-</i> <i>tus</i> ...	6	<i>nigromarginatus</i> , LABRICH- THYS ...	29, 212
<i>monswoodensis</i> , ACMÆA ...	251	<i>nigromarginatus</i> , PSEUDOLA- BRUS ...	29, 212
MONTMORILLONITE, a mine- ral allied to ...	67	<i>nigrotecta</i> , PŒPHILA ...	264
<i>moorei</i> , TRIGONIA ...	249	NIOBE, sp. ...	100
MORDACIA <i>mordax</i> ...	231	<i>nitens</i> , MONACANTHUS ...	216
<i>mordax</i> , MORDACIA ...	231	<i>nitens</i> , STEPHANOLEPIS ...	216
<i>mordax</i> , PETROMYZON ...	231	Nodules and Coprolites ...	114
MUELLERIA <i>echinites</i> ...	13	NOMEUS <i>gronovii</i> ...	200
MUGIL <i>dobula</i> ...	197	<i>norfolcensis</i> , APOGON ...	164, 202
MULGOA ...	281	NOTOSCOPELUS <i>ejectus</i> ...	150, 193
<i>coxii</i> ...	283	NOVACULA <i>jacksonensis</i> ...	213
MULLOIDES <i>samoensis</i> ...	3	NOVACULICHTHYS <i>jackson-</i> <i>ensis</i> ...	213
<i>multimaculata</i> , DIÆA ...	105	<i>novæ-cambriæ</i> , NEOPERCIS ...	238
<i>mundanus</i> , SIPUNCULUS ...	73	<i>novæ-hollandiæ</i> , CHALINURA ...	325
MURÆNA <i>afra</i> ...	144, 191	<i>novæ-hollandiæ</i> , TAMA ...	325
<i>flavimarginata</i> ...	145, 191	<i>nubila</i> , MURÆNA ...	145, 191
<i>nebulosa</i> ...	191	<i>nubilus</i> , GYMNOTHORAX ...	145, 191
<i>nubila</i> ... ..	145, 191	<i>nucleus</i> , CYPRÆA ...	4
<i>thyrsoidea</i> ...	144, 191	NUCULA <i>sejugata</i> ...	108
MURÆNICHTHYS <i>nicholsæ</i> ...	142, 190	NYCTERIBIA <i>pteropus</i> ...	78
<i>murdochi</i> , LEIOSTRACA ...	97	O.	
<i>murina</i> , LAMPONA ...	322	<i>oblonga</i> , ECHINOMETRA ...	12
<i>musiva</i> , HELICINA ...	4	<i>oblongus</i> , SPHEROIDES ...	218
MYCTOPHUM <i>hygomii</i> ...	153, 193	<i>oblongus</i> , TETRAODON ...	218
<i>opalinum</i> ...	153, 193	<i>obsœna</i> , LAMPONA ...	322
<i>phengodes</i> ...	152, 193	<i>occatoria</i> , MISSULENA ...	62
<i>reinhardtii</i> ...	154, 194	<i>occatorium</i> , ERIODON ...	62
<i>myops</i> , SALMO ...	148, 192, 232		
<i>myops</i> , TRACHINOCEPHALUS ...	148, 192, 232		
MYRINA <i>minuta</i> ...	89		

	PAGE		PAGE
<i>oceanica</i> , GĒHYRA ...	...	PEMPHERIS <i>unwini</i> ...	201
<i>octo</i> , AMYNA ...	...	<i>pennantii</i> , var. <i>nigrescens</i> ,	
<i>ocularis</i> , PARAPERCIS ...	238	PLATYCERCUS ...	266
<i>oculatus</i> , MONACANTHUS ...	40	PENTACEROPSIS <i>recurvirostris</i> xiii.	
OCYPODA <i>cordimana</i> ...	11	PERCA <i>fasciata</i> ...	166, 203
<i>olivieri</i> , CENOBITA ...	11	<i>perditio</i> , LABRUS ...	213
<i>opalinum</i> , MYCTOPHUM 153,	193	<i>perditio</i> , LEPIDAPLOIS ...	213
<i>opercularis</i> , HALICHÆRES ...	212	<i>perexiguus</i> , DRASSODES ...	321
<i>opercularis</i> , LETHRINUS 166,	205	<i>periophthalmus</i> , SALARIAS ...	3
<i>opercularis</i> , PLATYGLOSSUS	212	<i>perlata</i> , DAIRA ...	8
OPHICHTHUS <i>versicolor</i> 22,	190	<i>perna</i> , MELINA ...	5
OPHICHTHYS <i>pinguis</i> 22,	190	<i>perspicillata</i> , ÆTHOPRORA 149,	193
OPHIOCOMA <i>brevipes</i> ...	12	<i>petitiana</i> , VANIKORO ...	4
OPHIORRHINUS ...	284	PETRAÏTES <i>roseus</i> ...	181, 224
<i>angustifrons</i> ...	285	Petroglyphs, Aboriginal 118,	271
<i>grandiceps</i> ...	285	PETROMYZON <i>mordax</i> ...	231
OPHISURUS <i>versicolor</i> 22,	190	PETROPHASSA <i>albipennis</i> , eggs	269
OPISTHOGNATHUS <i>jacksonien-</i>		PETROSCIERTES <i>icelii</i> 181,	223
<i>sis</i> ...	240	PHÆTON <i>rubricauda</i> ...	138
<i>orientalis</i> , CHLAMYDODERA,		PHAROPTERYX <i>nigriceans</i> ...	204
<i>bower</i> of ...	270	PHASCOGALE <i>blythi</i> ...	123
ORTHIS <i>lenticularis</i> ...	101	<i>phengodes</i> , MYCTOPHUM 152,	193
OSTRACION <i>concatenatus</i> ...	217	<i>phengodes</i> . SCOPELUS 152,	193
<i>cornutum</i> ...	37, 218	PHILYPNODON ...	284
<i>fornasini</i> ...	217	<i>grandiceps</i> ...	285
<i>tuberculatum</i> ...	218	<i>philyra</i> , MICIPPA ...	8
		PHORONIS <i>australis</i> ...	73
		<i>psammophyla</i> ...	73
		PHOSPHATIC specimens, analy-	
		ses of ...	13
		PHYSCOSOMA <i>japonica</i> ...	73
		<i>picta</i> , CORIS ...	26, 172, 210
		Pictographs, Aboriginal ...	80
		<i>pictus</i> , GYMNOTHORAX ...	3
		<i>pictus</i> , LABRUS ...	26, 172, 210
		<i>pinguis</i> , BASCANICHTHYS 22,	190
		<i>pinguis</i> , OPHICHTHYS 22,	190
		PISOCRINUS <i>yassensis</i> ...	289
		var. <i>lobata</i> ...	292
		<i>platei</i> , CALLANTHIAS ...	56
		<i>platurus</i> , TYLOSURUS ...	3
		PLATOPHRYS <i>pantherinus</i> ...	226
		PLATYCERCUS <i>barnardi</i> 266,	267
		<i>elegans</i> ...	265, 266, 267
		<i>eximius</i> ...	265, 267
		<i>flaveolus</i> ...	267
		<i>ignitus</i> ...	267
		<i>mastersianus</i> ...	267
		<i>pennantii</i> , var. <i>nigre-</i>	
		<i>scens</i> ...	266
		PLATYGLOSSUS <i>opercularis</i> ...	212
		PLATYSTACUS <i>anguillaris</i> 141,	188
		PLATYSTETHUS <i>cultratum</i> ...	161
		<i>guentheri</i> ...	161
		PLECTROPOMA <i>cinctum</i> ...	202
		PLESIOPS <i>nigriceans</i> ...	204



	PAGE		PAGE
<i>rubricauda</i> , PHÆTON ...	138	<i>sculptus</i> , TRACHYCOSMUS ...	320
<i>rubrocapitatum</i> , ERIODON ...	64	<i>scurra</i> , CYPRÆA ...	4
<i>rufopileum</i> , TRIPTERYGION	182, 225	SCYMNUS <i>brasiliensis</i>	141, 188
<i>rugosa</i> , CENOBITA ...	11	SEBASTES <i>scaber</i> ...	175, 220
<i>russelii</i> , TRACHINOTUS ...	199	SEBASTOPSIS <i>guamensis</i>	175, 220
RUVETTUS <i>pretiosus</i> ...	3	<i>scaber</i> ...	175, 220
<b>S.</b>			
<i>saccata</i> , THOPHA ...	116	<i>sejugata</i> , NUCULA ...	108
SALARIAS <i>alboapicalis</i>	181, 224	<i>semicineta</i> , CORIS ...	26
<i>insula</i> ...	223	<i>semicinctus</i> , HOLACANTHUS	37, 215
<i>marmoratus</i> ...	181, 223	<i>semicocinneum</i> ERIODON ...	65
<i>meleagris</i> ...	3	<i>semipunctatus</i> , ASTERROPTERIX	280
<i>periophthalmus</i>	3	SERIOLA <i>cultrata</i> ...	161
<i>quadricornis</i>	181, 223	<i>gracilis</i> ...	162, 200
<i>variolosus</i> ...	224	<i>lalandi</i> ...	199
<i>salebrosus</i> , POLTYS ...	104	<i>serpens</i> , GEMPYLUS ...	198
SALMO <i>myops</i> ...	148, 192, 232	SERRANUS <i>dämellii</i> ...	203
<i>varius</i> ...	192	<i>fuscoguttatus</i>	203
<i>samoensis</i> , MULLOIDES ...	3	<i>rhyncholepis</i> ...	165, 203
<i>sanctæ-helenæ</i> CARANX ...	199	<i>setifer</i> , XIPHASIA ...	45, 223
<i>sanctæ-helenæ</i> , DECAPTERUS	199	<i>signatus</i> , GNAPHOSOIDES ...	322
SAUROPTERYGIAN remains	312, 315	<i>signatus</i> , UPENEUS ...	198
<i>saxatilis</i> , CHÆTODON	170, 209, 235	<i>signifer</i> , DENDROSTOMA ...	73
<i>saxatilis</i> , GLYPHISODON	170, 209, 235	<i>silaceus</i> , DRASSODES ...	321
<i>scaber</i> , SEBASTES ...	175, 220	SILLAGO <i>ciliata</i> ...	206
<i>scaber</i> , SEBASTOPSIS	175, 220	SIPUNCULUS <i>australis</i>	73
<i>scabricula</i> , ERIPHIA ...	9	<i>mundanus</i> ...	73
SCAPHITES <i>eruciformis</i> ...	112	sp. ...	73
SCARICHTHYS <i>auritus</i> ...	213	SISTRUM <i>dumosum</i> ...	4
SCARUS <i>auritus</i> ...	213	<i>horridum</i> ...	4
<i>pyrrhostethus</i>	214	SOLEA <i>ramsayi</i> ...	226
SCHEDOPHILUS <i>maculatus</i>	163, 201	SOLEGNATHUS <i>spinosissimus</i>	196
SCHISMOPE <i>beddomei</i> ...	89	<i>somersetensis</i> , HEMICLŒA ...	319
<i>brevis</i> ...	90	<i>somersetensis</i> , HEMICLŒINA	319
SCHIZOCHIRUS ...	241	SOMPHOPORA ...	19
<i>insolens</i> ...	242	<i>sordida</i> , LAMPONA ...	322
SCIÆNA <i>aurata</i> ...	205	SPAROSOMUS ...	166
<i>cultrata</i> ...	161, 200	SPARUS <i>ravi</i> ...	162, 200
<i>cylindrica</i> ...	221	SPHECOTHERES <i>maxillaris</i> ...	337
<i>jarbua</i> ...	205	SPHEROIDES <i>altipinnis</i> ...	218
<i>trutta</i> ...	204	<i>hypselogeneion</i> ...	218
SCISSURELLA <i>lyttletonensis</i>	91	<i>oblongus</i> ...	218
<i>rosea</i> ...	90	<i>spinosissimus</i> , SOLEGNATHUS	196
SCOMBER <i>atun</i> ...	56	<i>spinosus</i> , CENOBITA ...	11
SCOMBRESOX <i>forsteri</i> ...	195	<i>splendens</i> , CIRRHITICHTHYS	167, 207
SCOPELUS <i>cuvieri</i> ...	156	SPRATELLOIDES <i>gracilis</i> ...	192
<i>hygomi</i> ...	153, 193	<i>spretus</i> , CADULUS ...	89
<i>phengodes</i> ...	152, 193	SQUALUS <i>glaucus</i> ...	188
<i>reinhardtii</i> ...	154, 194	<i>squammipinnis</i> , PARMA ...	xiii.
<i>scopus</i> , ZENOPSIS ...	30, 214	<i>stellæformis</i> , ACMÆA ...	4
SCORPENA <i>cookii</i> ...	220	<i>stellatus</i> , TETRAODON ...	219
<i>guamensis</i> ...	175, 220	STENOGRYA <i>gracilis</i> ...	5
SCORPIS <i>æquipinnis</i>	167, 206	STEPHANOCIRCUS ...	53, 54
		<i>dasyuri</i> ...	53
		<i>mars</i> ...	53
		STEPHANOLEPIS <i>nitens</i> ...	216



	PAGE
STERNA <i>candida</i> ... ..	2
<i>fuliginosa</i> ... ..	138
STERNOPTYCHIDES <i>amabilis</i>	194
STETHOJULIS <i>axillaris</i> ... ..	212
STICHUS <i>mermisoides</i> ... ..	255
STIGMODERA <i>cydista</i> ... ..	246
<i>stolida</i> , CYPRÆA ... ..	4
<i>stolidus</i> , ANOUS ... ..	138
STORENA ... ..	323
<i>albomaculata</i> ... ..	323
STORENOSOMA ... ..	324
<i>lycosoides</i> ... ..	324
<i>strigatus</i> , ATYPICHTHYS ... ..	206
<i>strigatus</i> , ATYPUS ... ..	206
<i>strigatus</i> , CHÆTODON ... ..	215
<i>strigatus</i> , MICROCANTHUS ... ..	215
STROMBOLITUITES .. ..	76
STURNUS <i>vulgaris</i> ... ..	338
<i>subarquata</i> , TRINGA ... ..	126
<i>substriata</i> , DAPHNELLA ... ..	97
<i>substriata</i> , MITROMORPHA ... ..	97
SULA <i>cyanops</i> ... ..	138
<i>sundevalli</i> , HEMICLEA ... ..	318
<i>suteri</i> , RISSOA ... ..	96
<i>sutherlandi</i> , CIMOLIOSAURUS	312
SYMMORPHUS <i>leucopygius</i> ... ..	338
SYMPHURUS, sp. ... ..	187
SYNODUS <i>varius</i> ... ..	192
<i>syrix</i> , CALAMOHERPE ... ..	1

T.

<i>taniatus</i> , CLIBANARIUS ... ..	11
<i>taniura</i> , KUHLLIA ... ..	3, 164, 201
<i>taniurus</i> , DULES ... ..	164, 201
<i>talpa</i> , CYPRÆA ... ..	4
TAMA ... ..	324
<i>eucalypti</i> ... ..	325
<i>fickerti</i> ... ..	325
<i>novæ-hollandiæ</i> ... ..	325
TAPES <i>fabagella</i> ... ..	89
TATARE <i>rehsei</i> ... ..	1
TAVAU ... ..	74, 133
TERAPON <i>jarbua</i> ... ..	205
<i>teres</i> , CYPRÆA ... ..	4
TETRAGNATHA <i>panopea</i> ... ..	5
TETRAGONOPTRUS <i>trifasciatus</i>	32
TETRAGONURUS <i>cuvieri</i> ... ..	201
TETRAODON <i>hispidus</i> ... ..	219
<i>hypselogeneion</i> ... ..	38, 218
<i>meleagris</i> ... ..	219
<i>oblongus</i> ... ..	218
<i>stellatus</i> ... ..	219
<i>valentini</i> ... ..	219
TETRAROGE <i>gallus</i> ... ..	167

	PAGE
TETRODON <i>altipinnis</i> ... ..	218
<i>callisternus</i> ... ..	xiii., 219
<i>caudofasciatus</i> ... ..	xiii.
<i>lagocephalus</i> , var. <i>stel-</i>	
<i>latus</i> ... ..	219
<i>tessellatus</i> , GYMNOTHORAX	3
TEUTHIS <i>lineatus</i> ... ..	3
<i>triolestegus</i> ... ..	3
THALASSEMA, sp. ... ..	73
THALASSOMA <i>aneitense</i> ... ..	209
<i>berendti</i> ... ..	171
<i>dorsale</i> ... ..	26, 210
<i>janseni</i> ... ..	25, 210
<i>lunare</i> ... ..	210
<i>melanochir</i> ... ..	3
<i>purpurea</i> ... ..	3
<i>trilobatum</i> ... ..	171, 209
<i>theisii</i> , ARANEUS ... ..	5
<i>theridion</i> , TROGLODYTES ... ..	327
<i>thopha</i> , SACCATA ... ..	116
<i>thyrsites</i> , ATUN ... ..	56
<i>niger</i> ... ..	159
<i>thyrsoides</i> , GYMNOTHORAX	144, 191
<i>thyrsoides</i> , MURÆNA ... ..	144, 191
<i>tibicen</i> , CALCINUS ... ..	12
<i>tibicen</i> , HOLACANTHUS ... ..	215
<i>tigris</i> , CYPRÆA ... ..	4
Topaz ... ..	296, 305
TOTANUS <i>incanus</i> ... ..	2
Tourmaline ... ..	302
TRACHINOCEPHALUS <i>myops</i>	148,
192, 232	
TRACHINOTUS <i>baillonii</i>	25, 200
<i>russelii</i> ... ..	199
TRACHYCOSMUS <i>sculptus</i> ... ..	320
TRACHYPOMA <i>macracanthus</i>	202
<i>translata</i> , REMIGIA ... ..	7
<i>transmarina</i> , NACERDES ... ..	7
<i>trapezina</i> , HOCHSTETTERIA	89
<i>tricinctus</i> , CHÆTODON	32, 214
TRIDACNA <i>elongata</i> ... ..	5
<i>trifasciatus</i> , CHÆTODON	32, 214
<i>trifasciatus</i> , TETRAGONOPTRUS	32
TRIGONIA, opalized ... ..	248
<i>moorei</i> ... ..	249
<i>trilobatum</i> , THALASSOMA	171, 209
<i>trilobatus</i> , LABRUS ... ..	171, 209
TRILOBITE remains ... ..	98
<i>trimaculata</i> , GÜNTHERIA ... ..	211
<i>trimaculata</i> , JULIS ... ..	211
TRINGA <i>subarquata</i> ... ..	126
<i>triolestegus</i> , TEUTHIS ... ..	3
TRIPTYERYGION <i>atrogulare</i>	184, 225
<i>nigripenne</i> ... ..	182, 224
<i>rufopileum</i> ... ..	182, 225
<i>trispinosus</i> , GONODACTYLUS	12

	PAGE
<i>TROCHUS maculatus</i> ...	4
<i>troglydites</i> , ECTATOSTICA ...	327
<i>troglydites</i> , THERIDION ...	327
TROPIDICHTHYS <i>callisternus</i> ...	219
<i>caudofasciatus</i> ...	xiii.
<i>valentini</i> ...	219
TROPIDOSTETHUS <i>rhothophi-</i>	
<i>lus</i> ...	xiii., 234
<i>trossulus</i> , MONACANTHUS ...	40
<i>troudeti</i> , CONOCEPHALUS ...	7
<i>truncatus</i> , CHELMO ...	35
<i>trutta</i> , ARRIPIS ...	204
<i>trutta</i> , SCIÆNA ...	204
Tubercle, reptilian dermal	113
<i>tuberculatum</i> , OSTRACION ...	218
TURBO <i>argyrostomus</i> ...	4
<i>turcarum</i> , ECHINOTHRIX ...	12
<i>twistii</i> , ANAMPSES ...	211
TYLOSURUS <i>platurus</i> ...	3
<i>typus</i> , HISTIOPTERUS ...	61
U.	
ULOBORUS <i>geniculatus</i> ...	5
<i>umbraculatus</i> , MONOCREPIDIUS	6
<i>umbrostygma</i> , JULIS ...	171
<i>unicornis</i> , ACANTHURUS ...	216
<i>unicornis</i> , CHÆTODON ...	216
<i>unicornis</i> , NASEUS ...	3
<i>unwini</i> , PARAPRIACANTHUS	201
<i>unwini</i> , PEMIPHERIS ...	201
UPENEUS <i>pleurostigma</i> ...	198
<i>signatus</i> ...	198
V.	
<i>valentini</i> , TETRAODON ...	219
<i>valentini</i> , TROPIDICHTHYS ...	219
<i>variolatus</i> , ANAMPSES ...	172
<i>variolosus</i> , SALARIAS ...	224

	PAGE
<i>varius</i> , SALMO ...	192
<i>varius</i> , SYNODUS ...	192
<i>venatoria</i> , HETEROPODA ...	6
<i>ventricosa</i> , CYPRÆA ...	4
VENUS <i>reticulata</i> ...	5
<i>venusta</i> , PÆCILIPTA ..	333
<i>versicolor</i> , OPHICHTHUS	22, 190
<i>versicolor</i> , OPHISURUS	22, 190
VERTICIPRONUS ...	88
<i>mytilus</i> ...	88
Vesuvianite ...	301
<i>volitans</i> , GASTEROSTEUS ...	221
<i>volitans</i> , PTEROIS ...	221
VANIKORO <i>petitiana</i> ...	4
<i>viridis</i> , ALLOGOBIUS	177, 222
<i>viridis</i> , BONELLIA ...	73
<i>vulgaris</i> , STURNUS ...	338

## W.

<i>wellingtonensis</i> , FOSSOPORA	16
Wolframite ...	303

## X.

XENOGRAMMA ...	157
<i>carinatum</i> ...	158, 198
XESURUS <i>maculatus</i> ...	216
XIPHASIA <i>setifer</i> ...	45, 223

## Y.

<i>yassensis</i> , PISOCRINUS ...	289
var. <i>lobata</i> , PISOCRINUS	292

## Z.

<i>zebra</i> , PTEROIS ...	221
ZENOPSIS <i>scopus</i> ...	30, 214
ZOSTEROPS <i>cærulesceus</i> ...	338
<i>lateralis</i> ...	338





51002~

