

12 An Essay on the Unrealized Potential of Predictive Microbiology

Tom McMeekin

CONTENTS

- 12.1 Introduction
- 12.2 A Short History and the Philosophy of Predictive Microbiology
- 12.3 The Basics of Predictive Modeling
- 12.4 Addressing Concerns in Predictive Modeling
- 12.5 Identifying Opportunities from Predictive Modeling
- 12.6 Modeling Attachment to and Detachment from Surfaces
- 12.7 Modeling Fungal Growth
- 12.8 Application of Predictive Microbiology
- 12.9 Concluding Remarks
- Acknowledgments
- References

12.1 INTRODUCTION

This book presents contemporary views of the state of the art of predictive modeling of microbial growth in foods, which, it is worth noting, has been the subject of much research for more than 30 years. Contained herein the reader will sense that the “front end” of the modeling process (data collection, model developing, model fitting) has a scientifically sound basis and that the “middle bit” (tertiary models, applications software, expert systems, etc.) should make the technology readily available.

However, one continues to have the sense that the predictive models and the databases upon which they are based have not nearly reached their potential. This “wrap up” chapter is intended to reinforce the view that predictive microbiology research has addressed, and continues to address, perceived weaknesses of the concept and offers the view that its potential as a food safety management tool remains to be realized. The views expressed are personal, but probably shared by others who have engaged in this type of research for many years. The style adopted is that of an “essay” (i.e., a written composition less elaborate than a treatise) in the

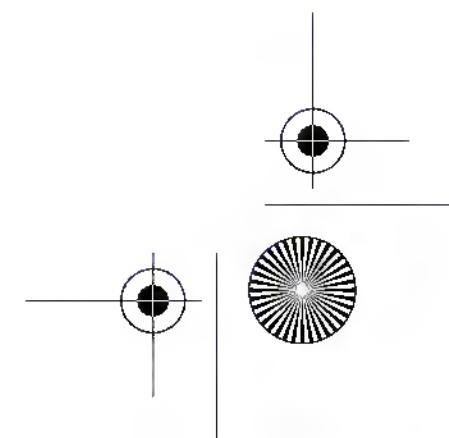
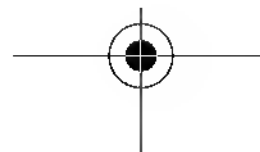
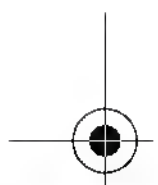

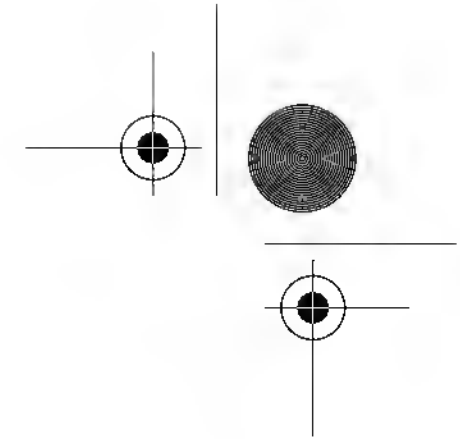
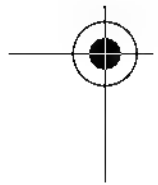

hope that a less formal presentation may encourage greater consideration by potential users of the concept.

12.2 A SHORT HISTORY AND THE PHILOSOPHY OF PREDICTIVE MICROBIOLOGY

Esty and Meyer⁷ devised a mathematical model to describe the thermal death kinetics of *Clostridium botulinum* type A spores that was used immediately, and since that time as the basis for heat processing of nonacid canned foods. Its use continues, despite subsequent understanding that a log-linear model may be an oversimplified description of the rate at which death occurs. Log-linear kinetics ignore the complications of “shoulders” and “tails,” because the performance criterion applied, a 12-log-cycle reduction in spore numbers, introduces a very large safety margin. Practitioners of heat processing use the time/temperature combinations derived with great confidence in the microbiological outcome. Such confidence and immediate and continuing application of the process suggest a single purpose rather than the earliest introduction of the concept of predictive microbiology. This would have implied considering the consequences of selecting less severe processing conditions.

In searching for the origin of predicting microbial behavior in foods, the trail appears to begin with Scott²⁵ who researched the effect of temperature on microbial growth on meat and wrote:

A knowledge of the rate of growth of certain micro-organisms at different temperatures is essential to studies of the spoilage of chilled beef. Having these data, it should be possible to predict the relative influence on spoilage exerted by the various organisms at each storage temperature. Further, it would be feasible to predict the possible extent of the changes in populations which various organisms may undergo during the initial cooling of sides of beef in the meatworks when the meat surfaces are frequently at temperatures very favourable to microbial proliferation.

Scott²⁴ also studied the effect of water availability on microbial growth on meat and, it is interesting to note that while explicit models were not developed, the knowledge accumulated was sufficient to allow shipments of nonfrozen meat from Australia to markets in the U.K. and Europe, based on the combined effects of temperature, water availability, and modified atmosphere. Later in this chapter we will return to the proposition that significant benefit can be obtained from accumulated knowledge or patterns of microbial population responses without transforming that knowledge into an explicit mathematical description.

So, why bother taking the additional steps necessary to convert a response pattern into a mathematical model? The answer is both practical and philosophical. In the practical sense, the additional effort required to construct and validate a model will, if properly carried out, lead to formulation of a general rule describing the effect of the environmental responses studied on the growth, death, or survival of the target population. A response pattern, on the other hand, is more likely to describe the outcome of limited experimental trials, the applicability of which will require testing

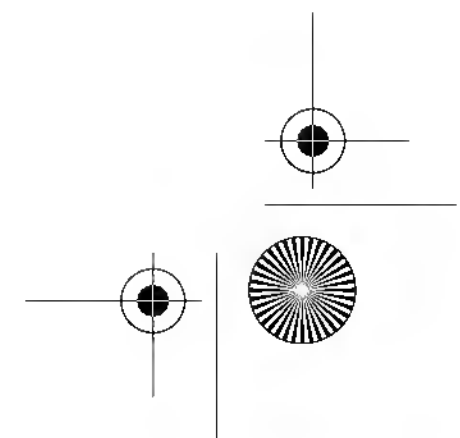
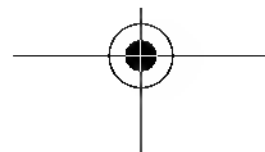
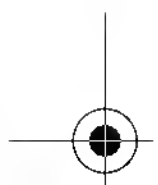
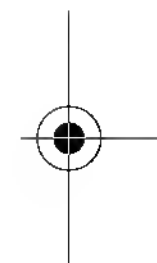
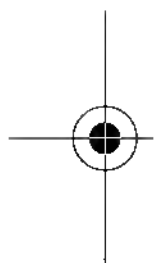

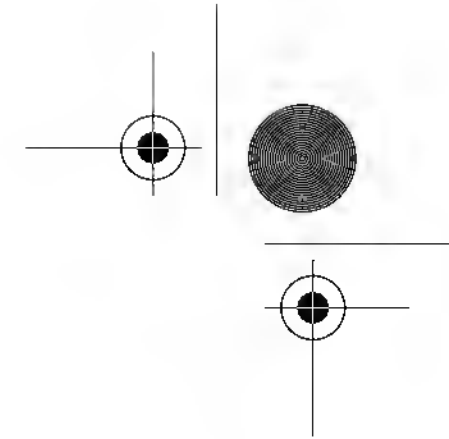
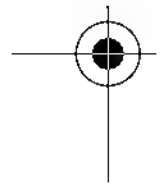

under even slightly changed conditions. Challenge tests are a well-established means of describing a response pattern, or ensuring that a performance criterion for a particular product/process combination is met.

Like the botulinum cook, the processing criteria or formulations scrutinized by challenge tests will “overcook” the situation to ensure a very high probability that the process will not “fail dangerous.” The value of properly constructed and validated models to replace, or significantly reduce, the need for expensive and time-consuming challenge tests by providing a generally applicable solution is well documented. As all microbial population responses are variable and characterized by a distribution,¹⁸ knowledge of that distribution takes the predicted outcome to the next level by allowing calculation of confidence limits for the predictions. The increased precision available in turn allows greater confidence in specifying minimal processing conditions, thus preserving the nutritional and quality characteristics of a product without leading to microbial food safety or shelf-life problems.

The philosophical reasons to develop a predictive model lie in the nature of science itself as expressed by Lord Kelvin: “When you can measure what you are speaking about and express it in numbers you know something about it; but when you cannot measure it, when you cannot express it in numbers your knowledge is of a meagre and unsatisfactory kind.”

Thus, quantitative science is inherently more useful than the qualitative description of a phenomenon, in that the latter is embodied in the former. Nevertheless, we should not lose sight of the fact that qualitative information is better than no knowledge, and that semiquantitative response patterns may be appropriate to address a particular question, to serve as a starting point or, as a “check and balance,” when moving towards quantitative descriptions of microbial population responses. When using “black box” modeling approaches, such as polynomial models or artificial neural networks, *a priori* knowledge is a valuable adjunct providing reality checks to ensure that the developing model actually describes the observed biological response.⁹

The history and philosophy of science likewise suggest that moving from an empirical or phenomenological description to a mechanistic or deterministic description of a process represents an advance in the “good science” hierarchy. The former descriptions are pragmatic in nature and give rise to stochastic models in which the data are described by useful mathematical relationships. Mechanistic models, on the other hand, have a theoretical basis, allowing interpretation of the observed response on the basis of underlying theory; e.g., in considering microbial growth Monod¹⁷ noted that, “There is little doubt that as further advances are made towards a more integrated picture of cell physiology, the determination of growth constants will have a much greater place in the arsenal of microbiology.”

Of the secondary models commonly used in predictive microbiology, none can be viewed as truly mechanistic, although some are regarded as more mechanistic than others. Thus, Arrhenius-type temperature dependence models for microbial growth are often thought to have a greater mechanistic basis than do Belehradek-type (square-root or Ratkowsky-type) models. This contention would not have found support from Belehradek² who, because of the origin of Arrhenius models in chemical kinetics, wrote:

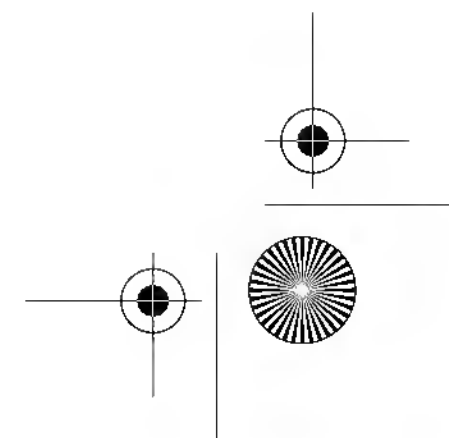
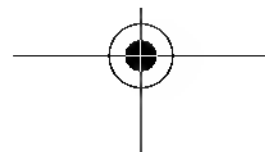
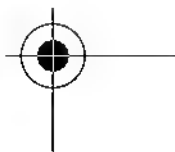
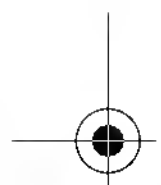
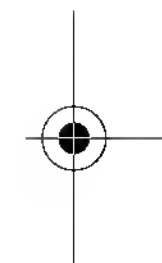
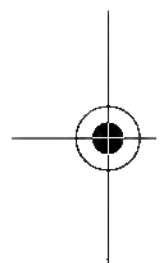

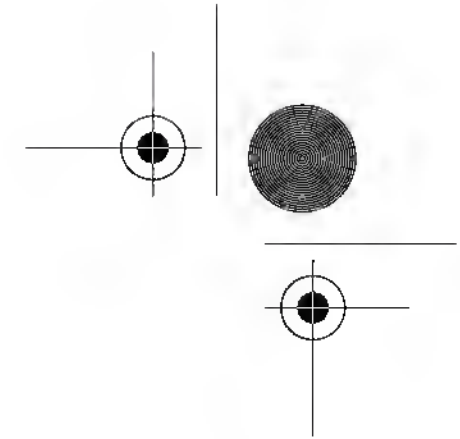
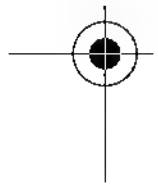

The problem of temperature coefficients in biology was initiated by chemists and has suffered from the beginning from this circumstance. Attempts to apply chemical temperature–velocity formulae (the Q_{10} rule and the Van't Hoff–Arrhenius law) to biological processes failed because some of the temperature constants used in chemistry (Q_{10} , μ) can be said not to hold good in biological reactions.

While it may be argued that mechanistic models are more amenable to refinement as knowledge of the system increases, development of fully mechanistic models for microbial growth has been limited by inability, to date, to provide quantitative values for all model parameters. Thermodynamic mechanistic models for the denaturation of proteins based on the enthalpy and entropy convergence temperatures and the heat capacity change⁸ appear to apply to a wide range of proteins.¹⁹ The growth of bacterial populations also seems amenable to this approach as foreshadowed by Ross and Olley in Chapter 10 of McMeekin et al.¹³ and Ross²² using *Escherichia coli* as an example. The ever increasing speed of computer simulation has recently enabled Drs. Olley, Ratkowsky, and Ross to apply this thermodynamic model to a very wide range of bacteria, including true psychrophiles.

Heat capacity change, which is the driving force for protein denaturation, may also explain the temperature response for bacterial growth, although it has not been measured for whole cells. This lends support to June Olley's long held view that the master reaction controlling temperature dependence is, in fact, the unfolding of proteins (or other macromolecules), exposing hydrophobic groups to interactions with surrounding water. Recent protein unfolding studies suggest that exposing polar surfaces may also be involved.¹⁹

When mechanistic models are invoked it is prudent to check the magnitude and sign (+ or –) of parameter estimates. Inappropriate parameter values, e.g., enormous activation energies, indicate that the model does not describe biological reality even though a mechanistic basis may have been inferred. Moving to an even greater level of “malpractice” in predictive model development one encounters situations in which very limited data sets have been fitted to models with a surfeit of parameters, resulting in an apparently perfect fit of the data to the model. This scenario represents an exercise in curve fitting unique to the data set used to develop the model and, in the end, because of false expectations based on erroneous assumptions of a mechanistic, or even a solid, quantitative foundation, is significantly less useful than describing a general response pattern.

12.3 THE BASICS OF PREDICTIVE MODELING

The rules for model selection were laid down by Ratkowsky in Chapter 2 of a previous book on predictive modeling,¹³ viz parsimony, parameter estimation properties, range of variables, stochastic assumption, and interpretability of parameters. These continue to apply to the primary and secondary models described in Chapter 2 and Chapter 3 of this book and their use is supported by the model fitting techniques described in Chapter 4.

An important prerequisite to model fitting is the need to plan ahead by selecting an experimental design appropriate to the purpose of the study and to understand

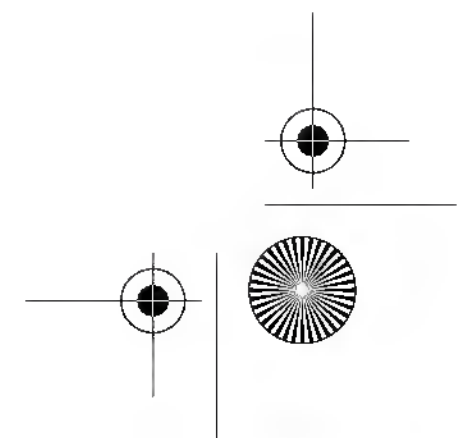
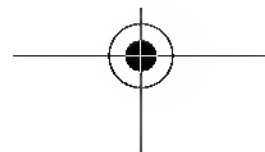
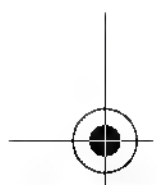
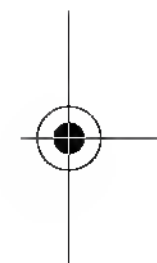
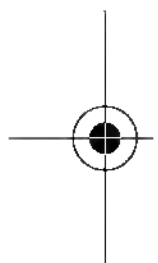

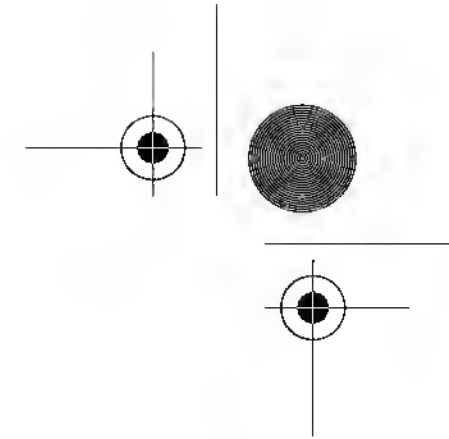
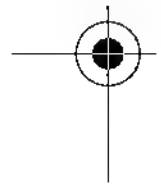

the limitations of the method of data collection selected. While “traditional” viable count and turbidimetric methods continue to dominate in modeling studies, several alternatives are given in [Chapter 1](#) of this book. The search, as is the case in developing detection methods, is driven by:

1. The desire to obtain results in a compressed time frame
2. Ease-of-use characteristics, including automation to reduce cost and reduce the physical burden involved in collecting sufficient data at appropriate, usually close, time intervals and over an appropriate, often extended, time period

Regardless of the method chosen, the standard remains the viable count method against which other methods require rigorous validation. Despite the labor-intensive, time-consuming nature of viable count methods, they can, with good laboratory practice, perform with sensitivity, accuracy, precision, reproducibility, and repeatability.

[Chapter 5](#) of this book provides a timely reminder that the test of a predictive model is not how well it performs in well-controlled laboratory conditions, but how well it predicts the behavior of microbial populations in real foods and in environments experienced under practical conditions of food production, processing, and storage. Indeed, some researchers have advanced the opinion that initial development of models in laboratory media represents wasted effort if subsequently the model fails to provide an adequate description of a target organism’s behavior in food.⁵ In particular, Brocklehurst (see [Chapter 5](#), this book) and colleagues have drawn attention to important effects of food structure, including emulsions and surfaces that may significantly affect microbial behavior.

Similar caveats on the performance and limits of models were advanced by Ross²³ under the headings Model Applicability and Model Accuracy. The necessity that models are applied only to relevant situations requires enunciation of the conditions under which the model performs well and the boundaries beyond which predictions should not be made. If a model is deemed appropriate, its accuracy must also be considered, and this determination must take account of the fact that all microbial responses are variable. Commonly used measures to evaluate model performance are the bias and accuracy factors.²¹ Note use of the term “evaluate” by this author, whereas most authors use “validate” to describe the process of ensuring that a model performs well in real foods subjected to anticipated conditions.

12.4 ADDRESSING CONCERNS IN PREDICTIVE MODELING

While variability is recognized as a characteristic feature of response times, such as the generation time or lag phase duration of a microbial population, that variability is characterized by distributions such as the gamma distribution in which the variance is proportional to the square of the response time.¹⁸ This knowledge enables variability to be incorporated in models and confidence limits to be determined.

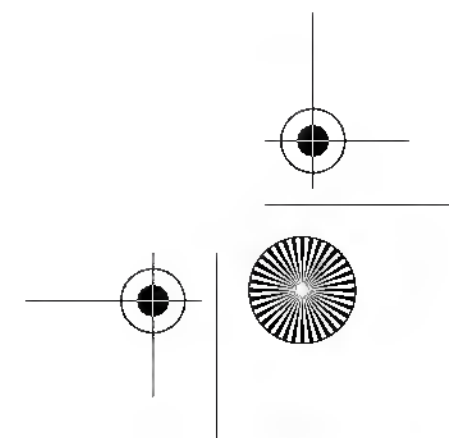
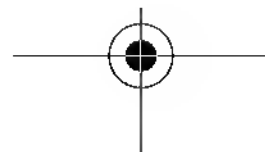
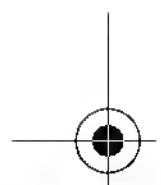
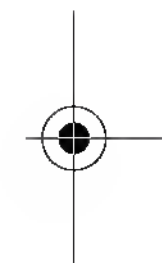
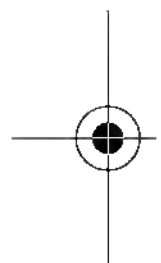

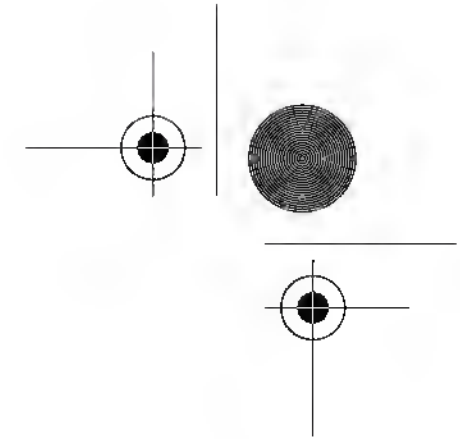
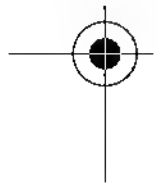

A more difficult suite of problems arises from the ability of microorganisms to adapt readily to the selective pressures of the food environment. Variability and adaptability were considered by Bridson and Gould³ in a dichotomy described respectively as classical vs. quantal microbiology, where it was argued that “large populations of microorganisms obey the rules of taxonomy but the individual cells exhibit uncertainties (caused by mutations and fluctuating local environments) which are buried within the macropopulations” and “the functional stability of classical microbiology masks minority subpopulations which, nevertheless, contribute to the complex dynamics of microbial populations.”

Conditions under which the adaptability of individual cells will influence the performance of a predictive model include those where small numbers of cells are found in a harsh environment causing decline in the viable population. This situation, often found in food processing environments, will lead to a few viable cells repairing, resolving the lag phase, and becoming the parent stock for the next phase of active growth.¹⁴

Adaptability and conditions where the rules of quantal microbiology apply give rise to uncertainty and the remaining challenges for predictive modeling. These now are centered on assessment of the initial conditions in a food, which will determine the level of contamination (expressed as concentration or prevalence in a sample), the initial physiological state of the population (or the survivors from an original population), and the complexity of the food system, including the microenvironment in which an individual organism is deposited. Uncertainty may also arise if interactions occur between different components of the microbiota and in fluctuating environments. The impact of the latter will depend on the magnitude of the fluctuations. Approaches to deal with dynamic environments and history effect on microbial growth and survival are discussed in [Chapter 7](#) and [Chapter 9](#), respectively.

Fluctuating environments, particularly with respect to temperature, probably represent a normal situation in food processing and during storage and distribution, and the consensus is that lag times will be affected but that there is little (if any) effect on generation times once the lag phase has been resolved. As an example, in the author’s laboratory, cycling *Streptococcus thermophilus* between 30 and 40°C produced immediate changes to the anticipated growth rate. The microbiological outcome of such fluctuations can, therefore, be predicted easily by a growth rate temperature dependence model.

When temperature fluctuations are larger, a transient lag phase may be introduced before exponential growth is resumed. A good example of this behavior was provided by Baranyi et al.¹ working with *Brochothrix thermosphacta*. When the incubation temperature was dropped from 25 to 5°C, the growth rate changed as anticipated, but a shift from 25 to 3°C induced a lag phase in this psychrotolerant spoilage bacterium.

Modeling the effects of severe fluctuations in temperature or other environmental factors will be more difficult in that both lag and growth phases need to be considered and, in some instances, the model will also have to account for death of a proportion of the population. These situations provide examples where patterns of microbial population behavior, without an explicit mathematical description, may indicate a

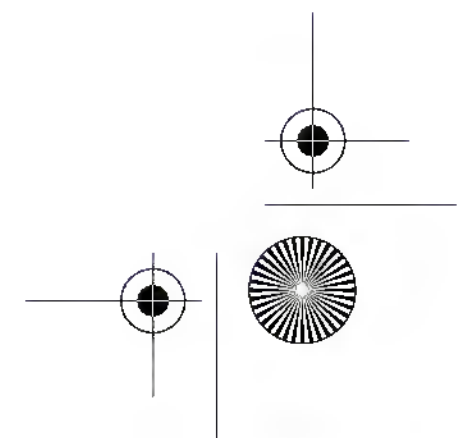
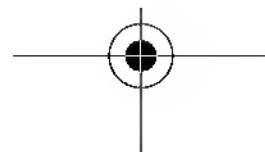
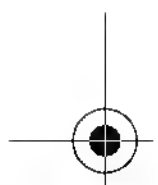
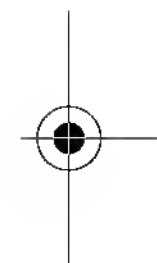
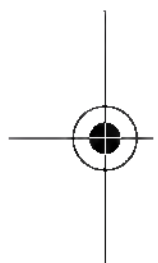

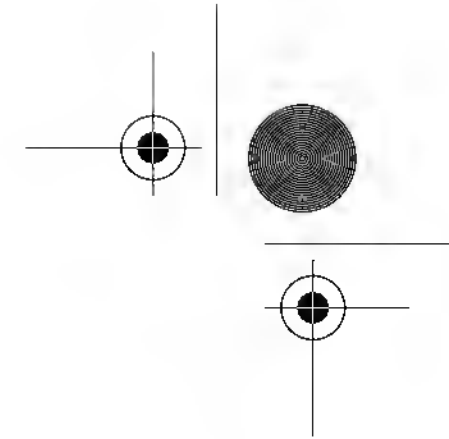
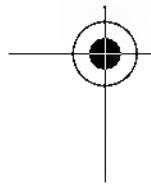

practical control situation. Let us consider a temperature-based example that has been studied at the pilot-plant level, and a laboratory-based water-activity example.

In the former, a pilot-plant-scale cheese-milk pasteurizer was used to study the development and control of thermophilic streptococci biofilms during milk pasteurization. Under normal operating conditions thermophilic streptococci grew on pasteurizer plates where the bulk milk temperature was between 35 and 50°C, and were detected in the product stream after 8 to 10 h. Introducing a temperature step change in the growth region of 55°C for 10 min with a 60-min interval between step changes resulted in a 20-h production run without detectable growth of thermophilic streptococci.¹¹

In the latter example, Mellefont et al.,¹⁵ using optical density (OD) methods showed that abrupt osmotic downshifts significantly increased the lag times of Gram-negative organisms, but those of Gram-positive organisms were largely unaffected. Further studies using viable count methods at close time intervals indicated that the apparent increase in lag time in fact comprises a death phase, a true lag period and growth back to the initial population levels (Mellefont, L.A., personal communication).

Returning to temperature shifts, Mellefont and Ross¹⁶ found that downshifts induced significant increases in the lag phase duration of *Escherichia coli* and *Klebsiella oxytoca* that were dependent on the magnitude of the shift. These authors suggested that lags were introduced when the culture was shifted to temperatures beyond the normal physiological temperature range (NPTR) for growth, where cells are required to do additional work to adjust to the new environment and the rate at which that work is done.²⁰ At temperatures within the NPTR, the energy requirement for cellular functions to proceed is unchanged, the cells are “cruising,” and thus shifts within this region are characterized by a simple change of rate without interruption to the growth cycle. This is a plausible hypothesis but much more work is required to firm up the concept and determine the physiological significance of the NPTR. The notion of a normal physiological range for other factors such as water activity and acidity should also be addressed.

Thus, predicting lag phase duration in foods is considered problematic because of the twin uncertainties of the initial physiological state of organisms and the numbers initially contaminating a product. Despite the fact that lag phase models can be developed in the laboratory with reasonable success (as the uncertainties above are minimized), this has remained one of the more intractable problems in predictive modeling.

A potential solution, however, was provided by Ross²³ using the trusted modelers device of moving from a kinetic to a probabilistic modeling approach to confront increasing uncertainty in describing initial conditions. The approach was to concede that while lag times are highly variable, the variability can be reduced by using the concept of relative lag times or “generation time equivalents,” i.e., the ratio of lag time to generation time. By this device it was shown that although lag times may take almost any value, there is a common pattern of distribution of relative lag times for a wide range of species across a wide range of conditions. That common distribution of relative lag times has a sharp peak in the range of four to six generation time equivalents accounting for >80% of lag phase duration determinations.²³ This stochastic approach has significance for the application of predictive models in that

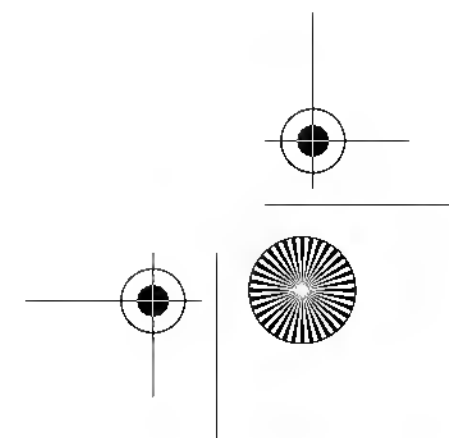
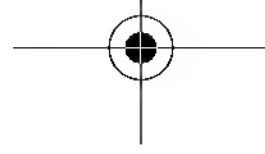
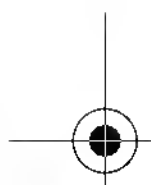
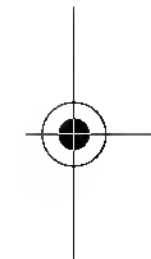
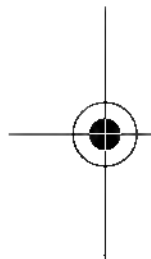

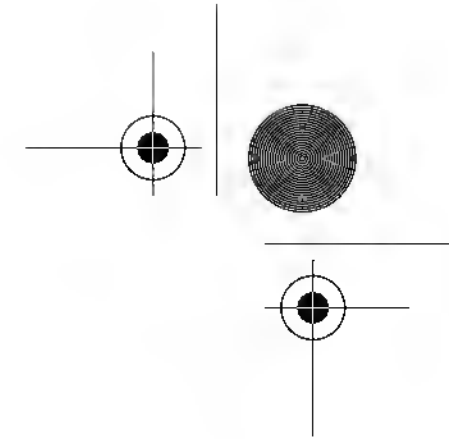
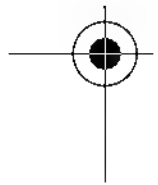

when an adjustment of ~5 generation time equivalents is added to generation time predictions, good agreement of observed microbial proliferation on carcasses during chilling was observed.

12.5 IDENTIFYING OPPORTUNITIES FROM PREDICTIVE MODELING

In a practical sense it is clear that interrupting the exponential growth phase of a target organism is an effective strategy to buy time before critical limits of spoilage or pathogenic bacteria are reached. In the pasteurizer example, interrupting growth by intermittent temperature changes has the potential to more than double the run time of the heat exchanger with respect to thermophilic streptococci. An alternative biofilm control strategy is to minimize microbial adhesion to the pasteurizer plates, e.g., by a Teflon surface coating. However, this approach is inherently limited in its efficacy, with a 50% reduction in the initial load translating to an extension in run time equivalent to one generation time, for *S. thermophilus* ~20 min, and a 90% reduction to ~3 generations (~1 h) at its optimum temperature.

Buying time may also be useful in the context of a sequence of processing operations if the effect of changes occurring during each operation on microbial population dynamics is understood. Meat processing provides an interesting case study as regulatory authorities contemplate mandating a microbial “kill” step for certain pathogens during the conversion of live animals to meat. This philosophy will require the application of an intervention to achieve a reduction in pathogen numbers and, with current technology, the options are acid or hot water treatments. But could a better understanding of the chilling process reveal a potentially valuable intervention step without the significant cost burden of acid or hot water cabinets or steam pasteurization equipment? Such an opportunity is suggested by the results of Chang et al.⁴ who studied reduction of bacteria on pork carcasses associated with chilling, concluding that “the effects of chilling techniques on microbial populations could provide pork processors with an additional intervention for pork slaughter or information to modify and/or improve the chilling process.”

While lowering temperature and, in many chilling operations, simultaneously reducing surface water activity may not result in as great a reduction in microbial numbers as a heat treatment, understanding and “tweaking” these operations may prove valuable:

1. To identify and characterize a new critical control point (CCP)
2. As part of the “farm to fork” philosophy where every operation has an impact on the final level of risk to the consumer

Food safety professionals write often about the Hurdle concept in which multiple barriers confront microbial contaminants to delay resolution of the lag phase and the onset of exponential growth. However, mostly we think of applying hurdles via the intrinsic properties of the food (water activity, pH, organic acid concentration, etc.) and the extrinsic conditions of storage (temperature, atmosphere, etc.).

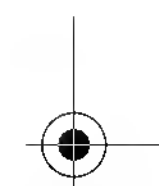
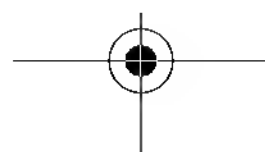
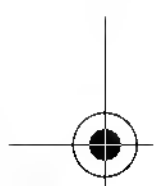
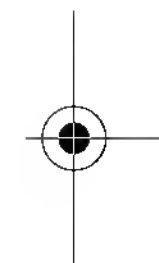
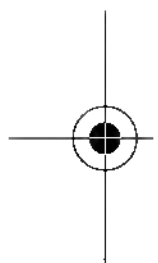

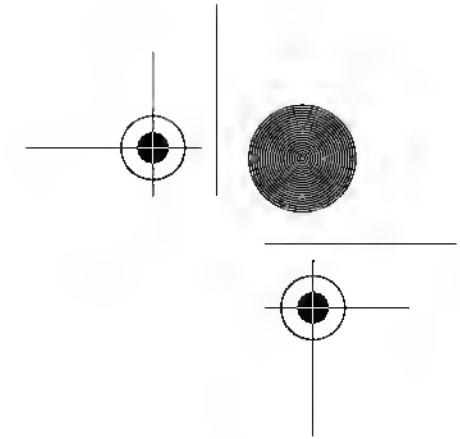
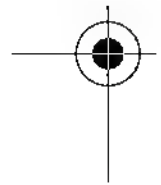

It may also be useful to think of the cumulative effect of hurdles applied in a sequence of processing operations leading to a final product. In the meat chilling situation outlined above, hurdles leading to inactivation and stasis of microbial populations will be supplemented by the effect of downstream processes. A case in point is freezing cartons of meat destined for the hamburger trade, where ice crystal formation might be expected to cause further damage to cells injured during chilling.

12.6 MODELING ATTACHMENT TO AND DETACHMENT FROM SURFACES

Don Schaffner, in [Chapter 10](#) of this book, draws attention to a recent research trend in food microbiology concerned with modeling contamination and decontamination processes. This subject was reviewed recently by den Aantrekker et al.⁶ Encompassed within the general area, researchers will need to consider contamination of foods and food contact surfaces (including hands), transfer of organisms to foods from surfaces and vice versa, removal of organisms from surfaces, the potential for and significance of recontamination of foods with small numbers of pathogens, etc.

The field of research, arising from the propensity of organisms to become intimately associated with surfaces as a survival mechanism, has spawned a subdiscipline of microbiology concerned with a continuum from the early events of adhesion to the formation of mature biofilms and their detachment from surfaces. Two aspects of these types of studies will be considered briefly here. The first is modeling attachment and detachment of biofilms, a general treatment of which was reviewed⁶ under the heading Recontamination through Equipment. From this readers will be able to identify the relevant original literature. A specific example of this type of study, supporting the step change control strategy for *S. thermophilus* biofilms¹¹ was reported by Lee.¹² The model developed suggested that increasing the generation times of *S. thermophilus* represents the most effective way of controlling biofilm formation and subsequent detachment into cheese-milk.

The second aspect considers the important role of fluid transport in contamination events, which, in this author's opinion, is an obvious but often overlooked phenomenon in recent times. However, a considerable literature was generated on the role of fluid transfer in poultry processing in the 1970s (a quarter of a century ago), mainly by Dr. S Notermans and colleagues in The Netherlands and Dr. CJ Thomas and colleagues at the University of Tasmania. A model formulated to describe contamination during immersion chilling of poultry carcasses relies on the observation that the number of bacteria transferred from processing water to the skin of a broiler carcass is directly proportional to the number of organisms in the water. Effectively, when the carcass (or any other surface) is removed from a liquid it carries with it a sample of the liquid in which the density of the organisms is the same as that of the bulk liquid. The simple relationship has found utility, e.g., in the design of countercurrent immersion chillers in which the carcasses exit the chiller at the point where the microbial load in the water is lowest.

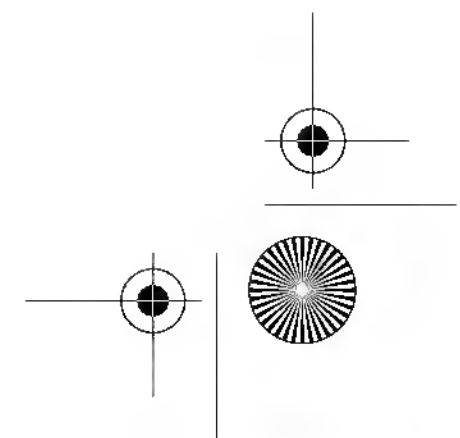
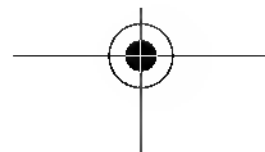
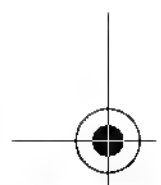
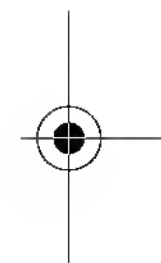
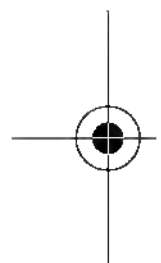

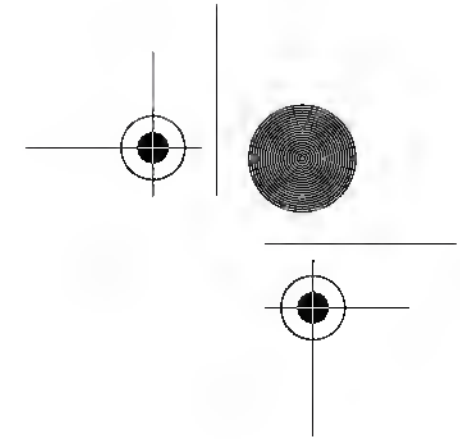
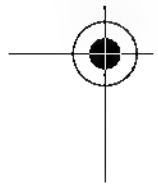

12.7 MODELING FUNGAL GROWTH

The great majority of predictive modeling studies to date have described the effect of environmental factors on bacterial growth. Viruses and parasites effectively have no growth ecology in foods, but patterns of decline have been described, e.g., for the effect of freezing on *Trichinella* in pork. As we are reminded in [Chapter 11](#), molds are very important food spoilage organisms and the toxins they produce may lead, usually in the longer term, to public health problems. Despite their importance in food microbiology, the study of predictive mycology is very limited when compared with studies on bacteria. Nevertheless, sufficient material is available for Philippe Dantigny to provide a short review of fungal modeling studies in foods, including some interesting points for discussion such as the inability of the square-root model to describe the effects of temperature on the kinetics of mold growth.

Insights might also arise from returning to the plant pathology literature that, almost 50 years ago when I was a boy in Northern Ireland, was the basis of public broadcasts predicting the likelihood of potato blight (*Phytophthora infestans*) or apple scab (*Venturia inaequalis*) problems as a result of prevailing climatic conditions (temperature and relative humidity). In essence, these forecasts might be considered an early example of risk assessment, predicting the incidence of plant disease rather than human disease.

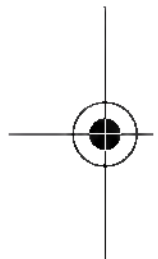

12.8 APPLICATION OF PREDICTIVE MICROBIOLOGY

To use predictive models practically in the food industry requires devices that monitor the environmental conditions in that part of the paddock to plate continuum of interest and a means to translate that environmental history into an estimate of the growth, survival, or death of a target organism.

The devices available are chemical or physical monitors where the interpretative function is built into the device, e.g., as a color change resulting from a chemical reaction or, in physical mode, the extent of migration of a dye along a wick.¹³ Implicit in the efficacy of monitors with a built-in interpretative function is that the rate at which the chemical or physical change occurs mimics that of microbial behavior under the same conditions. Unfortunately, such monitors are based almost exclusively on Arrhenius reaction kinetics, which deviate from biological response rates as limits for growth are approached. Often these regions are of greatest interest in predicting the shelf life and safety of foods.

An alternative to built-in interpretation is to construct a tertiary model,²⁶ usually a spreadsheet-based program that converts a monitored temperature history into an estimate of microbial growth potential. Many such programs are available and prominent ones are described in [Chapter 6](#) of this book. That chapter also describes a most significant initiative in predictive modeling: the development of COMBASE, initially by combining the U.S.-developed Pathogen Modeling Program and the U.K.-developed Food MicroModel, but to which other significant databases could be added. Further, the authors of Chapter 6 draw attention to the main pillars of predictive microbiology software packages: databases and mathematical models. Here they point out that while most chapters in this book deal with aspects of

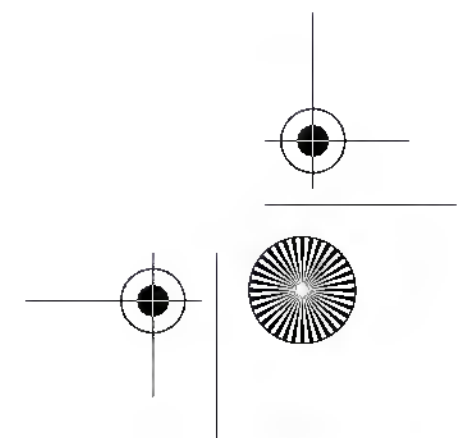
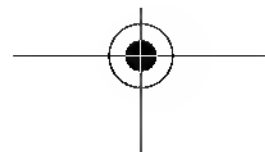
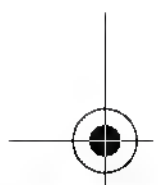
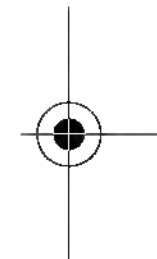

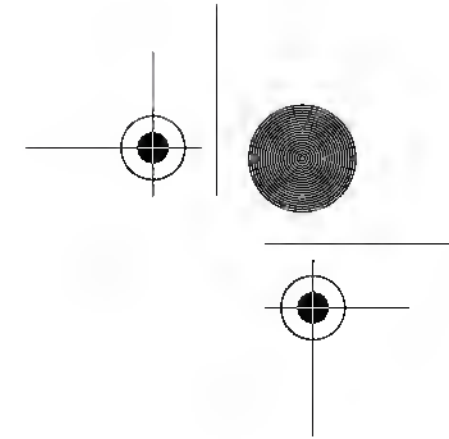
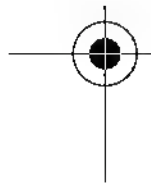

mathematical modeling, more emphasis needs to be placed on the value of databases and the scientific study termed Bioinformatics. The power of the database, perhaps through the agency of a mathematical model or algorithm, is described via the use of Expert Systems that provide decision support. These include the possibility of in-line real-time systems.

Such developments highlight the interface of predictive microbiology with information technology systems, allowing the application of models in food safety management strategies including Hazard Analysis Critical Control Point (HACCP), Quantitative Risk Assessment, and Food Safety Objectives. Much has been written about specific opportunities for predictive models to underpin these strategies that need not be repeated here, e.g., see [Chapter 8](#) of this book. Further, there is a particular role for predictive models in comparing the microbiological outcomes of various operations in food manufacture. Predictive models based on detailed knowledge of the microbial ecology of any product/pathogen combination enable us to:

1. Quantify the effect of preservation technologies on microbial populations
2. Optimize existing or suggest new processing procedures
3. Indicate risk management options
4. Identify regulations that are unwarranted
5. Support the need for outcome-based regulations
6. Enable equivalence determinations

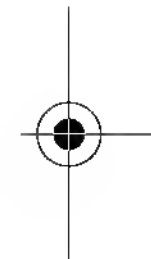
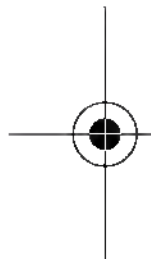

The last two applications are likely to become prominent in the global debate on regulatory frameworks to assure the safety of food in international trade and attendant market access issues that sit alongside the protection of public health.

However, reticence to realize the potential value of predictive modeling applications continues as exemplified by comments from the Food Safety and Inspection Service (FSIS) of the USDA. In July 2002, FSIS issued a notice entitled "Use of microbial pathogen computer modeling in HACCP plans" (www.usda.fsis.gov) that presented a particularly negative account of the potential to use microbial pathogen computer modeling (MPCM) programs in the development and use of HACCP plans. While acknowledging that MPCM may be useful in "supporting hazard analyses, developing critical limits and evaluating the relative severity caused by process deviations," FSIS states categorically, "It is not possible or appropriate to rely solely upon a predictive modeling program to determine the safety of food and processing systems." Furthermore, "determining pathogen growth and survival, and controlling it in food products often requires complete and thorough analysis by an independent microbiology laboratory, challenge studies and surveys of the literature."

In effect, FSIS listed the elements of a properly conducted and independently evaluated predictive modeling study:

- Thorough analysis of the literature to reveal general patterns of microbial population behavior
- Challenge studies to validate that the proposed model is applicable in practice

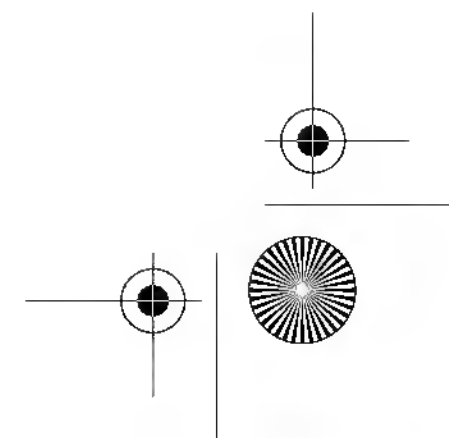
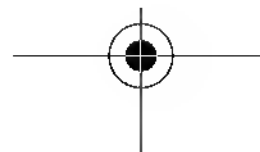
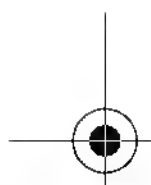

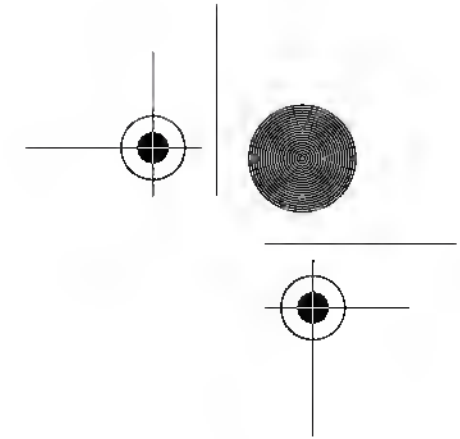
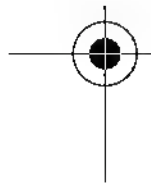

- Independent evaluation to verify that an MCPM program consistently allows a process to meet agreed critical levels at identified CCPs

There is, of course, a requirement for those proposing the use of predictive models in HACCP plans to ensure that the model predictions are used conservatively. This is a fact well recognized by predictive modeling researchers who promote caution in the use of models, e.g., McMeekin and Ross.¹⁴ These authors recognized clearly that

there are two criteria that must be satisfied if any form of application software is to be used effectively. The first is a properly developed and validated model and the second the ability of an operator to interpret correctly the microbiological significance of the results. Poorly performing models coupled with poor interpretation continue to be the greatest threat to widespread use of predictive microbiology as a technology with the potential to assure the microbiological quality and safety of foods.

A somewhat different perspective on the use of predictive models to evaluate food safety was provided by an International Food Technology (IFT) committee in their report “Evaluation and Definition of Potentially Hazardous Foods.” This was prepared for the FDA (Dec. 31, 2001; IFT/FDA Contract No 223-98-2333, Task Order No 4).

In this report IFT recognizes that certain foods have combinations of pH, a_w , preservatives, etc., that restrict microbial growth and may, therefore, not require refrigeration to protect public health. Under certain circumstances time alone can be used to control product safety, e.g., “if *S. aureus* is a concern the Pathogen Modeling Program V.5.1 could be used to estimate the time of storage where the pathogen could grow.”

The committee further suggests that general growth models such as Pathogen Modeling Program should be used conservatively or in combination with challenge testing. However, if an in-house model has been developed and validated for a particular food, it could be used itself or with challenge testing.

12.9 CONCLUDING REMARKS

This is only the third major book devoted to predictive microbiology in approximately 30 years of scientific endeavor in the field. The first,¹³ referred to in the Preface of this book, appeared in 1993; the second,²³ which focused on predictive models for the meat industry, was not widely distributed.

The chapters in this book cover the entire gamut of predictive modeling research and it is appropriate that the “middle” chapter, [Chapter 6](#), describes database development, the fulcrum on which predictive modeling swings.

Here we find a description of how new knowledge is accumulated and stored in databases that, when properly constructed, are dynamic information repositories to which new information can be added at any time and from which that found to be “dodgy” can be deleted. Speaking the same language is an important element of database construction and a prerequisite to merging existing databases. The authors

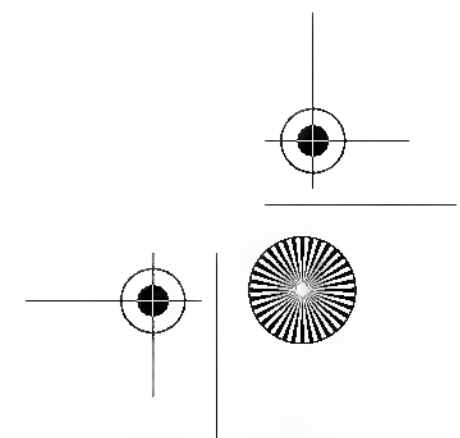
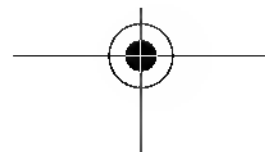
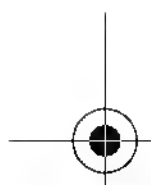
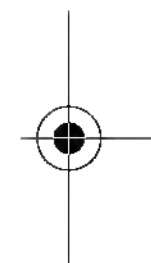
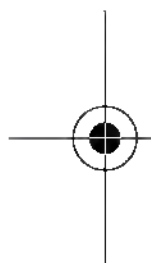

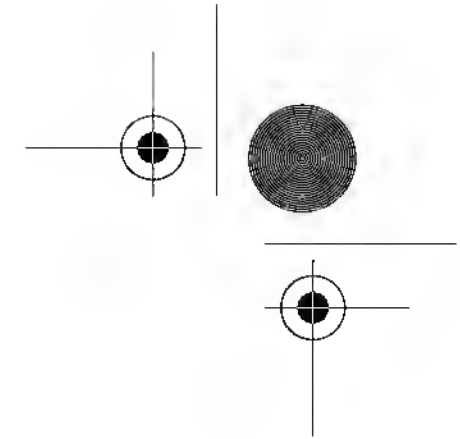
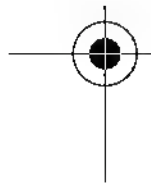

of [Chapter 6](#) have expended considerable effort to make two major databases — Pathogen Modeling Program and Food MicroModel — compatible and to merge these into COMBASE. This initiative will also guide researchers toward the best way to collect and collate new information so that it can be easily integrated into existing databases. Properly supported, the COMBASE initiative will be a watershed in the evolution of predictive modeling and its widespread application.

Much of what underpins a predictive models database is regarded by many as difficult science. However, this need not unduly concern potential users of models if there is confidence that the underpinning science is sound. What comes after this point, in the form of user-friendly interpretative devices, will determine whether or not the potential of predictive microbiology is realized.

Many specific applications have been suggested for predictive models and some are mentioned earlier in this chapter. However, in a more general sense, the value of predictive models and databases lies in their support of food safety management strategies such as HACCP, Quantitative Risk Assessment, and Food Safety Objectives.

In particular, the role of quantitative information in empowering the HACCP concept must not be undersold. HACCP is a simple, but elegant, concept by which safety is built into a process. It works well where critical control points, e.g., a lethal heat process, can be identified. Its value is less obvious where critical control points do not stand out, e.g., in the conversion of muscle to meat. Its value is compromised where the HACCP concept is virtual rather than real, i.e., where generic criteria are applied to satisfy mandatory requirements that a process is HACCP-based rather than using criteria derived from a knowledge of microbial population behavior.

The challenge now for predictive microbiology is to move from the phase of model development and model validation (evaluation) to *process validation* and *verification* studies that will enable models to be used with confidence in HACCP systems as demonstrated by Jericho et al.¹⁰

The “hard yakka” (Australian vernacular for hard work) has been done in developing the databases and models and now there are tantalizing prospects for in-line control of processes, appropriate corrective actions, and sound food safety management decisions arising from the concept of predictive microbiology.

ACKNOWLEDGMENTS

The author is indebted to Dr. June Olley for stimulating discussions in the preparation of this essay and to Meat and Livestock Australia (MLA) for continuing support of predictive modeling research.

REFERENCES

1. Baranyi, J., Robinson, T.P., Kaloti, A., and Mackey, B.M., Predicting growth of *Brochothrix thermosphacta* at changing temperature. *Int. J. Food Microbiol.* 27, 61, 1995.
2. Belehradek, J., Temperature coefficients in biology. *Biol. Rev. Biol. Proc. Camb. Philos. Soc.* 5, 30, 1930.

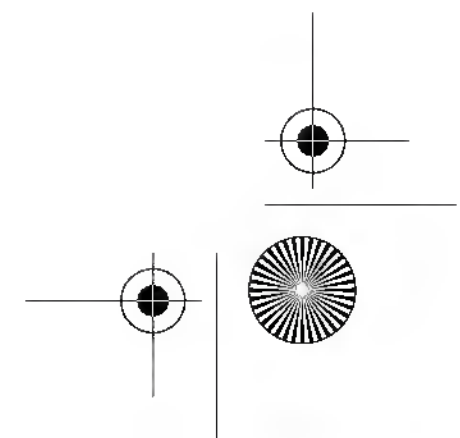
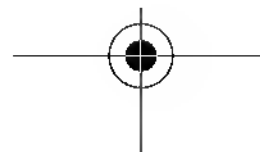
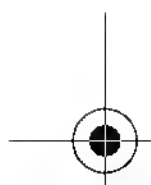
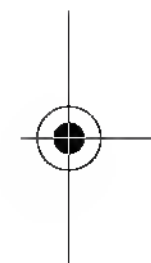
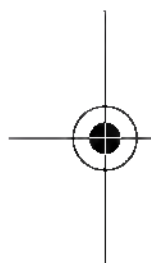

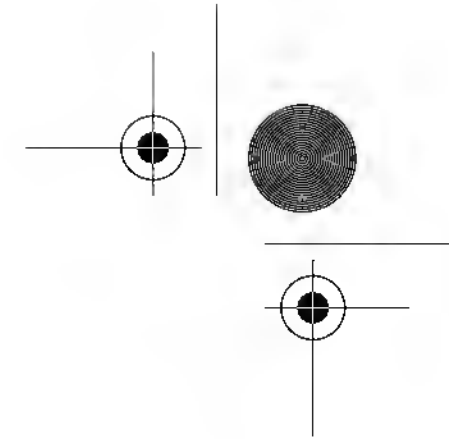
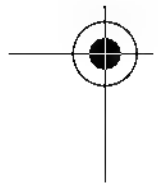

3. Bridson, E.Y. and Gould, G.W., Quantal microbiology. *Lett. Appl. Microbiol.* 30, 95, 2000.
4. Chang, V.P., Mills, E.W., and Cutter, C.N., Reduction of bacteria on pork carcasses associated with chilling method. *J. Food Prot.* 66, 1019, 2003.
5. Dalgaard, P., Mejlholm, O., and Huss, H.H., Application of an iterative approach for development of a microbial model predicting the shelf-life of packed fish. *Int. J. Food Microbiol.* 38, 169, 1997.
6. den Aantrekker, E.D., Boon, R.M., Zwietering, M.H., and van Schothorst, M., Quantifying recontamination through factory environments: a review. *Int. J. Food Microbiol.* 80, 117, 2002.
7. Esty, J.R. and Meyer, K.F., The heat resistance of the spore of *B. botulinum* and allied anaerobes, XI. *J. Infect. Dis.* 31, 650, 1922.
8. Fu, L. and Friere, E., On the origin of the enthalpy and entropy convergence temperatures in protein folding. *Proc. Natl. Acad. Sci.* 89, 9335, 1992.
9. Geeraerd, A.H., Valdramidis, V.P., Devlignere, F., Bernaerts, H., Debevere, J., and Van Impe, J.F., Development of a novel modelling methodology by incorporating *a priori* microbiological knowledge in a black box approach. *Proc. 18th International ICFMH Symposium*, Lillehammer, Norway, 2002, p. 135.
10. Jericho, K.W.F., O'Laney, G., and Kozub, G.C., Verification of the hygienic adequacy of beef carcass cooling processes by microbiological culture and the temperature-function integration technique. *J. Food Prot.* 61, 1347, 1998.
11. Knight, G., Nicol, R.S., and McMeekin, T.A., Temperature step changes: a novel approach to control biofilms of thermotolerant streptococci in a pilot plant-scale cheese-milk pasteuriser. *Int. J. Food Microbiol.* In press.
12. Lee, M.W., *Growth Rate and Detachment Rate of a Biofilm of Thermotolerant Bacteria*, M.Sc. thesis, Monash University, Clayton, VI, 1998.
13. McMeekin, T.A., Olley, J., Ratkowsky, D.A., and Ross, T. *Predictive Microbiology: Theory and Application*. Research Studies Press Ltd., Taunton, U.K., 1993.
14. McMeekin, T.A. and Ross, T., Predictive microbiology: providing a knowledge-based framework for change management. *Int. J. Food Microbiol.* 78, 133, 2002.
15. Mellefont, L.A., McMeekin, T.A., and Ross, T., The effect of abrupt osmotic shifts on the lag phase duration of food borne bacteria. *Int. J. Food Microbiol.* 83, 281, 2003.
16. Mellefont, L.A. and Ross, T., The effect of abrupt shifts in temperature on the lag phase duration of *Escherichia coli* and *Klebsiella oxytoca*. *Int. J. Food Microbiol.* 83, 295, 2003.
17. Monod, J., The growth of bacterial cultures. *Ann. Rev. Microbiol.* 3, 371, 1949.
18. Ratkowsky, D.A., Ross, T., Macario, N., Dommert, T.W., and Kamperman, L., Choosing probability distributions for modelling generation time variability. *J. Appl. Bacteriol.* 80, 131, 1996.
19. Robertson, A.D. and Murphy, K.P., Protein structure and the energetics of protein stability. *Chem. Rev.* 97, 1251, 1997.
20. Robinson, T.P., Ocio, M.J., Kaloti, A., and Mackey, B.M., The effect of growth environment on the lag phase of *Listeria monocytogenes*. *Int. J. Food Microbiol.* 44, 83, 1998.
21. Ross, T., Indices for performance evaluation of predictive models in food microbiology. *J. Appl. Bacteriol.* 81, 501, 1996.
22. Ross, T., Assessment of a theoretical model for the effects of temperature on bacterial growth rate. Predictive microbiology applied to chill food preservation. *Proc. Conf. No. 1997/2, Comm. C2*, Quimper, France, International Institute Refrigeration, Sydney, 1999, p. 64.

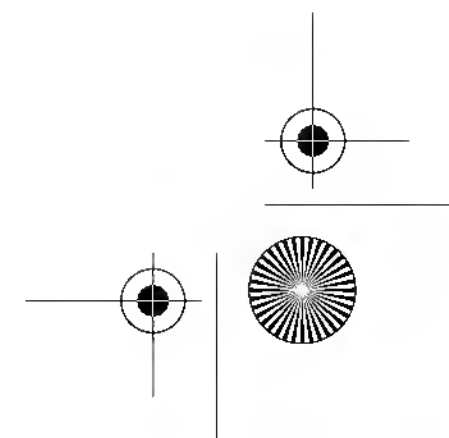
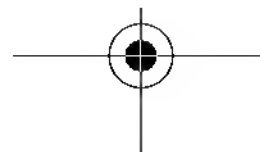
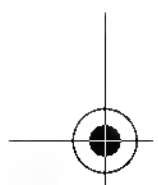
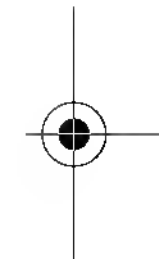
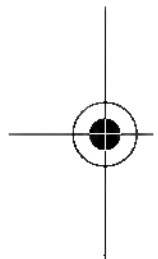

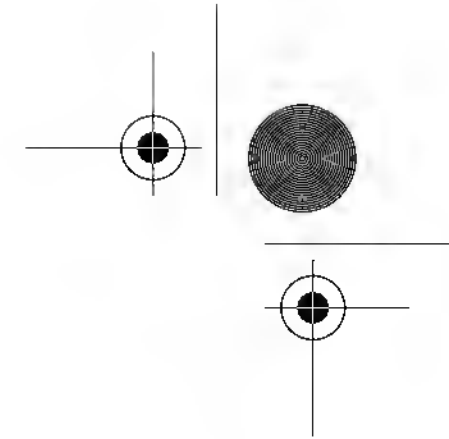
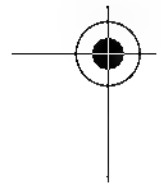

23. Ross, T., *Predictive Microbiology for the Meat Industry*, Meat and Livestock Australia, Sydney, 1999, 196 pp.
24. Scott, W.J., The growth of microorganisms on ox muscle. I. The influence of water content of substrate on rate of growth at -1°C . *J. Counc. Sci. Ind. Res. (Aust.)* 9, 177, 1936.
25. Scott, W.J., The growth of microorganisms on ox muscle. II. The influence of temperature. *J. Counc. Sci. Ind. Res. (Aust.)* 10, 338, 1937.
26. Whiting, R.C. and Buchanan, R.L., A classification of models for predictive microbiology. *Food Microbiol.* 10, 175, 1993.

