



McGraw-Hill Book Co., Inc.

PUBLISHERS OF BOOKS FOR

Coal Age ▽ Electric Railway Journal
Electrical World ▽ Engineering News-Record
American Machinist ▽ The Contractor
Engineering & Mining Journal ▽ Power
Metallurgical & Chemical Engineering
Electrical Merchandising

THEORY AND CALCULATIONS
OF
ELECTRICAL APPARATUS

BY
CHARLES PROTEUS STEINMETZ, A. M., PH. D.

FIRST EDITION
SECOND IMPRESSION

McGRAW-HILL BOOK COMPANY, INC.
239 WEST 39TH STREET. NEW YORK

LONDON: HILL PUBLISHING CO., LTD.
6 & 8 BOUVERIE ST., E. C.

1917

PREFACE

In the twenty years since the first edition of "Theory and Calculation of Alternating Current Phenomena" appeared, electrical engineering has risen from a small beginning to the world's greatest industry; electricity has found its field, as the means of universal energy transmission, distribution and supply, and our knowledge of electrophysics and electrical engineering has increased many fold, so that subjects, which twenty years ago could be dismissed with a few pages discussion, now have expanded and require an extensive knowledge by every electrical engineer.

In the following volume I have discussed the most important characteristics of the numerous electrical apparatus, which have been devised and have found their place in the theory of electrical engineering. While many of them have not yet reached any industrial importance, experience has shown, that not infrequently apparatus, which had been known for many years but had not found any extensive practical use, become, with changes of industrial conditions, highly important. It is therefore necessary for the electrical engineer to be familiar, in a general way, with the characteristics of the less frequently used types of apparatus.

In some respects, the following work, and its companion volume, "Theory and Calculation of Electric Circuits," may be considered as continuations, or rather as parts of "Theory and Calculation of Alternating Current Phenomena." With the 4th edition, which appeared nine years ago, "Alternating Current Phenomena" had reached about the largest practical bulk, and when rewriting it recently for the 5th edition, it became necessary to subdivide it into three volumes, to include at least the most necessary structural elements of our knowledge of electrical engineering. The subject matter thus has been distributed into three volumes: "Alternating Current Phenomena," "Electric Circuits," and "Electrical Apparatus."

CHARLES PROTEUS STEINMETZ.

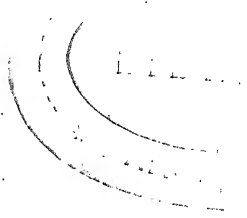

CONTENTS

	PAGE
PREFACE	v
CHAPTER I.—SPEED CONTROL OF INDUCTION MOTORS.	
<i>I. Starting and Acceleration</i>	
1. The problems of high torque over wide range of speed, and of constant speed over wide range of load—Starting by armature rheostat	1
2. A. Temperature starting device—Temperature rise increasing secondary resistance with increase of current—Calculation of motor	2
3. Calculation of numerical instance—Its discussion—Estimation of required temperature rise	4
4. B. Hysteresis starting device—Admittance of a closed magnetic circuit with negligible eddy current loss—Total secondary impedance of motor with hysteresis starting device	5
5. Calculation of numerical instance—Discussion—Similarity of torque curve with that of temperature starting device—Close speed regulation—Disadvantage of impairment of power factor and apparent efficiency, due to introduction of reactance—Required increase of magnetic density	6
6. C. Eddy current starting device—Admittance of magnetic circuit with high eddy current losses and negligible hysteresis—Total secondary impedance of motor with eddy current starting device—Numerical instance	8
7. Double maximum of torque curve—Close speed regulation—High torque efficiency—Poor power factor, requiring increase of magnetic density to get output—Relation to double squirrel cage motor and deep bar motor	10
<i>II. Constant Speed Operation</i>	
8. Speed control by armature resistance—Disadvantage of inconstancy of speed with load—Use of condenser in armature or secondary—Use of pyro-electric resistance	12
9. Speed control by variation of the effective frequency: concatenation—By changing the number of poles: multispeed motors	13
10. A. Pyro-electric speed control—Characteristic of pyro-electric conductor—Close speed regulation of motor—Limitation of pyro-electric conductors.	14
11. B. Condenser speed control—Effect of condenser in secondary,	

	PAGE
giving high current and torque at resonance speed—Calculation of motor	16
12. Equations of motor—Equation of torque—Speed range of maximum torque	17
13. Numerical instance—Voltampere capacity of required condenser.	18
14. <i>C.</i> Multispeed motors—Fractional pitch winding, and switching of six groups of coils in each phase, at a change of the number of poles	20
15. Discussion of the change of motor constants due to a change of the number of poles, with series connection of all primary turns—Magnetic density and inferior performance curves at lower speeds.	21
16. Change of constants for approximately constant maximum torque at all speeds—Magnetic density and change of coil connection	22
17. Instance of $4 \div 6 \div 8$ pole motor—Numerical calculation and discussion.	23

CHAPTER II. MULTIPLE SQUIRREL CAGE INDUCTION MOTOR.

18. Superposition of torque curves of high resistance low reactance, and low resistance high reactance squirrel cage to a torque curve with two maxima, at high and at low speed	27
19. Theory of multiple squirrel cage based on the use of the true induced voltage, corresponding to the resultant flux which passes beyond the squirrel cage—Double squirrel cage induction motor	28
20. Relations of voltages and currents in the double squirrel cage induction motor	29
21. Equations, and method of calculation	30
22. Continued: torque and power equation	31
23. Calculation of numerical instance of double squirrel cage motor, speed and load curves—Triple squirrel cage induction motor	32
24. Equation between the voltages and currents in the triple squirrel cage induction motor	34
25. Calculation of voltages and currents	35
26. Equation of torque and power of the three squirrel cages, and their resultant	37
27. Calculation of numerical instance of triple squirrel cage induction motor—Speed and load curves	37

CHAPTER III. CONCATENATION.

Cascade or Tandem Control of Induction Motors

28. Synchronizing of concatenated couple at half synchronism—The two speeds of a couple of equal motors and the three

CONTENTS

ix

	PAGE
speeds of a couple of unequal motors—Internally concatenated motor	40
29. Generator equation of concatenated couple above half synchronism—Second range of motor torque near full synchronism—Generator equation above full synchronism—Inefficiency of second motor speed range—Its suppression by resistance in the secondary of the second motor	41
30. General equation and calculation of speed and slip of concatenated couple	42
31. Calculation of numerical instances	44
32. Calculation of general concatenated couple	45
33. Continued	46
34. Calculation of torque and power of the two motors, and of the couple.	47
35. Numerical instance	48
36. Internally concatenated motor—Continuation of windings into one stator and one rotor winding—Fractional pitch—No interference of magnetic flux required—Limitation of available speed—Hunt motor	49
37. Effect of continuation of two or more motors on the characteristic constant and the performance of the motor.	50

CHAPTER IV. INDUCTION MOTOR WITH SECONDARY EXCITATION.

38. Large exciting current and low power factor of low speed induction motors and motors of high overload capacity—Instance	52
39. Induction machine corresponding to synchronous machine excited by armature reaction, induction machine secondary corresponding to synchronous machine field—Methods of secondary excitation: direct current, commutator, synchronous machine, commutating machine, condenser	53
40. Discussion of the effect of the various methods of secondary excitation on the speed characteristic of the induction motor	55

Induction Motor Converted to Synchronous

41. Conversion of induction to synchronous motor—Relation of exciting admittance and self-inductive impedance as induction motor, to synchronous impedance and coreless as synchronous motor—Danielson motor	57
42. Fundamental equation of synchronous motor—Condition of unity power factor—Condition of constant field excitation	60
43. Equations of power input and output, and efficiency	61
44. Numerical instance of standard induction motor converted to synchronous—Load curves at unity power factor excitation and at constant excitation	62
45. Numerical instance of low speed high excitation induction motor converted to synchronous motor—Load curves at unity	

	PAGE
power factor and at constant field excitation—Comparison with induction motor	67
46. Comparison of induction motor and synchronous motor regarding armature reaction and synchronous impedance—Poor induction motor makes good, and good induction motor makes poor synchronous motor	69

Induction Motor Concatenated with Synchronous

47. Synchronous characteristic and synchronizing speed of concatenated couple—Division of load between machines—The synchronous machine as small exciter	71
48. Equation of concatenated couple of synchronous and induction motor—Reduction to standard synchronous motor equation	72
49. Equation of power output and input of concatenated couple	74
50. Calculation of numerical instance of 56 polar high excitation induction motor concatenated to 4 polar synchronous	75
51. Discussion. High power factor at all loads, at constant synchronous motor excitation	76

Induction Motor Concatenated with Commutating Machine

52. Concatenated couple with commutating machine asynchronous—Series and shunt excitation—Phase relation adjustable—Speed control and power factor control—Two independent variables with concatenated commutating machine, against one with synchronous machine—Therefore greater variety of speed and load curves	78
53. Representation of the commutating machine by an effective impedance, in which both components may be positive or negative, depending on position of commutator brushes	80
54. Calculation of numerical instance, with commutating machine series excited for reactive anti-inductive voltage—Load curves and their discussion	82

Induction Motor with Condenser in Secondary Circuit

55. Shunted capacity neutralizing lagging current of induction motor—Numerical instance—Effect of wave shape distortion—Condenser in tertiary circuit of single-phase induction motor—Condensers in secondary circuit—Large amount of capacity required by low frequency	84
56. Numerical instance of low speed high excitation induction motor with capacity in secondary—Discussion of load curves and of speed	86
57. Comparison of different methods of secondary excitation, by power factor curves: low at all loads; high at all loads, low at light, high at heavy loads—By speed: synchronous or constant speed motors and asynchronous motors in which the speed decreases with increasing load	88

CONTENTS

xi

Induction Motor with Commutator

	PAGE
58. Wave shape of commutated full frequency current in induction motor secondary—Its low frequency component—Full frequency reactance for rotor winding—The two independent variables: voltage and phase—Speed control and power factor correction, depending on brush position	89
59. Squirrel cage winding combined with commutated winding—Heyland motor—Available only for power factor control—Its limitation	91

CHAPTER V. SINGLE-PHASE INDUCTION MOTOR.

60. Quadrature magnetic flux of single-phase induction motor produced by armature currents—The torque produced by it—The exciting ampere-turns and their change between synchronism and standstill.	93
61. Relations between constants per circuit, and constants of the total polyphase motor—Relation thereto of the constants of the motor on single-phase supply—Derivation of the single-phase motor constants from those of the motor as three-phase or quarter-phase motor.	94
62. Calculation of performance curves of single-phase induction motor—Torque and power	96
63. The different methods of starting single-phase induction motors—Phase splitting devices; inductive devices; monocyclic devices; phase converter	96
64. Equations of the starting torque, starting torque ratio, volt-ampere ratio and apparent starting torque efficiency of the single-phase induction motor starting device	98
65. The constants of the single-phase induction motor with starting device.	100
66. The effective starting impedance of the single-phase induction motor—Its approximation—Numerical instance	101
67. Phase splitting devices—Series impedances with parallel connections of the two circuits of a quarter-phase motor—Equations	103
68. Numerical instance of resistance in one motor circuit, with motor of high and of low resistance armature	104
69. Capacity and inductance as starting device—Calculation of values to give true quarter-phase relation	106
70. Numerical instance, applied to motor of low, and of high armature resistance	108
71. Series connection of motor circuits with shunted impedance—Equations, calculations of conditions of maximum torque ratio—Numerical instance	109
72. Inductive devices—External inductive devices—Internal inductive devices	111
73. Shading coil—Calculations of voltage ratio and phase angle	112

	PAGE
74. Calculations of voltages, torque, torque ratio and efficiency . . .	114
75. Numerical instance of shading coil of low, medium and high resistances, with motors of low, medium and high armature resistance	116
76. Monocyclic starting device—Applied to three-phase motor—Equations of voltages, currents, torque, and torque efficiency . . .	117
77. Instance of resistance inductance starting device, of condenser motor, and of production of balanced three-phase triangle by capacity and inductance	120
78. Numerical instance of motor with low resistance, and with high resistance armature—Discussion of acceleration	121

CHAPTER VI. INDUCTION MOTOR REGULATION AND STABILITY.

1. *Voltage Regulation and Output*

79. Effect of the voltage drop in the line and transformer impedance on the motor—Calculation of motor curves as affected by line impedance, at low, medium and high line impedance . . .	123
80. Load curves and speed curves—Decrease of maximum torque and of power factor by line impedance—Increase of exciting current and decrease of starting torque—Increase of resistance required for maximum starting torque.	126

2. *Frequency Pulsation*

81. Effect of frequency pulsation—Slight decrease of maximum torque—Great increase of current at light load	131
---	-----

3. *Load and Stability*

82. The two motor speed at constant torque load—One unstable and one stable point—Instability of motor, on constant torque load, below maximum torque point	132
83. Stability at all speeds, at load requiring torque proportional to square of speed: ship propellor, centrifugal pump—Three speeds at load requiring torque proportional to speed—Two stable and one unstable speed—The two stable and one unstable branch of the speed curve on torque proportional to speed	134
84. Motor stability function of the character of the load—General conditions of stability and instability—Single-phase motor . . .	136

4. *Generator Regulation and Stability*

85. Effect of the speed of generator regulation on maximum output of induction motor, at constant voltage—Stability coefficient of motor—Instance	137
---	-----

CONTENTS

xiii

	PAGE
86. Relation of motor torque curve to voltage regulation of system—Regulation coefficient of system—Stability coefficient of system	138
87. Effect of momentum on the stability of the motor—Regulation of overload capacity—Gradual approach to instability	141

CHAPTER VII. HIGHER HARMONICS IN INDUCTION MOTORS.

88. Component torque curves due to the higher harmonics of the impressed voltage wave, in a quarter-phase induction motor; their synchronous speed and their direction, and the resultant torque curve	144
89. The component torque curves due to the higher harmonics of the impressed voltage wave, in a three-phase induction motor—True three-phase and six-phase winding—The single-phase torque curve of the third harmonic	147
90. Component torque curves of normal frequency, but higher number of poles, due to the harmonics of the space distribution of the winding in the air-gap of a quarter-phase motor—Their direction and synchronous speeds	150
91. The same in a three-phase motor—Discussion of the torque components due to the time harmonics of higher frequency and normal number of poles, and the space harmonics of normal frequency and higher number of poles	154
92. Calculation of the coefficients of the trigonometric series representing the space distribution of quarter-phase, six-phase and three-phase, full pitch and fractional pitch windings	155
93. Calculation of numerical values for 0, $\frac{1}{6}$, $\frac{1}{3}$, $\frac{1}{2}$ pitch deficiency, up to the 21st harmonic	157

CHAPTER VII. SYNCHRONIZING INDUCTION MOTORS.

94. Synchronizing induction motors when using common secondary resistance	159
95. Equation of motor torque, total torque and synchronizing torque of two induction motors with common secondary rheostat	160
96. Discussion of equations—Stable and unstable position—Maximum synchronizing power at 45° phase angle—Numerical instance	163

CHAPTER IX. SYNCHRONOUS INDUCTION MOTOR.

97. Tendency to drop into synchronism, of single circuit induction motor secondary—Motor or generator action at synchronism—Motor acting as periodically varying reactance, that is, as reaction machine—Low power factor—Pulsating torque below synchronism, due to induction motor and reaction machine torque superposition	166
--	-----

CHAPTER X. HYSTERESIS MOTOR.

	PAGE
98. Rotation of iron disc in rotating magnetic field—Equations— Motor below, generator above synchronism	168
99. Derivation of equations from hysteresis law—Hysteresis torque of standard induction motor, and relation to size	169
100. General discussion of hysteresis motor—Hysteresis loop collapsing or expanding	170

CHAPTER XI. ROTARY TERMINAL SINGLE-PHASE INDUCTION MOTORS.

101. Performance and method of operation of rotary terminal single-phase induction Motor—Relation of motor speed to brush speed and slip corresponding to the load	172
102. Application of the principle to a self-starting single-phase power motor with high starting and accelerating torque, by auxiliary motor carrying brushes	173

CHAPTER XII. FREQUENCY CONVERTER OR GENERAL ALTERNATING
CURRENT TRANSFORMER.

103. The principle of the frequency converter or general alternating current transformer—Induction motor and transformer special cases—Simultaneous transformation between primary elec- trical and secondary electrical power, and between electrical and mechanical power—Transformation of voltage and of fre- quency—The air-gap and its effect	176
104. Relation of e.m.f., frequency, number of turns and exciting current	177
105. Derivation of the general alternating current transformer— Transformer equations and induction motor equations, special cases thereof	178
106. Equation of power of general alternating current transformer .	182
107. Discussion: between synchronism and standstill—Backward driving—Beyond synchronism—Relation between primary electrical, secondary electrical and mechanical power	184
108. Calculation of numerical instance	185
109. The characteristic curves: regulation curve, compounding curve—Connection of frequency converter with synchronous machine, and compensation for lagging current—Derivation of equation and numerical instance	186
110. Over-synchronous operation—Two applications, as double synchronous generator, and as induction generator with low frequency exciter	190
111. Use as frequency converter—Use of synchronous machine or induction machine as second machine—Slip of frequency— Advantage of frequency converter over motor generator	191
112. Use of frequency converter—Motor converter, its advantages and disadvantages—Concatenation for multispeed operation . .	192

CONTENTS

xv

CHAPTER XIII. SYNCHRONOUS INDUCTION GENERATOR.

	PAGE
113. Induction machine as asynchronous motor and asynchronous generator	194
114. Excitation of induction machine by constant low frequency voltage in secondary—Operation below synchronism, and above synchronism	195
115. Frequency and power relation—Frequency converter and synchronous induction generator.	196
116. Generation of two different frequencies, by stator and by rotor. 198	
117. Power relation of the two frequencies—Equality of stator and rotor frequency: double synchronous generator—Low rotor frequency: induction generator with low frequency exciter, Stanley induction generator	198
118. Connection of rotor to stator by commutator—Relation of frequencies and powers to ratio of number of turns of stator and rotor	199
119. Double synchronous alternator—General equation—Its armature reaction	201
120. Synchronous induction generator with low frequency excitation—(a) Stator and rotor fields revolving in opposite direction—(b) In the same direction—Equations	203
121. Calculation of instance, and regulation of synchronous induction generator with oppositely revolving fields	204
122. Synchronous induction generator with stator and rotor fields revolving in the same direction—Automatic compounding and over-compounding, on non-inductive load—Effect of inductive load	205
123. Equations of synchronous induction generator with fields revolving in the same direction.	207
124. Calculation of numerical instance	209

CHAPTER XIV. PHASE CONVERSION AND SINGLE-PHASE GENERATION.

125. Conversion between single-phase and polyphase requires energy storage—Capacity, inductance and momentum for energy storage—Their size and cost per Kva	212
126. Industrial importance of phase conversion from single-phase to polyphase, and from balanced polyphase to single-phase	213
127. Monocyclic devices—Definition of monocyclic as a system of polyphase voltages with essentially single-phase flow of energy—Relativity of the term—The monocyclic triangle for single-phase motor starting	214
128. General equations of the monocyclic square	216
129. Resistance—inductance monocyclic square—Numerical instance on inductive and on non-inductive load—Discussion	218
130. Induction phase converter—Reduction of the device to the simplified diagram of a double transformation	220
131. General equation of the induction phase converter	222

	PAGE
132. Numerical instance—Inductive load—Discussion and comparisons with monocyclic square	223
133. Series connection of induction phase converter in single-phase induction motor railway—Discussion of its regulation	226
134. Synchronous phase converter and single-phase generation—Control of the unbalancing of voltage due to single-phase load, by stationary induction phase balancing with reverse rotation of its polyphase system—Synchronous phase balancer.	227
135. Limitation of single-phase generator by heating of armature coils—By double frequency pulsation of armature reaction—Use of squirrel cage winding in field—Its size—Its effect on the momentary short circuit current	229
136. Limitation of the phase converter in distributing single-phase load into a balanced polyphase system—Solution of the problem by the addition of a synchronous phase balancer to the synchronous phase converter—Its construction	230
137. The various methods of taking care of large single-phase loads—Comparison of single-phase generator with polyphase generator and phase converter—Apparatus economy	232

CHAPTER XV. SYNCHRONOUS RECTIFIERS.

138. Rectifiers for battery charging—For arc lighting—The arc machine as rectifier—Rectifiers for compounding alternators—For starting synchronous motors—Rectifying commutator—Differential current and sparking on inductive load—Resistance bypass—Application to alternator and synchronous motor	234
139. Open circuit and short circuit rectification—Sparking with open circuit rectification on inductive load, and shift of brushes	237
140. Short circuit rectification on non-inductive and on inductive load, and shift of brushes—Rising differential current and flashing around the commutator—Stability limit of brush position, between sparking and flashing—Commutating e.m.f. resulting from unsymmetrical short circuit voltage at brush shift—Sparkless rectification	239
141. Short circuit commutation in high inductance, open circuit commutation in low inductance circuits—Use of double brush to vary short circuit—Effect of load—Thomson Houston arc machine—Brush arc machine—Storage battery charging	243
142. Reversing and contact making rectifier—Half wave rectifier and its disadvantage by unidirectional magnetization of transformer—The two connections full wave contact making rectifiers—Discussion of the two types of full wave rectifiers—The mercury arc rectifier	245
143. Rectifier with intermediary segments—Polyphase rectification—Star connected, ring connected and independent phase	

CONTENTS

xvii

	PAGE
rectifiers—Y connected three-phase rectifier—Delta connected three-phase rectifier—Star connected quarter-phase rectifier—Quarter-phase rectifier with independent phases—Ring connected quarter-phase rectifier—Wave shapes and their discussion—Six-phase rectifier	250
144. Ring connection or independent phases preferable with a large number of phases—Thomson Houston arc machine as constant current alternator with three-phase star connected rectifier—Brush arc machine as constant current alternator with quarter-phase rectifiers in series connection	254
145. Counter e.m.f. shunt at gaps of polyphase ring connected rectifier—Derivation of counter e.m.f. from synchronous motor—Leblanc's Panchahuteur—Increase of rectifier output with increasing number of phases	255
146. Discussion: stationary rectifying commutator with revolving brushes—Permutator—Rectifier with revolving transformer—Use of synchronous motor for phase splitting in feeding rectifying commutator: synchronous converter—Conclusion	257

CHAPTER XVI. REACTION MACHINES.

147. Synchronous machines operating without field excitation	260
148. Operation of synchronous motor without field excitation depending on phase angle between resultant m.m.f. and magnetic flux, caused by polar field structure—Energy component of reactance	261
149. Magnetic hysteresis as instance giving energy component of reactance, as effective hysteretic resistance	262
150. Make and break of magnetic circuit—Types of reaction machines—Synchronous induction motor—Reaction machine as converter from d.-c. to a.-c.	263
151. Wave shape distortion in reaction machine, due to variable reactance, and corresponding hysteresis cycles	264
152. Condition of generator and of motor action of the reactance machine, as function of the current phase	267
153. Calculation of reaction machine equation—Power factor and maximum power	268
154. Current, power and power factor—Numerical instance	271
155. Discussion—Structural similarity with inductor machine	272

CHAPTER XVII. INDUCTOR MACHINES.

156. Description of inductor machine type—Induction by pulsating unidirectional magnetic flux	274
157. Advantages and disadvantages of inductor type, with regards to field and to armature	275
158. The magnetic circuit of the inductor machine, calculation of magnetic flux and hysteresis loss	276

	PAGE
159. The Stanley type of inductor alternator—The Alexanderson high frequency inductor alternator for frequencies of 100,000 cycles and over	279
160. The Eickemeyer type of inductor machine with bipolar field—The converter from direct current to high frequency alternating current of the inductor type	280
161. Alternating current excitation of inductor machine, and high frequency generation of pulsating amplitude. Its use as amplifier—Amplification of telephone currents by high frequency inductor in radio communication	281
162. Polyphase excitation of inductor, and the induction motor inductor frequency converter.	282
163. Inductor machine with reversing flux, and magneto communication—Transformer potential regulator with magnetic commutation	284
164. The interlocking pole type of field design in alternators and commutating machines	286
165. Relation of inductor machine to reaction machine—Half synchronous operation of standard synchronous machine as inductor machine	287
 CHAPTER XVIII. SURGING OF SYNCHRONOUS MOTORS.	
166. Oscillatory adjustment of synchronous motor to changed condition of load—Decrement of oscillation—Cumulative oscillation by negative decrement.	288
167. Calculation of equation of electromechanical resonance	289
168. Special cases and example	292
169. Anti-surging devices and pulsation of power	293
170. Cumulative surging—Due to the lag of some effect behind its cause—Involving a frequency transformation of power	296
 CHAPTER XIX. ALTERNATING CURRENT MOTORS IN GENERAL.	
171. Types of alternating-current motors.	300
172. Equations of coil revolving in an alternating field.	302
173. General equations of alternating-current motor.	304
174. Polyphase induction motor, equations.	307
175. Polyphase induction motor, slip, power, torque.	310
176. Polyphase induction motor, characteristic constants	312
177. Polyphase induction motor, example	313
178. Singlephase induction motor, equations	314
179. Singlephase induction motor, continued	316
180. Singlephase induction motor, example.	318
181. Polyphase shunt motor, general	319
182. Polyphase shunt motor, equations	320
183. Polyphase shunt motor, adjustable speed motor	321
184. Polyphase shunt motor, synchronous speed motor	323
185. Polyphase shunt motor, phase control by it	324
186. Polyphase shunt motor, short-circuit current under brushes	327
187. Polyphase series motor, equations	327
188. Polyphase series motor, example	330

CONTENTS

xix

CHAPTER XX. SINGLE-PHASE COMMUTATOR MOTORS.

	PAGE
189. General: proportioning of parts of a.-c. commutator motor different from d.-c.	331
190. Power factor: low field flux and high armature reaction required—Compensating winding necessary to reduce armature self-induction	332
191. The three circuits of the single-phase commutator motor—Compensation and over-compensation—Inductive compensation—Possible power factors	336
192. Field winding and compensating winding: massed field winding and distributed compensating winding—Under-compensation at brushes, due to incomplete distribution of compensating winding.	338
193. Fractional pitch armature winding to secure complete local compensation—Thomson's repulsion motor—Eickemeyer inductively compensated series motor	339
194. Types of varying speed single-phase commutator motors: conductive and inductive compensation; primary and secondary excitation; series and repulsion motors—Winter—Eichberg—Latour motor—Motor control by voltage variation and by change of type	341
195. The quadrature magnetic flux and its values and phases in the different motor types	345
196. Commutation: e.m.f. of rotation and e.m.f. of alternation—Polyphase system of voltages—Effect of speed	347
197. Commutation determined by value and phase of short circuit current—High brush contact resistance and narrow brushes	349
198. Commutator leads—Advantages and disadvantages of resistance leads in running and in starting	351
199. Counter e.m.f. in commutated coil: partial, but not complete neutralization possible	354
200. Commutating field—Its required intensity and phase relations: quadrature field	356
201. Local commutating pole—Neutralizing component and reversing component of commutating field—Discussion of motor types regarding commutation	358
202. Motor characteristics: calculation of motor—Equation of current, torque, power	361
203. Speed curves and current curves of motor—Numerical instance—Hysteresis loss increases, short circuit current decreases power factor	364
204. Increase of power factor by lagging field magnetism, by resistance shunt across field	366
205. Compensation for phase displacement and control of power factor by alternating current commutator motor with lagging field flux, as effective capacity—Its use in induction motors and other apparatus	370
206. Efficiency and losses: the two kinds of core loss	370

	PAGE
207. Discussion of motor types: compensated series motors: conductive and inductive compensation—Their relative advantages and disadvantages	371
208. Repulsion motors: lagging quadrature flux—Not adapted to speeds much above synchronism—Combination type: series repulsion motor	373
209. Constructive differences—Possibility of changing from type to type, with change of speed or load	375
210. Other commutator motors: shunt motor—Adjustable speed polyphase induction motor—Power factor compensation: Heyland motor—Winter-Eichberg motor	377
211. Most general form of single-phase commutator motor, with two stator and two rotor circuits and two brush short circuits	381
212. General equation of motor	382
213. Their application to the different types of single-phase motor with series characteristic	383
214. Repulsion motor: Equations	385
215. Continued	388
216. Discussion of commutation current and commutation factor	391
217. Repulsion motor and repulsion generator	394
218. Numerical instance	395
219. Series repulsion motor: equations	397
220. Continued	398
221. Study of commutation—Short circuit current under brushes	403
222. Commutation current	404
223. Effect of voltage ratio and phase, on commutation	406
224. Condition of vanishing commutation current	408
225. Numerical example	411
226. Comparison of repulsion motor and various series repulsion motor	414
227. Further example—Commutation factors	415
228. Over-compensation—Equations	418
229. Limitation of preceding discussion—Effect and importance of transient in short circuit current	419

CHAPTER XXI. REGULATING POLE CONVERTER.

230. Change of converter ratio by changing position angle between brushes and magnetic flux, and by change of wave shape	422
A. Variable ratio by change of position angle between commutator brushes and resultant magnetic flux	422
231. Decrease of a.-c. voltage by shifting the brushes—By shifting the magnetic flux—Electrical shifting of the magnetic flux by varying the excitation of the several sections of the field pole	422
232. Armature reaction and commutation—Calculation of the resultant armature reaction of the converter with shifted magnetic flux	426
233. The two directions of shift flux, the one spoiling, the other	

CONTENTS

xxi

	PAGE
improving commutation—Demagnetizing armature reaction and need of compounding by series field	429
<i>B.</i> Variable ratio by change of the wave shape of the Y voltage	429
234. Increase and decrease of d.-c. voltage by increase or decrease of maximum a.-c. voltage by higher harmonic—Illustration by third and fifth harmonic	430
235. Use of the third harmonic in the three-phase system—Transformer connection required to limit it to the local converter circuit—Calculation of converter wave as function of the pole arc	432
236. Calculation of converter wave resulting from reversal of middle of pole arc	435
237. Discussion	436
238. Armature reaction and commutation—Proportionality of resultant armature reaction to deviation of voltage ratio from normal	437
239. Commutating flux of armature reaction of high a.-c. voltage—Combination of both converter types, the wave shape distortion for raising, the flux shift for lowering the a.-c. voltage—Use of two pole section, the main pole and the regulating pole	437
240. Heating and rating—Relation of currents and voltages in standard converter	439
241. Calculation of the voltages and currents in the regulating pole converter	440
242. Calculating of differential current, and of relative heating of armature coil	442
243. Average armature heating of n phase converter	444
244. Armature heating and rating of three-phase and of six-phase regulating pole converter	445
245. Calculation of phase angle giving minimum heating or maximum rating	446
246. Discussion of conditions giving minimum heating—Design—Numerical instance	448

CHAPTER XXII. UNIPOLAR MACHINES.

Homopolar Machines—Acyclic Machines

247. Principle of unipolar, homopolar or acyclic machine—The problem of high speed current collection—Fallacy of unipolar induction in stationary conductor—Immaterial whether magnet standstill or revolves—The conception of lines of magnetic force	450
248. Impossibility of the coil wound unipolar machine—All electromagnetic induction in turn must be alternating—Illustration of unipolar induction by motion on circular track	452
249. Discussion of unipolar machine design—Drum type and disc type—Auxiliary air-gap—Double structure—Series connection of conductors with separate pairs of collector rings	454

	PAGE
250. Unipolar machine adapted for low voltage, or for large size high speed machines—Theoretical absence of core loss—Possibility of large core loss by eddies, in core and in collector rings, by pulsating armature reaction	456
251. Circular magnetization produced by armature reaction—Liability to magnetic saturation and poor voltage regulation—Compensating winding—Most serious problem the high speed collector rings	457
252. Description of unipolar motor meter	458
 CHAPTER XXIII. REVIEW.	
253. Alphabetical list of machines: name, definition, principal characteristics, advantages and disadvantages	459
 CHAPTER XXIV. CONCLUSION.	
254. Little used and unused types of apparatus—Their knowledge important due to the possibility of becoming of great industrial importance—Illustration by commutating pole machine	472
255. Change of industrial condition may make new machine types important—Example of induction generator for collecting numerous small water powers	473
256. Relative importance of standard types and of special types of machines	474
257. Classification of machine types into induction, synchronous, commutating and unipolar machines—Machine belonging to two and even three types	474
 INDEX	 477

THEORY AND CALCULATION OF ELECTRICAL APPARATUS

CHAPTER I .

SPEED CONTROL OF INDUCTION MOTORS

I. STARTING AND ACCELERATION

1. Speed control of induction motors deals with two problems: to produce a high torque over a wide range of speed down to standstill, for starting and acceleration; and to produce an approximately constant speed for a wide range of load, for constant-speed operation.

In its characteristics, the induction motor is a shunt motor, that is, it runs at approximately constant speed for all loads, and this speed is synchronism at no-load. At speeds below full speed, and at standstill, the torque of the motor is low and the current high, that is, the starting-torque efficiency and especially the apparent starting-torque efficiency are low.

Where starting with considerable load, and without excessive current, is necessary, the induction motor thus requires the use of a resistance in the armature or secondary, just as the direct-current shunt motor, and this resistance must be a rheostat, that is, variable, so as to have maximum resistance in starting, and gradually, or at least in a number of successive steps, cut out the resistance during acceleration.

This, however, requires a wound secondary, and the squirrel-cage type of rotor, which is the simplest, most reliable and therefore most generally used, is not adapted for the use of a starting rheostat. With the squirrel-cage type of induction motor, starting thus is usually done—and always with large motors—by lowering the impressed voltage by autotransformer, often in a number of successive steps. This reduces the starting current, but correspondingly reduces the starting torque, as it does not change the apparent starting-torque efficiency.

The higher the rotor resistance, the greater is the starting torque, and the less, therefore, the starting current required for

a given torque when starting by autotransformer. However, high rotor resistance means lower efficiency and poorer speed regulation, and this limits the economically permissible resistance in the rotor or secondary.

Discussion of the starting of the induction motor by armature rheostat, and of the various speed-torque curves produced by various values of starting resistance in the induction-motor secondary, are given in "Theory and Calculation of Alternating-current Phenomena" and in "Theoretical Elements of Electrical Engineering."

As seen, in the induction motor, the (effective) secondary resistance should be as low as possible at full speed, but should be high at standstill—very high compared to the full-speed value—and gradually decrease during acceleration, to maintain constant high torque from standstill to speed. To avoid the inconvenience and complication of operating a starting rheostat, various devices have been proposed and to some extent used, to produce a resistance, which automatically increases with increasing slip, and thus is low at full speed, and higher at standstill.

A. Temperature Starting Device

2. A resistance material of high positive temperature coefficient of resistance, such as iron and other pure metals, operated at high temperature, gives this effect to a considerable extent: with increasing slip, that is, decreasing speed of the motor, the secondary current increases. If the dimensions of the secondary resistance are chosen so that it rises considerably in temperature, by the increase of secondary current, the temperature and therewith the resistance increases.

Approximately, the temperature rise, and thus the resistance rise of the secondary resistance, may be considered as proportional to the square of the secondary-current, i_1 , that is, represented by:

$$r = r^0 (1 + ai_1^2). \quad (1)$$

As illustration, consider a typical induction motor, of the constants:

$$\begin{aligned} e_0 &= 110; \\ Y_0 &= g - jb = 0.01 - 0.1j; \\ Z_0 &= r_0 + jx_0 = 0.1 + 0.3j; \\ Z_1 &= r_1 + jx_1 = 0.1 + 0.3j; \end{aligned}$$

the speed-torque curve of this motor is shown as *A* in Fig. 1.

Suppose now a resistance, r , is inserted in series into the secondary circuit, which when cold—that is, at light-load—equals the internal secondary resistance:

$$r^0 = r_1 = 0.1,$$

but increases so as to double with 100 amp. passing through it. This resistance can then be represented by:

$$\begin{aligned} r &= r^0 (1 + i_1^2 10^{-4}) \\ &= 0.1 (1 + i_1^2 10^{-4}), \end{aligned}$$

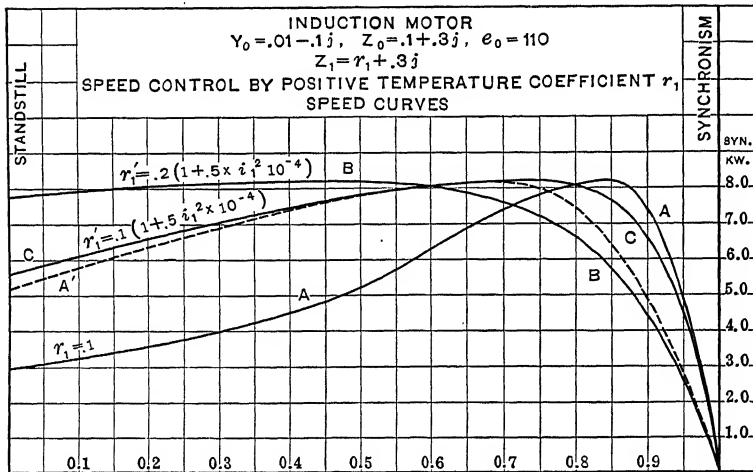

FIG. 1.—High-starting and acceleration torque of induction motor by positive temperature coefficient of secondary resistance.

and the total secondary resistance of the motor then is:

$$\begin{aligned} r'_1 &= r_1 + r_0 (1 + a i_1^2) \\ &= 0.2 (1 + 0.5 i_1^2 10^{-4}). \end{aligned} \tag{2}$$

To calculate the motor characteristics for this varying resistance, r'_1 , we use the feature, that a change of the secondary resistance of the induction motor changes the slip, s , in proportion to the change of resistance, but leaves the torque, current, power-factor, torque efficiency, etc., unchanged, as shown on page 322 of "Theoretical Elements of Electrical Engineering." We thus calculate the motor for constant secondary resistance, r_1 , but otherwise the same constants, in the manner discussed on page 318 of "Theoretical Elements of Electrical Engineering."

This gives curve *A* of Fig. 1. At any value of torque, *T*, corresponding to slip, *s*, the secondary current is:

$$i_1 = e \sqrt{a_1^2 + a_2^2},$$

herefrom follows by (2) the value of r'_1 , and from this the new value of slip:

$$s' \div s = r'_1 \div r_1. \quad (3)$$

The torque, *T*, then is plotted against the value of slip, *s'*, and gives curve *B* of Fig. 1. As seen, *B* gives practically constant torque over the entire range from near full speed, to standstill.

Curve *B* has twice the slip at load, as *A*, as its resistance has been doubled.

3. Assuming, now, that the internal resistance, r_1 , were made as low as possible, $r_1 = 0.05$, and the rest added as external resistance of high temperature coefficient: $r^0 = 0.05$, giving the total resistance:

$$r'_1 = 0.1 (1 + 0.5 i_1^2 10^{-4}). \quad (4)$$

This gives the same resistance as curve *A*: $r'_1 = 0.1$, at light-load, where i_1 is small and the external part of the resistance cold. But with increasing load the resistance, r'_1 , increases, and the motor gives the curve shown as *C* in Fig. 1.

As seen, curve *C* is the same near synchronism as *A*, but in starting gives twice as much torque as *A*, due to the increased resistance.

C and *A* thus are directly comparable: both have the same constants and same speed regulation and other performance at speed, but *C* gives much higher torque at standstill and during acceleration.

For comparison, curve *A'* has been plotted with constant resistance $r_1 = 0.2$, so as to compare with *B*.

Instead of inserting an external resistance, it would be preferable to use the internal resistance of the squirrel cage, to increase in value by temperature rise, and thereby improve the starting torque.

Considering in this respect the motor shown as curve *C*. At standstill, it is: $i_1 = 153$; thus $r'_1 = 0.217$; while cold, the resistance is: $r'_1 = 0.1$. This represents a resistance rise of 117 per cent. At a temperature coefficient of the resistance of 0.35, this represents a maximum temperature rise of 335°C. As seen,

by going to temperature of about 350°C. in the rotor conductors—which naturally would require fireproof construction—it becomes possible to convert curve *A* into *C*, or *A'* into *B*, in Fig. 1.

Probably, the high temperature would be permissible only in the end connections, or the squirrel-cage end ring, but then, iron could be used as resistance material, which has a materially higher temperature coefficient, and the required temperature rise thus would probably be no higher.

B. Hysteresis Starting Device

4. Instead of increasing the secondary resistance with increasing slip, to get high torque at low speeds, the same result can be produced by the use of an effective resistance, such as the effective or equivalent resistance of hysteresis, or of eddy currents.

As the frequency of the secondary current varies, a magnetic circuit energized by the secondary current operates at the varying frequency of the slip, *s*.

At a given current, i_1 , the voltage required to send the current through the magnetic circuit is proportional to the frequency, that is, to *s*. Hence, the susceptance is inverse proportional to *s*:

$$b' = \frac{b}{s} \quad (5)$$

The angle of hysteretic advance of phase, α , and the power-factor, in a closed magnetic circuit, are independent of the frequency, and vary relatively little with the magnetic density and thus the current, over a wide range,¹ thus may approximately be assumed as constant. That is, the hysteretic conductance is proportional to the susceptance:

$$g' = b' \tan \alpha. \quad (6)$$

Thus, the exciting admittance, of a closed magnetic circuit of negligible resistance and negligible eddy-current losses, at the frequency of slip, *s*, is given by:

$$\begin{aligned} Y' &= g' - jb' = b' (\tan \alpha - j) \\ &= \frac{g}{s} - j \frac{b}{s} = \frac{b}{s} (\tan \alpha - j) \end{aligned} \quad (7)$$

¹ "Theory and Calculation of Alternating-current Phenomena," Chapter XII.

Assuming $\tan \alpha = 0.6$, which is a fair value for a closed magnetic circuit of high hysteresis loss, it is:

$$Y' = \frac{b}{s} (0.6 - j),$$

the exciting admittance at slip, s .

Assume then, that such an admittance, Y' , is connected in series into the secondary circuit of the induction motor, for the purpose of using the effective resistance of hysteresis, which increases with the frequency, to control the motor torque curve.

The total secondary impedance then is:

$$\begin{aligned} Z'_1 &= Z_1 + \frac{1}{Y'} \\ &= \left(r_1 + \frac{gs}{y^2} \right) + js \left(x_1 + \frac{b}{y^2} \right), \end{aligned} \quad (8)$$

where: $Y = g - jb$ is the admittance of the magnetic circuit at full frequency, and

$$y = \sqrt{g^2 + b^2}.$$

5. For illustration, assume that in the induction motor of the constants:

$$\begin{aligned} e_0 &= 100; \\ Y_0 &= 0.02 - 0.2j; \\ Z_0 &= 0.05 + 0.15j; \\ Z_1 &= 0.05 + 0.15j; \end{aligned}$$

a closed magnetic circuit is connected into the secondary, of full frequency admittance,

$$Y = g - jb;$$

and assume:

$$\begin{aligned} g &= 0.6b; \\ b &= 4; \end{aligned}$$

thus, by (8):

$$Z'_1 = (0.05 + 0.11s) + 0.335js. \quad (9)$$

The characteristic curves of this induction motor with hysteresis starting device can now be calculated in the usual manner, differing from the standard motor only in that Z_1 is not constant, and the proper value of r_1 , x_1 and m has to be used for every slip, s .

Fig. 2 gives the speed-torque curve, and Fig. 3 the load curves of this motor.

For comparison is shown, as T' , in dotted lines, the torque curve of the motor of constant secondary resistance, and of the constants:

$$\begin{aligned}
 Y_0 &= 0.01 - 0.1j; \\
 Z_0 &= 0.01 + 0.3j; \\
 Z_1 &= 0.1 + 0.3j;
 \end{aligned}$$

As seen, the hysteresis starting device gives higher torque at standstill and low speeds, with less slip at full speed, thus a materially superior torque curve.

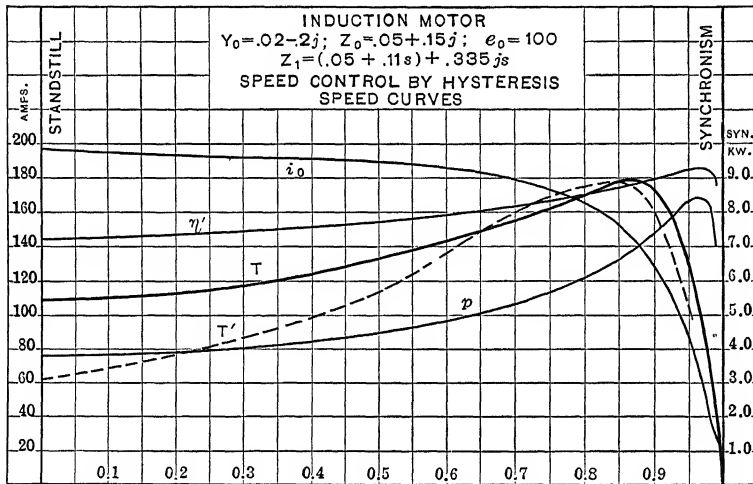

FIG. 2.—Speed curves of induction motor with hysteresis starting device.

p represents the power-factor, η the efficiency, γ the apparent efficiency, η' the torque efficiency and γ' the apparent torque efficiency.

However, T corresponds to a motor of twice the admittance and half the impedance of T' . That is, to get approximately the same output, with the hysteresis device inserted, as without it, requires a rewinding of the motor for higher magnetic density, the same as would be produced in T' by increasing the voltage $\sqrt{2}$ times.

It is interesting to note in comparing Fig. 2 with Fig. 1, that the change in the torque curve at low and medium speed, produced by the hysteresis starting device, is very similar to that produced by temperature rise of the secondary resistance; at

speed, however, the hysteresis device reduces the slip, while the temperature device leaves it unchanged.

The foremost disadvantage of the use of the hysteresis device is the impairment of the power-factor, as seen in Fig. 3 as p .

The introduction of the effective resistance representing the hysteresis of necessity introduces a reactance, which is higher than the resistance, and thereby impairs the motor characteristics.

Comparing Fig. 3 with Fig. 176, page 319 of "Theoretical

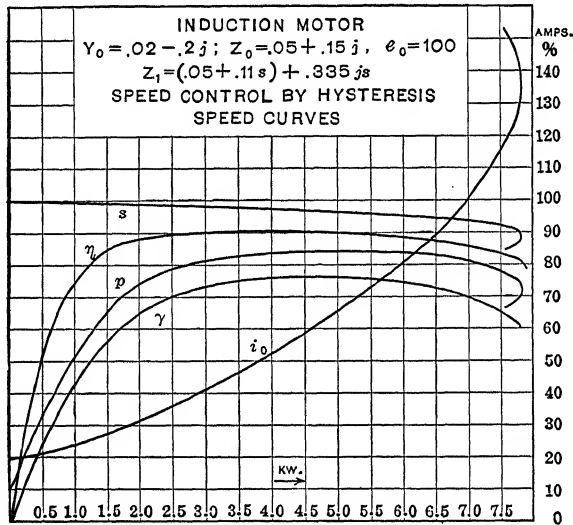

FIG. 3.—Load curves of induction motor with hysteresis starting device.

Elements of Electrical Engineering," which gives the load curves of T' of Fig. 2, it is seen that the hysteresis starting device reduced the maximum power-factor, p , from 91 per cent. to 84 per cent., and the apparent efficiency, γ , correspondingly.

This seriously limits the usefulness of the device.

C. Eddy-current Starting Device

6. Assuming that, instead of using a well-laminated magnetic circuit, and utilizing hysteresis to give the increase of effective resistance with increasing slip, we use a magnetic circuit having very high eddy-current losses: very thick laminations or solid iron, or we directly provide a closed high-resistance secondary winding around the magnetic circuit, which is inserted into the induction-motor secondary for increasing the starting torque.

The susceptance of the magnetic circuit obviously follows the same law as when there are no eddy currents. That is:

$$b' = \frac{b}{s} \quad (10)$$

At a given current, i_1 , energizing the magnetic circuit, the induced voltage, and thus also the voltage producing the eddy currents, is proportional to the frequency. The currents are proportional to the voltage, and the eddy-current losses, therefore, are proportional to the square of the voltage. The eddy-current conductance, g , thus is independent of the frequency.

The admittance of a magnetic circuit consuming energy by eddy currents (and other secondary currents in permanent closed circuits), of negligible hysteresis loss, thus is represented, as function of the slip, by the expression:

$$Y' = g - j \frac{b}{s} \quad (11)$$

Connecting such an admittance in series to the induction-motor secondary, gives the total secondary impedance:

$$\begin{aligned} Z'_1 &= Z_1 + \frac{1}{Y'} \\ &= \left(r_1 + \frac{g}{g^2 + \frac{b^2}{s^2}} \right) + j \left(s x_1 + \frac{b}{s \left(g^2 + \frac{b^2}{s^2} \right)} \right) \end{aligned} \quad (12)$$

Assuming:

$$g = b. \quad (13)$$

That is, 45° phase angle of the exciting circuit of the magnetic circuit at full frequency—which corresponds to complete screening of the center of the magnet core—we get:

$$Z'_1 = \left(r_1 + \frac{s^2}{b(1+s^2)} \right) + js \left(x_1 + \frac{1}{b(1+s^2)} \right) \quad (14)$$

Fig. 4 shows the speed curves, and Fig. 5 the load curves, calculated in the standard manner, of a motor with eddy-current starting device in the secondary, of the constants:

$$\begin{aligned} e_0 &= 100; \\ Y_0 &= 0.03 - 0.3 j; \\ Z_0 &= 0.033 + 0.1 j; \\ Z_1 &= 0.033 + 0.1 j; \\ b &= 3; \end{aligned}$$



thus:

$$Z'_1 = \left(0.033 + \frac{0.33 s^2}{1 + s^2}\right) + j \left(0.1 + \frac{0.33}{1 + s^2}\right).$$

7. As seen, the torque curve has a very curious shape: a maximum at 7 per cent. slip, and a second higher maximum at standstill.

The torque efficiency is very high at all speeds, and practically constant at 82 per cent. from standstill to fairly close of full speed, when it increases.

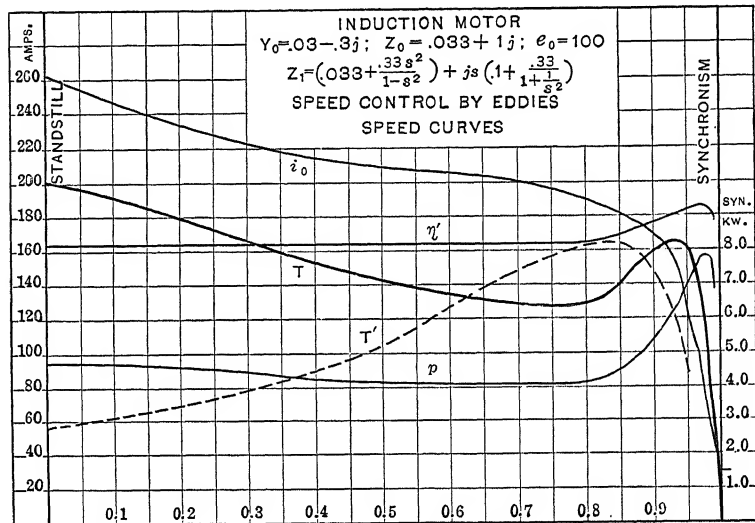

FIG. 4.—Speed curves of induction motor with eddy-current starting device.

But the power-factor is very poor, reaching a maximum of 78 per cent. only, and to get the output from the motor, required rewinding it to give the equivalent of a $\sqrt{3}$ times as high voltage.

For comparison, in dotted lines as T' is shown the torque curves of the standard motor, of same maximum torque. As seen, in the motor with eddy-current starting device, the slip at load is very small, that is, the speed regulation very good. Aside from the poor power-factor, the motor constants would be very satisfactory.

The low power-factor seriously limits the usefulness of the device.

By differently proportioning the eddy-current device to the secondary circuit, obviously the torque curve can be modified

and the starting torque reduced, the depression in the torque curve between full-speed torque and starting torque eliminated, etc.

Instead of using an external magnetic circuit, the magnetic circuit of the rotor or induction-motor secondary may be used, and in this case, instead of relying on eddy currents, a definite secondary circuit could be utilized, in the form of a second squirrel cage embedded deeply in the rotor iron, that is, a double squirrel-cage motor.

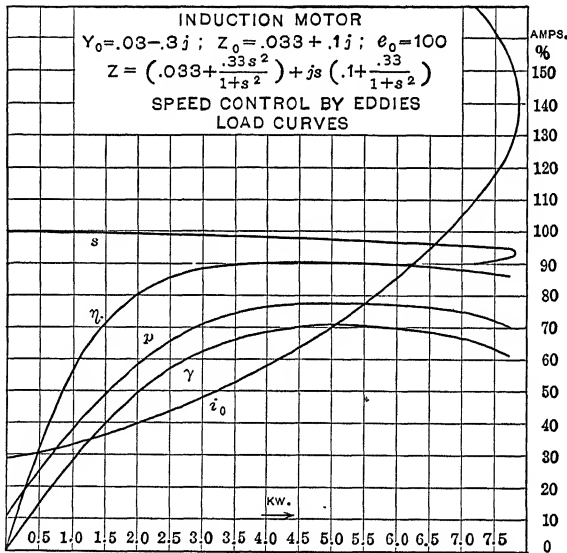

FIG. 5.—Load curves of induction motor with eddy-current starting device.

In the discussion of the multiple squirrel-cage induction motor, Chapter II, we shall see speed-torque curves of the character as shown in Fig. 4. By the use of the rotor iron as magnetic circuit, the impairment of the power-factor is somewhat reduced, so that the multiple squirrel-cage motor becomes industrially important.

A further way of utilizing eddy currents for increasing the effective resistance at low speeds, is by the use of deep rotor bars. By building the rotor with narrow and deep slots filled with solid deep bars, eddy currents in these bars occur at higher frequencies, or unequal current distribution. That is, the current flows practically all through the top of the bars at the high

frequency of low motor speeds, thus meeting with a high resistance. With increasing motor speed and thus decreasing secondary frequency, the current penetrates deeper into the bar, until at full speed it passes practically uniformly throughout the entire bar, in a circuit of low resistance—but somewhat increased reactance.

The deep-bar construction, the eddy-current starting device and the double squirrel-cage construction thus are very similar in the motor-performance curves, and the double squirrel cage, which usually is the most economical arrangement, thus will be discussed more fully in Chapter II.

II. CONSTANT-SPEED OPERATION

8. The standard induction motor is essentially a constant-speed motor, that is, its speed is practically constant for all loads, decreasing slightly with increasing load, from synchronism at no-load. It thus has the same speed characteristics as the direct-current shunt motor, and in principle is a shunt motor.

In the direct-current shunt motor, the speed may be changed by: resistance in the armature, resistance in the field, change of the voltage supply to the armature by a multivolt supply circuit, as a three-wire system, etc.

In the induction motor, the speed can be reduced by inserting resistance into the armature or secondary, just as in the direct-current shunt motor, and involving the same disadvantages: the reduction of speed by armature resistance takes place at a sacrifice of efficiency, and at the lower speed produced by armature resistance, the power input is the same as it would be with the same motor torque at full speed, while the power output is reduced by the reduced speed. That is, speed reduction by armature resistance lowers the efficiency in proportion to the lowering of speed. The foremost disadvantage of speed control by armature resistance is, however, that the motor ceases to be a constant-speed motor, and the speed varies with the load: with a given value of armature resistance, if the load and with it the armature current drops to one-half, the speed reduction of the motor, from full speed, also decreases to one-half, that is, the motor speeds up, and if the load comes off, the motor runs up to practically full speed. Inversely, if the load increases, the speed slows down proportional to the load.

With considerable resistance in the armature, the induction

motor thus has rather series characteristic than shunt characteristic, except that its speed is limited by synchronism.

Series resistance in the armature thus is not suitable to produce steady running at low speeds.

To a considerable extent, this disadvantage of inconstancy of speed can be overcome:

(a) By the use of capacity or effective capacity in the motor secondary, which contracts the range of torque into that of approximate resonance of the capacity with the motor inductance, and thereby gives fairly constant speed, independent of the load, at various speed values determined by the value of the capacity.

(b) By the use of a resistance of very high negative temperature coefficient in the armature, so that with increase of load and current the resistance decreases by its increase of temperature, and thus keeps approximately constant speed over a wide range of load.

Neither of these methods, however, avoids the loss of efficiency incident to the decrease of speed.

9. There is no method of speed variation of the induction motor analogous to field control of the shunt motor, or change of the armature supply voltage by a multivolt supply system. The field excitation of the induction motor is by what may be called armature reaction. That is, the same voltage, impressed upon the motor primary, gives the energy current and the field exciting current, and the field excitation thus can not be varied without varying the energy supply voltage, and inversely. Furthermore, the no-load speed of the induction motor does not depend on voltage or field strength, but is determined by synchronism.

The speed of the induction motor can, however, be changed:

(a) By changing the impressed frequency, or the effective frequency.

(b) By changing the number of poles of the motor.

Neither of these two methods has any analogy in the direct-current shunt motor: the direct-current shunt motor has no frequency relation to speed, and its speed is not determined by the number of poles, nor is it feasible, with the usual construction of direct-current motors, to easily change the number of poles.

In the induction motor, a change of impressed frequency correspondingly changes the synchronous speed. The effect of a change of frequency is brought about by concatenation of the

motor with a second motor, or by internal concatenation of the motor: hereby the effective frequency, which determines the no-load or synchronous speed, becomes the difference between primary and secondary frequency.

Concatenation of induction motors is more fully discussed in Chapter III.

As the no-load or synchronous speed of the induction motor depends on the number of poles, a change of the number of poles changes the motor speed. Thus, if in a 60-cycle induction motor, the number of poles is changed from four to six and to eight, the speed is changed from 1800 to 1200 and to 900 revolutions per minute.

This method of speed variation of the induction motor, by changing the number of poles, is the most convenient, and such "multispeed motors" are extensively used industrially.

A. Pyro-electric Speed Control

10. Speed control by resistance in the armature or secondary has the disadvantage that the speed is not constant, but at a change of load and thus of current, the voltage consumed by the armature resistance, and therefore the speed changes. To give constancy of speed over a range of load would require a resistance, which consumes the same or approximately the same voltage at all values of current. A resistance of very high negative temperature coefficient does this: with increase of current and thus increase of temperature, the resistance decreases, and if the decrease of resistance is as large as the increase of current, the voltage consumed by the resistance, and therefore the motor speed, remains constant.

Some pyro-electric conductors (see Chapter I, of "Theory and Calculation of Electric Circuits") have negative temperature coefficients sufficiently high for this purpose. Fig. 6 shows the current-resistance characteristic of a pyro-electric conductor, consisting of cast silicon (the same of which the characteristic is given as rod II in Fig. 6 of "Theory and Calculation of Electric Circuits"). Inserting this resistance, half of it and one and one-half of it into the secondary of the induction motor of constants: $e_0 = 110$; $Y_0 = 0.01 - 0.1j$; $Z_0 = 0.1 + 0.3j$; $Z_1 = 0.1 + 0.3j$ gives the speed-torque curves shown in Fig. 7.

The calculation of these curves is as follows: The speed-torque curve of the motor with short-circuited secondary, $r = 0$,

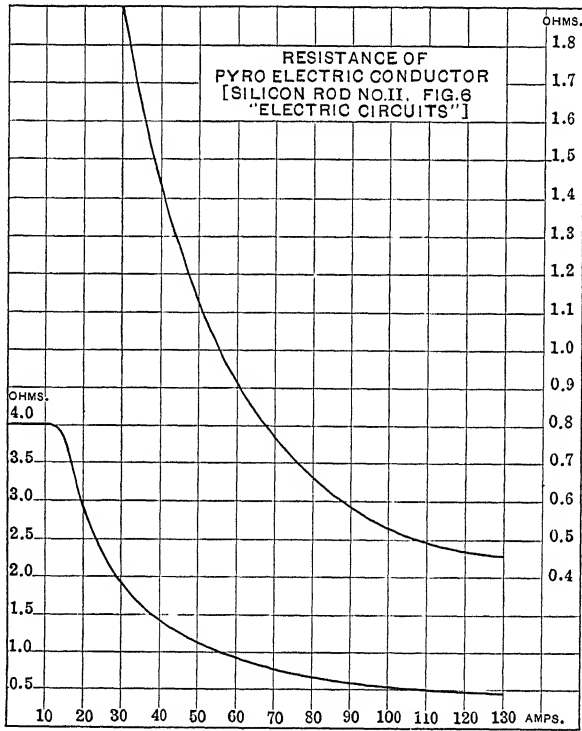

Fig. 6.—Variation of resistance of pyro-electric conductor, with current.

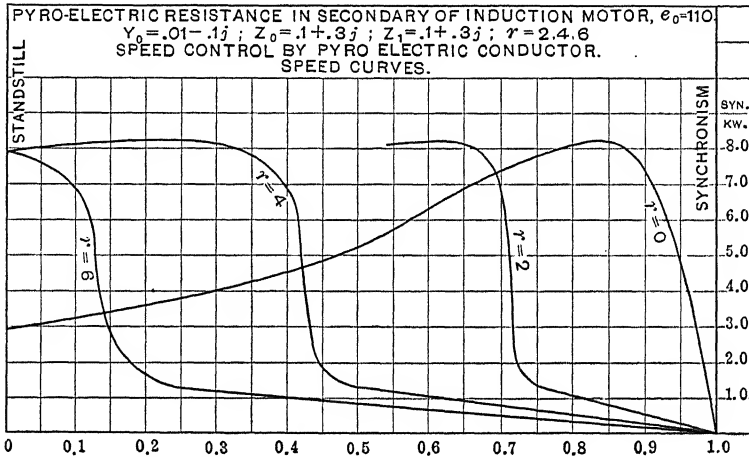

Fig. 7.—Speed control of induction motor by pyro-electric conductor, speed curves

is calculated in the usual way as described on page 318 of "Theoretical Elements of Electrical Engineering." For any value of slip, s , and corresponding value of torque, T , the secondary current is $i_1 = e \sqrt{a_1^2 + a_2^2}$. To this secondary current corresponds, by Fig. 6, the resistance, r , of the pyro-electric conductor, and the insertion of r thus increases the slip in proportion to the increased secondary resistance: $\frac{r + r_1}{r_1}$, where $r_1 = 0.1$ in the present instance. This gives, as corresponding to the torque, T , the slip:

$$s' = \frac{r + r_1}{r_1} s,$$

where s = slip at torque, T , with short-circuited armature, or resistance, r_1 .

As seen from Fig. 7, very close constant-speed regulation is produced by the use of the pyro-electric resistance, over a wide range of load, and only at light-load the motor speeds up.

Thus, good constant-speed regulation at any speed below synchronism, down to very low speeds, would be produced—at a corresponding sacrifice of efficiency, however—by the use of suitable pyro-electric conductors in the motor armature.

The only objection to the use of such pyro-electric resistances is the difficulty of producing stable pyro-electric conductors, and permanent terminal connections on such conductors.

B. Condenser Speed Control

11. The reactance of a condenser is inverse proportional to the frequency, that of an inductance is directly proportional to the frequency. In the secondary of the induction motor, the frequency varies from zero at synchronism, to full frequency at standstill. If, therefore, a suitable capacity is inserted into the secondary of an induction motor, there is a definite speed, at which inductive reactance and capacity reactance are equal and opposite, that is, balance, and at and near this speed, a large current is taken by the motor and thus large torque developed, while at speeds considerably above or below this resonance speed, the current and thus torque of the motor are small.

The use of a capacity; or an effective capacity (as polarization cell or aluminum cell) in the induction-motor secondary should therefore afford, at least theoretically, a means of speed control by varying the capacity.

Let, in an induction motor:

$Y_0 = g - jb$ = primary exciting admittance;

$Z_0 = r_0 + jx_0$ = primary self-inductive impedance;

$Z_1 = r_1 + jx_1$ = internal self-inductive impedance, at full frequency;

and let the condenser, C , be inserted into the secondary circuit.

The capacity reactance of C is

$$k = \frac{1}{2\pi fC} \quad (1)$$

at full frequency, and $\frac{k}{s}$ at the frequency of slip, s .

The total secondary impedance, at slip, s , thus is:

$$Z_1^s = r_1 + j \left(sx_1 - \frac{k}{s} \right) \quad (2)$$

and the secondary current:

$$I_1 = \frac{sE}{r_1 + j \left(sx_1 - \frac{k}{s} \right)}; i_1 = \frac{se}{\sqrt{r_1^2 + \left(sx_1 - \frac{k}{s} \right)^2}} \quad (3)$$

$$= E (a_1 - ja_2),$$

where:

$$\left. \begin{aligned} a_1 &= \frac{sr_1}{m} \\ a_2 &= \frac{s \left(sx_1 - \frac{k}{s} \right)}{m} \\ m &= r_1^2 + \left(sx_1 - \frac{k}{s} \right)^2 \end{aligned} \right\} \quad (4)$$

The further calculation of the condenser motor, then, is the same as that of the standard motor.¹

12. Neglecting the exciting current:

$$I_{00} = EY$$

the primary current equals the secondary current:

$$I_0 = I_1$$

and the primary impressed voltage thus is:

$$E_0 = E + Z_0 I_0$$

¹ "Theoretical Elements of Electrical Engineering," 4th edition, p. 318.

and, substituting (3) and rearranging, gives:

$$E = \frac{\dot{E}_0 \left\{ r_1 + j \left(sx_1 - \frac{k}{s} \right) \right\}}{(r_1 + sr_0) + j \left(sx_1 + sx_0 - \frac{k}{s} \right)}, \quad (5)$$

or, absolute:

$$e^2 = \frac{e_0^2 \left\{ r_1^2 + \left(sx_1 - \frac{k}{s} \right)^2 \right\}}{(r_1 + sr_0)^2 + \left(sx_1 + sx_0 - \frac{k}{s} \right)^2}. \quad (6)$$

The torque of the motor is:

$$T = e^2 a_1$$

and, substituting (4) and (6):

$$T = \frac{sr_1 e_0^2}{(r_1 + sr_0)^2 + \left(sx_1 + sx_0 - \frac{k}{s} \right)^2}. \quad (7)$$

As seen, this torque is a maximum in the range of slip, s , where the second term in the denominator vanishes, while for values of s , materially differing therefrom, the second term in the denominator is large, and the torque thus small.

That is, the motor regulates for approximately constant speed near the value of s , given by:

$$sx_1 + sx_0 - \frac{k}{s} = 0,$$

that is:

$$s_0 = \sqrt{\frac{k}{x_0 + x_1}} \quad (8)$$

and $s_0 = 1$, that is, the motor gives maximum torque near standstill, for:

$$k = x_0 + x_1. \quad (9)$$

13. As instances are shown, in Fig. 8, the speed-torque curves of a motor of the constants:

$$\begin{aligned} Y_0 &= 0.01 - 0.1j, \\ Z_0 &= Z_1 = 0.1 + 0.3j, \end{aligned}$$

for the values of capacity reactance:

$k = 0, 0.012, 0.048, 0.096, 0.192, 0.3, 0.6$ —denoted respectively by 1, 2, 3, 4, 5, 6, 7.

The impressed voltage of the motor is assumed to be varied with the change of capacity, so as to give the same maximum torque for all values of capacity.

The volt-ampere capacity of the condenser is given, at the frequency of slip, s , by:

$$Q' = i_1^2 \frac{k}{s};$$

substituting (3) and (6), this gives:

$$Q' = \frac{se_0^2 k}{(r_1 + sr_0)^2 + \left(sx_1 + sx_0 - \frac{k}{s} \right)^2}$$

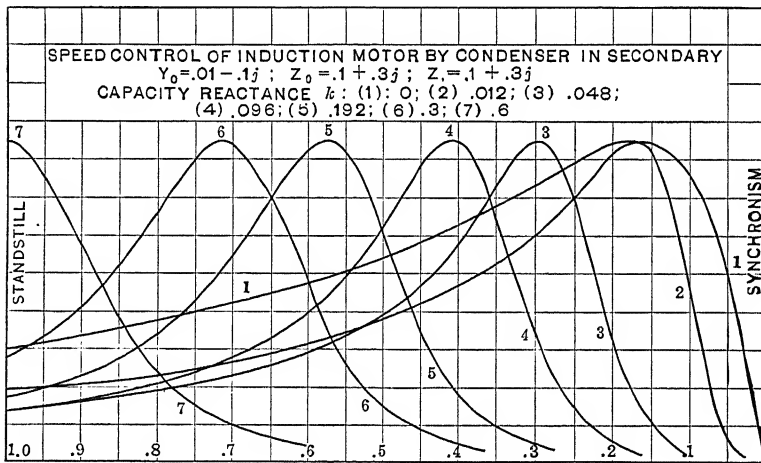

FIG. 8.—Speed control of induction motor by condenser in secondary circuit. Speed curves.

and, compared with (7), this gives:

$$Q' = \frac{k}{r_1} T.$$

At full frequency, with the same voltage impressed upon the condenser, its volt-ampere capacity, and thus its 60-cycle rating, would be:

$$Q'_0 = \frac{Q'}{s} = \frac{k}{sr_1} T.$$

As seen, a very large amount of capacity is required for speed control. This limits its economic usefulness, and makes the use of a cheaper form of effective or equivalent capacity desirable.

C. Multispeed Motors

14. The change of speed by changing the number of poles, in the multispeed induction motor, involves the use of fractional-pitch windings: a primary turn, which is of full pole pitch for a given number of motor poles, is fractional pitch for a smaller number of poles, and more than full pitch for a larger number of poles. The same then applies to the rotor or secondary, if containing a definite winding. The usual and most frequently employed squirrel-cage secondary obviously has no definite number of poles, and thus is equally adapted to any number of poles.

As an illustration may be considered a three-speed motor changing between four, six and eight poles.

Assuming that the primary winding is full-pitch for the six-polar motor, that is, each primary turn covers one-sixth of the motor circumference. Then, for the four-polar motor, the primary winding is $\frac{2}{3}$ pitch, for the eight-polar motor it is $\frac{4}{3}$ pitch—which latter is effectively the same as $\frac{2}{3}$ pitch.

Suppose now the primary winding is arranged and connected as a six-polar three-phase winding. Comparing it with the same primary turns, arranged as a four-polar three-phase winding, or eight-polar three-phase winding, the turns of each phase can be grouped in six sections:

Those which remain in the same phase when changing to a winding for different number of poles.

Those which remain in the same phase, but are reversed when changing the number of poles.

Those which have to be transferred to the second phase.

Those which have to be transferred to the second phase in the reverse direction.

Those which have to be transferred to the third phase.

Those which have to be transferred to the third phase in the reverse direction.

The problem of multispeed motor design then is, so to arrange the windings, that the change of connection of the six coil groups of each phase, in changing from one number of poles to another, is accomplished with the least number of switches.

15. Considering now the change of motor constants when changing speed by changing the number of poles. Assuming that at all speeds, the same primary turns are connected in series, and are merely grouped differently, it follows, that the self-inductive impedances remain essentially unchanged by a change of the number of poles from n to n' . That is:

$$\begin{aligned} Z_0 &= Z'_0, \\ Z_1 &= Z'_1. \end{aligned}$$

With the same supply voltage impressed upon the same number of series turns, the magnetic flux per pole remains unchanged by the change of the number of poles. The flux density, therefore, changes proportional to the number of poles:

$$\frac{B'}{B} = \frac{n'}{n};$$

therefore, the ampere-turns per pole required for producing the magnetic flux, also must be proportional to the number of poles:

$$\frac{F'}{F} = \frac{n'}{n}.$$

However, with the same total number of turns, the number of turns per pole are inverse proportional to the number of poles:

$$\frac{N'}{N} = \frac{n}{n'}.$$

In consequence hereof, the exciting currents, at the same impressed voltage, are proportional to the square of the number of poles:

$$\frac{i'_{00}}{i_{00}} = \frac{n'^2}{n^2},$$

and thus the exciting susceptances are proportional to the square of the number of poles:

$$\frac{b'}{b} = \frac{n'^2}{n^2}.$$

The magnetic flux per pole remains the same, and thus the magnetic-flux density, and with it the hysteresis loss in the primary core, remain the same, at a change of the number of poles. The tooth density, however, increases with increasing number of poles, as the number of teeth, which carry the same flux per pole, decreases inverse proportional to the number of

poles. Since the tooth densities must be chosen sufficiently low not to reach saturation at the highest number of poles, and their core loss is usually small compared with that in the primary core itself, it can be assumed approximately, that the core loss of the motor is the same, at the same impressed voltage, regardless of the number of poles. This means, that the exciting conductance, g , does not change with the number of poles.

Thus, if in a motor of n poles, we change to n' poles, or by the ratio

$$a = \frac{n'}{n},$$

the motor constants change, approximately:

from:

$$Z_0 = r_0 + jx_0,$$

$$Z_1 = r_1 + jx_1,$$

$$Y_0 = g - jb,$$

to:

$$Z_0 = r_0 + jx_0.$$

$$Z_1 = r_1 + jx_1.$$

$$Y_0 = g - ja^2b.$$

16. However, when changing the number of poles, the pitch of the winding changes, and allowance has to be made herefore in the constants: a fractional-pitch winding, due to the partial neutralization of the turns, obviously has a somewhat higher exciting admittance, and lower self-inductive impedance, than a full-pitch winding.

As seen, in a multispeed motor, the motor constants at the higher number of poles and thus the lower speed, must be materially inferior than at the higher speed, due to the increase of the exciting susceptance, and the performance of the motor, and especially its power-factor and thus the apparent efficiency, are inferior at the lower speeds.

When retaining series connection of all turns for all speeds, and using the same impressed voltage, torque in synchronous watts, and power are essentially the same at all speeds, that is, are decreased for the lower speed and larger number of poles only as far as due to the higher exciting admittance. The actual torque thus would be higher for the lower speeds, and approximately inverse proportional to the speed.

As a rule, no more torque is required at low speed than at high speed, and the usual requirement would be, that the multispeed motor should carry the same torque at all its running speeds, that is, give a power proportional to the speed.

This would be accomplished by lowering the impressed voltage

for the larger number of poles, about inverse proportional to the square root of the number of poles:

$$e'_0 = \frac{e_0}{\sqrt{a}}$$

since the output is proportional to the square of the voltage.

The same is accomplished by changing connection from multiple connection at higher speeds to series connection at lower speeds, or from delta connection at higher speeds, to Y at lower speeds.

If, then, the voltage per turn is chosen so as to make the actual torque proportional to the synchronous torque at all speeds, that

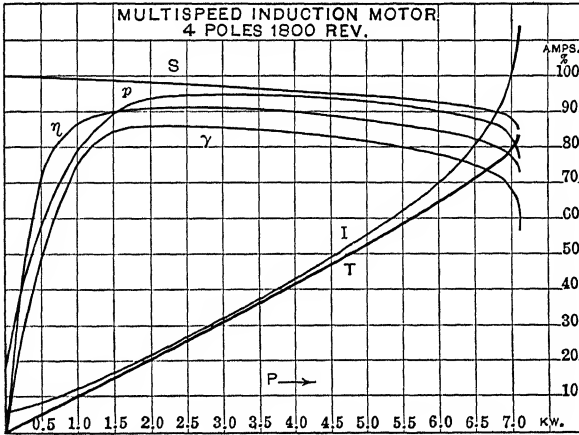

FIG. 9.—Load curves for multispeed induction motor, highest speed, four poles.

is, approximately equal, then the magnetic flux per pole and the density in the primary core decreases with increasing number of poles, while that in the teeth increases, but less than at constant impressed voltage.

The change of constants, by changing the number of poles by the ratio:

$$\frac{n'}{n} = a$$

thus is:

from: e_0, Y_0, Z_0, Z_1 to e_0, aY_0, aZ_0, aZ_1

and the characteristic constant is changed from ϑ to $a^2\vartheta$.

17. As numerical instance may be considered a 60-cycle 100-volt motor, of the constants:

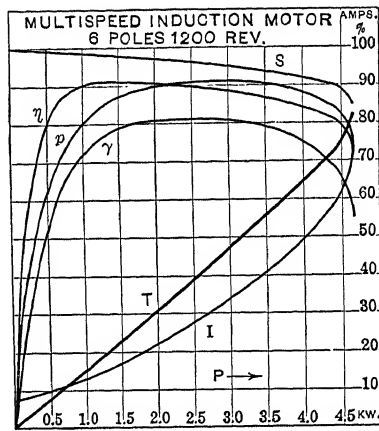

FIG. 10.—Load curve of multi-speed induction motor, middle speed, six poles.

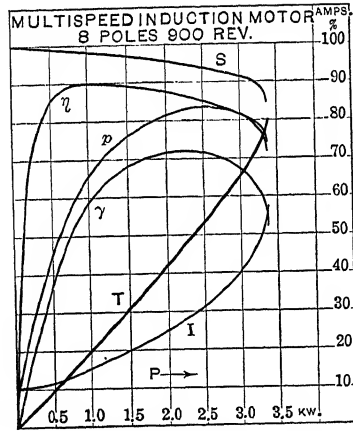

FIG. 11.—Load curves of multi-speed induction motor, low speed, eight poles.

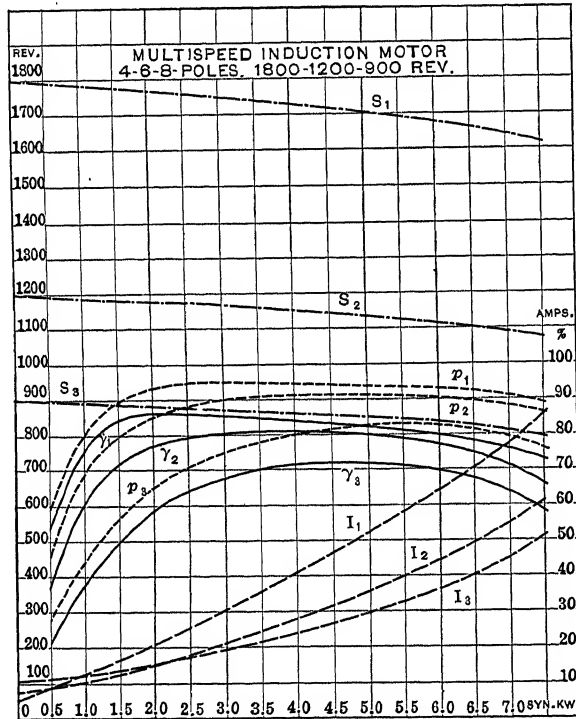

FIG. 12.—Comparison of load curves of three-speed induction motor.

Four poles, 1800 rev.: $Z_0 = r_0 + jx_0 = 0.1 + 0.3 j$;

$Z_1 = r_1 + jx_1 = 0.1 + 0.3 j$; $Y_0 = g - jb = 0.01 - 0.05 j$.

Six poles, 1200 rev.: $Z_0 = r_0 + jx_0 = 0.15 + 0.45 j$;

$Z_1 = r_1 + jx_1 = 0.15 + 0.45 j$; $Y_0 = g - jb = 0.0067 - 0.0667 j$.

Eight poles, 900 rev.: $Z_0 = r_0 + jx_0 = 0.2 + 0.6 j$;

$Z_1 = r_1 + jx_1 = 0.2 + 0.6 j$; $Y_0 = g - jb = 0.005 - 0.1 j$.

Figs. 9, 10 and 11 show the load curves of the motor, at the three different speeds. Fig. 12 shows the load curves once more,

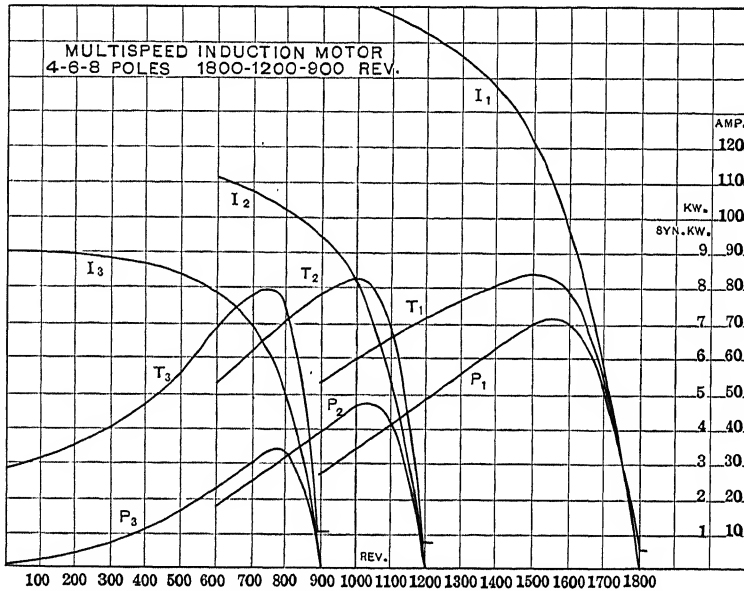

Fig. 13.—Speed torque curves of three-speed induction motor.

with all three motors plotted on the same sheet, but with the torque in synchronous watts (referred to full speed or four-polar synchronism) as abscissæ, to give a better comparison. S denotes the speed, I the current, p the power-factor and γ the apparent efficiency. Obviously, carrying the same load, that is, giving the same torque at lower speed, represents less power output, and in a multispeed motor the maximum power output should be approximately proportional to the speed, to operate at all speeds at the same part of the motor characteristic. Therefore, a comparison of the different speed curves by the power output does not show the performance as well as a comparison on the basis of torque, as given in Fig. 12.

As seen from Fig. 12, at the high speed, the motor performance is excellent, but at the lowest speed, power-factor and apparent efficiency are already low, especially at light-load.

The three current curves cross: at the lowest speed, the motor takes most current at no-load, as the exciting current is highest; at higher values of torque, obviously the current is greatest at the highest speed, where the torque represents most power.

The speed regulation is equally good at all speeds.

Fig. 13 then shows the speed curves, with revolutions per minute as abscissæ, for the three numbers of poles. It gives current, torque and power as ordinates, and shows that the maximum torque is nearly the same at all three speeds, while current and power drop off with decrease of speed.

CHAPTER II

MULTIPLE SQUIRREL-CAGE INDUCTION MOTOR

18. In an induction motor, a high-resistance low-reactance secondary is produced by the use of an external non-inductive resistance in the secondary, or in a motor with squirrel-cage secondary, by small bars of high-resistance material located close to the periphery of the rotor. Such a motor has a great slip of speed under load, therefore poor efficiency and poor speed regulation, but it has a high starting torque and torque at low and intermediate speed. With a low resistance fairly high-reactance secondary, the slip of speed under load is small, therefore efficiency and speed regulation good, but the starting torque and torque at low and intermediate speeds is low, and the current in starting and at low speed is large. To combine good starting with good running characteristics, a non-inductive resistance is used in the secondary, which is cut out during acceleration. This, however, involves a complication, which is undesirable in many cases, such as in ship propulsion, etc. By arranging then two squirrel cages, one high-resistance low-reactance one, consisting of high-resistance bars close to the rotor surface, and one of low-resistance bars, located deeper in the armature iron, that is, inside of the first squirrel cage, and thus of higher reactance, a "double squirrel-cage induction motor" is derived, which to some extent combines the characteristics of the high-resistance and the low-resistance secondary. That is, at starting and low speed, the frequency of the magnetic flux in the armature, and therefore the voltage induced in the secondary winding is high, and the high-resistance squirrel cage thus carries considerable current, gives good torque and torque efficiency, while the low-resistance squirrel cage is ineffective, due to its high reactance at the high armature frequency. At speeds near synchronism, the secondary frequency, being that of slip, is low, and the secondary induced voltage correspondingly low. The high-resistance squirrel cage thus carries little current and gives little torque. In the low-resistance squirrel cage, due to its low reactance at the low frequency of slip, in spite of the relatively

low induced e.m.f., considerable current is produced, which is effective in producing torque. Such double squirrel-cage induction motor thus gives a torque curve, which to some extent is a superposition of the torque curve of the high-resistance and that of the low-resistance squirrel cage, has two maxima, one at low speed, and another near synchronism, therefore gives a fairly good torque and torque efficiency over the entire speed range from standstill to full speed, that is, combines the good features of both types. Where a very high starting torque requires locating the first torque maximum near standstill, and large size and high efficiency brings the second torque maximum very close to synchronism, the drop of torque between the two maxima may be considerable. This is still more the case, when the motor is required to reverse at full speed and full power, that is, a very high torque is required at full speed backward, or at or near slip $s = 2$. In this case, a triple squirrel cage may be used, that is, three squirrel cages inside of each other: the outermost, of high resistance and low reactance, gives maximum torque below standstill, at backward rotation; the second squirrel cage, of medium resistance and medium reactance, gives its maximum torque at moderate speed; and the innermost squirrel cage, of low resistance and high reactance, gives its torque at full speed, near synchronism.

Mechanically, the rotor iron may be slotted down to the innermost squirrel cage, so as to avoid the excessive reactance of a closed magnetic circuit, that is, have the magnetic leakage flux or self-inductive flux pass an air gap.

19. In the calculation of the standard induction motor, it is usual to start with the mutual magnetic flux, Φ , or rather with the voltage induced by this flux, the mutual inductive voltage $E = e$, as it is most convenient, with the mutual inductive voltage, e , as starting point, to pass to the secondary current by the self-inductive impedance, to the primary current and primary impressed voltage by the primary self-inductive impedance and exciting admittance.

In the calculation of multiple squirrel-cage induction motors, it is preferable to introduce the true induced voltage, that is, the voltage induced by the resultant magnetic flux interlinked with the various circuits, which is the resultant of the mutual and the self-inductive magnetic flux of the respective circuit. This permits starting with the innermost squirrel cage, and

gradually building up to the primary circuit. The advantage hereof is, that the current in every secondary circuit is in phase with the true induced voltage of this circuit, and is $i_1 = \frac{e_1}{r_1}$, where r_1 is the resistance of the circuit. As e_1 is the voltage induced by the resultant of the mutual magnetic flux coming from the primary winding, and the self-inductive flux corresponding to the $i_1 x_1$ of the secondary, the reactance, x_1 , does not enter any more in the equation of the current, and e_1 is the voltage due to the magnetic flux which passes beyond the circuit in which e_1 is induced. In the usual induction-motor theory, the mutual magnetic flux, Φ , induces a voltage, E , which produces a current, and this current produces a self-inductive flux, Φ'_1 , giving rise to a counter e.m.f. of self-induction $I_1 x_1$, which subtracts from E . However, the self-inductive flux, Φ'_1 , interlinks with the same conductors, with which the mutual flux, Φ , interlinks, and the actual or resultant flux interlinkage thus is $\Phi_1 = \Phi - \Phi'_1$, and this produces the true induced voltage $e_1 = E - I_1 x_1$, from which the multiple squirrel-cage calculation starts.¹

Double Squirrel-cage Induction Motor

20. Let, in a double squirrel-cage induction motor:

E_2 = true induced voltage in inner squirrel cage, reduced to full frequency,

I_2 = current, and

$Z_2 = r_2 + jx_2$ = self-inductive impedance at full frequency, reduced to the primary circuit.

E_1 = true induced voltage in outer squirrel cage, reduced to full frequency,

I_1 = current, and

$Z_1 = r_1 + jx_1$ = self-inductive impedance at full frequency, reduced to primary circuit.

E = voltage induced in secondary and primary circuits by mutual magnetic flux,

E_0 = voltage impressed upon primary,

I_0 = primary current,

$Z_0 = r_0 + jx_0$ = primary self-inductive impedance, and

$Y_0 = g - jb$ = primary exciting admittance.

¹See "Electric Circuits", Chapter XII. Reactance of Induction Apparatus.

621-313

N17

3324

The leakage reactance, x_2 , of the inner squirrel cage is that due to the flux produced by the current in the inner squirrel cage, which passes between the two squirrel cages, and does not include the reactance due to the flux resulting from the current, I_2 , which passes beyond the outer squirrel cage, as the latter is mutual reactance between the two squirrel cages, and thus meets the reactance, x_1 .

It is then, at slip s :

$$I_2 = \frac{s\dot{E}_2}{r_2}. \quad (1)$$

$$I_1 = \frac{s\dot{E}_1}{r_1}. \quad (2)$$

$$I_0 = I_2 + I_1 + Y_0\dot{E}. \quad (3)$$

and:

$$\dot{E}_1 = \dot{E}_2 + jx_2 I_2. \quad (4)$$

$$\dot{E} = \dot{E}_1 + jx_1 (I_1 + I_2). \quad (5)$$

$$\dot{E}_0 = \dot{E} + Z_0 I_0. \quad (6)$$

The leakage flux of the outer squirrel cage is produced by the m.m.f. of the currents of both squirrel cages, $I_1 + I_2$, and the reactance voltage of this squirrel cage, in (5), thus is $jx_1 (I_1 + I_2)$.

As seen, the difference between \dot{E}_1 and \dot{E}_2 is the voltage induced by the flux which leaks between the two squirrel cages, in the path of the reactance, x_2 , or the reactance voltage, $x_2 I_2$; the difference between \dot{E} and \dot{E}_1 is the voltage induced by the rotor flux leaking outside of the outer squirrel cage. This has the m.m.f. $I_1 + I_2$, and the reactance x_1 , thus is the reactance voltage $x_1 (I_1 + I_2)$. The difference between \dot{E}_0 and \dot{E} is the voltage consumed by the primary impedance: $Z_0 I_0$. (4) and (5) are the voltages reduced to full frequency; the actual voltages are s times as high, but since all three terms in these equations are induced voltages, the s cancels.

21. From the equations (1) to (6) follows:

$$\dot{E}_1 = \dot{E}_2 \left(1 + j \frac{sx_2}{r_2} \right). \quad (7)$$

$$I_1 = \frac{s\dot{E}_2}{r_1} \left(1 + j \frac{sx_2}{r_2} \right). \quad (8)$$

$$\begin{aligned} \dot{E} &= \dot{E}_2 \left(1 + j \frac{sx_2}{r_2} \right) + jx_1 \left[\frac{s\dot{E}_2}{r_1} \left(1 + j \frac{sx_2}{r_2} \right) + \frac{s\dot{E}_2}{r_2} \right] \\ &= \dot{E}_2 \left\{ \left(1 - \frac{s^2 x_1 x_2}{r_1 r_2} \right) + j s \left(\frac{x_1}{r_1} + \frac{x_1}{r_2} + \frac{x_2}{r_2} \right) \right\} \\ &= \dot{E}_2 (a_1 + ja_2), \end{aligned} \quad (9)$$

where:

$$\left. \begin{aligned} a_1 &= 1 - \frac{s^2 x_1 x_2}{r_1 r_2} \\ a_2 &= s \left(\frac{x_1}{r_1} + \frac{x_1}{r_2} + \frac{x_2}{r_2} \right) \end{aligned} \right\} \quad (10)$$

thus the exciting current:

$$\begin{aligned} I_{00} &= Y_0 E \\ &= E_2 (g - jb) (a_1 + ja_2) \\ &= E_2 (b_1 + jb_2), \end{aligned} \quad (11)$$

where:

$$\left. \begin{aligned} b_1 &= a_1 g + a_2 b \\ b_2 &= a_2 g - a_1 b \end{aligned} \right\} \quad (12)$$

and the total primary current is (3):

$$\begin{aligned} I_0 &= E_2 \left\{ \frac{s}{r_2} + \frac{s}{r_1} \left(1 + j \frac{s x_2}{r_2} \right) + b_1 + jb_2 \right\} \\ &= E_2 (c_1 + jc_2), \end{aligned} \quad (13)$$

where:

$$\left. \begin{aligned} c_1 &= \frac{s}{r_2} + \frac{s}{r_1} + b_1 \\ c_2 &= \frac{s^2 x_2}{r_1 r_2} + b_2 \end{aligned} \right\} \quad (14)$$

and the primary impressed voltage (6):

$$\begin{aligned} E_0 &= E_2 \{ a_1 + ja_2 + (r_0 + jx_0) (c_1 + jc_2) \} \\ &= E_2 (d_1 + jd_2), \end{aligned} \quad (15)$$

where:

$$\left. \begin{aligned} d_1 &= a_1 + r_0 c_1 - x_0 c_2 \\ d_2 &= a_2 + r_0 c_2 + x_0 c_1 \end{aligned} \right\} \quad (16)$$

hence, absolute:

$$e_2 = \frac{e_0}{\sqrt{d_1^2 + d_2^2}} \quad (17)$$

$$i_0 = e_2 \sqrt{c_1^2 + c_2^2}. \quad (18)$$

22. The torque of the two squirrel cages is given by the product of current and induced voltage in phase with it, as:

$$\begin{aligned} D_2 &= /E_2, I_2/' \\ &= \frac{s e_2^2}{r_2}. \end{aligned} \quad (19)$$

$$\begin{aligned} D_1 &= /E_1, I_1/' \\ &= \frac{s e_1^2}{r_1} \\ &= \frac{s e_2^2}{r_1} \left(1 + \frac{s^2 x_2^2}{r_2^2} \right), \end{aligned} \quad (20)$$

hence, the total torque:

$$D = D_2 + D_1, \quad (21)$$

and the power output:

$$P = (1 - s) D. \quad (22)$$

(Herefrom subtracts the friction loss, to give the net power output.)

The power input is:

$$\begin{aligned} P_0 &= /E_0, I_0/' \\ &= e_2^2(c_1d_1 + c_2d_2), \end{aligned} \quad (23)$$

and the volt-ampere input:

$$Q = e_0i_0.$$

Herefrom then follows the power-factor $\frac{P_0}{Q}$, the torque efficiency $\frac{D}{P_0}$, the apparent torque efficiency $\frac{D}{Q}$, the power efficiency $\frac{P}{P_0}$ and the apparent power efficiency $\frac{P}{Q}$.

23. As illustrations are shown, in Figs. 14 and 15, the speed curves and the load curves of a double squirrel-cage induction motor, of the constants:

$$\begin{aligned} e_0 &= 110 \text{ volts;} \\ Z_0 &= 0.1 + 0.3 j; \\ Z_1 &= 0.5 + 0.2 j; \\ Z_2 &= 0.08 + 0.4 j; \\ Y_0 &= 0.01 - 0.1 j; \end{aligned}$$

the speed curves for the range from $s = 0$ to $s = 2$, that is, from synchronism to backward rotation at synchronous speed. The total torque as well as the two individual torques are shown on the speed curve. These curves are derived by calculating, for the values of s :

$$s = 0, 0.01, 0.02, 0.05, 0.1, 0.15, 0.2, 0.3, \\ 0.4, 0.6, 0.8, 1.0, 1.2, 1.4, 1.6, 1.8, 2.0,$$

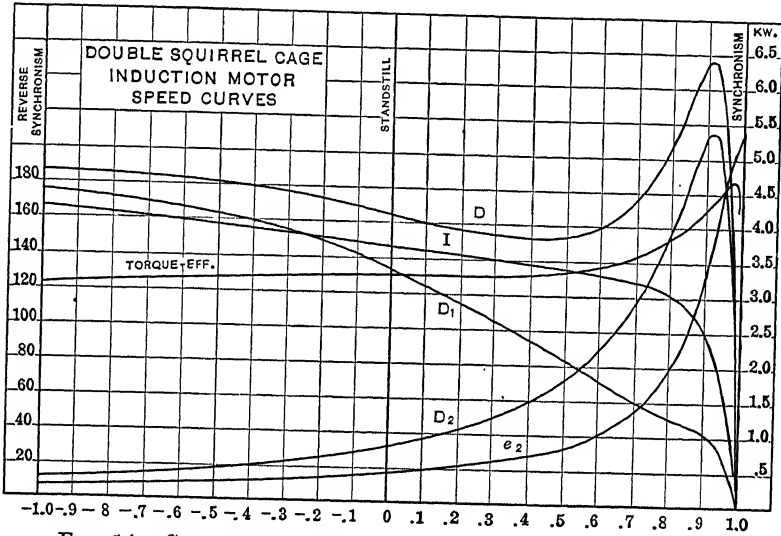

Fig. 14.—Speed curves of double squirrel-cage induction motor.

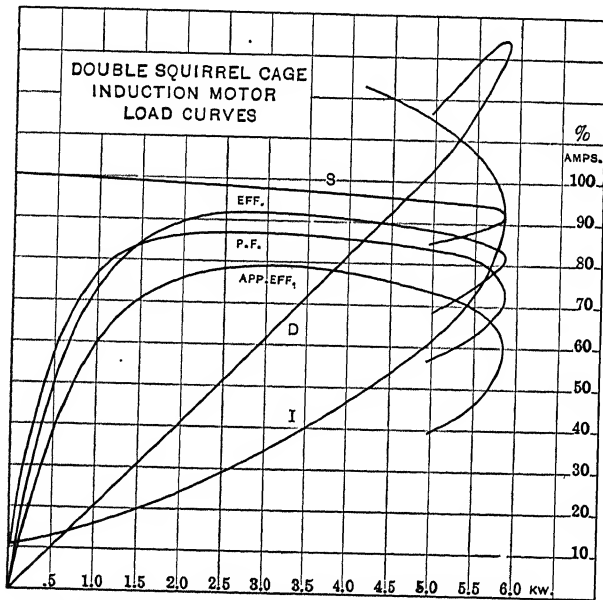

Fig. 15.—Load curves of double squirrel-cage induction motor.

the values:

$$\begin{aligned}
 a_1 &= 1 - \frac{s^2 x_1 x_2}{r_1 r_2}, \\
 a_2 &= s \left(\frac{x_1}{r_1} + \frac{x_1}{r_2} + \frac{x_2}{r_2} \right), \\
 b_1 &= a_1 g + a_2 \bar{b}, \\
 b_2 &= a_2 g - a_1 \bar{b}, \\
 c_1 &= \frac{s}{r_2} + \frac{s}{r_1} + b_1, \\
 c_2 &= \frac{s^2 x_2}{r_1 r_2} + b_2, \\
 d_1 &= a_1 + r_0 c_1 - x_0 c_2, \\
 d_2 &= a_2 + r_0 c_2 + x_0 c_1, \\
 e_2^2 &= \frac{e_0^2}{d_1^2 + d_2^2}, \\
 e_2 &, \\
 i_0 &= e_2 \sqrt{c_1^2 + c_2^2}, \\
 D_2 &= \frac{s e_2^2}{r_2}, \\
 D_1 &= \frac{s e_2^2}{r_1} \left(1 + \frac{s^2 x_2^2}{r_2^2} \right), \\
 D &= D_1 + D_2, \\
 P &= (1 - s) D, \\
 P_0 &= e_2^2 (c_1 d_1 + c_2 d_2), \\
 Q &= e_0 i_0,
 \end{aligned}$$

and:

$$\frac{P}{P_0}, \frac{D}{P_0}, \frac{P}{Q}, \frac{D}{Q}, \frac{P_0}{Q}.$$

Triple Squirrel-cage Induction Motor

24. Let:

Φ = flux, E = voltage, I = current, and $Z = r + jx$ = self-inductive impedance, at full frequency and reduced to primary circuit, and let the quantities of the innermost squirrel cage be denoted by index 3, those of the middle squirrel cage by 2, of the outer squirrel cage by 1, of the primary circuit by 0, and the mutual inductive quantities without index.

Also let: $Y_0 = g - jb$ = primary exciting admittance.

It is then, at slip s :

current in the innermost squirrel cage:

$$I_3 = \frac{s \bar{E}_3}{r_3}; \quad (1)$$

current in the middle squirrel cage:

$$I_2 = \frac{s\dot{E}_2}{r_2}; \quad (2)$$

current in the outer squirrel cage:

$$I_1 = \frac{s\dot{E}_1}{r_1}; \quad (3)$$

primary current:

$$I_0 = I_3 + I_2 + I_1 + Y_0\dot{E}. \quad (4)$$

The voltages are related by:

$$\dot{E}_2 = \dot{E}_3 + jx_3I_3, \quad (5)$$

$$\dot{E}_1 = \dot{E}_2 + jx_2(I_2 + I_3), \quad (6)$$

$$\dot{E} = \dot{E}_1 + jx_1(I_1 + I_2 + I_3), \quad (7)$$

$$\dot{E}_0 = \dot{E} + Z_0I_0, \quad (8)$$

where x_3 is the reactance due to the flux leakage between the third and the second squirrel cage; x_2 the reactance of the leakage flux between second and first squirrel cage; x_1 the reactance of the first squirrel cage and x_0 that of the primary circuit, that is, $x_1 + x_0$ corresponds to the total leakage flux between primary and outer most squirrel cage.

\dot{E}_3 , \dot{E}_2 and \dot{E}_1 are the true induced voltages in the three squirrel cages, \dot{E} the mutual inductive voltage between primary and secondary, and \dot{E}_0 the primary impressed voltage

25. From equations (1) to (8) then follows:

$$\dot{E}_2 = \dot{E}_3 \left(1 + j \frac{sx_3}{r_3} \right), \quad (9)$$

$$I_2 = \frac{s}{r_2} \dot{E}_3 \left(1 + j \frac{sx_3}{r_3} \right), \quad (10)$$

$$\begin{aligned} \dot{E}_1 &= \dot{E}_3 \left\{ 1 + j \frac{sx_3}{r_3} + \frac{sx_2}{r_2} \left(1 + j \frac{sx_3}{r_3} \right) + j \frac{sx_2}{r_3} \right\} \\ &= \dot{E}_3 \left\{ \left(1 - \frac{s^2x_2x_3}{r_2r_3} \right) + js \left(\frac{x_2}{r_2} + \frac{x_2}{r_3} + \frac{x_3}{r_3} \right) \right\} \\ &= \dot{E}_3 (a_1 + ja_2), \end{aligned} \quad (11)$$

where:

$$\left. \begin{aligned} a_1 &= 1 - \frac{s^2x_2x_3}{r_2r_3} \\ a_2 &= s \left(\frac{x_2}{r_2} + \frac{x_2}{r_3} + \frac{x_3}{r_3} \right) \end{aligned} \right\} \quad (12)$$

$$I_1 = \frac{s}{r_1} \dot{E}_3 (a_1 + ja_2), \quad (13)$$

$$\begin{aligned}
 E &= E_3 \left\{ a_1 + ja_2 + j \frac{sx_1}{r_1} (a_1 + ja_2) + j \frac{sx_1}{r_2} \left(1 + j \frac{sx_2}{r_3} \right) + j \frac{sx_1}{r_3} \right\} \\
 &= E_3 \left\{ \left(a_1 - \frac{sx_1 a_2}{r_1} - \frac{s^2 x_1 x_2}{r_2 r_3} \right) + j \left(a_2 + \frac{sx_1 a_1}{r_1} + \frac{sx_1}{r_2} + \frac{sx_1}{r_3} \right) \right\} \\
 &= E_3 (b_1 + jb_2), \tag{14}
 \end{aligned}$$

where:

$$\left. \begin{aligned}
 b_1 &= a_1 - \frac{sx_1 a_2}{r_1} - \frac{s^2 x_1 x_2}{r_2 r_3} \\
 b_2 &= a_2 + \frac{sx_1 a_1}{r_1} + \frac{sx_1}{r_2} + \frac{sx_1}{r_3}
 \end{aligned} \right\} \tag{15}$$

thus the exciting current:

$$\begin{aligned}
 I_{00} &= Y_0 E \\
 &= E_3 (b_1 + jb_2) (g - jb) \\
 &= E_3 (c_1 + jc_2), \tag{16}
 \end{aligned}$$

where:

$$\begin{aligned}
 c_1 &= b_1 g + b_2 b, \\
 c_2 &= b_2 g - b_1 b, \tag{17}
 \end{aligned}$$

and the total primary current, by (4):

$$\begin{aligned}
 I_0 &= E_3 \left\{ \frac{s}{r_1} (a_1 + ja_2) + \frac{s}{r_2} \left(1 + j \frac{sx_2}{r_3} \right) + \frac{s}{r_3} + c_1 + jc_2 \right\} \\
 &= E_3 (d_1 + jd_2), \tag{18}
 \end{aligned}$$

where:

$$\left. \begin{aligned}
 d_1 &= \frac{s}{r_1} a_1 + \frac{s}{r_2} + \frac{s}{r_3} + c_1 \\
 d_2 &= \frac{s}{r_1} a_2 + \frac{s^2 x_2}{r_2 r_3} + c_2
 \end{aligned} \right\} \tag{19}$$

$$\begin{aligned}
 Z_0 I_0 &= E_3 (d_1 + jd_2) (r_0 + jx_0) \\
 &= E_3 (f_1 + jf_2), \tag{20}
 \end{aligned}$$

where:

$$\left. \begin{aligned}
 f_1 &= r_0 d_1 - x_0 d_2 \\
 f_2 &= r_0 d_2 + x_0 d_1
 \end{aligned} \right\} \tag{21}$$

thus, the primary impressed voltage, by (8):

$$\begin{aligned}
 E_0 &= E_3 (b_1 + jb_2 + f_1 + jf_2) \\
 &= E_3 (y_1 + jy_2), \tag{22}
 \end{aligned}$$

where:

$$\left. \begin{aligned}
 g_1 &= b_1 + f_1 \\
 g_2 &= b_2 + f_2
 \end{aligned} \right\} \tag{23}$$

hence, absolute:

$$e_3 = \frac{e_0}{\sqrt{g_1^2 + g_2^2}}, \quad (24)$$

$$i_0 = e_3 \sqrt{d_1^2 + d_2^2}, \quad (25)$$

$$e_2 = e_3 \sqrt{1 + \frac{s^2 x_3^2}{r_3^2}}, \quad (26)$$

$$e_1 = e_3 \sqrt{a_1^2 + a_2^2}. \quad (27)$$

26. The torque of the innermost squirrel cage thus is:

$$D_3 = \frac{se_3^2}{r_3}; \quad (28)$$

that of the middle squirrel cage:

$$D_2 = \frac{se_2^2}{r_2}; \quad (29)$$

and that of the outer squirrel cage:

$$D_1 = \frac{se_1^2}{r_1}; \quad (30)$$

the total torque of the triple squirrel-cage motor thus is:

$$D = D_1 + D_2 + D_3, \quad (31)$$

and the power:

$$P = (1 - s) D, \quad (32)$$

the power input is:

$$\begin{aligned} P_0 &= /E_0, I_0/' \\ &= e_3^2 (d_1 g_1 + d_2 g_2), \end{aligned} \quad (33)$$

and the volt-ampere input:

$$Q = e_0 i_0. \quad (34)$$

Herefrom then follows the power-factor $\frac{P_0}{Q}$, the torque efficiency $\frac{D}{P_0}$, apparent torque efficiency $\frac{D}{Q}$, power efficiency $\frac{P}{P_0}$ and apparent power efficiency $\frac{P}{Q}$.

27. As illustrations are shown, in Figs. 16 and 17, the speed and the load curves of a triple squirrel-cage motor with the constants:

$$\begin{aligned} e_0 &= 110 \text{ volts;} \\ Z_0 &= 0.1 + 0.3 j; \\ Z_1 &= 0.8 + 0.1 j; \\ Z_2 &= 0.2 + 0.3 j; \\ Z_3 &= 0.05 + 0.8 j; \\ Y_0 &= 0.01 - 0.1 j; \end{aligned}$$

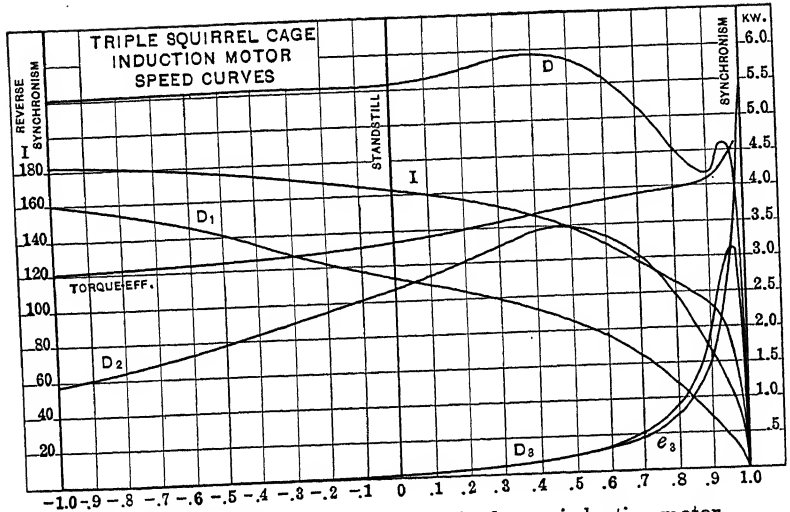

Fig. 16.—Speed curves of triple squirrel-cage induction motor.

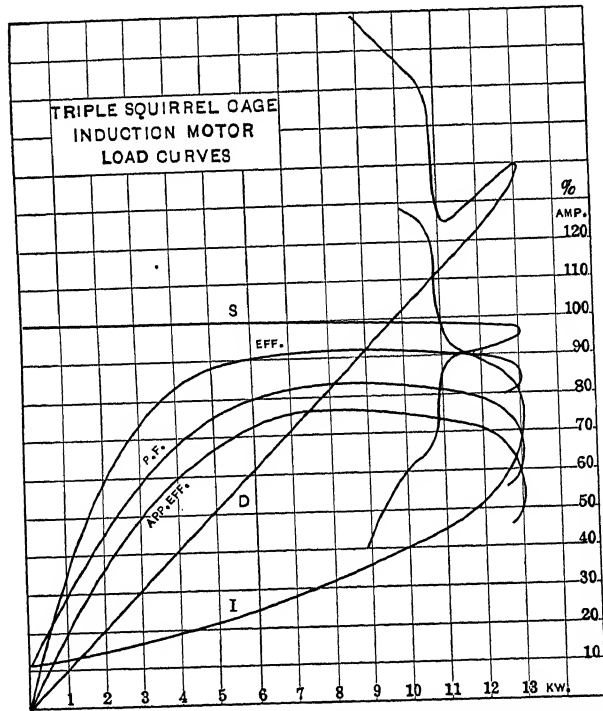

Fig. 17.—Load curves of triple squirrel-cage induction motor.

the speed curves are shown from $s = 0$ to $s = 2$, and on them, the individual torques of the three squirrel cages are shown in addition to the total torque.

These numerical values are derived by calculating, for the values of s :

$$s = 0, 0.01, 0.02, 0.05, 0.1, 0.15, 0.20, 0.30, \\ 0.40, 0.60, 0.80, 1.0, 1.2, 1.4, 1.6, 1.8, 20,$$

the values:

$$a_1 = 1 - \frac{s^2 x_2 x_3}{r_2 r_3},$$

$$a_2 = s \left(\frac{x_2}{r_2} + \frac{x_2}{r_3} + \frac{x_3}{r_3} \right),$$

$$b_1 = a_1 - \frac{s x_1 a_2}{r_1} - \frac{s^2 x_1 x_2}{r_2 r_3},$$

$$b_2 = a_2 + \frac{s x_1 a_1}{r_1} + \frac{s x_1}{r_2} + \frac{s x_1}{r_3},$$

$$c_1 = b_1 g + b_2 b,$$

$$c_2 = b_2 g + b_1 b,$$

$$d_1 = \frac{s a_1}{r_1} + \frac{s}{r_2} + \frac{s}{r_3} + c_1,$$

$$d_2 = \frac{s a_2}{r_1} + \frac{s^2 x_3}{r_2 r_3} + \frac{s}{r_2} + c_2,$$

$$f_1 = r_0 d_1 - x_0 d_2,$$

$$f_2 = r_0 d_2 + x_0 d_1,$$

$$g_1 = b_1 + f_1,$$

$$g_2 = b_2 + f_2,$$

$$e_3^2 = \frac{e_0^2}{g_1^2 + g_2^2},$$

$$e_3,$$

$$i_0 = e_3 \sqrt{d_1^2 + d_2^2},$$

$$e_3^2 = e_3^2 \left(1 + \frac{s^2 x_3^2}{r_3^2} \right),$$

$$e_1^2 = e_3^2 (a_1^2 + a_2^2),$$

$$D_3 = \frac{s e_3^2}{r_3},$$

$$D_2 = \frac{s e_2^2}{r_2},$$

$$D_1 = \frac{s e_1^2}{r_1},$$

$$D = D_1 + D_2 + D_3,$$

$$P = (1 - s) D,$$

$$P_0 = e_3^2 (d_1 g_1 + d_2 g_2),$$

$$Q = e_0 i_0,$$

and

$$\frac{P}{P_0}, \frac{D}{P_0}, \frac{P}{Q}, \frac{D}{Q}, \frac{P_0}{Q}$$

CHAPTER III

CONCATENATION

Cascade or Tandem Control of Induction Motors

28. If of two induction motors the secondary of the first motor is connected to the primary of the second motor, the second machine operates as a motor with the voltage and frequency impressed upon it by the secondary of the first machine. The first machine acts as general alternating-current transformer or frequency converter (see Chapter XII), changing a part of the primary impressed power into secondary electrical power for the supply of the second machine, and a part into mechanical work.

The frequency of the secondary voltage of the first motor, and thus the frequency impressed upon the second motor, is the frequency of slip below synchronism, s . The frequency of the secondary of the second motor is the difference between its impressed frequency, s , and its speed. Thus, if both motors are connected together mechanically, to turn at the same speed, $1 - s$, and have the same number of poles, the secondary frequency of the second motor is $2s - 1$, hence equal to zero at $s = 0.5$. That is, the second motor reaches its synchronism at half speed. At this speed, its torque becomes zero, the power component of its primary current, and thus the power component of the secondary current of the first motor, and thus also the torque of the first motor becomes zero. That is, a system of two concatenated equal motors, with short-circuited secondary of the second motor, approaches half synchronism at no-load, in the same manner as a single induction motor approaches synchronism. With increasing load, the slip below half synchronism increases.

In reality, at half synchronism, $s = 0.5$, there is a slight torque produced by the first motor, as the hysteresis energy current of the second motor comes from the secondary of the first motor, and therein, as energy current, produces a small torque.

More generally, any pair of induction motors connected in concatenation divides the speed so that the sum of their two

respective speeds approaches synchronism at no-load; or, still more generally, any number of concatenated induction motors run at such speeds that the sum of their speeds approaches synchronism at no-load.

With mechanical connection between the two motors, concatenation thus offers a means of operating two equal motors at full efficiency at half speed in tandem, as well as at full speed, in parallel, and thereby gives the same advantage as does series parallel control with direct-current motors.

With two motors of different number of poles, rigidly connected together, concatenation allows three speeds: that of the one motor alone, that of the other motor alone, and the speed of concatenation of both motors. Such concatenation of two motors of different numbers of poles, has the disadvantage that at the two highest speeds only one motor is used, the other idle, and the apparatus economy thus inferior. However, with certain ratios of the number of poles, it is possible to wind one and the same motor structure so as to give at the same time two different numbers of poles: For instance, a four-polar and an eight-polar winding; and in this case, one and the same motor structure can be used either as four-polar motor, with the one winding, or as eight-polar motor, with the other winding, or in concatenation of the two windings, corresponding to a twelve-polar speed. Such "internally concatenated" motors thus give three different speeds at full apparatus economy. The only limitation is, that only certain speeds and speed ratios can economically be produced by internal concatenation.

29. At half synchronism, the torque of the concatenated couple of two equal motors becomes zero. Above half synchronism, the second motor runs beyond its impressed frequency, that is, becomes a generator. In this case, due to the reversal of current in the secondary of the first motor (this current now being out-flowing or generator current with regards to the second motor) its torque becomes negative also, that is, the concatenated couple becomes an induction generator above half synchronism. When approaching full synchronism, the generator torque of the second motor, at least if its armature is of low resistance, becomes very small, as this machine is operating very far above its synchronous speed. With regards to the first motor, it thus begins to act merely as an impedance in the secondary circuit, that is, the first machine becomes a motor again. Thus, somewhere between

half synchronism and synchronism, the torque of the first motor becomes zero, while the second motor still has a small negative or generator torque. A little above this speed, the torque of the concatenated couple becomes zero—about at two-thirds synchronism with a couple of low-resistance motors—and above this, the concatenated couple again gives a positive or motor torque—though the second motor still returns a small negative torque—and again approaches zero at full synchronism. Above full synchronism, the concatenated couple once more becomes generator, but practically only the first motor contributes to the generator torque above and the motor torque below full synchronism. Thus, while a concatenated couple of induction motors has two operative motor speeds, half synchronism and full synchronism, the latter is uneconomical, as the second motor holds back, and in the second or full synchronism speed range, it is more economical to cut out the second motor altogether, by short-circuiting the secondary terminals of the first motor.

With resistance in the secondary of the second motor, the maximum torque point of the second motor above half synchronism is shifted to higher speeds, nearer to full synchronism, and thus the speed between half and full synchronism, at which the concatenated couple loses its generator torque and again becomes motor, is shifted closer to full synchronism, and the motor torque in the second speed range, below full synchronism, is greatly reduced or even disappears. That is, with high resistance in the secondary of the second motor, the concatenated couple becomes generator or brake at half synchronism, and remains so at all higher speeds, merely loses its braking torque when approaching full synchronism, and regaining it again beyond full synchronism.

The speed torque curves of the concatenated couple, shown in Fig. 18, with low-resistance armature, and in Fig. 19, with high resistance in the armature or secondary of the second motor, illustrate this.

30. The numerical calculation of a couple of concatenated induction motors (rigidly connected together on the same shaft or the equivalent) can be carried out as follows:

Let:

$$\begin{aligned}n &= \text{number of pairs of poles of the first motor,} \\n' &= \text{number of pairs of poles of the second motor,}\end{aligned}$$

$$a = \frac{n'}{n} = \text{ratio of poles,} \quad (1)$$

f = supply frequency.

Full synchronous speed of the first motor then is:

$$S_0 = \frac{f}{n}; \quad (2)$$

of the second motor:

$$S'_0 = \frac{f}{n'}. \quad (3)$$

At slip s and thus speed ratio $(1 - s)$ of the first motor, its speed is:

$$S = (1 - s)S_0 = (1 - s)\frac{f}{n}, \quad (4)$$

and the frequency of its secondary circuit, and thus the frequency of the primary circuit of the second motor:

$$sf;$$

synchronous speed of the second motor at this frequency is:

$$sS'_0 = s\frac{f}{n'};$$

the speed of the second motor, however, is the same as that of the first motor, S ,

hence, the slip of speed of the second motor below its synchronous speed, is:

$$s\frac{f}{n'} - (1 - s)\frac{f}{n} = \left(\frac{s}{n'} - \frac{1 - s}{n}\right)f,$$

and the slip of frequency thus is:

$$s' = n' \left(\frac{s}{n'} - \frac{1 - s}{n} \right) = s - a(1 - s),$$

$$s' = s(1 + a) - a. \quad (5)$$

This slip of the second motor, s' , becomes zero, that is, the couple reaches the synchronism of concatenation, for:

$$s_0 = \frac{a}{1 + a}. \quad (6)$$

The speed in this case is:

$$\begin{aligned} S_0^0 &= (1 - s_0) \frac{f}{n} \\ &= \frac{f}{n(1+a)} \end{aligned} \quad (7)$$

31. If:

$$a = 1,$$

that is, two equal motors, as for instance two four-polar motors

$$n = n' = 4,$$

it is:

$$\begin{aligned} s_0 &= 0.5, \\ S_0^0 &= \frac{f}{2n} = \frac{f}{8}, \end{aligned}$$

while at full synchronism:

$$S_0 = \frac{f}{n} = \frac{f}{4},$$

If:

$$\begin{aligned} a &= 2, \\ n &= 4, \\ n' &= 8, \end{aligned}$$

it is:

$$\begin{aligned} s_0 &= \frac{2}{3}, \\ S_0^0 &= \frac{f}{3n} = \frac{f}{12}, \end{aligned}$$

that is, corresponding to a twelve-polar motor.

While:

$$S_0 = \frac{f}{n} = \frac{f}{4},$$

if:

$$\begin{aligned} a &= 0.5, \\ n &= 8, \\ n' &= 4, \end{aligned}$$

it is:

$$\begin{aligned} s_0 &= \frac{1}{3}, \\ S_0^0 &= \frac{f}{1.5n} = \frac{f}{12}. \end{aligned}$$

that is, corresponding to a twelve-polar motor again. That is, as regards to the speed of the concatenated couple, it is immaterial in which order the two motors are concatenated.

32. It is then, in a concatenated motor couple of pole ratio:

$$a = \frac{n'}{n}$$

if:

s = slip of first motor below full synchronism.

The primary circuit of the first motor is of full frequency.

The secondary circuit of the first motor is of frequency s .

The primary circuit of the second motor is of frequency s .

The secondary circuit of the second motor is of frequency $s' = s(1 + a) - a$.

Synchronism of concatenation is reached at:

$$s_0 = \frac{a}{1 + a}$$

Let thus:

e_0 = voltage impressed of first motor primary;

$Y_0 = g - jb$ = exciting admittance of first motor;¹

$Y'_0 = g' - jb'$ = exciting admittance of second motor;

$Z_0 = r_0 + jx_0$ = self-inductive impedance of first motor primary;

$Z'_0 = r'_0 + jx'_0$ = self-inductive impedance of second motor primary;

$Z_1 = r_1 + jx_1$ = self-inductive impedance of first motor secondary;

$Z'_1 = r'_1 + jx'_1$ = self-inductive impedance of second motor secondary.

Assuming all these quantities reduced to the same number of turns per circuit, and to full frequency, as usual.

If:

e = counter e.m.f. generated in the second motor by its mutual magnetic flux, reduced to full frequency.

It is then:

secondary current of second motor:

$$I'_1 = \frac{s'e}{r'_1 + js'x'_1} = \frac{[s(1 + a) - a]e}{r'_1 + j[s(1 + a) - a]x'_1} = e(a_1 - ja_2), \quad (8)$$

where:

$$\left. \begin{aligned} a_1 &= \frac{r'_1 [s(1+a) - a]}{m} \\ a_2 &= \frac{x'_1 [s(1+a) - a]^2}{m} \end{aligned} \right\} \quad (9)$$

$$m = r'_1{}^2 + x'_1{}^2 (s(1+a) - a)^2; \quad (10)$$

exciting current of second motor:

$$I'_{00} = eY' = e(g' - jb'), \quad (11)$$

hence, primary current of second motor, and also secondary current of first motor:

$$\begin{aligned} I'_0 &= I_1 = I'_1 + I'_{00} \\ &= e(b_1 - jb_2), \end{aligned} \quad (12)$$

where:

$$\begin{aligned} b_1 &= a_1 + g', \\ b_2 &= a_2 + b', \end{aligned} \quad (13)$$

the impedance of the circuit comprising the primary of the second, and the secondary of the first motor, is:

$$Z = Z_1^s + Z'_{0'}{}^2 = (r_1 + r'_{0'}) + js(x_1 + x'_{0'}), \quad (14)$$

hence, the counter e.m.f., or induced voltage in the secondary of the first motor, of frequency is:

$$sE_1 = se + I_1 Z,$$

hence, reduced to full frequency:

$$\begin{aligned} E_1 &= e + \frac{I_1 Z}{s} \\ &= e(c_1 + jc_2), \end{aligned} \quad (15)$$

where:

$$\left. \begin{aligned} c_1 &= 1 + \frac{r_1 + r'_{0'}}{s} b_1 + (x_1 + x'_{0'}) b_2 \\ c_2 &= (x_1 + x'_{0'}) b_1 - \frac{r_1 + r'_{0'}}{s} b_2 \end{aligned} \right\} \quad (16)$$

33. The primary exciting current of the first motor is:

$$\begin{aligned} I_{00} &= E_1 Y \\ &= e(d_1 - jd_2), \end{aligned} \quad (17)$$

where:

$$\left. \begin{aligned} d_1 &= c_1 g + c_2 b \\ d_2 &= c_1 b - c_2 g \end{aligned} \right\} \quad (18)$$

thus, the total primary current of the first motor, or supply current:

$$\begin{aligned} I_0 &= I_1 + I_{00} \\ &= e(f_1 - jf_2), \end{aligned} \quad (19)$$

where:

$$\begin{cases} f_1 = b_1 + d_1 \\ f_2 = b_2 + d_2 \end{cases} \quad (20)$$

and the primary impressed voltage of the first motor, or supply voltage:

$$\begin{aligned} E_0 &= E_1 + Z_0 I_0 \\ &= e(g_1 + jg_2), \end{aligned} \quad (21)$$

where:

$$\begin{cases} g_1 = c_1 + r_0 f_1 + x_0 f_2 \\ g_2 = c_2 + x_0 f_1 - r_0 f_2 \end{cases} \quad (22)$$

and, absolute:

$$e_0 = e \sqrt{g_1^2 + g_2^2}, \quad (23)$$

thus:

$$e = \frac{e_0}{\sqrt{g_1^2 + g_2^2}}. \quad (24)$$

Substituting now this value of e in the preceding, gives the values of the currents and voltages in the different circuits.

34. It thus is, supply current:

$$i_0 = e \sqrt{f_1^2 + f_2^2} = e_0 \sqrt{\frac{f_1^2 + f_2^2}{g_1^2 + g_2^2}},$$

power input:

$$\begin{aligned} P_0 &= /E_0, I_0/' \\ &= e^2 (f_1 g_1 - f_2 g_2) \\ &= e_0^2 \frac{f_1 g_1 - f_2 g_2}{g_1^2 + g_2^2}. \end{aligned}$$

volt-ampere input:

$$Q = e_0 i_0,$$

and herefrom power-factor, etc.

The torque of the second motor is:

$$\begin{aligned} T' &= /e_1 I_1/' \\ &= e^2 a_1. \end{aligned}$$

The torque of the first motor is:

$$\begin{aligned} T_1 &= /E_1, I_0/' \\ &= e^2 (c_1 f_1 - c_2 f_2), \end{aligned}$$

hence, the *total torque* of the concatenated couple:

$$T = T' + T_1 = e^2 (a_1 + c_1 f_1 - c_2 f_2),$$

and herefrom the power output:

$$P = (1 - s) T,$$

thus the torque and power efficiencies and apparent efficiencies, etc.

35. As instances are calculated, and shown in Fig. 18, the speed

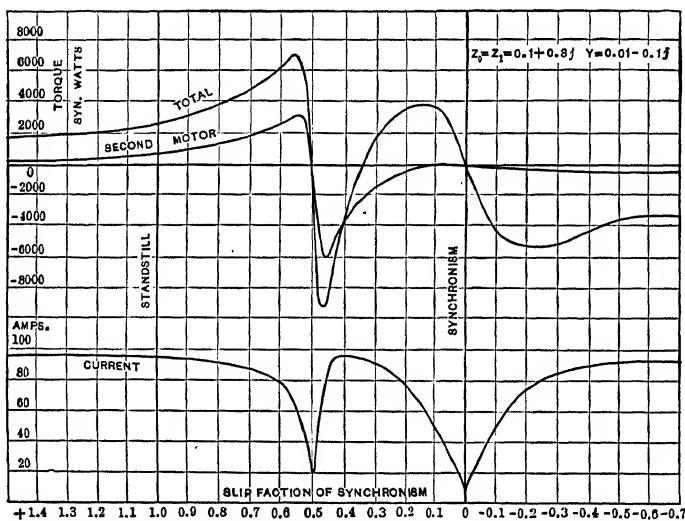

Fig. 18.—Speed torque curves of concatenated couple with low resistance secondary.

torque curves of the concatenated couple of two equal motors: $a = 1$, of the constants: $e_0 = 110$ volts.

$$\begin{aligned} Y &= Y' = 0.01 - 0.1 j; \\ Z_0 &= Z'_0 = 0.1 + 0.3 j; \\ Z_1 &= Z'_1 = 0.1 + 0.3 j. \end{aligned}$$

Fig. 18 also shows, separately, the torque of the second motor, and the supply current.

Fig. 19 shows the speed torque curves of the same concatenated couple with an additional resistance $r = 0.5$ inserted into the secondary of the second motor.

The load curves of the same motor, Fig. 18, for concatenated running, and also separately the load curves of either motor,

are given on page 358 of "Theoretical Elements of Electrical Engineering."

36. It is possible in concatenation of two motors of different number of poles, to use one and the same magnetic structure for both motors. Suppose the stator is wound with an n -polar primary, receiving the supply voltage, and at the same time with an n' polar short-circuited secondary winding. The rotor is wound with an n -polar winding as secondary to the n -polar primary winding, but this n -polar secondary winding is not short-circuited, but connected to the terminals of a second

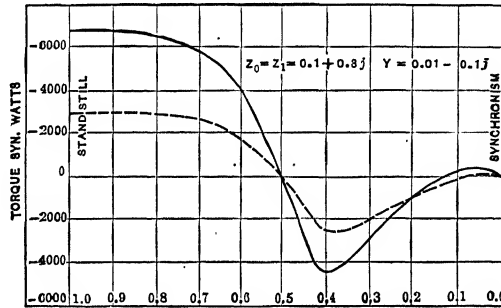

FIG. 19.—Speed-torque curves of concatenated couple with resistance in second secondary.

n' -polar winding, also located on the rotor. This latter thus receives the secondary current from the n -polar winding and acts as n' -polar primary to the short-circuited stator winding as secondary. This gives an n -polar motor concatenated to an n' -polar, and the magnetic structure simultaneously carries an n -polar and an n' -polar magnetic field. With this arrangement of "internal concatenation," it is essential to choose the number of poles, n and n' , so that the two rotating fields do not interfere with each other, that is, the n' -polar field does not induce in the n -polar winding, nor the n -polar field in the n' -polar winding. This is the case if the one field has twice as many poles as the other, for instance a four-polar and an eight-polar field.

If such a fractional-pitch winding is used, that the coil pitch is suited for an n -polar as well as an n' -polar winding, then the same winding can be used for both sets of poles. In the stator, the equipotential points of a $2p$ -polar winding are points of opposite polarity of a p -polar winding, and thus, by connecting together the equipotential points of a $2p$ -polar primary winding,

this winding becomes at the same time a p -polar short-circuited winding. On the rotor, in some slots, the secondary current of the n -polar and the primary current of the n' -polar winding flow in the same direction, in other slots flow in opposite direction, thus neutralize in the latter, and the turns can be omitted in concatenation—but would be put in for use of the structure as single motor of n , or of n' poles, where such is desired. Thus, on the rotor one single winding also is sufficient, and this arrangement of internal concatenation with single stator and single rotor winding thus is more efficient than the use of two separate motors, and gives somewhat better constants, as the self-inductive impedance of the rotor is less, due to the omission of one-third of the turns in which the currents neutralize (Hunt motor).

The disadvantage of this arrangement of internal concatenation with single stator and rotor winding is the limitation of the available speeds, as it is adapted only to $4 \div 8 \div 12$ poles and multiples thereof, thus to speed ratios of $1 \div \frac{1}{2} \div \frac{1}{3}$, the last being the concatenated speed.

Such internally concatenated motors may be used advantageously sometime as constant-speed motors, that is, always running in concatenation, for very slow-speed motors of very large number of poles.

37. Theoretically, any number of motors may be concatenated. It is rarely economical, however, to go beyond two motors in concatenation, as with the increasing number of motors, the constants of the concatenated system rapidly become poorer.

If:

$$\begin{aligned} Y_0 &= g - jb, \\ Z_0 &= r_0 + jx_0, \\ Z_1 &= r_1 + jx_1, \end{aligned}$$

are the constants of a motor, and we denote:

$$\begin{aligned} Z &= Z_0 + Z_1 = (r_0 + r_1) + j(x_0 + x_1) \\ &= r + jx \end{aligned}$$

then the characteristic constant of this motor—which characterizes its performance—is:

$$\vartheta = yz;$$

if now two such motors are concatenated, the exciting admittance of the concatenated couple is (approximately):

as the first motor carries the exciting current of the second motor.

The total self-inductive impedance of the couple is that of both motors in series:

$$Z' = 2 Z;$$

thus the characteristic constant of the concatenated couple is:

$$\begin{aligned} \mathcal{J}' &= y' z' \\ &= 4 yz \\ &= 4 \mathcal{J}, \end{aligned}$$

that is, four times as high as in a single motor; in other words, the performance characteristics, as power-factor, etc., are very much inferior to those of a single motor.

With three motors in concatenation, the constants of the system of three motors are:

$$\begin{aligned} Y'' &= 3 Y, \\ Z'' &= 3 Z, \end{aligned}$$

thus the characteristic constant:

$$\begin{aligned} \mathcal{J}'' &= y'' z'' \\ &= 9 yz \\ &= 9 \mathcal{J}, \end{aligned}$$

or nine times higher than in a single motor. In other words, the characteristic constant increases with the square of the number of motors in concatenation, and thus concatenation of more than two motors would be permissible only with motors of very good constants.

The calculation of a concatenated system of three or more motors is carried out in the same manner as that of two motors, by starting with the secondary circuit of the last motor, and building up toward the primary circuit of the first motor.

CHAPTER IV

INDUCTION MOTOR WITH SECONDARY EXCITATION

38. While in the typical synchronous machine and commutating machine the magnetic field is excited by a direct current, characteristic of the induction machine is, that the magnetic field is excited by an alternating current derived from the alternating supply voltage, just as in the alternating-current transformer. As the alternating magnetizing current is a wattless reactive current, the result is, that the alternating-current input into the induction motor is always lagging, the more so, the larger a part of the total current is given by the magnetizing current. To secure good power-factor in an induction motor, the magnetizing current, that is, the current which produces the magnetic field flux, must be kept as small as possible. This means as small an air gap between stator and rotor as mechanically permissible, and as large a number of primary turns per pole, that is, as large a pole pitch, as economically permissible.

In motors, in which the speed—compared to the motor output—is not too low, good constants can be secured. This, however, is not possible in motors, in which the speed is very low, that is, the number of poles large compared with the output, and the pole pitch thus must for economical reasons be kept small—as for instance a 100-hp. 60-cycle motor for 90 revolutions, that is, 80 poles—or where the requirement of an excessive momentary overload capacity has to be met, etc. In such motors of necessity the exciting current or current at no-load—which is practically all magnetizing current—is a very large part of full-load current, and while fair efficiencies may nevertheless be secured, power-factor and apparent efficiency necessarily are very low.

As illustration is shown in Fig. 20 the load curve of a typical 100-hp. 60-cycle 80-polar induction motor (90 revolutions per minute) of the constants:

Impressed voltage:	$e_0 = 500.$
Primary exciting admittance:	$Y_0 = 0.02 - 0.6 j.$
Primary self-inductive impedance:	$Z_0 = 0.1 + 0.3 j.$
Secondary self-inductive impedance:	$Z_1 = 0.1 + 0.3 j.$

As seen, at full-load of 75 kw. output, the efficiency is 80 per cent., which is fair for a slow-speed motor.

But the power-factor is 55 per cent., the apparent efficiency only 44 per cent., and the exciting current is 75 per cent. of full-load current.

This motor-load curve may be compared with that of a typical induction motor, of exciting admittance:

$$Y_0 = 0.01 - 0.1j,$$

given on page 234 of "Theory and Calculation of Alternating-current Phenomena" 5th edition, and page 319 of "Theoretical

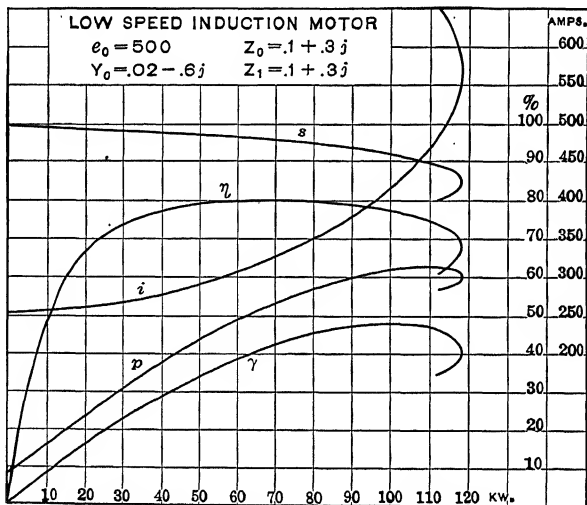

FIG. 20.—Low-speed induction motor, load curves.

Elements of Electrical Engineering," 4th edition, to see the difference.

39. In the synchronous machine usually the stator, in commutating machines the rotor is the armature, that is, the element to which electrical power is supplied, and in which electrical power is converted into the mechanical power output of the motor. The rotor of the typical synchronous machine, and the stator of the commutating machine are the field, that is, in them no electric power is consumed by conversion into mechanical work, but their purpose is to produce the magnetic field flux, through which the armature rotates.

In the induction machine, it is usually the stator, which is the

primary, that is, which receives electric power and converts it into mechanical power, and the primary or stator of the induction machine thus corresponds to the armature of the synchronous or commutating machine. In the secondary or rotor of the induction machine, low-frequency currents—of the frequency of slip—are induced by the primary, but the magnetic field flux is produced by the exciting current which traverses the primary or armature or stator. Thus the induction machine may be considered as a machine in which the magnetic field is produced by the armature reaction, and corresponds to a synchronous machine, in which the field coils are short-circuited and the field produced by armature reaction by lagging currents in the armature.

As the rotor or secondary of the induction machine corresponds structurally to the field of the synchronous or commutating machine, field excitation thus can be given to the induction machine by passing a current through the rotor or secondary and thereby more or less relieving the primary of its function of giving the field excitation.

Thus in a slow-speed induction motor, of very high exciting current and correspondingly poor constants, by passing an exciting current of suitable value through the rotor or secondary, the primary can be made non-inductive, or even leading current produced, or—with a lesser exciting current in the rotor—at least the power-factor increased.

Various such methods of secondary excitation have been proposed, and to some extent used.

1. Passing a direct current through the rotor for excitation.

In this case, as the frequency of the secondary currents is the frequency of slip, with a direct current, the frequency is zero, that is, the motor becomes a synchronous motor.

2. Excitation through commutator, by the alternating supply current, either in shunt or in series to the armature.

At the supply frequency, f , and slip, s , the frequency of rotation and thus of commutation is $(1 - s)f$, and the full frequency currents supplied to the commutator thus give in the rotor the effective frequency, $f - (1 - s)f = sf$, that is, the frequency of slip, thus are suitable as exciting currents.

3. Concatenation with a synchronous motor.

If a low-frequency synchronous machine is mounted on the induction-motor shaft, and its armature connected into the induc-

tion-motor secondary, the synchronous machine feeds low-frequency exciting currents into the induction machine, and thereby permits controlling it by using suitable voltage and phase.

If the induction machine has n times as many poles as the synchronous machine, the frequency of rotation of the synchronous machine is $\frac{1}{n}$ that of the induction machine, or $\frac{1-s}{n}$. However, the frequency generated by the synchronous machine must be the frequency of the induction-machine secondary currents, that is, the frequency of slip s .

Hence:

$$\frac{1-s}{n} = s,$$

or:

$$s = \frac{1}{n+1},$$

that is, the concatenated couple is synchronous, that is, runs at constant speed at all loads, but not at synchronous speed, but at constant slip $\frac{1}{n+1}$.

4. Concatenation with a low-frequency commutating machine.

If a commutating machine is mounted on the induction-motor shaft, and connected in series into the induction-motor secondary, the commutating machine generates an alternating voltage of the frequency of the currents which excite its field, and if the field is excited in series or shunt with the armature, in the circuit of the induction machine secondary, it generates voltage at the frequency of slip, whatever the latter may be. That is, the induction motor remains asynchronous, increases in slip with increase of load.

5. Excitation by a condenser in the secondary circuit of the induction motor.

As the magnetizing current required by the induction motor is a reactive, that is, wattless lagging current, it does not require a generator for its production, but any apparatus consuming leading, that is, generating lagging currents, such as a condenser, can be used to supply the magnetizing current.

40. However, condenser, or synchronous or commutating machine, etc., in the secondary of the induction motor do not merely give the magnetizing current and thereby permit power-factor control, but they may, depending on their design or application, change the characteristics of the induction machine, as regards to speed and speed regulation, the capacity, etc.

If by synchronous or commutating machine a voltage is inserted into the secondary of the induction machine, this voltage may be constant, or varied with the speed, the load, the slip, etc., and thereby give various motor characteristics. Furthermore, such voltage may be inserted at any phase relation from zero to 360° . If this voltage is inserted 90° behind the secondary current, it makes this current leading or magnetizing and so increases the power-factor. If, however, the voltage is inserted in phase with the secondary induced voltage of the induction machine, it has no effect on the power-factor, but merely lowers the speed of the motor if in phase, raises it if in opposition to the secondary induced voltage of the induction machine, and hereby permits speed control, if derived from a commutating machine. For instance, by a voltage in phase with and proportional to the secondary current, the drop of speed of the motor can be increased and series-motor characteristics secured, in the same manner as by the insertion of resistance in the induction-motor secondary. The difference however is, that resistance in the induction-motor secondary reduces the efficiency in the same proportion as it lowers the speed, and thus is inefficient for speed control. The insertion of an e.m.f., however, while lowering the speed, does not lower the efficiency, as the power corresponding to the lowered speed is taken up by the inserted voltage and returned as output of the synchronous or commutating machine. Or, by inserting a voltage proportional to the load and in opposition to the induced secondary voltage, the motor speed can be maintained constant, or increased with the load, etc.

If then a voltage is inserted by a commutating machine in the induction-motor secondary, which is displaced in phase by angle α from the secondary induced voltage, a component of this voltage: $\sin \alpha$, acts magnetizing or demagnetizing, the other component: $\cos \alpha$, acts increasing or decreasing the speed, and thus various effects can be produced.

As the current consumed by a condenser is proportional to the frequency, while that passing through an inductive reactance is inverse proportional to the frequency, when using a condenser in the secondary circuit of the induction motor, its effective impedance at the varying frequency of slip is:

$$Z_1^s = r_1 + j \left(sx_1 - \frac{x_2}{s} \right),$$

where x_2 is the capacity reactance at full frequency.

For $s = 0$, $Z_1^s = \infty$, that is, the motor has no power at or near synchronism.

For:

$$sx_1 - \frac{x_2}{s} = 0,$$

or

$$s = \sqrt{\frac{x_2}{x_1}},$$

it is:

$$Z_1^s = r_1,$$

and the current taken by the motor is a maximum. The power output thus is a maximum not when approaching synchronism, as in the typical induction motor, but at a speed depending on the slip,

$$s_0 = \sqrt{\frac{x_2}{x_1}},$$

and by varying the capacity reactance, x_2 , various values of resonance slip, s_0 , thus can be produced, and thereby speed control of the motor secured. However, for most purposes, this is uneconomical, due to the very large values of capacity required.

Induction Motor Converted to Synchronous

41. If, when an induction motor has reached full speed, a direct current is sent through its secondary circuit, unless heavily loaded and of high secondary resistance and thus great slip, it drops into synchronism and runs as synchronous motor.

The starting operations of such an induction motor in conversion to synchronous motor thus are (Fig. 21):

- | | |
|---|----|
| First step: secondary closed through resistance: | A. |
| Second step: resistance partly cut out: | B. |
| Third step: resistance all cut out: | C. |
| Fourth step: direct current passed through the secondary: | D. |

In this case, for the last or synchronous-motor step, usually the direct-current supply will be connected between one phase and the other two phases, the latter remaining short-circuited to each other, as shown in Fig. 21, D. This arrangement retains a short-circuit in the rotor—now the field—in quadrature with the excitation, which acts as damper against hunting (Danielson motor).

In the synchronous motor, Fig. 21, *D*, produced from the induction motor, Fig. 21, *C*, it is:

Let:

$Y_0 = g - jb$ = primary exciting admittance of the induction machine,

$Z_0 = r_0 + jx_0$ = primary self-inductive impedance,

$Z_1 = r_1 + jx_1$ = secondary self-inductive impedance.

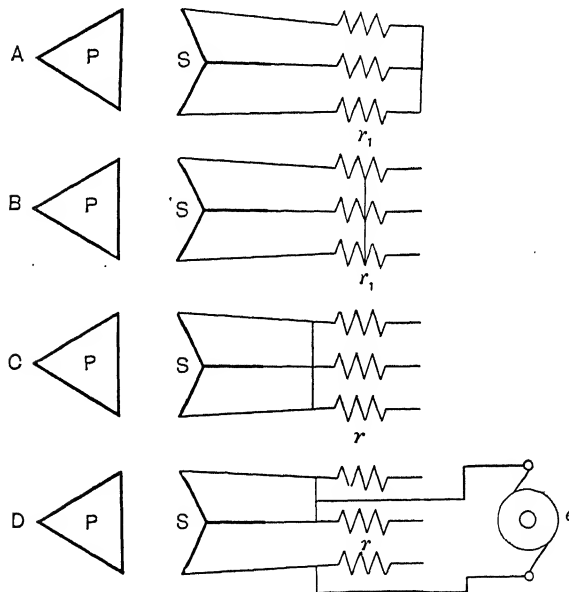

FIG. 21.—Starting of induction motor and conversion to synchronous.

The secondary resistance, r_1 , is that of the field exciting winding, thus does not further come into consideration in calculating the motor curves, except in the efficiency, as $i_1^2 r_1$ is the loss of power in the field, if i_1 = field exciting current. x_1 is of little further importance, as the frequency is zero. It represents the magnetic leakage between the synchronous motor poles.

r_0 is the armature resistance and x_0 the armature self-inductive reactance of the synchronous machine.

However, x_0 is *not* the synchronous impedance, which enters the equation of the synchronous machine, but is only the self-inductive part of it, or the true armature self-inductance. The

mutual inductive part of the synchronous impedance, or the effective reactance of armature reaction, x' , is not contained in x_0 .

The effective reactance of armature reaction of the synchronous machine, x' , represents the field excitation consumed by the armature m.m.f., and is the voltage corresponding to this field excitation, divided by the armature current which consumes this field excitation.

b , the exciting susceptance, is the magnetizing armature current, divided by the voltage induced by it, thus, x' , the effective reactance of synchronous-motor armature reaction, is the reciprocal of the exciting susceptance of the induction machine.

The total or synchronous reactance of the induction machine as synchronous motor thus is:

$$\begin{aligned} x &= x_0 + x' \\ &= x_0 + \frac{1}{b}. \end{aligned}$$

The exciting conductance, g , represents the loss by hysteresis, etc., in the iron of the machine. As synchronous machine, this loss is supplied by the mechanical power, and not electrically, and the hysteresis loss in the induction machine as synchronous motor thus is: e^2g .

We thus have:

The induction motor of the constants, per phase:

$$\begin{aligned} \text{Exciting admittance:} & \quad Y_0 = g - jb, \\ \text{Primary self-inductive impedance:} & \quad Z_0 = r_0 + jx_0, \\ \text{Secondary self-inductive impedance:} & \quad Z_1 = r_1 + jx_1, \end{aligned}$$

by passing direct current through the secondary or rotor, becomes a synchronous motor of the constants, per phase:

$$\begin{aligned} \text{Armature resistance:} & \quad r_0, \\ \text{Synchronous impedance:} & \quad x = x_0 + \frac{1}{b}. \end{aligned} \quad (1)$$

Total power consumed in field excitation:

$$P = 2 i^2 r_1, \quad (2)$$

where i = field exciting current.

Power consumed by hysteresis:

$$P = e^2g. \quad (3)$$

42. Let, in a synchronous motor:

$$\begin{aligned} E_0 &= \text{impressed voltage,} \\ E &= \text{counter e.m.f., or nominal induced} \\ &\quad \text{voltage,} \\ Z &= r + jx = \text{synchronous impedance,} \\ I &= i_1 - ji_2 = \text{current,} \end{aligned}$$

it is then:

$$\begin{aligned} E_0 &= E + ZI \\ &= E + (ri_1 + xi_2) + j(xi_1 - ri_2), \end{aligned} \quad (4)$$

or:

$$\begin{aligned} E &= E_0 - ZI \\ &= E_0 - (ri_1 + xi_2) - j(xi_1 - ri_2), \end{aligned} \quad (5)$$

or, reduced to absolute values, and choosing:

$$\begin{aligned} E &= e = \text{real axis in equation (4),} \\ E_0 &= e_0 = \text{real axis in equation (5),} \\ e_0^2 &= (e + ri_1 + xi_2)^2 + (xi_1 - ri_2)^2 [e = \text{real axis}], \quad (6) \\ e_e^2 &= (e_0 - ri_1 + xi_2)^2 + (xi_1 - ri_2)^2 [e_0 = \text{real axis}]. \quad (7) \end{aligned}$$

Equations (6) and (7) are the two forms of the fundamental equation of the synchronous motor, in the form most convenient for the calculation of load and speed curves.

In (7), i_1 is the energy component, and i_2 the reactive component of the current with respect to the *impressed* voltage, but *not* with respect to the induced voltage; in (6), i_1 is the energy component and i_2 the reactive component of the current with respect to the *induced* voltage, but *not* with respect to the impressed voltage.

The condition of motor operation at unity power-factor is:

$$i_2 = 0 \text{ in equation (7).}$$

Thus:

$$e^2 = (e_0 - ri_1)^2 + x^2i_1^2 \quad (8)$$

at no-load, for $i_1 = 0$, this gives: $e = e_0$, as was to be expected.

Equation (8) gives the variation of the induced voltage and thus of the field excitation, required to maintain unity power-factor at all loads, that is, currents, i_1 .

From (8) follows:

$$i_1 = \frac{re_0 \pm \sqrt{z^2e^2 - x^2e_0^2}}{z^2} \quad (9)$$

Thus, the minimum possible value of the counter e.m.f., e , is given by equating the square root to zero, as:

$$e = \frac{x}{z} e_0.$$

For a given value of the counter e.m.f., e , that is, constant field excitation, it is, from (7):

$$i_2 = \frac{x e_0}{z^2} \pm \sqrt{\frac{e^2}{z^2} - \left(i_1 - \frac{r e_0}{z^2}\right)^2}, \quad (10)$$

or, if the synchronous impedance, x , is very large compared with r , and thus, approximately:

$$z = x: \\ i_2 = \frac{e_0}{x} \pm \sqrt{\frac{e^2}{x^2} - i_1^2}. \quad (11)$$

The maximum value, which the energy current, i_1 , can have, at a given counter e.m.f., e , is given by equating the square root to zero, as:

$$i_1 = \frac{e}{x}. \quad (12)$$

For: $i_1 = 0$, or at no-load, it is, by (11):

$$i_2 = \frac{e_0 \pm e}{x}.$$

Equations (9) and (12) give two values of the currents i_1 and i_2 , of which one is very large, corresponds to the upper or unstable part of the synchronous motor-power characteristics shown on page 325 of "Theory and Calculation of Alternating-current Phenomena," 5th edition.

43. Denoting, in equation (5):

$$E = e' - j e'', \quad (13)$$

and again choosing $E_0 = e_0$, as the real axis, (5) becomes:

$$e' - j e'' = (e_0 - r i_1 - x i_2) - j (x i_1 - r i_2), \quad (14)$$

and the electric power input into the motor then is:

$$P_0 = /E_0, I'' \\ = e_0 i_1, \quad (15)$$

the power output at the armature conductor is:

$$P_1 = /E, I'' \\ = e' i_1 + e'' i_2,$$

hence by (14):

$$P_1 = i_1 (e_0 - ri_1 - xi_2) + i_2 (xi_1 - ri_2), \quad (16)$$

expanded, this gives:

$$\begin{aligned} P_1 &= e_0 i_1 - r(i_1^2 + i_2^2) \\ &= P_0 - ri^2, \end{aligned} \quad (17)$$

where: i = total current. That is, the power output at the armature conductors is the power input minus the $i^2 r$ loss.

The current in the field is:

$$i_0 = eb, \quad (18)$$

hence, the $i^2 r$ loss in the field; of resistance, r_1 .

$$i_0^2 r_1 = e^2 b^2 r_1. \quad (19)$$

The hysteresis loss in the induction motor of mutual induced voltage, e , is: $e^2 g$, or approximately:

$$P' = e_0^2 g, \quad (20)$$

in the synchronous motor, the nominal induced voltage, e , does not correspond to any flux, but may be very much higher, than corresponds to the magnetic flux, which gives the hysteresis loss, as it includes the effect of armature reaction, and the hysteresis loss thus is more nearly represented by $e_0^2 g$ (20). The difference, however, is that in the synchronous motor the hysteresis loss is supplied by the mechanical power, and not the electric power, as in the induction motor.

The net mechanical output of the motor thus is:

$$\begin{aligned} P &= P_1 - i_0^2 r_1 - P' \\ &= P_0 - i^2 r - i_0^2 r_1 - e^2 g \\ &= e_0 i_1 - i^2 r - e^2 b^2 r_1 - e^2 g, \end{aligned} \quad (21)$$

and herefrom follow efficiency, power-factor and apparent efficiency.

44. Considering, as instance, a typical good induction motor, of the constants:

$$\begin{aligned} e_0 &= 500 \text{ volts;} \\ Y_0 &= 0.01 - 0.1 j; \\ Z_0 &= 0.1 + 0.3 j; \\ Z_1 &= 0.1 + 0.3 j. \end{aligned}$$

The load curves of this motor, as induction motor, calculated in the customary way, are given in Fig. 22.

Converted into a synchronous motor, it gives the constants:
Synchronous impedance (1):

$$Z = r + jx = 0.1 + 10.3j.$$

Fig. 23 gives the load characteristics of the motor, with the power output as abscissæ, with the direct-current excitation, and thereby the counter e.m.f., e , varied with the load, so as to maintain unity power-factor.

The calculation is made in tabular form, by calculating for various successive values of the energy current (here also the total current) i_1 , input, the counter e.m.f., e , by equation (8):

$$e^2 = (500 - 0.1 i_1)^2 + 100.61 i_1^2,$$

the power input, which also is the volt-ampere input, the power-factor being unity, is:

$$P_0 = e_0 i_1 = 500 i_1.$$

From e follow the losses, by (17), (19) and (20):

in armature resistance:	$0.1 i_1^2$;
in field resistance:	$0.001 e^2$;
hysteresis loss:	2.5 kw.;

and thus the power output:

$$P = 500 i_1 - 2.5 - 0.1 i_1^2 - 0.001 e^2$$

and herefrom the efficiency.

Fig. 23 gives the total current as i , the nominal induced voltage as e , and the apparent efficiency which here is the true efficiency, as γ .

As seen, the nominal induced voltage has to be varied very greatly with the load, indeed, almost proportional thereto. That is, to maintain unity power-factor in this motor, the field excitation has to be increased almost proportional to the load.

It is interesting to investigate what load characteristics are given by operating at constant field excitation, that is, constant nominal induced voltage, e , as this would usually represent the operating conditions.

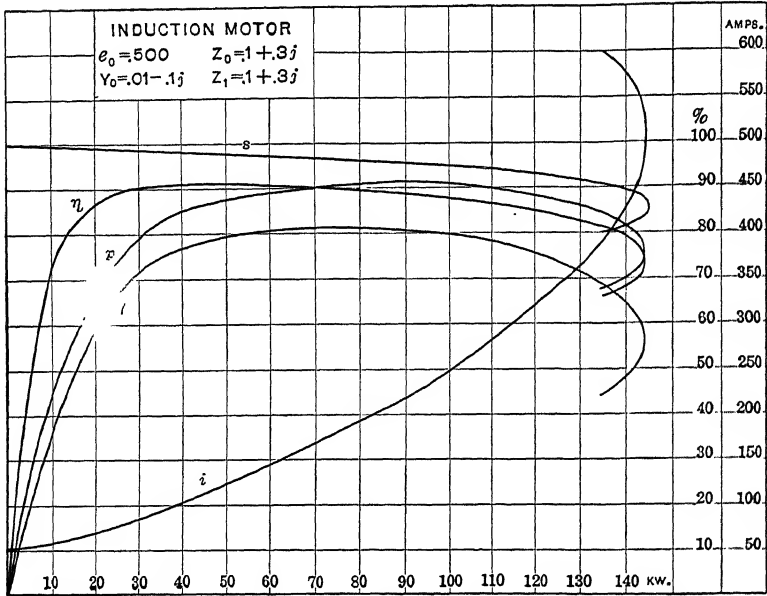

FIG. 22.—Load curves of standard induction motor.

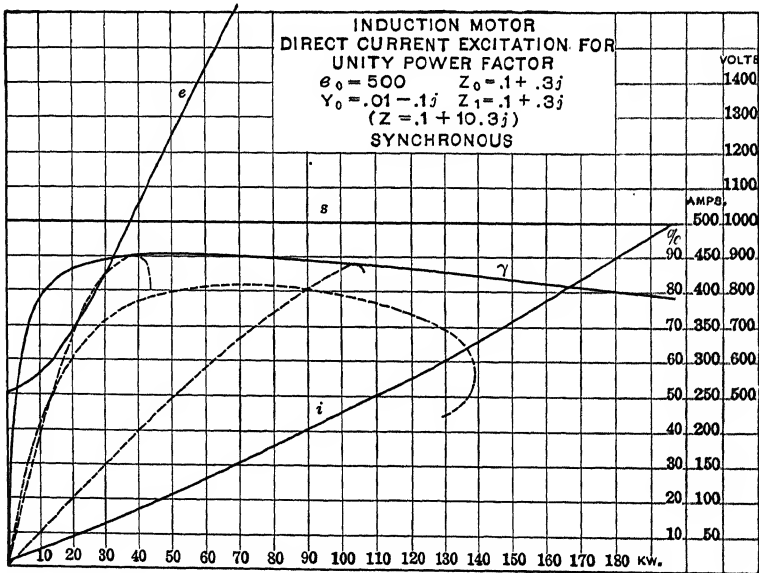

FIG. 23.—Load curves at unity power-factor excitation, of standard induction motor converted to synchronous motor.

Figs. 24 and 25 thus give the load characteristics of the motor, at constant field excitation, corresponding to:

in Fig. 24: $e = 2 e_0$;

in Fig. 25: $e = 5 e_0$.

For different values of the energy current, i_1 , from zero up to the maximum value possible under the given field excitation,

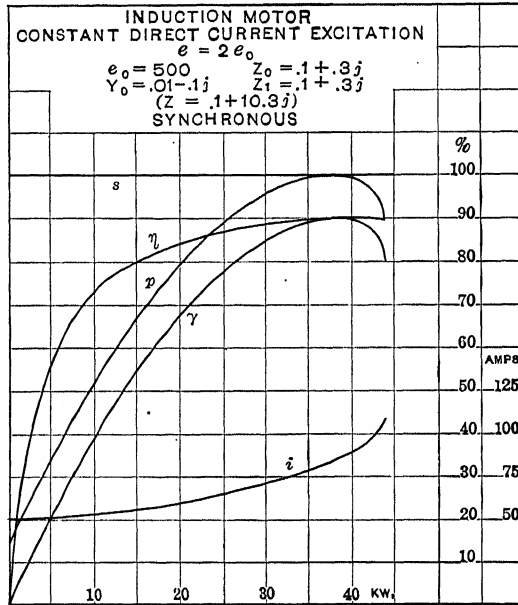

FIG. 24.—Load curves at constant excitation $2e$, of standard induction motor converted to synchronous motor.

as given by equation (12), the reactive current, i_2 , is calculated by equation (11):

Fig. 24: $i_2 = 48.5 - \sqrt{9410 - i_1^2}$;

Fig. 25: $i_2 = 48.5 - \sqrt{58,800 - i_1^2}$.

The total current then is:

$$i = \sqrt{i_1^2 + i_2^2}$$

the volt-ampere input:

$$Q = e_0 i$$

the power input:

$$P_0 = e_0 i_1$$

the power output given by (21), and herefrom efficiency η , power-factor p and apparent efficient, γ , calculated and plotted.

Figs. 24 and 25 give, with the power output as abscissæ, the total current input, efficiency, power-factor and apparent efficiency.

As seen from Figs. 24 and 25, the constants of the motor as synchronous motor with constant excitation, are very bad: the no-load current is nearly equal to full-load current, and power-

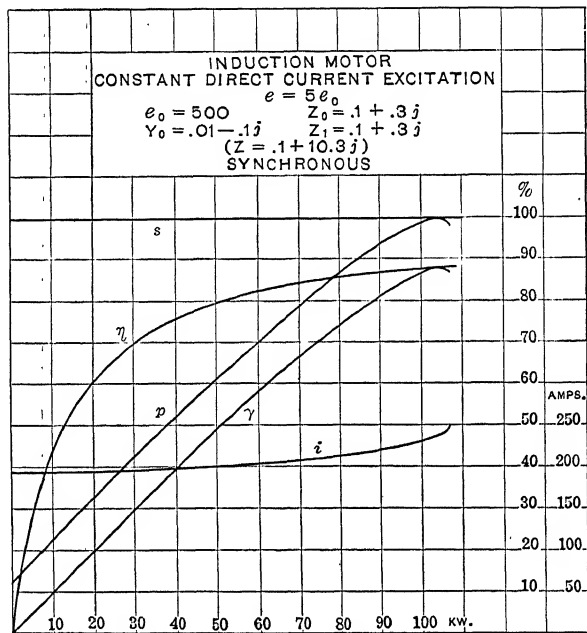

FIG. 25.—Load curves at constant excitation $5e$, of standard induction motor converted to synchronous motor.

factor and apparent efficiency are very low except in a narrow range just below the maximum output point, at which the motor drops out of step.

Thus this motor, and in general any reasonably good induction motor, would be spoiled in its characteristics, by converting it into a synchronous motor with constant field excitation.

In Fig. 23 are shown, for comparison, in dotted lines, the apparent efficiency taken from Figs. 24 and 25, and the apparent efficiency of the machine as induction motor, taken from Fig. 22.

45. As further instance, consider the conversion into a synchronous motor of a poor induction motor: a slow-speed motor of very high exciting current, of the constants:

$$\begin{aligned} e_0 &= 500; \\ Y_0 &= 0.02 - 0.6j; \\ Z_0 &= 0.1 + 0.3j; \\ Z_1 &= 0.1 + 0.3j. \end{aligned}$$

The load curves of this machine as induction motor are given in Fig. 20.

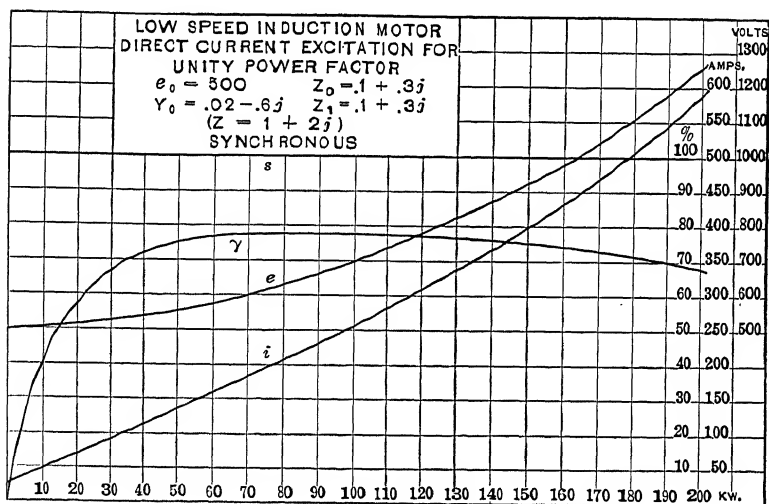

Fig. 26.—Load curves of low-speed high-excitation induction motor converted to synchronous motor, at unity power-factor excitation.

Converted to a synchronous motor, it has the constants:
Synchronous impedance:

$$Z = 0.1 + 1.97j.$$

Calculated in the same manner, the load curves, when varying the field excitation with changes of load so as to maintain unity power-factor, are given in Fig. 26, and the load curves for constant field excitation giving a nominal induced voltage:

$$e = 1.5 e_0$$

are given in Fig. 27.

As seen, the increase of field excitation required to maintain

unity power-factor, as shown by curve e in Fig. 26, while still considerable, is very much less in this poor induction motor, than it was in the good induction motor Figs. 22 to 25.

The constant-excitation load curves, Fig. 27, give characteristics, which are very much superior to those of the motor as induction motor. The efficiency is not materially changed, as was to be expected, but the power-factor, p , is very greatly improved at all loads, is 96 per cent. at full-load, rises to unity above full-

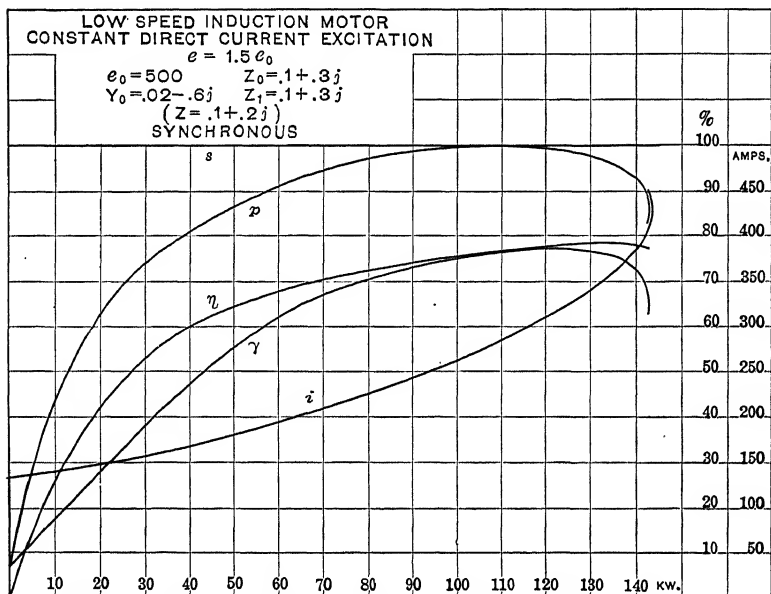

FIG. 27.—Load curve of low-speed high-excitation induction motor converted to synchronous motor, at constant field excitation.

load (assumed as 75 kw.) and is given at quarter-load already higher than the maximum reached by this machine as straight induction motor.

For comparison, in Fig. 28 are shown the curves of apparent efficiency, with the power output as abscissæ, of this slow-speed motor, as:

I as induction motor (from Fig. 20);

S_0 as synchronous motor with the field excitation varying to maintain unity power-factor (from Fig. 26);

S as synchronous motor with constant field excitation (from Fig. 27).

As seen, in the constants at load, constant excitation, S , is practically as good as varying unity power-factor excitation, S_0 , drops below it only at partial load, though even there it is very greatly superior to the induction-motor characteristic, I .

It thus follows:

By converting it into a synchronous motor, by passing a direct current through the rotor, a good induction motor is spoiled, but a poor induction motor, that is, one with very high exciting current, is greatly improved.

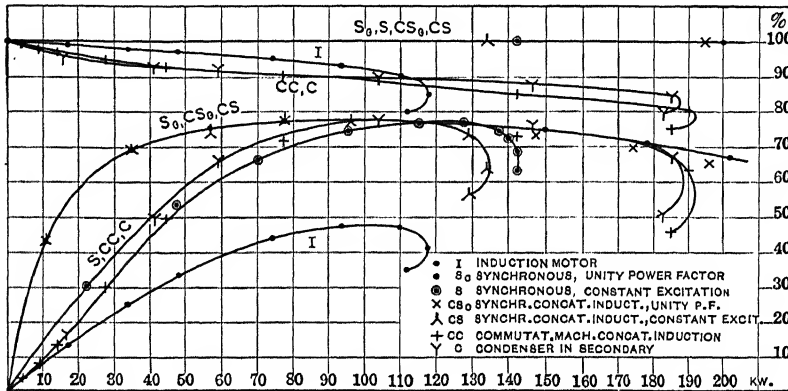

FIG. 28.—Comparison of apparent efficiency and speed curves of high-excitation induction motor with various forms of secondary excitation.

46. The reason for the unsatisfactory behavior of a good induction motor, when operated as synchronous motor, is found in the excessive value of its synchronous impedance.

Exciting admittance in the induction motor, and synchronous impedance in the synchronous motor, are corresponding quantities, representing the magnetizing action of the armature currents. In the induction motor, in which the magnetic field is produced by the magnetizing action of the armature currents, very high magnetizing action of the armature current is desirable, so as to produce the magnetic field with as little magnetizing current as possible, as this current is lagging, and spoils the power-factor. In the synchronous motor, where the magnetic field is produced by the direct current in the field coils, the magnetizing action of the armature currents changes the resultant field excitation, and thus requires a corresponding change of the field current to overcome it, and the higher the armature reaction, the more

has the field current to be changed with the load, to maintain proper excitation. That is, low armature reaction is necessary.

In other words, in the induction motor, the armature reaction magnetizes, thus should be large, that is, the synchronous reactance high or the exciting admittance low; in the synchronous motor the armature reaction interferes with the impressed field excitation, thus should be low, that is, the synchronous impedance low or the exciting admittance high.

Therefore, a good synchronous motor makes a poor induction motor, and a good induction motor makes a poor synchronous motor, but a poor induction motor—one of high exciting admittance, as Fig. 20—makes a fairly good synchronous motor.

Here a misunderstanding must be guarded against: in the theory of the synchronous motor, it is explained, that high synchronous reactance is necessary for good and stable synchronous-motor operation, and for securing good power-factors at all loads, at constant field excitation. A synchronous motor of low synchronous impedance is liable to be unstable, tending to hunt and give poor power-factors due to excessive reactive currents.

This apparently contradicts the conclusions drawn above in the comparison of induction and synchronous motor.

However, the explanation is found in the meaning of high and low synchronous reactance, as seen by expressing the synchronous reactance in per cent.: the percentage synchronous reactance is the voltage consumed by full-load current in the synchronous reactance, as percentage of the terminal voltage.

When discussing synchronous motors, we consider a synchronous reactance of 10 to 20 per cent. as low, and a synchronous reactance of 50 to 100 per cent. as high.

In the motor, Figs. 22 to 25, full-load current—at 75 kw. output—is about 180 amp. At a synchronous reactance of $x = 10.3$, this gives a synchronous reactance voltage at full-load current, of 1850, or a synchronous reactance of 370 per cent.

In the poor motor, Figs. 20, 26 and 27, full-load current is about 200 amp., the synchronous reactance $x = 1.97$, thus the reactance voltage 394, or 79 per cent., or of the magnitude of good synchronous-motor operation.

That is, the motor, which as induction motor would be considered as of very high exciting admittance, giving a low synchronous impedance when converted into a synchronous motor, would as synchronous motor, and from the viewpoint of synchronous-

motor design, be considered as a high synchronous impedance motor, while the good induction motor gives as synchronous motor a synchronous impedance of several hundred per cent., that is far beyond any value which ever would be considered in synchronous-motor design.

Induction Motor Concatenated with Synchronous

47. Let an induction machine have the constants:

$$Y_0 = g - jb = \text{primary exciting admittance,}$$

$$Z_0 = r_0 + jx_0 = \text{primary self-inductive impedance,}$$

$$Z_1 = r_1 + jx_1 = \text{secondary self-inductive impedance at full frequency, reduced to primary,}$$

and let the secondary circuit of this induction machine be connected to the armature terminals of a synchronous machine mounted on the induction-machine shaft, so that the induction-motor secondary currents traverse the synchronous-motor armature, and let:

$$Z_2 = r_2 + jx_2 = \text{synchronous impedance of the synchronous machine, at the full frequency impressed upon the induction machine.}$$

The frequency of the synchronous machine then is the frequency of the induction-motor secondary, that is, the frequency of the induction-motor slip. The synchronous-motor frequency also is the frequency of synchronous-motor rotation, or $\frac{1}{n}$ times the frequency of induction-motor rotation, if the induction motor has n times as many poles as the synchronous motor.

Herefrom follows:

$$\frac{1-s}{n} = s,$$

or:

$$s = \frac{1}{n+1}, \quad (1)$$

that is, the concatenated couple runs at constant slip, $s = \frac{1}{n+1}$, thus constant speed,

$$1-s = \frac{n}{n+1} \text{ of synchronism.} \quad (2)$$

Thus the machine couple has synchronous-motor characteristics, and runs at a speed corresponding to synchronous speed of a motor having the sum of the induction-motor and synchronous-motor poles as number of poles.

If $n = 1$, that is, the synchronous motor has the same number of poles as the induction motor,

$$\begin{aligned}s &= 0.5, \\ 1 - s &= 0.5,\end{aligned}$$

that is, the concatenated couple operates at half synchronous speed, and shares approximately equally in the power output.

If the induction motor has 76 poles, the synchronous motor four poles, $n = 19$, and:

$$\begin{aligned}s &= 0.05, \\ 1 - s &= 0.95,\end{aligned}$$

that is, the couple runs at 95 per cent. of the synchronous speed of a 76-polar machine, thus at synchronous speed of an 80-polar machine, and thus can be substituted for an 80-polar induction motor. In this case, the synchronous motor gives about 5 per cent., the induction motor 95 per cent. of the output; the synchronous motor thus is a small machine, which could be considered as a synchronous exciter of the induction machine.

48. Let:

$E_0 = e'_0 + je''_0$ = voltage impressed upon induction motor.

$E_1 = e'_1 + je''_1$ = voltage induced in induction motor, by mutual magnetic flux, reduced to full frequency.

$E_2 = e'_2 + je''_2$ = nominal induced voltage of synchronous motor, reduced to full frequency.

$I_0 = i'_0 - ji''_0$ = primary current in induction motor.

$I_1 = i'_1 - ji''_1$ = secondary current of induction motor and current in synchronous motor.

Denoting by Z^s the impedance, Z , at frequency, s , it is:

Total impedance of secondary circuit, at frequency, s :

$$\begin{aligned}Z^s &= Z_1^s + Z_2^s \\ &= (r_1 + r_2) + j^s(x_1 + x_2),\end{aligned}\tag{3}$$

and the equations are:
in primary circuit:

$$E_0 = E_1 + Z_0 I_0; \quad (4)$$

in secondary circuit:

$$sE_1 = sE_2 + Z^s I_1; \quad (5)$$

and, current:

$$I_0 = I_1 + Y E_1. \quad (6)$$

From (6) follows:

$$I_1 = I_0 - Y E_1, \quad (7)$$

and, substituting (7) into (5):

$$sE_1 = sE_2 + Z^s I_0 - Z^s Y E_1,$$

hence:

$$E_1 = \frac{s\dot{E}_2 + Z^s \dot{I}_0}{s + Z^s Y}; \quad (8)$$

substituting (8) into (4) gives:

$$E_0 = \frac{s\dot{E}_2 + (Z^s + sZ_0 + Z^s Z_0 Y) \dot{I}_0}{s + Z^s Y},$$

and, transposed:

$$E_0 \left(1 + \frac{Z^s}{s} Y\right) = E_2 + \left[\frac{Z^s}{s} + Z_0 \left(1 + \frac{Z^s}{s} Y\right)\right] I_0, \quad (9)$$

or:

$$\frac{\dot{E}_2}{1 + \frac{Z^s}{s} Y} = E_0 - \left(\frac{Z^s}{s + Z^s Y} + Z_0\right) I_0. \quad (10)$$

Denoting:

$$\left. \begin{aligned} \frac{r_1 + r_2}{s} &= r' \\ x_1 + x_2 &= x' \\ \frac{Z^s}{s} &= r' + jx' = Z' \end{aligned} \right\} \quad (11)$$

and:

it is, substituting into (9) and (10):

$$E_0 (1 + Z' Y) = E_2 + (Z' + Z_0 + Z' Z_0 Y) I_0, \quad (12)$$

$$\frac{\dot{E}_2}{1 + Z' Y} = E_0 - \left(\frac{Z'}{1 + Z' Y} + Z_0\right) I_0. \quad (13)$$

Denoting:

$$\frac{\dot{E}_2}{1 + ZY} = E = e' + je'' \quad (14)$$

as a voltage which is proportional to the nominal induced voltage of the synchronous motor, and:

$$\frac{Z'}{1 + Z'Y} + Z_0 = Z = r + jx \quad (15)$$

and substituting (14) and (15) into (13), gives:

$$E = E_0 - ZI_0. \quad (16)$$

This is the standard synchronous-motor equation, with impressed voltage, E_0 , current, I_0 , synchronous impedance, Z , and nominal induced voltage, E .

Choosing the impressed voltage, $E_0 = e_0$ as base line, and substituting into (16), gives:

$$e' + je'' = (e_0 - ri'_0 - xi''_0) - j(xi'_0 - ri''_0), \quad (17)$$

and, absolute:

$$e^2 = (e_0 - ri'_0 - x_0i''_0)^2 + (x_0i'_0 - r_0i''_0)^2. \quad (18)$$

From this equation (18) the load and speed curves of the concatenated couple can now be calculated in the same manner as in any synchronous motor.

That is, the concatenated couple, of induction and synchronous motor, can be replaced by an equivalent synchronous motor of the constants, e , e_0 , Z and I_0 .

49. The power output of the synchronous machine is:

$$P_2 = /I_1, sE_2/,'$$

where:

$$/a + jb, c + jd/'$$

denotes the effective component of the double-frequency product: $(ac + bd)$; see "Theory and Calculation of Alternating-current Phenomena," Chapter XVI, 5th edition.

The power output of the induction machine is:

$$P_1 = /I_1, (1 - s) E_1/,' \quad (20)$$

thus, the total power output of the concatenated couple:

$$\begin{aligned} P &= P_1 + P_2 \\ &= /I_1, sE_2 + (1 - s)E_1/;' \end{aligned} \quad (21)$$

substituting (7) into (21):

$$P = /I_0 - YE_1, sE_2 + (1 - s)E_1/''; \quad (22)$$

from (8) follows:

$$sE_2 = E_1 (s + Z^s Y) - Z^s I_0,$$

and substituting this into (22), gives:

$$P = /I_0 - YE_1, E_1 (1 + Z^s Y) - Z^s I_0/''; \quad (23)$$

from (4) follows:

$$E_1 = E_0 - Z_0 I_0,$$

and substituting this into (23) gives:

$$P = /I_0 (1 + Z_0 Y) - YE_0, E_0 (1 + Z^s Y) - I_0 (Z^s + Z_0 + Z_0 Z^s Y)/''. \quad (24)$$

Equation (24) gives the power output, as function of impressed voltage, E_0 , and supply current, I_0 .

The power input into the concatenated couple is given by:

$$P_0 = /E_0, I_0/'', \quad (25)$$

or, choosing $E_0 = e_0$ as base line:

$$P_0 = e_0 i_0'. \quad (26)$$

The apparent power, or volt-ampere input is given by:

$$Q = e_0 i_0, \quad (27)$$

where:

$$i_0 = \sqrt{i_0'^2 + i_0''^2}$$

is the total primary current.

From P , P_0 and Q now follow efficiency, power-factor and apparent efficiency.

50. As an instance may be considered the power-factor control of the slow-speed 80-polar induction motor of Fig. 20, by a small synchronous motor concatenated into its secondary circuit.

Impressed voltage:

$$e_0 = 500 \text{ volts.}$$

Choosing a four-polar synchronous motor, the induction machine would have to be redesigned with 76 poles, giving:

$$\begin{aligned} n &= 19, \\ s &= 0.05. \end{aligned}$$

With the same rotor diameter of the induction machine, the pole pitch would be increased inverse proportional to the number of poles, and the exciting susceptance decreased with the square thereof, thus giving the constants:

$$\begin{aligned} Y_0 &= g - jb = 0.02 - 0.54 j; \\ Z_0 &= r_0 + jx_0 = 0.1 + 0.3 j; \\ Z_1 &= r_1 + jx_1 = 0.1 + 0.3 j. \end{aligned}$$

Assuming as synchronous motor synchronous impedance, reduced to full frequency:

$$Z_2 = r_2 + jx_2 = 0.02 + 0.2 j$$

this gives, for $s = 0.05$:

$$Z^s = (r_1 + r_2) + js(x_1 + x_2) = 0.12 + 0.025j,$$

and:

$$Z' = r' + jx' = \frac{Z^s}{s} = 2.4 + 0.5 j,$$

$$Z = r + jx = 0.84 + 1.4 j,$$

and from (14):

$$\begin{aligned} E &= \frac{\dot{E}_2}{1.32 - 1.29 j}, \\ e &= \frac{e_2}{1.84}, \end{aligned}$$

thus:

$$\frac{e_2^2}{3.39} = (500 - 0.84 i'_0 - 1.4 i''_0)^2 + (1.4 i'_0 - 0.84 i''_0)^2, \quad (28)$$

and the power output:

$$\begin{aligned} P &= /I_0(0.836 + 0.048 j) - (10 - 270 j), \\ &\quad (508 - 32 j) - I_0(0.241 + 0.326 j)'. \quad (29) \end{aligned}$$

51. Fig. 29 shows the load curves of the concatenated couple, under the condition that the synchronous-motor excitation and thus its nominal induced voltage, e_2 , is varied so as to maintain unity power-factor at all loads, that is:

$$i''_0 = 0;$$

this gives from equation (28):

$$\frac{e_2^2}{3.39} = (500 - 0.84 i'_0)^2 + 1.96 i'_0{}^2,$$

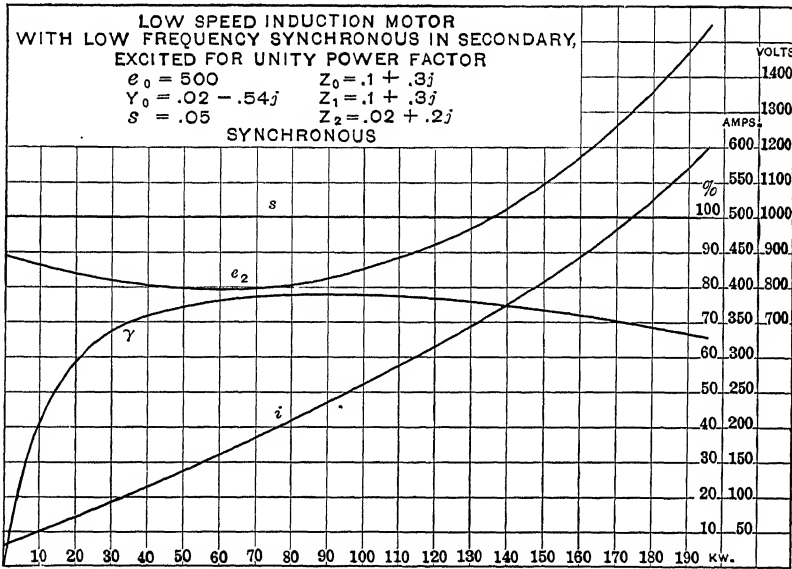

Fig. 29.—Load curves of high-excitation induction motor concatenated with synchronous, at unity power-factor excitation.

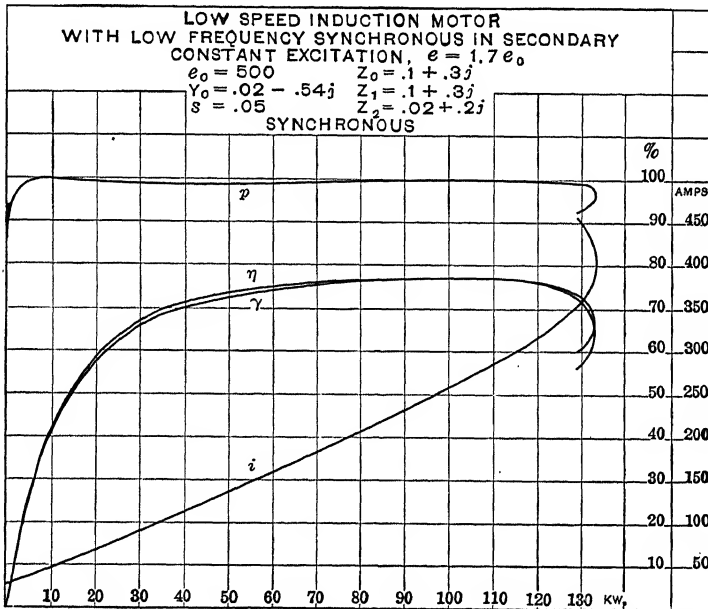

Fig. 30.—Load curves of high-excitation induction motor concatenated with synchronous, at constant excitation.

$$\begin{aligned}
 P &= / (0.8361 i'_0 - 10) + j (0.048 i'_0 + 270), \\
 &\quad (508 = 0.241 i'_0) - j (32 + 0.326 i'_0 / \\
 &= (0.836 i'_0 - 10) (508 - 0.241 i'_0) - (0.048 i'_0 + 270) \\
 &\quad (32 + 0.326 i'_0).
 \end{aligned}$$

As seen from the curve, e_2 , of the nominal induced voltage, the synchronous motor has to be overexcited at all loads. However, e_2 first decreases, reaches a minimum and then increases again, thus is fairly constant over a wide range of load, so that with this type of motor, constant excitation should give good results.

Fig. 30 then shows the load curves of the concatenated couple for constant excitation, on overexcitation of the synchronous motor of 70 per cent., or

$$e_2 = 850 \text{ volts.}$$

(It must be kept in mind, that e_2 is the voltage reduced to full frequency and turn ratio 1:1 in the induction machine: At the slip, $s = 0.05$, the actual voltage of the synchronous motor would be $se_2 = 42.5$ volts, even if the number of secondary turns of the induction motor equals that of the primary turns, and if, as usual, the induction motor is wound for less turns in the secondary than in the primary, the actual voltage at the synchronous motor terminals is still lower.)

As seen from Fig. 30:

the power-factor is practically unity over the entire range of load, from less than one-tenth load up to the maximum output point, and the current input into the motor thus is practically proportional to the load.

The load curves of this concatenated couple thus are superior to those, which can be produced in a synchronous motor at constant excitation.

For comparison, the curve of apparent efficiency, from Fig. 30, is plotted as CS in Fig. 28. It merges indistinguishably into the unity power-factor curve, S_0 , except at its maximum output point.

Induction Motor Concatenated with Commutating Machine

52. While the alternating-current commutating machine, especially of the polyphase type, is rather poor at higher frequencies, it becomes better at lower frequencies, and at the extremely low frequency of the induction-motor secondary, it is practically as

good as the direct-current commutating machine, and thus can be used to insert low-frequency voltage into the induction-motor secondary.

With series excitation, the voltage of the commutating machine is approximately proportional to the secondary current, and the speed characteristic of the induction motor remains essentially the same: a speed decreasing from synchronism at no-load, by a slip, s , which increases with the load.

With shunt excitation, the voltage of the commutating machine is approximately constant, and the concatenated couple thus tends toward a speed differing from synchronism.

In either case, however, the slip, s , is not constant and independent of the load, and the motor couple not synchronous, as when using a synchronous machine as second motor, but the motor couple is asynchronous, decreasing in speed with increase of load.

The phase relation of the voltage produced by the commutating machine, with regards to the secondary current which traverses it, depends on the relation of the commutator brush position with regards to the field excitation of the respective phases, and thereby can be made anything between 0 and 2π , that is, the voltage inserted by the commutating machine can be energy voltage in phase—reducing the speed—or in opposition to the induction-motor induced voltage—increasing the speed; or it may be a reactive voltage, lagging and thereby supplying the induction-motor magnetizing current, or leading and thereby still further lowering the power-factor. Or the commutating machine voltage may be partly in phase—modifying the speed—and partly in quadrature—modifying the power-factor.

Thus the commutating machine in the induction-motor secondary can be used for power-factor control or for speed control or for both.

It is interesting to note that the use of the commutating machine in the induction-motor secondary gives two independent variables: the value of the voltage, and its phase relation to the current of its circuit, and the motor couple thus has two degrees of freedom. With the use of a synchronous machine in the induction-motor secondary this is not the case; only the voltage of the synchronous machine can be controlled, but its phase adjusts itself to the phase relation of the secondary circuit, and the synchronous-motor couple thus has only one degree of freedom. The reason is: with a synchronous motor concatenated to

the induction machine, the phase of the synchronous machine is fixed in space, by the synchronous-motor poles, thus has a fixed relation with regards to the induction-motor primary system. As, however, the induction-motor secondary has no fixed position relation with regards to the primary, but can have any position slip, the synchronous-motor voltage has no fixed position with regards to the induction-motor secondary voltage and current, thus can assume any position, depending on the relation in the secondary circuit. Thus if we assume that the synchronous-motor field were shifted in space by α position degrees (electrical): this would shift the phase of the synchronous-motor voltage by α degrees, and the induction-motor secondary would slip in position by the same angle, thus keep the same phase relation with regards to the synchronous-motor voltage. In the couple with a commutating machine as secondary motor, however, the position of the brushes fixes the relation between commutating-machine voltage and secondary current, and thereby imposes a definite phase relation in the secondary circuit, irrespective of the relations between secondary and primary, and no change of relative position between primary and secondary can change this phase relation of the commutating machine.

Thus the commutating machine in the secondary of the induction machine permits a far greater variation of conditions of operation, and thereby gives a far greater variety of speed and load curves of such concatenated couple, than is given by the use of a synchronous motor in the induction-motor secondary.

53. Assuming the polyphase low-frequency commutating machine is series-excited, that is, the field coils (and compensating coils, where used) in series with the armature. Assuming also that magnetic saturation is not reached within the range of its use.

The induced voltage of the commutating machine then is proportional to the secondary current and to the speed.

$$\text{Thus:} \quad e_2 = p i_1 \quad (1)$$

is the commutating-machine voltage at full synchronous speed, where i_1 is the secondary current and p a constant depending on the design.

At the slip, s , and thus the speed $(1 - s)$, the commutating machine voltage thus is:

$$(1 - s) e_2 = (1 - s) p i_1. \quad (2)$$

As this voltage may have any phase relation with regards to the current, i_1 , we can put:

$$E_2 = (p_1 + jp_2)I_1 \quad (3)$$

where:

$$p = \sqrt{p_1^2 + p_2^2} \quad (4)$$

and:

$$\tan \omega = \frac{p_2}{p_1} \quad (5)$$

is the angle of brush shift of the commutating machine.

$(p_1 + jp_2)$ is of the nature and dimension of an impedance, and we thus can put:

$$Z^0 = p_1 + jp_2 \quad (6)$$

as the effective impedance representing the commutating machine. At the speed $(1 - s)$, the commutating machine is represented by the effective impedance:

$$(1 - s)Z^0 = (1 - s)p_1 + j(1 - s)p_2. \quad (7)$$

It must be understood, however, that in the effective impedance of the commutating machine,

$$Z^0 = p_1 + jp_2,$$

p_1 as well as p_2 may be negative as well as positive.

That is, the energy component of the effective impedance, or the effective resistance, p_1 , of the commutating machine, may be negative, representing power supply. This simply means, that the commutator brushes are set so as to make the commutating machine an electric generator, while it is a motor, if p_1 is positive.

If $p_1 = 0$, the commutating machine is a producer of wattless or reactive power, inductive for positive, anti-inductive for negative, p_2 .

The calculation of an induction motor concatenated with a commutating machine thus becomes identical with that of the straight induction motor with short-circuited secondary, except that in place of the secondary inductive impedance of the induction motor is substituted the total impedance of the secondary circuit, consisting of:

1. The secondary self-inductive impedance of the induction machine.

2. The self-inductive impedance of the commutating machine comprising resistance and reactance of armature and of field, and compensating winding, where such exists.

3. The effective impedance representing the commutating machine.

It must be considered, however, that in (1) and (2) the resistance is constant, the reactance proportional to the slip, s , while (3) is proportional to the speed $(1 - s)$.

54. Let:

$Y_0 = g - jb$ = primary exciting admittance of the induction motor.

$Z_0 = r_0 + jx_0$ = primary self-inductive impedance of the induction motor.

$Z_1 = r_1 + jx_1$ = secondary self-inductive impedance of the induction motor, reduced to full frequency.

$Z_2 = r_2 + jx_2$ = self-inductive impedance of the commutating machine, reduced to full frequency.

$Z^0 = p_1 + jp_2$ = effective impedance representing the voltage induced in the commutating machine, reduced to full frequency.

The total secondary impedance, at slip, s , then is:

$$\begin{aligned} Z^s &= (r_1 + jsx_1) + (r_2 + jsx_2) + (1 - s)(p_1 + jp_2) \\ &= [r_1 + r_2 + (1 - s)p_1] + j[s(x_1 + x_2) + (1 - s)p_2] \quad (8) \end{aligned}$$

and, if the mutual inductive voltage of the induction motor is chosen as base line, e , in the customary manner, the secondary current is:

$$I_1 = \frac{se}{Z^s} = (a_1 - ja_2)e, \quad (9)$$

where:

$$\left. \begin{aligned} a_1 &= \frac{s[r_1 + r_2 + (1 - s)p_1]}{m} \\ a_2 &= \frac{s[s(x_1 + x_2) + (1 - s)p_2]}{m} \end{aligned} \right\} \quad (10)$$

and:

$$m = [r_1 + r_2 + (1 - s) p_1]^2 + [s(x_1 + x_2) + (1 - s) p_2]^2.$$

The remaining calculation is the same as on page 318 of "Theoretical Elements of Electrical Engineering," 4th edition.

As an instance, consider the concatenation of a low-frequency commutating machine to the low-speed induction motor, Fig. 20.

The constants then are:

Impressed voltage:	$e_0 = 500;$
Exciting admittance:	$Y_0 = 0.02 - 0.6 j;$
Impedances:	$Z_0 = 0.1 + 0.3 j;$
	$Z_1 = 0.1 + 0.3 j;$
	$Z_2 = 0.02 + 0.3 j;$
	$Z^0 = -0.2 j.$

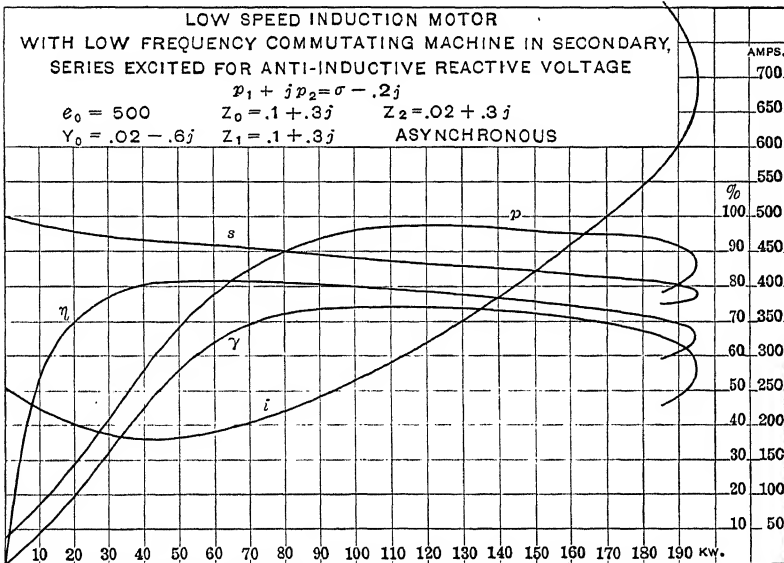

FIG. 31.—Load curves of high-excitation induction motor concatenated with commutating machine as reactive anti-inductive impedance.

That is, the commutating machine is adjusted to give only reactive lagging voltage, for power-factor compensation.

It then is:

$$Z^s = 0.12 + j [0.6 s - 0.2 (1 - s)].$$

The load curves of this motor couple are shown in Fig. 31. As

seen, power-factor and apparent efficiency rise to high values, and even the efficiency is higher than in the straight induction motor. However, at light-load the power-factor and thus the apparent efficiency falls off, very much in the same manner as in the concatenation with a synchronous motor.

It is interesting to note the relatively great drop of speed at light-load, while at heavier load the speed remains more nearly constant. This is a general characteristic of anti-inductive impedance in the induction-motor secondary, and shared by the use of an electrostatic condenser in the secondary.

For comparison, on Fig. 28 the curve of apparent efficiency of this motor couple is shown as *CC*.

Induction Motor with Condenser in Secondary Circuit

55. As a condenser consumes leading, that is, produces lagging reactive current, it can be used to supply the lagging component of current of the induction motor and thereby improve the power-factor.

Shunted across the motor terminals, the condenser consumes a constant current, at constant impressed voltage and frequency, and as the lagging component of induction-motor current increases with the load, the characteristics of the combination of motor and shunted condenser thus change from leading current at no-load, over unity power-factor to lagging current at overload. As the condenser is an external apparatus, the characteristics of the induction motor proper obviously are not changed by a shunted condenser.

As illustration is shown, in Fig. 32, the slow-speed induction motor Fig. 20, shunted by a condenser of 125 kva. per phase. Fig. 32 gives efficiency, η , power-factor, p , and apparent efficiency, γ , of the combination of motor and condenser, assuming an efficiency of the condenser of 99.5 per cent., that is, 0.5 per cent. loss in the condenser, or $Z = 0.0025 - 0.5j$, that is, a condenser just neutralizing the magnetizing current.

However, when using a condenser in shunt, it must be realized that the current consumed by the condenser is proportional to the frequency, and therefore, if the wave of impressed voltage is greatly distorted, that is, contains considerable higher harmonics—especially harmonics of high order—the condenser may produce considerable higher-frequency currents, and thus by distortion

of the current wave lower the power-factor, so that in extreme cases the shunted condenser may actually lower the power-factor. However, with the usual commercial voltage wave shapes, this is rarely to be expected.

In single-phase induction motors, the condenser may be used in a tertiary circuit, that is, a circuit located on the same member (usually the stator) as the primary circuit, but displaced in posi-

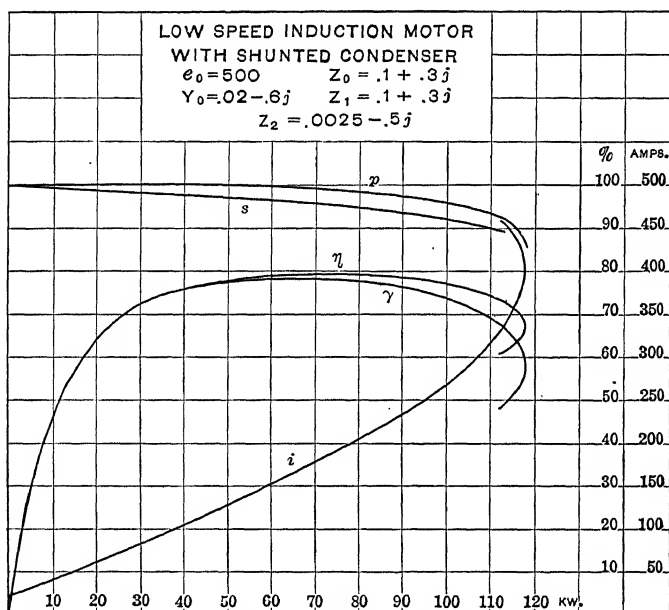

FIG. 32.—Load curves of high-excitation induction motor with shunted condenser.

tion therefrom, and energized by induction from the secondary. By locating the tertiary circuit in mutual induction also with the primary, it can be used for starting the single-phase motor, and is more fully discussed in Chapter V.

A condenser may also be used in the secondary of the induction motor. That is, the secondary circuit is closed through a condenser in each phase. As the current consumed by a condenser is proportional to the frequency, and the frequency in the secondary circuit varies, decreasing toward zero at synchronism, the current consumed by the condenser, and thus the secondary current of the motor tends toward zero when approaching synchronism,

and peculiar speed characteristics result herefrom in such a motor. At a certain slip, s , the condenser current just balances all the reactive lagging currents of the induction motor, resonance may thus be said to exist, and a very large current flows into the motor, and correspondingly large power is produced. Above this "resonance speed," however, the current and thus the power rapidly fall off, and so also below the resonance speed.

It must be realized, however, that the frequency of the secondary is the frequency of slip, and is very low at speed, thus a very great condenser capacity is required, far greater than would be sufficient for compensation by shunting the condenser across the primary terminals. In view of the low frequency and low voltage of the secondary circuit, the electrostatic condenser generally is at a disadvantage for this use, but the electrolytic condenser, that is, the polarization cell, appears better adapted.

56. Let then, in an induction motor, of impressed voltage, e_0 :

$$Y_0 = g - jb = \text{exciting admittance};$$

$$Z_0 = r_0 + jx_0 = \text{primary self-inductive impedance};$$

$$Z_1 = r_1 + jx_1 = \text{secondary self-inductive impedance at full frequency};$$

and let the secondary circuit be closed through a condenser of capacity reactance, at full frequency:

$$Z_2 = r_2 - jx_2,$$

where r_2 , representing the energy loss in the condenser, usually is very small and can be neglected in the electrostatic condenser, so that:

$$Z_2 = -jx_2.$$

The inductive reactance, x_1 , is proportional to the frequency, that is, the slip, s , and the capacity reactance, x_2 , inverse proportional thereto, and the total impedance of the secondary circuit, at slip, s , thus is:

$$Z^s = r_1 + j \left(sx_1 - \frac{x_2}{s} \right), \quad (1)$$

thus the secondary current:

$$\begin{aligned} I_1 &= \frac{es}{Z^s} \\ &= e(a_1 - ja_2), \end{aligned} \quad (2)$$

where:

$$\left. \begin{aligned} a_1 &= \frac{r_1}{m}, \\ a_2 &= \frac{\left(sx_1 - \frac{x_2}{s}\right)}{m}, \\ m &= r_1^2 + \left(sx_1 + \frac{x_2}{s}\right)^2. \end{aligned} \right\} \quad (3)$$

All the further calculations of the motor characteristics now are the same as in the straight induction motor.

As instance is shown the low-speed motor, Fig. 20, of constants:

$$\begin{aligned} e_0 &= 500; \\ Y_0 &= 0.02 - 0.6 j; \\ Z_0 &= 0.1 + 0.3 j; \\ Z_1 &= 0.1 + 0.3 j; \end{aligned}$$

with the secondary closed by a condenser of capacity impedance:

$$Z_2 = -0.012 j,$$

thus giving:

$$Z^s = 0.1 + 0.3 j \left(s - \frac{0.04}{s} \right).$$

Fig. 33 shows the load curves of this motor with condenser in the secondary. As seen, power-factor and apparent efficiency are high at load, but fall off at light-load, being similar in character as with a commutating machine concatenated to the induction machine, or with the secondary excited by direct current, that is, with conversion of the induction into a synchronous motor.

Interesting is the speed characteristic: at very light-load the speed drops off rapidly, but then remains nearly stationary over a wide range of load, at 10 per cent. slip. It may thus be said, that the motor tends to run at a nearly constant speed of 90 per cent. of synchronous speed.

The apparent efficiency of this motor combination is plotted once more in Fig. 28, for comparison with those of the other motors, and marked by *C*.

Different values of secondary capacity give different operating speeds of the motor: a lower capacity, that is, higher capacity

reactance, x_2 , gives a greater slip, s , that is, lower operating speed, and inversely, as was discussed in Chapter I.

57. It is interesting to compare, in Fig. 28, the various methods of secondary excitation of the induction motor, in their effect in improving the power-factor and thus the apparent efficiency of a motor of high exciting current and thus low power-factor, such as a slow-speed motor.

The apparent efficiency characteristics fall into three groups:

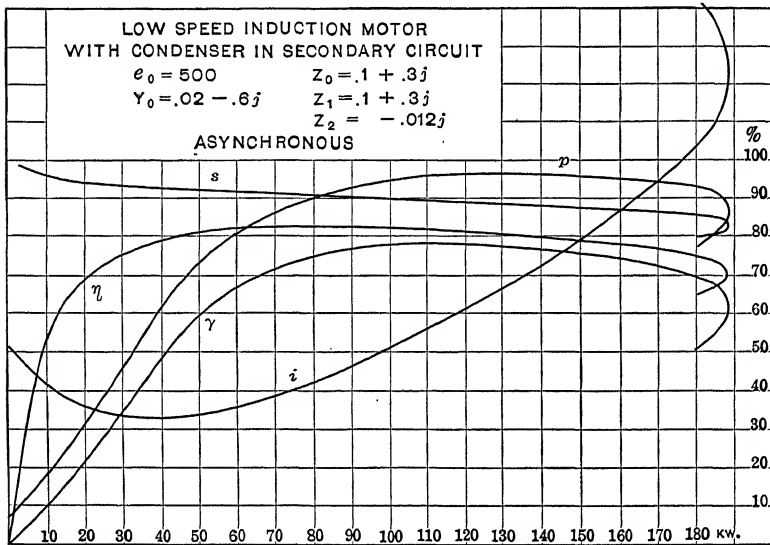

Fig. 33.—Load curves of high-excitation induction motor with condensers in secondary circuits.

1. Low apparent efficiency at all loads: the straight slow-speed induction motor, marked by I .

2. High apparent efficiency at all loads:

The synchronous motor with unity power-factor excitation, S_0 .

Concatenation to synchronous motor with unity power-factor excitation, CS_0 .

Concatenation to synchronous motor with constant excitation, CS .

These three curves are practically identical, except at great overloads.

3. Low apparent efficiency at light-loads, high apparent

efficiency at load, that is, curves starting from (1) and rising up to (2).

Hereto belong: The synchronous motor at constant excitation, marked by *S*.
Concatenation to a commutating machine, *CC*.
Induction motor with condenser in secondary circuit, *C*.

These three curves are very similar, the points calculated for the three different motor types falling within the narrow range between the two limit curves drawn in Fig. 28.

Regarding the speed characteristics, two types exist: the motors S_0 , S , CS_0 and CS are synchronous, the motors I , CC and C are asynchronous.

In their efficiencies, there is little difference between the different motors, as is to be expected, and the efficiency curves are almost the same up to the overloads where the motor begins to drop out of step, and the efficiency thus decreases.

Induction Motor with Commutator

58. Let, in an induction motor, the turns of the secondary winding be brought out to a commutator. Then by means of brushes bearing on this commutator, currents can be sent into the secondary winding from an outside source of voltage.

Let then, in Fig. 34, the full-frequency three-phase currents supplied to the three commutator brushes of such a motor be shown as *A*. The current in a secondary coil of the motor, supplied from the currents, *A*, through the commutator, then is shown as *B*. Fig. 34 corresponds to a slip, $s = \frac{1}{8}$. As seen from Fig. 34, the commutated three-phase current, *B*, gives a resultant effect, which is a low-frequency wave, shown dotted in Fig. 34 *B*, and which has the frequency of slip, *s*, or, in other words, the commutated current, *B*, can be resolved into a current of frequency, *s*, and a higher harmonic of irregular wave shape.

Thus, the effect of low-frequency currents, of the frequency of slip, can be produced in the induction-motor secondary by impressing full frequency upon it through commutator and brushes.

The secondary circuit, through commutator and brushes, can be connected to the supply source either in series to the primary,

or in shunt thereto, and thus gives series-motor characteristics, or shunt-motor characteristics.

In either case, two independent variables exist, the value of the voltage impressed upon the commutator, and its phase, and the phase of the voltage supplied to the secondary circuit may be varied, either by varying the phase of the impressed voltage by a suitable transformer, or by shifting the brushes on the commutator and thereby the relative position of the brushes with regards to the stator, which has the same effect.

However, with such a commutator motor, while the resultant magnetic effect of the secondary currents is of the low frequency

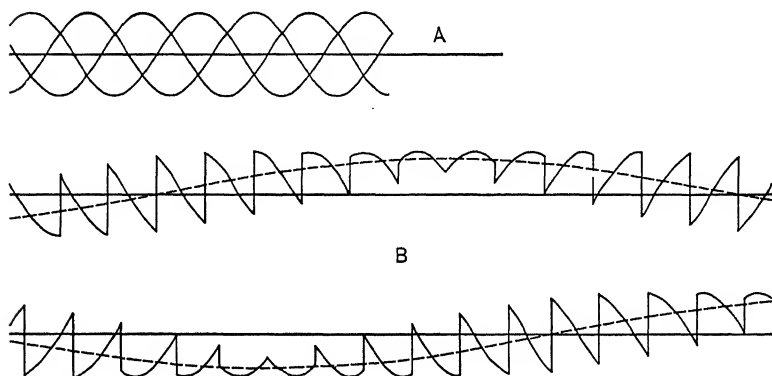

FIG. 34.—Commutated full-frequency current in induction motor secondary.

of slip, the actual current in each secondary coil is of full frequency, as a section or piece of a full-frequency wave, and thus it meets in the secondary the full-frequency reactance. That is, the secondary reactance at slip, s , is not: $Z^s = r_1 + jsx_1$, but is: $Z^s = r_1 + jx_1$, in other words is very much larger than in the motor with short-circuited secondary.

Therefore, such motors with commutator always require power-factor compensation, by shifting the brushes or choosing the impressed voltage so as to be anti-inductive.

Of the voltage supplied to the secondary through commutator and brushes, a component in phase with the induced voltage lowers the speed, a component in opposition raises the speed, and by varying the commutator supply voltage, speed control of such an induction motor can be produced in the same manner and of the same character, as produced in a direct-current motor

by varying the field excitation. Good constants can be secured, if in addition to the energy component of impressed voltage, used for speed control, a suitable anti-inductive wattless component is used.

However, this type of motor in reality is not an induction motor any more, but a shunt motor or series motor, and is more fully discussed in Chapter XIX, on "General Alternating-current Motors."

59. Suppose, however, that in addition to the secondary winding connected to commutator and brushes, a short-circuited squirrel-cage winding is used on the secondary. Instead of this, the commutator segments may be shunted by resistance, which gives the same effect, or merely a squirrel-cage winding used, and on one side an end ring of very high resistance employed, and the brushes bear on this end ring, which thus acts as commutator.

In either case, the motor is an induction motor, and has the essential characteristics of the induction motor, that is, a slip, s , from synchronism, which increases with the load; however, through the commutator an exciting current can be fed into the motor from a full-frequency voltage supply, and in this case, the current supplied over the commutator does not meet the full-frequency reactance, x_1 , of the secondary, but only the low-frequency reactance, sx_1 , especially if the commutated winding is in the same slots with the squirrel-cage winding: the short-circuited squirrel-cage winding acts as a short-circuited secondary to the high-frequency pulsation of the commutated current, and therefore makes the circuit non-inductive for these high-frequency pulsations, or practically so. That is, in the short-circuited conductors, local currents are induced equal and opposite to the high-frequency component of the commutated current, and the total resultant of the currents in each slot thus is only the low-frequency current.

Such short-circuited squirrel cage in addition to the commutated winding, makes the use of a commutator practicable for power-factor control in the induction motor. It forbids, however, the use of the commutator for speed control, as due to the short-circuited winding, the motor must run at the slip, s , corresponding to the load as induction motor. The voltage impressed upon the commutator, and its phase relation, or the brush position, thus must be chosen so as to give only magnetizing, but

no speed changing effects, and this leaves only one degree of freedom.

The foremost disadvantage of this method of secondary excitation of an induction motor, by a commutated winding in addition to the short-circuited squirrel cage, is that secondary excitation is advantageous for power-factor control especially in slow-speed motors of very many poles, and in such, the commutator becomes very undesirable, due to the large number of poles. With such motors, it therefore is preferable to separate the commutator, placing it on a small commutating machine of a few poles, and concatenating this with the induction motor. In motors of only a small number of poles, in which a commutator would be less objectionable, power-factor compensation is rarely needed. This is the foremost reason that this type of motor (the Heyland motor) has found no greater application.

CHAPTER V

SINGLE-PHASE INDUCTION MOTOR

60. As more fully discussed in the chapters on the single-phase induction motor, in "Theoretical Elements of Electrical Engineering" and "Theory and Calculation of Alternating-current Phenomena," the single-phase induction motor has inherently, no torque at standstill, that is, when used without special device to produce such torque by converting the motor into an unsymmetrical ployphase motor, etc. The magnetic flux at standstill is a single-phase alternating flux of constant direction, and the line of polarization of the armature or secondary currents, that is, the resultant m.m.f. of the armature currents, coincides with the axis of magnetic flux impressed by the primary circuit. When revolving, however, even at low speeds, torque appears in the single-phase induction motor, due to the axis of armature polarization being shifted against the axis of primary impressed magnetic flux, by the rotation. That is, the armature currents, lagging behind the magnetic flux which induces them, reach their maximum later than the magnetic flux, thus at a time when their conductors have already moved a distance or an angle away from coincidence with the inducing magnetic flux. That is, if the armature currents lag $\frac{\pi}{2} = 90^\circ$ beyond the primary main flux, and reach their maximum 90° in time behind the magnetic flux, at the slip, s , and thus speed $(1 - s)$, they reach their maximum in the position $(1 - s)\frac{\pi}{2} = 90(1 - s)$ electrical degrees behind the direction of the main magnetic flux. A component of the armature currents then magnetizes in the direction at right angles (electrically) to the main magnetic flux, and the armature currents thus produce a quadrature magnetic flux, increasing from zero at standstill, to a maximum at synchronism, and approximately proportional to the quadrature component of the armature polarization, P :

$$P \sin (1 - s) \frac{\pi}{2}$$

The torque of the single-phase motor then is produced by the action of the quadrature flux on the energy currents induced by the main flux, and thus is proportional to the quadrature flux.

At synchronism, the quadrature magnetic flux produced by the armature currents becomes equal to the main magnetic flux produced by the impressed single-phase voltage (approximately, in reality it is less by the impedance drop of the exciting current in the armature conductors) and the magnetic disposition of the single-phase induction motor thus becomes at synchronism identical with that of the polyphase induction motor, and approximately so near synchronism.

The magnetic field of the single-phase induction motor thus may be said to change from a single-phase alternating field at standstill, over an unsymmetrical rotating field at intermediate speeds, to a uniformly rotating field at full speed.

At synchronism, the total volt-ampere excitation of the single-phase motor thus is the same as in the polyphase motor at the same induced voltage, and decreases to half this value at standstill, where only one of the two quadrature components of magnetic flux exists. The primary impedance of the motor is that of the circuits used. The secondary impedance varies from the joint impedance of all phases, at synchronism, to twice this value at standstill, since at synchronism all the secondary circuits correspond to the one primary circuit, while at standstill only their component parallel with the primary circuit corresponds.

61. Hereby the single-phase motor constants are derived from the constants of the same motor structure as polyphase motor.

Let, in a polyphase motor:

$$Y = g - jb = \text{primary exciting admittance;}$$

$$Z_0 = r_0 + jx_0 = \text{primary self-inductive impedance;}$$

$$Z_1 = r_1 + jx_1 = \text{secondary self-inductive impedance (reduced to the primary by the ratio of turns, in the usual manner);}$$

the characteristic constant of the motor then is:

$$\delta = Y (Z_0 + Z_1). \quad (1)$$

The total, or resultant admittance respectively impedance of

the motor, that is, the joint admittance respectively impedance of all the phases, then is:

In a *three-phase motor*:

$$\left. \begin{aligned} Y^0 &= 3 Y, \\ Z_0^0 &= \frac{1}{3} Z_0, \\ Z_1^0 &= \frac{1}{3} Z_1. \end{aligned} \right\} \quad (2)$$

In a *quarter-phase motor*:

$$\left. \begin{aligned} Y^0 &= 2 Y, \\ Z_0^0 &= \frac{1}{2} Z_0, \\ Z_1^0 &= \frac{1}{2} Z_1. \end{aligned} \right\} \quad (3)$$

In the same motor, as *single-phase motor*, it is then: at synchronism: $s = 0$.

$$\left. \begin{aligned} Y' &= Y^0, \\ Z'_0 &= 2 Z_0^0, \\ Z'_1 &= Z_1^0, \end{aligned} \right\} \quad (4)$$

hence the characteristic constant:

$$\begin{aligned} \vartheta'_0 &= Y' (Z'_0 + Z'_1) \\ &= Y^0 (2 Z_0^0 + Z_1^0), \end{aligned} \quad (5)$$

at standstill: $s = 1$:

$$\left. \begin{aligned} Y' &= \frac{1}{2} Y^0, \\ Z'_0 &= 2 Z_0^0, \\ Z'_1 &= 2 Z_1^0, \end{aligned} \right\} \quad (6)$$

hence, the characteristic constant:

$$\vartheta'_1 = Y^0 (Z_0^0 + Z_1^0) \quad (7)$$

approximately, that is, assuming linear variation of the constants with the speed or slip, it is then: at slip, s :

$$\left. \begin{aligned} Y' &= Y^0 \left(1 - \frac{s}{2}\right), \\ Z'_0 &= 2 Z_0, \\ Z'_1 &= Z_1^0 (1 + s). \end{aligned} \right\} \quad (8)$$

This gives, in a three-phase motor:

$$\left. \begin{aligned} Y' &= 3Y \left(1 - \frac{s}{2}\right), \\ Z'_0 &= \frac{2}{3} Z_0, \\ Z'_1 &= \frac{1+s}{3} Z_1. \end{aligned} \right\} \quad (9)$$

In a quarter-phase motor:

$$\left. \begin{aligned} Y' &= 2 Y \left(1 - \frac{s}{2}\right), \\ Z'_0 &= Z_0, \\ Z'_1 &= \frac{1+s}{2} Z_1^0. \end{aligned} \right\} \quad (10)$$

Thus the characteristic constant, \mathcal{V}' , of the single-phase motor is higher, that is, the motor inferior in its performance than the polyphase motor; but the quarter-phase motor makes just as good—or poor—a single-phase motor as the three-phase motor.

62. The calculation of the performance curves of the single-phase motor from its constants, then, is the same as that of the polyphase motor, except that:

In the expression of torque and of power, the term $(1 - s)$ is added, which results from the decreasing quadrature flux, and it thus is:

Torque:

$$\begin{aligned} T' &= T (1 - s) \\ &= (1 - s) a_1 e^2. \end{aligned} \quad (11)$$

Power:

$$\begin{aligned} P' &= P (1 - s) \\ &= (1 - s)^2 a_1 e^2. \end{aligned} \quad (12)$$

However, these expressions are approximate only, as they assume a variation of the quadrature flux proportional to the speed.

63. As the single-phase induction motor is not inherently self-starting, starting devices are required. Such are:

(a) Mechanical starting.

As in starting a single-phase induction motor it is not necessary, as in a synchronous motor, to bring it up to full speed, but the motor begins to develop appreciable torque already at low speed, it is quite feasible to start small induction motors by hand, by a pull on the belt, etc., especially at light-load and if of high-resistance armature.

(b) By converting the motor in starting into a shunt or series motor.

This has the great objection of requiring a commutator, and a commutating-machine rotor winding instead of the common induction-motor squirrel-cage winding. Also, as series motor, the liability exists in the starting connection, of running away;

as shunt motor, sparking is still more severe. Thus this method is used to a limited extent only.

(c) By shifting the axis of armature or secondary polarization against the axis of inducing magnetism.

This requires a secondary system, which is electrically unsymmetrical with regards to the primary system, and thus, since the secondary is movable with regards to the primary, requires means of changing the secondary circuit, that is, commutator brushes short-circuiting secondary coils in the position of effective torque, and open-circuiting them in the position of opposing torque.

Thus this method leads to the various forms of repulsion motors, of series and of shunt characteristic.

It has the serious objection of requiring a commutator and a corresponding armature winding; though the limitation is not quite as great as with the series or shunt motor, since in the repulsion motors the armature current is an induced secondary current, and the armature thus independent of the primary system regards current, voltage and number of turns.

(d) By shifting the axis of magnetism, that is producing a magnetic flux displaced in phase and in position from that inducing the armature currents, in other words, a quadrature magnetic flux, such as at speed is being produced by the rotation.

This method does not impose any limitation on stator and rotor design, requires no commutator and thus is the method almost universally employed.

It thus may be considered somewhat more in detail.

The infinite variety of arrangements proposed for producing a quadrature or starting flux can be grouped into three classes:

A. Phase-splitting Devices.—The primary system of the single-phase induction motor is composed of two or more circuits displaced from each other in position around the armature circumference, and combined with impedances of different inductance factors so as to produce a phase displacement between them.

The motor circuits may be connected in series, and shunted by the impedance, or they may be connected in shunt with each other, but in series with their respective impedance, or they may be connected with each other by transformation, etc.

B. Inductive Devices.—The motor is excited by two or more circuits which are in inductive relation with each other so as to produce a phase displacement.

This inductive relation may be established outside of the motor by an external phase-splitting device, or may take place in the motor proper.

C. Monocyclic Devices.—An essentially reactive quadrature voltage is produced outside of the motor, and used to energize a cross-magnetic circuit in the motor, either directly through a separate motor coil, or after combination with the main voltage to a system of voltages of approximate three-phase or quarter-phase relation.

D. Phase Converter.—By a separate external phase converter—usually of the induction-machine type—the single-phase supply is converted into a polyphase system.

Such phase converter may be connected in shunt to the motor, or may be connected in series thereto.

This arrangement requires an auxiliary machine, running idle, however. It therefore is less convenient, but has the advantage of being capable of giving full polyphase torque and output to the motor, and thus would be specially suitable for railroading.

64. If:

Φ_0 = main magnetic flux of single-phase motor, that is, magnetic flux produced by the impressed single-phase voltage, and

Φ = auxiliary magnetic flux produced by starting device, and if

ω = space angle between the two fluxes, in electrical degrees, and

ϕ = time angle between the two fluxes,

then the torque of the motor is proportional to:

$$T = a \Phi \Phi_0 \sin \omega \sin \phi; \quad (13)$$

in the same motor as polyphase motor, with the magnetic flux, Φ_0 , the torque is:

$$T_0 = a \Phi_0^2; \quad (14)$$

thus the *torque ratio* of the starting device is:

$$t = \frac{T}{T_0} = \frac{\Phi}{\Phi_0} \sin \omega \sin \phi, \quad (15)$$

or, if:

Φ' = quadrature flux produced by the starting device, that is,

component of the auxiliary flux, in quadrature to the main flux, Φ_0 , in time and in space, it is:

Single-phase motor starting torque:

$$T = a\Phi'\Phi_0, \quad (16)$$

and starting-torque ratio:

$$t = \frac{\Phi'}{\Phi_0}. \quad (17)$$

As the magnetic fluxes are proportional to the impressed voltages, in coils having the same number of turns, it is: starting torque of single-phase induction motor:

$$\left. \begin{aligned} T &= be_0e \sin \omega \sin \phi \\ &= be_0e', \end{aligned} \right\} \quad (18)$$

and, starting-torque ratio:

$$\left. \begin{aligned} t &= \frac{e}{e_0} \sin \omega \sin \phi \\ &= \frac{e'}{e_0}, \end{aligned} \right\} \quad (19)$$

where:

e_0 = impressed single-phase voltage,

e = voltage impressed upon the auxiliary or starting winding, reduced to the same number of turns as the main winding, and

e' = quadrature component, in time and in space, of this voltage, e ,

and the comparison is made with the torque of a quarter-phase motor of impressed voltage, e_0 , and the same number of turns.

Or, if by phase-splitting, monocyclic device, etc., two voltages, e_1 and e_2 , are impressed upon the two windings of a single-phase induction motor, it is:

Starting torque:

$$T = be_1e_2 \sin \omega \sin \phi \quad (20)$$

and, starting-torque ratio:

$$t = \frac{e_1e_2}{e_0^2} \sin \omega \sin \phi, \quad (21)$$

where e_0 is the voltage impressed upon a quarter-phase motor, with which the single-phase motor torque is compared, and all

these voltages, e_1 , e_2 , e_0 , are reduced to the same number of turns of the circuits, as customary.

If then:

Q = volt-amperes input of the single-phase motor with starting device, and
 Q_0 = volt-amperes input of the same motor with polyphase supply,

$$q = \frac{Q}{Q_0} \quad (22)$$

is the volt-ampere ratio, and thus:

$$v = \frac{t}{q} \quad (23)$$

is the ratio of the apparent starting-torque efficiency of the single-phase motor with starting device, to that of the same motor as polyphase motor. v may thus be called the *apparent torque efficiency* of the single-phase motor-starting device.

In the same manner the apparent power efficiency of the starting device would result by using the power input instead of the volt-ampere input.

65. With a starting device producing a quadrature voltage, e' ,

$$t = \frac{e'}{e_0} \quad (24)$$

is the ratio of the quadrature voltage to the main voltage, and also is the starting-torque ratio.

The quadrature flux:

$$e' = te_0 \quad (25)$$

requires an exciting current, equal to t times that of the main voltage in the motor without starting device, the exciting current at standstill is:

$$e_0 Y' = \frac{e_0 Y^0}{2}$$

and in the motor with starting device giving voltage ratio, t , the total exciting current at standstill thus is:

$$\frac{e_0 Y^0}{2} (1 + t)$$

and thus, the exciting admittance:

$$Y^* = \frac{Y^0}{2} (1 + t); \quad (27)$$

in the same manner, the secondary impedance at standstill is:

$$Z'_1 = \frac{2Z_1^0}{1 + t} \quad (28)$$

and thus

in the single-phase induction motor with starting device producing at standstill the ratio of quadrature voltage to main voltage

$$t = \frac{e'}{e_0}$$

the constants are, at slip, s ,

$$\left. \begin{aligned} Y^* &= Y^0 \left\{ 1 - \frac{s(1-t)}{2} \right\}, \\ Z'_0 &= 2Z_0^0, \\ Z'_1 &= \frac{1+s}{1+st} Z_1^0. \end{aligned} \right\} \quad (29)$$

However, these expressions (29) are approximate only, as they assume linear variation with s , and furthermore, they apply only under the condition, that the effect of the starting device does not vary with the speed of the motor, that is, that the voltage ratio, t , does not depend on the effective impedance of the motor. This is the case only with a few starting devices, while many depend upon the effective impedance of the motor, and thus with the great change of the effective impedance of the motor with increasing speed, the conditions entirely change, so that no general equations can be given for the motor constants.

66. Equations (18) to (23) permit a simple calculation of the starting torque, torque ratio and torque efficiency of the single-phase induction motor with starting device, by comparison with the same motor as polyphase motor, by means of the calculation of the voltages, e' , e_1 , e_2 , etc., and this calculation is simply that of a compound alternating-current circuit, containing the induction motor as an effective impedance. That is, since the only determining factor in the starting torque is the voltage impressed upon the motor, the internal reactions of the motor do not come into consideration, but the motor merely acts as an effective impedance. Or in other words, the consideration of the internal

reaction of the motor is eliminated by the comparison with the polyphase motor.

In calculating the effective impedance of the motor at standstill, we consider the same as an alternating-current transformer, and use the equivalent circuit of the transformer, as discussed in Chapter XVII of "Theory and Calculation of Alternating-current Phenomena." That is, the induction motor is considered as two impedances, Z_0 and Z_1 , connected in series to the

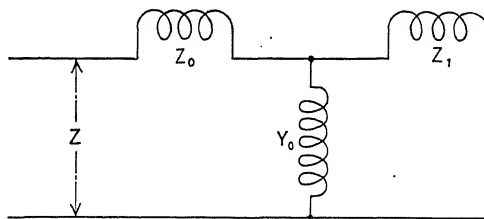

Fig. 35.—The equivalent circuit of the induction motor.

impressed voltage, with a shunt of the admittance, Y_0 , between the two impedances, as shown in Fig. 35.

The effective impedance then is:

$$\begin{aligned} Z &= Z_0 + \frac{1}{\frac{1}{Z_1} + Y_0} \\ &= Z_0 + \frac{Z_1}{1 + Z_1 Y_0}; \end{aligned} \quad (30)$$

approximately, this is:

$$Z_a = Z_0 + Z_1. \quad (31)$$

This approximation (31), is very close, if Z_1 is highly inductive, as a short-circuited low-resistance squirrel cage, but ceases to be a satisfactory approximation if the secondary is of high resistance, for instance, contains a starting rheostat.

As instances are given in the following the correct values of the effective impedance, Z , from equation (30), the approximate value (31), and their difference, for a three-phase motor without starting resistance, with a small resistance, with the resistance giving maximum torque at standstill, and a high resistance:

$Y_0:$	$Z_0:$	$Z_1:$	$Z:$	$Z_a:$	$\Delta:$
0.01 - 0.1j	0.1 + 0.3j	0.1 + 0.3j	0.195 + 0.592j	0.2 + 0.6j	- 0.005 - 0.008j
		0.25 + 0.3j	0.336 + 0.596j	0.35 + 0.6j	- 0.014 - 0.004j
		0.6 + 0.3j	0.661 + 0.620j	0.7 + 0.6j	- 0.039 + 0.020j
		1.6 + 0.3j	1.552 + 0.804j	1.7 + 0.6j	- 0.148 + 0.204j

A. PHASE-SPLITTING DEVICES

Parallel Connection

67. Let the motor contain two primary circuits at right angles (electrically) in space with each other, and of equal effective impedance:

$$Z = r + jx.$$

These two motor circuits are connected in parallel with each

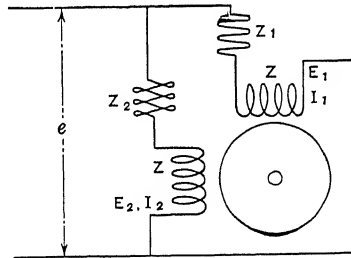

FIG. 36.—Diagram of phase-splitting device with parallel connection of motor circuits.

other between the same single-phase mains of voltage, e_0 , but the first motor circuit contains in series the impedance

$$Z_1 = r_1 + jx_1,$$

the second motor circuit the impedance:

$$Z_2 = r_2 + jx_2,$$

as shown diagrammatically in Fig. 36.

The two motor currents then are:

$$I_1 = \frac{e_0}{Z + Z_1} \text{ and } I_2 = \frac{e_0}{Z + Z_2}, \tag{32}$$

$$I = I_1 + I_2, \tag{33}$$

the two voltages across the two motor coils:

$$\begin{aligned} E_1 &= I_1 Z \quad \text{and} \quad E_2 = I_2 Z \\ &= e_0 \frac{Z}{Z + Z_1}, \quad = e_0 \frac{Z}{Z + Z_2}, \end{aligned} \quad (34)$$

and the phase angle between E_1 and E_2 is given by:

$$m (\cos \phi + j \sin \phi) = \frac{Z + Z_1}{Z + Z_2}. \quad (35)$$

Denoting the absolute values of the voltages and currents by small letters, it is:

$$T = be_1e_2 \sin \phi; \quad (36)$$

in the motor as quarter-phase motor, with voltage, e_0 , impressed per circuit, it is:

$$T_0 = be_0^2, \quad (37)$$

hence, the torque ratio:

$$t = \frac{e_1e_2}{e_0^2} \sin \phi. \quad (38)$$

The current per circuit, in the machine as quarter-phase motor, is:

$$i_0 = \frac{e_0}{z}, \quad (39)$$

hence the volt-amperes:

$$Q_0 = 2e_0i_0, \quad (40)$$

while the volt-amperes of the single-phase motor, inclusive starting impedances, are:

$$Q = e_0i, \quad (41)$$

thus:

$$q = \frac{i}{2i_0} = \frac{iz}{2e_0} \quad (42)$$

and, the apparent torque efficiency of the starting device:

$$v = \frac{t}{q} = \frac{2e_1e_2 \sin \phi}{e_0iz} \quad (43)$$

68. As an instance, consider the motor of effective impedance:

$$Z = r + jx = 0.1 + 0.3j,$$

thus:

$$z = 0.316,$$

and assume, as the simplest case, a resistance, $a = 0.3$, inserted in series to the one motor circuit. That is:

$$\begin{aligned} Z_1 &= 0, \\ Z_2 &= a. \end{aligned} \quad (44)$$

It is then:

$$(32): I = \frac{e_0}{r + jx} = \frac{e_0}{0.1 + 0.3j} \quad I_2 = \frac{e_0}{r + a + jx} = \frac{e_0}{0.4 + 0.3j}$$

$$= e_0(1 - 3j), \quad = e_0(1.6 - 1.2j);$$

$$(33): \quad \begin{aligned} I &= e_0(2.6 - 4.2j), \\ i &= 4.94 e_0; \end{aligned}$$

$$(34): \quad \begin{aligned} E_1 &= e_0, & E_2 &= e_0 \frac{r + jx}{r + a + jx} = e_0 \frac{0.1 + 0.3j}{0.4 + 0.3j}, \\ e_1 &= e_0, & e_2 &= 0.632 e_0; \end{aligned}$$

$$(35): \quad \begin{aligned} m(\cos \phi + j \sin \phi) &= \frac{r + jx}{r + a + jx} = \frac{0.1 + 0.3j}{0.4 + 0.3j} \\ &= 0.52 + 0.36j, \end{aligned}$$

$$\tan \phi = \frac{0.36}{0.52},$$

$$\sin \phi = 0.57;$$

$$(38): \quad t = 0.36;$$

$$(43): \quad v = 0.46.$$

Thus this arrangement gives 46 per cent., or nearly half as much starting torque per volt-ampere taken from the supply circuit, as the motor would give as polyphase motor.

However, as polyphase motor with low-resistance secondary, the starting torque per volt-ampere input is low.

With a high-resistance motor armature, which on polyphase supply gives a good apparent starting-torque efficiency, v would be much lower, due to the lower angle, ϕ . In this case, however, a reactance, $+ja$, would give fairly good starting-torque efficiency.

In the same manner the effect of reactance or capacity inserted into one of the two motor coils can be calculated.

As instances are given, in Fig. 37, the apparent torque efficiency, v , of the single-phase induction-motor starting device consisting of the insertion, in one of the two parallel motor circuits, of various amounts of reactance, inductive or positive, and capacity

or negative, for a low secondary resistance motor of impedance:

$$Z = 0.1 + 0.3j$$

and a high resistance armature, of the motor impedance:

$$Z = 0.3 + 0.1j$$

resistance inserted into the one motor circuit, has the same effect

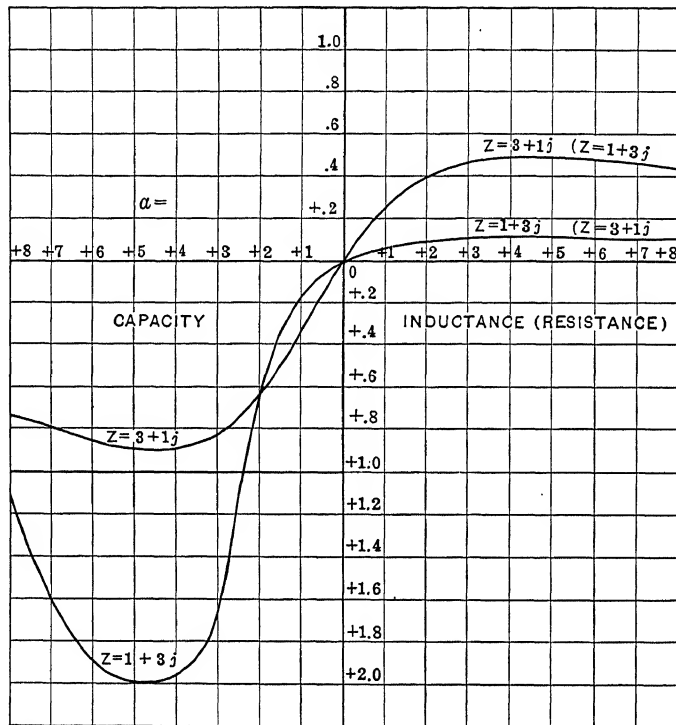

FIG. 37.—Apparent starting-torque efficiencies of phase-splitting device, parallel connection of motor circuits.

in the first motor, as positive reactance in the second motor, and inversely.

69. Higher values of starting-torque efficiency are secured by the use of capacity in the one, and inductance in the other motor circuit. It is obvious that by resistance and inductance alone, 90° phase displacement between the two component currents, and thus true quarter-phase relation, can not be reached.

As resistance consumes energy, the use of resistance is justified

only due to its simplicity and cheapness, where moderate starting torques are sufficient, and thus the starting-torque efficiency less important. For producing high starting torque with high starting-torque efficiency, thus, only capacity and inductance would come into consideration.

Assume, then, that the one impedance is a capacity:

$$x_2 = -k, \quad \text{or:} \quad Z_2 = -jk, \quad (45)$$

while the other, x_1 , may be an inductance or also a capacity, whatever may be desired:

$$Z_1 = +jx_1, \quad (46)$$

where x_1 is negative for a capacity.

It is, then:

$$(35): m (\cos \phi + j \sin \phi) = \frac{r + j(x_1 + x)}{r - j(k - x)} = \frac{[r^2 - (x_1 + x)(k - x)] + jr x_1 k}{r^2 + (k - x)^2}. \quad (47)$$

True quadrature relation of the voltages, e_1 and e_2 , or angle,

$\phi = \frac{\pi}{2}$, requires:

$$\cos \phi = 0,$$

thus:

$$(x_1 + x)(k - x) = r^2 \quad (48)$$

and the two voltages, e_1 and e_2 , are equal, that is, a true quarter-phase system of voltages is produced, if in

$$(34): \quad [Z + Z_1] = [Z + Z_2],$$

where the [] denote the absolute values.

This gives:

$$r^2 + (x_1 + x)^2 = r^2 + (k - x)^2,$$

or:

$$x_1 + x = k - x, \quad (49)$$

hence, by (48):

$$\left. \begin{aligned} x_1 + x &= k - x = r, \\ k &= r + x, \\ x_1 &= r - x. \end{aligned} \right\} \quad (50)$$

Thus, if $x > r$, or in a low-resistance motor, the second reactance, x_1 , also must be a capacity.

70. Thus, let:
in a low-resistance motor:

$$\begin{aligned} Z &= r + jx = 0.1 + 0.3j, \\ k &= 0.4, \quad x_1 = -0.2, \\ Z_2 &= -0.4j, \quad Z_1 = -0.2j, \end{aligned}$$

that is, both reactances are capacities.

$$(34): \quad \begin{aligned} e_1 &= e_2 = 2.23 e_0, \\ t &= 5, \end{aligned}$$

that is, the torque is five times as great as on true quarter-phase supply.

$$\begin{aligned} I_1 &= \frac{e_0}{0.1 + 0.1j}, & I_2 &= \frac{e_0}{0.1 - 0.1j}, \\ I &= 10 e_0 = i, \end{aligned}$$

that is, non-inductive, or unity power-factor.

$$\begin{aligned} i_0 &= \frac{e_0}{Z} = 3.16 e_0, \\ q &= 1.58, \\ v &= 3.16, \end{aligned}$$

that is, the apparent starting-torque efficiency, or starting torque per volt-ampere input, of the single-phase induction motor with starting devices consisting of two capacities giving a true quarter-phase system, is 3.16 as high as that of the same motor on a quarter-phase voltage supply, and the circuit is non-inductive in starting, while on quarter-phase supply, it has the power-factor 31.6 per cent. in starting.

In a high-resistance motor:

$$Z = 0.3 + 0.1j,$$

it is:

$$\begin{aligned} k &= 0.4, \quad x_1 = 0.2, \\ Z_2 &= -0.4j, \quad Z_1 = +0.2j, \end{aligned}$$

that is, the one reactance is a capacity, the other an inductance.

$$\begin{aligned} e_1 &= e_2 = 0.743 e_0, \\ t &= 0.555, \\ i &= 3.33 e_0, \\ i_0 &= 3.16 e_0, \\ q &= 0.527, \\ v &= 1.055, \end{aligned}$$

that is, the starting-torque efficiency is a little higher than with quarter-phase supply. In other words:

This high-resistance motor gives 5.5 per cent. more torque per volt-ampere input, with unity power-factor, on single-phase supply, than it gives on quarter-phase supply with 95 per cent. power-factor.

The value found for the low-resistance motor, $t = 5$, is however not feasible, as it gives: $e_1 = e_2 = 2.23 e_0$, and in a quarter-phase motor designed for impressed voltage, e_0 , the impressed voltage, $2.23 e_0$, would be far above saturation. Thus the motor would have to be operated at lower supply voltage single-phase, and then give lower t , though the same value of $v = 3.16$. At $e_1 = e_2 = e_0$, the impressed voltage of the single-phase circuit would be about 45 per cent. of e_0 , and then it would be: $t = 1$.

Thus, in the low-resistance motor, it would be preferable to operate the two motor circuits in series, but shunted by the two different capacities producing true quarter-phase relation.

Series Connection

71. The calculation of the single-phase starting of a motor with two coils in quadrature position, shunted by two impedances

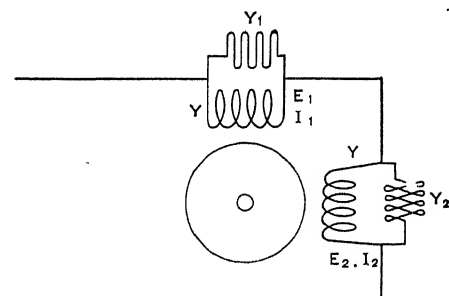

FIG. 38.—Diagram of phase-splitting device with series connection of motor circuits

of different power-factor, as shown diagrammatically in Fig. 38, can be carried out in the same way as that of parallel connection, except that it is more convenient in series connection to use the term "admittance" instead of impedance.

That is, let the effective admittance per motor coil equal:

$$Y = \frac{1}{Z} = g - jb,$$

and the two motor coils be shunted respectively by the admittances:

$$\left. \begin{aligned} Y_1 &= g_1 - jb_1, \\ Y_2 &= g_2 - jb_2, \end{aligned} \right\} \quad (52)$$

it is then:

$$I = \frac{e_0}{\frac{1}{Y + Y_1} + \frac{1}{Y + Y_2}}, \quad (53)$$

the current consumed by the motor, and:

$$E_1 = \frac{I}{Y + Y_1} \quad \text{and} \quad E_2 = \frac{I}{Y + Y_2}, \quad (54)$$

the voltages across the two motor circuits.

The phase difference between E_1 and E_2 thus is given by

$$m (\cos \phi + j \sin \phi) = \frac{Y + Y_2}{Y + Y_1}, \quad (55)$$

and herefrom follows t , q and v .

As instance consider a motor of effective admittance per circuit:

$$Y = g - jb = 1 - 3j,$$

with the two circuits connected in series between single-phase mains of voltage, e_0 , and one circuit shunted by a non-inductive resistance of conductance, g_1 .

What value of g_1 gives maximum starting torque, and what is this torque?

It is:

$$(53): I = \frac{e_0}{\frac{1}{g + g_1 - jb} + \frac{1}{g - jb}} = \frac{e_0 (g - jb)(g + g_1 - jb)}{2g + g_1 - 2jb}; \quad (56)$$

$$(54): E_1 = \frac{e_0 (g - jb)}{2g + g_1 - 2jb}; \quad E_2 = \frac{e_0 (g + g_1 - jb)}{2g + g_1 - 2jb}; \quad (57)$$

$$(55): m (\cos \phi + j \sin \phi) = \frac{g + g_1 - jb}{g - jb} = \frac{[g(g + g_1) + b^2] + jg_1b}{g^2 + b^2};$$

hence:

$$\begin{aligned} \tan \phi &= \frac{g_1b}{g(g + g_1) + b^2}, \\ \sin \phi &= \frac{g_1b}{\sqrt{g_1^2b^2 + [g(g + g_1) + b^2]^2}} \end{aligned} \quad (58)$$

and thus:

$$t = \frac{e_1 e_2 \sin \phi}{e_0^2} = \frac{g_1 b}{[(2g + g_1)^2 + 4b^2]}$$

$$= \frac{g_1 b}{(2g + g_1)^2 + 4b^2}, \quad (59)$$

and for maximum, t :

$$\frac{dt}{dg_1} = 0,$$

thus:

$$g_1 = 2\sqrt{g^2 + b^2}$$

$$= 2y = 6.32, \quad (60)$$

or, substituting back:

$$(59): \quad t = \frac{b}{4(g + y)} = 0.18. \quad (61)$$

As in single-phase operation, the voltage, e_0 , is impressed upon the two quadrature coils in series, each coil receives only about $\frac{e_0}{\sqrt{2}}$. Comparing then the single-phase starting torque with that of a quarter-phase motor of impressed voltage, $\frac{e_0}{\sqrt{2}}$, it is:

$$t = 0.36.$$

The reader is advised to study the possibilities of capacity and reactance (inductive or capacity) shunting the two motor coils, the values giving maximum torque, those giving true quarter-phase relation, and the torque and apparent torque efficiencies secured thereby.

B. INDUCTIVE DEVICES

External Inductive Devices

72. Inductively divided circuit: in its simplest form, as shown diagrammatically in Fig. 39, the motor contains two circuits at right angles, of the same admittance.

The one circuit (1) is in series with the one, the other (2) with the other of two coils wound on the same magnetic circuit, M . By proportioning the number of turns, n_1 and n_2 , of the two coils, which thus are interlinked inductively with each other on the external magnetic circuit, M , a considerable phase displacement

between the motor coils, and thus starting torque can be produced, especially with a high-resistance armature, that is, a motor with starting rheostat.

A full discussion and calculation of this device is contained in the paper on the "Single-phase Induction Motor," page 63, A. I. E. E. *Transactions*, 1898.

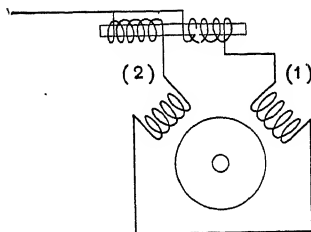

FIG. 39.—External inductive device.

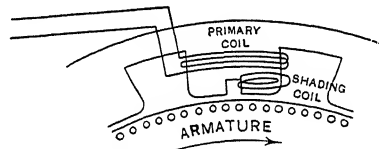

FIG. 40.—Diagram of shading coil.

Internal Inductive Devices

The exciting system of the motor consists of a stationary primary coil and a stationary secondary coil, short-circuited upon itself (or closed through an impedance), both acting upon the revolving secondary.

The stationary secondary can either cover a part of the pole face excited by the primary coil, and is then called a "shading coil," or it has the same pitch as the primary, but is angularly displaced therefrom in space, by less than 90° (usually 45° or 60°), and then has been called accelerating coil.

The shading coil, as shown diagrammatically in Fig. 40, is the simplest of all the single-phase induction motor-starting devices, and therefore very extensively used, though it gives only a small starting torque, and that at a low apparent starting-torque efficiency. It is almost exclusively used in very small motors which require little starting torque, such as fan motors, and thus industrially constitutes the most important single-phase induction motor-starting device.

73. Let, all the quantities being reduced to the primary number of turns and frequency, as customary in induction machines:

$Z_0 = r_0 + jx_0 =$ primary self-inductive impedance,

$Y = g - jb =$ primary exciting admittance of unshaded poles (assuming total pole unshaded),

$Y' = g' - jb'$ = primary exciting admittance of shaded poles
(assuming total pole shaded).

If the reluctivity of the shaded portion of the pole is the same as that of the unshaded, then $Y' = Y$; in general, if

b = ratio of reluctivity of shaded to unshaded portion of pole,

$$Y' = bY,$$

b either = 1, or, sometimes, $b > 1$, if the air gap under the shaded portion of the pole is made larger than that under the unshaded portion.

$Y_1 = g_1 - jb_1$ = self-inductive admittance of the revolving secondary or armature,

$Y_2 = g_2 - jb_2$ = self-inductive admittance of the stationary secondary or shading coil, inclusive its external circuit, where such exists.

Z_0 , Y_1 and Y_2 thus refer to the self-inductive impedances, in which the energy component is due to effective resistance, and Y and Y' refer to the mutual inductive impedances, in which the energy component is due to hysteresis and eddy currents.

a = shaded portion of pole, as fraction of total pole; thus

$(1 - a)$ = unshaded portion of pole.

If:

e_0 = impressed single-phase voltage,

E_1 = voltage induced by flux in unshaded portion of pole,

E_2 = voltage induced by flux in shaded portion of pole,

I_0 = primary current,

it is then:

$$e_0 = E_1 + E_2 + Z_0 I_0. \quad (62)$$

The secondary current in the armature under the unshaded portion of the pole is:

$$I_1 = E_1 Y_1. \quad (63)$$

The primary exciting current of the unshaded portion of the pole:

$$I_{00} = \frac{E_1 Y}{1 - a}, \quad (64)$$

thus:

$$I_0 = I_1 + I_{00} = E_1 \left\{ Y_1 + \frac{Y}{1 - a} \right\}. \quad (65)$$

The secondary current under the shaded portion of the pole is:

$$I'_1 = E_2 Y_1. \quad (66)$$

The current in the shading coil is:

$$I_2 = E_2 Y_2. \quad (67)$$

The primary exciting current of the shaded portion of the pole is:

$$I'_{00} = \frac{\dot{E}_2 b Y}{a}, \quad (68)$$

thus:

$$I_0 = I'_1 + I'_{00} + I_2 = E_2 \left\{ Y_1 + \frac{b}{a} Y + Y_2 \right\}; \quad (69)$$

from (65) and (69) follows:

$$\frac{\dot{E}_1}{E_2} = \frac{Y_1 + \frac{b}{a} Y + Y_2}{Y_1 + \frac{Y}{1-a}} = m (\cos \phi + j \sin \phi), \quad (70)$$

and this gives the angle, ϕ , of phase displacement between the two component voltages, E_1 and E_2 .

If, as usual, $b = 1$, and

if $a = 0.5$, that is, half the pole is shaded, it is:

$$\frac{\dot{E}_1}{E_2} = \frac{Y_1 + 2Y + Y_2}{Y_1 + 2Y}. \quad (71)$$

74. Assuming now, as first approximation, $Z_0 = 0$, that is, neglecting the impedance drop in the single-phase primary coil—which obviously has no influence on the phase difference between the component voltages, and the ratio of their values, that is, on the approximation of the devices to polyphase relation—then it is:

$$E_1 + E_2 = e_0; \quad (72)$$

thus, from (70):

$$\left. \begin{aligned} E_1 &= e_0 \frac{Y_1 + \frac{b}{a} Y + Y_2}{2 Y_1 + Y \left(\frac{b}{a} + \frac{1}{1-a} \right) + Y_2} \\ E_2 &= e_0 \frac{Y_1 + \frac{Y}{1-a}}{2 Y_1 + Y \left(\frac{b}{a} + \frac{1}{1-a} \right) + Y_2}; \end{aligned} \right\} \quad (73)$$

or, for:

$$\left. \begin{aligned} b &= 1; a = 0.5; \\ E_1 &= \frac{Y_1 + 2Y + Y_2}{2Y_1 + 4Y + Y_2}, \\ E_2 &= \frac{Y_1 + 2Y}{2Y_1 + 4Y + Y_2} \end{aligned} \right\} \quad (74)$$

and the primary current, or single-phase supply current is, by substituting (73) into (65):

$$I_0 = e_0 \frac{\left(Y_1 + \frac{Y}{1-a}\right) \left(Y_1 + \frac{b}{a}Y + Y_2\right)}{2Y_1 + Y\left(\frac{b}{a} + \frac{1}{1-a}\right) + Y_2}; \quad (75)$$

or, for:

$$\left. \begin{aligned} b &= 1; a = 0.5: \\ I_0 &= e_0 \frac{(Y_1 + 2Y)(Y_1 + 2Y + Y_2)}{2Y_1 + 4Y + Y_2} \end{aligned} \right\} \quad (76)$$

and herefrom follows, by reducing to absolute values, the torque, torque ratio, volt-ampere input, apparent torque efficiency, etc.

Or, denoting:

$$\left. \begin{aligned} Y_1 + \frac{Y}{1-a} &= Y^0, \\ Y + \frac{b}{a}Y + Y_2 &= Y', \end{aligned} \right\} \quad (77)$$

it is:

$$(70): \quad \frac{E_1}{E_2} = \frac{Y'}{Y^0} = m (\cos \phi + j \sin \phi); \quad (78)$$

$$(73): \quad \left. \begin{aligned} E_1 &= \frac{e_0 Y'}{Y^0 + Y'} \\ E_2 &= \frac{e_0 Y^0}{Y^0 + Y'} \end{aligned} \right\} \quad (79)$$

$$(75): \quad I_0 = \frac{e_0 Y^0 Y'}{Y^0 + Y'} \quad (80)$$

$$T = A e_1 e_2 \sin \phi,$$

$$Q = e_0 i_0;$$

and for a quarter-phase motor, with voltage $\frac{e_0}{\sqrt{2}}$ impressed per

circuit, neglecting the primary impedance, z_0 , to be comparable with the shaded-coil single-phase motor, it is:

$$i_0 = \frac{e_0}{\sqrt{2}} (Y + Y_1),$$

$$Q_0 = \frac{2e_0 i_0}{\sqrt{2}} = e_0^2 / Y + Y_1 /,$$

$$T_0 = A \frac{e_0^2}{2},$$

thus:

$$q = \frac{i_0 \sqrt{2}}{i_0' \sqrt{2}},$$

$$t = \frac{2e_1 e_2}{e_0^2} \sin \phi,$$

$$v = \frac{t}{q}.$$

75. As instances are given in the following table the component voltages, e_1 and e_2 , the phase angle, ϕ , between them, the primary current, i_0 , the torque ratio, t , and the apparent starting-torque efficiency, v , for the shaded-pole motor with the constants:

Impressed voltage: $e_0 = 100$;
 Primary exciting admittance: $Y = 0.001 - 0.01 j$.
 $b = 1$, that is, uniform air gap.
 $a = 0.5$, that is, half the pole is shaded.

And for the three motor armatures:

Low resistance: $Y_1 = 0.01 - 0.03 j$,
 Medium resistance: $Y_1 = 0.02 - 0.02 j$,
 High resistance: $Y_1 = 0.03 - 0.01 j$;

and for the three kinds of shading coils:

Low resistance: $Y_2 = 0.01 - 0.03 j$,
 Medium resistance: $Y_2 = 0.02 - 0.02 j$,
 High resistance: $Y_2 = 0.03 - 0.01 j$.

As seen from this table, the phase angle, ϕ , and thus the starting torque, t , are greatest with the combination of low-resistance armature and high-resistance shading coil, and of high-resistance armature with low-resistance shading coil; but in the first case the torque is in opposite direction—accelerating coil—from what

it is in the second case—lagging coil. In either case, the torque efficiency is low, that is, the device is not suitable to produce high starting-torque efficiencies, but its foremost advantage is the extreme simplicity.

The voltage due to the shaded portion of the pole, e_2 , is less than that due to the unshaded portion, e_1 , and thus a somewhat higher torque may be produced by shading more than half of the pole: $a > 0.5$.

A larger air gap: $b > 1$, under the shaded portion of the pole, or an external non-inductive resistance inserted into the shading coil, under certain conditions increases the torque somewhat—at a sacrifice of power-factor—particularly with high-resistance armature and low-resistance shading coil.

$$e_0 = 100 \text{ volts; } a = 0.5; b = 1; Y = 0.001 - 0.01 j.$$

$Y_1:$	$Y_2:$	$e_1:$	$e_2:$	$\phi:$	$i_0:$	$t_1:$	$v:$
$\times 10^{-2}$	$\times 10^{-2}$					per cent.	per cent.
1 - 3j	1 - 3j	38.3	61.8	+ 1.9	1.97	+ 1.56	+ 4.07
	2 - 2j	40.3	60.2	+11.0	2.07	+ 9.28	+23.00
	3 - 1j	42.0	59.8	+21.5	2.17	+18.36	+43.70
2 - 2j	1 - 3j	37.2	62.9	- 4.3	1.70	- 3.52	- 9.65
	2 - 2j	38.5	61.7	+ 6.2	1.76	+ 5.12	+13.60
	3 - 1j	39.2	62.0	+17.3	1.80	+14.44	+37.40
3 - 1j	1 - 3j	37.6	63.0	-11.9	1.66	- 9.76	-25.80
	2 - 2j	37.8	62.5	- 0.8	1.66	- 0.66	- 1.75
	3 - 1j	37.4	63.0	+10.3	1.64	+ 8.44	+22.60

Monocyclic Starting Device

76. The monocyclic starting device consists in producing externally to the motor a system of polyphase voltages with single-phase flow of energy, and impressing it upon the motor, which is wound as polyphase motor.

If across the single-phase mains of voltage, e , two impedances of different inductance factors, Z_1 and Z_2 , are connected in series, as shown diagrammatically in Fig. 41, the two voltages, E_1 and E_2 , across these two impedances are displaced in phase from each other, thus forming with the main voltage a voltage triangle. The altitude of this triangle, or the voltage, E_0 , between the com-

mon connection of the two impedances, and a point inside of the main voltage, e (its middle, if the two impedances are equal), is a voltage in quadrature with the main voltage, and is a teaser voltage or quadrature voltage of the monocyclic system, e , E_1 , E_2 , that is, it is of limited energy and drops if power is taken off from it. (See Chapter XIV.)

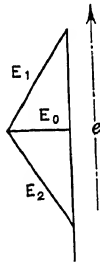

FIG. 41. Monocyclic triangle.

Let then, in a three-phase wound motor, operated single-phase with monocyclic starting device, and shown diagrammatically in Fig. 42:

e = voltage impressed between single-phase lines,
 I = current in single-phase lines,
 Y = effective admittance per motor circuit,

Y_1 , E_1 and I'_1 , and Y_2 , E_2 and I'_2 = admittance, voltage and current respectively, in the two impedances of the monocyclic starting device,

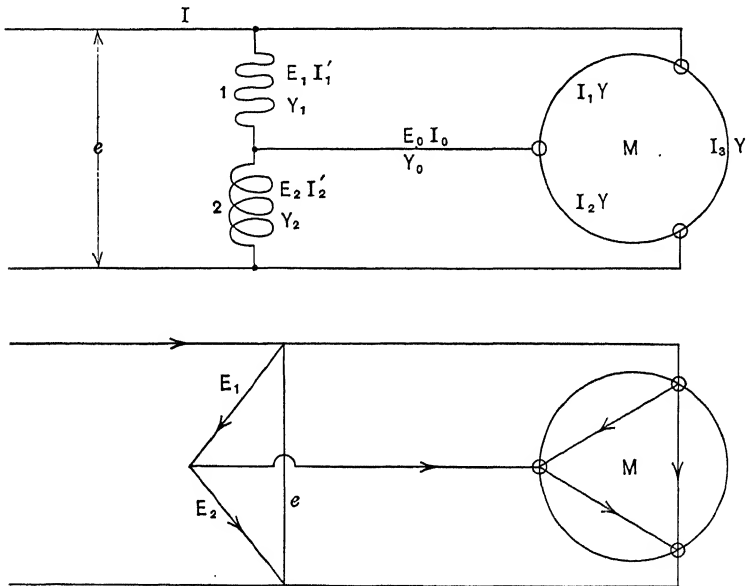

FIG. 42.—Three-phase motor with monocyclic starting device.

I_1 , I_2 and I_3 = currents in the three motor circuits.
 E_0 and I_0 = voltage and current of the quadrature circuit from the common connection of the two impedances, to the motor.

It is then, counting the voltages and currents in the direction indicated by the arrows of Fig. 42:

$$I_0 = I'_1 - I'_2 = I_2 - I_1; \quad (81)$$

substituting:

$$\left. \begin{aligned} I'_1 &= E_1 Y_1, \\ I'_2 &= E_2 Y_2, \\ I_2 &= E_2 Y, \\ I_1 &= E_1 Y, \end{aligned} \right\} \quad (82)$$

gives:

$$E_1 Y_1 - E_2 Y_2 = (E_2 - E_1) Y,$$

thus:

$$\frac{E_1}{E_2} = \frac{Y_2 + Y}{Y_1 + Y} = m (\cos \phi + j \sin \phi). \quad (83)$$

This gives the phase angle, ϕ , between the voltages, E_1 and E_2 , of the monocyclic triangle. Since:

$$E_1 + E_2 = e, \quad (84)$$

it is, by (83):

$$\left. \begin{aligned} E_1 &= e \frac{Y_2 + Y}{Y_1 + Y_2 + 2Y} \\ E_2 &= e \frac{Y_1 + Y}{Y_1 + Y_2 + 2Y} \end{aligned} \right\} \quad (85)$$

and the quadrature voltage:

$$\begin{aligned} E_0 &= \frac{1}{2}(E_2 - E_1) \\ &= \frac{e}{2} \frac{Y_1 - Y_2}{Y_1 + Y_2 + 2Y} \end{aligned} \quad (86)$$

and the total current input into the motor, inclusive starting device:

$$\begin{aligned} I &= I'_1 + I_1 + I_3 \\ &= E_1 Y_1 + E_1 Y + e Y \\ &= e \left\{ \frac{(Y_1 + Y)(Y_2 + Y)}{Y_1 + Y_2 + 2Y} + Y \right\} \\ &= e \frac{Y_1 Y_2 + 2Y(Y_1 + Y_2) + 3Y^2}{Y_1 + Y_2 + 2Y} \end{aligned} \quad (87)$$

As with the balanced three-phase motor, the quadrature component of voltage numerically is $\frac{e}{2} \sqrt{3}$, it is, when denoting by:

E_0^j the numerical value of the imaginary term of E_0 ; the torque ratio is:

$$t = \frac{2 E_0^j}{e \sqrt{3}} \quad (88)$$

The volt-ampere ratio is:

$$q = \frac{i}{3 i_3} \quad (89)$$

thus the apparent starting-torque efficiency:

$$v = \frac{t}{q} \quad (90)$$

etc.

77. Three cases have become of special importance:

(a) The resistance-reactance monocyclic starting device; where one of the two impedances, Z_1 and Z_2 , is a resistance, the other an inductance. This is the simplest and cheapest arrangement, gives good starting torque, though a fairly high current consumption and therefore low starting-torque efficiency, and is therefore very extensively used for starting single-phase induction motors. After starting, the monocyclic device is cut out and the power consumption due to the resistance, and depreciation of the power-factor due to the inductance, thereby avoided.

This device is discussed on page 333 of "Theoretical Elements of Electrical Engineering" and page 253 of "Theory and Calculation of Alternating-current Phenomena."

(b) The "condenser in the tertiary circuit," which may be considered as a monocyclic starting device, in which one of the two impedances is a capacity, the other one is infinity. The capacity usually is made so as to approximately balance the magnetizing current of the motor, is left in circuit after starting, as it does not interfere with the operation, does not consume power, and compensates for the lagging current of the motor, so that the motor has practically unity power-factor for all loads. This motor gives a moderate starting torque, but with very good starting-torque efficiency, and therefore is the most satisfactory single-phase induction motor, where very high starting torque is not needed. It was extensively used some years ago, but went out of use due to the trouble with the condensers of these early days, and it is therefore again coming into use, with the development of the last years, of a satisfactory condenser.

The condenser motor is discussed on page 249 of "Theory and Calculation of Alternating-current Phenomena."

(c) The condenser-inductance monocyclic starting device. By suitable values of capacity and inductance, a balanced three-phase triangle can be produced, and thereby a starting torque equal to that of the motor on three-phase voltage supply, with an apparent starting-torque efficiency superior to that of the three-phase motor.

Assuming thus:

$$\left. \begin{aligned} Y_1 &= +jb_1 = \text{capacity,} \\ Y_2 &= -jb_2 = \text{inductance,} \\ Y &= g - jb. \end{aligned} \right\} \quad (91)$$

If the voltage triangle, e , E_1 , E_2 , is a balanced three-phase triangle, it is:

$$\left. \begin{aligned} E_1 &= \frac{e}{2} (1 - j\sqrt{3}), \\ E_2 &= \frac{e}{2} (1 + j\sqrt{3}). \end{aligned} \right\} \quad (92)$$

Substituting (91) and (92) into (83), and expanding gives:

$$(b_2 - b_1 + 2b) \sqrt{3} - j(b_2 + b_1 - 2g\sqrt{3}) = 0;$$

thus:

$$\left. \begin{aligned} b_2 - b_1 + 2b &= 0, \\ b_2 + b_1 - 2g\sqrt{3} &= 0; \end{aligned} \right\}$$

hence:

$$\left. \begin{aligned} b_1 &= g\sqrt{3} + b, \\ b_2 &= g\sqrt{3} - b; \end{aligned} \right\} \quad (93)$$

thus, if:

$$b > g\sqrt{3},$$

the second reactance, Z_2 , must be a capacity also; if

$$b < g\sqrt{3},$$

only the first reactance, Z_1 , is a capacity, but the second is an inductance.

78. Considering, as an instance, a low-resistance motor, and a high-resistance motor:

(a)

$$Y = g - jb = 1 - 3j,$$

(b)

$$Y = g - jb = 3 - j,$$

it is:

$$\begin{array}{ll} b_1 = 4.732, \text{ capacity,} & b_1 = 6.196, \text{ capacity,} \\ b_2 = -1.268, \text{ capacity,} & b_2 = 4.196, \text{ inductance.} \end{array}$$

It is, by (86) and (92)

$$E_0^j = \frac{e}{2} (E_2 - E_1) = \frac{e}{2} \sqrt{3};$$

thus:

$$\begin{aligned} t &= 1, \text{ as was to be expected.} \\ I_3 &= e (g - jb), \\ i_3 &= e \sqrt{g^2 + b^2} \\ &= 3.16 e; \end{aligned}$$

it is, however, by (87):

$$I = e (3g - jb);$$

thus:

$$i = 4.243 e, \qquad i = 9.06 e,$$

and by (89):

$$q = 0.448, \qquad q = 0.956,$$

thus:

$$v = 2.232, \qquad v = 1.046.$$

Further discussion of the various single-phase induction motor-starting devices, and also a discussion of the acceleration of the motor with the starting device, and the interference or non-interference of the starting device with the quadrature flux and thus torque produced in the motor by the rotation of the armature, is given in a paper on the "Single-phase Induction Motor," A. I. E. E. *Transactions*, 1898, page 35, and a supplementary paper on "Notes on Single-phase Induction Motors," A. I. E. E. *Transactions*, 1900, page 25.

CHAPTER VI

INDUCTION-MOTOR REGULATION AND STABILITY

1. VOLTAGE REGULATION AND OUTPUT

79. Load and speed curves of induction motors are usually calculated and plotted for constant-supply voltage at the motor terminals. In practice, however, this condition usually is only approximately fulfilled, and due to the drop of voltage in the step-down transformers feeding the motor, in the secondary and the primary supply lines, etc., the voltage at the motor terminals drops more or less with increase of load. Thus, if the voltage at the primary terminals of the motor transformer is constant, and such as to give the rated motor voltage at full-load, at no-load the voltage at the motor terminals is higher, but at overload lower by the voltage drop in the internal impedance of the transformers. If the voltage is kept constant in the center of distribution, the drop of voltage in the line adds itself to the impedance drop in the transformers, and the motor supply voltage thus varies still more between no-load and overload.

With a drop of voltage in the supply circuit between the point of constant potential and the motor terminals, assuming the circuit such as to give the rated motor voltage at full-load, the voltage at no-load and thus the exciting current is higher, the voltage at overload and thus the maximum output and maximum torque of the motor, and also the motor impedance current, that is, current consumed by the motor at standstill, and thereby the starting torque of the motor, are lower than on a constant-potential supply. Hereby then the margin of overload capacity of the motor is reduced, and the characteristic constant of the motor, or the ratio of exciting current to short-circuit current, is increased, that is, the motor characteristic made inferior to that given at constant voltage supply, the more so the higher the voltage drop in the supply circuit.

Assuming then a three-phase motor having the following constants: primary exciting admittance, $Y = 0.01 - 0.1 j$; primary self-inductive impedance, $Z_0 = 0.1 + 0.3 j$; secondary self-induc-

tive impedance, $Z_1 = 0.1 + 0.3j$; supply voltage, $e_0 = 110$ volts, and rated output, 5000 watts per phase.

Assuming this motor to be operated:

1. By transformers of about 2 per cent. resistance and 4 per cent. reactance voltage, that is, transformers of good regulation, with constant voltage at the transformer terminals.

2. By transformers of about 2 per cent. resistance and 15 per cent. reactance voltage, that is, very poorly regulating transformers, at constant supply voltage at the transformer primaries.

3. With constant voltage at the generator terminals, and about 8 per cent. resistance, 40 per cent. reactance voltage in line and transformers between generator and motor.

This gives, in complex quantities, the impedance between the motor terminals and the constant voltage supply:

1. $Z = 0.04 + 0.08j$,
2. $Z = 0.04 + 0.3j$,
3. $Z = 0.16 + 0.8j$.

It is assumed that the constant supply voltage is such as to give 110 volts at the motor terminals at full-load.

The load and speed curves of the motor, when operating under these conditions, that is, with the impedance, Z , in series between the motor terminals and the constant voltage supply, e_1 , then can be calculated from the motor characteristics at constant terminal voltage, e_0 , as follows:

At slip, s , and constant terminal voltage, e_0 , the current in the motor is i_0 , its power-factor $p = \cos \theta$. The effective or equivalent impedance of the motor at this slip then is $z^0 = \frac{e_0}{i_0}$, and, in complex quantities, $Z^0 = \frac{e_0}{i_0} (\cos \theta + j \sin \theta)$, and the total impedance, including that of transformers and line, thus is:

$$Z_1 = Z^0 + Z = \left(\frac{e_0}{i_0} \cos \theta + r \right) + j \left(\frac{e_0}{i_0} \sin \theta + x \right),$$

or, in absolute values:

$$z_1 = \sqrt{\left(\frac{e_0}{i_0} \cos \theta + r \right)^2 + \left(\frac{e_0}{i_0} \sin \theta + x \right)^2},$$

and, at the supply voltage, e_1 , the current thus is:

and the voltage at the motor terminals is:

$$e'_0 = z^0 i_1 = \frac{z^0}{z_1} e_1.$$

If e_0 is the voltage required at the motor terminals at full-load, and i_0^0 the current, z_1^0 the total impedance at full-load, it is:

$$i_0^0 = \frac{e_1}{z_1^0};$$

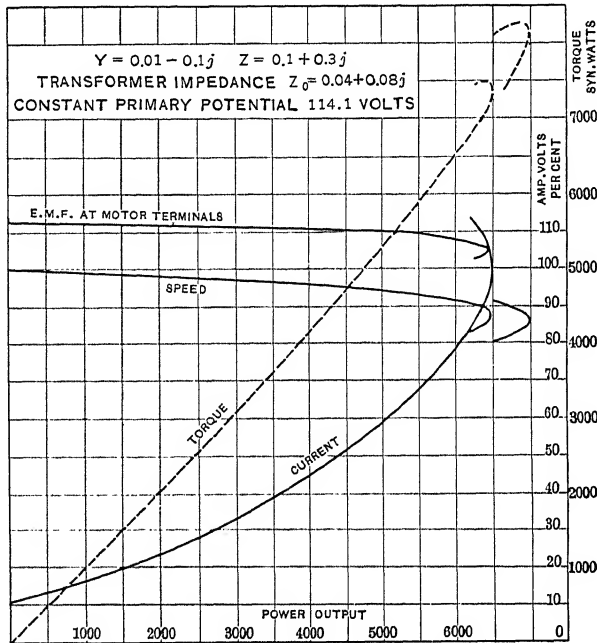

FIG. 43.—Induction-motor load curves corresponding to 110 volts at motor terminals at 5000 watts load.

hence, the required constant supply voltage is:

$$e_1 = z_1^0 i_0^0,$$

and the speed and torque curves of the motor under this condition then are derived from those at constant supply voltage, e_0 , by multiplying all voltages and currents by the factor $\frac{e'_0}{e_0}$, that is, by the ratio of the actual terminal voltage to the full-load terminal voltage, and the torque and power by multiplying with

the square of this ratio, while the power-factors and the efficiencies obviously remain unchanged.

In this manner, in the three cases assumed in the preceding, the load curves are calculated, and are plotted in Figs. 43, 44, and 45.

80. It is seen that, even with transformers of good regulation, Fig. 43, the maximum torque and the maximum power are ap-

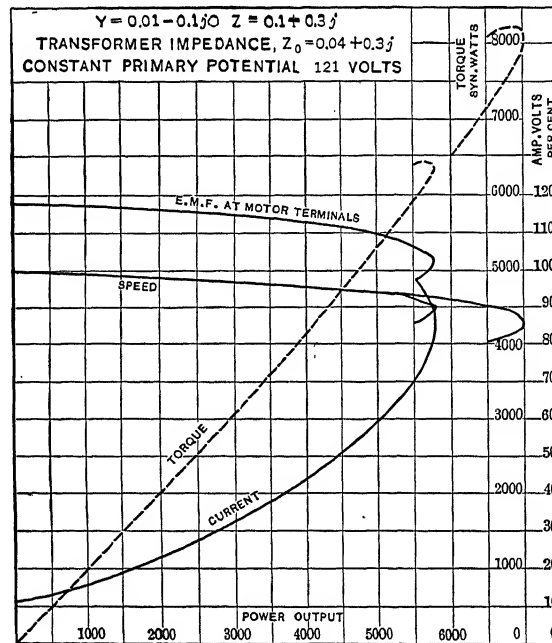

FIG. 44.—Induction-motor load curves corresponding to 110 volts at motor terminals at 5000 watts load.

preciably reduced. The values corresponding to constant terminal voltage are shown, for the part of the curves near maximum torque and maximum power, in Figs. 43, 44, and 45.

In Figs. 46, 47, 48, and 49 are given the speed-torque curves of the motor, for constant terminal voltage, $Z = 0$, and the three cases above discussed; in Fig. 46 for short-circuited secondaries, or running condition; in Fig. 47 for 0.15 ohm; in Fig. 48 for 0.5 ohm; and in Fig. 49 for 1.5 ohms additional resistance inserted in the armature. As seen, the line and transformer impedance very appreciably lowers the torque, and

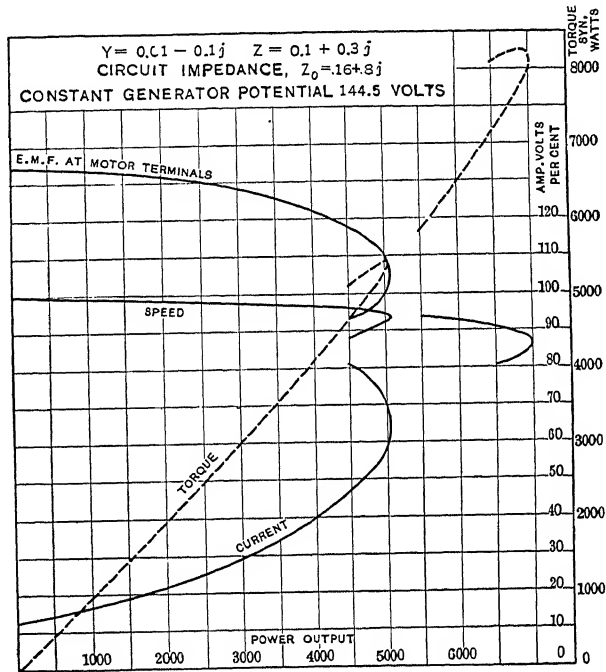

FIG. 45.—Induction-motor load curves corresponding to 110 volts at motor terminals at 500 watts load.

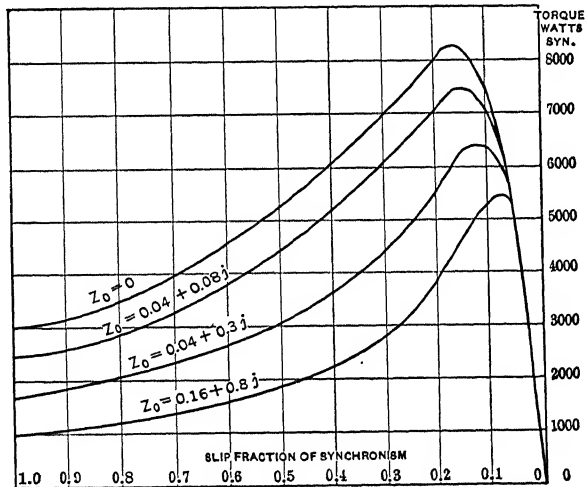

FIG. 46.—Induction-motor speed torque characteristics with short-circuited secondary.

especially the starting torque, which, with short-circuited armature, in the case 3 drops to about one-third the value given at constant supply voltage.

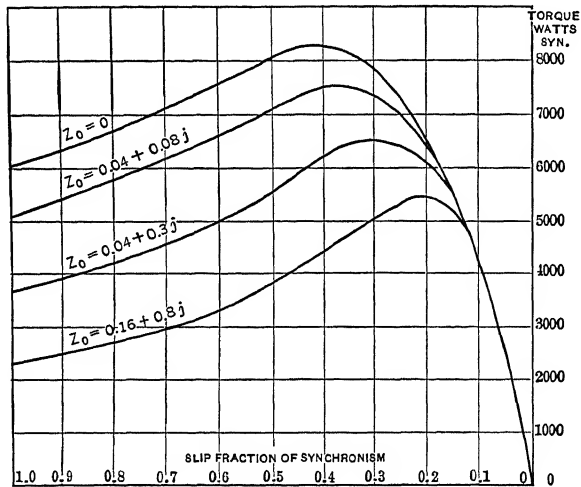

Fig. 47.—Induction-motor speed torque characteristics with a resistance of 0.15 ohm in secondary circuit.

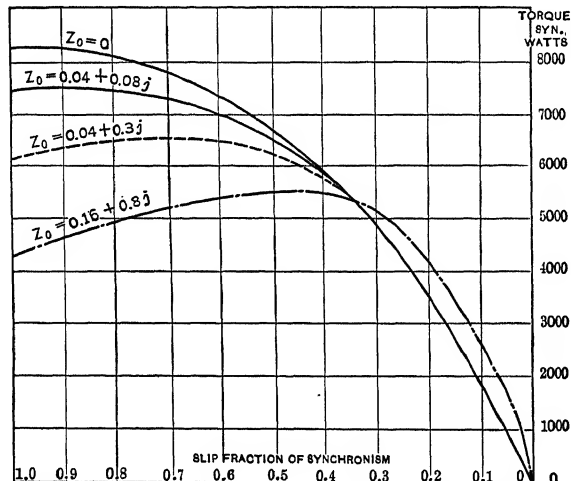

Fig. 48.—Induction-motor speed torque characteristics with a resistance of 0.5 ohm in secondary circuit.

It is interesting to note that in Fig. 48, with a secondary resistance giving maximum torque in starting, at constant ter-

minal voltage, with high impedance in the supply, the starting torque drops so much that the maximum torque is shifted to about half synchronism.

In induction motors, especially at overloads and in starting, it therefore is important to have as low impedance as possible between the point of constant voltage and the motor terminals.

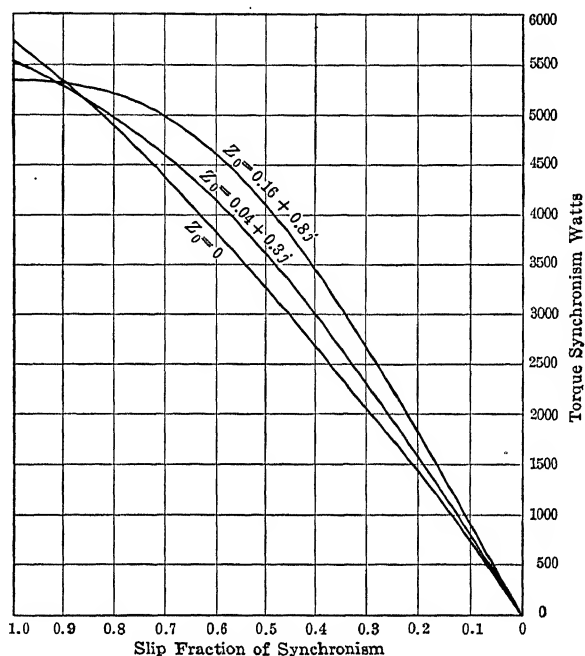

FIG. 49.—Induction-motor speed current characteristics with a resistance of 1.5 ohms in secondary circuit.

In Table I the numerical values of maximum power, maximum torque, starting torque, exciting current and starting current are given for above motor, at constant terminal voltage and for the three values of impedance in the supply lines, for such supply voltage as to give the rated motor voltage of 110 volts at full load and for 110 volts supply, voltage. In the first case, maximum power and torque drop down to their full-load values with the highest line impedance, and far below full-load values in the latter case.

ELECTRICAL APPARATUS

 TABLE I.—VOLTAGE REGULATION AND OUTPUT
 $Y = 0.01 - 0.1j$, $Z = 0.1 + 0.3j$

Line and transformer impedance, z_0	E.m.f. at motor terminals			Power		Torque			Starting torque			Current			Per cent. exciting current at $\frac{2}{3}$ max. num. Excit. Start.	Char-acter-istic constant, $\gamma = \frac{I}{I_{start}}$	
	Open circuit	No-load	5000 watts output	Stand-still	Max. watts	Per cent. of 5000 watts	Max. syn. watts	Per cent. of 5300 watts	Starting torque		Excit-ing	Starting					
									$r_1 = 0.1$	$r_1 = 0.6$		$r_1 = 0.1$	$r_1 = 0.25$	$r_1 = 0.25$			$r_1 = 0.6$
0	110.0	110.0	110	110.0	7000	1.400	8250	1.555	2950	6050	8250	10.70	176	160	120	17.4	6.10
0.04-0.08j	114.1	113.3	110	99.5	6450	1.290	7500	1.415	2420	5100	7450	11.00	159	147	114	20.0	6.90
0.04-0.3j	121.0	118.0	110	82.0	5780	1.156	6460	1.220	1635	3650	6150	11.45	131	124	104	24.7	8.75
0.16-0.8j	144.5	134.0	110	63.0	5070	1.014	5450	1.030	965	2260	4400	13.10	101	97	88	35.8	13.00
0	110.0	110.0	...	110.0	7000	1.400	8250	1.555	2950	6050	8250	10.70	176	160	120	17.4	6.10
0.04-0.08j	110.0	109.0	...	95.5	5970	1.194	6940	1.315	2250	4730	6920	11.00	153	147	114	20.0	6.90
0.04-0.3j	110.0	107.5	...	74.6	4780	0.956	5330	1.005	1360	3030	5100	11.45	119	124	104	24.7	8.75
0.16-0.8j	110.0	102.0	...	48.0	2940	0.588	3170	0.600	560	1310	2550	13.10	77	97	88	35.8	13.00

2. FREQUENCY PULSATION

81. If the frequency of the voltage supply pulsates with sufficient rapidity that the motor speed can not appreciably follow the pulsations of frequency, the motor current and torque also pulsate; that is, if the frequency pulsates by the fraction, p , above and below the normal, at the average slip, s , the actual slip pulsates between $s + p$ and $s - p$, and motor current and

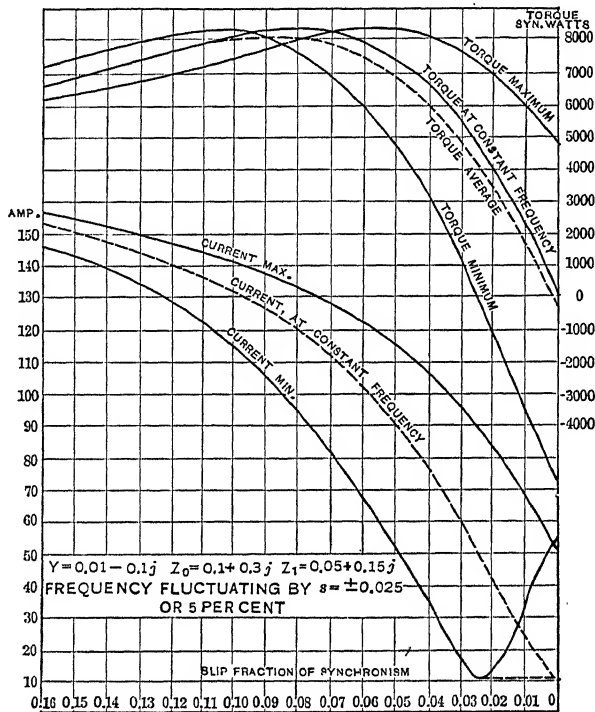

FIG. 50.—Effect of Frequency Pulsation on Induction Motor.

torque pulsate between the values corresponding to the slips, $s + p$ and $s - p$. If then the average slip $s < p$, at minimum frequency, the actual slip, $s - p$, becomes negative; that is, the motor momentarily generates and returns energy.

As instance are shown, in Fig. 50, the values of current and of torque for maximum and minimum frequency, and for the average frequency, for $p = 0.025$, that is, 2.5 per cent. pulsation of frequency from the average. As seen, the pulsation of current is moderate until synchronism is approached, but be-

comes very large near synchronism, and from slip, $s = 0.025$, up to synchronism the average current remains practically constant, thus at synchronism is very much higher than the current at constant frequency. The average torque also drops somewhat below the torque corresponding to constant frequency, as shown in the upper part of Fig. 50.

3. LOAD AND STABILITY

82. At constant voltage and constant frequency the torque of the polyphase induction motor is a maximum at some definite speed and decreases with increase of speed over that corresponding to the maximum torque, to zero at synchronism; it also decreases with decrease of speed from that at the maximum torque point, to a minimum at standstill, the starting torque. This maximum torque point shifts toward lower speed with increase of the resistance in the secondary circuit, and the starting torque thereby increases. Without additional resistance inserted in the secondary circuit the maximum torque point, however, lies at fairly high speed not very far below synchronism, 10 to 20 per cent. below synchronism with smaller motors of good efficiency. Any value of torque between the starting torque and the maximum torque is reached at two different speeds. Thus in a three-phase motor having the following constants: impressed e.m.f., $e_0 = 110$ volts; exciting admittance, $Y = 0.01 - 0.1j$; primary impedance, $Z_0 = 0.1 + 0.3j$, and secondary impedance, $Z_1 = 0.1 + 0.3j$, the torque of 5.5 synchronous kw. is reached at 54 per cent. of synchronism and also at the speed of 94 per cent. of synchronism, as seen in Fig. 51.

When connected to a load requiring a constant torque, irrespective of the speed, as when pumping water against a constant head by reciprocating pumps, the motor thus could carry the load at two different speeds, the two points of intersection of the horizontal line, L , in Fig. 51, which represents the torque consumed by the load, and the motor-torque curve, D . Of these two points, d and c , the lower one, d , represents unstable conditions of operation; that is, the motor can not operate at this speed, but either stops or runs up to the higher speed point, c , at which stability is reached. At the lower speed, d , a momentary decrease of speed, as by a small pulsation of voltage, load, etc., decreases the motor torque, D , below the torque, L , required by the load, thus causes the motor to slow down, but in doing

so its torque further decreases, and it slows down still more, loses more torque, etc., until it comes to a standstill. Inversely, a momentary increase of speed increases the motor torque, D , beyond the torque, L , consumed by the load, and thereby causes an acceleration, that is, an increase of speed. This increase of speed, however, increases the motor torque and thereby the speed still further, and so on, and the motor increases in speed up to the point, c , where the motor torque, D , again becomes

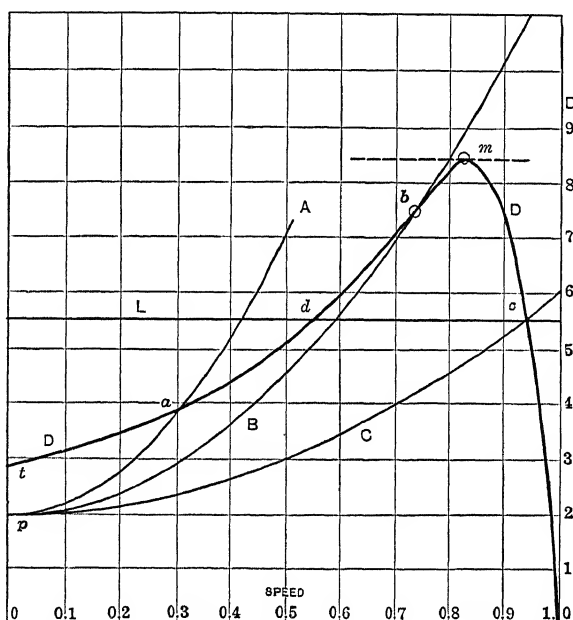

Fig. 51.—Speed-torque characteristics of induction motor and load for determination of the stability point.

equal to the torque consumed by the load. A momentary increase of speed beyond c decreases the motor torque, D , and thus limits itself, and inversely a momentary decrease of speed below c increases the motor torque, D , beyond L , thus accelerates and recovers the speed; that is, at c the motor speed is stable.

With a load requiring constant torque the induction motor thus is unstable at speeds below that of the maximum torque point, but stable above it; that is, the motor curve consists of two branches, an unstable branch, from standstill, t , to the maxi-

imum torque point, m , and a stable branch, from the maximum torque point, m , to synchronism.

83. It must be realized, however, that this instability of the lower branch of the induction-motor speed curve is a function of the nature of the load, and as described above applies only to a load requiring a constant torque, L . Such a load the motor could not start (except by increasing the motor torque at low speeds by resistance in the secondary), but when brought up to a speed above d would carry the load at speed, c , in Fig. 51.

If, however, the load on the motor is such as to require a torque which increases with the square of the speed, as shown by curve, C , in Fig. 51, that is, consists of a constant part p (friction of bearings, etc.) and a quadratic part, as when driving a ship's propeller or driving a centrifugal pump, then the induction motor is stable over the entire range of speed, from standstill to synchronism. The motor then starts, with the load represented by curve C , and runs up to speed, c . At a higher load, represented by curve B , the motor runs up to speed, b , and with excessive overload, curve A , the motor would run up to low speed, point a , only, but no overload of such nature would stop the motor, but merely reduce its speed, and inversely, it would always start, but at excessive overloads run at low speed only. Thus in this case no unstable branch of the motor curve exists, but it is stable over the entire range.

With a load requiring a torque which increases proportionally to the speed, as shown by C in Fig. 52, that is, which consists of a constant part, p , and a part proportional to the speed, as when driving a direct-current generator at constant excitation, connected to a constant resistance as load—as a lighting system—the motor always starts, regardless of the load—provided that the constant part of the torque, p , is less than the starting torque. With moderate load, C , the motor runs up to a speed, c , near synchronism. With very heavy load, A , the motor starts, but runs up to a low speed only. Especially interesting is the case of an intermediary load as represented by line B in Fig. 52. B intersects the motor-torque curve, D , in three points, b_1, b_2, b_3 ; that is, three speeds exist at which the motor gives the torque required by the load: 24 per cent., 60 per cent., and 88 per cent. of synchronism. The speeds b_1 and b_3 are stable, the speed b_2 unstable. Thus, with this load the motor starts from standstill, but does not run up to a speed near synchronism, but

accelerates only to speed b_1 , and keeps revolving at this low speed (and a correspondingly very large current). If, however, the load is taken off and the motor allowed to run up to synchronism or near to it, and the load then put on, the motor slows down only to speed b_3 , and carries the load at this high speed; hence, the motor can revolve continuously at two different speeds, b_1 and b_3 , and either of these speeds is stable; that is, a momentary increase of speed decreases the motor torque below that

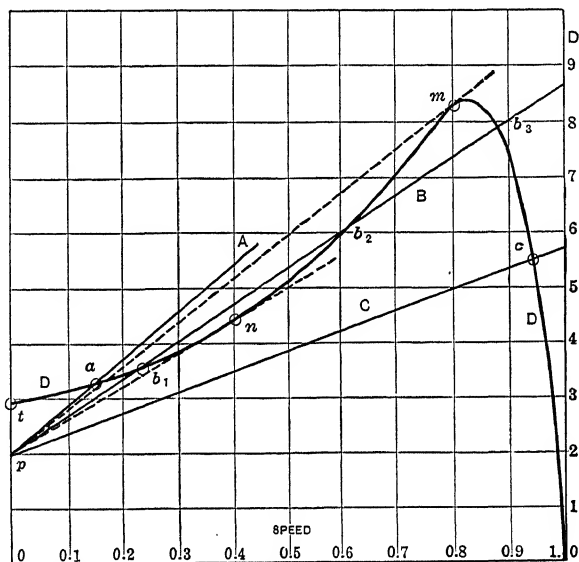

FIG. 52.—Speed torque characteristics of induction motor and load for determination of the stability point.

required by the load, and thus limits itself, and inversely a decrease of motor speed increases its torque beyond that corresponding to the load, and thus restores the speed. At the intermediary speed, b_2 , the conditions are unstable, and a momentary increase of speed causes the motor to accelerate up to speed b_3 , a momentary decrease of speed from b_2 causes the motor to slow down to speed b_1 , where it becomes stable again. In the speed range between b_2 and b_3 the motor thus accelerates up to b_3 , in the speed range between b_2 and b_1 it slows down to b_1 .

For this character of load, the induction-motor speed curve, D , thus has two stable branches, a lower one, from standstill, t , to the point n , and an upper one, from point m to synchronism,

where m and n are the points of contact of the tangents from the required starting torque, p , on to the motor curve, D ; these two stable branches are separated by the unstable branch, from n to m , on which the motor can not operate.

84. The question of stability of motor speed thus is a function not only of the motor-speed curve but also of the character of the load in its relation to the motor-speed curve, and if the change of motor torque with the change of speed is less than the change of the torque required by the load, the condition is stable, otherwise it is unstable; that is, it must be $\frac{dD}{dS} < \frac{dL}{dS}$ to give stability, where L is the torque required by the load at speed, S .

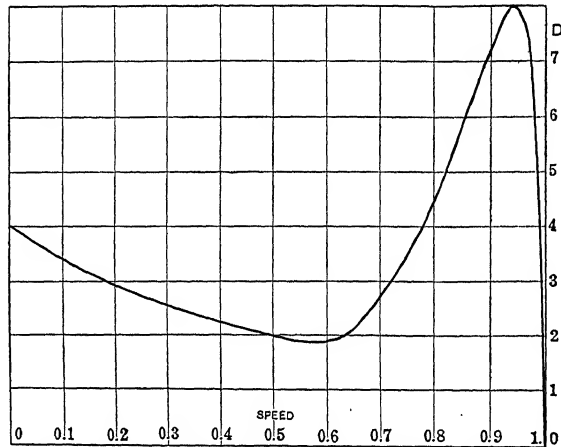

FIG. 53.—Speed-torque characteristic of single-phase induction motor.

Occasionally on polyphase induction motors on a load as represented in Fig. 52 this phenomenon is observed in the form that the motor can start the load but can not bring it up to speed. More frequently, however, it is observed on single-phase induction motors in which the maximum torque is nearer to synchronism, with some forms of starting devices which decrease in their effect with increasing speed and thus give motor-speed characteristics of forms similar to Fig. 53. With a torque-speed curve as shown in Fig. 53, even at a load requiring constant torque, three speed points may exist of which the middle one is unstable. In polyphase synchronous motors and converters, when starting by alternating current, that is, as

induction machines, the phenomenon is frequently observed that the machine starts at moderate voltage, but does not run up to synchronism, but stops at an intermediary speed, in the neighborhood of half speed, and a considerable increase of voltage, and thereby of motor torque, is required to bring the machine beyond the dead point, or rather "dead range," of speed and make it run up to synchronism. In this case, however, the phenomenon is complicated by the effects due to varying magnetic reluctance (magnetic locking), inductor machine effect, etc.

Instability of such character as here described occurs in electric circuits in many instances, of which the most typical is the electric arc in a constant-potential supply. It occurs whenever the effect produced by any cause increases the cause and thereby becomes cumulative. When dealing with energy, obviously the effect must always be in opposition to the cause (Lenz's Law), as result of the law of conservation of energy. When dealing with other phenomena, however, as the speed-torque relation or the volt-ampere relation, etc., instability due to the effect assisting the cause, intensifying it, and thus becoming cumulative, may exist, and frequently does exist, and causes either indefinite increase or decrease, or surging or hunting, as more fully discussed in Chapters X and XI, of "Theory and Calculation of Electric Circuits."

4. GENERATOR REGULATION AND STABILITY

85. If the voltage at the induction-motor terminals decreases with increase of load, the maximum torque and output are decreased the more the greater the drop of voltage. But even if the voltage at the induction motor terminals is maintained constant, the maximum torque and power may be reduced essentially, in a manner depending on the rapidity with which the voltage regulation at changes of load is effected by the generator or potential regulator, which maintains constancy of voltage, and the rapidity with which the motor speed can change, that is, the mechanical momentum of the motor and its load.

This instability of the motor, produced by the generator regulation, may be discussed for the case of a load requiring constant torque at all loads, though the corresponding phenomenon may exist at all classes of load, as discussed under 3, and may occur even with a load proportional to the square of the speed, as ship propellers.

The torque curve of the induction motor at constant terminal voltage consists of two branches, a stable branch, from the maximum torque point to synchronism, and an unstable branch, that is, a branch at which the motor can not operate on a load requiring constant torque, from standstill to maximum torque. With increasing slip, s , the current, i , in the motor increases. If then $D =$ torque of the motor, $\frac{dD}{di}$ is positive on the stable, negative on the unstable branch of the motor curve, and this rate of change of the torque, with change of current, expressed as fraction of the current, is:

$$k_s = \frac{1}{D} \frac{dD}{di};$$

it may be called the *stability coefficient* of the motor.

If k_s is positive, an increase of i , caused by an increase of slip, s , that is, by a decrease of speed, increases the torque, D , and thereby checks the decrease of speed, and inversely, that is, the motor is stable.

If, however, k_s is negative, an increase of i causes a decrease of D , thereby a decrease of speed, and thus further increase of i and decrease of D ; that is, the motor slows down with increasing rapidity, or inversely, with a decrease of i , accelerates with increasing rapidity, that is, is unstable.

For the motor used as illustration in the preceding, of the constants $e = 110$ volts; $Y = 0.01 - 0.1 j$; $Z_0 = 0.1 + 0.3 j$, $Z_1 = 0.1 + 0.3 j$, the stability curve is shown, together with speed, current, and torque, in Fig. 54, as function of the output. As seen, the stability coefficient, k_s , is very high for light-load, decreases first rapidly and then slowly, until an output of 7000 watts is approached, and then rapidly drops below zero; that is, the motor becomes unstable and drops out of step, and speed, torque, and current change abruptly, as indicated by the arrows in Fig. 54.

The stability coefficient, k_s , characterizes the behavior of the motor regarding its load-carrying capacity. Obviously, if the terminal voltage of the motor is not constant, but drops with the load, as discussed in 1, a different stability coefficient results; which intersects the zero line at a different and lower torque.

86. If the induction motor is supplied with constant terminal voltage from a generator of close inherent voltage regulation

and of a size very large compared with the motor, over a supply circuit of negligible impedance, so that a sudden change of motor current can not produce even a momentary tendency of change of the terminal voltage of the motor, the stability curve, k_s , of Fig. 54 gives the performance of the motor. If, however,

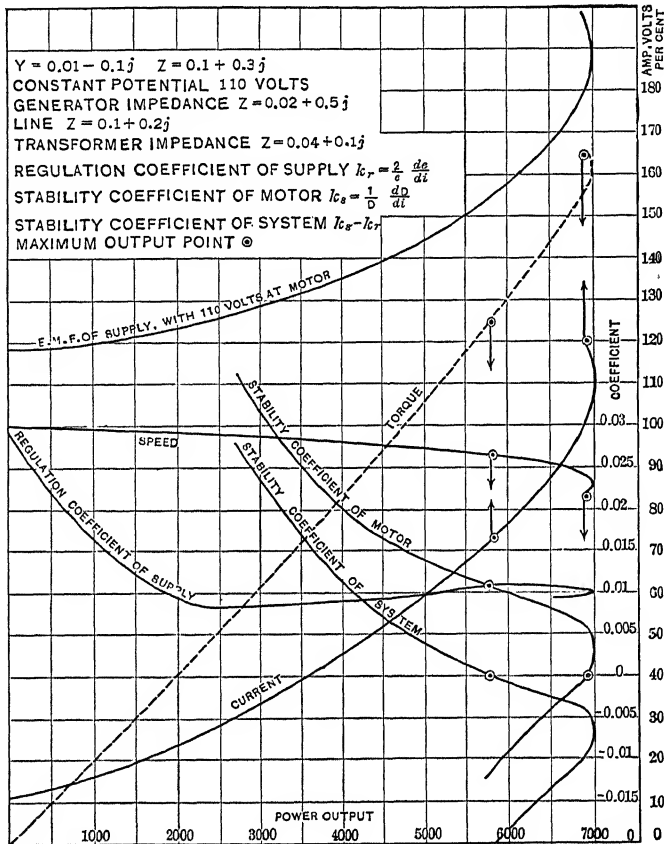

FIG. 54.—Induction-motor load curves.

at a change of load and thus of motor current the regulation of the supply voltage to constancy at the motor terminals requires a finite time, even if this time is very short, the maximum output of the motor is reduced thereby, the more so the more rapidly the motor speed can change.

Assuming the voltage control at the motor terminals effected

by hand regulation of the generator or the potential regulator in the circuit supplying the motor, or by any other method which is slower than the rate at which the motor speed can adjust itself to a change of load, then, even if the supply voltage at the motor terminals is kept constant, for a momentary fluctuation of motor speed and current, the supply voltage momentarily varies, and with regard to its stability the motor corresponds not to the condition of constant supply voltage but to a supply voltage which varies with the current, hence the limit of stability is reached at a lower value of motor torque.

At constant slip, s , the motor torque, D , is proportional to the square of the impressed e.m.f., e^2 . If by a variation of slip caused by a fluctuation of load the motor current, i , varies by di , if the terminal voltage, e , remains constant the motor torque, D , varies by the fraction $k_s = \frac{1}{D} \frac{dD}{di}$, or the stability coefficient of the motor. If, however, by the variation of current, di , the impressed e.m.f., e , of the motor varies, the motor torque, D , being proportional to e^2 , still further changes, proportional to the change e^2 , that is, by the fraction $k_r = \frac{1}{e^2} \frac{de^2}{di} = \frac{2}{e} \frac{de}{di}$, and the total change of motor torque resultant from a change, di , of the current, i , thus is $k_0 = k_s + k_r$.

Hence, if a momentary fluctuation of current causes a momentary fluctuation of voltage, the stability coefficient of the motor is changed from k_s to $k_0 = k_s + k_r$, and as k_r is negative, the voltage, e , decreases with increase of current, i , the stability coefficient of the system is reduced by the effect of voltage regulation of the supply, k_r , and k_r thus can be called the *regulation coefficient of the system*.

$k_r = \frac{2}{e} \frac{de}{di}$ thus represents the change of torque produced by the momentary voltage change resulting from a current change di in the system; hence, is essentially a characteristic of the supply system and its regulation, but depends upon the motor only in so far as $\frac{de}{di}$ depends upon the power-factor of the load.

In Fig. 54 is shown the regulation coefficient, k_r , of the supply system of the motor, at 110 volts maintained constant at the motor terminals, and an impedance, $Z = 0.16 + 0.8 j$, between motor terminals and supply e.m.f. As seen, the regulation coefficient of the system drops from a maximum of about 0.03,

at no-load, down to about 0.01, and remains constant at this latter value, over a very wide range.

The resultant stability coefficient, or *stability coefficient of the system* of motor and supply, $k_0 = k_s + k_r$, as shown in Fig. 54, thus drops from very high values at light-load down to zero at the load at which the curves, k_s and k_r , in Fig. 54 intersect, or at 5800 kw., and there become negative; that is, the motor drops out of step, although still far below its maximum torque point, as indicated by the arrows in Fig. 54.

Thus, at constant voltage maintained at the motor terminals by some regulating mechanism which is slower in its action than the retardation of a motor-speed change by its mechanical momentum, the motor behaves up to 5800 watts output in exactly the same manner as if its terminals were connected directly to an unlimited source of constant voltage supply, but at this point, where the slip is only 7 per cent. in the present instance, the motor suddenly drops out of step without previous warning, and comes to a standstill, while at inherently constant terminal voltage the motor would continue to operate up to 7000 watts output, and drop out of step at 8250 synchronous watts torque at 16 per cent. slip.

By this phenomenon the maximum torque of the motor thus is reduced from 8250 to 6300 synchronous watts, or by nearly 25 per cent.

87. If the voltage regulation of the supply system is more rapid than the speed change of the motor as retarded by the momentum of motor and load, the regulation coefficient of the system as regards to the motor obviously is zero, and the motor thus gives the normal maximum output and torque. If the regulation of the supply voltage, that is, the recovery of the terminal voltage of the motor with a change of current, occurs at about the same rate as the speed of the motor can change with a change of load, then the maximum output as limited by the stability coefficient of the system is intermediate between the minimum value of 6300 synchronous watts and its normal value of 8250 synchronous watts. The more rapid the recovery of the voltage and the larger the momentum of motor and load, the less is the motor output impaired by this phenomenon of instability. Thus, the loss of stability is greatest with hand regulation, less with automatic control by potential regulator, the more so the more rapidly the regulator works; it is very little

with compounded alternators, and absent where the motor terminal voltage remains constant without any control by practically unlimited generator capacity and absence of voltage drop between generator and motor.

Comparing the stability coefficient, k_s , of the motor load and the stability coefficient, k_0 , of the entire system under the assumed conditions of operation of Fig. 54, it is seen that the former intersects the zero line very steeply, that is, the stability remains high until very close to the maximum torque point, and the motor thus can be loaded up close to its maximum torque without impairment of stability. The curve, k_0 , however, intersects the zero-line under a sharp angle, that is, long before the limit of stability is reached in this case the stability of the system has dropped so close to zero that the motor may drop out of step by some momentary pulsation. Thus, in the case of instability due to the regulation of the system, the maximum output point, as found by test, is not definite and sharply defined, but the stability gradually decreases to zero, and during this decrease the motor drops out at some point. Experimentally the difference between the dropping out by approach to the limits of stability of the motor proper and that of the system of supply is very marked by the indefiniteness of the latter.

In testing induction motors it thus is necessary to guard against this phenomenon by raising the voltage beyond normal before every increase of load, and then gradually decrease the voltages again to normal.

A serious reduction of the overload capacity of the motor, due to the regulation of the system, obviously occurs only at very high impedance of the supply circuit; with moderate impedance the curve, k_r , is much lower, and the intersection between k_r and k_s occurs still on the steep part of k_s , and the output thus is not materially decreased, but merely the stability somewhat reduced when approaching maximum output.

This phenomenon of the impairment of stability of the induction motor by the regulation of the supply voltage is of practical importance, as similar phenomena occur in many instances. Thus, with synchronous motors and converters the regulation of the supply system exerts a similar effect on the overload capacity, and reduces the maximum output so that the motor drops out of step, or starts surging, due to the approach to the stability limit of the entire system. In this case, with syn-

chronous motors and converters, increase of their field excitation frequently restores their steadiness by producing leading currents and thereby increasing the power-carrying capacity of the supply system, while with surging caused by instability of the synchronous motor the leading currents produced by increase of field excitation increase the surging, and lowering the field excitation tends toward steadiness.

CHAPTER VII

HIGHER HARMONICS IN INDUCTION MOTORS

88. The usual theory and calculation of induction motors, as discussed in "Theoretical Elements of Electrical Engineering" and in "Theory and Calculation of Alternating-current Phenomena," is based on the assumption of the sine wave. That is, it is assumed that the voltage impressed upon the motor per phase, and therefore the magnetic flux and the current, are sine waves, and it is further assumed, that the distribution of the winding on the circumference of the armature or primary, is sinusoidal in space. While in most cases this is sufficiently the case, it is not always so, and especially the space or air-gap distribution of the magnetic flux may sufficiently differ from sine shape, to exert an appreciable effect on the torque at lower speeds, and require consideration where motor action and braking action with considerable power is required throughout the entire range of speed.

Let then:

$$e = e_1 \cos \phi + e_3 \cos (3 \phi - \alpha_3) + e_5 \cos (5 \phi - \alpha_5) + e_7 \cos (7 \phi - \alpha_7) + e_9 \cos (9 \phi - \alpha_9) + \dots \quad (1)$$

be the voltage impressed upon one phase of the induction motor.

If the motor is a quarter-phase motor, the voltage of the second motor phase, which lags 90° or $\frac{\pi}{2}$ behind the first motor phase, is:

$$\begin{aligned} e' &= e_1 \cos \left(\phi - \frac{\pi}{2} \right) + e_3 \cos \left(3 \phi - \frac{3\pi}{2} - \alpha_3 \right) + e_5 \cos \left(5 \phi - \frac{5\pi}{2} - \alpha_5 \right) \\ &\quad + e_7 \cos \left(7 \phi - \frac{7\pi}{2} - \alpha_7 \right) + e_9 \cos \left(9 \phi - \frac{9\pi}{2} - \alpha_9 \right) + \dots \\ &= e_1 \cos \left(\phi - \frac{\pi}{2} \right) + e_3 \cos \left(3 \phi - \alpha_3 + \frac{\pi}{2} \right) + e_5 \cos \left(5 \phi - \alpha_5 - \frac{\pi}{2} \right) \\ &\quad + e_7 \cos \left(7 \phi - \alpha_7 + \frac{\pi}{2} \right) + e_9 \cos \left(9 \phi - \alpha_9 - \frac{\pi}{2} \right) + \dots \quad (2) \end{aligned}$$

The magnetic flux produced by these two voltages thus consists of a series of component fluxes, corresponding respectively

to the successive components. The secondary currents induced by these component fluxes, and the torque produced by the secondary currents, thus show the same components.

Thus the motor torque consists of the sum of a series of components:

The main or fundamental torque of the motor, given by the usual sine-wave theory of the induction motor, and due to the fundamental voltage wave:

$$\left. \begin{aligned} e_1 \cos \phi \\ e_1 \cos \left(\phi - \frac{\pi}{2} \right) \end{aligned} \right\} \quad (3)$$

is shown as T_1 in Fig. 55, of the usual shape, increasing from standstill, with increasing speed, up to a maximum torque, and then decreasing again to zero at synchronism.

The third harmonics of the voltage waves are:

$$\left. \begin{aligned} e_3 \cos (3 \phi - \alpha_3), \\ e_3 \cos \left(3 \phi - \alpha_3 + \frac{\pi}{2} \right) \end{aligned} \right\} \quad (4)$$

As seen, these also constitute a quarter-phase system of voltage, but the second wave, which is lagging in the fundamental, is 90° leading in the third harmonic, or in other words, the third harmonic gives a backward rotation of the poles with triple frequency. It thus produces a torque in opposite direction to the fundamental, and would reach its synchronism, that is, zero torque, at one-third of synchronism in negative direction, or at the speed $S = -\frac{1}{3}$, given in fraction of synchronous speed. For backward rotation above one-third synchronism, this triple harmonic then gives an induction generator torque, and the complete torque curve given by the third harmonics thus is as shown by curve T_3 of Fig. 55.

The fifth harmonics:

$$\left. \begin{aligned} e_5 \cos (5 \phi - \alpha_5), \\ e_5 \cos \left(5 \phi - \alpha_5 - \frac{\pi}{2} \right) \end{aligned} \right\} \quad (5)$$

give again phase rotation in the same direction as the fundamental, that is, motor torque, and assist the fundamental. But synchronism is reached at one-fifth of the synchronous speed of the fundamental, or at: $S = +\frac{1}{5}$, and above this speed, the

fifth harmonic becomes induction generator, due to oversynchronous rotation, and retards. Its torque curve is shown as T_5 in Fig. 55.

The seventh harmonic again gives negative torque, due to backward phase rotation of the phases, and reaches synchronism at $S = -1/7$, that is, one-seventh speed in backward rotation, as shown by curve T_7 in Fig. 55.

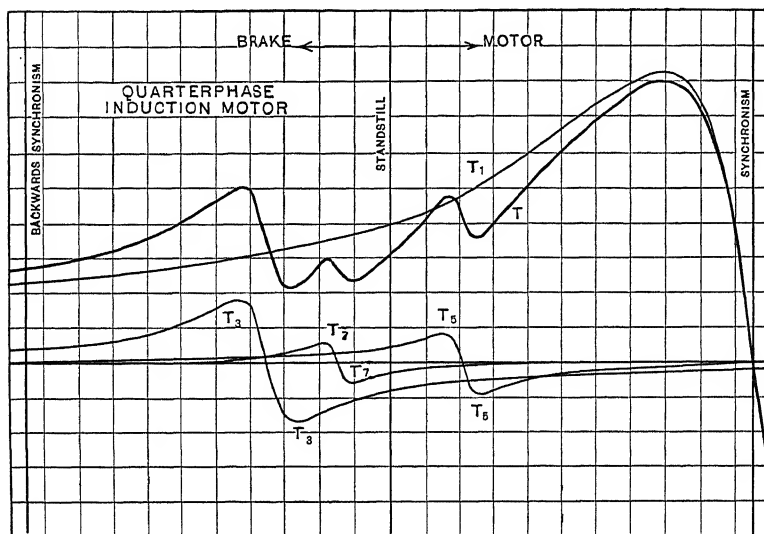

FIG. 55.—Quarter-phase induction motor, component harmonics and resultant torque.

The ninth harmonic again gives positive motor torque up to its synchronism, $S = 1/9$, and above this negative induction generator torque, etc.

We then have the effects of the various harmonics on the

QUARTER-PHASE INDUCTION MOTOR

Order of harmonics.....	1	3	5	7	9	11	13
Phase rotation.....	+	-	+	-	+	-	+
Synchronous speed: $S = \dots$	+1	$-1/3$	$+1/5$	$-1/7$	$+1/9$	$-1/11$	$+1/13$
Torque positive up to: $S = \dots$ otherwise negative.	+1	-	$+1/5$	-	$+1/9$	-	$+1/13$

Adding now the torque curves of the various voltage harmonics, T_3, T_5, T_7 , to the fundamental torque curve, T_1 , of the induction motor, gives the resultant torque curve, T .

As seen from Fig. 55, if the voltage harmonics are considerable, the torque curve of the motor at lower speeds, forward and backward, that is, when used as brake, is rather irregular, showing depressions or "dead points."

89. Assume now, the general voltage wave (1) is one of the three-phase voltages, and is impressed upon one of the phases of a three-phase induction motor. The second and third phase then is lagging by $\frac{2\pi}{3}$ and $\frac{4\pi}{3}$ respectively behind the first phase (1):

$$\begin{aligned}
 e' &= e_1 \cos\left(\phi - \frac{2\pi}{3}\right) + e_3 \cos\left(3\phi - \frac{6\pi}{3} - \alpha_3\right) \\
 &+ e_5 \cos\left(5\phi - \frac{10\pi}{3} - \alpha_5\right) + e_7 \cos\left(7\phi - \frac{14\pi}{3} - \alpha_7\right) \\
 &+ e_9 \cos\left(9\phi - \frac{18\pi}{3} - \alpha_9\right) + \dots \\
 &= e_1 \cos\left(\phi - \frac{2\pi}{3}\right) + e_3 \cos(3\phi - \alpha_3) \\
 &+ e_5 \cos\left(5\phi - \alpha_5 + \frac{2\pi}{3}\right) + e_7 \cos\left(7\phi - \alpha_7 - \frac{2\pi}{3}\right) \\
 &+ e_9 \cos(9\phi - \alpha_9) + \dots \\
 e'' &= e_1 \cos\left(\phi - \frac{4\pi}{3}\right) + e_3 \cos(3\phi - \alpha_3) \\
 &+ e_5 \cos\left(5\phi - \alpha_5 + \frac{4\pi}{3}\right) + e_7 \cos\left(7\phi - \alpha_7 - \frac{4\pi}{3}\right) \\
 &+ e_9 \cos(9\phi - \alpha_9) + \dots
 \end{aligned} \tag{6}$$

Thus the voltage components of different frequency, impressed upon the three motor phases, are:

$e_1 \cos \phi$	$e_3 \cos$ $(3\phi - \alpha_3)$	$e_5 \cos$ $(5\phi - \alpha_5)$	$e_7 \cos$ $(7\phi - \alpha_7)$	$e_9 \cos$ $(9\phi - \alpha_9)$
$e_1 \cos$ $\left(\phi - \frac{2\pi}{3}\right)$	$e_3 \cos$ $(3\phi - \alpha_3)$	$e_5 \cos$ $\left(5\phi - \alpha_5 + \frac{2\pi}{3}\right)$	$e_7 \cos$ $\left(7\phi - \alpha_7 - \frac{2\pi}{3}\right)$	$e_9 \cos$ $(9\phi - \alpha_9)$
$e_1 \cos$ $\left(\phi - \frac{4\pi}{3}\right)$	$e_3 \cos$ $(3\phi - \alpha_3)$	$e_5 \cos$ $\left(5\phi - \alpha_5 + \frac{4\pi}{3}\right)$	$e_7 \cos$ $\left(7\phi - \alpha_7 - \frac{4\pi}{3}\right)$	$e_9 \cos$ $(9\phi - \alpha_9)$
Fundamental....	3d	5th	7th	9th

As seen, in this case of the three-phase motor, the third harmonics have no phase rotation, but are in phase with each other, or single-phase voltages. The fifth harmonic gives backward phase rotation, and thus negative torque, while the seventh harmonic has the same phase rotation, as the fundamental, thus adds its torque up to its synchronous speed, $S = +\frac{1}{7}$, and above this gives negative or generator torque. The ninth harmonic again is single-phase.

Fig. 56 shows the fundamental torque, T_1 , the higher harmonics

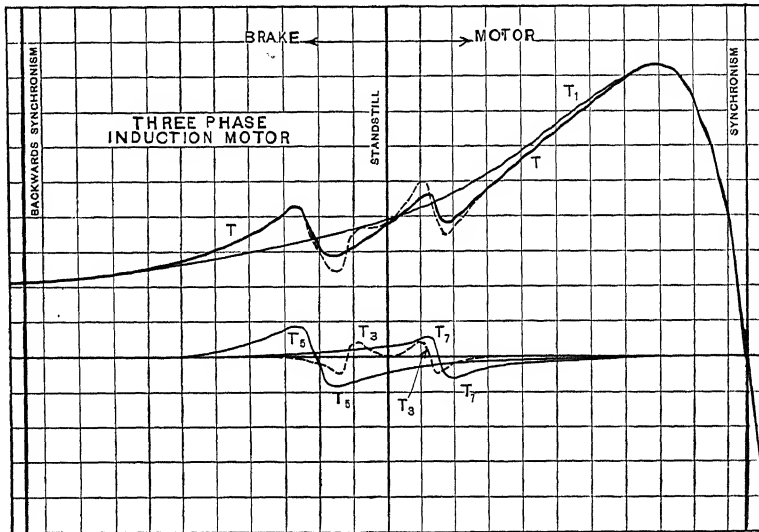

FIG. 56.—Three-phase induction motor, component harmonics and resultant torque.

of torque, T_5 and T_7 , and the resultant torque, T . As seen, the distortion of the torque curve is materially less, due to the absence, in Fig. 56, of the third harmonic torque.

However, while the third harmonic (and its multiples) in the three-phase system of voltages are in phase, thus give no phase rotation, they may give torque, as a single-phase induction motor has torque, at speed, though at standstill the torque is zero.

Fig. 57 B shows diagrammatically, as T , the development of the air-gap distribution of a true three-phase winding, such as used in synchronous converters, etc. Each phase 1, 2, 3, covers one-third of the pitch of a pair of poles or $\frac{2\pi}{3}$, of the upper layer,

and its return, 1', 2', 3', covers another third of the circumference of two poles, in the lower layer of the armature winding, 180° away from 1, 2, 3. However, this type of true three-phase winding is practically never used in induction or synchronous machines, but the type of winding is used, which is shown as *S*, in Fig. 57 *C*. This is in reality a six-phase winding: each of the three

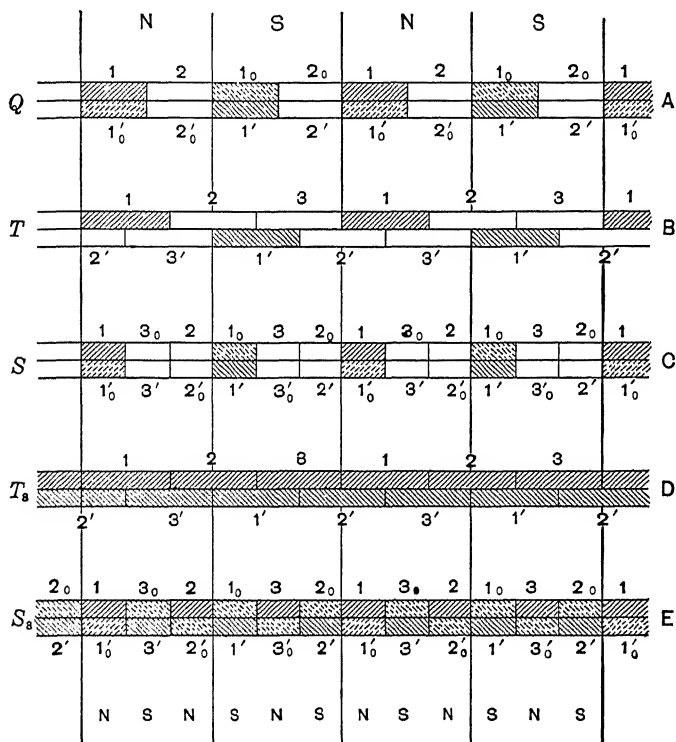

FIG. 57.—Current distribution at air gap of induction motor, fundamental and harmonics.

phases, 1, 2, 3, covers only one-sixth of the pitch of a pair of poles, or $\frac{\pi}{3}$ or 60°, and between the successive phases is placed the opposite phase, connected in the reverse direction. Thus the return conductors of phases 1, 2, 3 of the upper layer, are shown in the lower layer as 1', 2', 3'; in the upper layer, above 1', 2', 3', is placed again the phase 1, 2, 3, but connected in the reverse direction, and indicated as 1₀, 2₀, 3₀. As 1₀ is connected in the reverse direction to 1, and 1' is the return of 1, 1₀ is in

phase with $1'$, and the return of $1_0: 1'_0$, is in the lower layer, in phase with, and beneath 1. Thus the phase rotation is: 1, -3, 2, -1, 3, -2, 1, etc.

For comparison, Fig. 57 *A* shows the usual quarter-phase winding, Q , of the same general type as the winding, Fig. 57 *C*.

If then the three third harmonics of 1, 2 and 3 are in phase with each other, for these third harmonics the true three-phase winding, T , gives the phase diagram shown as T_3 in Fig. 57 *D*. As seen, the current flows in one direction, single-phase, throughout the entire upper layer, and in the opposite direction in the lower layer, and thus its magnetizing action neutralizes, that is, there can be no third harmonic flux in the true three-phase winding.

The third harmonic diagram of the customary six-phase arrangement of three-phase winding, S , is shown as S_3 in Fig. 57 *E*. As seen, in this case alternately the single-phase third harmonic current flows in one direction for 60° or $\frac{\pi}{3}$, and in the opposite direction for the next $\frac{\pi}{3}$. In other words, a single-phase m.m.f. and single-phase flux exists, of three times as many poles as the fundamental flux.

Thus, with the usual three-phase induction-motor winding, a third harmonic in the voltage wave produces a single-phase triple harmonic flux of three times the number of motor poles, and this gives a single-phase motor-torque curve, that is, a torque which, starting with zero at standstill, increases to a maximum in positive direction or assisting, and then decreases again to zero at its synchronous speed, and above this, becomes negative as single-phase induction-generator torque. Triple frequency with three times the number of poles gives a synchronous speed of $S = \pm \frac{1}{9}$. That is, the third harmonic in a three-phase voltage may give a single-phase motor torque with a synchronous speed of one-ninth that of the fundamental torque, and in either direction, as shown as T_3 in dotted lines, in Fig. 56.

As usually the third harmonic is absent in three-phase voltages, such a triple harmonic single-phase torque, as shown dotted in Fig. 56, is of rare occurrence: it could occur only in a four-wire three-phase system, that is, system containing the three phase-wires and the neutral.

90. All the torque components produced by the higher harmonics of the voltage wave have the same number of motor poles

as the fundamental (except the single-phase third harmonic above discussed, and its multiples, which have three times as

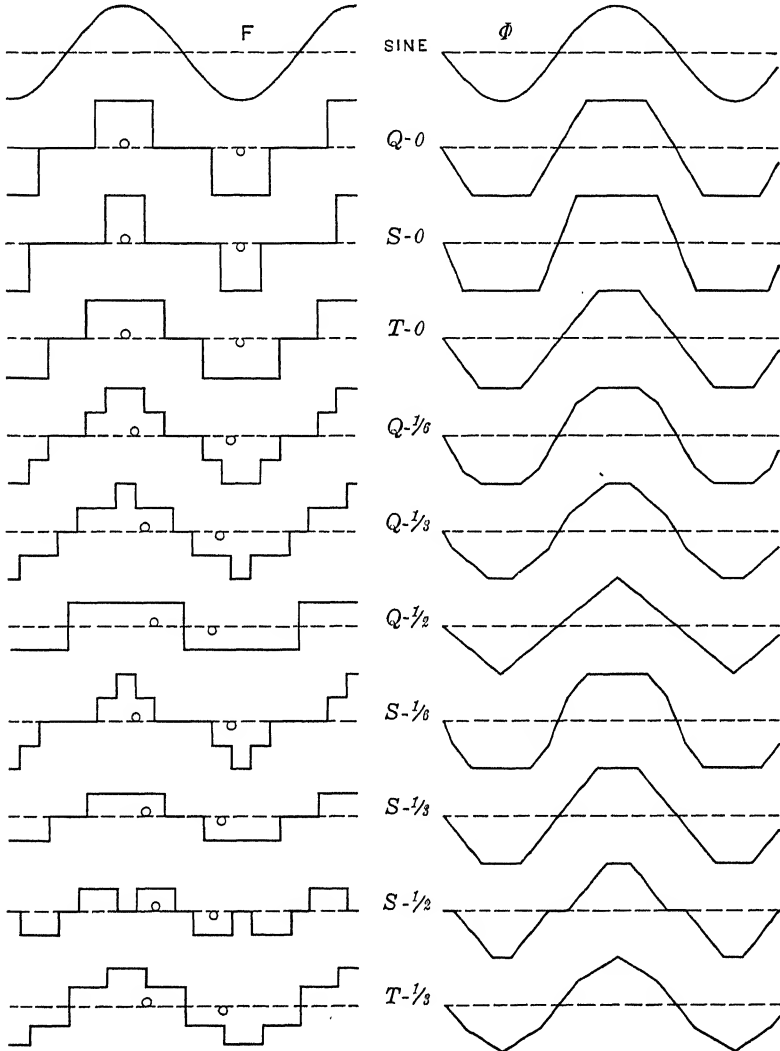

FIG. 58.—Current and flux distribution in induction-motor air gap, with different types of windings

many motor poles), but a lower synchronous speed, due to their higher frequency.

Torque harmonics may also occur, having the fundamental

frequency, but higher number of pairs of poles than the fundamental, and thus lower synchronous speeds, due to the deviation of the space distribution of the motor winding from sine.

The fundamental motor torque, T_1 , of Figs. 55 and 56, is given by a sine wave of voltage and thus of flux, if the winding of each phase is distributed around the circumference of the motor air gap in a sinusoidal manner, as shown as F' under "Sine," in Fig. 58, and the flux distribution of each phase around the circumference of the air gap is sinusoidal also, as shown as Φ under "Sine," in Fig. 58.

This, however, is never the case, but the winding is always distributed in a non-sinusoidal manner.

The space distribution of magnetizing force and thus of flux of each phase, along the circumference of the motor air gap, thus can in the general case be represented by a trigonometric series, with ω as space angle, in electrical degrees, that is, counting a pair of poles as 2π or 360° . It is then:

The distribution of the conductors of one phase, in the motor air gap:

$$F = F_0 \{ \cos \omega + a_3 \cos 3 \omega + a_5 \cos 5 \omega + a_7 \cos 7 \omega + a_9 \cos 9 \omega + \dots \}; \quad (8)$$

here the assumption is made, that all the harmonics are in phase, that is, the magnetic distribution symmetrical. This is practically always the case, and if it were not, it would simply add phase angle, α_m , to the harmonics, the same as in paragraphs 88 and 89, but would make no change in the result, as the component torque harmonics are independent of the phase relations between the harmonic and the fundamental, as seen below.

In a quarter-phase motor, the second phase is located 90° or $\omega = \frac{\pi}{2}$ displaced in space, from the first phase, and thus represented by the expression:

$$\begin{aligned} F' &= F_0 \left\{ \cos \left(\omega - \frac{\pi}{2} \right) + a_3 \cos \left(3 \omega - \frac{3\pi}{2} \right) + a_5 \cos \left(5 \omega - \frac{5\pi}{2} \right) \right. \\ &\quad \left. + a_7 \cos \left(7 \omega - \frac{7\pi}{2} \right) + a_9 \cos \left(9 \omega - \frac{9\pi}{2} \right) + \dots \right\} \\ &= F_0 \left\{ \cos \left(\omega - \frac{\pi}{2} \right) + a_3 \cos \left(3 \omega + \frac{\pi}{2} \right) + a_5 \cos \left(5 \omega - \frac{\pi}{2} \right) \right. \\ &\quad \left. + a_7 \cos \left(7 \omega + \frac{\pi}{2} \right) + a_9 \cos \left(9 \omega - \frac{\pi}{2} \right) + \dots \right\}. \quad (9) \end{aligned}$$

Such a general or non-sinusoidal space distribution of magnetizing force and thus of magnetic flux, as represented by F and F' , can be considered as the superposition of a series of sinusoidal magnetizing forces and magnetic fluxes:

$$\left. \begin{array}{lll} \cos \omega & a_3 \cos 3\omega & a_5 \cos 5\omega \\ \cos\left(\omega - \frac{\pi}{2}\right) & a_3 \cos\left(3\omega + \frac{\pi}{2}\right) & a_5 \cos\left(5\omega - \frac{\pi}{2}\right) \\ a_7 \cos 7\omega & a_9 \cos 9\omega & \\ a_7 \cos\left(7\omega + \frac{\pi}{2}\right) & a_9 \cos\left(9\omega - \frac{\pi}{2}\right) & \end{array} \right\} \quad (10)$$

The first component:

$$\left. \begin{array}{l} \cos \omega, \\ \cos\left(\omega - \frac{\pi}{2}\right), \end{array} \right\} \quad (10)$$

gives the fundamental torque of the motor, as calculated in the customary manner, and represented by T_1 in Figs. 55 and 56.

The second component of space distribution of magnetizing force:

$$\left. \begin{array}{l} a_3 \cos 3\omega, \\ a_3 \cos\left(3\omega + \frac{\pi}{2}\right), \end{array} \right\} \quad (11)$$

gives a distribution, which makes three times as many cycles in the motor-gap circumference, than (10), that is, corresponds to a motor of three times as many poles. This component of space distribution of magnetizing force would thus, with the fundamental voltage and current wave, give a torque curve reaching synchronism as one-third speed; with the third harmonic of the voltage wave, (11) would reach synchronism at one-ninth, with the fifth harmonic of the voltage wave at one-fifteenth of the normal synchronous speed.

In (11), the sign of the second term is reversed from that in (10), that is, in (11), the space rotation is backward from that of (10). In other words, (11) gives a synchronous speed of $S = -\frac{1}{3}$ with the fundamental or full-frequency voltage wave.

The third component of space distribution:

$$\left. \begin{array}{l} a_5 \cos 5\omega, \\ a_5 \cos\left(5\omega - \frac{\pi}{2}\right), \end{array} \right\} \quad (12)$$

gives a motor of five times as many poles as (10), but with same space rotation as (10), and this component thus would give a torque, reaching synchronism at $S = +\frac{1}{5}$.

In the same manner, the seventh space harmonic gives $S = -\frac{1}{7}$, the ninth space harmonic $S = +\frac{1}{9}$, etc.

91. As seen, the component torque curves of the harmonics of the space distribution of magnetizing force and magnetic flux in the motor air gap, have the same characteristics as the component torque due to the time harmonics of the impressed voltage wave, and thus are represented by the same torque diagrams:

Fig. 55 for a quarter-phase motor,

Fig. 56 for a three-phase motor.

Here again, we see that the three-phase motor is less liable to irregularities in the torque curve, caused by higher harmonics, than the quarter-phase motor is.

Two classes of harmonics thus may occur in the induction motor, and give component torques of lower synchronous speed:

Time harmonics, that is, harmonics of the voltage wave, which are of higher frequency, but the same number of motor poles, and

Space harmonics, that is, harmonics in the air-gap distribution, which are of fundamental frequency, but of a higher number of motor poles.

Compound harmonics, that is, higher space harmonics of higher time harmonics, theoretically exist, but their torque necessarily is already so small, that they can be neglected, except where they are intentionally produced in the design.

We thus get the two classes of harmonics, and their characteristics:

Order of harmonic	1	3	5	7	9	11	13	15	17	
<i>Quarter-phase motor:</i>										
Phase rotation.....	+	-	+	-	+	-	+	-	+	
Synchronous speed.....	+1	$-\frac{1}{3}$	$+\frac{1}{5}$	$-\frac{1}{7}$	$+\frac{1}{9}$	$-\frac{1}{11}$	$+\frac{1}{13}$	$-\frac{1}{15}$	$+\frac{1}{17}$	
Time H {	Frequency.....	f	$3f$	$5f$	$7f$	$9f$	$11f$	$13f$	$15f$	$17f$
	No. of poles.....	p	p	p	p	p	p	p	p	p
Space H {	Frequency.....	f	f	f	f	f	f	f	f	
	No. of poles.....	p	$3p$	$5p$	$7p$	$9p$	$11p$	$13p$	$15p$	$17p$
<i>Three-phase motor:</i>										
Phase rotation.....	+	0	-	+	0	-	+	0	-	
Synchronous speed.....	+1	$(\pm \frac{1}{3})$	$-\frac{1}{5}$	$+\frac{1}{7}$	$(\pm \frac{1}{9})$	$-\frac{1}{11}$	$+\frac{1}{13}$	$(\pm \frac{1}{15})$	$-\frac{1}{17}$	
Time H {	Frequency.....	f	$3f$	$5f$	$7f$	$9f$	$11f$	$13f$	$15f$	$17f$
	No. of poles.....	p	$(3p)$	p	p	$(3p)$	p	p	$(3p)$	p
Space H {	Frequency.....	f	f	f	f	f	f	f	f	
	No. of poles.....	p	0	$5p$	$7p$	0	$11p$	$13p$	0	$17p$

92. The space harmonics usually are more important than the time harmonics, as the space distribution of the winding in the motor usually materially differs from sinusoidal, while the deviation of the voltage wave from sine shape in modern electric power-supply systems is small, and the time harmonics thus usually negligible.

The space harmonics can easily be calculated from the distribution of the winding around the periphery of the motor air gap. (See "Engineering Mathematics," the chapter on the trigonometric series.)

A number of the more common winding arrangements are shown in Fig. 58, in development. The arrangement of the conductors of one phase is shown to the left, under F , and the wave shape of the m.m.f. and thus the magnetic flux produced by it is shown under Φ to the right. The pitch of a turn of the winding is indicated under F .

Fig. 58 shows:

Full-pitch quarter-phase winding: $Q - 0$.

Full-pitch six-phase winding: $S - 0$.

This is the three-phase winding almost always used in induction and synchronous machines.

Full-pitch three-phase winding: $T - 0$.

This is the true three-phase winding, as used in closed-circuit armatures, as synchronous converters, but of little importance in induction and synchronous motors.

$\frac{5}{6}$, $\frac{2}{3}$ and $\frac{1}{2}$ -pitch quarter-phase windings:

$$Q - \frac{1}{6}; Q - \frac{1}{3}; Q - \frac{1}{2}.$$

$\frac{5}{6}$, $\frac{2}{3}$ and $\frac{1}{2}$ -pitch six-phase windings:

$$S - \frac{1}{6}; S - \frac{1}{3}; S - \frac{1}{2}.$$

$\frac{2}{3}$ -pitch true three-phase windings: $T - \frac{1}{3}$.

As seen, the pitch deficiency, p , is denoted by the index.

Denoting the winding, F , on the left side of Fig. 58, by the Fourier series:

$$F = F_0 (\cos \omega + a_3 \cos 3 \omega + a_5 \cos 5 \omega + a_7 \cos 7 \omega + \dots). \quad (13)$$

It is, in general:

$$F_0 a_n = \frac{4}{\pi} \int_0^{\frac{\pi}{2}} F \cos n \omega d \omega. \quad (14)$$

If, then: $p =$ pitch deficiency,
 $q =$ number of phases

(four with quarter-phase, Q , six with six-phase, S , three with three-phase, T);

any fractional pitch winding then consists of the superposition of two layers:

$$\text{From } \omega = 0 \text{ to } \omega = \frac{\pi}{q} + \frac{p\pi}{2},$$

and

$$\text{from } \omega = 0 \text{ to } \omega = \frac{\pi}{q} - \frac{p\pi}{2},$$

and the integral (14) become:

$$\begin{aligned} F_0 a_n &= \frac{4F}{\pi} \left\{ \int_0^{\frac{\pi}{q} + \frac{p\pi}{2}} \cos n\omega d\omega + \int_0^{\frac{\pi}{q} - \frac{p\pi}{2}} \cos n\omega d\omega \right\} \\ &= \frac{4F}{n\pi} \left\{ \sin n \left(\frac{\pi}{q} + \frac{p\pi}{2} \right) + \sin n \left(\frac{\pi}{q} - \frac{p\pi}{2} \right) \right\} \\ &= \frac{8F}{n\pi} \sin \frac{n\pi}{q} \cos \frac{pn\pi}{2}, \end{aligned} \quad (15)$$

as for: $n = 1; a_n = 1$, it is, substituted in (15):

$$\frac{8F}{\pi} = \frac{F_0}{\sin \frac{\pi}{q} \cos \frac{p\pi}{2}}; \quad (16)$$

hence, substituting (16) into (15):

$$a_n = \frac{\sin \frac{n\pi}{q} \cos \frac{pn\pi}{2}}{\sin \frac{\pi}{q} \cos \frac{p\pi}{2}}. \quad (17)$$

For full-pitch winding:

$$p = 0.$$

It is, from (17):

$$a_n^0 = \frac{\sin \frac{n\pi}{q}}{\sin \frac{\pi}{q}}, \quad (18)$$

and for a fractional-pitch winding of pitch deficiency, p , it thus is:

$$a_n = a_n^0 \frac{\cos \frac{pn\pi}{2}}{\cos \frac{p\pi}{2}}. \quad (19)$$

93. By substituting the values: $q = 4, 6, 3$ and $p = 0, \frac{1}{6}, \frac{1}{3}, \frac{1}{2}$, into equation (17), we get the coefficients a_n of the trigonometric series:

$$F = F_0 \{ \cos \omega + a_3 \cos 3 \omega + a_5 \cos 5 \omega + a_7 \cos 7 \omega + \dots \}, \quad (20)$$

which represents the current distribution per phase through the air gap of the induction machine, shown by the diagrams F of Fig. 58.

The corresponding flux distribution, Φ , in Fig. 58, expressed by a trigonometric series:

$$\Phi = \Phi_0 \{ \sin \omega + b_3 \sin 3 \omega + b_5 \sin 5 \omega + b_7 \sin 7 \omega + \dots \} \quad (21)$$

could be calculated in the same manner, from the constructive characteristics of Φ in Fig. 58.

It can, however, be derived immediately from the consideration, that Φ is the summation, that is, the integral of F :

$$\Phi = \int F d\omega \quad (22)$$

and herefrom follows:

$$b_n = \frac{a_n}{n} \quad (23)$$

and this gives the coefficients, b_n , of the series, Φ .

In the following tables are given the coefficients a_n and b_n , for the winding arrangements of Fig. 58, up to the twenty-first harmonic.

As seen, some of the lower harmonics are very considerable thus may exert an appreciable effect on the motor torque at low speeds, especially in the quarter-phase motor.

ELECTRICAL APPARATUS

SPACE HARMONICS OF MOTOR WINDING

	q	p	n =	3	5	7	9	11	13	15	17	19	21
Sine.....	any	any	$a_n =$ $b_n =$	zero	-0.2000 - $\frac{1}{2}$	-0.1429 - $\frac{1}{4}$	+0.1111 + $\frac{1}{3}$	+0.0909 + $\frac{1}{11}$	-0.0769 - $\frac{1}{13}$	-0.0667 - $\frac{1}{15}$	+0.0588 + $\frac{1}{17}$	+0.0526 + $\frac{1}{19}$	-0.0476 - $\frac{1}{21}$
Q-0.....	4	0	$a_n =$ $b_n =$	+0.3333 + $\frac{1}{3}$	-0.0400 -0.0400	-0.0204 -0.0204	+0.0123 +0.0123	+0.0082 +0.0082	-0.0059 -0.0059	-0.0044 -0.0044	+0.0035 +0.0035	+0.0028 +0.0028	-0.0023 -0.0023
S-0.....	6	0	$a_n =$ $b_n =$	+0.6667 + $\frac{2}{3}$	+0.2000 +0.2000	+0.1429 +0.1429	-0.2222 - $\frac{2}{9}$	-0.0909 - $\frac{1}{11}$	+0.0769 + $\frac{1}{13}$	+0.1333 + $\frac{1}{3}$	+0.0588 + $\frac{1}{17}$	-0.0526 - $\frac{1}{19}$	-0.0952 - $\frac{2}{21}$
T-0.....	3	0	$a_n =$ $b_n =$	+0.2222 0	+0.0400 -0.0400	-0.0204 + $\frac{1}{4}$	-0.0247	-0.0082 - $\frac{1}{11}$	+0.0059 + $\frac{1}{13}$	+0.0089	+0.0035 +0.0035	-0.0028 +0.0028	-0.0045 0
Q- $\frac{1}{2}$...	4	$\frac{1}{2}$	$a_n =$ $b_n =$	0 +0.244	-0.0400 -0.0536	+0.0204 +0.0383	0 -0.0813	-0.0082 -0.0909	+0.0059 +0.0769	0 +0.0488	-0.0035 -0.0158	+0.0023 +0.0141	0 -0.0349
Q- $\frac{1}{3}$...	4	$\frac{1}{3}$	$a_n =$ $b_n =$	0 +0.0813	-0.0107 +0.200	+0.0055 +0.1429	-0.0090 +0.0055	+0.0090 +0.0090	-0.0769 -0.0059	+0.0033 +0.0033	-0.0009 -0.0588	+0.0008 -0.0526	0 0
Q- $\frac{1}{4}$...	4	$\frac{1}{4}$	$a_n =$ $b_n =$	0 +0.3333	+0.0400 +0.2000	+0.0204 +0.1429	0 +0.1111	-0.0082 -0.0909	-0.0059 +0.0769	0 -0.0667	-0.0035 +0.0588	-0.0028 -0.0526	0 +0.0476
S- $\frac{1}{2}$...	6	$\frac{1}{2}$	$a_n =$ $b_n =$	+0.488 +0.1627	+0.0536 +0.0107	+0.0383 +0.0055	+0.0204 +0.0181	+0.0082 +0.0082	-0.0769 +0.0059	-0.0976 +0.0065	-0.0158 -0.0009	-0.0141 +0.0526	-0.0698 -0.0033
S- $\frac{1}{3}$...	6	$\frac{1}{3}$	$a_n =$ $b_n =$	0 0	-0.2000 +0.0400	+0.1429 +0.0204	0 0	-0.0909 -0.0082	+0.0769 +0.0059	0 +0.1333	-0.0588 +0.0035	+0.0526 +0.0028	0 +0.0952
S- $\frac{1}{4}$...	6	$\frac{1}{4}$	$a_n =$ $b_n =$	-0.6667 -0.2222	-0.2000 -0.0400	-0.1429 -0.0204	-0.2222 -0.0247	+0.0909 +0.0909	-0.0769 -0.0059	+0.0089 0	+0.0588 +0.0035	+0.0526 -0.0028	0 +0.0952
T- $\frac{1}{2}$...	3	$\frac{1}{2}$	$a_n =$ $b_n =$	0 0	+0.2000 +0.0400	-0.1429 -0.0204	-0.0247 0	-0.0909 -0.0082	+0.0769 +0.0059	0 +0.1333	+0.0035 +0.0035	-0.0028 -0.0028	0 +0.0952
max.	max.		=	+0.6667 $\frac{2}{3}$	0.2000 $\frac{1}{5}$	0.1429 $\frac{1}{7}$	0.2222 $\frac{2}{9}$	0.0909 $\frac{1}{11}$	0.0769 $\frac{1}{13}$	0.1333 $\frac{1}{3}$	0.0588 $\frac{1}{17}$	0.0526 $\frac{1}{19}$	0.0952 $\frac{2}{21}$

CHAPTER VIII

SYNCHRONIZING INDUCTION MOTORS

94. Occasionally two or more induction motors are operated in parallel on the same load, as for instance in three-phase rail-roading, or when securing several speeds by concatenation. In this case the secondaries of the induction motors may be connected in multiple and a single rheostat used for starting and speed control. Thus, when using two motors in concatenation for speeds from standstill to half synchronism, from half synchronism to full speed, the motors may also be operated on a single rheostat by connecting their secondaries in parallel. As in parallel connection the frequency of the secondaries must be the same, and the secondary frequency equals the slip, it follows that the motors in this case must operate at the same slip, that is, at the same frequency of rotation, or in synchronism with each other. If the connection of the induction motors to the load is such that they can not operate in exact step with each other, obviously separate resistances must be used in the motor secondaries, so as to allow different slips. When rigidly connecting the two motors with each other, it is essential to take care that the motor secondaries have exactly the same relative position to their primaries so as to be in phase with each other, just as would be necessary when operating two alternators in parallel with each other when rigidly connected to the same shaft or when driven by synchronous motors from the same supply. As in the induction-motor secondary an e.m.f. of definite frequency, that of slip, is generated by its rotation through the revolving motor field, the induction-motor secondary is an alternating-current generator, which is short-circuited at speed and loaded by the starting rheostat during acceleration, and the problem of operating two induction motors with their secondaries connected in parallel on the same external resistance is thus the same as that of operating two alternators in parallel. In general, therefore, it is undesirable to rigidly connect induction-motor secondaries mechanically if they are electrically connected in parallel, but it is preferable to have their mechanical connection

sufficiently flexible, as by belting, etc., so that the motors can drop into exact step with each other and maintain step by their synchronizing power.

It is of interest, then, to examine the synchronizing power of two induction motors which are connected in multiple with their secondaries on the same rheostat and operated from the same primary impressed voltage.

95. Assume two equal induction motors with their primaries connected to the same voltage supply and with their secondaries connected in multiple with each other to a common resistance, r , and neglecting for simplicity the exciting current and the voltage drop in the impedance of the motor primaries as not materially affecting the synchronizing power.

Let $Z_1 = r_1 + jx_1 =$ secondary self-inductive impedance at full frequency; $s =$ slip of the two motors, as fraction of synchronism; $e_0 =$ absolute value of impressed voltage and thus, when neglecting the primary impedance, of the voltage generated in the primary by the rotating field.

If then the two motor secondaries are out of phase with each other by angle 2τ , and the secondary of the motor 1 is behind in the direction of rotation and the secondary of the motor 2 ahead of the average position by angle τ , then:

$$E_1 = se_0 (\cos \tau + j \sin \tau) = \text{secondary generated} \\ \text{e.m.f. of the first motor,} \quad (1)$$

$$E_2 = se_0 (\cos \tau - j \sin \tau) = \text{secondary generated} \\ \text{e.m.f. of the second motor.} \quad (2)$$

And if $I_1 =$ current coming from the first, $I_2 =$ current coming from the second motor secondary, the total current, or current in the external resistance, r , is:

$$I = I_1 + I_2; \quad (3)$$

it is then, in the circuit comprising the first motor secondary and the rheostat, r ,

$$E_1 - I_1 Z - I r = 0, \quad (4)$$

in the circuit comprising the second motor secondary and the rheostat, r ,

$$E_2 - I_2 Z - I r = 0, \quad (5)$$

where

$$Z = r_1 + jsx_1;$$

substituting (3) into (4) and (5) and rearranging gives:

$$\begin{aligned} E_1 - I_1 (Z + r) - I_2 r &= 0, \\ E_2 - I_1 r - I_2 (Z + r) &= 0. \end{aligned}$$

These two equations added and subtracted give:

$$\begin{aligned} E_1 + E_2 - (I_1 + I_2) (Z + 2r) &= 0, \\ E_1 - E_2 - (I_1 - I_2) Z &= 0; \end{aligned}$$

hence,

$$\text{and } \left. \begin{aligned} I_1 + I_2 &= \frac{E_1 + E_2}{Z + 2r} \\ I_1 - I_2 &= \frac{E_1 - E_2}{Z} \end{aligned} \right\} \quad (6)$$

Substituting for convenience the abbreviations,

$$\left. \begin{aligned} \frac{1}{Z + 2r} &= Y = g - jb, \\ \frac{1}{Z} &= Y_1 = g_1 - jb_1, \end{aligned} \right\} \quad (7)$$

into equations (6) and substituting (1) and (2) into (6), gives:

$$\begin{aligned} I_1 + I_2 &= 2 se_0 Y \cos \tau, \\ I_1 - I_2 &= + 2 j se_0 Y_1 \sin \tau; \end{aligned} \quad (8)$$

hence,

$$I_2^1 = se_0 \{ Y \cos \tau \mp j Y_1 \sin \tau \} \quad (9)$$

is the current in the secondary circuit of the motor, and therefore also the primary load current, that is, the primary current corresponding to the secondary current, and thus, when neglecting the exciting current also the primary motor current, where the upper sign corresponds to the first, or lagging, the lower sign to the second, or leading, motor.

Substituting in (9) for Y and Y_1 gives:

$$I_2^1 = se_0 \{ (g \cos \tau \pm b_1 \sin \tau) - j (b \cos \tau \mp g_1 \sin \tau) \}, \quad (10)$$

the primary e.m.f. corresponding hereto is:

$$E_2^1 = e_0 \{ \cos \tau \mp j \sin \tau \}, \quad (11)$$

where again the upper sign corresponds to the first, the lower to the second motor.

The power consumed by the current, I_2^1 , with the e.m.f., E_2^1 ,

is the sum of the products of the horizontal components, and of the vertical components, that is, of the real components and of the imaginary components of these two quantities (as a horizontal component of one does not represent any power with a vertical component of the other quantity, being in quadrature therewith).

$$P_2^1 = |E_2^1 I_2^1|,$$

where the brackets denote that the sum of the product of the corresponding parts of the two quantities is taken.

As discussed in the preceding, the *torque* of an induction motor, in synchronous watts, equals the power consumed by the primary counter e.m.f.; that is:

$$D_2^1 = P_2^1,$$

and substituting (10) and (11) this gives:

$$\begin{aligned} D_2^1 &= se_0^2 \{ \cos \tau (g \cos \tau \pm b_1 \sin \tau) \mp \sin \tau (b \cos \tau \mp g_1^* \sin \tau) \} \\ &= se_0^2 \left\{ \frac{g_1 + g}{2} - \frac{g_1 - g}{2} \cos 2\tau \pm \frac{b_1 - b}{2} \sin 2\tau \right\}, \end{aligned} \quad (12)$$

and herefrom follows the motor output or power, by multiplying with $(1 - s)$.

The sum of the torques of both motors, or the *total torque*, is:

$$2 D_t = D_1 + D_2 = se_0^2 \{ (g_1 + g) - (g_1 - g) \cos 2\tau \}. \quad (13)$$

The difference of the torque of both motors, or the *synchronizing torque*, is:

$$2 D_s = se_0^2 (b_1 - b) \sin 2\tau, \quad (14)$$

where, by (7),

$$\left. \begin{aligned} g_1 &= \frac{r_1}{m_1}, & g &= \frac{r_1 - 2r}{m}, \\ b_1 &= \frac{sx_1}{m_1}, & b &= \frac{sx_1}{m}, \\ m_1 &= r_1^2 + s^2x_1^2, & m &= (r_1 + 2r)^2 + s^2x_1^2, \end{aligned} \right\} \quad (15)$$

In these equations primary exciting current and primary impedance are neglected. The primary impedance can be introduced in the equations, by substituting $(r_1 + sr_0)$ for r_1 , and $(x_1 + x_0)$ for x_1 , in the expression of m_1 and m , and in this case only the exciting current is neglected, and the results are sufficiently accurate for most purposes, except for values of speed

very close to synchronism, where the motor current is appreciably increased by the exciting current. It is, then:

$$\left. \begin{aligned} m_1 &= (r_1 + rs_0)^2 + s^2 (x_1 + x_0)^2, \\ m &= (r_1 + sr_0 + 2r)^2 + s^2 (x_1 + x_0)^2; \end{aligned} \right\} \quad (16)$$

all the other equations remain the same.

From (15) and (16) follows

$$\frac{b_1 - b}{2} = \frac{2srx_1(r_1 + sr_0 + r)}{mm_1}, \quad (17)$$

hence, is always positive.

96. $(b_1 - b)$ is always positive, that is, the synchronizing torque is positive in the first or lagging motor, and negative in the second or leading motor; that is, the motor which lags in position behind gives more power and thus accelerates, while the motor which is ahead in position gives less power and thus drops back. Hence, the two motor armatures pull each other into step, if thrown together out of phase, just like two alternators.

The synchronizing torque (14) is zero if $\tau = 0$, as obvious, as for $\tau = 0$ both motors are in step with each other. The synchronizing torque also is zero if $\tau = 90^\circ$, that is, the two motor armatures are in opposition. The position of opposition is unstable, however, and the motors can not operate in opposition, that is, for $\tau = 90^\circ$, or with the one motor secondary short-circuiting the other; in this position, any decrease of τ below 90° produces a synchronizing torque which pulls the motors together, to $\tau = 0$, or in step. Just as with alternators, there thus exist two positions of zero synchronizing power—with the motors in step, that is, their secondaries in parallel and in phase, and with the motors in opposition, that is, their secondaries in opposition—and the former position is stable, the latter unstable, and the motors thus drop into and retain the former position, that is, operate in step with each other, within the limits of their synchronizing power.

If the starting rheostat is short-circuited, or $r = 0$, it is, by (15), $b_1 = b$, and the synchronizing power vanishes, as is obvious, since in this case the motor secondaries are short-circuited and thus independent of each other in their frequency and speed.

With parallel connection of induction-motor armatures a synchronizing power thus is exerted between the motors as long as any appreciable resistance exists in the external circuit, and

the motors thus tend to keep in step until the common starting resistance is short-circuited and the motors thereby become independent, the synchronizing torque vanishes, and the motors can slip against each other without interference by cross-currents.

Since the term $\frac{b_1 - b}{2}$ contains the slip, s , as factor, the synchronizing torque decreases with increasing approach to synchronous speed.

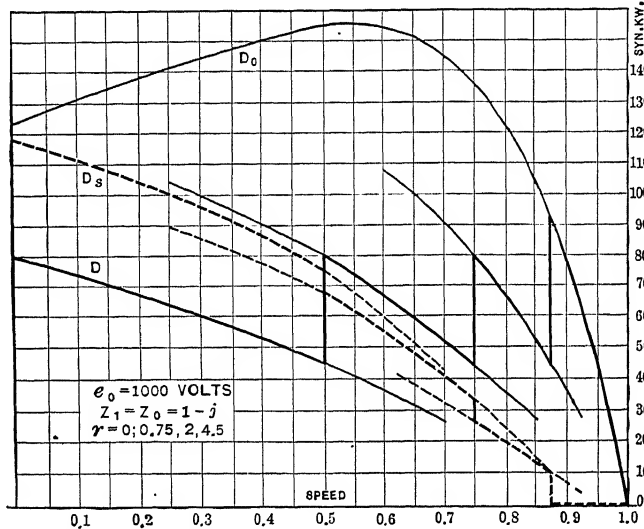

FIG. 59.—Synchronizing induction motors: motor torque and synchronizing torque.

For $\tau = 0$, or with the motors in step with each other, it is, by (12), (15), and (16):

$$D_2^1 = se_0^2 g = \frac{se_0^2 (r_1 + 2r)}{(r_1 + sr_0 + 2r)^2 + s^2 (x_1 + x_0)^2}, \quad (18)$$

that is, the same value as found for a single motor. (As the resistance r is common to both motors, for each motor it enters as $2r$.)

For $\tau = 90^\circ$, or the unstable positions of the motors, it is:

$$D_2^1 = se_0^2 g_1 = \frac{se_0^2 r_1}{(r_1 + sr_0)^2 + s^2 (x_1 + x_0)^2}; \quad (19)$$

that is, the same value as the motor would give with short-

circuited armature. This is to be expected, as the two motor armatures short-circuit each other.

The synchronizing torque is a maximum for $\tau = 45^\circ$, and is, by (14), (15), and (16):

$$D_s = se_0^2 \frac{b_1 - b}{2}. \tag{20}$$

As instances are shown, in Fig. 59, the motor torque, from equation (18), and the maximum synchronizing torque, from equation (20), for a motor of 5 per cent. drop of speed at full-load and very high overload capacity (a maximum power nearly two and a half times and a maximum torque somewhat over three times the rated value), that is, of low reactance, as can be produced at low frequency, and is desirable for intermittent service, hence of the constants:

$$\begin{aligned} Z_1 &= Z_0 = 1 + j, \\ Y &= 0.005 - 0.02 j, \\ e_0 &= 1000 \text{ volts,} \end{aligned}$$

for the values of additional resistance inserted into the armatures:

$$r = 0; 0.75; 2; 4.5,$$

giving the values:

$$\begin{aligned} g_1 &= \frac{1}{m_1}, & g &= \frac{1 + 2r}{m}, \\ b_1 &= \frac{2s}{m_1}, & b &= \frac{sx_1}{m}, \\ m_1 &= (1 + s)^2 + 4s^2, & m &= (1 + s + 2r)^2 + 4s^2. \end{aligned}$$

As seen, in this instance the synchronizing torque is higher than the motor torque up to half speed, slightly below the motor torque between half speed and three-quarters speed, but above three-quarters speed rapidly drops, due to the approach to synchronism, and becomes zero when the last starting resistance is cut out.

CHAPTER IX

SYNCHRONOUS INDUCTION MOTOR

97. The typical induction motor consists of one or a number of primary circuits acting upon an armature movable thereto, which contains a number of closed secondary circuits, displaced from each other in space so as to offer a resultant closed secondary circuit in any direction and at any position of the armature or secondary, with regards to the primary system. In consequence thereof the induction motor can be considered as a transformer, having to each primary circuit a corresponding secondary circuit—a secondary coil, moving out of the field of the primary coil, being replaced by another secondary coil moving into the field.

In such a motor the torque is zero at synchronism, positive below, and negative above, synchronism.

If, however, the movable armature contains one closed circuit only, it offers a closed secondary circuit only in the direction of the axis of the armature coil, but no secondary circuit at right angles therewith. That is, with the rotation of the armature the secondary circuit, corresponding to a primary circuit, varies from short-circuit at coincidence of the axis of the armature coil with the axis of the primary coil, to open-circuit in quadrature therewith, with the periodicity of the armature speed. That is, the apparent admittance of the primary circuit varies periodically from open-circuit admittance to the short-circuited transformer admittance.

At synchronism such a motor represents an electric circuit of an admittance varying with twice the periodicity of the primary frequency, since twice per period the axis of the armature coil and that of the primary coil coincide. A varying admittance is obviously identical in effect with a varying reluctance, which will be discussed in the chapter on reaction machines. That is, the induction motor with one closed armature circuit is, at synchronism, nothing but a reaction machine, and consequently gives zero torque at synchronism if the maxima and minima of the periodically varying admittance coincide with the maximum

and zero values of the primary circuit, but gives a definite torque if they are displaced therefrom. This torque may be positive or negative according to the phase displacement between admittance and primary circuit; that is, the lag or lead of the maximum admittance with regard to the primary maximum. Hence an induction motor with single-armature circuit at synchronism acts either as motor or as alternating-current generator according to the relative position of the armature circuit with respect to the primary circuit. Thus it can be called a synchronous induction motor or synchronous induction generator, since it is an induction machine giving torque at synchronism.

Power-factor and apparent efficiency of the synchronous induction motor as reaction machine are very low. Hence it is of practical application only in cases where a small amount of power is required at synchronous rotation, and continuous current for field excitation is not available.

The current produced in the armature of the synchronous induction motor is of double the frequency impressed upon the primary.

Below and above synchronism the ordinary induction motor, or induction generator, torque is superimposed upon the synchronous-induction machine torque. Since with the frequency of slip the relative position of primary and of secondary coil changes, the synchronous-induction machine torque alternates periodically with the frequency of slip. That is, upon the constant positive or negative torque below or above synchronism an alternating torque of the frequency of slip is superimposed, and thus the resultant torque pulsating with a positive mean value below, a negative mean value above, synchronism.

When started from rest, a synchronous induction motor will accelerate like an ordinary single-phase induction motor, but not only approach synchronism, as the latter does, but run up to complete synchronism under load. When approaching synchronism it makes definite beats with the frequency of slip, which disappear when synchronism is reached.

CHAPTER X

HYSTERESIS MOTOR

98. In a revolving magnetic field, a circular iron disk, or iron cylinder of uniform magnetic reluctance in the direction of the revolving field, is set in rotation, even if subdivided so as to preclude the production of eddy currents. This rotation is due to the effect of hysteresis of the revolving disk or cylinder, and such a motor may thus be called a hysteresis motor.

Let I be the iron disk exposed to a rotating magnetic field or resultant m.m.f. The axis of resultant magnetization in the disk, I , does not coincide with the axis of the rotating field, but lags behind the latter, thus producing a couple. That is, the component of magnetism in a direction of the rotating disk, I , ahead of the axis of rotating m.m.f., is rising, thus below, and in a direction behind the axis of rotating m.m.f. decreasing, that is, above proportionality with the m.m.f., in consequence of the lag of magnetism in the hysteresis loop, and thus the axis of resultant magnetism in the iron disk, I , does not coincide with the axis of rotating m.m.f., but is shifted backward by an angle, α , which is the angle of hysteretic lead.

The induced magnetism gives with the resultant m.m.f. a mechanical couple:

$$D = m\mathfrak{F}\Phi \sin \alpha,$$

where

\mathfrak{F} = resultant m.m.f.,

Φ = resultant magnetism,

α = angle of hysteretic advance of phase,

m = a constant.

The apparent or volt-ampere input of the motor is:

$$P = m\mathfrak{F}\Phi.$$

Thus the apparent torque efficiency:

$$\frac{P}{Q} = \sin \alpha,$$

where

Q = volt-ampere input,

and the power of the motor is:

$$P = (1 - s) D = (1 - s) m\mathfrak{F}\Phi \sin \alpha,$$

where

$$s = \text{slip as fraction of synchronism.}$$

The apparent efficiency is:

$$\frac{P}{Q} = (1 - s) \sin \alpha.$$

Since in a magnetic circuit containing an air gap the angle, α , is small, a few degrees only, it follows that the apparent efficiency of the hysteresis motor is low, the motor consequently unsuitable for producing large amounts of mechanical power.

From the equation of torque it follows, however, that at constant impressed e.m.f., or current—that is, constant \mathfrak{F} —the torque is constant and independent of the speed; and therefore such a motor arrangement is suitable, and occasionally used as alternating-current meter.

For $s < 0$, we have $\alpha < 0$,

and the apparatus is an hysteresis generator.

99. The same result can be reached from a different point of view. In such a magnetic system, comprising a movable iron disk, I , of uniform magnetic reluctance in a revolving field, the magnetic reluctance—and thus the distribution of magnetism—is obviously independent of the speed, and consequently the current and energy expenditure of the impressed m.m.f. independent of the speed also. If, now:

V = volume of iron of the movable part,

\mathfrak{B} = magnetic density,

and

η = coefficient of hysteresis,

the energy expended by hysteresis in the movable disk, I , is per cycle:

$$W_0 = V\eta\mathfrak{B}^{1.6},$$

hence, if f = frequency, the power supplied by the m.m.f. to the rotating iron disk in the hysteretic loop of the m.m.f. is:

$$P_0 = fV\eta\mathfrak{B}^{1.6}.$$

At the slip, sf , that is, the speed $(1 - s)f$, the power expended by hysteresis in the rotating disk is, however:

$$P_1 = sfV\eta\mathfrak{B}^{1.6}.$$

Hence, in the transfer from the stationary to the revolving member the magnetic power:

$$P = P_0 - P_1 = (1 - s) fV\eta\mathcal{B}^{1.6},$$

has disappeared, and thus reappears as mechanical work, and the torque is:

$$D = \frac{P}{(1 - s)f} = V\eta\mathcal{B}^{1.6},$$

that is, independent of the speed.

Since, as seen in "Theory and Calculation of Alternating-current Phenomena," Chapter XII, $\sin \alpha$ is the ratio of the energy of the hysteretic loop to the total apparent energy of the magnetic cycle, it follows that the apparent efficiency of such a motor can never exceed the value $(1 - s) \sin \alpha$, or a fraction of the primary hysteretic energy.

The primary hysteretic energy of an induction motor, as represented by its conductance, g , being a part of the loss in the motor, and thus a very small part of its output only, it follows that the output of a hysteresis motor is a small fraction only of the output which the same magnetic structure could give with secondary short-circuited winding, as regular induction motor.

As secondary effect, however, the rotary effort of the magnetic structure as hysteresis motor appears more or less in all induction motors, although usually it is so small as to be neglected.

However, with decreasing size of the motor, the torque of the hysteresis motor decreases at a lesser rate than that of the induction motor, so that for extremely small motors, the torque as hysteresis motor is comparable with that as induction motor.

If in the hysteresis motor the rotary iron structure has not uniform reluctance in all directions—but is, for instance, bar-shaped or shuttle-shaped—on the hysteresis-motor effect is superimposed the effect of varying magnetic reluctance, which tends to bring the motor to synchronism, and maintain it therein, as shall be more fully investigated under "Reaction Machine" in Chapter XVI.

100. In the hysteresis motor, consisting of an iron disk of uniform magnetic reluctance, which revolves in a uniformly rotating magnetic field, below synchronism, the magnetic flux rotates in the armature with the frequency of slip, and the resultant line of magnetic induction in the disk thus lags, in space, behind the synchronously rotating line of resultant m.m.f.

of the exciting coils, by the angle of hysteretic lead, α , which is constant, and so gives, at constant magnetic flux, that is, constant impressed e.m.f., a constant torque and a power proportional to the speed.

Above synchronism, the iron disk revolves faster than the rotating field, and the line of resulting magnetization in the disk being behind the line of m.m.f. with regard to the direction of rotation of the magnetism in the disk, therefore is ahead of it in space, that is, the torque and therefore the power reverses at synchronism, and above synchronism the apparatus is an hysteresis generator, that is, changes at synchronism from motor to generator. At synchronism such a disk thus can give mechanical power as motor, with the line of induction lagging, or give electric power as generator, with the line of induction leading the line of rotation m.m.f.

Electrically, the power transferred between the electric circuit and the rotating disk is represented by the hysteresis loop. Below synchronism the hysteresis loop of the electric circuit has the normal shape, and of its constant power a part, proportional to the slip, is consumed in the iron, the other part, proportional to the speed, appears as mechanical power. At synchronism the hysteresis loop collapses and reverses, and above synchronism the electric supply current so traverses the normal hysteresis loop in reverse direction, representing generation of electric power. The mechanical power consumed by the hysteresis generator then is proportional to the speed, and of this power a part, proportional to the slip above synchronism, is consumed in the iron, the other part is constant and appears as electric power generated by the apparatus in the inverted hysteresis loop.

This apparatus is of interest especially as illustrating the difference between hysteresis and molecular magnetic friction: the hysteresis is the power represented by the loop between magnetic induction and m.m.f. or the electric power in the circuit, and so may be positive or negative, or change from the one to the other, as in the above instance, while molecular magnetic friction is the power consumed in the magnetic circuit by the reversals of magnetism. Hysteresis, therefore, is an electrical phenomenon, and is a measure of the molecular magnetic friction only if there is no other source or consumption of power in the magnetic circuit.

CHAPTER XI

ROTARY TERMINAL SINGLE-PHASE INDUCTION MOTOR

101. A single-phase induction motor, giving full torque at starting and at any intermediate speed, by means of leading the supply current into the primary motor winding through brushes moving on a segmental commutator connected to the primary

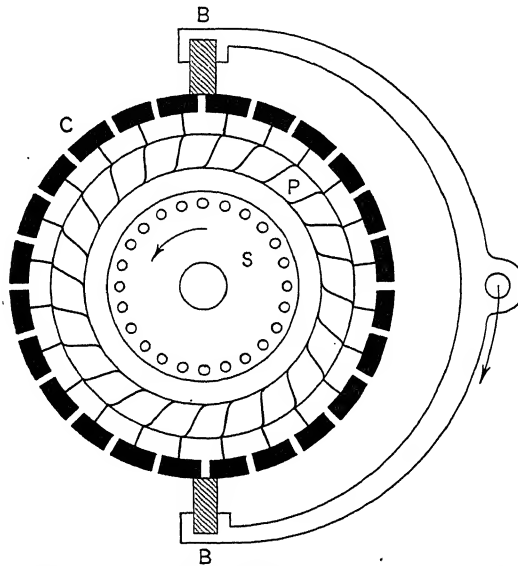

FIG. 60.—Diagram of rotary terminal single-phase induction motor.

winding, was devised and built by R. Eickemeyer in 1891, and further work thereon done later in Germany, but never was brought into commercial use.

Let, in Fig. 60, *P* denote the primary stator winding of a single-phase induction motor, *S* the revolving squirrel-cage secondary winding. The primary winding is arranged as a ring (or drum) winding and connected to a stationary commutator, *C*. The single-phase supply current is led into the primary winding, *P*, through two brushes bearing on the two (electrically) opposite

points of the commutator, C . These brushes, B , are arranged so that they can be revolved.

With the brushes, B , at standstill on the stationary commutator, C , the rotor, S , has no torque, and the current in the stator, P , is the usual large standstill current of the induction motor. If now the brushes, B , are revolved at synchronous speed, f , in the direction shown by the arrow, the rotor, S , again has no torque, but the stator, P , carries only the small exciting current of the motor, and the electrical conditions in the motor are the same, as would be with stationary brushes, B , at synchronous speed of the rotor, S . If now the brushes, B , are slowed down below synchronism, f , to speed, f_1 , the rotor, S , begins to turn, in reverse direction, as shown by the arrow, at a speed, f_2 , and a torque corresponding to the slip, $s = f - (f_1 + f_2)$.

Thus, if the load on the motor is such as to require the torque given at the slip, s , this load is started and brought up to full speed, $f - s$, by speeding the brushes, B , up to or near synchronous speed, and then allowing them gradually to come to rest: at brush speed, $f_1 = f - s$, the rotor starts, and at decreasing, f_1 , accelerates with the speed $f_2 = f - s - f_1$, until, when the brushes come to rest: $f_1 = 0$, the rotor speed is $f_2 = f - s$.

As seen, the brushes revolve on the commutator only in starting and at intermediate speeds, but are stationary at full speed. If the brushes, B , are rotated at oversynchronous speed: $f_1 > f$, the motor torque is reversed, and the rotor turns in the same direction as the brushes. In general, it is:

$$f_1 + f_2 + s = f,$$

where

$$\begin{aligned} f_1 &= \text{brush speed,} \\ f_2 &= \text{motor speed,} \\ s &= \text{slip required to give the desired torque,} \\ f &= \text{supply frequency.} \end{aligned}$$

102. An application of this type of motor for starting larger motors under power, by means of a small auxiliary motor, is shown diagrammatically, in section, in Fig. 61.

P_0 is the stationary primary or stator, S_0 the revolving squirrel-cage secondary of the power motor. The stator coils of P_0 connect to the segments of the stationary commutator, C_0 , which receives the single-phase power current through the brushes, B_0 .

These brushes, B_0 , are carried by the rotating squirrel-cage secondary, S_1 , of a small auxiliary motor. The primary of this, P_1 , is mounted on the power shaft, A , of the main motor, and carries the commutator, C_1 , which receives current from the brushes, B_1 .

These brushes are speeded up to or near synchronism by some means, as hand wheel, H , and gears, G , and then allowed to slow down. Assuming the brushes were rotating in counter-clockwise direction. Then, while they are slowing down, the (external) squirrel-cage rotor, S_1 , of the auxiliary motor starts and

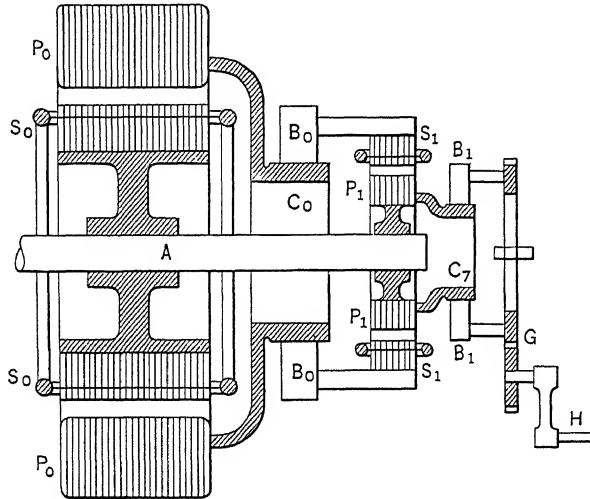

FIG. 61.—Rotary terminal single-phase induction motor with controlling motor.

speeds up, in clockwise direction, and while the brushes, B_1 , come to rest, S_1 comes up to full speed, and thereby brings the brushes, B_0 , of the power motor up to speed in clockwise rotation. As soon as B_0 has reached sufficient speed, the power motor gets torque and its rotor, S_0 , starts, in counter-clockwise rotation. As S_0 carries P_1 , with increasing speed of S_0 and P_1 , S_1 and with it the brushes, B_0 , slow down, until full speed of the power motor, S_0 , is reached, the brushes, B_0 , stand still, and the brushes, B_1 , by their friction on the commutator, C_1 , revolve together with C_1 , P_1 and S_0 .

In whichever direction the brushes, B_1 , are started, in the same direction starts the main motor, S_0 .

If by overload the main motor, S_0 , drops out of step and slows down, the slowing down of P_1 starts S_1 , and with it the brushes, B_0 , at the proper differential speed, and so carries full torque down to standstill, that is, there is no actual dropping out of the motor, but merely a slowing down by overload.

The disadvantage of this motor type is the sparking at the commutator, by the short-circuiting of primary coils during the passage of the brush from segment to segment. This would require the use of methods of controlling the sparking, such as used in the single-phase commutator motors of the series type, etc. It was the difficulty of controlling the sparking, which side-tracked this type of motor in the early days, and later, with the extensive introduction of polyphase supply, the single-phase motor problem had become less important.

CHAPTER XII

FREQUENCY CONVERTER OR GENERAL ALTERNATING-CURRENT TRANSFORMER

103. In general, an alternating-current transformer consists of a magnetic circuit, interlinked with two electric circuits or sets of electric circuits, the primary circuit, in which power, supplied by the impressed voltage, is consumed, and the secondary circuit, in which a corresponding amount of electric power is produced; or in other words, power is transferred through space, by magnetic energy, from primary to secondary circuit. This power finds its mechanical equivalent in a repulsive thrust acting between primary and secondary conductors. Thus, if the secondary is not held rigidly, with regards to the primary, it will be repelled and move. This repulsion is used in the constant-current transformer for regulating the current for constancy independent of the load. In the induction motor, this mechanical force is made use of for doing the work: the induction motor represents an alternating-current transformer, in which the secondary is mounted movably with regards to the primary, in such a manner that, while set in motion, it still remains in the primary field of force. This requires, that the induction motor field is not constant in one direction, but that a magnetic field exists in every direction, in other words that the magnetic field successively assumes all directions, as a so-called rotating field.

The induction motor and the stationary transformer thus are merely two applications of the same structure, the former using the mechanical thrust, the latter only the electrical power transfer, and both thus are special cases of what may be called the "general alternating-current transformer," in which both, power and mechanical motion, are utilized.

The general alternating-current transformer thus consists of a magnetic circuit interlinked with two sets of electric circuits, the primary and the secondary, which are mounted rotatably with regards to each other. It transforms between primary electrical and secondary electrical power, and also between

electrical and mechanical power. As the frequency of the revolving secondary is the frequency of slip, thus differing from the primary, it follows, that the general alternating-current transformer changes not only voltages and current, but also frequencies, and may therefore be called "frequency converter." Obviously, it may also change the number of phases.

Structurally, frequency converter and induction motor must contain an air gap in the magnetic circuit, to permit movability between primary and secondary, and thus they require a higher magnetizing current than the closed magnetic circuit stationary transformer, and this again results in general in a higher self-inductive impedance. Thus, the frequency converter and induction motor magnetically represent transformers of high exciting admittance and high self-inductive impedance.

104. The mutual magnetic flux of the transformer is produced by the resultant m.m.f. of both electric circuits. It is determined by the counter e.m.f., the number of turns, and the frequency of the electric circuit, by the equation:

$$E = \sqrt{2} \pi f n \Phi 10^{-8}$$

where

$$\begin{aligned} E &= \text{effective e.m.f.,} \\ f &= \text{frequency,} \\ n &= \text{number of turns,} \\ \Phi &= \text{maximum magnetic flux.} \end{aligned}$$

The m.m.f. producing this flux, or the resultant m.m.f. of primary and secondary circuit, is determined by shape and magnetic characteristic of the material composing the magnetic circuit, and by the magnetic induction. At open secondary circuit, this m.m.f. is the m.m.f. of the primary current, which in this case is called the exciting current, and consists of a power component, the magnetic power current, and a reactive component, the magnetizing current.

In the general alternating-current transformer, where the secondary is movable with regard to the primary, the rate of cutting of the secondary electric circuit with the mutual magnetic flux is different from that of the primary. Thus, the frequencies of both circuits are different, and the generated e.m.fs. are not proportional to the number of turns as in the stationary transformer, but to the product of number of turns into frequency.

105. Let, in a general alternating-current transformer:

$$s = \text{ratio } \frac{\text{secondary}}{\text{primary}} \text{ frequency, or "slip";}$$

thus, if:

$$f = \text{primary frequency, or frequency of impressed e.m.f.,}$$

$$sf = \text{secondary frequency;}$$

and the e.m.f. generated per secondary turn by the mutual flux has to the e.m.f. generated per primary turn the ratio, s ,

$s = 0$ represents synchronous motion of the secondary;

$s < 0$ represents motion above synchronism—driven by external mechanical power, as will be seen;

$s = 1$ represents standstill;

$s > 1$ represents backward motion of the secondary,

that is, motion against the mechanical force acting between primary and secondary (thus representing driving by external mechanical power).

Let:

n_0 = number of primary turns in series per circuit;

n_1 = number of secondary turns in series per circuit;

$$a = \frac{n_0}{n_1} = \text{ratio of turns;}$$

$Y = g - jb$ = primary exciting admittance per circuit;

where:

g = effective conductance;

b = susceptance;

$Z_0 = r_0 + jx_0$ = internal primary self-inductive impedance per circuit,

where:

r_0 = effective resistance of primary circuit;

x_0 = self-inductive reactance of primary circuit;

$Z_{11} = r_1 + jx_1$ = internal secondary self-inductive impedance per circuit at standstill, or for $s = 1$,

where:

r_1 = effective resistance of secondary coil;

x_1 = self-inductive reactance of secondary coil at standstill, or full frequency, $s = 1$.

Since the reactance is proportional to the frequency, at the slip, s , or the secondary frequency, sf , the secondary impedance is:

$$Z_1 = r_1 + jsx_1.$$

Let the secondary circuit be closed by an external resistance, r , and an external reactance, and denote the latter by x at frequency, f , then at frequency, sf , or slip, s , it will be $= sx$, and thus:

$$Z = r + jsx = \text{external secondary impedance.}^1$$

Let:

E_0 = primary impressed e.m.f. per circuit,

E' = e.m.f. consumed by primary counter e.m.f.,

E_1 = secondary terminal e.m.f.,

E'_1 = secondary generated e.m.f.,

e = e.m.f. generated per turn by the mutual magnetic flux, at full frequency, f ,

I_0 = primary current,

I_{00} = primary exciting current,

I_1 = secondary current.

It is then:

Secondary generated e.m.f.:

$$E'_1 = sn_1e.$$

Total secondary impedance:

$$Z_1 + Z = (r_1 + r) + js(x_1 + x);$$

hence, secondary current:

$$I_1 = \frac{E'_1}{Z_1 + Z} = \frac{sn_1e}{(r_1 + r) + js(x_1 + x)}$$

¹ This applies to the case where the secondary contains inductive reactance only; or, rather, that kind of reactance which is proportional to the frequency. In a condenser the reactance is inversely proportional to the frequency, in a synchronous motor under circumstances independent of the frequency. Thus, in general, we have to set, $x = x' + x'' + x'''$, where x' is that part of the reactance which is proportional to the frequency, x'' that part of the reactance independent of the frequency, and x''' that part of the reactance which is inversely proportional to the frequency; and have thus, at slip, s , or frequency, sf , the external secondary reactance, $sx' + x'' + \frac{x'''}{s}$.

Secondary terminal voltage:

$$E_1 = E'_1 - I_1 Z_1 = I_1 Z$$

$$= sn_1 e \left\{ 1 - \frac{r_1 + jsx_1}{(r_1 + r) + js(x_1 + x)} \right\} = \frac{sn_1 e (r + jsx)}{(r_1 + r) + js(x_1 + x)}$$

c.m.f. consumed by primary counter e.m.f.

$$E' = n_0 e;$$

hence, primary exciting current:

$$I_{00} = E' Y_0 = n_0 e (g - jb).$$

Component of primary current corresponding to secondary current, I_1 :

$$I'_{0} = \frac{I_1}{a}$$

$$= \frac{n_0 s e}{a^2 \{ (r_1 + r) + js(x_1 + x) \}};$$

hence, total primary current:

$$I_0 = I_{00} + I'_{0}$$

$$= sn_0 e \left\{ \frac{1}{a^2} \frac{1}{(r_1 + r) + js(x_1 + x)} + \frac{g - jb}{s} \right\}.$$

Primary impressed e.m.f.:

$$E_0 = E' + I_0 Z_0$$

$$= n_0 e \left\{ 1 + \frac{s}{a^2} \frac{r_0 + jx_0}{(r_1 + r) + js(x_1 + x)} + (r_0 + jx_0)(g - jb) \right\}.$$

We get thus, as the

Equations of the General Alternating-current Transformer, of ratio of turns, a ; and ratio of frequencies, s ; with the e.m.f. generated per turn at full frequency, e , as parameter, the values:

Primary impressed e.m.f.:

$$E_0 = n_0 e \left\{ 1 + \frac{s}{a^2} \frac{r_0 + jx_0}{(r_1 + r) + js(x_1 + x)} + (r_0 + jx_0)(g - jb) \right\}.$$

Secondary terminal voltage.

$$E_1 = sn_1 e \left\{ 1 - \frac{r_1 + jsx_1}{(r_1 + r) + js(x_1 + x)} \right\} = sn_1 \frac{e (r + jsx)}{(r_1 + r) + js(x_1 + x)}.$$

Primary current:

$$I_0 = sn_0 e \left\{ \frac{1}{a^2} \frac{1}{(r_1 + r) + js(x_1 + x)} + \frac{g - jb}{s} \right\}.$$

Secondary current:

$$I_1 = \frac{sn_1e}{(r_1 + r) + js(x_1 + x)}$$

Therefrom, we get:

Ratio of currents:

$$\frac{\dot{I}_0}{I_1} = \frac{1}{a} \left\{ 1 + \frac{a^2}{s} (g - jb) [(r_1 + r) + js(x_1 + x)] \right\}.$$

Ratio of e.m.f.s.:

$$\frac{\dot{E}_0}{E_1} = a \lambda \frac{s}{s} \left\{ \frac{1 + \frac{s}{a^2} \frac{r_0 + jx_0}{(r_1 + r) + js(x_1 + x)} + (r_0 + jx_0)(g - jb)}{1 - \frac{r_1 + jsx_1}{(r_1 + r) + js(x_1 + x)}} \right\}.$$

Total apparent primary impedance:

$$Z_t = \frac{\dot{E}_0}{I_0} = \frac{a^2}{s} \{ (r_1 + r) + js(x_1 + x) \} \left\{ \frac{1 + \frac{s}{a^2} \frac{r_0 + jx_0}{(r_1 + r) + js(x_1 + x)} + (r_0 + jx_0)(g - jb)}{1 + \frac{a^2}{s} (g - jb) [(r_1 + r) + js(x_1 + x)]} \right\},$$

where:

$$x = x' + \frac{x''}{s} + \frac{x'''}{s^2}$$

in general secondary circuit as discussed in footnote, page 179.

Substituting in these equations:

$$s = 1,$$

gives the

General Equations of the Stationary Alternating-current Transformer

Substituting in the equations of the general alternating-current transformer:

$$Z = 0,$$

gives the

General Equations of the Induction Motor

Substituting:

$$(r_1 + r)^2 + s^2(x_1 + x)^2 = z_k^2,$$

and separating the real and imaginary quantities:

$$E_0 = n_0 e \left\{ \left[1 + \frac{s}{a^2 z_k^2} (r_0 (r_1 + r) + s x_0 (x_1 + x)) + (r_0 g + x_0 b) \right] \right. \\ \left. - j \left[\frac{s}{a^2 z_k^2} (s r_0 (x_1 + x) - x_0 (r_1 + r)) + (r_0 b - x_0 g) \right] \right\}, \\ I_0 = s n_0 e \left\{ \left[\frac{r_1 + r}{a^2 z_k^2} + \frac{g}{s} \right] - j \left[\frac{s(x_1 + x)}{a^2 z_k^2} + \frac{b}{s} \right] \right\}, \\ I_1 = \frac{s n_1 e}{z_k^2} \left\{ (r_1 + r) - j s (x_1 + x) \right\}.$$

Neglecting the exciting current, or rather considering it as a separate and independent shunt circuit outside of the transformer, as can approximately be done, and assuming the primary impedance reduced to the secondary circuit as equal to the secondary impedance:

$$Y_0 = 0, \quad \frac{Z_0}{a^2} = Z_1.$$

Substituting this in the equations of the general transformer we get:

$$E_0 = n_0 e \left\{ 1 + \frac{s}{z_k^2} [r_1 (r_1 + r) + s x_1 (x_1 + x)] \right. \\ \left. - \frac{j s}{z_k^2} [s r_1 (x_1 + x) - x_1 (r_1 + r)] \right\}, \\ E_1 = \frac{s n_1 e}{z_k^2} \{ [r (r_1 + r) + s^2 x (x_1 + x)] - j s [r x_1 - x r_1] \}, \\ I_0 = - \frac{s n_1 e}{a z_k^2} \{ (r_1 + r) - j s (x_1 + x) \}, \\ I_1 = \frac{s n_1 e}{z_k^2} \{ (r_1 + r) - j s (x_1 + x) \}.$$

106. The true power is, in symbolic representation:

$$P = [E I]^1,$$

denoting:

$$\frac{s n_1^2 e^2}{z_k^2} = w$$

gives:

Secondary output of the transformer:

$$P_1 = [E_1 I_1]^1 = \left(\frac{s n_1 e}{z_k} \right)^2 r = s r w;$$

Internal loss in secondary circuit:

$$P_1^1 = i_1^2 r_1 = \left(\frac{sn_1 e}{z_k} \right)^2 r_1 = sr_1 w;$$

Total secondary power:

$$P_1 + P_1^1 = \left(\frac{sn_1 e}{z_k} \right)^2 (r + r_1) = sw (r + r_1);$$

Internal loss in primary circuit:

$$P_0^1 = i_0^2 r_0 = i_0^2 r_1 a^2 = \left(\frac{sn_1 e}{z_k} \right)^2 r_1 = sr_1 w;$$

Total electrical output, plus loss:

$$P^1 = P_1 + P_1^1 + P_0^1 = \left(\frac{sn_1 e}{z_k} \right)^2 (r + 2r_1) = sw (r + 2r_1);$$

Total electrical input of primary:

$$P_0 = [E_0 I_0]^1 = s \left(\frac{n_1 e}{z_k} \right)^2 (r + r_1 + sr_1) = w (r + r_1 + sr_1);$$

Hence, mechanical output of transformer:

$$P = P_0 - P^1 = w (1 - s) (r + r_1);$$

Ratio:

$$\frac{\text{mechanical output}}{\text{total secondary power}} = \frac{P}{P_1 + P_1^1} = \frac{1 - s}{s} = \frac{\text{speed}}{\text{slip}}$$

Thus,

In a general alternating transformer of ratio of turns, a , and ratio of frequencies, s , neglecting exciting current, it is:

Electrical input in primary:

$$P_0 = \frac{sn_1^2 e^2 (r + r_1 + r_1 s)}{(r_1 + r)^2 + s^2 (x_1 + x)^2};$$

Mechanical output:

$$P = \frac{s(1 - s)n_1^2 e^2 (r + r_1)}{(r_1 + r)^2 + s^2 (x_1 + x)^2};$$

Electrical output of secondary:

$$P_1 = \frac{s^2 n_1^2 e^2 r}{(r_1 + r)^2 + s^2 (x_1 + x)^2};$$

Losses in transformer:

$$P_0^1 + P_1^1 = P^1 = \frac{2s^2 n_1^2 e^2 r_1}{(r_1 + r)^2 + s^2 (x_1 + x)^2}.$$

Of these quantities, P^1 and P_1 are always positive; P_0 and P can be positive or negative, according to the value of s . Thus the apparatus can either produce mechanical power, acting as a motor, or consume mechanical power; and it can either consume electrical power or produce electrical power, as a generator.

107. At:

$$s = 0, \text{ synchronism, } P_0 = 0, P = 0, P_1 = 0.$$

At $0 < s < 1$, between synchronism and standstill.

P_1 , P and P_0 are positive; that is, the apparatus consumes electrical power, P_0 , in the primary, and produces mechanical power, P , and electrical power, $P_1 + P_1^1$, in the secondary, which is partly, P_1^1 , consumed by the internal secondary resistance, partly, P_1 , available at the secondary terminals.

In this case:

$$\frac{P_1 + P_1^1}{P} = \frac{s}{1 - s};$$

that is, of the electrical power consumed in the primary circuit, P_0 , a part P_0^1 is consumed by the internal primary resistance, the remainder transmitted to the secondary, and divides between electrical power, $P_1 + P_1^1$, and mechanical power, P , in the proportion of the slip, or drop below synchronism, s , to the speed: $1 - s$.

In this range, the apparatus is a motor.

At $s > 1$; or backward driving, $P < 0$, or negative; that is, the apparatus requires mechanical power for driving.

Then:

$$P_0 - P_0^1 - P_1^1 < P_1;$$

that is, the secondary electrical power is produced partly by the primary electrical power, partly by the mechanical power, and the apparatus acts simultaneously as transformer and as alternating-current generator, with the secondary as armature.

The ratio of mechanical input to electrical input is the ratio of speed to synchronism.

In this case, the secondary frequency is higher than the primary.

At:

$$s < 0, \text{ beyond synchronism,}$$

$P < 0$; that is, the apparatus has to be driven by mechanical power.

$P_0 < 0$; that is, the primary circuit produces electrical power from the mechanical input.

At:

$$r + r_1 + sr_1 = 0, \text{ or, } s = -\frac{r + r_1}{r_1};$$

the electrical power produced in the primary becomes less than required to cover the losses of power, and P_0 becomes positive again.

We have thus:

$$s < -\frac{r + r_1}{r_1}$$

consumes mechanical and primary electric power; produces secondary electric power.

$$-\frac{r + r_1}{r_1} < s < 0$$

consumes mechanical, and produces electrical power in primary and in secondary circuit.

$$0 < s < 1$$

consumes primary electric power, and produces mechanical and secondary electrical power

$$1 < s$$

consumes mechanical and primary electrical power; produces secondary electrical power.

108. As an example, in Fig. 62 are plotted, with the slip, s , as abscissæ, the values of:

Secondary electrical output as	Curve I.;
total internal loss	as Curve II.;
mechanical output	as Curve III.;
primary electrical output	as Curve IV.;

for the values:

$$\begin{array}{ll} n_1 e = 100.0; & r = 0.4; \\ r_1 = 0.1; & x = 0.3; \\ x_1 = 0.2; & \end{array}$$

hence:

$$P_1 = \frac{16,000 s^2}{1 + s^2};$$

$$P_0 + P_1 = \frac{8000 s^2}{1 + s^2};$$

$$P_0 = \frac{4000 s (5 + s)}{1 + s^2};$$

$$P = \frac{20,000 s (1 - s)}{1 + s^2}.$$

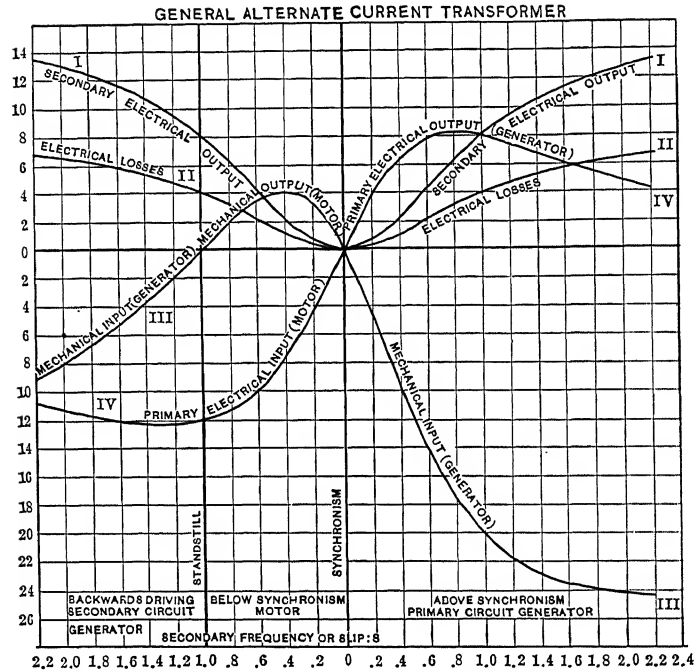

Fig. 62.—Speed-power curves of general alternating-current transformer.

109. Since the most common practical application of the general alternating-current transformer is that of frequency converter, that is, to change from one frequency to another, either with or without change of the number of phases, the following characteristic curves of this apparatus are of great interest:

1. The regulation curve; that is, the change of secondary terminal voltage as function of the load at constant impressed primary voltage.

2. The compounding curve; that is, the change of primary impressed voltage required to maintain constant secondary terminal voltage.

In this case the impressed frequency and the speed are constant, and consequently the secondary frequency is also constant. Generally the frequency converter is used to change from a low frequency, as 25 cycles, to a higher frequency, as 60 or 62.5 cycles, and is then driven backward, that is, against its torque, by mechanical power. Mostly a synchronous motor is employed, connected to the primary mains, which by overexcitation compensates also for the lagging current of the frequency converter.

Let:

$Y = g - jb$ = primary exciting admittance per circuit of the frequency converter.

$Z_1 = r_1 + jx_1$ = internal self-inductive impedance per secondary circuit, at the secondary frequency.

$Z_0 = r_0 + jx_0$ = internal self-inductive impedance per primary circuit at the primary frequency.

a = ratio of secondary to primary turns per circuit.

b = ratio of number of secondary to number of primary circuits.

c = ratio of secondary to primary frequencies.

Let:

e = generated e.m.f. per secondary circuit at secondary frequency.

$Z = r + jx$ = external impedance per secondary circuit at secondary frequency, that is load on secondary system, where $x = 0$ for non-inductive load.

To calculate the characteristics of the frequency converter, we then have:

the total secondary impedance:

$$Z + Z_1 = (r + r_1) + j(x + x_1);$$

the secondary current:

$$I_1 = \frac{e}{Z + Z_1} = e(a_1 - ja_2);$$

where:

$$a_1 = \frac{r + r_1}{(r + r_1)^2 + (x + x_1)^2} \text{ and } a_2 = \frac{x + x_1}{(r + r_1)^2 + (x + x_1)^2};$$

and the secondary terminal voltage:

$$E_1 = ZI_1 = e \frac{Z}{Z + Z_1};$$

$$= e (r + jx) (a_1 - ja_2) = e (b_1 - jb_2);$$

where:

$$b_1 = (ra_1 + xa_2) \text{ and } b_2 = (ra_2 - xa_1):$$

primary generated e.m.f. per circuit:

$$E^1 = \frac{e}{ac};$$

primary load current per circuit:

$$I^1 = abI_1 = abe (a_1 - ja_2);$$

primary exciting current per circuit:

$$I_{00} = \frac{Y_0 e}{ac} = (g - jb) \frac{e}{ac};$$

thus, total primary current:

$$I_0 = I^1 + I_{00} = e (c_1 - jc_2);$$

where:

$$c_1 = aba_1 + \frac{g}{ac} \text{ and } c_2 = aba_2 + \frac{b}{ac};$$

and the primary terminal voltage:

$$E_0 = E^1 + I_0 Z_0$$

$$= e (d_1 - jd_2)$$

where:

$$d_1 = \frac{1}{ac} + r_0 c_1 + x_0 c_2 \text{ and } d_2 = r_0 c_2 - x_0 c_1;$$

or the absolute value is:

$$e_0 = e \sqrt{d_1^2 + d_2^2}, \quad e = \frac{e_0}{\sqrt{d_1^2 + d_2^2}};$$

substituting this value of e in the preceding equations, gives, as function of the primary impressed e.m.f., e_0 :

secondary current:

$$I_1 = \frac{e_0 (a_1 - ja_2)}{\sqrt{d_1^2 + d_2^2}} \text{ or, absolute, } I_1 = e_0 \sqrt{\frac{a_1^2 + a_2^2}{d_1^2 + d_2^2}};$$

secondary terminal voltage:

$$E_1 = \frac{e_0 (b_1 - jb_2)}{\sqrt{d_1^2 + d_2^2}} \quad E_1 = e_0 \sqrt{\frac{b_1^2 + b_2^2}{d_1^2 + d_2^2}};$$

primary current:

$$I_0 = \frac{e_0 (c_1 - jc_2)}{\sqrt{d_1^2 + d_2^2}} \qquad I_0 = e_0 \sqrt{\frac{c_1^2 + c_2^2}{d_1^2 + d_2^2}}$$

primary impressed e.m.f.:

$$E_0 = \frac{e_0 (d_1 - jd_2)}{\sqrt{d_1^2 + d_2^2}}$$

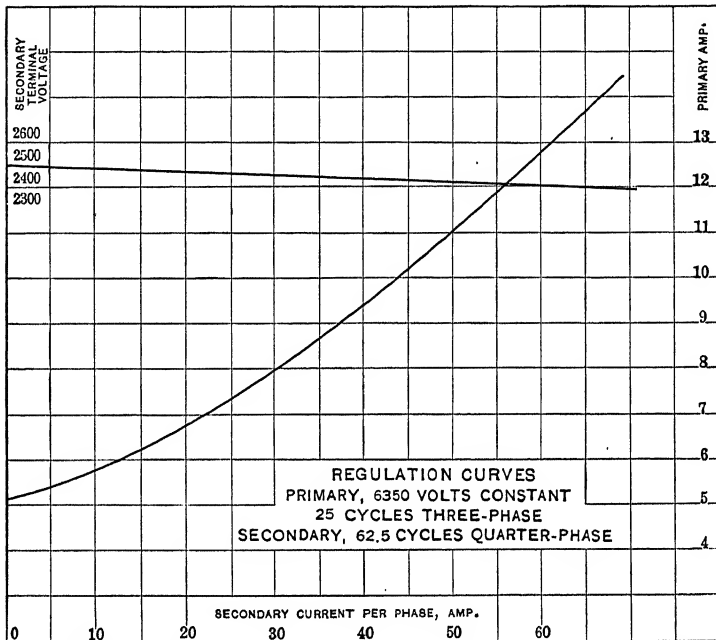

FIG. 63.—Regulation curves of frequency converter.

secondary output:

$$P_1 = [E_1 I_1]^1 = \frac{e_0^2 (a_1 b_1 + a_2 b_2)}{d_1^2 + d_2^2};$$

primary electrical input:

$$P_0 = [E_0 I_0]^1 = \frac{e_0^2 (c_1 d_1 + c_2 d_2)}{d_1^2 + d_2^2};$$

primary apparent input, volt-amperes:

$$P_{a_0} = e_0 I_0.$$

Substituting thus different values for the secondary external impedance, Z , gives the regulation curve of the frequency converter.

Such a curve, taken from tests of a 200-kw. frequency converter changing from 6300 volts, 25 cycles, three-phase, to 2500 volts, 62.5 cycles, quarter-phase, is given in Fig. 63.

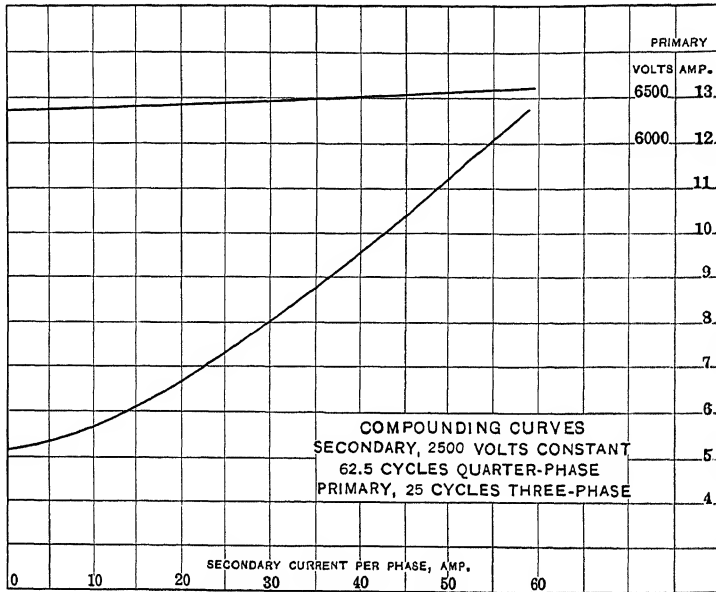

Fig. 64.—Compounding curve of frequency converter.

From the secondary terminal voltage:

$$E_1 = e (b_1 - jb_2),$$

it follows, absolute:

$$e_1 = e \sqrt{b_1^2 + b_2^2}, \quad e = \frac{e_1}{\sqrt{b_1^2 + b_2^2}}.$$

Substituting these values in the above equation gives the quantities as functions of the secondary terminal voltage, that is, at constant, e_1 , or the compounding curve.

The compounding curve of the frequency converter above mentioned is given in Fig. 64.

110. When running above synchronism: $s < 0$, the general alternating-current transformer consumes mechanical power and

produces electric power in both circuits, primary and secondary, thus can not be called a frequency converter, and the distinction between primary and secondary circuits ceases, but both circuits are generator circuits. The machine then is a two-frequency induction generator. As the electric power generated at the two frequencies is proportional to the frequencies, this gives a limitation to the usefulness of the machine, and it appears suitable only in two cases:

(a) If $s = -1$, both frequencies are the same, and stator and rotor circuits can be connected together, in parallel or in series, giving the "double synchronous-induction generator." Such machines have been proposed for steam-turbine alternators of small and moderate sizes, as they permit, with bipolar construction, to operate at twice the maximum speed available for the synchronous machine, which is 1500 revolutions for 25 cycles, and 3600 revolutions for 60 cycles.

(b) If s is very small, so that the power produced in the low-frequency circuit is very small and may be absorbed by a small "low-frequency exciter."

Further discussion of both of these types is given in the Chapter XIII on the "Synchronous Induction Generator."

111. The use of the general alternating-current transformer as frequency converter is always accompanied by the production of mechanical power when lowering, and by the consumption of mechanical power when raising the frequency. Thus a second machine, either induction or synchronous, would be placed on the frequency converter shaft to supply the mechanical power as motor when raising the frequency, or absorb the power as generator, when lowering the frequency. This machine may be of either of the two frequencies, but would naturally, for economical reasons, be built for the supply frequency, when motor, and for the generated or secondary frequency, when generator.

Such a couple of frequency converter and driving motor and auxiliary generator has over a motor-generator set the advantage, that it requires a total machine capacity only equal to the output, while with a motor-generator set the total machine capacity equals twice the output. It has, however, the disadvantage not to be as standard as the motor and the generator.

If a synchronous machine is used, the frequency is constant; if an induction machine is used, there is a slip, increasing with the load, that is, the ratio of the two frequencies slightly varies

with the load, so that the latter arrangement is less suitable when tying together two systems of constant frequencies.

112. Frequency converters may be used:

(a) For producing a moderate amount of power of a higher or a lower frequency, from a large alternating-current system.

(b) For tying together two alternating-current systems of different frequencies, and interchange power between them, so that either acts as reserve to the other. In this case, electrical power transfer may be either way.

(c) For local frequency reduction for commutating machines, by having the general alternating-current transformer lower the frequency, for instance from 60 to 30 cycles, and take up the lower frequency, as well as the mechanical power in a commutating machine on the frequency converter shaft. Such a combination has been called a "*Motor Converter*."

Thus, instead of a 60-cycle synchronous converter, such a 60/30-cycle motor converter would offer the advantage of the lower frequency of 30 cycles in the commutating machine. The commutating machine then would receive half its input electrically, as synchronous converter, half mechanically, as direct-current generator, and thus would be half converter and half generator; the induction machine on the same shaft would change half of its 60-cycle power input into mechanical power, half into 30-cycle electric power.

Such motor converter is smaller and more efficient than a motor-generator set, but larger and less efficient than a synchronous converter.

Where phase control of the direct-current voltage is desired, the motor converter as a rule does not require reactors, as the induction machine has sufficient internal reactance.

(d) For supplying low frequency to a second machine on the same shaft, for speed control, as "*concatenated motor couple*." That is, two induction motors on the same shaft, operating in parallel, give full speed, and half speed is produced, at full efficiency, by concatenating the two induction machines, that is, using the one as frequency converter for feeding the other.

By using two machines of different number of poles, p_1 and p_2 , on the same shaft, four different speeds can be secured, corresponding respectively to the number of poles: $p_1 + p_2$, p_2 , p_1 , $p_1 - p_2$. That is, concatenation of both machines, operation

of one machine only, either the one or the other, and differential concatenation.

Further discussion hereof see under "Concatenation."

In some forms of secondary excitation of induction machines, as by low-frequency synchronous or commutating machine in the secondary, the induction machine may also be considered as frequency converter. Regarding hereto see "Induction Motors with Secondary Excitation."

CHAPTER XIII

SYNCHRONOUS INDUCTION GENERATOR

113. If an induction machine is driven above synchronism, the power component of the primary current reverses, that is, energy flows outward, and the machine becomes an induction generator. The component of current required for magnetization remains, however, the same; that is, the induction generator requires the supply of a reactive current for excitation, just as the induction motor, and so must be connected to some apparatus which gives a lagging, or, what is the same, consumes a leading current.

The frequency of the e.m.f. generated by the induction generator, f , is lower than the frequency of rotation or speed, f_0 , by the frequency, f_1 , of the secondary currents. Or, inversely, the frequency, f_1 , of the secondary circuit is the frequency of slip—that is, the frequency with which the speed of mechanical rotation slips behind the speed of the rotating field, in the induction motor, or the speed of the rotating field slips behind the speed of mechanical rotation, in the induction generator.

As in every transformer, so in the induction machine, the secondary current must have the same ampere-turns as the primary current less the exciting current, that is, the secondary current is approximately proportional to the primary current, or to the load of the induction generator.

In an induction generator with short-circuited secondary, the secondary currents are proportional, approximately, to the e.m.f. generated in the secondary circuit, and this e.m.f. is proportional to the frequency of the secondary circuit, that is, the slip of frequency behind speed. It so follows that the slip of frequency in the induction generator with short-circuited secondary is approximately proportional to the load, that is, such an induction generator does not produce constant synchronous frequency, but a frequency which decreases slightly with increasing load, just as the speed of the induction motor decreases slightly with increase of load.

Induction generator and induction motor so have also been

called asynchronous generator and asynchronous motor, but these names are wrong, since the induction machine is not independent of the frequency, but depends upon it just as much as a synchronous machine—the difference being, that the synchronous machine runs exactly in synchronism, while the induction machine approaches synchronism. The real asynchronous machine is the commutating machine.

114. Since the slip of frequency with increasing load on the induction generator with short-circuited secondary is due to the increase of secondary frequency required to produce the secondary e.m.f. and therewith the secondary currents, it follows: if these secondary currents are produced by impressing an e.m.f. of constant frequency, f_1 , upon the secondary circuit, the primary frequency, f , does not change with the load, but remains constant and equal to $f = f_0 - f_1$. The machine then is a *synchronous-induction machine*—that is, a machine in which the speed and frequency are rigid with regard to each other, just as in the synchronous machine, except that in the synchronous-induction machine, speed and frequency have a constant difference, while in the synchronous machine this difference is zero, that is, the speed equals the frequency.

By thus connecting the secondary of the induction machine with a source of constant low-frequency, f_1 , as a synchronous machine, or a commutating machine with low-frequency field excitation, the primary of the induction machine at constant speed, f_0 , generates electric power at constant frequency, f , independent of the load. If the secondary $f_1 = 0$, that is, a continuous current is supplied to the secondary circuit, the primary frequency is the frequency of rotation and the machine an ordinary synchronous machine. The synchronous machine so appears as a special case of the synchronous-induction machine and corresponds to $f_1 = 0$.

In the synchronous-induction generator, or induction machine with an e.m.f. of constant low frequency, f_1 , impressed upon the secondary circuit, by a synchronous machine, etc., with increasing load, the primary and so the secondary currents change, and the synchronous machine so receives more power as synchronous motor, if the rotating field produced in the secondary circuit revolves in the same direction as the mechanical rotation—that is, if the machine is driven above synchronism of the e.m.f. impressed upon the secondary circuit—or the synchronous

machine generates more power as alternator, if the direction of rotation of the secondary revolving field is in opposition to the speed. In the former case, the primary frequency equals speed minus secondary impressed frequency: $f = f_0 - f_1$; in the latter case, the primary frequency equals the sum of speed and secondary impressed frequency: $f = f_0 + f_1$, and the machine is a frequency converter or general alternating-current transformer, with the frequency, f_1 , as primary, and the frequency, f , as secondary, transforming up in frequency to a frequency, f , which is very high compared with the impressed frequency, so that the mechanical power input into the frequency converter is very large compared with the electrical power input.

The synchronous-induction generator, that is, induction generator in which the secondary frequency or frequency of slip is fixed by an impressed frequency, so can also be considered as a frequency converter or general alternating-current transformer.

115. To transform from a frequency, f_1 , to a frequency, f_2 , the frequency, f_1 , is impressed upon the primary of an induction machine, and the secondary driven at such a speed, or frequency of rotation, f_0 , that the difference between primary impressed frequency, f_1 , and frequency of rotation, f_0 , that is, the frequency of slip, is the desired secondary frequency, f_2 .

There are two speeds, f_0 , which fulfill this condition: one below synchronism: $f_0 = f_1 - f_2$, and one above synchronism: $f_0 = f_1 + f_2$. That is, the secondary frequency becomes f_2 , if the secondary runs slower than the primary revolving field of frequency, f_1 , or if the secondary runs faster than the primary field, by the slip, f_2 .

In the former case, the speed is below synchronism, that is, the machine generates electric power at the frequency, f_2 , in the secondary, and consumes electric power at the frequency, f_1 , in the primary. If $f_2 < f_1$, the speed $f_0 = f_1 - f_2$ is between standstill and synchronism, and the machine, in addition to electric power, generates mechanical power, as induction motor, and as has been seen in the chapter on the "General Alternating-current Transformer," it is, approximately:

Electric power input \div electric power output \div mechanical power output = $f_1 \div f_2 \div f_0$.

If $f_2 > f_1$, that is, the frequency converter increases the frequency, the rotation must be in backward direction, against the rotating field, so as to give a slip, f_2 , greater than the impressed

frequency, f_1 , and the speed is $f_0 = f_2 - f_1$. In this case, the machine consumes mechanical power, since it is driven against the torque given by it as induction motor, and we have:

Electric power input \div mechanical power input \div electric power output = $f_1 \div f_0 \div f_2$.

That is, the three powers, primary electric, secondary electric, and mechanical, are proportional to their respective frequencies.

As stated, the secondary frequency, f_2 , is also produced by driving the machine above synchronism, f_1 , that is, with a negative slip, f_2 , or at a speed, $f_0 = f_1 + f_2$. In this case, the machine is induction generator, that is, the primary circuit generates electric power at frequency f_1 , the secondary circuit generates electric power at frequency f_2 , and the machine consumes mechanical power, and the three powers again are proportional to their respective frequencies:

Primary electric output \div secondary electric output \div mechanical input = $f_1 \div f_2 \div f_0$.

Since in this case of oversynchronous rotation, both electric circuits of the machine generate, it can not be called a frequency converter, but is an electric generator, converting mechanical power into electric power at two different frequencies, f_1 and f_2 , and so is called a synchronous-induction machine, since the sum of the two frequencies generated by it equals the frequency of rotation or speed—that is, the machine revolves in synchronism with the sum of the two frequencies generated by it.

It is obvious that like all induction machines, this synchronous-induction generator requires a reactive lagging current for excitation, which has to be supplied to it by some outside source, as a synchronous machine, etc.

That is, an induction machine driven at speed, f_0 , when supplied with reactive exciting current of the proper frequency, generates electric power in the stator as well as in the rotor, at the two respective frequencies, f_1 and f_2 , which are such that their sum is in synchronism with the speed, that is:

$$f_1 + f_2 = f_0;$$

otherwise the frequencies, f_1 and f_2 , are entirely independent. That is, connecting the stator to a circuit of frequency, f_1 , the rotor generates frequency, $f_2 = f_0 - f_1$, or connecting the rotor to

a circuit of frequency, f_2 , the stator generates a frequency $f_1 = f_0 - f_2$.

116. The power generated in the stator, P_1 , and the power generated in the rotor, P_2 , are proportional to their respective frequencies:

$$P_1 : P_2 : P_0 = f_1 : f_2 : f_0,$$

where P_0 is the mechanical input (approximately, that is, neglecting losses).

As seen here the difference between the two circuits, stator and rotor, disappears—that is, either can be primary or secondary, that is, the reactive lagging current required for excitation can be supplied to the stator circuit at frequency, f_1 , or to the rotor circuit at frequency, f_2 , or a part to the stator and a part to the rotor circuit. Since this exciting current is reactive or wattless, it can be derived from a synchronous motor or converter, as well as from a synchronous generator, or an alternating commutating machine:

As the voltage required by the exciting current is proportional to the frequency, it also follows that the reactive power input or the volt-amperes excitation, is proportional to the frequency of the exciting circuit. Hence, using the low-frequency circuit for excitation, the exciting volt-amperes are small.

Such a synchronous-induction generator therefore is a two-frequency generator, producing electric power simultaneously at two frequencies, and in amounts proportional to these frequencies. For instance, driven at 85 cycles, it can connect with the stator to a 25-cycle system, and with the rotor to a 60-cycle system, and feed into both systems power in the proportion of $25 \div 60$, as is obvious from the equations of the general alternating-current transformer in the preceding chapter

117. Since the amounts of electric power at the two frequencies are always proportional to each other, such a machine is hardly of much value for feeding into two different systems, but of importance are only the cases where the two frequencies generated by the machine can be reduced to one.

This is the case:

1. If the two frequencies are the same: $f_1 = f_2 = \frac{f_0}{2}$. In this case, stator and rotor can be connected together, in parallel or in series, and the induction machine then generates electric power at half the frequency of its speed, that is, runs at double

synchronism of its generated frequency. Such a "double synchronous alternator" so consists of an induction machine, in which the stator and the rotor are connected with each other in parallel or in series, supplied with the reactive exciting current by a synchronous machine—for instance, by using synchronous converters with overexcited field as load—and driven at a speed equal to twice the frequency required. This type of machine may be useful for prime movers of very high speeds, such as steam turbines, as it permits a speed equal to twice that of the bipolar synchronous machine (3000 revolutions at 25, and 7200 revolutions at 60 cycles).

2. If of the two frequencies, one is chosen so low that the amount of power generated at this frequency is very small, and can be taken up by a synchronous machine or other low-frequency machine, the latter then may also be called an exciter. For instance, connecting the rotor of an induction machine to a synchronous motor of $f_2 = 4$ cycles, and driving it at a speed of $f_0 = 64$ cycles, generates in the stator an e.m.f. at $f_1 = 60$ cycles, and the amount of power generated at 60 cycles is $6\frac{3}{4} = 15$ times the power generated by 4 cycles. The machine then is an induction generator driven at 15 times its synchronous speed. Where the power at frequency, f_2 , is very small, it would be no serious objection if this power were not generated, but consumed. That is, by impressing $f_2 = 4$ cycles upon the rotor, and driving it at $f_0 = 56$ cycles, in opposite direction to the rotating field produced in it by the impressed frequency of 4 cycles, the stator also generates an e.m.f. at $f_1 = 60$ cycles. In this case, electric power has to be put into the machine by a generator at $f_2 = 4$ cycles, and mechanical power at a speed of $f_0 = 56$ cycles, and electric power is produced as output at $f_1 = 60$ cycles. The machine thus operated is an ordinary frequency converter, which transforms from a very low frequency, $f_2 = 4$ cycles, to frequency $f_1 = 60$ cycles or 15 times the impressed frequency, and the electric power input so is only one-fifteenth of the electric power output, the other fourteen-fifteenths are given by the mechanical power input, and the generator supplying the impressed frequency, $f_2 = 4$ cycles, accordingly is so small that it can be considered as an exciter.

118. 3. If the rotor of frequency, f_2 , driven at speed, f_0 , is connected to the external circuit through a commutator, the effective frequency supplied by the commutator brushes to the

external circuit is $f_0 - f_2$; hence equals f_1 , or the stator frequency. Stator and rotor so give the same effective frequency, f_1 , and irrespective of the frequency, f_2 generated in the rotor, and the frequencies, f_1 and f_2 , accordingly become indefinite, that is, f_1 may be any frequency. f_2 then becomes $f_0 - f_1$, but by the commutator is transformed to the same frequency, f_1 . If the stator and rotor were used on entirely independent electric circuits, the frequency would remain indeterminate. As soon, however, as stator and rotor are connected together, a relation appears due to the transformer law, that the secondary ampere-turns must equal the primary ampere-turns (when neglecting the exciting ampere-turns). This makes the frequency dependent upon the number of turns of stator and rotor circuit.

Assuming the rotor circuit is connected in multiple with the stator circuit—as it always can be, since by the commutator brushes it has been brought to the same frequency. The rotor e.m.f. then must be equal to the stator e.m.f. The e.m.f., however, is proportional to the frequency times number of turns, and it is therefore:

$$n_2 f_2 = n_1 f_1,$$

where: n_1 = number of effective stator turns,
 n_2 = number of effective rotor turns, and f_1

and f_2 are the respective frequencies.

Herefrom follows:

$$f_1 \div f_2 = n_2 \div n_1;$$

that is, the frequencies are inversely proportional to the number of effective turns in stator and in rotor.

Or, since $f_0 = f_1 + f_2$ is the frequency of rotation:

$$f_1 \div f_0 = n_2 \div (n_1 + n_2)$$

$$f_1 = \frac{n_2}{n_1 + n_2} f_0.$$

That is, the frequency, f_1 , generated by the synchronous-induction machine with commutator, is the frequency of rotation, f_0 , times the ratio of rotor turns, n_2 , to total turns, $n_1 + n_2$.

Thus, it can be made anything by properly choosing the number of turns in the rotor and in the stator, or, what amounts to the same, interposing between rotor and stator a transformer of the proper ratio of transformation.

The powers generated by the stator and by the rotor, however, are proportional to their respective frequencies, and so are inversely proportional to their respective turns.

$$P_1 \div P_2 = f_1 \div f_2 = n_2 \div n_1;$$

if n_1 and n_2 , and therewith the two frequencies, are very different, the two powers, P_1 and P_2 , are very different, that is, one of the elements generates very much less power than the other, and since both elements, stator and rotor, have the same active surface, and so can generate approximately the same power, the machine is less economical.

That is, the commutator permits the generation of any desired frequency, f_1 , but with best economy only if $f_1 = \frac{f_0}{2}$, or half-synchronous frequency, and the greater the deviation from this frequency, the less is the economy. If one of the frequencies is very small, that is, f_1 is either nearly equal to synchronism, f_0 , or very low, the low-frequency structure generates very little power.

By shifting the commutator brushes, a component of the rotor current can be made to magnetize and the machine becomes a self-exciting, alternating-current generator.

The use of a commutator on alternating-current machines is in general undesirable, as it imposes limitations on the design, for the purpose of eliminating destructive sparking, as discussed in the chapter on "Alternating-Current Commutating Machines."

The synchronous-induction machines have not yet reached a sufficient importance to require a detailed investigation, so only two examples may be considered.

119. 1. *Double Synchronous Alternator.*

Assume the stator and rotor of an induction machine to be wound for the same number of effective turns and phases, and connected in multiple or in series with each other, or, if wound for different number of turns, connected through transformers of such ratios as to give the same effective turns when reduced the same circuit by the transformer ratio of turns.

Let:

$Y_1 = g - jb$ = exciting admittance of the stator,

$Z_1 = r_1 + jx_1$ = self-inductive impedance of the stator,

$Z_2 = r_2 + jx_2$ = self-inductive impedance of the rotor,

and:

e = e.m.f. generated in the stator by the mutual inductive magnetic field, that is, by the magnetic flux corresponding to the exciting admittance, Y_1 ;

and:

I = total current, or current supplied to the external circuit,

I_1 = stator current,

I_2 = rotor current.

With series connection of stator and rotor:

$$I = I_1 = I_2,$$

with parallel connection of stator and rotor:

$$I = I_1 + I_2.$$

Using the equations of the general induction machine, the slip of the secondary circuit or rotor is:

$$s = -1;$$

the exciting admittance of the rotor is:

$$Y_2 = g - jsb = g + jb,$$

and the rotor generated e.m.f.:

$$E'_2 = se = -e;$$

that is, the rotor must be connected to the stator in the opposite direction to that in which it would be connected at standstill, or in a stationary transformer.

That is, magnetically, the power components of stator and rotor current neutralize each other. Not so, however, the reactive components, since the reactive component of the rotor current:

$$I_2 = i'_2 + j i''_2,$$

in its reaction on the stator is reversed, by the reversed direction of relative rotation, or the slip, $s = -1$, and the effect of the rotor current, I_2 , on the stator circuit accordingly corresponds to:

$$I'_2 = i'_2 - j i''_2;$$

hence, the total magnetic effect is:

$$I_1 - I'_2 = (i'_1 - i'_2) + j (i''_1 + i''_2);$$

and since the total effect must be the exciting current:

$$I_0 = i'_0 + j''_0,$$

it follows that:

$$i'_1 - i'_2 = i'_0 \text{ and } i''_1 + i''_2 = i''_0.$$

Hence, the stator power current and rotor power current, i'_1 and i'_2 , are equal to each other (when neglecting the small hysteresis power current). The synchronous exciter of the machine must supply in addition to the magnetizing current, the total reactive current of the load. Or in other words, such a machine requires a synchronous exciter of a volt-ampere capacity equal to the volt-ampere excitation plus the reactive volt-amperes of the load, that is, with an inductive load, a large exciter machine. In this respect, the double-synchronous generator is analogous to the induction generator, and is therefore suited mainly to a load with leading current, as over-excited converters and synchronous motors, in which the reactive component of the load is negative and so compensates for the reactive component of excitation, and thereby reduces the size of the exciter.

This means that the double-synchronous alternator has zero armature reaction for non-inductive load, but a demagnetizing armature reaction for inductive, a magnetizing armature reaction for anti-inductive load, and the excitation, by alternating-reactive current, so has to be varied with the character of the load, in general in a far higher degree than with the synchronous alternator.

120. 2. *Synchronous-induction Generator with Low-frequency Excitation.*

Here two cases exist:

(a) If the magnetic field of excitation revolves in opposite direction to the mechanical rotation.

(b) If it revolves in the same direction.

In the first case (a) the exciter is a low-frequency generator and the machine a frequency converter, calculated by the same equations.

Its voltage regulation is essentially that of a synchronous alternator: with increasing load, at constant voltage impressed upon the rotor or exciter circuit, the voltage drops moderately at non-inductive load, greatly at inductive load, and rises at

anti-inductive load. To maintain constant terminal voltage, the excitation has to be changed with a change of load and character of load. With a low-frequency synchronous machine as exciter, this is done by varying the field excitation of the exciter.

At constant field excitation of the synchronous exciter, the regulation is that due to the impedance between the nominal generated e.m.f. of the exciter, and the terminal voltage of the stator—that is, corresponds to:

$$Z = Z_0 + Z_2 + Z_1.$$

Here Z_0 = synchronous impedance of the exciter, reduced to full frequency, f_1 ,

Z_2 = self-inductive impedance of the rotor, reduced to full frequency, f_1 ,

Z_1 = self-inductive impedance of the stator.

If then E_0 = nominal generated e.m.f. of the exciter generator, that is, corresponding to the field excitation, and, $I_1 = i - ji_1$ = stator current or output current, the stator terminal voltage is:

$$E_1 = E_0 + ZI_1, \text{ or, } E_0 = E + (r + jx)(i - ji_1);$$

and, choosing $E_1 = e_1$ as real axis, and expanding:

$$E_0 = (e_1 + ri + xi_1) + j(xi - ri_1),$$

and the absolute value:

$$e_0^2 = (e_1 + ri + xi_1)^2 + (xi - ri_1)^2, \\ e_1 = \sqrt{e_0^2 - (xi - ri_1)^2 - (ri + xi_1)^2}.$$

121. As an example is shown, in Fig. 65, in dotted lines, with the total current, $I = \sqrt{i^2 + i_1^2}$, as abscissæ, the voltage regulation of such a machine, or the terminal voltage, e_1 , with a four-cycle synchronous generator as exciter of the 60-cycle synchronous-induction generator, driven as frequency converter at 56 cycles.

1. For non-inductive load, or $I_1 = i$. (Curve I.)
2. For inductive load of 80 per cent. power-factor, or $I_1 = I(0.8 - 0.6j)$. (Curve II.)
3. For anti-inductive load of 80 per cent. power-factor, or $I_1 = I(0.8 + 0.6j)$. (Curve III.)

For the constants:

$$\begin{aligned} e_0 &= 2000 \text{ volts,} & Z_2 &= 1 + 0.5 j, \\ Z_1 &= 0.1 + 0.3 j, & Z_0 &= 0.5 + 0.5 j; \end{aligned}$$

hence:

$$Z = 1.6 + 1.3 j.$$

Then:

$$e_1 = \sqrt{4 \times 10^6 - (1.3 i - 1.6 i_1)^2} - (1.6 i + 1.3 i_1);$$

hence, for non-inductive load, $i_1 = 0$:

$$e_1 = \sqrt{4 \times 10^6 - 1.69 i^2} - 1.6 i;$$

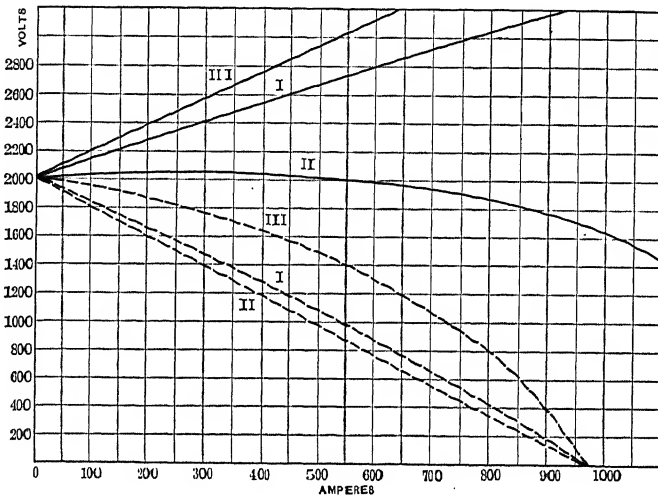

FIG. 65.—Synchronous induction generator regulation curves.

for inductive load of 80 per cent. power-factor $i_1 = 0.6 I, i = 0.8 I$:

$$e_1 = \sqrt{4 \times 10^6 - 0.0064 I^2} - 2.06 I;$$

and for anti-inductive load of 80 per cent. power-factor $i_1 = -0.6 I, i = 0.8 I$:

$$e_1 = \sqrt{4 \times 10^6 - 4 I^2} - 0.5 I.$$

As seen, due to the internal impedance, and especially the resistance of this machine, the regulation is very poor, and even at the chosen anti-inductive load no rise of voltage occurs.

122. Of more theoretical interest is the case (b), where the

exciter is a synchronous motor, and the synchronous-induction generator produces power in the stator and in the rotor circuit. In this case, the power is produced by the generated e.m.f., E (e.m.f. of mutual induction, or of the rotating magnetic field), of the induction machine, and energy flows outward in both circuits, in the stator into the receiving circuit, of terminal voltage, E_1 , in the rotor against the impressed e.m.f. of the synchronous motor exciter, E_0 . The voltage of one receiving circuit, the stator, therefore, is controlled by a voltage impressed upon another receiving circuit, the rotor, and this results in some interesting effects in voltage regulation.

Assume the voltage, E_0 , impressed upon the rotor circuit as the nominal generated e.m.f. of the synchronous-motor exciter, that is, the field corresponding to the exciter field excitation, and assume the field excitation of the exciter, and therewith the voltage, E_0 , to be maintained constant.

Reducing all the voltages to the stator circuit by the ratio of their effective turns and the ratio of their respective frequencies, the same e.m.f., E , is generated in the rotor circuit as in the stator circuit of the induction machine.

At no-load, neglecting the exciting current of the induction machine, that is, with no current, we have $E_0 = E = E_1$.

If a load is put on the stator circuit by taking a current, I , from the same, the terminal voltage, E_1 , drops below the generated e.m.f., E , by the drop of voltage in the impedance, Z_1 , of the stator circuit. Corresponding to the stator current, I_1 , a current, I_2 , then exists in the rotor circuit, giving the same ampere-turns as I_1 , in opposite direction, and so neutralizing the m.m.f. of the stator (as in any transformer). This current, I_2 , exists in the synchronous motor, and the synchronous motor e.m.f., E_0 , accordingly drops below the generated e.m.f., E , of the rotor, or, since E_0 is maintained constant, E rises above E_0 with increasing load, by the drop of voltage in the rotor impedance, Z_2 , and the synchronous impedance, Z_0 , of the exciter.

That is, the stator terminal voltage, E_1 , drops with increasing load, by the stator impedance drop, and rises with increasing load by the rotor and exciter impedance drop, since the latter causes the generated e.m.f., E , to rise.

If then the impedance drop in the rotor circuit is greater than that in the stator, with increasing load the terminal voltage, E_1 , of the machine rises, that is, the machine automatically

overcompounds, at constant-exciter field excitation, and if the stator and the rotor impedance drops are equal, the machine compounds for constant voltage.

In such a machine, by properly choosing the stator and rotor impedances, automatic rise, decrease or constancy of the terminal voltage with the load can be produced.

This, however, applies only to non-inductive load. If the current, I , differs in phase from the generated e.m.f., E , the corresponding current, I_2 , also differs; but a lagging component of I_1 corresponds to a leading component in I_2 , since the stator circuit slips behind, the rotor circuit is driven ahead of the rotating magnetic field, and inversely, a leading component of I_1 gives a lagging component of I_2 . The reactance voltage of the lagging current in one circuit is opposite to the reactance voltage of the leading current in the other circuit, therefore does not neutralize it, but adds, that is, instead of compounding, regulates in the wrong direction.

123. The automatic compounding of the synchronous induction generator with low-frequency synchronous-motor excitation so fails if the load is not non-inductive.

Let:

$Z_1 = r_1 + jx_1 =$ stator self-inductive impedance,

$Z_2 = r_2 + jx_2 =$ rotor self-inductive impedance, reduced to the stator circuit by the ratio of the effective turns, $t = \frac{n_2}{n_1}$, and the

ratio of frequencies, $a = \frac{f_2}{f_1}$;

$Z_0 = r_0 + jx_0 =$ synchronous impedance of the synchronous-motor exciter;

$E_1 =$ terminal voltage of the stator, chosen as real axis, $= e_1$;

$E_0 =$ nominal generated e.m.f. of the synchronous-motor exciter, reduced to the stator circuit;

$E =$ generated e.m.f. of the synchronous-induction generator stator circuit, or the rotor circuit reduced to the stator circuit.

The actual e.m.f. generated in the rotor circuit then is $E' = taE$, and the actual nominal generated e.m.f. of the synchronous exciter is $E'_0 = taE_0$.

Let:

$I_1 = i - ji_1 =$ current in the stator circuit, or the output current of the machine.

The current in the rotor circuit, in which the direction of rotation is opposite, or ahead of the revolving field, then is, when neglecting the exciter current:

$$I_2 = i + ji_1.$$

(If Y = exciting admittance, the exciting current is $I_0 = EY$, and the total rotor current then $I_0 + I_2$.)

Then in the rotor circuit:

$$E = E_0 + (Z_0 + Z_2) I_2, \quad (1)$$

and in the stator circuit:

$$E = E_1 + Z_1 I_1. \quad (2)$$

Hence:

$$E_1 = E_0 + I_2 (Z_0 + Z_2) - I_1 Z_1, \quad (3)$$

or, substituting for I_1 and I_2 :

$$E_1 = E_0 + i (Z_0 + Z_2 - Z_1) + ji_1 (Z_0 + Z_2 + Z_1). \quad (4)$$

Denoting now:

$$\begin{aligned} Z_0 + Z_1 + Z_2 &= Z_3 = r_3 + jx_3, \\ Z_0 + Z_2 - Z_1 &= Z_4 = r_4 + jx_4, \end{aligned} \quad (5)$$

and substituting:

$$E_1 = E_0 + iZ_4 + ji_1Z_3, \quad (6)$$

or, since $E_1 = e_1$:

$$\begin{aligned} E_0 &= e_1 - iZ_4 - ji_1Z_3 \\ &= (e_1 - r_4i + x_3i_1) - j(x_4i + r_3i_1), \end{aligned} \quad (7)$$

or the absolute value:

$$e_0^2 = (e_1 - r_4i + x_3i_1)^2 + (x_4i + r_3i_1)^2. \quad (8)$$

Hence:

$$e_1 = \sqrt{e_0^2 - (x_4i + r_3i_1)^2} + r_4i - x_3i_1. \quad (9)$$

That is, the terminal voltage, e_1 , decreases due to the decrease of the square root, but may increase due to the second term.

At no-load:

$$i = 0, i_1 = 0 \text{ and } e_1 = e_0.$$

At non-inductive load:

$$i_1 = 0 \text{ and } e_1 = \sqrt{e_0^2 - x_4^2 i^2} + r_4 i. \quad (10)$$

e_1 first increases, from its no-load value, e_0 , reaches a maximum, and then decreases again.

Since:

$$r_4 = r_0 + r_2 - r_1,$$

$$x_4 = x_0 + x_2 - r_1,$$

at: $r_4 = 0 \text{ and } x_4 = 0,$

or,

$$r_1 = r_0 + r_2,$$

$$x_1 = x_0 + x_2,$$

and:

$e_1 = e_0$, that is, in this case the terminal voltage is constant at all non-inductive loads, at constant exciter excitation.

In *general*, or for $I_1 = i - j i_1$,

if i_1 is positive or inductive load, from equation (9) follows that the terminal voltage, e_1 , drops with increasing load; while

if i_1 is negative or anti-inductive load, the terminal voltage, e_1 , rises with increasing load, ultimately reaches a maximum and then decreases again.

From equation (9) follows, that by changing the impedances, the amount of compounding can be varied. For instance, at non-inductive load, or in equation (10) by increasing the resistance, r_4 , the voltage, e_1 , increases faster with the load.

That is, the overcompounding of the machine can be increased by inserting resistance in the rotor circuit.

124. As an example is shown, in Fig. 65, in full line, with the total current, $I = \sqrt{i^2 + i_1^2}$, as abscissæ, the voltage regulation of such a machine, or the terminal voltage, e_1 , with a four-cycle synchronous motor as exciter of a 60-cycle synchronous-induction generator driven at 64-cycles speed.

1. For non-inductive load, or $I_1 = i$. (Curve I.)
2. For inductive load of 80 per cent. power-factor; or $I_1 = I (0.8 - 0.6 j)$. (Curve II.)
3. For anti-inductive load of 80 per cent. power-factor; or $I_1 = I (0.8 + 0.6 j)$. (Curve III.)

For the constants:

$$\begin{aligned} e_0 &= 2000 \text{ volts.} & Z_0 &= 0.5 + 0.5j. \\ Z_1 &= 0.1 + 0.3j. & a &= 0.067. \\ Z_2 &= 1 + 0.5j. & t &= 1, \text{ that is, the} \\ & & & \text{same number of} \\ & & & \text{turns in stator} \\ & & & \text{and rotor} \end{aligned}$$

Then:

$$Z_3 = 1.6 + 1.3j \text{ and } Z_4 = 1.4 + 0.7j.$$

Hence; substituting in equation (9):

$$e_1 = \sqrt{4 \times 10^6 - (0.7i + 1.6i_1)^2 + 1.4i - 1.3i_1};$$

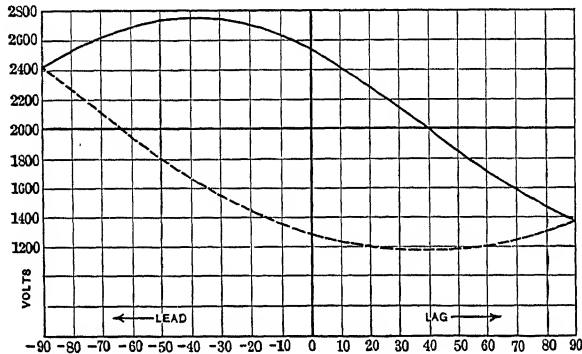

Fig. 66.—Synchronous induction generator, voltage regulation with power-factor of load.

thus, for non-inductive load, $i_1 = 0$:

$$e_1 = \sqrt{4 \times 10^6 - 0.49 i^2 + 1.4 i};$$

for inductive load of 80 per cent. power-factor $i_1 = 0.6 I$; $i = 0.8 I$:

$$e_1 = \sqrt{4 \times 10^6 - 2.31 I^2 + 0.34 I};$$

and for anti-inductive load of 80 per cent. power-factor $i_1 = -0.6 I$; $i = 0.8 I$:

$$e_1 = \sqrt{4 \times 10^6 - 0.16 I^2 + 1.9 I}.$$

Comparing the curves of this example with those of the same machine driven as frequency converter with exciter generator,

and shown in dotted lines in the same chart (Fig. 65), it is seen that the voltage is maintained at load far better, and especially at inductive load the machine gives almost perfect regulation of voltage, with the constants assumed here.

To show the variation of voltage with a change of power-factor, at the same output in current, in Fig. 66, the terminal voltage, e_1 , is plotted with the phase angle as abscissæ, from wattless anti-inductive load, or 90° lead, to wattless inductive load, or 90° lag, for constant current output of 400 amp. As seen, at wattless load both machines give the same voltage but for energy load the type (b) gives with the same excitation a higher voltage, or inversely, for the same voltage the type (a) requires a higher excitation. It is, however, seen that with the same current output, but a change of power-factor, the voltage of type (a) is far more constant in the range of inductive load, while that of type (b) is more constant on anti-inductive load, and on inductive load very greatly varies with a change of power-factor.

CHAPTER XIV

PHASE CONVERSION AND SINGLE-PHASE GENERATION

125. Any polyphase system can, by means of two stationary transformers, be converted into any other polyphase system, and in such conversion, a balanced polyphase system remains balanced, while an unbalanced system converts into a polyphase system of the same balance factor.¹

In the conversion between single-phase system and polyphase system, a storage of energy thus must take place, as the balance factor of the single-phase system is zero or negative, while that of the balanced polyphase system is unity. For such energy storage may be used capacity, or inductance, or momentum or a combination thereof:

Energy storage by capacity, that is, in the dielectric field, required per kilovolt-ampere at 60 cycles about 2000 c.c. of space, at a cost of about \$10. Inductance, that is, energy storage by the magnetic field, requires about 1000 c.c. per kilovolt-ampere at 60 cycles, at a cost of \$1, while energy storage by momentum, as kinetic mechanical energy, assuming iron moving at 30 meter-seconds, stores 1 kva. at 60 cycles by about 3 c.c., at a cost of 0.2c., thus is by far the cheapest and least bulky method of energy storage. Where large amounts of energy have to be stored, for a very short time, mechanical momentum thus is usually the most efficient and cheapest method.

However, size and cost of condensers is practically the same for large as for small capacities, while the size and cost of inductance decreases with increasing, and increases with decreasing kilovolt-ampere capacity. Furthermore, the use of mechanical momentum means moving machinery, requiring more or less attention, thus becomes less suitable, for smaller values of power. Hence, for smaller amounts of stored energy, inductance and capacity may become more economical than momentum, and for very small amounts of energy, the condenser may be the cheapest device. The above figures thus give only the approxi-

¹ "Theory and Calculation of Alternating-current Phenomena," 5th edition, Chapter XXXII.

mate magnitude for medium values of energy, and then apply only to the active energy-storing structure, under the assumption, that during every energy cycle (or half cycle of alternating current and voltage), the entire energy is returned and stored again. While this is the case with capacity and inductance, when using momentum for energy storage, as flywheel capacity, the energy storage and return is accomplished by a periodic speed variation, thus only a part of the energy restored, and furthermore, only a part of the structural material (the flywheel, or the rotor of the machine) is moving. Thus assuming that only a quarter of the mass of the mechanical structure (motor, etc.) is revolving, and that the energy storage takes place by a pulsation of speed of 1 per cent., then 1 kva. at 60 cycles would require 600 c.c. of material, at 40c.

Obviously, at the limits of dielectric or magnetic field strength, or at the limits of mechanical speeds, very much larger amounts of energy per bulk could be stored. Thus for instance, at the limits of steam-turbine rotor speeds, about 400 meter-seconds, in a very heavy material as tungsten, 1 c.c. of material would store about 200 kva. of 60-cycle energy, and the above figures thus represent only average values under average conditions.

126. Phase conversion is of industrial importance in changing from single-phase to polyphase, and in changing from polyphase to single-phase.

Conversion from single-phase to polyphase has been of considerable importance in former times, when alternating-current generating systems were single-phase, and alternating-current motors required polyphase for their operation. With the practically universal introduction of three-phase electric power generation, polyphase supply is practically always available for stationary electric motors, at least motors of larger size, and conversion from single-phase to polyphase thus is of importance mainly:

(a) To supply small amounts of polyphase current, for the starting of smaller induction motors operated on single-phase distribution circuits, 2300 volts primary, or 110/220 volts secondary, that is, in those cases, in which the required amount of power is not sufficient to justify bringing the third phase to the motor: with larger motors, all the three phases are brought to the motor installation, thus polyphase supply used.

(b) For induction-motor railway installations, to avoid the

combination and inconvenience incident to the use of two trolley wires. In this case, as large amounts of polyphase power are required, and economy in weight is important, momentum is generally used for energy storage, that is an induction machine is employed as phase converter, and then is used either in series or in shunt to the motor.

For the small amounts of power required by use (*a*), generally inductance or capacity are employed; and even then usually the conversion is made not to polyphase, but to monocyclic, as the latter is far more economical in apparatus.

Conversion from polyphase to single-phase obviously means the problem of deriving single-phase power from a balanced polyphase system. A single-phase load can be taken from any phase of a polyphase system, but such a load, when considerable, unbalances the polyphase system, that is, makes the voltages of the phases unequal and lowers the generator capacity. The problem thus is, to balance the voltages and the reaction of the load on the generating system.

This problem has become of considerable importance in the last years, for the purpose of taking large single-phase loads, for electric railway, furnace work, etc., from a three-phase supply system as a central station or transmission line. For this purpose, usually synchronous phase converters with synchronous phase balancers are used.

As illustration may thus be considered in the following the monocyclic device, the induction phase converter, and the synchronous phase converter and balancer.

Monocyclic Devices

127. The name "monocyclic" is applied to a polyphase system of voltages (whether symmetrical or unsymmetrical), in which the flow of energy is essentially single-phase.

For instance, if, as shown diagrammatically in Fig. 67, we connect, between single-phase mains, *AB*, two pairs of non-inductive resistances, *r*, and inductive reactances, *x* (or in general, two pairs of impedances of different inductance factors), such that $r = x$, consuming the voltages E_1 and E_2 respectively, then the voltage $e_0 = CD$ is in quadrature with, and equal to, the voltage $e = AB$, and the two voltages, e and e_0 , constitute a monocyclic system of quarter-phase voltages: e gives the energy

axis of the monocyclic system, and e_0 the quadrature or wattless axis. That is, from the axis, e , power can be drawn, within the limits of the power-generating system back of the supply voltage. If, however, an attempt is made to draw power from the monocyclic quadrature voltage, e_0 , this voltage collapses.

If then the two voltages, e and e_0 , are impressed upon a quarter-phase induction motor, this motor will not take power equally from both phases, e and e_0 , but takes power essentially only from phase, e . In starting, and at heavy load, a small amount of power is taken also from the quadrature voltage, e_0 , but at light-load, power may be returned into this voltage, so that in general the average power of e_0 approximates zero, that is, the voltage, e_0 , is wattless.

A monocyclic system thus may be defined as a system of polyphase voltages, in which one of the power axis, the main axis or energy axis, is constant potential, and the other power axis, the auxiliary or quadrature axis, is of dropping characteristic and therefore of limited power. Or it may be defined as a polyphase system of voltage, in which the power available in the one power axis of the system is practically unlimited compared with that of the other power axis.

A monocyclic system thus is a system of polyphase voltage, which at balanced polyphase load becomes unbalanced, that is, in which an unbalancing of voltage or phase relation occurs when all phases are loaded with equal loads of equal inductance factors.

In some respect, all methods of conversion from single-phase to polyphase might be considered as monocyclic, in so far as the quadrature phase produced by the transforming device is limited by the capacity of the transforming device, while the main phase is limited only by the available power of the generating system. However, where the power available in the quadrature phase produced by the phase converter is sufficiently large not to constitute a limitation of power in the polyphase device supplied by it, or in other words, where the quadrature phase produced by the phase converter gives essentially a constant-potential voltage under the condition of the use of the device, then the system is not considered as monocyclic, but is essentially polyphase.

In the days before the general introduction of three-phase power generation, about 20 years ago, monocyclic systems were

extensively used, and monocyclic generators built. These were single-phase alternating-current generators, having a small quadrature phase of high inductance, which combined with the main phase gives three-phase or quarter-phase voltages. The auxiliary phase was of such high reactance as to limit the quadrature power and thus make the flow of energy essentially single-phase, that is, monocyclic. The purpose hereof was to permit the use of a small quadrature coil on the generator, and thereby to preserve the whole generator capacity for the single-phase main voltage, without danger of overloading the quadrature phase in case of a high motor load on the system. The general introduction of the three-phase system superseded the monocyclic generator, and monocyclic devices are today used only for local production of polyphase voltages from single-phase supply, for the starting of small single-phase induction motors, etc. The advantage of the monocyclic feature then consists in limiting the output and thereby the size of the device, and making it thereby economically feasible with the use of the rather expensive energy-storing devices of inductance (and capacity) used in this case.

The simplest and most generally used monocyclic device consists of two impedances, Z_1 and Z_2 , of different inductance factors (resistance and inductance, or inductance and capacity), connected across the single-phase mains, A and B . The common connection, C , between the two impedances, Z_1 and Z_2 , then is displaced in phase from the single-phase supply voltage, A and B , and gives with the same a system of out-of-phase voltages, AC , CB and AB , or a—more or less unsymmetrical—three-phase triangle. Or, between this common connection, C , and the middle, D , of an autotransformer connected between the single-phase mains, AB , a quadrature voltage, CD , is produced.

This "monocyclic triangle" ACB , in its application as single-phase induction motor-starting device, is discussed in Chapter V.

Two such monocyclic triangles combined give the monocyclic square, Fig. 67.

128. Let then, in the monocyclic square shown diagrammatically in Fig. 67:

$$Y_1 = g_1 - jb_1 = \text{admittance } AC \text{ and } DB;$$

$$Y_2 = g_2 - jb_2 = \text{admittance } CB \text{ and } AD;$$

and let:

$$Y_0 = g_0 - jb_0 = \text{admittance of the load on}$$

the monocyclic quadrature voltage, $E_0 = CD$, and current, I_0 . Denoting then:

$E = e =$ supply voltage, AB , and $I =$ supply current, and $E_1, E_2 =$ voltages, $I_1, I_2 =$ currents in the two sides of the monocyclic square.

It is then, counting voltages and currents in the direction indicated by the arrows in Fig. 67:

$$\left. \begin{aligned} E_2 + E_1 &= e, \\ E_2 - E_1 &= E_0; \end{aligned} \right\} \quad (1)$$

hence:

$$\left. \begin{aligned} E_2 &= \frac{E + E_0}{2}, \\ E_1 &= \frac{e - E_0}{2}; \end{aligned} \right\} \quad (2)$$

and:

$$\left. \begin{aligned} I &= I_1 + I_2, \\ I_0 &= I_1 - I_2; \end{aligned} \right\} \quad (3)$$

substituting:

$$\left. \begin{aligned} I_0 &= E_0 Y_0, \\ I_1 &= E_1 Y_1, \\ I_2 &= E_2 Y_2; \end{aligned} \right\} \quad (4)$$

into (3) gives:

$$\left. \begin{aligned} I &= E_1 Y_1 + E_2 Y_2, \\ E_0 Y_0 &= E_1 Y_1 - E_2 Y_2; \end{aligned} \right\} \quad (5)$$

substituting (2) into (5) gives:

$$E_0 = \frac{e(Y_1 - Y_2)}{Y_1 + Y_2 + 2Y_0}; \quad (6)$$

substituting (6) into (2) gives:

$$\left. \begin{aligned} E_1 &= \frac{e(Y_2 + Y_0)}{Y_1 + Y_2 + 2Y_0}, \\ E_2 &= \frac{e(Y_1 + Y_0)}{Y_1 + Y_2 + 2Y_0}; \end{aligned} \right\} \quad (7)$$

substituting (7) and (6) into (4) and (5) gives the currents:

$$\left. \begin{aligned} I_0 &= \frac{eY_0(Y_1 - Y_2)}{Y_1 + Y_2 + 2Y_0}, \\ I &= \frac{e(Y_0Y_1 + Y_0Y_2 + 2Y_1Y_2)}{Y_1 + Y_2 + 2Y_0}, \\ I_1 &= \frac{eY_1(Y_2 + Y_0)}{Y_1 + Y_2 + 2Y_0}, \\ I_2 &= \frac{eY_2(Y_1 + Y_0)}{Y_1 + Y_2 + 2Y_0}. \end{aligned} \right\} \quad (8)$$

129. For a combination of equal resistance and reactance:

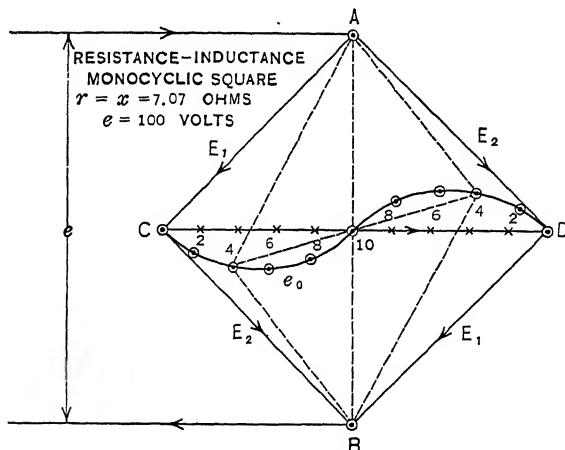

Fig. 67.—Resistance-inductance monocyclic square, topographical regulation characteristic.

$$Y_1 = a,$$

$$Y_2 = -ja;$$

and a load:

$$Y_0 = a(p - jq);$$

equations (6) and (8) give:

$$E_0 = \frac{e(1+j)}{1-j+2(p-jq)},$$

$$I_0 = \frac{ea(p-jq)(1+j)}{1-j+2(p-jq)},$$

$$I = \frac{ea[(p-jq)(1-j)-2j]}{1-j+2(p-jq)}.$$

Fig. 67 shows the voltage diagram, and Fig. 68 the regulation, that is, the values of e_0 and i , with i_0 as abscissæ, for:

$$e = 100 \text{ volts,}$$

$$a = 0.1 \sqrt{2} \text{ mho.}$$

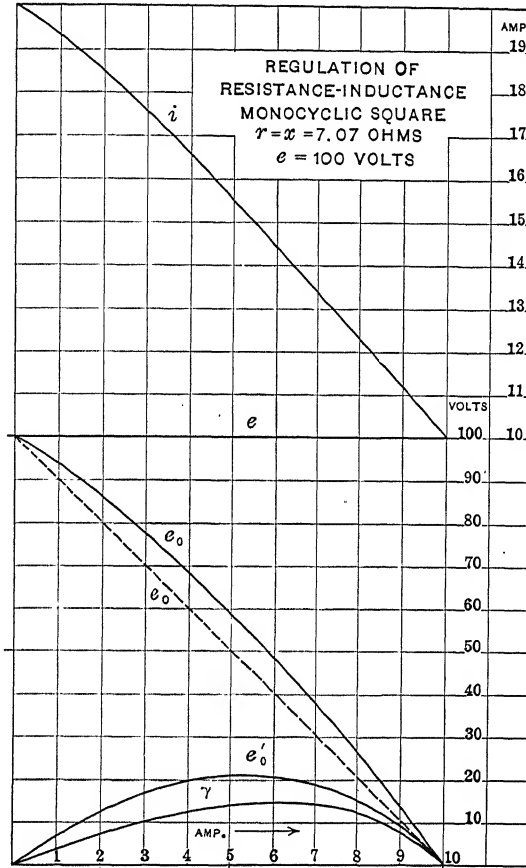

FIG. 68.—Resistance-inductance monocyclic square, regulation curve.

For: $q = 0$, that is, non-inductive load, the voltage diagram is a curve shown by circles in Fig. 67, for 0, 2, 4, 6, 8 and 10 amp. load, the latter being the maximum or short-circuit value.

For $q = p$, or a load of 45° load, the voltage diagram is the straight line shown by crosses in Fig. 67. That is, in this case, the monocyclic voltage, e_0 , is in quadrature with the supply voltage,

e , at all loads, while for non-inductive load the monocyclic voltage, e_0 , not only shrinks with increasing load, but also shifts in phase, from quadrature position, and the diagram is in the latter case shown for 4 amp. load by the dotted lines in Fig. 67.

In Fig. 68 the drawn lines correspond to non-inductive load. The regulation for 45° lagging load is shown by dotted lines in Fig. 68.

e'_0 shows the quadrature component of the monocyclic voltage, e_0 , at non-inductive load. That is, the component of e_0 , which is in phase with e , and therefore could be neutralized by inserting into e_0 a part of the voltage, e , by transformation.

As seen in Fig. 68, the supply current is a maximum of 20 amp. at no-load, and decreases with increasing load, to 10 amp. at short-circuit load.

The apparent efficiency of the device, that is, the ratio of the volt-ampere output:

$$Q_0 = e_0 i_0$$

to the volt-ampere input:

$$Q = ei$$

is given by the curve, γ , in Fig. 68.

As seen, the apparent efficiency is very low, reaching a maximum of 14 per cent. only.

If the monocyclic square is produced by capacity and inductance, the extreme case of dropping of voltage, e_0 , with increase of current, i_0 , is reached in that the circuit of the voltage, e_0 , becomes a constant-current circuit, and this case is more fully discussed in Chapter XIV of "Theory and Calculation of Electric Circuits" as a constant-potential constant-current transforming device.

Induction Phase Converter

130. The magnetic field of a single-phase induction motor at or near synchronism is a uniform rotating field, or nearly so, deviating from uniform intensity and uniform rotation only by the impedance drop of the primary winding. Thus, in any coil displaced in position from the single-phase primary coil of the induction machine, a voltage is induced which is displaced in phase from the supply voltage by the same angle as the coil is displaced in position from the coil energized by the supply voltage. An induction machine running at or near synchronism thus can be used as phase converter, receiving single-phase sup-

ply voltage, E_0 , and current, I_0 , in one coil, and producing a voltage of displaced phase, E_2 , and current of displaced phase, I_2 , in another coil displaced in position.

Thus if a quarter-phase motor shown diagrammatically in Fig. 69A is operated by a single-phase voltage, E_0 , supplied to the one

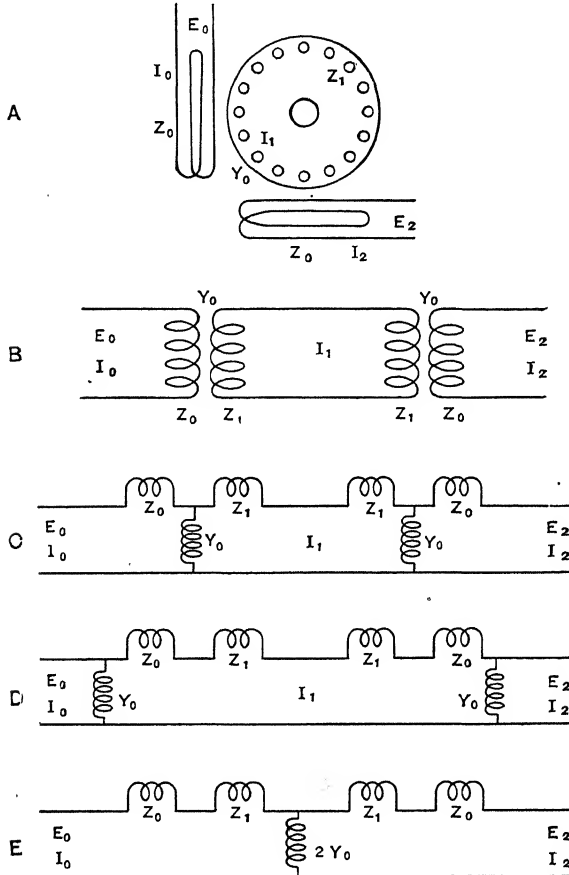

FIG. 69.—Induction phase converter diagram.

phase, in the other phase a quadrature voltage, E_2 , is produced and quadrature current can be derived from this phase.

The induction machine, Fig. 69A, is essentially a transformer, giving two transformations in series: from the primary supply circuit, E_0I_0 , to the secondary circuit or rotor, E_1I_1 , and from the rotor circuit, E_1I_1 , as primary circuit, to the other stator circuit

or second phase, E_2I_2 , as secondary circuit. It thus can be represented diagrammatically by the double transformer Fig. 69B.

The only difference between Fig. 69A and 69B is, that in Fig. 69A the synchronous rotation of the circuit, E_1I_1 , carries the current, I_1 , 90° in space to the second transformer, and thereby produces a 90° time displacement. That is, primary current and voltage of the second transformer of Fig. 69B are identical in intensity with the secondary currents and voltage of the first transformer, but lag behind them by a quarter period in space and thus also in time. The momentum of the rotor takes care of the energy storage during this quarter period.

As the double transformer, Fig. 69B, can be represented by the double divided circuit, Fig. 69C,¹ Fig. 69C thus represents the induction phase converter, Fig. 69A, in everything except that it does not show the quarter-period lag.

As the equations derived from Fig. 69C are rather complicated, the induction converter can, with sufficient approximation for most purposes, be represented either by the diagram Fig. 69D, or by the diagram Fig. 69E. Fig. 69D gives the exciting current of the first transformer too large, but that of the second transformer too small, so that the two errors largely compensate. The reverse is the case in Fig. 69E, and the correct value, corresponding to Fig. 69C, thus lies between the limits 69D and 69E. The error made by either assumption, 69D or 69E, thus must be smaller than the difference between these two assumptions.

131. Let:

$Y_0 = g_0 - jb_0 =$ primary exciting admittance of the induction machine,

$Z_0 = r_0 + jx_0 =$ primary, and thus also tertiary self-inductive impedance,

$Z_1 = r_1 + jx_1 =$ secondary self-inductive impedance,
all at full frequency, and reduced to the same number of turns.

Let:

$Y_2 = g_2 - jb_2 =$ admittance of the load on the second phase;
denoting further:

$$Z = Z_0 + Z_1,$$

¹ "Theory and Calculation of Alternating-current Phenomena," 5th edition, page 204.

it is, then, choosing the diagrammatic representation, Fig. 69D:

$$I_0 - E_0 Y_0 = I_2 + E_2 Y_0 = I_1, \quad (9)$$

$$E_0 = E_2 + 2Z(I_2 + E_2 Y_0), \quad (10)$$

$$I_2 = E_2 Y_2; \quad (11)$$

substituting (11) into (10) and transposing, gives:

$$E_2 = \frac{\dot{E}_0}{1 + 2Z(Y_0 + Y_2)}; \quad (12)$$

if the diagram, Fig. 69E, is used, it is:

$$E_2 = \frac{\dot{E}_0}{1 + 2Z(Y_0 + Y_2[1 + Y_0 Z])}, \quad (13)$$

which differs very little from (12).

And, substituting (11) and (12) into (9):

$$\left. \begin{aligned} I_0 &= E_2(Y_0 + Y_2) + E_0 Y_0, \\ &= E_0 \frac{Y_2 + 2Y_0 + 2ZY_0(Y_0 + Y_2)}{1 + 2Z(Y_0 + Y_2)}. \end{aligned} \right\} \quad (14)$$

Equations (11), (12) and (13) give for any value of load, Y_2 , on the quadrature phase, the values of voltage, E_2 , and current, I_2 , of this phase, and the supply current, I_0 , at supply voltage, E_0 .

It must be understood, however, that the actual quadrature voltage is not E_2 , but is jE_2 , carried a quarter phase forward by the rotation, as discussed before.

132. As instance, consider a phase converter operating at constant supply voltage:

$$E_0 = e_0 = 100 \text{ volts};$$

of the constants:

$$Y_0 = 0.01 - 0.1j,$$

$$Z_0 = Z_1 = 0.05 + 0.15j;$$

thus:

$$Z = 0.1 + 0.3j;$$

and let:

$$\begin{aligned} Y_2 &= a(p - jq) \\ &= a(0.8 - 0.6j), \end{aligned}$$

that is, a load of 80 per cent. power-factor, which corresponds about to the average power-factor of an induction motor.

It is, then, substituted into (11) to (13):

$$E_2 = \frac{100}{(1.062 + 0.52 \cdot a) + j(0.36 a - 0.028)},$$

$$I_2 = \frac{(80 - 60j) a}{(1.062 + 0.52 a) + j(0.36 a - 0.028)};$$

for:

$a = 0$, or no-load, this gives:

$$e_2 = 94.1,$$

$$i_2 = 0,$$

$$i_0 = 19.5;$$

for:

$a = \infty$, or short-circuit, this gives:

$$e_2 = 0,$$

$$i_2 = 159,$$

$$i_1 = 169.$$

The voltage diagram is shown in Fig. 70, and the load characteristics or regulation curves in Fig. 71.

As seen: the voltage, e_2 , is already at no-load lower than the supply voltage, e_0 , due to the drop of voltage of the exciting current in the self-inductive impedance of the phase converter.

In Fig. 70 are marked by circles the values of voltage, e_2 , for every 20 per cent. of the short-circuit current.

Fig. 71 gives the quadrature component of the voltage, e_2 , as e'_2 , and the apparent efficiency, or ratio of volt-ampere output to volt-ampere input:

$$\gamma = \frac{e_2 i_2}{e_0 i_0},$$

and the primary supply current, i_0 .

It is interesting to compare the voltage diagram and especially the load and regulation curves of the induction phase converter, Figs. 70 and 71, with those of the monocyclic square, Figs. 67 and 68.

As seen, in the phase converter, the supply current at no-load is small, is a mere induction-machine exciting current, and increases with the load and approximately proportional thereto.

The no-load input of both devices is practically the same, but the voltage regulation of the phase converter is very much better: the voltage drops to zero at 159 amp. output, while that of the

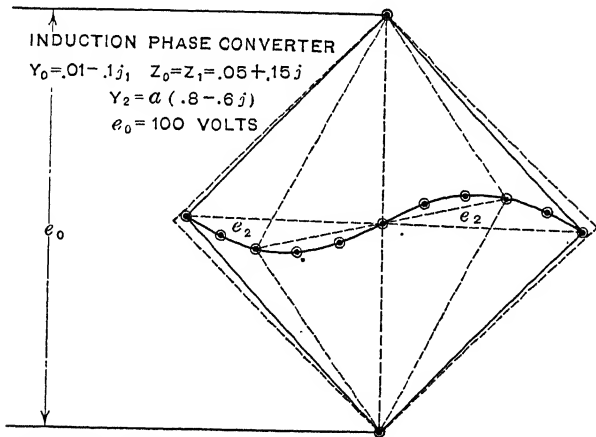

Fig. 70.—Induction phase converter, topographic regulation characteristic

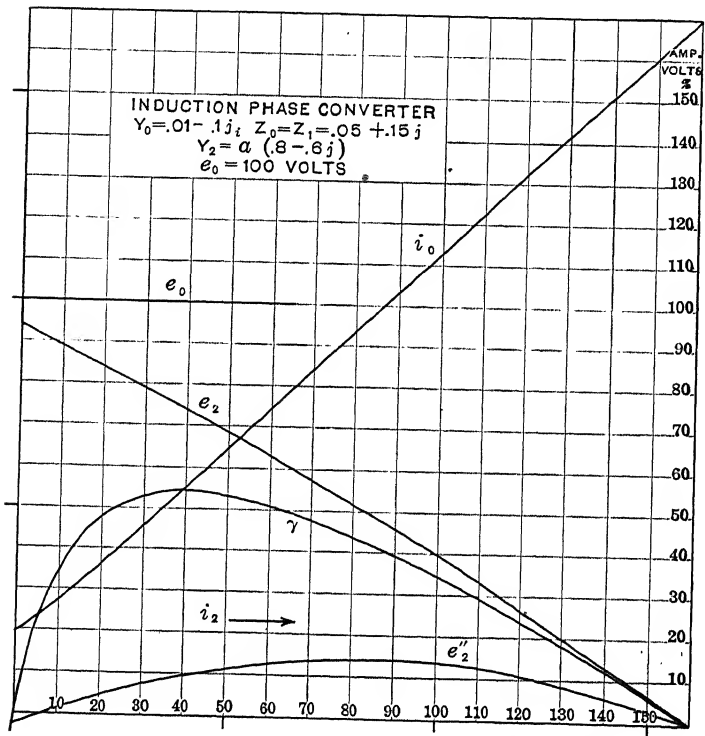

Fig. 71.—Induction phase converter, regulation curve.

monocyclic square reaches zero already at 10 amp. output. This illustrates the monocyclic character of the latter, that is, the limitation of the output of the quadrature voltage.

As the result hereof, the phase converter reaches fairly good apparent efficiencies, 54 per cent., and reaches these already at moderate loads.

The quadrature component, e''_2 , of the voltage, e_0 , is much smaller with the phase converter, and, being in phase with the supply voltage, e_0 , can be eliminated, and rigid quadrature relation of e_2 with e_0 maintained, by transformation of a voltage $-e''_2$ from the single-phase supply into the secondary. Furthermore, as e''_2 is approximately proportional to i_0 —except at very low loads—it could be supplied without regulation, by a series transformer, that is, by connecting the primary of a transformer in series with the supply circuit, i_0 , the secondary in series with e_2 . Thereby e_2 would be maintained in almost perfect quadrature relation to e_0 at all important loads.

Thus the phase converter is an energy-transforming device, while the monocyclic square, as the name implies, is a device for producing an essentially wattless quadrature voltage.

133. A very important use of the induction phase converter is in series with the polyphase induction motor for which it supplies the quadrature phase.

In this case, the phase, e_0, i_0 of the phase converter is connected in series to one phase, e'_0, i_0 , of the induction motor driving the electric car or polyphase locomotive, into the circuit of the single-phase supply voltage, $e = e_0 + e'_0$, and the second phase of the phase converter, e_2, i_2 , is connected to the second phase of the induction motor.

This arrangement still materially improves the polyphase regulation: the induction motor receives the voltages:

$$e'_0 = e - e_0,$$

and:

$$e'_2 = e_2.$$

At no-load, e_2 is a maximum. With increasing load, $e_2 = e'_2$ drops, and hereby also drops the other phase voltage of the induction motor, e'_0 . This, however, raises the voltage, $e_0 = e - e'_0$, on the primary phase of the phase converter, and hereby raises the secondary phase voltage, $e_2 = e'_2$, thus maintains the

two voltages e'_0 and e'_2 impressed upon the induction motor much more nearly equal, than would be the case with the use of the phase converter in shunt to the induction motor.

Series connection of the induction phase converter, to the induction motor supplied by it, thus automatically tends to regulate for equality of the two-phase voltages, e'_0 and e'_2 , of the induction motor. Quadrature position of these two-phase voltages can be closely maintained by a series transformer between i_0 and i_2 , as stated above.

It is thereby possible to secure practically full polyphase motor output from an induction motor operated from single-phase supply through a series-phase converter, while with parallel connection of the phase converter, the dropping quadrature voltage more or less decreases the induction motor output. For this reason, for uses where maximum output, and especially maximum torque at low speed and in acceleration is required, as in railroading, the use of the phase converter in series connections to the motor is indicated.

Synchronous Phase Converter and Single-phase Generation

134. While a small amount of single-phase power can be taken from a three-phase or in general a polyphase system without disturbing the system, a large amount of single-phase power results in unbalancing of the three-phase voltages and impairment of the generator output.

With balanced load, the impedance voltages, $e' = iz$, of a three-phase system are balanced three-phase voltages, and their effect can be eliminated by inserting a three-phase voltage into the system by three-phase potential regulator or by increasing the generator field excitation. The impedance voltages of a single-phase load, however, are single-phase voltages, and thus, combined with the three-phase system voltage, give an unbalanced three-phase system. That is, in general, the loaded phase drops in voltage, and one of the unloaded phases rises, the other also drops, and this the more, the greater the impedance in the circuit between the generated three-phase voltage and the single-phase load. Large single-phase load taken from a three-phase transmission line—as for instance by a supply station of a single-phase electric railway—thus may cause an unbalancing of the transmission-line voltage sufficient to make it useless.

A single-phase system of voltage, e , may be considered as combination of two balanced three-phase systems of opposite phase

rotation: $\frac{e}{2}, \frac{ee}{2}, \frac{ee^2}{2}$ and $\frac{e}{2}, \frac{ee^2}{2}, \frac{ee}{2}$, where $\epsilon = \sqrt[3]{1} = \frac{-1 + j\sqrt{3}}{2}$,

The unbalancing of voltage caused by a single-phase load of impedance voltage, $e = iz$, thus is the same as that caused by two three-phase impedance voltages, $e/2$, of which the one has the same, the other the opposite phase rotation as the three-phase supply system. The former can be neutralized by raising the supply voltage by $e/2$, by potential regulator or generator excitation. This means, regulating the voltage for the average drop. It leaves, however, the system unbalanced by the impedance voltage, $e/2$, of reverse-phase rotation. The latter thus can be compensated, and the unbalancing eliminated, by inserting into the three-phase system a set of three-phase voltages, $e/2$, of reverse-phase rotation. Such a system can be produced by a three-phase potential regulator by interchanging two of the phases. Thus, if A, B, C are the three three-phase supply voltages, impressed upon the primary or shunt coils a, b, c of a three-phase potential regulator, and 1, 2, 3 are the three secondary or series coils of the regulator, then the voltages induced in 1, 3, 2 are three-phase of reverse-phase rotation to A, B, C , and can be inserted into the system for balancing the unbalancing due to single-phase load, in the resultant voltage: $A + 1, B + 3, C + 2$. It is obviously necessary to have the potential regulator turned into such position, that the secondary voltages 1, 3, 2 have the proper phase relation. This may require a wider range of turning than is provided in the potential regulator for controlling balanced voltage drop.

It thus is possible to restore the voltage balance of a three-phase system, which is unbalanced by a single-phase load of impedance voltage, e' , by means of two balanced three-phase potential regulators of voltage range, $e'/2$, connected so that the one gives the same, the other the reverse phase rotation of the main three-phase system.

Such an apparatus producing a balanced polyphase system of reversed phase rotation, for inserting in series into a polyphase system to restore the balance on single-phase load, is called a *phase balancer*, and in the present case, a *stationary induction phase balancer*.

A synchronous machine of opposite phase rotation to the main system voltages, and connected in series thereto, would then be a *synchronous phase balancer*.

The purpose of the phase balancer, thus, is the elimination of the voltage unbalancing due to single-phase load, and its capacity must be that of the single-phase impedance volt-amperes. It obviously can not equalize the load on the phases, but the flow of power of the system remains unbalanced by the single-phase load.

135. The capacity of large synchronous generators is essentially determined by the heating of the armature coils. Increased load on one phase, therefore, is not neutralized by lesser load on the other phases, in its limitation of output by heating of the armature coils of the generators.

The most serious effect of unbalanced load on the generator is that due to the pulsating armature reaction. With balanced polyphase load, the armature reaction is constant in intensity and in direction, with regards to the field. With single-phase load, however, the armature reaction is pulsating between zero and twice its average value, thus may cause a double-frequency pulsation of magnetic flux, which, extending through the field circuit, may give rise to losses and heating by eddy currents in the iron, etc. With the slow-speed multipolar engine-driven alternators of old, due to the large number of poles and low peripheral speed, the ampere-turns armature reaction per pole amounted to a few thousand only, thus were not sufficient to cause serious pulsation in the magnetic-field circuit. With the large high-speed turbo-alternators of today, of very few poles, and to a somewhat lesser extent also with the larger high-speed machines driven by high-head waterwheels, the armature reaction per pole amounts to very many thousands of ampere-turns. Section and length of the field magnetic circuit are very large. Even a moderate pulsation of armature reaction, due to the unbalancing of the flow of power by single-phase load, then, may cause very large losses in the field structure, and by the resultant heating seriously reduce the output of the machine.

It then becomes necessary either to balance the load between the phases, and so produce the constant armature reaction of balanced polyphase load, or to eliminate the fluctuation of the armature reaction. The latter is done by the use of an effective squirrel-cage short-circuit winding in the pole faces. The double-frequency pulsation of armature reaction induces double-frequency currents in the squirrel cage—just as in the single-phase induction motor—and these induced currents demagnetize, when

the armature reaction is above, and magnetize when it is below the average value, and thereby reduce the fluctuation, that is, approximate a constant armature reaction of constant direction with regards to the field—that is, a uniformly rotating magnetic field with regards to the armature.

However, for this purpose, the m.m.f. of the currents induced in the squirrel-cage winding must equal that of the armature winding, that is, the total copper cross-section of the squirrel cage must be of the same magnitude as the total copper cross-section of the armature winding. A small squirrel cage, such as is sufficient for starting of synchronous motors and for anti-hunting purposes, thus is not sufficient in high armature-reaction machines to take care of unbalanced single-phase load.

A disadvantage of the squirrel-cage field winding, however, is, that it increases the momentary short-circuit current of the generator, and retards its dying out, therefore increases the danger of self-destruction of the machine at short-circuit. In the first moment after short-circuit, the field poles still carry full magnetic flux—as the field can not die out instantly. No flux passes through the armature—except the small flux required to produce the resistance drop, ir . Thus practically the total field flux must be shunted along the air gap, through the narrow section between field coils and armature coils. As the squirrel-cage winding practically bars the flux to cross it, it thereby further reduces the available flux section and so increases the flux density and with it the momentary short-circuit current, which gives the m.m.f. of this flux.

It must also be considered that the reduction of generator output resulting from unequal heating of the armature coils due to unequal load on the phases is not eliminated by a squirrel-cage winding, but rather additional heat produced by the currents in the squirrel-cage conductors.

136. A synchronous machine, just as an induction machine, may be generator, producing electric power, or motor, receiving electric power, or phase converter, receiving electric power in some phase, the motor phase, and generating electric power in some other phase, the generator phase. In the phase converter, the total resultant armature reaction is zero, and the armature reaction pulsates with double frequency between equal positive and negative values. Such phase converter thus can be used to produce polyphase power from a single-phase supply. The in-

duction phase converter has been discussed in the preceding, and the synchronous phase converter has similar characteristics, but as a rule a better regulation, that is, gives a better constancy of voltage, and can be made to operate without producing lagging currents, by exciting the fields sufficiently high.

However, a phase converter alone can not distribute single-phase load so as to give a balanced polyphase system. When transferring power from the motor phase to the generator phase, the terminal voltage of the motor phase equals the induced voltage plus the impedance drop in the machine, that of the generator phase equals induced voltage minus the impedance drop, and the voltage of the motor phase thus must be higher than that of the generator phase by twice the impedance voltage of the phase converter (vectorially combined).

Therefore, in converting single-phase to polyphase by phase converter, the polyphase system produced can not be balanced in voltage, but the quadrature phase produced by the converter is less than the main phase supplied to it, and drops off the more, the greater the load.

In the reverse conversion, however, distributing a single-phase load between phases of a polyphase system, the voltage of the generator phase of the converter must be higher, that of the motor phase lower than that of the polyphase system, and as the generator phase is lower in voltage than the motor phase, it follows, that the phase converter transfers energy only when the polyphase system has become unbalanced by more than the voltage drop in the converter. That is, while a phase converter may reduce the unbalancing due to single-phase load, it can never restore complete balance of the polyphase system, in voltage and in the flow of power. Even to materially reduce the unbalancing, requires large converter capacity and very close voltage regulation of the converter, and thus makes it an uneconomical machine.

To balance a polyphase system under single-phase load, therefore, requires the addition of a phase balancer to the phase converter. Usually a synchronous phase balancer, would be employed in this case, that is, a small synchronous machine of opposite phase rotation, on the shaft of the phase converter, and connected in series thereto. Usually it is connected into the neutral of the phase converter. By the phase balancer, the voltage of the motor phase of the phase converter is raised above the generator phase so as to give a power transfer sufficient

to balance the polyphase system, that is, to shift half of the single phase power by a quarter period, and thus produce a uniform flow of power.

Such synchronous phase balancer constructively is a synchronous machine, having two sets of field poles, *A* and *B*, in quadrature with each other. Then by varying or reversing the excitation of the two sets of field poles, any phase relation of the reversely rotating polyphase system of the balancer to that of the converter can be produced, from zero to 360° .

137. Large single-phase powers, such as are required for single-phase railroading, thus can be produced.

(a) By using single-phase generators and separate single-phase supply circuits.

(b) By using single-phase generators running in multiple with the general three-phase system, and controlling voltage and mechanical power supply so as to absorb the single-phase load by the single-phase generators. In this case, however, if the single-phase load uses the same transmission line as the three-phase load, phase balancing at the receiving circuit may be necessary.

(c) By taking the single-phase load from the three-phase system. If the load is considerable, this may require special construction of the generators, and phase balancers.

(d) By taking the power all as balanced three-phase power from the generating system, and converting the required amount to single-phase, by phase converter and phase balancer. This may be done in the generating station, or at the receiving station where the single-phase power is required.

Assuming that in addition to a balanced three-phase load of power, P_0 , a single-phase load of power, P , is required. Estimating roughly, that the single-phase capacity of a machine structure is half the three-phase capacity of the structure—which probably is not far wrong—then the use of single-phase generators gives us P_0 -kw. three-phase, and P -kw. single-phase generators, and as the latter is equal in size to $2P$ -kw. three-phase capacity, the total machine capacity would be $P_0 + 2P$.

Three-phase generation and phase conversion would require $P_0 + P$ kw. in three-phase generators, and phase converters transferring half the single-phase power from the phase which is loaded by single-phase, to the quadrature phase. That is, the phase converter must have a capacity of $P/2$ kw. in the motor phase, and $P/2$ kw. capacity in the generator phase, or a total

capacity of P kw. Thus the total machine capacity required for both kinds of load would again be $P_0 + 2 P$ kw. three-phase rating.

Thus, as regards machine capacity, there is no material difference between single-phase generation and three-phase generation with phase conversion, and the decision which arrangement is preferable will largely depend on questions of construction and operation. A more complete discussion on single-phase generation and phase conversion is given in *A. I. E. E. Transactions*, November, 1916.

CHAPTER XV

SYNCHRONOUS RECTIFIER

SELF-COMPOUNDING ALTERNATORS—SELF-STARTING SYNCHRO-
NOUS MOTORS—ARC RECTIFIER—BRUSH AND THOMSON
HOUSTON ARC MACHINE—LEBLANC PANCHAHUTEUR—
PERMUTATOR—SYNCHRONOUS CONVERTER

138. Rectifiers for converting alternating into direct current have been designed and built since many years. As mechanical rectifiers, mainly single-phase, they have found a limited use for small powers since a long time, and during the last years arc rectifiers have found extended use for small and moderate powers, for storage-battery charging and for series arc lighting by constant direct current. For large powers, however, the rectifier does not appear applicable, but the synchronous converter takes its place. The two most important types of direct-current arc-light machines, however, have in reality been mechanical rectifiers, and for compounding alternators, and for starting synchronous motors, rectifying commutators have been used to a considerable extent.

Let, in Fig. 72, e be the alternating voltage wave of the supply source, and the connections of the receiver circuit with this supply source be periodically and synchronously reversed, at the zero points of the voltage wave, by a reversing commutator driven by a small synchronous motor, shown in Fig. 73. In the receiver circuit the voltage wave then is unidirectional but pulsating, as shown by e_0 in Fig. 74.

If receiver circuit and supply circuit both are non-inductive, the current in the receiver circuit is a pulsating unidirectional current, shown as i_0 in dotted lines in Fig. 74, and derived from the alternating current, i , Fig. 72, in the supply circuit.

If, however, the receiver circuit is inductive, as a machine field, then the current, i_0 , in Fig. 75, pulsates less than the voltage, e_0 , which produces it, and the current thus does not go down to zero, but is continuous, and its pulsation the less, the higher the inductance. The current, i , in the alternating supply circuit, how-

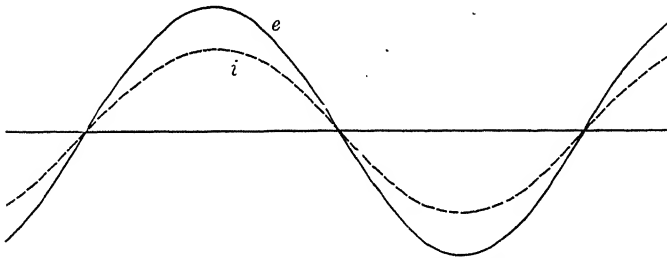

FIG. 72.—Alternating sine wave.

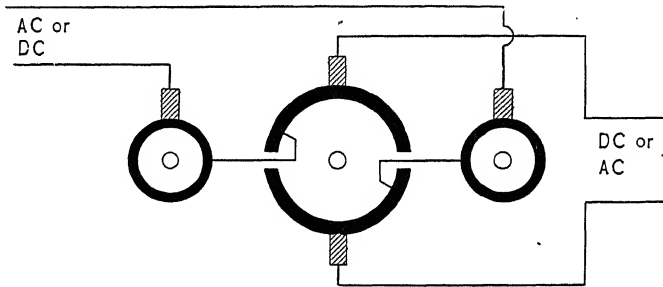

FIG. 73.—Rectifying commutator.

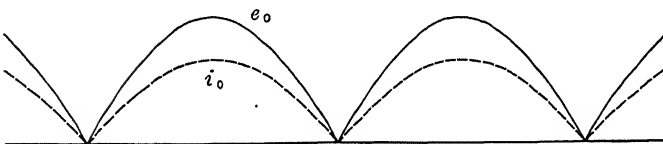

FIG. 74.—Rectified wave on non inductive load.

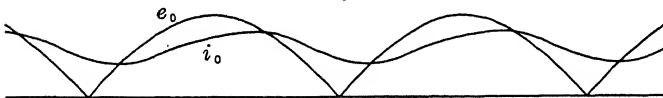

FIG. 75.—Rectified wave on inductive load.

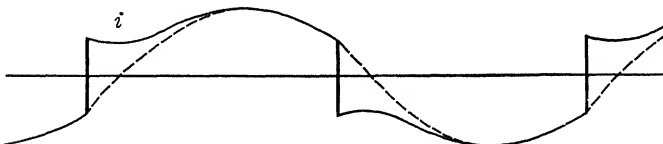

FIG. 76.—Alternating supply wave to rectifier on inductive load.

ever, from which the direct current, i_0 , is derived by reversal, must go through zero twice during each period, thus must have the shape shown as i in Fig. 76, that is, must abruptly reverse. If, however, the supply circuit contains any self-inductance—and every circuit contains some inductance—the current can not change instantly, but only gradually, the slower, the higher the inductance, and the actual current in the supply circuit assumes

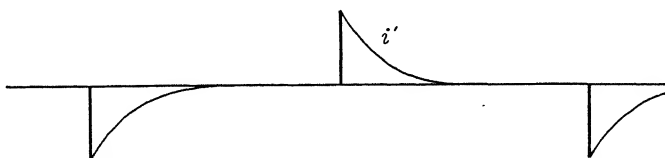

FIG. 77.—Differential current on rectifier on inductive load.

a shape like that shown in dotted lines in Fig. 76. Thus the current in the alternating part and that in the rectified part of the circuit can not be the same, but a difference must exist, as shown as i' in Fig. 77. This current, i' , passes between the two parts

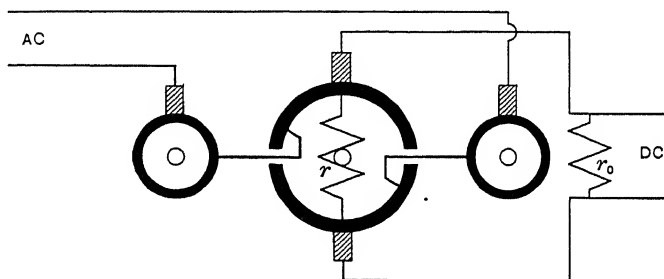

FIG. 78.—Rectifier with A.C. and D.C. shunt resistance for inductive load

of the circuit, as arc at the rectifier brushes, and causes the rectifying commutator to spark, if there is any appreciable inductance in the circuit. The intensity of the sparking current depends on the inductance of the rectified circuit, its duration on that of the alternating supply circuit.

By providing a byepath for this differential current, i' , the sparking is mitigated, and thereby the amount of power, which can be rectified, increased. This is done by shunting a non-inductive resistance across the rectified circuit, r_0 , or across the alternating circuit, r , or both, as shown in Fig. 78. If this resistance is low, it consumes considerable power and finally increases sparking

by the increase of rectified current; if it is high, it has little effect. Furthermore, this resistance should vary with the current.

The belt-driven alternators of former days frequently had a compounding series field excited by such a rectifying commutator on the machine shaft, and by shunting 40 to 50 per cent. of the power through the two resistance shunts, with careful setting of brushes as much as 2000 watts have been rectified from single-phase 125-cycle supply.

Single-phase synchronous motors were started by such rectifying commutators through which the field current passed, in series with the armature, and the first long-distance power trans-

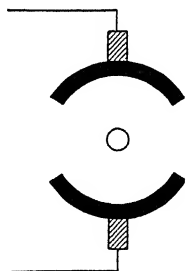

Fig. 79.—Open-circuit rectifier.

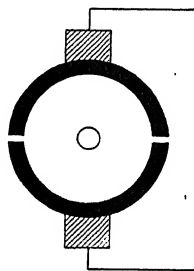

Fig. 80.—Short-circuit rectifier.

mission in America (Telluride) was originally operated with single-phase machines started by rectifying commutator—the commutator, however, requiring frequent renewal.

139. The reversal of connection between the rectified circuit and the supply circuit may occur either over open-circuit, or over short-circuit. That is, either the rectified circuit is first disconnected from the supply circuit—which open-circuits both—and then connected in reverse direction, or the rectified circuit is connected to the supply circuit in reverse direction, before being disconnected in the previous direction—which short-circuits both circuits. The former, open-circuit rectification, results if the width of the gap between the commutator segments is greater than the width of the brushes, Fig. 79, the latter, short-circuit rectification, results if the width of the gap is less than the width of the brushes, Fig. 80.

In open-circuit rectification, the alternating and the rectified voltage are shown as e and e_0 in Fig. 81. If the circuit is non-inductive, the rectified current, i_0 , has the same shape as the vol-

tage, e_0 , but the alternating current, i , is as shown in Fig. 81 as i . If the circuit is inductive, vicious sparking occurs in this case with open-circuit rectification, as the brush when leaving the

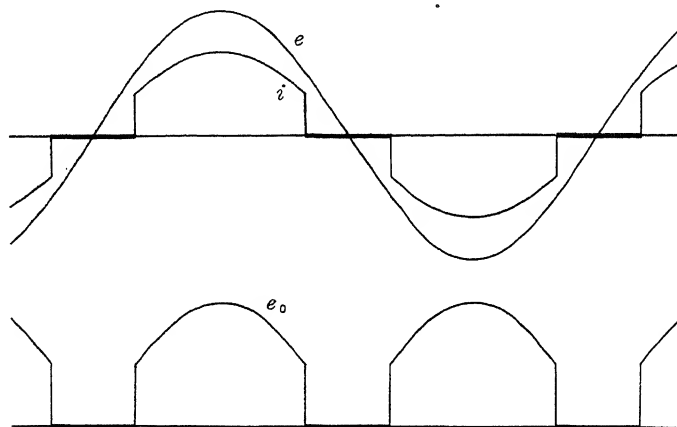

FIG. 81.—Voltage and current waves in open-circuit rectifier on non-inductive load.

commutator segment must suddenly interrupt the current. That is, the current does not stop suddenly, but continues to flow as an arc at the commutator surface, and also, when making con-

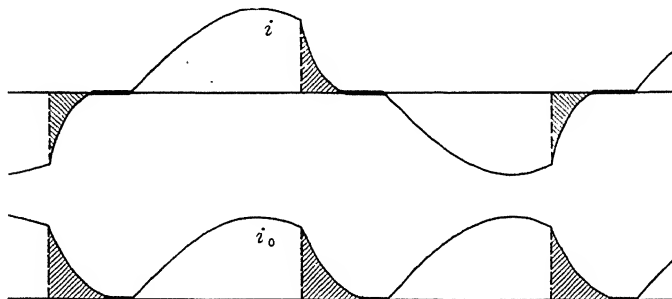

FIG. 82.—Voltage and current wave in open-circuit rectifier on inductive load, showing sparking.

tact between brush and segment, the current does not instantly reach full value, but gradually, and the current wave thus is as shown as i and i_0 in Fig. 82, where the shaded area is the arcing current at the commutator.

Sparkless rectification may be produced in a circuit of moderate

inductance, with open-circuit rectification, by shifting the brushes so that the brushes open the circuit only at the moment when the (inductive) current has reached zero value or nearly so, as

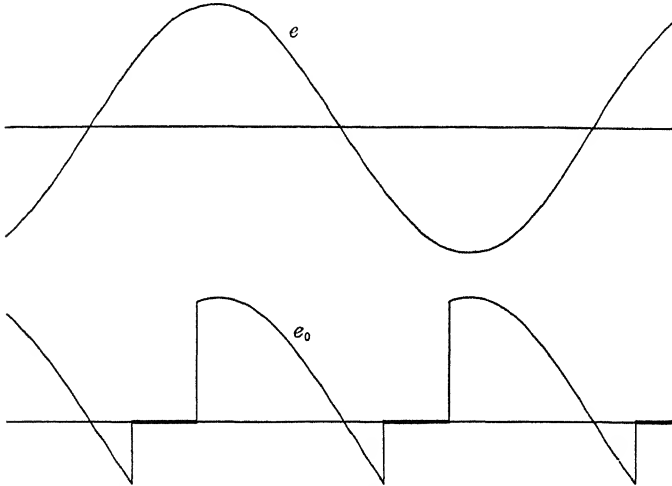

FIG. 83.—Voltage waves of open-circuit rectifier with shifted brushes.

shown in Figs. 83 and 84. In this case, the brush maintains contact until the voltage, e , has not only gone to zero, but reversed sufficiently to stop the current, and the rectified voltage then is shown by e_0 in Fig. 83, the current by i and i_0 in Fig. 84.

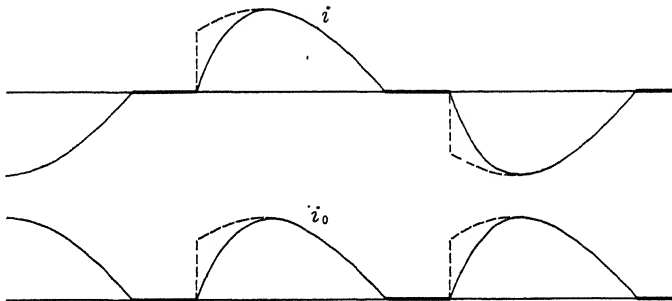

FIG. 84.—Current waves of open-circuit rectifier with shifted brushes.

140. With short-circuit commutation the voltage waves are as shown by e and e_0 in Fig. 85. With a non-inductive supply and non-inductive receiving circuit, the currents would be as shown by i and i_0 in Fig. 86. That is, during the period of short-circuit,

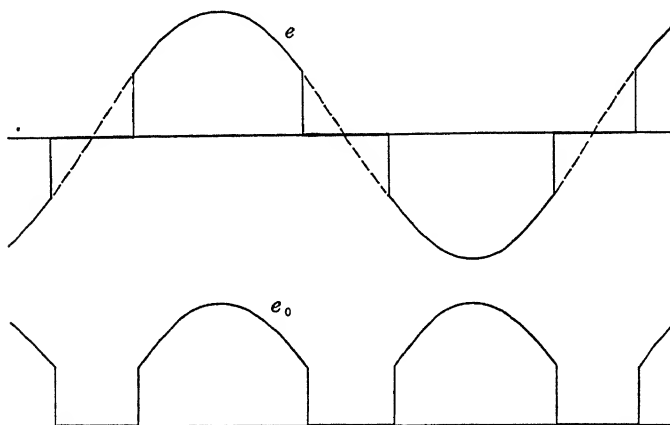

FIG. 85.—Voltage waves of short-circuit rectifier.

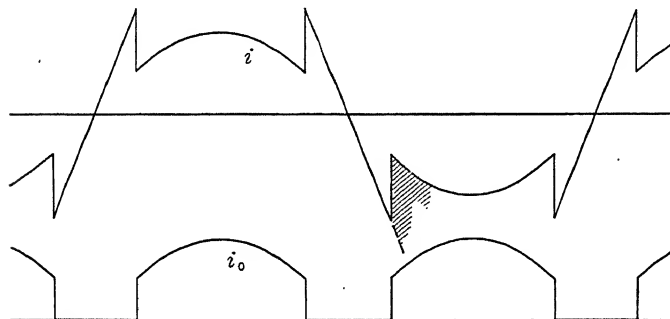

FIG. 86.—Current waves of short-circuit rectifier on non-inductive load.

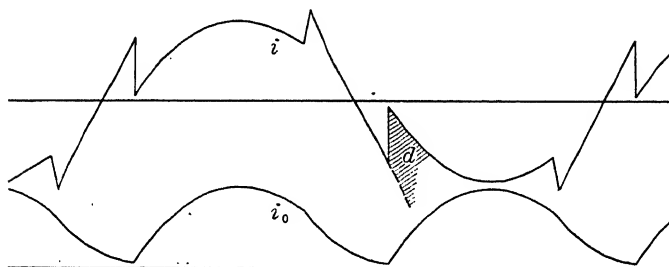

FIG. 87.—Current waves of short circuit rectifier on moderately inductive load, showing flashing.

the current in the rectified circuit is zero, and is high, is the short-circuit current of the supply voltage, in the supply circuit.

Inductance in the rectified circuit retards the dying out of the current, but also retards its rise, and so changes the rectified current wave to the shapes shown—for increasing values of inductance—as i_0 in Figs. 87, 88 and 89.

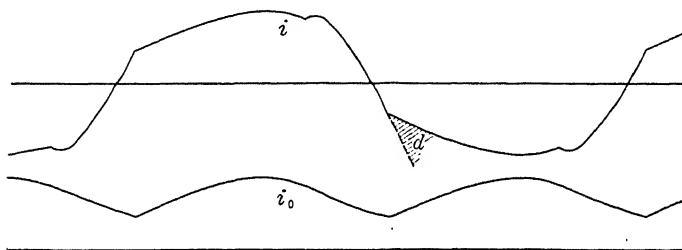

FIG. 88.—Current waves of short-circuit rectifier on inductive load at the stability limit.

Inductance in the supply circuit reduces the excess current value during the short-circuit period, and finally entirely eliminates the current rise, but also retards the decrease and reversal of the supply current, and the latter thus assumes the shapes shown—for successively increasing values of inductance—as i in Figs. 87, 88 and 89.

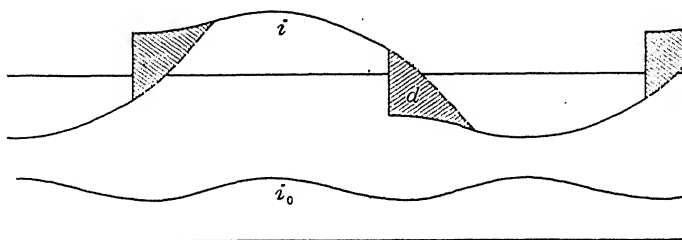

FIG. 89.—Current waves of short-circuit rectifier on highly inductive load, showing sparking but no flashing.

As seen, in Figs. 86 and 87, the alternating supply current has during the short-circuit reversed and reached a value at the end of the short-circuit, higher than the rectified current, and at the moment when the brush leaves the short-circuit, a considerable current has to be broken, that is, sparking occurs. In Figs. 86 and 87, this differential current which passes as arc at the commutator, is shown by the dotted area. It is increasing with in-

creasing spark length, that is, the spark or arc at the commutator has no tendency to go out—except if the inductance is very small—but persists: flashing around the commutator occurs and short-circuits the supply permanently.

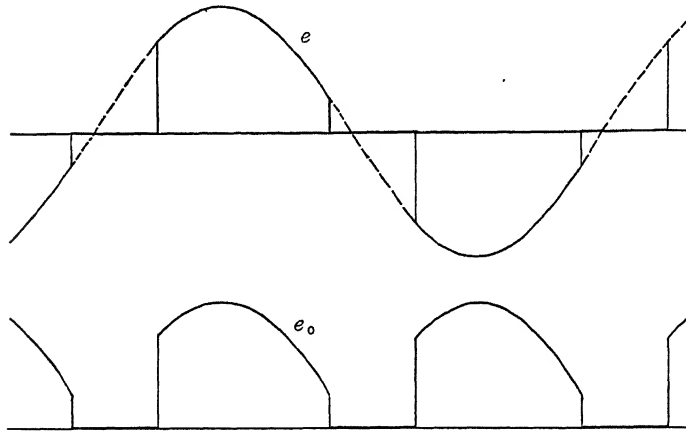

FIG. 90.—Voltage wave of short-circuit rectifier with shifted brushes.

In Fig. 89, the alternating current at the end of the short-circuit has not yet reversed, and a considerable differential current, shown by the dotted area, d , passes as arc. Vicious

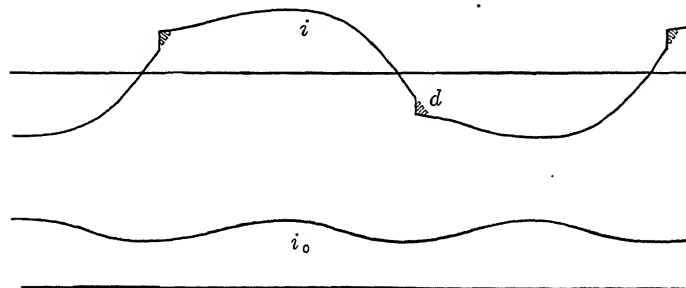

FIG. 91.—Current waves of short-circuit rectifier with inductive load and the brushes shifted to give good rectification.

sparking thus occurs, but in this case no flashing around the commutator, as with increasing spark length the differential current decreases and finally dies out.

In Fig. 88, the alternating current at the end of the short-circuit has just reached the same value as the rectified current,

thus no current change and no sparking occurs. However, if the short-circuit should last a moment longer, a rising differential current would appear and cause flashing around the commutator. Thus, Fig. 88 just represents the stability limit between the stable (but badly sparking) condition, Fig. 89, and the unstable or flashing conditions, Figs. 87 and 86.

By shifting the brushes so as to establish and open the short-circuit later, as shown in Fig. 90, the short-circuited alternating e.m.f.—shown dotted in Figs. 90 and 85—ceases to be symmetrical, that is, averaging zero as in Fig. 85, and becomes unsymmetrical, with an average of the same sign as the next following voltage wave. It thus becomes a *commutating* e.m.f., causes a more rapid reversal of the alternating current during the short-circuit period, and the circuit conditions, Fig. 89, then change to that of Fig. 91. That is, the current produced by the short-circuited alternating voltage has at the end of the short-circuit period reached nearly, but not quite the same value as the rectified current, and a short faint spark occurs due to the differential current, d . This Fig. 91 then represents about the best condition of stable, and practically sparkless commutation: a greater brush shift would reach the stability limit similar as Fig. 88, a lesser brush shift leave unnecessarily severe sparking, as Fig. 89.

141. Within a wide range of current and of inductance—especially for highly inductive circuits—practically sparkless and stable rectification can be secured by short-circuit commutation by varying the duration of the short-circuit, and by shifting the brushes, that is, changing the position of the short-circuit during the voltage cycle.

Within a wide range of current and of inductance, in low-inductance circuits, practically sparkless and stable rectification can be secured also by open-circuit rectification, by varying the duration of the open-circuit, and by shifting the brushes.

The duration of open-circuit or short-circuit can be varied by the use of two brushes in parallel, which can be shifted against each other so as to span a lesser or greater part of the circumference of the commutator, as shown in Fig. 92.

Short-circuit commutation is more applicable to circuits of high, open-circuit commutation to circuits of low inductance.

But, while either method gives good rectification if overlap and brush shift are right, they require a shift of the brushes with every change of load or of inductivity of the load, and this limits the

practical usefulness of rectification, as such readjustment with every change of circuit condition is hardly practicable.

Short-circuit rectification has been used to a large extent on constant-current circuits; it is the method by which the Thomson-

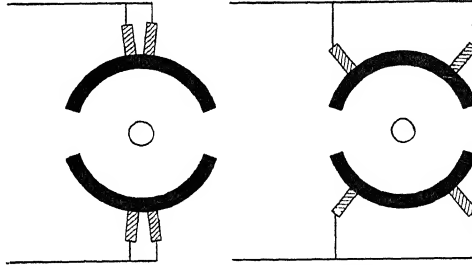

FIG. 92.—Double-brush rectifier.

Houston (three-phase) and the Brush arc machine (quarter-phase) commutates. For more details on this see "Theory and Calculations of Transient Phenomena," Section II.

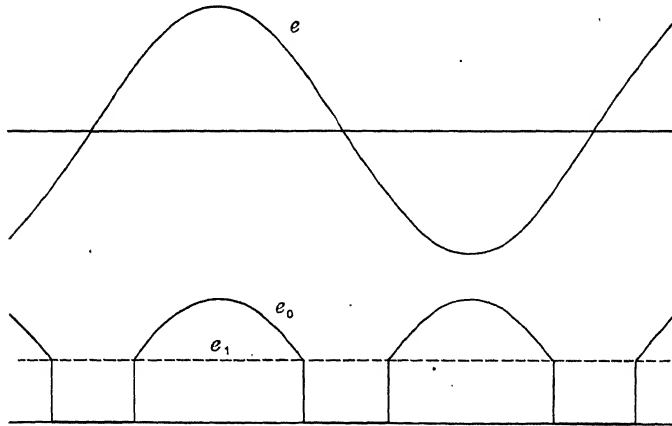

FIG. 93.—Voltage waves of open-circuit rectifier charging storage battery.

Open-circuit rectification has found a limited use on non-inductive circuits containing a counter e.m.f., that is, in charging storage batteries.

If, in Fig. 93, e_0 is the rectified voltage, and e_1 the counter e.m.f. of the storage battery, the current is $i_0 = \frac{e_0 - e_1}{r}$, where r = effective resistance of the battery, and if the counter e.m.f. of the

battery, e_1 , equals the initial and the final value of e_0 , as in Fig. 93, $e_0 - e$ and thus i_0 start and end with zero, that is, no abrupt change of current occurs, and moderate inductivity thus gives no trouble. The current waves then are: i and i_0 in Fig. 94.

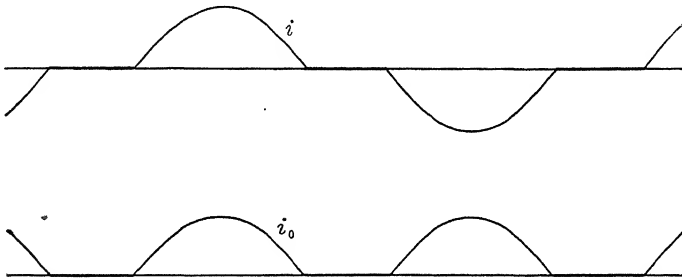

FIG. 94.—Current waves of open-circuit rectifier charging storage battery.

142. Rectifiers may be divided into reversing rectifiers, like those discussed heretofore, and shown, together with its supply transformer, in Figs. 95 and 96, and contact-making rectifiers, shown in Figs. 97 and 98, or in its simplest form, as half-wave rectifier, in Fig. 99.

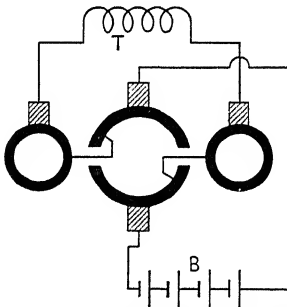

FIG. 95.—Reversing rectifier with alternating-current rotor.

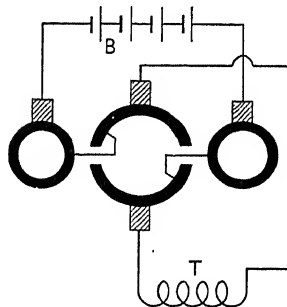

FIG. 96.—Reversing rectifier with direct-current rotor.

As seen, in Fig. 99, contact is made between the rectified circuit and the alternating supply source, T , during one-half wave only, but the circuit is open during the reverse half wave, and the rectified circuit, B , thus carries a series of separate impulses of current and voltage as shown in Fig. 100 as i_1 . However, in this case the current in the alternating supply circuit is unidirectional also, is the same current, i_1 . This current produces in the transformer, T , a unidirectional magnetization, and, if of appreciable

magnitude, that is, larger than the exciting current of the transformer, it saturates the transformer iron. Running at or beyond magnetic saturation, the primary exciting current of the transformer then becomes excessive, the hysteresis heating due to the unsymmetrical magnetic cycle is greatly increased, and the transformer endangered or destroyed.

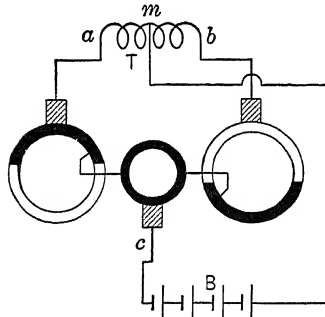

FIG. 97.—Contact-making rectifier with direct-current rotor.

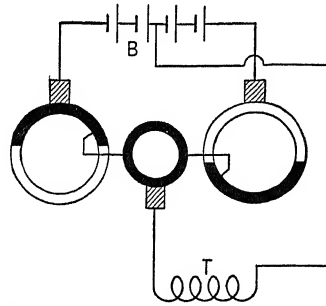

FIG. 98.—Contact-making rectifier with alternating-current rotor.

Half-wave rectifiers thus are impracticable except for extremely small power.

The full-wave contact-making rectifier, Fig. 97 or 98, does not have this objection. In this type of rectifier, the connection between rectified receiver circuit and alternating supply circuit are not synchronously reversed, as in Fig. 95 or 96, but in Fig. 97 one side of the rectified circuit, *B*, is permanently connected to the middle *m* of the alternating supply circuit, *T*, while the other side of the rectified circuit is synchronously connected and disconnected with the two sides, *a* and *b*, of the alternating supply circuit.

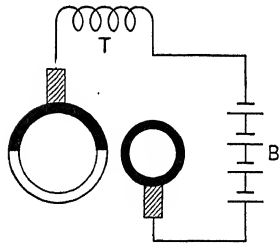

FIG. 99.—Half-wave rectifier, contact making.

Or we may say: the rectified circuit takes one-half wave from the one transformer half coil, *ma*, the other half wave from the other transformer half coil, *mb*. Thus, while each of the two transformer half coils carries unidirectional current, the unidirectional currents in the two half coils flow in opposite direction, thus give magnetically the same effect as one alternating

current in one half coil, and no unidirectional magnetization results in the transformer.

In the contact-making rectifier, Fig. 98, the two halves of the rectified circuit, or battery, *B*, alternately receive the two successive half waves of the transformer, *T*.

The voltage and current waves of the rectifier, Fig. 97, are shown in Fig. 100. *e* is the voltage wave of the alternating sup-

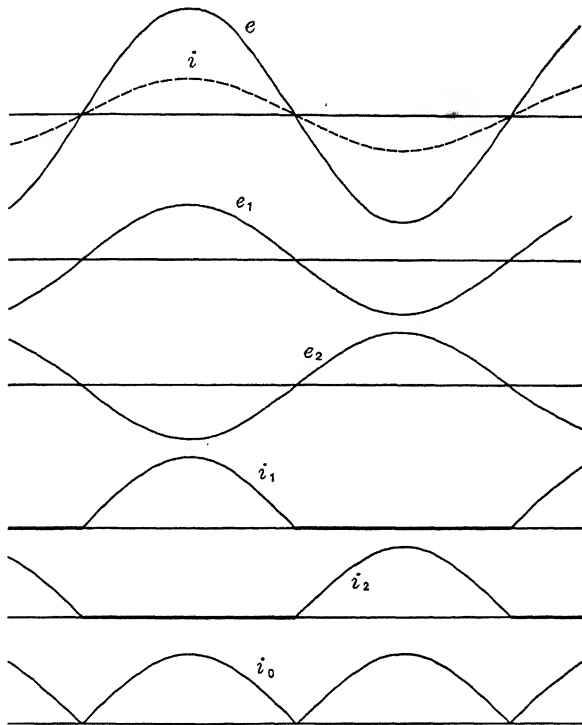

FIG. 100.—Voltage and current waves of contact-making rectifier with direct-current rotor.

ply source, from *a* to *b*. *e*₁ and *e*₂ then are the voltage waves of the two half coils, *am* and *bm*, *i*₁ and *i*₂ the two currents in these two half coils, and *i*₀ the rectified current, and voltage in the circuit from *m* to *c*. The current, *i*₁, in the one, and, *i*₂, in the other half coil, naturally has magnetically the same effect on the primary, as the current, $i_1 + i_2 = i_0$, in one half coil, or the current, $i_0/2 = i$, in the whole coil, *ab*, would have. Thus it may be said: in the (full-wave) contact-making rectifier, Fig. 97, the rectified

voltage, e_0 , is one-half the alternating voltage, e , and the rectified current, i_0 , is twice the alternating current, i . However, the i^2r in the secondary coil, ab , is greater, by $\sqrt{2}$, than it would be with the alternating current, $i = i_0/2$.

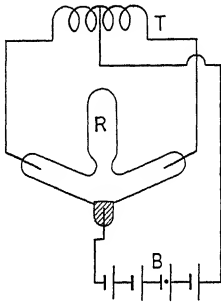

FIG. 101.—Mercury-arc rectifier, contact making.

Inversely, in the contact-making rectifier, Fig. 98, the rectified voltage is twice the alternating voltage, the rectified current half the alternating current.

Contact-making rectifiers of the type Fig. 97 are extensively used as arc rectifiers, more particularly the mercury-arc rectifier shown diagrammatically in Fig. 101. This may be compared with Fig. 97. That is, the making of contact during one half wave, and opening it during the reverse half wave, is accomplished not by mechanical synchronous rotation, but by the use of the arc as unidirectional conductor:¹ with the voltage gradient in one direction, the arc conducts; with the reverse voltage gradient

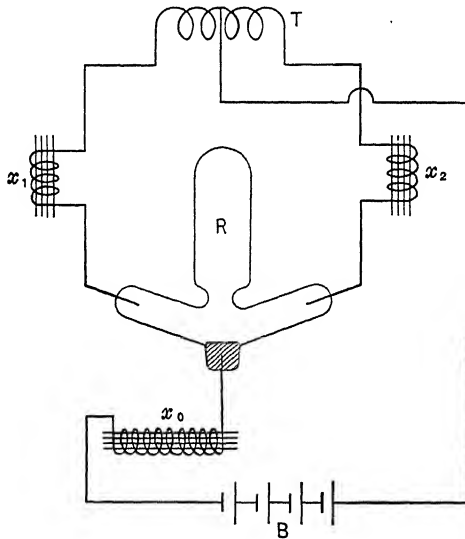

FIG. 102.—Diagram of mercury-arc rectifier with its reactances.

tional conductor:¹ with the voltage gradient in one direction, the arc conducts; with the reverse voltage gradient

¹ See Chapter II of "Theory and Calculation of Electric Circuits."

—the other half wave—it does not conduct. A large inductance is used in the rectified circuit, to reduce the pulsation of current, and inductances in the two alternating supply circuits—either separate inductances, or the internal reactance of the transformer—to prolong and thereby overlap the two half waves, and maintain the rectifying mercury arc in the vacuum tube. A diagram of a mercury-arc rectifier with its reactances, x_1 , x_2 , x_0 ,

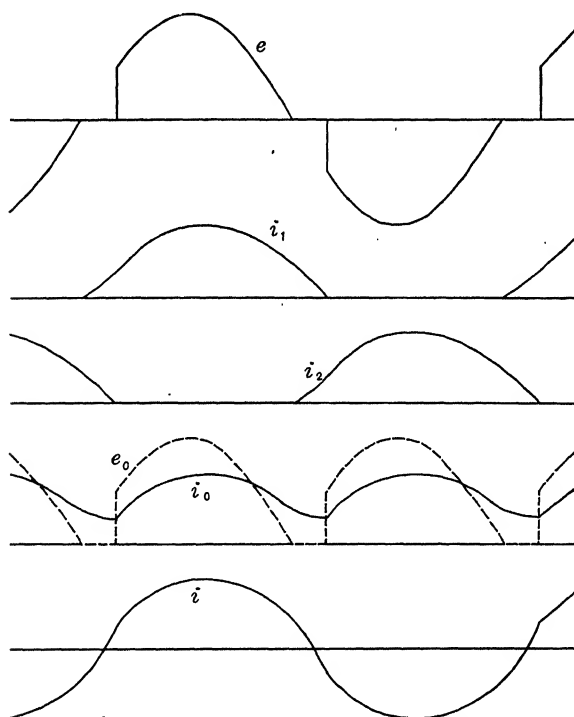

FIG. 103.—Voltage and current waves of mercury-arc rectifier.

is shown in Fig. 102. The “A.C. reactances” x_1 and x_2 often are a part of the supply transformer; the “D.C. reactance” x_0 is the one which limits the pulsation of the rectified current. The waves of currents, i_1 , i_2 and i_0 , as overlapped by the inductances, x_1 , x_2 and x_0 , are shown in Fig. 103.

Full description and discussion of the mercury-arc rectifier is contained in “Theory and Calculation of Transient Phenomena,” Section II, and in “Radiation, Light and Illumination.”

143. To reduce the sparking at the rectifying commutator, the gap between the segments may be divided into a number of gaps, by small auxiliary segments, as shown in Fig. 104, and these then connected to intermediate points of the shunting re-

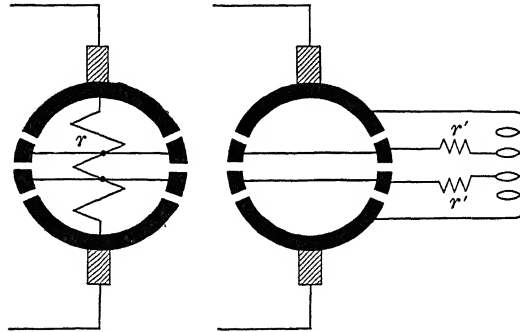

FIG. 104.—Rectifier with intermediate segments.

sistance, r , which takes the differential current, $i_0 - i$, or the auxiliary segments may be connected to intermediate points of the winding of the transformer, T , which feeds the rectifier, through resistances, r' , and the supply voltage thus successively

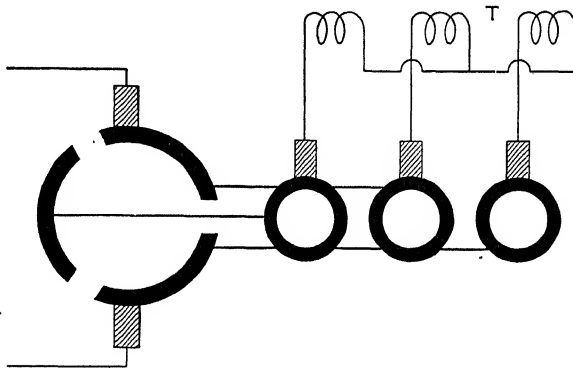

FIG. 105.—Three-phase Y-connected rectifier.

rectified. Or both arrangements may be combined, that is, the intermediate segments connected to intermediate points of the resistance, r , and intermediate points of the transformer winding, T .

Polyphase rectification can yield somewhat larger power than

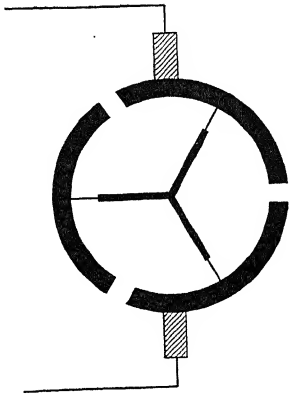

FIG. 106.—Three-phase Y-connected rectifier, simplified diagram.

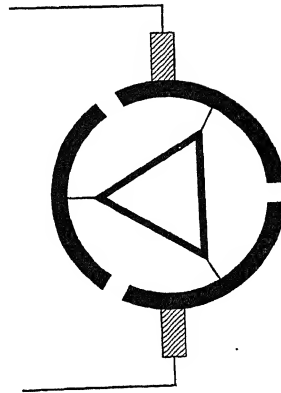

FIG. 107.—Three-phase delta-connected rectifier.

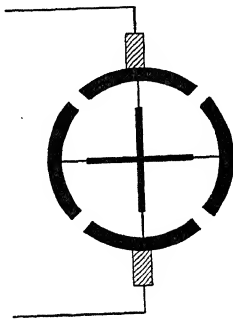

FIG. 108.—Quarter-phase star-connected rectifier.

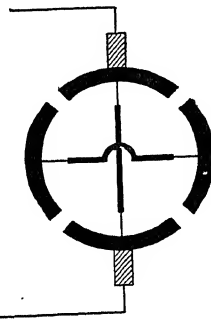

FIG. 109.—Quarter-phase rectifier with independent phases.

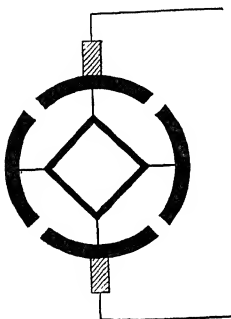

FIG. 110.—Quarter-phase ring-connected rectifier.

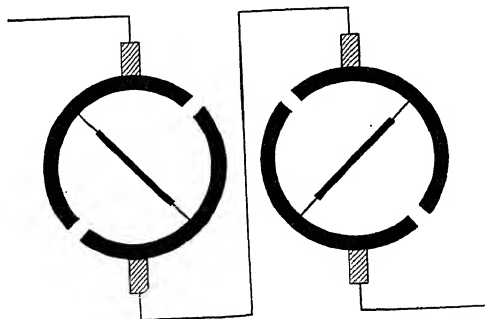

FIG. 111.—Quarter-phase rectifier with two commutators.

single-phase rectification. In polyphase rectification, the segments and circuits may be in star connection, or in ring connection, or independent.

Thus, Fig. 105 shows the arrangement of a star-connected (or Y-connected) three-phase rectifier. The arrangement of Fig. 105 is shown again in Fig. 106, in simpler representation, by showing the phases of the alternating supply circuit, and their relation to each other and to the rectifier segments, by heavy black lines inside of the commutator.

Fig. 107 shows a ring or delta-connected three-phase rectifier.

Fig. 108 a star-connected quarter-phase rectifier and Fig. 109 a quarter-phase rectifier with two independent quadra-

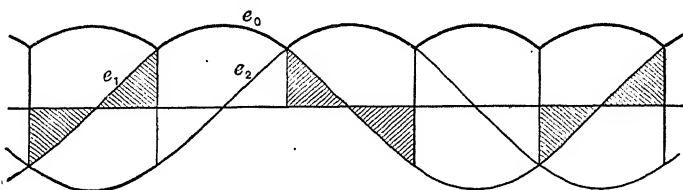

Fig. 112.—Voltage waves of quarter-phase star-connected rectifier.

ture phases, while Fig. 110 shows a ring-connected quarter-phase rectifier.

The voltage waves of the two coils in Fig. 109 are shown as e_1 and e_2 in Fig. 112, in thin lines, and the rectified voltage by the heavy black line, e_0 , in Fig. 112. As seen, in star connection, the successive phases alternate in feeding the rectified circuit, but only one phase is in circuit at a time, except during the time of the overlap of the brushes when passing the gap between successive segments. At that time, two successive phases are in multiple, and the current changes from the phase of decreasing voltage to that of rising voltage. Only a part of the voltage wave is thus used. The unused part of the wave, e_1 , is shown shaded in Fig. 112.

Fig. 113 shows the voltages of the four phases, e_1, e_2, e_3, e_4 , in ring connection, Fig. 110, and as e_0 the rectified voltage. As seen, in this case, all the phases are always in circuit, two phases always in series, except during the overlap of the brushes at the gap between the segments, when a phase is short-circuited during commutation. The rectified voltage is higher than that of each phase, but twice as many coils are required as sources of supply voltage, each carrying half the rectified current.

By using two commutators in series, as shown in Fig. 111, the two phases can be retained continuously in circuit while using

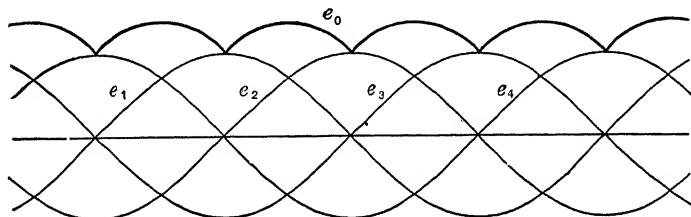

FIG. 113.—Voltage waves of water-phase ring-connected rectifier.

only two coils—but two commutators are required. The voltage waves then are shown in Fig. 114.

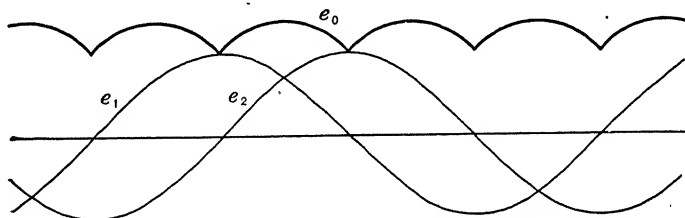

FIG. 114.—Voltage waves of quarter-phase rectifier with two commutators.

A star-connected six-phase rectifier is shown in Fig. 115, with the voltage waves in Fig. 117. The unused part of wave e_1 is

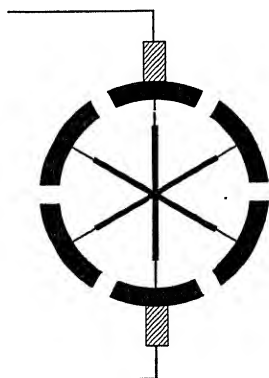

FIG. 115.—Six-phase star-connected rectifier.

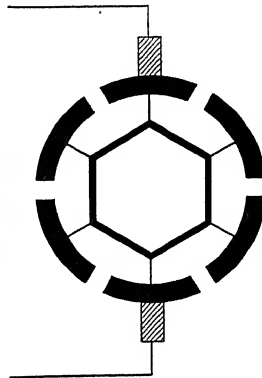

FIG. 116.—Six-phase ring-connected rectifier.

shown shaded. A six-phase ring-connected rectifier in Fig. 116, with the voltage waves in Fig. 118.

144. As seen, with larger number of phases, star connection becomes less and less economical, as a lesser part of the alternating voltage wave is used in the rectified voltage: in quarter-phase

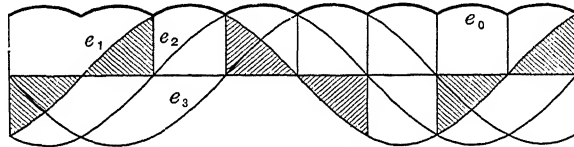

FIG. 117.—Voltage waves of six-phase star-connected rectifier.

rectification 90° or one-half, in six-phase rectification 60° or one-third, etc. In ring connection, however, all the phases are

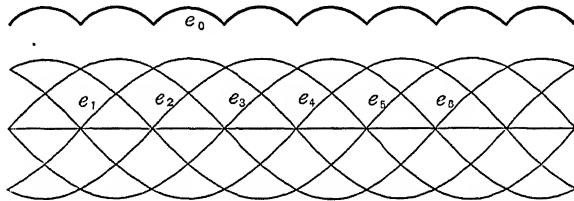

FIG. 118.—Voltage waves of six-phase ring-connected rectifier.

continuously in circuit, and thus no loss of economy occurs by the use of the higher number of phases.

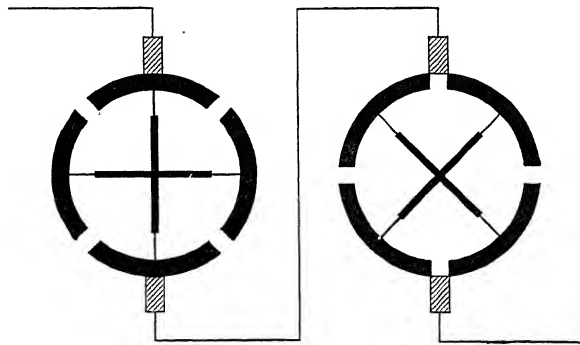

FIG. 119.—Rectifying commutators of the Brush arc machine.

Therefore, ring connection is generally used in rectification of a larger number of phases, and star connection is never used beyond quarter-phase, that is, four phases, and where a higher number of phases is desired, to increase the output, several

rectifying commutators are connected in series, as shown in Fig. 119. This represents two quarter-phase rectifiers in series displaced from each other by 45° , that is, an eight-phase system.

Three-phase star-connected rectification, Fig. 106, has been used in the Thomson-Houston arc machine, and quarter-phase rectification, Fig. 108, in the Brush arc machine, and for larger powers, several such commutators were connected in series, as in Fig. 119. These machines are polyphase (constant-current)

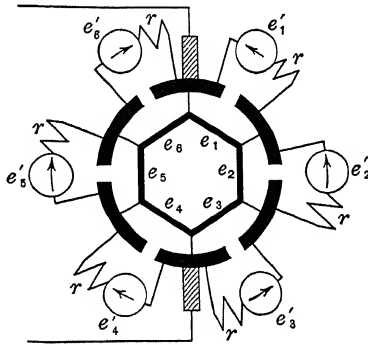

FIG. 120.—Counter e.m.f. shunting gaps of six-phase rectifier.

alternators connected to rectifying commutators on the armature shaft.

For a more complete discussion of the rectification of arc machine see "Theory and Calculation of Transient Electric Phenomena," Section II.

145. Even with polyphase rectification, the power which can be rectified is greatly limited by the sparking caused by the differential current, that is, the difference between the rectified current, i_0 , which never reverses, but is practically constant, and the alternating supply current. Resistances shunting the gaps between adjoining segments, as byepath for this differential current, consume power and mitigate the sparking to a limited extent only. A far more effective method of eliminating the sparking is by shunting this differential current not through a mere non-inductive resistance, but through a non-inductive resistance which contains an alternating counter e.m.f. equal to that of the supply phase, as shown diagrammatically in Fig. 120.

In Fig. 120, e_1 to e_6 are the six phases of a ring-connected six-phase system; e'_1 to e'_6 are e.m.fs. of very low self-inductance

and moderate resistance, r , shunted between the rectifier segments. Fig. 121 then shows the wave shape of the current, $i_0 - i$, which passes through these counter e.m.fs., e' (assuming that the circuit of e' , r , contains no appreciable self-inductance).

Such polyphase counter e.m.fs. for shunting the differential current between the segments, can be derived from the synchronous motor which drives the rectifying commutator. By winding the synchronous-motor armature ring connected and

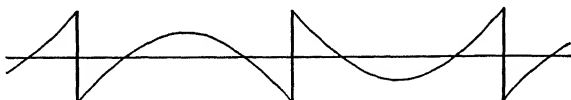

FIG. 121.—Wave shape of differential current.

of the same number of phases as the rectifying commutator, and using a revolving-armature synchronous motor, the synchronous-motor armature coils can be connected to the rectifier segments, and bypass the differential current. To carry this current, the armature conductor of the synchronous motor has to be increased in size, but as the differential current is small, this is relatively

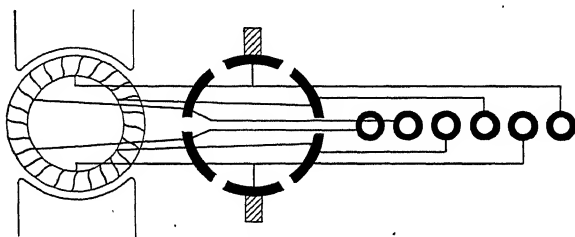

FIG. 122.—Leblanc's Panchahuteur.

little. Hereby the output which can be derived from a polyphase rectifier can be very largely increased, the more, the larger the number of phases. This is Leblanc's Panchahuteur, shown diagrammatically in Fig. 122 for six phases.

Such polyphase rectifier with non-inductive counter e.m.f. byepath through the synchronous-motor armature requires as many collector rings as rectifier segments. It can rectify large currents, but is limited in the voltage per phase, that is, per segment, to 20 to 30 volts at best, and the larger the

required rectified voltage, the larger thus must be the number of phases.

146. Any number of phases can be produced in the secondary system from a three-phase or quarter-phase primary polyphase system by transformation through two or three suitably designed stationary transformers, and a large number of phases thus is not objectionable regarding its production by transformation. The serious objection to the use of a large number of phases (24, 81, etc.) is, that each phase requires a collector ring to lead the current to the corresponding segment of the rectifying commutator.

This objection is overcome by various means:

1. The rectifying commutator is made stationary and the brushes revolving. The synchronous motor then has revolving

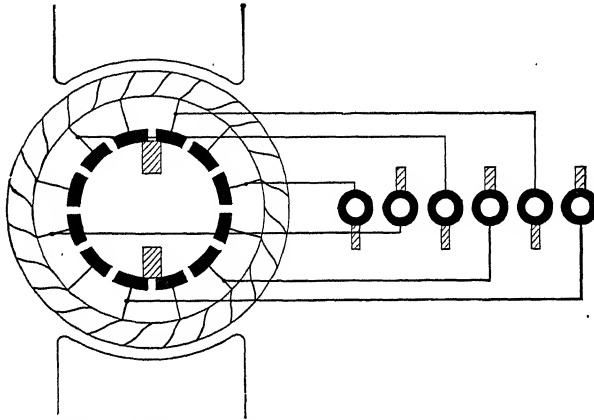

FIG. 123.—Phase splitting by synchronous-motor armature: synchronous converter.

field and stationary armature, and the connection from the stationary polyphase transformer to the commutator segments and the armature coils is by stationary leads.

Such a machine is called a *permutator*. It has been built to a limited extent abroad. It offers no material advantage over the synchronous converter, but has the serious disadvantage of revolving brushes. This means, that the brushes can not be inspected or adjusted during operation, that if one brush sparks by faulty adjustment, etc., it is practically impossible to find out which brush is at fault, and that due to the action of centrifugal forces on the brushes, the liability to troubles is greatly increased.

For this reason, the permutator has never been introduced in this country, and has practically vanished abroad.

2. The transformer is mounted on the revolving-motor structure, thereby revolving, permitting direct connection of its secondary leads with the commutator segments. In this case only the three or four primary phases have to be lead into the rotor by collector rings.

The mechanical design of such structure is difficult, the transformer, not open to inspection during operation, and exposed to centrifugal forces, which limit its design, exclude oil and thus limit the primary voltage, so that with a high-voltage primary-supply system, double transformation becomes necessary.

As this construction offers no material advantage over (3), it has never reached beyond experimental design.

3. A lesser number of collector rings and supply phases is used, than the number of commutator segments and synchronous-motor armature coils, and the latter are used as autotransformers to divide each supply phase into two or more phases feeding successive commutator segments. Fig. 123 shows a 12-phase rectifying commutator connected to a 12-phase synchronous motor with six collector rings for a six-phase supply, so that each supply phase feeds two motor phases or coils, and thereby two rectifier segments. Usually, more than two segments are used per supply phase. The larger the number of commutator segments per supply phase, the larger is the differential current in the synchronous motor armature coils, and the larger thus must be this motor.

Calculation, however, shows that there is practically no gain by the use of more than 12 supply phases, and very little gain beyond six supply phases, and that usually the most economical design is that using six supply phases and collector rings, no matter how large a number of phases is used on the commutator.

Fig. 123 is the well-known synchronous converter, which hereby appears as the final development, for large powers, of the synchronous rectifier.

This is the reason why the synchronous rectifier apparently has never been developed for large powers: the development of the polyphase synchronous rectifier for high power, by increasing the number of phases, bypassing the differential current which causes the sparking, by shunting the commutator segments with the armature coils of the motor, and finally reducing the number

of collector rings and supply phases by phase splitting in the synchronous-motor armature, leads to the synchronous converter as the final development of the high-power polyphase rectifier.

For "synchronous converter" see "Theoretical Elements of Electrical Engineering," Part II, C. For some special types of synchronous converter see under "Regulating Pole Converter" in the following Chapter XXI.

CHAPTER XVI

REACTION MACHINES

147. In the usual treatment of synchronous machines and induction machines, the assumption is made that the reactance, x , of the machine is a constant. While this is more or less approximately the case in many alternators, in others, especially in machines of large armature reaction, the reactance, x , is variable, and is different in the different positions of the armature coils in the magnetic circuit. This variation of the reactance causes phenomena which do not find their explanation by the theoretical calculations made under the assumption of constant reactance.

It is known that synchronous motors or converters of large and variable reactance keep in synchronism, and are able to do a considerable amount of work, and even carry under circumstances full load, if the field-exciting circuit is broken, and thereby the counter e.m.f., E_1 , reduced to zero, and sometimes even if the field circuit is reversed and the counter e.m.f., E_1 , made negative.

Inversely, under certain conditions of load, the current and the e.m.f. of a generator do not disappear if the generator field circuit is broken, or even reversed to a small negative value, in which latter case the current is against the e.m.f., E_0 , of the generator.

Furthermore, a shuttle armature without any winding (Fig. 126) will in an alternating magnetic field revolve when once brought up to synchronism, and do considerable work as a motor.

These phenomena are not due to remanent magnetism nor to the magnetizing effect of eddy currents, because they exist also in machines with laminated fields, and exist if the alternator is brought up to synchronism by external means and the remanent magnetism of the field poles destroyed beforehand by application of an alternating current.

These phenomena can not be explained under the assumption of a constant synchronous reactance; because in this case, at no-field excitation, the e.m.f. or counter e.m.f. of the machine

is zero, and the only e.m.f. existing in the alternator is the e.m.f. of self-induction; that is, the e.m.f. induced by the alternating current upon itself. If, however, the synchronous reactance is constant, the counter e.m.f. of self-induction is in quadrature with the current and wattless; that is, can neither produce nor consume energy.

In the synchronous motor running without field excitation, always a large lag of the current behind the impressed e.m.f. exists; and an alternating-current generator will yield an e.m.f. without field excitation only when closed by an external circuit of large negative reactance; that is, a circuit in which the current leads the e.m.f., as a condenser, or an overexcited synchronous motor, etc.

148. The usual explanation of the operation of the synchronous machine without field excitation is self-excitation by reactive armature currents. In a synchronous motor a lagging, in a generator a leading armature current magnetizes the field, and in such a case, even without any direct-current field excitation, there is a field excitation and thus a magnetic field flux, produced by the m.m.f. of the reactive component of the armature currents. In the polyphase machine, this is constant in intensity and direction, in the single-phase machine constant in direction, but pulsating in intensity, and the intensity pulsation can be reduced by a short-circuit winding around the field structure, as more fully discussed under "Synchronous Machines."

Thus a machine as shown diagrammatically in Fig. 124, with a polyphase (three-phase) current impressed on the rotating armature, *A*, and no winding on the field poles, starts, runs up to synchronous and does considerable work as synchronous motor, and under load may even give a fairly good (lagging) power-factor. With a single-phase current impressed upon the armature, *A*, it does not start, but when brought up to synchronism, continues to run as synchronous motor. Driven by mechanical power, with a leading current load it is a generator.

However, the operation of such machines depends on the existence of a polar field structure, that is a structure having a low reluctance in the direction of the field poles, $P - P$, and a high reluctance in quadrature position thereto. Or, in other words, the armature reactance with the coil facing the field poles is high, and low in the quadrature position thereto.

In a structure with uniform magnetic reluctance, in which

therefore the armature reactance does not vary with the position of the armature in the field, as shown in Fig. 125, such self-excitation by reactive armature currents does not occur, and direct-current field excitation is always necessary (except in the so-called "hysteresis motor").

Vectorially this is shown in Figs. 124 and 125 by the relative position of the magnetic flux, Φ , the voltage, E , in quadrature to Φ , and the m.m.f. of the current, I . In Fig. 125, where I and Φ coincide, I and E are in quadrature, that is, the power zero. Due to the polar structure in Fig. 124, I and Φ do not coincide,

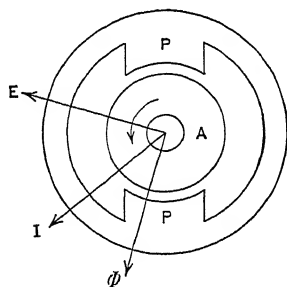

FIG. 124.—Diagram of machine with polar structure.

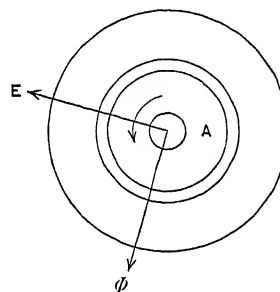

FIG. 125.—Diagram of machine with uniform reluctance.

thus I is not in quadrature to E , but contains a positive or a negative energy component, making the machine motor or generator.

As the voltage, E , is produced by the current, I , it is an e.m.f. of self-induction, and self-excitation of the synchronous machine by armature reaction can be explained by the fact that the counter e.m.f. of self-induction is not wattless or in quadrature with the current, but contains an energy component; that is, that the reactance is of the form $X = h + jx$, where x is the wattless component of reactance and h the energy component of reactance, and h is positive if the reactance consumes power—in which case the counter e.m.f. of self-induction lags more than 90° behind the current—while h is negative if the reactance produces power—in which case the counter e.m.f. of self-induction lags less than 90° behind the current.

149. A case of this nature occurs in the effect of hysteresis, from a different point of view. In "Theory and Calculation of Alternating Current" it was shown, that magnetic hysteresis distorts the current wave in such a way that the equivalent sine wave,

that is, the sine wave of equal effective strength and equal power with the distorted wave, is in advance of the wave of magnetism by what is called the angle of hysteretic advance of phase α . Since the e.m.f. generated by the magnetism, or counter e.m.f. of self-induction lags 90° behind the magnetism, it lags $90^\circ + \alpha$ behind the current; that is, the self-induction in a circuit containing iron is not in quadrature with the current and thereby wattless, but lags more than 90° and thereby consumes power, so that the reactance has to be represented by $X = h + jx$, where h is what has been called the "effective hysteretic resistance."

A similar phenomenon takes place in alternators of variable reactance, or, what is the same, variable magnetic reluctance.

Operation of synchronous machines without field excitation is most conveniently treated by resolving the synchronous reactance, x_0 , in its two components, the armature reaction and the true armature reactance, and once more resolving the armature reaction into a magnetizing and a distorting component, and considering only the former, in its effect on the field. The true armature self-inductance then is usually assumed as constant. Or, both armature reactance and self-inductance, are resolved into the two quadrature components, in line and in quadrature with the field poles, as shown in Chapters XXI and XXIV of "Alternating-Current Phenomena," 5th edition.

150. However, while a machine comprising a stationary single-phase "field coil," A , and a shuttle-shaped rotor, R , shown diagrammatically as bipolar in Fig. 126, might still be interpreted in this matter, a machine as shown diagrammatically in Fig. 127, as four-polar machine, hardly allows this interpretation. In Fig. 127, during each complete revolution of the rotor, R , it four times closes and opens the magnetic circuit of the single-phase alternating coil, A , and twice during the revolution, the magnetism in the rotor, R , reverses.

A machine, in which induction takes place by making and breaking (opening and closing) of the magnetic circuit, or in general, by the periodic variation of the reluctance of the magnetic circuit, is called a *reaction machine*.

Typical forms of such reaction machines are shown diagrammatically in Figs. 126 and 127. Fig. 126 is a bipolar, Fig. 127 is a four-polar machine. The rotor is shown in the position of closed magnetic circuit, but the position of open magnetic circuit is shown dotted,

Instead of cutting out segments of the rotor, in Fig. 126, the same effect can be produced, with a cylindrical rotor, by a short-circuited turn, *S*, as shown in Fig. 128. This gives a periodic variation of the effective reluctance, from a minimum, shown in Fig. 128, to a maximum in the position shown in dotted lines in Fig. 128.

This latter structure is the so-called "synchronous-induction motor," Chapter VIII, which here appears as a special form of the reaction machine.

If a direct current is sent through the winding of the machine,

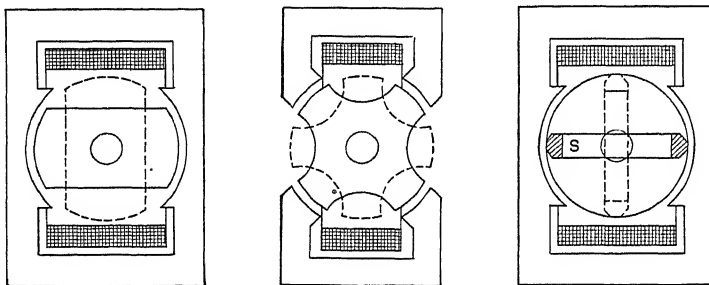

FIG. 126.—Bipolar reaction machine.

FIG. 127.—Four-polar reaction machine.

FIG. 128.—Synchronous-induction motor as reaction machine.

Fig. 126 or 127, a pulsating voltage and current is produced in this winding. By having two separate windings, and energizing the one by a direct current, we get a converter, from direct current in the first, to alternating current in the second winding. The maximum voltage in the second winding can not exceed the voltage, per turn, in the exciting winding, thus is very limited, and so is the current. Higher values are secured by inserting a high inductance in series in the direct-current winding. In this case, a single winding may be used and the alternating-circuit shunted across the machine terminals, inside of the inductance.

151. Obviously, if the reactance or reluctance is variable, it will perform a complete cycle during the time the armature coil moves from one field pole to the next field pole, that is, during one-half wave of the main current. That is, in other words, the reluctance and reactance vary with twice the frequency of the alternating main current. Such a case is shown in Figs. 129 and 130. The impressed e.m.f., and thus at negligible resistance, the counter e.m.f., is represented by the sine wave,

E , thus the magnetism produced thereby is a sine wave, Φ , 90° ahead of E . The reactance is represented by the sine wave, x ,

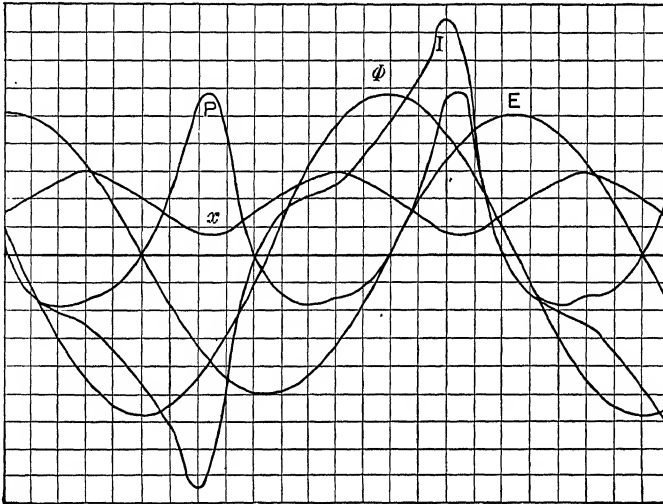

FIG. 129.—Wave shapes in reaction machine as generator.

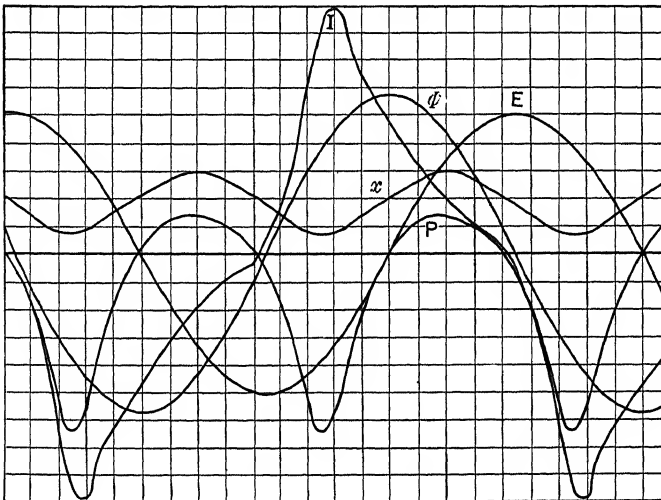

FIG. 130.—Wave shape in reaction machine as motor.

varying with the double frequency of E , and shown in Fig. 129 to reach the maximum value during the rise of magnetism, in

Fig. 130 during the decrease of magnetism. The current, I , required to produce the magnetism, Φ , is found from Φ and x in combination with the cycle of molecular magnetic friction of the material, and the power, P , is the product, IE . As seen in Fig.

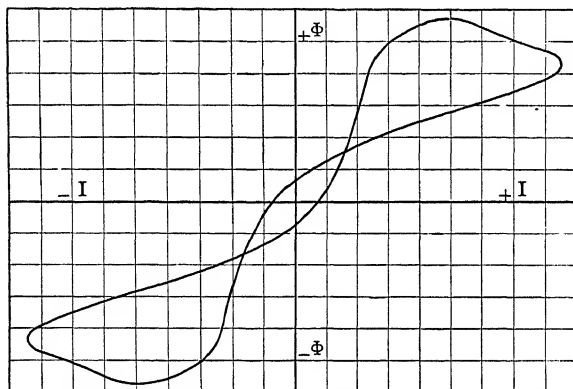

FIG. 131.—Hysteresis loop of reaction machine as generator.

129, the positive part of P is larger than the negative part; that is, the machine produces electrical energy as generator. In Fig. 130 the negative part of P is larger than the positive;

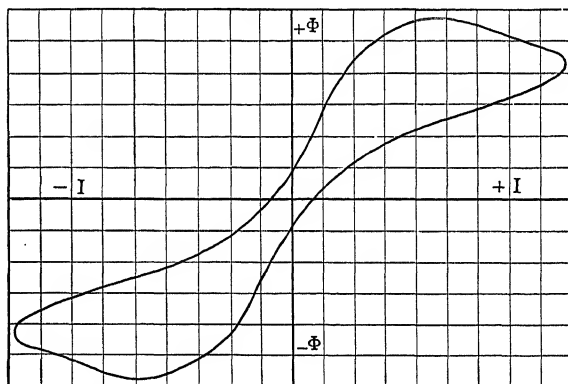

FIG. 132.—Hysteresis loop of reaction machine as motor.

that is, the machine consumes electrical energy and produces mechanical energy as synchronous motor. In Figs. 131 and 132 are given the two hysteretic cycles or looped curves, Φ , I under the two conditions. They show that, due to the variation of

reactance, x , in the first case, the hysteretic cycle has been overturned so as to represent, not consumption, but production of electrical energy, while in the second case the hysteretic cycle has been widened, representing not only the electrical energy consumed by molecular magnetic friction, but also the mechanical output.

152. It is evident that the variation of reluctance must be symmetrical with regard to the field poles; that is, that the two extreme values of reluctance, maximum and minimum, will take place at the moment when the armature coil stands in front of the field pole, and at the moment when it stands midway between the field poles.

The effect of this periodic variation of reluctance is a distortion of the wave of e.m.f., or of the wave of current, or of both. Here again, as before, the distorted wave can be replaced by the equivalent sine wave, or sine wave of equal effective intensity and equal power.

The instantaneous value of magnetism produced by the armature current—which magnetism generates in the armature conductor the e.m.f. of self-induction—is proportional to the instantaneous value of the current divided by the instantaneous value of the reluctance. Since the extreme values of the reluctance coincide with the symmetrical positions of the armature with regard to the field poles—that is, with zero and maximum value of the generated e.m.f., E_0 , of the machine—it follows that, if the current is in phase or in quadrature with the generated e.m.f., E_0 , the reluctance wave is symmetrical to the current wave, and the wave of magnetism therefore symmetrical to the current wave also. Hence the equivalent sine wave of magnetism is of equal phase with the current wave; that is, the e.m.f. of self-induction lags 90° behind the current, or is wattless.

Thus at no-phase displacement, and at 90° phase displacement, a reaction machine can neither produce electrical power nor mechanical power.

If, however, the current wave differs in phase from the wave of e.m.f. by less than 90° , but more than zero degrees, it is unsymmetrical with regard to the reluctance wave, and the reluctance will be higher for rising current than for decreasing current, or it will be higher for decreasing than for rising current, according to the phase relation of current with regard to generated e.m.f., E_0 .

In the first case, if the reluctance is higher for rising, lower for decreasing, current, the magnetism, which is proportional to current divided by reluctance, is higher for decreasing than for rising current; that is, its equivalent sine wave lags behind the sine wave of current, and the e.m.f. or self-induction will lag more than 90° behind the current; that is, it will consume electrical power, and thereby deliver mechanical power, and do work as a synchronous motor.

In the second case, if the reluctance is lower for rising, and higher for decreasing, current, the magnetism is higher for rising than for decreasing current, or the equivalent sine wave of magnetism leads the sine wave of the current, and the counter e.m.f. of self-induction lags less than 90° behind the current; that is, yields electric power as generator, and thereby consumes mechanical power.

In the first case the reactance will be represented by $X = h + jx$, as in the case of hysteresis; while in the second case the reactance will be represented by $X = -h + jx$.

153. The influence of the periodical variation of reactance will obviously depend upon the nature of the variation, that is, upon the shape of the reactance curve. Since, however, no matter what shape the wave has, it can always be resolved in a series of sine waves of double frequency, and its higher harmonics, in first approximation the assumption can be made that the reactance or the reluctance varies with double frequency of the main current; that is, is represented in the form:

$$x = a + b \cos 2\beta.$$

Let the inductance be represented by:

$$\begin{aligned} L &= l + l' \cos 2\beta, \\ &= l(1 + \gamma \cos 2\beta); \end{aligned}$$

where γ = amplitude of variation of inductance.

Let:

θ = angle of lag of zero value of current behind maximum value of the inductance, L .

Then, assuming the current as sine wave, or replacing it by the equivalent sine wave of effective intensity, I , current:

$$i = I \sqrt{2} \sin(\beta - \theta).$$

The magnetism produced by this current is:

$$\Phi = \frac{Li}{n},$$

where n = number of turns.

Hence, substituted:

$$\Phi = \frac{UI\sqrt{2}}{n} \sin(\beta - \theta) (1 + \gamma \cos 2\beta),$$

or, expanded:

$$\Phi = \frac{UI\sqrt{2}}{n} \left\{ \left(1 - \frac{\gamma}{2}\right) \cos \theta \sin \beta - \left(1 + \frac{\gamma}{2}\right) \sin \theta \cos \beta \right\},$$

when neglecting the term of triple frequency as wattless.

Thus the e.m.f. generated by this magnetism is:

$$\begin{aligned} e &= -n \frac{d\Phi}{dt} \\ &= -2\pi fn \frac{d\Phi}{d\beta}; \end{aligned}$$

hence, expanded:

$$e = -2\pi f l I \sqrt{2} \left\{ \left(1 - \frac{\gamma}{2}\right) \cos \theta \cos \beta + \left(1 + \frac{\gamma}{2}\right) \sin \theta \sin \beta \right\},$$

and the effective value of e.m.f.:

$$\begin{aligned} E &= 2\pi f l I \sqrt{\left(1 - \frac{\gamma}{2}\right)^2 \cos^2 \theta + \left(1 + \frac{\gamma}{2}\right)^2 \sin^2 \theta} \\ &= 2\pi f l I \sqrt{1 + \frac{\gamma^2}{4} - \gamma \cos 2\theta}. \end{aligned}$$

Hence, the apparent power, or the volt-amperes:

$$\begin{aligned} Q &= IE = 2\pi f l I^2 \sqrt{1 + \frac{\gamma^2}{4} - \gamma \cos 2\theta} \\ &= \frac{E^2}{2\pi f l \sqrt{1 + \frac{\gamma^2}{4} - \gamma \cos 2\theta}}. \end{aligned}$$

The instantaneous value of power is:

$$\begin{aligned} p &= ei \\ &= -4\pi f l I^2 \sin(\beta - \theta) \left\{ \left(1 - \frac{\gamma}{2}\right) \cos \theta \cos \beta + \right. \\ &\quad \left. \left(1 + \frac{\gamma}{2}\right) \sin \theta \sin \beta \right\}; \end{aligned}$$

and, expanded:

$$p = -2\pi f l I^2 \left\{ \left(1 + \frac{\gamma}{2}\right) \sin 2\theta \sin^2 \beta - \left(1 - \frac{\gamma}{2}\right) \sin 2\theta \cos^2 \beta + \sin 2\beta \left(\cos 2\theta - \frac{\gamma}{2}\right) \right\}.$$

Integrated, the effective value of power is:

$$P = -\pi f l I^2 \gamma \sin 2\theta;$$

hence, negative, that is, the machine consumes electrical, and produces mechanical, power, as synchronous motor, if $\theta > 0$, that is, with lagging current; positive, that is, the machine produces electrical, and consumes mechanical power, as generator, if $\theta > 0$, that is, with leading current.

The power-factor is:

$$p = \frac{P}{Q} = \frac{\gamma \sin 2\theta}{2 \sqrt{1 + \frac{\gamma^2}{4} - \gamma \cos 2\theta}};$$

hence, a maximum, if:

$$\frac{dp}{d\theta} = 0;$$

or, expanded:

$$\cos 2\theta = \frac{2}{\gamma} \quad \text{and} \quad = \frac{\gamma}{2}.$$

The power, P , is a maximum at given current, I , if:

$$\sin 2\theta = 1;$$

that is:

$$\theta = 45^\circ;$$

at given e.m.f., E , the power is:

$$P = - \frac{E^2 \gamma \sin 2\theta}{4 \pi f l \left(1 + \frac{\gamma^2}{4} - \gamma \cos 2\theta\right)};$$

hence, a maximum at:

$$\frac{dP}{d\theta} = 0;$$

or, expanded:

$$\cos 2\theta = \frac{\pm \gamma}{1 + \gamma^2}.$$

154. We have thus, at impressed e.m.f., E , and negligible resistance, if we denote the mean value of reactance:

$$x = 2\pi fl.$$

Current:

$$I = \frac{E}{x \sqrt{1 + \frac{\gamma^2}{4} - \gamma \cos 2\theta}}$$

Volt-amperes:

$$Q = \frac{E^2}{x \sqrt{1 + \frac{\gamma^2}{4} - \gamma \cos 2\theta}}$$

Power:

$$P = - \frac{E^2 \gamma \sin 2\theta}{2x \left(1 + \frac{\gamma^2}{4} - \gamma \cos 2\theta\right)}$$

Power-factor:

$$p = \cos (E, I) = \frac{\gamma \sin 2\theta}{2 \sqrt{1 + \frac{\gamma^2}{4} - \gamma \cos 2\theta}}$$

Maximum power at:

$$\cos 2\theta = \frac{\gamma}{1 + \frac{\gamma^2}{4}}$$

Maximum power-factor at:

$$\cos 2\theta = \frac{2}{\gamma} \text{ and } = \frac{\gamma}{2}$$

$\theta > 0$: synchronous motor, with lagging current,

$\theta < 0$: generator, with leading current.

As an example is shown in Fig. 133, with angle θ as abscissæ, the values of current, power, and power-factor, for the constants, $E = 110$, $x = 3$, and $\gamma = 0.8$.

$$I = \frac{41}{\sqrt{1.45 - \cos 2\theta}},$$

$$P = \frac{-2017 \sin 2\theta}{1.45 - \cos 2\theta},$$

$$p = \cos (E, I) = \frac{0.447 \sin 2\theta}{\sqrt{1.45 - \cos 2\theta}}$$

As seen from Fig. 133, the power-factor, p , of such a machine is very low—does not exceed 40 per cent. in this instance.

Very similar to the reaction machine in principle and character of operation are the synchronous induction motor, Chapter IX, and the hysteresis motor, Chapter X, either of which is a generator above synchronism, and at synchronism can be motor as

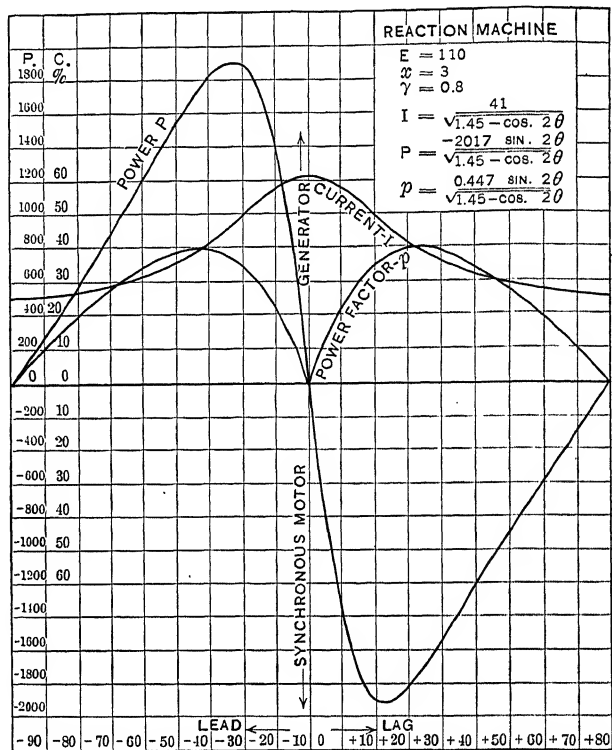

Fig. 133.—Load curves of reaction machine.

well as generator, depending on the relative position between stator field and rotor.

155. The low power-factor and the low weight efficiency bar the reaction machine from extended use for large powers. So also does the severe wave-shape distortion produced by it, and it thus has found a very limited use only in small sizes.

It has, however, the advantage of a high degree of exactness in keeping in step, that is, it does not merely keep in synchronism and drifts more or less over a phase angle with respect to the

impressed voltage, but the relative position of the rotor with regards to the phase of the impressed voltage is more accurately maintained. Where this feature is of importance, as in driving a contact-maker, a phase indicator or a rectifying commutator, the reaction machine has an advantage, especially in a system of fluctuating frequency, and it is used to some extent for such purposes.

This feature of exact step relation is shared also, though to a lesser extent, by the synchronous motor with self-excitation by lagging currents, and ordinarily small synchronous motors, but without field excitation (or with great underexcitation or overexcitation) are often used for the same purpose.

Machines having more or less the characteristics of the reaction machine have been used to a considerable extent in the very early days, for generating constant alternating current for series arc lighting by Jablochhoff candles, in the 70's and early 80's.

Structurally, the reaction machine is similar to the inductor machine, but the essential difference is, that the former operates by making and breaking the magnetic circuit, that is, periodically changing the magnetic flux, while the inductor machine operates by commutating the magnetic flux, that is, periodically changing the flux path, but without varying the total value of the magnetic flux.

CHAPTER XVII

INDUCTOR MACHINES

INDUCTOR ALTERNATORS, ETC.

156. Synchronous machines may be built with stationary field and revolving armature, as shown diagrammatically in Fig. 134, or with revolving field and stationary armature, Fig. 135, or with stationary field and stationary armature, but revolving magnetic circuit.

The revolving-armature type was the most frequent in the early days, but has practically gone out of use except for special

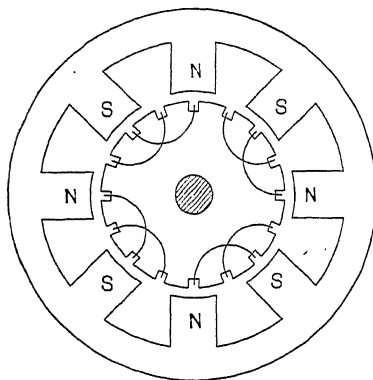

FIG. 134.—Revolving armature alternator

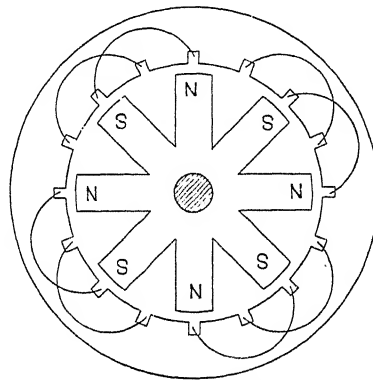

FIG. 135.—Revolving field alternator.

purposes, and for synchronous commutating machines, as the revolving-armature type of structure is almost exclusively used for commutating machines. The revolving-field type is now almost exclusively used, as the standard construction of alternators, synchronous motors, etc. The inductor type had been used to a considerable extent, and had a high reputation in the Stanley alternator. It has practically gone out of use for standard frequencies, due to its lower economy in the use of materials, but has remained a very important type of construction, as it is especially adapted for high frequencies and other special conditions, and in this field, its use is rapidly increasing.

A typical inductor alternator is shown in Fig. 136, as eight-pole quarter-phase machine.

Its armature coils, A , are stationary. One stationary field coil, F , surrounds the magnetic circuit of the machine, which consists of two sections, the stationary external one, B , which contains the armature, A , and a movable one, C , which contains the inductor, N . The inductor contains as many polar projections, N , as there are cycles or pairs of poles. The magnetic flux in the air gap and inductor does not reverse or alternate, as in the revolving-field type of alternator, Fig. 135, but is constant in direction, that is, all the inductor teeth are of the same polarity, but the flux density varies or pulsates, between a maximum, B_1 , in front of the inductor teeth, and a minimum, B_2 , though in the same direction, in front of the inductor slots. The magnetic flux, Φ , which interlinks with the armature coils, does not alternate between two equal and opposite values, $+\Phi_0$ and

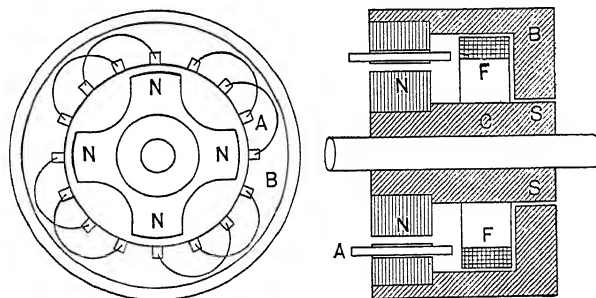

FIG. 136.—Inductor alternator.

$-\Phi_0$, as in Fig. 135, but pulsates between a high value, Φ_1 , when an inductor tooth stands in front of the armature coil, and a low value in the same direction, Φ_2 , when the armature coil faces an inductor slot.

157. In the inductor alternator, the voltage induction thus is brought about by shifting the magnetic flux produced by a stationary field coil, or by what may be called *magneto commutation*, by means of the inductor.

The flux variation, which induces the voltage in the armature turns of the inductor alternator, thus is $\Phi_1 - \Phi_2$, while that in the revolving-field or revolving-armature type of alternator is $2\Phi_0$.

The general formula of voltage induction in an alternator is:

$$e = \sqrt{2} \pi f n \Phi_0, \quad (1)$$

where:

f = frequency, in hundreds of cycles,
 n = number of armature turns in series,
 Φ_0 = maximum magnetic flux, alternating
 through the armature turns, in megalines,
 e = effective value of induced voltage.

$\Phi_1 - \Phi_2$ taking the place of $2 \Phi_0$, in the inductor alternator, the equation of voltage induction thus is:

$$e = \sqrt{2} \pi f n \frac{\Phi_1 - \Phi_2}{2} \quad (2)$$

As seen, Φ_1 must be more than twice as large as Φ_0 , that is, in an inductor alternator, the maximum-magnetic flux interlinked with the armature coil must be more than twice as large as in the standard type of alternator.

In modern machine design, with the efficient methods of cooling now available, economy of materials and usually also efficiency make it necessary to run the flux density up to near saturation at the narrowest part of the magnetic circuit—which usually is the armature tooth. Thus the flux, Φ_0 , is limited merely by magnetic saturation, and in the inductor alternator, Φ_1 , would be limited to nearly the same value as, Φ_0 , in the standard machine, and $\frac{\Phi_1 - \Phi_2}{2}$ thus would be only about one-half or less of the permissible value of Φ_0 . That is, the output of the inductor alternator armature is only about one-half that of the standard alternator armature. This is obvious, as we would double the voltage of the inductor alternator armature, if instead of pulsating between Φ_1 and Φ_2 or approximately zero, we would alternate between Φ_1 and $-\Phi_1$.

On the other hand, the single field-coil construction gives a material advantage in the material economy of the field, and in machines having very many field poles, that is, high-frequency alternators, the economy in the field construction overbalances the lesser economy in the use of the armature, especially as at high frequencies it is not feasible any more to push the alternating flux, Φ_0 , up to or near saturation values. Therefore, for high-frequency generators, the inductor alternator becomes the economically superior types, and is preferred, and for extremely high frequencies (20,000 to 100,000 cycles) the inductor alternator becomes the only feasible type, mechanically.

158. In the calculation of the magnetic circuit of the inductor

alternator, if Φ_0 is the amplitude of flux pulsation through the armature coil, as derived from the required induced voltage by equation (1), let:

p = number of inductor teeth, that is, number of pairs of poles (four in the eight-polar machine, Fig. 136).

ρ_1 = magnetic reluctance of air gap in front of the inductor tooth, which should be as low as possible,

ρ_2 = magnetic reluctance of leakage path through inductor slot into the armature coil, which should be as high as possible,

it is:

$$\Phi_1 \div \Phi_2 = \frac{1}{\rho_1} \div \frac{1}{\rho_2}; \quad (3)$$

and as:

$$\Phi_1 - \Phi_2 = 2 \Phi_0, \quad (4)$$

it follows:

$$\left. \begin{aligned} \Phi_1 &= 2 \Phi_0 \frac{\rho_2}{\rho_2 - \rho_1}, \\ \Phi_2 &= 2 \Phi_0 \frac{\rho_1}{\rho_2 - \rho_1}; \end{aligned} \right\} \quad (5)$$

and the total flux through the magnetic circuit, C , and out from all the p inductor teeth and slots thus is:

$$\begin{aligned} \Phi &= p (\Phi_1 + \Phi_2) \\ &= 2 p \Phi_0 \frac{\rho_2 + \rho_1}{\rho_2 - \rho_1} \\ &= 2 p \Phi_0 \left\{ 1 + \frac{2 \rho_1}{\rho_2 - \rho_1} \right\}. \end{aligned} \quad (6)$$

In the corresponding standard alternator, with $2 p$ poles, the total flux entering the armature is:

$$2 p \Phi_0$$

and if ρ_1 is the reluctance of the air gap between field pole and armature face, ρ_2 the leakage reluctance between the field poles, the ratio of the leakage flux between the field poles, Φ' , to the armature flux, Φ_0 , is:

$$\Phi_0 \div \Phi' = \frac{1}{\rho_1} \div \frac{1}{\rho_2}; \quad (7)$$

hence:

$$\Phi' = \Phi_0 \frac{\rho_1}{\rho_2}, \quad (8)$$

and the flux in the field pole, thus, is:

$$\Phi_0 + 2\Phi' = \Phi_0 \left(1 + \frac{2\rho_1}{\rho_2}\right);$$

hence the total magnetic flux of the machine, of $2p$ poles:

$$\Phi = 2p\Phi_0 \left(1 + \frac{2\rho_1}{\rho_2}\right). \quad (9)$$

As in (6), ρ_1 is small compared with ρ_2 , $\frac{2\rho_1}{\rho_2 - \rho_1}$ in (6) differs little from $\frac{2\rho_1}{\rho_2}$ in (9). That is:

As regards to the total magnetic flux required for the induction of the same voltage in the same armature, no material difference exists between the inductor machine and the standard machine; but in the armature teeth the inductor machine requires more than twice the maximum magnetic flux of the standard

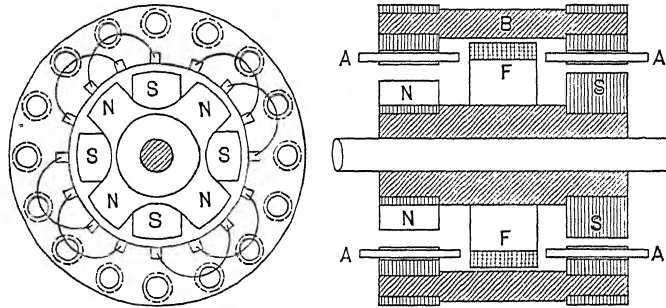

FIG. 137.—Stanley inductor alternator.

alternator, and thereby is at a disadvantage where the limit of magnetic density in the armature is set only by magnetic saturation.

As regards to the hysteresis loss in the armature of the inductor alternator, the magnetic cycle is an unsymmetrical cycle, between two values of the same direction, B_1 and B_2 , and the loss therefore is materially greater than it would be with a symmetrical cycle of the same amplitude. It is given by:

$$w = \eta_0 \left(\frac{B_1 - B_2}{2}\right)^{1.6},$$

where:

$$\eta_0 = \eta [1 + \beta B^2].$$

Regarding hereto see "Theory and Calculation of Electric Circuits," under "Magnetic Constants."

However, as by the saturation limit, the amplitude of the magnetic pulsation in the inductor machine may have to be kept very much lower than in the standard type, the core loss of the machine may be no larger, or may even be smaller than that of the standard type, in spite of the higher hysteresis coefficient, η_0 .

159. The inductor-machine type. Fig. 136, must have an

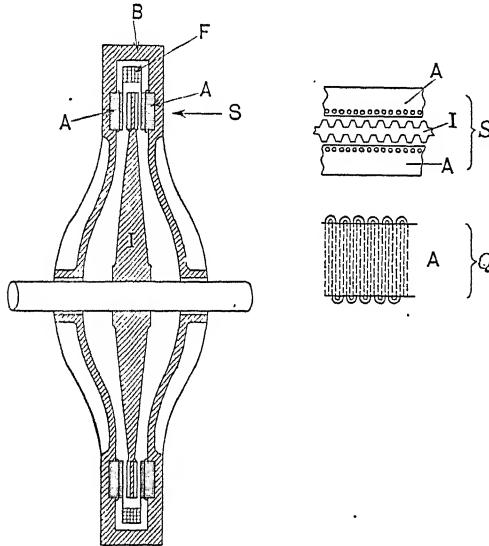

FIG. 138.—Alexanderson high frequency inductor alternator.

auxiliary air gap in the magnetic circuit, separating the revolving from the stationary part, as shown at *S*.

It, therefore, is preferable to double the structure, Fig. 136, by using two armatures and inductors, with the field coil between them, as shown in Fig. 137. This type of alternator has been extensively built, as the Stanley alternator, mainly for 60 cycles, and has been a very good and successful machine, but has been superseded by the revolving-field type, due to the smaller size and cost of the latter.

Fig. 137 shows the magnetic return circuit, *B*, between the two armatures, *A*, and the two inductors *N* and *S* as constructed of a number of large wrought-iron bolts, while Fig. 136 shows the return as a solid cast shell.

A modification of this type of inductor machine is the Alexanderson inductor alternator, shown in Fig. 138, which is being built for frequencies up to 200,000 cycles per second and over, for use in wireless telegraphy and telephony.

The inductor disc, *I*, contains many hundred inductor teeth, and revolves at many thousands of revolutions between the two armatures, *A*, as shown in the enlarged section, *S*. It is surrounded by the field coil, *F*, and outside thereof the magnetic return, *B*. The armature winding is a single-turn wave winding threaded through the armature faces, as shown in section *S* and face view, *Q*. It is obvious that in the armature special iron of extreme thinness of lamination has to be used, and the rotating inductor, *I*, built to stand the enormous centrifugal stresses of the great peripheral speed. We must realize that even with

an armature pitch of less than $\frac{1}{10}$ in. per pole, we get at 100,000 cycles per second peripheral speeds approaching bullet velocities, over 1000 miles per hour. For the lower frequencies of long distance radio communication, 20,000 to 30,000 cycles, such machines have been built for large powers.

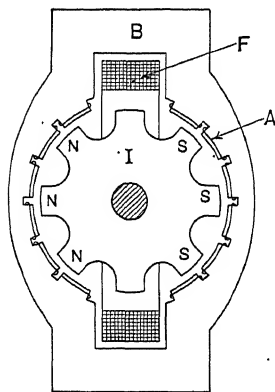

FIG. 139.—Eickemeyer inductor alternator.

160. Fig. 139 shows the Eickemeyer type of inductor alternator. In this, the field coil *F* is not concentric to the shaft, and the inductor teeth not all of the same polarity, but the field coil, as seen in Fig. 139, surrounds the inductor, *I*, longitudinally,

and with the magnetic return *B* thus gives a bipolar magnetic field. Half the inductor teeth, the one side of the inductor, thus are of the one, the other half of the other polarity, and the armature coils, *A*, are located in the (laminated) pole faces of the bipolar magnetic structure. Obviously, in larger machines, a multipolar structure could be used instead of the bipolar of Fig. 139. This type has the advantage of a simpler magnetic structure, and the further advantage, that all the magnetic flux passes at right angles to the shaft, just as in the revolving field or revolving armature alternator. In the types, Figs. 136 and 137, magnetic flux passes, and the field exciting coil magnetizes

longitudinally to the shaft, and thus magnetic stray flux tends to pass along the shaft, closing through bearings and supports, and causing heating of bearings. Therefore, in the types 136 and 137, magnetic barrier coils have been used where needed, that is, coils concentric to the shaft, that is, parallel to the field coil, and outside of the inductor, that is, between inductor and bearings, energized in opposite direction to the field coils. These coils then act as counter-magnetizing coils in keeping magnetic flux out of the machine bearings.

The type, Fig. 139, is especially adapted for moderate frequencies, a few hundreds to thousands of cycles. A modification of it, adopted as converter, is used to a considerable extent: the inductor, I , is supplied with a bipolar winding connected to a commutator, and the machine therefore is a bipolar commutating machine in addition to a high-frequency inductor alternator (16-polar in Fig. 139). It thus may be operated as converter, receiving power by direct-current supply, as direct-current motor, and producing high-frequency alternating power in the inductor pole-face winding.

161. If the inductor alternator, Fig. 139, instead of with direct current, is excited with low-frequency alternating current, that

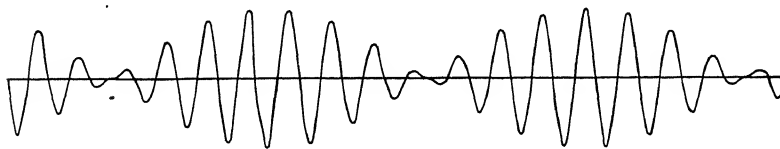

FIG. 140.—Voltage wave of inductor alternator with single-phase excitation.

is, an alternating current passed through the field coil, F , of a frequency low compared with that generated by the machine as inductor alternator, then the high-frequency current generated by the machine as inductor alternator is not of constant amplitude, but of a periodically varying amplitude, as shown in Fig. 140. For instance, with 60-cycle excitation, a 64-polar inductor (that is, inductor with 32 teeth), and a speed of 1800 revolutions, we get a frequency of approximately 1000 cycles, and a voltage and current wave about as shown in Fig. 140.

The power required for excitation obviously is small compared with the power which the machine can generate. Suppose, therefore, that the high-frequency voltage of Fig. 140 were rectified. It would then give a voltage and current, pulsating

with the frequency of the exciting current, but of a power, as many times greater, as the machine output is greater than the exciting power.

Thus such an inductor alternator with alternating-current excitation can be used as amplifier. This obviously applies equally much to the other types, as shown in Figs. 136, 137 and 138.

Suppose now the exciting current is a telephone or microphone current, the rectified generated current then pulsates with the frequencies of the telephone current, and the machine is a telephonic amplifier.

Thus, by exciting the high-frequency alternator in Fig. 138, by a telephone current, we get a high-frequency current, of an amplitude, pulsating with the telephone current, but of many times greater power than the original telephone current. This high-frequency current, being of the frequency suitable for radio communication, now is sent into the wireless sending antennæ, and the current received from the wireless receiving antennæ, rectified, gives wireless telephonic communications. As seen, the power, which hereby is sent out from the wireless antennæ, is not the insignificant power of the telephone current, but is the high-frequency power generated by the alternator with telephonic excitation, and may be many kilowatts, thus permitting long-distance radio telephony.

It is obvious, that the high inductance of the field coil, F , of the machine, Fig. 138, would make it impossible to force a telephone current through it, but the telephonic exciting current would be sent through the armature winding, which is of very low inductance, and by the use of the capacity the armature made self-exciting by leading current.

Instead of sending the high-frequency machine current, which pulsates in amplitude with telephonic frequency, through radio transmission and rectifying the receiving current, we can rectify directly the generated machine current and so get a current pulsating with the telephonic frequency, that is, get a greatly amplified telephone current, and send this into telephone circuits for long-distance telephony.

162. Suppose, now, in the inductor alternator, Fig. 139, with low-frequency alternating-current excitation, giving a voltage wave shown in Fig. 140, we use several alternators excited by low-frequency currents of different phases, or instead of a single-

phase field, as in Fig. 139, we use a polyphase exciting field. This is shown, with three exciting coils or poles energized by three-phase currents, in Fig. 141. The high-frequency voltages of pulsating amplitude, induced by the three phases, then superpose a high-frequency wave of constant amplitude, and we get, in Fig. 141, a high-frequency alternator with polyphase field excitation.

Instead of using definite polar projection for the three-phase bipolar exciting winding, as shown in Fig. 141, we could use a distributed winding, like that in an induction motor, placed in the same slots as the inductor-alternator armature winding. By

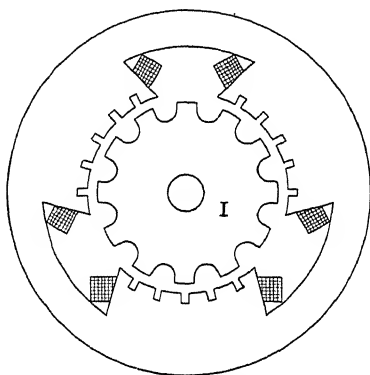

FIG. 141.—Inductor alternator with three-phase excitation.

placing a bipolar short-circuited winding on the inductor, the three-phase exciting winding of the high-frequency (24-polar) inductor alternator also becomes a bipolar induction-motor primary winding, supplying the power driving the machine. That is, the machine is a combination of a bipolar induction motor and a 24-polar inductor alternator, or a frequency converter.

Instead of having a separate high-frequency inductor-alternator armature winding, and low-frequency induction motor winding, we can use the same winding for both purposes, as shown diagrammatically in Figs. 142 and 143. The stator winding, Fig. 142, bipolar, or four-polar 60-cycle, is a low-frequency winding, for instance, has one slot per inductor pole, that is, twice as many slots as the inductor has teeth. Successive turns then differ from each other by 180° in phase, for the high-frequency inductor voltage. Thus grouping the winding in

two sections, 1 and 3, and 2 and 4, the high-frequency voltages in the two sections are opposite in phase from each other. Connecting, then, as shown in Fig. 143, 1 and 2 in series, and 4 and 3 in series into the two phases of the quarter-phase supply circuit, no high-frequency induction exists in either phase, but the high-frequency voltage is generated between the middle points

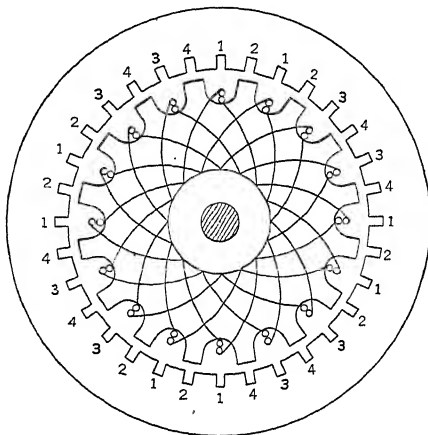

Fig. 142.—Induction type of high-frequency inductor alternator.

of the two phases, as shown in Fig. 143, and we thus get another form of a frequency converter, changing from low-frequency polyphase to high-frequency single-phase.

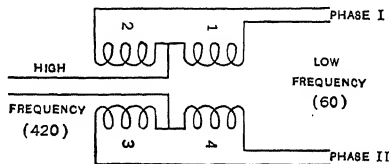

Fig. 143.—Diagram of connection of induction type of inductor alternator.

163. A type of inductor machine, very extensively used in small machines—as ignition dynamos for gasoline engines—is shown in Fig. 144. The field, F , and the shuttle-shaped armature, A , are stationary, and an inductor, I , revolves between field and armature, and so alternately sends the magnetic field flux through the armature, first in one, then in the opposite direction. As seen, in this type, the magnetic flux in the armature reverses, by what may be called *magnetic commutation*. Usually in these

small machines the field excitation is not by direct current, but by permanent magnets.

This principle of magnetic commutation, that is, of reversing

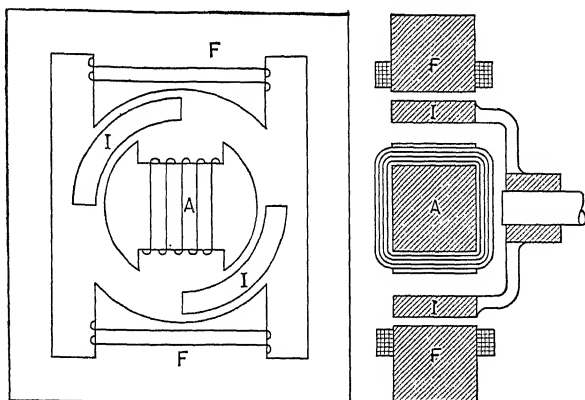

FIG. 144.—Magneto inductor machine.

the magnetic flux produced by a stationary coil, in another stationary coil by means of a moving “magneto commutator” or inductor, has been extensively used in single-phase feeder

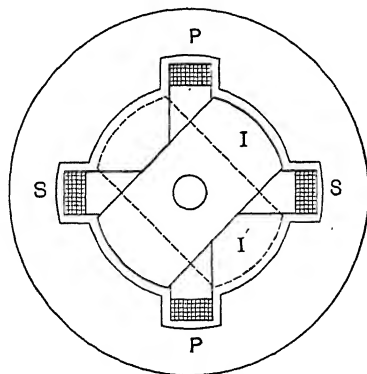

FIG. 145.—Magneto commutation voltage regulator.

regulators, the so-called “magneto regulators.” It is illustrated in Fig. 145. *P* is the primary coil (shunt coil connected across the alternating supply circuit), *S* the secondary coil (connected in series into the circuit which is to be regulated) the magnetic inductor, *I*, in the position shown in drawn lines sends the mag-

netic flux produced by the primary coil, through the secondary coil, in the direction opposite to the direction, in which it would send the magnetic flux through the secondary coil when in the position I' , shown in dotted lines. In vertical position, the inductor, I , would pass the magnetic flux through the primary coil, without passing it through the secondary coil, that is, without inducing voltage in the secondary. Thus by moving the shuttle or inductor, I , from position I over the vertical position to the position I' , the voltage induced in the secondary coil, S , is varied from maximum boosting over to zero to maximum lowering.

164. Fig. 146 shows a type of machine, which has been and still is used to some extent, for alternators as well as for direct-

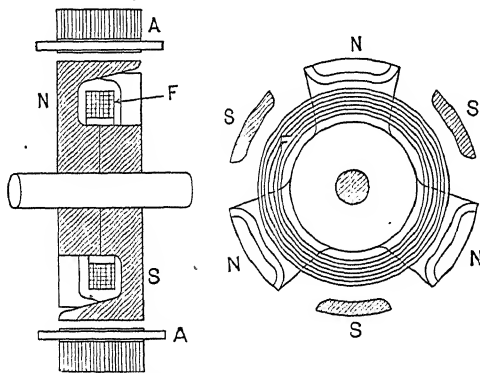

FIG. 146.—Semi-inductor type of machine.

current commutating machines, and which may be called an inductor machine, or at least has considerable similarity with the inductor type. It is shown in Fig. 146 as six-polar machine, with internal field and external armature, but can easily be built with internal armature and external field. The field contains one field coil, F , concentric to the shaft. The poles overhang the field coils, and all poles of one polarity, N , come from the one side, all poles of the other polarity from the other side of the field coil. The magnetic structure thus consists of two parts which interlock axially, as seen in Fig. 146.

The disadvantage of this type of field construction is the high flux leakage between the field poles, which tends to impair the regulation in alternators, and makes commutation more difficult for direct-current machines. It offers, however, the advantage

of simplicity and material economy in machines of small and moderate size, of many poles, as for instance in small very low-speed synchronous motors, etc.

165. In its structural appearance, inductor machines often have a considerable similarity with reaction machines. The characteristic difference between the two types, however, is, that in the reaction machine voltage is induced by the pulsation of the magnetic flux by pulsating reluctance of the magnetic circuit of the machine. The magnetic pulsation in the reaction machine thus extends throughout the entire magnetic circuit of the machine, and if direct-current excitation were used, the voltage would be induced in the exciting circuit also. In the inductor machine, however, the total magnetic flux does not pulsate, but is constant, and no voltage is induced in the direct-current exciting circuit. Induction is produced in the armature by shifting the—constant—magnetic flux locally from armature coil to armature coil. The important problem of inductor alternator design—and in general of the design of magneto commutation apparatus—is to have the shifting of the magnetic flux from path to path so that the total reluctance and thus the total magnetic flux does not vary, otherwise excessive eddy-current losses would result in the magnetic structure.

It is interesting to note, that the number of inductor teeth is one-half the number of poles. An inductor with p projections thus gives twice as many cycles per revolution, thus as synchronous motor would run at half the speed of a standard synchronous machine of p poles.

As the result hereof, in starting polyphase synchronous machines by impressing polyphase voltage on the armature and using the hysteresis and the induced currents in the field poles, for producing the torque of starting and acceleration, there frequently appears at half synchronism a tendency to drop into step with the field structure as inductor. This results in an increased torque when approaching, and a reduced torque when passing beyond half synchronism, thus produces a drop in the torque curve and is liable to produce difficulty in passing beyond half speed in starting. In extreme cases, it may result even in a negative torque when passing half synchronism, and make the machine non-self-starting, or at least require a considerable increase of voltage to get beyond half synchronism, over that required to start from rest.

CHAPTER XVIII

SURGING OF SYNCHRONOUS MOTORS

166. In the theory of the synchronous motor the assumption is made that the mechanical output of the motor equals the power developed by it. This is the case only if the motor runs at constant speed. If, however, it accelerates, the power input is greater; if it decelerates, less than the power output, by the power stored in and returned by the momentum. Obviously, the motor can neither constantly accelerate nor decelerate, without breaking out of synchronism.

If, for instance, at a certain moment the power produced by the motor exceeds the mechanical load (as in the moment of throwing off a part of the load), the excess power is consumed by the momentum as acceleration, causing an increase of speed. The result thereof is that the phase of the counter e.m.f., e , is not constant, but its vector, e , moves backward to earlier time, or counter-clockwise, at a rate depending upon the momentum. Thereby the current changes and the power developed changes and decreases. As soon as the power produced equals the load, the acceleration ceases, but the vector, e , still being in motion, due to the increased speed, further reduces the power, causing a retardation and thereby a decrease of speed, at a rate depending upon the mechanical momentum. In this manner a periodic variation of the phase relation between e and e_0 , and corresponding variation of speed and current occurs, of an amplitude and period depending upon the circuit conditions and the mechanical momentum.

If the amplitude of this pulsation has a positive decrement, that is, is decreasing, the motor assumes after a while a constant position of e regarding e_0 , that is, its speed becomes uniform. If, however, the decrement of the pulsation is negative, an infinitely small pulsation will continuously increase in amplitude, until the motor is thrown out of step, or the decrement becomes zero, by the power consumed by forces opposing the pulsation, as anti-surging devices, or by the periodic pulsation of the synchronous reactance, etc. If the decrement is zero, a pulsation

started once will continue indefinitely at constant amplitude. This phenomenon, a surging by what may be called electro-mechanical resonance, must be taken into consideration in a complete theory of the synchronous motor.

167. Let:

$E_0 = e_0 =$ impressed e.m.f. assumed as zero vector.

$E = e (\cos \beta - j \sin \beta) =$ e.m.f. consumed by counter e.m.f. of motor, where:

$\beta =$ phase angle between E_0 and E .

Let:

$$Z = r + jx,$$

$$\text{and } z = \sqrt{r^2 + x^2}$$

$=$ impedance of circuit between

E_0 and E , and

$$\tan \alpha = \frac{x}{r}.$$

The current in the system is:

$$\begin{aligned} I_0 &= \frac{e_0 - E}{Z} = \frac{e_0 - e \cos \beta + je \sin \beta}{r + jx} \\ &= \frac{1}{z} \{ [e_0 \cos \alpha - e \cos (\alpha + \beta)] \\ &\quad - j [e_0 \sin \alpha - e \sin (\alpha + \beta)] \} \quad (1) \end{aligned}$$

The power developed by the synchronous motor is:

$$\begin{aligned} P_0 &= [EI]^1 = \frac{e}{z} \{ [\cos \beta [e_0 \cos \alpha - e \cos (\alpha + \beta)] \\ &\quad + \sin \beta [e_0 \sin \alpha - e \sin (\alpha + \beta)]] \\ &= \frac{e}{z} \{ [e_0 \cos (\alpha - \beta) - e \cos \alpha] \}. \quad (2) \end{aligned}$$

If, now, a pulsation of the synchronous motor occurs, resulting in a change of the phase relation, β , between the counter e.m.f., e , and the impressed e.m.f., e_0 (the latter being of constant frequency, thus constant phase), by an angle, δ , where δ is a periodic function of time, of a frequency very low compared with the impressed frequency, then the phase angle of the counter e.m.f., e , is $\beta + \delta$; and the counter e.m.f. is:

$$E = e \{ \cos (\beta + \delta) - j \sin (\beta + \delta) \},$$

hence the current:

$$\begin{aligned}
 I &= \frac{1}{z} \{ [e_0 \cos \alpha - e \cos (\alpha + \beta + \delta)] \\
 &\quad - j [e_0 \sin \alpha - e \sin (\alpha + \beta + \delta)] \} \\
 &= I_0 + \frac{2e}{z} \sin \frac{\delta}{2} \left\{ \sin \left(\alpha + \beta + \frac{\delta}{2} \right) + j \cos \left(\alpha + \beta + \frac{\delta}{2} \right) \right\} \quad (3)
 \end{aligned}$$

the power:

$$\begin{aligned}
 P &= \frac{e}{z} \{ e_0 \cos (\alpha - \beta - \delta) - e \cos \alpha \} \\
 &= P_0 + \frac{2ee_0}{z} \sin \frac{\delta}{2} \sin \left(\alpha - \beta - \frac{\delta}{2} \right). \quad (4)
 \end{aligned}$$

Let now:

- v_0 = mean velocity (linear, at radius of gyration) of synchronous machine;
- s = slip, or decrease of velocity, as fraction of v_0 , where s is a (periodic) function of time; hence
- $v = v_0 (1 - s)$ = actual velocity, at time, t .

During the time element, dt , the position of the synchronous motor armature regarding the impressed e.m.f., e_0 , and thereby the phase angle, $\beta + \delta$, of e , changes by:

$$\begin{aligned}
 d\delta &= 2\pi f s dt \\
 &= s d\theta, \quad (5)
 \end{aligned}$$

where:

$$\theta = 2\pi ft,$$

and

$$f = \text{frequency of impressed e.m.f., } e_0.$$

Let:

- m = mass of revolving machine elements, and
- $M_0 = \frac{1}{2} m v_0^2$ = mean mechanical momentum, reduced to joules or watt-seconds; then the momentum at time, t , and velocity $v = v_0 (1 - s)$ is:

$$M = \frac{1}{2} m v_0^2 (1 - s)^2,$$

and the change of momentum during the time element, dt , is:

$$\frac{dM}{dt} = - m v_0^2 (1 - s) \frac{ds}{dt};$$

hence, for small values of s :

$$\begin{aligned}\frac{dM}{dt} &= -mv_0^2 \frac{ds}{d\theta} \frac{d\theta}{dt} \\ &= -2M_0 \frac{ds}{d\theta} \frac{d\theta}{dt};\end{aligned}\quad (6)$$

Since:

$$\frac{d\theta}{dt} = 2\pi f$$

and from (5):

$$\begin{aligned}s &= \frac{d\delta}{d\theta}, \\ \frac{ds}{d\theta} &= \frac{d^2\delta}{d\theta^2}\end{aligned}$$

it is:

$$\frac{dM}{dt} = -4\pi f M_0 \frac{d^2\delta}{d\theta^2}.\quad (7)$$

Since, as discussed, the change of momentum equals the difference between produced and consumed power, the excess of power being converted into momentum, it is:

$$P - P_0 = \frac{dM}{dt},\quad (8)$$

and, substituting (4) and (7) into (8) and rearranging:

$$\frac{ee_0}{z} \sin \frac{\delta}{2} \sin \left(\alpha - \beta - \frac{\delta}{2} \right) + 2\pi f M_0 \frac{d^2\delta}{d\theta^2} = 0.\quad (9)$$

Assuming δ as a small angle, that is, considering only small oscillations, it is:

$$\begin{aligned}\sin \frac{\delta}{2} &= \frac{\delta}{2}, \\ \sin \left[\alpha - \beta - \frac{\delta}{2} \right] &= \sin (\alpha - \beta);\end{aligned}$$

hence, substituted in (18):

$$\frac{ee_0}{z} \delta \sin (\alpha - \beta) + 4\pi f M_0 \frac{d^2\delta}{d\theta^2} = 0,\quad (10)$$

and, substituting:

$$a = \frac{ee_0 \sin (\alpha - \beta)}{4\pi f z M_0}\quad (11)$$

it is:

$$a\delta + \frac{d^2\delta}{d\theta^2} = 0.\quad (12)$$

This differential equation is integrated by:

$$\delta = A\epsilon^{C\theta}, \quad (13)$$

which, substituted in (12) gives:

$$\begin{aligned} aA\epsilon^{C\theta} + AC^2\epsilon^{C\theta} &= 0, \\ a + C^2 &= 0, \\ C &\pm \sqrt{-a}. \end{aligned} \quad (14)$$

168. 1. If $a < 0$, it is:

$$\delta = A_1\epsilon^{+m\theta} + A_2\epsilon^{-m\theta},$$

where:

$$m = \sqrt{-a} = \sqrt{-\frac{ee_0 \sin(\beta - \alpha)}{4\pi fz M_0}}.$$

Since in this case, $\epsilon^{+m\theta}$ is continually increasing, the synchronous motor is unstable. That is, without oscillation, the synchronous motor drops out of step, if $\beta > \alpha$.

2. If $a > 0$, it is, denoting:

$$\begin{aligned} n &= +\sqrt{a} = +\sqrt{\frac{ee_0 \sin(\alpha - \beta)}{4\pi fz M_0}}, \\ \delta &= A_1\epsilon^{+jn\theta} + A_2\epsilon^{-jn\theta}, \end{aligned}$$

or, substituting for $\epsilon^{+jn\theta}$ and $\epsilon^{-jn\theta}$ the trigonometric functions:

$$\delta = (A_1 + A_2) \cos n\theta + j(A_1 - A_2) \sin n\theta,$$

or,

$$\delta = B \cos(n\theta + \gamma). \quad (15)$$

That is, the synchronous motor is in stable equilibrium, when oscillating with a constant amplitude B , depending upon the initial conditions of oscillation, and a period, which for small oscillations gives the frequency of oscillation:

$$f_0 = nf = \sqrt{\frac{fee_0 \sin(\alpha - \beta)}{4\pi z M_0}}. \quad (16)$$

As instance, let:

$e_0 = 2200$ volts. $Z = 1 + 4j$ ohms, or, $z = 4.12$; $\alpha = 76^\circ$.

And let the machine, a 16-polar, 60-cycle, 400-kw., revolving-field, synchronous motor, have the radius of gyration of 20 in., a weight of the revolving part of 6000 lb.

The momentum then is $M_0 = 850,000$ joules.

Deriving the angles, β , corresponding to given values of output, P , and excitation, e , from the polar diagram, or from the symbolic

representation, and substituting in (16), gives the frequency of oscillation:

$P = 0:$

$e = 1600$ volts;	$\beta = -2^\circ;$	$f_0 = 2.17$ cycles,	
			or 130 periods per minute.
2180 volts	+ 3°	2.50 cycles,	
			or 150 periods per minute.
2800 volts	+ 5°	2.85 cycles,	
			or 169 periods per minute.

$P = 400$ kw.

$e = 1600$ volts;	$\beta = 33^\circ;$	$f_0 = 1.90$ cycles,	
			or 114 periods per minute.
2180 volts	21°	2.31 cycles,	
			or 139 periods per minute.
2800 volts	22°	2.61 cycles,	
			or 154 periods per minute.

As seen, the frequency of oscillation does not vary much with the load and with the excitation. It slightly decreases with increase of load, and it increases with increase of excitation.

In this instance, only the momentum of the motor has been considered, as would be the case for instance in a synchronous converter.

In a direct-connected motor-generator set, assuming the momentum of the direct-current-generator armature equal to 60 per cent. of the momentum of the synchronous motor, the total momentum is $M_0 = 1,360,000$ joules, hence, at no-load:

$$P = 0,$$

$e = 1600$ volts;	$f_0 = 1.72$ cycles, or 103 periods per minute.
	1.98 cycles, or 119 periods per minute.
	1.23 cycles, or 134 periods per minute.

169. In the preceding discussion of the surging of synchronous machines, the assumption has been made that the mechanical power consumed by the load is constant, and that no damping or anti-surging devices were used.

The mechanical power consumed by the load varies, however, more or less with the speed, approximately proportional to the speed if the motor directly drives mechanical apparatus, as pumps, etc., and at a higher power of the speed if driving direct-current generators, or as synchronous converter, especially

when in parallel with other direct-current generators. Assuming, then, in the general case the mechanical power consumed by the load to vary, within the narrow range of speed variation considered during the oscillation, at the p th power of the speed, in the preceding equation instead of P_0 is to be substituted, $P_0(1-s)^p = P_0(1-ps)$.

If anti-surging devices are used, and even without these in machines in which eddy currents can be produced by the oscillation of slip, in solid field poles, etc., a torque is produced more or less proportional to the deviation of speed from synchronism. This power assumes the form, $P_1 = c^2s$, where c is a function of the conductivity of the eddy-current circuit and the intensity of the magnetic field of the machine. c^2 is the power which would be required to drive the magnetic field of the motor through the circuits of the anti-surging device at full frequency, if the same relative proportions could be retained at full frequency as at the frequency of slip, s . That is, P_1 is the power produced by the motor as induction machine at slip s . Instead of P , the power generated by the motor, in the preceding equations the value, $P + P_1$, has to be substituted, then:

The equation (8) assumes the form:

$$P + P_1 - P_0(1-ps) = \frac{dM}{dt},$$

or:

$$(P - P_0) - (P_1 + pP_0s) = \frac{dM}{dt}, \quad (17)$$

or, substituting (7) and (4):

$$2e \frac{e_0}{z} \sin \frac{\delta}{2} \sin \left[\alpha - \beta - \frac{\delta}{2} \right] + (c^2 + pP_0) \frac{d\delta}{d\theta} + 4\pi f M_0 \frac{d^2\delta}{d\theta^2} = 0; \quad (18)$$

and, for small values of δ :

$$a\delta + 2b \frac{d\delta}{d\theta} + \frac{d^2\delta}{d\theta^2} = 0,$$

$$a = \frac{ee_0 \sin(\alpha - \beta)}{4\pi f z M_0}, \quad (19)$$

$$b = \frac{c^2 + pP_0}{8\pi f M_0}. \quad (20)$$

Of these two terms b represents the consumption, a the oscillation of energy by the pulsation of phase angle, β . b and a thus

have a similar relation as resistance and reactance in alternating-current circuits, or in the discharge of condensers. a is the same term as in paragraph 167.

Differential equation (19) is integrated by:

$$\delta = A\epsilon^{c\theta}, \tag{21}$$

which, substituted in (19), gives:

$$\begin{aligned} aA\epsilon^{c\theta} + 2bCA\epsilon^{c\theta} + C^2A\epsilon^{c\theta} &= 0, \\ a + 2bC + C^2 &= 0, \end{aligned}$$

which equation has the two roots:

$$\begin{aligned} C_1 &= -b + \sqrt{b^2 - a}, \\ C_2 &= -b - \sqrt{b^2 - a}. \end{aligned} \tag{22}$$

1. If $a < 0$, or negative, that is $\beta > \alpha$, C_1 is positive and C_2 negative, and the term with C_1 is continuously increasing, that is, the synchronous motor is unstable, and, without oscillation, drifts out of step.

2. If $0 < a < b^2$, or a positive, and b^2 larger than a (that is, the energy-consuming term very large), C_1 and C_2 are both negative, and, by substituting, $+\sqrt{b^2 - a} = g$, it is:

$$C_1 = -(b - g), \quad C_2 = -(b + g);$$

hence:

$$\delta = A_1\epsilon^{-(b-g)\theta} + A_2\epsilon^{-(b+g)\theta}. \tag{23}$$

That is, the motor steadies down to its mean position logarithmically, or without any oscillation.

$$b^2 > a,$$

hence:

$$\frac{(c^2 + pP_0)^2}{16\pi fM_0} > \frac{ee_0 \sin(\alpha - \beta)}{2} \tag{24}$$

is the condition under which no oscillation can occur.

As seen, the left side of (24) contains only mechanical, the right side only electrical terms.

3. $a > b^2$.

In this case, $\sqrt{b^2 - a}$ is imaginary, and, substituting:

$$g = \sqrt{a - b^2},$$

it is:

$$\begin{aligned} C_1 &= -b + jg, \\ C_2 &= -b - jg, \end{aligned}$$

hence:

$$\delta = \epsilon^{-b\theta} [A_1 \epsilon^{+i\theta} + A_2 \epsilon^{-i\theta}],$$

and, substituting the trigonometric for the exponential functions, gives ultimately:

$$\delta = B \epsilon^{-b\theta} \cos (\theta + \gamma). \quad (25)$$

That is, the motor steadies down with an oscillation of period:

$$f_0 = gf \\ = \sqrt{\frac{f e e_0 \sin (\alpha - \beta)}{4 \pi z M_0} - \frac{(c^2 + p P_0)^2}{64 \pi^2 M_0^2}}, \quad (26)$$

and decrement or attenuation constant:

$$b = \frac{c^2 + p P_0}{8 \pi f M_0}. \quad (27)$$

170. It follows, however, that under the conditions considered, a cumulative surging, or an oscillation with continuously increasing amplitude, can not occur, but that a synchronous motor, when displaced in phase from its mean position, returns thereto either aperiodically, if $b^2 > \alpha$, or with an oscillation of vanishing amplitude, if $b^2 < \alpha$. At the worst, it may oscillate with constant amplitude, if $b = 0$.

Cumulative surging can, therefore, occur only if in the differential equation (19):

$$a\delta + 2b \frac{d\delta}{d\theta} + \frac{d^2\delta}{d\theta^2} = 0, \quad (28)$$

the coefficient, b , is negative.

Since c^2 , representing the induction motor torque of the damping device, etc., is positive, and pP_0 is also positive (p being the exponent of power variation with speed), this presupposes the existence of a third and negative term, $\frac{-h^2}{8 \pi f M_0}$, in b :

$$b = \frac{c^2 + p P_0 - h^2}{8 \pi f M_0}. \quad (29)$$

This negative term represents a power:

$$P_2 = -h^2 s; \quad (30)$$

that is, a retarding torque during slow speed, or increasing β , and accelerating torque during high speed, or decreasing β .

The source of this torque may be found external to the motor, or internal, in its magnetic circuit.

External sources of negative, P_2 , may be, for instance, the magnetic field of a self-exciting, direct-current generator, driven by the synchronous motor. With decrease of speed, this field decreases, due to the decrease of generated voltage, and increases with increase of speed. This change of field strength, however, lags behind the exciting voltage and thus speed, that is, during decrease of speed the output is greater than during increase of speed. If this direct-current generator is the exciter of the synchronous motor, the effect may be intensified.

The change of power input into the synchronous motor, with change of speed, may cause the governor to act on the prime mover driving the generator, which supplies power to the motor, and the lag of the governor behind the change of output gives a pulsation of the generator frequency, of e_0 , which acts like a negative power, P_2 . The pulsation of impressed voltage, caused by the pulsation of β , may give rise to a negative, P_2 , also.

An internal cause of a negative term, P_2 , is found in the lag of the synchronous motor field behind the resultant m.m.f. In the preceding discussion, e is the "nominal generated e.m.f." of the synchronous machine, corresponding to the field excitation. The actual magnetic flux of the machine, however, does not correspond to e , and thus to the field excitation, but corresponds to the resultant m.m.f. of field excitation and armature reaction, which latter varies in intensity and in phase during the oscillation of β . Hence, while e is constant, the magnetic flux is not constant, but pulsates with the oscillations of the machine. This pulsation of the magnetic flux lags behind the pulsation of m.m.f., and thereby gives rise to a term in b in equation (28). If P_0 , β , e , e_0 , Z are such that a retardation of the motor increases the magnetizing, or decreases the demagnetizing force of the armature reaction, a negative term, P_2 , appears, otherwise a positive term.

P_2 in this case is the energy consumed by the magnetic cycle of the machine at full frequency, assuming the cycle at full frequency as the same as at frequency of slip, s .

Or inversely, e may be said to pulsate, due to the pulsation of armature reaction, with the same frequency as β , but with a phase, which may either be lagging or leading. Lagging of the pulsation of e causes a negative, leading a positive, P_2 .

P_2 , therefore, represents the power due to the pulsation of e

caused by the pulsation of the armature reaction, as discussed in "Theory and Calculation of Alternating-Current Phenomena."

Any appliance increasing the area of the magnetic cycle of pulsation, as short-circuits around the field poles, therefore, increases the steadiness of a steady and increases the unsteadiness of an unsteady synchronous motor.

In self-exciting synchronous converters, the pulsation of e is intensified by the pulsation of direct-current voltage caused thereby, and hence of excitation.

Introducing now the term, $P_2 = -h^2s$, into the differential equations of paragraph 169, gives the additional cases:

$b < 0$, or negative, that is:

$$\frac{c^2 + pP_0 - h^2}{8\pi fM_0} < 0. \quad (31)$$

Hence, denoting:

$$b_1 = -b = \frac{h^2 - c^2 - pP_0}{8\pi fM_0}, \quad (32)$$

gives:

$$\begin{aligned} 4. \text{ If: } \quad & b_1^2 > a, \quad g = +\sqrt{b_1^2 - a}, \\ & \delta = A_1\epsilon^{+(b_1+f)\theta} + A_2\epsilon^{+(b_1-f)\theta}. \end{aligned} \quad (33)$$

That is, without oscillation, the motor drifts out of step, in unstable equilibrium.

$$\begin{aligned} 5. \text{ If: } \quad & a > b_1^2, \quad g = \sqrt{a - b_1^2}, \\ & \delta = B\epsilon^{+b_1\theta} \cos(g\theta + \delta). \end{aligned} \quad (34)$$

That is, the motor oscillates, with constantly increasing amplitude, until it drops out of step. This is the typical case of cumulative surging by electro-mechanical resonance.

The problem of surging of synchronous machines, and its elimination, thus resolves into the investigation of the coefficient:

$$b = \frac{c^2 + pP_0 - h^2}{8\pi fM_0}, \quad (35)$$

while the frequency of surging, where such exists, is given by:

$$f_0 = \sqrt{\frac{fee_0 \sin(\alpha - \beta)}{4\pi z_0 M_0} - \frac{(c^2 + pP_0 - h^2)^2}{64\pi^2 M_0^2}}. \quad (36)$$

Case (4), steady drifting out of step, has only rarely been observed.

The avoidance of surging thus requires:

1. An elimination of the term h^2 , or reduction as far as possible.
2. A sufficiently large term, c^2 , or
3. A sufficiently large term, pP_0 .

(1) refers to the design of the synchronous machine and the system on which it operates. (2) leads to the use of electromagnetic anti-surging devices, as an induction motor winding in the field poles, short-circuits between the poles, or around the poles, and (3) leads to flexible connection to a load or a momentum, as flexible connection with a flywheel, or belt drive of the load.

The conditions of steadiness are:

$$\beta > \alpha,$$

$$c^2 + pP_0 - h^2 > 0,$$

and if:

$$\frac{(c^2 + pP_0 - h^2)^2}{16 \pi f M_0} > \frac{ee_0 \sin(\alpha - \beta)}{z},$$

no oscillation at all occurs, otherwise an oscillation with decreasing amplitude.

As seen, cumulative oscillation, that is, hunting or surging, can occur only, if there is a source of power supply converting into low-frequency pulsating power, and the mechanism of conversion is a lag of some effect—in the magnetic field of the machine, or external—which causes the forces restoring the machine into step, to be greater than the forces which oppose the deviation from the position in step corresponding to the load. For further discussion of the phenomenon of cumulative surging, and of cumulative oscillations in general, see Chapter XI of "Theory and Calculation of Electric Circuits."

CHAPTER XIX

ALTERNATING-CURRENT MOTORS IN GENERAL

171. The starting point of the theory of the polyphase and single-phase induction motor usually is the general alternating-current transformer. Coming, however, to the commutator motors, this method becomes less suitable, and the following more general method preferable.

In its general form the alternating-current motor consists of one or more stationary electric circuits magnetically related to one or more rotating electric circuits. These circuits can be excited by alternating currents, or some by alternating, others by direct current, or closed upon themselves, etc., and connection can be made to the rotating member either by collector rings—that is, to fixed points of the windings—or by commutator—that is, to fixed points in space.

The alternating-current motors can be subdivided into two classes—those in which the electric and magnetic relations between stationary and moving members do not vary with their relative positions, and those in which they vary with the relative positions of stator and rotor. In the latter a cycle of rotation exists, and therefrom the tendency of the motor results to lock at a speed giving a definite ratio between the frequency of rotation and the frequency of impressed e.m.f. Such motors, therefore, are synchronous motors.

The main types of synchronous motors are as follows:

1. One member supplied with alternating and the other with direct current—polyphase or single-phase synchronous motors.
2. One member excited by alternating current, the other containing a single circuit closed upon itself—synchronous induction motors.
3. One member excited by alternating current, the other of different magnetic reluctance in different directions (as polar construction)—reaction motors.
4. One member excited by alternating current, the other by alternating current of different frequency or different direction of rotation—general alternating-current transformer or frequency converter and synchronous-induction generator.

(1) is the synchronous motor of the electrical industry. (2) and (3) are used occasionally to produce synchronous rotation without direct-current excitation, and of very great steadiness of the rate of rotation, where weight efficiency and power-factor are of secondary importance. (4) is used to some extent as frequency converter or alternating-current generator.

(2) and (3) are occasionally observed in induction machines, and in the starting of synchronous motors, as a tendency to lock at some intermediate, occasionally low, speed. That is, in starting, the motor does not accelerate up to full speed, but the acceleration stops at some intermediate speed, frequently half speed, and to carry the motor beyond this speed, the impressed voltage may have to be raised or even external power applied. The appearance of such "dead points" in the speed curve is due to a mechanical defect—as eccentricity of the rotor—or faulty electrical design: an improper distribution of primary and secondary windings causes a periodic variation of the mutual inductive reactance and so of the effective primary inductive reactance, (2) or the use of sharply defined and improperly arranged teeth in both elements causes a periodic magnetic lock (opening and closing of the magnetic circuit, (3) and so a tendency to synchronize at the speed corresponding to this cycle.

Synchronous machines have been discussed elsewhere. Here shall be considered only that type of motor in which the electric and magnetic relations between the stator and rotor do not vary with their relative positions, and the torque is, therefore, not limited to a definite synchronous speed. This requires that the rotor when connected to the outside circuit be connected through a commutator, and when closed upon itself, several closed circuits exist, displaced in position from each other so as to offer a resultant closed circuit in any direction.

The main types of these motors are:

1. One member supplied with polyphase or single-phase alternating voltage, the other containing several circuits closed upon themselves—polyphase and single-phase induction machines.

2. One member supplied with polyphase or single-phase alternating voltage, the other connected by a commutator to an alternating voltage—compensated induction motors, commutator motors with shunt-motor characteristic.

3. Both members connected, through a commutator, directly

or inductively, in series with each other, to an alternating voltage—alternating-current motors with series-motor characteristic.

Herefrom then follow three main classes of alternating-current motors:

Synchronous motors.

Induction motors.

Commutator motors.

There are, however, numerous intermediate forms, which belong in several classes, as the synchronous-induction motor, the compensated-induction motor, etc.

172. An alternating current, I , in an electric circuit produces a magnetic flux, Φ , interlinked with this circuit. Considering equivalent sine waves of I and Φ , Φ lags behind I by the angle of hysteretic lag, α . This magnetic flux, Φ , generates an e.m.f., $E = 2\pi fn\Phi$, where f = frequency, n = number of turns of electric circuit. This generated e.m.f., E , lags 90° behind the magnetic flux, Φ , hence consumes an e.m.f. 90° ahead of Φ , or $90 - \alpha$ degrees ahead of I . This may be resolved in a reactive component: $E' = 2\pi fn\Phi \cos \alpha = 2\pi fLI = xI$, the e.m.f. consumed by self-induction, and power component: $E'' = 2\pi fn\Phi \sin \alpha = 2\pi fHI = r''I$ = e.m.f. consumed by hysteresis (eddy currents, etc.), and is, therefore, in vector representation denoted by:

$$E' = jxI \text{ and } E'' = r''I,$$

where:

$$x = 2\pi fL = \text{reactance,}$$

and

$$L = \text{inductance,} \\ r'' = \text{effective hysteretic resistance.}$$

The ohmic resistance of the circuit, r' , consumes an e.m.f. $r'I$, in phase with the current, and the total or effective resistance of the circuit is, therefore, $r = r' + r''$, and the total e.m.f. consumed by the circuit, or the impressed e.m.f., is:

$$E = (r + jx) I = ZI,$$

where:

$$Z = r + jx = \text{impedance, in vector denotation,} \\ z = \sqrt{r^2 + x^2} = \text{impedance, in absolute terms.}$$

If an electric circuit is in inductive relation to another electric circuit, it is advisable to separate the inductance, L , of the cir-

cuit in two parts—the self-inductance, S , which refers to that part of the magnetic flux produced by the current in one circuit which is interlinked only with this circuit but not with the other circuit, and the mutual inductance, M , which refers to that part of the magnetic flux interlinked also with the second circuit. The desirability of this separation results from the different character of the two components: The self-inductive reactance generates a reactive e.m.f. and thereby causes a lag of the current, while the mutual inductive reactance transfers power into the second circuit, hence generally does the useful work of the apparatus. This leads to the distinction between the self-inductive impedance, $Z_0 = r_0 + jx_0$, and the mutual inductive impedance, $Z = r + jx$.

The same separation of the total inductive reactance into self-inductive reactance and mutual inductive reactance, represented respectively by the self-inductive or “leakage” impedance, and the mutual inductive or “exciting” impedance has been made in the theory of the transformer and the induction machine. In those, the mutual inductive reactance has been represented, not by the mutual inductive impedance, Z , but by its reciprocal value, the exciting admittance: $Y = \frac{1}{Z}$. It is then:

r_0 is the coefficient of power consumption by ohmic resistance, hysteresis and eddy currents of the self-inductive flux—effective resistance.

x_0 is the coefficient of e.m.f. consumed by the self-inductive or leakage flux—self-inductive reactance.

r is the coefficient of power consumption by hysteresis and eddy currents due to the mutual magnetic flux (hence contains no ohmic resistance component).

x is the coefficient of e.m.f. consumed by the mutual magnetic flux.

The e.m.f. consumed by the circuit is then:

$$E = Z_0 I + Z I. \quad (1)$$

If one of the circuits rotates relatively to the other, then in addition to the e.m.f. of self-inductive impedance: $Z_0 I$, and the e.m.f. of mutual-inductive impedance or e.m.f. of alternation: $Z I$, an e.m.f. is consumed by rotation. This e.m.f. is in phase with the flux through which the coil rotates—that is, the flux parallel to the plane of the coil—and proportional to the speed—

that is, the frequency of rotation—while the e.m.f. of alternation is 90° ahead of the flux alternating through the coil—that is, the flux parallel to the axis of the coil—and proportional to the frequency. If, therefore, Z' is the impedance corresponding to the former flux, the e.m.f. of rotation is $-jSZ'I$, where S is the ratio of frequency of rotation to frequency of alternation, or the speed expressed in fractions of synchronous speed. The total e.m.f. consumed in the circuit is thus:

$$E = Z_0 I + Z I - jSZ' I. \quad (2)$$

Applying now these considerations to the alternating-current motor, we assume all circuits reduced to the same number of turns—that is, selecting one circuit, of n effective turns, as starting point, if n_i = number of effective turns of any other circuit, all the e.m.f.s. of the latter circuit are divided, the currents multiplied with the ratio, $\frac{n_i}{n}$, the impedances divided, the admittances multiplied with $(\frac{n_i}{n})^2$. This reduction of the constants of all circuits to the same number of effective turns is convenient by eliminating constant factors from the equations, and so permitting a direct comparison.

When speaking, therefore, in the following of the impedance, etc., of the different circuits, we always refer to their reduced values, as it is customary in induction-motor designing practice, and has been done in preceding theoretical investigations.

173. Let, then, in Fig. 147:

E_0, I_0, Z_0 = impressed voltage, current and self-inductive impedance respectively of a stationary circuit,

E_1, I_1, Z_1 = impressed voltage, current and self-inductive impedance

respectively of a rotating circuit,

τ = space angle between the axes of the two circuits,

Z = mutual inductive, or exciting impedance in the direction of the axis of the stationary coil,

Z' = mutual inductive, or exciting impedance in the direction of the axis of the rotating coil,

Z'' = mutual inductive or exciting impedance in the direction at right angles to the axis of the rotating coil,

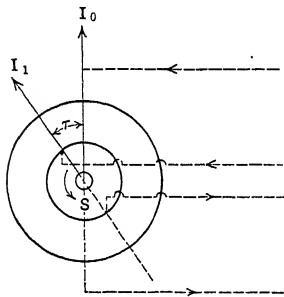

FIG. 147.

S = speed, as fraction of synchronism, that is, ratio of frequency of rotation to frequency of alternation.

It is then:

E.m.f. consumed by self-inductive impedance, $Z_0 I_0$.

E.m.f. consumed by mutual-inductive impedance, $Z (I_0 + I_1 \cos \tau)$ since the m.m.f. acting in the direction of the axis of the stationary coil is the resultant of both currents. Hence:

$$E_0 = Z_0 I_0 + Z (I_0 + I_1 \cos \tau). \quad (3)$$

In the rotating circuit, it is:

E.m.f. consumed by self-inductive impedance, $Z_1 I_1$.

E.m.f. consumed by mutual-inductive impedance or "e.m.f. of alternation": $Z' (I_1 + I_0 \cos \tau)$. (4)

E.m.f. of rotation, $-jSZ'' I_0 \sin \tau$. (5)

Hence the impressed e.m.f.:

$$E_1 = Z_1 I_1 + Z' (I_1 + I_0 \cos \tau) - jSZ'' I_0 \sin \tau. \quad (6)$$

In a structure with uniformly distributed winding, as used in induction motors, etc., $Z' = Z'' = Z$, that is, the exciting impedance is the same in all directions.

Z is the reciprocal of the "exciting admittance," Y of the induction-motor theory.

In the most general case, of a motor containing n circuits, of which some are revolving, some stationary, if:

E_k, I_k, Z_k = impressed e.m.f., current and self-inductive impedance respectively of any circuit, k .

Z^i , and Z^{ii} = exciting impedance parallel and at right angles respectively to the axis of a circuit, i ,

τ_k^i = space angle between the axes of coils k and i , and

S = speed, as fraction of synchronism, or "frequency of rotation."

It is then, in a coil, i :

$$E_i = Z_i I_i + Z^i \sum_1^n I_k \cos \tau_k^i - jSZ^{ii} \sum_1^n I_k \sin \tau_k^i, \quad (7)$$

where:

$$Z_i I_i = \text{e.m.f. of self-inductive impedance}; \quad (8)$$

$$Z^i \sum_1^n I_k \cos \tau_k^i = \text{e.m.f. of alternation}; \quad (9)$$

$$E'_i = -jSZ^{ii} \sum_1^n I_k \sin \tau_k^i = \text{e.m.f. of rotation}; \quad (10)$$

which latter = 0 in a stationary coil, in which $S = 0$.

The power output of the motor is the sum of the powers of all the e.m.fs. of rotation, hence, in vector denotation:

$$\begin{aligned} P &= \sum_1^n [E'_i, I_i]^1 \\ &= -S \sum_1^n [jZ^{ii} \sum_1^n I_k \sin \tau_k^i, I_i]^1, \end{aligned} \quad (11)$$

and herefrom the torque, in synchronous watts:

$$D = \frac{P}{S} = - \sum_1^n [jZ^{ii} \sum_1^n I_k \sin \tau_k^i, I_i]^1. \quad (12)$$

The power input, in vector denotation, is:

$$\left. \begin{aligned} P_0 &= \sum_1^n [E_i, I_i] \\ &= \sum_1^n [E_i, I_i]^1 + \sum_1^n [E_i, I_i]^j \\ &= P_0^1 + jP_0^j; \end{aligned} \right\} \quad (13)$$

and therefore:

$$\begin{aligned} P_0^1 &= \text{true power input;} \\ P_0^j &= \text{wattless volt-ampere input;} \\ Q &= \sqrt{P_0^1{}^2 + P_0^j{}^2} = \text{apparent, or volt-ampere} \\ &\quad \text{input;} \\ \frac{P}{P_0^1} &= \text{efficiency;} \\ \frac{P}{Q} &= \text{apparent efficiency;} \\ \frac{D}{P_0^1} &= \text{torque efficiency;} \\ \frac{D}{Q} &= \text{apparent torque efficiency;} \\ \frac{P_0^1}{Q} &= \text{power-factor.} \end{aligned}$$

From the n circuits, $i = 1, 2, \dots, n$, thus result n linear equations, with $2n$ complex variables, I_i and E_i .

Hence n further conditions must be given to determine the variables. These obviously are the conditions of operation of the n circuits.

Impressed e.m.fs. E_i may be given.

Or circuits closed upon themselves $E_i = 0$.

Or circuits connected in parallel $c_i E_i = c_k E_k$, where c_i and c_k

are the reduction factors of the circuits to equal number of effective turns, as discussed before.

Or circuits connected in series: $\frac{\dot{I}_i}{c_i} = \frac{\dot{I}_k}{c_k}$, etc.

When a rotating circuit is connected through a commutator, the frequency of the current in this circuit obviously is the same as the impressed frequency. Where, however, a rotating circuit is permanently closed upon itself, its frequency may differ from the impressed frequency, as, for instance, in the polyphase induction motor it is the frequency of slip, $s = 1 - S$, and the self-inductive reactance of the circuit, therefore, is $s\omega$; though in its reaction upon the stationary system the rotating system necessarily is always of full frequency.

As an illustration of this method, its application to the theory of some motor types shall be considered, especially such motors as have either found an extended industrial application, or have at least been seriously considered.

1. POLYPHASE INDUCTION MOTOR

174. In the polyphase induction motor a number of primary circuits, displaced in position from each other, are excited by polyphase e.m.fs. displaced in phase from each other by a phase angle equal to the position angle of the coils. A number of secondary circuits are closed upon themselves. The primary usually is the stator, the secondary the rotor.

In this case the secondary system always offers a resultant closed circuit in the direction of the axis of each primary coil, irrespective of its position.

Let us assume two primary circuits in quadrature as simplest form, and the secondary system reduced to the same number of phases and the same number of turns per phase as the primary system. With three or more primary phases the method of procedure and the resultant equations are essentially the same.

Let, in the motor shown diagrammatically in Fig. 148:

E_0 and $-jE_0$, I_0 and $-jI_0$, $Z_0 =$ impressed e.m.f., currents and self-inductive impedance respectively of the primary system.

0 , I_1 and $-jI_1$, $Z_1 =$ impressed e.m.f., currents and self-inductive impedance respectively of the secondary system, reduced to the primary. $Z =$ mutual-inductive impedance between primary and secondary, constant in all directions.

$S = \text{speed}$; $s = 1 - S = \text{slip}$, as fraction of synchronism.
The equation of the primary circuit is then, by (7):

$$E_0 = Z_0 I_0 + Z(I_0 - I_1). \quad (14)$$

The equation of the secondary circuit:

$$0 = Z_1 I_1 + Z(I_1 - I_0) + jSZ(jI_1 - jI_0), \quad (15)$$

from (15) follows:

$$I_1 = I_0 \frac{Z_0(1-S)}{Z(1-S) + Z_1} = I_0 \frac{Zs}{Zs + Z_1}; \quad (16)$$

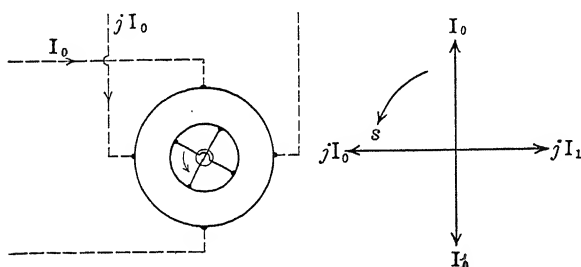

FIG. 14S.

and, substituted in (14):

Primary current:

$$I_0 = E_0 \frac{Zs + Z_1}{ZZ_0s + ZZ_1 + Z_0Z_1} \quad (17)$$

Secondary current:

$$I_1 = E_0 \frac{Zs}{ZZ_0s + ZZ_1 + Z_0Z_1} \quad (18)$$

Exciting current:

$$I_{00} = I_0 - I_1 = E_0 \frac{Z_1}{ZZ_0s + ZZ_1 + Z_0Z_1} \quad (19)$$

E.m.f. of rotation:

$$\begin{aligned} E' &= jSZ(jI_1 - jI_0) = SZ(I_0 - I_1). \\ &= SE_0 \frac{ZZ_1}{ZZ_0s + ZZ_1 + Z_0Z_1} \\ &= (1-s) E_0 \frac{ZZ_1}{ZZ_0s + ZZ_1 + Z_0Z_1} \end{aligned} \quad (20)$$

It is, at synchronism; $s = 0$:

$$\begin{aligned} I_0 &= \frac{\dot{E}_0}{Z + Z_0}; \\ I_1 &= 0; \\ I_{00} &= I_0; \\ E' &= \frac{\dot{E}_0 Z}{Z + Z_0} = \frac{\dot{E}_0}{1 + \frac{Z_0}{Z}}. \end{aligned}$$

At standstill:

$$\begin{aligned} s &= 1; \\ I_0 &= \frac{\dot{E}_0 (Z + Z_1)}{ZZ_0 + ZZ_1 + Z_0 Z_1}; \\ I_1 &= \frac{\dot{E}_0 Z}{ZZ_0 + ZZ_1 + Z_0 Z_1}; \\ I_{00} &= \frac{E_0 Z_1}{ZZ_0 + ZZ_1 + Z_0 Z_1}; \\ E' &= 0. \end{aligned}$$

Introducing as parameter the counter e.m.f., or e.m.f. of mutual induction:

$$E = E_0 - Z_0 I_0, \quad (21)$$

or:

$$E_0 = E + Z_0 I_0, \quad (22)$$

it is, substituted:

Counter e.m.f.:

$$E = E_0 \frac{ZZ_1}{ZZ_0 s + ZZ_1 + Z_0 Z_1}; \quad (23)$$

hence:

Primary impressed e.m.f.:

$$E_0 = E \frac{ZZ_0 s + Z_1 + ZZ_0 Z_1}{ZZ_1}, \quad (24)$$

E.m.f. of rotation:

$$E' = ES = E(1 - s). \quad (25)$$

Secondary current

$$I_1 = \frac{Es}{Z_1}. \quad (26)$$

Primary current:

$$I_0 = E \frac{Z_s + Z_1}{ZZ_1} = \frac{\dot{E}s}{Z_1} + \frac{\dot{E}}{Z} \quad (27)$$

Exciting current:

$$I_{00} = \frac{\dot{E}}{Z} = EY. \quad (28)$$

These are the equations from which the transformer theory of the polyphase induction motor starts.

175. Since the frequency of the secondary currents is the frequency of slip, hence varies with the speed, $S = 1 - s$, the secondary self-inductive reactance also varies with the speed, and so the impedance:

$$Z_1 = r_1 + j s x_1. \quad (29)$$

The power output of the motor, per circuit, is

$$\begin{aligned} P &= [E', I_1] \\ &= \frac{e_0^2 z^2 s (1 - s)}{[ZZ_{0s} + ZZ_1 + Z_0 Z_1]^2} (r_1 - j s x_1), \end{aligned} \quad (30)$$

where the brackets [] denote the absolute value of the term included by it, and the small letters, e_0 , z , etc., the absolute values of the vectors, E_0 , Z , etc.

Since the imaginary term of power seems to have no physical meaning, it is:

Mechanical power output:

$$P = \frac{e_0^2 z^2 s (1 - s) r_1}{[ZZ_{0s} + ZZ_1 + Z_0 Z_1]^2}. \quad (31)$$

This is the power output at the armature conductors, hence includes friction and windage.

The torque of the motor is:

$$\begin{aligned} D &= \frac{P}{1 - s} \\ &= \frac{e_0^2 z^2 r_1 s}{[ZZ_{0s} + ZZ_1 + Z_0 Z_1]^2} - j \frac{e_0^2 z^2 x_1 s^2}{[ZZ_{0s} + ZZ_1 + Z_0 Z_1]^2}. \end{aligned} \quad (32)$$

The imaginary component of torque seems to represent the radial force or thrust acting between stator and rotor. Omitting this we have:

$$D = \frac{e_0^2 z^2 r_1 s}{[ZZ_{0s} + ZZ_1 + Z_0 Z_1]^2}. \quad (33)$$

The power input of the motor per circuit is:

$$\begin{aligned} P_0 &= [E_0, I_0] \\ &= e_0^2 \left[1, \frac{Z_s + Z_1}{ZZ_0s + ZZ_1 + Z_0Z_1} \right] \\ &= P'_0 - jP_0j \end{aligned} \quad (34)$$

where:

$$\begin{aligned} P'_0 &= \text{true power,} \\ P_0j &= \text{reactive or "wattless power,"} \\ Q &= \sqrt{P'^2_0 + P_0j^2} = \text{volt-ampere input.} \end{aligned}$$

Herefrom follows power-factor, efficiency, etc.

Introducing the parameter: E , or absolute e , we have:

Power output:

$$\begin{aligned} P &= [E', I_1] \\ &= \left[eS, \frac{eS}{Z_1} \right] \\ &= e^2sS \left[1, \frac{1}{Z_1} \right] \\ &= \frac{e^2sSr_1}{z_1^2} - j \frac{e^2s^2Sx_1}{z_1^2} \\ &= \frac{i_1^2Sr_1}{s} - ji_1^2Sx_1. \end{aligned} \quad (35)$$

Power input:

$$\begin{aligned} P_0 &= [E_0, I_0] \\ &= e^2 \left[\frac{ZZ_0s + ZZ_1 + Z_0Z_1}{ZZ_1}, \frac{Z_s + Z_1}{ZZ_1} \right] \\ &= e^2 \left[\frac{Z_0(Z_s + Z_1)}{ZZ_1} + 1, \frac{Z_s + Z_1}{ZZ_1} \right] \\ &= e^2 \left[\frac{Z_s + Z_1}{ZZ_1} \right]^2 \left\{ [Z_01 [+ e^2] 1, \frac{s}{Z_1} + \frac{1}{Z}] \right\} \\ &= e^2 \left[\frac{Z_s + Z_1}{ZZ_1} \right]^2 \left\{ [Z_0, 1] + \frac{e^2s}{z_0^2z_1^2} [Z_1, 1] + \frac{e^2}{z^2} [Z, 1] \right\} \\ &= e^2 \left[\frac{Z_s + Z_1}{ZZ_1} \right]^2 \left\{ (r_0 - jx_0) + \frac{e^2s}{z_1^2} (r_1 - jsx_1) + \frac{e^2}{z^2} (r - jx) \right\} \\ &= i_0^2 (r_0 - jx_0) + i_1^2 \left(\frac{r_1}{s} - jx_1 \right) + i_{00}^2 (r - jx). \end{aligned} \quad (36)$$

And since:

$$\frac{r_1}{s} = \frac{S + s}{s} r_1 = \frac{sSr_1}{s} + r_1,$$

and:

$$\frac{i_1^2 S r_1}{s} = P,$$

it is:

$$P_0 = (i_0^2 r_0 + i_1^2 r_1 + i_{00}^2 r + P) - j (i_0^2 x_0 + i_1^2 x_1 + i_{00}^2 x). \quad (37)$$

Where:

- $i_0^2 r_0$ = primary resistance loss,
- $i_1^2 r_1$ = secondary resistance loss,
- $i_{00}^2 r$ = core loss (and eddy-current loss),
- P = output,
- $i_0^2 x_0$ = primary reactive volt-amperes,
- $i_1^2 x_1$ = secondary reactive volt-amperes,
- $i_{00}^2 x$ = magnetizing volt-amperes.

176. Introducing into the equations, (16), (17), (18), (19), (23) the terms:

$$\left. \begin{aligned} \frac{Z_0}{Z} &= \lambda_0, \\ \frac{Z_1}{Z} &= \lambda_1. \end{aligned} \right\} \quad (38)$$

Where λ_0 and λ_1 are small quantities, and $\lambda = \lambda_0 + \lambda_1$ is the "characteristic constant" of the induction motor theory, it is:

Primary current:

$$I_0 = \frac{\dot{E}_0}{Z} \frac{s + \lambda_1}{s\lambda_0 + \lambda_1 + \lambda_0\lambda_1} = \frac{\dot{E}_0}{Z} \frac{s + \lambda_1}{s\lambda_0 + \lambda_1}. \quad (39)$$

Secondary current:

$$I_1 = \frac{\dot{E}_0}{Z} \frac{s}{s\lambda_0 + \lambda_1 + \lambda_0\lambda_1} = \frac{\dot{E}_0}{Z} \frac{s}{s\lambda_0 + \lambda_1}. \quad (40)$$

Exciting current:

$$I_{00} = \frac{\dot{E}_0}{Z} \frac{\lambda_1}{s\lambda_0 + \lambda_1 + \lambda_0\lambda_1} = \frac{\dot{E}_0}{Z} \frac{\lambda_1}{s\lambda_0 + \lambda_1}. \quad (41)$$

E.m.f. of rotation:

$$E' = E_0 S \frac{\lambda_1}{s\lambda_0 + \lambda_1 + \lambda_0\lambda_1} = E_0 S \frac{\lambda_1}{s\lambda_0 + \lambda_1}. \quad (42)$$

Counter e.m.f.:

$$E = E_0 \frac{\lambda_1}{s\lambda_0 + \lambda_1 + \lambda_0\lambda_1} = E_0 \frac{\lambda_1}{s\lambda_0 + \lambda_1}. \quad (43)$$

177. As an example are shown, in Fig. 149, with the speed as abscissæ, the curves of a polyphase induction motor of the constants:

$$e_0 = 320 \text{ volts,}$$

$$Z = 1 + 10j \text{ ohms,}$$

$$Z_0 = Z_1 = 0.1 + 0.3j \text{ ohms;}$$

hence:

$$\lambda_0 = \lambda_1 = 0.0307 - 0.0069j.$$

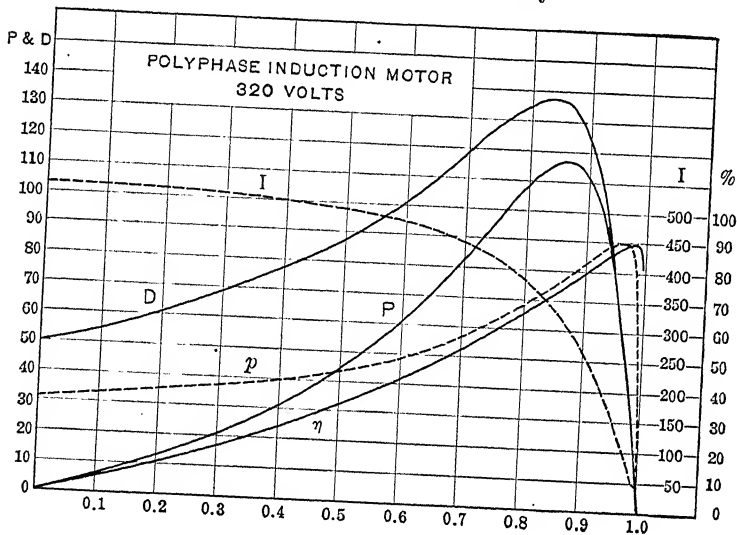

Fig. 149.

It is:

$$I_0 = \frac{320\{10.30s - (s + 0.1)j\}}{(1.03 + 1.63s) - j(0.11 - 5.99s)} \text{ amp.}$$

$$D = \frac{2048(1-s)}{(1.03 + 1.63s)^2 + (0.11 - 5.99s)^2} \text{ synchronous kw.}$$

$$P = (1-s)D$$

$$\tan \theta'' = \frac{0.11 - 5.99s}{1.03 + 1.63s}$$

$$\tan \theta' = \frac{s + 0.1}{10.3s}$$

$$\cos(\theta' - \theta'') = \text{power-factor.}$$

Fig. 149 gives, with the speed S as abscissæ: the current, I ; the power output, P ; the torque, D ; the power-factor, p ; the efficiency, η .

The curves show the well-known characteristics of the poly-phase induction motor: approximate constancy of speed at all loads, and good efficiency and power-factor within this narrow-speed range, but poor constants at all other speeds.

1. SINGLE-PHASE INDUCTION MOTOR

178. In the single-phase induction motor one primary circuit acts upon a system of closed secondary circuits which are displaced from each other in position on the secondary member.

Let the secondary be assumed as two-phase, that is, containing or reduced to two circuits closed upon themselves at right angles

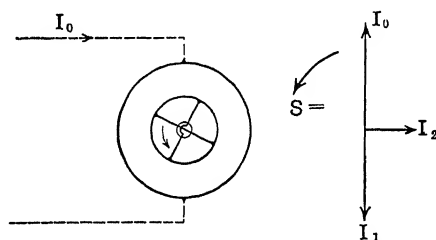

FIG. 150.—Single-phase induction motor.

to each other. While it then offers a resultant closed secondary circuit to the primary circuit in any position, the electrical disposition of the secondary is not symmetrical, but the directions parallel with the primary circuit and at right angles thereto are to be distinguished. The former may be called the secondary energy circuit, the latter the secondary magnetizing circuit, since in the former direction power is transferred from the primary to the secondary circuit, while in the latter direction the secondary circuit can act magnetizing only.

Let, in the diagram Fig. 150:

\mathcal{E}_0 , I_0 , Z_0 = impressed e.m.f., current and self-inductive impedance, respectively, of the primary circuit,

I_1 , Z_1 = current and self-inductive impedance, respectively, of the secondary energy circuit,

I_2 , Z_1 = current and self-inductive impedance, respectively, of the secondary magnetizing circuit,

Z = mutual-inductive impedance,

S = speed,

and let $s_0 = 1 - S^2$ (where s_0 is not the slip).

It is then, by equation (7):

Primary circuit:

$$E_0 = Z_0 I_0 + Z (I_0 - I_1). \quad (44)$$

Secondary energy circuit:

$$0 = Z_1 I_1 + Z (I_1 - I_0) - jSZI_2. \quad (45)$$

Secondary magnetizing circuit:

$$0 = Z_1 I_2 + Z I_2 - jSZ (I_0 - I_1); \quad (46)$$

hence, from (45) and (46):

$$I_1 = I_0 \frac{Z (Z_{s_0} + Z_1)}{Z^2_{s_0} + 2ZZ_1 + Z_1^2}, \quad (47)$$

$$I_2 = + jSI_0 \frac{ZZ_1}{Z^2_{s_0} + 2ZZ_1 + Z_1^2} \quad (48)$$

and, substituted in (44):

Primary current:

$$I_0 = E_0 \frac{Z^2_{s_0} + 2ZZ_1 + Z_1^2}{K}. \quad (49)$$

Secondary energy current:

$$I_1 = E_0 \frac{Z (Z_{s_0} + Z_1)}{K}. \quad (50)$$

Secondary magnetizing current:

$$I_2 = + jSE_0 \frac{ZZ_1}{K}. \quad (51)$$

E.m.f. of rotation of secondary energy circuit:

$$E_1 = - jSZI_2 = S^2 E_0 \frac{ZZ_1}{K}. \quad (52)$$

E.m.f. of rotation of secondary magnetizing circuit:

$$E'_2 = - jSZ (I_0 - I_1) = - jSE_0 \frac{ZZ_1 (Z + Z_1)}{K}; \quad (53)$$

where:

$$K = Z_0 (Z^2_{s_0} + 2ZZ_1 + Z_1^2) + ZZ_1 (Z + Z_1). \quad (54)$$

It is, at synchronism, $S = 1$, $s_0 = 0$:

$$I_0 = E_0 \frac{2Z + Z_1}{Z_0 (2Z + Z_1) + Z (Z + Z_1)};$$

$$I_1 = E_0 \frac{Z}{Z_0 (2Z + Z_1) + Z (Z + Z_1)};$$

$$I_2 = + jE_0 \frac{Z}{Z_0 (2Z + Z_1) + Z (Z + Z_1)}.$$

Hence, at synchronism, the secondary current of the single-phase induction motor does not become zero, as in the polyphase motor, but both components of secondary current become equal.

At standstill, $S = 0$, $s_0 = 1$, it is:

$$I_0 = E_0 \frac{Z + Z_1}{ZZ_0 + ZZ_1 + Z_0Z_1};$$

$$I_1 = E_0 \frac{Z}{ZZ_0 + ZZ_1 + Z_0Z_1};$$

$$I_2 = 0.$$

That is, primary and secondary current corresponding thereto have the same values as in the polyphase induction motor, as was to be expected.

179. Introducing as parameter the counter e.m.f., or e.m.f. of mutual induction:

$$E = E_0 - Z_0I_0,$$

and substituting for I_0 from (49), it is:

Primary impressed e.m.f.:

$$E_0 = E \frac{Z_0(Z^2s_0 + 2ZZ_1 + Z_1^2) + ZZ_1(Z + Z_1)}{ZZ_1(Z + Z_1)}. \quad (55)$$

Primary current:

$$I_0 = E \frac{Z^2s_0 + 2ZZ_1 + Z_1^2}{ZZ_1(Z + Z_1)}. \quad (56)$$

Secondary energy circuit:

$$I_1 = E \frac{Zs_0 + Z_1}{Z_1(Z + Z_1)} = \frac{s_0\dot{E}}{Z_1} + \frac{S^2\dot{E}}{Z + Z_1}. \quad (57)$$

$$E'_1 = S^2E \frac{Z}{Z + Z_1}. \quad (58)$$

Secondary magnetizing circuit:

$$I_2 = +j \frac{S\dot{E}}{Z + Z_1}. \quad (59)$$

$$E'_2 = jSE. \quad (60)$$

And:

$$I_0 - I_1 = \frac{\dot{E}}{Z}. \quad (61)$$

These equations differ from the equations of the polyphase induction motor by containing the term $s_0 = (1 - S^2)$, instead of $s = (1 - S)$, and by the appearance of the terms, $\frac{S\dot{E}}{Z + Z_1}$ and $\frac{S^2\dot{E}}{Z + Z_1}$, of frequency $(1 + S)$, in the secondary circuit.

The power output of the motor is:

$$\begin{aligned} P &= [E_1, I_1] + [E_2, I_2] \\ &= \frac{S^2 e_0^2 z^2}{[K]^2} \{ [ZZ_1, Z_{s_0} + Z_1] - [Z_1(Z + Z_1), Z_1] \} \\ &= \frac{S^2 e_0^2 z^2 r_1 (s_0 z^2 - z_1^2)}{[K]^2}, \end{aligned} \quad (62)$$

and the torque, in synchronous watts:

$$D = \frac{P}{S} = \frac{S e_0^2 z^2 r_1 (s_0 z^2 - z_1^2)}{[K]^2}. \quad (63)$$

From these equations it follows that at synchronism torque and power of the single-phase induction motor are already negative.

Torque and power become zero for:

$$s_0 z^2 - z_1^2 = 0,$$

hence:

$$S = \sqrt{1 - \left(\frac{z_1}{z}\right)^2}, \quad (64)$$

that is, very slightly below synchronism.

Let $z = 10$, $z_1 = 0.316$, it is, $S = 0.9995$.

In the single-phase induction motor, the torque contains the speed S as factor, and thus becomes zero at standstill.

Neglecting quantities of secondary order, it is, approximately:

$$I_0 = E_0 \frac{Z_{s_0} + 2Z_1}{Z(Z_{0s_0} + Z_1) + 2Z_0Z_1}, \quad (65)$$

$$I_1 = E_0 \frac{Z_{s_0} + Z_1}{Z(Z_{0s_0} + Z_1) + 2Z_0Z_1}, \quad (66)$$

$$I_2 = +jSE_0 \frac{Z_1}{Z(Z_{0s_0} + Z_1) + 2Z_0Z_1}, \quad (67)$$

$$E_1 = S^2 E_0 \frac{ZZ_1}{Z(Z_{0s_0} + Z_1) + 2Z_0Z_1}, \quad (68)$$

$$E_2 = -jSE_0 \frac{ZZ_1}{Z(Z_{0s_0} + Z_1) + 2Z_0Z_1}, \quad (69)$$

$$P = \frac{S^2 e_0^2 z^2 r_1 s_0}{[Z(Z_{0s_0} + Z_1) + 2Z_0Z_1]^2}, \quad (70)$$

$$D = \frac{S e_0^2 z^2 r_1 s_0}{[Z(Z_{0s_0} + Z_1) + 2Z_0Z_1]^2}. \quad (71)$$

This theory of the single-phase induction motor differs from that based on the transformer feature of the motor, in that it represents more exactly the phenomena taking place at inter-

mediate speeds, which are only approximated by the transformer theory of the single-phase induction motor.

For studying the action of the motor at intermediate and at low speed, as for instance, when investigating the performance of a starting device, in bringing the motor up to speed, that is, during acceleration, this method so is more suited. An application to the "condenser motor," that is, a single-phase induction motor using a condenser in a stationary tertiary circuit (under an angle, usually 60° , with the primary circuit) is given in the paper on "Alternating-Current Motors," A. I. E. E. *Transactions*, 1904.

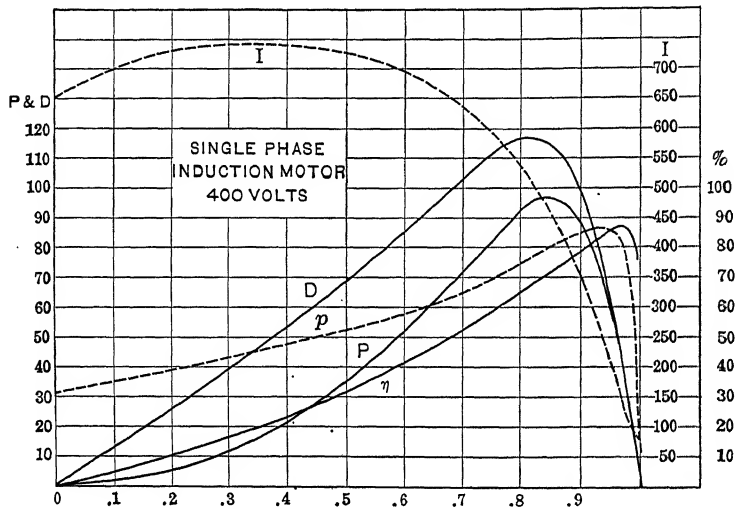

FIG. 151.

180. As example are shown, in Fig. 151, with the speed as abscissæ, the curves of a single-phase induction motor, having the constants:

$$e_0 = 400 \text{ volts,}$$

$$Z = 1 + 10j \text{ ohms,}$$

and:

$$Z_0 = Z_1 = 0.1 + 0.3j \text{ ohms;}$$

hence:

$$I_0 = 400 \frac{N}{K} \text{ amp. ;}$$

$$N = (s_0 + 0.2) + j(10s_0 + 0.6 - 0.6S);$$

$$K = (0.1 + 0.3j)N + (1 + 10j)(0.1 + j)(0.3 - 0.3S);$$

$$D = \frac{1616 S s_0}{[K]^2} \text{ synchronous kw.}$$

Fig. 151 gives, with the speed, S , as abscissæ: the current, I_0 , the power output, P , the torque, D , the power-factor, p , the efficiency, η .

3. POLYPHASE SHUNT MOTOR

181. Since the characteristics of the polyphase motor do not depend upon the number of phases, here, as in the preceding, a two-phase system may be assumed: a two-phase stator winding acting upon a two-phase rotor winding, that is, a closed-coil rotor winding connected to the commutator in the same manner as in direct-current machines, but with two sets of brushes in quadrature position excited by a two-phase system of the same frequency. Mechanically the three-phase system here has the advantage of requiring only three sets of brushes instead of four

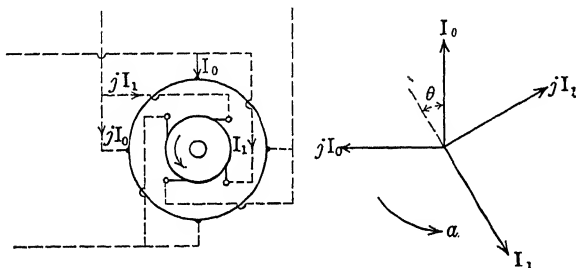

FIG. 152.

as with the two-phase system, but otherwise the general form of the equations and conclusions are not different.

Let \mathcal{E}_0 and $-j\mathcal{E}_0$ = e.m.fs. impressed upon the stator, \mathcal{E}_1 and $-j\mathcal{E}_1$ = e.m.fs. impressed upon the rotor, θ_0 = phase angle between e.m.f., \mathcal{E}_0 and \mathcal{E}_1 , and θ_1 = position angle between the stator and rotor circuits. The e.m.fs., \mathcal{E}_0 and $-j\mathcal{E}_0$, produce the same rotating e.m.f. as two e.m.fs. of equal intensity, but displaced in phase and in position by angle θ_0 from \mathcal{E}_0 and $j\mathcal{E}_0$, and instead of considering a displacement of phase, θ_0 , and a displacement of position, θ_1 , between stator and rotor circuits, we can, therefore, assume zero-phase displacement and displacement in position by angle $\theta_0 + \theta_1 = \theta$. Phase displacement between stator and rotor e.m.fs. is, therefore, equivalent to a shift of brushes, hence gives no additional feature beyond those produced by a shift of the commutator brushes.

Without losing in generality of the problem, we can, therefore, assume the stator e.m.fs. in phase with the rotor e.m.fs., and the polyphase shunt motor can thus be represented diagrammatically by Fig. 152.

182. Let, in the polyphase shunt motor, shown two-phase in diagram, Fig. 152:

E_0 and $-jE_0$, I_0 and $-jI_0$, Z_0 = impressed e.m.fs., currents and self-inductive impedance respectively of the stator circuits,

cE_0 and $-jcE_0$, I_1 and $-jI_1$, Z_1 = impressed e.m.fs., currents and self-inductive impedance respectively of the rotor circuits, reduced to the stator circuits by the ratio of effective turns, c ,

Z = mutual-inductive impedance,

S = speed; hence $s = 1 - S$ = slip,

θ = position angle between stator and rotor circuits, or "brush angle."

It is then:

Stator:

$$E_0 = Z_0 I_0 + Z(I_0 - I_1 \cos \theta - jI_1 \sin \theta). \quad (72)$$

Rotor:

$$cE_0 = Z_1 I_1 + Z(I_1 - I_0 \cos \theta + jI_0 \sin \theta) - jSZ(-jI_1 + I_0 \sin \theta + jI_0 \cos \theta). \quad (73)$$

Substituting:

$$\left. \begin{aligned} \sigma &= \cos \theta - j \sin \theta, \\ \delta &= \cos \theta + j \sin \theta, \end{aligned} \right\} \quad (74)$$

it is:

$$\sigma \delta = 1, \quad (75)$$

and:

$$E_0 = Z_0 I_0 + Z(I_0 - \delta I_1), \quad (76)$$

$$\begin{aligned} cE_0 &= Z_1 I_1 + Z(I_1 - \sigma I_0) + jSZ(jI_1 - j\sigma I_0) \\ &= Z_1 I_1 + sZ(I_1 - \sigma I_0). \end{aligned} \quad (77)$$

Herefrom follows:

$$I_0 = E_0 \frac{(s + \delta c)Z + Z_1}{sZZ_0 + ZZ_1 + Z_0Z_1}, \quad (78)$$

$$I_1 = E_0 \frac{(\sigma s + c)Z + cZ_1}{sZZ_0 + ZZ_1 + Z_0Z_1}, \quad (79)$$

for $c = 0$, this gives:

$$I_0 = E_0 \frac{sZ + Z_1}{sZZ_0 + ZZ_1 + Z_0Z_1},$$

$$I_1 = \sigma E_0 \frac{sZ}{sZZ_0 + ZZ_1 + Z_0Z_1},$$

that is, the polyphase induction-motor equations, $\sigma = \cos \theta + j \sin \theta = 1^{\frac{\theta}{\pi}}$ representing the displacement of position between stator and rotor currents.

This shows the polyphase induction motor as a special case of the polyphase shunt motor, for $c = o$.

The e.m.fs. of rotation are:

$$\begin{aligned} E'_1 &= -jSZ(-jI_1 + I_0 \sin \theta + jI_0 \cos \theta) \\ &= SZ(\sigma I_0 - I_1); \end{aligned}$$

hence:

$$E'_1 = SE_0 \frac{Z(\sigma Z_1 - cZ_0)}{sZZ_0 + ZZ_1 + Z_0Z_1} \quad (80)$$

The power output of the motor is:

$$\begin{aligned} P &= [E_1, I_1] \\ &= \frac{Se_0^2}{[sZZ_0 + ZZ_1 + Z_0Z_1]^2} [(\sigma Z_1 - cZ_0)Z, (\sigma s + c)Z + cZ_0], \quad (81) \end{aligned}$$

which, suppressing terms of secondary order, gives:

$$P = \frac{Se_0^2 z^2 \{s(r_1 + c(x_0 \sin \theta - r_0 \cos \theta)) + c(r_1 \cos \theta + x_1 \sin \theta - cr_0)\}}{[sZZ_0 + ZZ_1 + Z_0Z_1]^2}, \quad (82)$$

for $Sc = o$, this gives:

$$P = \frac{Se_0^2 z^2 sr_1}{[sZZ_0 + ZZ_1 + Z_0Z_1]^2}$$

the same value as for the polyphase induction motor.

In general, the power output, as given by equation (82), becomes zero:

$$P = o,$$

for the slip

$$s_0 = -c \frac{r_1 \cos \theta + x_1 \sin \theta - cr_0}{r_1 + c(x_0 \sin \theta - r_0 \cos \theta)} \quad (83)$$

183. It follows herefrom, that the speed of the polyphase shunt motor is limited to a definite value, just as that of a direct-current shunt motor, or alternating-current induction motor. In other words, the polyphase shunt motor is a constant-speed motor, approaching with decreasing load, and reaching at no-load a definite speed:

$$S_0 = 1 - s_0. \quad (84)$$

The no-load speed, S_0 , of the polyphase shunt motor is, however, in general not synchronous speed, as that of the induction

motor, but depends upon the brush angle, θ , and the ratio, c , of rotor \div stator impressed voltage.

At this no-load speed, S_0 , the armature current, I_1 , of the polyphase shunt motor is in general not equal to zero, as it is in the polyphase induction motor.

Two cases are therefore of special interest:

1. Armature current, $I_1 = 0$, at no-load, that is, at slip, s_0 .
2. No-load speed equals synchronism, $s_0 = 0$.

1. The armature or rotor current (79):

$$I_1 = E_0 \frac{\sigma s Z + c(Z + Z_1)}{s Z Z_0 + Z Z_1 + Z_0 Z_1},$$

becomes zero, if:

$$c = -\sigma s \frac{Z}{Z + Z_1},$$

or, since Z_1 is small compared with Z , approximately:

$$c = -\sigma s = -s (\cos \theta - j \sin \theta);$$

hence, resolved:

$$\begin{aligned} c &= -s \cos \theta, \\ 0 &= s \sin \theta; \end{aligned}$$

hence:

$$\left. \begin{aligned} \theta &= 0, \\ c &= -s. \end{aligned} \right\} \quad (85)$$

That is, the rotor current can become zero only if the brushes are set in line with the stator circuit or without shift, and in this case the rotor current, and therewith the output of the motor, becomes zero at the slip, $s = -c$.

Hence such a motor gives a characteristic curve very similar to that of the polyphase induction motor, except that the stator tends not toward synchronism but toward a definite speed equal to $(1 + c)$ times synchronism.

The speed of such a polyphase motor with commutator can, therefore, be varied from synchronism by the insertion of an e.m.f. in the rotor circuit, and the percentage of variation is the same as the ratio of the impressed rotor e.m.f. to the impressed stator e.m.f. A rotor e.m.f., in opposition to the stator e.m.f. reduces, in phase with the stator e.m.f., increases the free-run speed of the motor. In the former case the rotor impressed e.m.f. is in opposition to the rotor current, that is, the rotor returns power to the system in the proportion in which the speed

is reduced, and the speed variation, therefore, occurs without loss of efficiency, and is similar in its character to the speed control of a direct-current shunt motor by varying the ratio between the e.m.f. impressed upon the armature and that impressed upon the field.

Substituting in the equations:

$$\left. \begin{aligned} \theta &= 0, \\ s + c &= s_1 \end{aligned} \right\} \quad (86)$$

it is:

$$I_0 = E_0 \frac{s_1 Z + Z_1}{sZZ_0 + ZZ_1 + Z_0Z_1}, \quad (87)$$

$$I_1 = E_0 \frac{s_1 Z}{sZZ_0 + ZZ_1 + Z_0Z_1}, \quad (88)$$

$$P = \frac{S e_0^2 z^2 s_1 (r_1 - cr_0)}{[sZZ_0 + ZZ_1 + Z_0Z_1]^2}. \quad (89)$$

These equations of I_0 and I_1 are the same as the polyphase induction-motor equations, except that the slip from synchronism, s , of the induction motor, is, in the numerator, replaced by the slip from the no-load speed, s_1 .

Insertion of voltages into the armature of an induction motor in phase with the primary impressed voltages, and by a commutator, so gives a speed control of the induction motor without sacrifice of efficiency, with a sacrifice, however, of the power-factor, as can be shown from equation (87).

184. 2. The no-load speed of the polyphase shunt motor is in synchronism, that is, the no-load slip, $s_0 = 0$, or the motor output becomes zero at synchronism, just as the ordinary induction motor, if, in equation (83):

$$r_1 \cos \theta + x_1 \sin \theta - cr_0 = 0;$$

hence:

$$c = \frac{r_1 \cos \theta + x_1 \sin \theta}{r_0}. \quad (90)$$

or, substituting:

$$\frac{x_1}{r_1} = \tan \alpha_1, \quad (91)$$

where α_1 is the phase angle of the rotor impedance, it is:

$$c = \frac{z_1}{r_0} \cos (\alpha_1 - \theta),$$

or:

$$\cos (\alpha_1 - \theta) = \frac{r_0}{z_1} c, \quad (92)$$

or:

$$c = \frac{z_1 \cos (\alpha_1 - \theta)}{r_0}. \quad (93)$$

Since r_0 is usually very much smaller than z_1 , if c is not very large, it is:

$$\cos (\alpha_1 - \theta) = 0;$$

nence:

$$\theta = 90^\circ - \alpha_1. \quad (94)$$

That is, if the brush angle, θ , is complementary to the phase angle of the self-inductive rotor impedance, α_1 , the motor tends toward approximate synchronism at no-load.

Hence:

At given brush angle, θ , a value of secondary impressed e.m.f., cE_0 , exists, which makes the motor tend to synchronize at no-load (93), and,

At given rotor-impressed e.m.f., cE_0 , a brush angle, θ , exists, which makes the motor synchronize at no-load (92).

185. 3. In the general equations of the polyphase shunt motor, the stator current, equation (78):

$$I_0 = E_0 \frac{sZ + Z_1 + \delta cZ}{sZZ_0 + ZZ_1 + Z_0Z_1},$$

can be resolved into a component:

$$I''_0 = E_0 \frac{sZ + Z_1}{sZZ_0 + ZZ_1 + Z_0Z_1}, \quad (95)$$

which does not contain c , and is the same value as the primary current of the polyphase induction motor, and a component:

$$I''_0 = E_0 \frac{\delta cZ}{sZZ_0 + ZZ_1 + Z_0Z_1}. \quad (96)$$

Resolving I''_0 , it assumes the form:

$$\begin{aligned} I''_0 &= E_0 \delta c (A_1 - jA_2) \\ &= c \{A_1 \cos \theta + A_2 \sin \theta\} + j \{A_1 \sin \theta - A_2 \cos \theta\}. \end{aligned} \quad (97)$$

This second component of primary current, I''_0 , which is produced by the insertion of the voltage, cE_0 , into the secondary circuit, so contains a power component:

$$i'_0 = c (A_1 \cos \theta + A_2 \sin \theta), \quad (98)$$

and a wattless or reactive component:

$$i''_0 = +jc (A_1 \sin \theta - A_2 \cos \theta); \quad (99)$$

where:

$$I''_0 = i'_0 - ji''_0. \quad (100)$$

The reactive component, i''_0 , is zero, if:

$$A_1 \sin \theta - A_2 \cos \theta = 0; \quad (101)$$

hence:

$$\tan \theta_1 = + \frac{A_2}{A_1}. \quad (102)$$

In this case, that is, with brush angle, θ_1 , the secondary impressed voltage, cE , does not change the reactive current, but adds or subtracts, depending on the sign of c , energy, and so raises or lowers the speed of the motor: case (1).

The power component, i'_0 , is zero, if:

$$A_1 \cos \theta + A_2 \sin \theta = 0, \quad (103)$$

hence:

$$\tan \theta_2 = - \frac{A_1}{A_2}. \quad (104)$$

In this case, that is, with brush angle, θ_2 , the secondary impressed voltage, cE , does not change power or speed, but produces wattless lagging or leading current. That is, with the brush position, θ_2 , the polyphase shunt motor can be made to produce lagging or leading currents, by varying the voltage impressed upon the secondary, cE , just as a synchronous motor can be made to produce lagging or leading currents by varying its field excitation, and plotting the stator current, I_0 , of such a polyphase shunt motor, gives the same V-shaped phase characteristics as known for the synchronous motor.

These two phase angles or brush positions, θ_1 and θ_2 , are in quadrature with each other.

There result then two distinct phenomena from the insertion of a voltage by commutator, into an induction-motor armature: a change of speed, in the brush position, θ_1 , and a change of phase angle, in the brush position, θ_2 , at right angles to θ_1 .

For any intermediate brush position, θ , a change of speed so results corresponding to a voltage:

$$cE \cos (\theta_1 - \theta);$$

and a change of phase angle corresponding to a voltage.

$$\begin{aligned} & cE \cos (\theta_2 - \theta), \\ & = cE \sin (\theta_1 - \theta), \end{aligned}$$

and by choosing then such a position, θ , that the wattless current produced by the component in phase with θ_2 , is equal and opposite to the wattless lagging current of the motor proper, I'_0 , the polyphase shunt motor can be made to operate at unity power-factor at all speeds (except very low speeds) and loads. This, however, requires shifting the brushes with every change of load or speed.

When using the polyphase shunt motor as generator of wattless current, that is, at no-load and with brush position, θ_2 , it is:

$$s = 0;$$

hence, from (78):

$$I_0 = E_0 \frac{\delta cZ + Z_1}{Z_1 (Z + Z_0)}, \quad (105)$$

$$I'_0 = \frac{\dot{E}_0}{Z + Z_0} \quad (106)$$

or, approximately:

$$I'_0 = \frac{\dot{E}_0}{Z},$$

that is, primary exciting current:

$$I''_0 = E_0 \frac{\delta cZ}{Z_1 (Z + Z_0)}, \quad (107)$$

or, approximately, neglecting Z_0 against Z :

$$\left. \begin{aligned} I''_0 &= \frac{\dot{E}_0 \delta c}{Z_1} \\ &= \frac{\dot{E}_0 c (\cos \theta + j \sin \theta)}{r_1 + jx_1}, \\ &= \frac{\dot{E}_0 c}{z_1^2} \{ (r_1 \cos \theta + x_1 \sin \theta) - j (x_1 \cos \theta - r_1 \sin \theta) \}, \end{aligned} \right\} (108)$$

and, since the power component vanishes:

$$r_1 \cos \theta + x_1 \sin \theta = 0,$$

or:

$$\tan \theta_2 = -\frac{r_1}{x_1}. \quad (109)$$

Substituting (109) in (108) gives:

$$\begin{aligned} I''_0 &= -\frac{\dot{E}j_0c}{z_1^2} (x_1 \cos \theta_2 - r_1 \sin \theta_2) \\ &= -j \frac{\dot{E}_0c}{z_1}; \end{aligned} \quad (110)$$

and:

$$\begin{aligned} I_0 &= \frac{\dot{E}_0}{Z} - j \frac{E_0c}{z_1} \\ &= E_0 \left\{ \frac{r}{z^2} - j \left(\frac{c}{z_1} - \frac{x}{z^2} \right) \right\}. \end{aligned} \quad (111)$$

186. In the exact predetermination of the characteristics of such a motor, the effect of the short-circuit current under the brushes has to be taken into consideration, however. When a commutator is used, by the passage of the brushes from segment to segment coils are short-circuited. Therefore, in addition to the circuits considered above, a closed circuit on the rotor has to be introduced in the equations for every set of brushes. Reduced to the stator circuit by the ratio of turns, the self-inductive impedance of the short-circuit under the brushes is very high, the current, therefore, small, but still sufficient to noticeably affect the motor characteristics, at least at certain speeds. Since, however, this phenomenon will be considered in the chapters on the single-phase motors, it may be omitted here.

4. POLYPHASE SERIES MOTOR

187. If in a polyphase commutator motor the rotor circuits are connected in series to the stator circuits, entirely different

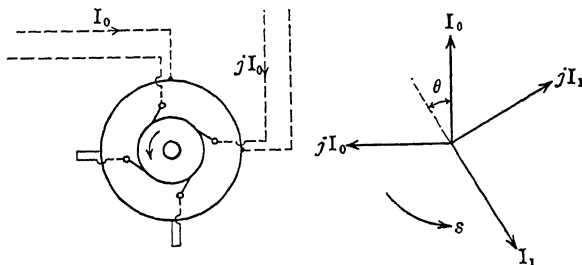

FIG. 153.

characteristics result, and the motor no more tends to synchronize nor approaches a definite speed at no-load, as a shunt motor, but with decreasing load the speed increases indefinitely. In short,

the motor has similar characteristics as the direct-current series motor.

In this case we may assume the stator reduced to the rotor by the ratio of effective turns.

Let then, in the motor shown diagrammatically in Fig. 153:

E_0 and $-jE_0$, I_0 and $-jI_0$, Z_0 = impressed e.m.f.s., currents and self-inductive impedance of stator circuits, assumed as two-phase, and reduced to the rotor circuits by the ratio of effective turns, c ,

E_1 and $-jE_1$, I_1 , and $-jI_1$, Z_1 = impressed e.m.f.s. currents and self-inductive impedance of rotor circuits,

Z = mutual-inductance impedance,

S = speed; and, $s = 1 - S$ = slip,

θ = brush angle,

c = ratio of effective stator turns to rotor turns.

If, then:

E and $-jE$ = impressed e.m.f.s., I and $-jI$ = currents of motor, it is:

$$I_1 = I, \quad (112)$$

$$I_0 = cI, \quad (113)$$

$$cE_0 + E_1 = E; \quad (114)$$

and, stator, by equation (7):

$$E_0 = Z_0 I_0 + Z(I_0 - I_1 \cos \theta - jI_1 \sin \theta); \quad (115)$$

rotor:

$$E_1 = Z_1 I_1 + Z(I_1 - I_0 \cos \theta + jI_0 \sin \theta) - jSZ(-jI_1 + I_0 \sin \theta + jI_0 \cos \theta); \quad (116)$$

and, e.m.f. of rotation:

$$E' = -jSZ(-jI_1 + I_0 \sin \theta + jI_1 \cos \theta). \quad (117)$$

Substituting (112), (113) in (115), (116), (117), and (115), (116) in (114) gives:

$$I = \frac{E}{(c^2 Z_0 + Z_1) + Z(1 + c^2 - 2c \cos \theta) + SZ(c\sigma - 1)}; \quad (118)$$

where:

$$\sigma = \cos \theta - j \sin \theta, \quad (119)$$

and:

$$E' = \frac{SZ E (c\sigma - 1)}{(c^2 Z_0 + Z_1) + Z(1 + c^2 - 2c \cos \theta) + SZ(c\sigma - 1)}; \quad (120)$$

and the power output:

$$P = [E'_1, I_1]' = \frac{Se^2 \{ c(r \cos \theta + x \sin \theta) - r \}}{[(c^2 Z_0 + Z_1) + Z(1 + c^2 - 2c \cos \theta) + SZ(c\sigma - 1)]^2} \quad (121)$$

The characteristics of this motor entirely vary with a change of the brush angle, θ . It is, for $\theta = 0$: $P = \frac{Se^2 r(x-1)}{[K]^2}$, hence

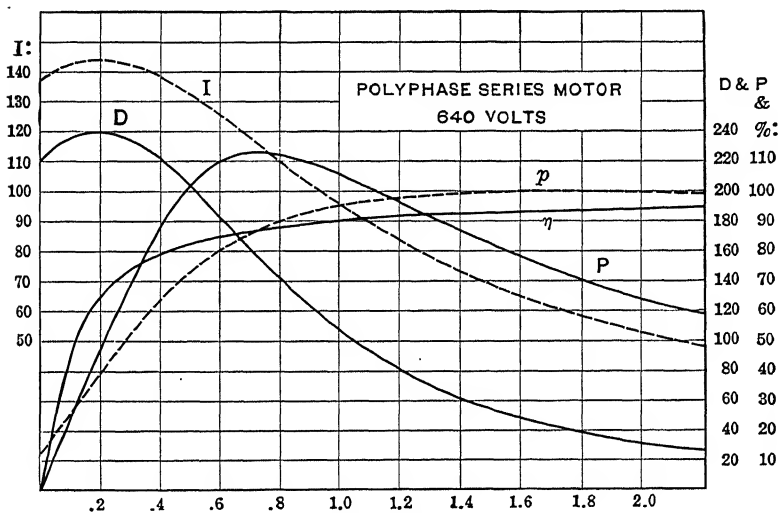

FIG. 154.

very small, while for $\theta = 90^\circ$: $P = \frac{Se^2(xc - r)}{[K]^2}$, hence considerable. Some brush angles give positive P : motor, others negative, P , generator.

In such a motor, by choosing θ and c appropriately, unity power-factor or leading current as well as lagging current can be produced.

That is, by varying c and θ , the power output and therefore the speed, as well as the phase angle of the supply current or the power-factor can be varied, and the machine used to produce lagging as well as leading current, similarly as the polyphase shunt motor or the synchronous motor. Or, the motor can be operated at constant unity power-factor at all loads and speeds (except very low speeds), but in this case requires changing the

brush angle, θ , and the ratio, c , with the change of load and speed. Such a change of the ratio, c , of rotor \div stator turns can be produced by feeding the rotor (or stator) through a transformer of variable ratio of transformation, connected with its primary circuit in series to the stator (or rotor).

188. As example is shown in Fig. 154, with the speed as abscissæ, and values from standstill to over double synchronous speed, the characteristic curves of a polyphase series motor of the constants:

$$\begin{aligned} e &= 640 \text{ volts,} \\ Z &= 1 + 10j \text{ ohms,} \\ Z_0 = Z_1 &= 0.1 + 0.3j \text{ ohms,} \\ c &= 1, \\ \theta &= 37^\circ; (\sin \theta = 0.6; \cos \theta = 0.8); \end{aligned}$$

hence:

$$\begin{aligned} I &= \frac{640}{(0.6 + 5.8 S) + j(4.6 - 2.6 S)} \text{ amp.,} \\ P &= \frac{4673 S}{(0.6 + 5.8 S)^2 + (4.6 - 2.6 S)^2} \text{ kw.} \end{aligned}$$

As seen, the motor characteristics are similar to those of the direct-current series motor: very high torque in starting and at low speed, and a speed which increases indefinitely with the decrease of load. That is, the curves are entirely different from those of the induction motors shown in the preceding. The power-factor is very high, much higher than in induction motors, and becomes unity at the speed $S = 1.77$, or about one and three-quarter synchronous speed.

CHAPTER XX

SINGLE-PHASE COMMUTATOR MOTORS

I. General

189. Alternating-current commutating machines have so far become of industrial importance mainly as motors of the series or varying-speed type, for single-phase railroading, and as constant-speed motors or adjustable-speed motors, where efficient acceleration under heavy torque is necessary. As generators, they would be of advantage for the generation of very low frequency, since in this case synchronous machines are uneconomical, due to their very low speed, resultant from the low frequency.

The direction of rotation of a direct-current motor, whether shunt or series motor, remains the same at a reversal of the impressed e.m.f., as in this case the current in the armature circuit and the current in the field circuit and so the field magnetism both reverse. Theoretically, a direct-current motor therefore could be operated on an alternating impressed e.m.f. provided that the magnetic circuit of the motor is laminated, so as to follow the alternations of magnetism without serious loss of power, and that precautions are taken to have the field reverse simultaneously with the armature. If the reversal of field magnetism should occur later than the reversal of armature current, during the time after the armature current has reversed, but before the field has reversed, the motor torque would be in opposite direction and thus subtract; that is, the field magnetism of the alternating-current motor must be in phase with the armature current, or nearly so. This is inherently the case with the series type of motor, in which the same current traverses field coils and armature windings.

Since in the alternating-current transformer the primary and secondary currents and the primary voltage and the secondary voltage are proportional to each other, the different circuits of the alternating-current commutator motor may be connected with each other directly (in shunt or in series, according to the type of the motor) or inductively, with the interposition of a

transformer, and for this purpose either a separate transformer may be used or the transformer feature embodied in the motor, as in the so-called repulsion type of motors. This gives to the alternating-current commutator motor a far greater variety of connections than possessed by the direct-current motor.

While in its general principle of operation the alternating-current commutator motor is identical with the direct-current motor, in the relative proportioning of the parts a great difference exists. In the direct-current motor, voltage is consumed by the counter e.m.f. of rotation, which represents the power output of the motor, and by the resistance, which represents the power loss. In addition thereto, in the alternating-current motor voltage is consumed by the inductance, which is wattless or reactive and therefore causes a lag of current behind the voltage, that is, a lowering of the power-factor. While in the direct-current motor good design requires the combination of a strong field and a relatively weak armature, so as to reduce the armature reaction on the field to a minimum, in the design of the alternating-current motor considerations of power-factor predominate; that is, to secure low self-inductance and therewith a high power-factor, the combination of a strong armature and a weak field is required, and necessitates the use of methods to eliminate the harmful effects of high armature reaction.

As the varying-speed single-phase commutator motor has found an extensive use as railway motor, this type of motor will as an instance be treated in the following, and the other types discussed in the concluding paragraphs.

II. Power-factor

190. In the commutating machine the magnetic field flux generates the e.m.f. in the revolving armature conductors, which gives the motor output; the armature reaction, that is, the magnetic flux produced by the armature current, distorts and weakens the field, and requires a shifting of the brushes to avoid sparking due to the short-circuit current under the commutator brushes, and where the brushes can not be shifted, as in a reversible motor, this necessitates the use of a strong field and weak armature to keep down the magnetic flux at the brushes. In the alternating-current motor the magnetic field flux generates in the armature conductors by their rotation the e.m.f. which does the work of the motor, but, as the field flux is alternating, it also generates

in the field conductors an e.m.f. of self-inductance, which is not useful but wattless, and therefore harmful in lowering the power-factor, hence must be kept as low as possible.

This e.m.f. of self-inductance of the field, e_0 , is proportional to the field strength, Φ , to the number of field turns, n_0 , and to the frequency, f , of the impressed e.m.f.:

$$e_0 = 2 \pi f n_0 \Phi 10^{-8}, \quad (1)$$

while the useful e.m.f. generated by the field in the armature conductors, or "e.m.f. of rotation," e , is proportional to the field strength, Φ , to the number of armature turns, n_1 , and to the frequency of rotation of the armature, f_0 :

$$e = 2 \pi f_0 n_1 \Phi 10^{-8}. \quad (2)$$

This later e.m.f., e , is in phase with the magnetic flux, Φ , and so with the current, i , in the series motor, that is, is a power e.m.f., while the e.m.f. of self-inductance, e_0 , is wattless, or in quadrature with the current, and the angle of lag of the motor current thus is given by:

$$\tan \theta = \frac{e_0}{e + ir}, \quad (3)$$

where ir = voltage consumed by the motor resistance. Or approximately, since ir is small compared with e (except at very low speed):

$$\tan \theta = \frac{e_0}{e}, \quad (4)$$

and, substituting herein (1) and (2):

$$\tan \theta = \frac{f}{f_0} \frac{n_0}{n_1}. \quad (5)$$

Small angle of lag and therewith good power-factor therefore require high values of f_0 and n_1 and low values of f and n_0 .

High f_0 requires high motor speeds and as large number of poles as possible. Low f means low impressed frequency; therefore 25 cycles is generally the highest frequency considered for large commutating motors.

High n_1 and low n_0 means high armature reaction and low field excitation, that is, just the opposite conditions from that required for good commutator-motor design.

Assuming synchronism, $f_0 = f$, as average motor speed—750 revolutions with a four-pole 25-cycle motor—an armature reac-

tion, n_1 , equal to the field excitation, n_0 , would then give $\tan \theta = 1$, $\theta = 45^\circ$, or 70.7 per cent. power-factor; that is, with an armature reaction beyond the limits of good motor design, the power-factor is still too low for use.

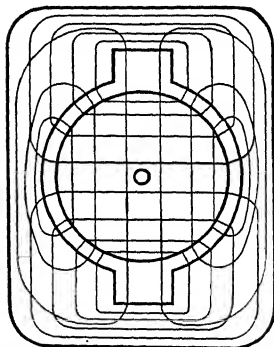

FIG. 155.—Distribution of main field and field of armature reaction.

The armature, however, also has a self-inductance; that is, the magnetic flux produced by the armature current as shown diagrammatically in Fig. 155 generates a reactive e.m.f. in the armature conductors, which again lowers the power-factor. While this armature self-inductance is low with small number of armature turns, it becomes considerable when the number of armature turns, n_1 , is large compared with the field turns, n_0 .

Let \mathcal{R}_0 = field reluctance, that is, reluctance of the magnetic field circuit, and $\mathcal{R}_1 = \frac{l}{b}$ = the armature reluctance, that is, $b = \frac{\mathcal{R}_1}{\mathcal{R}_0}$ = ratio of reluctances of the armature and the field magnetic circuit; then, neglecting magnetic saturation, the field flux is

$$\Phi = \frac{n_0 i}{\mathcal{R}_0},$$

the armature flux is:

$$\Phi_1 = \frac{n_1 i}{\mathcal{R}_1} = \frac{n_1 b i}{\mathcal{R}_0} = \frac{n_1}{n_0} b \Phi, \quad (6)$$

and the e.m.f. of self-inductance of the armature circuit is:

$$\begin{aligned} e_1 &= 2 \pi f n_1 \Phi_1 10^{-8} \\ &= 2 \pi f \frac{n_1^2}{n_0} b \Phi 10^{-8}; \end{aligned} \quad (7)$$

hence, the total e.m.f. of self-inductance of the motor, or wattless e.m.f., by (1) and (7) is:

$$e_0 + e_1 = 2 \pi f \Phi 10^{-8} \left(\frac{n_0^2 + b n_1^2}{n_0} \right); \quad (8)$$

and the angle of lag, θ , is given by:

$$\begin{aligned} \tan \theta &= \frac{e_0 + e_1}{e} \\ &= \frac{f}{f_0} \frac{n_0^2 + bn_1^2}{n_0n_1}; \end{aligned} \tag{9}$$

or, denoting the ratio of armature turns to field turns by

$$\begin{aligned} q &= \frac{n_1}{n_0}, \\ \tan \theta &= \frac{f}{f_0} \left(\frac{1}{q} + bq \right), \end{aligned} \tag{10}$$

and this is a minimum; that is, the power-factor a maximum, for:

$$\frac{d}{dq} \{ \tan \theta \} = 0,$$

or:

$$q_0 = \frac{1}{\sqrt{b}}, \tag{11}$$

and the maximum power-factor of the motor is then given by:

$$\tan \theta_0 = \frac{f}{f_0} \frac{2}{\sqrt{b}}. \tag{12}$$

Therefore the greater b is the higher the power-factor that can be reached by proportioning field and armature so that

$$\frac{n_1}{n_0} = q_0 = \frac{1}{\sqrt{b}}.$$

Since b is the ratio of armature reluctance to field reluctance, good power-factor thus requires as high an armature reluctance and as low a field reluctance as possible; that is, as good a magnetic field circuit and poor magnetic armature circuit as feasible. This leads to the use of the smallest air gaps between field and armature which are mechanically permissible. With an air gap of 0.10 to 0.15 in. as the smallest safe value in railway work, b can not well be made larger than about 4.

Assuming, then, $b = 4$, gives $q = 2$, that is, twice as many armature turns as field turns; $n_1 = 2 n_0$.

The angle of lag in this case is, by (12), at synchronism: $f_0 = f$,
 $\tan \theta_0 = 1$,

giving a power-factor of 70.7 per cent.

It follows herefrom that it is not possible, with a mechanically

safe construction, at 25 cycles to get a good power-factor at moderate speed, from a straight series motor, even if such a design as discussed above were not inoperative, due to excessive distortion and therefore destructive sparking.

Thus it becomes necessary in the single-phase commutator motor to reduce the magnetic flux of armature reaction, that is, increase the effective magnetic reluctance of the armature far beyond the value of the true magnetic reluctance. This is accomplished by the compensating winding devised by Eickemeyer, by surrounding the armature with a stationary winding closely adjacent and parallel to the armature winding, and energized by a current in opposite direction to the armature current, and of the same m.m.f., that is, the same number of ampere-turns, as the armature winding.

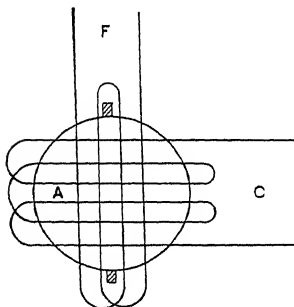

FIG. 156.—Circuits of single-phase commutator motor.

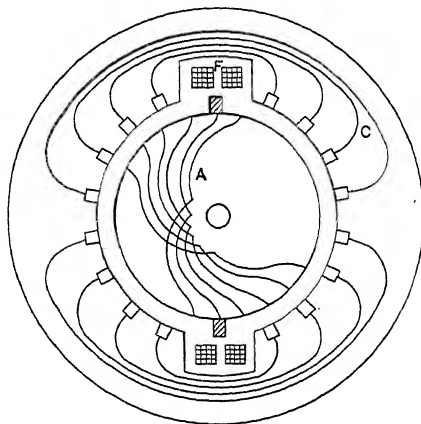

FIG. 157.—Massed field winding and distributed compensating winding.

191. Every single-phase commutator motor thus comprises a field winding, *F*, an armature winding, *A*, and a compensating winding, *C*, usually located in the pole faces of the field, as shown in Figs. 156 and 157.

The compensating winding, *C*, is either connected in series (but in reversed direction) with the armature winding, and then has the same number of effective turns, or it is short-circuited upon itself, thus acting as a short-circuited secondary with the armature winding as primary, or the compensating winding is energized by the supply current, and the armature short-circuited as

secondary. The first case gives the conductively compensated series motor, the second case the inductively compensated series motor, the third case the repulsion motor.

In the first case, by giving the compensating winding more turns than the armature, overcompensation, by giving it less turns, undercompensation, is produced. In the second case always complete (or practically complete) compensation results, irrespective of the number of turns of the winding, as primary and secondary currents of a transformer always are opposite in direction, and of the same m.m.f. (approximately), and in the third case a somewhat less complete compensation.

With a compensating winding, C , of equal and opposite m.m.f. to the armature winding, A , the resultant armature reaction is zero, and the field distortion, therefore, disappears; that is, the ratio of the armature turns to field turns has no direct effect on the commutation, but high armature turns and low field turns can be used. The armature self-inductance is reduced from that corresponding to the armature magnetic flux, Φ_1 , in Fig. 155 to that corresponding to the magnetic leakage flux, that is, the magnetic flux passing between armature turns and compensating turns, or the "slot inductance," which is small, especially if relatively shallow armature slots and compensating slots are used.

The compensating winding, or the "cross field," thus fulfils the twofold purpose of reducing the armature self-inductance to that of the leakage flux, and of neutralizing the armature reaction and thereby permitting the use of very high armature ampere-turns.

The main purpose of the compensating winding thus is to decrease the armature self-inductance; that is, increase the effective armature reluctance and thereby its ratio to the field reluctance, b , and thus permit the use of a much higher ratio, $q = \frac{\mu_1}{\mu_0}$, before maximum power-factor is reached, and thereby a higher power-factor.

Even with compensating winding, with increasing q , ultimately a point is reached where the armature self-inductance equals the field self-inductance, and beyond this the power-factor again decreases. It becomes possible, however, by the use of the compensating winding, to reach, with a mechanically good design, values of b as high as 16 to 20.

Assuming $b = 16$ gives, substituted in (11) and (12):

$$q = 4;$$

that is, four times as many armature turns as field turns, $n_1 = 4 n_0$ and:

$$\tan \theta_0 = \frac{f}{2f_0};$$

hence, at synchronism:

$$f_0 = f : \tan \theta_0 = 0.5, \text{ or } 89 \text{ per cent. power-factor.}$$

At double synchronism, which about represents maximum motor speed at 25 cycles:

$$f_0 = 2f : \tan \theta_0 = 0.25, \text{ or } 98 \text{ per cent. power-factor;}$$

that is, very good power-factors can be reached in the single-phase commutator motor by the use of a compensating winding, far higher than are possible with the same air gap in polyphase induction motors.

III. Field Winding and Compensating Winding

192. The purpose of the field winding is to produce the maximum magnetic flux, Φ , with the minimum number of turns, n_0 . This requires as large a magnetic section, especially at the air gap, as possible. Hence, a massed field winding with definite polar projections of as great pole arc as feasible, as shown in Fig. 157, gives a better power-factor than a distributed field winding.

The compensating winding must be as closely adjacent to the armature winding as possible, so as to give minimum leakage flux between armature conductors and compensating conductors, and therefore is a distributed winding, located in the field pole faces, as shown in Fig. 157.

The armature winding is distributed over the whole circumference of the armature, but the compensating winding only in the field pole faces. With the same ampere-turns in armature and compensating winding, their resultant ampere-turns are equal and opposite, and therefore neutralize, but locally the two windings do not neutralize, due to the difference in the distribution curves of their m.m.fs. The m.m.f. of the field winding is constant over the pole faces, and from one pole corner to the next pole corner reverses in direction, as shown diagrammatically by F in Fig. 158, which is the development of Fig. 157. The m.m.f. of the armature is a maximum at the brushes, midway between the field poles, as shown by A in Fig. 158, and from there decreases to zero in the center of the field pole. The m.m.f. of

the compensating winding, however, is constant in the space from pole corner to pole corner, as shown by *C* in Fig. 158, and since the total m.m.f. of the compensating winding equals that of the armature, the armature m.m.f. is higher at the brushes, the compensating m.m.f. higher in front of the field poles, as shown by curve *R* in Fig. 158, which is the difference between *A* and *C*; that is, with complete compensation of the resultant armature and compensating winding, locally undercompensation exists at the brushes, overcompensation in front of the field

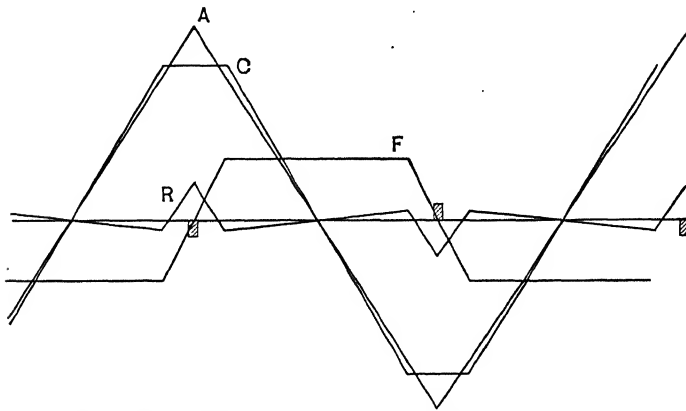

FIG. 158.—Distribution of m.m.f. in compensated motor.

poles. The local undercompensated armature reaction at the brushes generates an e.m.f. in the coil short-circuited under the brush, and therewith a short-circuit current of commutation and sparking. In the conductively compensated motor, this can be avoided by overcompensation, that is, raising the flat top of the compensating m.m.f. to the maximum armature m.m.f., but this results in a lowering of the power-factor, due to the self-inductive flux of overcompensation, and therefore is undesirable.

193. To get complete compensation even locally requires the compensating winding to give the same distribution curve as the armature winding, or inversely. The former is accomplished by distributing the compensating winding around the entire circumference of the armature, as shown in Fig. 159. This, however, results in bringing the field coils further away from the armature surface, and so increases the magnetic stray flux of the field winding, that is, the magnetic flux, which passes through the field coils, and there produces a reactive voltage of self-in-

ductance, but does not pass through the armature conductors, and so does no work; that is, it lowers the power factor, just as overcompensation would do. The distribution curve of the

armature winding can, however, be made equal to that of the compensating winding, and therewith local complete compensation secured, by using a fractional pitch armature winding of a pitch equal to the pole arc. In this case, in the space between the pole corners, the currents are in opposite direction in the upper and the lower layer of conductors in each armature slot, as shown in Fig. 160, and thus neutralize magnetically; that is, the armature reaction extends only over the space of the armature circumference covered by the pole arc, where it is neutralized

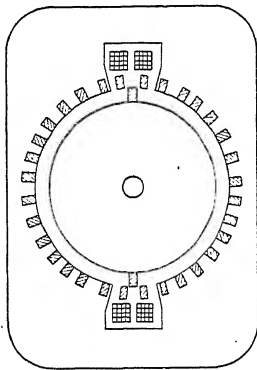

FIG. 159.—Completely distributed compensating winding.

by the compensating winding in the pole face.

To produce complete compensation even locally, without impairing the power-factor, therefore, requires a fractional-pitch

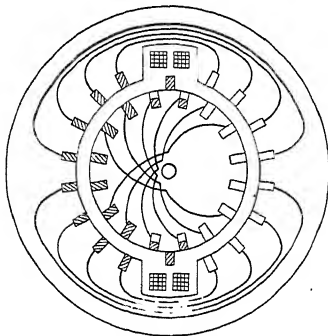

FIG. 160.—Fractional pitch armature winding.

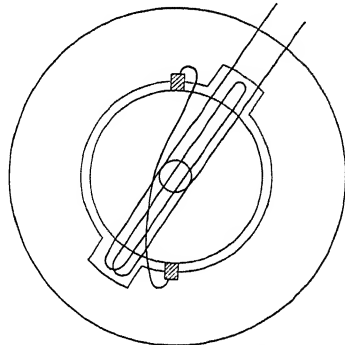

FIG. 161.—Repulsion motor with massed winding.

armature winding, of a pitch equal to the field pole arc, or some equivalent arrangement.

Historically, the first compensated single-phase commutator motors, built about 20 years ago, were Prof. Elihu Thomson's repulsion motors. In these the field winding and compensating

winding were massed together in a single coil, as shown diagrammatically in Fig. 161. Repulsion motors are still occasionally built in which field and compensating coils are combined in a single distributed winding, as shown in Fig. 162. Soon after the first repulsion motor, conductively and inductively compensated series motors were built by Eickemeyer, with a massed field winding and a separate compensating winding, or cross coil, either as single coil or turn or distributed in a number of coils or turns, as shown diagrammatically in Fig. 163, and by W. Stanley.

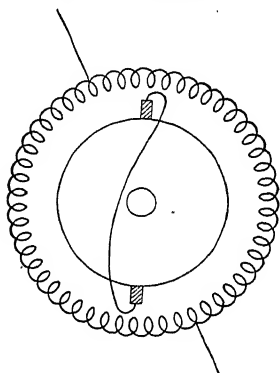

Fig. 162.—Repulsion motor with distributed winding.

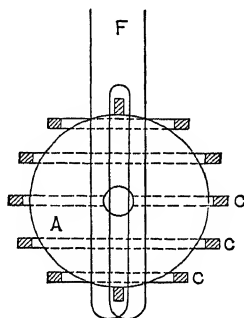

Fig. 163.—Eickemeyer inductively compensated series motor.

For reversible motors, separate field coils and compensating coils are always used, the former as massed, the latter as distributed winding, since in reversing the direction of rotation either the field winding alone must be reversed or armature and compensating winding are reversed while the field winding remains unchanged.

IV. Types of Varying-speed Single-phase Commutator Motors

194. The armature and compensating windings are in inductive relations to each other. In the single-phase commutator motor with series characteristic, armature and compensating windings therefore can be connected in series with each other, or the supply voltage impressed upon the one, the other closed upon itself as secondary circuit, or a part of the supply voltage impressed upon the one, and another part upon the other circuit, and in either of these cases the field winding may be connected in series either to the compensating winding or to the armature winding. This gives the motor types, denoting the armature by

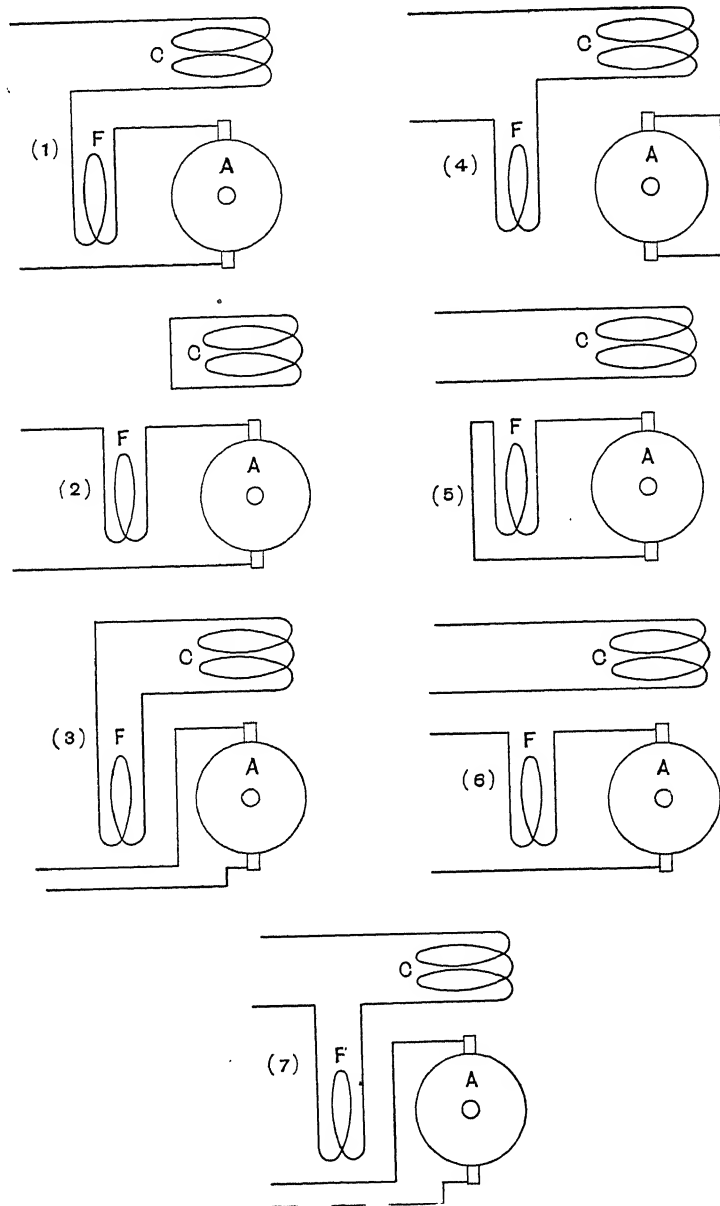

FIG. 164.—Types of alternating-current commutating motors.

A , the compensating winding by C , and the field winding by F , shown in Fig. 164.

Primary	Secondary	
$A + F$. . .	Series motor.
$A + C + F$. . .	Conductively compensated series motor. (1)
$A + F$	C	Inductively compensated series motor. (2)
A	$C + F$	Inductively compensated series motor with secondary excitation, or inverted repulsion motor. (3)
$C + F$	A	Repulsion motor. (4)
C	$A + F$	Repulsion motor with secondary excitation. (5)
$A + F, C$. . .	Series repulsion motors.
$A, C + F$. . .	

Since in all these motor types all three circuits are connected directly or inductively in series with each other, they all have the same general characteristics as the direct-current series motor; that is, a speed which increases with a decrease of load, and a torque per ampere input which increases with increase of current, and therefore with decrease of speed, and the different motor types differ from each other only by their commutation as affected by the presence or absence of a magnetic flux at the brushes, and indirectly thereby in their efficiency as affected by commutation losses.

In the conductively compensated series motor, by the choice of the ratio of armature and compensating turns, overcompensation, complete compensation, or undercompensation can be produced. In all the other types, armature and compensating windings are in inductive relation, and the compensation therefore approximately complete.

A second series of motors of the same varying speed characteristics results by replacing the stationary field coils by armature excitation, that is, introducing the current, either directly or by transformer, into the armature by means of a second set of brushes at right angles to the main brushes. Such motors are used to some extent abroad. They have the disadvantage of

requiring two sets of brushes, but the advantage that their power-factor can be controlled and above synchronism even leading current produced. Fig. 165 shows diagrammatically such a motor, as designed by Winter-Eichberg-Latour, the so-called compensated repulsion motor. In this case compensated means compensated for power-factor.

The voltage which can be used in the motor armature is limited by the commutator: the voltage per commutator segment is limited by the problem of sparkless commutation, the number

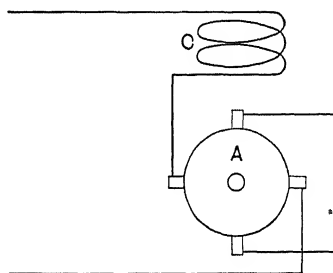

FIG. 165.—Type of alternating-current commutating motor.

of commutator segments from brush to brush is limited by mechanical consideration of commutator speed and width of segments. In those motor types in which the supply current traverses the armature, the supply voltage is thus limited to values even lower than in the direct-current motor, while in the repulsion motor (4 and 5), in which the armature is the

secondary circuit, the armature voltage is independent of the supply voltage, so can be chosen to suit the requirements of commutation, while the motor can be built for any supply voltage for which the stator can economically be insulated.

Alternating-current motors as well as direct-current series motors can be controlled by series parallel connection of two or more motors. Further control, as in starting, with direct-current motors is carried out by rheostat, while with alternating-current motors potential control, that is, a change of supply voltage by transformer or autotransformer, offers a more efficient method of control. By changing from one motor type to another motor type, potential control can be used in alternating-current motors without any change of supply voltage, by appropriately choosing the ratio of turns of primary and secondary circuit. For instance, with an armature wound for half the voltage and thus

twice the current as the compensating winding (ratio of turns $\frac{n_2}{n_1} = 2$), a change of connection from type 3 to type 2, or from type 5 to type 4, results in doubling the field current and there-

with the field strength. A change of distribution of voltage between the two circuits, in types 6 and 7, with *A* and *C* wound for different voltages, gives the same effect as a change of supply voltage, and therefore is used for motor control.

195. In those motor types in which a transformation of power occurs between compensating winding, *C*, and armature winding, *A*, a transformer flux exists in the direction of the brushes, that is, at right angles to the field flux. In general, therefore, the single-phase commutator motor contains two magnetic fluxes in quadrature position with each other, the main flux or field flux, Φ , in the direction of the axis of the field coils, or at right angles to the armature brushes, and the quadrature flux, or transformer flux, or commutating flux, Φ_1 , in line with the armature brushes, or in the direction of the axis of the compensating winding, that is, at right angles (electrical) with the field flux.

The field flux, Φ , depends upon and is in phase with the field current, except as far as it is modified by the magnetic action of the short-circuit current in the armature coil under the commutator brushes.

In the conductively compensated series motor, 1, the quadrature flux is zero at complete compensation, and in the direction of the armature reaction with undercompensation, in opposition to the armature reaction at overcompensation, but in either case in phase with the current and so approximately with the field.

In the other motor types, whatever quadrature flux exists is not in phase with the main flux, but as transformer flux is due to the resultant m.m.f. of primary and secondary circuit.

In a transformer with non-inductive or nearly non-inductive secondary circuit, the magnetic flux is nearly 90° in time phase behind the primary current, a little over 90° ahead of the secondary current, as shown in transformer diagram, Fig. 166.

In a transformer with inductive secondary, the magnetic flux is less than 90° behind the primary current, more than 90° ahead of the secondary current, the more so the higher is the inductivity of the secondary circuit, as shown by the transformer diagram, Fig. 166.

Herefrom it follows that:

In the inductively compensated series motor, 2, the quadrature flux is very small and practically negligible, as very little voltage is consumed in the low impedance of the secondary circuit, *C*; whatever flux there is, lags behind the main flux.

In the inductively compensated series motor with secondary excitation, or inverted repulsion motor, 3, the quadrature flux, Φ_1 , is quite large, as a considerable voltage is required for the field excitation, especially at moderate speeds and therefore high currents, and this flux, Φ_1 , lags behind the field flux, Φ , but this lag is very much less than 90° , since the secondary circuit is

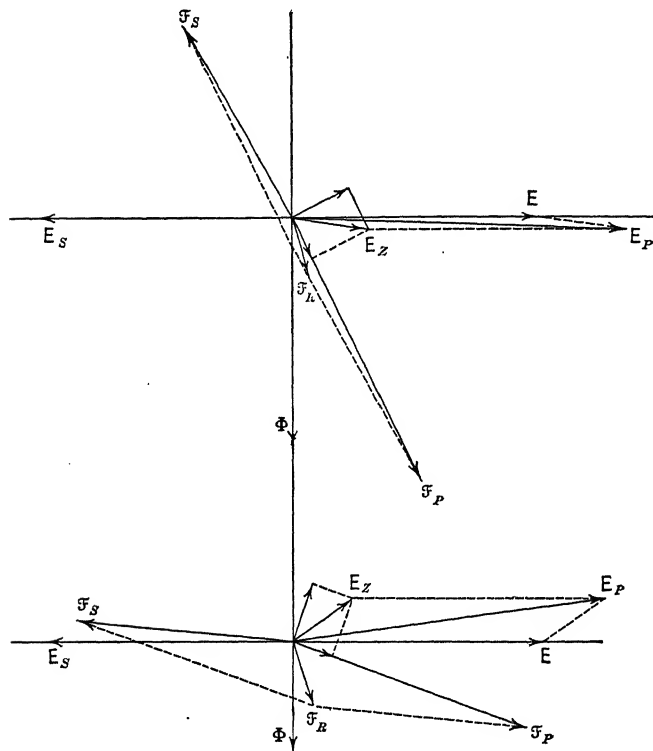

FIG. 166.—Transformer diagram, inductive and non-inductive load.

highly inductive; the motor field thus corresponding to the conditions of the transformer diagram, Fig. 166. As result hereof, the commutation of this type of motor is very good, flux, Φ_1 , having the proper phase and intensity required for a commutating flux, as will be seen later, but the power-factor is poor.

In the repulsion motor, 4, the quadrature flux is very considerable, since all the voltage consumed by the rotation of the armature is induced in it by transformation from the compen-

sating winding, and this quadrature flux, Φ_1 , lags nearly 90° behind the main flux, Φ , since the secondary circuit is nearly non-inductive, especially at speed.

In the repulsion motor with secondary excitation, 5, the quadrature flux, Φ_1 , is also very large, and practically constant, corresponding to the impressed e.m.f., but lags considerably less than 90° behind the main flux, Φ , the secondary circuit being inductive, since it contains the field coil, F . The lag of the flux, Φ_1 , increases with increasing speed, since with increasing speed the e.m.f. of rotation of the armature increases, the e.m.f. of self-inductance of the field decreases, due to the decrease of current, and the circuit thus becomes less inductive.

The series repulsion motors 6 and 7, give the same phase relation of the quadrature flux, Φ_1 , as the repulsion motors, 5 and 6, but the intensity of the quadrature flux, Φ_1 , is the less the smaller the part of the supply voltage which is impressed upon the compensating winding.

V. Commutation

196. In the commutator motor, the current in each armature coil or turn reverses during its passage under the brush. In the armature coil, while short-circuited by the commutator brush, the current must die out to zero and then increase again to its original value in opposite direction. The resistance of the armature coil and brush contact accelerates, the self-inductance retards the dying out of the current, and the former thus assists, the latter impairs commutation. If an e.m.f. is generated in the armature coil by its rotation while short-circuited by the commutator brush, this e.m.f. opposes commutation, that is, retards the dying out of the current, if due to the magnetic flux of armature reaction, and assists commutation by reversing the armature current, if due to the magnetic flux of overcompensation, that is, a magnetic flux in opposition to the armature reaction.

Therefore, in the direct-current commutator motor with high field strength and low armature reaction, that is, of negligible magnetic flux of armature reaction, fair commutation is produced with the brushes set midway between the field poles—that is, in the position where the armature coil which is being commutated encloses the full field flux and therefore cuts no flux and has no generated e.m.f.—by using high-resistance carbon brushes,

as the resistance of the brush contact, increasing when the armature coil begins to leave the brush, tends to reverse the current. Such "resistance commutation" obviously can not be perfect; perfect commutation, however, is produced by impressing upon the motor armature at right angles to the main field, that is, in the position of the commutator brushes, a magnetic field opposite to that of the armature reaction and proportional to the armature current. Such a field is produced by overcompensation or by the use of a commutating pole or interpole.

As seen in the foregoing, in the direct-current motor the counter e.m.f. of self-inductance of commutation opposes the reversal of current in the armature coil under the commutator brush, and this can be mitigated in its effect by the use of high-resistance brushes, and overcome by the commutating field of overcompensation. In addition hereto, however, in the alternating-current commutator motor an e.m.f. is generated in the coil short-circuited under the brush, by the alternation of the magnetic flux, and this e.m.f., which does not exist in the direct-current motor, makes the problem of commutation of the alternating-current motor far more difficult. In the position of commutation no e.m.f. is generated in the armature coil by its rotation through the magnetic field, as in this position the coil encloses the maximum field flux; but as this magnetic flux is alternating, in this position the e.m.f. generated by the alternation of the flux enclosed by the coil is a maximum. This "e.m.f. of alternation" lags in time 90° behind the magnetic flux which generates it, is proportional to the magnetic flux and to the frequency, but is independent of the speed, hence exists also at standstill, while the "e.m.f. of rotation"—which is a maximum in the position of the armature coil midway between the brushes, or parallel to the field flux—is in phase with the field flux and proportional thereto and to the speed, but independent of the frequency. In the alternating-current commutator motor, no position therefore exists in which the armature coil is free from a generated e.m.f., but in the position parallel to the field, or midway between the brushes, the e.m.f. of rotation, in phase with the field flux, is a maximum, while the e.m.f. of alternation is zero, and in the position under the commutator brush, or enclosing the total field flux, the e.m.f. of alternation, in electrical space quadrature with the field flux, is a maximum, the e.m.f. of rotation absent, while in any other position of the armature coil its generated e.m.f. has

a component due to the rotation—a power e.m.f.—and a component due to the alternation—a reactive e.m.f. The armature coils of an alternating-current commutator motor, therefore, are the seat of a system of polyphase e.m.fs., and at synchronism the polyphase e.m.fs. generated in all armature coils are equal, above synchronism the e.m.f. of rotation is greater, while below synchronism the e.m.f. of alternation is greater, and in the latter case the brushes thus stand at that point of the commutator where the voltage between commutator segments is a maximum. This e.m.f. of alternation, short-circuited by the armature coil in the position of commutation, if not controlled, causes a short-circuit current of excessive value, and therewith destructive sparking; hence, in the alternating-current commutator motor it is necessary to provide means to control the short-circuit current under the commutator brushes, which results from the alternating character of the magnetic flux, and which does not exist in the direct-current motor; that is, in the alternating-current motor the armature coil under the brush is in the position of a short-circuited secondary, with the field coil as primary of a transformer; and as in a transformer primary and secondary ampere-turns are approximately equal, if n_0 = number of field turns per pole and i = field current, the current in a single armature turn, when short-circuited by the commutator brush, tends to become $i_0 = n_0 i$, that is, many times full-load current; and as this current is in opposition, approximately, to the field current, it would demagnetize the field; that is, the motor field vanishes, or drops far down, and the motor thus loses its torque. Especially is this the case at the moment of starting; at speed, the short-circuit current is somewhat reduced by the self-inductance of the armature turn. That is, during the short time during which the armature turn or coil is short-circuited by the brush the short-circuit current can not rise to its full value, if the speed is considerable, but it is still sufficient to cause destructive sparking.

197. The character of the commutation of the motor, and therefore its operativeness, thus essentially depends upon the value and the phase of the short-circuit currents under the commutator brushes. An excessive short-circuit current gives destructive sparking by high-current density under the brushes and arcing at the edge of the brushes due to the great and sudden change of current in the armature coil when leaving the

brush. But even with a moderate short-circuit current, the sparking at the commutator may be destructive and the motor therefore inoperative, if the phase of the short-circuit current greatly differs from that of the current in the armature coil after it leaves the brush, and so a considerable and sudden change of

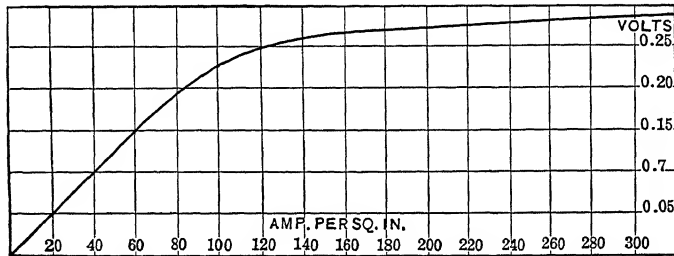

FIG. 167.—E.m.f. consumed at contact of copper brush.

current must take place at the moment when the armature coil leaves the brush. That is, perfect commutation occurs, if the short-circuit current in the armature coil under the commutator brush at the moment when the coil leaves the brush has the same value and the same phase as the main-armature current in

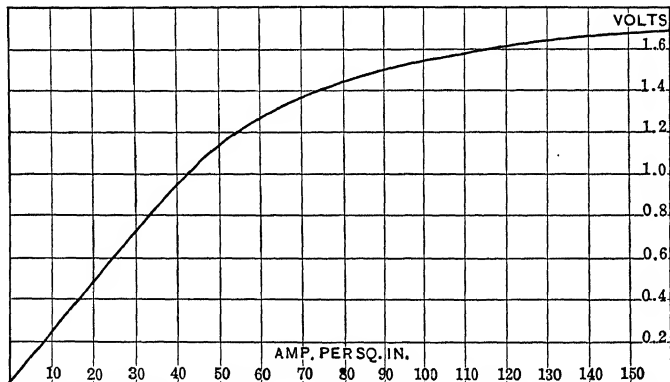

FIG. 168.—E.m.f. consumed at contact of high-resistance carbon brush.

the coil after leaving the brush. The commutation of such a motor therefore is essentially characterized by the difference between the main-armature current after, and the short-circuit current before leaving the brush. The investigation of the short-circuit current under the commutator brushes therefore is of

fundamental importance in the study of the alternating-current commutator motor, and the control of this short-circuit current the main problem of alternating-current commutator motor design.

Various means have been proposed and tried to mitigate or eliminate the harmful effect of this short-circuit current, as high resistance or high reactance introduced into the armature coil during commutation, or an opposing e.m.f. either from the outside, or by a commutating field.

High-resistance brush contact, produced by the use of very narrow carbon brushes of high resistivity, while greatly improving the commutation and limiting the short-circuit current so that it does not seriously demagnetize the field and thus cause the motor to lose its torque, is not sufficient, for the reason that the resistance of the brush contact is not high enough and also is not constant. The brush contact resistance is not of the nature of an ohmic resistance, but more of the nature of a counter e.m.f.; that is, for large currents the potential drop at the brushes becomes approximately constant, as seen from the volt-ampere characteristics of different brushes given in Figs. 167 and 168. Fig. 167 gives the voltage consumed by the brush contact of a copper brush, with the current density as abscissæ, while Fig. 168 gives the voltage consumed by a high-resistance carbon brush, with the current density in the brush as abscissæ. It is seen that such a resistance, which decreases approximately inversely proportional to the increase of current, fails in limiting the current just at the moment where it is most required, that is, at high currents.

Commutator Leads

198. Good results have been reached by the use of metallic resistances in the leads between the armature and the commutator. As shown diagrammatically in Fig. 169, each commutator segment connects to the armature, *A*, by a high non-inductive resistance, *CB*, and thus two such resistances are always in the circuit of the armature coil short-circuited under the brush, but also one or two in series with the armature main circuit, from brush to brush. While considerable power may therefore be consumed in these high-resistance leads, nevertheless the efficiency of the motor is greatly increased by their use; that is, the reduction in the loss of power at the commutator by the reduction

of the short-circuit current usually is far greater than the waste of power in the resistance leads. To have any appreciable effect, the resistance of the commutator lead must be far higher than that of the armature coil to which it connects. Of the e.m.f. of rotation, that is, the useful generated e.m.f., the armature resistance consumes only a very small part, a few per cent. only. The e.m.f. of alternation is of the same magnitude as the e.m.f. of rotation—higher below, lower above synchronism. With a short-circuit current equal to full-load current, the resistance of

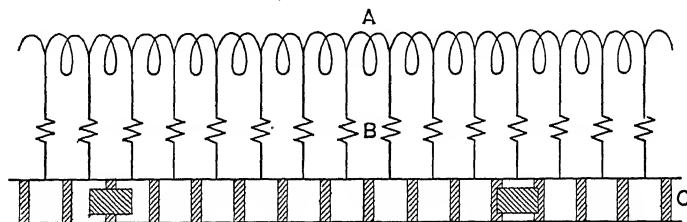

FIG. 169.—Commutation with resistance leads.

the short-circuit coil would consume only a small part of the e.m.f. of alternation, and to consume the total e.m.f. the short-circuit current therefore would have to be about as many times larger than the normal armature current as the useful generated e.m.f. of the motor is larger than the resistance drop in the armature. Long before this value of short-circuit current is reached the magnetic field would have disappeared by the demagnetizing force of the short-circuit current, that is, the motor would have lost its torque.

To limit the short-circuit current under the brush to a value not very greatly exceeding full-load current, thus requires a resistance of the lead, many times greater than that of the armature coil. The i^2r in the lead, and thus the heat produced in it, then, is many times greater than that in the armature coil. The space available for the resistance lead is, however, less than that available for the armature coil.

It is obvious herefrom that it is not feasible to build these resistance leads so that each lead can dissipate continuously, or even for any appreciable time, without rapid self-destruction, the heat produced in it while in circuit.

When the motor is revolving, even very slowly, this is not necessary, since each resistance lead is only a very short time in

circuit, during the moment when the armature coils connecting to it are short-circuited by the brushes; that is, if n_1 = number of armature turns from brush to brush, the lead is only $\frac{2}{n_1}$ of the time in circuit, and though excessive current densities in materials of high resistivity are used, the heating is moderate. In starting the motor, however, if it does not start instantly, the current continues to flow through the same resistance leads, and thus they are overheated and destroyed if the motor does not start promptly. Hence care has to be taken not to have such motors stalled for any appreciable time with voltage on.

The most serious objection to the use of high-resistance leads, therefore, is their liability to self-destruction by heating if the motor fails to start immediately, as for instance in a railway motor when putting the voltage on the motor before the brakes are released, as is done when starting on a steep up-grade to keep the train from starting to run back.

Thus the advantages of resistance commutator leads are the improvement in commutation resulting from the reduced short-circuit current, and the absence of a serious demagnetizing effect on the field at the moment of starting, which would result from an excessive short-circuit current under the brush, and such leads are therefore extensively used; their disadvantage, however, is that when they are used the motor must be sure to start immediately by the application of voltage, otherwise they are liable to be destroyed.

It is obvious that even with high-resistance commutator leads the commutation of the motor can not be as good as that of the motor on direct-current supply; that is, such an alternating-current motor inherently is more or less inferior in commutation to the direct-current motor, and to compensate for this effect far more favorable constants must be chosen in the motor design than permissible with a direct-current motor, that is, a lower voltage per commutator segment and lower magnetic flux per pole, hence a lower supply voltage on the armature, and thus a larger armature current and therewith a larger commutator, etc.

The insertion of reactance instead of resistance in the leads connecting the commutator segments with the armature coils of the single-phase motor also has been proposed and used for limiting the short-circuit current under the commutator brush.

Reactance has the advantage over resistance, that the voltage

consumed by it is wattless and therefore produces no serious heating and reactive leads of low resistance thus are not liable to self-destruction by heating if the motor fails to start immediately.

On account of the limited space available in the railway motor considerable difficulty, however, is found in designing sufficiently high reactances which do not saturate and thus decrease at larger currents.

At speed, reactance in the armature coils is very objectionable in retarding the reversal of current, and indeed one of the most important problems in the design of commutating machines is to give the armature coils the lowest possible reactance. Therefore, the insertion of reactance in the motor leads interferes seriously with the commutation of the motor at speed, and thus requires the use of a suitable commutating or reversing flux, that is, a magnetic field at the commutator brushes of sufficient strength to reverse the current, against the self-inductance of the armature coil, by means of an e.m.f. generated in the armature coil by its rotation. This commutating flux thus must be in phase with the main current, that is, a flux of overcompensation. Reactive leads require the use of a commutating flux of overcompensation to give fair commutation at speed.

Counter E.m.fs. in Commutated Coil

199. Theoretically, the correct way of eliminating the destructive effect of the short-circuit current under the commutator brush resulting from the e.m.f. of alternation of the main flux would be to neutralize the e.m.f. of alternation by an equal but opposite e.m.f. inserted into the armature coil or generated therein. Practically, however, at least with most motor types, considerable difficulty is met in producing such a neutralizing e.m.f. of the proper intensity as well as phase. Since the alternating current has not only an intensity but also a phase displacement, with an alternating-current motor the production of commutating flux or commutating voltage is more difficult than with direct-current motors in which the intensity is the only variable.

By introducing an external e.m.f. into the short-circuited coil under the brush it is not possible entirely to neutralize its e.m.f. of alternation, but simply to reduce it to one-half. Several such arrangements were developed in the early days by Eickemeyer,

for instance the arrangement shown in Fig. 170, which represents the development of a commutator. The commutator consists of alternate live segments, S , and dead segments, S' , that is, segments not connected to armature coils, and shown shaded in Fig. 170. Two sets of brushes on the commutator, the one, B_1 ,

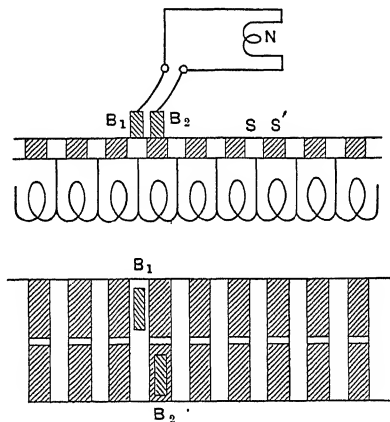

FIG. 170.—Commutation with external e.m.f.

ahead in position from the other, B_2 , by one commutator segment, and connected to the first by a coil, N , containing an e.m.f. equal in phase, but half in intensity, and opposite, to the e.m.f. of alternation of the armature coil; that is, if the armature coil contains a single turn, coil N is a half turn located in the main

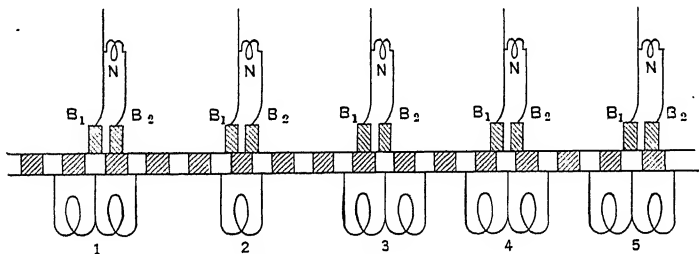

FIG. 171.—Commutation by external e.m.f.

field space; if the armature coil, A , contains m turns, $\frac{m}{2}$ turns in the main field space are used in coil, N . The dead segments, S' , are cut between the brushes, B_1 and B_2 , so as not to short-circuit between the brushes.

In this manner, during the motion of the brush over the com-

mutator, as shown by Fig. 171 in its successive steps, in position:

1. There is current through brush, B_1 ;
2. There is current through both brushes, B_1 and B_2 , and the armature coil, A , is closed by the counter e.m.f. of coil, N , that is, the difference, $A - N$, is short-circuited;
3. There is current through brush B_2 ;
4. There is current through both brushes, B_1 and B_2 , and the coil, N , is short-circuited;
5. The current enters again by brush B_1 ;

thus alternately the coil, N , of half the voltage of the armature coil, A , or the difference between A and N is short-circuited, that is, the short-circuit current reduced to one-half.

Complete elimination of the short-circuit current can be produced by generating in the armature coil an opposing e.m.f. This e.m.f. of neutralization, however, can not be generated by the alternation of the magnetic flux through the coil, as this would require a flux equal but opposite to the full field flux traversing the coil, and thus destroy the main field of the motor. The neutralizing e.m.f., therefore, must be generated by the rotation of the armature through the commutating field, and thus can occur only at speed; that is, neutralization of the short-circuit current is possible only when the motor is revolving, but not while at rest.

200. The e.m.f. of alternation in the armature coil short-circuited under the commutator brush is proportional to the main field, Φ , to the frequency, f , and is in quadrature with the main field, being generated by its rate of change; hence, it can be represented by

$$e_0 = 2 \pi f \Phi 10^{-8} j. \quad (17)$$

The e.m.f., e_1 , generated by the rotation of the armature coil through a commutating field, Φ' , is, however, in phase with the field which produces it; and since e_1 must be equal and in phase with e_0 to neutralize it, the commutating field, Φ' , therefore, must be in phase with e_0 , hence in quadrature with Φ ; that is, the commutating field, Φ' , of the motor must be in quadrature with the main field, Φ , to generate a neutralizing voltage, e_1 , of the proper phase to oppose the e.m.f. of alternation in the short-circuited coil. This e.m.f., e_1 , is proportional to its generating field, Φ' , and to the speed, or frequency of rotation, f_0 , hence is:

$$e_1 = 2 \pi f_0 \Phi' 10^{-8}, \quad (18)$$

and from $e_1 = e_0$ it then follows that:

$$\Phi' = j\Phi \frac{f}{f_0}; \quad (19)$$

that is, the commutating field of the single-phase motor must be in quadrature behind and proportional to the main field, proportional to the frequency and inversely proportional to the speed; hence, at synchronism, $f_0 = f$, the commutation field equals the main field in intensity, and, being displaced therefrom in quadrature both in time and in space, the motor thus must have a uniform rotating field, just as the induction motor.

Above synchronism, $f_0 > f$, the commutating field, Φ' , is less than the main field; below synchronism, however, $f_0 < f$, the commutating field must be greater than the main field to give complete compensation. It obviously is not feasible to increase the commutating field much beyond the main field, as this would require an increase of the iron section of the motor beyond that required to do the work, that is, to carry the main field flux. At standstill Φ' should be infinitely large, that is, compensation is not possible.

Hence, by the use of a commutating field in time and space quadrature, in the single-phase motor the short-circuit current under the commutator brushes resulting from the e.m.f. of alternation can be entirely eliminated at and above synchronism, and more or less reduced below synchronism, the more the nearer the speed is to synchronism, but no effect can be produced at standstill. In such a motor either some further method, as resistance leads, must be used to take care of the short-circuit current at standstill, or the motor designed so that its commutator can carry the short-circuit current for the small fraction of time when the motor is at standstill or running at very low speed.

The main field, Φ , of the series motor is approximately inversely proportional to the speed, f_0 , since the product of speed and field strength, $f_0\Phi$, is proportional to the e.m.f. of rotation, or useful e.m.f. of the motor, hence, neglecting losses and phase displacements, to the impressed e.m.f., that is, constant. Substituting therefore $\Phi = \frac{f}{f_0} \Phi_0$, where $\Phi_0 =$ main field at synchronism, into equation (19):

$$\Phi' = j\Phi_0 \left(\frac{f}{f_0}\right)^2; \quad (20)$$

that is, the commutating field is inversely proportional to the square of the speed; for instance, at double synchronism it should be one-quarter as high as at synchronism, etc.

201. Of the quadrature field, Φ' , only that part is needed for commutation which enters and leaves the armature at the position of the brushes; that is, instead of producing a quadrature field, Φ' , in accordance with equation (20), and distributed around the armature periphery in the same manner as the main field, Φ , but in quadrature position thereto, a local commutating field may be used at the brushes, and produced by a commutating pole or commutating coil, as shown diagrammatically in Fig. 172

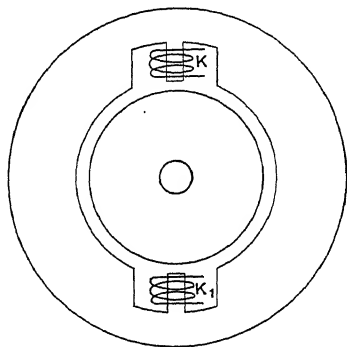

FIG. 172.—Commutation with commutating poles.

as K_1 and K . The excitation of this commutating coil, K , then would have to be such as to give a magnetic air-gap density \mathcal{B}' relative to that of the main field, \mathcal{B} , by the same equations (19) and (20):

$$\left. \begin{aligned} \mathcal{B}' &= j\mathcal{B} \frac{f}{f_0} \\ &= j\mathcal{B}_0 \left(\frac{f}{f_0} \right)^2 \end{aligned} \right\} \quad (21)$$

As the alternating flux of a magnetic circuit is proportional to the voltage which it consumes, that is, to the voltage impressed upon the magnetizing coil, and lags nearly 90° behind it, the magnetic flux of the commutating poles, K , can be produced by energizing these poles by an e.m.f. e , which is varied with the speed of the motor, by equation:

$$e = e_0 \left(\frac{f}{f_0} \right)^2, \quad (22)$$

where e_0 is its proper value at synchronism.

Since \mathcal{B}' lags 90° behind its supply voltage, e , and also lags 90° behind \mathcal{B} , by equation (2), and so behind the supply current and, approximately, the supply e.m.f. of the motor, the voltage, e , required for the excitation of the commutating poles is approximately in phase with the supply voltage of the motor; that is, a part thereof can be used, and is varied with the speed of the motor.

Perfect commutation, however, requires not merely the elimination of the short-circuit current under the brush, but requires a reversal of the load current in the armature coil during its passage under the commutator brush. To reverse the current, an e.m.f. is required proportional but opposite to the current and therefore with the main field; hence, to produce a reversing e.m.f. in the armature coil under the commutator brush a second commutating field is required, in phase with the main field and approximately proportional thereto.

The commutating field required by a single-phase commutator motor to give perfect commutation thus consists of a component in quadrature with the main field, or the neutralizing component, which eliminates the short-circuit current under the brush, and a component in phase with the main field, or the reversing component, which reverses the main current in the armature coil under the brush; and the resultant commutating field thus must lag behind the main field, and so approximately behind the supply voltage, by somewhat less than 90° , and have an intensity varying approximately inversely proportional to the square of the speed of the motor.

Of the different motor types discussed under IV, the series motors, 1 and 2, have no quadrature field, and therefore can be made to commute satisfactorily only by the use of commutator leads, or by the addition of separate commutating poles. The inverted repulsion motor, 3, has a quadrature field, which decreases with increase of speed, and therefore gives a better commutation than the series motors, though not perfect, as the quadrature field does not have quite the right intensity.

The repulsion motors, 4 and 5, have a quadrature field, lagging nearly 90° behind the main field, and thus give good commutation at those speeds at which the quadrature field has the right intensity for commutation. However, in the repulsion motor with secondary excitation, 5, the quadrature field is constant and independent of the speed, as constant supply voltage

is impressed upon the commutating winding, C , which produces the quadrature field, and in the direct repulsion motor, 4, the quadrature field increases with the speed, as the voltage consumed by the main field F decreases, and that left for the compensating winding, C , thus increases with the speed, while to give proper commutating flux it should decrease with the square of the speed. It thus follows that the commutation of the repulsion motors improves with increase of speed, up to that speed where the quadrature field is just right for commutating field—which is about at synchronism—but above this speed the commutation rapidly becomes poorer, due to the quadrature field being far in excess of that required for commutating.

In the series repulsion motors, 6 and 7, a quadrature field also exists, just as in the repulsion motors, but this quadrature field depends upon that part of the total voltage which is impressed upon the commutating winding, C , and thus can be varied by varying the distribution of supply voltage between the two circuits; hence, in this type of motor, the commutating flux can be maintained through all (higher) speeds by impressing the total voltage upon the compensating circuit and short-circuiting the armature circuit for all speeds up to that at which the required commutating flux has decreased to the quadrature flux given by the motor, and from this speed upward only a part of the supply voltage, inversely proportional (approximately) to the square of the speed, is impressed upon the compensating circuit, the rest shifted over to the armature circuit. The difference between 6 and 7 is that in 6 the armature circuit is more inductive, and the quadrature flux therefore lags less behind the main flux than in 7, and by thus using more or less of the field coil in the armature circuit its inductivity can be varied, and therewith the phase displacement of the quadrature flux against the main flux adjusted from nearly 90° lag to considerably less lag, hence not only the proper intensity but also the exact phase of the required commutating flux produced.

As seen herefrom, the difference between the different motor types of IV is essentially found in their different actions regarding commutation.

It follows herefrom that by the selection of the motor-type quadrature fluxes, Φ_1 , can be impressed upon the motor, as commutating flux, of intensities and phase displacements against the main flux, Φ , varying over a considerable range. The main

advantage of the series-repulsion motor type is the possibility which this type affords, of securing the proper commutating field at all speeds down to that where the speed is too low to induce sufficient voltage of neutralization at the highest available commutating flux.

VI. Motor Characteristics

202. The single-phase commutator motor of varying speed or series characteristic comprises three circuits, the armature, the compensating winding, and the field winding, which are connected in series with each other, directly or indirectly.

The impressed e.m.f. or supply voltage of the motor then consists of the components:

1. The e.m.f. of rotation, e_1 , or voltage generated in the armature conductors by their rotation through the magnetic field, Φ . This voltage is in phase with the field, Φ , and therefore approximately with the current, i , that is, is power e.m.f., and is the voltage which does the useful work of the motor. It is proportional to the speed or frequency of rotation, f_0 , to the field strength, Φ , and to the number of effective armature turns, n_1 .

$$e_1 = 2 \pi f_0 n_1 \Phi 10^{-8}. \quad (23)$$

The number of effective armature turns, n_1 , with a distributed winding, is the projection of all the turns on their resultant direction. With a full-pitch winding of n series turns from brush to brush, the effective number of turns thus is:

$$n_1 = m [\text{avg } \cos]_{-\frac{\pi}{2}}^{+\frac{\pi}{2}} = \frac{2}{\pi} m. \quad (24)$$

With a fractional-pitch winding of the pitch of τ degrees, the effective number of turns is:

$$n_1 = m \frac{\tau}{\pi} [\text{avg } \cos]_{-\frac{\tau}{2}}^{+\frac{\tau}{2}} = \frac{2}{\pi} m \sin \frac{\tau}{2}. \quad (25)$$

2. The e.m.f. of alternation of the field, e_0 , that is, the voltage generated in the field turns by the alternation of the magnetic flux, Φ , produced by them and thus enclosed by them. This voltage is in quadrature with the field flux, Φ , and thus approximately with the current I , is proportional to the frequency of the

impressed voltage, f , to the field strength, Φ , and to the number of field turns, n_0 .

$$e_0 = 2j\pi fn_0\Phi 10^{-8}. \quad (26)$$

3. The impedance voltage of the motor:

$$e' = IZ \quad (27)$$

and:

$$Z = r + jx,$$

where r = total effective resistance of field coils, armature with commutator and brushes, and compensating winding, x = total self-inductive reactance, that is, reactance of the leakage flux of armature and compensating winding—or the stray flux passing locally between the armature and the compensating conductors—plus the self-inductive reactance of the field, that is, the reactance due to the stray field or flux passing between field coils and armature.

In addition hereto, x comprises the reactance due to the quadrature magnetic flux of incomplete compensation or overcompensation, that is, the voltage generated by the quadrature flux, Φ' , in the difference between armature and compensating conductors, $n_1 - n_2$ or $n_2 - n_1$.

Therefore the total supply voltage, E , of the motor is:

$$E = e_1 + e_0 + e' \\ = 2\pi f n_1 \Phi 10^{-8} + 2j\pi f n_1 \Phi 10^{-8} + (r + jx) I. \quad (28)$$

Let, then, R = magnetic reluctance of field circuit, thus $\Phi = \frac{n_0 I}{R}$ = the magnetic field flux, when assuming this flux as in phase with the excitation I , and denoting:

$$\frac{2\pi f n_0^2 10^{-8}}{R} = x_0 \quad (30)$$

as the effective reactance of field inductance, corresponding to the e.m.f. of alternation:

$$\left. \begin{aligned} S &= \frac{f_0}{f} = \text{ratio of speed to frequency, or speed} \\ &\quad \text{as fraction of synchronism,} \\ c &= \frac{n_1}{n_0} = \text{ratio of effective armature turns to} \\ &\quad \text{field turns;} \end{aligned} \right\} \quad (31)$$

substituting (30) and (31) in (28):

$$\begin{aligned} E &= cSx_0I + jx_0I + (r + jx) I \\ &= [(r + cSx_0) + j(x + x_0)] I; \end{aligned} \tag{32}$$

or:

$$I = \frac{E}{(r + cSx_0) + j(x + x_0)}, \tag{33}$$

and, in absolute values:

$$i = \frac{e}{\sqrt{(r + cSx_0)^2 + (x + x_0)^2}}. \tag{34}$$

The power-factor is given by:

$$\tan \theta = \frac{x + x_0}{r + cSx}. \tag{35}$$

The useful work of the motor is done by the e.m.f. of rotation:

$$E_1 = cSx_0I,$$

and, since this e.m.f., E_1 , is in phase with the current, I , the useful work, or the motor output (inclusive friction, etc.), is:

$$\begin{aligned} P &= E_1I = cSx_0i^2 \\ &= \frac{cSx_0e^2}{(r + cSx_0)^2 + (x + x_0)^2}, \end{aligned} \tag{36}$$

and the torque of the motor is:

$$\begin{aligned} D &= \frac{P}{S} = cx_0i^2 \\ &= \frac{cx_0e^2}{(r + cSx_0)^2 + (x + x_0)^2}. \end{aligned} \tag{37}$$

For instance, let:

$$e = 200 \text{ volts, } c = \frac{n_1}{n_0} = 4,$$

$$Z = r + jx = 0.02 + 0.06 j, x_0 = 0.08;$$

then.

$$i = \frac{10,000}{\sqrt{(1 + 16 S)^2 + 49}} \text{ amp.},$$

$$\cot \theta = \frac{1 + 16 S}{7},$$

$$P = \frac{32,000 S}{(1 + 16 S)^2 + 49} \text{ kw.},$$

$$D = \frac{32,000}{(1 + 16 S)^2 + 49} \text{ svn. kw.}$$

203. The behavior of the motor at different speeds is best shown by plotting i , $p = \cos \theta$, P and D as ordinates with the speed, S , as abscissæ, as shown in Fig. 173.

In railway practice, by a survival of the practice of former times, usually the constants are plotted with the current, I , as abscissæ, as shown in Fig. 174, though obviously this arrangement does not as well illustrate the behavior of the motor.

Graphically, by starting with the current, I , as zero axis, OI , the motor diagram is plotted in Fig. 175.

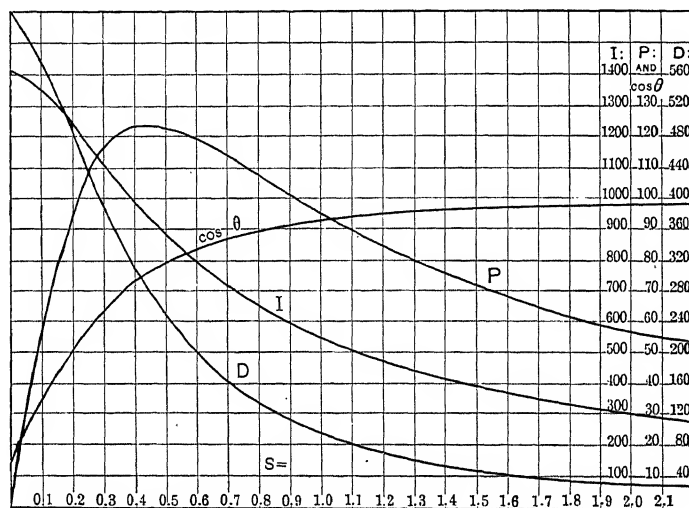

FIG. 173.—Single-phase commutator-motor speed characteristics.

The voltage consumed by the resistance, r , is $\overline{OE}_r = ir$, in phase with \overline{OI} ; the voltage consumed by the reactance, x , is $\overline{OE}_x = ix$, and 90° ahead of \overline{OI} . \overline{OE}_r and \overline{OE}_x combine to the voltage consumed by the motor impedance, $\overline{OE}' = iz$.

Combining $\overline{OE}' = iz$, $\overline{OE}_1 = e_1$, and $\overline{OE}_0 = e_0$ thus gives the terminal voltage, $\overline{OE} = e$, of the motor, and the phase angle, $\angle EOI = \theta$.

In this diagram, and in the preceding approximate calculation, the magnetic flux, Φ , has been assumed in phase with the current, I .

In reality, however, the equivalent sine wave of magnetic flux, Φ , lags behind the equivalent sine wave of exciting current, I , by the angle of hysteresis lag, and still further by the power

consumed by eddy currents, and, especially in the commutator motor, by the power consumed in the short-circuit current under the brushes, and the vector, $\overline{O\Phi}$, therefore is behind the current vector, \overline{OI} , by an angle α , which is small in a motor in which the short-circuit current under the brushes is eliminated and the eddy currents are negligible, but may reach considerable values in the motor of poor commutation.

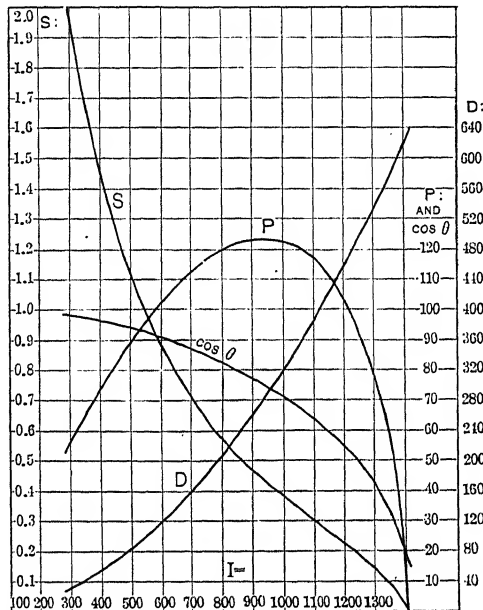

FIG. 174.—Single-phase commutator-motor current characteristics.

Assuming then, in Fig. 176, $\overline{O\Phi}$ lagging behind \overline{OI} by angle α , \overline{OE}_1 is in phase with $\overline{O\Phi}$, hence lagging behind \overline{OI} ; that is, the e.m.f. of rotation is not entirely a power e.m.f., but contains a wattless lagging component. The e.m.f. of alternation, \overline{OE}_0 , is 90° ahead of $\overline{O\Phi}$, hence less than 90° ahead of \overline{OI} , and therefore contains a power component representing the power consumed by hysteresis, eddy currents, and the short-circuit current under the brushes.

Completing now the diagram, it is seen that the phase angle, θ , is reduced, that is, the power-factor of the motor increased by

the increased loss of power, but is far greater than corresponding thereto. It is the result of the lag of the e.m.f. of rotation, which produces a lagging e.m.f. component partially compensating for the leading e.m.f. consumed by self-inductance, a lag of the e.m.f. being equivalent to a lead of the current.

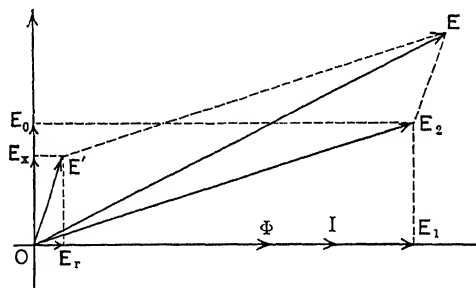

FIG. 175.—Single-phase commutator-motor vector diagram.

As the result of this feature of a lag of the magnetic flux, Φ , by producing a lagging e.m.f. of rotation and thus compensating for the lag of current by self-inductance, single-phase motors having poor commutation usually have better power-factors, and

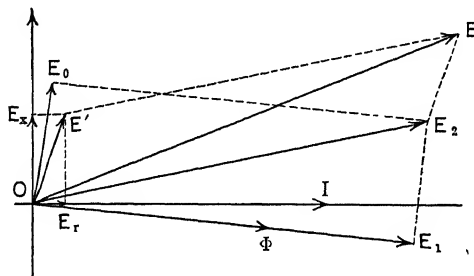

FIG. 176.—Single-phase commutator-motor diagram with phase displacement between flux and current.

improvement in commutation, by eliminating or reducing the short-circuit current under the brush, usually causes a slight decrease in the power-factor, by bringing the magnetic flux, Φ , more nearly in phase with the current, I .

204. Inversely, by increasing the lag of the magnetic flux, Φ , the phase angle can be decreased and the power-factor improved. Such a shift of the magnetic flux, Φ , behind the supply current, i , can be produced by dividing the current, i , into components, i'

and i'' , and using the lagging component for field excitation. This is done most conveniently by shunting the field by a non-inductive resistance. Let r_0 be the non-inductive resistance in shunt with the field winding, of reactance, $x_0 + x_1$, where x_1 is

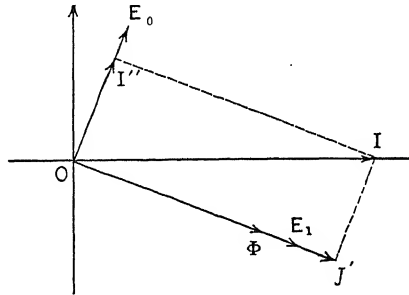

FIG. 177.—Single-phase commutator-motor improvement of power-factor by introduction of lagging e.m.f. of rotation.

that part of the self-inductive reactance, x , due to the field coils. The current, i' , in the field is lagging 90° behind the current, i'' , in a non-inductive resistance, and the two currents have the ratio $i' = \frac{r_0}{x_0 + x_1} i''$; hence, dividing the total current, \overline{OI} , in this proportion into the two quadrature components, $\overline{OI'}$ and $\overline{OI''}$,

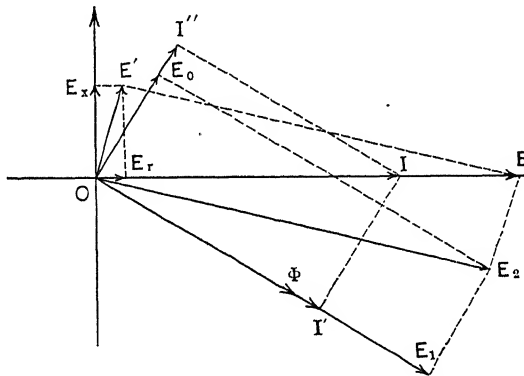

FIG. 178.—Single-phase commutator motor. Unity power-factor produced by lagging e.m.f. of rotation.

in Fig. 177, gives the magnetic flux, $\overline{O\Phi}$, in phase with $\overline{OI'}$, and so lagging behind \overline{OI} , and then the e.m.f. of rotation is $\overline{OE_1}$, the e.m.f. of alternation $\overline{OE_0}$, and combining $\overline{OE_1}$, $\overline{OE_0}$, and $\overline{OE'}$

gives the impressed e.m.f., \overline{OE} , nearer in phase to \overline{OI} than with $\overline{O\Phi}$ in phase with \overline{OI} .

In this manner, if the e.m.fs. of self-inductance are not too large, unity power-factor can be produced, as shown in Fig. 178.

Let \overline{OI} = total current, $\overline{OE'}$ = impedance voltage of the motor, \overline{OE} = impressed e.m.f. or supply voltage, and assumed in phase with \overline{OI} . \overline{OE} then must be the resultant of $\overline{OE'}$ and of $\overline{OE_2}$, the voltage of rotation plus that of alternation, and resolving therefore $\overline{OE_2}$ into two components, $\overline{OE_1}$ and $\overline{OE_0}$, in quadra-

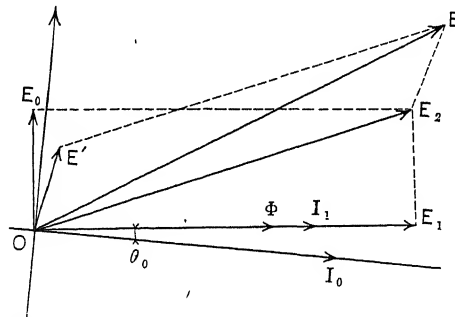

FIG. 179.—Single-phase commutator-motor diagram with secondary excitation.

ture with each other, and proportional respectively to the e.m.f. of rotation and the e.m.f. of alternation, gives the magnetic flux, $\overline{O\Phi}$, in phase with the e.m.f. of rotation, $\overline{OE_1}$, and the component of current in the field, $\overline{OI'}$, and in the non-inductive resistance, $\overline{OI''}$, in phase and in quadrature respectively with $\overline{O\Phi}$, which combined make up the total current. The projection of the e.m.f. of rotation $\overline{OE_1}$ on \overline{OI} then is the power component of the e.m.f., which does the work of the motor, and the quadrature projection of, $\overline{OE_1}$, is the compensating component of the e.m.f. of rotation, which neutralizes the wattless component of the e.m.f. of self-inductance.

Obviously such a compensation involves some loss of power in the non-inductive resistance, r_0 , shunting the field coils, and as the power-factor of the motor usually is sufficiently high, such compensation is rarely needed.

In motors in which some of the circuits are connected inductively in series with the others the diagram is essentially the same, except

that a phase displacement exists between the secondary and the primary current. The secondary current, I_1 , of the transformer lags behind the primary current, I_0 , slightly less than 180° ; that is, considered in opposite direction, the secondary current leads the primary by a small angle, θ_0 , and in the motors with secondary excitation the field flux, Φ , being in phase with the field current, I_1 (or lagging by angle α behind it), thus leads the primary current, I_0 , by angle θ_0 (or angle $\theta_0 - \alpha$). As a lag of the magnetic flux Φ increases, and a lead thus decreases the power-factor, motors with secondary field excitation usually have a slightly

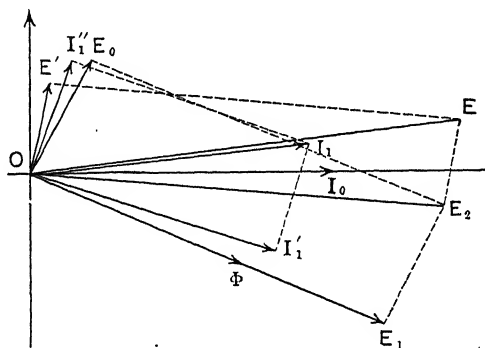

Fig. 180.—Single-phase commutator motor with secondary excitation power-factor improved by shunting field winding with non-inductive circuit.

lower power-factor than motors with primary field excitation, and therefore, where desired, the power-factor may be improved by shunting the field with a non-inductive resistance, r_0 . Thus for instance, if, in Fig. 179, OI_0 = primary current, OI_1 = secondary current, OE_1 , in phase with OI_1 , is the e.m.f. of rotation, in the case of the secondary field excitation, and OE_0 , in quadrature ahead of OI_1 , is the e.m.f. of alternation, while OE' is the impedance voltage, and OE_1 , OE_0 and OE' combined give the supply voltage, OE , and $EOI = \theta$ the angle of lag.

Shunting the field by a non-inductive resistance, r_0 , and thus resolving the secondary current OI_1 into the components OI'_1 in the field and OI''_1 in the non-inductive resistance, gives the diagram Fig. 180, where $\alpha = I'_1 O \Phi$ = angle of lag of magnetic field.

205. The action of the commutator in an alternating-current motor, in permitting compensation for phase displacement and thus allowing a control of the power-factor, is very interesting and important, and can also be used in other types of machines, as induction motors and alternators, by supplying these machines with a commutator for phase control.

A lag of the current is the same as a lead of the e.m.f., and inversely a leading current inserted into a circuit has the same effect as a lagging e.m.f. inserted. The commutator, however, produces an e.m.f. in phase with the current. Exciting the field by a lagging current in the field, a lagging e.m.f. of rotation is produced which is equivalent to a leading current. As it is easy to produce a lagging current by self-inductance, the commutator thus affords an easy means of producing the equivalent of a leading current. Therefore, the alternating-current commutator is one of the important methods of compensating for lagging currents. Other methods are the use of electrostatic or electrolytic condensers and of overexcited synchronous machines.

Based on this principle, a number of designs of induction motors and other apparatus have been developed, using the commutator for neutralizing the lagging magnetizing current and the lag caused by self-inductance, and thereby producing unity power-factor or even leading currents. So far, however, none of them has come into extended use.

This feature, however, explains the very high power-factors feasible in single-phase commutator motors even with considerable air gaps, far larger than feasible in induction motors.

VII. Efficiency and Losses

206. The losses in single-phase commutator motors are essentially the same as in other types of machines:

(a) Friction losses—air friction or windage, bearing friction and commutator brush friction, and also gear losses or other mechanical transmission losses.

(b) Core losses, as hysteresis and eddy currents. These are of two classes—the alternating core loss, due to the alternation of the magnetic flux in the main field, quadrature field, and armature and the rotating core loss, due to the rotation of the armature; through the magnetic field. The former depends upon the frequency, the latter upon the speed.

(c) Commutation losses, as the power consumed by the short-

circuit current under the brush, by arcing and sparking, where such exists.

(d) i^2r losses in the motor circuits—the field coils, the compensating winding, the armature and the brush contact resistance.

(e) Load losses, mainly represented by an effective resistance, that is, an increase of the total effective resistance of the motor beyond the ohmic resistance.

Driving the motor by mechanical power and with no voltage on the motor gives the friction and the windage losses, exclusive of commutator friction, if the brushes are lifted off the commutator, inclusive, if the brushes are on the commutator. Energizing now the field by an alternating current of the rated frequency, with the commutator brushes off, adds the core losses to the friction losses; the increase of the driving power then measures the rotating core loss, while a wattmeter in the field exciting circuit measures the alternating core loss.

Thus the alternating core loss is supplied by the impressed electric power, the rotating core loss by the mechanical driving power.

Putting now the brushes down on the commutator adds the commutation losses.

The ohmic resistance gives the i^2r losses, and the difference between the ohmic resistance and the effective resistance, calculated from wattmeter readings with alternating current in the motor circuits at rest and with the field unexcited, represents the load losses.

However, the different losses so derived have to be corrected for their mutual effect. For instance, the commutation losses are increased by the current in the armature; the load losses are less with the field excited than without, etc.; so that this method of separately determining the losses can give only an estimate of their general magnitude, but the exact determination of the efficiency is best carried out by measuring electric input and mechanical output.

VIII. Discussion of Motor Types

207. Varying-speed single-phase commutator motors can be divided into two classes, namely, compensated series motors and repulsion motors. In the former, the main supply current is through the armature, while in the latter the armature is closed upon itself as secondary circuit; with the compensating winding

as primary or supply circuit. As the result hereof the repulsion motors contain a transformer flux, in quadrature position to the main flux, and lagging behind it, while in the series motors no such lagging quadrature flux exists, but in quadrature position to the main flux, the flux either is zero—complete compensation—or in phase with the main flux—over- or undercompensation.

A. Compensated Series Motors

Series motors give the best power-factors, with the exception of those motors in which by increasing the lag of the field flux a compensation for power-factor is produced, as discussed in V. The commutation of the series motor, however, is equally poor at all speeds, due to the absence of any commutating flux, and with the exception of very small sizes such motors therefore are inoperative without the use of either resistance leads or commutating poles. With high-resistance leads, however, fair operation is secured, though obviously not of the same class with that of the direct-current motor; with commutating poles or coils producing a local quadrature flux at the brushes good results have been produced abroad.

Of the two types of compensation, conductive compensation, 1, with the compensating winding connected in series with the armature, and inductive compensation, 2, with the compensated winding short-circuited upon itself, inductive compensation necessarily is always complete or practically complete compensation, while with conductive compensation a reversing flux can be produced at the brushes by overcompensation, and the commutation thus somewhat improved, especially at speed, at the sacrifice, however, of the power-factor, which is lowered by the increased self-inductance of the compensating winding. On the short-circuit current under the brushes, due to the e.m.f. of alternation, such overcompensation obviously has no helpful effect. Inductive compensation has the advantage that the compensating winding is not connected with the supply circuit, can be made of very low voltage, or even of individually short-circuited turns, and therefore larger conductors and less insulation used, which results in an economy of space, and therewith an increased output for the same size of motor. Therefore inductive compensation is preferable where it can be used. It is not permissible, however, in motors which are required to operate also on direct current, since with direct-current supply no induction takes place

and therefore the compensation fails, and with the high ratio of armature turns to field turns, without compensation, the field distortion is altogether too large to give satisfactory commutation, except in small motors.

The inductively compensated series motor with secondary excitation, or inverted repulsion motor, 3, takes an intermediary position between the series motors and the repulsion motors; it is a series motor in so far as the armature is in the main supply circuit, but magnetically it has repulsion-motor characteristics, that is, contains a lagging quadrature flux. As the field excitation consumes considerable voltage, when supplied from the compensating winding as secondary circuit, considerable voltage must be generated in this winding, thus giving a corresponding transformer flux. With increasing speed and therewith decreasing current, the voltage consumed by the field coils decreases, and therewith the transformer flux which generates this voltage. Therefore, the inverted repulsion motor contains a transformer flux which has approximately the intensity and the phase required for commutation; it lags behind the main flux, but less than 90° , thus contains a component in phase with the main flux, as reversing flux, and decreases with increase of speed. Therefore, the commutation of the inverted repulsion motor is very good, far superior to the ordinary series motor, and it can be operated without resistance leads; it has, however, the serious objection of a poor power-factor, resulting from the lead of the field flux against the armature current, due to the secondary excitation, as discussed in V. To make such a motor satisfactory in power-factor requires a non-inductive shunt across the field, and thereby a waste of power. For this reason it has not come into commercial use.

B. Repulsion Motors

208. Repulsion motors are characterized by a lagging quadrature flux, which transfers the power from the compensating winding to the armature. At standstill, and at very low speeds, repulsion motors and series motors are equally unsatisfactory in commutation; while, however, in the series motors the commutation remains bad (except when using commutating devices), in the repulsion motors with increasing speed the commutation rapidly improves, and becomes perfect near synchronism. As the result hereof, under average conditions a much inferior com-

mutation can be allowed in repulsion motors at very low speeds than in series motors, since in the former the period of poor commutation lasts only a very short time. While, therefore, series motors can not be satisfactorily operated without resistance leads (or commutating poles), in repulsion motors resistance leads are not necessary and not used, and the excessive current density under the brushes in the moment of starting permitted, as it lasts too short a time to cause damage to the commutator.

As the transformer field of the repulsion motor is approximately constant, while the proper commutating field should decrease with the square of the speed, above synchronism the transformer field is too large for commutation, and at speeds considerably above synchronism—50 per cent. and more—the repulsion motor becomes inoperative because of excessive sparking. At synchronism, the magnetic field of the repulsion motor is a rotating field, like that of the polyphase induction motor.

Where, therefore, speeds far above synchronism are required, the repulsion motor can not be used; but where synchronous speed is not much exceeded the repulsion motor is preferred because of its superior commutation. Thus when using a commutator as auxiliary device for starting single-phase induction motors the repulsion-motor type is used. For high frequencies, as 60 cycles, where peripheral speed forbids synchronism being greatly exceeded, the repulsion motor is the type to be considered.

Repulsion motors also may be built with primary and secondary excitation. The latter usually gives a better commutation, because of the lesser lag of the transformer flux, and therefore with a greater in-phase component, that is, greater reversing flux, especially at high speeds. Secondary excitation, however, gives a slightly lower power-factor.

A combination of the repulsion-motor and series-motor types is the series repulsion motor, 6 and 7. In this only a part of the supply voltage is impressed upon the compensating winding and thus transformed to the armature, while the rest of the supply voltage is impressed directly upon the armature, just as in the series motor. As result thereof the transformer flux of the series repulsion motor is less than that of the repulsion motor, in the same proportion in which the voltage impressed upon the compensating winding is less than the total supply voltage. Such a motor, therefore, reaches equality of the transformer flux with the commutating flux, and gives perfect commutation at a

higher speed than the repulsion motor, that is, above synchronism. With the total supply voltage impressed upon the compensating winding, the transformer flux equals the commutating flux at synchronism. At n times synchronous speed the commutating flux should be $\frac{1}{n^2}$ of what it is at synchronism, and by impressing $\frac{1}{n^2}$ of the supply voltage upon the compensating winding, the rest on the armature, the transformer flux is reduced to $\frac{1}{n^2}$ of its value, that is, made equal to the required commutating flux at n times synchronism.

In the series repulsion motor, by thus gradually shifting the supply voltage from the compensating winding to the armature and thereby reducing the transformer flux, it can be maintained equal to the required commutating flux at all speeds from synchronism upward; that is, the series repulsion motor arrangement permits maintaining the perfect commutation, which the repulsion motor has near synchronism, for all higher speeds.

With regard to construction, no essential difference exists between the different motor types, and any of the types can be operated equally well on direct current by connecting all three circuits in series. In general, the motor types having primary and secondary circuits, as the repulsion and the series repulsion motors, give a greater flexibility, as they permit winding the circuits for different voltages, that is, introducing a ratio of transformation between primary and secondary circuit. Shifting one motor element from primary to secondary, or inversely, then gives the equivalent of a change of voltage or change of turns. Thus a repulsion motor in which the stator is wound for a higher voltage, that is, with more turns, than the rotor or armature, when connecting all the circuits in series for direct-current operation, gives a direct-current motor having a greater field excitation compared with the armature reaction, that is, the stronger field which is desirable for direct-current operating but not permissible with alternating current.

209. In general, the constructive differences between motor types are mainly differences in connection of the three circuits. For instance, let F = field circuit, A = armature circuit, C = compensating circuit, T = supply transformer, R = resistance used in starting and at very low speeds. Connecting, in Fig. 181, the armature, A , between field F and compensating winding, C .

With switch 0 open the starting resistance is in circuit; closing switch 0 short-circuits the starting resistance and gives the running conditions of the motor.

With all the other switches open the motor is a conductively compensated series motor.

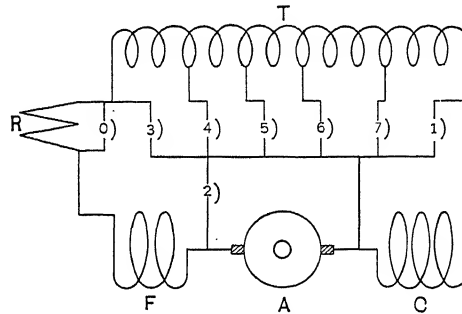

FIG. 181.—Alternating-current commutator motor arranged to operate either as series or repulsion motor.

Closing 1 gives the inductively compensated series motor.

Closing 2 gives the repulsion motor with primary excitation.

Closing 3 gives the repulsion motor with secondary excitation.

Closing 4 or 5 or 6 or 7 gives the successive speed steps of the series repulsion motor with armature excitation.

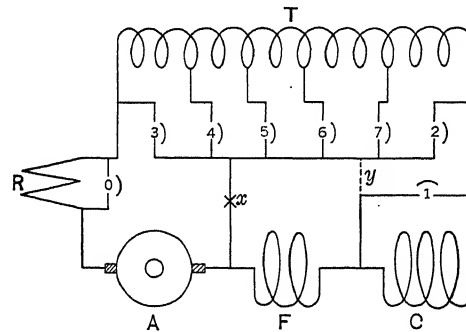

FIG. 182.—Alternating-current commutator motor arranged to operate either as series or repulsion motor.

Connecting, in Fig. 182, the field, *F*, between armature, *A*, and compensating winding, *C*, the resistance, *R*, is again controlled by switch 0.

All other switches open gives the conductively compensated series motor.

Switch 1 closed gives the inductively compensated series motor.

Switch 2 closed gives the inductively compensated series motor with secondary excitation, or inverted repulsion motor.

Switch 3 closed gives the repulsion motor with primary excitation.

Switches 4 to 7 give the different speed steps of the series repulsion motor with primary excitation.

Opening the connection at x and closing at y (as shown in dotted line), the steps 3 to 7 give respectively the repulsion motor with secondary excitation and the successive steps of the series repulsion motor with armature excitation.

Still further combinations can be produced in this manner, as for instance, in Fig. 181, by closing 2 and 4, but leaving 0 open, the field, F , is connected across a constant-potential supply, in series with resistance, R , while the armature also receives constant voltage, and the motor then approaches a finite speed, that is, has shunt motor characteristic, and in starting, the main field, F , and the quadrature field, AC , are displaced in phase, so give a rotating or polyphase field (unsymmetrical).

To discuss all these motor types with their in some instances very interesting characteristics obviously is not feasible. In general, they can all be classified under series motor, repulsion motor, shunt motor, and polyphase induction motor, and combinations thereof.

IX. Other Commutator Motor

210. Single-phase commutator motors have been developed as varying-speed motors for railway service. In other directions commutators have been applied to alternating-current motors and such motors developed:

(a) For limited speed, or of the shunt-motor type, that is, motors of similar characteristic as the single-phase railway motor, except that the speed does not indefinitely increase with decreasing load but approaches a finite no-load value. Several types of such motors have been developed, as stationary motors for elevators, variable-speed machinery, etc., usually of the single-phase type.

By impressing constant voltage upon the field the magnetic field flux is constant, and the speed thus reaches a finite limiting value at which the e.m.f. of rotation of the armature through

the constant field flux consumes the impressed voltage of the armature. By changing the voltage supply to the field different speeds can be produced, that is, an adjustable-speed motor. The main problem in the design of such motors is to get the field excitation in phase with the armature current and thus produce a good power-factor.

(b) Adjustable-speed polyphase induction motors. In the secondary of the polyphase induction motor an e.m.f. is generated which, at constant impressed e.m.f. and therefore approximately constant flux, is proportional to the slip from synchronism. With short-circuited secondary the motor closely approaches synchronism. Inserting resistance into the secondary reduces the speed by the voltage consumed in the secondary. As this is proportional to the current and thus to the load, the speed control of the polyphase induction motor by resistance in the secondary gives a speed which varies with the load, just as the speed control of a direct-current motor by resistance in the armature circuit; hence, the speed is not constant, and the operation at lower speeds inefficient. Inserting, however, a constant voltage into the secondary of the induction motor the speed is decreased if this voltage is in opposition, and is increased if this voltage is in the same direction as the secondary generated e.m.f., and in this manner a speed control can be produced. If c = voltage inserted into the secondary, as fraction of the voltage which would be induced in it at full frequency by the rotating field, then the polyphase induction motor approaches at no-load and runs at load near to the speed $(1 - c)$ or $(1 + c)$ times synchronism, depending upon the direction of the inserted voltage.

Such a voltage inserted into the induction-motor secondary must, however, have the frequency of the motor secondary currents, that is, of slip, and therefore can be derived from the full-frequency supply circuit only by a commutator revolving with the secondary. If cf is the frequency of slip, then $(1 - c)f$ is the frequency of rotation, and thus the frequency of commutation, and at frequency, f , impressed upon the commutator the effective frequency of the commutated current is $f - (1 - c)f = cf$, or the frequency of slip, as required.

Thus the commutator affords a means of inserting voltage into the secondary of induction motors and thus varying its speed.

However, while these commutated currents in their resultant

give the effect of the frequency of slip, they actually consist of sections of waves of full frequency, that is, meet the full stationary impedance in the rotor secondary, and not the very much lower impedance of the low-frequency currents in the ordinary induction motor.

If, therefore, the brushes on the commutator are set so that the inserted voltage is in phase with the voltage generated in the secondary, the power-factor of the motor is very poor. Shifting the brushes, by a phase displacement between the generated and the inserted voltage, the secondary currents can be made to lead, and thereby compensate for the lag due to self-inductance and unity power-factor produced. This, however, is the case only at one definite load, and at all other loads either overcompensation or undercompensation takes place, resulting in poor power-factor, either lagging or leading. Such a polyphase adjustable-speed motor thus requires shifting of the brushes with the load or other adjustment, to maintain reasonable power-factor, and for this reason has not been used.

(c) Power-factor compensation. The production of an alternating magnetic flux requires wattless or reactive volt-amperes, which are proportional to the frequency. Exciting an induction motor not by the stationary primary but by the revolving secondary, which has the much lower frequency of slip, reduces the volt-amperes excitation in the proportion of full frequency to frequency of slip, that is, to practically nothing. This can be done by feeding the exciting current into the secondary by commutator. If the secondary contains no other winding but that connected to the commutator, the motor gives a poor power-factor. If, however, in addition to the exciting winding, fed by the commutator, a permanently short-circuited winding is used, as a squirrel-cage winding, the exciting impedance of the former is reduced to practically nothing by the short-circuit winding coincident with it, and so by overexcitation unity power-factor or even leading current can be produced. The presence of the short-circuited winding, however, excludes this method from speed control, and such a motor (Heyland motor) runs near synchronism just as the ordinary induction motor, differing merely by the power-factor. Regarding hereto see Chapter on "Induction Motors with Secondary Excitation."

This method of excitation by feeding the alternating current through a commutator into the rotor has been used very success-

fully abroad in the so-called "compensated repulsion motor" of Winter-Eichberg. This motor differs from the ordinary repulsion motor merely by the field coil, *F*, in Fig. 183 being replaced by a set of exciting brushes, *G*, in Fig. 184, at right angles to the main brushes of the armature, that is, located so that the m.m.f. of the current between the brushes, *G*, magnetizes in the same

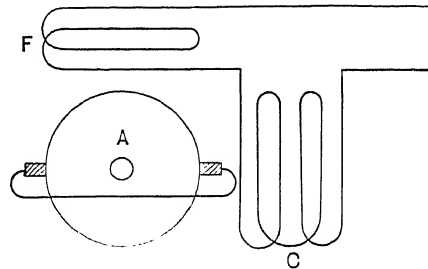

FIG. 183.—Plain repulsion motor.

direction as the field coils, *F*, in Fig. 183. Usually the exciting brushes are supplied by a transformer or autotransformer, so as to vary the excitation and thereby the speed.

This arrangement then lowers the e.m.f. of self-inductance of field excitation of the motor from that corresponding to full fre-

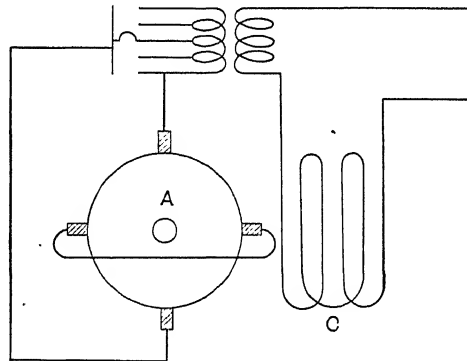

FIG. 184.—Winter-Eichberg motor.

quency in the ordinary repulsion motor to that of the frequency of slip, hence to a negative value above synchronism; so that hereby a compensation for lagging current can be produced above synchronism, and unity power-factor or even leading currents produced.

211. *Theoretical Investigation.*—In its most general form, the single-phase commutator motor, as represented by Fig. 185, comprises: two armature or rotor circuits in quadrature with each other, the *main*, or *energy*, and the *exciting* circuit of the armature where such exists, which by a multisegmental commutator are connected to two sets of brushes in quadrature position with each other. These give rise to two short-circuits, also in quadrature position with each other and caused respectively by the main and by the exciting brushes. Two stator circuits, the

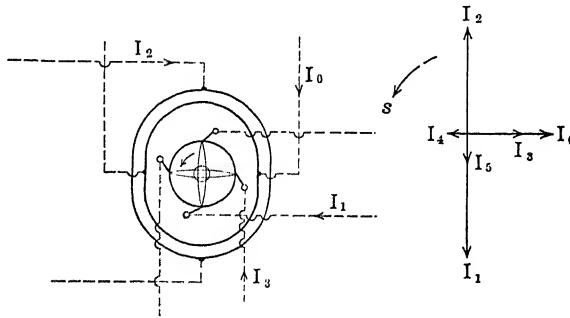

FIG. 185.

field, or exciting, and the cross, or compensating circuit, also in quadrature with each other, and in line respectively with the exciting and the main armature circuit.

These circuits may be separate, or may be parts or components of the same circuit. They may be massed together in a single slot of the magnetic structure, or may be distributed over the whole periphery, as frequently done with the armature windings, and then as their effective number of turns must be considered their vector resultant, that is:

$$n = \frac{2}{\pi} n' ;$$

where n' = actual number of turns in series between the armature brushes, and distributed over the whole periphery, that is, an arc of 180° electrical. Or the windings of the circuit may be distributed only over an arc of the periphery of angle, ω , as frequently the case with the compensating winding distributed in the pole face of pole arc, ω ; or with fractional-pitch armature windings of pitch, ω . In this case, the effective number of turns

is:

$$n = \frac{2}{\omega} n' \sin \frac{\omega}{2}$$

where n' with a fractional-pitch armature winding is the number of series turns in the pitch angle, ω , that is:

$$n' = \frac{\omega}{\pi} n'',$$

n'' being the number of turns in series between the brushes, since in the space $(\pi - \omega)$ outside of the pitch angle the armature conductors neutralize each other, that is, conductors carrying current in opposite direction are superposed upon each other. See fractional-pitch windings, chapter "Commutating Machine," "Theoretical Elements of Electrical Engineering."

212. Let:

E_0, I_0, Z_0 = impressed voltage, current and self-inductive impedance of the magnetizing or exciter circuit of stator (field coils), reduced to the rotor energy circuit by the ratio of effective turns, c_0 ,

E_1, I_1, Z_1 = impressed voltage, current and self-inductive impedance of the rotor energy circuit (or circuit at right angles to I_0),

E_2, I_2, Z_2 = impressed voltage, current and self-inductive impedance of the stator compensating circuit (or circuit parallel to I_1) reduced to the rotor circuit by the ratio of effective turns, c_2 .

E_3, I_3, Z_3 = impressed voltage, current and self-inductive impedance of the exciting circuit of the rotor, or circuit parallel to I_0 ,

I_4, Z_4 = current and self-inductive impedance of the short-circuit under the brushes, I_1 , reduced to the rotor circuit,

I_5, Z_5 = current and self-inductive impedance of the short-circuit under the brushes, I_3 , reduced to the rotor circuit,

Z = mutual impedance of field excitation, that is, in the direction of I_0, I_3, I_4 ,

Z' = mutual impedance of armature reaction, that is, in the direction of I_1, I_2, I_5 .

Z' usually either equals Z , or is smaller than Z .

I_4 and I_5 are very small, Z_4 and Z_5 very large quantities.

Let S = speed, as fraction of synchronism.

Using then the general equations 7 Chapter XIX, which apply to any alternating-current circuit revolving with speed, S , through a magnetic field energized by alternating-current circuits, gives for the six circuits of the general single-phase commutator motor the six equations:

$$E_0 = Z_0 I_0 + Z (I_0 + I_3 - I_4), \tag{1}$$

$$E_1 = Z_1 I_1 + Z' (I_1 + I_5 - I_2) - jSZ (I_0 + I_3 - I_4), \tag{2}$$

$$E_2 = Z_2 I_2 + Z' (I_2 - I_1 - I_5), \tag{3}$$

$$E_3 = Z_1 I_3 + Z (I_3 + I_0 - I_4) - jSZ (I_2 - I_1 - I_5), \tag{4}$$

$$0 = Z_4 I_4 + Z (I_4 - I_0 - I_3) - jSZ (I_1 + I_5 - I_2), \tag{5}$$

$$0 = Z_5 I_5 + Z' (I_5 + I_1 - I_2) - jSZ (I_0 + I_3 - I_4). \tag{6}$$

These six equations contain ten variables:

$$I_0, I_1, I_2, I_3, I_4, I_5, E_0, E_1, E_2, E_3,$$

and so leave four independent variables, that is, four conditions, which may be chosen.

Properly choosing these four conditions, and substituting them into the six equations (1) to (6), so determines all ten variables. That is, the equations of practically all single-phase commutator motors are contained as special cases in above equations, and derived therefrom, by substituting the four conditions, which characterize the motor.

Let then, in the following, the reduction factors to the armature circuit, or the ratio of effective turns of a circuit, i , to the effective turns of the armature circuit, be represented by c_i . That is,

$$c_i = \frac{\text{number of effective turns of circuit, } i}{\text{number of effective turns of armature circuit}};$$

and if E_i, I_i, Z_i are voltage, current and impedance of circuit, i , reduced to the armature circuit, then the actual voltage, current and impedance of circuit, i , are:

$$c_i E_i, \frac{I_i}{c_i}, c_i^2 Z_i.$$

213. The different forms of single-phase commutator motors, of series characteristic are, as shown diagrammatically in Fig. 186:

1. Series motor:

$$e = c_0 E_0 + E_1; I_0 = c_0 I_1; I_2 = 0; I_3 = 0.$$

2. Conductively compensated series motor (Eickemeyer motor):

$$e = c_0 E_0 + E_1 + c_2 E_2; I_0 = c_0 I_1; I_2 = c_2 I_1; I_3 = 0.$$

3. Inductively compensated series motor (Eickemeyer motor):

$$e = c_0 E_0 + E_1; E_2 = 0; I_0 = c_0 I_1; I_3 = 0.$$

4. Inverted repulsion motor, or series motor with secondary excitation:

$$e = E_1; c_0 E_0 + c_2 E_2 = 0; c_2 I_0 = c_0 I_2; I_3 = 0.$$

5. Repulsion motor (Thomson motor):

$$e = c_0 E_0 + c_2 E_2; E_1 = 0; c_2 I_0 = c_0 I_2; I_3 = 0.$$

6. Repulsion motor with secondary excitation:

$$e = c_2 E_2; c_0 E_0 + E_1 = 0; I_0 = c_0 I_1; I_3 = 0.$$

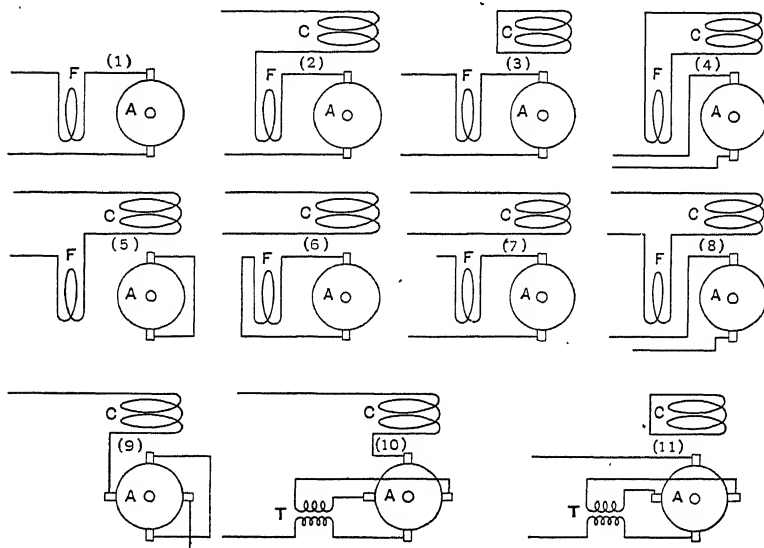

FIG. 186.

7. Series repulsion motor with secondary excitation:

$$e_1 = c_0 E_0 + E_1; e_2 = E_2; I_0 = c_0 I_1; I_3 = 0.$$

8. Series repulsion motor with primary excitation (Alexander-
sen motor):

$$e_1 = E_1; e_2 = c_0 E_0 + c_2 E_2; c_2 I_0 = c_0 I_2; I_3 = 0.$$

9. Compensated repulsion motor (Winter and Eichberg
motor):

$$e = c_2 E_2 + c_3 E_3; E_1 = 0; I_0 = 0; c_3 I_2 = c_2 I_3.$$

10. Rotor-excited series motor with conductive compensation:

$$e = E_1 + c_2 E_2 + c_3 E_3; I_2 = c_2 I_1; I_3 = c_3 I_1; I_0 = 0.$$

11. Rotor-excited series motor with inductive compensation:

$$e = E_1 + c_3 E_3; E_2 = 0; I_0 = 0; I_3 = c_3 I_1.$$

Numerous other combinations can be made and have been proposed.

All of these motors have series characteristics, that is, a speed increasing with decrease of load.

(1) to (8) contain only one set of brushes on the armature; (9) to (11) two sets of brushes in quadrature.

Motors with shunt characteristic, that is, a speed which does not vary greatly with the load, and reaches such a definite limiting value at no-load

that the motor can be considered a constant-speed motor, can also be derived from the above equations. For instance:

Compensated shunt motor (Fig. 187):

$$E_1 = 0; c_2 E_2 = c_3 E_3 = e; I_0 = 0.$$

In general, a series characteristic results, if the field-exciting circuit and the armature energy circuit are connected in series with each other directly or inductively, or related to each other so that the currents in the two circuits are more or less proportional to each other. Shunt characteristic results, if the voltage impressed upon the armature energy circuit, and the field excitation, or rather the magnetic field flux, whether produced or induced by the internal reactions of the motor, are constant, or, more generally, proportional to each other.

Repulsion Motor

As illustration of the application of these general equations, paragraph 212, may be considered the theory of the repulsion motor (5), in Fig. 186.

214. Assuming in the following the armature of the repulsion motor as short-circuited upon itself, and applying to the motor the equations (1) to (6), the four conditions characteristic of the repulsion motor are:

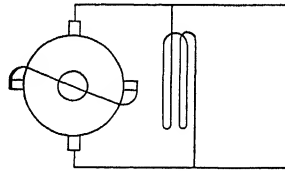

FIG. 187.

1. Armature short-circuited upon itself. Hence:

$$E_1 = 0.$$

2. Field circuit and cross-circuit in series with each other connected to a source of impressed voltage, e . Hence, assuming the compensating circuit or cross-circuit of the same number of effective turns as the rotor circuit, or, $c_2 = 1$:

$$c_0 E_0 + E_2 = e.$$

Herefrom follows:

$$3. I_0 = c_0 I_2.$$

4. No armature excitation used, but only one set of commutator brushes; hence:

$$I_3 = 0,$$

and therefore:

$$I_5 = 0.$$

Substituting these four conditions in the six equations (1) to (6), gives the three repulsion motor equations:

Primary circuit:

$$Z_2 I_2 + Z' (I_2 - I_1) + c_0^2 Z_0 I_2 + c_0 Z (c_0 I_2 - I_4) = e; \quad (7)$$

Secondary circuit:

$$Z_1 I_1 + Z' (I_1 - I_2) - jSZ (c_0 I_2 - I_4) = 0; \quad (8)$$

Brush short-circuit:

$$Z_4 I_4 + Z (I_4 - c_0 I_2) - jSZ' (I_1 - I_2) = 0; \quad (9)$$

Substituting now the abbreviations:

$$Z_2 + c_0^2 (Z_0 + Z) = Z_3, \quad (10)$$

$$\frac{Z'}{Z} = A, \quad (11)$$

$$\frac{Z_1}{Z'} = \lambda_1, \quad (12)$$

$$\frac{Z}{Z_4 + Z} = \lambda_4; \quad (13)$$

where λ_1 and λ_4 , especially the former, are small quantities.

From (9) then follows:

$$I_4 = \lambda_4 \{ I_2 (c_0 - jSA) + jSI_1 A \}; \quad (14)$$

from (8) follows, by substituting (14) and rearranging:

$$I_1 = I_2 \frac{1 + \frac{jSc_0}{A} - \lambda_4 S \left(S + \frac{jc_0}{A} \right)}{1 + \lambda_1 - \lambda_4 S^2}, \quad (15)$$

and, substituting (15) in (14), gives:

$$I_4 = \lambda_4 I_2 \frac{(c_0 - jSA)(1 + \lambda_1 - \lambda_4 S^2) + jSA - S^2 c_0 - \lambda_4 jS(SA + jc_0)}{1 + \lambda_1 - \lambda_4 S^2},$$

or, canceling terms of secondary order in the numerator:

$$I_4 = \lambda_4 I_2 \frac{c_0(1 - S^2)}{1 + \lambda_1 - \lambda_4 S^2}. \quad (16)$$

Equation (7) gives, substituting (10) and rearranging:

$$I_2(Z_3 + Z') - I_1 Z' - I_4 c_0 Z = e. \quad (17)$$

Substituting (15) and (16) herein, and rearranging, gives:

Primary Current:

$$I_2 = \frac{e(1 + \lambda_1 - S^2 \lambda_4)}{ZK}, \quad (18)$$

where:

$$K = (A_3 - jSc_0) + \lambda_1(A_3 + A) - \lambda_4(S^2 A_3 - S^2 c_0 + c_0^2 - jSc_0), \quad (19)$$

and:

$$A_3 = \frac{Z_3}{Z}, \quad (20)$$

or, since approximately:

$$A_3 = c_0^2, \quad (21)$$

it is:

$$K = (A_3 - jSc_0) + \lambda_1(c_0^2 + A) - \lambda_4 c_0(c_0 - jS). \quad (22)$$

Substituting (18), (19), (20) in (15) and (16), gives:

Secondary Current:

$$I_1 = \frac{e \left\{ 1 + \frac{jSc_0}{A} - \lambda_4 S \left(S + \frac{jc_0}{A} \right) \right\}}{ZK}. \quad (23)$$

Brush Short-circuit Current:

$$I_4 = \frac{\lambda_4 e c_0 (1 - S^2)}{ZK}. \quad (24)$$

As seen, for $S = 1$, or at synchronism, $I_4 = 0$, that is, the short-circuit current under the commutator brushes of the repulsion motor disappears at synchronism, as was to be expected, since the armature coils revolve synchronously in a rotating field.

215. The *e.m.f. of rotation*, that is, the e.m.f. generated in the rotor by its rotation through the magnetic field, which e.m.f., with the current in the respective circuit, produces the torque and so gives the power developed by the motor, is:

Main circuit:

$$E'_1 = jSZ (c_0 I_2 - I_4). \quad (25)$$

Brush short-circuit:

$$E'_4 = jSZ' (I_1 - I_2). \quad (26)$$

Substituting (18), (23), (24) into (25) and (26), and rearranging, gives:

Main Circuit E.m.f. of Rotation:

$$E'_1 = \frac{jSc_0e}{K} \{1 + \lambda_1 - \lambda_4\}. \quad (27)$$

Brush Short-circuit E.m.f. of Rotation:

$$E'_4 = \frac{Se}{K} \{Sc_0 + j\lambda_1 A - c_0 \lambda_4\}; \quad (28)$$

or, neglecting smaller terms:

$$E'_4 = \frac{S^2 c_0 e}{K}. \quad (29)$$

The *Power* produced by the main armature circuit is:

$$P_1 = [E'_1, I_1]^1,$$

hence, substituting (22) and (27):

$$P_1 = \left[\frac{jSc_0e}{K} \{1 + \lambda_1 - \lambda_4\}, \frac{e \left\{ 1 + \frac{jSc_0}{A} - \lambda_4 S \left(S + \frac{jC_0}{A} \right) \right\}}{ZK} \right]^1. \quad (30)$$

Let:

$$m = [ZK] \quad (31)$$

be the absolute value of the complex product, ZK , and:

$$\left. \begin{aligned} \frac{1}{A} &= \alpha' + j\alpha'' \\ \lambda_1 &= \lambda'_1 - j\lambda''_1 \\ \lambda_4 &= \lambda'_4 + j\lambda''_4 \end{aligned} \right\} \quad (32)$$

it is, substituting (31), (32) in (30), and expanding:

$$P_1 = \frac{Sc_0e^2}{m^2} \{ [x(1 - Sc_0\alpha'') - rSc_0\alpha'] + (1 - Sc_0r'') [x(\lambda'_1 - \lambda'_4) - r(\lambda''_1 + \lambda''_4)] - Sc_0\alpha' [r(\lambda'_1 - \lambda'_4) + x(\lambda''_1 + \lambda''_4)] - x(\lambda'_4S^2 - \lambda'_4Sc_0\alpha'' + \lambda''_4Sc_0\alpha') + r(\lambda'_4Sc_0\alpha' - \lambda''_4S^2 + \lambda''_4Sc_0\alpha'') \}, \quad (33)$$

after canceling terms of secondary order.

As first approximation follows herefrom:

$$\begin{aligned} P_1 &= \frac{Sc_0e^2x}{m^2} \left(1 - Sc_0\alpha'' - \frac{r}{x} Sc_0\alpha' \right) \\ &= \frac{Sc_0e^2x}{m^2} \left\{ 1 - Sc_0 \left(\alpha'' + \frac{r}{x} \alpha' \right) \right\} \\ &= \frac{Se^2x}{c_0(1 + S^2)} \left\{ 1 - Sc_0 \left(\alpha'' + \frac{r}{x} \alpha' \right) \right\}, \end{aligned} \quad (34)$$

hence a maximum for the speed S , given by:

$$\frac{dP_1}{dS} = 0,$$

or:

$$S_0 = \sqrt{1 + c_0^2 \left(\alpha'' + \frac{r}{x} \alpha' \right)^2} - c_0 \left(\alpha'' + \frac{r}{x} \alpha' \right), \quad (35)$$

and equal to:

$$P_1^0 = \frac{e^2x}{2} \left\{ \sqrt{1 + c_0^2 \left(\alpha'' + \frac{r}{x} \alpha' \right)^2} - c_0 \left(\alpha'' + \frac{r}{x} \alpha' \right) \right\}. \quad (36)$$

The complete expression of the power of the main circuit is, from (33):

$$P_1 = \frac{Sc_0e^2x}{m^2} \left\{ \left[1 - Sc_0 \left(\alpha'' + \frac{r}{x} \alpha' \right) \right] - b_0 - b_1S - b_2S^2 \right\}, \quad (37)$$

where b_0, b_1, b_2 are functions of $\lambda'_1, \lambda''_1, \lambda'_4, \lambda''_4$, as derived by rearranging (33).

The Power produced in the brush short-circuit is:

$$P_4 = [E'_4, I'_4]^2;$$

hence, substituting (24) and (28):

$$\begin{aligned} P_4 &= \left[\frac{S^2 c_0 e}{K}, \frac{\lambda_4 e c_0 (1 - S^2)}{ZK} \right]^1 \\ &= \frac{S^2 c_0^2 e^2 (1 - S^2)}{m^2} \left[r - jx, \lambda'_4 - j\lambda''_4 \right] \\ &= \frac{S' c_0^2 e^2 (1 - S^2)}{m^2} (r\lambda'_4 + x\lambda''_4); \end{aligned} \quad (38)$$

hence positive, or assisting, below synchronism, retarding above synchronism.

The total *Power*, or *Output* of the motor then is:

$$P = P_1 + P_4,$$

or:

Power Output:

$$\begin{aligned} P = \frac{Sc_0 e^2 x}{m^2} \left\{ \left[1 - Sc_0 \left(\alpha'' + \frac{r}{x} \alpha' \right) \right] - b_0 + S \left[c_0 \left(\lambda''_4 + \frac{r}{x} \lambda'_4 \right) - b_1 \right] \right. \\ \left. - S^2 b_2 - S^3 c_0 \left(\lambda''_4 + \frac{r}{x} \lambda'_4 \right) \right\}; \end{aligned} \quad (39)$$

or, approximately:

$$P = \frac{Sc_0 e^2 x}{m^2} \left\{ 1 - Sc_0 \left(\alpha'' + \frac{r}{x} \alpha' \right) \right\} \quad (40)$$

$$= \frac{Se^2 x \left\{ 1 - Sc_0 \left(\alpha'' + \frac{r}{x} \alpha' \right) \right\}}{c_0 (1 + S^2)}; \quad (41)$$

hence:

Torque:

$$D = \frac{P}{S},$$

given in synchronous watts.

The power input into the motor, and the volt-ampere input, are, if:

$$\left. \begin{aligned} I_2 &= i'_2 - j i''_2, \\ i_2 &= \sqrt{i'^2_2 + i''^2_2}, \end{aligned} \right\} \quad (42)$$

given by:

Power Input:

$$P_0 = e i'_2, \quad (43)$$

Volt-ampere Input:

$$P_{a_0} = ei_2, \quad (44)$$

Power-factor:

$$p = \frac{i'_2}{i_2}, \quad (45)$$

Efficiency:

$$\eta = \frac{P}{P_0}, \quad (46)$$

Apparent Efficiency:

$$p\eta = \frac{P}{P_{a_0}}, \quad (47)$$

etc.

216. While excessive values of the short-circuit current under the commutator brushes, I_4 , give bad commutation, due to excessive current densities under the brushes, the best commutation corresponds not to the minimum value of I_4 —as the zero value at synchronism in the repulsion motor—but to that value of I_4 for which the sudden change of current in the armature coil is a minimum, at the moment where the coil leaves the commutator brush.

I_4 is the short-current in the armature coil during commutation, reduced to the armature circuit, I'_4 , by the ratio of effective turns:

$$c_4 = \frac{\text{short-circuited turns under brushes}}{\text{total effective armature turns}}. \quad (48)$$

The actual current in the short-circuited coils during commutation then, is:

$$I'_4 = \frac{I_4}{c_4}, \quad (49)$$

or, if we denote:

$$\frac{\lambda_4}{c_4} = A_4, \quad (50)$$

where A_4 is a fairly large quantity, and substitute (24), it is:

$$I'_4 = \frac{A_4 ec_0 (1 - S^2)}{ZK}. \quad (51)$$

Before an armature coil passes under the commutator brushes, it carries the current, $-I_1$; while under the brushes, it carries the current, I'_4 ; and after leaving the brushes, it carries the current, $+I_1$.

While passing under the commutator brushes, the current in the armature coils must change from, $-I_1$, to I'_4 , or by:

$$I'_o = I'_4 + I_1. \quad (52)$$

In the moment of leaving the commutator brushes, the current in the armature coils must change from, I'_4 to $+I_1$, or by:

$$I_o = I_1 - I'_4. \quad (53)$$

The value, I'_o , or the current change in the armature coils while entering commutation, is of less importance, since during this change the armature coils are short-circuited by the brushes.

Of fundamental importance for the commutation is the value, I_o , of the current change in the armature coils while leaving the commutator brushes, since this change has to be brought about by the resistance of the brush contact while the coil approaches the edge of the brush, and if considerable, can not be completed thereby, but the current, I_o , passes as arc beyond the edge of the brushes.

Essential for good commutation, therefore, is that the current, I_o , should be zero or a minimum, and the study of the commutation of the single-phase commutator thus resolves itself largely into an investigation of the *commutation current*, I_o , or its absolute value, i_o .

The ratio of the commutation current, i_o , to the main armature current, i_1 , can be called the *commutation constant*:

$$k = \frac{i_o}{i_1}. \quad (54)$$

For good commutation, this ratio should be small or zero.

The product of the commutation current, i_o , and the speed, S , is proportional to the voltage induced by the break of this current, or the voltage which maintains the arc at the edge of the commutator brushes, if sufficiently high, and may be called the *commutation voltage*:

$$e_c = Si_o. \quad (55)$$

In the repulsion motor, it is, substituting (23) and (51) in (53), and dropping the term with λ_4 , as of secondary order:

Commutation Current:

$$I_o = \frac{e \left\{ 1 + \frac{jSc_o}{A} - A_4c_o(1 - S^2) \right\}}{ZK}. \quad (56)$$

Commutation Constant:

$$\left. \begin{aligned} \frac{I_g}{I_1} &= \frac{1 + \frac{jSc_0}{A} - A_4c_0(1 - S^2)}{1 + \frac{jSc_0}{A}} \\ &= 1 - \frac{A_4c_0(1 - S^2)}{1 + \frac{jSc_0}{A}} \end{aligned} \right\} \quad (57)$$

Or, denoting:

$$A_4 = \alpha'_4 + j\alpha''_4; \quad (58)$$

substituting (32) and expanding:

$$\left. \begin{aligned} I_g &= \frac{e \{1 - c_0 [S\alpha'' + (1 - S^2)\alpha'_4] - jc_0 [(1 - S^2)\alpha''_4 - S\alpha']\}}{ZD} \\ \frac{I_g}{I_1} &= \frac{e \{1 - c_0 [S\alpha'' + (1 - S^2)\alpha'_4] - jc_0 [(1 - S^2)\alpha''_4 - S\alpha']\}}{(1 - Sc_0\alpha'') + jSc_0\alpha'} \end{aligned} \right\} \quad (59)$$

and, absolute:

$$i_g = \frac{e}{m} \sqrt{\{1 - c_0 [S\alpha'' + (1 - S^2)\alpha'_4]\}^2 + c_0^2 \{(1 - S^2)\alpha''_4 - S\alpha'\}^2} \quad (60)$$

$$k = \sqrt{\frac{\{1 - c_0 [S\alpha'' + (1 - S^2)\alpha'_4]\}^2 + c_0^2 \{(1 - S^2)\alpha''_4 - S\alpha'\}^2}{(1 - Sc_0\alpha'')^2 + S^2c_0^2\alpha'^2}} \quad (61)$$

Perfect commutation, or $I_g = 0$, would require from equation (58):

$$\left. \begin{aligned} 1 - c_0 [S\alpha'' + (1 - S^2)\alpha'_4] &= 0, \\ (1 - S^2)\alpha''_4 - S\alpha' &= 0; \end{aligned} \right\} \quad (62)$$

or:

$$\left. \begin{aligned} \alpha'_4 &= \frac{1 - c_0S\alpha''}{c_0(1 - S^2)}, \\ \alpha''_4 &= \frac{S\alpha'}{1 - S^2} = 1 - \alpha'_4. \end{aligned} \right\} \quad (63)$$

This condition can usually not be fulfilled.

The commutation is best for that speed, S , when the commutation current, i_g , is a minimum, that is:

$$\left. \begin{aligned} \frac{di_g}{dS} &= 0; \\ \text{hence:} & \\ \frac{d}{dS} \{ (1 - c_0 [S\alpha'' + (1 - S^2)\alpha'_4])^2 + c_0^2 ((1 - S^2)\alpha''_4 - S\alpha')^2 \} &= 0 \end{aligned} \right\} \quad (64)$$

This gives a cubic equation in S , of which one root, $0 < S_1 < 1$, represents a minimum.

The relative commutation, that is, relative to the current consumed by the motor, is best for the value of speed, S_2 , where the commutation factor, k , is a minimum, that is:

$$\frac{dk}{dS} = 0. \quad (65)$$

217. The power output of the repulsion motor becomes zero at the approximate speed given by substituting $P = 0$ in the approximate equation (40), as:

$$S_0 = \frac{1}{c_0 (\alpha'' + \frac{r}{x} \alpha')} \quad (66)$$

and above this speed, the power, P , is negative, that is, the repulsion motor consumes power, acting as brake.

This value, S_0 , however, is considerably reduced by using the complete equations (39), that is, considering the effect of the short-circuit current under the brushes, etc.

For $S < 0$, $P < 0$; that is, the power is negative, and the machine a generator, when driven backward, or, what amounts to the same electrically, when reversing either the field-circuit, I_0 , or the primary energy circuit, I_2 . In this case, the machine then is a *repulsion generator*.

The equations of the *repulsion generator* are derived from those of the *repulsion motor*, given heretofore, by reversing the sign of S .

The power, P_4 , of the short-circuit current under the brushes reverses at synchronism, and becomes negative above synchronism. The explanation is: This short-circuit current, I_4 , and a corresponding component of the main current, I_1 , are two currents produced in quadrature in an armature or secondary, short-circuited in two directions at right angles with each other, and so offering a short-circuited secondary to the single-phase primary, in any direction, that is, constituting a single-phase induction motor. The short-circuit current under the brushes so superimposes in the repulsion motor, upon the repulsion-motor torque, a single-phase induction-motor torque, which is positive below synchronism, zero at synchronism, and negative above synchronism, as induction-generator torque. It thereby lowers

the speed, S_0 , at which the total torque vanishes, and reduces the power-factor and efficiency.

218. As an example are shown in Fig. 188 the characteristic curves of a repulsion motor, with the speed, S , as abscissæ, for the constants:

Impressed voltage: $e = 500$ volts.
 Exciting impedance, main field: $Z = 0.25 + 3j$ ohms.
 cross field: $Z' = 0.25 + 2.5j$ ohms.

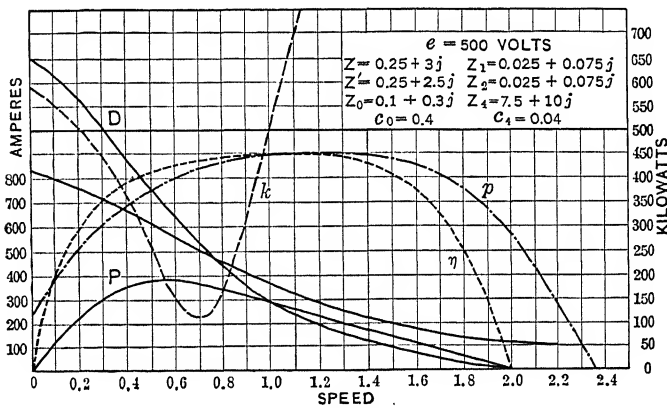

FIG. 188.

Self-inductive impedance, main field: $Z_0 = 0.1 + 0.3j$ ohms.
 cross field: $Z_2 = 0.025 + 0.075j$ ohms.
 armature: $Z_1 = 0.025 + 0.075j$ ohms.
 brush short-circuit: $Z_4 = 7.5 + 10j$ ohms.
 Reduction factor, main field: $c_0 = 0.4$.
 brush short-circuit: $c_4 = 0.04$.

Hence:

$$Z_3 = 0.08 + 0.60j \text{ ohms.}$$

$$A = 0.835 - 0.014j.$$

$$\frac{1}{A} = \alpha' + j\alpha'' = 1.20 + 0.02j.$$

$$\lambda_1 = 0.031 - 0.007j.$$

$$\lambda_4 = 0.179 + 0.087j.$$

$$A_4 = 4.475 + 2.175j.$$

$$A_3 = 0.202 - 0.010j.$$

Then, substituting in the preceding equations:

$$K = (0.204 - 0.035 S) - j(0.031 + 0.328 S),$$

$$ZK = (0.144 + 0.975 S) + j(0.604 - 0.187 S).$$

Primary or Supply Current:

$$I_2 = \frac{500 \{(1.031 - 0.179 S^2) - j(0.007 + 0.087 S^2)\}}{ZK}.$$

Secondary or Armature Current:

$$I_1 = \frac{500 \{(1 + 0.048 S - 0.179 S^2) + j(0.4 S - 0.087 S^2)\}}{ZK}.$$

Brush Short-circuit Current:

$$I_4 = \frac{500 (1 - S^2) (0.072 - 0.035 j)}{ZK},$$

and absolute:

$$i_4 = \frac{40 (1 - S^2)}{m}.$$

Commutation Factor:

$$k = \sqrt{\frac{(1.508 S^2 - 0.673)^2 + (0.718 - 0.4 S - 0.704 S^2)^2}{(0.697 + 0.4 S - 0.014)^2}}.$$

Main E.m.f. of Rotation:

$$E'_1 = \frac{500 S (4.052 + 0.792 j)}{ZK}.$$

Commutation E.m.f. of Rotation:

$$E'_4 = \frac{500 S^2 (0.4 - 4.8 j)}{ZK}.$$

Power of Main Armature Circuit:

$$P_1 = \frac{250 S}{m^2} (4.052 - 0.122 S - 0.657 S^2), \text{ in kw.}$$

Power of Brush Short-circuit:

$$P_4 = \frac{49.2 S^2 (1 - S^2)}{m^2}, \text{ in kw.}$$

Total Power Output:

$$P = \frac{250 S}{m^2} (4.052 + 0.075 S - 0.657 S^2 - 0.197 S^3).$$

Torque:

$$D = \frac{250}{m^2} (4.052 + 0.075 S - 0.657 S^2 - 0.197 S^3),$$

etc.

These curves are derived by calculating numerical values in tabular form, for $S = 0, 0.2, 0.4, 0.6, 0.8, 1.0, 1.2, 1.4, 1.6, 1.8, 2.0, 2.2, 2.4$.

As seen from Fig. 188, the power-factor, p , rises rapidly, reaching fairly high values at comparatively low speeds, and remains near its maximum of 90 per cent. over a wide range of speed. The efficiency, η , follows a similar curve, with 90 per cent. maximum near synchronism. The power, P , reaches a maximum of 192 kw. at 60 per cent. of synchronism—450 revolutions with a four-pole 25-cycle motor—is 143 kw. at synchronism, and vanishes, together with the torque, D , at double synchronism. The torque at synchronism corresponds to 143 kw., the starting torque to 657 synchronous kw.

The commutation factor, k , starts with 1.18 at standstill, the same value which the same motor would have as series motor, but rapidly decreases, and reaches a minimum of 0.23 at 70 per cent. of synchronism, and then rises again to 1.00 at synchronism, and very high values above synchronism. That is, the commutation of the repulsion is fair already at very low speeds, becomes very good somewhat below synchronism, but poor at speeds considerably above synchronism: this agrees with the experience on such motors.

In the study of the commutation, the short-circuit current under the commutator brushes has been assumed as secondary alternating current. This is completely the case only at standstill, but at speed, due to the limited duration of the short-circuit current in each armature coil—the time of passage of the coil under the brush—an exponential term superimposes upon the alternating, and so modifies the short-circuit current and thereby the commutation factor, the more, the higher the speed, and greater thereby the exponential term is. The determination of this exponential term is beyond the scope of the present work, but requires the methods of evaluation of transient or momentary electric phenomena, as discussed in "Theory and Calculation of Transient Electric Phenomena and Oscillations."

B. Series Repulsion Motor

219. As further illustration of the application of these fundamental equations of the single-phase commutator motor, (1) to (6), a motor may be investigated, in which the four independent constants are chosen as follows:

1. Armature and field connected in series with each other. That is:

$$E_1 + c_0 E_0 = E = e_1, \quad (67)$$

where:

c_0 = reduction factor of field winding to armature; that is, ratio of effective $\frac{\text{field turns}}{\text{armature turns}}$.

It follows herefrom:

$$I_0 = c_0 I_1. \quad (68)$$

2. The e.m.f. impressed upon the compensating winding is given, and is in phase with the e.m.f., e_1 , which is impressed upon field plus armature:

$$E_2 = e_2. \quad (69)$$

That is, E_2 is supplied by the same transformer or compensator as e_1 , in series or in shunt therewith.

3. No rotor-exciting circuit is used:

$$I_3 = 0, \quad (70)$$

and therefore:

4. No rotor-exciting brushes, or brushes in quadrature position with the main-armature brushes, are used, and so:

$$I_5 = 0, \quad (71)$$

that is, the armature carries only one set of brushes, which give the short-circuit current, I_4 .

Since the compensating circuit, e_2 , is an independent circuit, it can be assumed as of the same number of effective turns as the armature, that is, e_2 is the e.m.f. impressed upon the compensating circuit, reduced to the armature circuit. (The actual e.m.f. impressed upon the compensating circuit thus would be:

$c_2 e_2$, where c_2 = ratio effective $\frac{\text{compensating turns}}{\text{armature turns}}$.)

220. Substituting (68) into (1), (2), (3), and (5), and (1) and (2) into (67), gives the three motor equations:

$$e_1 = Z_1 I_1 + Z' (I_1 - I_2) - jSZ (c_0 I_1 - I_4) \left\{ \begin{array}{l} + c_0^2 Z_0 I_1 + c_0 Z (c_0 I_0 - I_4), \end{array} \right. \quad (72)$$

$$e_2 = Z_2 I_2 + Z' (I_2 - I_1), \quad (73)$$

$$0 = Z_4 I_4 + Z (I_4 - c_0 I_1) - jSZ' (I_1 - I_2). \quad (74)$$

Substituting now:

$$\left. \begin{aligned}
 Y' &= \frac{1}{Z'} = \text{quadrature, or transformer exciting admittance,} \\
 \frac{Z_2}{Z'} &= \lambda_2 = \lambda'_2 - j\lambda''_2, \\
 \frac{Z}{Z + Z_4} &= \lambda_4 = \lambda'_4 + j\lambda''_4, \\
 \frac{Z'}{Z} &= A = \alpha' - j\alpha'' = \text{impedance ratio of the two quadrature fluxes,} \\
 Z_1 + c_0^2 (Z_0 + Z) &= Z_3, \\
 \frac{Z_3}{Z} &= A_3 = \alpha'_3 + j\alpha''_3,
 \end{aligned} \right\} \quad (75)$$

and:

$$\left. \begin{aligned}
 e &= e_1 + e_2, \\
 i &= \frac{e_2}{e}.
 \end{aligned} \right\} \quad (76)$$

Adding (72) and (73), and rearranging, gives:

$$e = Z_2 I_2 + I_1 (Z_3 - jSc_0 Z) - I_4 Z (c_0 - jS);$$

or:

$$\frac{e}{Z} = \lambda_2 A I_2 + I_1 (A_3 - jSc_0) - I_4 (c_0 - jS). \quad (77)$$

From (73) follows:

$$e_2 Y' = I_2 (1 + \lambda_2) - I_1,$$

or:

$$I_1 = I_2 (1 + \lambda_2) - etY',$$

and:

$$I_2 = I_1 (1 - \lambda_2) + etY'. \quad (78)$$

From (74) follows:

$$0 = I_4 (Z + Z_4) - I_1 (c_0 Z + jSZ') + jSZ' I_2. \quad (79)$$

Since I_4 is a small current, small terms, as λ_2 , can be neglected in its evaluation. That is, when substituting (78) in (79), λ_2 can be dropped:

$$\left. \begin{aligned}
 I_1 &= I_2 - etY', \\
 I_2 &= I_1 + etY',
 \end{aligned} \right\} \text{approximately.} \quad (80)$$

Hence, (80) substituted in (79) gives:

$$0 = I_4 (Z + Z_4) - c_0 Z I_1 + jSet,$$

or:

$$0 = \frac{I_4}{\lambda_4} - c_0 I_1 + \frac{jSet}{Z}.$$

Hence:

$$I_4 = \lambda_4 \left\{ c_0 I_1 - \frac{jSet}{Z} \right\}. \quad (81)$$

and actual value of short-circuit current:

$$I'_4 = b\lambda_4 \left\{ I_1 - \frac{jSet}{c_0 Z} \right\}, \quad (82)$$

where:

$$\left. \begin{aligned} b &= \frac{c_0}{c_4}, \text{ a fairly large quantity, and} \\ c_4 &= \text{reduction factor of brush short-circuit} \\ &\quad \text{to armature circuit.} \end{aligned} \right\} \quad (83)$$

The commutation current then is:

$$\begin{aligned} I_o &= I_1 - I'_4 \\ &= I_1 (1 - b\lambda_4) + \frac{jSetb\lambda_4}{c_0 Z}. \end{aligned} \quad (84)$$

Substituting (81) and (80) into (77), gives:

$$I_1 = \frac{e}{Z} \frac{1 - jSt\lambda_4(c_0 - jS) - t\lambda_2}{A_3 - jSc_0 - \lambda_4 c_0(c_0 - jS) + \lambda_2 A},$$

or, denoting:

$$K = A_3 - jSc_0 - \lambda_4 c_0(c_0 - jS) + \lambda_2 A,$$

it is:

$$I_1 = \frac{e \{ 1 - jSt\lambda_4(c_0 - jS) - t\lambda_2 \}}{ZK}. \quad (85)$$

It is, approximately:

$$\left. \begin{aligned} A_3 &= \frac{Z_3}{Z} = c_0^2, \\ \lambda_2 &= 0, \end{aligned} \right\} \quad (86)$$

hence:

$$K = c_0 (1 - c_0\lambda_4) (c_0 - jS), \quad (87)$$

$$\begin{aligned} I_1 &= \frac{e \{ 1 - jSt\lambda_4(c_0 - jS) \}}{c_0 Z (1 - c_0\lambda_4) (c_0 - jS)} \\ &= \frac{e}{c_0 Z (1 - c_0\lambda_4)} \left\{ \frac{1}{c_0 - jS} - jSt\lambda_4 \right\}. \end{aligned} \quad (88)$$

Substituting now (85) respectively (87), (88) into (78), (81) (84), and into:

$$\left. \begin{aligned} E'_1 &= jSZ (c_0 I_1 - I_4), \\ E'_4 &= jSZ' (I_1 - I_2), \end{aligned} \right\} \quad (89)$$

gives the

Equations of the Series Repulsion Motor:

$$\left. \begin{aligned} K &= A_3 - jSc_0 - \lambda_4 c_0 (c_0 - jS) + \lambda_2 A, \\ \text{approximately:} \\ K &= c_0 (1 - c_0 \lambda_4) (c_0 - jS). \end{aligned} \right\} \quad (90)$$

Inducing, or Compensator Current:

$$\left. \begin{aligned} I_2 &= \frac{e \{1 - jSt\lambda_4 (c_0 - jS) - (1 + t)\lambda_2\}}{ZK} + \frac{et(1 - \lambda_2)}{Z'} \\ \text{approximately:} \\ I_2 &= \frac{e}{c_0 Z (1 - c_0 \lambda_4) (c_0 - jS)} - \frac{jSt\lambda_4 e}{c_0 Z (1 - c_0 \lambda_4)} + \frac{te}{Z'} \end{aligned} \right\} \quad (91)$$

Armature, or Secondary Current:

$$\left. \begin{aligned} I_1 &= \frac{e \{1 - jSt\lambda_4 (c_0 - jS) - t\lambda_2\}}{ZK}, \\ \text{approximately:} \\ I_1 &= \frac{e}{c_0 Z (1 - c_0 \lambda_4)} \left\{ \frac{1}{c_0 - jS} - jSt\lambda_4 \right\}. \end{aligned} \right\} \quad (92)$$

Brush Short-circuit Current:

$$\left. \begin{aligned} I_4 &= \frac{e\lambda_4}{Z(1 - c_0\lambda_4)} \left\{ \frac{1}{c_0 - jS} - jSt(1 + \lambda_4 - c_0\lambda_4) \right\}, \\ \text{approximately:} \\ I_4 &= \frac{e\lambda_4}{Z(1 - c_0\lambda_4)} \left\{ \frac{1}{c_0 - jS} - jSt \right\}. \end{aligned} \right\} \quad (93)$$

Commutation Current:

$$\left. \begin{aligned} I_o &= \frac{e}{c_0 Z (1 - c_0 \lambda_4)} \left\{ \frac{1 - \lambda_4 b}{c_0 - jS} + jSt\lambda_4 [(b - 1) \right. \\ &\quad \left. + b\lambda_4 (1 - c_0)] \right\}, \\ \text{approximately:} \\ I_o &= \frac{e}{c_0 Z (1 - c_0 \lambda_4)} \left\{ \frac{1 - \lambda_4 b}{c_0 - jS} + jSt\lambda_4 b \right\}. \end{aligned} \right\} \quad (94)$$

Main E.m.f. of Rotation:

$$E'_1 = \frac{jSe}{1 - c_0\lambda_4} \left\{ \frac{1 - \lambda_4}{c_0 - jS} + jSt\lambda_4^2(1 - c_0) \right\},$$

approximately:

$$E'_1 = \frac{jSe(1 - \lambda_4)}{(1 - c_0\lambda_4)(c_0 - jS)}. \quad (95)$$

Quadrature E.m.f. of Rotation:

$$E'_4 = +jSte. \quad (96)$$

Power Output:

$$P = P_1 + P_4 \\ = [E'_1, I_1]^1 + [E'_4, I_4]^1.$$

Power Input:

$$P_0 = [e_1, I_1]^1 + [e_2, I_2]^1. \quad (98)$$

Volt-ampere Input:

$$P = e_1i_1 + e_2i_2 \\ = e\{(1 - t)i_1 + ti_2\},$$

where the small letters, i_1 and i_2 , denote the absolute values of the currents, I_1 and I_2 .

When i_1 and i_2 are derived from the same compensator or transformer (or are in shunt with each other, as branches of the same circuit, if $e_1 = e_2$), as usually the case, in the primary circuit the current corresponds not to the sum, $\{(1 - t)i_1 + ti_2\}$ of the secondary currents, but to their resultant, $[(1 - t)I_1 + tI_2]^1$, and if the currents, I_1 and I_2 , are out of phase with each other, as is more or less the case, the absolute value of their resultant is less than the sum of the absolute values of the components. The volt-ampere input, reduced to the primary source of power, then is:

$$P_{a_0} = e[(1 - t)I_1 + tI_2]^1, \quad (99)$$

and:

$$P_{a_0} < P_a.$$

From these equations then follows the torque: $D = \frac{P}{S}$, the power-factor, $p = \frac{P_0}{P_{a_0}}$, etc.

These equations (90) to (99) contain two terms, one with, and one without $t = \frac{e_2}{e}$, and so, for the purpose of investigating the

effect of the distribution of voltage, e , between the circuits, e_1 and e_2 , they can be arranged in the form: $F = K_1 + tK_2$.

For:

$$t = 0,$$

that is, all the voltage impressed upon the armature circuit, and the compensating circuit short-circuited, these equations are those of the *inductively compensated series motor*.

For:

$$t = 1,$$

that is, all the voltage impressed upon the compensating or inducing circuit, and the armature circuit closed in short-circuit, that is, the armature energizing the field, the equations are those of the *repulsion motor with secondary excitation*.

For:

$$t > 1,$$

a reverse voltage is impressed upon the armature circuit.

Study of Commutation

221. The commutation of the alternating-current commutator motor mainly depends upon:

(a) The short-circuit current under the commutator brush, which has the actual value: $I'_4 = \frac{I_4}{c_4}$. High short-circuit current causes arcing under the brushes, and glowing, by high current density:

(b) The commutation current, that is, the current change in the armature coil in the moment of leaving the brush short-circuit, $I_c = I_1 - I'_4$. This current, and the e.m.f. produced by it, SI_c , produce sparking at the edge of the commutator brushes, and is destructive, if considerable.

(a) Short-circuit Current under Brushes

Using the approximate equation (93), the actual value of the short-circuit current under the brushes is:

$$I'_4 = \frac{e\lambda_4 b}{c_0 Z (1 - c_0 \lambda_4)} \left\{ \frac{1}{c_0 - jS} - jSt \right\}; \quad (100)$$

where:

$b = \frac{c_0}{c_4}$, or $\frac{1}{b} =$ reduction factor of short-circuit under brushes,

to field circuit, that is:

$$b = \frac{\text{number of field turns}}{\text{number of effective short-circuit turns}} \quad (101)$$

hence a large quantity.

The absolute value of the short-circuit current, therefore, is:

$$i'_4 = \frac{e\lambda_4^0 b \sqrt{c_0^2 + S^2 (1 - t(c_0^2 + S^2))^2}}{c_0 z [1 - c_0 \lambda_4] (c_0^2 + S^2)} \quad (102)$$

hence a minimum for that value of t , where:

$$\begin{aligned} f &= c_0^2 + S^2 (1 - t(c_0^2 + S^2))^2 = \text{minimum, or} \\ &= 1 - t(c_0^2 + S^2) = 0, \text{ hence,} \end{aligned}$$

$$t = \frac{1}{c_0^2 + S^2},$$

and:

$$S = \sqrt{\frac{1}{t} - c_0^2}.$$

That is, $t = \frac{e_2}{e} = \frac{1}{S_2 + c_0^2}$ gives minimum short-circuit current at speed, S , and inversely, speed $S = \sqrt{\frac{1}{t} - c_0^2}$, gives minimum short-circuit current at voltage ratio, t .

For $t = 1$, or the repulsion motor with secondary excitation, the short-circuit current is minimum at speed, $S = \sqrt{1 - c_0^2}$, or somewhat below synchronism, and is $i'_4 = \frac{4c_0 e}{z}$, while in the repulsion motor with primary excitation, the short-circuit current is a minimum, and equals zero, at synchronism $S = 1$.

The lower the voltage ratio, $t = \frac{e_2}{e}$, the higher is the speed, S , at which the short-circuit current reaches a minimum.

The short-circuit current, I'_4 , however, is of far less importance than the commutation current, I_a .

(b) Commutation Current

222. While the value, $I'_a = I'_4 + I_1$, or the current change in the armature coils while entering commutation, is of minor importance, of foremost importance for good commutation is that the current change in the armature coils, when leaving the short-circuit under the brushes:

$$I_a = I_1 - I'_4 \quad (103)$$

is zero or a minimum.

Using the approximate equation of the commutation current (94), it is:

$$I_o = c_o Z (1 - c_o \lambda_4) \left\{ \frac{1 - \lambda_4 b}{c_o - jS} + jSt\lambda_4 b \right\}$$

$$= c_o Z (1 - c_o \lambda_4) (c_o - jS) \{1 - \lambda_4 b + jS(c_o - jS)t\lambda_4 b\}; \quad (104)$$

and, denoting:

$$\lambda_4 = \lambda'_4 + j\lambda''_4,$$

it is, expanded:

$$I_o = c_o Z (1 - c_o \lambda_4) (c_o + jS) \{ [1 - \lambda'_4 b + Stb(S\lambda'_4 - c_o \lambda''_4)] - j[\lambda''_4 b - Stb(c_o \lambda'_4 + S\lambda''_4)] \}; \quad (105)$$

hence, absolute:

$$i_o = \frac{e}{c_o Z [1 - c_o \lambda_4] \sqrt{c_o^2 + S^2}}$$

$$\sqrt{[1 - \lambda'_4 b + Stb(S\lambda'_4 - c_o \lambda''_4)]^2 + [\lambda''_4 b - Stb(c_o \lambda'_4 + S\lambda''_4)]^2}, \quad (106)$$

where $[1 - c_o \lambda_4]$ denotes the absolute value of $(1 - c_o \lambda_4)$.

The commutation current is zero, if either $S = \infty$, that is, infinite speed, which is obvious but of no practical interest, or the parenthesis in (105) vanishes.

Since this parenthesis is complex, it vanishes when both of its terms vanish. This gives the two equations:

$$\left. \begin{aligned} 1 - \lambda'_4 b + Stb(S\lambda'_4 - c_o \lambda''_4) &= 0, \\ \lambda''_4 b - Stb(c_o \lambda'_4 + S\lambda''_4) &= 0. \end{aligned} \right\} \quad (107)$$

From these two equations are calculated the two values, the speed, S , and the voltage ratio, t , as:

$$\left. \begin{aligned} S_0 &= \frac{c_o(b\lambda_4^2 - \lambda'_4)}{\lambda''_4}, \\ t_0 &= \frac{\lambda''_4^2}{c_o^2 b \lambda_4^2 (b\lambda_4^2 - \lambda'_4)}; \end{aligned} \right\} \quad (108)$$

hence:

$$S_0 t_0 = \frac{\lambda''_4}{c_o b \lambda_4^2}.$$

For instance, if:

$$\begin{aligned} Z &= 0.25 + 3j, \\ Z_4 &= 5 + 2.5j; \end{aligned}$$

hence:

$$\lambda_4 = \frac{Z}{Z + Z_4} = 0.307 + 0.248j = \lambda'_4 + j\lambda''_4,$$

$$c_0 = 0.4,$$

$$c_4 = 0.04;$$

hence:

$$b = 10;$$

and herefrom:

$$S_0 = 2.02,$$

$$t_0 = 0.197$$

that is, at about double synchronism, for $e_2 = te = 0.197 e$, or about 20 per cent. of e , the commutation current vanishes.

In general, there is thus in the series repulsion motor only one speed, S_0 , at which, if the voltage ratio has the proper value, t_0 , the commutation current, i_g , vanishes, and the commutation is perfect. At any other speed some commutation current is left, regardless of the value of the voltage ratio, t .

With the two voltages, e_1 and e_2 , in phase with each other, the commutation current can not be made to vanish at any desired speed, S .

223. It remains to be seen, therefore, whether by a phase displacement between e_1 and e_2 , that is, if e_2 is chosen out of phase with the total voltage, e , the commutation current can be made to vanish at any speed, S , by properly choosing the value of the voltage ratio, and the phase difference.

Assuming, then, e_2 out of phase with the total voltage, e , hence denoting it by:

$$E_2 = e_2 (\cos \theta_2 - j \sin \theta_2), \quad (109)$$

the voltage ratio, t , now also is a complex quantity, and expressed by:

$$T = \frac{E_2}{e} = t (\cos \theta_2 - j \sin \theta_2) = t' - jt''. \quad (110)$$

Substituting (110) in (105), and rearranging, gives:

$$I_g = \frac{e}{c_0 Z (1 - c_0 \lambda_4) (c_0 - jS)} \{ [1 - \lambda'_4 b + St'b (S\lambda'_4 - c_0 \lambda''_4) + St''b (c_0 \lambda'_4 + S\lambda''_4)] - j[\lambda''_4 b - St'b (c_0 \lambda'_4 + S\lambda''_4) + St''b (S\lambda'_4 - c_0 \lambda''_4)] \}; \quad (111)$$

and this expression vanishes, if:

$$\left. \begin{aligned} 1 - \lambda'_4 b + St'b (S\lambda'_4 - c_0 \lambda''_4) + St''b (c_0 \lambda'_4 + S\lambda''_4) &= 0, \\ \lambda''_4 b - St'b (c_0 \lambda'_4 + S\lambda''_4) + St''b (S\lambda'_4 - c_0 \lambda''_4) &= 0. \end{aligned} \right\}$$

and herefrom follows:

$$\left. \begin{aligned} t' &= \frac{Sb_4^2 - S\lambda'_4 + c_0\lambda''_4}{Sb\lambda_4^2(S^2 + c_0^2)} = \frac{1}{c_0^2 + S^2} \left\{ 1 - \frac{S\lambda'_4 - c_0\lambda''_4}{Sb\lambda_4^2} \right\}, \\ t'' &= \frac{c_0b\lambda_4^2 - c_0\lambda'_4 - S\lambda''_4}{Sb\lambda_4^2(S^2 + c_0^2)} = \frac{1}{c_0^2 + S^2} \left\{ \frac{c_0}{S} - \frac{c_0\lambda'_4 + S\lambda''_4}{Sb\lambda_4^2} \right\}; \end{aligned} \right\} \quad (112)$$

or approximately:

$$\left. \begin{aligned} t' &= \frac{1}{c_0^2 + S^2}, \\ t'' &= \frac{c_0}{S(c_0^2 + S^2)}. \end{aligned} \right\} \quad (113)$$

$t'' = 0$ substituted in equation (112) gives $S = S_0$, the value recorded in equation (108).

It follows herefrom, that with increasing speed, S , t' and still more t'' , decrease rapidly. For $S = 0$, t' and t'' become infinite. That is, at standstill, it is not possible by this method to produce zero commutation current.

The phase angle, θ_2 , of the voltage ratio, $T = t' - jt''$, is given by:

$$\tan \theta_2 = \frac{t''}{t'} = \frac{c_0b\lambda_4^2 - c_0\lambda'_4 - S\lambda''_4}{Sb\lambda_4^2 - S\lambda'_4 + c_0\lambda''_4}, \quad (114)$$

rearranged, this gives:

$$\frac{c_0 \sin \theta_2 + S \cos \theta_2}{c_0 \sin \theta_2 - S \sin \theta_2} = \frac{b\lambda_4^2 - \lambda'_4}{\lambda''_4}; \quad (115)$$

and, denoting:

$$\frac{S}{c_0} = \tan \sigma, \quad (116)$$

where σ may be called the "speed angle," it is, substituted in (115):

$$\begin{aligned} \tan (\theta_2 + \sigma) &= \frac{b\lambda_4^2 - \lambda'_4}{\lambda''_4}, \\ &= \text{constant}; \end{aligned} \quad (117)$$

hence:

$$\theta_2 + \sigma = \gamma, \quad (118)$$

and:

$$\theta_2 = \gamma - \sigma. \quad (119)$$

$\frac{b\lambda_4^2 - \lambda'_4}{\lambda''_4}$ is a large quantity, hence γ near 90° .

σ is also near 90° for all speeds, S , except very slow speeds, since in (116) c_0 is a small quantity.

Hence θ_2 is near zero for all except very low speeds.

For very low speeds, σ is small, and θ_2 thus large and positive.

That is, the voltage, E_2 , impressed upon the compensating circuit to get negligible commutation current, must be approximately in phase with e for all except low speeds. At low speeds, it must lag, the more, the lower the speed. Its absolute value is very large at low speeds, but decreases rapidly with increasing speed, to very low values.

For instance, let, as before:

$$\lambda_4 = 0.304 - 0.248j,$$

$$c_0 = 0.4,$$

$$b = 10;$$

it is:

$$\tan(\theta_2 + \sigma) = 5.05,$$

$$\theta_2 + \sigma = 79^\circ;$$

hence:

$$\theta_2 = 79^\circ - \sigma.$$

$\theta_2 = 0$ for $\sigma = 79^\circ$; hence, by (116), $S_0 = 2.02$, or double synchronism. Above this speed, θ_2 is leading, but very small, since the maximum leading value, for infinite speed, $S = \infty$, is given by $\sigma = 90^\circ$, as, $\theta_2 = -11^\circ$. Below the speed, S_0 , θ_2 is positive, or lagging;

for $S = 1$, it is $\sigma = 68^\circ$, $\theta_2 = +11^\circ$, hence still approximately in phase;

for $S = 0.4$, it is $\sigma = 45^\circ$, $\theta_2 = 34^\circ$; hence E_2 is still nearer in phase than in quadrature to e .

The corresponding values of $T = t' + t''$ are, from (112):

$$S = 2.02, \theta_2 = 0, \quad T = 0.197, \quad t = 0.197,$$

$$S = 1, \theta_2 = +11^\circ, \quad T = 0.747 + 0.140j, \quad t = 0.760,$$

$$S = 0.4, \theta_2 = 34^\circ, \quad T = 3.00 - 2.00j, \quad t = 3.61.$$

224. The introduction of a phase displacement between the compensating voltage, E_2 , and the total voltage, e , in general is more complicated, and since for all but the lowest speeds the required phase displacement, θ_2 , is small, it is usually sufficient to employ a compensating voltage, e_2 , in phase with e .

In this case, no value of t exists, which makes the commutation current vanish entirely, except at the speed, S_0 .

The problem then is, to determine for any speed, S , that value

of the voltage ratio, t , which makes the commutation current, i_o , a minimum. This value is given by:

$$\frac{di_o}{dt} = 0, \tag{120}$$

where i_o is given by equation (106).

Since equation (106) contains t only under the square root, the minimum value of i_o is given also by:

$$\frac{dK}{dt} = 0,$$

where:

$$K = [1 - b\lambda'_4 + Stb(S\lambda'_4 - c_0\lambda''_4)]^2 + [b\lambda''_4 - Stb(c_0\lambda'_4 + S\lambda''_4)]^2.$$

Carrying out this differentiation, and expanding, gives:

$$t = \frac{Sb\lambda_4^2 - S\lambda'_4 + c_0\lambda''_4}{Sb\lambda_4^2(c_0^2 + S^2)} = \frac{1}{c_0^2 + S^2} \left\{ 1 - \frac{S\lambda'_4 - c_0\lambda''_4}{Sb\lambda_4^2} \right\}. \tag{121}$$

This is the same value as the real component, t' , of the complex voltage ratio, T_1 , which caused the commutation current to vanish entirely, and was given by equation (112).

It is, approximately:

$$t = \frac{1}{c_0^2 + S^2}. \tag{122}$$

Substituting (121) into (105) gives the value of the minimum commutation current, i_o .

Since the expression is somewhat complicated, it is preferable to introduce trigonometric functions, that is, substitute:

$$\tan \delta = \frac{\lambda''_4}{\lambda'_4}, \tag{123}$$

where δ is the phase angle of λ_4 , and therefore:

$$\left. \begin{aligned} \lambda''_4 &= \lambda_4 \sin \delta, \\ \lambda'_4 &= \lambda_4 \cos \delta, \end{aligned} \right\} \tag{124}$$

and also to introduce, as before, the speed angle (116):

$$\left. \begin{aligned} \tan \sigma &= \frac{S}{c_0}, \\ q &= \sqrt{c_0^2 + S^2}; \end{aligned} \right\} \tag{125}$$

hence:

$$\left. \begin{aligned} S &= q \sin \sigma, \\ c_0 &= q \cos \sigma. \end{aligned} \right\} \tag{126}$$

Substituting these trigonometric values into the expression (121) of the voltage ratio for minimum commutation current, it is:

$$t = \frac{1}{q^2} - \frac{\sin(\sigma - \delta)}{Sbq\lambda_4} \quad (127)$$

Substituting (117) into (106) and expanding gives a relatively simple value, since most terms eliminate:

$$I_o = e \left\{ \frac{[\cos^2(\sigma - \delta) + b\lambda(\sin\sigma \sin(\sigma - \delta) - \cos\delta)] + j[\sin(\sigma - \delta)\cos(\sigma - \delta) - b\lambda_4(\sin\sigma \cos(\sigma - \delta) - \sin\delta)]}{c_0 Z (1 - c_0\lambda_4, (c_0 + jS))} \right\} \quad (128)$$

and the absolute value:

$$i_{\sigma 0} = \frac{e(\cos(\sigma - \delta) - b\lambda_4 \cos\sigma)}{c_0 z [1 - c_0\lambda_4] \sqrt{c_0^2 + S^2}} \quad (129)$$

or, resubstituting for σ and δ :

$$i_{\sigma 0} = \frac{e \{ S\lambda''_4 - c_0(\lambda_4^2 b - \lambda'_4) \}}{c_0 z [1 - c_0\lambda_4] (c_0^2 + S^2)} \quad (130)$$

From (129) and (130) follows, that $i_{\sigma 0} = 0$, or the commutation current vanishes, if:

$$\cos(\sigma - \delta) - b\lambda_4 \cos\sigma = 0, \quad (131)$$

or:

$$S\lambda''_4 - c_0(\lambda_4^2 b - \lambda'_4) = 0.$$

This gives, substituting, $\lambda''_4 = \sqrt{\lambda_4^2 - \lambda'^2_4}$, and expanding:

$$\left. \begin{aligned} \lambda'_4 &= \frac{\lambda_4}{c_0^2 + S^2} \{ b\lambda_4 c_0^2 \pm S \sqrt{S^2 - c_0^2 (b^2 \lambda_4^2 - 1)} \}, \\ \cos(\sigma - \delta) &= \frac{b\lambda_4 c_0}{\sqrt{c_0^2 + S^2}} \end{aligned} \right\} \quad (132)$$

From (131) follows:

$$\cos(\sigma - \delta) = b\lambda_4 \cos\sigma.$$

Since $\cos(\sigma - \delta)$ must be less than one, this means:

$$b\lambda_4 \cos\sigma < 1,$$

or:

$$\lambda_4 < \frac{1}{b \cos\sigma},$$

or:

$$\lambda_4 < \frac{\sqrt{c_0^2 + S^2}}{c_0 b},$$

or, inversely:

$$S > c_0 \sqrt{b^2 \lambda_4^2 - 1}.$$

(133)

That is:

The commutation current, i_g , can be made to vanish at any speed, S , at given impedance factor, λ_4 , by choosing the phase angle of the impedance of the short-circuited coil, δ , or the resistance component, λ' , provided that λ_4 is sufficiently small, or the speed, S , sufficiently high, to conform with equations (133).

From (132) follows as the minimum value of speed, S , at which the commutation current can be made to vanish, at given λ_4 :

$$S_1 = c_0 \sqrt{b^2 \lambda_4^2 - 1},$$

and:

$$\lambda'_4 = \frac{1}{b};$$

hence:

$$\lambda''_4 = \sqrt{\lambda_4^2 - \frac{1}{b^2}}.$$

For high values of speed, S , it is, approximately:

$$\begin{aligned} \cos(\sigma - \delta) &= 0, \\ \sigma - \delta &= 90^\circ, \\ \tan \sigma &= \frac{S}{c_0}; \end{aligned}$$

hence:

$$\frac{\sigma = 90^\circ}{\delta = 0},$$

$$\lambda'_4 = \lambda_4.$$

That is, the short-circuited coil under the brush contains no inductive reactance, hence:

At low and medium speeds, some inductive reactance in the short-circuited coils is advantageous, but for high speeds it is objectionable for good commutation.

225. As an example are shown, in Figs. 189 and 192, the characteristic curves of series-repulsion motors, for the constants:

Impressed voltage:	$e = 500$ volts,
Exciting impedance, main field:	$Z = 0.25 + 3j$ ohms,
Exciting impedance, cross field:	$Z' = 0.25 + 2.5j$ ohms,
Self-inductive impedance, main field:	$Z_0 = 0.1 + 0.3j$ ohms,
Self-inductive impedance, cross field:	$Z_2 = 0.025 + 0.075j$ ohms,

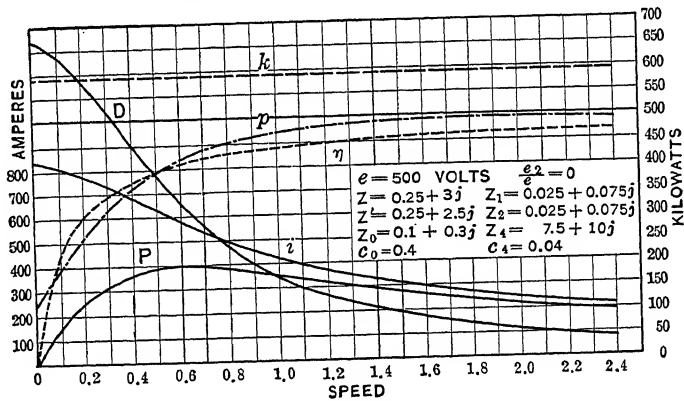

Fig. 189.—Inductively compensated series motor.

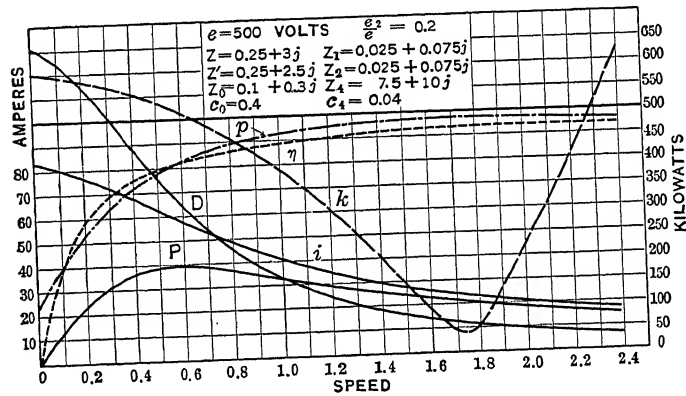

Fig. 190.—Series repulsion motor.

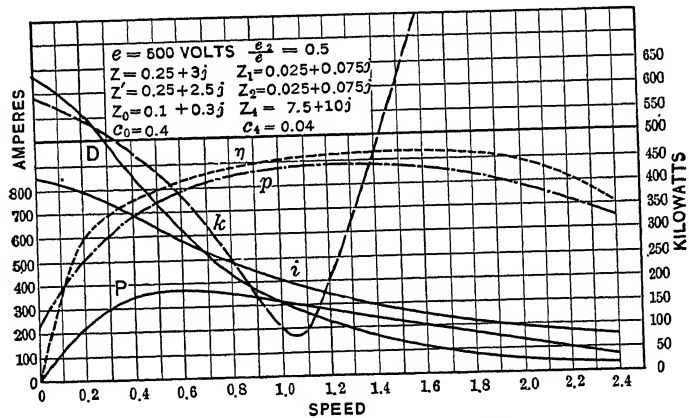

Fig. 191.—Series repulsion motor.

Self-inductive impedance arma-
ture:

$$Z_1 = 0.025 + 0.075 j \text{ ohms,}$$

Self-inductive impedance, brush
short-circuit:

$$Z_4 = 7.5 + 10 j \text{ ohms,}$$

Reduction factor, main field:
brush short-circuit

$$c_0 = 0.4,$$

$$c_4 = 0.04;$$

that is, the same constants as used in the repulsion motor,
Fig. 188.

Curves are plotted for the voltage ratios:

$t = 0$: inductively compensated series motor, Fig. 189.

$t = 0.2$: series repulsion motor, high-speed, Fig. 190.

$t = 0.5$: series repulsion motor, medium-speed, Fig. 191.

$t = 1.0$: repulsion motor with secondary excitation, low-speed,
Fig. 192.

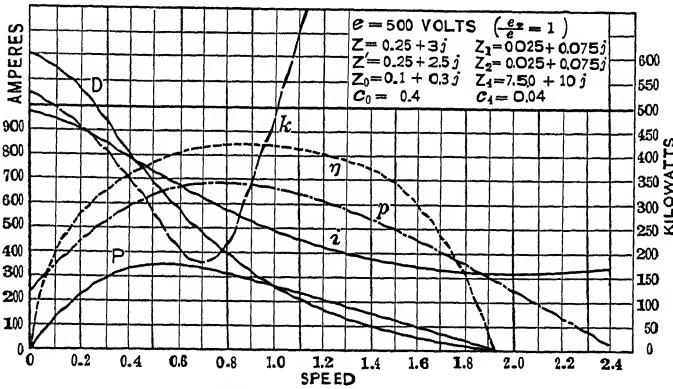

Fig. 192.—Repulsion motor, secondary excitation.

It is, from above constants:

$$Z_3 = Z_1 + c_0^2 (Z_0 + Z) = 0.08 + 0.60 j.$$

$$A_3 = \frac{Z_3}{Z} = 0.202 - 0.010 j.$$

$$A = \frac{Z'}{Z} = 0.835 - 0.014 j.$$

$$\lambda_2 = \frac{Z_2}{Z'} = 0.031 - 0.007 j.$$

$$\lambda_4 = \frac{Z}{Q + Z_4} = 0.179 + 0.087 j.$$

$$b = \frac{c_0}{c_4} = 10.$$

Hence, substituting into the preceding equations:

$$(90) \quad ZK = Z_3 - jSc_0Z - \lambda_4c_0Z(c_0 - jS) + \lambda_2Z' \\ = (0.160 + 0.975S) + j(0.590 - 0.187S),$$

$$(92) \quad I_1 = \frac{e}{ZK} - \frac{et}{ZK} \{jS\lambda_4(c_0 - jS) + \lambda_2\} \\ = \frac{e}{ZK} + \frac{et}{ZK} \{(-0.031 + 0.035S - 0.179S^2) \\ - j(-0.007 + 0.072S + 0.087S^2)\},$$

$$(91) \quad I_2 = I_1(0.969 + 0.007j) + et(0.010 - 0.096j)$$

(93)

$$I_4 = \frac{e(0.072 + 0.035j) + Set\{(0.016 - 0.072S) - j0.045 + 0.035S\}}{ZK},$$

etc.

226. As seen, these four curves are very similar to each other and to those of the repulsion motor, with the exception of the commutation current, i_c , and commutation factor, $k = \frac{i_c}{i}$.

The commutation factor of the compensated series motor, that is, the ratio of current change in the armature coil while leaving the brushes, to total armature current, is constant in the series motor, at all speeds. In the series repulsion motors, the commutation factor, k , starts with the same value at standstill, as the series motor, but decreases with increasing speed, thus giving a superior commutation to that of the series motor, reaches a minimum, and then increases again. Beyond the minimum commutation factor, the efficiency, power-factor, torque and output of the motor first slowly, then rapidly decrease, due to the rapid increase of the commutation losses. These higher values, however, are of little practical value, since the commutation is bad.

The higher the voltage ratio, t , that is, the more voltage is impressed upon the compensating circuit, and the less upon the armature circuit, the lower is the speed at which the commutation factor is a minimum, and the commutation so good or perfect. That is, with $t = 1$, or the repulsion motor with secondary excitation, the commutation is best at 70 per cent. of synchronism, and gets poor above synchronism. With $t = 0.5$, or a series repulsion motor with half the voltage on the compensating, half on the armature circuit, the commutation is best just above synchronism, with the motor constants chosen in this instance, and

gets poor at speeds above 150 per cent. of synchronism. With $t = 0.2$, or only 20 per cent. of the voltage on the compensating circuit, the commutation gets perfect at double synchronism.

Best commutation thus is secured by shifting the supply voltage with increasing speed from the compensating to the armature circuit.

$t > 1$, or a reverse voltage, $-e_1$, impressed upon the armature circuit, so still further improves the commutation at very low speeds.

For high values of t , however, the power-factor of the motor falls off somewhat.

The impedance of the short-circuited armature coils, chosen in the preceding example:

$$Z_4 = 7.5 + 10j,$$

corresponds to fairly high resistance and inductive reactance in the commutator leads, as frequently used in such motors.

227. As a further example are shown in Fig. 193 and Fig. 194 curves of a motor with low-resistance and low-reactance commutator leads, and high number of armature turns, that is, low reduction factor of field to armature circuit, of the constants:

$$Z_4 = 4 + 2j;$$

hence:

$$\lambda_4 = 0.373 + 0.267j,$$

and:

$$c_0 = 0.3,$$

$$c_4 = 0.03,$$

the other constants being the same as before.

Fig. 193 shows, with the speed as abscissæ, the current, torque, power output, power-factor, efficiency and commutation current, i_g , under such a condition of operation, that at low speeds $t = 1.0$, that is, the motor is a repulsion motor with secondary excitation, and above the speed at which $t = 1.0$ gives best commutation (90 per cent. of synchronism in this example), t is gradually decreased, so as to maintain i_g a minimum, that is, to maintain best commutation.

As seen, at 10 per cent. above synchronism, i_g drops below i , that is, the commutation of the motor becomes superior to that of a good direct-current motor.

Fig. 194 then shows the commutation factors, $k = \frac{i_g}{i}$, of the

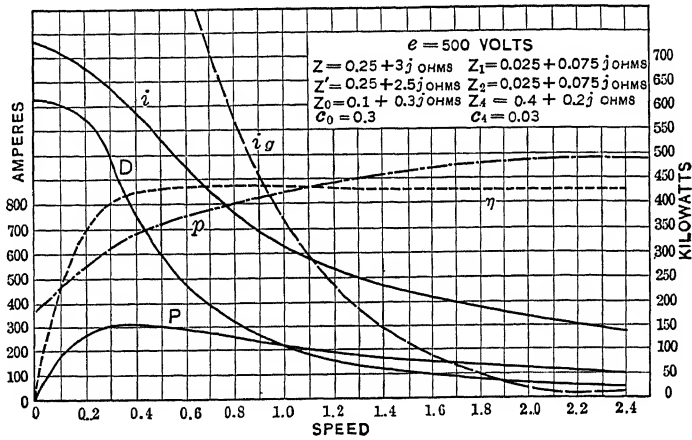

FIG. 193.

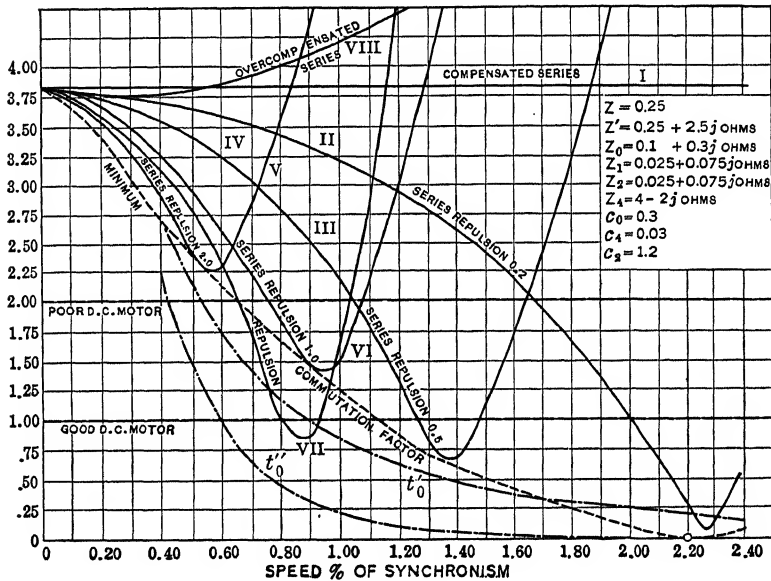

FIG. 194.

at motors, all under the assumption of the same constants:

$$\begin{aligned} Z &= 0.25 + 3j, \\ Z' &= 0.25 + 2.5j, \\ Z_0 &= 0.1 + 0.3j, \\ Z_2 &= 0.025 + 0.075j, \\ Z_1 &= 0.025 + 0.075j, \\ Z_4 &= 4 + 2j, \\ c_0 &= 0.3, \\ c_4 &= 0.03. \end{aligned}$$

re I gives the commutation factor of the motor as induct-compensated series motor ($t = 0$), as constant, $k = 3.82$, the current change at leaving the brushes is 3.82 times in current. Such condition, under continued operation, give destructive sparking.

re II shows the series repulsion motor, with 20 per cent. of ltage on the compensating winding, $t = 0.2$; and

re III with half the voltage on the compensating winding, $t = 0.1$.

re IV corresponds to $t = 1$, or all the voltage on the coming winding, and the armature circuit closed upon itself: on motor with secondary excitation.

re V corresponds to $t = 2$, or full voltage in reverse direction sed upon the armature, double voltage on the compen-winding.

re VI gives the minimum commutation factor, as derived ying t with the speed, in the manner discussed before.

further comparison are given, for the same motor nts:

re VII, the plain repulsion motor, showing its good com-on below synchronism, and poor commutation above onism; and

re VIII, an overcompensated series motor, that is, cons-ly compensated series motor, in which the compensating g contains 20 per cent. more ampere-turns than the arma-) giving 20 per cent. overcompensation.

seen, overcompensation does not appreciably improve itation at low speeds, and spoils it at higher speeds.

194 also gives the two components of the compensating E_2 , which are required to give perfect commutation, or mmutation current:

$t'_0 = \frac{e'_2}{e}$ = component in phase with e , giving quadrature flux:

$t''_0 = \frac{e''_2}{e}$ = component in quadrature with e , giving flux in phase with e .

228. In direct-current motors, overcompensation greatly improves commutation, and so is used in the form of a compensating winding, commutating pole or interpole. In such direct-current motors, the reverse field of the interpole produces a current in the short-circuited armature coil, by its rotation, in the same direction as the armature current in the coil after leaving the brushes, and by proper proportioning of the commutating field, the commutation current, i_o , thus can be made to vanish, that is, perfect commutation produced.

In alternating-current motors, to make the commutation current vanish and so produce perfect commutation, the current in the short-circuited coil must not only be equal to the armature current in intensity, but also in phase, that is, the commutating field must not only have the proper intensity, but also the proper phase.

In paragraph 223 we have seen that the commutating field has the proper phase to make i_o vanish, if produced by a voltage impressed upon the compensating winding:

$$E_2 = Te,$$

which for all except very low speeds is very nearly in phase with e . The magnetic flux produced by this voltage, or the commutating flux, so is nearly in quadrature with e , and therefore approximately in quadrature with the current in the motor, at such speeds where the current, i , is nearly in phase with e . The commutating flux produced by conductive overcompensation, however, is in phase with the current, i , hence is of a wrong phase properly to commutate.

That is, in the alternating-current commutator motor, the commutating flux should be approximately in quadrature with the main flux or main current, and so can not be produced by the main current by overcompensation, but is produced by the combined magnetizing action of the main current and a secondary current produced thereby, since in a transformer the resultant flux lags approximately 90° behind the primary current.

The same results we can get directly by investigating the commutation current of the overcompensated series motor. This motor is characterized by:

$$1. \quad e = E_1 + c_0 E_0 + c_2 E_2;$$

where $c_2 = 1 + q =$ reduction factor of compensating circuit to armature.

$$2. \quad I_0 = c_0 I, I_2 = c_2 I, I_1 = I.$$

Substituting into the fundamental equations of the single-phase commutator motor gives the results:

$$I = \frac{e}{ZK},$$

$$I_4 = \frac{\lambda_4 (c_0 - jSgA)}{ZK} e,$$

$$I_g = \frac{e}{ZK} \left\{ 1 - b\lambda_4 \left(1 - jS \frac{q}{c_0} A \right) \right\};$$

where:

$$ZK = (Z_3 + Z_5 + jSc_0Z) + jS\lambda_4 (c_0Z - jSgZ').$$

To make I_g vanish, it must therefore be:

$$q = \frac{c}{SbA} \left\{ \frac{\lambda'^4_4}{\lambda^2_4} - j \left(b - \frac{\lambda'_4}{\lambda^2_4} \right) \right\},$$

or approximately:

$$q = -j \frac{c_0}{S} \frac{x}{x'}$$

or, with the numerical values of the preceding instance:

$$q = \frac{0.046 - 0.295j}{S}$$

That is, the overcompensating component, q , must be approximately in quadrature with the current, I , hence can not be produced by this current under the conditions considered here; and overcompensation, while it may under certain conditions improve the commutation, can as a rule not give perfect commutation in a series alternating-current motor.

229. The preceding study of commutation is based on the assumption of the short-circuit current under the brush as alternating current. This, however, is strictly the case only at standstill, as already discussed in the paragraphs on the repulsion motor. At speed, an exponential term, due to the abrupt

change of current in the armature coil when passing under the brush, superimposes upon the e.m.f. generated in the short-circuited coil, and so on the short-circuit current under the brush, and modifies it the more, the higher the speed, that is, the quicker the current change. This exponential term of e.m.f. generated in the armature coil short-circuited by the commutator brush, is the so-called "e.m.f. of self-induction of commutation." It exists in direct-current motors as well as in alternating-current motors, and is controlled by overcompensation, that is, by a commutating field in phase with the main field, and approximately proportional to the armature current.

The investigation of the exponential term of generated e.m.f. and of short-circuit current, the change of the commutation current and commutation factor brought about thereby and the study of the commutating field required to control this exponential term leads into the theory of transient phenomena, that is, phenomena temporarily occurring during and immediately after a change of circuit condition.¹

The general conclusions are:

The control of the e.m.f. of self-induction of commutation of the single-phase commutator motor requires a commutating field, that is, a field in quadrature position in space to the main field, approximately proportional to the armature current and in phase with the armature current, hence approximately in phase with the main field.

Since the commutating field required to control, in the armature coil under the commutator brush, the e.m.f. of alternation of the main field, is approximately in quadrature behind the main field—and usually larger than the field controlling the e.m.f. of self-induction of commutation—it follows that the total commutating field, or the quadrature flux required to give best commutation, must be ahead of the values derived in paragraphs 221 to 224.

As the field required by the e.m.f. of alternation in the short-circuited coil was found to lag for speeds below the speed of best commutation, and to lead above this speed, from the position in quadrature behind the main field, the total commutating field must lead this field controlling the e.m.f. of alternation, and it follows:

¹ See "Theory and Calculations of Transient Electric Phenomena and Oscillations," Sections I and II.

Choosing the e.m.f., E_2 , impressed upon the compensating winding in phase with, and its magnetic flux, therefore in quadrature (approximately), behind the main field, gives a commutation in the repulsion and the series repulsion motor which is better than that calculated from paragraphs 221 to 224, for all speeds up to the speed of best commutation, but becomes inferior for speeds above this. Hence the commutation of the repulsion motor and of the series repulsion motor, when considering the self-induction of commutation, is superior to the calculated values below, inferior above the critical speed, that is, the speed of minimum commutation current. The commutation of the overcompensated series motor is superior to the values calculated in the preceding, though not of the same magnitude as in the motors with quadrature commutating flux.

It also follows that an increase of the inductive reactance of the armature coil increases the exponential and decreases the alternating term of e.m.f. and therewith the current in the short-circuited coil, and therefore requires a commutating flux earlier in phase than that required by an armature coil of lower reactance, hence improves the commutation of the series repulsion and the repulsion motor at low speeds, and spoils it at high speeds, as seen from the phase angles of the commutating flux calculated in paragraphs 221 to 224.

Causing the armature current to lag, by inserting external inductive reactance into the armature circuit, has the same effect as leading commutating flux: it improves commutation at low, impairs it at high speeds. In consequence hereof the commutation of the repulsion motor with secondary excitation—in which the inductive reactance of the main field circuit is in the armature circuit—is usually superior, at moderate speeds, to that of the repulsion motor with primary excitation, except at very low speeds, where the angle of lag of the armature current is very large.

CHAPTER XXI

REGULATING POLE CONVERTERS

230. With a sine wave of alternating voltage, and the commutator brushes set at the magnetic neutral, that is, at right angles to the resultant magnetic flux, the direct voltage of a synchronous converter is constant at constant impressed alternating voltage. It equals the maximum value of the alternating voltage between two diametrically opposite points of the commutator, or "diametrical voltage," and the diametrical voltage is twice the voltage between alternating lead and neutral, or star or *Y* voltage of the polyphase system.

A change of the direct voltage, at constant impressed alternating voltage (or inversely), can be produced:

Either by changing the position angle between the commutator brushes and the resultant magnetic flux, so that the direct voltage between the brushes is not the maximum diametrical alternating voltage but only a part thereof.

Or by changing the maximum diametrical alternating voltage, at constant effective impressed voltage, by wave-shape distortion by the superposition of higher harmonics.

In the former case, only a reduction of the direct voltage below the normal value can be produced, while in the latter case an increase as well as a reduction can be produced, an increase if the higher harmonics are in phase, and a reduction if the higher harmonics are in opposition to the fundamental wave of the diametrical or *Y* voltage.

A. Variable Ratio by a Change of the Position Angle between Commutator Brushes and Resultant Magnetic Flux

231. Let, in the commutating machine shown diagrammatically in Fig. 195, the potential difference, or alternating voltage between one point, *a*, of the armature winding and the neutral, 0 (that is, the *Y* voltage, or half the diametrical voltage) be represented by the sine wave, Fig. 197. This potential difference is a maximum, *e*, when *a* stands at the magnetic neutral, at *A* or *B*.

If, therefore, the brushes are located at the magnetic neutral, A and B , the voltage between the brushes is the potential difference between A and B , or twice the maximum Y voltage, $2e$, as indicated in Fig. 197. If now the brushes are shifted by an angle, τ , to position C and D , Fig. 196, the direct voltage between

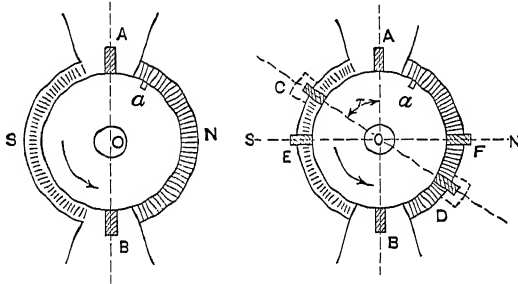

FIG. 195.—Diagram of commutating machine with brushes in the magnetic neutral.

FIG. 196.—E.m.f. variation by shifting the brushes.

the brushes is the potential difference between C and D , or $2e \cos \tau$ with a sine wave. Thus, by shifting the brushes from the position A, B , at right angles with the magnetic flux, to the position E, F , in line with the magnetic flux, any direct voltage be-

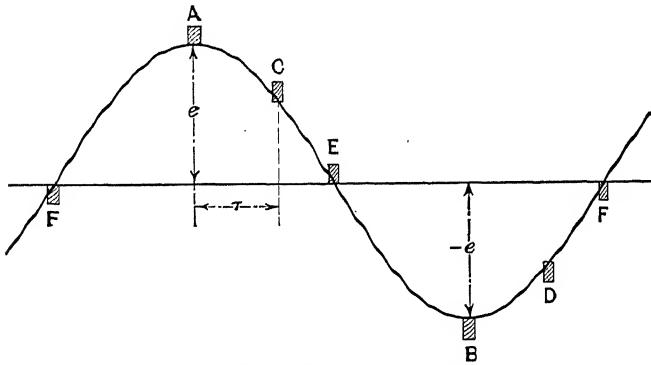

FIG. 197.—Sine wave of e.m.f.

tween $2e$ and 0 can be produced, with the same wave of alternating voltage, a .

As seen, this variation of direct voltage between its maximum value and zero, at constant impressed alternating voltage, is in-

dependent of the wave shape, and thus can be produced whether the alternating voltage is a sine wave or any other wave.

It is obvious that, instead of shifting the brushes on the commutator, the magnetic field poles may be shifted, in the opposite direction, by the same angle, as shown in Fig. 198, *A, B, C*.

Instead of mechanically shifting the field poles, they can be shifted electrically, by having each field pole consist of a number of sections, and successively reversing the polarity of these sections, as shown in Fig. 199, *A, B, C, D*.

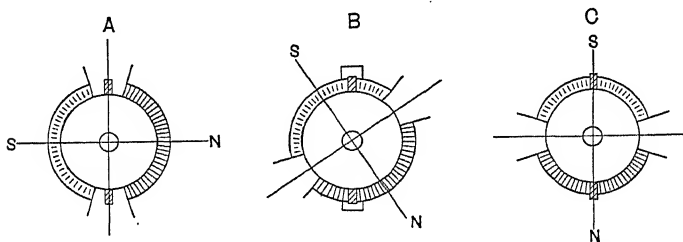

FIG. 198.—E.m.f. variation by mechanically shifting the poles.

Instead of having a large number of field pole sections, obviously two sections are sufficient, and the same gradual change can be brought about by not merely reversing the sections but reducing the excitation down to zero and bringing it up again in opposite direction, as shown in Fig. 200, *A, B, C, D, E*.

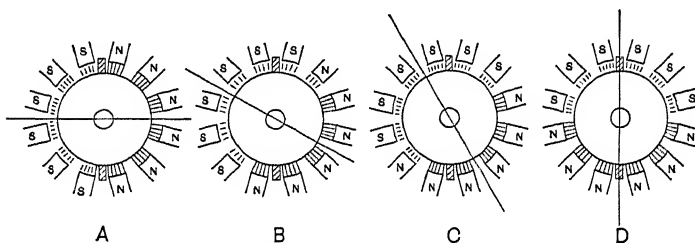

FIG. 199.—E.m.f. variation by electrically shifting the poles.

In this case, when reducing one section in polarity, the other section must be increased by approximately the same amount, to maintain the same alternating voltage.

When changing the direct voltage by mechanically shifting the brushes, as soon as the brushes come under the field pole faces, self-inductive sparking on the commutator would result if the iron of the field poles were not kept away from the brush

position by having a slot in the field poles, as indicated in dotted line in Fig. 196 and Fig. 198, *B*. With the arrangement in Figs. 196 and 198, this is not feasible mechanically, and these arrange-

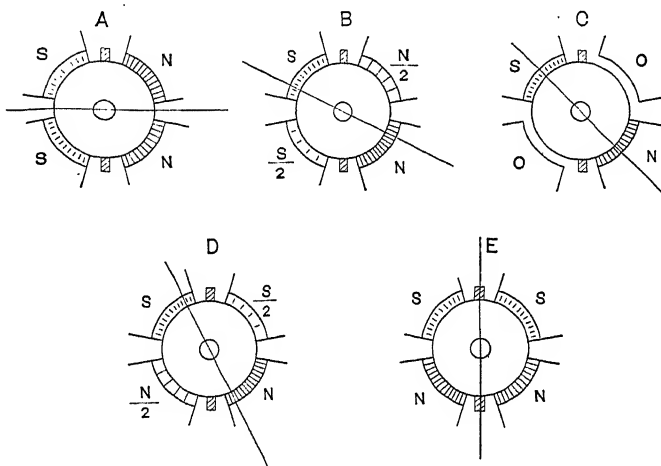

FIG. 200.—E.m.f. variation by shifting-flux distribution.

ments are, therefore, unsuitable. It is feasible, however, as shown in Figs. 199 and 200, that is, when shifting the resultant magnetic flux electrically, to leave a commutating space between

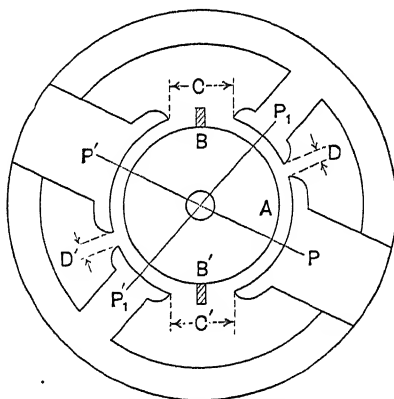

FIG. 201.—Variable ratio or split-pole converter.

the polar projections of the field at the brushes, as shown in Fig. 200, and thus secure as good commutation as in any other commutating machine.

Such a variable-ratio converter, then, comprises an armature A , Fig. 201, with the brushes, B, B' , in fixed position and field poles, P, P' , separated by interpolar spaces, C, C' , of such width as required for commutation. Each field pole consists of two parts, P and P_1 , usually of different relative size, separated by a narrow space, DD' , and provided with independent windings. By varying, then, the relative excitation of the two polar sections, P and P_1 , an effective shift of the resultant field flux and a corresponding change of the direct voltage is produced.

As this method of voltage variation does not depend upon the wave shape, by the design of the field pole faces and the pitch of the armature winding the alternating voltage wave can be made as near a sine wave as desired. Usually not much attention is paid hereto, as experience shows that the usual distributed winding of the commutating machine gives a sufficiently close approach to sine shape.

Armature Reaction and Commutation

232. With the brushes in quadrature position to the resultant magnetic flux, and at normal voltage ratio, the direct-current generator armature reaction of the converter equals the synchronous-motor armature reaction of the power component of the alternating current, and at unity power-factor the converter thus has no resultant armature reaction, while with a lagging or leading current it has the magnetizing or demagnetizing reaction of the wattless component of the current.

If by a shift of the resultant flux from quadrature position with the brushes, by angle, τ , the direct voltage is reduced by factor $\cos \tau$, the direct current and therewith the direct-current armature reaction are increased, by factor, $\frac{1}{\cos \tau}$, as by the law of conservation of energy the direct-current output must equal the alternating-current input (neglecting losses). The direct-current armature reaction, \mathfrak{F} , therefore ceases to be equal to the armature reaction of the alternating energy current, \mathfrak{F}_0 , but is greater by factor, $\frac{1}{\cos \tau}$:

$$\mathfrak{F} = \frac{\mathfrak{F}_0}{\cos \tau}.$$

The alternating-current armature reaction, \mathfrak{F}_0 , at no phase displacement, is in quadrature position with the magnetic flux.

The direct-current armature reaction, \mathcal{F} , however, appears in the position of the brushes, or shifted against quadrature position by angle τ ; that is, the direct-current armature reaction is not in opposition to the alternating-current armature reaction, but differs therefrom by angle τ , and so can be resolved into two components, a component in opposition to the alternating-current armature reaction, \mathcal{F}_0 , that is, in quadrature position with the resultant magnetic flux:

$$\mathcal{F}'' = \mathcal{F} \cos \tau = \mathcal{F}_0,$$

that is, equal and opposite to the alternating-current armature reaction, and thus neutralizing the same; and a component in quadrature position with the alternating-current armature reaction, \mathcal{F}_0 , or in phase with the resultant magnetic flux, that is, magnetizing or demagnetizing:

$$\mathcal{F}' = \mathcal{F} \sin \tau = \mathcal{F}_0 \tan \tau;$$

that is, in the variable-ratio converter the alternating-current armature reaction at unity power-factor is neutralized by a component of the direct-current armature reaction, but a resultant armature reaction, \mathcal{F}' , remains, in the direction of the resultant magnetic field, that is, shifted by angle $(90 - \tau)$ against the position of brushes. This armature reaction is magnetizing or demagnetizing, depending on the direction of the shift of the field, τ .

It can be resolved into two components, one at right angles with the brushes:

$$\mathcal{F}'_1 = \mathcal{F}' \cos \tau = \mathcal{F}_0 \sin \tau,$$

and one, in line with the brushes:

$$\mathcal{F}'_2 = \mathcal{F}' \sin \tau = \mathcal{F} \sin^2 \tau = \mathcal{F}_0 \sin \tau \tan \tau,$$

as shown diagrammatically in Figs. 202 and 203.

There exists thus a resultant armature reaction in the direction of the brushes, and thus harmful for commutation, just as in the direct-current generator, except that this armature reaction in the direction of the brushes is only $\mathcal{F}'_2 = \mathcal{F} \sin^2 \tau$, that is, $\sin^2 \tau$ of the value of that of a direct-current generator.

The value of \mathcal{F}'_2 can also be derived directly, as the difference between the direct-current armature reaction, \mathcal{F} , and the com-

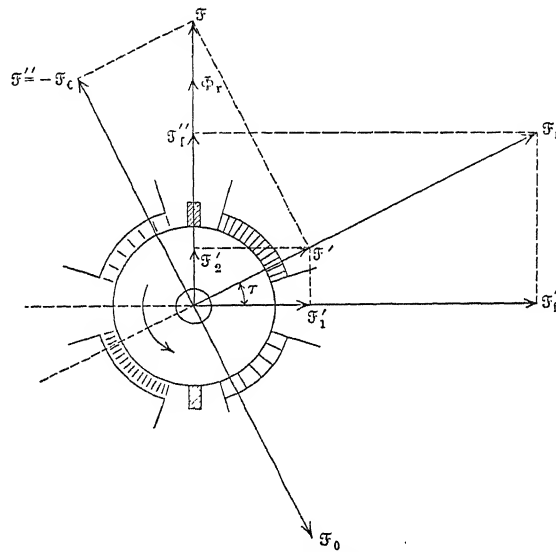

FIG. 202.—Diagram of m.m.f.s. in split-pole converter.

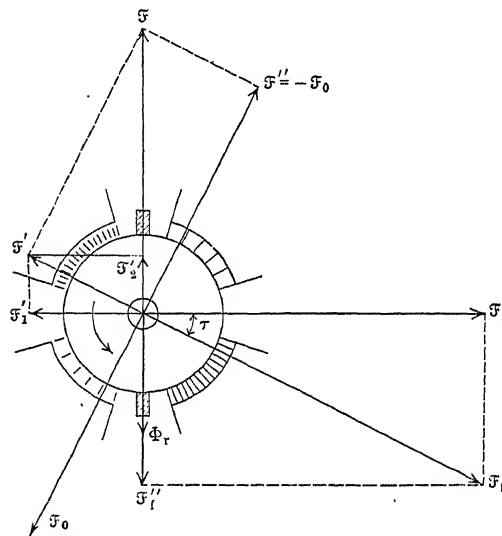

FIG. 203.—Diagram of m.m.f.s. in split-pole converter.

ponent of the alternating-current armature reaction, in the direction of the brushes, $\mathfrak{F}_0 \cos \tau$, that is:

$$\mathfrak{F}'_2 = \mathfrak{F} - \mathfrak{F}_0 \cos \tau = \mathfrak{F} (1 - \cos^2 \tau) = \mathfrak{F} \sin^2 \tau = \mathfrak{F}_0 \sin \tau \tan \tau.$$

233. The shift of the resultant magnetic flux, by angle τ , gives a component of the m.m.f. of field excitation, $\mathfrak{F}''_f = \mathfrak{F}_f \sin \tau$, (where $\mathfrak{F}_f =$ m.m.f. of field excitation), in the direction of the commutator brushes, and either in the direction of armature reaction, thus interfering with commutation, or in opposition to the armature reaction, thus improving commutation.

If the magnetic flux is shifted in the direction of armature rotation, that is, that section of the field pole weakened toward which the armature moves, as in Fig. 202, the component \mathfrak{F}''_f of field excitation at the brushes is in the same direction as the armature reaction, \mathfrak{F}'_2 , thus adds itself thereto and impairs the commutation, and such a converter is hardly operative. In this case the component of armature reaction, \mathfrak{F}' , in the direction of the field flux is magnetizing.

If the magnetic flux is shifted in opposite direction to the armature reaction, that is, that section of the field pole weakened which the armature conductor leaves, as in Fig. 203, the component, \mathfrak{F}''_f , of field excitation at the brushes is in opposite direction to the armature reaction, \mathfrak{F}'_2 , therefore reverses it, if sufficiently large, and gives a commutating or reversing flux, Φ_r , that is, improves commutation so that this arrangement is used in such converters. In this case, however, the component of armature reaction, \mathfrak{F}' , in the direction of the field flux is demagnetizing, and with increasing load the field excitation has to be increased by \mathfrak{F}' to maintain constant flux. Such a converter thus requires compounding, as by a series field, to take care of the demagnetizing armature reaction.

If the alternating current is not in phase with the field, but lags or leads, the armature reaction of the lagging or leading component of current superimposes upon the resultant armature reaction, \mathfrak{F}' , and increases it—with lagging current in Fig. 202, leading current in Fig. 203—or decreases it—with lagging current in Fig. 203, leading current in Fig. 202—and with lag of the alternating current, by phase angle, $\theta = \tau$, under the conditions of Fig. 203, the total resultant armature reaction vanishes, that is, the lagging component of synchronous-motor armature reaction compensates for the component of the direct-current reaction,

which is not compensated by the armature reaction of the power component of the alternating current. It is interesting to note that in this case, in regard to heating, output based thereon, etc., the converter equals that of one of normal voltage ratio.

B. Variable Ratio by Change of Wave Shape of the Y Voltage

234. If in the converter shown diagrammatically in Fig. 204 the magnetic flux disposition and the pitch of the armature winding are such that the potential difference between the point,

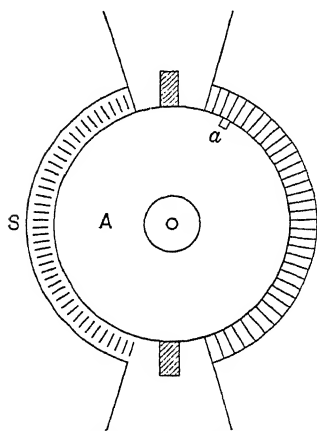

FIG. 204.—Variable ratio converter by changing wave shape of the Y. e.m.f.

a, of the armature and the neutral *O*, or the Y voltage, is a sine wave, Fig. 205 A, then the voltage ratio is normal. Assume, however, that the voltage curve, *a*, differs from sine shape by the superposition of some higher harmonics: the third harmonic in Figs. 205 B and C; the fifth harmonic in Figs. 205 D and E. If, then, these higher harmonics are in phase with the fundamental, that is, their maxima coincide, as in Figs. 205 B and D, they increase the maximum of the alternating voltage, and thereby the direct voltage; and if these harmonics are in opposition to the funda-

mental, as in Figs. 205 C and E, they decrease the maximum alternating and thereby the direct voltage, without appreciably affecting the effective value of the alternating voltage. For instance, a higher harmonic of 30 per cent. of the fundamental increases or decreases the direct voltage by 30 per cent., but varies the effective alternating voltage only by $\sqrt{1 + 0.3^2} = 1.044$, or 4.4 per cent.

The superposition of higher harmonics thus offers a means of increasing as well as decreasing the direct voltage, at constant alternating voltage, and without shifting the angle between the brush position and resultant magnetic flux.

Since, however, the terminal voltage of the converter does not only depend on the generated e.m.f. of the converter, but also on that of the generator, and is a resultant of the two e.m.f.s. in approximately inverse proportion to the impedances from the converter terminals to the two respective generated e.m.f.s., for

varying the converter ratio only such higher harmonics can be used which may exist in the Y voltage without appearing in the converter terminal voltage or supply voltage.

In general, in an n -phase system an n th harmonic existing in the star or Y voltage does not appear in the ring or delta voltage,

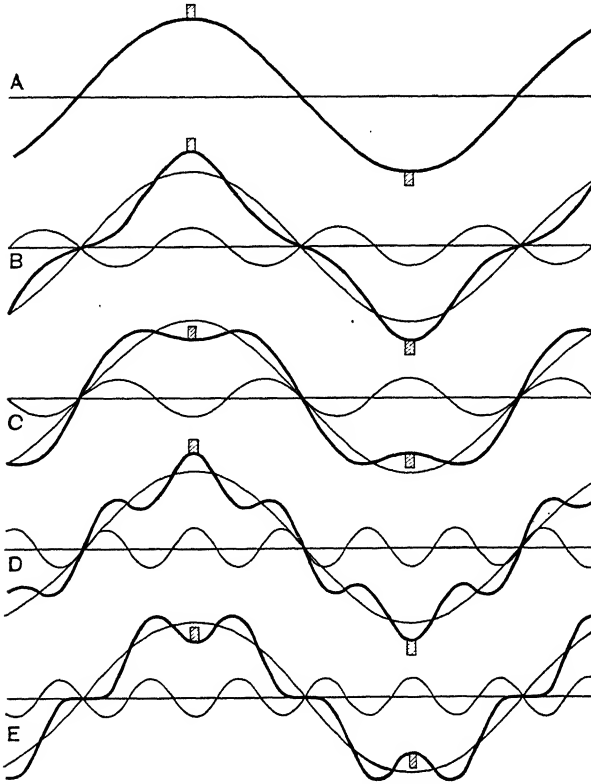

FIG. 205.—Superposition of harmonics to change the e.m.f. ratio.

as the ring voltage is the combination of two star voltages displaced in phase by $\frac{180}{n}$ degrees for the fundamental, and thus by 180° , or in opposition, for the n th harmonic.

Thus, in a three-phase system, the third harmonic can be introduced into the Y voltage of the converter, as in Figs. 205 B and C, without affecting or appearing in the delta voltage, so can be used for varying the direct-current voltage, while the fifth harmonic can not be used in this way, but would reappear and

cause a short-circuit current in the supply voltage, hence should be made sufficiently small to be harmless.

235. The third harmonic thus can be used for varying the direct voltage in the three-phase converter diagrammatically shown in Fig. 206 A, and also in the six-phase converter with

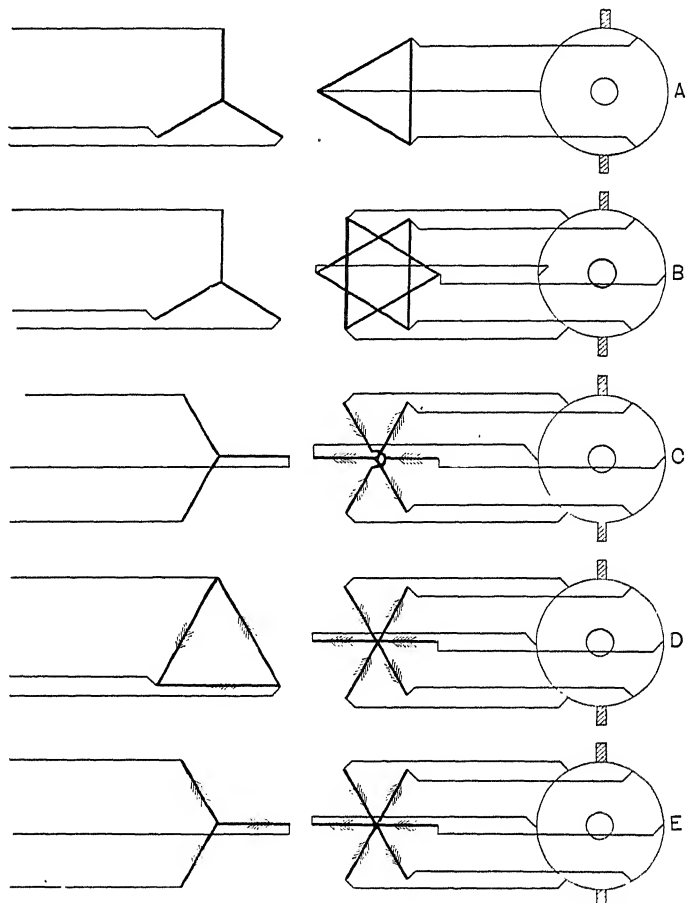

FIG. 206.—Transformer connections for varying the e.m.f. ratio by superposition of the third harmonic.

double-delta connection, as shown in Fig. 206 B, or double-Y connection, as shown in Fig. 206 C, since this consists of two separate three-phase triangles of voltage supply, and neither of them contains the third harmonic. In such a six-phase converter with double-Y connection, Fig. 206 C, the two neutrals, however,

must not be connected together, as the third harmonic voltage exists between the neutrals. In the six-phase converter with diametrical connections, the third harmonic of the Y voltage appears in the terminal voltage, as the diametrical voltage is twice the Y voltage. In such a converter, if the primaries of the sup-

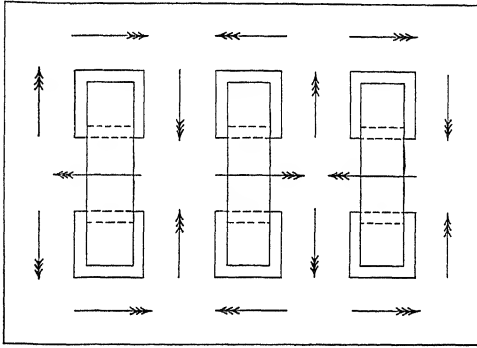

FIG. 207.—Shell-type transformers.

ply transformers are connected in delta, as in Fig. 206 D, the third harmonic is short-circuited in the primary voltage triangle, and thus produces excessive currents, which cause heating and interfere with the voltage regulation, therefore, this arrangement

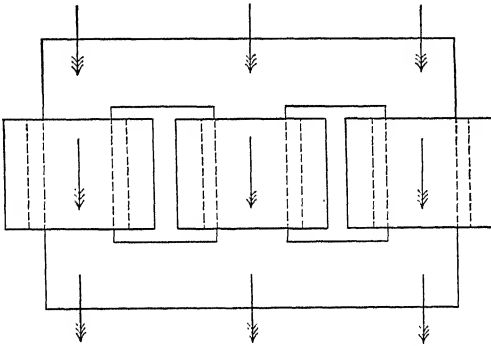

FIG. 208.—Core-type transformer.

is not permissible. If, however, the primaries are connected in Y , as in Fig. 206 E, and either three separate single-phase transformers, or a three-phase transformer with three independent magnetic circuits, is used, as in Fig. 207, the triple-frequency voltages in the primary are in phase with each other between

the line and the neutral, and thus, with isolated neutral, can not produce any current. With a three-phase transformer as shown in Fig. 208, that is, in which the magnetic circuit of the third harmonic is open, triple-frequency currents can exist in the secondary and this arrangement therefore is not satisfactory.

In two-phase converters, higher harmonics can be used for regulation only if the transformers are connected in such a manner that the regulating harmonic, which appears in the converter terminal voltage, does not appear in the transformer terminals, that is, by the connection analogous to Figs. 206 E and 207.

Since the direct-voltage regulation of a three-phase or six-phase converter of this type is produced by the third harmonic,

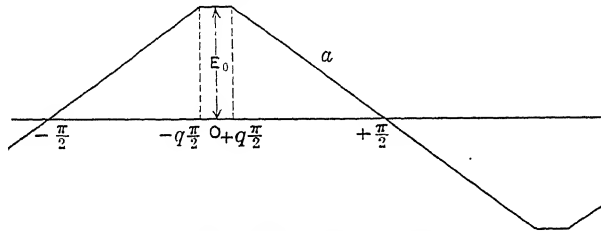

Fig. 209.—Y c.m.f. wave.

the problem is to design the magnetic circuit of the converter so as to produce the maximum third harmonic, the minimum fifth and seventh harmonics.

If q = interpolar space, thus $(1 - q)$ = pole arc, as fraction of pitch, the wave shape of the voltage generated between the point, a , of a full-pitch distributed winding—as generally used for commutating machines—and the neutral, or the induced Y voltage of the system is a triangle with the top cut off for distance q , as shown in Fig. 209, when neglecting magnetic spread at the pole corners.

If then e_0 = voltage generated per armature turn while in front of the field pole (which is proportional to the magnetic density in the air gap), m = series turns from brush to brush, the maximum voltage of the wave shown in Fig. 209 is:

$$E_0 = me_0(1 - q);$$

developed into a Fourier series, this gives, as the equation of the voltage wave a , Fig. 188:

$$e = \frac{8 E_0}{(1 - q) \pi^2} \sum_1^{\infty} \frac{\cos \frac{(2n - 1) q \pi}{2}}{(2n - 1)^2} \cos (2n - 1) \theta;$$

or, substituting for E_0 , and denoting:

$$A = \frac{8 m e_0}{\pi^2},$$

$$e = A \sum_1^{\infty} \frac{\cos \frac{2n-1}{2} q\pi}{(2n-1)^2} \cos (2n-1) \theta$$

$$= A \left\{ \cos q \frac{\pi}{2} \cos \theta + \frac{1}{9} \cos 3 q \frac{\pi}{2} \cos 3 \theta + \frac{1}{25} \cos 5 q \frac{\pi}{2} \cos 5 \theta \right. \\ \left. + \frac{1}{49} \cos 7 q \frac{\pi}{2} \cos 7 \theta + \dots \right\}.$$

Thus the third harmonic is a positive maximum for $q = 0$, or 100 per cent. pole arc, and a negative maximum for $q = \frac{2}{3}$, or 33.3 per cent. pole arc.

For maximum direct voltage, q should therefore be made as small, that is, the pole arc as large, as commutation permits. In general, the minimum permissible value of q is about 0.15 to 0.20.

The fifth harmonic vanishes for $q = 0.20$ and $q = 0.60$, and the seventh harmonic for $q = 0.143$, 0.429 , and 0.714 .

For small values of q , the sum of the fifth and seventh harmonics is a minimum for about $q = 0.18$, or 82 per cent. pole arc. Then for $q = 0.18$, or 82 per cent. pole arc:

$$e_1 = A \{ 0.960 \cos \theta + 0.0736 \cos 3 \theta + 0.0062 \cos 5 \theta \\ - 0.0081 \cos 7 \theta + \dots \} \\ = 0.960 A \{ \cos \theta + 0.0766 \cos 3 \theta + 0.0065 \cos 5 \theta \\ - 0.0084 \cos 7 \theta + \dots \};$$

that is, the third harmonic is less than 8 per cent., so that not much voltage rise can be produced in this manner, while the fifth and seventh harmonics together are only 1.3 per cent., thus negligible.

236. Better results are given by reversing or at least lowering the flux in the center of the field pole. Thus, dividing the pole face into three equal sections, the middle section, of 27 per cent. pole arc, gives the voltage curve, $q = 0.73$, thus:

$$e_2 = A \{ 0.411 \cos \theta - 0.1062 \cos 3 \theta + 0.0342 \cos 5 \theta \\ - 0.0035 \cos 7 \theta \dots \} \\ = 0.411 A \{ \cos \theta - 0.258 \cos 3 \theta + 0.083 \cos 5 \theta \\ - 0.0085 \cos 7 \theta \dots \}.$$

The voltage curves given by reducing the pole center to one-

half intensity, to zero, reversing it to half intensity, to full intensity, and to such intensity that the fundamental disappears, then are given by:

Center part of pole density	(1) full, $e = e_1$	$= 0.960 A \{ \cos \theta + 0.077 \cos 3 \theta$ $+ 0.0065 \cos 5 \theta - 0.0084 \cos 7 \theta. . . \}$
	(2) 0.5, $e = e_1 - 0.5 e_2$	$= 0.755 A \{ \cos \theta + 0.168 \cos 3 \theta$ $- 0.0144 \cos 5 \theta - 0.0085 \cos 7 \theta. . . \}$
	(3) 0, $e = e_1 - e_2$	$= 0.549 A \{ \cos \theta + 0.328 \cos 3 \theta$ $- 0.053 \cos 5 \theta - 0.084 \cos 7 \theta. . . \}$
	(4) -0.5 $e = e_1 - 1.5 e_2$	$= 0.344 A \{ \cos \theta + 0.680 \cos 3 \theta$ $- 0.131 \cos 5 \theta - 0.0084 \cos 7 \theta. . . \}$
	(5) - full, $e = e_1 - 2 e_2$	$= 0.138 A \{ \cos \theta + 2.07 \cos 3 \theta$ $- 0.45 \cos 5 \theta - 0.008 \cos 7 \theta. . . \}$
	(6) -1.17, $e = e_1 - 2.34 e_2$	$= 0.322 A \{ \cos 3 \theta - 0.227 \cos 5 \theta. . . \}$.

It is interesting to note that in the last case the fundamental frequency disappears and the machine is a generator of triple frequency, that is, produces or consumes a frequency equal to three times synchronous frequency. In this case the seventh harmonic also disappears, and only the fifth is appreciable, but could be greatly reduced by a different kind of pole arc. From above table follows:

	(1)	(2)	(3)	(4)	(5)	(6)	normal
Maximum funda- mental alter- nating volts...	0.960	0.755	0.549	0.344	0.138	0	0.960
Direct volts.....	1.033	0.883	0.743	0.578	0.423	0.322	0.960

237. It is seen that a considerable increase of direct voltage beyond the normal ratio involves a sacrifice of output, due to the decrease or reversal of a part of the magnetic flux, whereby the air-gap section is not fully utilized. Thus it is not advisable to go too far in this direction.

By the superposition of the third harmonic upon the fundamental wave of the Y voltage, in a converter with three sections per pole, thus an increase of direct voltage over its normal voltage can be produced by lowering the excitation of the middle section and raising that of the outside sections of the field pole, and also inversely a decrease of the direct voltage below its normal value by raising the excitation of the middle section

and decreasing that of the outside sections of the field poles; that is, in the latter case making the magnetic flux distribution at the armature periphery peaked, in the former case by making the flux distribution flat-topped or even double-peaked.

Armature Reaction and Commutation

238. In such a split-pole converter let p equal ratio of direct voltage to that voltage which it would have, with the same alternating impressed voltage, at normal voltage ratio, where $p > 1$ represents an overnormal, $p < 1$ a subnormal direct voltage. The direct current, and thereby the direct-current armature reaction, then is changed from the value which it would have at normal voltage ratio, by the factor $\frac{1}{p}$, as the product of direct volts and amperes must be the same as at normal voltage ratio, being equal to the alternating power input minus losses.

With unity power-factor, the direct-current armature reaction, \mathfrak{F} , in a converter of normal voltage ratio is equal and opposite, and thus neutralized by the alternating-current armature reaction, \mathfrak{F}_0 , and at a change of voltage ratio from normal, by factor p , and thus change of direct current by factor $\frac{1}{p}$. The direct-current armature reaction thus is:

$$\mathfrak{F} = \frac{\mathfrak{F}_0}{p}$$

hence, leaves an uncompensated resultant.

As the alternating-current armature reaction at unity power-factor is in quadrature with the magnetic flux, and the direct-current armature reaction in line with the brushes, and with this type of converter the brushes stand at the magnetic neutral, that is, at right angles to the magnetic flux, the two armature reactions are in the same direction in opposition with each other, and thus leave the resultant, in the direction of the commutator brushes:

$$\begin{aligned}\mathfrak{F}' &= \mathfrak{F} - \mathfrak{F}_0 \\ &= \mathfrak{F}_0 \left(\frac{1}{p} - 1 \right).\end{aligned}$$

The converter thus has an armature reaction proportional to the deviation of the voltage ratio from normal.

239. If $p > 1$, or overnormal direct voltage, the armature

reaction is negative, or motor reaction, and the magnetic flux produced by it at the commutator brushes thus a commutating flux. If $p < 1$, or subnormal direct voltage, the armature reaction is positive, that is, the same as in a direct-current generator, but less in intensity, and thus the magnetic flux of armature reaction tends to impair commutation. In a direct-current generator, by shifting the brushes to the edge of the field poles, the field flux is used as reversing flux to give commutation. In this converter, however, decrease of direct voltage is produced by lowering the outside sections of the field poles, and the edge of the field may not have a sufficient flux density to give commuta-

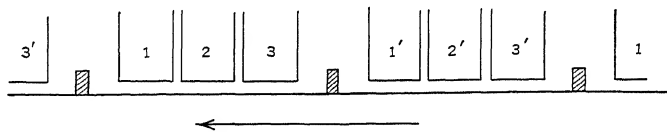

Fig. 210.—Three-section pole for variable-ratio converter.

tion, with a considerable decrease of voltage below normal, and thus a separate commutating pole is required. Preferably this type of converter should be used only for raising the voltage, for lowering the voltage the other type, which operates by a shift of the resultant flux, and so gives a component of the main field flux as commutating flux, should be used, or a combination of both types.

With a polar construction consisting of three sections, this can be done by having the middle section at low, the outside sections at high excitation for maximum voltage, and, to decrease the voltage, raise the excitation of the center section, but instead of lowering both outside sections, leave the section in the direction of the armature rotation unchanged, while lowering the other outside section twice as much, and thus produce, in addition to the change of wave shape, a shift of the flux, as represented by the scheme Fig. 210.

Magnetic Density

Pole section . . .	1	2	3	1'	2'	3'
Max. voltage . . .	$+\mathfrak{B}$	0	$+\mathfrak{B}$	$-\mathfrak{B}$	0	$-\mathfrak{B}$
	$+\frac{2}{3}\mathfrak{B}$	$+\frac{1}{3}\mathfrak{B}$	$+\mathfrak{B}$	$-\frac{2}{3}\mathfrak{B}$	$-\frac{1}{3}\mathfrak{B}$	$-\mathfrak{B}$
	$+\mathfrak{B}\frac{1}{3}$	$+\frac{2}{3}\mathfrak{B}$	$\mathfrak{B}+\mathfrak{B}$	$-\frac{1}{3}\mathfrak{B}$	$-\frac{2}{3}\mathfrak{B}$	$-\mathfrak{B}$
	0	$+\mathfrak{B}$	$+\mathfrak{B}$	0	$-\mathfrak{B}$	$-\mathfrak{B}$
Min. voltage . . .	$-\frac{1}{3}\mathfrak{B}$	$\mathfrak{B}+\frac{1}{3}\mathfrak{B}$	$+\mathfrak{B}$	$+\frac{1}{3}\mathfrak{B}$	$-\frac{1}{3}\mathfrak{B}$	$-\mathfrak{B}$

Where the required voltage range above normal is not greater than can be produced by the third harmonic of a large pole arc with uniform density, this combination of voltage regulation by both methods can be carried out with two sections of the field poles, of which the one (toward which the armature moves) is greater than the other, as shown in Fig. 211, and the variation then is as follows:

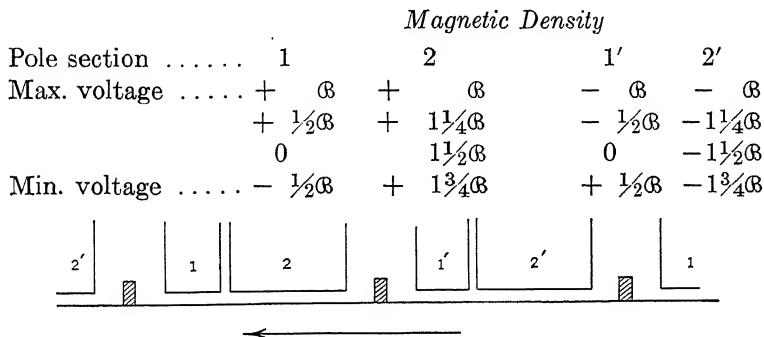

FIG. 211.—Two-section pole for variable-ratio converter.

Heating and Rating

240. The distribution of current in the armature conductors of the variable-ratio converter, the wave form of the actual or differential current in the conductors, and the effect of the wattless current thereon, are determined in the same manner as in the standard converter, and from them are calculated the local heating in the individual armature turns and the mean armature heating.

In an n -phase converter of normal voltage ratio, let E_0 = direct voltage; I_0 = direct current; E^0 = alternating voltage between adjacent collector rings (ring voltage), and I^0 = alternating current between adjacent collector rings (ring current); then, as seen in the preceding:

$$E^0 = \frac{E_0 \sin \frac{\pi}{n}}{\sqrt{2}}, \tag{1}$$

and as by the law of conservation of energy, the output must equal the input, when neglecting losses:

$$I^0 = \frac{I_0 \sqrt{2}}{n \sin \frac{\pi}{n}}, \tag{2}$$

where I^0 is the power component of the current corresponding to the direct-current output.

The voltage ratio of a converter can be varied:

(a) By the superposition of a third harmonic upon the star voltage, or diametrical voltage, which does not appear in the ring voltage, or voltage between the collector rings of the converter.

(b) By shifting the direction of the magnetic flux.

(a) can be used for raising the direct voltage as well as for lowering it, but is used almost always for the former purpose, since when using this method for lowering the direct voltage commutation is impaired.

(b) can be used only for lowering the direct voltage.

It is possible, by proportioning the relative amounts by which the two methods contribute to the regulation of the voltage, to maintain a proper commutating field at the brushes for all loads and voltages. Where, however, this is not done, the brushes are shifted to the edge of the next field pole, and into the fringe of its field, thus deriving the commutating field.

241. In such a variable-ratio converter let, then, t = intensity of the third harmonic, or rather of that component of it which is in line with the direct-current brushes, and thus does the voltage regulation, as fraction of the fundamental wave. t is chosen as positive if the third harmonic increases the maximum of the fundamental wave (wide pole arc) and thus raises the direct voltage, and negative when lowering the maximum of the fundamental and therewith the direct voltage (narrow pole arc).

p_l = loss of power in the converter, which is supplied by the current (friction and core loss) as fraction of the alternating input (assumed as 4 per cent. in the numerical example).

τ_b = angle of brush shift on the commutator, counted positive in the direction of rotation.

θ_1 = angle of time lag of the alternating current (thus negative for lead).

τ_a = angle of shift of the resultant field from the position at right angles to the mechanical neutral (or middle between the pole corners of main poles and auxiliary poles), counted positive in the direction opposite to the direction of armature rotation, that is, positive in that direction in which the field flux has been shifted to get good commutation, as discussed in the preceding article.

Due to the third harmonic, t , and the angle of shift of the field flux, τ_a , the voltage ratio differs from the normal by the factor:

$$(1 + t) \cos \tau_a,$$

and the ring voltage of the converter thus is:

$$E = \frac{E^0}{(1 + t) \cos \tau_a}; \quad (3)$$

hence, by (1):

$$E = \frac{E_0 \sin \frac{\pi}{n}}{\sqrt{2} (1 + t) \cos \tau_a}. \quad (4)$$

and the power component of the ring current corresponding to the direct-current output thus is, when neglecting losses, from (2):

$$\begin{aligned} I' &= I^0 (1 + t) \cos \tau_a \\ &= \frac{I_0 \sqrt{2} (1 + t) \cos \tau_a}{n \sin \frac{\pi}{n}}. \end{aligned} \quad (5)$$

Due to the loss, p_l , in the converter, this current is increased by $(1 + p_l)$ in a direct converter, or decreased by the factor $(1 - p_l)$ in an inverted converter.

The *power component* of the alternating current thus is:

$$\begin{aligned} I_1 &= I' (1 + p_l) \\ &= I_0 \frac{\sqrt{2} (1 + t) (1 + p_l) \cos \tau_a}{n \sin \frac{\pi}{n}}, \end{aligned} \quad (6)$$

where p_l may be considered as negative in an inverted converter.

With the angle of lag θ_1 , the *reactive component* of the current is:

$$I_2 = I_1 \tan \theta_1,$$

and the *total alternating ring current* is:

$$\begin{aligned} I &= \frac{I_1}{\cos \theta_1} \\ &= \frac{I_0 \sqrt{2} (1 + t) (1 + p_l) \cos \tau_a}{n \sin \frac{\pi}{n} \cos \theta_1}, \end{aligned} \quad (7)$$

or, introducing for simplicity the abbreviation:

$$k = \frac{(1+t)(1+p_l)\cos\tau_a}{\cos\theta_1}, \quad (8)$$

it is:

$$I = \frac{I_0 k \sqrt{2}}{n \sin \frac{\pi}{n}}. \quad (9)$$

242. Let, in Fig. 212, $\overline{A'O'A}$ represent the center line of the magnetic field structure.

The resultant magnetic field flux, $\overline{O\Phi}$, then leads \overline{OA} by angle $\Phi OA = \tau_a$.

The resultant m.m.f. of the alternating power current, I_1 , is $\overline{OI_1}$,

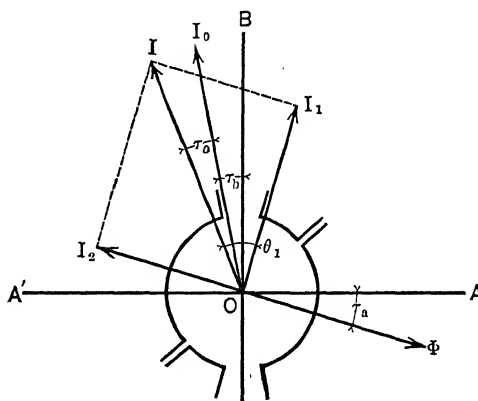

FIG. 212.—Diagram of variable ratio converter.

at right angles to $\overline{O\Phi}$, and the resultant m.m.f. of the alternating reactive current, I_2 , is $\overline{OI_2}$, in opposition to $\overline{O\Phi}$, while the total alternating current, I , is \overline{OI} , lagging by angle θ_1 behind $\overline{OI_1}$.

The m.m.f. of direct-current armature reaction is in the direction of the brushes, thus lagging by angle τ_b behind the position \overline{OB} , where $BOA = 90^\circ$, and given by $\overline{OI_0}$.

The angle by which the direct-current m.m.f., $\overline{OI_0}$, lags in space behind the total alternating m.m.f., \overline{OI} , thus is, by Fig. 212:

$$\tau_0 = \theta_1 - \tau_a - \tau_b. \quad (10)$$

If the alternating m.m.f. in a converter coincides with the direct-current m.m.f., the alternating current and the direct current are in phase with each other in the armature coil midway

between adjacent collector rings, and the current heating thus a minimum in this coil.

Due to the lag in space, by angle τ_0 , of the direct-current m.m.f. behind the alternating current m.m.f., the reversal of the direct current is reached in time before the reversal of the alternating current in the armature coil; that is, the alternating current lags behind the direct current by angle, $\theta_0 = \tau_0$, in the

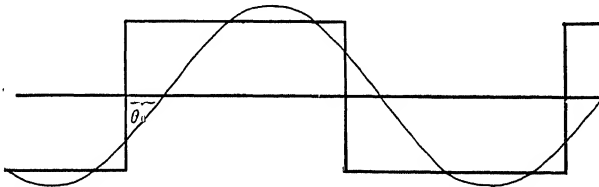

FIG. 213.—Alternating and direct current in a coil midway between adjacent collector leads.

armature coil midway between adjacent collector leads, as shown by Fig. 213, and in an armature coil displaced by angle, τ , from the middle position between adjacent collector leads the alternating current thus lags behind the direct current by angle $(\tau + \theta_0)$, where τ is counted positive in the direction of armature rotation (Fig. 214).

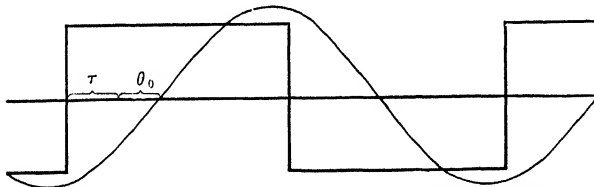

FIG. 214.—Alternating and direct current in a coil at the angle τ from the middle position.

The alternating current in armature coil, i , thus can be expressed by:

$$i = I\sqrt{2} \sin (\theta - \tau - \theta_0); \tag{11}$$

hence, substituting (9):

$$i = \frac{2 I_0 k}{n \sin \frac{\pi}{n}} \sin (\theta - \tau - \theta_0), \tag{12}$$

and as the direct current in this armature coil is $\frac{I_0}{2}$, and opposite

to the alternating current, i , the *resultant current* in the armature coil, τ , is:

$$\begin{aligned} i_0 &= i - \frac{I_0}{2} \\ &= \frac{I_0}{2} \left\{ \frac{4k}{n \sin \frac{\pi}{n}} \sin(\theta - \tau - \theta_0) - 1 \right\}, \end{aligned} \quad (13)$$

and the ratio of heating, of the resultant current, i_0 , compared with the current, $\frac{I_0}{2}$, of the same machine as direct-current generator of the same output, thus is:

$$\frac{i_0^2}{\left(\frac{I_0}{2}\right)^2} = \left\{ \frac{4k}{n \sin \frac{\pi}{n}} \sin(\theta - \tau - \theta_0) - 1 \right\}^2. \quad (14)$$

Averaging (14) over one half wave gives the relative heating of the armature coil, τ , as:

$$\gamma_\tau = \frac{1}{\pi} \int_0^\pi \frac{i_0^2}{\left(\frac{I_0}{2}\right)^2} d\theta = \frac{1}{\pi} \int_0^\pi \left\{ \frac{4k}{n \sin \frac{\pi}{n}} \sin(\theta - \tau - \theta_0) - 1 \right\}^2 d\theta. \quad (15)$$

Integrated, this gives:

$$\gamma_\tau = \frac{8k^2}{n^2 \sin^2 \frac{\pi}{n}} + 1 - \frac{16k \cos(\tau + \theta_0)}{\pi n \sin \frac{\pi}{n}}. \quad (16)$$

243. Herefrom follows the local heating in any armature coil, τ , in the coils adjacent to the leads by substituting $\tau = \pm \frac{\pi}{n}$, and also follows the average armature heating by averaging γ_τ from $\tau = -\frac{\pi}{n}$ to $\tau = +\frac{\pi}{n}$.

The average armature heating of the n -phase converter therefore is:

$$\Gamma = \frac{2n}{\pi} \int_{-\frac{\pi}{n}}^{+\frac{\pi}{n}} \gamma_\tau d\tau,$$

or, integrated:

$$\Gamma = \frac{8k^2}{n^2 \sin^2 \frac{\pi}{n}} + 1 - \frac{16k \cos \theta_0}{\pi^2}. \quad (17)$$

This is the same expression as found for the average armature heating of a converter of normal voltage ratio, when operating with an angle of lag, θ_0 , of the alternating current, where k denotes the ratio of the total alternating current to the alternating power current corresponding to the direct-current output.

In an n -phase variable ratio converter (split-pole converter), the average armature heating thus is given by:

$$\Gamma = \frac{8k^2}{n^2 \sin^2 \frac{\pi}{n}} + 1 - \frac{16k \cos \theta_0}{\pi^2}, \quad (18)$$

where

$$k = \frac{(1+t)(1+p_l) \cos \tau_a}{\cos \theta_1}, \quad (8)$$

$$\theta_0 = \theta_1 - \tau_a - \tau_b; \quad (10)$$

and t = ratio of third harmonic to fundamental alternating voltage wave; p_l = ratio of loss to output; θ_1 = angle of lag of alternating current; τ_a = angle of shift of the resultant magnetic field in opposition to the armature rotation, and τ_b = angle of shift of the brushes in the direction of the armature rotation.

244. For a three-phase converter, equation (18) gives ($n = 3$):

$$\left. \begin{aligned} \Gamma &= \frac{32k^2}{27} + 1 - 1.621k \cos \theta_0 \\ &= 1.185k^2 + 1 - 1.621k \cos \theta_0. \end{aligned} \right\} \quad (19)$$

For a six-phase converter, equation (18) gives ($n = 6$):

$$\left. \begin{aligned} \Gamma &= \frac{8k^2}{9} + 1 - 1.621k \cos \theta_0 \\ &= 0.889k^2 + 1 - 1.621k \cos \theta_0. \end{aligned} \right\} \quad (20)$$

For a converter of normal voltage ratio:

$$t = 0, \quad \tau_a = 0,$$

using no brush shift:

$$\tau_b = 0;$$

when neglecting the losses:

$$p_l = 0,$$

it is:

$$k = \frac{1}{\cos \theta_1},$$

$$\theta_0 = \theta_1,$$

and equations (19) and (20) assume the form:

Three-phase:

$$\Gamma = \frac{1.185}{\cos^2 \theta_1} - 0.621.$$

Six-phase:

$$\Gamma = \frac{0.889}{\cos^2 \theta_1} - 0.621.$$

The equation (18) is the most general equation of the relative heating of the synchronous converter, including phase displacement, θ_1 , losses, p_i , shift of brushes, τ_b , shift of the resultant magnetic flux, τ_a , and the third harmonic, t .

While in a converter of standard or normal ratio the armature heating is a minimum for unity power-factor, this is not in general the case, but the heating may be considerably less at same lagging current, more at leading current, than at unity power-factor, and inversely.

245. It is interesting therefore to determine under which conditions of phase displacement the armature heating is a minimum so as to use these conditions as far as possible and avoid conditions differing very greatly therefrom, as in the latter case the armature heating may become excessive.

Substituting for k and θ_0 from equations (8) and (10) into equation (18) gives:

$$\Gamma = 1 + \frac{8(1+t)^2(1+p_i)^2 \cos^2 \tau_a}{n^2 \sin^2 \frac{\pi}{n} \cos^2 \theta_1} - \frac{16(1+t)(1+p_i) \cos \tau_a \cos(\theta_1 - \tau_a - \tau_b)}{\pi^2 \cos \theta_1}. \quad (19)$$

Substituting:

$$\frac{n}{\pi} \sin \frac{\pi}{n} = m, \quad (20)$$

which is a constant of the converter type, and is for a three-phase converter, $m_3 = 0.744$; for a six-phase converter, $m_6 = 0.955$; and rearranging, gives:

$$\Gamma = 1 + \frac{8}{\pi^2} \frac{(1+t)^2(1+p_i)^2 \cos^2 \tau_a}{m^2} - \frac{16}{\pi^2} (1+t)(1+p_i) \cos \tau_a \cos(\tau_a + \tau_b)$$

$$\begin{aligned}
& + \frac{8}{\pi^2} \frac{(1+t)^2 (1+pl)^2 \cos^2 \tau_a \tan^2 \theta_1}{m^2} \\
& - \frac{16}{\pi^2} (1+t) (1+pl) \cos \tau_a \sin (\tau_a + \tau_b) \tan \theta_1. \quad (21)
\end{aligned}$$

Γ is a minimum for the value, θ_1 , of the phase displacement given by:

$$\frac{d\Gamma}{d \tan \theta_1} = 0,$$

and this gives, differentiated:

$$\tan \theta_2 = \frac{m^2 \sin (\tau_a + \tau_b)}{(1+t) (1+pl) \cos \tau_a}. \quad (22)$$

Equation (22) gives the phase angle, θ_2 , for which, at given τ_a , τ_b , t and pl , the armature heating becomes a minimum.

Neglecting the losses, pl , if the brushes are not shifted, $\tau_b = 0$, and no third harmonic exists, $t = 0$:

$$\tan \theta'_2 = m^2 \tan \tau_a,$$

where $m^2 = 0.544$ for a three-phase, 0.912 for a six-phase converter.

For a six-phase converter it thus is approximately $\theta'_2 = \tau_a$, that is, the heating of the armature is a minimum if the alternating current lags by the same angle (or nearly the same angle) as the magnetic flux is shifted for voltage regulation.

From equation (22) it follows that energy losses in the converter reduce the lag, θ_2 , required for minimum heating; brush shift increases the required lag; a third harmonic, t , decreases the required lag if additional, and increases it if subtractive.

Substituting (22) into (21) gives the minimum armature heating of the converter, which can be produced by choosing the proper phase angle, θ_2 , for the alternating current. It is then, after some transpositions:

$$\begin{aligned}
\Gamma_0 &= 1 + \frac{8}{\pi^2} \left\{ \left[\frac{(1+t) (1+pl) \cos \tau_a}{m} \right]^2 - 2(1+t) (1+pl) \right. \\
&\quad \left. \cos \tau_a \cos (\tau_a + \tau_b) - m^2 \sin^2 (\tau_a + \tau_b) \right\} \\
&= 1 - \frac{8m^2}{\pi^2} \left\{ 1 - \left[\frac{(1+t) (1+pl) \cos \tau_a}{m^2} - \cos (\tau_a + \tau_b) \right]^2 \right\} \quad (23)
\end{aligned}$$

The term Γ_0 contains the constants t , pl , τ_a , τ_b only in the square under the bracket and thus becomes a minimum if this

square vanishes, that is, if between the quantities t , p_l , τ_a , τ_b such relations exist that:

$$\frac{(1+t)(1+p_l)\cos\tau_a}{m^2} - \cos(\tau_a + \tau_b) = 0. \quad (24)$$

246. Of the quantities t , p_l , τ_a , τ_b ; p_l and τ_b are determined by the machine design. t and τ_a , however, are equivalent to each other, that is, the voltage regulation can be accomplished, either by the flux shift, τ_a , or by the third harmonic, t , or by both, and in the latter case can be divided between τ_a and t so as to give any desired relations between them.

Equation (24) gives:

$$t = 1 - \frac{m^2 \cos(\tau_a + \tau_b)}{(1 + p_l \cos \tau_a)}, \quad (25)$$

and by choosing the third harmonic, t , as function of the angle of flux shift τ_a , by equation (25), the converter heating becomes a minimum, and is:

$$\Gamma_0^0 = 1 - \frac{8m^2}{\pi^2}; \quad (26)$$

hence:

$$\Gamma_0^0 = 0.551 \text{ for a three-phase converter,} \quad (27)$$

$$\Gamma_0^0 = 0.261 \text{ for a six-phase converter.} \quad (28)$$

Substituting (25) into (22) gives:

$$\tan \theta_2 = \tan(\tau_a + \tau_b);$$

hence:

$$\theta_2 = \tau_a + \tau_b; \quad (29)$$

or, in other words, the converter gives minimum heating Γ_0^0 if the angle of lag, θ_2 , equals the sum of the angle of flux shift, τ_a , and of brush shift, τ_b .

It follows herefrom that, regardless of the losses, p_l , of the brush shift, τ_b , and of the amount of voltage regulation required, that is, at normal voltage ratio as well as any other ratio, the same minimum converter heating Γ_0^0 can be secured by dividing the voltage regulation between the angle of flux shift, τ_a , and the third harmonic, t , in the manner as given by equation (25), and operating at a phase angle between alternating current and voltage equal to the sum of the angles of flux shift, τ_a , and of brush shift τ_b ; that is, the heating of the split-pole converter can be made the same as that of the standard converter of normal voltage ratio.

Choosing $p_i = 0.04$, or 4 per cent. loss of current, equation (25) gives, for the three-phase and for the six-phase converter:

(a) no brush shift ($\tau_b = 0$):

$$\left. \begin{aligned} t_3^0 &= 0.467, \\ t_6^0 &= 0.123; \end{aligned} \right\} \quad (30)$$

that is, in the three-phase converter this would require a third harmonic of 46.7 per cent., which is hardly feasible; in the six-phase converter it requires a third harmonic of 12.3 per cent., which is quite feasible.

(b) 20° brush shift ($\tau_b = 20$):

$$\left. \begin{aligned} t_3^0 &= 1 - 0.533 \frac{\cos(\tau_a + \tau_b)}{\cos \tau_a}, \\ t_6^0 &= 1 - 0.877 \frac{\cos(\tau_a + \tau_b)}{\cos \tau_a}; \end{aligned} \right\} \quad (31)$$

for $\tau_a = 0$, or no flux shift, this gives:

$$\left. \begin{aligned} t_3^{00} &= 0.500, \\ t_6^{00} &= 0.176. \end{aligned} \right\} \quad (32)$$

Since $\frac{\cos(\tau_a + \tau_b)}{\cos \tau_a} < 1$ for brush shift in the direction of armature rotation, it follows that shifting the brushes increases the third harmonic required to carry out the voltage regulation without increase of converter heating, and thus is undesirable.

It is seen that the third harmonic, t , does not change much with the flux shift, τ_a , but remains approximately constant, and positive, that is, voltage raising.

It follows herefrom that the most economical arrangement regarding converter heating is to use in the six-phase converter a third harmonic of about 17 to 18 per cent. for raising the voltage (that is, a very large pole arc), and then do the regulation by shifting the flux, by the angle, τ_a , without greatly reducing the third harmonic; that is, keep a wide pole arc excited.

As in a three-phase converter the required third harmonic is impracticably high, it follows that for variable voltage ratio the six-phase converter is preferable, because its armature heating can be maintained nearer the theoretical minimum by proportioning t and τ_a .

CHAPTER XXII

UNIPOLAR MACHINES

Homopolar or Acyclic Machines

247. If a conductor, C , revolves around one pole of a stationary magnet shown as NS in Fig. 215, a continuous voltage is induced in the conductor by its cutting of the lines of magnetic force of the pole, N , and this voltage can be supplied to an external circuit, D , by stationary brushes, B_1 and B_2 , bearing on the ends of the revolving conductor, C .

The voltage is:

$$e = f\Phi 10^{-8},$$

where f is the number of revolutions per second, Φ the magnetic flux of the magnet, cut by the conductor, C .

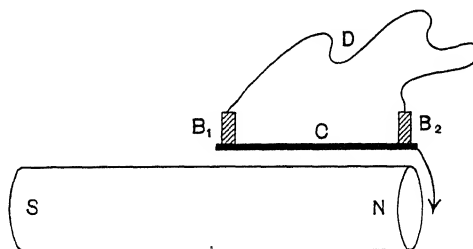

FIG. 215.—Diagrammatic illustration of unipolar machine with two high-speed collectors.

Such a machine is called a unipolar machine, as the conductor during its rotation traverses the same polarity, in distinction of bipolar or multipolar machines, in which the conductor during each revolution passes two or many poles. A more correct name is homopolar machine, signifying uniformity of polarity, or acyclic machine, signifying absence of any cyclic change: in all other electromagnetic machines, the voltage induced in a conductor changes cyclically, and the voltage in each turn is alternating, thus having a frequency, even if the terminal voltage and current at the commutator are continuous.

By bringing the conductor, C , over the end of the magnet close to the shaft, as shown in Fig. 216, the peripheral speed of motion of brush, B_2 , on its collector ring can be reduced. However, at least one brush, B_1 , in Fig. 216, must bear on a collector ring (not shown in Figs. 215 and 216) at full conductor speed, because the total magnetic flux cut by the conductor, C , must pass through this collector ring on which B_1 bears. Thus an essential characteristic of the unipolar machine is collection of the current from the periphery of the revolving conductor, at its maximum speed. It is the unsolved problem of satisfactory current collection from high-speed collector rings, at speeds of two or more miles per

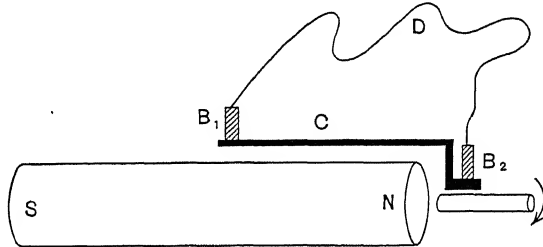

FIG. 216.—Diagrammatic illustration of unipolar machine with one high-speed collector.

minute, which has stood in the way of the commercial introduction of unipolar machines.

Electromagnetic induction is due to the *relative* motion of conductor and magnetic field, and every electromagnetic device is thus reversible with regards to stationary and rotary elements. However, the hope of eliminating high-speed collector rings in the unipolar machine, by having the conductor standstill and the magnet revolve, is a fallacy: in Figs. 215 and 216, the conductor, C , revolves, and the magnet, NS , and the external circuit, D , stands still. The mechanical reversal thus would be, to have the conductor, C , stand still, and the magnet, NS , and the *external circuit* revolve, and this would leave high-speed current collection.

Whether the magnet, NS , stands still or revolves, is immaterial in any case, and the question, whether the lines of force of the magnet are stationary or revolve, if the magnet revolves around its axis, is meaningless. If, with revolving conductor, C , and stationary external circuit, D , the lines of force of the magnet are assumed as stationary, the induction is in C , and the return circuit in D ; if the lines of force are assumed as revolving, the

induction is in D , and C is the return, but the voltage in the circuit, CD , is the same. If, then, C and D both stand still, either there is no induction in either, or, assuming the lines of magnetic force to revolve, equal and opposite voltages are induced in C and D , and the voltage in circuit, CD , is zero just the same. However, the question whether the lines of force of a revolving magnet rotate or not, is meaningless for this reason: the lines of force are a pictorial representation of the magnetic field in space. The magnetic field at any point is characterized by an intensity and a direction, and as long as intensity and direction at any point are constant or stationary, the magnetic field is constant or stationary. This is the case in Figs. 215 and 216, regardless whether the magnet revolves around its axis or not, and the rotation of the magnet thus has no effect whatsoever on the induction phenomena. The magnetic field is stationary at any point of space outside of the magnet, and it is also stationary at any point of space inside of the magnet, even if the magnet revolves, and at the same time it is stationary also with regards to any element of the revolving magnet. Using then the pictorial representation of the lines of magnetic force, we can assume these lines of force as stationary in space, or as revolving with the rotating magnet, whatever best suits the convenience of the problem at hand: but whichever assumption we make, makes no difference on the solution of the problem, if we reason correctly from the assumption.

248. As in the unipolar machine each conductor (corresponding to a half turn of the bipolar or multipolar machine) requires a separate high-speed collector ring, many attempts have been made (and are still being made) to design a coil-wound unipolar machine, that is, a machine connecting a number of peripheral conductors in series, without going through collector rings. This is an impossibility, and unipolar induction, that is, continues induction of a unidirectional voltage, is possible only in an open conductor, but not in a coil or turn, as the voltage electromagnetically induced in a coil or turn must always be an alternating voltage.

The fundamental law of electromagnetic induction is, that the induced voltage is proportional to the rate of cutting of the conductor through the lines of force of the magnetic field. Applying this to a closed circuit or turn: every line of magnetic force cut by a turn must either go from the outside to the inside, or from the inside to the outside of the turn. This means: the voltage

induced in a turn is proportional (or equal, in absolute units) to the rate of change of the number of lines of magnetic force enclosed by the turn, and a decrease of the lines of force enclosed by the turn, induces a voltage opposite to that induced by an increase. As the number of lines of force enclosed by a turn can not perpetually increase (or decrease), it follows, that a voltage can not be induced perpetually in the same direction in a turn. Every increase of lines of force enclosed by the turn, inducing

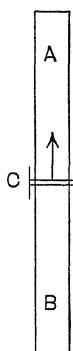

FIG. 217.—Mechanical analogy of bipolar induction.

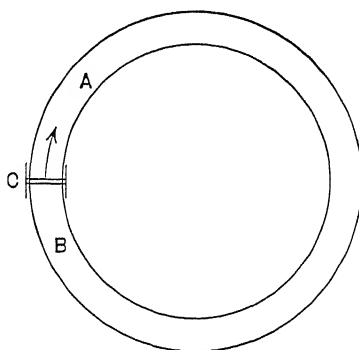

FIG. 218.—Mechanical analogy* of unipolar induction.

a voltage in it, must sometime later be followed by an equal decrease of the lines of force enclosed by the turn, which induces an equal voltage in opposite direction. Thus, averaged over a sufficiently long time, the total voltage induced in a turn must always be zero, that is, the voltage, if periodical, must be alternating, regardless how the electromagnetic induction takes place, whether the turn is stationary or moving, as a part of a machine, transformer, reactor or any other electromagnetic induction device. Thus continuous-voltage induction in a closed turn is impossible, and the coil-wound unipolar machine thus a fallacy. Continuous induction in the unipolar machine is possible only because the circuit is not a closed one, but consists of a conductor or half turn, sliding over the other half turn. Mechanically the relation can be illustrated by Figs. 217 and 218. If in Fig. 217 the carriage, *C*, moves along the straight track of finite length—a closed turn of finite area—the area, *A*, in front of *C* decreases, that *B* behind the carriage, *C*, increases, but this decrease and increase can not go on indefinitely, but at some time *C* reaches the end of the track, *A* has decreased to zero, *B* is a

maximum, and any further change can only be an increase of A and decrease of B , by a motion of C in opposite direction, representing induction of a reverse voltage. On the endless circular

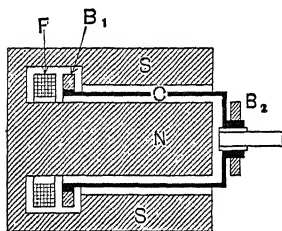

FIG. 219.—Drum type of unipolar machine with stationary magnet core, section.

track, Fig. 218, however, the carriage, C , can continuously move in the same direction, continuously reduce the area, A , in front and increase that of B behind C , corresponding to continuous induction in the same direction, in the unipolar machine.

249. In the industrial design of a unipolar machine, naturally a closed magnetic circuit would be used, and the form, Fig. 216, would be executed as shown in length section in Fig. 219. N is the same pole as in Fig. 216, but the magnetic return circuit is shown by S , concentrically surrounding N . C is the cylindrical conductor, revolving in the cylindrical gap between N and S . B_1 and B_2 are the two sets of brushes bearing in the cylindrical gap at the end of the conductor, C , and F is the field exciting winding.

The construction, Fig. 219, has the mechanical disadvantage of a relatively light structure, C , revolving at high speed between two stationary structures, N and S . As it is immaterial whether the magnet is stationary or revolving, usually the inner core, N , is revolved with the conductor, as shown in Figs. 221 and 222. This shortens the gap between N and S , but introduces an auxiliary gap, G . Fig. 221 has the disadvantage of a magnetic end thrust, and thus the construction, Fig. 222, is generally used, or its duplication, shown in Fig. 223.

The disk type of unipolar machine, shown in section in Fig. 220, has been frequently proposed in former times, but is economically inferior to the construction of Figs. 221, 222 and 223. The limitation of the unipolar machine is the high collector speed. In Fig. 220, the average conductor speed is less than the collector speed, and the latter thus relatively

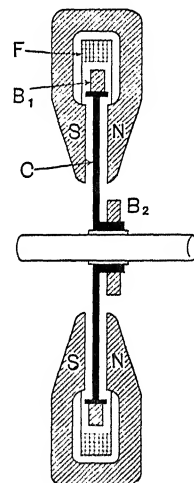

FIG. 220.—Disc type of unipolar machine, section.

higher than in Figs. 221 to 223, where it equals the conductor speed.

Higher voltages then can be given by a single conductor, are

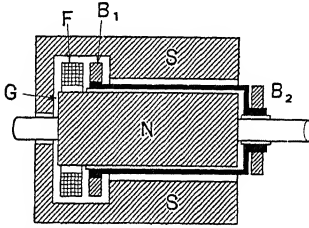

FIG. 221.—Drum type of unipolar machine with revolving magnet core and auxiliary end gap, section.

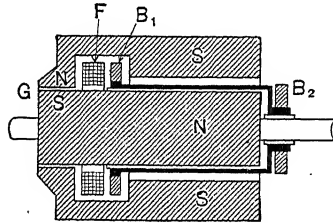

FIG. 222.—Drum type of unipolar machine with revolving magnet core and auxiliary cylinder gap, section.

derived in the unipolar machine by connecting a number of conductors in series. In this case, every series conductor obviously

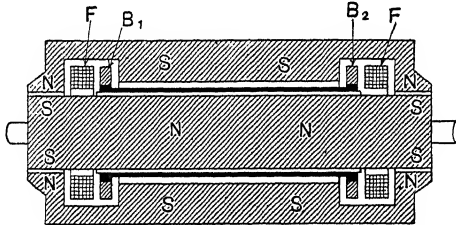

FIG. 223.—Double drum type of unipolar machine, section.

requires a separate pair of collector rings. This is shown in Figs. 224 and 225, the cross-section and length section of the rotor of

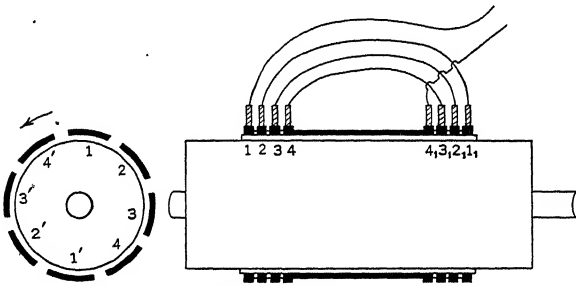

FIG. 224.—Multi-conductor unipolar machine, cross-section.

FIG. 225.—Multi-conductor unipolar machine, length section.

a four-circuit unipolar. As seen in Fig. 224, the cylindrical conductor is slotted into eight sections, and diametrically opposite

sections, 1 and 1', 2 and 2', 3 and 3', 4 and 4', are connected in multiple (to equalize the flux distribution) between four pairs of collector rings, shown in Fig. 225 as 1 and 1₁, 2 and 2₁, 3 and 3₁, 4 and 4₁. The latter are connected in series. This machine, Figs. 224 and 225, thus could also be used as a three-wire or five-wire machine, or as a direct-current converter, by bringing out intermediary connections, from the collector rings 2, 3, 4.

250. As each conductor of the unipolar machine requires a separate pair of collector rings, with a reasonably moderate number of collector rings, unipolar machines of medium capacity are suited for low voltages only, such as for electrolytic machines, and have been built for this purpose to a limited extent, but in general it has been found more economical by series connection of the electrolytic cells to permit the use of higher voltages, and then employ standard machines.

For commercial voltages, 250 or 600, to keep the number of collector rings reasonably moderate, unipolar machines require very large magnetic fluxes—that is, large units of capacity—and very high peripheral speeds. The latter requirement made this machine type unsuitable during the days of the slow-speed direct-connected steam engine, but when the high-speed steam turbine arrived, the study of the design of high-powered steam-turbine-driven unipolars was undertaken, and a number of such machines built and installed.

In the huge turbo-alternators of today, the largest loss is the core loss: hysteresis and eddies in the iron, which often is more than all the other losses together. Theoretically, the unipolar machine has no core loss, as the magnetic flux does not change anywhere, and solid steel thus is used throughout—and has to be used, due to the shape of the magnetic circuit. However, with the enormous magnetic fluxes of these machines, in solid iron, the least variation of the magnetic circuit, such as caused by small inequalities of the air gap, by the reaction of the armature currents, etc., causes enormous core losses, mostly eddies, and while theoretically the unipolar has no core loss, designing experience has shown, that it is a very difficult problem to keep the core loss in such machines down to reasonable values. Furthermore, in and at the collector rings, the magnetic reaction of the armature currents is alternating or pulsating. Thus in Figs. 224 and 225, the point of entrance of the current from the armature conductors into the collector rings revolves with the rotation

of the machine, and from this point flows through the collector ring, distributing between the next brushes. While this circular flow of current in the collector ring represents effectively a fraction of a turn only, with thousands of amperes of current it represents thousands of ampere-turns m.m.f., causing high losses, which in spite of careful distribution of the brushes to equalize the current flow in the collector rings, can not be entirely eliminated.

251. The unipolar machine is not free of armature reaction, as often believed. The current in all the armature conductors (Fig. 224) flows in the same direction, and thereby produces a circular magnetization in the magnetic return circuit, *S*, shown by the arrow in Fig. 224. While the armature conductor magnetically represents one turn only, in the large machines it represents many thousand ampere-turns. As an instance, assume a peripheral speed of a steam-turbine-driven unipolar machine, of 12,000 ft. per minute, at 1800 revolutions per minute. This gives an armature circumference of 80 in. At $\frac{1}{2}$ in. thickness of the conductor, and 2500 amp. per square inch, this gives 100,000 ampere-turns m.m.f. of armature reaction, which probably is sufficient to magnetically saturate the iron in the pole faces, in the direction of the arrow in Fig. 224. At the greatly lowered permeability at saturation, with constant field excitation the voltage of the machine greatly drops, or, to maintain constant voltage, a considerable increase of field excitation under load is required. Large unipolar machines thus are liable to give poor voltage regulation and to require high compounding.

To overcome the circular armature reaction, a counter m.m.f. may be arranged in the pole faces, by returning the current of each collector ring 1₁, 2₁, 3₁, 4₁, of Fig. 225, to the collector rings on the other end of the machine, 2, 3, 4 in Fig. 225, not through an external circuit, but through conductors imbedded in the pole face, as shown in Fig. 226 as 1', 2', 3', 4'.

The most serious problem of the unipolar machine, however, is that of the high-speed collector rings, and this has not yet been solved. Collecting very large currents by numerous collector

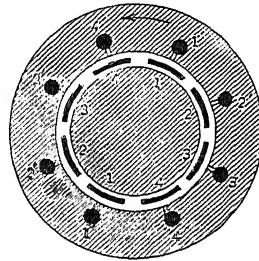

FIG. 226.— Multi-conductor unipolar machine with compensating pole face winding, cross-section.

rings at speeds of 10,000 to 15,000 ft. per minute, leads to high losses and correspondingly low machine efficiency, high temperature rise, and rapid wear of the brushes and collector rings, and this has probably been the main cause of abandoning the development of the unipolar machine for steam-turbine drive.

A contributing cause was that, when the unipolar steam-turbine generator was being developed, the days of the huge direct-current generator were over, and its place had been taken by turbo-alternator and converter, and the unipolar machine offered

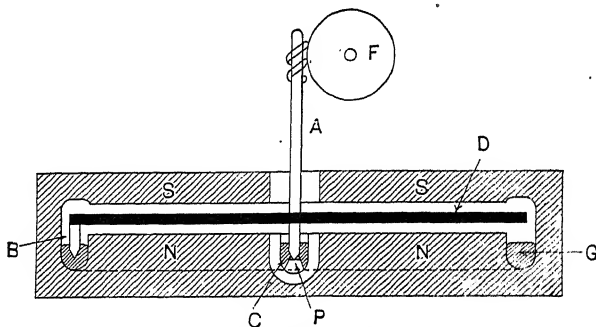

FIG. 227.—Unipolar motor meter.

no advantage in reliability, or efficiency, but the disadvantage of lesser flexibility, as it requires a greater concentration of direct-current generation in one place, than usually needed.

252. The unipolar machine may be used as motor as well as generator, and has found some application as motor meter. The general principle of a unipolar meter may be illustrated by Fig. 227.

The meter shaft, *A*, with counter, *F*, is pivoted at *P*, and carries the brake disk and conductor, a copper or aluminum disk, *D*, between the two poles, *N* and *S*, of a circular magnet. The shaft, *A*, dips into a mercury cup, *C*, which is insulated and contains the one terminal, while the other terminal goes to a circular mercury trough, *G*. An iron pin, *B*, projects from the disk, *D*, into this mercury trough and completes the circuit.

CHAPTER XXIII

REVIEW

253. In reviewing the numerous types of apparatus, methods of construction and of operation, discussed in the preceding, an alphabetical list of them is given in the following, comprising name, definition, principal characteristics, advantages and disadvantages, and the paragraph in which they are discussed.

Alexanderson High-frequency Inductor Alternator.—159. Comprises an inductor disk of very many teeth, revolving at very high speed between two radial armatures. Used for producing very high frequencies, from 20,000 to 200,000 cycles per second.

Amortisseur.—Squirrel-cage winding in the pole faces of the synchronous machine, proposed by Leblanc to oppose the hunting tendency, and extensively used.

Amplifier.—161. An apparatus to intensify telephone and radio telephone currents. High-frequency inductor alternator excited by the telephone current, usually by armature reaction through capacity. The generated current is then rectified, before transmission in long-distance telephony, after transmission in radio telephony.

Arc Machines.—138. Constant-current generators, usually direct-current, with rectifying commutators. The last and most extensively used arc machines were:

Brush Arc Machine.—141-144. A quarter-phase constant-current alternator with rectifying commutators.

Thomson-Houston Arc Machine.—141-144. A three-phase Y-connected constant-current alternator with rectifying commutator.

The development of alternating-current series arc lighting by constant-current transformers greatly reduced the importance of the arc machine, and when in the magnetite lamp arc lighting returned to direct current, the development of the mercury-arc rectifier superseded the arc machine.

Asynchronous Motor.—Name used for all those types of alternating-current (single-phase or polyphase) motors or motor couples, which approach a definite synchronous speed at no-load, and slip below this speed with increasing load.

Brush Arc Machine.—(See "Arc Machines.")

Compound Alternator.—138. Alternator with rectifying commutator, connected in series to the armature, either conductively, or inductively through transformer, and exciting a series field winding by the rectified current. The limitation of the power, which can be rectified, and the need of readjusting the brushes with a change of the inductivity of the load, has made such compounding unsuitable for the modern high-power alternators.

Condenser Motor.—77. Single-phase induction motor with condenser in tertiary circuit on stator, for producing starting torque and high power-factor. The space angle between primary and tertiary stator circuit usually is 45° to 60° , and often a three-phase motor is used, with single-phase supply on one phase, and condenser on a second phase. With the small amount of capacity, sufficient for power-factor compensation, usually the starting torque is small, unless a starting resistance is used, but the torque efficiency is high.

Concatenation.—III, 28. Chain connection, tandem connection, cascade connection. Is the connection of the secondary of an induction machine with a second machine. The second machine may be:

1. An *Induction Machine*.—The couple then is asynchronous. Hereto belong:

The *induction frequency converter* or *general alternating-current transformer*, XII, 103. It transforms between alternating-current systems of different frequency, and has over the induction-motor generator set the advantage of higher efficiency and lesser capacity, but the disadvantage of not being standard.

The *concatenated couple of induction motors*, 9, 28, 111. It permits multispeed operation. It has the disadvantage against the multispeed motor, that two motors are required; but where two or more motors are used, as in induction-motor railroading, it has the advantage of greater simplicity.

The *internally concatenated motor (Hunt motor)*, 36. It is more efficient than the concatenated couple or the multispeed motor, but limited in design to certain speeds and speed ratios.

2. A *Synchronous Machine*.—The couple then is synchronous. Hereto belong:

The *synchronous frequency converter*, XII, 103. It has a definite frequency ratio, while that of the induction frequency con-

verter slightly changes with the load, by the slip of the induction machine.

Induction Motor with Low-frequency Synchronous Exciter.—47. The synchronous exciter in this case is of small capacity, and gives speed control and power-factor compensation.

Induction Generator with Low-frequency Exciter.—110, 121. Synchronous induction generator. *Stanley induction generator.* In this case, the low-frequency exciter may be a synchronous or a commutating machine or any other source of low frequency. The phase rotation of the exciter may be in the reverse direction of the main machine, or in the same direction. In the first case, the couple may be considered as a frequency converter driven backward at many times synchronous speed, the exciter is motor, and the generated frequency less than the speed. In the case of the same phase rotation of exciter and main machine, the generated frequency is higher than the speed, and the exciter also is generator. This synchronous induction generator has peculiar regulation characteristics, as the armature reaction of non-inductive load is absent.

3. A *Synchronous Commutating Machine.*—112. The couple is synchronous, and called *motor converter*. It has the advantage of lower frequency commutation, and permits phase control by the internal reactance of the induction machine. It has higher efficiency and smaller size than a motor-generator set, but is larger and less efficient than the synchronous converter, and therefore has not been able to compete with the latter.

4. A *direct-current commutating machine*, as exciter, 41. This converts the induction machine into a synchronous machine (*Danielson motor*). A good induction motor gives a poor synchronous motor, but a bad induction motor, of very low power-factor, gives a good synchronous motor, of good power-factor, etc.

5. An *alternating-current commutating machine*, as low-frequency exciter, 52. The couple then is asynchronous. This permits a wide range of power-factor and speed control as motor. As generator it is one form of the Stanley induction generator discussed under (2).

6. A *Condenser.*—This permits power-factor compensation, 55, and speed control, 11. The power-factor compensation gives good values with very bad induction motors, of low power-factor, but is uneconomical with good motors. Speed control

usually requires excessive amounts of capacity, and gives rather poor constants. The machine is asynchronous.

Danielson Motor.—41. An induction motor converted to a synchronous motor by direct-current excitation. (See "Concatenation (4).")

Deep-bar Induction Motor.—7. Induction motor with deep and narrow rotor bars. At the low frequency near synchronism, the secondary current traverses the entire rotor conductor, and the secondary resistance thus is low. At high slips, as in starting, unequal current distribution in the rotor bars concentrates the current in the top of the bars, thus gives a greatly increased effective resistance, and thereby higher torque. However, the high reactance of the deep bar somewhat impairs the power-factor. The effect is very closely the same as in the double squirrel cage. (See "Double Squirrel-cage Induction Motor.")

Double Squirrel-cage Induction Motor.—II, 18. Induction motor having a high-resistance low-reactance squirrel cage, close to the rotor surface, and a low-resistance high-reactance squirrel cage, embedded in the core. The latter gives torque at good speed regulation near synchronism, but carries little current at lower speeds, due to its high reactance. The surface squirrel cage gives high torque and good torque efficiency at low speeds and standstill, due to its high resistance, but little torque near synchronism. The combination thus gives a uniformly high torque over a wide speed range, but at some sacrifice of power-factor, due to the high reactance of the lower squirrel cage. To get close speed regulation near synchronism, together with high torque over a very wide speed range, for instance, down to full speed in reverse direction (motor brake), a *triple squirrel cage* may be used, one high resistance low reactance, one medium resistance and reactance, and one very low resistance and high reactance (24).

Double Synchronous Machine.—110, 119. An induction machine, in which the rotor, running at double synchronism, is connected with the stator, either in series or in parallel, but with reverse phase rotation of the rotor, so that the two rotating fields coincide and drop into step at double synchronism. The machine requires a supply of lagging current for excitation, just like any induction machine. It may be used as synchronous induction generator, or as synchronous motor. As generator, the armature reaction neutralizes at non-inductive; but not at inductive load,

and thus gives peculiar regulation characteristics, similar as the Stanley induction generator. It has been proposed for steam-turbine alternators, as it would permit higher turbine speed (3000 revolutions at 25 cycles) but has not yet been used. As motor it has the disadvantage that it is not self-starting.

Eickemeyer Inductively Compensated Single-phase Series Motor.—193. Single-phase commutating machine with series field and inductive compensating winding.

Eickemeyer Inductor Alternator.—160. Inductor alternator with field coils parallel to shaft, so that the magnetic flux disposition is that of a bipolar or multipolar machine, in which the multitooth inductor takes the place of the armature of the standard machine. Voltage induction then takes place in armature coils in the pole faces, and the magnetic flux in the inductor reverses, with a frequency much lower than that of the induced voltage. This type of inductor machine is specially adopted for moderately high frequencies, 300 to 2000 cycles, and used in inductor alternators and *inductor converters*. In the latter, the inductor carries a low-frequency closed circuit armature winding connected to a commutator to receive direct current as motor.

Eickemeyer Rotary Terminal Induction Motor.—XI, 101. Single-phase induction motor with closed circuit primary winding connected to commutator. The brushes leading the supply current into the commutator stand still at full speed, but revolve at lower speeds and in starting. This machine can give full maximum torque at any speed down to standstill, depending on the speed of the brushes, but its disadvantage is sparking at the commutator, which requires special consideration.

Frequency Converter or General Alternating-current Transformer.—XII, 103. Transforms a polyphase system into another polyphase system of different frequency and where desired of different voltage and different number of phases. Consists of an induction machine concatenated to a second machine, which may be an induction machine or a synchronous machine, thus giving the *induction frequency converter* and the *synchronous frequency converter*. (See "Concatenation.") In the synchronous frequency converter the frequency ratio is rigidly constant, in the induction frequency converter it varies slightly with the load, by the slip of the induction machine. When increasing the frequency, the second machine is motor, when decreasing the frequency, it is generator. Above synchronism, both machines are generators

and the machine thus a synchronous induction generator. In concatenation, the first machine always acts as frequency converter. The frequency converter has the advantage of lesser machine capacity than the motor generator, but the disadvantage of not being standard yet.

Heyland Motor.—59, 210. Squirrel-cage induction motor with commutator for power-factor compensation.

Hunt Motor.—36. Internally concatenated induction motor. (See "Concatenation (1).")

Hysteresis Motor.—X, 98. Motor with polyphase stator and laminated rotor of uniform reluctance in all directions, without winding. Gives constant torque at all speeds, by the hysteresis of the rotor, as motor below and as *generator* above synchronism, while at synchronism it may be either. Poor power-factor and small output make it feasible only in very small sizes, such as motor meters.

Inductor Machines.—XVII, 156. Synchronous machine, generator or motor, in which field and armature coils stand still and the magnetic field flux is constant, and the voltage is induced by changing the flux path, that is, admitting and withdrawing the flux from the armature coils by means of a revolving inductor. The inducing flux in the armature coils thus does not alternate, but pulsates without reversal. For standard frequencies the inductor machine is less economical and little used, but it offers great constructive advantages at high frequencies and is the only feasible type at extremely high frequencies. Excited by alternating currents, the inductor machine may be used as amplifier (see "Amplifier"); excited by polyphase currents, it is an *induction inductor frequency converter*, 162; with a direct-current winding on the inductor, it is a direct-current *high-frequency converter*. (See "Eickemeyer Inductor Alternator.")

Leading current, power-factor compensation and phase control can be produced by:

Condenser.

Polarization cell.

Overexcited synchronous motor or synchronous converter.

Induction machine concatenated to condenser, to synchronous motor or to low-frequency commutating machine.

Alternating-current commutating machine with lagging field excitation.

Leblanc's Panchahuteur.—145. Synchronous rectifier of many

phases, fed by polyphase transformer increasing the number of phases, and driven by a synchronous motor having as many circuits as the rectifier has phases, each synchronous motor circuit being connected in shunt to the corresponding rectifier phase to bypass the differential current and thereby reduce inductive sparking. Can rectify materially more power than the standard rectifier, but is inferior to the converter.

Magneto Commutation.—163. Apparatus in which the induction is varied, with stationary inducing (exciting) and induced coils, by shifting or reversing the magnetic flux path by means of a movable part of the magnetic circuit, the *inductor*. Applied to stationary induction apparatus, as voltage regulators, and to synchronous machines, as inductor alternator.

Monocyclic.—127. A system of polyphase voltages with essentially single-phase flow of power. A system of polyphase voltages, in which one phase regulates for constant voltage, that is, a voltage which does not materially drop within the range of power considered, while the voltage in quadrature phase thereto is of limited power, that is, rapidly drops with increase of load. Monocyclic systems, as the square or the triangle, are derived from single-phase supply by limited energy storage in inductance or capacity, and used in those cases, as single-phase induction motor starting, where the use of a phase converter would be uneconomical.

Motor Converter.—112. An induction machine concatenated with a synchronous commutating machine. (See "Concatenation (3).") The latter thus receives part of the power mechanically, part electrically, at lower frequency, and thereby offers the advantages incident to a lower frequency in a commutating machine. It permits phase control by the internal reactance of the induction machine. Smaller than a motor-generator set, but larger than a synchronous converter, and the latter therefore preferable where it can be used.

Multiple Squirrel-cage Induction Motor.—(See "Double Squirrel-cage Induction Motor.")

Multispeed Induction Motor.—14. Polyphase Induction Motor with the primary windings arranged so that by the operation of a switch, the number of poles of the motor, and thereby its speed can be changed. It is the most convenient method of producing several economical speeds in an induction motor, and therefore is extensively used. At the lower speed, the power-factor necessarily is lower.

Permutator.—146. Machine to convert polyphase alternating to direct current, consisting of a stationary polyphase transformer with many secondary phases connected to a stationary commutator, with a set of revolving brushes driven by a synchronous motor. Thus essentially a synchronous converter with stationary armature and revolving field, but with two armature windings, primary and secondary. The foremost objection is the use of revolving brushes, which do not permit individual observation and adjustment during operation, and thus are liable to sparking.

Phase Balancer.—134. An apparatus producing a polyphase system of opposite phase rotation for insertion in series to a polyphase system, to restore the voltage balance disturbed by a single-phase load. It may be:

A *stationary induction-phase balancer*, consisting of an induction regulator with reversed phase rotation of the series winding.

A *synchronous-phase balancer*, consisting of a synchronous machine of reversed phase rotation, having two sets of field windings in quadrature. By varying, or reversing the excitation of the latter, any phase relation of the balancer voltage with those of the main polyphase system can be produced. The synchronous phase balancer is mainly used, connected into the neutral of a synchronous phase converter, to control the latter so as to make the latter balance the load and voltage of a polyphase system with considerable single-phase load, such as that of a single-phase railway system.

Polyphase Commutator Motor.—Such motors may be shunt, 181, or series type, 187, for multispeed, adjustable-speed and varying-speed service. In commutation, they tend to be inferior to single-phase commutator motors, as their rotating field does not leave any neutral direction, in which a commutating field could be produced, such as is used in single-phase commutator motors. Therefore, polyphase commutator motors have been built with separate phases and neutral spaces between the phases, for commutating fields: *Scherbius motor*.

Reaction Machines.—XVI, 147. Synchronous machine, motor or generator, in which the voltage is induced by pulsation of the magnetic reluctance, that is, by make and break of the magnetic circuit. It thus differs from the inductor machine, in that in the latter the total field flux is constant, but is shifted with regards to the armature coils, while in the reaction machine the

total field flux pulsates. The reaction machine has low output and low power-factor, but the type is useful in small synchronous motors, due to the simplicity resulting from the absence of direct-current field excitation.

Rectifiers.—XV, 138. Apparatus to convert alternating into direct current by synchronously changing connections. Rectification may occur either by synchronously reversing connections between alternating-current and direct-current circuit: *reversing rectifier*, or by alternately making contact between the direct-current circuit and the alternating-current circuit, when the latter is of the right direction, and opening contact, when of the reverse direction: *contact-making rectifier*. Mechanical rectifiers may be of either type. Arc rectifiers, such as the mercury-arc rectifier, which use the unidirectional conduction of the arc, necessarily are contact-making rectifiers.

Full-wave rectifiers are those in which the direct-current circuit receives both half waves of alternating current; *half-wave rectifiers* those in which only alternate half waves are rectified, the intermediate or reverse half waves suppressed. The latter type is permissible only in small sizes, as the interrupted pulsating current traverses both circuits, and produces in the alternating-current circuit a unidirectional magnetization, which may give excessive losses and heating in induction apparatus. The foremost objection to the mechanical rectifier is, that the power which can be rectified without injurious inductive sparking, is limited, especially in single-phase rectifiers, but for small amounts of power, as for battery charging and constant-current arc lighting they are useful. However, even there the arc rectifier is usually preferable. The *brush arc machine* and the *Thomson Houston arc machine* were polyphase alternators with rectifying commutators.

Regulating Pole Converter.—Variable-ratio converter. Split-pole converter, XXI, 230. A synchronous converter, in which the ratio between direct-current voltage and alternating-current voltage can be varied at will, over a considerable range, by shifting the direction of the resultant magnetic field flux so that the voltage between the commutator brushes is less than maximum alternating-current voltage, and by changing, at constant impressed effective alternating voltage, the maximum alternating-current voltage and with it the direct-current voltage, by the superposition of a third harmonic produced in the converter in

such a manner, that this harmonic exists only in the local converter circuit. This is done by separating the field pole into two parts, a larger main pole, which has constant excitation, and a smaller regulating pole, in which the excitation is varied and reversed. A resultant armature reaction exists in the regulating pole converter, proportional to the deviation of the voltage ratio from standard, and requires the use of a series field. Regulating pole converters are extensively used for adjustable voltage service, as direct-current distribution, storage-battery charging, etc., due to their simplicity and wide voltage range at practically unity power-factor, while for automatic voltage control under fluctuating load, as railway service, phase control of the standard converter is usually preferred.

Repulsion Generator.—217. Repulsion motor operated as generator.

Repulsion Motor.—194, 208, 214. Single-phase commutator motor in which the armature is short-circuited and energized by induction from a stationary compensating winding as primary. Usually of varying speed or series characteristic. Gives better commutation than the series motor at moderate speeds.

Rotary Terminal Single-phase Induction Motor.—XI, 101. (See "Eickemeyer Rotary Terminal Induction Motor.")

Shading Coil.—73. A short-circuited turn surrounding a part of the pole face of a single-phase induction motor with definite poles, for the purpose of giving a phase displacement of the flux, and thereby a starting torque. It is the simplest and cheapest single-phase motor-starting device, but gives only low starting torque and low torque efficiency, thus is not well suited for larger motors. It thus is very extensively used in small motors, almost exclusively in alternating-current fan motors.

Single-phase Commutator Motor.—XX, 189. Commutator motor with alternating-current field excitation, and such modifications of design, as result therefrom. That is, lamination of the magnetic structure, high ratio of armature reaction to field excitation, and compensation for armature reaction and self-induction, etc. Such motor thus comprises three circuits: the armature circuit, the field circuit, and the compensating circuit in quadrature, on the stator, to the field circuit. These circuits may be energized by conduction, from the main current, or by induction, as secondaries with the main current as primary. If the armature receives the main current, the motor is

a series or shunt motor; if it is closed upon itself, directly or through another circuit, the motor is called a *repulsion motor*. A combination of both gives the *series repulsion motor*.

Single-phase commutator motors of series characteristic are used for alternating-current railroading, of shunt characteristic as stationary motors, as for instance the *induction repulsion motor*, either as constant-speed high-starting-torque motors, or as adjustable-speed motors.

Lagging the field magnetism, as by shunted resistance, produces a lead of the armature current. This can be used for power-factor compensation, and single-phase commutator motors thereby built with very high power-factors. Or the machine, with lagging-quadrature field excitation, can be used as effective capacity. The single-phase commutator motor is the only type which, with series field excitation, gives a varying-speed motor of series-motor characteristics, and with shunt excitation or its equivalent, give speed variation and adjustment like that of the direct-current motor with field control, and is therefore extensively used. Its disadvantage, however, is the difficulty and limitation in design, resulting from the e.m.f. induced in the short-circuited coils under the brush, by the alternation of the main field, which tends toward sparking at the commutator.

Single-phase Generation.—135.

Speed Control of Polyphase Induction Motor.—

By *resistance in the secondary*, 8. Gives a speed varying with the load.

By *pyro-electric resistance in the secondary*, 10. Gives good speed regulation at any speed, but such pyro-electric conductors tend toward instability.

By *condenser in the secondary*, 11. Gives good speed regulation, but rather poor power-factor, and usually requires an uneconomically large amount of capacity.

By *commutator*, 58. Gives good speed regulation and permits power-factor control, but has the disadvantage and complication of an alternating-current commutator.

By *concatenation* with a low-frequency commutating machine as exciter, 52. Has the disadvantage of complication.

Stanley Induction Generator.—117. Induction machine with low-frequency exciter. (See "Concatenation (2).")

Stanley Inductor Alternator.—159. Inductor machine with two armatures and inductors, and a concentric field coil between the same. (See "Inductor Machine.")

Starting Devices.—Polyphase induction motor:

Resistance of high temperature coefficient, 2. Gives good torque curve at low speed and good regulation at speed, but requires high temperature in the resistance.

Hysteresis device, 4. Gives good speed regulation and good torque at low speed and in starting, but somewhat impairs the power-factor.

Eddy-current device, 5; *double and triple squirrel-cage*, 18, 20, 24; and *deep-bar rotor*, 7. Give good speed regulation combined with good torque at low speed and in starting, but somewhat impairs the power-factor. (See "Double Squirrel-cage Induction Motor" and "Deep-bar Induction Motor.")

Single-phase induction motor:

Phase-splitting devices, 67. Resistance in one phase, 68. *Inductive devices*, 72. Shading coil, 73. (See "Shading Coil.")

Monocyclic devices, 76. Resistance-reactance device or monocyclic triangle. Condenser motor, 77. (See "Condenser Motor.")

Repulsion-motor starting.

Series-motor starting.

Synchronous-induction Generator.—XIII, 113. Induction machine, in which the secondary is connected so as to fix a definite speed. This may be done:

1. By connecting the secondary, in reverse phase rotation, in shunt or in series to the primary: *double synchronous generator*. (See "Double Synchronous Machine.")

2. By connecting the secondary in shunt to the primary through a commutator. In this case, the resultant frequency is fixed by speed and ratio of primary to secondary turns.

3. By connecting the secondary to a source of constant low frequency: *Stanley induction generator*. In this case, the low-frequency phase rotation impressed upon the secondary may be in the same or in opposite direction to the speed. (See "Concatenation (2).")

Synchronous-induction Motor.—IX, 97. An induction motor with single-phase secondary. Tends to drop into step as synchronous motor, and then becomes generator when driven by power. Its low power-factor makes it unsuitable except for small sizes, where the simplicity due to the absence of direct-current excitation may make it convenient as self-starting synchronous motor. As reaction machine, 150.

Thomson-Houston Arc Machine.—141-144. Three-phase Y-

connected constant-current alternator with rectifying commutator.

Thomson Repulsion Motor.—193. Single-phase compensated commutating machine with armature energized by secondary current, and field coil and compensating coil combined in one coil.

Unipolar Machines.—Unipolar or acyclic machine, XXII, 247. Machine in which a continuous voltage is induced by the rotation of a conductor through a constant and uniform magnetic field. Such machines must have as many pairs of collector rings as there are conductors, and the main magnetic flux of the machine must pass through the collector rings, hence current collection occurs from high-speed collector rings. Coil windings are impossible in unipolar machines. Such machines either are of low voltage, or of large size and high speed, thus had no application before the development of the high-speed steam turbine, and now three-phase generation with conversion by synchronous converter has eliminated the demand for very large direct-current generating units. The foremost disadvantage is the high-speed current collection, which is still unsolved, and the liability to excessive losses by eddy currents due to any asymmetry of the magnetic field.

Winter-Eichbery-Latour Motor.—194. Single-phase compensated series-type motor with armature excitation, that is, the exciting current, instead of through the field, passes through the armature by a set of auxiliary brushes in quadrature with the main brushes. Its advantage is the higher power-factor, due to the elimination of the field inductance, but its disadvantage the complication of an additional set of alternating-current commutator brushes.

CHAPTER XXIV

CONCLUSION

254. Numerous apparatus, structural features and principles have been invented and more or less developed, but have found a limited industrial application only, or are not used at all, because there is no industrial demand for them. Nevertheless a knowledge of these apparatus is of great importance to the electrical engineer. They may be considered as filling the storehouse of electrical engineering, waiting until they are needed. Very often, in the development of the industry, a demand arises for certain types of apparatus, which have been known for many years, but not used, because they offered no material advantage, until with the change of the industrial conditions their use became very advantageous and this led to their extensive application.

Thus for instance the commutating pole ("interpole") in direct-current machines has been known since very many years, has been discussed and recommended, but used very little, in short was of practically no industrial importance, while now practically all larger direct-current machines and synchronous converters use commutating poles. For many years, with the types of direct-current machines in use, the advantage of the commutating pole did not appear sufficient to compensate for the disadvantage of the complication and resultant increase of size and cost. But when with the general introduction of the steam-turbine high-speed machinery became popular, and higher-speed designs were introduced in direct-current machinery also, with correspondingly higher armature reaction and greater need of commutation control, the use of the commutating pole became of material advantage in reducing size and cost of apparatus, and its general introduction followed.

Similarly we have seen the three-phase transformer find general introduction, after it had been unused for many years; so also the alternating-current commutator motor, etc.

Thus for a progressive engineer, it is dangerous not to be familiar with the characteristics and possibilities of the known but

unused types of apparatus, since at any time circumstances may arise which lead to their extensive introduction.

255. With many of these known but unused or little used apparatus, we can see and anticipate the industrial condition which will make their use economical or even necessary, and so lead to their general introduction.

Thus, for instance, the induction generator is hardly used at all today. However, we are only in the beginning of the water-power development, and thus far have considered only the largest and most concentrated powers, and for these, as best adapted, has been developed a certain type of generating station, comprising synchronous generators, with direct-current exciting circuits, switches, circuit-breakers, transformers and protective devices, etc., and requiring continuous attendance of expert operating engineers. This type of generating station is feasible only with large water powers. As soon, however, as the large water powers will be developed, the industry will be forced to proceed to the development of the numerous scattered small powers. That is, the problem will be, to collect from a large number of small water powers the power into one large electric system, similar as now we distribute the power of one large system into numerous small consumption places.

The new condition, of collecting numerous small powers—from a few kilowatts to a few hundred kilowatts—into one system, will require the development of an entirely different type of generating station: induction generators driven by small and cheap waterwheels, at low voltage, and permanently connected through step-up transformers to a collecting line, which is controlled from some central synchronous station. A cheap hydraulic development, no regulation of waterwheel speed or generator voltage, no attendance in the station beyond an occasional inspection, in short an automatically operating induction generator station controlled from the central receiving station.

In many cases, we can not anticipate what application an unused type of apparatus may find, and when its use may be economically demanded, or we can only in general realize, that with the increasing use of electric power, and with the introduction of electricity as the general energy supply of modern civilization, the operating requirements will become more diversified, and where today one single type of machine suffices—as the squirrel-cage induction motor—various modifications thereof

will become necessary, to suit the conditions of service, such as the double squirrel-cage induction motor in ship propulsion and similar uses, the various types of concatenation of induction machines with synchronous and commutating machines, etc.

256. In general, a new design or new type of machine or apparatus has economically no right of existence, if it is only just as good as the existing one.

A new type, which offers only a slight advantage in efficiency, size, cost of production or operation, etc., over the existing type, is economically preferable only, if it can entirely supersede the existing type; but if its advantage is limited to certain applications, very often, even usually, the new type is economically inferior, since the disadvantage of producing and operating two different types of apparatus may be greater than the advantage of the new type. Thus a standard type is economically superior and preferable to a special one, even if the latter has some small superiority, unless, and until, the industry has extended so far, that both types can find such extensive application as to justify the existence of two standard types. This, for instance, was the reason which retarded the introduction of the three-phase transformer: its advantage was not sufficient to justify the duplication of standards, until three-phase systems had become very numerous and widespread.

In other words, the advantage offered by a new type of apparatus over existing standard types, must be very material, to economically justify its industrial development.

The error most frequently made in modern engineering is not the undue adherence to standards, but is the reverse. The undue preference of special apparatus, sizes, methods, etc., where standards would be almost as good in their characteristics, and therefore would be economically preferable. It is the most serious economic mistake, to use anything special, where standard can be made to serve satisfactorily, and this mistake is the most frequent in modern electrical engineering, due to the innate individualism of the engineers.

257. However, while existing standard types of apparatus are economically preferable wherever they can be used, it is obvious that with the rapid expansion of the industry, new types of apparatus will be developed, introduced and become standard, to meet new conditions, and for this reason, as stated above, a knowledge of the entire known field of apparatus is necessary to the engineer.

Most of the less-known and less-used types of apparatus have been discussed in the preceding, and a comprehensive list of them is given in Chapter XXIII, together with their definitions and short characterization.

While electric machines are generally divided into induction machines, synchronous machines and commutating machines, this classification becomes difficult in considering all known apparatus, as many of them fall in two or even all three classes, or are intermediate, or their inclusion in one class depends on the particular definition of this class.

Induction machines consist of a magnetic circuit inductively related, that is, interlinked with two sets of electric circuits, which are movable with regards to each other.

They thus differ from transformers or in general stationary induction apparatus, in that the electric circuits of the latter are stationary with regards to each other and to the magnetic circuit.

In the induction machines, the mechanical work thus is produced—or consumed, in generators—by a disappearance or appearance of electrical energy in the transformation between the two sets of electric circuits, which are movable with regards to each other, and of which one may be called the primary circuit, the other the secondary circuit. The magnetic field of the induction machine inherently must be an alternating field (usually a polyphase rotating field) excited by alternating currents.

Synchronous machines are machines in which the frequency of rotation has a fixed and rigid relation to the frequency of the supply voltage.

Usually the frequency of rotation is the same as the frequency of the supply voltage: in the standard synchronous machine, with direct-current field excitation.

The two frequencies, however, may be different: in the double synchronous generator, the frequency of rotation is twice the frequency of alternation; in the synchronous-induction machine, it is a definite percentage thereof; so also it is in the induction machine concatenated to a synchronous machine, etc.

Commutating machines are machines having a distributed armature winding connected to a segmental commutator.

They may be direct-current or alternating-current machines.

Unipolar machines are machines in which the induction is produced by the constant rotation of the conductor through a constant and continuous magnetic field.

The list of machine types and their definitions, given in Chapter XXIII, shows numerous instances of machines belonging into several classes.

The most common of these double types is the converter, or synchronous commutating machine.

Numerous also are the machines which combine induction-machine and synchronous-machine characteristics, as the double synchronous generator, the synchronous-induction motor and generator, etc.

The synchronous-induction machine comprising a polyphase stator and polyphase rotor connected in parallel with the stator through a commutator, is an induction machine, as stator and rotor are inductively related through one alternating magnetic circuit; it is a synchronous machine, as its frequency is definitely fixed by the speed (and ratio of turns of stator and rotor), and it also is a commutating machine.

Thus it is an illustration of the impossibility of a rigid classification of all the machine types.

3324

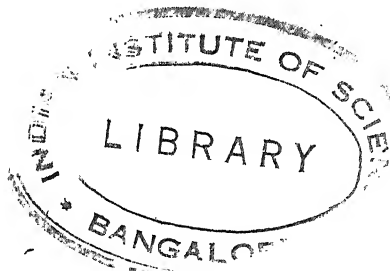



INDEX

Also see alphabetical list of apparatus in Chapter XXIII.

A

Acyclic, *see* Unipolar.
Adjustable speed polyphase motor,
321, 378
Alexanderson very high frequency
inductor alternator, 279
Amplifier, 281
Arc rectifier, 248
Armature reaction of regulating
pole converter, 426, 437
of unipolar machine, 457

B

Balancer, phase, 228
Battery charging rectifier, 244
Brush arc machine as quarterphase
rectifier, 244, 254

C

Capacity storing energy in phase
conversion, 212
Cascade control, *see* Concatenation.
Coil distribution giving harmonic
torque in induction motor,
151
Commutating e.m.f. in rectifier, 239
field, singlephase commutator
motor, 355, **359**
machine, concatenation with in-
duction motor, 55, **78**
pole machine, 472
poles, singlephase commutator
motor, 358
Commutation current, repulsion
motor, 392
series repulsion motor, 400,
404,
factor, repulsion motor, 392

Commutation factor of series repul-
sion motor, 415
of regulating pole converter,
426, 437
of series repulsion motor, **403**
of singlephase commutator
motor, **347**
Commutator excitation of induction
motor, 54, **89**
induction generator, 200
leads, singlephase commutator
motor, 351
motors, singlephase, **331**
Compensated series motor, 372
Compensating winding, singlephase
commutator motor, 336,
338
Concatenation of induction motors,
14, **40**
Condenser excitation of induction
motor secondary, 55, **84**
singlephase induction motor,
120
speed control of induction
motor, 13, **16**
Contact making rectifier, 245
Cumulative oscillation of synchro-
nous machine, 299

D

Deep bar rotor of induction motor,
11
Delta connected rectifier, 251
Direct current in induction motor
secondary, 54, **57**
Disc type of unipolar machine, 454
Double squirrel cage induction
motor, **29**
Double synchronous induction gen-
erator, 191, 199, **201**
Drum type of unipolar machine, 454

E

- Eddy current starting device of induction motor, 8
 - in unipolar machine, 456
- Eickemeyer high frequency inductor alternator, 280

F

- Flashing of rectifier, 249
- Frequency converter, 176
 - pulsation, effect in induction motor, 131
- Full wave rectifier, 245

G

- General alternating current motor, 300
- Generator regulation affecting induction motor stability, 137

H

- Half wave rectifier, 245
- Harmonic torque of induction motor, 144
- Heyland motor, 92
- Higher harmonic torques in induction motor, 144
- Homopolar, *see* Unipolar.
- Hunt motor, 49
- Hunting, *see* Surging.
- Hysteresis generator, 169
 - motor, 168
 - starting device of induction motor, 5

I

- Independent phase rectifier, 251
- Inductance storing energy in phase conversion, 212
- Inductive compensation of single-phase commutator motor, 343
 - devices starting singlephase induction motor, 97, 111

- Inductive excitation of singlephase commutator motor, 343
- Induction frequency converter, 191
 - generator, 473
 - motor inductor frequency converter, 284
 - phase balancer stationary, 228
 - phase converter, 220
- Inductor machines, 274
- Interlocking pole type of machine, 286
- Internally concatenated induction motor, 41, 49

L

- Lead of current produced by lagging field of singlephase commutator motor, 366
- Leblanc's rectifier, 256
- Load and stability of induction motor, 132
- Low frequency exciter of induction generator, 199, 203

M

- Magneto commutation, 285
 - inductor machine, 285
- Mechanical starting of singlephase induction motor, 96
- Mercury arc rectifier, 247
- Meter, unipolar, 458
- Momentum storing energy in phase conversion, 212
- Monocyclic devices, 214
 - starting singlephase induction motor, 98, 117
- Motor converter, 192
- Multiple speed induction motor, 14, 20
- Multiple squirrel cage induction motor, 11, 27

O

- Open circuit rectifier, 237
- Over compensation, singlephase commutator motor, 418

P

- Permutator, 257
- Phase balancer, 228
 - control by polyphase shunt motor, 324
 - by commutating machine with lagging field flux, 370
- conversion, 212
- converter starting singlephase induction motor, 98
- splitting devices starting single-phase induction motor, 97, 103
- Polyphase excitation of inductor alternator, 283
- induction motor, 307
- rectifier, 250
- series motor, 327
- shunt motor, 319
- Position angle of brushes affecting converter ratio, 422
- Power factor compensation by commutator motor, 379
- of frequency converter, 178, 184
- Pyroelectric speed control of induction motor, 14

Q

- Quarterphase rectifier, 251

R

- Reaction converter, 264
 - machine, 260
- Rectifier, synchronous, 234
- Regulating pole converter, 422
- Regulation coefficient of system and induction motor stability, 140
 - of induction motor, 123
- Regulator, voltage-, magneto commutation, 285
- Repulsion motor, 343, 373, 385
 - starting of singlephase induction motor, 97
- Resistance speed control of induction motor, 12
- Reversing rectifier, 245
- Ring connected rectifier, 251
- Rotary terminal singlephase induction motor, 172

S

- Secondary excitation of induction motor, 52
- Self induction of commutation, 420
- Semi-inductor type of machine, 286
- Series repulsion motor, 343, 374, 397
- Shading coil starting device, 112
- Short circuit rectifier, 237
- Shunt resistance of rectifier, 235
 - and series motor starting of singlephase induction motor, 96
- Singlephase commutator motor, 331
 - generation, 212, 229
 - induction motor, 93, 314
 - self starting by rotary terminals, 172
- Six-phase rectifier, 253
 - regulating pole converter, 446
- Split pole converter, *see* Regulating pole converter.
- Square, monocyte, 216
- Stability coefficient of induction motor, 138
 - of system containing induction motor, 141
- Stability of induction motor and generator regulation, 137
 - limit of rectifier, 249
 - and load of induction motor, 132
- Stanley inductor alternator, 275
- Star connected rectifier, 251
- Surging of synchronous machine, 288
- Synchronizing induction motor on common rheostat, 159
- Synchronous exciter of induction motor, 72
 - frequency converter, 191
 - induction generator, 191, 194
 - induction generator with low frequency exciter, 199, 203
 - induction motor, 166
 - as reaction machine, 264

Synchronous machines, surging, 288
 motor, concatenation with in-
 duction motor, 54, 71
 phase balancer, 228
 phase converter, 227
 rectifier, 234

T

Tandem control, *see* Concatenation.
 Temperature starting device of
 induction motor, 2
 Third harmonic wave controlling
 converter ratio, 432
 Thomson-Houston arc machine as
 three-phase rectifier, 244,
 255
 Three-phase rectifier, 251
 regulating pole converter, 445
 transformer, 472
 Transformer, general alternating, 176
 Triangle, monocyclic, 216
 Triple squirrel cage induction motor.

34

U

Unipolar induction, 452
 machines, 450
 motor meter, 458

V

Variable ratio converter, *see* Regu-
 lating pole converter.

W

Wave shape affecting converter
 ratio, 430
 harmonics giving induction
 motor torque, 145
 Winter-Eichberg motor, 380

Y

Y connected rectifier, 251

