

Q.630.7
Iŝ6c
no.1055
cop.5

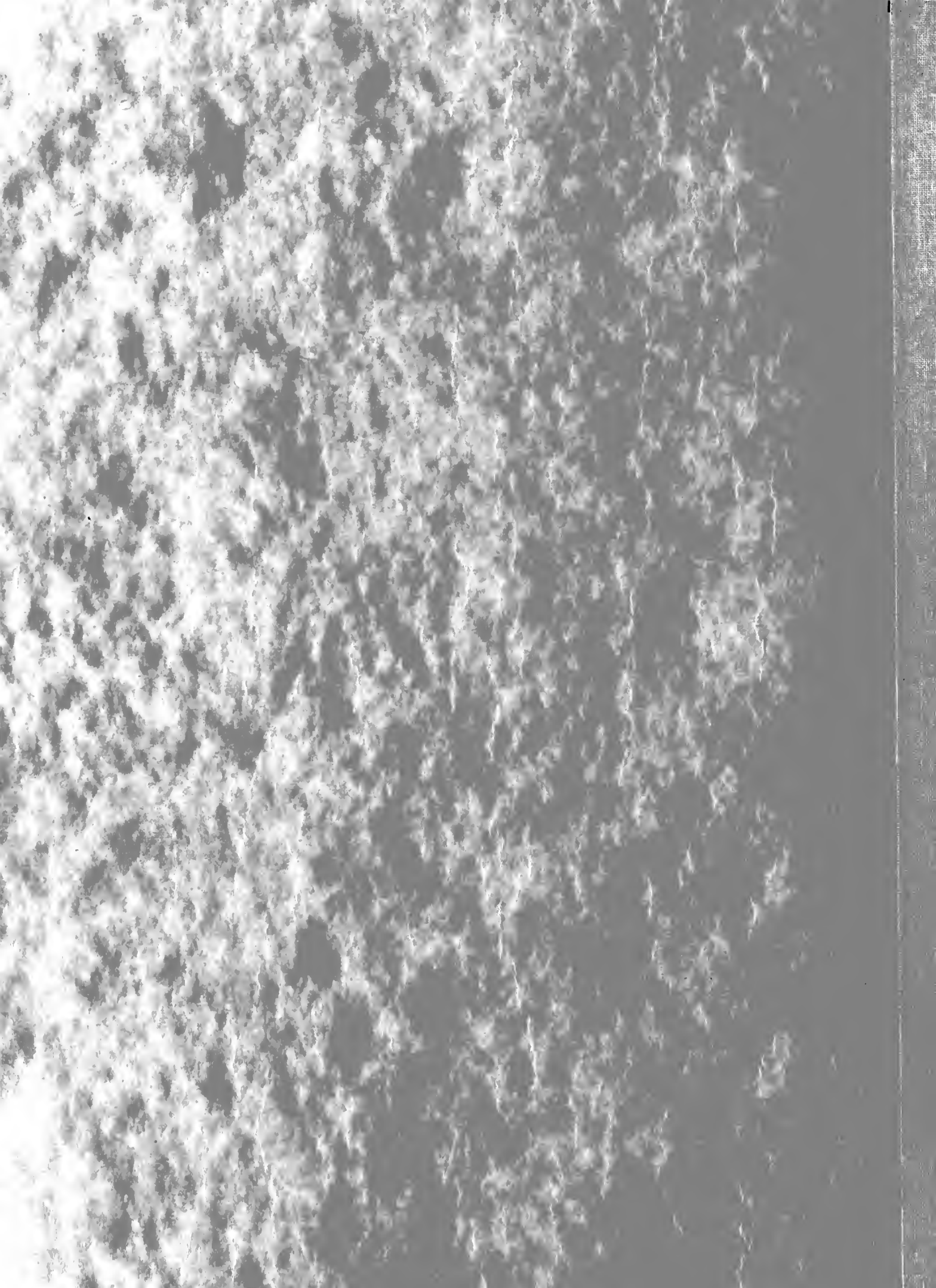

UNIVERSITY OF
ILLINOIS LIBRARY
AT URBANA-CHAMPAIGN
AGRICULTURE

Digitized by the Internet Archive
in 2011 with funding from
University of Illinois Urbana-Champaign

<http://www.archive.org/details/advancedsewingte1055mead>

CIRCULATING COPY
AGRICULTURE LIBRARY

UNIVERSITY OF ILLINOIS
AGRICULTURE LIBRARY



ADVANCED SEWING TECHNIQUES

UNIVERSITY OF ILLINOIS AT URBANA-CHAMPAIGN
COLLEGE OF AGRICULTURE CIRCULAR 1055
COOPERATIVE EXTENSION SERVICE

CONTENTS

Special Techniques.....	2	Machine-made buttonholes.....	25
Supporting Fabrics.....	3	Hand-worked buttonholes.....	25
Interfacing.....	3	Bound buttonholes.....	26
Underlining.....	5	Fabric button loops.....	28
Lining.....	5	Thread loops.....	30
Seams.....	8	Belts.....	31
Corded or piped seams.....	9	Straight tie belt.....	31
Welt seams.....	9	Tie-sash belt.....	31
Slot seams.....	10	Belt with interfacing.....	31
Preventing puckered seams.....	10	Belt with belt backing.....	32
Zippers.....	11	Attaching the buckle.....	32
Lapped zippers.....	11	Eyelets in the lapped end of the belt.....	32
Centered zippers.....	12	Belt carriers.....	33
Hand-applied zippers.....	13	Hems.....	34
Hidden zippers.....	13	Rolled hems.....	34
One-Piece Shaped Facing.....	14	Horsehair braid hems.....	34
Attached Collars.....	17	Wide, triple-thick hems.....	34
Flat collars.....	17	Hems with tape.....	35
Rolled collars.....	18	Bias-rolled hems.....	35
Standing collars.....	19	Finishing Touches.....	36
Other collars.....	19	French binding.....	36
Sleeves.....	20	Bias binding for corners.....	36
Set-in sleeves.....	20	Single-thread darts.....	37
Kimono and raglan sleeves.....	22	Covered or padded snaps.....	37
Putting in a gusset.....	22	Hanging snaps.....	37
Buttons, Buttonholes, and Loops.....	24	Thread-covered hooks and eyes.....	38
Buttons.....	24	Hidden hooks.....	38
Buttonholes.....	24	Thread eyes.....	38
Placement of buttonholes.....	24	Inner waistbands.....	38
		Shoulder-strap stays.....	39
		Weights.....	39

This circular has been prepared by **Marjorie Mead** and **Esther Siemen**, extension clothing specialists. Part of the 4-H sewing skills series, it is also issued as 4H 279.

UNIVERSITY OF ILLINOIS
AT URBANA-CHAMPAIGN
COLLEGE OF AGRICULTURE
COOPERATIVE EXTENSION SERVICE
CI055

IL6c AGX
no. 1055
cop 13

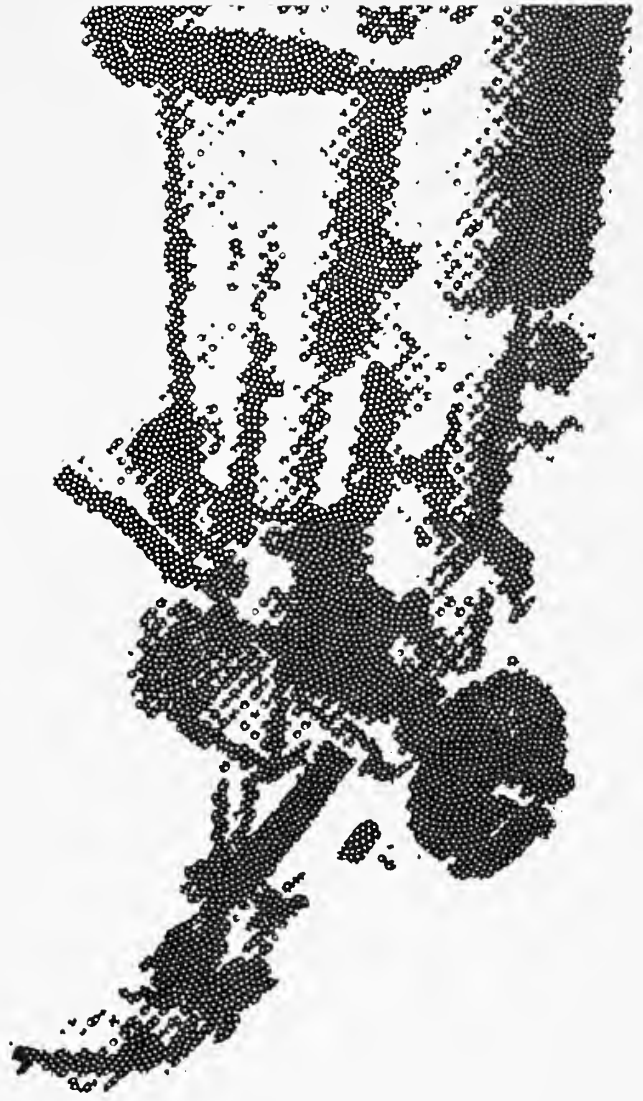

ADVANCED SEWING TECHNIQUES

This publication is designed to help home sewers develop skills beyond the basic construction techniques used with simple patterns. Included are tips on how to achieve special touches that can give the homesewn garment a couture look.

In some instances, several methods of handling certain details are included. The design of the garment and the kind of fabric will help you decide what method to use. However you proceed, there are certain standards of appearance and durability you will want to attain, standards that are described with the various construction techniques.

For more information about handling specific types of fabrics, contact your Extension Adviser in Home Economics for the topics that interest you in the following pamphlet series.

Bonded Fabrics
Deep Pile Fabrics
Directional Fabrics
Double-Faced Fabrics
Durable Press Fabrics
Fabrics for Special Occasions
Knit Fabrics

Leather
Plaids and Stripes
Pressing Equipment and Techniques
Sewing with Wool
Sheer Fabrics
Vinyl

SPECIAL TECHNIQUES

The techniques discussed here will be mentioned several times in this publication. You will find them quite useful for giving your garments a smooth, finished look.

grading seams

Grading — also called feathering, beveling, blending, and layering — is the process of trimming the seam allowances of a seam to different widths (Fig. 1). This removes bulk so that the seam will lie flat when joining heavy fabrics, garment pieces plus interfacing, and so on.

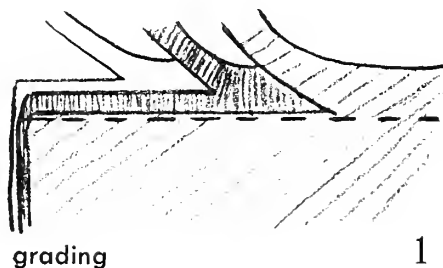

basic hand stitches

As you sew, you will find many uses for the following hand stitches, particularly when basting or putting finishing touches on your garment.

Hand basting is used with fabrics that may slip under machine-stitching even though they are pinned. Firmly stitch a straight row along the seamline or stitching line, beginning and ending with a short backstitch (Fig. 2).

Slip-basting (or hidden basting) is used on the right sides of garments when you want to match stripes and plaids or make alterations. Use fairly large stitches; slip the needle through the upper (folded) layer of fabric, then take a stitch in the lower layer (Fig. 3).

Slip-stitching, usually used for hems, is permanent

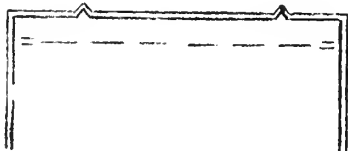

hand basting

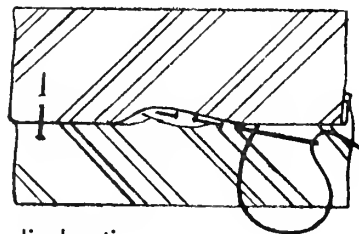

slip-basting

and invisible on both sides of a garment. Slip the needle through the folded edge of the hem, then catch just one thread in the lower layer of fabric (Fig. 4).

Blind-stitching is a common hemming stitch that is inconspicuous on both sides of the garment. Roll back the finished hem edge. Take a small stitch in the garment, then take a small stitch in the hem (Fig. 5). Space the stitches about $\frac{1}{4}$ " to $\frac{1}{2}$ " apart.

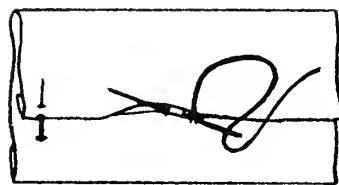

slip-stitching

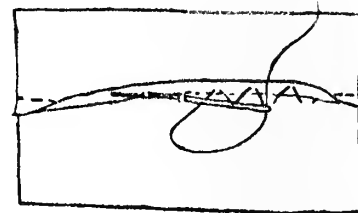

blind-stitching

Catch-stitching is most often used with tapeless hems in lined garments and with heavy fabrics. Starting at the left, make a cross-stitch pattern by inserting the needle from right to left — first in the hem, then in the garment (Fig. 6). Catch one thread in the garment.

Bar tacks are used to reinforce points of strain. Make two or three long stitches the length of the bar tack. Follow with small overhand stitches through the fabric and across the lengthwise threads (Fig. 7).

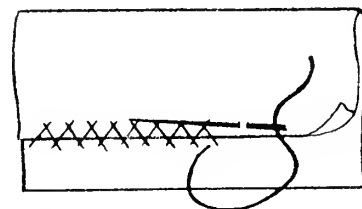

catch-stitching

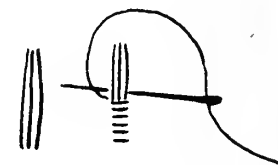

bar tacks

basic machine stitches

Stay-stitching prevents stretching on curved and bias edges. Stitch with a regular stitch (12 to 15 per inch) on a single thickness of fabric, within the seam allowance (about $\frac{1}{8}$ " from the seamline). See Figure 8. Stitch on the seamline, however, on deep curves or a neckline, as these garment constructions are often clipped to the seamline.

Ease-stitching is used to distribute fullness evenly in such areas as sleeve caps and circular hems. Stitch at 10 stitches per inch, and leave the thread ends unfastened (Fig. 9). For slight fullness, use a pin to gently pull up the thread, and work the ease in smoothly. For more

SUPPORTING FABRICS

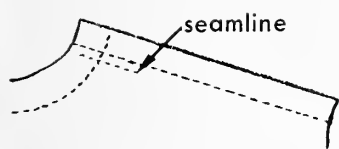

stay-stitching

8

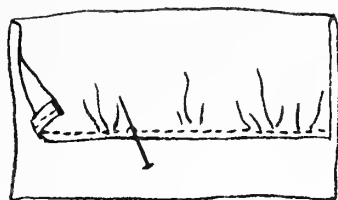

ease-stitching

9

fullness, pull the thread from both ends. Press to help ease in the fullness.

Machine-basting uses the longest stitch on your machine, usually 6 per inch (Fig. 10). Machine-basting is used with zipper openings, with seams (when fitting a garment), and in transferring pattern markings to the outside of the fabric.

Topstitching may be decorative or functional or both. Sewing from the right side of a garment, stitch with a regular stitch (12 to 15 per inch) through all thicknesses (Fig. 11). This helps hold seam edges in place and is often used with waistbands, collars, cuffs, yokes, and patch pockets.

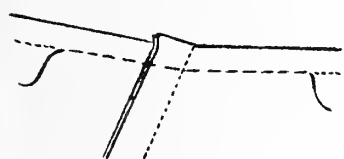

machine-basting

10

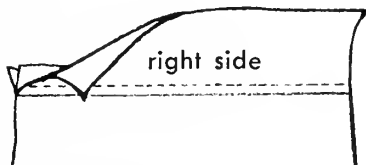

topstitching

11

Understitching keeps facings from rolling to the outside of a garment. With the garment right side out, open out the facing; turn all seam allowances so that they are under the facing. Stitch on the facing, very close to the seam, through all layers of fabric (Fig. 12).

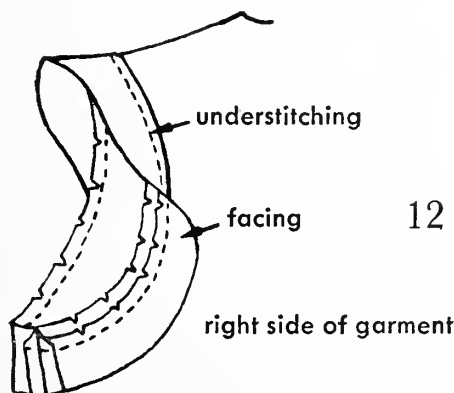

12

Supporting fabrics can prevent stretching and bagging in soft fabrics; add body to a garment in such areas as the edge of the front opening, lapel, and collar; and keep rough-textured fabrics from rubbing against your skin. By choosing the appropriate supporting fabric, you can lift a garment out of the ordinary and give it that "certain something" found in much expensive ready-to-wear.

The three types of supporting fabrics commonly used are interfacing, underlining, and lining. Which type will give the best results and where best to use it are determined by the silhouette of the pattern design and by the texture and weight of the garment fabric. What is sometimes confusing, however, is the fact that there are many trade names for the same kind of fabric and that one kind of fabric may be used as either interfacing, underlining, or lining, depending upon the outer fabric and the effect desired. To help you select the type of supporting fabric you need, each type is discussed in detail here.

Interfacing

Interfacing is a piece of fabric sewn between the facing and the outer fabric to give a garment body and shape. It strengthens edges where buttons, buttonholes, and other fasteners are sewn; adds a smooth finish to necklines, collars, pocket flaps, cuffs, and waistbands; helps mold a design into a smooth shape or flare; gives body to front facings, necklines, and sheer facings; and increases garment life and keeps clothing looking new.

Commercial patterns do not always suggest using interfacing. In particular, interfacing is unnecessary when the garment fabric has enough body to be used without a supporting fabric — some polyester knits are quite full-bodied — or when the garment has been lined with a sturdy lining. As you gain sewing experience, you will be able to decide more easily whether interfacing is called for. Don't hesitate to ask a fabric saleswoman her opinion.

selecting interfacing materials

Your choice of interfacing will often depend on what is available; when possible, however, base your decision on the following considerations:

What finished effect do you want — gentle rolls, sharp creases, extra body, stability, or what? Fold the outer fabric over the interfacing to see if the combination gives the desired effect.

How does the weight of the outer fabric compare with that of the interfacing? The interfacing should never be the heavier of the two; it should give body without bulk.

What kind of care will your fabric need? Interfacing must be compatible with the garment fabric for laundering, dry cleaning, and ironing. A garment of durable press cotton, for example, should be interfaced with durable press cotton interfacing; otherwise, the interfacing might shrink and pucker the garment in the interfaced area.

Will the interfacing show through and change the color of the outer fabric, or are the colors compatible?

What is the character of the outer fabric — is it firm or soft, does it stretch or stay firm? Interfacings for stretch fabrics must be as elastic as the outer garment; where stretch is not desirable, the interfacing should be firm enough to support and maintain the shape of the outer fabric.

types of interfacing materials

There are three general types of interfacing fabrics: woven, nonwoven, and iron-on.

Woven interfacings are suitable for all types of outer fabrics and patterns. Some of the cotton interfacings, however, such as organdy, lawn, muslin, and batiste, may need to be shrunk before they are used. Woven interfacings should be cut on the same grain as the outer fabric.

Nonwoven interfacings have less give than woven ones and do not mold or shape well. Those labeled “bias” will take some shaping, but nonwovens are usually best where you want to build firmness rather than mold and shape. They can be cut in any direction.

Iron-on interfacings do not adhere equally well to all fabrics, so always test press on a scrap of fabric before using in a garment construction. Determine how much heat is needed for firm adhesion and whether the outline of the interfacing will show through on the right side of the fabric. Because they have little or no give and are fairly heavy, iron-on interfacings should not be used in large areas but only for detail work in small areas. The outer fabric will become heavier or stiffer where an iron-on is applied, so be careful that the additional weight is not too much for lightweight fabrics.

applying interfacing to a garment

There is no one best way to apply an interfacing. Follow your pattern instructions, or use the following suggestions if they are not included with the pattern.

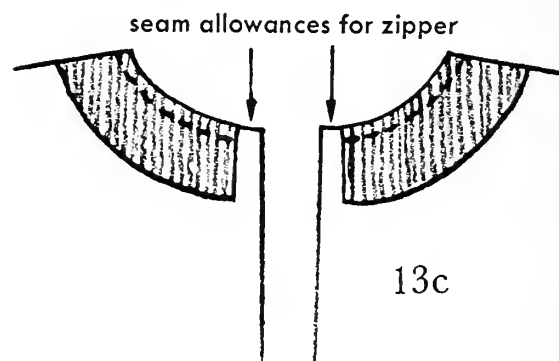
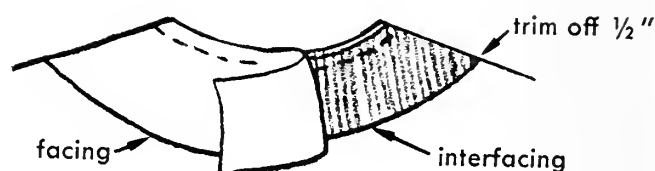
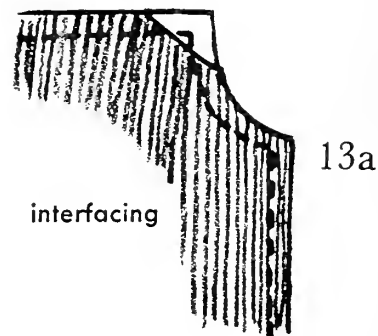

Eliminate bulkiness. After the interfacing is cut out, clip off the corners of the interfacing in pointed areas, such as at collar and lapel points. Trim just beyond the seamline (Fig 13a). Keep the interfacing from showing from beneath the finished edge of the neckline and armhole facings by trimming off $\frac{1}{2}$ ” of the outer edge of the interfacing (Fig. 13b). At the neck opening for a zipper placket, the neckline interfacing should come just to the seamline; trim $\frac{5}{8}$ ” off at each end of the interfacing, as shown in Figure 13c.

In general, apply interfacing directly to the wrong side of the garment. This helps keep the seam allowance from showing through on the right side of the finished garment.

Note: If pressed directly onto the garment, iron-on interfacings may leave an outline. Press a piece of the interfacing onto a scrap of fabric; if an outline shows, press the interfacing onto the facing instead of the garment.

Stitch the interfacing and the garment piece together on the seamline. After all the interfacing is stitched in place, stitch the garment pieces together, press the seams open, and trim the interfacings so that the

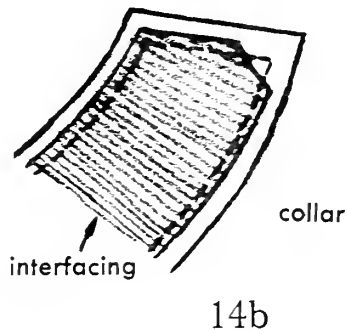
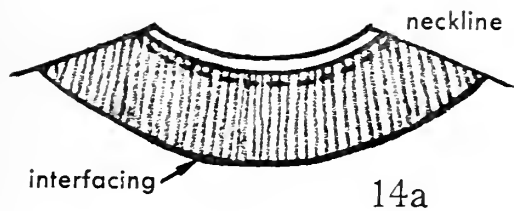

seam allowances of the interfacings are narrower than the seam allowances of the garment (Fig. 14a and b). If the interfacing fabric is firm, trim the interfacing to $\frac{1}{8}$ " from the seamline. If it frays badly, do not trim that close.

After stitching, pressing, and trimming seams, turn the garment to the right side. Work out corners carefully, understitch if necessary (see page 3), and give the garment a good pressing.

Underlining

Underlining (sometimes called backing) gives body, firmness, and shape to an outer fabric. Occasionally, underlining is used to build an unusual silhouette into a garment.

selecting underlining fabrics

The type of underlining fabric used will depend upon the kind of fabric you are underlining and your reasons for underlining. Use the following general guides to help you make a good choice.

The underlining fabric should be firmly woven, especially if it is used under a soft or loosely woven outer fabric to prevent sagging and stretching. The underlining should be the same weight as, or lighter than, the outer fabric, and its color should match or blend with that of a sheer or open-weave outer fabric. The underlining fabric and the outer fabric should have similar fiber contents and care requirements; that is, they should be both washable or both dry cleanable, have the same temperature sensitivities, etc. Finally, the underlining should have the hand (crispness or softness) that will create the effect you wish.

Suggested underlining fabrics include sheath lining

fabrics, which may be cotton or blends of rayon and acetate; cotton fabrics, such as percale, batiste, lawn, or muslin; silk organza; crepe lining fabrics of various weights; taffeta; Si Bonne, Undercurrent, Butterfly, and other fabrics developed specifically for use as underlinings.

applying underlinings

Cut underlining pieces from the same pattern pieces as the garment fabric. Baste together the two fabrics and handle as one fabric during garment construction. Transfer pattern markings to the underlining fabric only, not underlining and garment fabric.

Before stitching darts, baste down the center of the dart through both layers of fabric. If the dart is rather wide, cut through the center fold and press it open; trim the sides to $\frac{1}{4}$ " to $\frac{1}{2}$ " wide (Fig. 15).

To make the hem, trim off the underlining fabric at the hemline and turn the garment hem up over the underlining. If the garment fabric is lightweight, catch the hem to the underlining only. With a heavy garment fabric, catch the hem to the underlining and take an occasional stitch through both the underlining and the outer fabric.

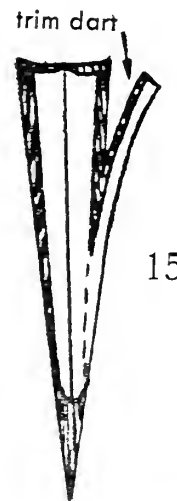

Lining

Lining serves several purposes: it relieves direct strain on the outer fabric, prevents wrinkles, and enhances the appearance of certain fabrics, especially sheers. It also gives a finished appearance to a garment whose interior will be displayed, such as a jacket worn over a dress.

selecting lining fabrics

The guides for selecting underlining fabrics are equally useful for choosing lining fabrics. The following fabrics are suitable, depending upon the effect you desire.

Silk or China silk — lightweight and pliable, this adds beauty and makes garments comfortable to slip into and out of. For jackets, skirts, and dresses.

Crepe — lightweight and pliable. For jackets and for dresses made of jersey or other fabrics that stretch somewhat or are loosely woven.

Taffeta — crisp and adds body; can be used with lightweight fabrics when extra weight is desired to hold flares, etc.; also good with mediumweight and heavy fabrics. For jackets, skirts, and dresses.

Satin — adds body and gives a rich appearance. For jackets.

Cotton prints — add color to a costume, but garments lined with cotton are not as easy to take on and off as those lined with other fabrics. For jackets.

applying lining

Prepare the lining fabrics by straightening and pressing them so they are grainline perfect. Shrinking is usually not necessary and should not be done at all with some lining fabrics, notably crepe and taffeta. Check fabric labels to see whether dry cleaning is recommended.

In general, to line a garment, join the lining pieces together, fit the lining into the garment, and stitch together by hand or machine. Specific kinds of garments are lined as follows.

Skirts. The skirt should be finished before lining except for the waistband and hem. Use the skirt pattern to cut lining pieces, and transfer pattern markings to the lining fabric. Stitch darts and join seams, leaving open the skirt placket portion of the seams. If you are sure what length the lining should be, hem it before putting it in the skirt.

With wrong sides of garment and lining together, baste the waistline seam of the skirt lining to the skirt, matching seams and darts. This seam will eventually be covered by the skirt band or the waistline facing. In the placket area, turn under the raw edges of the lining and whipstitch them to the zipper tape. After the lining is in place, sew the waistband to the skirt and, if you have not already done so, hem the lining.

Dresses. Dress design and fabric will determine how completely a dress should be lined and by what method.

For a *sleeveless dress*, baste the lining in place around the armholes. Finish the armholes with a shaped facing, bias binding, or other finish, as directed in the garment pattern instructions.

For a *dress with sleeves*, make the entire lining separately; with loose basting stitches attach the lining to the shoulders at the seamlines and either around the arm-

holes or along raglan seams. Turn under the edge of the sleeve lining and slip-stitch it (see page 2) to the hem of the sleeve; or, baste the edge of the sleeve lining to the edge of the sleeve and finish with a cuff, a shaped facing, or binding.

Baste the lining in place around the neckedge, then finish the neckline with a shaped facing, collar, or other construction method. Or, after completing the neckline construction, attach the lining to the edge of the neckline facing with slip-stitching.

For a *dress with no waistline seam*, attach the lining to the garment at the neckline, shoulders, and armholes. You can either tack the lining loosely at the side seams or let it hang free; the latter is often preferable for knit fabrics.

If the *dress has a waistline seam*, baste the lining to the waistline seams of the bodice and skirt separately; sew the lining into the waistline seam when the bodice and skirt are joined.

Hem the lining separately from the dress.

Jackets. Jackets can be lined by machine- or hand-stitching or by a combination of both methods. The following directions are for the hand-sewn method, as used in well-made ready-to-wear. This method gives a jacket the look of quality.

Stay-stitch the lining pieces at the neckline and armholes and around the caps of the sleeves. Lengthen the stitches around the sleeve caps and ease in fullness.

Stitch the darts. If there is a center back pleat, baste and press the pleat in the direction your pattern instructions suggest. Usually the inside fold of the pleat goes to the left side of center back. Join the front and back lining pieces at the underarm seams only. Press the lining before you attach it to the jacket.

Attach the lining to the jacket by the following steps, completing one side (either right or left) before working on the other.

1. With wrong sides of the lining and jacket together, match side seams at the notches and baste one side of the lining seam allowance to one side of the garment seam allowance (Fig. 16). This basting will be left in to help hold the lining in place permanently.

2. Match the front lining piece to notches at the front armseye and at the shoulder seam. Baste into position at the armhole seamline and across the shoulder. Match the back lining piece to the back of the armhole, turning under the seam allowance at the shoulder seam. Baste the back of the lining into place around the armhole and across the shoulder. See Figure 17a.

3. Turn under the seam allowances of the front edges and of the back neckline of the lining. You will have to clip the seam allowance of the back neckline to make it lie flat. The back neck lining will come to the

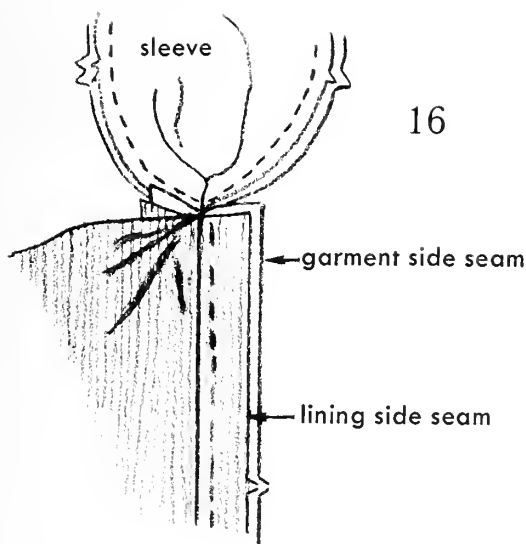

16

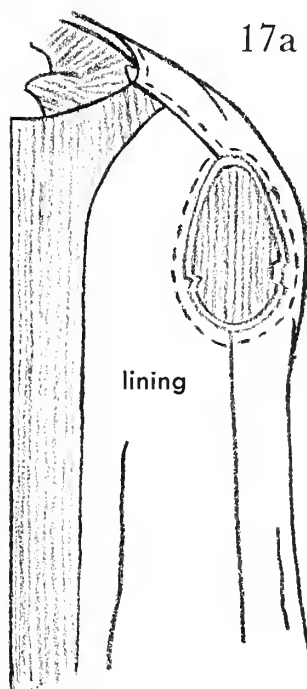

17a

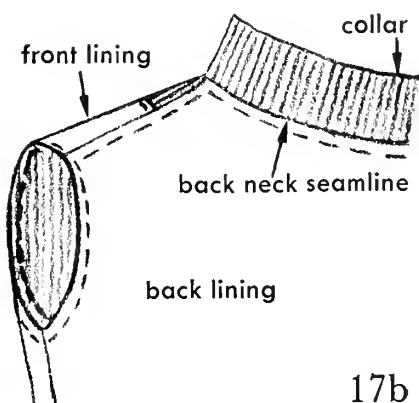

17b

neckline seam of the collar or to the edge of the back neck facing if there is one (Fig. 17b). Baste.

Slip-stitch the edges of the lining to the garment at the front edges, the back neckline, and across the shoulder seams. Leave the front edges of the lining open about 4" from the hemline of the jacket; this will make hemming the lining to the jacket easier. Be sure to keep the crosswise and lengthwise grainlines of both the lining and the garment straight.

4. To hem the lower edge of the jacket, first pin the lining to the jacket about 5" from the finished jacket hemline. Either have someone wear the jacket or hang it on a hanger as you pin so you will not pull the lining too taut.

Trim the lining so that it hangs 1/2" below the finished hemline of the jacket (unless your pattern instructions direct otherwise). Turn under 1/4" of the lining, pin this fold 3/4" above the jacket hemline, and slip-stitch in place (Fig. 18a). When the pins are removed, a pleat or tuck will fall into place at the hem, allowing some ease in the lining.

5. The hem of the jacket facing should already be finished. After you attach the lining (step 2), turn under the edge of the facing between the hem and the lining and slip-stitch in place. Hem the remaining lower front edges of the lining to the facing (Fig. 18b).

6. Finish the sleeve lining around the armholes by either of the following methods:

Method One — Turn the sleeve lining wrong side

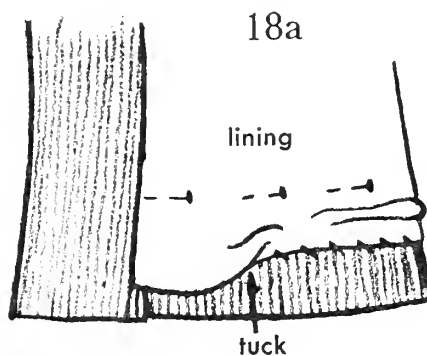

18a

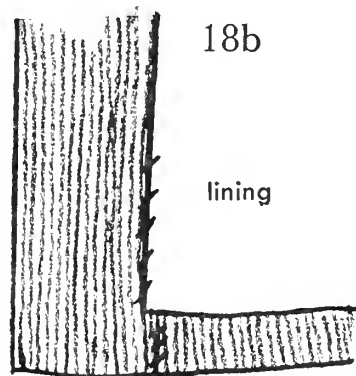

18b

out and match it to the wrong side of the sleeve at the underarm seam. Baste one side of the sleeve lining seam allowance to one side of the garment sleeve seam allowance.

Run your hand through the sleeve lining and grasp the lower edge of the sleeve. Turn the lining over the sleeve, easing fullness at the cap of the sleeve. Turn under slightly more than $\frac{5}{8}$ " for a seam allowance (around the cap only) and lap the sleeve lining over the garment lining around the jacket armhole. If the cap of the sleeve lining has a great deal of fullness, lap it about $\frac{1}{4}$ " beyond the armhole seamline (around the cap only).

Pin and baste if necessary; slip-stitch the sleeve lining to the garment around the armhole.

Method Two— Follow method one to turn the lining over the sleeve. Ease the fullness at the sleeve cap. Then place the seamline around the sleeve cap lining over the seamline of the garment armhole; baste. The basting will be left in the garment.

Turn under the armhole seam allowances of the front and back lining pieces. Lap the front and back pieces over the seam allowance of the sleeve lining, matching seamlines. Slip-stitch the front and back lining to the sleeve lining around the armholes.

The shoulder seams of the front and back lining pieces can be machine stitched before the armhole is finished, or you can finish them by slip-stitching when you finish the armholes.

7. Remove any basting stitches from the center back pleat. Use feather stitches or catch stitches (see page 2) to fasten the pleat at the neck edge and across the waistline (Fig. 19).

8. Give the lining a final press.

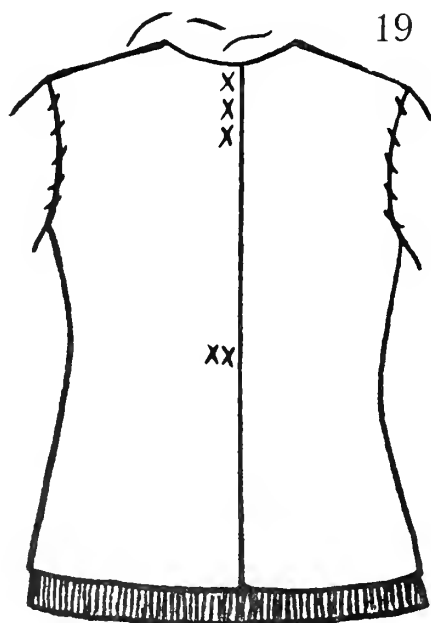

SEAMS

Plain seam construction is a necessary part of garment construction. Other kinds of seam finishes, however, can add decorative detail and a look of originality to a garment. Pattern designs that call for decorative seams will include instructions for making them. If you decide to feature seams on a garment yourself, you will want to keep the following points in mind as you select fabric and plan your garment:

A decorative seam finish shows up better on plain fabrics than on printed or heavily textured materials.

A decorative seam finish must be planned so that it adds to the beauty of the garment design. It should not look like an afterthought or make the garment seem overdone.

Some decorative seams finishes, such as the welt seam (page 9), require a wider than usual $\frac{5}{8}$ " seam allowance. If your pattern doesn't allow for extra seam allowances, you must cut out your garment a little larger. A $\frac{3}{4}$ " seam allowance is usually adequate.

When decorating with machine topstitching, stitch length is important. Test several different stitch lengths on a scrap of your fabric until you are pleased with one. Emphasize topstitching with heavy thread—silk buttonhole twist is good in both the bobbin and the needle. Use a size 16 needle. You may have to adjust the machine tension.

Topstitching can also be done by hand. Figure 20 shows different effects you can get from different stitches. To help make topstitching lines straight, place a strip of cellophane or masking tape along the seam line and use the other edge as a guide for the topstitching seam (Fig. 21). A commercial tape marked to guide topstitching is also available.

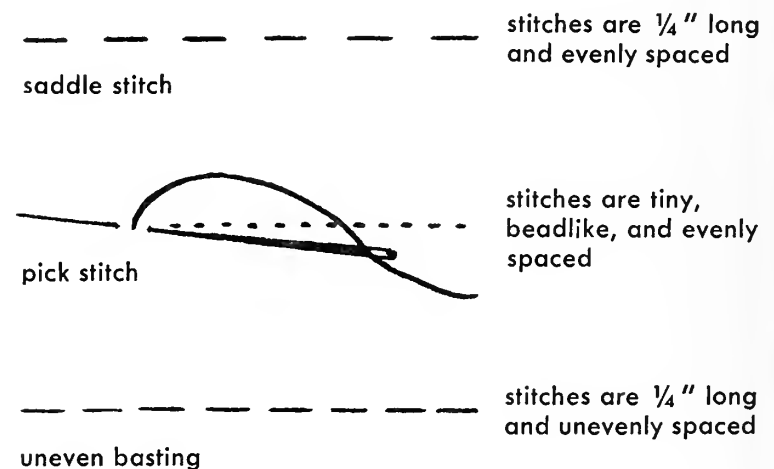

20

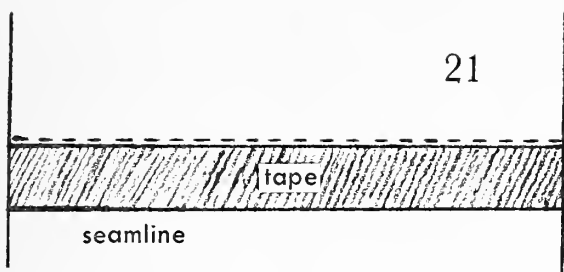

Corded or piped seams

A piped seam is made by folding a strip of bias fabric and sewing it into a seam. A corded seam has commercial cord or yarn inside the bias fold of fabric that is sewn into the seam.

A corded or piped seam can be used at the waistline instead of a belt, around a collarless neckline, in seamlines to emphasize a certain design line, or wherever else seems appropriate.

making the bias strip

Cut a strip of fabric on the bias as long and wide as necessary (see bias directions on page 29). If you are using cording, the bias strip should be wide enough to fold over the cord, be stitched together, and leave $\frac{1}{4}$ " to $\frac{1}{2}$ " seam allowance.

For cording, place the fabric strip over the cord with the wrong side of the fabric against the cord (Fig. 22b). For piping, fold the bias strip in half lengthwise, wrong sides together. The width of the piping will determine how wide to stitch the piping seamline: measure the desired distance from the fold and baste-stitch the raw edges of the piping together along this line (Fig. 22c).

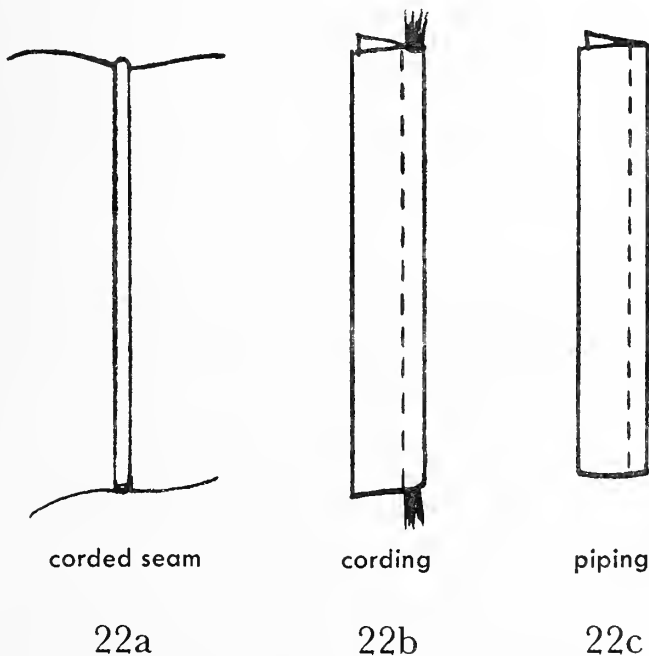

stitching

In general, to stitch a seam with cording or piping, first attach the bias strip to one garment piece, then stitch the other garment piece at the seam. If a gathered edge is to be joined to a straight one, pin the bias strip to the ungathered piece. If the seamline is curved, pin the cording or piping to the outward curve.

Match the seamlines of one side of the seam of the garment and the bias strip. Pin the piping or cording in place, holding it taut. Stitch the cording or piping to the garment fabric by sewing as close as possible to the cord or the width of piping. Use a cording or zipper foot if the cord is $\frac{1}{8}$ " or more in diameter; a regular presser foot can be used with smaller cords.

After stitching the cording or piping to one layer of garment fabric, attach the other garment piece at that seam. Pin the right sides of the two garment pieces together and stitch. It is easier to stitch when the layer of fabric with cording (or piping) attached is on top; you can then stitch over the stitches that hold the cording in place.

Trim the seam allowance on the bias strip to $\frac{1}{8}$ ". Grade the seams of the garment pieces (see page 2).

Welt seams

To be effective, a welt seam must be made in a fabric heavy enough to appear slightly padded between the seamline and the second row of stitching (Fig. 23).

With the right sides of the fabric together, stitch a plain seam; a $\frac{5}{8}$ -inch seam allowance will be adequate unless the welt is to be wider than $\frac{3}{8}$ ". Trim off to about $\frac{1}{4}$ " the seam allowance that will lie against the garment and be inside the welt.

Press the seam open, then turn both seam allowances to one side and press again, keeping a slight roll on the

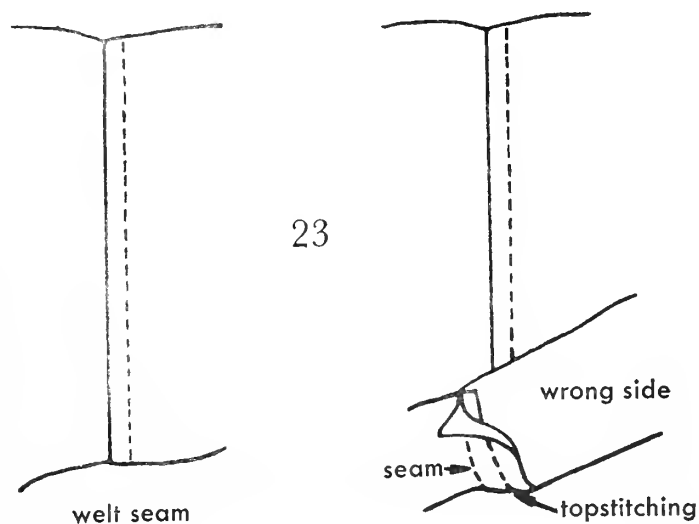

right side of the garment along the turned edge (do not press severely flat). The seam allowances of a welt seam are usually turned as follows:

- armhole — away from the sleeve
- shoulder — toward the front
- yoke lines — toward the neckline and shoulder
- center back — toward the right
- underarm — toward the front
- edges of center panels — toward the center front or center back

Finish the raw edge of the upper seam allowance if necessary. From the right side, stitch through the garment and seam allowances at the desired distance from the seamline — usually $\frac{1}{4}$ " or $\frac{3}{8}$ " away.

Slot seams

The slot seam (Fig. 24) resembles an inverted pleat and is effective in firm fabrics that give crisp edges or in lined fabrics where the lining helps to give a sharp edge. The fabric used to back a slot seam may be cut from either the garment fabric or the same kind of fabric in a contrasting color.

Machine-baste the seam on the wrong side of the fabric. If you want topstitching $\frac{1}{2}$ " or more from the seamline, you must cut out your pattern pieces with seam allowances wider than $\frac{5}{8}$ ". Finish the edges of the seam allowance to prevent raveling if necessary and press the basted seam open.

Cut a strip of self- or contrasting fabric that is slightly wider than the combined width of the two seam allowances and that has the same grain as the seamline (crosswise or lengthwise). The strip can be cut on the bias if the seam is curved or if the design of the fabric

permits a special effect. Put the strip under the seam and pin through the outer fabric and seam allowance.

From the right side of the garment stitch about $\frac{1}{2}$ " from each side of the seam line. The exact distance will be specified in pattern directions that have a slot seam as part of the design.

Remove the basting stitches that are holding the seam closed and give the seam a final press.

Preventing puckered seams

Many easy-care fabrics are difficult to sew without getting puckered seams. The following tips will help minimize the problem, but in some cases — especially with closely woven easy-care fabrics — nothing seems to work.

Be sure your sewing machine is clean. There should be no dust or lint in the stitch-forming mechanism or between the tension disks.

Check the machine tension. One of the major fiber companies recommends an unbalanced tension (looser upper tension) for some durable press fabrics. Keep the pull or tension on the presser foot easy, however, by placing one hand on the fabric in front of the presser foot and one behind. Use enough pressure so that the fabric need only be guided through the stitching process.

The pressure on the presser foot should be light. Use only enough pressure to guide the fabric through the stitching process.

Try different kinds of thread to find the one that stitches best on the fabric you are using. Core-spun threads are recommended for synthetic fabrics and for fabrics with a durable press finish, and silk thread is good for wool fabrics. Cotton thread can shrink and cause pucker in stable (nonpliable) fabrics, such as those with a durable press finish, but mercerized cotton thread can be used on cotton fabrics that are not durable press.

If you have a zigzag machine, try a narrow zigzag stitch. This will allow more give than straight stitching.

Again, if you use a zigzag machine, never do straight (non-zigzag) stitching on the plate with the large needle hole, which is designed specifically for zigzagging. The machine needle will carry the fabric down into the needle hole, and puckering can result.

Reduce the number of stitches per inch. On fabrics that give pucker problems, the maximum desirable number of stitches per inch would be 10 to 12.

Sew at a moderate, even speed.

As a last resort, sew with tissue paper or newsprint between the fabric and the feed dog.

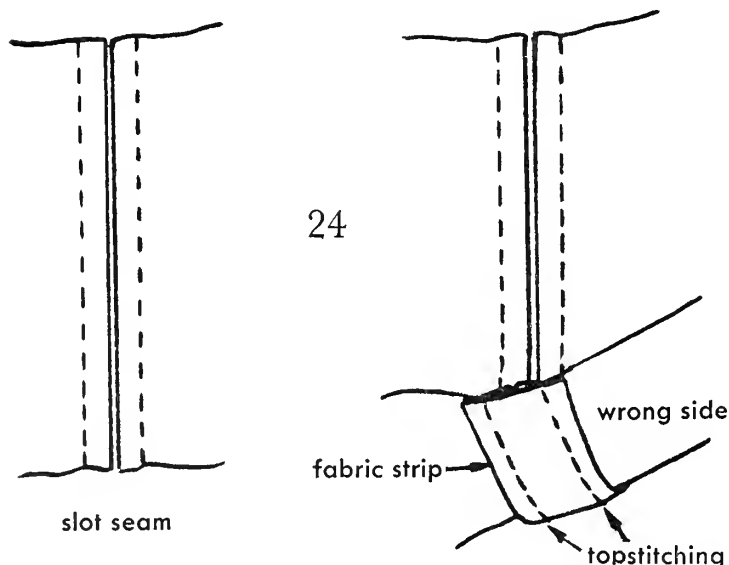

ZIPPERS

Several methods for applying zippers are presented here: lapped, centered, hand-stitched, and "hidden." The method or type of zipper chosen will depend upon the location of the placket, the weight and texture of the fabric, and the design details of the garment. The teeth or coil of an inserted zipper should be covered, and the stitching should be straight without seam puckering or zipper buckling. Zippers intended to be decorative as well as functional, such as bulky novelty zippers, will often leave the zipper teeth exposed.

Lapped zippers

This method may be used in side or center back openings. A fold of fabric conceals the zipper teeth and extends over the edge of the other side of the placket; one line of stitching is visible on the outside of the garment (Fig. 25).

Close the placket opening with machine-basting on the seam line. To remove this stitching easily after completing the placket, clip the basting about every 2 inches. Press the seam open.

Attach the zipper foot to the sewing machine and adjust it to the right side of the needle. Open the zipper and place it face down on the extended seam allowance only. The edge of the teeth should be even with the seamline, and the metal pull tab will be at the lower end of the placket. The top of the teeth should be at the waistline seam of a skirt or $\frac{3}{8}$ " from the neckline seam of a bodice. Machine-stitch through tape and seam allowance only, beginning at the bottom of the tape (Fig. 26a).

Shift the zipper foot to the left side of the needle. Close the zipper and turn it face up. Smooth away the

fabric from the zipper, leaving a narrow fold of about $\frac{1}{8}$ " between the seamline and the teeth. Stitch along the edge of this fold close to the teeth of the zipper, stitching through the fold and tape only (Fig. 26b).

Spread the garment flat, right side out, with the zipper face up on the other seam allowance. Stitch across the bottom, turn, and stitch up the side of the placket (Fig. 26c). You will be stitching through three thicknesses—the tape, the seam allowance, and the

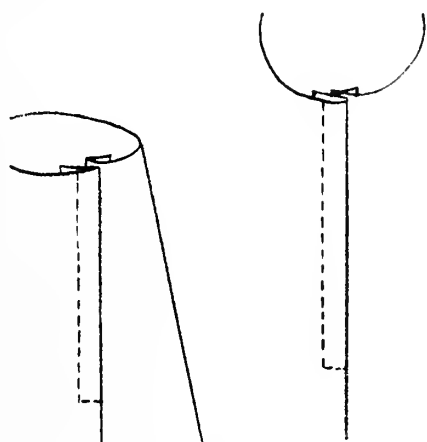

25

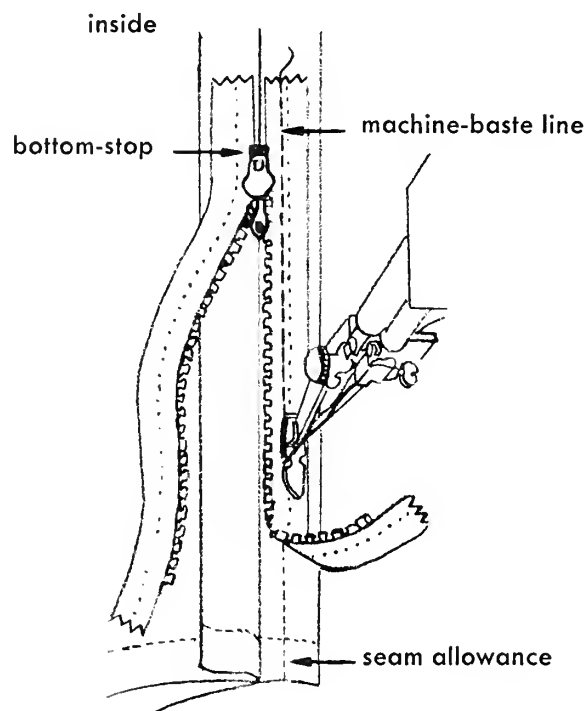

26a

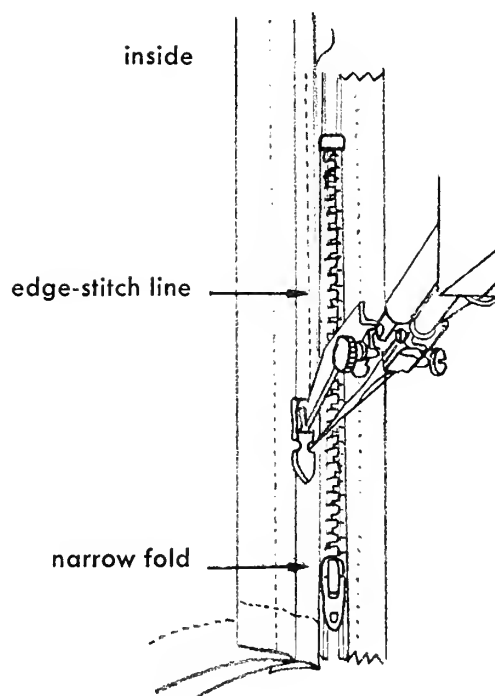

26b

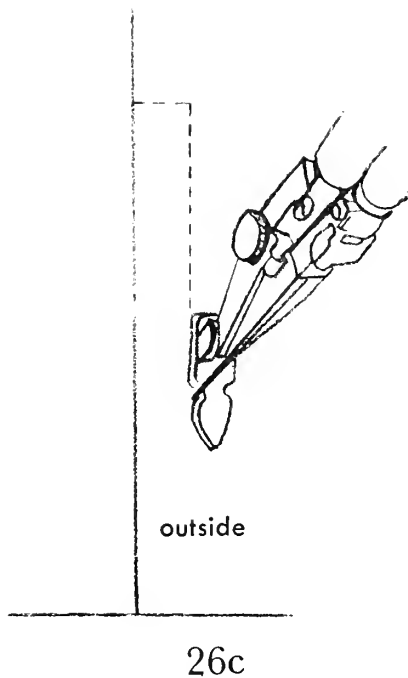

garment. *Note:* Some people find it easier to do this stitching from the wrong side of the garment.

Remove the machine-basting.

Centered zippers

This method is used most frequently for center back or center front openings or with fabrics that are too bulky for the lapped application. Two folds of fabric conceal the zipper teeth, and two lines of stitching — one on each side of the seamline — are visible on the outside of the garment (Fig. 27).

Close the placket opening with machine-basting, as described for lapped zippers. Press the seam open. Attach the zipper foot to the sewing machine and adjust it to the right side of the needle.

With the top of the placket opening toward you, place the right seam allowance flat on the machine.

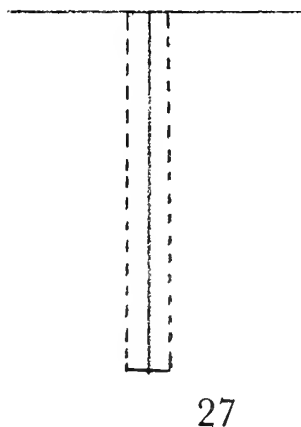

Open the zipper and place it face down with one tape on the extended seam allowance and the teeth or coil against the seamline. The top of the zipper opening should be about 1" from the edge of the placket opening to allow for seam allowances and clearance for finishing. Machine-baste close to the teeth through the tape and seam allowance only (Fig. 28a).

Adjust the zipper foot to the left side of the needle. Smooth the other seam allowance and place the free side of the zipper so that the teeth are along the seamline. Have the pull tab turned up. Beginning at the top of the pull tab, machine-baste through the zipper tape and seam allowance only (Fig. 28b).

Close the zipper. Turn the garment right side out and spread the placket area flat. Mark the bottom of the zipper with a pin. Beginning at the bottom edge,

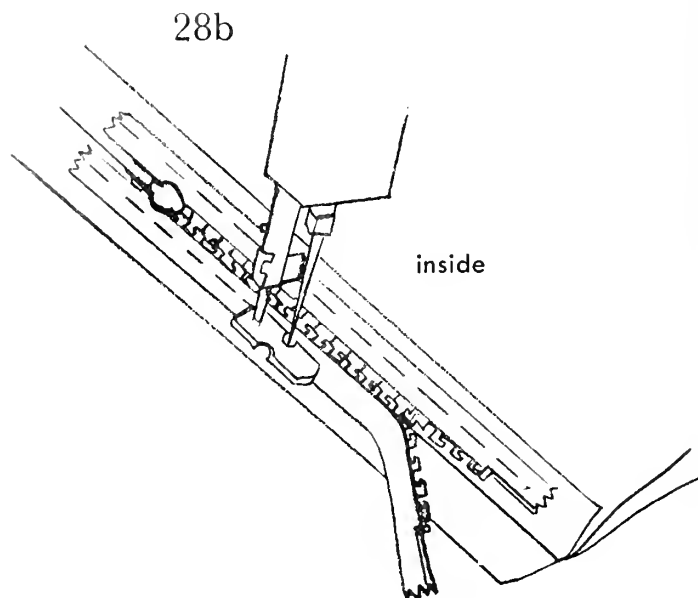
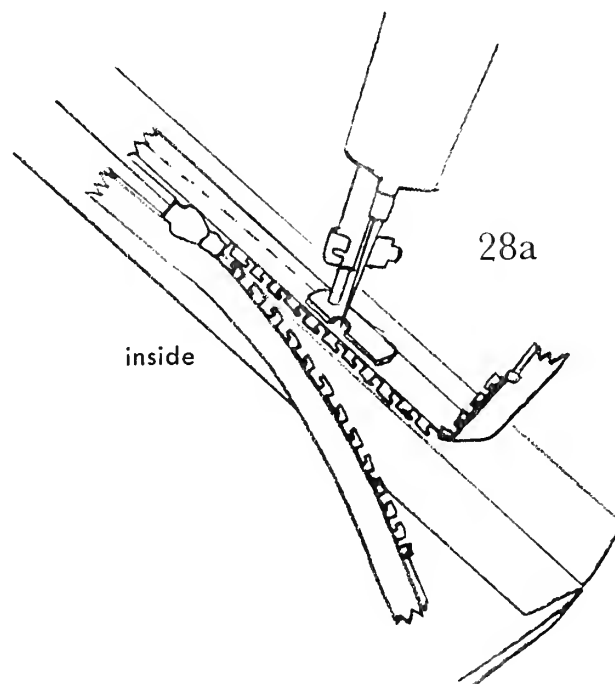

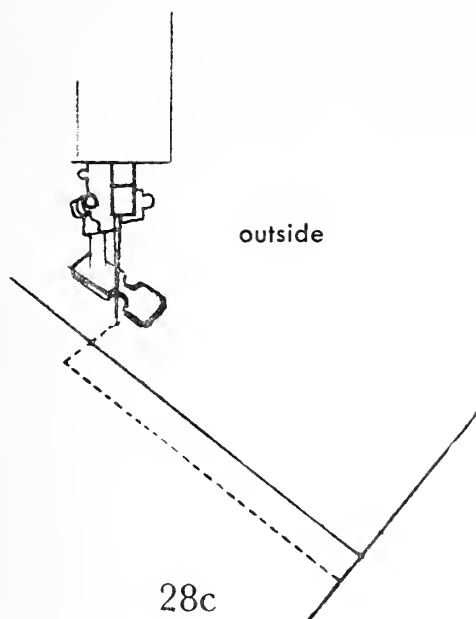

stitch through the tape, seam allowance, and garment along one side of the zipper to the top. To stitch the other side, adjust the zipper foot to the other side of the needle; stitch across the bottom, pivot, and stitch up the other side (Fig. 28c).

As you sew the second row of stitching, push the garment slightly toward the seamline to ease the fabric across the zipper and prevent the opening from widening when the basting is removed.

Remove the basting and press on the inside of the garment with a press cloth. Use a steam iron to touch up the right side if necessary.

Hand-applied zippers

The partially and completely hand-sewn methods of applying zippers are frequently used when fabrics require careful handling, when a visible line of machine-stitching is not wanted, or when it is impossible to suitably match thread color with the fabric.

partially hand-sewn

With this method, the first steps are the same as those in the lapped or centered machine methods; only the stitching visible on the outside of the garment is done by hand. For the step in which machine-stitching shows as topstitching, substitute the hand backstitch.

To backstitch, pull the needle through the zipper tape and the fabric, then place the needle in the fabric 1 or 2 threads back from where it came out and take a small stitch through the fabric and tape (Fig. 29). Continue this stitch for the entire seam. Spacing of the stitching should be planned according to the thickness and texture of the fabric with which you are working.

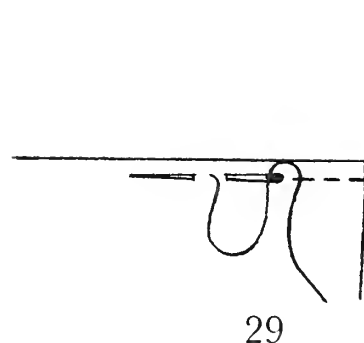

completely hand-sewn

The same steps are followed as for regular machine method of applying a lapped or center zipper, except that all stitching is done by hand.

Hidden zippers

This type of zipper is sewn into a completely open seam. The seam below the placket area is not sewn and the placket area is not basted shut as in other methods. No topstitching shows. The zipper is sewn to the right side of the fabric along the seamline and is machine-stitched from top to bottom.

This method requires a special presser foot; special grooves allow the foot to ride on the zipper so that the stitching can be done close to the zipper teeth (Fig. 30a). With the open zipper face-down on one seam allowance,

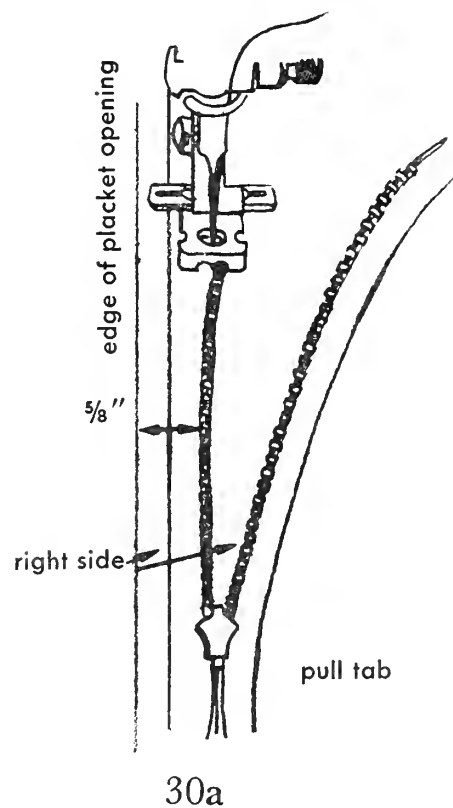

stitch on the seamline just to the top of the pull tab. Then, on the seamline, stitch the other side of the opened zipper to the other seam allowance (Fig. 30b). Close the zipper. Adjust the special presser foot to one side or use a regular zipper foot to stitch the garment seam below the placket area (Fig. 30c).

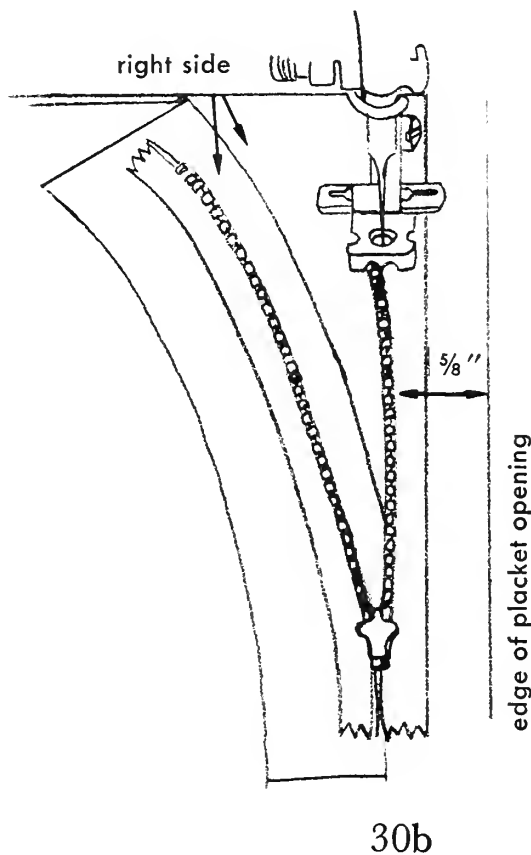

30b

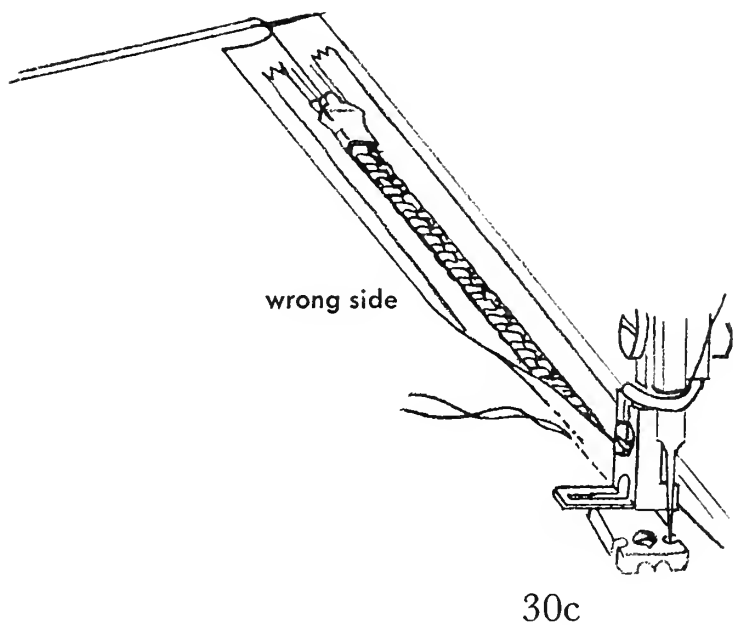

30c

ONE-PIECE SHAPED FACING

A one-piece fitted facing can be used to face the entire neck and armhole area of a collarless, sleeveless garment. There are several ways to apply this kind of facing. You may wish to follow your pattern, or you may want to study the three methods given here.

In method one, the shoulder seams of the garment and facing are left open; after the facing is turned, the shoulder seams are closed with machine and hand stitching. In method two, all stitching is machine stitching; this method makes it a little more difficult to handle the garment pieces but, when done well, gives a beautifully finished armhole. Method three can be used when there is a seamline at the center back or center front of the garment.

method one

Join the garment front and back pieces at the side seams; press the seams open. Join the facing front and back pieces at the side seams; press the seams open. Leave the garment and facing shoulder seams open at this stage.

To keep the facing from showing on the right side of the finished garment, make the seams turn under slightly. With the right sides of the garment and facing together, pin the neckline and armhole edges of the garment $\frac{1}{8}$ " inside the edges of the facing (Fig. 31). On the seamline of the facing, stitch around the neckline and armholes to $\frac{5}{8}$ " from the shoulder edges. The seam allowance of the garment piece will be $\frac{1}{2}$ " wide. Grade and clip the seam allowances (Fig. 32).

Turn the facing to the inside and press flat. The seamline will now be slightly to the inside of the garment, preventing the facing from rolling to the outside. If desired, understitch (see page 3) around the neckline and armholes to keep the facing firmly inside.

Fold the facing seam allowances back and stitch the garment shoulder seams; trim and press the seams open (Fig. 33a). Turn in the facing seam allowances and

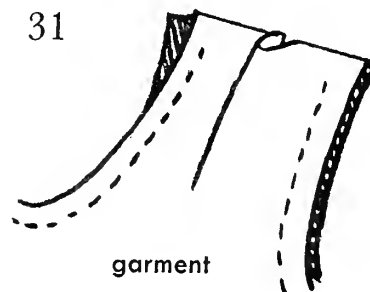

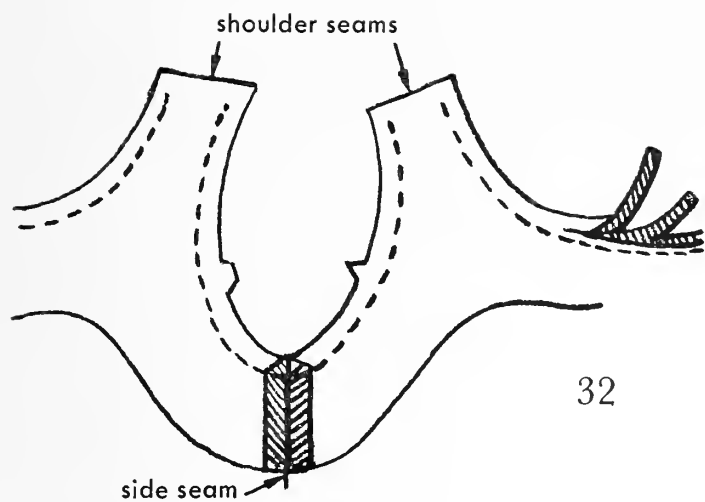

32

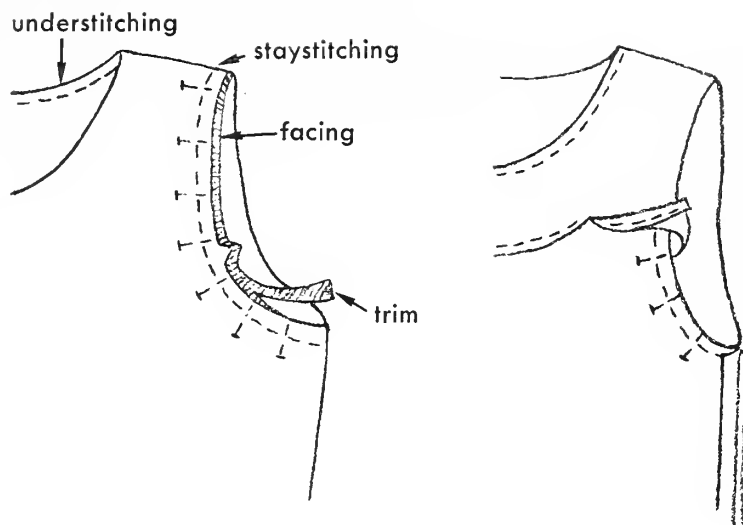

34a

34b

Turn the garment wrong side out. With the wrong side of the back toward you, turn the underarm area of the facing to the right side of the bodice, rolling the facing back as you go. Stitch (Fig. 34b); press. Trim and grade the seam allowances. Turn the facing to the wrong side of the garment. Understitch.

Repeat the procedure for the front side of the armhole from underarm seam to the shoulder seam.

Give the garment a final press around the neckline and armholes.

method three

Join the front and back garment pieces at the shoulder seams; press. Join the front and back facing pieces at the shoulder seams; trim the seam allowances and press. Place the right sides of the garment and facing together (Fig. 35), matching shoulder seams, notches,

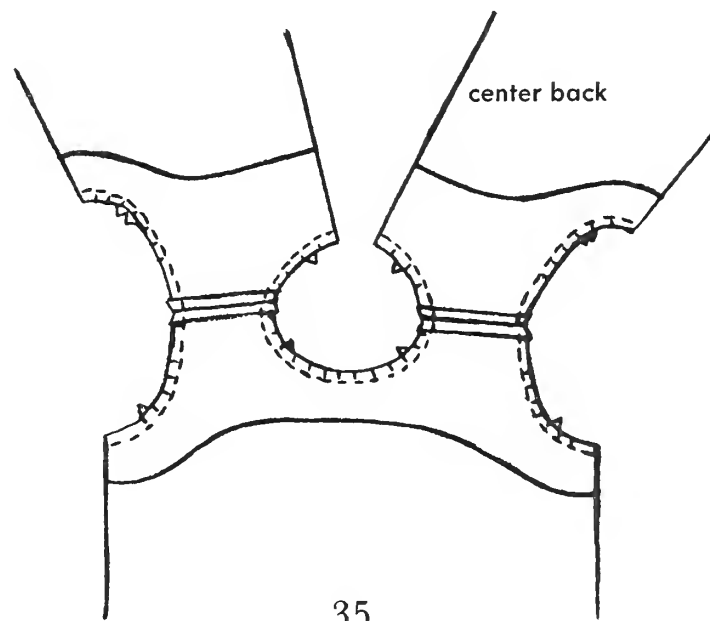

35

slip-stitch them together (Fig. 33b). Trim them first if the fabric is bulky.

method two

Join the front and back garment pieces at the shoulder seam and underarm seams. Repeat for front and back facing pieces. Press seams open. To reduce bulkiness, trim the shoulder seam allowances of the facing about $\frac{1}{8}$ " narrower than the garment shoulder seams. About every half inch clip seam allowances to within $\frac{1}{8}$ " of the neckline seam of both garment and facing.

Place the right sides of the garment and facing pieces together at the neckline, matching notches, shoulder seams, center front, and center back. Stitch the facing to the garment at the neckline seam; press seam open. Trim by layering or grading, leaving the wider seam allowance on the garment side. Turn the facing to the inside of the garment and understitch.

With the garment right side out, pin the facing to the garment around the armholes at the seamline and trim away any excess facing that extends beyond the armhole edge of the garment (Fig. 34a). Remove pins.

and open edges of the center back or front. Stitch the facing to the blouse at the neckline and armholes. Trim and clip seam allowances.

Insert your hand between the facing and the blouse. Do this from the front if the center back is open or from the back if the center front is open. Pull each side of the back (or front) through the shoulder openings (Fig. 36). Press and stay-stitch where possible.

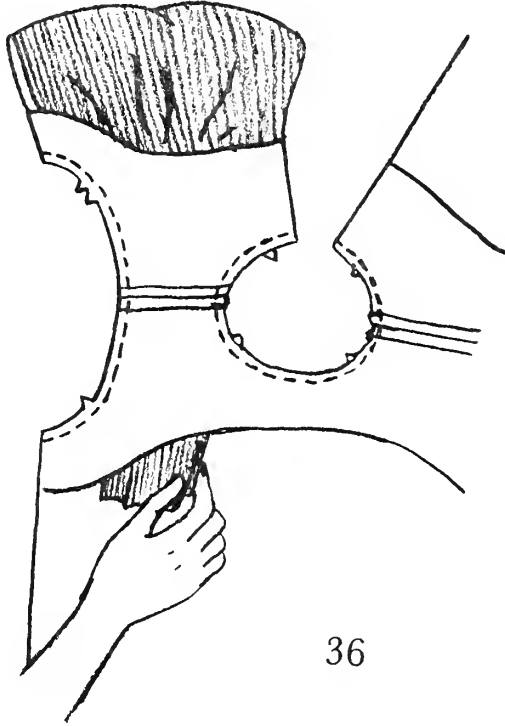

36

Finish the center back or front opening with a zipper or other method indicated by the pattern design. Stitch the side seams through the facing and garment in one continuous line of stitching. The facing should be free of the garment, not turned to the garment (Fig. 37). Press the seams open and press the facing into place.

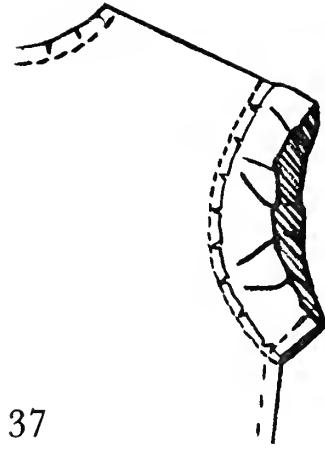

37

join facing to side seams

Whichever method is used to attach the one-piece facing, the underarm seams of the facing will need to be fastened to the side seams of the garment. Either hand bar tacking (see page 2) or machine-stitching in the seamline through both facing and garment will do this nicely (Fig. 38).

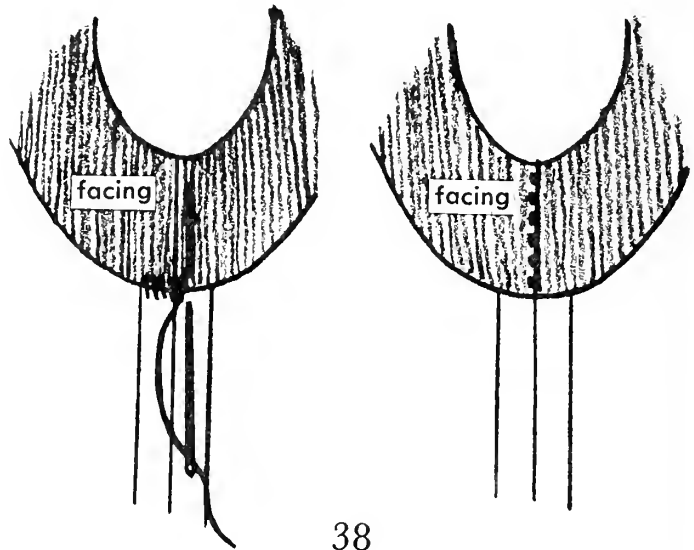

38

ATTACHED COLLARS

Attached collars are classified according to the shape of the *neckline* edge of the collar pattern — flat, rolled, and standing (Fig. 39). The shape of the *outer* edge determines the design of the collar, such as round collars (Peter Pan) and middy or sailor collars. Follow the directions for the appropriate *neckline* edge of your garment.

39

neckline of figure

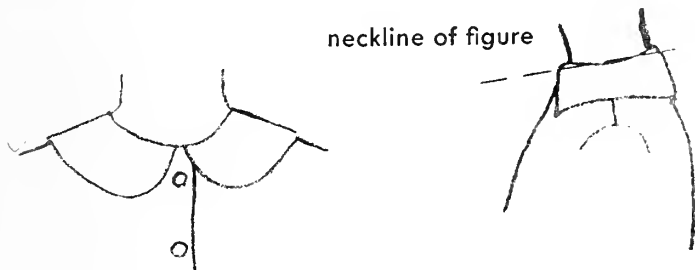

flat collar

neckline of figure

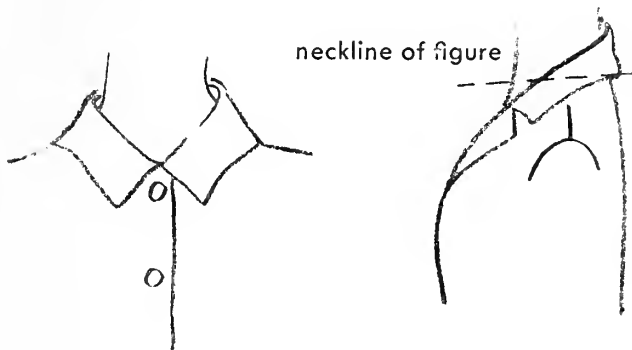

rolled collar

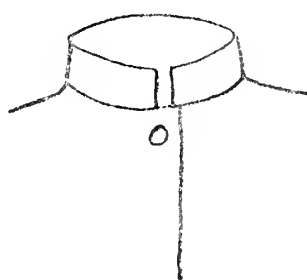

standing collar

Flat collars

A flat collar lies flat on the wearer. The neckline edge of the collar is nearly identical to the neck edge of the garment, and both the upper and under pieces of the collar are cut from the same pattern piece. Make and apply a flat collar as follows:

1. *Apply the interfacing.* Cut the interfacing as directed in the pattern instructions; usually the collar pattern piece is used. If the collar has points, clip the corners of the interfacing to inside the seam allowance of the collar at the corners. Machine-baste the interfacing to the under collar $\frac{1}{2}$ " from the outer edges (Fig. 40a).

2. *Make the collar.* Pin together the upper collar and the under collar with interfacing attached. Stitch across the ends and around the outer edge on the seam line; do not stitch the neck edge.

Trim the interfacing seam allowance to $\frac{1}{8}$ " (Fig. 40b). Press the seam open and trim the seams by grading or "feathering" the seam allowance (see page 2). Leave the widest seam allowance on the upper collar (Fig. 40c).

If the collar is round, cut out wedges in the seam allowance to eliminate bulk in the seam (Fig. 40d).

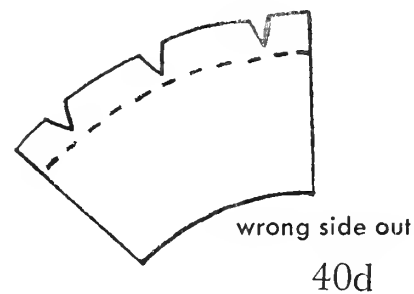
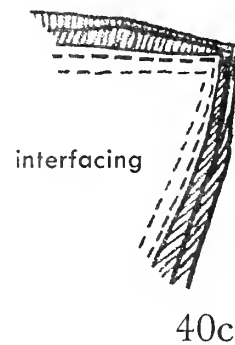
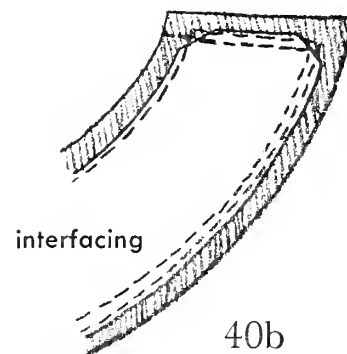
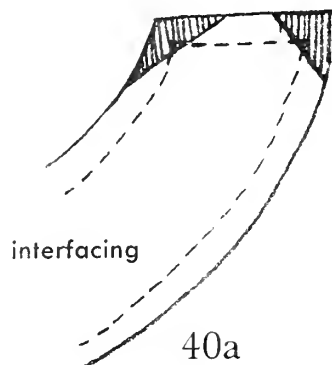

Turn the collar right side out and press. The seamline on the ends and on the outer edge should be slightly to the underside of the collar. Understitching (see page 3) around the outer edge will help hold the under collar in place. Machine-baste the neckline edges together; clip the neck seam allowance to $\frac{1}{8}$ " from the seamline at about every half inch.

3. *Attach the collar to the bodice.* Clip the neck edge of the garment to $\frac{1}{8}$ " from the seamline at about every half inch. Pin the collar to the right side of the garment, matching center front, center back, shoulder seams, and notches. The edges of the collar should not extend beyond the center of the garment but must meet at the center front or center back opening.

Baste the collar to the garment by pulling the neck edge seamline into a straight line and stitching together.

4. *Apply a shaped facing.* A shaped or fitted facing is the easiest kind of finish for a collar and is often used by pattern companies. Stay-stitch the neck edges of the front and back facing pieces, then join them at the shoulder seams. Finish the outer edge of the facing with a suitable method — pinking, slip-stitching, binding, etc. — depending on how likely the fabric is to ravel. Clip the neck seam allowance to $\frac{1}{8}$ " from the seamline at about every half inch.

Place the facing (right sides together) against the collar, which has already been basted to the garment; match shoulder seams, notches, center front, and center back. Stitch the facing in place, press, and grade the seam allowances. Understitching can help hold the facing in position.

5. *Finish the neckline.* Slip-stitch the ends of the facing to the zipper tape near the teeth of the zipper. Sew a hook and eye at the top of the zipper.

Rolled collars

When a collar rolls or folds away from the neckline, the interfacing (if any) will "travel" further than the under collar, and the upper collar will have to go further than either the interfacing or the lower collar (Fig. 41a). If some allowance is not made for this roll, the under collar may show at the outer seam edge. The following method, which can be used on any style of rolled collar, makes a collar with edges that turn under instead of up.

1. *Attach the interfacing.* Stay-stitch the interfacing to the under collar on the seamline at the neck edge. Roll the interfacing and under collar over your hand as they will be when the garment is worn. Now, pin together the interfacing and the under collar near the outer edges — the outer edge of the under collar will extend beyond the edge of the interfacing (Fig. 41b). Stitch the two pieces together on the under collar seam-

line (place the outer edge of the under collar next to your seam guide); this means the interfacing seam allowance will be less than $\frac{5}{8}$ ".

2. *Roll the upper collar.* With wrong sides together, pin the upper collar to the under collar with the interfacing at the neckline edge. Roll the upper collar over the under collar by hand until the pieces are positioned as they will be in the finished garment; pin together at the outer edges (Fig. 41c). If your pattern did not allow for enough roll in the upper collar, the under collar and the interfacing will extend beyond the upper collar. At this point an experienced seamstress can trim the three layers (upper collar, interfacing, and under collar) so that the outer edges are even. If you prefer, however, you may wish to proceed as in step 3.

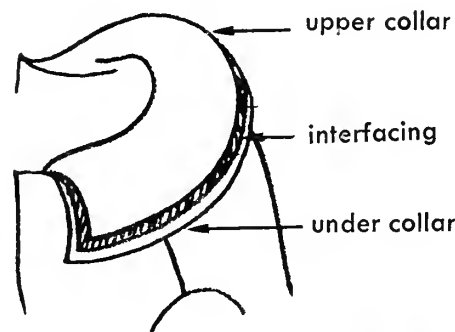

41a

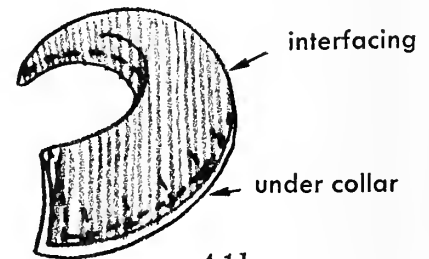

41b

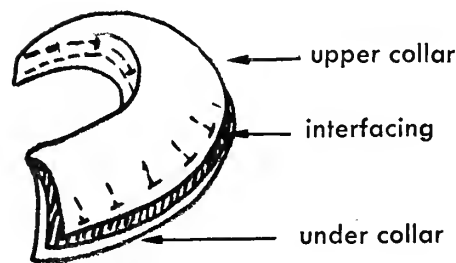

41c

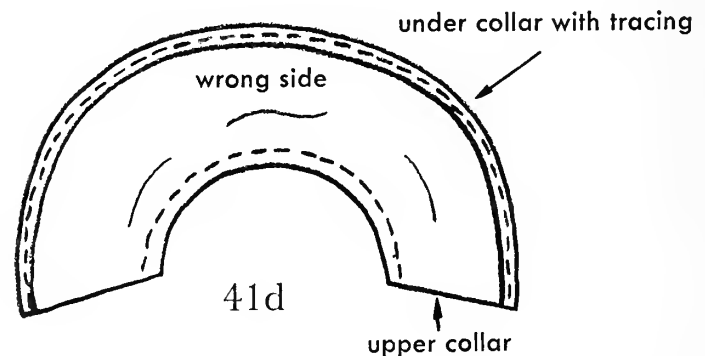

41d

3. *Mark the upper collar.* Place tracing paper right side up on a smooth surface. Put the right side of the under collar on the tracing paper and use a tracing wheel to trace along the outer edge of the upper collar. Remove the pins. Place the outer edge of the upper collar against the traced line on the under collar (Fig. 41d) and stitch the collar pieces together.

4. *Attach the collar to the bodice.* After the roll of the collar has been established, follow your pattern instructions or steps 3, 4, and 5 in the flat collar method.

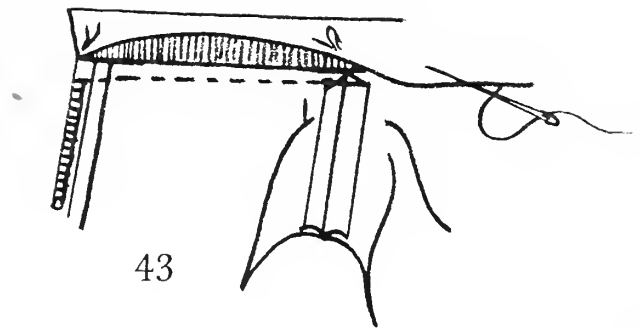

Standing collars

This kind of collar is often called a mandarin collar. It can be made as follows:

1. *Apply the interfacing.* A standing collar will curve around the neck better if a bias-cut interfacing is used; if more stiffness is desired, however, you can use a nonwoven interfacing. Cut the interfacing according to the collar pattern but without seam allowances. Catch-stitch (see page 2) the interfacing to the side of the collar that will be worn away from the neck (Fig. 42).

2. *Make the collar.* If the collar is cut in one piece to be folded through the center, fold wrong sides together and stitch across the ends. Press and trim the seams. Turn the collar right side out; if you plan to finish it with a shaped facing, baste the neck edges together.

If the collar is cut in two pieces, pin the right sides of the two pieces together and sew across the ends and the outer edge. Press the seam open, trim, and turn collar right side out. Baste the neck edges together if you plan to finish with a shaped facing.

3. *Attach the collar.* Finish with a shaped facing as on page 18, or, if there is no facing, proceed as follows.

Insert the zipper or prepare a buttonhole closure with the facings turned in place; the collar will finish the neckline from one edge of the opening to the other. Pin and stitch the right side of the interfaced half of the collar to the right side of the garment neckline, matching centers of front and back, shoulder seams, and notches. Trim and grade the seams (see page 2), leaving the garment seam allowance wider than the collar seam allowance. Press the seam toward the collar. Turn under the seam allowance of the remaining edge of the collar and slip-stitch to the wrong side of the garment (Fig. 43).

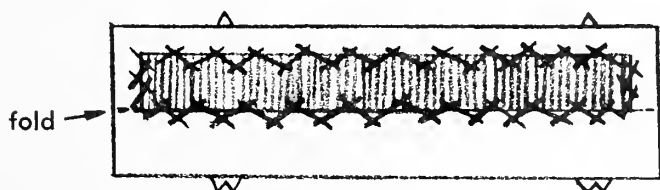

42

Other collars

The *shawl collar* (Fig. 44a) is designed to be part of the garment front. Its outer edge may be notched, curved, or scalloped. Follow your pattern instructions, being especially careful to stitch accurately on the seamlines and to clip exactly where indicated.

The *bias turnover collar*, sometimes called a *turtle neck*, is a one-piece standing collar made wide enough to fold over and cover the neckline seam (Fig. 44b). When woven fabrics are used, this collar is cut on the bias; when knit fabrics are used, however, their stretchability makes this unnecessary. Attach a bias turnover collar the same way as a standing collar.

A *tie collar* is actually a standing or turnover collar that has been cut long enough to permit tying the ends into a bow or knot (Fig. 44c). Attach it to the bodice like a standing collar.

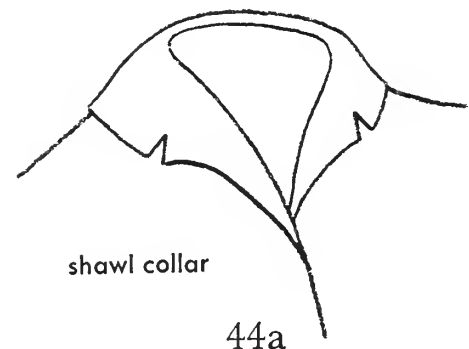

shawl collar

44a



bias turnover collar

44b



tie collar

44c

SLEEVES

Sleeves are a crucial part of a garment because they are so important to its appearance and comfort. Of the many styles of sleeves possible, the currently popular set-in sleeves, kimono sleeves, and raglan sleeves are discussed here.

Set-in sleeves

A sleeve that is to be set into a garment (Fig. 45) is always cut fuller than the armhole so that it can be shaped over the top of the arm and thus have enough ease for a comfortable fit. It takes skill to ease and shape the sleeve into place without getting a gathered look. Read both methods for shaping sleeves given below, then decide which one is best suited to the fabric you are using and your proficiency as a seamstress.



method one: one or two rows of gathering

With the right side of the sleeve facing you, sew along the seamline of the cap of the sleeve as follows. With the regular machine-stitch length, sew from the sleeve edge to the first notch. Using longer stitches, sew around the top of the sleeve cap to the second notch. Return to the regular stitch length and stitch to the other sleeve edge (Fig. 46a). If you find it easier to distribute the fullness with two rows of stitching instead of one, make a second row in the seam allowance about $\frac{1}{4}$ " from the seamline.

Clip the bobbin thread at one or both notches and pull the thread to ease in fullness evenly. Most of the fullness will be eased above the notches on each side, where the sleeve most nearly runs on the true bias (Fig. 46b). There should, however, be no gathering or puckering for about one inch at the very top of the sleeve.

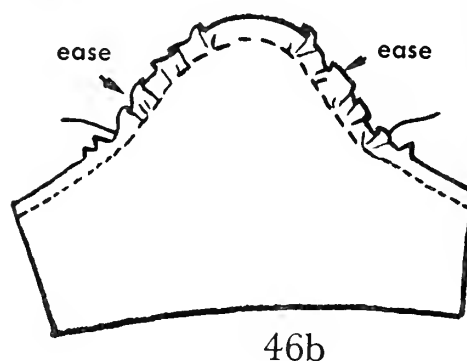
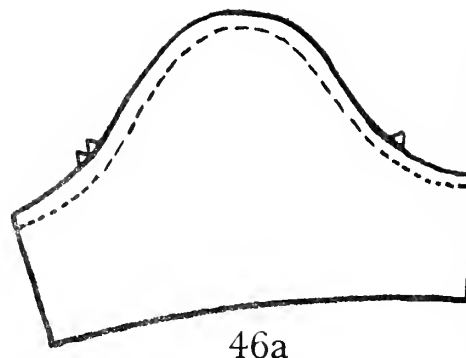

method two: off-grain stitching

This method is especially good with crease-resistant and wash-and-wear fabrics. Use tracing paper on the wrong side of the fabric to mark the seamline around the sleeve cap. With the regular machine stitch length, staystitch the sleeve from the seam edges to the notches. Stitch *off-grain* around the cap of the sleeve (between the notches).

To stitch off-grain, place your index fingers opposite each other in front of the needle and at each side of the presser foot (Fig. 47a). Pull the fabric off-grain and take 4 or 5 stitches where the fabric is pulled. Stop the machine, then pull and stitch the next short area. Continue around the sleeve cap (Fig. 47b). If the fullness is not quite evenly distributed, clip stitches to release excess fullness, or restitch where more ease is needed.

applying the sleeve

Whichever method you use to ease fullness, check the fit by pinning the sleeve into the armhole. Always be sure to ease evenly. With some fabrics, particularly wool, you can shrink out the excess fullness in the sleeve's seam allowance. First pin the sleeve in position and adjust ease. Remove the sleeve from the garment and put the sleeve top over the end of a sleeve board. Do not let the cap extend more than $\frac{3}{4}$ " over the board. Use a steam iron to ease out the fullness at the seamline and in the seam allowance (Fig. 48).

After the sleeve has been fitted to the armhole, unpin it from the bodice and proceed as follows:

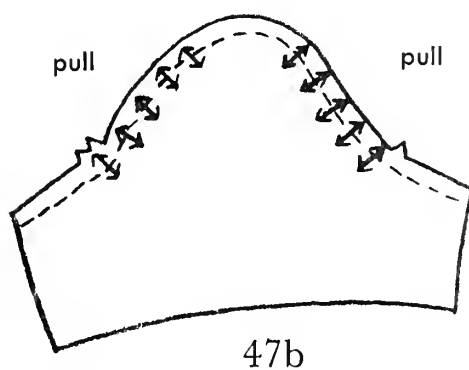
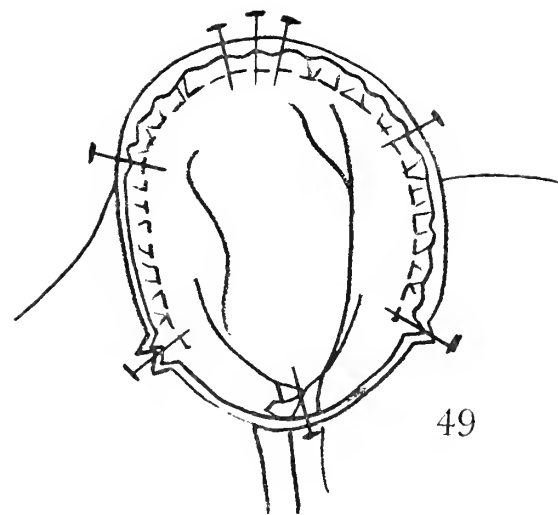
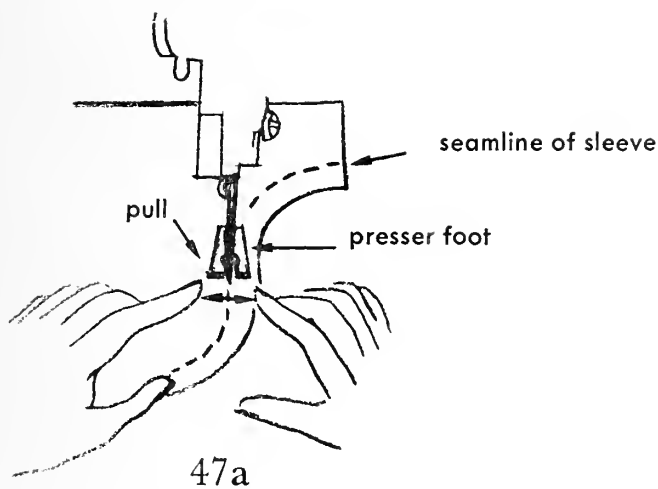

Complete the sleeve. Sew the sleeve seam. Press and finish the seam if necessary. Unless the length of the sleeve is not yet determined (if it must be marked and hemmed), go ahead and finish the lower edge of the sleeve.

Set the sleeve. Turn the bodice wrong side out. Place the sleeve in the armhole, with right sides of the blouse and sleeve together. Pin together, matching underarm seams, shoulder seams, notches, and other markings (Fig. 49). Place more pins between the pins you just used, using as many as necessary to hold the ease in place for stitching.

Stitch the sleeve. Place the garment under your machine needle, sleeve side up. Beginning at one of the notches, stitch toward the underarm seam and continue

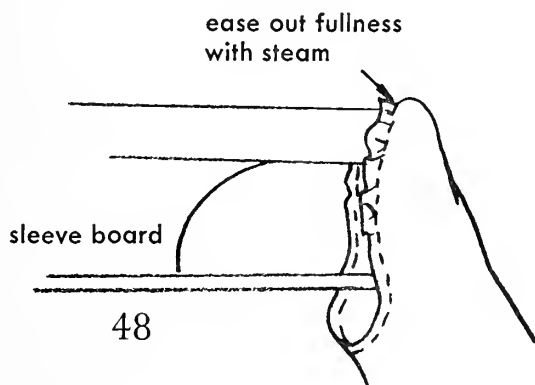

around the armhole. For extra strength, restitch the seam between notches in the underarm area.

Finish the sleeve. With fabrics that are not transparent, you may wish to stitch a second time around the armhole, $\frac{1}{8}$ " to $\frac{1}{4}$ " outside the seamline (in the seam allowance). Trim the seam to $\frac{3}{8}$ " wide, thereby reducing underarm bulkiness.

Press. A soft roll at the armhole is more attractive than a flat seamline. Place your garment wrong side out on the ironing board and press lightly along the seam on the sleeve side. To avoid flattening the sleeve cap, press into it no deeper than $\frac{3}{8}$ " to $\frac{5}{8}$ ".

standards for a well-made set-in sleeve

After you have completed both sleeves on the garment, check your work against the following standards:

Each sleeve should have a smooth, rounded cap with no pleats or gathers unless they are called for in the pattern; if gathers are used, they should be evenly distributed.

There should be ease in the underarm area as well as the sleeve cap area.

Each sleeve should have a good armhole line; that is, the armhole curve should be stitched exactly on the seamline, and the seams of the garment and sleeve should match at the underarm.

The grain of the garment and sleeves should be correct: the crosswise grain should be parallel with the floor, and the lengthwise grain should be perpendicular to the floor.

Elbow darts should be located correctly. If there are three darts, the center one should be in line with the elbow; if two, there should be one on each side of the elbow.

The lower edge of the sleeve should be neatly and appropriately finished with hem, cuff, or facing.

Kimono and raglan sleeves

A kimono sleeve is cut in one piece with the bodice (Fig. 50a). Before cutting a garment with kimono sleeves, be sure the pattern fits, especially in two key areas. Check the shoulder length from the base of the neck where the arm joins the body: a kimono sleeve should follow the slope of the shoulder and the curve of the arm so that the garment has no "hump" over the shoulder. Also, check the ease allowance across the shoulder blades, front chest, and bust: there must be adequate ease for comfort where a normal armhole would be located, but no bagginess. Some vertical wrinkling is natural for the design — the sleeves must be full enough for the wearer to comfortably lift her arms.

Raglan sleeves (Fig. 50b) are similar to kimono sleeves but have seams running from the neckline to the underarm area on the bodice front and back. Check the fit of raglan sleeve patterns in the same areas as kimono sleeves.

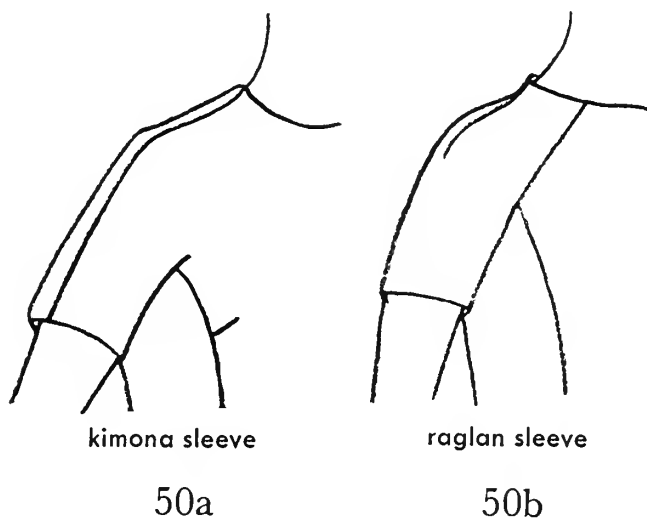

reinforcing the underarm seam

The underarm seam of a kimono or raglan sleeve is always a weak construction area. To keep this seam from tearing out, reinforce it with *one* of the following methods:

1. Stitch the underarm seam, stretching it slightly as you stitch. Stitch again on exactly the same stitching just completed. Clip the seam allowance and press the seam open (Fig. 51a).

2. Stitch the underarm seam, stretching it slightly as you stitch. Clip the seam allowance and press the seam open. Topstitch close to the seamline on each side of the seam, through both the seam allowance and the garment (Fig. 51b).

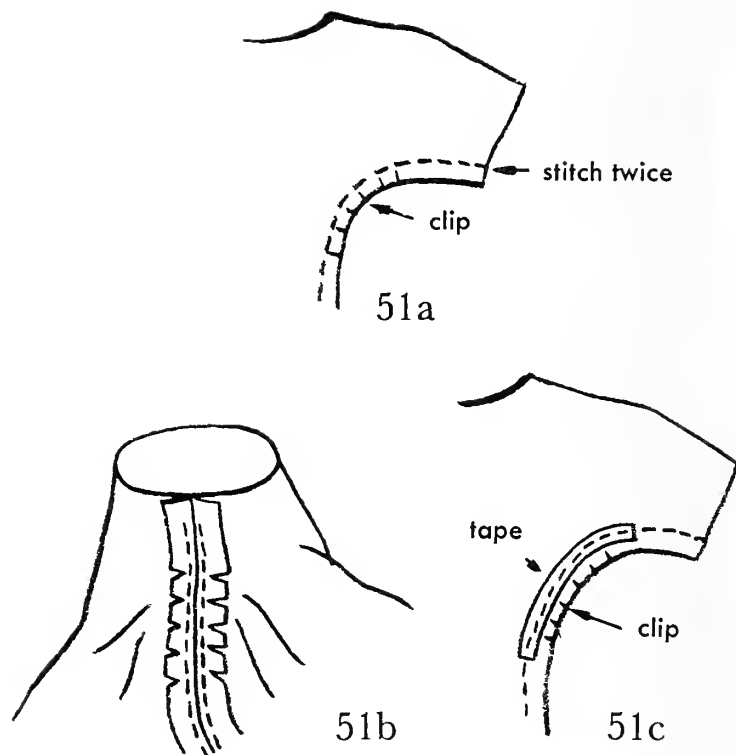

3. Baste the underarm seam. Place a piece of straight tape (not bias tape) so that it is centered on the seamline. Stitch the seam through the tape and the garment. Clip the seam allowance — but not the tape — and press the seam open (Fig. 51c).

Whichever method you use, finish the seam edges according to the kind of fabric used. If the fabric frays badly, for example, the edges of the slashes may need to be overcast or machine-stitched.

Putting in a gusset

A gusset gives additional length to the underarm area of a garment so that the arm may be raised more comfortably. It also allows for a more closely fitted sleeve, which eliminates some of the underarm fullness that is characteristic of a kimono sleeve. Occasionally, a gusset is used in combination with a set-in sleeve.

For all gussets, whether diamond-shaped or triangular (half-diamond), you must slash the bodice to a point. This point is a very weak spot in the garment and must be reinforced before you insert the gusset. To reinforce the point, use *either* of the following methods:

1. After stitching the seamline, adjust the sewing machine for a short stitch (15 per inch) and stay-stitch on the seamline. Make one stitch across the point to help separate the two lines of stitching (Fig. 52).

2. Place a rectangular piece of firmly woven fabric in the area of the point of the slash, on the right side of

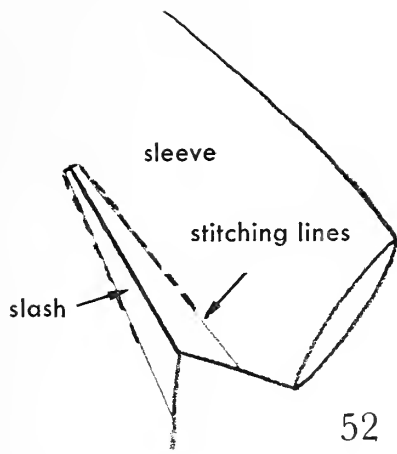

the fabric. Stitch it in place with stay-stitching. After you slash the bodice, pull the fabric to the wrong side. *Note:* Seam tape, press-on tape, or bar tacks may also be used to reinforce the point before you slash.

Cut the gusset and slash the bodice according to your pattern. The gusset is then usually inserted by one of two methods, both of which are given here:

method one: join the seams of the gusset and the garment

Place right sides of gusset and garment together, matching seamlines, notches, and corners. The seam allowance of the gusset will be even on all sides. The seam allowance of the garment will taper off at the reinforced points (Fig. 53), so take care to match the seamlines accurately.

Stitch each side separately, backstitching at each end or point. Be sure all markings are carefully matched. Or, stitch in one continuous row of stitching, pivoting the fabric (with needle down) at each point. Press the seam allowance of the gusset flat; the seam allowances of the garment will be against the garment.

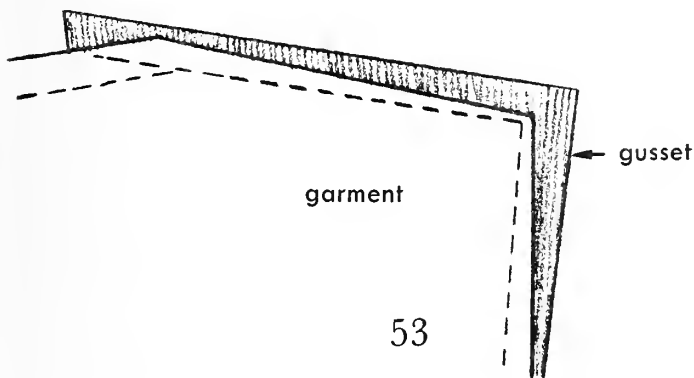

method two: overlap and topstitch

Turn under the seam allowance of the bodice around the opening for the gusset. Press. With the right sides of the garment and gusset facing you, lap the gusset opening in the garment over the gusset piece, matching seams, notches, and points. Pin or baste. Topstitch the garment to the gusset, stitching close to the edge of the opening in the garment. The finished construction is shown below in Figures 54a and 54b.

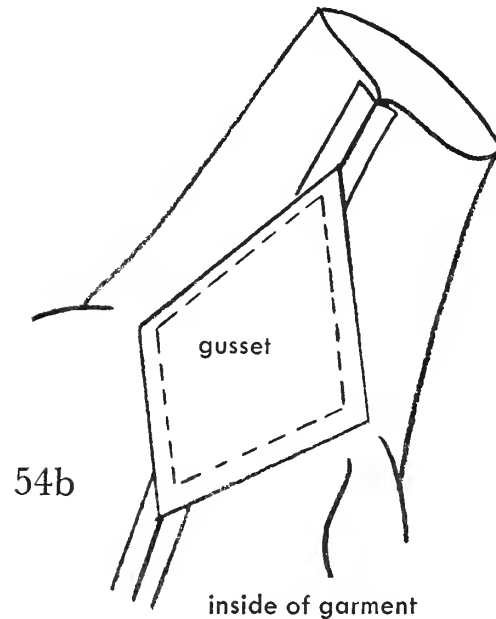
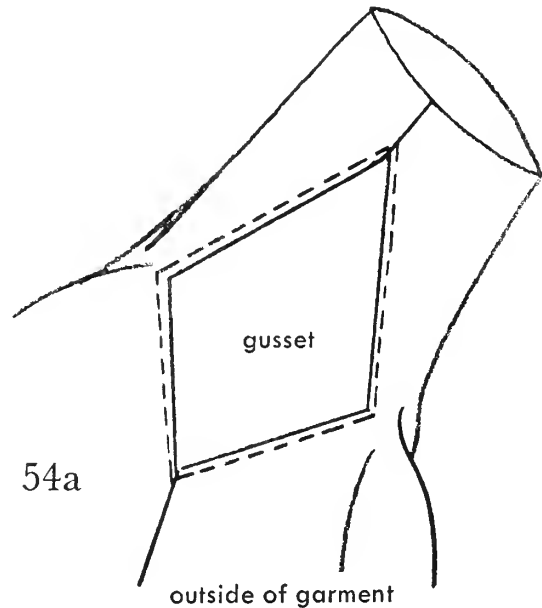

BUTTONS, BUTTONHOLES, AND LOOPS

Selecting the “just right” button for each particular fabric and silhouette is a very important but not always easy decision to make. To help make your selection, keep the following points in mind.

Shop with a large swatch of fabric. This helps eliminate mistakes in color, texture, style, and weight, since with a large enough piece of fabric you can see the button in relationship to the area of fabric on which it will be worn.

Consider the weight of fabric. Heavyweight fabrics can support heavyweight buttons, but lightweight fabrics require lightweight buttons. Sometimes, however, the design or color of a lightweight button can give the impression of being heavy.

Pay attention to fabric designs. Solid buttons with little texture will be best for prints or stripes — the fabric itself is the center of interest, and the button should not be distracting. For tweeds, checks, and plaids a colored button in an accent color works best. For solid colored fabrics, the buttons can be either color-coordinated with the fabric or contrasted in color or texture to create exciting focal points. When in doubt, you can use metal almost anywhere.

Consider the style of the garment. A simple button is usually best on a garment that requires many buttons; for an uncomplicated design in a solid fabric, however, an unusual shape or design of button can add interest to the garment. Ball or half-ball buttons are appropriate for designs that use loop closures. For a double-breasted garment with two rows of buttons, use a button without a shank or with only a small shank for the row of buttons that is purely decorative; these buttons will lie flat against the fabric and not droop.

sewing on a button

Buttons should be sewn securely but not tightly against the garment. Thread a needle with about 15 inches of heavy-duty thread or doubled regular thread. Insert the needle into the fabric where the center of the button will be, then make two or three stitches to anchor the thread. Bring the needle through the hole in the button, then back through the button and fabric to the wrong side of the garment.

To make a shank, place a pin or small nail on top of the button under the first stitch (Fig. 55a); after five or six stitches have been made through the button to hold

it securely in place, remove the pin or nail and pull up on the button to adjust the threads evenly. Bring the needle to between the button and the garment and wind the thread tightly around the stitches several times to make the shank (Fig. 55b). Pull the needle back to the wrong side of the fabric and take three or four stitches, one on top of the other. The shank makes the button look better and wear longer, and the buttonhole will slip over the button more easily.

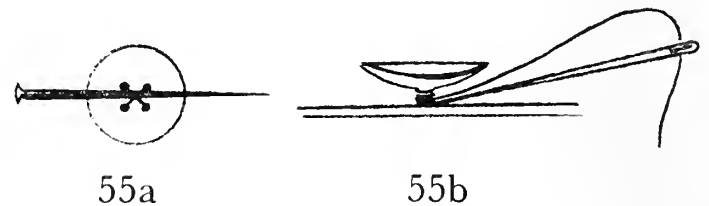

Buttonholes

Buttonholes should be sturdily constructed, evenly spaced on the garment, and identical to each other. In general, a buttonhole is as long as its button is wide and thick, but check the length by making a practice buttonhole. It should be just long enough to let the button slip through easily; if it is too long, the button is likely to come unfastened.

Use interfacing to strengthen the parts of the garment where the buttons and buttonholes will be. A straight strip of interfacing is sufficient, or you may wish to cut interfacing the shape of the facing piece if the collar is to be interfaced also. The type of fabric used for interfacing depends upon the weight of the garment fabric and the kind of care the garment will require (see pages 3 and 4).

Placement of buttonholes

Patterns usually show where to put buttons and buttonholes. On a woman's garment with a front closing, the right front laps over the left front; the *buttonholes*, therefore, go on the right front and the *buttons* on the left front. When the garment is buttoned, the buttons should be on the center front line of the garment (Fig. 56a). To insure this, both buttons and buttonholes must be correctly placed.

Mark the center front line on both right and left sides of the closure. The buttons will be centered on the line, but the buttonholes should have the ends nearest the edge of the lapover come a little past the center front (Fig. 56b). This is done because the buttons will pull to the end of the buttonhole nearest the lap; how far over they pull will depend upon the size of the button or the shank — about $\frac{1}{8}$ " past the center line is average.

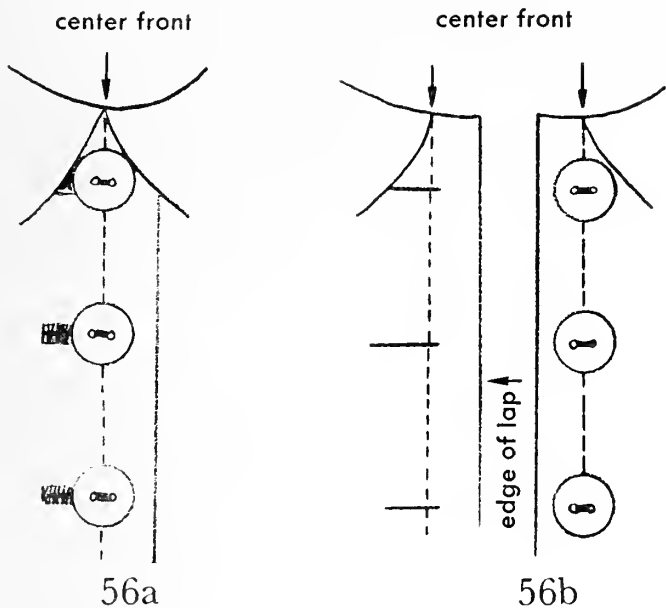

56a

56b

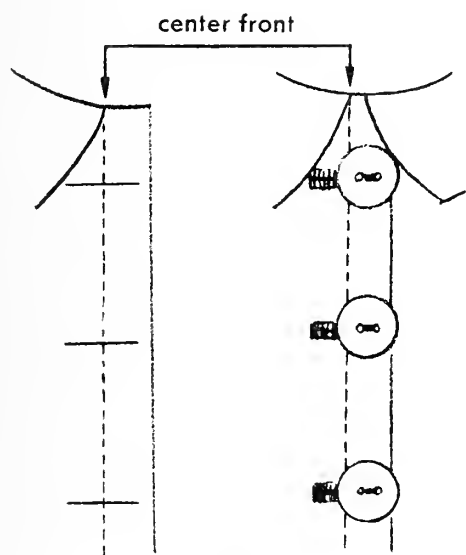

56c

If the buttonholes are placed too close to the edge of the lap, the buttons will come out past the edge of the lap when buttoned (Fig. 56c). Notice how the top button is nearer one edge of the collar than the other.

Measure the vertical spacing of the buttons with a ruler and sew them on. To position the buttonholes, measure again, this time with the material lapped over the buttons. This prevents puckers of fabric between the buttons when buttoned.

Machine-made buttonholes

Machine-made buttonholes are very good on cottons or other launderable fabrics. They are not hard to make, but it takes practice to have them turn out good-looking

and strong. Study carefully the directions that come with your buttonhole attachment or your automatic sewing machine. Practice on scraps of cloth until you are confident of your technique.

Mark the place for the buttonhole accurately on the garment. Determine how long it should be and adjust the sewing machine or attachment to make that length. The width of the stitch is usually called the *bight*. Set the bight adjuster so that the width of the stitch is the right size for the length of the buttonhole. A wide stitch can be used on long buttonholes and indeed should be used on heavy cloth.

Before you make a buttonhole in your garment, be sure to make a sample buttonhole on some leftover fabric from your garment *plus* the same kind of reinforcement (interfacing, etc.) you are using. If your sample buttonhole is not firm and good looking, readjust the attachment. Make more samples until you make a good buttonhole. *Then* make the buttonholes in your garment.

Stitch around the buttonhole twice to make it firm; use a narrower bight for the second stitching. Fasten the threads on the under side. Cut a single line from the center of the buttonhole to the stitching at both ends, being careful not to cut the stitching.

Hand-worked buttonholes

This type of buttonhole is often used in fine construction on lightweight fabrics. The two edges of the buttonhole should be the same length and straight with the grain. The stitches should be uniform (about 1/16" long) and close together. The end nearest the front edge, where there will be some pull, is fanned; the other end is usually finished with a bar tack.

Mark the position of the buttonhole on the right side, exactly on the grain. Machine-stitch a narrow rectangle 1/8" wide around the marked line, curving the outside end (Fig. 57a); the top and bottom will be 1/16" from the marked line. This stitching will keep the fabric from fraying and can be used to gauge how deep your hand stitches are. Cut the buttonhole, on the grain.

Using a single thread, begin work at the edge of the buttonhole farthest from center front. Fasten the thread with a knot. Hold the buttonhole slit so that the two edges won't spread open.

For the first stitch insert the needle into the slash and bring it up through the two layers of cloth exactly below the end of the slit, just below the machine-stitched line. With the needle still in the cloth, pass the strand of thread from the eye of the needle around the point of the

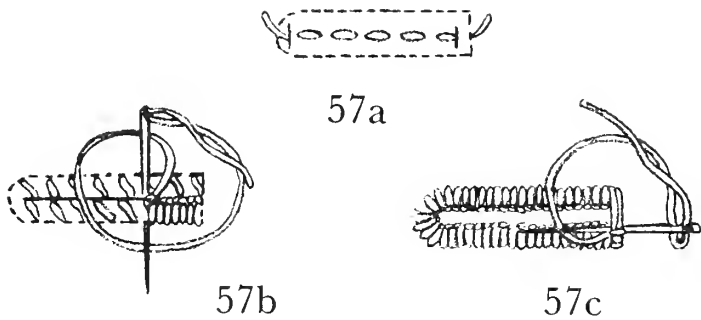

needle in the direction in which you are sewing (Fig. 57b). Pull the needle through the cloth and straight up from the edge of the slit. Hold the stitch in with your thumbnail just below the edge of the slash so that the purl or twist will be on the edge. Don't pull too tight. Repeat until coming to the fan end; there, radiate five to seven stitches around the end.

Continue until you reach the bar end. The last stitch should end exactly opposite the first one. Take two or three longer stitches across this end, one thread exactly on top of the other. Hold these longer threads in place with several small stitches to form a bar tack (Fig. 57c; see also page 2). Fasten the thread securely on the wrong side by running the needle under the completed stitches for about $\frac{1}{2}$ ".

Bound buttonholes

Bound buttonholes give a professional look to any garment. They should generally be used on "better" garments and with those that will be dry cleaned. As usual, the buttonholes should begin and end in line with each other and all should be the same width. In addition, both folds of the binding for bound buttonholes should be the same width and should meet in the center; corners should be square and firmly held.

To mark the buttonhole channel, machine baste the center front line on both front pieces after you have attached the interfacing. On the buttonhole side, baste a line parallel to the center line and $\frac{1}{8}$ " from it toward the front edge of the garment. After determining the length of the buttonholes, baste another line parallel to the first two and a buttonhole length from the second parallel line. Cross these parallel lines with buttonhole lines as illustrated in Figure 58. Use contrasting thread so that the position of the buttonholes is plainly marked. Be certain that all lines are stitched *on the grain line of the fabric and the interfacing*.

Now you are ready to make the bound part of the buttonhole by either the bias cord or the patch (window) method.

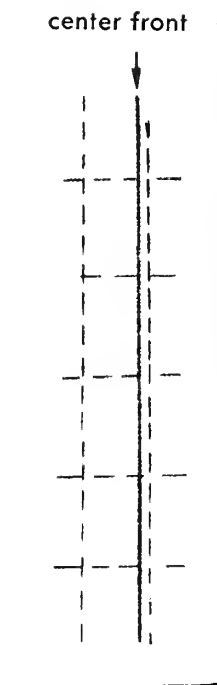

58

bias cord method

Cut bias strips of material $1\frac{1}{2}$ " wide and 4 times the length of all the buttonholes combined. Fold the strip in half along its length, wrong sides together, and stitch $\frac{1}{8}$ " from the folded edge (Fig. 59a); trim one side of the strip to $\frac{1}{8}$ " from the stitching (Fig. 59b).

Use a large darning needle or a tubing turner to thread yarn through the channel. Cut the strip into sections, each twice the length of the buttonhole.

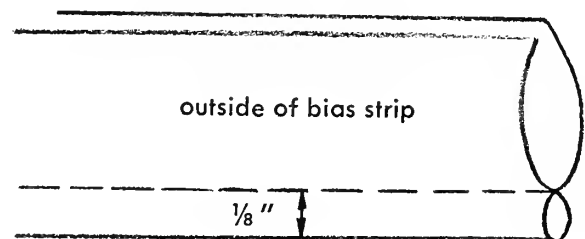

59a

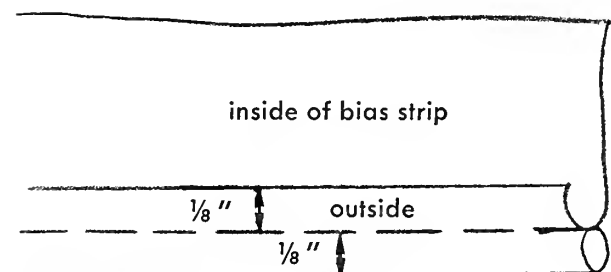

59b

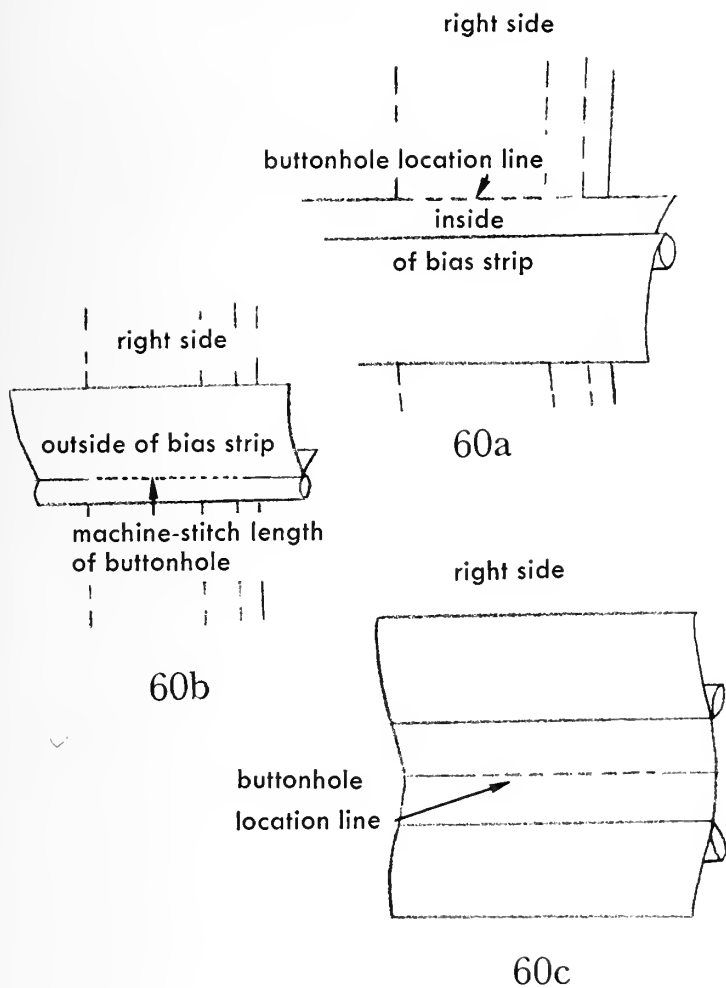

Place the cut edge of the strip on a location line on the right side of the garment (Fig. 60a). Put the wide edge of the strip over the cut edge, and with small stitches (about 20 per inch) stitch the marked length of the buttonhole right on the original cord stitching (Fig. 60b). Do not stitch past the marked length. Tightly secure the ends of the stitching. Repeat for the other side of the buttonhole with another section of bias strip (Fig. 60c).

On the wrong side, put the tip of your scissors through the center of the buttonhole location line and clip diagonally to each end of stitching. Make a deep V on each end (Fig. 61a). Be careful to clip *to* each corner but not *through* it; this is essential for square corners.

Turn the strips to the wrong side of the garment. Gently pull the ends of the strips to square the corners. Holding the garment away from the strips, machine-stitch back and forth over the triangle and strip at each end of the buttonhole (Fig. 61b).

When the buttonhole is finished, cut away excess fabric from the strips on the back side, leaving about a half inch of fabric all around.

patch or window method

This method is especially suitable for fabrics that ravel easily or are bulky. Interfacing may be applied to

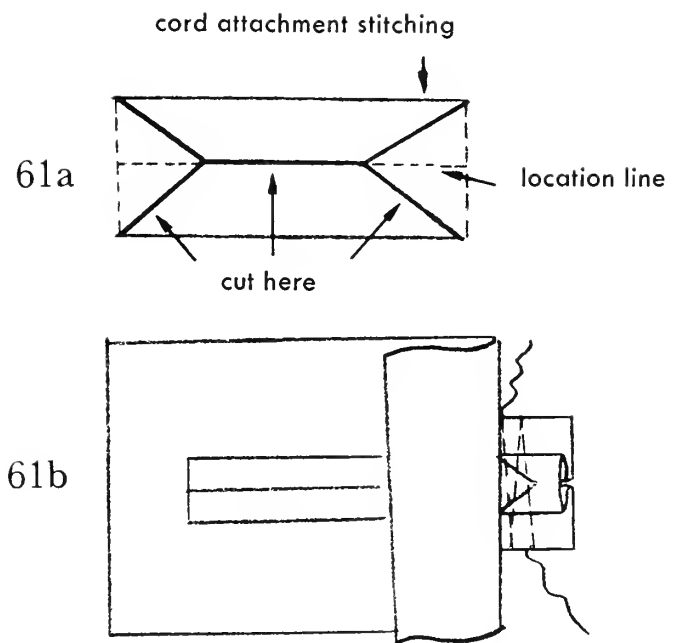

the buttonhole area of the garment before or after the buttonhole is made.

For the patch itself, use a crisp, sheer fabric such as organza. It should be cut 1" wider and 1" longer than the buttonhole. Center the patch over the buttonhole marking on the right side of the garment and pin. Emphasize faint markings with tailor's chalk.

Machine-stitch $\frac{1}{8}$ " from each side of the markings, using small stitches (about 20 per inch). Start at the middle of the marking and pivot at the corners, carefully counting the stitches at each end to be sure each line is the same length. Overlap stitches where you began. Slash, being careful not to cut the stitching, and leave ample tabs at the end (Fig. 62a).

Turn the patch through the slash to the wrong side of the garment and press the seam allowances away from the opening (Fig. 62b). You now have a neatly finished opening in your garment.

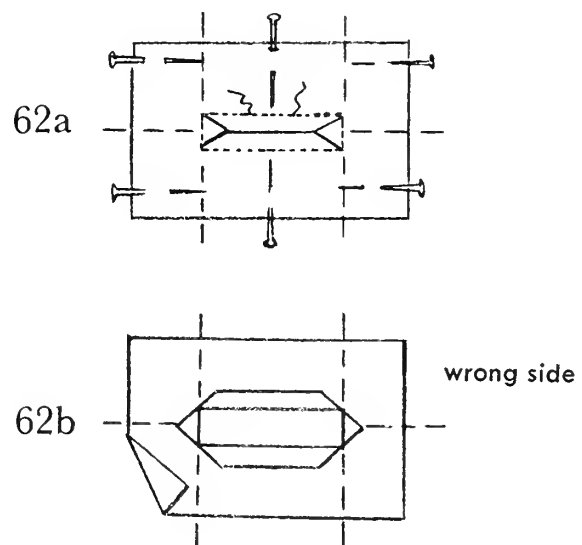

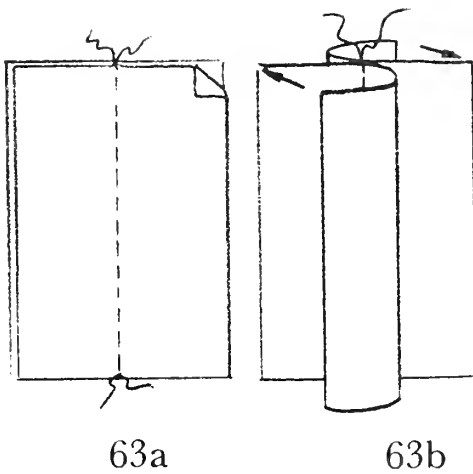

Cut two strips of your garment fabric $1\frac{1}{2}$ " longer and wider than the buttonhole. Baste the two strips right sides together along the center, forming a seam (Fig. 63a); press the seam open (Fig. 63b).

Working from the right side, place the strips on the wrong side of the buttonhole opening so that the basted seam is at the center of the opening; this forms the two even lips of the buttonhole. Pin the strips in place close to each end (Fig. 64).

Turn the garment to the wrong side. Pin the long seam allowances of the opening to the strips to hold the lips in place, then stitch on the garment (outside the buttonhole) alongside the previous stitching so that the organza does not show on the outside. Extend the stitching lines about $\frac{1}{2}$ " on both ends of the seam through the organza and strips (Fig. 65).

If desired, cord the buttonhole as described in the previous method. Secure the ends as shown in Figure 61b. Trim the excess fabric from the patch and strips, and press.

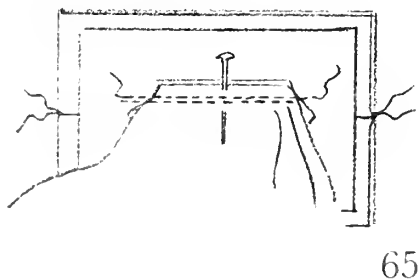
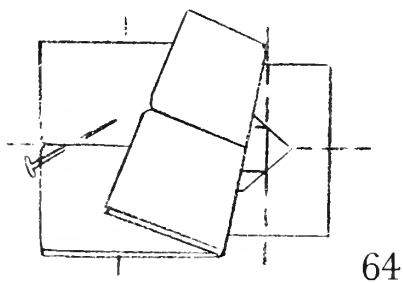

finishing the facing behind the buttonhole

Making bound buttonholes requires you to finish the back of the buttonholes in the facing. You can do this in one of two ways:

1. Slit the garment facing exactly behind the buttonhole. Fold the cut edges under and slip-stitch them into position around the back of the buttonhole (Fig. 66a). This is most successful on lightweight fabrics.

2. For heavier fabrics, cut a rectangular piece of firmly woven fabric — either the lining fabric or some fabric more lightweight than the garment fabric will do. Put this piece on the facing, right sides together, over the buttonhole. Stitch a rectangle as long and as wide as the finished buttonhole (Fig. 66b). Cut through the center of the stitched rectangle and clip into the corners as you did with the buttonhole. Pull through to the wrong side of the facing, press, and slip-stitch in place around the back of the buttonhole.

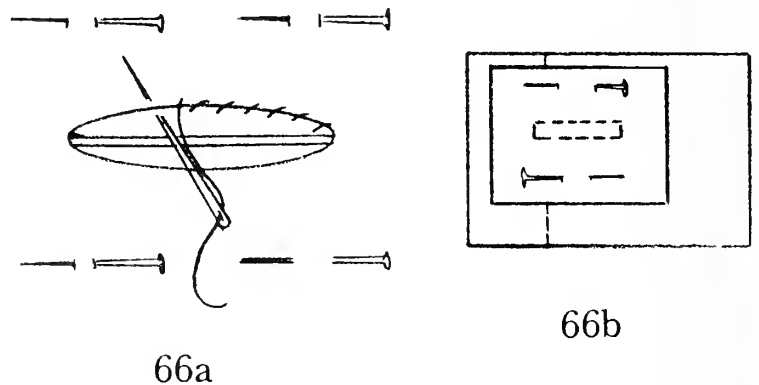

Fabric button loops

Fabric loops that extend beyond the finished edge of a garment can take the place of buttonholes. Garments on which they are used must have a separate facing piece to conceal the raw ends of the loops. Buttons used with this type of fastening are usually ball or half-ball shaped, but any shape can be used.

making the tubing

The tubing used for the loops may be corded, self-filled, or unfilled. Whichever type you choose, first determine the size of tubing you want. This will depend upon the weight and texture of the fabric and upon the type of button you want to use. In general, a $1\frac{1}{2}$ -inch strip of bias is used with mediumweight fabrics. The bias strip will be as long as the total number of loop lengths to be cut; remember to include two seam allowances for each loop cut. For example, suppose you want to have 5 loops, each $1\frac{1}{2}$ " long. Your bias strip will need to be at least $5 \times (1\frac{1}{2} + \frac{5}{8} + \frac{5}{8})$ or $13\frac{3}{4}$ " long. The loop itself

should be long enough to hold a button firmly but must also let the button be buttoned and unbuttoned easily.

To make bias tubing, always use true bias; that is, use fabric cut on a line that makes a 45° angle with the lengthwise threads of the fabric. To find this line, fold the fabric so that the warp yarns of the upper layer run in the same direction as the filling yarns of the lower layer. This folded edge is on the true bias. Cut strips the width you want parallel to this edge (Fig. 67). Press the strips, pulling them lengthwise to remove any stretch.

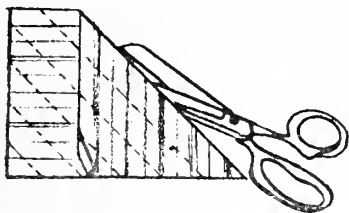

67

To make corded tubing, cut commercial cording double the length of the bias strip needed plus about 6 inches. Cut one end of the bias strip to a point and fold wrong side out over half the length of the cord (Fig. 68a).

Using a cording foot and short stitches, stitch across the cord to anchor the cord to the bias strip, then pivot the needle to stitch the length of the strip. Make your first stitches a little away from the cord, then taper in to stitch as close to the cord as possible (Fig. 68b); this makes it easier to start turning the cord later. As you sew, stretch the bias strip so the stitching won't break when you turn the cord. Finish the stitching by tapering away from the cord as you did with the first few stitches.

Now you have stitched half the cord inside the bias strip and left half uncovered. Trim the seam to 1/8". Work the bias back over the uncovered section of the cord, pulling the end of the encased cord. Cut off the extra cord. Your corded tubing, which is now right side out, is ready to cut into loop-length sections.

With self-filled tubing, the diameter of the tubing (and hence the width to cut the bias strips) depends upon the bulk of the fabric used. For example, a tubing of lightweight fabric such as organdy should be no more than 1/8" wide; tubing in heavier fabrics will be wider.

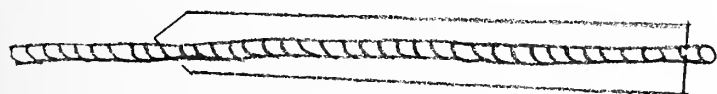

68a

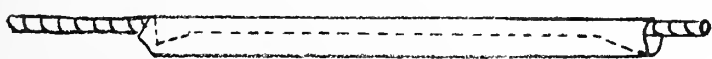

68b

Cut the bias strips 4 times as wide as the desired finished width. Fold each strip in half lengthwise, wrong side out. As with corded tubing, begin and end your stitching with a funnel shape. Stitch down the center of the strip, halfway between the folded edge and the cut edge (Fig. 69). Stretch the strip as you stitch. Use either of the following methods to turn the strip right side out:



69

1. Turn the strip with a commercial tubing turner (Fig. 70a). Slip the turner into the tubing, gathering the fabric until the hook comes out at the other end of the tube. Attach the hook securely to the seam area at the end of the tubing and pull the turner gently back through the tubing (Fig. 70b).

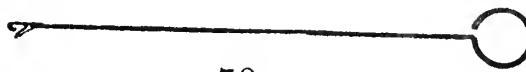

70a



70b

2. Use a heavy tapestry needle and heavy thread such as crochet thread or buttonhole twist. Double the thread and knot it about 2" longer than the tubing. Fasten the knotted end of the thread securely to the seam area at one end of the tubing. Insert the needle into and through the tubing, turning the tube right side out.

Unfilled tubing is made like self-filled tubing except that the bias strip is cut just wide enough to allow for the desired width of tubing plus seam allowances. After stitching, trim the seam allowances to 1/8", press the seam open, and turn the tubing just as with self-filled.

attaching loops to a garment

Loop fastenings should all be the same size and evenly spaced on the garment. Prepare the edge of the garment by basting once on seamline and again on a line parallel to the seamline. This helps position the ends of the loops. Add basting cross marks to mark the vertical spacing of the loops (Fig. 71).

Button loops may be attached in either of two ways, as shown in Figure 72. The only difference is whether the ends of the loops are brought together or left open. With

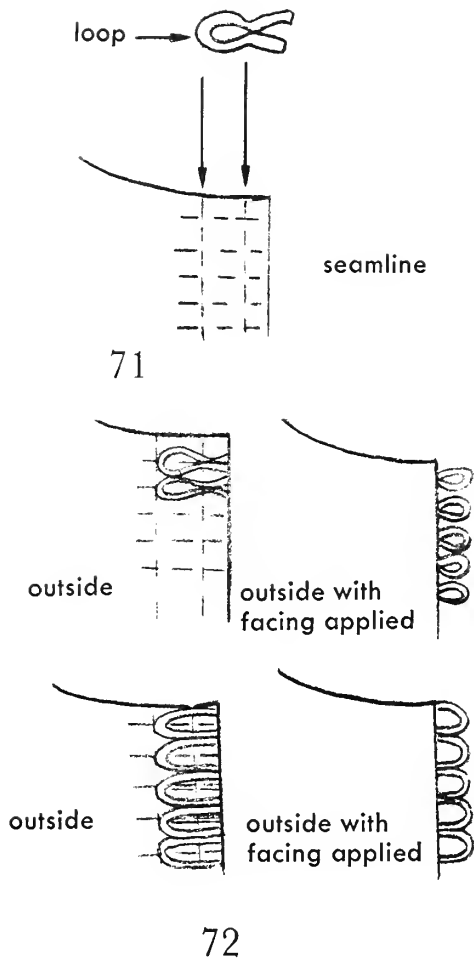

opening that laps. The loop is fastened to the edge of one side of the opening after the facing has been attached.

Use a double thread. From between the facing and the garment bring the needle through the seam to the right side of the garment and take two short backstitches. Where the thread has been drawn through, take a short stitch and partially draw the new stitch up, leaving about a 2-inch loop. Hold the needle and thread with the left hand; with the right hand, reach through the loop and draw the thread back through to form a new loop (Fig. 74a and b). Keep pulling the second loop until the first loop is pulled tight. This forms a small stitch similar to a crochet stitch.

Continue making loops until the chain of stitches is the correct length. Bring the needle through the last loop and pull it up to secure the chain. Insert the needle back through the seamline to between the garment and the facing, take several backstitches, and fasten off the thread.

either style, hand baste the loops into position with firm, small stitches to hold them in place when you machine-stitch. After the loops are attached, trim off any excess tubing in the seam allowance, remove the lines of basting, and apply the facing.

Thread loops

Thread loops with buttons (Fig. 73) can be used on an opening where the edges just come together or on an

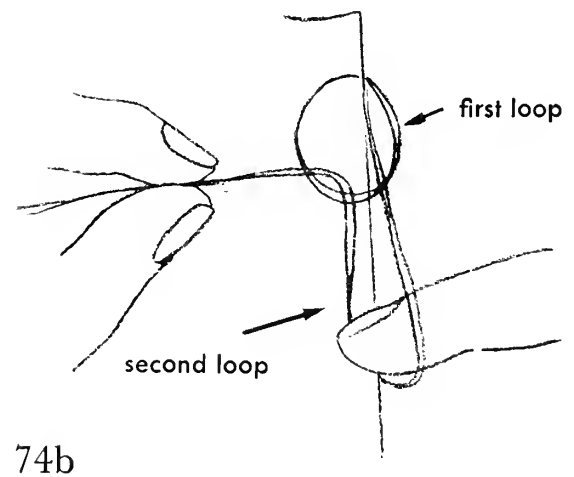
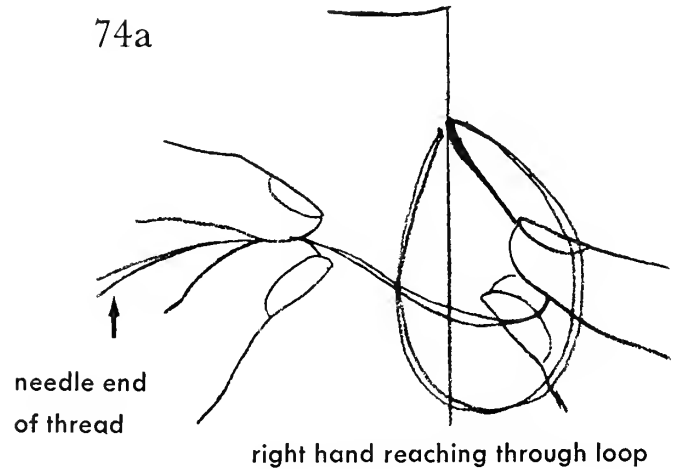
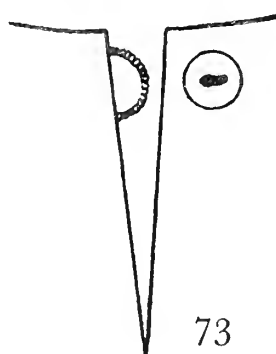

BELTS

Directions are given here for making a straight tie belt, a tie-sash belt, a belt with interfacing, and a belt with belt backing. Except for the tie-sash, most belts are made on the lengthwise grain of the fabric.

If you use a commercial kit to make a belt, follow the instructions that come with it.

Straight tie belt

The simple tie belt can be tied in a bow but is more commonly tied in a square knot with 6- to 8-inch tie ends falling down over the skirt. The strip of fabric for the belt should be twice as wide as the finished belt plus 1" for two ½-inch seam allowances. The ends of the belt may be rounded or pointed instead of squared off.

Fold the strip lengthwise, right sides together, and pin. Stitch a seam on the ends and side of the belt, leaving about 2" unstitched near the middle of the belt (Fig. 75). Grade the seams (see page 2) and trim the corners to reduce bulk. Press the seam open to help make a flatter seamline after the belt is turned.

Turn the belt right side out by pushing the ends of the belt through the gap in the seam. This can be done with the eraser end of a pencil or with any other bluntly rounded shape that will not tear the fabric. Work the seam out to the edge of the belt. Close the gap in the seam with slip-stitching. Press. Topstitch the edge of the belt if you wish.

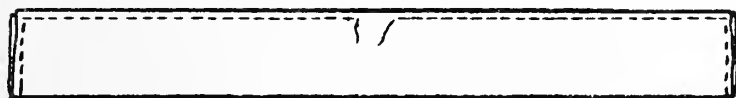

75

Tie-sash belt

The tie-sash belt is cut on the true-bias grain. It can be wrapped snugly or even be crushed without appearing bulky; the ends drape gracefully from the waistline. You may choose any length and width for the sash and tie it with a bow or a knot.

Cut enough bias strips to make the belt as long and as wide as you wish (see page 29 for cutting true bias strips). The strips should be twice as wide as the finished belt plus 1" for two ½-inch seam allowances. Join the

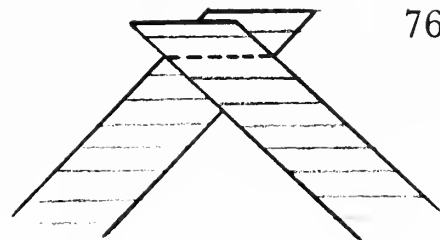

76

bias strips with narrow seams, matching the lengthwise or crosswise grain (Fig. 76).

Fold the belt strip (the joined bias strips) lengthwise, right sides together, and proceed as with the straight tie belt above. If the belt is very wide, you may wish to leave more than a 2-inch gap for turning the belt. After turning and slip-stitching, press.

Belt with interfacing

Belts with a plain lapped fastening are as long as the waist measurement plus about 4 inches for finishing seams and the lap. Belts with a buckle will need about 2 inches more. The belt strip should be twice as wide as the finished belt plus ¾" more for two ¾-inch seam allowances. The lap end of the belt may be rounded, pointed, or squared off.

If the belt is to be washable, shrink the interfacing. Cut the interfacing as wide as the finished belt and 1" shorter than the outer fabric strip. Shape the lap end to correspond to the fabric strip.

With the fabric belt strip wrong side up on the ironing board, steam press the ¾-inch seam allowance on one lengthwise edge of the fabric back against the fabric strip (Fig. 77a). Open the seam allowance and place one lengthwise edge of the interfacing on the



77a

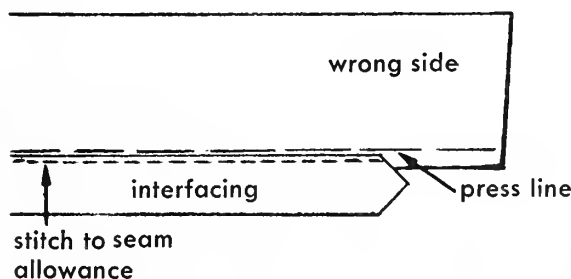

77b

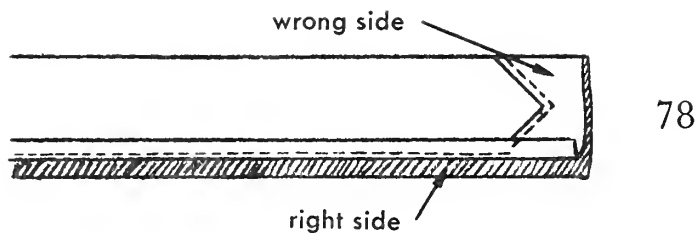

pressed seamline mark of the belt fabric, overlapping the seam allowance. Stitch the interfacing to the seam allowance, keeping the interfacing edge matched to the pressed line of the fabric seam allowance (Fig. 77b).

To stitch the lap end of the belt, fold the belt lengthwise with right sides together and stitch *against* the shaped end of the interfacing but not *through* it (Fig. 78). Trim the seam allowances to $\frac{1}{8}$ "; grade the edges on bulky fabrics. Turn the end right side out. For a lapped belt with no buckle, finish the other end the same way. For a belt with a buckle, the other end will be finished when the buckle is attached (see section below).

In either case, finish the open lengthwise seam as follows. Fold the fabric over the unfastened lengthwise edge of the interfacing, right side out. Steam press, drawing the fabric tightly across the interfacing. Turn under the raw edge of the fabric so that the folded line lies just $\frac{1}{16}$ " inside the edge of the belt.

Slip-stitch the folded edge to the belt (Fig. 79). If you plan to have topstitching anyway, omit the slip-stitching and machine-stitch about $\frac{1}{8}$ " from all edges. Press. A plain lapped belt with no buckle may be fastened with hooks, snaps, or a nylon tape fastener such as Velcro.

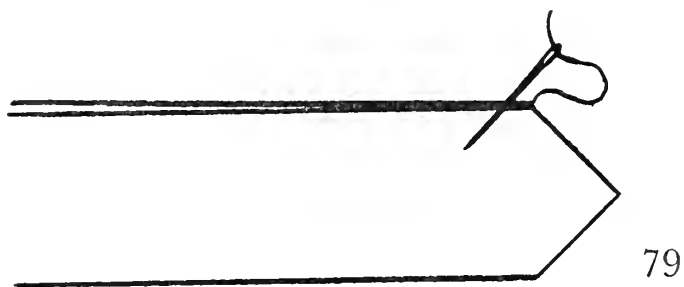

Belt with belt backing

Cut the belt backing 6" longer than the waist measurement. Shape the lap end. Cut the fabric $\frac{3}{4}$ " wider and $\frac{1}{2}$ " longer than the backing.

Turn under and press $\frac{3}{8}$ " along the long edges of the fabric at the lap end, following the shape of the backing. Trim off any excess fabric at the lap end to prevent bulkiness (Fig. 80a).

Pin or baste the backing onto the fabric, keeping the seam allowances turned under and all edges even. Stitch close to the edge all around the belt (Fig. 80b).

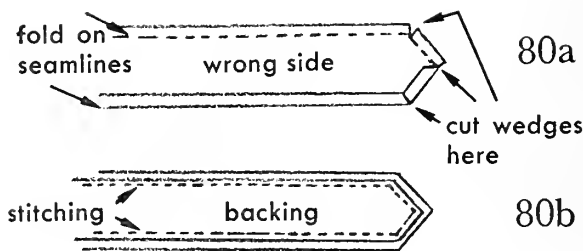

Attaching the buckle

Turn about 1" of the buckle end of the belt back to the wrong side. Cut a small oval opening at the folded edge for the tongue of the buckle. Buttonhole stitch (see page 25) around the edge of the hole, using a double thread or buttonhole twist. Be sure to catch all layers of the belt. Insert the tongue of the buckle through the opening, turn under the end of the belt, and slip-stitch to the underside (Fig. 81).

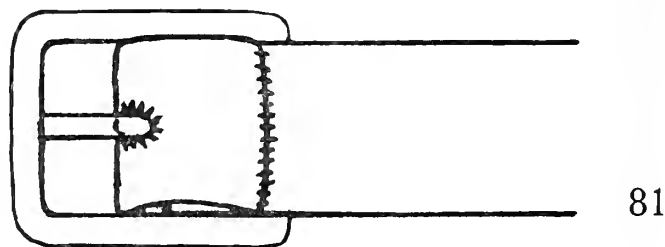

Eyelets in the lapped end of the belt

Try on the belt over the dress with which you will wear it and mark the point on the lap that coincides with the tongue at the front edge of the buckle. Make an eyelet at this point, stitching with either an automatic machine eyelet attachment or the hand buttonhole stitch.

For a handmade eyelet, puncture a hole with scissors tips, a punch, or some other sharp tool, then stitch around the hole with the buttonhole stitch (Fig. 82). Be sure that the stitches are very close together and deep enough to catch all layers of the belt firmly.

For a machine-made eyelet, follow the directions that come with the sewing machine or attachment.

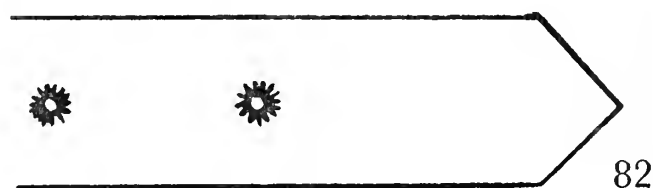

Belt carriers

Belt carriers or keepers hold the belt in position over the waistline seam. Carriers are usually placed at the side seams of the garment, half above and half below the waistline; occasionally, placing them at center front or center back is more effective. Carriers should be about $\frac{1}{4}$ " longer than the belt is wide.

For most purposes thread carriers, being less noticeable, are preferable to self-fabric carriers. Use thread the

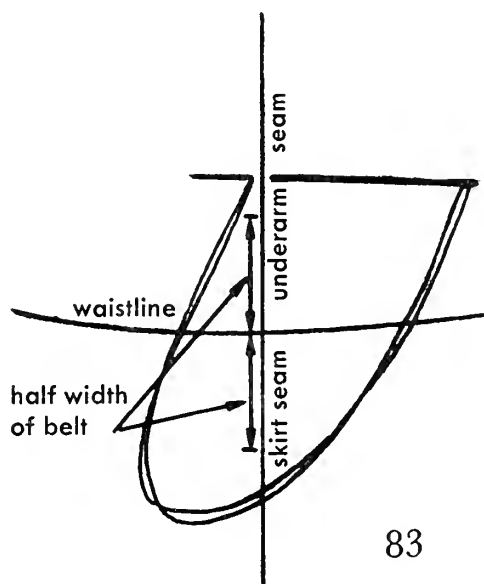

color of the garment unless the belt is in a contrasting color, in which case match the belt.

A chain thread carrier is made the same way as button loops (page 30). Begin on the wrong side of the garment at a point a little more than half the width of the belt above the waistline seam. Take two short backstitches through the side seam allowances and bring the needle through to the right side. Take a short stitch where the thread has been drawn through to make your first loop (Fig. 83). Continue as on page 30.

When the carrier is the desired length, finish off the chain. Insert the needle back through the side seam at a point a little more than half the width of the belt below the waistline seam (Fig. 84). Take several backstitches on the wrong side of the garment and fasten off the thread.

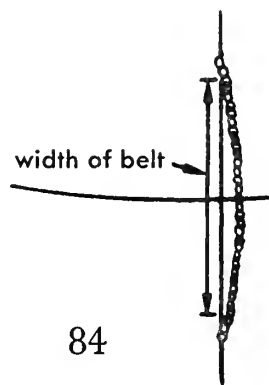

HEMS

Different kinds of garments may require different kinds of hems, but all hems should be evenly wide, durable, and as inconspicuous as possible on the outside of the garment.

Rolled hems

The rolled hem is a narrow finish for fine, lightweight fabrics (Fig. 85). Trim the hem allowance to $\frac{1}{4}$ " and fold the raw edge in $\frac{1}{8}$ ". Slip the needle into the fold so that the knot will be hidden. Take a small stitch below the raw edge and again in the fold; work from right to left, spacing stitches about $\frac{1}{4}$ " apart. Draw the thread to form a roll after each few stitches (Fig. 86).

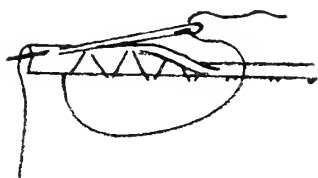
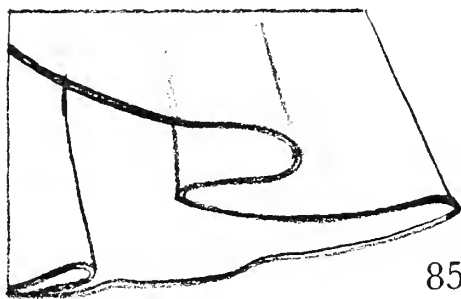

Horsehair braid hems

Horsehair braid gives body to hems of sheer fabrics and stiffens the hem of full skirts to make them stand out. The width of braid to use depends on the fabric you are using and the effect you wish to create. The top edge of wide braid has a special heavy thread that can be drawn up to shape the garment; narrow braid is the same on both edges.

To apply *wide braid*, trim any excess fabric to $\frac{1}{4}$ " below the marked hemline. Match the bottom edge of the braid to the marked hemline on the right side of the skirt (Fig. 87a). Topstitch the braid to the skirt; overlap the braid ends 1 to 2 inches. On a flat surface turn the

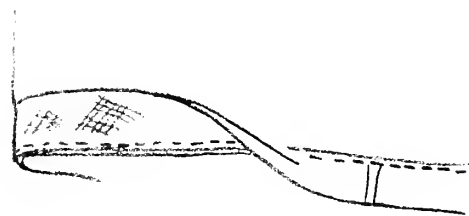
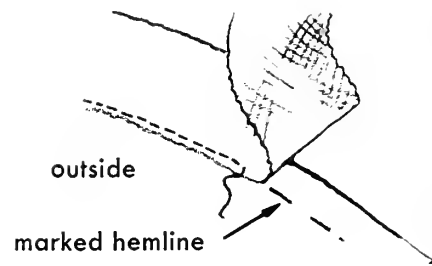

braid to the inside of the garment; pin and baste close to the fold (Fig. 87b). Draw up the free edge of the braid to match the contour of the skirt and pin or baste to the skirt. Stitch the hem.

Apply *narrow braid* to a garment with the same steps. Finish by topstitching close to the edge through both braid and fabric (Fig. 88), then catch the free edge of the braid to the seams only. If you prefer, omit the topstitching after turning the hem and hem the free edge of the braid to the skirt as with wide braid above.

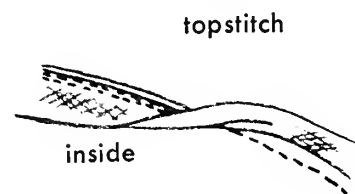

Wide, triple-thick hems

On sheer or very lightweight fabric, use a hem of triple thickness for added body. This method is suitable only for straight or relatively straight hemlines, however — not circular skirts. You will not need to finish the raw edge of the hem, as it will be hidden at the fold of the hemline.

Mark and cut the hem allowance twice as deep as the finished hem width will be. Fold along the center of the hem allowance so that the raw edge is on the hemline; pin or baste in place. Fold again on the hemline and pin or baste (Fig. 89). Attach the first folded edge to the garment.

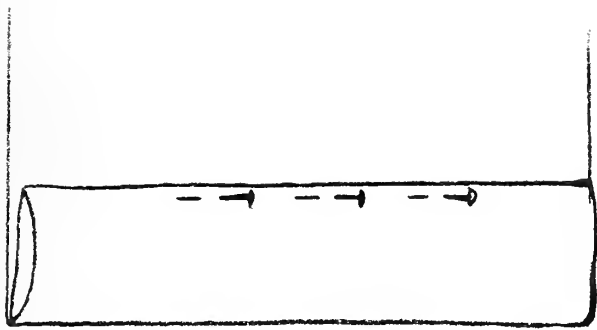

89

Hems with tape

You need tape hems only for fabrics that ravel excessively, and then only when the raveling cannot be controlled by pinking or stitching the edge of the hem.

Pin or baste the hem in place and press the hemline. Place the tape smoothly on the raw edge of the hem with about half the width of the tape extending over the raw edge (Fig. 90a). Pin the tape to the hem and stitch along the lower edge of the tape. Hem the upper edge of the tape to the garment with hand stitches (Fig. 90b).

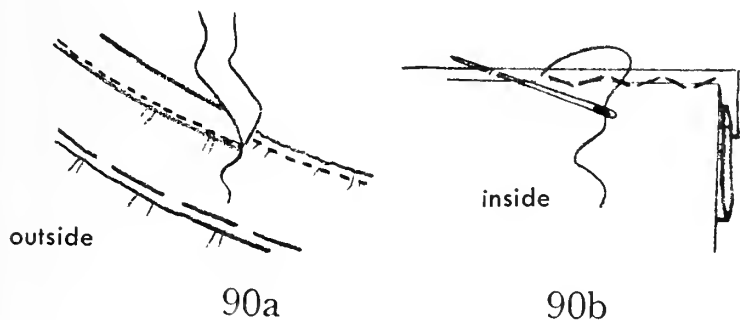

90a

90b

Bias-rolled hems

Inserting a bias strip of fabric in the hem of an underlined garment gives the hem edge a soft, rolled look.

The bias strip may be cut from interfacing fabrics or from lamb's wool; interfacing will add more body, while lamb's wool will give a very soft look. Consider the garment fabric and the effect desired when you make this kind of hem.

Cut the bias strip long enough to reach around the hem plus $\frac{1}{2}$ " for seams. The width of the strip will depend on the width of the hem. The strip will extend $\frac{5}{8}$ " beyond the fold of the hem and will end $\frac{1}{2}$ " to 1" below the top edge of the hem; for a 3-inch hem, therefore, a bias strip $2\frac{3}{4}$ " wide would be adequate.

Establish the hemline, then mark the fold of the hemline with basting thread. Place the lower edge of the bias strip $\frac{5}{8}$ " below the hem fold. Attach the strip to the *underlining* with a long running stitch at the upper edge of the strip and at the hemline (Fig. 91a); do not catch any outer fabric.

Finish the raw edge of the garment fabric according to the type of fabric and the type of care intended for the garment. Turn up the hem on the fold line and pin. Hand-stitch the edge of the hem to the underlining and to the seam allowances (Fig. 91b).

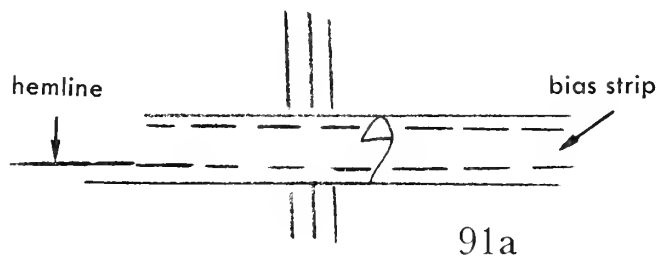

91a

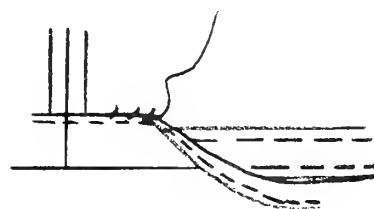

91b

FINISHING TOUCHES

Sometimes that “added touch” or special technique can transform an otherwise commonplace garment into one that is very special. Bindings, single thread darts, various fasteners, and weights are discussed here as “something extra.”

Bindings

French binding

On sheer fabrics, omit the facings and finish the seam edges of necklines and armholes with narrow French binding. To make French binding, cut a true bias strip (see page 29) — either self-fabric or contrasting fabric — six times as wide as you want the finished binding to be. Narrow binding ($\frac{1}{4}$ " to $\frac{1}{2}$ ") is usual for very lightweight fabrics; heavier fabrics will need wider bindings. Fold the strip lengthwise through the center with the right side of the fabric out. Stitch the raw edges of the bias strip to the right side of the garment, making the seam at one-third the width of the folded bias strip. Turn the folded edge over the seam and hand-hem in place (Fig. 92). If you prefer, machine-stitch from the right side along the first stitching line after you turn the edge over the seam.

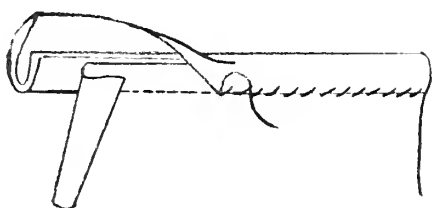

92

bias binding for corners

Handling outside corners on areas such as collars and pockets or inside corners on a square neck or at some other such detail need not be difficult. Careful placement of the binding and accurate, straight stitching are the keys to smooth construction.

To bind an *outside corner*, stitch toward the corner until you are one width of seam allowance from the edge. Backstitch to fasten the thread. Fold the binding at a right angle to the first stitching and stitch to form a miter (Fig. 93a). Begin stitching again at the corner and con-

tinue in the new direction across the fold. Turn the bias over the seam. Form a miter in the opposite direction, turn under the raw edge, pin, and slip-stitch the edge to the wrong side (Fig. 93b).

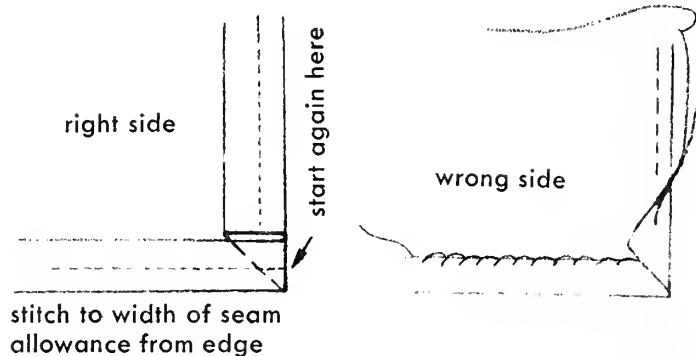

93a

93b

For a quick topstitched method, stitch the binding to the edge of the fabric (Fig. 93c). Cut off the thread and fold the binding at a right angle along the next edge to form the miter. Start stitching again at the point of miter (Fig. 93d). Bring the loose threads to the wrong side and fasten.

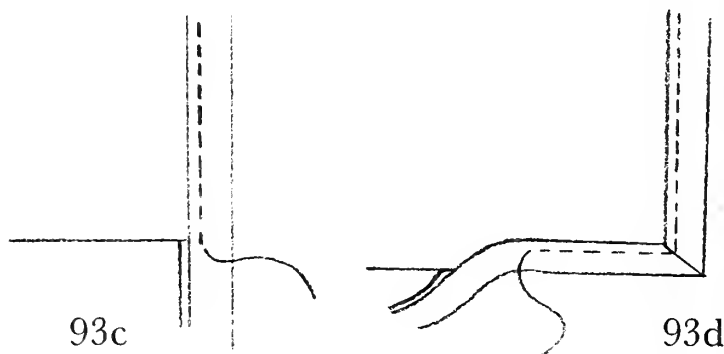

93c

93d

To apply binding on an *inside corner*, stitch to one width of seam allowance beyond the corner (the point of miter). Pivot the fabric on the needle and bring the strip around the corner, stretching it around the needle; continue stitching (Fig. 94a). Form a miter in the corner on the wrong side and slip-stitch the binding in place (Fig. 94b).

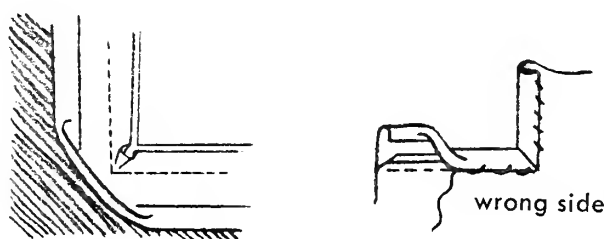

94a

94b

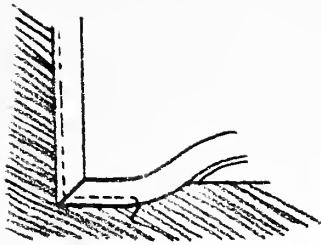

94c

For a quick topstitched application of binding, stitch to one width of seam allowance beyond the corner. Pivot the fabric on the needle; bring the tape around the corner to form a miter and continue stitching (Fig. 94c). Fasten the miter in place with a few hand stitches on the wrong side.

Single-thread darts

Use this method when you are working with sheer fabrics or when you want the darts in certain areas of the garment to have special style and interest. The stitching is started at the point of the dart, and no knot or back-stitching is used to fasten the thread.

If the dart is to be decorative, pin it so that the fold is to the outside of the garment. Handle the fabric carefully to prevent stretching.

Unthread the machine needle. Draw the bobbin thread up through the threading points of the machine, winding enough on an extra spool to complete a single dart. Now lower the needle into the edge of the fold at the extreme end point of the dart. Lower the presser foot and stitch toward the seam edge.

Fasteners

Sometimes an extra touch in applying fasteners can give a garment a special look.

covered or padded snaps

If snaps must be located where they will be conspicuous when the garment is worn, you can make the garment more attractive — and add a look of quality — by covering the snaps with a lightweight fabric. Use the garment fabric if it is lightweight or perhaps a lining fabric in a matching color. One of the following methods is suggested.

In *Method I*, the complete snap is covered:

Cut small circles of fabric so that they will extend about $\frac{1}{8}$ " beyond the edges of the snap. Hold one circle

over the top (ball) section of the snap and position the section on the garment. Hand-stitch the snap, tucking in the raw edges with the needle. Repeat for the lower (socket) section of the snap. If raw edges slip out around the edge of the snap, make a few blind stitches into the snap covering and through one fabric thickness directly underneath the snap.

In *Method II*, the ball of the snap extends beyond the cover:

To cover snaps $\frac{1}{2}$ " in diameter, cut circles of fabric approximately 1" in diameter. With the point of your scissors, punch a small hole in the center of one circle of fabric. Place this circle over the top (ball) section of the snap. Sew by hand around the edge of the circle. Draw up the thread and fasten neatly on the underside (Fig. 95). Place the second circle over the bottom (socket) section of the snap and close the snap. While the snap is closed, stitch around the edge of the second circle. Draw up the thread and fasten neatly on the underside. Pull the snap open and place the sections in the correct position on the garment. Stitch in place, feeling with the needle for the holes in each snap section.



95

hanging snaps

Hanging snaps may be used in place of hooks and eyes to fasten a garment area where overlap is not included, such as at the back of a standing collar. Position and stitch the ball half of the snap as usual; attach the socket half of the snap by stitching through one hole only. This allows the socket half to extend out from the edge of the closure and fasten easily (Fig. 96).

96

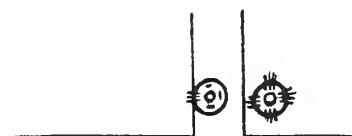

thread-covered hooks and eyes

To help camouflage large hooks and eyes, cover them completely with thread or buttonhole twist that matches the garment. Sew them onto the garment with overhand stitches, then work around the entire hook or eye with a continuous blanket stitch (Fig. 97). Be careful not to sew to the garment the part of the eye where the hook will be attached.

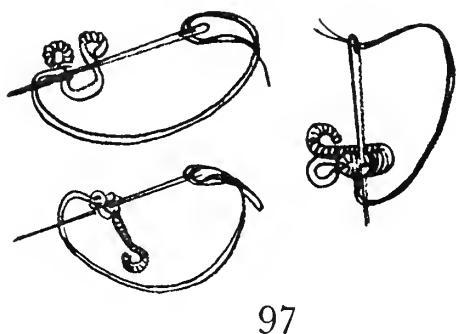

hidden hooks

If you use a hook on a front closing, try hiding the hook. On the facing mark the point where you want the hook and eye to meet. Make a small opening in the weave of the fabric at this mark. With the blunt end of a needle, gently force the threads apart but try not to break them (Fig. 98a). If the fabric is closely woven and the weave cannot be separated, use the extreme tips of your scissors to make a tiny slit.

Insert one loop of the hook into the small opening or slit in the facing. Work the other loop into the opening and slip the hook into position underneath with only the bill end of the hook exposed (Fig. 98b). Sew the hidden loops into place against the facing, making the stitches as invisible as possible. Fasten the bill end of the hook and, if a slit was made in the fabric, sew up the ends to prevent ripping (Fig. 98c).

thread eyes

In better garments thread eyes are often used instead of metal ones. Stitched with thread that matches the garment, they may be worked on the very edge of an opening or placed just inside the edge. Make several overlapping bar stitches, then cover the strands with buttonhole stitches (Fig. 99). See page 25 for how to make buttonhole stitches.

Thread eyes may also be made like thread loops (see page 30).

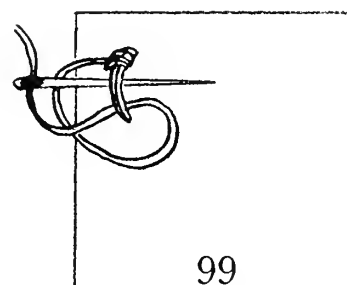
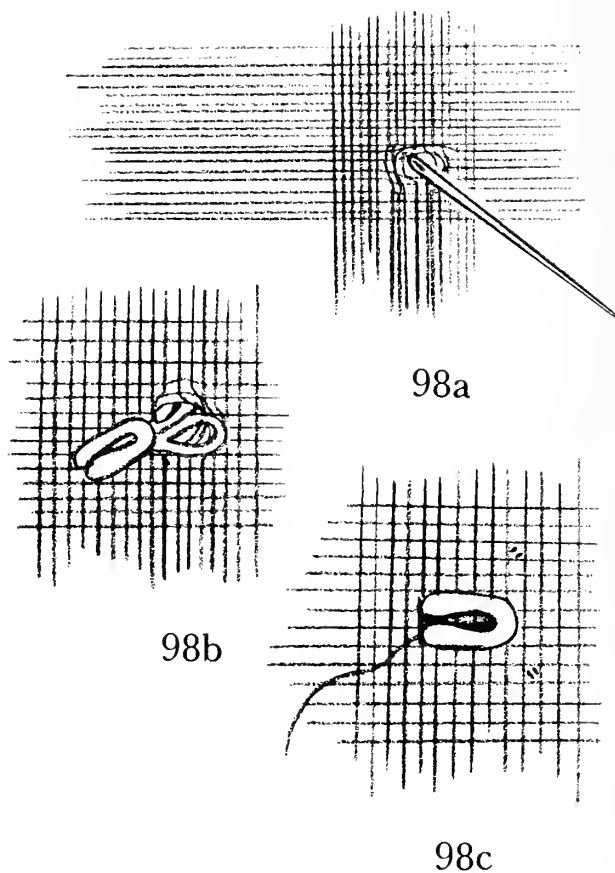

inner waistbands

Another "extra" construction is an inner waistband that uses hooks and eyes to reduce strain on zippers and other waistline fasteners. This helps keep the waistline of the garment in place and is especially useful in stretchy and delicate fabrics. Cut preshrunk grosgrain ribbon (good weight, 1" wide) as long as the waistline plus 1". Turn under and stitch $\frac{1}{2}$ " at each end. Sew hooks and eyes to the ends of the ribbon. Attach this waistband by hand to the inside waist seam, leaving about $\frac{1}{2}$ " of each end free. If there is no waistline seam, tack the waistband to the seam allowances and darts at the waistline of the garment.

shoulder-strap stays

These stays keep lingerie straps from showing on women with sloping shoulders or who wear garments with wide-scooped necklines. Use either of two simple methods to construct shoulder strap stays.

Method One: Cut a piece of seam binding tape about 3" long. Fold it double and stitch the edges together. Tack one end to the shoulder seam allowance. Sew the ball half of a snap to the free end of the tape and the socket half to the garment (Fig. 100).

Method Two: Make a thread chain (see page 30)

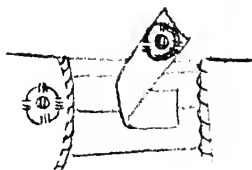

100

on the shoulder seamline about $\frac{1}{4}$ " from the armhole. Complete the chain by pulling the needle through the last loop to form a knot. Sew the ball half of the snap to the free end of the chain and the socket half to the shoulder seam of the garment.

Weights

Weights are often placed at hems or in a cowl neckline to enhance the hang or drape of a garment. Be sure the weight you select can be laundered or dry cleaned.

Round lead weights resemble coins and come in different sizes and weights. They may be sewn permanently within the layers of a garment or covered with lining fabric and held in place with a small safety pin. Chain weights are used specifically in hems; they come in various weights and are sold by the yard or in prepackaged lengths. Tack the chain along the bottom of the garment, $1\frac{1}{2}$ " from the lower edge (or just below the lining hem fold); tuck the chain ends behind the facings.

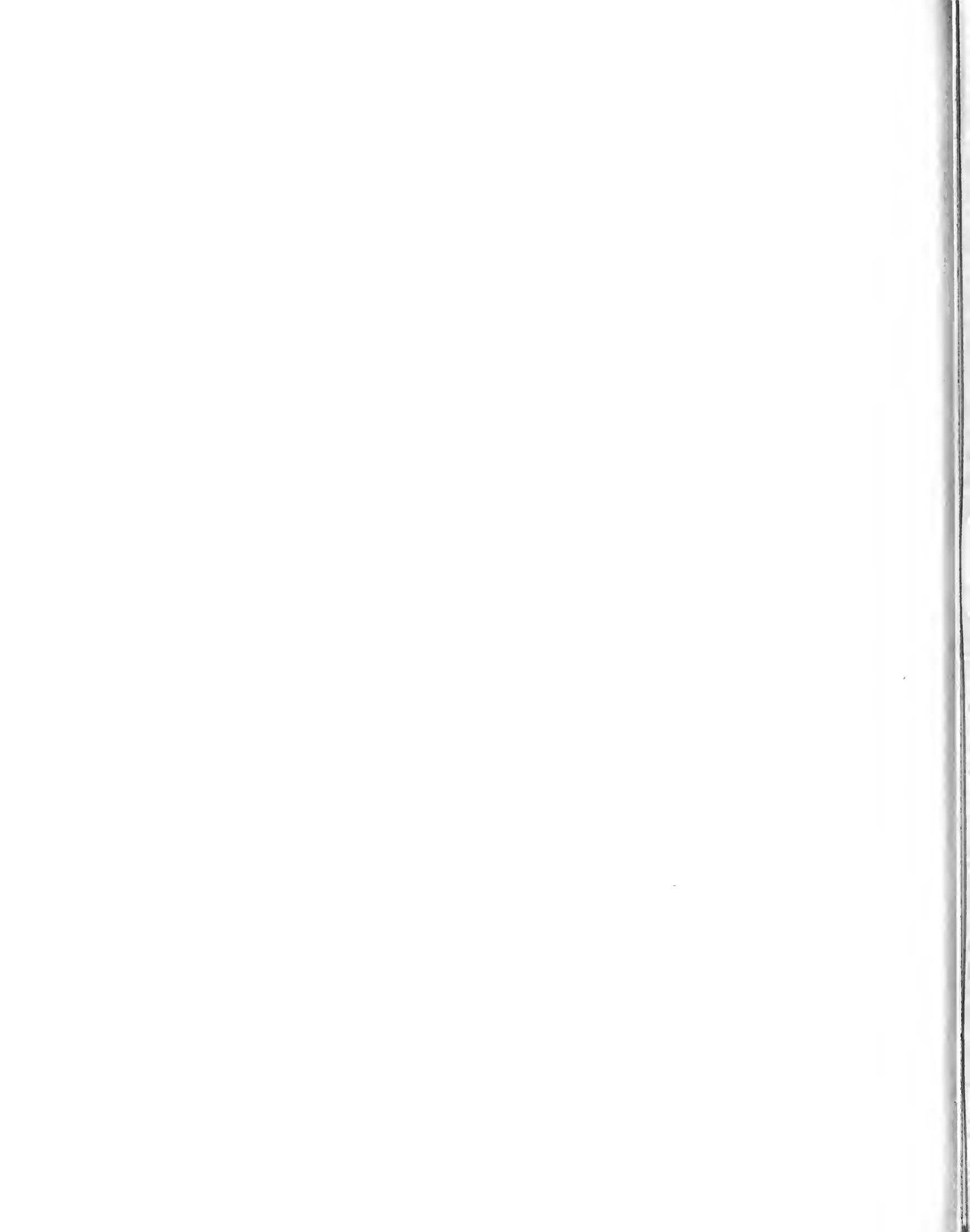

Urbana, Illinois

April, 1972

Issued in furtherance of Cooperative Extension Work, Acts of May 8 and June 30, 1914, in cooperation with the U.S. Department of Agriculture. JOHN B. CLAR, Director, Cooperative Extension Service, University of Illinois at Urbana-Champaign.

10M—4-72—19358



<



UNIVERSITY OF ILLINOIS-URBANA
Q. 630.71L6C C005
CIRCULAR URBANA, ILL.
1055 1972



3 0112 019532883