







THE ADVANCE OF PHOTOGRAPHY



CALIFORNIA

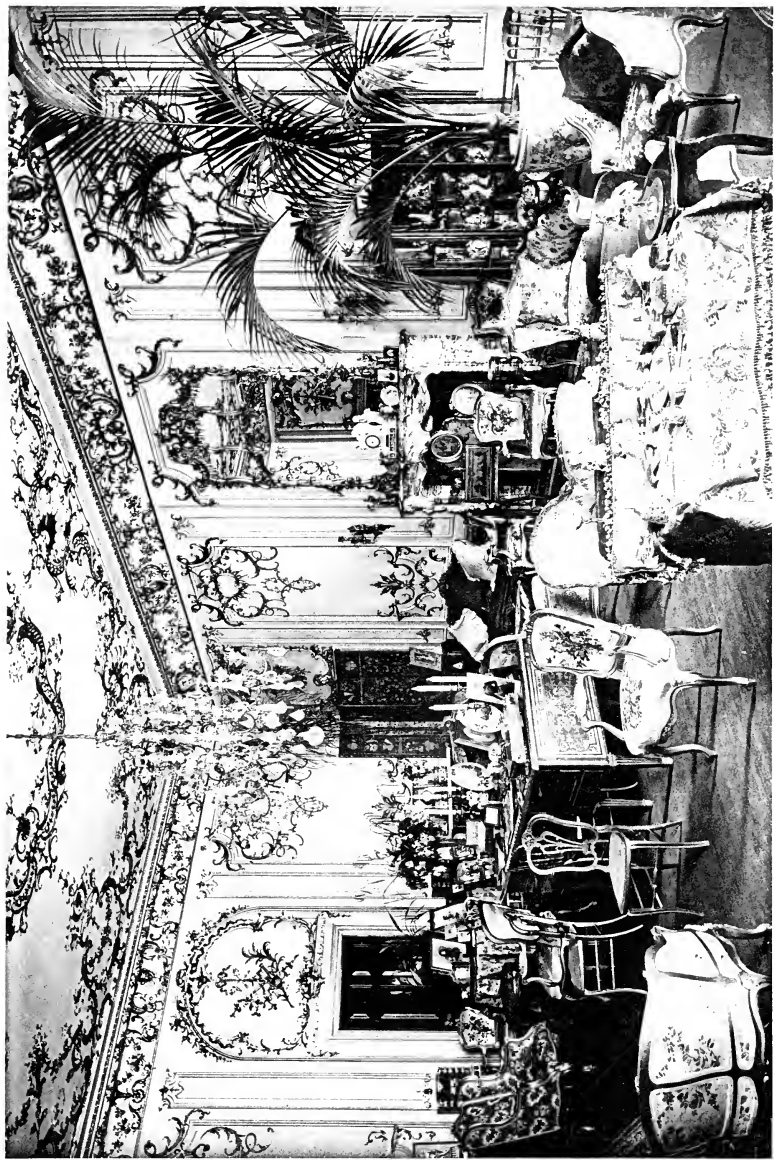

Photo: Richard L. Brown, N.Y.C.

Mrs. in Bondage, Japkin, Collyer, pos. 8461, New York, N.Y., W.C.

THE ADVANCE OF PHOTOGRAPHY.

ITS HISTORY AND
MODERN APPLICATIONS

BY

A. E. GARRETT, B.Sc.

FELLOW OF THE PHYSICAL SOCIETY OF LONDON
FELLOW OF THE ROYAL ASTRONOMICAL SOCIETY
FELLOW OF THE ROYAL GEOGRAPHICAL SOCIETY
ETC.

WITH ILLUSTRATIONS



LONDON
KEGAN PAUL, TRENCH, TRÜBNER & CO. L^{TD}
1911

TR
145
G.

NO WIND
ABANDONED

PREFACE

NEARLY forty years have now elapsed since the first edition of Vogel's "Chemistry of Light and Photography" was issued, and no revision has been made of that work since 1883.

During the last thirty years the science of photography has developed with very rapid strides. The perfection of the dry plate, the introduction of orthochromatic photography, and the scientific investigation of the many problems confronting the practical photographer have been landmarks in that progress.

Then, again, much interest has centred round the application of photography for recording results obtained in various branches of scientific research; while the advent of Röntgen-ray photography, the transmission of photographs from place to place by electrical means (photo-telegraphy), and the improvements made in the photography and projection of photographs of moving objects, have opened up new fields of interest for workers in this science.

On the other hand, Vogel's "Chemistry of Light and Photography" is still considered a classic with respect to those branches of the subject with which it deals. Thus, although the present book is of necessity practically a new work, it is based upon the lines laid down in the original publication.

The historical account given in Vogel's edition is so

v

complete and is of such interest, that it has with slight alterations been adopted *in toto*.

I should like to express my thanks to the many firms which have so readily come to my assistance in the loan of blocks, etc., for the illustrations, and especially to thank the following gentlemen :—

Professor Hale for the excellent photographs obtained at Mount Wilson, Professor R. W. Wood for the photographs obtained with invisible light, Mr T. Thorne Baker for the illustrations of the Korn process and Telectograph process, Mr C. O. Bannister for microphotographs of metallurgical specimens, Messrs Swain & Co. for illustrations of the three-colour process and the effect of line screens, Messrs H. Cox & Co. for the radiographs, Messrs Ilford for the illustrations concerning orthochromatic plates, and Messrs Martin Hood & Larkin for the fine collotype which appears as frontispiece and the illustration of lithographic work.

A. E. GARRETT.

LONDON, *June* 1911.

CONTENTS

CHAP.	PAGE
I. HISTORICAL SURVEY	1
II. THE CHEMICAL ACTION OF LIGHT	36
PSEUDO-PHOTOGRAPHIC EFFECTS	72
III. THE PHOTOGRAPHIC IMPORTANCE OF THE CHROMIUM COMPOUNDS	78
IV. LENSES	104
V. CAMERA APPLIANCES	134
VI. DRY PLATES, FILMS AND PAPERS	159
VII. ART IN PHOTOGRAPHY	199
VIII. SOME EARLY APPLICATIONS OF PHOTOGRAPHY	214
IX. PHOTOGRAPHY IN NATURAL COLOURS	227
X. BOOK ILLUSTRATIONS	264
XI. ASTRONOMICAL PHOTOGRAPHY	281
XII. MICRO-PHOTOGRAPHY AND PROJECTION APPARATUS	321
XIII. RÖNTGEN-RAY PHOTOGRAPHY	342
XIV. PHOTO-TELEGRAPHY	360
XV. ANIMATED PHOTOGRAPHY	368
INDEX	377

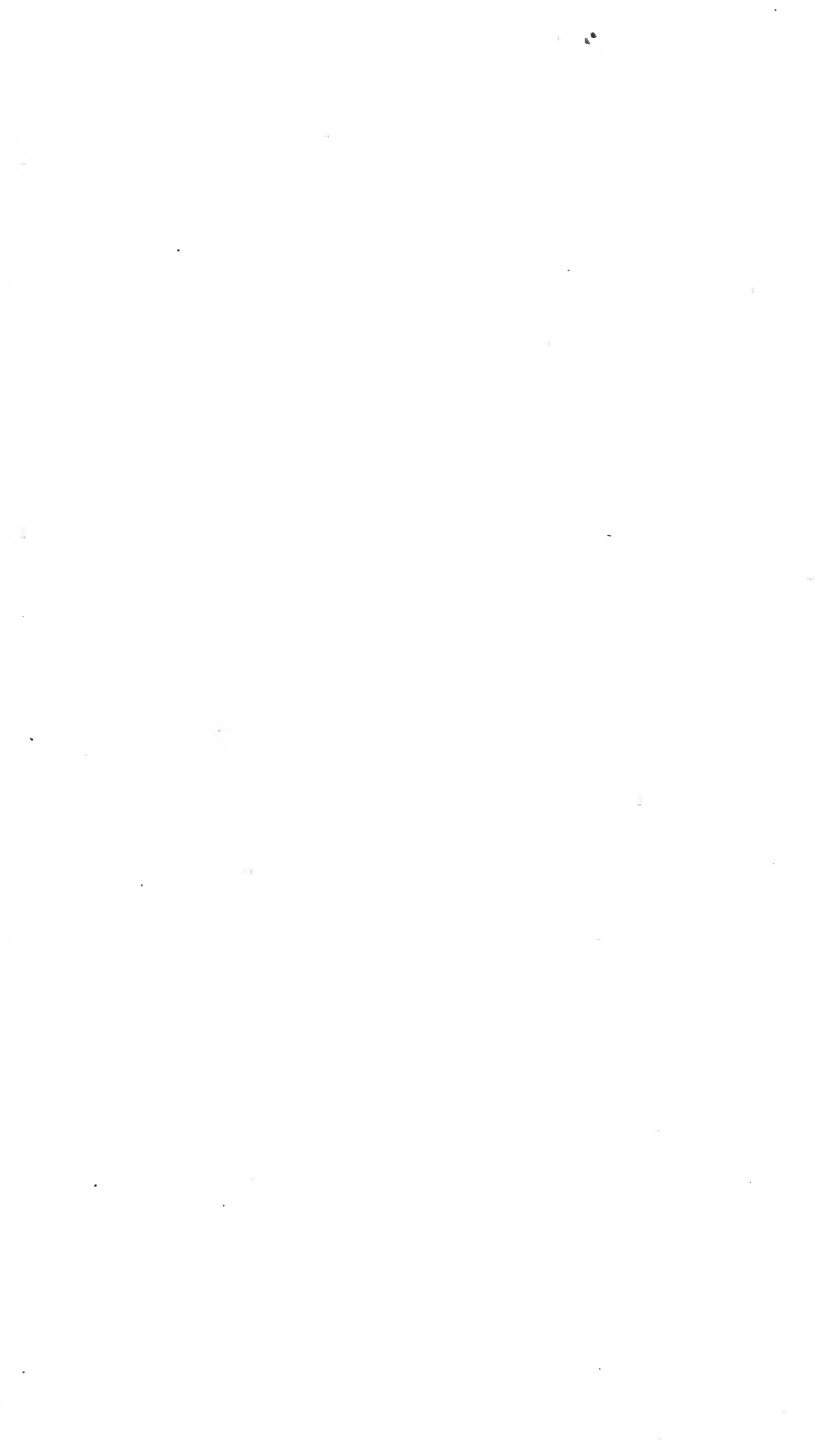

LIST OF ILLUSTRATIONS

	<i>Frontispiece</i>
	Figs. Page
Collotype	5
Leaf photographs	1, 2 5
Camera obscura	3, 4 7
Leaf photograph	5 18
" "	6 19
Wet plate dark slide	7 27
Printing-frame	8 30
Vignetting	9 32
Wave illustration	10 37
Diagram to illustrate—	
Refraction	11 41
" in raindrop	12 41
" " prism	13 42
Spectrum	14 43
Solomon's lamp	15 49
Flash bag	16 50
Diagram to illustrate—	
Path of sun's rays	17 52
Lines of latitude	18 54
Crystal of chrome alum	19 79
Electrotyping	20 83
Gelatine relief	21 86
Action of light on bichromated gelatine	22 87
Refraction of light	23 104
" "	24 104
" " through plate glass	25 105
" " " glass prism	26 105
" " " "	27 106
Connection between lens and prism	28 106
Action of lens on parallel rays	29 107
Conjugate foci	30 107
Formation of image by lens	31 107
Types of lenses	32 109
Spherical aberration	33 110
Focal lines	34 112
Circle of least confusion	34a 112
Distortion of image by lenses	35 113

	Figs.	Page
Diagram to illustrate—		
Compound lens	36	114
Telephoto lens	37	118
Rapid rectilinear lens	38	123
Ross homocentric lens	39	124
Portrait lens	40	124
Dallmeyer-Bergheim portrait lens	41	125
Diffusion of focus apparatus	42	126
Wide angle lens	43	127
Rapid wide angle combination	44	128
Front combination	45	128
Back „	46	128
Lens with telephoto attachment	47	129
Adon telephoto lens	47a	131
Busch Bis-Telar	48	132
Photographs to show effect produced by using Cooke extension lenses	49, 50, 51	To face page 133
		Page
An early camera	52	134
Diagram to illustrate—		
Formation of image in pinhole camera	53	135
Effect of size of pinhole	54	136
Sanderson stand camera	55	140
„ patent camera front	56	141
Panros camera on stand	57	143
The Kodak camera	58	144
„ „ „	59	145
Houghton folding reflex camera	60	146
„ „ „ „	61	146
Naturalist camera	62	147
Bebe camera	63	147
The Ticka camera	64	148
Panoramic camera	65	148
Stereoscopic camera	66	149
The stereoscope	67	151
The stereoscope lenses	68	151
Diagram to illustrate—		
Path of light through lenses	69	152
American stereoscope	70	153
Enlarging easel	71	155
„ lantern	72	155
Studio camera on stand	73	156
Thornton-Pickard shutter	74	157
		Between pages
Photograph showing halation effect	75	160
„ of same, using backed plate	76	& 161

	Figs.	Page
Arrangement of telescope for photography	116	286
Refracting telescope	117	288
	To face page	
Eclipse of sun	118	290
Eclipse of sun	119	290
Corona during eclipse	120	291
Diagram to illustrate—		Page
Arrangement of telescope (Rutherford)	121	293
Spectroheliograph	122	295
	Between pages	
Direct photograph of sunspot (Mount Wilson)	123	296
Photograph, calcium flocculi " "	124	&
" hydrogen " " "	125	297
	To face page	
" sunspot, using H α line " "	126	298
Tower telescope, Mount Wilson	127	299
		Page
Spectroscope	128	307
" with photographic attachment	129	308
Diagram to illustrate—		
Measurement of distance of star	130	312
Transit of Venus	131	313
Effect of exposure of plate to weak light	132	318
Solar microscope	133	321
	To face page	
Modern Microscope	134	322
		Page
Diagram to illustrate formation of image in microscope	135	324
Camera attached to microscope (horizontal)	136	325
" " " " (vertical)	137	326
	To face page	
Micro-photograph transverse section, leaf tea-plant	138	328
	Between pages	
Arrangement for photographing larger objects	138a	328
Embryo of armadillo	139	&329
		Page
Microsummar lens	140	329
	Between pages	
Camera for micro-photography in metallurgical laboratory	141	330
Carbon steel (micro-photo)	142	&
Silver cupellation bead (micro-photo)	143	331
		Page
Small model micro-photography metallurgical laboratory	144	331
The stage of the microscope	145	333
Diagram to illustrate path of rays of light	146	334
Early projection lantern	147	336
Modern projection apparatus	148	337
Diagram to illustrate—		
Path of rays of light	149	339

LIST OF ILLUSTRATIONS

xiii

	Figs.	Page
Diagram to illustrate—		
Path of rays of light	150	340
Projection of opaque objects	151	341
Parts of Ruhmkorff's coil	152	344
Coil as used for radiographic work	153	346
Röntgen-ray tube	154	349
Diagram to illustrate—		
Arrangement with electrolytic break	155	351
" " " " " "	156	352
Water cooled tube	157	352
Apparatus for obtaining instantaneous radiographs	158	355
To illustrate photograph obtained with soft tube	159	356
To illustrate photograph obtained with correct tube	160	&
" " " " " " hard tube	160a	357
		Page
Diagram to illustrate effect due to selenium cell	161	361
" " " " Belin's method	162	362
		To face page
Photograph obtained by Korn's process	163	362
" " " telegraph process	164	366
		Page
Camera for obtaining cinematograph films	165	369
Combination apparatus (ordinary projection and cinematograph)	166	372
Cinematograph reversing apparatus	167	373

OTHER ILLUSTRATIONS

Map to illustrate lithographic process—Plate I.		To face page 100
Illustrations of effects produced by diffusion of focus—		Between pages 126
Plates II., III., IV., and V.}	& 127



THE

ADVANCE OF PHOTOGRAPHY

ITS HISTORY AND MODERN APPLICATIONS

HISTORICAL SURVEY

Action of Sunlight.—The light which radiates from the great central body of our planetary system produces manifold effects upon the animate and inanimate world, some of which are at once evident to the senses, and have been known for thousands of years, while others, again, are not so apparent to the eye, and have been discovered, examined, and utilized only through the observations of modern times.

The first effect which every person, however uncultivated, notices when, after the darkness of night, the sun rises, is that bodies become visible. The rays from the source of light are thrown back (reflected) from various bodies, they reach our eyes, and produce an impression upon the retina, the result of which is the perception of material objects by the eye. But soon another effect is observed, not by the eye, but by the sense of feeling. The sun's rays not only illumine bodies upon which they fall, but heat them, as is felt when the hand is held in the rays. Both effects, the shining, or illuminating, and the warming effects of the sunbeams, differ very essentially from each other. The illuminating effect we perceive instantaneously; the heating effect is only felt after a certain time,

which may be shorter or longer, as the heating power of the sun is stronger or weaker.

In addition to these two effects of sunlight, there is a third, which generally requires a still longer period to make itself noticed, and cannot be directly perceived either by the eye or by the sense of feeling, but only by the peculiar changes which light produces in the material world. This is the chemical effect of light.

Physical v. Chemical Change.—If we take a piece of wood, and bend or saw it, we change its form ; if we rub it, it becomes warm—we change its temperature, but it still remains wood. These changes, which do not affect the substance or matter of a body, we term physical.

But if we set fire to a piece of wood, strong-smelling gases ascend, ashes are deposited, and a black residue remains, which is totally different from the wood. By this process a new substance—charcoal—has been produced. *Material* changes of this kind we term chemical changes ;—and such chemical changes are, in an especial manner, produced by heat. If, for instance, we heat a bright iron wire red hot, it undergoes apparently only a physical (not a material) change. But if we allow it to cool, we find the bright rod has become dull and black ; that it has acquired a brittle, black surface, which easily breaks away on bending the rod, and differs entirely from the bright, tough, flexible iron. Here again a chemical change—that is to say, a change of substance—has taken place ; the iron has been converted into another body, into iron scale, because it has combined with a component part of the surrounding air—with oxygen.

Chemical changes of this kind are not only produced by heat, but also by light.

Fading of Coloured Fabrics.—It has long been known that when the colours with which fabrics are dyed are not the so-called fast colours, they fade in the light—that is, become paler. In this case the colouring matter changes

into a colourless or differently coloured body ; and that this is the effect of light is evident from the fact that those parts of the material in question which are covered up from the light—beneath the folds, for example—remain unchanged. This effect of light upon colour has been long turned to practical use in the bleaching of linen. The unbleached fabric is spread out in the sunlight, and repeatedly moistened with water ; and thus, through the combined effect of light and moisture, the dark colouring substance becomes gradually soluble, and can then be removed from the linen by boiling it in alkaline lye.

It was formerly believed that the changes we have just described were caused by the heat which is produced in bodies by the sun's rays. That this is an erroneous view is evident from the fact that fabrics dyed in colours which are not fast can be exposed for months together in the temperature of a hot oven without any bleaching effect ; and further, that wax, which the sunlight likewise bleaches, becomes darker, rather than paler, through heat.

As we remarked before, the bleaching effect of sunlight is a slow process, and this circumstance renders the phenomenon less striking. A sudden and rapid occurrence surprises us, and stirs us up to inquire and to reflect.

Silver Chloride and Silver Nitrate.—In the mines of Freiberg is occasionally found a vitreous dull-shining silver ore, which, on account of its appearance, is called horn silver (chloride of silver).

This horn silver consists of silver and chlorine in chemical combination, and this compound can be artificially produced by passing chlorine gas over metallic silver, or by adding a solution of nitrate of silver to a solution of common salt (sodium chloride). This horn silver in its original position in the earth's crust is completely colourless, but when it is exposed to the daylight it assumes, in a few minutes, a violet tint.

In another substance containing silver this phenomenon

is still more apparent. Silver, placed in nitric acid, is dissolved with effervescence, and if the solution is evaporated, a solid mass of crystals is obtained. This is not silver, but a combination of this body with nitric acid. This nitrate of silver is totally different from ordinary silver; it is easily soluble in water; it has a bitter, disagreeable taste; it fuses readily and destroys organic matter; and it is therefore used as a corrosive agent, under the name of lunar caustic.

Fingers which have grasped lunar caustic, skin which has been cauterized by it, or in fact any light coloured objects sprinkled with a solution of it, quickly assume a dark colour. This can be at once observed by moistening a small piece of paper with a silver nitrate solution, allowing it to dry, and then placing it in the light.

Indelible Ink.—These properties were soon made use of to produce a so-called indelible ink, which is nothing more than a solution of one part of nitrate of silver in four parts of water, mixed with a thick solution of gum. Written characters traced with this ink upon linen cloth are pale; but, when dried in the sunlight, quickly become dark brown, and are not injured by washing. A quill, not a steel pen, must be used, as steel decomposes the nitrate of silver.

From the discovery of the blackening of paper saturated with lunar caustic to the invention of photography there was but a step; yet it was long before anyone thought of producing pictures by the help of light alone, and still longer before these attempts were crowned with success.

Experiments of Wedgwood and Davy.—Wedgwood, the son of the celebrated manufacturer of porcelain who produced the popular Wedgwood ware, and Davy, the celebrated chemist, made the first attempts in the year 1802. They placed flat bodies, such as the leaves of plants, upon paper prepared with nitrate of silver. Light was thus kept from the parts of the paper covered by the

objects, these parts remained white, whilst the uncovered portions of the paper were blackened by the light ; and thus was produced a white outline, or “ white silhouette,” of the superimposed objects upon a black ground (see figs. 1 and 2).

Wedgwood produced in this manner copies of drawings upon glass, in white lines upon a black ground ; and this process became the basis of a mode of treatment which attained great importance, under the name of the *lichtpau*s process.

Unfortunately these pictures were not durable. They

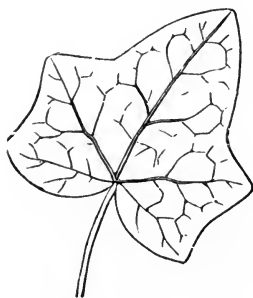

Fig. 1.



Fig. 2.

had to be kept in the dark, and could only be exhibited in a subdued light. If they remained long exposed to the light, the white parts also became black ; and thus the picture disappeared. No means were then known to make the pictures durable—that is to say, to make them unalterable by light, or, as we now say, to *fix* them. But the first step towards the discovery of photography was made ; and the idea of producing pictures of objects without the help of the draughtsman became, after these first attempts, so extremely attractive that, from that time, both in England and in France, a large number of private persons occupied themselves with the subject with the greatest enthusiasm.

It is clear that by the process of Wedgwood and Davy only flat bodies could be copied, and, notwithstanding all the improvements of which the process was still susceptible, it admitted of only a limited application.

The Camera Obscura.—But Wedgwood had already conceived the idea of the possibility of producing pictures of any bodies whatsoever by the action of light on sensitized paper. He tried to effect this by the aid of an interesting optical instrument which has the property of forming flat images of solid objects. This instrument is the camera obscura. The origin of this camera is by no means certain; it has been attributed by some to Leonardo da Vinci, and by others to Porta, and although there is no mention in their writings of any apparatus of this nature, it is probable that a form of this camera was introduced by da Vinci at the beginning of the sixteenth century, and an improved form by Porta about the middle of that century. That it was possible to project outside objects through a small hole into a darkened room was known by Euclid, and Levi ben Gerson appears to have made some apparatus at the beginning of the fourteenth century for this purpose. The first record of apparatus of this kind was Alberti's show-box somewhere about the year 1437, and the first instance in which a definite mention occurs of the use of a convex lens in connection with the camera appears to be in D. Barbaro's "Treatise on Perspective," 1568. The first portable camera obscura was in all probability made by Kepler.

The formation of the image by means of this instrument will be easily understood from the following brief description.

If a small hole be made in the window shutter of a completely darkened room on a sunny day, a clear image of the landscape will be seen on the opposite wall of the room.

Let a be a poplar, o the hole, and w the back wall of the

room, then from each point of the poplar rays of light will travel towards the hole, and beyond that in straight lines to the wall. It is now clear that to the point a' light can only arrive from the point a of the poplar, which is

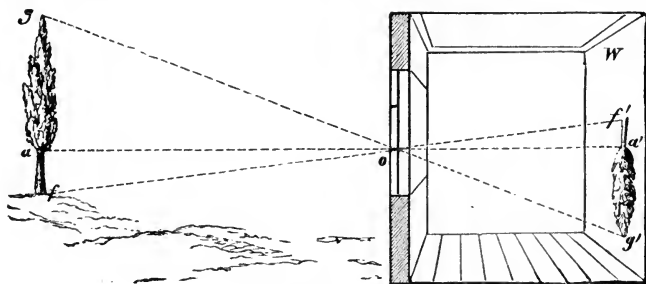

Fig. 3.

situated on the extension of the line $a'o$. Therefore this point of the wall can only reflect light, which in its colour and position corresponds to the point a . The same remark applies to the points f and g , and the result accordingly is that on the wall an inverted image of the tree is visible.

An improved instrument was soon obtained by using instead of the room a small box (fig. 4) which had a

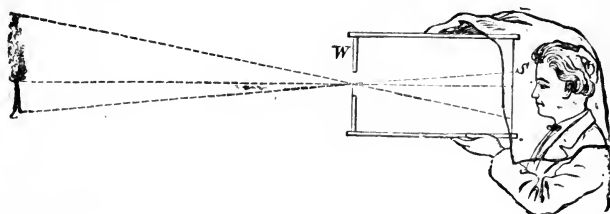

Fig. 4.

movable semi-transparent screen in place of the solid wall. On this screen the image of an object in front of the box is clearly visible, if a minute hole is made in the front side, which is best if composed of a thin tin plate. The light

should be excluded by covering the head with a black cloth, as indicated in the diagram.

These images appear still more beautiful if, instead of a hole, a glass lens is substituted. This lens, at a certain distance, which is equal to that of its focus, casts a distinct image of distant objects, which is much better defined and clearer than that which is produced by a hole.

In this improved form the instrument was employed by Wedgwood and Davy. Their idea was to fix on sensitized paper the image produced upon the screen. They fastened a piece of paper saturated with a silver salt upon the place of the image, and left it there for several hours—unfortunately without result. The image was not bright enough to make a visible impression upon the sensitized paper, or the paper was not sufficiently sensitive.

Action of Light on Asphalt—Nicophore Nièpce.—It now became necessary to find a more sensitive preparation to catch the indistinct image; and this was achieved by a Frenchman—Nicophore Nièpce. He had recourse to a very peculiar substance, the sensitiveness of which to light was before unknown to anyone—asphalt, or the bitumen of Judæa. This black mineral pitch, which is found near the Dead Sea, the Caspian, and many other places, is soluble in ethereal oils—such as oil of turpentine, oil of lavender—as well as in petroleum, ether, etc. If a solution of this substance is poured upon a metal plate, and allowed to cover the surface, a thin fluid coating adheres to it, which soon dries and leaves behind a thin brown film of asphalt. This film of asphalt does not become darker in the light, but it loses by light its property of solubility in ethereal oils.

If such a plate, therefore, is put in the place of the image on the camera obscura, the asphalt coating will remain soluble on all the dark places (shadows) of the image, whilst on the light spots it will become insoluble. The eye, it is true, does not perceive these changes; the plate,

after being exposed to the influence of light, appears the same as before the exposure. But if oil of lavender is poured over the coating of asphalt, it dissolves all the spots that have remained unchanged, and leaves behind all those that have been changed by light—that is, have been rendered insoluble. Thus, after several hours' exposure in the camera obscura, and subsequent treatment with ethereal oils, Nièpce succeeded, in fact, in obtaining a picture. This picture was very imperfect, it is true, but interesting as a first attempt to fix the images of the camera, and still more interesting as evidence that there are bodies which lose their solubility in the sunlight. This fact was again made use of long after the death of Nièpce, and it led to one of the finest applications of photography, that of heliography, or the combination of photography with copper-plate printing, which Nièpce himself, to all appearance, had already known.

From experiments which have been recently carried out by Dr V. Vojtěch it seems highly probable that this property of the insolubility of asphalt in turpentine after it has been exposed to light is entirely due to chemical changes, since no such action takes place when the asphalt is placed in an atmosphere of either nitrogen, carbon dioxide, or hydrogen during the exposure to light.

A Copper-plate Print.—A copper-plate print is produced thus :—A smooth plate of copper is engraved with the burin (or graving tool)—that is to say, the lines which should appear black in the picture are cut deeply in the plate. In producing impressions, ink is first rubbed into these cuts, and then a sheet of paper is placed upon the plate and subjected to the action of a roller press, whereby the ink is transferred to the paper and produces the copper-plate impression. Nièpce endeavoured to utilize light in producing these engraved copper-plates in place of the laborious process of cutting. To effect this he covered the copper-plate with asphalt, as before stated, and

exposed it to the light beneath a drawing on paper. In this case the black lines of the drawing kept back the light; and, accordingly, in these places the asphalt coating remained soluble; under the white paper, on the contrary, it became insoluble. Therefore, when lavender oil was afterwards poured over the plate, the parts of the asphalt which had become insoluble adhered to the plate, whilst the soluble parts were dissolved and removed, and the plate in those places was laid bare. Thus a film of asphalt, in which the original drawing appeared as if engraved, was obtained on the plate.

If a corrosive acid is now poured on such a plate, it can only act on the metal in those places where it is not protected by the asphalt; and in such places this metal plate was in fact eaten into. Thus an incised drawing upon a metal plate was produced by the corrosive action of the acid, and a plate was obtained which, after cleaning, could be used for printing like an engraved copper-plate. Copper-plate prints of this kind have been found amongst the papers left by Nièpce. These prints he called "heliographs," and he showed them to his friends as far back as 1826. This method, in an improved form, has been much used, especially in the printing of paper money, when it is requisite to produce a number of engraved plates which are all to be absolutely alike, so that one piece of paper money may perfectly correspond to another, and may therefore be distinguished from counterfeits.

Daguerre's Experiments.—Nièpce's impressions were undoubtedly very imperfect, and therefore remained unnoticed. He himself gave them up, and again entered upon a series of experiments to fix the charming images of the camera obscura. In 1829 Daguerre joined him; and both carried on experiments in common until 1833, when Nièpce died without having obtained the reward of his long-continued efforts. Daguerre went on with the experiments; and he would not, perhaps, have got further

than Niépce if a fortunate accident had not worked in his favour.

He made experiments with iodide of silver plates, which he produced by exposing silver plates to the vapour of iodine, a peculiar and very volatile chemical element. Under this treatment, the silver plate assumes a pale yellow colour, which is peculiar to the compound of iodine and silver. These plates of iodide of silver are sensitive to light, they take a brown colour when exposed to it, and thus an image is produced upon them when they are exposed to the action of light in the camera. A very long exposure to light, however, is necessary to accomplish this end; and the thought could scarcely have arisen of taking the likeness of any person in this manner, since he would have been obliged to remain motionless for hours.

One day Daguerre placed aside as useless, in a closet in which were some chemical substances, several plates that had been exposed too short a time to the light, and therefore as yet showed no image. After some time he happened to look at the plates, and was not a little astonished to see an image upon them. He immediately divined that this must have arisen through the operation on the plates of some chemical substance which was lying in the closet. He therefore proceeded to take out of the closet one chemical after the other, and placed there plates which had been exposed to the light, when, after remaining there some hours, images were again produced upon them. At length he thought that he had removed in succession all the chemical substances from the closet; and still images were produced upon the plates. He was now on the point of believing the closet to be bewitched, when he discovered on the floor a dish containing mercury, which he had hitherto overlooked. He conceived the notion that the vapour from this substance—for mercury gives off vapour even at an ordinary temperature—must have been the magic power which produced the image.

To test the accuracy of this supposition, he again took a plate that had been exposed to light for a short time in the camera obscura, and on which no image was yet visible. He exposed this plate to the vapour of mercury, and, to his intense delight, an image appeared, and the world was enriched by a most valuable discovery.

Compared with the beautiful pictures which it is possible to produce now by means of the prepared sensitized papers, daguerreotypes were but very poor productions. The appearance of these pictures was injured by the ugly mirror-like surface, which prevented a clear view of them. No such objections were felt in the year 1839, when Daguerre's discovery was first spread abroad by report. Pictures were said to be produced without a draughtsman by the operation of the sun's rays alone. That was of itself wonderful; but it was still more wonderful that, by the mysterious operation of light, every substance impressed its own image on the plate. How many extravagant hopes, how many evil prognostications, were associated with the report of this mysterious invention?

It was prophesied that painting would come to an end, and that artists would die of starvation.

Then came sceptics who declared the whole thing impossible. These persons were reduced to silence by the testimony of Humboldt, Biot, and Arago, the three celebrated scientific men to whom Daguerre disclosed his secret in 1838. The excitement grew. Through the influence of Arago an application was made to secure to Daguerre a yearly pension of 6000 francs, provided he made public his discovery. The French Chamber of Deputies agreed; and, after a long and tiresome delay, the discovery was at length disclosed to the expectant world.

It was at a memorable public *séance* of the French Academy of Sciences in the Palais Mazarin, on the 19th of August 1839, that Daguerre, in the presence of all the great authorities in art, science, and diplomacy,

who were then in Paris, illustrated his process by experiment.

Arago declared that "France had adopted this discovery, and was proud to hand it as a present to the whole world"; and henceforth, unhindered by the quackery of mystery, and unfettered by the right of patent,¹ the discovery of Daguerre made the round of the civilized world.

Daguerre quickly gathered round him a number of pupils from all quarters of the globe; and they transplanted the process to their homes, and became in their turn centres of activity, which daily added to the number of disciples of the art.

Sachse, a dealer in art living in Berlin, was initiated into Daguerre's discovery on the 22nd of April 1839, and was appointed Daguerre's agent in Germany. On the 22nd of September, four weeks after the publication of the discovery, Sachse had already produced the first picture at Berlin. These pictures were gazed at as wonders, and each copy was paid for at the rate of from £1 to £2; while original impressions of Daguerre fetched as much as £5. On the 30th of September Sachse made experiments in the Park of Charlottenburg, in the presence of King Friedrich Wilhelm the Fourth. In October the earliest types of Daguerre apparatus were being sold in Berlin. The first set of apparatus was purchased by Beuth for the Royal Academy of Industry at Berlin, and is still to be seen there. After the introduction of the apparatus, it was in the power of every one to carry out the system; and a great number of daguerreotypists started into existence.

The first objects photographed by Sachse were architectural views, statuary, and paintings, which for two years found a ready sale as curiosities. It was in 1840 that he first represented groups of living persons, and in

¹ It was only in England that the process was patented, before its publication, on the 15th of July 1839.

this way photography became especially an art of portraiture. It made the taking of portraits its principal means of support, and in two years there were daguerreotypists in all the capitals of Europe.

In America a painter, Professor Morse, afterwards the inventor of the Morse telegraph, was the first to prepare daguerreotypes ; and his coadjutor was Professor Draper.

The Daguerreotype.—Let us now consider more closely the process employed in producing daguerreotype plates. A silver plate, or in the place of it a silver-plated copper-plate, serves to receive the image. It is rubbed smooth by means of tripoli and olive oil ; and then receives its highest polish with rouge and water and cotton-wool. It is only a perfectly polished plate that can be used for the process. This burnished plate is placed with its polished side downward upon an open square box, the bottom of which is strewn with a thin layer of iodine. This iodine evaporates, its vapour comes into contact with the silver, and instantly combine with it. By this means the plate first assumes a yellow straw-colour, next red, then violet, and lastly blue. The plate, protected from the light, is then placed in the camera obscura, where the image on the ground-glass slide is visible, and “exposed” for a certain time. It is afterwards brought back into the dark, and put into a second box, upon the metal floor of which there is mercury. This mercury is slightly warmed by means of a spirit lamp. At first no trace of the image is visible on the plate. This does not appear until the mercury vapour is condensed on those parts of the plate which have been affected by the light ; and this condensation is in proportion to the change which the light has caused. During this process the mercury is condensed into very minute white globules, which can be very well discerned under the microscope. This operation is called the development of the picture.

After the development the remaining iodide of silver,

which is still sensitive to light, must be removed to render the image durable—that is, “to fix it.” This is effected by using a solution of hypo-sulphite of soda, which dissolves the iodide of silver. Nothing more is required after this than to wash with water and dry, and the daguerreotype is completed. Sometimes, in order to protect the picture, it was customary to gild it. A solution of chloride of gold was poured over, and then it was warmed; a thin film of gold was deposited, which contributed essentially to the durability of the pictures. A picture of this nature, however, is easily injured, and requires the protection of frame and glass.

Daguerre’s first pictures needed an exposure of twenty minutes—too long for taking portraits. But soon after it was found that bromine, an element having many points of resemblance with iodine, employed in combination with the latter, produced much more sensitive plates, which required far less time, perhaps not more than from one to two minutes, for exposure.

In the early period of photography persons were obliged to sit in the full sunlight, and allow the dazzling rays to fall directly upon the face—a torture which is clearly marked and visible on the portraits still preserved of these photographic victims, in the blackened shadows, the distorted muscles, and the half-closed eyes. These caricatures could certainly not bear any comparison with a good drawing from life, nor probably would portrait-photography have ever succeeded if it had not become possible to obtain good results in a moderated light. This was attained by the invention of a new lens—the double objective portrait lens of Professor Petzval, of Vienna.

This new lens was distinguished by the fact that it produced a much brighter picture than the old lens of Daguerre, so that it was now possible to take less dazzlingly illuminated objects. This lens was invented by Petzval in 1841. Voigtländer ground the lens according to his

directions, and soon one of Voigtländer's lenses became indispensable to every daguerreotypist. By employing bromide with iodide of silver, and Voigtländer's lens, the exposure was reduced to seconds.

The daguerreotype art had therewith reached its zenith. However delicate the pictures so produced appeared, it was found, after the first enthusiasm had gone and had given place to a cold spirit of criticism, that much still remained to be desired.

First, the glare of the pictures made it difficult to look at them. Then there were several marked deviations from nature : yellow objects often produced little or no effect, and appeared black ; on the other hand, blue objects, which appear dark to the eye, frequently, though not always, came out white.

Thus a well-grounded æsthetic objection was brought against these pictures.

It was indisputable that the daguerreotype greatly surpassed painting in the wonderful clearness of detail, and the fabulous truthfulness with which it reproduced the outlines of objects. The daguerreotype plate gave more than the artist, but for that very reason it gave too much. It reproduced the subordinate objects as faithfully as the principal object in the picture.

The artist of merit has no cause to fear photography. On the contrary, it proves advantageous to him by the fabulous fidelity of its drawing—through it he learns to reproduce the outline of things correctly—nor can it be disputed that, since the invention of photography, a decidedly closer study of nature and a greater truthfulness are visible in the works of our ablest painters.

We shall see further on, how even photography appropriated the æsthetic principles according to which painters proceed in preparing their portraits, and how thereby a certain artistic stamp was given to these productions, which raised them far above those of the early period.

But this result was only possible when the technical part of photography had been brought to perfection, and a material better adapted to artistic work than an unyielding silver plate had been introduced.

Experiments of Fox Talbot.—In the same year that Daguerre published his process for the production of images on silver plates, Fox Talbot gave to the world a process for preparing drawings on paper by the help of light. Talbot was an English gentleman of fortune, who, like many Englishmen of leisure and means, employed his time in scientific observations. He plunged paper into a solution of common salt, dried it, and then put it into a solution of silver. In this way he obtained a paper which was much more sensitive to light than that employed by Wedgwood. He employed this paper in copying the leaves of plants. Talbot himself says, “Nothing gives more beautiful copies of leaves, flowers, etc., than this paper, especially under the summer sun; the light works through the leaves, and copies even the minutest veins.”

The pictures copied in this way in the sunlight are naturally not durable, because the paper still contains salts of silver, and is therefore sensitive to light. But Talbot offered the means of fixing the pictures—he plunged them in a hot solution of common salt; in this way the greater part of the silver salts was removed, and the pictures did not blacken to any considerable extent in the light.

The celebrated Sir John Herschel carried out this fixing process even more successfully by plunging the pictures into a solution of hypo-sulphite of soda. This salt, which dissolves the salts of silver, was at that time very expensive, costing six shillings per pound.

By this means the production of a durable sun-picture on paper, which Wedgwood had in vain attempted, was rendered possible. This method gave, indeed, only pictures of flat objects which could be easily pressed

on paper ; for instance, leaves of plants, patterns of stuffs, etc.

*Lichtpau*s Process.—The process was again resumed, under the name of *lichtpau*s papier, after it had almost been forgotten. We give (in Fig. 5) a faithful imitation of one of these leaf-prints which were at the time very popular in America. The leaves—such as ferns and the like—were suitably chosen, pressed between blotting paper



Fig. 5.

and dried, then gummed on one side and arranged upon a glass plate in a small printing frame. As soon as the whole was dry the print could be commenced.

To many persons this process appeared only an agreeable pastime, but it soon gained an increasing importance as an aid in copying drawings, maps, plans, copper-plate impressions, and so forth.

This work of copying, which used to cost the artisan and artist many hours of time and labour, and yet was after all inaccurate, can be accomplished with the least possible trouble by the help of the process described above.

In this copying process a drawing was placed on a piece of sensitized paper, and, after being firmly pressed by a glass plate, exposed to the light. The light penetrates through all the white spots of the drawing, and colours brown those parts of the paper lying under them ; whilst the black lines of the drawing keep back the light, and

thus the underlying paper remains white in these places. Therefore, if sufficient time is given for the operation of the light, a white copy on a dark brown ground is obtained in this manner, which is fixed and washed exactly like the leaf-prints described above. This copy is reversed with reference to the original, like an object and its reflection in a mirror ; in other respects it is a faithful representation, stroke for stroke.

The largest as well as the smallest drawing could be copied equally well, copies several feet square often being made. Large printing frames were used for this purpose, and large wooden dishes covered with a coating of asphalt were employed for fixing and washing the prints. This operation was known by the name of the *lichtpau* process. The black copy is, of course, a negative picture, but a white copy could be prepared from this by placing it upon the sensitized paper ; then the light shines through all the white lines, and colours the paper lying under them of a dark hue, whilst it remains white under the dark places of the negative. In this manner a picture called a positive was produced, which perfectly resembled the original. The washing and fixing were carried out just as with the negative. Fig. 6 represents a positive of this kind taken from the negative (fig. 5).

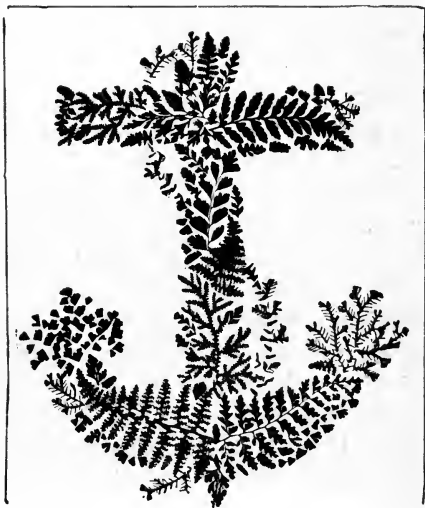

Fig. 6.

This process made relatively little progress for more than thirty years after the experiments of Talbot. The explanation of this fact is, no doubt, to be found in the circumstance that the paper prints were, as then made, not very distinct, being often rendered worthless by spots and stains. Another reason is that the preparation of the paper required especial care, and therefore frequently failed to give good results in the hands of the inexperienced. Further, the papers prepared according to this method soon spoiled, and had on that account to be used immediately after their preparation. These disadvantages were removed by the invention of Romain Talbot's *lichtpau*s paper, which was sold ready prepared and could be kept for months ; and by this means the process became much more widely used.

Talbot's Paper for Camera Obscura.—Talbot, the inventor of this paper process, carried out further researches, in the endeavour to represent on paper, by the help of the camera obscura, objects which cannot be pressed upon sensitized paper—for example, a person or a landscape.

He attained this object two years after Daguerre's discovery, by means of paper prepared with iodide of silver.

He dipped paper in a solution of nitrate of silver, and then in a solution of iodide of potassium. He thus obtained a slightly sensitive paper, but one that could always be rendered very sensitive, by plunging it into a solution of gallate of silver.¹

When this paper was exposed to the light in the camera obscura, a picture was not at once formed—this was only clearly developed after lying some time in the dark, or by subsequent treatment with gallate of silver—but it came out as a negative, and not as a positive. Thus, for example, in taking a portrait, the shirt appeared black, also the face ; while the black coat, on the contrary, came out white.

¹ The nature of this peculiar process is explained further on.

The picture was fixed by plunging it in a solution of hypo-sulphite of soda.

The negative thus obtained is a picture on a plane surface of a solid object, and Talbot prepared positive pictures from negatives of this kind.

He placed the negative upon a piece of sensitized paper prepared with chloride of silver, as previously described, and allowed the light to act upon it. This shone through the white places of the negative, and imparted a dark colour to those parts of the sensitized paper lying under them, while the dark places of the negative protected the paper lying under them from the effects of the light. Thus he obtained a positive picture from a negative. He could repeat the process as often as he pleased, and therefore was in a position to prepare, by the aid of light, many positives from a single negative. Photography was thus classed among the arts that multiply copies, and this circumstance exercised an important result on its future development.

Daguerre's method only gave a single picture at a time ; if more were required, the person had to sit several times. In Talbot's method a single sitting sufficed to produce hundreds of pictures.

It must be admitted that the earlier pictures of the Talbot process were not remarkably engaging. Every roughness of the paper and each small speck of dirt were imprinted on the positive, which on this account could not be compared in point of delicacy with the fine daguerreotypes ; but the method was soon improved.

Experiments of Nièpce de St Victor.—Nièpce de St Victor, nephew of Nicophore Nièpce, the friend of Daguerre, conceived the happy idea of substituting glass for paper in the preparation of the negative. He coated glass plates with a solution of albumen in which iodide of potassium was dissolved.

A solution of this kind can be easily prepared by

beating up white of egg to the consistency of snow, and allowing it to settle. The glass plates, after being coated with this solution, were dried, and then dipped into a solution of nitrate of silver. Iodide of silver was formed in this manner—the coating turned yellow, and became very sensitive to light.

Nièpce put these glass plates in the place of the image in the camera obscura, and suffered the light to act upon them.

No change was at first visible, but one became clearly perceptible when the picture was immersed in a solution of gallic acid. Thus Nièpce obtained a negative on glass without the blemishes which appeared on the paper negatives.

He prepared prints from this negative by exactly the same process that had been employed by Fox Talbot.

Nièpce invented his method in 1847. It excited much attention, but had its drawbacks: the preparation of the albumen and the treatment with salts of silver and gallic acid was a dirty process. Therefore the method appeared to those who had been accustomed to the daguerreotype, dirty and unpleasant, and many were deterred from trying it.

On the other hand, the advantages of the new process in multiplying prints were so evident that it could not be overlooked; therefore, even those who had an objection to soiling their fingers nevertheless zealously devoted themselves to the work.

The readiness with which albumen decomposes was, however, a great disadvantage in the new process. Hence the experimenters sought to avoid this by adopting a more durable substance.

Discovery of Collodion.—This was afforded by the discovery of gun-cotton made by Schönbein and Böttcher in 1847. Schönbein found that ordinary cotton-wool dipped in a mixture of nitric and sulphuric acids assumes

explosive properties similar to those of gunpowder. It was conceived that this substance would be an important substitute for gunpowder, but it was soon found that its explosive property was very unequal, being sometimes too strong and at other times too weak. On the other hand, another very useful property of this substance was observed—its solubility in a mixture of alcohol and ether. This solution leaves behind it a transparent membrane forming an excellent sticking-plaster for wounds. Thus the same substance that was destined to be a substitute for gunpowder, as a destructive agent for producing wounds, became actually a remedy for the latter.

This solution of gun-cotton was called collodion. In recent years, owing to the work of Count Hilaire de Chardonnet and others, this property has been made use of in the preparation of artificial silk from cotton and wood-pulp, which latter, being mainly composed of cellulose, behaves in a similar manner to cotton when subjected to the above treatment.

The thought occurred to several photographic experimenters to try this substance instead of the white of egg, as a coating for glass plates ; but the attempts did not at first lead to any satisfactory results. At length Archer published in England a full description of a collodion negative process surpassing in the beauty of its results, in simplicity and certainty, Nièpce's white of egg process.

Archer's Experiments.—Archer coated glass plates with collodion, in which an iodide had been dissolved ; he immersed this in a solution of nitrate of silver, and thus obtained a membrane of collodion impregnated with sensitive iodide of silver, which he then exposed in the camera.

The invisible change produced by the light became visible on pouring gallic acid, or the still more powerful chemical agent, pyrogallic acid, over the plate ; or, instead

of this, a solution of proto-sulphate of iron could be used if desired.

Very delicate, clear negatives were obtained by this process, which yielded much more beautiful paper prints than the original paper negatives of Talbot. A very essential improvement was subsequently made in the preparation of photographic paper by coating it with white of egg, according to the process of Nièpce de St Victor. This gave the paper a brilliant surface, and a warmer and more beautiful tone to the prints upon it, thus giving the pictures a brighter appearance than those produced upon the ordinary paper.

Thus Talbot's process, which at first seemed hardly worth notice compared with that of Daguerre, was gradually so perfected by successive improvements that it ultimately took precedence of Daguerre's. After 1853, paper pictures from collodion negatives came more and more into vogue, whilst the demand for daguerreotypes fell off, and the production of the latter soon ceased altogether, except in some few places in America.

Wet Plate Process.—As the wet plate process is now very little used except in the studios of process block manufacturers, it might be of interest to give at some length an account of the various operations to which the plate was subjected in preparing a negative by this old method. The preparation of the plate must take place in the dark room, a yellowish light being used.

The first operation required in preparing a sensitive plate—an operation which requires great care—is the cleaning of the glass. The plates, after being cut by the diamond, are placed for some hours in nitric acid, which destroys all impurities adhering to the surface. The acid is removed by washing, and the plate is then dried with a clean cloth. To the uninitiated it would then appear perfectly clean, but it must be subjected to further polishing, by rubbing with a few drops of spirits of wine ;

or, still better, of ammonia. The slightest touch with the finger or rub of the sleeve, the smallest drop of saliva which might chance to escape from the mouth in coughing, would spoil the polished surface; nay, even the atmospheric air produces with time the same effect. If a cleaned plate is left only twenty-four hours in the air, it gradually condenses vapours on its surface, and another cleansing is rendered necessary.

The cleaned glass is then coated with collodion. The collodion itself is, as we know, a solution of nitro-cellulose in a mixture of alcohol and ether, in which certain iodides and bromides—for instance, iodide of potassium and bromide of cadmium—have been dissolved. This solution must also be prepared with the greatest attention to cleanliness. The purity of the materials employed is likewise of the greatest importance. The solution must be allowed to stand a long time, and carefully poured off from any sediment. The coating of a plate with collodion requires a certain manual dexterity, and only succeeds with those who have witnessed the process and had some practice.

It is usual to hold the plate horizontally by one corner, or by a pneumatic holder under the centre of the plate, and to pour over the centre of it a pool of the thick fluid, and then to allow this to flow to all the four corners in succession by a gentle inclination of the plate, ultimately pouring off the superfluous fluid at one of the corners.

A considerable part of the fluid originally poured upon it remains, and adheres to the plate.

Whilst pouring off the excess of collodion streaks are liable to be formed, which would spoil the picture; to avoid this, the plate whilst being drained must be constantly kept in motion until the last drop has run off. The fluid stiffens into a soft, moist, spongy film. At this moment the plate must at once be immersed in the solution of nitrate of silver (called the silver bath).

And now a peculiar action of the fluids takes place, for the ether in the collodion film repels like fat the aqueous solution of silver, and a steady movement of the plate in the bath is necessary in order to make the solution adhere to the film.

This mechanical operation is accompanied simultaneously by a chemical change. The iodides and bromides in the film undergo a double decomposition with the nitrate of silver of the bath, with formation of iodide and bromide of silver and nitrates of the metals previously combined with the iodine and bromine. The iodide and bromide of silver colour the film yellow; and now the plate is ready to be exposed in the camera.

When the exposure has been accomplished the sensitive plate is brought back into the dark room. For the purpose of transporting and exposing the plate, which must of course be guarded very carefully from the daylight, a flat frame called the dark slide is employed. This dark slide differs slightly from those now used with dry plates, as will be seen from the following description and fig. 7. At the back of this slide is a door *D* opening upon hinges, and in front there is a sliding shutter *H*. In the corners are fixed four silver wires *d, d, d, d*, upon which the plate rests with its prepared side downwards, being held steadily in its place by a spring *f f*, fastened to the door *D*. The plate is carried in the dark slide to the camera and substituted for the movable ground-glass screen upon which the image of the object has been previously focussed. After the exposure the dark slide is removed from the camera and taken back to the dark room.

And now follows one of the most important operations, the development of the picture. Upon the plate there is as yet no trace of a picture visible. The action of the light produces a peculiar change of the iodide of silver which forms the important constituent of the film; this iodide acquires through the light the property of attract-

ing silver, if this is precipitated on the film ; this precipitate is produced by the following operation. If a silver solution is mixed with a very dilute solution of proto-sulphate of iron, there results by slow degrees a precipitate of metallic silver—not, however, as a shining mass, but as a grey powder. Now, a small quantity of the nitrate of silver solution from the bath always adheres to the film. If, therefore, a solution of proto-sulphate of iron is poured upon it, a silver precipitate is formed, and the picture suddenly makes its appearance, owing to the silver adhering to those parts affected by the light.

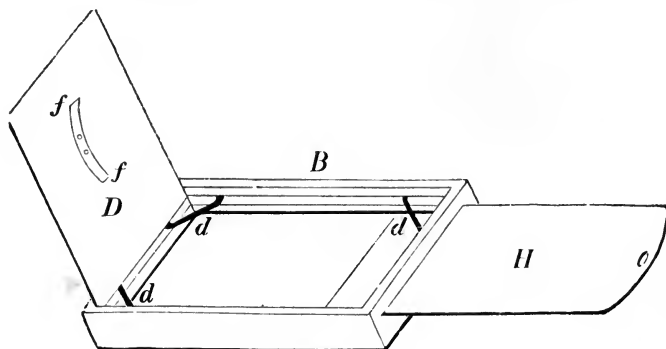

Fig. 7.

The features of a portrait that are first visible are the lightest—the shirt, then the face, and lastly the black coat. The negative thus obtained, however, is by no means completed by this operation.

The picture is usually too transparent to answer for the production of paper prints ; for the preparation of such a print depends upon the light shining through the transparent places of the negative, and colouring dark the paper beneath, while it fails to penetrate the parts which have to remain white. The opaque and transparent parts of the negative must be in sufficient contrast with each other to produce this effect.

The negative must, therefore, be more strongly defined, and this is produced by repeating the developing process. A mixture of solutions of green vitriol and of nitrate of silver is poured upon the picture, a silver precipitate is again formed on it, which adheres only to the dark parts of the negative, giving them a greater density. If the plate is not perfectly clean, silver is precipitated, in the processes of developing and intensifying, upon the dirt stains and produces spots. After the further development of the picture, or the so-called *intensifying process*, has been completed, it is only necessary to remove the iodide of silver, which diminishes the transparency of the clear parts of the plate. For this purpose a solution of hyposulphite of soda is poured on the plate. This salt has the property of dissolving salts of silver, which are insoluble in water, so that the iodide of silver vanishes under the influence of this solution. This is the fixing process. Lastly, the plate is washed and dried.

It must be borne in mind that all these different operations are performed on a film liable to be injured by the slightest touch.

Even when dried the picture is very liable to injury ; and therefore it is necessary, in order to protect it, to cover it with a varnish—that is, with a solution of a resin, such as shellac or sandarach, in spirits of wine. The fragile glass negative is therewith brought to completion.

The chief requisite for the success of these operations is routine ; accuracy is only attained by practising each part of the process. Faults that are made in any single operation are, as a general rule, irremediable ; and therefore it is absolutely essential to avoid them.

It was next necessary to obtain a positive from the negative. The old Talbot method was employed for that purpose. The positive was neither a correct nor an agreeable picture of the object, but often showed considerable

departure from nature, and was often inaccurate by giving too much prominence to accessories.

In the first period of photography these departures were overlooked. Everyone was content to possess a portrait which at least showed the outlines correctly; and what was defective in the negative it was sought to remedy by retouching the positive. But this made the pictures dear; and as it began to be the custom to order pictures by the dozen, the endeavour was made to evade this labour, which had to be applied to each individual picture, by carrying it out in the negative.

A single retouched negative gave any number of corrected prints which did not require to be retouched, and thus retouching negatives became the first and most important operation in producing a faithful and agreeable picture. The essential characteristic of this operation consists in entirely covering many parts. For example, the freckles and warts which are white in the negative are entirely removed by a pencil, or by spots of Indian ink. Other parts—for example, the ill-defined details of the hair—are brought out by pencil strokes. Many hard shadows, such as the wrinkles in the face, are softened off by slight touches of Indian ink. It must be constantly borne in mind during this operation that all the dark lines which the painter draws on the negative will appear light in the positive.

It is requisite, therefore, for successful retouching to know how to use the pencil and brush so as to produce the desired effect in the positive. The best draughtsman or painter is therefore far from being qualified for retouching a negative.

It is to be remarked that the negative retouch may, under certain circumstances, go too far.

Printing-out Paper.—In these early days the printing-out paper had to be made by those wishing to use it. The method of doing this was as follows :—

A piece of paper coated with white of egg and moistened with a solution of common salt is laid in a dish on a solution of nitrate of silver, and allowed to remain for about a minute. The solution is absorbed by the floating paper, and chloride of silver is formed by double decomposition of the nitrate of silver with the common salt.

The wet paper is but slightly sensitive; it becomes fully sensitive only after being dried. The dry paper, saturated with chloride and nitrate of silver, is then pressed upon the negative in the printing frame (fig. 8). Then the whole is exposed to the light. The same process

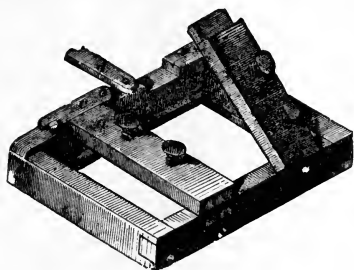

Fig. 8.

ensues which we have described in the part dealing with *lichtpau*s paper; the light shines through the clear places of the negative and colours the paper lying under them dark, the paper under the dark places of the negative remains white, while it assumes a slight colour under the half-tones. In this manner a faithful

positive copy of the negative is produced, presenting a beautiful violet-brown tint. We know from the description of the *lichtpau*s process that this print would not remain unaltered in the light for long, because the paper is still sensitive to light. The salts of silver contained in it must be removed if the impression is to be made lasting. To this end a solution of hypo-sulphite of soda is employed. If the prints be immersed in this solution, they become durable in the light; but, unfortunately, they suffer a peculiar change of colour, assuming an ugly brown tint. This tint is of no consequence in technical and scientific pictures, but detracts greatly from portraits and landscapes; and in order to give these a more agreeable tint, before fixing

them, they are immersed in a dilute solution of chloride of gold. This process is called toning.

Toning of Prints.—In this operation gold is precipitated on the picture, giving it a bluish shade ; and now the tone of the picture is not essentially altered by hypo-sulphite of soda.

The picture thus produced consists partly of gold, partly of silver, in a finely divided state, and only requires to be thoroughly washed in order to become perfectly permanent. If this washing is omitted, small particles of hypo-sulphite remain behind, which decompose and form on the picture yellow sulphide of silver. This accounts for the circumstance that the pictures of an earlier period, when from ignorance of this fact this thorough washing was neglected, so often became faded and yellow.

It is surprising what a small amount of silver and gold is required to give an intense colour to a whole sheet of paper. For in a sheet of perfectly blackened paper 44×47 centimetres there is only 0.15 gramme of silver, and in a photograph of the same size only 0.075 gramme ; in a carte de visite but 0.002 gramme.

It must be here remarked that prints bleach a little in the fixing process ; and hence the photographer usually lets the prints become darker than they are to remain. Thus even the printing process requires a practised eye, simple as it may appear.

Vignetting.—In certain cases tricks of art were employed then as now to produce agreeable effects, and among these is that of vignetting. Our readers are no doubt well acquainted with portraits on a white ground, the outlines of which gradually become confounded with the ground tint of the picture. This effect is produced in a very simple manner by placing what is called a mask over the copying frame. This mask is a piece of metal or cardboard (fig. 9) in which an oval hole *b* is cut. This is placed on the printing frame

$K K$, so that the part of the negative which is to be printed lies perpendicularly under it. This part is then acted upon by the broad perpendicular bundles of light $S S$, and intensely coloured, while the marginal parts lying under the mask are affected only by the narrow slanting pencils, $S' S'$, and therefore are coloured less intensely in proportion to their distance from the hole of the mask. Thus a gently vanishing margin is produced, looking very artistic, and yet only the result of a very simple trick of art.

The First Dry Plate.—As the chemical action of light upon the salts of silver became better known, it was found possible to prepare a sensitive plate and to delay using it

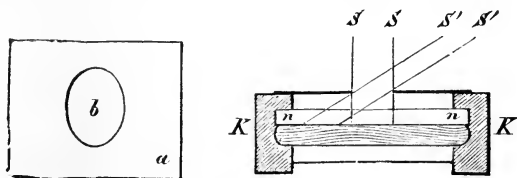

Fig. 9.

until after it was dry, and, in fact, had been kept some time. It was discovered that if bodies were present which could unite with the iodine of the silver iodide, then that substance was decomposed very much quicker by light than when the pure salt alone was present. Among these bodies were found to be such substances as extract of coffee or tea, morphine, and tannin, and it was by the aid of these that the early photographic dry plates were prepared. The method adopted with these plates was to wash away the nitrate of silver adhering to the moist plate, and then to coat the plate with a solution of either tannin or morphine. Such coatings can dry up without injury to the film of iodide of silver, and so a durable dry plate was obtained. The sensitiveness of these plates was considerably less than that of the moist plates. The

development of dry plates of this kind was commonly effected with pyrogallic acid. This substance is obtained by dry distillation of the gall-nut. It has a powerfully reducing action—that is, it precipitates metallic silver from silver solutions, exactly as green vitriol does.

But pyrogallic acid alone is not able to bring out an image on such an exposed dry plate, because another substance is necessary to yield the silver. This substance, viz., a solution of silver, is found on the plates themselves when they are wet. But in the case of these dry plates, the silver salt has been washed off; therefore mixed solutions of pyrogallic acid and nitrate of silver had to be employed as developer. Finely divided silver is precipitated, adheres to the exposed places, and thus brings out the image. Nevertheless, dry plates did not at first give such beautiful and secure results as moist plates.

Experiments of Carey Lea and others.—The first step towards perfecting dry plates was taken by Carey Lea. He found that the preparation of dry plates could be essentially simplified by producing the sensitive salts of silver in the collodion itself. He also found that bromide of silver gave more sensitive dry plates than iodide of silver, when a different developer was used. His mode of preparing dry plates depended, therefore, on the production of bromide of silver in collodion. He dissolved bromine salts in collodion, added a solution of silver, and thus produced silver bromide, which remained suspended in the glutinous medium, forming what was termed the *emulsion*. The superfluous salts were removed by washing with pure water, after the mixture had been left to dry in shallow saucers. This film, after being again dried, was dissolved in alcoholic ether, and gave a pure emulsion which dried instantly on the plates. The sensitiveness of these dry plates was about one-fourth as great as that of a wet iodized collodion plate.

The process of developing these dry plates, however,

is different from that described on p. 33. They are not developed by precipitating silver which adheres to the exposed spots, but by a process of reduction acting directly on the exposed portions of the bromide of silver and reducing it to metal. This was effected by washing with a very powerful reducing agent, such as pyrogallic acid mixed with ammonia (known as the alkaline or chemical developer), or by potassio-ferrous oxalate.

This emulsion process with bromide of silver was an important step ; still, the sensitiveness of the plates thus obtained was not high enough for them to compete successfully with the wet plates. This was not achieved till a new vehicle was adopted for the application of the bromide of silver—namely, gelatine. By dissolving gelatine and bromide of potassium in warm water, and adding a solution of silver, bromide of silver is formed, which remains suspended in the mucilaginous fluid. This, when cold, becomes rigid, and can then be cut up and washed with cold water to remove the superfluous salts ; warmth again causes it to dissolve, and it is applied to the glass plates in a horizontal position. The film soon sets, but it takes much longer to dry than a collodion film—twenty-four hours, or more.

This process would scarcely have excited any attention as compared with the use of collodion, but that it was discovered that the sensitiveness of these plates under certain conditions was as great as that of wet plates, and that this sensitiveness of the gelatine emulsion could be greatly increased simply by long warming. In fact, plates thus prepared were more than ten times as sensitive as collodion plates. This, which was discovered by Bennett in 1878, soon made gelatine plates extremely popular.

The plates were first of all manufactured on a large scale in England, and afterwards on the Continent.

This chapter has been devoted almost exclusively to the historical development of photography. Many of the

processes mentioned are not now in general use, but it is always instructive to try to follow the lines of growth of any art or science, as the reasons for the modern improvements then become the more apparent, and a better general grasp of the whole subject is the result.

THE CHEMICAL ACTION OF LIGHT

Light Waves.—Two sciences join hands to accomplish the wonders of photography. One is Optics, a division of Physics, and the other Chemistry. These alone are inadequate to fulfil the requirements of photography. Æsthetical claims have to be considered; and thus photography unites in itself the provinces of natural science and of the fine arts which at first sight seem remote and incapable of union. We shall consider first the principles of optics—that is, light—as the force which occasions the chemical changes in photography. We shall see that its chemical operations have not only become the basis of our art, but that they have played, and still play, a much more important part in the development of our planet.

We are aware of the existence of sun, moon, and planets. We know their distance; nay more, we know their elements, though we are separated from them by millions of miles.

We are indebted for all this knowledge to waves of light which come to us from these far-off bodies. In order that such waves may be transmitted from one place to another, it is necessary to assume the existence of some intervening medium.

Such a medium, to fulfil the requirements of a transmitter of light waves, must fill all space, have no weight, and yet be capable of acting in all respects like a perfect elastic, incompressible fluid. To this medium we give the name of *The Ether*.

If we throw a stone into water, waves are produced—that is, circles or rings of hills and valleys are formed,

which appear to widen out from a centre, and as they extend become gradually less prominent, until they finally disappear. If several stones are thrown at the same time into the water, each of them forms its own system of waves. These intersect each other in the most intricate manner; and, although an apparent confusion of rings takes place, it is wonderful that none of them disturbs the other, and that each circle widens out regularly from its own centre, where the stone fell into the water.

If a handful of sand, which contains many thousand grains, is thrown into water, and if the attention be directed to the undulations of a single grain, it will be remarked that this one, without being affected by the countless other waves, widens out in a regular circle.

These undulations are one of the most remarkable movements in nature, taking place not only in water, but in a modified form in the air, where they occasion the propagation of sound.

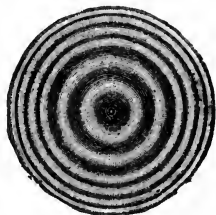

Fig. 10.

The peculiar feature of the undulatory movement consists in the fluid appearing to advance without really doing so. If, sitting on the side of a sheet of water, we see an undulation approach, it appears exactly as if the particles of water were approaching us from the origin of the movement.

It is easy to prove that this is an error by throwing sawdust or a piece of wood into the water. It dances up and down upon the ripples without moving from the spot. Indeed, the undulation is itself only an up and down motion of the particles of the water, and this movement is communicated further and further to the neighbouring particles.

Exactly in the same manner light spreads in undulations from a luminous body through the ether of space in all

directions. The direction of the propagation of the undulation we call a ray of light. We perceive it as soon as it reaches our eye, because the vibrating ether affects our retina.

Now, we know that the undulations of sound are able to set other bodies in motion. If the *A* string of a violin is struck, the *A* string of a piano standing near sounds distinctly with it. Nay, even if the damper of a piano is raised and any note be sung, instantly the string of the piano which has the same tone sounds. The same thing happens with a glass bell of the same tone. There are people even who can break a glass by a shrill tone of their voice. The glass is so shaken by the violent undulations communicated to it by the air, that it falls to pieces. Under such circumstances, it need not surprise us that the undulations of light agitate bodies so forcibly that they fall to pieces.

Realgar offers the most remarkable example of this kind. This is a beautiful mineral of a ruby red colour, in the form of splendid crystals composed of sulphur and arsenic. If a crystal of this kind be exposed for months to the light, it falls into powder; and in this way many very fine pieces of this beautiful mineral have been lost in the mineralogical museum of Berlin.

This is only a mechanical, and not a chemical, operation of light; but it gives an insight into its chemical action. Heat occasions chemical decomposition by expanding bodies, and thereby removing their atoms so far apart that the chemical power which unites them loses effect, and the component parts separate. Thus oxide of mercury is by heat resolved into its constituent parts, mercury and oxygen.

Decomposition is effected by light when the atoms of a body are agitated by its undulations—that is to say, are made to vibrate; and if these vibrations cause a separation of the parts to take place, the body falls to pieces.

Light waves are not a fiction. Not only has their existence been ascertained, but their size has been determined. The latter is extremely minute, but nevertheless is susceptible of measurement.

Analogy between Waves of Light and Waves of Sound.—The waves of sound and the waves of light have therefore a certain analogy; and as there are different notes in music, so are there different colours in light. The number of notes is great. The simplest piano now has six or more octaves, and there are other tones below and above these. But the number of colours is small; only seven of them can be distinguished—red, orange, yellow, green, blue, dark blue, and violet—the well-known colours of the rainbow. The painter, indeed, contents himself with three ground tints—yellow, blue, and red. All the others are the result of their mixture; and the large scale of colour of the painter consists not of simple tones of colour, but of what may be called chords of colour.

The deep tones of music are caused by few undulations occurring per second, the higher tones by more. For example, an \bar{a} string makes 420 vibrations in a second, the a an octave lower makes 210, the A 105.

In light, red is the colour which is produced by the slowest vibrations; it is the lowest tone in colours, and violet is the highest, being produced by vibrations nearly twice as rapid as red. With regard to tones, we know that they all spread with equal rapidity in the air; if this were not the case, a piece of music would be heard in the distance as a most disagreeable discord.

It is the same in the kingdom of light—the colours, without exception, are propagated through the ether with equal rapidity, the red as fast as the violet. But, whilst sound passes over only 1100 feet in the second, light traverses about 186,000 miles in the same time, and the deepest colour-tone—red—requires in a second 420 billion of vibrations—that is to say, a million times

a million as many as the tone which is marked in music with a bar over the \bar{a} ,¹ that is,

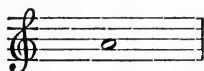

The small number of the colour-tones compared with the large number of musical tones is very striking. But the fact is, that, besides the seven visible colours, there exist invisible tones, which are both deeper and higher than the visible colours.

These invisible colour-tones are partly disclosed by the thermometer, which reveals the lower tones, and partly by substances sensitive to light. For it is remarkable that the colour-tones, which are higher than the violet, though invisible, have a powerful chemical effect.

We name the invisible tones of colour above violet, ultra-violet, and those below red, infra-red.

Refraction of Light.—In the common white light all the tones of colour are found together, and in combination they produce the effect of whiteness; but if we wish to examine the tones of colour separately, we must part them, and this may be done by the help of a prism.

Any polished crown-glass prism causes flames seen through it to appear like a rainbow containing the primitive colours we have named above. This separation of the colours in the prism takes place by refraction.

If a ray of light passes from one transparent medium to another, it is deflected from its rectilinear direction, and this deflection is named refraction.

For example, if the ray $a n$ (fig. 11) strikes a surface of water, it does not continue in its original direction $a n$, but in the direction $n b$. If through the point n , where

¹ We may here remark that the tone \bar{a} is not everywhere the same. The \bar{a} of the Berlin Opera is the highest—it has 437 vibrations; the Italian Opera at Paris only, on the contrary, 424 vibrations. We have adopted for the sake of simplicity a round number, 420.

the ray strikes the water, a perpendicular line $d f$ be drawn, the rule is that when a ray passes from a less dense medium (for example, air) into a denser one, it approaches the perpendicular, for $n b$ is evidently nearer to the $d f$ than $n a$. On the other hand, when a ray passes from a denser to a less dense medium, —for instance, from glass into air,— then the ray $n b$ departs from the perpendicular $n d$ —that is, the angle which the ray makes with the perpendicular after refraction is greater than the angle which it makes with it before.

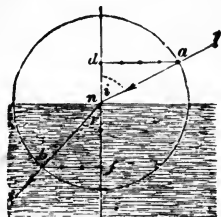

Fig. 11.

Now, it is a remarkable fact that light of different colours is refracted unequally.

If a bundle of rays of white sunlight is suffered to fall on a piece of glass, the violet rays are deflected more than the blue rays, the blue more than the green, yellow, and red; and the result of this is that the white bundle is decomposed into a rainbow-coloured fan, violet, indigo, blue, green, yellow, orange, and red.

This phenomenon is the cause of the rainbow. If a ray a falls on a drop of water (fig. 12), it is refracted and at the same time divided into a coloured fan, which is reflected from the back of the drop, suffers again refraction and dispersion at b , and issues as a broad bundle of colour. In open daylight this decomposition of white light by means of a prism cannot be clearly seen, because our eyes are dazzled by the bright light. In order to observe the pure colours of the spectrum, it is best to produce it in a darkened room, in which the light is allowed to enter only through a small slit (b , fig. 13).

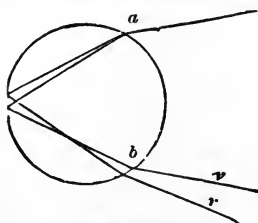

Fig. 12.

The Spectrum. Fraunhofer's Lines.—When a prism S is

placed behind the slit, a pure spectrum appears upon the opposite wall. If the slit is sufficiently narrow, a series of dark lines may be observed within the spectrum, at right angles to it.

These lines were first seen by Wollaston, but were studied more exactly by the celebrated optician Fraunhofer, and called after him Fraunhofer's lines.

The lines are always found in the same position, so that they can be considered as natural light lines, upon which the scale of colour is written; and as the music lines serve for the recognition of the musical notes, so do the lines of the spectrum indicate fixed points in the scale of colour.

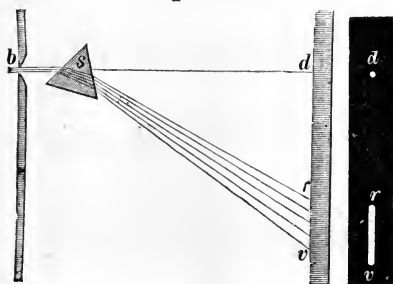

Fig. 13.

If we were to speak of the green of the spectrum, this would be a very vague designation; whereas by mentioning a line of the spectrum in the green, the part of spectrum is at once characterized. For this purpose Fraunhofer gave the most characteristic lines names, choosing for this purpose the letters of the alphabet; a certain line in the red he called *A*, another in the yellow *D*, one in the violet *H*, and another *H'*. As the number of lines reaches several thousand, these letters do not suffice to indicate them all. (See fig. 14.)

The lines thus named are found in the spectrum of the sunlight; the light of other stars commonly shows other lines. The light from artificial sources does not show dark, but bright lines; a flame coloured yellow with common salt shows, for example, two very characteristic lines in the yellow; a burning magnesium wire shows several blue and green lines when examined spectroscopically.

The situation of these lines agrees exactly with that of certain dark lines in the solar spectrum. For example, the yellow lines in a flame coloured with common salt exactly coincides with the *D* lines in that spectrum. The green lines in a flame of magnesium coincide exactly with lines *E* and *b*.

This remarkable coincidence led to the surmise that the lines in the sun's solar spectrum might owe their existence to the same substances that produced the coinciding bright lines in flames. Kirchoff converted this surmise into a certainty, and was thus able to determine from the lines in the solar spectrum the substances present

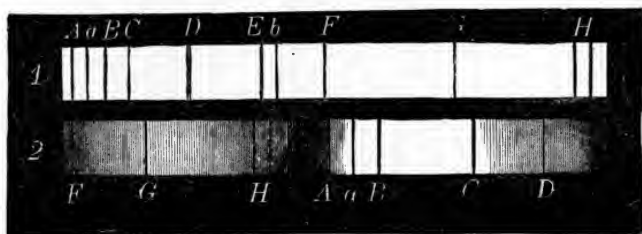

Fig. 14.

in the sun, and thus to demonstrate by spectrum analysis the chemical composition of a star distant many millions of miles.

Action of Coloured Light upon Photographic Plate.—But the spectrum contains still other wonders, which cannot be discerned by the human eye, although it is possible for this to be done by aid of the photographic plate.

If a sensitive plate be exposed to the action of the continuous spectrum, it is observed that the red and yellow rays have scarcely any action, whilst those of the green have but a very weak effect. Light blue produces more effect, dark indigo and violet the most; and in the space where no rays can be perceived by our eyes, a distinct action is produced, and this action extends beyond the

violet for a space almost as long as the whole visible spectrum.

From this fact the existence of the ultra-violet rays was ascertained. The retina of our eye and the photographic plate possess an entirely different sensitiveness. Our eye is affected most powerfully by yellow and green light. These colours appear to us the brightest, while the photographic plate is only slightly affected by them; on the other hand, indigo and violet rays, which appear dark to our eye, and even rays which to our eyes are invisible, produce a powerful action on the plate.

It is natural, therefore, that photography should represent many objects in a false light. Photography is much less sensitive than the human eye to feebly lighted objects. This is most clearly seen in the fact that the eye can easily perceive objects by moonlight which is 200,000 times weaker than that of the sun; whereas the old wet photographic plates were not able to produce any picture of a moonlit landscape, and even the more highly sensitive dry plates require a relatively long exposure for this purpose. The early photographic landscapes by moonlight which were offered for sale were taken in daylight and copied very darkly, so that they produced the effect of moonlight. Such pictures were at one time very popular in Venice.

This small sensitiveness of the ordinary photographic plate to feeble light explains the reason why shadows are generally too dark in photographs. To these defects must be added the false action of light,—blue generally appears light coloured, yellow and red, black. Yellow freckles appear, therefore, in a picture as black spots, and a blue coat becomes much too light. Blue (and therefore dark) flowers on a yellow ground produce, in photography, too light flowers on a too dark ground. Red and also fair golden hair becomes almost black. Even a very slight yellow shade has an unfavourable effect. A photograph

from a drawing is often blemished by little iron-mould specks in the paper invisible to the eye. These specks frequently appear as black points. There are faces with little yellow specks that do not strike the eye, but which come out very dark in photography. Some years ago a lady was photographed at Berlin, whose face had never presented specks in a photograph. To the surprise of the photographer, on taking her portrait specks appeared that were invisible in the original. A day later the lady sickened of the small-pox, and the specks, at first invisible to the eye, became then quite apparent. Photography in this case had detected before the human eye the pock-marks, which were, doubtless, slightly yellow.

In the photographs of paintings, if ordinary plates are used, such abnormal action of colour becomes still more evident, and can only be removed by appropriate retouching.

It is proper to observe, however, that by no means all shades of blue become light in photography. For example, indigo forms an exception, appearing as dark as in nature. The reason of this is, that indigo contains a considerable amount of red. On the other hand, cobalt blue and ultramarine produce almost the effect of white. Again, vermilion becomes dark, also English red ; whereas Turkey red, which contains blue, becomes very light. Chrome yellow becomes much darker than Naples yellow ; Schweinfurt's green becomes lighter than cinnabar green. No one of our pigments is a perfectly pure spectrum colour, but consists always of a mixture of different colours, and its light value therefore is essentially modified in photography.

If the effect of the colours of the spectrum on ordinary photographic plates is more narrowly examined, it is observed that the indigo produces the greatest action. Nevertheless, the differently sensitized photographic plates offer somewhat various results in this respect. Chloride of silver is most sensitive to violet, but non-

sensitive to blue. Bromide of silver is sensitive even to green, and iodide of silver only to violet and indigo. Mixtures of iodide and bromide of silver are sensitive both to blue and green.

Dr H. Vogel succeeded, in the end of 1873, in making photographic plates sensitive even to those colours that were before considered to be inoperative—*i.e.* yellow, orange, and red. He found that if certain coloured substances that absorb green light were added to bromide of silver, which is by itself but slightly sensitive to green, the sensitiveness of this bromide to green is considerably increased. In like manner, the addition of coloured substances absorbing yellow or red light makes bromide of silver sensitive to yellow and red light. After this discovery, it is not surprising that many of the difficulties attending the taking of coloured objects were soon overcome.

We shall return to this point when considering the various photographic dry plates.

Action of Ultra Violet Light upon Di-sulphate of Quinine.
—Mention has often been made of the photography of the invisible. The case already recorded of the photographs of invisible pock-marks belongs to this. But the photography of invisible quinine writing is especially understood by the term, photography of the invisible. If a writing is made on paper with a concentrated solution of di-sulphate of quinine, the result is scarcely visible. If this is photographed, it appears black and plainly visible in the picture. The di-sulphate of quinine has the property of lowering the tone of violet, of ultra-violet and blue rays—that is, of converting them into rays of less refractive power and of less chemical effect; therefore the light reflected from sulphate of quinine produces little or no photographic effect, and the written characters become black in the positive.

This property of the di-sulphate of quinine serves also

to make ultra-violet rays visible. If a piece of white card which has been painted thickly with a paste made from sulphate of quinine moistened with a little dilute sulphuric acid is held in the spectrum of an incandescent solid immediately beyond the violet end, the originally invisible ultra-violet part is seen to shine with a bluish green light. Other substances produce this effect, such as glass coloured with uranium, and fluor-spar from Devonshire, and therefore this property has received the name of fluorescence.

The aniline derivative *fluorescene* is a very brilliantly fluorescing substance. If a piece of paper is dipped in a solution of this, and then placed on the surface of water contained in a large beaker, a greenish tree-like fluorescence will grow in a downward direction from the point of contact of the paper with the water.

Chemical Action of Light from Various Sources.—From the facts just previously explained it follows that chemical effects are chiefly produced by the ultra-violet, violet, and blue rays. It is therefore evident that the chemical action of any light will be proportional to the amount of these rays it contains.

Lamplight (gas or petroleum) is very poor in such rays, and therefore acts but feebly on the photographic plate; photographers were thus enabled to prepare their less sensitive wet plates in a subdued lamplight.

This was also frequently done in the day by allowing the light to pass through yellow glass.

The white Bengal light, the flames of the blue Bengal light, and those of burning sulphur, produce a much more powerful chemical effect. The latter possesses only a small illuminating power, because it contains few yellow and red rays; but, on the other hand, it is rich in blue and violet. Photographs have been actually taken by help of these flames.

But the chemical action of the foregoing lights is greatly

surpassed by the effect of the lime, the magnesium, the incandescent gas and electric lights. The magnesium light is very simply produced by the burning of magnesium wire.

Magnesium is a metal which forms the chief component part of magnesia. Magnesia is nothing but magnesium rust—that is, a combination of magnesium with oxygen.

If magnesium wire or ribbon is burned, it combines with the oxygen of the air, producing a brilliant light and forming the oxide of magnesium. This light is very convenient in its application.

Magnesium in some form or other, very often as a powder, is so often used now for flash-light scenes that a large number of simple appliances are on the market by means of which the risk and dirt caused by the use of this substance as an illuminator are reduced to a minimum.

When the ribbon is used, it is often burnt by a lamp supplied with a clockwork arrangement, by means of which a continuous supply of ribbon is forthcoming at a constant rate. The powder form is much more effective as a light producer, since combustion takes place with much greater rapidity. When used in this form it is a very common practice to blow a certain definite quantity of the powder into a flame. Various kinds of lamps have been devised for this purpose, in some of which gas, and in others methylated spirit, is used. The powder is, of course, blown into the flame by means of some form of bellows, such, for example, as a pneumatic bulb.

Great care should be taken that the whole of the powder used is ignited. To ensure this the force of the air blast must be such that it carries the whole of the powder into the flame, but none of the powder should be projected beyond the flame.

In the early days of photography Dr Vogel repeatedly employed magnesium wire with success in taking photographs of the sculptures in the sepulchral monuments of

Egypt. When burning the magnesium wire, Solomon's lamp was used (fig. 15). This consists of a reel *K*, upon which the wire is coiled, a clockwork apparatus *G*, which conducts the wire from the reel between two rollers to the tube *R*, at the end (*f*) of which the wire is burned. The concave mirror *O* reflects the light in parallel rays.

By means of the handle *H*, the lamp supplying parallel rays can be turned in any direction, and the clockwork can be instantly stopped by the key *m*.

The duration of an ordinary magnesium flash extends over less than $\frac{1}{5}$ of a second, but effects which much more nearly approach to what may be considered instantaneous ($\frac{1}{50}$ sec. or less) can be obtained by using the so-called magnesium flash

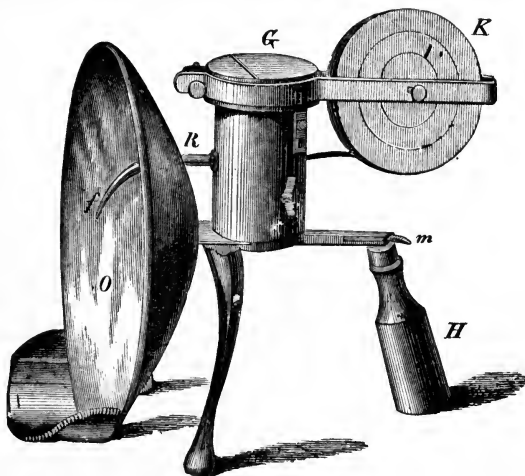

Fig. 15.

powders. These powders are made by mixing with ordinary magnesium powder certain proportions of substances which are extremely rich in oxygen, and hence favour rapid combustion, or, in other words, explosion.

Potassium chlorate is such a substance, and is one which is very frequently used for this purpose.

Persons who make use of such powders as these should be very careful to mix them only immediately before using. The utmost care should also be taken to avoid any kind of

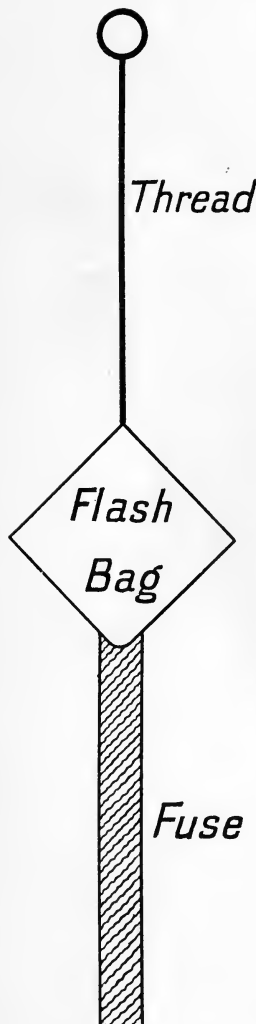

Fig. 16.

friction after the ingredients are mixed. If the chlorate is not in a sufficiently fine state it should be ground to the necessary degree of fineness before mixing with the magnesium powder.

When it is desired to fire any of this powder it should be placed in a shallow flat tray made of iron or lead, not in a heap but in a narrow strip. To ignite it, a very good plan is to use a piece of paper which has been steeped in a strong solution of potassium nitrate and then dried. This touch-paper should be arranged so that one end of it is in contact with the powder and the other projects over the edge of the tray. The far end from the powder being ignited, the operator has a chance to move to a safe distance before the powder is fired.

Of course, in cases where such an arrangement is used, the necessary focusing should be done previously by means of the ordinary lighting arrangements. When all is ready the shutter of the dark slide can be drawn, the cap of the camera can be removed, and the exposure made. Only those lights which shine directly into the lens need be actually put out. It would be quite possible for the operator to seat himself with the group if desired, if the length of fuse was made sufficiently great. Simple devices such as the Geka and Vesta flash bags are now obtainable, by means of which it is possible to dispense

with the more bulky apparatus which is commonly used for this work.

The flash bag is shaped as in diagram. The loop at the end of the thread can be attached to a nail or some suitable support, the end of the fuse ignited, and then sufficient time elapses before the flash takes place to enable the operator to move quite out of the way, or even to attach himself to the group if he so desires.

As more continuous forms of light having intense photographic effect are often required, use is made of the lime-light, incandescent gas, and electric lights for this purpose.

The two latter, together with acetylene lamps, are particularly useful for working with special classes of prepared papers, which are now being so largely used in the place of P.O.P. and also for copying and enlarging work.

The employment for portraiture of such dazzling artificial light as the electric light is attended with the great drawback of occasioning harshly defined shadows, which do not add to the beauty of the portrait. This difficulty is sometimes modified by placing another electric light of less power on the shaded side, but under such circumstances it is difficult, as in direct sunlight, to prevent contraction of the features.

Photographic Action of Sunlight.—Sunlight is the most important source of light for photographic purposes. The brightness of this light is, however, subject to great variations. Even the eye recognises that the sun is much brighter at noon than in the morning and evening. According to the measurements of Bouguer, this difference is so considerable that the sun at an elevation of 50° above the horizon is 1200 times brighter than at sunrise. The eye, moreover, perceives a decided difference of colour between the sun on the horizon and the sun at the zenith. The latter appears white, the former of a reddish hue; and, on examination with the spectroscope, it is found that in the

setting sun the reddish rays predominate, while the blue and violet are in part wanting.

For this reason the chemical action of sunlight is very feeble in the morning and the evening; it increases as the sun rises above the horizon, and it attains its greatest intensity about noon.

The cause of the red hue of the morning and evening sun is found in the fact that as the rays of light pass through the air a large amount of scattering of light takes place; this is especially so in the case of the blue rays—for which reason the air (that is, the sky) appears blue

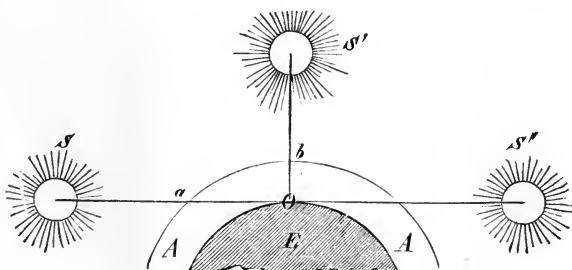

Fig. 17.

—whereas the yellow and red rays are more easily transmitted.

If *E* (fig. 17) is the earth surrounded by the atmosphere *A*, *S* the sun at the moment of sunrise, *S''* the sun at the moment of sunset for the place *O*, and *S'* the sun at noon, it is apparent that the sun's rays at sunrise and sunset have to travel much further through the atmosphere—namely, the distance between *a* and *O*—than when the sun is in the zenith *S'*. But in proportion as the stratum of atmosphere through which the sun's rays must pass to arrive at the spectator is thicker, the weaker becomes the light. The greater the amount of dispersion which takes place, the more difficult it is for the easily scattered rays to reach the earth. It follows from this that on high mountains the

chemical action of the rays of light must be more intense, and this has been proved by experiments on the Alps to be the case.

But not only are chemical effects produced by direct sunlight; the light of the blue sky, which is nothing but reflected sunlight, is likewise chemically active, and powerfully so, through its blue colour.

It has been already stated that the blue colour of the sky proceeds from the scattering of blue light which takes place in the passage of sunlight through the air. The quantity of this scattered light varies with the hour of the day, being strongest when the sun is highest (that is, at noon), and diminishes in proportion as the sun approaches the horizon. Photographers therefore choose the middle of the day—*i.e.* between 10 a.m. and 2 p.m.—for taking portraits, for which the light of the blue sky is preferred. During these hours the chemical effect of this light remains almost the same; afterwards it begins to diminish—quickly in winter, more slowly in summer. Thus the chemical power of light, according to Bunsen, expressed in degrees, is at Berlin :—

	12 o'clock.	1 o'clock.	2 o'clock.	3 o'clock.	4 o'clock.	5 o'clock.	6 o'clock.	7 o'clock.	8 o'clock.
June 21 .	38°	38	38	37	35	30	24	14	6
Dec. 21 .	20°	18	15	9	0	0			

It appears from this example how extraordinarily weak is the chemical action in winter (thus about noon on the 21st December it is only half as powerful as at noon on the 21st June); moreover, how small is the amount of chemical light which is diffused by the blue sky on the 21st December, on account of the shortness of the day. Therefore a longer exposure is necessary in winter than in summer, and, the printing process being slower, a longer time is required in winter to print the same number of pictures.

Now, the intensity of the blue sky light depends on the position of the sun, and the latter varies, not only

according to the different seasons, but also at the very same seasons on different parts of the earth.

If circles be drawn round the earth from pole to pole, we obtain what are called meridians (*m m*, fig. 18). At all places situated on the same meridian it is noon at the same time, but the height of the sun varies very much according to the distance of the place from the equator.

If circles be drawn round the earth parallel to the equator, they form the so-called lines of latitude. If the sun is perpendicular at noon at a particular place on the equator, at 10° of north latitude it is 10° lower—that is, the height of the sun (or the distance of the sun from the horizon expressed in angular measurement) is 80° . At 10° further north, the position of the sun, at the same time, is only 70° ; and at the pole, which is 90° from the equator, the height of the sun = 0—that is, the sun is on the horizon.

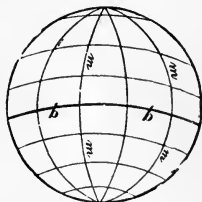

Fig. 18.

The chemical action of the blue sky light varies greatly, corresponding to the different positions of the sun at the same time. Thus, for example—

At Cairo, on the 21st Sept., the strength of light at noon	=	105°
At Heidelberg	"	57°
In Iceland	"	27°

Therefore, the lower the latitude of a place is, the richer it is in the amount of light available to the photographer. Accordingly, the American photographers are better off in this respect than those of Germany and England.

These differences in the chemical intensity of light are also essentially modified by the state of the weather. If the sky is covered with grey clouds, the chemical intensity of the light is considerably less than with a perfectly clear sky. On the other hand, white clouds increase the power of the light very decidedly. In the autumn the

chemical intensity of light is much greater than in spring, perhaps in consequence of the greater transparency of the air. According to Roscoe, it is in August and September more than one and a half times as great as in March or April.

These variations in the chemical intensity of light are very important to the life of plants. The green leaves of plants inhale carbonic acid and exhale oxygen under the influence of light. This breathing process does not take place without the presence of light. The green colour of leaves and the variegated colours of flowers only exist under the operation of light. In the dark, plants only develop sickly blossoms, like the well-known white sprouts of potatoes kept in cellars.

The necessity of light for the life of plants is also seen in the effort made by plants kept in darkened rooms to reach the apertures which admit light. Hence a plant develops with an energy proportional to the intensity of the light. The greater fruitfulness of the tropics is to be ascribed, not only to the higher temperature, but also to the greater chemical intensity of the light. Recent observations have established that the yellow and red rays, and not the blue and violet, produce the greatest chemical effect on the leaves of plants.

The Part played by Animal and Vegetable Life in determining the Constitution of the Atmosphere.—We have now arrived at the knowledge of the importance of light for the economy of nature. Atmospheric air is a mixture of two gases, oxygen and nitrogen. Nitrogen is a perfectly innocuous gas, serving to dilute the oxygen; for the latter, though essential to life, is injurious if undiluted.

In breathing, part of the oxygen is absorbed in the lungs; it forms, with the organic constituent parts of the body, carbonic acid and water. The carbonic acid and water are exhaled by us and dispersed again in the air.

It is easy to prove by an experiment that a considerable amount of carbonic acid is contained in the air we exhale. Carbonic acid forms with lime-water an insoluble precipitate, carbonate of lime. If now we blow the exhaled air through a glass tube into perfectly clear lime-water, the latter becomes milky by the formation of carbonate of lime. Hence, by the breathing of human beings and animals, the amount of oxygen in the air is continually being diminished and converted into carbonic acid. The same result is produced on a larger scale by the process of combustion. In this process a combination of wood or coal with oxygen takes place, and the result is again, principally, carbonic acid.

It might be supposed from this fact, that, in the course of time, the amount of oxygen in the air must diminish, while that of carbonic acid would increase. This actually takes place in closed spaces. Leblanc found that, after a lecture in one of the lecture rooms of the Sorbonne at Paris, the air had lost one per cent. of its oxygen.

In the open air no such a diminution of oxygen and increase of carbonic acid gas can be detected, and the reason of this is that the carbonic acid formed by combustion and the exhalations of animals is again decomposed by plants under the influence of light.

Plants absorb the carbonic acid, retaining the carbon and liberating the oxygen; by which means the oxygen lost by combustion and respiration is made again available.

There was a time when the atmosphere was much richer in carbonic acid gas than now. When the incandescent and fluid masses that once formed our earth gradually solidified, when the aqueous vapours were condensed as seas, the atmosphere contained almost all the carbon of the earth, combined with oxygen, as carbonic acid gas. The air was therefore at that time infinitely richer in carbonic acid than now. When at length the earth had cooled sufficiently for vegetation to be developed,

gigantic plants shot forth from the warm ground under the influence of the sunlight. They flourished luxuriantly in an atmosphere so rich in carbonic acid, the carbon of the carbonic acid passed over into the form of wood, and thus for thousands of years the carbonic acid in the atmosphere was continuously diminished. Revolutions of the earth's surface succeeded; whole tracts were buried under sand and clay; their forests decomposed, and were changed into coal. A fresh vegetation sprouted forth from the newly formed soil, and again absorbed under the influence of light the carbonic acid of the atmosphere, to be once more engulfed. Thus the carbon from the carbonic acid of the atmosphere was stored as coal in the depths of the earth; and thus the atmosphere, by the chemical effect of light, became continually richer in oxygen, until at length, after countless ages, it attained that wealth of oxygen which made the existence of man possible.

We see, therefore, that the chemical influence of light has played an important part in the development of our planet, and that it continues to do so in the economy of nature.

We will now enter the domain of chemistry, in order to explain the phenomena which occur when substances sensitive to light are exposed to its action.

The distinction between a physical and chemical change has been alluded to on p. 2.

Physical Changes produced by Light.—Now light is able to produce both chemical and physical changes. We have already stated that the red mineral, realgar, falls into a yellow powder when exposed to light. This is a physical change, for the yellow powder is still realgar, and if it is fused it forms, on cooling, compact red masses, which are again changed on exposure to the light. The number of physical changes of this kind occasioned by light is not great, but the phenomena are in themselves remarkable.

Moser has remarked that light has a certain action on almost all surfaces. He covered smoothly polished surfaces of silver, ivory, and glass with perforated screens, and exposed them to the light. After this he breathed upon them, or exposed them to the action of the vapour of mercury, and found that the vapour was condensed most powerfully where the light had reached the surface. Accordingly, Moser established the proposition: Light reacts on all bodies, and its action can be made visible by the greater condensation of vapours on the parts exposed to light.

Chemical Changes produced by Light.—The chemical changes effected by light are far more numerous than the physical, and their study is the special province of photo-chemistry.

Before passing to the more complicated phenomena of photography, we must make the reader acquainted with the simpler phenomena of the action of light.

It is remarkable that many elements present themselves in quite different forms, so that it might be supposed they were different substances. The yellow, inflammable, poisonous phosphorus, soluble in ether, and formerly used in the manufacture of matches, is changed by heating in a closed vessel, into a reddish substance difficult to kindle, not poisonous, and insoluble. This is, however, phosphorus, and passes by melting into the state of common phosphorus.

It is an interesting fact that this transformation of yellow into red phosphorus is effected not only by heat, but also by light. If yellow phosphorus be exposed for a long time to the light, it becomes red.

The oxygen of the air is also susceptible of similar changes. Ordinary oxygen is a colourless and inodorous gas. By the action of electricity, however, it is easily changed into another kind of gas, distinguished by a peculiar smell—the so-called sulphurous smell of lightning.

This gas, ozone, has a much more oxidizing or rusting effect than common oxygen.

Ozone is also formed by the action of light. If oil of turpentine be poured into a large bottle containing air, and agitated violently in the sunlight, ozone is formed.

Action of Light upon the Halogens.—Equally peculiar are the changes experienced in sunlight by two other elements, chlorine and bromine.

Chlorine is a yellowish-green gas, with a disagreeable smell, distinguished by its properties of bleaching coloured stuffs and destroying infectious matter. Bromine is a substance very similar to chlorine, but it exists in a fluid not in a gaseous state at ordinary temperatures, though it can be easily vaporized, and then appears as a brownish-red gas.

Both chlorine and bromine as well as compounds containing these elements show a peculiar behaviour towards light.

Chlorine gas behaves in a peculiar manner with hydrogen.

If this combustible gas is mixed with chlorine, and the mixture is exposed to the sunlight, an explosion takes place. This accompanies the chemical combination of chlorine and hydrogen to form a new body—*hydrochloric acid*—having no resemblance to chlorine or to hydrogen. This acid is of a sour taste, very soluble in water, does not bleach like chlorine, and is not combustible.

Another element—iodine—is very closely related to chlorine and bromine. It is a solid, appearing in the form of shining black crystals, and giving when heated a wonderful violet vapour.

The Halogen Compounds of Silver.—Iodine, bromine, and chlorine unite with metals, forming the iodides, bromides, and chlorides of the metals. Common salt is one of the best known combinations of this kind, consisting of chlorine and sodium. Sodium is a metal not employed

in the industrial arts, which possesses the property of powerfully attracting the oxygen of the air, or rusting, so that it has to be protected by being kept under naphtha. The chlorides, bromides, and iodides of the metals all show a nature analogous to salt. Chloride, bromide, and iodide of silver are particularly interesting to us. These three salts may be obtained by the direct action of chlorine, bromine, and iodine on silver ; but a more rapid method is to dissolve in water chloride, bromide, or iodide of sodium and to add to them a solution of a salt of silver.

If a silver coin is thrown into nitric acid, it is dissolved, forming nitrate of silver ; and this is obtained on evaporating the solution as a white soluble salt, which when fused is called lunar caustic.

If a solution of this substance be mixed with a solution of chloride of sodium, a white curdy precipitate of chloride of silver is formed by double decomposition. Chloride of sodium and nitrate of silver produce chloride of silver and nitrate of sodium.

Bromide or iodide of silver may be produced exactly in the same manner if bromide or iodide of sodium be added to a solution of silver nitrate.

Bromide, chloride, and iodide of silver are thus separated as precipitates, because they are all three insoluble in water. After being washed and dried, all three salts appear in the form of powders, the chloride being white, the bromide yellowish white, and the iodide yellow. All three are very stable bodies, not decomposed by heat, and insoluble in water, alcohol, or ether ; they are, however, dissolved by solutions of hypo-sulphite of soda or cyanide of potassium, by combining with these bodies to form new chemical compounds which are soluble in water.

These three stable compounds—chloride, bromide, and iodide of silver—show a marked sensitiveness to light, and this sensitiveness is the basis of modern photography.

By the light of a gas lamp in a dark room the chloride of silver appears perfectly white, but it quickly takes a violet tint in the daylight. It is often said that it becomes black; this, however, is not the case. This change of colour is the result of a chemical decomposition. The chlorine is in part set free, and may be detected by its odour if large quantities of chloride of silver be employed. The violet powder which remains behind was formerly thought to be metallic silver.

Metallic silver does, it is true, under certain circumstances, present itself in the form of a grey or violet powder. The violet-coloured body formed on exposing chloride of silver to light is not, however, metallic silver; it is only a combination of silver with chlorine, which contains half as much chlorine as chloride of silver. Silver and chlorine form two compounds—one white and rich in chlorine, the other violet and with little chlorine, named subchloride of silver. In the same manner, silver forms two compounds with bromine—one light yellow, rich in bromine, named bromide of silver; and a yellowish-grey compound, less rich in bromine, named subbromide of silver. Further, analogous to these there exist a yellow iodide of silver, and a green subiodide of silver, less rich in iodine. Subbromide and subiodide of silver are produced exactly in the same manner as the subchloride, by the operation of light. The chemist says, therefore, that bromide, chloride, and iodide of silver are reduced by the action of light to the corresponding subchloride, subbromide, and subiodide.

The change of colour by which this chemical change is accompanied is most striking with chloride of silver, less with bromide of silver, and least so with the iodide.

It would appear from this that chloride of silver is the most useful to photography. But this is not the case. Plates sensitized by means of bromide or bromide and

iodide of silver, and not of chloride of silver are exposed in the camera. The image thus produced by ordinary exposure is invisible, but becomes visible through a subsequent process, named the developing process.

In daguerreotypes the exposed plate of iodide of silver was further exposed to the vapour of mercury. In this case the vapour was condensed in fine globules on the exposed places, in proportion to the change caused by the light. In the treatment with collodion, the plate was washed over with a solution of green vitriol. This mixed with the adhering solution of silver, and precipitated from it a fine black silver powder, which adhered to the exposed places of the plate.

Therefore, in both cases we have a finely pulverized body, which is attracted and retained by the exposed places—a mysterious process, as interesting as it is practically important.

From this it appears that it is by no means the colouring of the silver salts which renders the image visible, but the subsequent developing process.

If an experiment be made with chloride, bromide, and iodide of silver simultaneously, by exposing and developing them, it is found that chloride of silver gives the feeblest picture under the developer, bromide of silver a stronger one, and iodide of silver the strongest. Therefore, the very body which was most strongly coloured by light is the least coloured under the developer, and the body which is least coloured by the light, viz., iodide of silver, is the most coloured under the developer.

The developing process is of immense importance. If it were attempted to produce a picture by exposure in the camera without developing, an exposure of hours would be required before the impression could be seen. The developing process permits, under favourable circumstances, the impression to become visible after an exposure of a very small fraction of a second.

Pure iodide of silver was formerly used in photography, but a mixture of iodide and bromide of silver is now preferred. This change was made because it was soon perceived that iodide of silver is very sensitive to *strong* light, but by no means so to weak light. For example, in taking a portrait, iodide of silver gives the light parts, such as the shirt and the face, in a few seconds with great clearness; whereas the darker parts, such as the shadows, the dark coat, etc., are very feebly given. But if some bromide of silver is mixed with the iodide, the coating of combined iodide and bromide of silver gives a weaker but still intense picture of the clear parts, while it gives a much better impression of the dark parts than iodide of silver alone.

The mixture of iodide and bromide of silver was effected in practice in the case of the wet plates by adding to the collodion a salt containing iodine and a salt containing bromine; for example, iodide of potassium and bromide of cadmium. Both are decomposed in the silver bath. Iodide of potassium and nitrate of silver produce iodide of silver and nitrate of potash, and in the same way bromide of cadmium and nitrate of silver produce bromide of silver and nitrate of cadmium.

Development of the Wet Plate.—In the case of the old wet plates a considerable quantity of the solution of silver remains also adhering mechanically to the collodion coating. This adhering solution of silver is by no means a matter of secondary importance; on the contrary, while developing, it affords the necessary material from which the fine silver powder is precipitated.

If the developer (for example, a solution of green vitriol) is mixed with a solution of silver, the silver is precipitated in the form of a fine powder. For green vitriol—protosulphate of iron—readily absorbs oxygen, and is changed thereby into persulphate of iron. Accordingly, if a body containing oxygen (for example, nitrate of silver) is mixed

with green vitriol, the latter withdraws at once the oxygen from the silver salt, and sets free the silver. Other bodies that readily combine with oxygen operate in like manner, namely, certain organic substances, such as pyrogallic acid and others. It was formerly thought that green vitriol reduced the iodide of silver affected by light. It can be easily proved that this view is false. For, if a wet plate is exposed and the nitrate of silver adhering to it is washed away, and then the developer poured upon it, no picture appears, proving that green vitriol alone is without action on exposed iodide of silver. But if a solution of silver is added, a picture appears immediately.

The solution of silver adhering to the plate plays, however, another part. If a wet plate is washed before it is exposed—that is, if all the nitrate of silver which adheres to it is removed, and it is then exposed—it will be remarked that it is far less sensitive than when the nitrate of silver is present.

This is explained by the peculiar property of many bodies sensitive to light.

There are bodies which in isolation are either not at all, or only very slightly, sensitive to light, but which become so in the presence of substances which are able to unite with one of the constituents liberated during exposure to light; for example, chloride of iron is not sensitive to light, but chloride of iron dissolved in ether is sensitive, because the liberated chlorine at once unites chemically with the ether.

The same remark applies to iodide of silver. This is, by itself alone, sensitive to light, but only slightly; in presence of a body which can combine with iodine, it is quickly decomposed in the light. Now, nitrate of silver, which reacts with iodine with the greatest ease, satisfies this condition; and this explains the greater sensitiveness of iodide of silver in the presence of nitrate of silver.

Other Substances Sensitive to Light.—The number of

substances sensitive to light is much greater than appears at first sight ; and in fact, on close investigation, it would probably be found that all substances are more or less sensitive. Even in the first period of photography, in the year 1840, Herschel observed the sensitiveness of salts of iron, Burnett that of salts of uranium, and Kratochvila prepared successful daguerreotypes on copper plates, in a manner analogous to that for silver plates.

It has long been known that a solution of ferric chloride, (a yellow substance composed of chlorine and iron) in ether, is bleached by light, the ferric becoming ferrous chloride, a colourless salt which contains less chlorine. The same change is produced in contact with paper ; thus, if clean paper be soaked in a solution of one part of ferric chloride in six of water, dried in the dark, and exposed under a negative, the yellow paper becomes white beneath the transparent parts of the negative, because the ferric chloride there becomes ferrous chloride. The faint picture thus produced may be easily coloured intensely dark by immersion in a solution of red prussiate of potash (*Potassium Ferricyanide*). This salt combines with the ferrous chloride to produce Turnbull's blue, but leaves the ferric chloride unchanged. In this manner a blue picture is obtained. If such a picture be plunged in a solution of gold, it becomes of a light blue colour, because the ferrous chloride produces a precipitate of metallic gold. And, similarly, all substances which form dark precipitates with ferrous chloride will serve to develop such pictures.

Another process consists in transforming the iron pictures into iodine pictures. A positive (for example, a drawing) is printed on a piece of paper sensitized with ferric chloride ; the print comes out in yellow lines of unchanged ferric chloride, on a white ground. If this is now immersed in a solution of iodide of potassium and starch, the ferric chloride decomposes the iodide, and sets free iodine, which combines with the starch, forming the dark

blue iodide of starch, and thus colours the lines of the picture.

There are several other methods of making the colour of the iron pictures darker. The pictures in Prussian blue gradually fade, for this dye is bleached by light (blue parasols rapidly lose their colour in the light). The same remark applies to pictures of iodide of starch; the gold pictures are too pale, and their preparation too costly.

The salts of uranium present the same phenomena as the salts of iron. Uranium itself is a rare metal, the salts of which are much used as colouring materials; thus, there is a yellow oxide which, when burnt into porcelain, colours it dark green, and fused with glass, imparts to it a beautiful grass green (uranium glass).

The best known salt of uranium is the nitrate, which in the presence of organic matter (for example, paper) is reduced by light to uranous nitrate. If a piece of paper be immersed in a solution of one part of the salt in five of water, dried in the dark, and exposed under a negative, a very faint picture is produced, which consists of uranous oxide. If the print is now immersed in a silver or gold solution, the picture becomes at once visible, since uranous oxide precipitates gold and silver as such from their solution (silver as a brown, gold a violet powder).

Uranium is, however, too scarce and too expensive to be employed generally in photography.

As will be perceived, the salts of iron and uranium are analogous to the salts of chromium, by only being sensitive to light in the presence of organic bodies. In a pure state salts of uranium and iron do not change in the light.

Copper forms with chlorine a green salt, soluble in water—cupric chloride,—which is reduced to cuprous chloride in the light. Obernetter took advantage of this fact, by mixing chloride of copper and chloride of iron together, and saturating paper with them. This was

exposed to light under a negative, then plunged in sulphocyanide of potassium, and ultimately treated with red prussiate of potash. The result produced by this somewhat complicated process was a brown picture.

Action of Light on Glass.—The celebrated physicist Faraday made the observation that flesh-coloured glass, which is stained with manganese, became rapidly brown in the light. This fact remained for a long time isolated, until, years later, other observations of the same kind were made.

A very handsome plate of glass was exhibited in a mirror shop at Berlin. It bore the inscription "Spiegel-manufactur" in brass letters. After being exhibited for years, the business was broken up, and the mirror, on account of its beauty, was taken away by its owner, the brass letters were removed, and the plate cleaned. To the surprise of the proprietor, the letters remained plainly visible on the glass, notwithstanding all attempts to remove them. The surface was even ground away, but this did not produce any effect on the letters. It was found that the glass had become yellow throughout, and that it remained white only at the places where the opaque letters had kept off the light. The plate of glass was cut into halves. One half, with the word "Spiegel," was placed in the Physical Museum of the University of Berlin.

Some very interesting observations on the action of light on glass were made by Gaffield, who found that almost all sorts of glass are affected by light, and that in many cases an exposure of only a few days suffices to produce a change. Gaffield cut the glass to be examined into two parts, placed one in the dark and the other in the light, and compared the two after a few days. In almost all cases he remarked that the colour of the glass became deeper on exposure to light. Two kinds only of German and Belgian green window glass were unaffected. The exposed glasses

recovered their original colour on being heated to redness.

This alteration of glass by light has a most injurious effect in photography. The yellow tinge, which the glass gradually assumes, absorbs a part of the chemically active light. This absorption makes itself strikingly evident, because the time of exposure for photographs must be continually lengthened.

The greatest change is produced in glass containing manganese. Peroxide of manganese, or black manganese, is frequently added to glass to bleach it. The oxygen of the peroxide converts the dark-green ferrous oxide contained in the glass into the lighter ferric oxide. In the light the converse reaction takes place. The ferric oxide is reduced to ferrous oxide, the oxygen combines again with the manganese to form black manganese, and thus the colour of the glass becomes deeper.

In many minerals the opposite effect to that in glass is produced on exposure to light; their colour becomes paler instead of deeper. This is the case with the Siberian topaz, which soon loses its golden-yellow colour in the light. A splendid crystal of topaz, six inches long, belonging to the Mineralogical Museum at Berlin, has in this manner lost much of the beauty of its appearance.

Action of Light having low Actinic Value.—Some very curious effects have been observed when light of which the actinic value is small has been allowed to act upon photographic plates and papers. The following, due to the researches of P. Villard,¹ are particularly interesting.

If a print is made on albuminised or salted paper by exposing for a few seconds in daylight until the darkest parts of the print just begin to appear, then the paper is taken out and exposed in sunlight under *green* or *yellow* glass, which completely cuts off the blue and ultra-violet

¹ *Soc. Franc. Phys. Bull.*, No. 1, pp. 5-27, 1907, and *Journ. de Physique*, 6, pp. 360-379, May, and pp. 445-457, June 1907.

lights. In ten hours the print will be found to have come up with all its details and clear in the high lights. The presence of a soluble salt of silver is absolutely essential for the success of this experiment. Bromide or chloride papers or plates will show this effect if they are exposed to yellow or green light in a bath of nitrate of silver or of silver chloride or bromide dissolved in ammonia or hyposulphite of soda, but the darkening is never as great as when printing papers are used. The effect can be strengthened with printing papers if they are soaked in a dilute solution of oxalic acid, after the very short exposure under the negative. This action is not equivalent to a longer exposure under the negative, but to a physical development or intensification of the print. Dry plates show no such action.

If we print very faintly on printing-out paper under a negative, and then continue the printing under green and yellow glass, the contrasts in the print are greatly increased. The continuation action due to the green and yellow rays is proportional to (1) the deposit already formed, and (2) the amount of these rays locally passing through the negative. The effect produced therefore depends, as regards densities, on the *square* of the relative transparency of different parts of the negative.

Platino-cyanide of barium browned by Röntgen rays can be regenerated by exposure to light, particularly in the green, yellow, and red. As stated elsewhere, a long exposure to these rays brings about a kind of solarisation effect, but it is always possible to annul this effect by exposure to light; the longer the plate has been exposed to the X-rays the longer must be the exposure to light in order to bring about its regeneration.

Suppose a dry plate has been exposed to Röntgen rays for just sufficient length of time to produce a visible effect on developing, then by exposing that plate to the action of red and infra-red rays before developing, it can be

regenerated in just about the same time that the violet rays would have taken to form a developable impression.

A dry gelatino-chloride plate which has been exposed in a camera a full time can be regenerated by exposure to the action of red and infra-red light for about four hours.

The feebler the impression the more rapid the destructive effect of the red rays ; but, on the contrary, the slower is the continuation effect produced by the green.

Sir W. de W. Abney¹ has also carried out experiments by which he has shown that the latent image on a sensitive plate can be destroyed by a prolonged exposure to red rays.

A. G. de Moncetz² has stated that when blue light or Röntgen rays have been used for fogging a plate, the fog can be completely destroyed by the action of infra-red rays of wave lengths extending from 800 to 1000 $\mu\mu$.

Should the plate be fogged by the action of Röntgen rays alone, he finds that exposure to rays of wave lengths between 920 and 1350 $\mu\mu$ increases instead of destroys the fog.

No effect is produced by these rays on the plates if they are not previously fogged, nor yet if they have been fogged by exposure to ordinary light.

It is a remarkable fact that the gelatino-chloride printing-out papers (P.O.P.), which are much less sensitive to the action of light than the gelatino-bromide plates, blacken far more readily when exposed to the action of light. Of course, the amount of exposure required to produce a developable image on the paper is enormously greater than that required by the plate.

A. P. H. Trivelli³ has recently offered a partial explanation of these phenomena based upon the relative sizes of the silver-haloid grains contained in the emulsion. The grain in the emulsion of the P.O.P. is of ultra-microscopic

¹ *Photo. Journ.*, 48, pp. 318-319, August 1908.

² *Comptes Rendus*, 146, pp. 1022-1024, 1908.

³ *Zeitschr. Wiss. Phot.* 9, pp. 168-172, Dec. 1910.

dimensions, while that of the plates has a diameter of 5-9 μ .

Although it can quite easily be shown that one would expect the final degree of blackening to be greater with fine-grained haloid for equal percentages of haloid in the emulsion, and it is further known that the degree of blackening produced by exposure to light attained with chloride is greater than that attained with bromide, while the developable image with bromide is the denser, the complete solution of the problem remains yet to be given.

Action of light on the visual purple.—No account of the chemical action of light would be complete without some reference to the way in which the visual purple—a substance present in the outer limbs of the rods of the retina—is affected when exposed to light.

Kühne carried out a number of experiments upon this purple, and obtained many important results. He found that it is bleached most rapidly by the greenish yellow rays of the spectrum, then by the green, and least of all by the red. When exposed to ordinary light it becomes yellow, and then white. By means of this purple, it is possible to obtain definite photographs on the retina of an excised eye, and these photographs can be fixed.

Dr Edridge-Green¹ has based his theory of colour vision upon the action of the visual purple. Briefly stated, his views are as follows:—Light falling upon the retina liberates the visual purple from the rods, and this then diffuses into the rod and cone layer of the retina. Light next causes its decomposition, a change in electrical conditions probably resulting. In this manner the ends of the cones are stimulated, and a visual impulse is set up which is conveyed through the optic nerve fibres to the brain. He assumes that the action produced by light varies according to its wave length just as takes place in other photo-chemical effects.

¹ For full account of his theory see "Colour Blindness," International Scientific Series.

Taking into consideration the effects which light is known to produce in inanimate substances, Dr Edridge-Green's theory would seem much more consistent with modern ideas, than the postulation of three distinct types of nerve fibre, as is done in the Young-Helmholtz theory.

PSEUDO-PHOTOGRAPHIC EFFECTS

A considerable amount of research has from time to time been carried out upon the effects produced when certain substances, such as wood, resin, various metals, etc., are placed in contact with a sensitive film. Perhaps of all English chemists the late Dr W. J. Russell took the greatest interest in this branch of the work.

In one set of experiments, the results of which were published in the *Photographic Journal*, Nov. 1908,¹ Dr Russell found that resin and various kinds of coal have the power of fogging a photographic plate when placed on it in the dark. The action of these substances under ordinary conditions of temperature is extremely slow. On the other hand, quite a noticeable effect takes place in some three or four hours when their temperature is between 30° and 40° C. In such cases absolute contact is by no means necessary.

Various explanations of this action have been given at different times, some scientists attributing it to chemical action, others to radiations given off by these substances, while some have even tried to account for it by the presence of emanations, like those emitted by the radioactive substances.

It now seems as if the question has been decided in favour of the first-named process.

Russell found that the shadows thrown by the resin were not bounded by straight lines, but were able to curve round a screen. Also the action was not capable of

¹ See also *Roy. Soc. Proc.*, B, Vol. 80.

passing through glass, mica, or aluminium foil even of extreme thinness, and it is not affected by an electric field. If the resin is dissolved in such an inactive liquid as alcohol, it renders the liquid active. He therefore came to the conclusion that the result could not be due to any radioactive products, but very probably was brought about by vapour given off.

Action of Metals.—A large number of experiments of a similar nature have been carried out by S. Saeland,¹ in which the action of various metals upon photographic plates were tested. The surface of the metal was first of all cleaned with emery paper and then placed in contact with, or very near to, a photographic plate for a considerable time.

A photographic effect was then observed. The effect was greatest with magnesium, next with aluminium, then with zinc. As the metal surface becomes changed by exposure to the action of the air, so it gradually loses its activity in this respect, and it is worth noting that the more active the metal when clean, the sooner does it lose its power. When the surface is again cleaned, the activity is brought back to its maximum value.

Not only did the pure metals which were tested behave in this way, but several amalgams, in particular those of zinc, behaved in a similar manner.

That this effect is in all probability brought about by chemical action taking place between the metal and the sensitive film is clearly indicated by the following experimental results. If some time elapses between the exposure of the plate and its development, the blackening is much more intense, and a rise in temperature produces a similar result.

If the pressure of the air is diminished the effect of the metal becomes less and less, until in a vacuum it has no apparent effect. When dry hydrogen gas is used in the place of air the metal is without effect upon the plate ;

¹ *Ann. d. Physik.*, 26, 5, pp. 899-917, 1908.

the effect also vanishes if perfectly dry air is used. Hence Saeland comes to the conclusion that it only takes place when under conditions favourable for the production of hydrogen peroxide. He finds that a solution of that substance has an action upon the plate similar to that obtained with the metals. His assumption is supported by the further fact that all action is stopped when a transverse stream of air is allowed to pass at the rate of 5 metres per second.

Action of Hydrogen Peroxide on Plate.—The action of hydrogen peroxide upon the photographic plate has been investigated by Dr Otsuki in the laboratory of the Technical High School of Hanover (1905). He came to the conclusion that the effect produced on a photographic plate by hydrogen peroxide is due to the change in the bromide of silver contained in the sensitive layer of the plate. Silver bromide under the action of the peroxide changes most probably to a lower bromide of silver, which is easily reduced by the developer. The latent image produced by hydrogen peroxide consists of this lower bromide of silver, and can be destroyed through the action of bromine vapour or bromine water. Thus in one of his experiments gelatino-bromide plates were exposed for two minutes to 30 per cent. aqueous solution of hydrogen peroxide, and then laid on a vessel containing concentrated bromine water for two hours, keeping the distance of 1 cm. between the plate and the surface of the bromine water. After thoroughly washing them under running water, they were developed for two minutes by means of 5 per cent. commercial rodinal. There was no darkening of the plate to be seen. If placed in a 5 per cent. bromine water for two minutes after exposure to the action of the peroxide, the same result was obtained. If developed for one minute by the rodinal immediately after exposure the plate became dark.

The question of these so-called Moser rays is, however,

not absolutely settled. E. Légrady¹ carried out some experiments with various metals and gases, and from the results he obtained he came to the conclusion that metals themselves have no action upon the photographic plate, their action depends upon the presence of moisture. Nitrogen gas also is found by him to increase the action. Since he obtained decided action in pure hydrogen gas he decided that the action of the metals cannot be ascribed to the generation and subsequent action of hydrogen peroxide. Also since he found hydrogen to have no action upon the plates in the absence of the metals, the active hydrogen must be in some way different from ordinary hydrogen; perhaps it is ionised. He considers this idea to be greatly strengthened by results obtained when further experiments were carried out with spongy platinum and palladium.

Action on Pith, etc., after being exposed to Sunlight.—Russell found that pith may be in contact with a photographic plate at a fairly high temperature for forty-eight hours and yet no trace of action be visible, yet if the pith has been exposed to sunlight for two or three hours it will then give a dark picture. The same action occurs with old printed matter, pure indiarubber, and many bodies which under ordinary conditions are but slightly active. It is not even necessary to expose these bodies to the action of sunlight; blue rays can produce a similar effect.

Becquerel Rays.—As stated elsewhere, Röntgen discovered the X-rays in 1895. In 1896 Becquerel made the discovery that salts of uranium emit invisible radiations which affect photographic plates and cause the surrounding atmospheric air to become a conductor of electricity. Since that time a number of substances have been found to emit these so-called Becquerel rays, and they are usually spoken of as radioactive bodies, the best known of them being radium.

¹ *Zeitschr. für Wiss. Photo.*, 6, 1908.

The photographic action of the positively charged particles (α -rays) emitted by these substances has been studied in some detail by S. Kinoshita¹ a further consideration of this question is, however, beyond the scope of this book.²

It may in passing be stated that a large amount of useful information with respect to radioactive substances has been obtained by the aid of photographic effects produced by the radiations they emit.

Phosphorescent Substances.—A somewhat curious effect produced by the action of phosphorescent substances has been noted by J. H. Player.³ He prepared a phosphorescent surface by coating a uniformly translucent sheet of paper with luminous calcium sulphide. This coated surface was then exposed for such a time to the action of full daylight until when taken into a dark room it was seen to glow with a bluish light. Some fifteen to twenty seconds' exposure was found to be sufficient for this purpose. The picture to be copied is laid perfectly flat on a piece of glass and the prepared surface is placed on the picture, care being taken to ensure uniform contact between the two. In an otherwise darkened room a strong source of yellow light (an ordinary gas flame will do) is then used to illuminate the picture, the light for this purpose acting for five to ten minutes and passing through the phosphorescent paper on to the picture. The prepared paper will at the end of this time be only faintly luminous. It is next removed from contact with the picture and placed in a frame in contact with a sheet of bromide extra rapid paper, the phosphorescent surface being face to face with the sensitive surface of the paper. This frame is then placed in a light tight box and heated to about 120° F. for about

¹ *Roy. Soc. Proc.*, Ser. A., pp. 432-453, March 1910.

² See also "The Radioactive Substances," *International Scientific Series* pp. 48, 113, 129 *et seq.*

³ *Photo. Journ.*, Nov. 1904.

twenty-five minutes. The bromide paper should then be developed in the usual way. Thus by this method it is possible to produce a positive print without an intervening negative.

Photo-electric Effect.—Another interesting phenomenon due to the action of light upon metals has been discovered and investigated during the last few years.

When a metallic surface is brightly illuminated by ultra-violet light negatively charged particles are set free from the surface into the surrounding air.

This action has been studied in the case of zinc, and is very clearly marked in the case of a liquid alloy of potassium and sodium. Prof. J. A. Fleming¹ has made use of this property in the case of that alloy to produce an electric cell which owes its activity entirely to the action of light upon the metallic surface.

¹ *Phil. Mag.*, 17, pp. 286-295, Feb. 1909.

THE PHOTOGRAPHIC IMPORTANCE OF THE CHROMIUM COMPOUNDS

NUMEROUS attempts have been made to substitute other sensitive materials for the expensive salts of silver, and some of these attempts have been crowned with success. It is true that no substance has been found permitting a negative to be prepared in the camera as easily as can be done by means of silver salts. But positives from existing negatives can be successfully produced by the help of many other metallic combinations. The results obtained by employing some of these are important, for they admit of multiplication in the printing press without the help of light. The compounds of chromium are the most useful in this respect, and the development of some of the principal photographic processes in which these substances are used will be next considered.

The Chromium Compounds.—A black mineral called chrome iron ore occurs in nature, especially in Sweden and America. If this is fused with carbonate and nitrate of potash, a beautiful orange-red salt is formed, which dissolves in water and readily crystallizes on evaporation. This orange-red salt is bichromate of potash. It consists, as implied by the name, of chromic acid and potash. The latter is the chief component part of the soap-boiler's ley; the former is a combination of the metal chromium, with oxygen. Chromium and oxygen combine together in several proportions, thus :

28	parts chromium	with 8	parts oxygen	form	protoxide of chromium.
28	„	„	12	„	„ sesquioxide of chromium.
28	„	„	16	„	„ dioxide of chromium.
28	„	„	24	„	„ chromic acid.

The last combination, chromic acid, is the best known of all. It may be prepared by adding sulphuric acid to a solution of chromate of potash: it crystallises in red needles, which readily part with their oxygen. Thus alcohol, dropped upon chromic acid, takes fire; the chromic acid instantaneously gives up part of its oxygen to the alcohol, and is changed into a green substance, sesquioxide of chromium. The sesquioxide of chromium forms salts with acids—for example, sulphate of chromium. This unites again readily with sulphate of potash to form a double salt, which is known by the name of chrome alum, and is sold crystallised in very beautiful dark violet octahedra (fig. 19). It is employed in dyeing, together with chromate of potash.

If chromate of potash be mixed with a solution of protosulphate of iron (green vitriol), a brown precipitate of peroxide of chromium is formed, the iron salt having removed a part of the oxygen from the chromate. This is often formed by the action on chromic acid or its salts of substances absorbing oxygen.

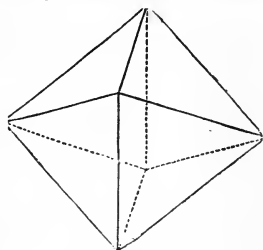

Fig. 19.

Chromic acid is of special interest to us, because both it and its salts are sensitive to light. Neither pure chromic acid, nor chromate of potash, are changed by light; they can be exposed for years to the sunlight without any decomposition being perceived. But as soon as a body is present that can unite with oxygen—for example, wood-fibre, paper, etc.—the light immediately produces its effect. This fact was published by Mungo Ponton, in the *New Philosophical Journal*, in the same year as the discovery of photography, that is in 1839. He writes:—

Experiments of Ponton.—“Paper immersed in bichromate of potash is powerfully and rapidly acted upon

by the sun's rays. . . . When an object is laid in the usual way on this paper, the portion exposed to the light speedily becomes tawny, passing more or less into a deep orange, according to the strength of the solution and the intensity of the light. The portion covered by the object retains the original bright yellow tint which it had before exposure, and the object is thus represented yellow upon an orange ground, there being several gradations of shade or tint according to the greater or less degree of transparency in the different parts of the object.

“ In this state, of course, the drawing, though very beautiful, is evanescent. To fix it, all that is required is careful immersion in water, when it will be found that those portions of the salt which have not been acted on by the light are readily dissolved out, while those which have been exposed to the light are completely fixed on the paper. By this second process the object is obtained white upon an orange ground, and quite permanent. If exposed for many hours together to strong sunshine, the colour of the ground is apt to lose in depth, but not more so than most other colouring matters.”

It appears that Ponton made experiments similar to those of Talbot, in the first period of silver photography. Perhaps he also copied leaves (see p. 17). The copies which are produced in this manner on chromate of potash are, however, immeasurably fainter than the copies on silvered paper.

They may be easily prepared by exposing under dried leaves, a drawing, or a negative in a printing frame, pieces of paper which have been soaked in a solution of chromate of potash for about a minute, and then hung up to dry in the dark or by lamplight.

The chromic acid is then reduced to brown peroxide of chromium, but if the exposure lasts very long the reducing process goes further, and a green oxide of

chromium is formed. In this case the picture appears fainter.

Ponton's experiment remained a mere curiosity until the inventor of photography on paper containing silver salts discovered another property of chromate of potash, which led to the most extensive applications.

Action of Chromium Compounds on Glue.—This property consists in the action of the combinations of chromium on glue.

Glue in its purest form, known by the name of gelatine, is insoluble in cold water, but it absorbs cold water like a sponge, and thereby swells. If it is warmed with water, it dissolves; but on cooling the solution solidifies to a jelly. This property is used to thicken soups. If to the warmed solution of glue be added alum, or a salt of the oxide of chromium, or chrome alum, the glue becomes insoluble in water, and forms a precipitate. On this is based the well-known system of white tanning; for in the tanning of a piece of leather the alum combines with the gelatine contained in the leather, and this becomes thereby insoluble, and at the same time durable.

Bichromate of potash and glue can be dissolved together in warm water in the dark, without the glue suffering any change from the chromate. If a plate or a sheet of paper be covered with such a solution of gelatine and bichromate of potash, and the film be allowed to dry, it becomes firm, and yet remains soluble in water as long as it is kept in the dark. But as soon as the film is exposed to the light, the bichromate of potash is reduced to oxide of chromium, and this tans the film of gelatine—that is, makes it insoluble in water.

Talbot's Discovery.—This observation was made by Fox Talbot in 1852, and, as a careful observer, he knew directly how to turn it to account. He coated a steel plate with a solution of chromate and gelatine, let it dry in the dark, and then exposed it under a drawing or a positive glass

picture. The black lines kept back the light. Accordingly, at these places the gelatine remained soluble, but was rendered insoluble under the white places, by the action of light. After exposure he washed the plates in the dark with warm water. By this means the places that had remained soluble under the black lines were dissolved; the others were retained on the plate. Thus Talbot obtained a drawing on the metal itself on a brown ground. This is worthless by itself, but it provides the means of producing a steel plate for engraving.

We have elsewhere explained the nature of steel and copper-plate engraving. Both processes consist in the production of a metal plate which contains, in incised lines, the drawing that is to be reproduced. These lines retain the ink which is rubbed upon the plate, and transfer it to the paper. The hard steel plates have the advantage of lasting for many more copies than the softer copper plate; only the steel engravings are far inferior to copper-plate in artistic beauty, and therefore the former have lost favour. But the steel engraving is very important for preparing technical and scientific diagrams, paper money, and the like, as less artistic beauty is required in their case. It was steel plates of this kind that Talbot produced by the help of light.

We have seen that his steel plate was covered with an insoluble film of gelatine, and that the metal was uncovered at all places where the light had not operated. He poured on it a fluid which ate into the steel—for example, a mixture of acetic acid and nitric acid. This mixture, of course, only attacked the steel where it was exposed, and thus produced an incised drawing in the steel plate, so that the latter, after being cleaned, gives as good an engraving as if it were the work of the engraver.

Thus a new process was found, based upon the chemical action of light, which was gradually to replace the more difficult work of the engraver.

We have mentioned in the first chapter a similar process, based on the application of asphalt, and later on a different one by Scamoni (see p. 222).

This discovery of Talbot was soon followed by a more productive one on the same ground.

Pretsch's Engravings.—An Austrian, Paul Pretsch, in 1854, prepared copper-engravings by a similar method, with the help of the electrotype process. He also took a film of gelatine, which contained chromate of potash, exposed this under a negative or a positive picture, and then washed it in hot water.

After doing this, all the places were retained which had become insoluble through the light, and after the washing and drying they stood out in high relief.

Accordingly, in copying under a positive, the lines which were black in the original appeared in low relief, and the white parts in high relief.

This film was placed in an electrotype apparatus. This apparatus has the property of precipitating copper or other metals on a prepared surface. It consists of a galvanic cell, and a trough containing a solution of sulphate of copper. The reliefs which are to be copied, having been made conductors of electricity by a coating of graphite, are suspended from the zinc pole *B* (fig. 20) of the battery in the sulphate of copper: to the copper pole *D*, a plate of copper is attached. As soon as the electric current passes, the solution is decomposed, and the copper adheres to the relief. The thickness of the copper depends on the time

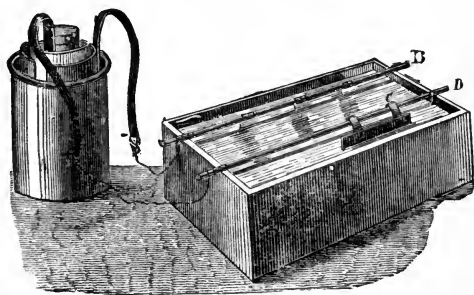

Fig 20.

the current is allowed to pass ; accordingly, plates of any thickness can be produced.

If the original is incised, the electrotype impression will be in relief, and *vice versa*. Therefore, in the above case an impression is obtained with lines in high relief.

This kind of plate is also adapted to give impressions, but rather differently from an incised copper plate. In the latter, the engraver's ink is rubbed into the incised marks, and then under strong pressure conveyed to paper.

In a plate with a picture in relief, the impression takes place as in printing ; the raised places are rubbed over with printer's ink by the help of a leather ball or a cylinder blackened with ink, and then printed on paper. Letter-press is produced in this manner ; all its letters are in high relief ; also all wood-cuts which accompany the text.

The printing-press is the simplest and cheapest mode of multiplying copies. It admits of the use of cheap papers, whilst copper-plate engraving requires a thick, soft, special paper. The printing-press, moreover, admits of woodcuts being printed in the text, whilst copper-plate printing requires special plates. Lastly, the printing-press works with extreme rapidity, whereas copper-plate printing requires much more time.

Further, the printing-press does not use up the type rapidly, as it works under feeble pressure ; while copper-plate printing, which requires strong pressure, wears the plate considerably, so that after striking off a thousand copies, the impressions are no longer as good as at first.

The production of photographic plates for the printing-press is of the greatest importance, and Pretsch at first took the lead here. His process did not, indeed, produce the most perfect results. The incised plate which he produced on the gelatine film by the help of light was not deep enough to produce a high relief in the galvanic impression ; but this is necessary, for otherwise the

printer's ink penetrates into the incised parts, which ought to remain white, while the washing of the exposed gelatine films with hot water easily destroys the finer parts of the picture, and this detracts materially from the value of the copies. Moreover, difficulties arise in preparing the electrotype plates; the film swells up and loses its form. In short, the affair is not so simple as it appears; little difficulties exist, and these occasion errors which the unprofessional hardly observe, but which considerably diminish the effectiveness of the picture.

At an early period it was found that these processes offered a special difficulty, viz., the reproduction of the transitions from light to shade—the half-tones. These were so very imperfect that the representation of natural objects—portraits and landscapes—was speedily given up, and people confined themselves to the reproduction of drawings, maps, and the like, on an enlarged or diminished scale, and thereby to producing stereotype plates for copper engraving and printing. This application is of no little importance, for it prepares, by the help of light, a metal plate for printing in as many hours as an engraver requires days, and at far less cost.

Gelatine Relief.—We have mentioned above the properties of gelatine, and remarked that it has the power of absorbing cold water and thus swelling up. This property is lost if the gelatine is saturated with chromate of potash and exposed to the light. If this exposure is made under a negative, all the places situated under the transparent parts lose this property, while the other places not affected by the light retain it. Accordingly, if the exposed film be thrown into water, the places which are not affected by light swell, whilst those affected by light are not altered. The result is a true relief,—the lights are in high relief, the shadows in low relief,—and this is so strong that it can be cast in plaster of Paris. For this purpose the relief is dried with blotting-paper, rubbed with oil, and then a paste of

plaster is poured over it. This soon hardens, and gives an impression of the gelatine relief, being in high relief where the gelatine is hollowed, and *vice versa* (fig. 21).

It appears as if a plate might be easily obtained for letter-press from such a gelatine relief. Let the gelatine film be exposed under a drawing. The black lines then keep back the light; accordingly, the gelatine particles come out in high relief on being wetted with water. The drawing is therefore represented in high relief, and this is exactly what the printer requires; nothing further would now be required than to cast the relief in plaster, and recast the plaster form in metal, as happens daily in the stereotyping of woodcuts. But unfortunately this process breaks down, owing to a trifling circumstance—the lines in the wet relief do not swell to the same height. But the



Fig. 21.

printing-press requires them to be perfectly level, otherwise they cannot be equally inked and printed.

On the other hand, the casting can be very well utilised as a picture in relief, if suitable retouches are given to it. Reliefs of this kind with portraits were sold some years ago for seals, but the execution was very imperfect, and therefore they soon lost favour.

But reliefs can be obtained in another way from an exposed gelatine film—namely, by hot water. As we have seen above, this dissolves the parts which, not having been affected by light, have remained soluble, while the parts affected by light, and therefore insoluble, remain untouched. These parts that have remained insoluble stand out as prominences.

Another precaution is necessary. Suppose that *N* (fig. 22 *a*) is a negative, that *c c* are its opaque parts, and *b* the semi-transparent, which are called half-tones. If a film of prepared gelatine *g* (fig. 22 *b*) is exposed under

them, the light penetrates in various degrees, according to its strength—most in the transparent places, less in the semi-transparent, and not at all in the opaque parts.

Accordingly, insoluble films of different thickness will be formed, as represented in *b*. The shaded parts in the figure denote the portions that have become insoluble.

If now the film of gelatine (fig. 22 *b*) is plunged in hot water, all the parts left white in the figure become dissolved ; but at the same time the half-tones

not adhering to the substratum *P*—for instance, paper—become detached and are torn off. Therefore a relief of the form *d* remains behind ; the half-tones (*y y*) are wanting. In order to avoid this a support must be given to the exposed surface to retain the half-tones.

For this purpose a piece of paper, moistened with white of egg, is laid on the exposed surface and becomes firmly attached to it. If the sheet is now immersed in hot water, the film *P* becomes detached from *g*, the little portions of gelatine remain attached to the albumenised paper ; the white places in fig. 22 *b* become dissolved, and all the half-tones *y y* adhere firmly to the new layer, as in fig. 22 *e*, and form a relief. This is named the transfer process. If the relief produced by cold water, described p. 85 (fig. 22 *c*), is compared with that produced with hot water (fig. 22 *e*), the difference is at once apparent :

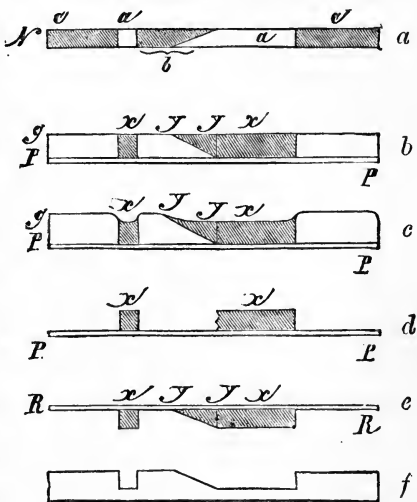

Fig. 22.

in the former case the parts not affected stand out in relief, in the latter case those exposed to light.

Woodbury Type.—A new printing process founded on the preceding, was invented by Woodbury in 1865, and has been called Woodbury-type, from its inventor.

The heliographic methods of printing previously described are apparently very simple. Pictures of all objects cannot, however, be prepared by these methods. A linear drawing, such as a map or letter-press, can be reproduced, either on an enlarged or diminished scale, by these methods; but pictures with half-tones, such as sepia drawings or photographs from nature, cannot be so copied.¹ The soft half-tones become rough and hard, rendering the picture very ugly. According to Osborne, the cause of this is found chiefly in the nature of half-tones in copper-plate printing, which are formed by a series of lines at various distances from each other or by roughening the plate; the latter method produces a series of points, which, according to their distances from each other, give a lighter or darker shade or half-tone. The half-tone of sepia drawings and photographs is quite different. It is not formed of strokes or points, but is a homogeneous light or dark colour.

Accordingly, it was first necessary to break up the photographic half-tone into a series of strokes or points, to make it a copper-plate half-tone, and this constitutes the difficulty.

Woodbury conceived the idea of producing, by a new printing process, homogeneous half-tones, perfectly similar to those of photographs or sepia drawings.

He produced a relief by exposing a film of prepared gelatine under a negative, and then treating it with hot water. This relief shows the dark parts of the original in high relief, and the light parts in low relief. For the negative is transparent where the original

¹ See half-tone process.

is black; hence the light passes unimpeded through those places. The half-tones are formed by the varying height of the gelatine film. (Compare fig. 22 *e*.)

If this gelatine relief is suffered to dry, it becomes wonderfully hard and firm. It can then be placed with a plate of lead under a strong press, and a *cliché* of the relief can be thus obtained in lead. The prominent parts of the gelatine relief appear, of course, depressed in the lead, and the depressions prominent, as represented in fig. 22 *f*.

Woodbury used this lead relief as a printing plate. But he did not print it off with oily printer's ink, which is too opaque, but with a semi-transparent gelatine ink. This was poured warm on the plate in a horizontal position, it penetrated into the depressions, and then a piece of paper was placed upon it and pressed gently down, the gelatine consolidated quickly, and an impression in relief was obtained on the paper. As the ink used was transparent, it appeared in thin sheets much less black than in the thick, and in places where its thickness gradually diminished, there occurred a transition from black to white—a perfectly homogeneous half-tone. As soon as the coating dried, the relief contracted considerably, but the semi-transparency remained, and thus it became possible to reproduce the most beautiful half-tones of photography by printing. Any colour could be used in this process.

This relief-printing of Woodbury attained a high importance. It made the multiplication of photographic negatives from a single printing form possible without the help of light. It was therefore of importance where a great number of pictures were required—for example, in the production of copies of oil-paintings and drawings. Photographers did not use it much in portraiture, because the production of a faultless gelatine relief and its impression on lead require great practice and an expensive

apparatus, which would not pay in the limited sphere of portrait photography.

By this relief process a good deal of work was at one time done by printing on glass; thus Goupil prepared copies of oil paintings by this method which were much in request. The Woodbury process was also used for preparing slides for projection by lantern.

Poitevin's Discoveries.—We have seen above that gelatine mixed with bichromate of potash becomes insoluble in the light. This fact was made by its discoverer, Talbot, the basis of heliography—that is, of photographic steel engraving. Poitevin, a Frenchman who did much to promote photography, founded on the same method another process: he produced pictures in various colours. He first used carbon as a pigment, thus obtaining carbon pictures.

The process is simple: Poitevin coated paper with prepared gelatine coloured with lampblack, and exposed this under a negative; he then washed the film in hot water, which dissolved those parts of the gelatine unaffected by the light, whilst the insoluble parts retained their colouring matter and thus formed a picture.

Practical difficulties occur even in this simple process. It has been already mentioned that the action of the light does not always penetrate the whole thickness of the film. The half-tones have, therefore, no support, and are torn off in washing (see fig. 22 *d*, p. 87). Before treating the films with hot water, it is therefore necessary to transfer them, as described in the part dealing with photo-reliefs. An albumenised sheet is pressed in the dark on the coloured film of gelatine, and then the whole is plunged into hot water; the half-tones adhere to the paper pressed upon them, and the image appears uninjured on it, as in fig. 22 *e*.

The picture is, of course, reversed—that is, what was

originally to the right in the lower image comes now to the left. That this is so can be easily seen by writing a word with thick ink in large letters on a piece of paper, and laying a piece of blotting-paper on the wet writing. The reversed impression of the writing is seen on removing the blotting paper. In the letter copying-press the same thing takes place, and therefore the letters are copied on very thin paper, that they may be read on the reversed side, because viewed from that side they appear in their first position. The gelatine prints cannot be printed on such thin paper; therefore, if the reversed position is inconvenient, the picture must be again transferred. This is managed in the following manner:—

The moist gelatine film is placed after exposure upon a smooth zinc plate, to which on drying it becomes very firmly attached. The copy thus glued to zinc is immersed in warm water, the paper becomes detached, and the developed image adheres to the zinc plate. A sheet of white paper is now fastened with glue upon the zinc plate, and allowed to dry. The gelatine picture adheres firmly to this paper, and may, with care, be detached from the zinc plate. The picture thus appears unreversed upon the paper.

The pictures thus obtained are very similar to those of the Woodbury-type; they surpass the latter, however, in the fineness of their details and the ease with which they may be produced.

The pigment impressions have a great advantage in the fact that they can be produced in any colour; genuine Indian ink may be used for them, and then perfectly durable pictures are obtained that do not turn yellow or black.

In the same way red, sepia, blue, and so on can be mixed with the gelatine, and thus pictures can be produced in those colours. This circumstance is important when it is wished to reproduce coloured drawings.

Abney's Work.—A very interesting observation was made by Abney, in England, in relation to the foregoing process. He remarked that if an exposed film of gelatine remained a long time in the dark the insolubility increases. Accordingly, a film of this kind which, freshly developed, would only give a faint image, after some hours gives a strongly defined image. This fact allows the time of exposure for pigment pictures to be considerably reduced—that is, a larger number of pictures to be made in the same time.

Marion's Work.—Still more interesting is an observation of Marion, at Paris. He exposed under a negative a sheet of paper sensitized with bichromate of potash, and then pressed it in the dark on a moist film of coloured gelatine also sensitized with bichromate. The gelatine became insoluble wherever the paper had been affected by the light, and on development with hot water a pigment picture was obtained on the paper.

We have seen that the parts of a gelatine film containing bichromate of potash, which are exposed to the action of light, become insoluble in water, and do not swell on being moistened; at the same time they acquire the property of adhering to fatty inks. Thus if an exposed film is moistened with a wet sponge, the unaltered places only absorb the water. If, on the other hand, printer's ink be rubbed over the film, those places only which have been changed by the light retain the ink. This fact was discovered by Poitevin, the author of many valuable discoveries in photographic chemistry.

If a piece of paper be pressed on such a film of gelatine, coated with printer's ink, the ink adheres to the paper, and thus a print is obtained of the negative, under which the film had been exposed.

This peculiar mode of printing gave at first very imperfect results. The process was rendered difficult from the fragile nature of the gelatine film, the difficulty of

finding the right time for exposure, the proper consistency of the printer's ink, and other obstacles. After a hundred impressions, the film of gelatine was generally so injured that it was useless. Tessié de Mothay, at Metz, obtained moderately good results with the process, but Albert, of Munich, was the first who succeeded in making it of any practical importance.

Albert Process: "*Lichtdrucke*."—All experimenters before Albert had transferred the gelatine film to metal, to which it only adhered imperfectly. Albert poured the gelatine solution of bichromate of potash in the dark, on glass, and, after drying, exposed it, glass upwards, for a short time to the light. In this way the light produced a superficial effect; the part of the gelatine adhering to the glass became insoluble, and thus firmly fixed. A negative was then placed on the film and exposed to the light. A faint greenish picture was thus produced. The exposed film was then washed in water until all the bichromate was removed, and then was suffered to dry.

To print from such a film, it was first rubbed with a sponge wetted with a dilute solution of glycerine. Those parts only of the film which were unaffected by light absorbed the water. A leathern roller was inked by rolling it on a slab of marble on which printer's ink had been spread, and then lightly passed several times over the gelatine film. All places which had been affected by the light retained ink from the roller, but not so the others, and finally a well-defined picture appeared on the originally almost colourless surface. As soon as it had been sufficiently inked, a piece of paper was laid upon it, and passed through rollers coated with india-rubber, the plate being laid on a sheet of the same material. In this manner the ink of the picture passed over to the paper, and produced thus an impression with all half-tones. The inking and printing could be repeated at option, and thus thousands of copies prepared if the plate was very firm.

These Albert-types were also known as "Lichtdrucke," and were in appearance very similar to prints obtained with silver salts. The process was well adapted for copying pencil and chalk drawings. It was largely used for preparing views having the appearance of ordinary photographs; Obernetter of Munich printed many such which had been obtained by the photographic department of the Prussian army during the Franco-Prussian War.

The brilliancy of these pictures was produced by giving them a coat of varnish.

If the prints by this process be compared with Woodbury-types, it is seen that the latter give the shades and dark parts better, but that the white parts often appear discoloured. The Woodbury-types are, however, much more like photographs than the Albert-types, for the latter have a lithographic tone. It is only by coating with varnish that they are made to resemble photographs.

Aniline Printing—Willis.—Aniline is a substance which resembles ammonia in its chemical relations, but having a different odour and a different chemical composition. The substance is obtained as a brown mass from coal tar on distillation.

If this brown fluid is treated with chlorine or nitric acid, or manganese and sulphuric acid, or arsenious acid, various shades of colour are produced. One specially interesting to us is the colour formed by heating aniline with chromate of potash and sulphuric acid; the result is a peculiar violet substance—aniline violet. Chromate of potash, as already seen, plays a part in some of our photo-chemical processes, and on this substance is based the aniline printing invented by Willis.

Willis immersed a piece of paper, in the dark room, in a solution of chromate of potash and sulphuric acid. He exposed the paper under a positive picture, *e.g.* a drawing or copper engraving. The light shines through the white paper, and in these places the chromic acid is

reduced to oxide of chromium, which does not affect aniline colours; on the other hand, the chromic acid remains unchanged under the black strokes, which keep back the light. After the exposure a very faint picture of unchanged yellow chromic acid is seen.

If this faint picture is exposed to the vapour of aniline, a brown colour is produced at the places where the yellow strokes exist, and in this manner the original faint yellow becomes well defined. To expose the prints to aniline vapour they are placed in a covered box with a piece of blotting-paper, moistened with a solution of aniline in benzine. This process produces a positive picture from a positive, and is therefore very valuable in producing faithful copies of drawings. These copies are, of course, reversed, as if seen in a mirror. This circumstance limits their use in many cases. We have already explained the reason of this reversal (p. 91). Copies can, however, be obtained in their proper position if the original drawing is very thin. In that case the back of the drawing is placed against the chromic acid paper, and the light is suffered to shine through it from the upper surface.

Another disadvantage of this process is that the chromic acid paper must be always freshly prepared, as it quickly spoils, and further, there is the difficulty of ascertaining the proper time for exposure. If the time is too short, unchanged chromic acid remains everywhere on the paper, and thus the whole picture is blackened by the aniline. If, again, the time is too long, the light acts gradually through the black strokes of the drawing, reduces the chromic acid, and the paper then remains entirely white in the aniline fumes, as no more chromic acid is present to form aniline colours. These circumstances limit the value of the method.

Lithography.—By lithography is understood a process of printing from a drawing or painting on a prepared stone.

Near the little Bavarian town of Solenhofen, there is a clayey, rather porous limestone, easily polished and worked. Such limestone is used for lithography.

The lithographic press differs essentially from copper-printing and book press, because the drawing on stone is neither raised nor incised. The lithographic stone forms, when ready for printing, a smooth surface; and in this the process is peculiar, differing from all other modes of printing. If a drawing is made on a lithographic stone with ink consisting of colour and a fatty substance, *e.g.* oil, and the stone is moistened with water, the porous stone is wetted only in those places where there is no oily colour, for oil repels water. An oily ink, such as printer's ink, is then rubbed on the stone with a leathern roller and only adheres to the previously inked spots—that is, to the drawing.

This peculiarity was discovered by Alois Senefelder in 1796. He also turned his discovery to practical account, and applied for patent rights in England, Austria, and Germany during the years 1800-1803.

After the stone has been inked as above, if a piece of paper is pressed upon it the ink passes over to the paper, and a lithographic impression is obtained. The stone can be evidently used any number of times, and thus thousands of copies can be produced. This style of printing has many advantages over copper engraving. The engraving of a copper plate is a difficult matter, often requiring a labour of years, whereas the drawing on stone is almost as easily made as on paper. In like manner, printing from a stone plate has fewer difficulties than that from a copper plate. Corrections are easier to make on the stone, and further, after the surface has been removed by grinding, the same stone may be used for another drawing, and so on for many years. These circumstances have brought lithography into general use: technical drawings, labels, circulars, visiting cards, price lists, calendars, illustrations of books, atlases,

scientific pictures, and a thousand other things are produced by lithography.

Chromo-Lithography.—A development of this process, called chromo-lithography, came into general use, and was at one time by far the most important method of producing coloured pictures mechanically. Chromo-lithography is rather more complicated than common lithography. If it is wished to make a chromo-lithograph of a painted picture, not only one stone, but a separate stone for every colour must be prepared. For example, to prepare a picture of an object in which blue, red, and yellow tones appear, a drawing in blue ink of all the blue parts must be made on a separate stone; a second and third stone are required for the yellow and red places. Prints must be made from each stone successively on the same piece of paper in the proper position, and thus a picture in colours is obtained. If such a picture is then coated with a brilliant varnish it becomes an “oleograph.”

If must not be understood that pictures of real artistic beauty could be prepared by these means by the ordinary printer, an artist's taste and knowledge of colour being necessary for chromo-lithography.

Zincography.—Closely related to lithography is zincography, which we shall glance at here before passing to photo-lithography.

Zinc, curiously enough, has the same property as lithographic stone; for if drawings in oily chalk be made on a zinc plate, and then the whole moistened with gum water, the plate may be inked with oil colours, and thus a picture be obtained of the chalk drawing. The printing, therefore, presents results similar to those of lithography; but the preparation for zinc printing has more difficulties than lithography, so that the use of zinc for this purpose is limited.

We have given a brief survey of the principles of lithography and zincography, as far as necessary to understand

what follows. Both processes resemble the Albert-type printing in many respects; in both cases the surface has the peculiarity of retaining ink in some places and repelling it in others—but, of course, lithography was invented long before Albert-type. When photography was invented it deprived lithography of an important branch—that of portraits. Even as late as 1850 it was still customary to produce lithographic portraits. The lithographs from oil paintings also suffered through photography.

Photo-Lithography.—Poitevin, who allied the two by inventing photo-lithography, endeavoured to economize the labour of the lithographic draughtsman, and to replace it by the chemical action of light. He coated lithographic stones with chromate of potassium and gelatine, and exposed them under a photographic negative. The picture thus obtained was then washed and inked. All parts affected by light took the colour, and gave an impression in the press. The first attempts of the kind were very imperfect; the pictures were especially wanting in half-tones, which were lost in washing, as they are in the pigment process. An improvement was introduced by Asser and Osborne; they printed the negatives on paper prepared with bichromate of potash coated with gum, gelatine or albumen, and then they inked this. Such paper has the peculiar property of retaining printer's ink on the exposed places only. After inking, the paper was carefully washed and then pressed on a lithographic stone. This absorbed the colour, and thus the picture was perfectly transferred to the stone, from which excellent lithographic prints could be obtained in the ordinary way. Though half-tones were thus produced, the impression fell far short of photographs in quality. The lithographic half-tone differs essentially from the photographic, which forms a homogeneous surface, while the lithographic half-tone appears as a mass of

black points more or less near together. The granular structure of the stone does not allow such delicacy as may be attained by photography.

In one branch photo-lithography surpasses all other reproducing arts—that is, in producing copies of maps which have been drawn by hand. The preparation of geographical maps requires much time and care. The outlines of mountains, rivers, and countries must be executed with the greatest exactitude, corresponding to the measurement. Frequently draughtsmen and engravers are employed for the various details, and though working conscientiously, inaccuracies are unavoidable, and make corrections necessary. All this takes time and trouble. If the object is now to make an enlarged or diminished copy of an existing map, the same difficulties occur, and the diminishing is especially troublesome. The pantograph is a useful aid here, but does not exclude need for attention in the draughtsman. In this respect photography is invaluable as an aid to map-making. With very great ease, enlarged or diminished copies of an original may be prepared as negatives by photography ; in a few hours this is copied on stone, and within a day photo-lithography can throw off thousands of enlarged, diminished or original sized copies.

If it were wished to make a lithographic stone drawing by hand, several days would be necessary, and it would be far less exact. No photographic printing process is as rapid as photo-lithography, and it has in consequence been much used in map-making, especially where a large number of copies are required. In the Franco-Prussian war, the advancing troops needed, before all things, maps of the territory to be occupied. But there was not a sufficient supply of maps of France to provide whole army corps. It is impossible to keep a stock of such maps, as no one can tell where a campaign will take place. Photo-lithography was here an im-

portant means of preparing thousands of copies from one original map, and thereby contributing to the successful advance of the German army, which, with these maps in hand, showed itself better acquainted with the enemy's territory than the enemy's troops themselves. The photo-lithographic establishment of the brothers Burchard, at Berlin, produced in the war of 1870-71, 500,000 maps. Plate I. is a specimen of this process.

Photo-Zincography.—The nature of photo-zincography will now be clear to the reader : for the treatment of the zinc plate and of the stone is the same. The negative is either copied directly on the zinc plate, coated with gelatine and bichromate, or a copy from the negative is prepared on chromo-gelatine paper, and the paper is then inked and transferred by pressure to the zinc plate. In both cases the prints may be taken directly from the zinc plate.

It must be remarked that, even without photography, direct mechanical copies of maps, writings, etc., can be made by a transfer process if the original be executed in oil colours. The back of the original is moistened with acidulated gum water, and then the face is inked with an oily ink which adheres only to the oily strokes of the drawing or printing. The original, thus freshly inked, is then placed on a fresh stone, or a freshly cleaned zinc plate, and pressed. The drawing passes over to the stone or the zinc, and can be easily multiplied by inking and printing. It is difficult to preserve the original, which is often much damaged by the pressure. Still more difficult is it to obtain clean lines, for the ink is often squeezed out by the pressure, and if the lines are close, as in the mountain lines of maps, they run together ; therefore the process has been more applied for copying old books, which have been reproduced page by page in this way.

It is self-evident that only reproductions of the original size can be made by this process.



Martin, Hood & Larkin, Litch, London W.C.

... ..

We have to mention another process of photo-lithography, based on the use of asphalt. We have already described this in our first chapter as a sensitive substance, and have also described a process called heliography, which produces, by means of photography, copper plates and steel plates for printing. Asphalt serves also for photo-lithography. A lithographic stone is sprinkled with a solution of asphalt in ether, allowed to dry in the dark, and exposed under a negative. The asphalt becomes insoluble on the exposed places, and is retained upon treating the stone with ether or benzine. If the stone is then damped, the moisture only penetrates where no asphalt covers the stone. On rolling it after this with an inked roller, the fatty ink is not retained by the damp places, and only adheres to the asphalt—that is, to the picture; thus a stone giving impressions is obtained. This method gave good results in the hands of several practitioners, and was preferred by many to the gelatine process, though asphalt is much less sensitive than the prepared gelatine.

Porcelain Decorations.—Photography has become allied to almost all the multiplying and descriptive arts, though it was at first looked upon as their rival. It is not surprising, therefore, that it has become a help in porcelain painting and decoration. The original method was invented by Poitevin, and subsequently was materially improved by Joubert in London and Obernetter at Munich. It consists in this: a mixture of gum, honey, and bichromate of potash is poured on glass; the film is carefully dried in the dark, and then exposed under a positive. This film of gum, when freshly prepared, is sticky, and retains any colouring matter strewn over it in powder, but after exposure to light the film loses its stickiness. If this exposure takes place under a drawing with black strokes, the film under them will retain its stickiness, but will lose it beneath the white, transparent parts of the paper.

Therefore, if any colouring matter in powder form be strewn over the film after exposure, it adheres where the strokes of the drawing have protected the film from the light, but not at other places, and thus a picture in powdered colour is obtained. If this coloured powder and the surface on which it is strewn are fire-proof—as glass and porcelain—the picture obtained can be burnt in, and pictures of various shades can be produced, according to the choice of the powdered colour. Pictures of this kind can be transferred from one surface to another. If a collodion film is poured upon the powdered picture and suffered to dry, and then the whole immersed in water, the collodion film with the picture can be easily separated from the surface on which it was produced, and transferred to and burnt into other surfaces—glasses, cups, etc.

The Pea-Sausage.—In the Franco-German campaign of 1870, the well-known pea-sausage¹ was one of the most important articles of food for the army, and was prepared daily by thousands. The fabrication of the interior portion caused little difficulty, but the obtaining so many skins created much difficulty. As the supply fell short, a substitute was sought in vegetable parchment. This paper, which is produced by dipping blotting-paper in sulphuric acid for about a second, then washing and drying, is distinguished by its skin-like properties of resistance. It is impenetrable to water, and difficult to tear. It is therefore used for the production of bank-notes. It was attempted to make sausage skins of this paper, by doubling a sheet cylindrically and pasting it together. No glue or gum can, however, resist the effect of the boiling water in which the sausage has to be cooked, and so the artificial sausage skin fell asunder. Dr Jacobson solved the problem by producing an adhesive substance, with the help of the chemical action of light, which could resist

¹ Erbswurst.

boiling water. He mixed the glue intended for the sausage skin with bichromate of potash, and exposed the glued parts to the light. This made the glue insoluble, and now the artificial skin endured boiling water thoroughly well. The number of sausage skins prepared in this way, by the chemical action of light, amounted to many hundred thousands.

The importance of the chromium compounds in photographic process will become still more evident by referring to the chapters on "Book Illustrations" and the "Preparation of Photographic Prints." The early developments in which salts of chromium were used are the only ones mentioned in this chapter.

LENSES

Refraction.—We have already pointed out that when a ray of light passes the border of two transparent media of unequal density, a change of direction takes place which is called refraction.



Fig. 23.

If a small coin is placed in an opaque cup, and the eye be kept in such a position that the edge of the vessel just conceals the coin, it becomes visible on pouring water into the cup, and this takes place by the refraction

which the rays experience in passing from the water to the air. (See fig. 23.)

The angle which the rays are bent out of their original course by the refraction is called the deflection.

This deflection increases in proportion to the obliqueness with which the rays fall upon the surface of the water.

In order to determine exactly the degree of the refraction, let a line be conceived to be drawn at right angles to the surface through the point of immersion n of the ray nl (fig. 24). This line is called the normal, and the angle i which the ray forms with this normal is called the angle of incidence, while the angle r which the refracted ray forms with the same normal is called the angle of refraction.

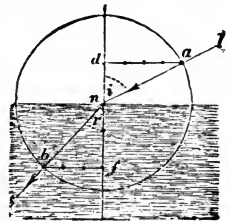

Fig. 24.

The ratio of the magnitude of the angle of incidence to the angle of refraction is peculiar. If a circle be described with centre n , and from the points a and b perpendicular lines ad and bf are let fall on the normal, the

ratios of these lines to the radius of the circle an or bn are what mathematicians call the sines of the angles. Thus ad/an is the sine of i , and bf/bn the sine of r . The ratio of the sine of the angle of incidence to the sine of the angle of refraction is constant.

This ratio is, when light leaves air for water, 4 to 3; that is, the sine bf/bn is three-quarter times as great as the sine ad/an , or the ratio ad/an is four-third times as great as bf/an . Light is still more refracted on entering glass. In this

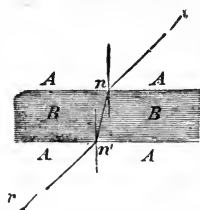

Fig. 25.

case the ratio of the sine is as 3 to 2. This ratio of the sines of the two angles is called the index of refraction.

If a ray of light ln falls upon a smooth sheet of glass (fig. 25), it experiences a similar refraction; it continues in the direction nn' , and the sine of the angle of refraction at n in the glass becomes two-thirds of the sine of the angle of incidence.

On issuing from the other side of the sheet of glass, another refraction takes place; but in this case the sine of the angle of refraction at n' in the air becomes one and a half times that of the angle in the glass, and as the angle at n is equal to the angle at n' , the angle of emergence of $n'r$ is of the same magnitude as the angle of incidence of ln —that is, the ray continues, after refraction, in its original direction. At all events, it only experiences a shifting parallel with itself. Therefore we see objects through our windows in the same direction in which they are really situated.



Fig. 26.

The result is entirely different when the spectator looks through a triangular glass (fig. 26). If the eye is at o , and an object at a , and a triangular prism be held close to the eye, the object does not appear to be at a , but in the direction of a' . The incident ray ad suffers a deflection at the

first face of the glass, taking the direction dc ; at the refraction on the second face it takes another, co . Both deflections are in the same direction.

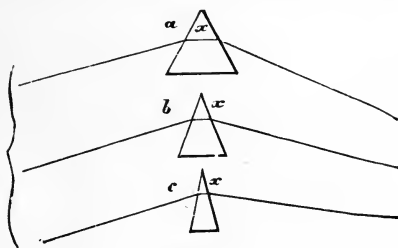

Fig. 27.

The greater the magnitude of the angle x which the two faces of the prism, through which the ray passes, make with each other, the greater is this deflection. Thus the deflection by the prism b (fig. 27) is

greater than by the prism c , and by the prism a it is greater than by b ; because the angle of refraction x is greater in b than in c , and in a it is greater than in b .

The Lens.—If a glass structure be erected, consisting of separate prisms of varying angles (fig. 28), and if a bundle of parallel rays be conceived to fall upon it, the ray a will be more strongly deflected than b , which falls on a prism having a smaller angle; and the latter, again, will be more

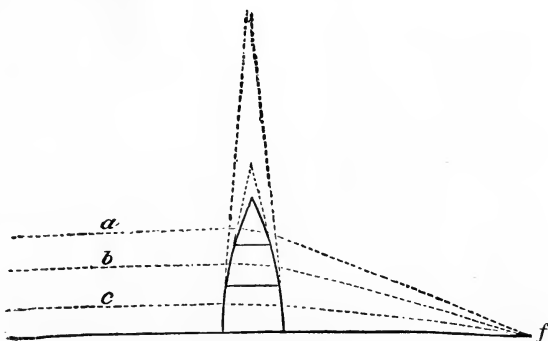

Fig. 28.

deflected than ray c , and the result may be that all the rays unite in one point f .

If instead of the separate prisms we substitute a solid

symmetrical mass of glass, we obtain the section of a lens, which has the property of uniting all parallel incident rays in one point. (See fig. 29.)

Every lens is contained between two curved faces. The connecting line running through the centres of the two surfaces is named the

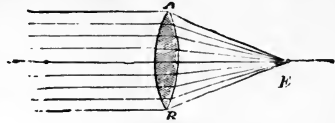

Fig. 29.

axis of the lens, and the point *F* (fig. 29), where the parallel incident rays unite, is the focus, while its distance from the lens is the *focal length*. But not only are parallel rays united in one point by the refraction due to a lens of this kind, the same thing occurs with the divergent rays which issue from any luminous point.

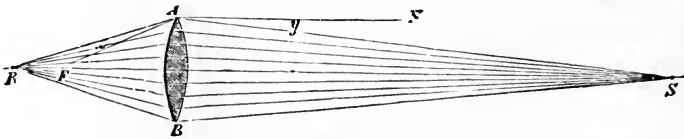

Fig. 30.

The point in which such rays are united is called the *conjugate focus* of the luminous point.

A luminous point *S*, for example, sends a cone of rays to the lens. After refraction these are united at *R*. If *S* be brought near to the lens, *R* removes further from it; if *S* be brought so near that its distance from the lens is twice

the focal length, then the converging point *R* is equally distant from the lens.

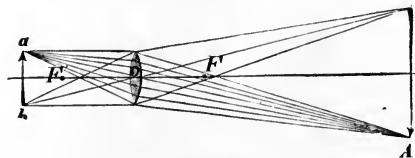

Fig. 31.

If, instead of the luminous point, an object (for example, an arrow *B A*) is placed before the lens, from each individual point of the object a cone of light proceeds to the lens, and all the rays of one and the same cone con-

verge in one point, the rays from A in a , and those issuing from B in b ; and the result is that a perfect miniature and inverted image of the arrow is produced.

If the arrow be moved near to the lens, its image is removed farther from the lens and becomes larger. For example, if the little arrow $a b$ is placed before the lens, it produces the enlarged picture $A B$.

But if the arrow be removed farther from the lens, its image approaches the lens, and becomes continually smaller. *Accordingly, a lens is able to project enlarged or diminished images of an object, the size of the image varying with the distance of the object from the lens.*

Different Classes of Spherical Lenses.—So far we have only been considering lenses both faces of which are convex. The lenses used for optical purposes are known as “spherical” lenses, since their faces are either plane or parts of a sphere. There are, however, lenses made which have cylindrical, elliptical, and even parabolical curved faces.

Of the spherical lenses there are six kinds, as shown in the following diagram (Fig. 32).

A	{	I. is double convex. II. „ plano convex. III. „ concavo convex (con- verging).	(con-	B	{	IV. is double concave. V. „ plano concave. VI. „ concavo convex (diverg- ing).
III. and VI. are often called meniscus lenses.						

The class A are all thicker at the centre than at the edges, and parallel rays of light falling upon one side of any of these will converge on the other side towards a point on their axes, hence these are called converging lenses. The Class B are all thinner at the centre than at the edge, and parallel rays falling on these will diverge on the other side, hence these are known as diverging lenses.

In order to understand some of the difficulties which beset the pioneers in the manufacture of photographic lenses, it will be necessary to deal in a little more detail

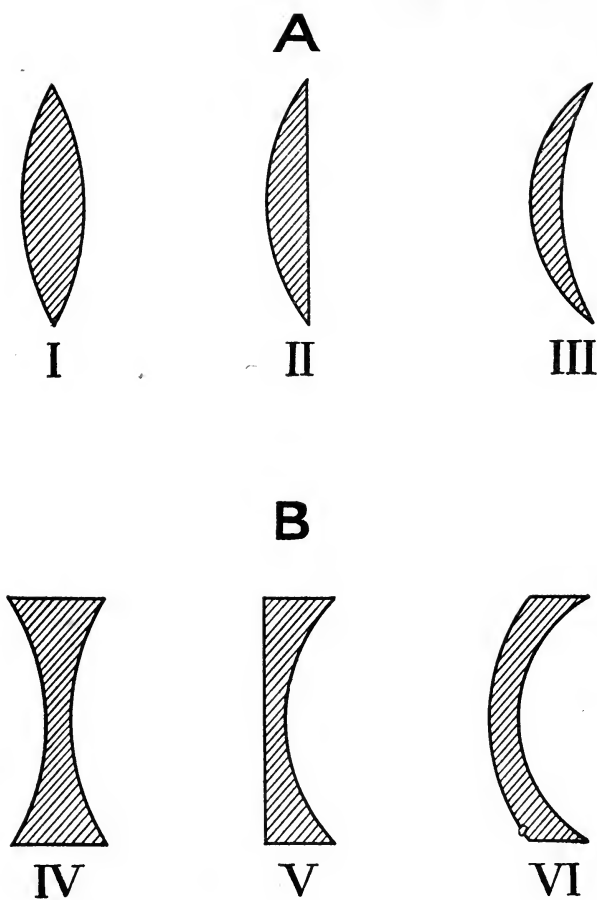

Fig. 32.

with the manner in which the rays of light are affected when made to pass through a simple thick lens.

Spherical Aberration.—We have assumed that when rays of light are parallel and pass through a converging lens they all come to a focus at one point on the principal axis of the lens ; such is very far from being the case

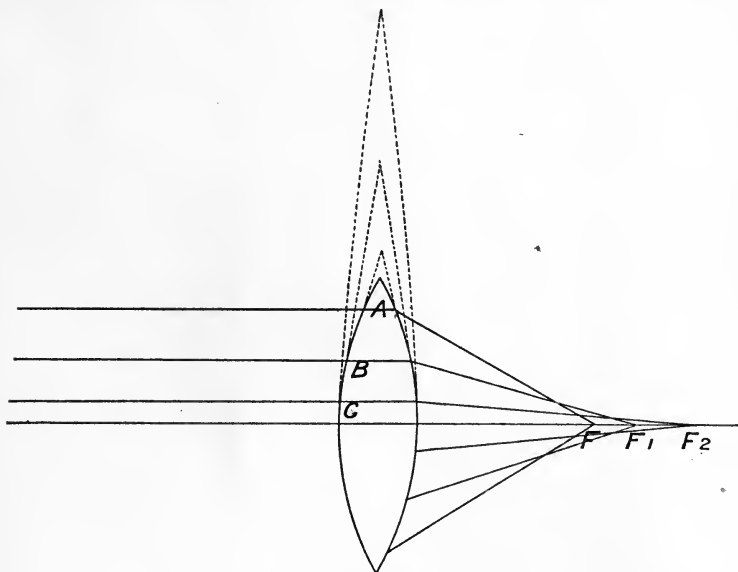

Fig. 33.

unless the *aperture*, *i.e.* the angle made by joining its edges to the principal focus of the lens, is very small.

The smaller the angle of a prism the less is any ray of light deflected in passing through it, and a reference to diagram (33) will make it clear, if we remember that a lens can be considered as built up of parts of prisms, that the part at *C* belongs to a prism having the smallest apical angle and that at *A* to one having the greatest. Thus the rays will come to a focus at F_2 , F_1 , and F respectively,

and instead of obtaining just one small distinct spot of light, it can readily be seen that a small blurred image will result when the screen is held anywhere between F_1 and F_2 .

This phenomenon is known as *Spherical Aberration*, and it need scarcely be added that unless this is overcome, sharp and clearly defined images must not be expected. Of course, if the aperture of the lens is reduced by means of stops, this makes the definition less hazy, but even then, when sharp at the centre, the image will still be somewhat indistinct at the edges, or *vice versa*.

Lenses, however, can be made so that rays of light which diverge from a point on the axis come to a focus at another point on the axis. Such points, as previously stated, are known as the *conjugate foci* of the lens, and the lens itself is spoken of as an *aplanatic lens*.

Lenses can be rendered more or less free from spherical aberration by grinding them so that their faces shall have suitable radii of curvature.

Mathematical investigation shows that such conditions are obtained when the two radii are to one another in the ratio $\frac{4 - 2\mu^2 + \mu}{2\mu^2 + 2\mu}$ where μ is the refractive index of the glass used.

The best results are obtained when the rays receive equal amounts of deviation at each surface of the lens. For this purpose light must enter the surface at an angle equal to that at which it emerges from the other, just as in the case of the prism. For this reason plano-convex lenses are often used, the convex surface being placed towards the incident light.

Spherical aberration may also be got rid of by combining different lenses of suitable curvature, as is done in the rapid rectilinear photographic lenses.

Circle of Least Confusion. Astigmatism.—Now suppose a parallel beam of light strikes a spherical refracting surface

at $A B$, and comes to a focus at F_1 . When the refracted beam of light crosses the axis $P Q$ it will, of course, hit it in different points. If the figure be supposed to rotate through a small angle, we can see that the whole of the refracted pencil will pass through two lines at F_1 and F_2 which are perpendicular to one another. The line F_2 is at right angles to the refracted beam of light, and forms the transverse section of it where it crosses the axis.

Then F_1 is called the *first focal line* and F_2 the *second focal line* of the refracted beam of light. Now imagine the change in shape of the cross section of the beam between the lines F_1 and F_2 to be represented as follows:—

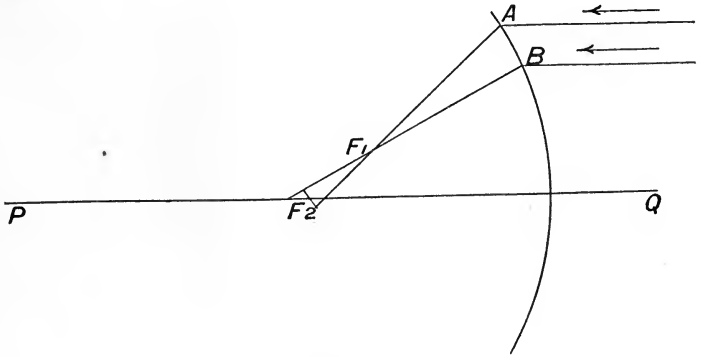

Fig. 34.

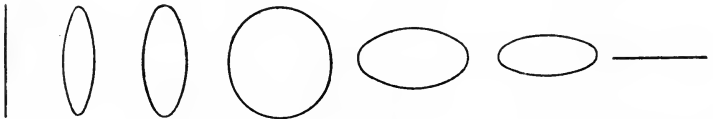

Fig. 34A.

and it will be seen that somewhere between the two the shape will be a circle. This circle is known as the *circle of least confusion*, and this forms the nearest approach

to a point focus to be found in the refracted beam of light.

When a lens suffers this defect, that is when it has no true focal point, it is said to be *astigmatic*.

To test whether a lens is astigmatic, focus a symmetrical black cross on a white background on the centre of the screen and move the camera slightly to one side; then if the lens is astigmatic the vertical line will be in focus when the horizontal one is not, and *vice versa*. This is a far worse fault in a lens than spherical aberration, since it cannot be remedied even by the use of a very small stop, although its effects are not so noticeable under such conditions. A

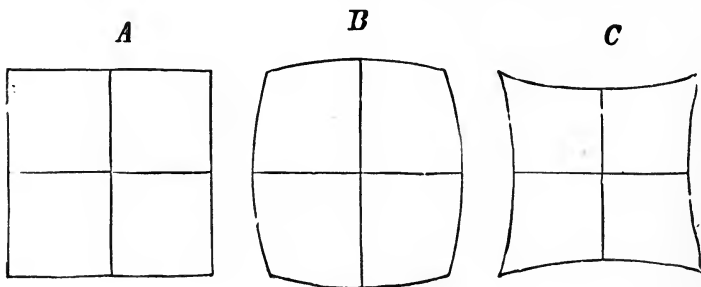

Fig. 35.

single lens forms an image on the screen which is distorted even when stops are used. This can be easily seen by focussing a square as in diagram (35). Then when the stop is placed in front of the lens the distortion is of the *pincushion* kind (C), when placed behind the lens the image is *barrel-shaped* (B). It must be understood that the distortion is very much exaggerated in these diagrams. Yet a little care will make it apparent to the most casual observer. Even supposing all these defects removed, there may still be one to look out for, which is of extreme importance in photographic work.

Chromatic Aberration. Achromatic Lenses.—When rays of white light pass through a lens from a point on its axis,

the light not only undergoes refraction, but also dispersion—that is, since white light is composite and is built up of violet, indigo, blue, green, yellow, orange and red rays of differing wave lengths, these will not all come to a focus at one and the same point on the axis. In other words, they would spread themselves out into a spectrum along the axis, the violet end being nearer the lens, since light of that colour is the most highly refracted. The blue would thus cover the smallest area, the red the greatest,

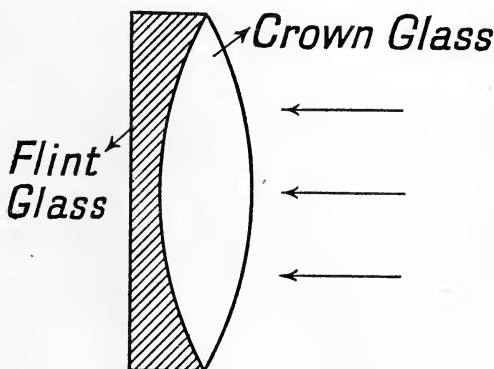

Fig. 36.

hence an image on a screen would have a red border and general red tint if focussed for red. This is known as *chromatic aberration*.

Now it is important in taking photos of coloured objects that they should all be in focus at the same time on the plane of the photographic plate, hence some steps must be taken to remedy this defect.

This has been done by using a compound lens made up as shown in the accompanying diagram (36); the arrows show the direction of the incident light.

A crown glass convergent lens is combined with a flint glass divergent lens; thus one tends to annul the work of the

other so far as dispersion is concerned, for crown glass is more strongly convergent for blue than red rays, and flint glass is more strongly divergent for blue than red rays.

If a lens is *achromatic*, then the rays of light which act most strongly upon the sensitive film will come to a focus at the same point as those which have most effect upon the eye. This makes it quite easy to test whether a lens is really achromatic, for if a chequered board be placed so that its plane is at right angles to the direction of the camera, and the middle square be carefully focussed on the screen, then, when a photograph of this has been taken, if it be found that some other square has the sharpest outline, the lens cannot be said to be achromatic. This of course should be done with the lens at full aperture.

The Flare Spot.—Sometimes it may occur that a more or less pronounced central fog is always to be seen on photographs taken with a certain lens. In this case the defect is due to what is known as a *flare spot* in the lens, and this can very often be remedied by slightly changing the position of the stops.

In the best lenses these faults are reduced to a minimum, and, in fact, it may be taken as granted that any lens of first-class make does not possess them.

Other Faults in Lenses.—There are still one or two points of interest with respect to the glass itself to which it is worth calling attention.

All lenses used for photographic work should be carefully protected from light when not actually in use, since a prolonged exposure to light tends to give the glass a yellowish tint, and this of course must have the effect of rendering the lens much slower in its action (see also p. 67).

Very minute specks or airbells, when present in the glass, have practically no ill effect as regards the photograph produced. On the other hand, when the glass has not been

properly annealed, so that the lens has no uniform action so far as light is concerned, or if striæ are present, the defect is a much more serious one. These imperfections can only be found out by those whose eyes are practised in this kind of work, and even then it is necessary to test with polarised light in order to be certain that the glass is not properly annealed. The striæ may sometimes be seen, if present, by focussing the camera upon a bright light in an otherwise darkened room. The ground glass screen should then be removed, and the eye placed in the position of the image of the light : in this way the presence of striæ can be detected.

Stages in the Development of Lenses.—The perfection of the photographic lens has only been the outcome of a vast amount of practical and theoretical work by a large number of eminent scientific men.

Not only had the material of which the lens is made to be considered, but a profound knowledge of mathematics was required in order to solve the problem as to the best shape of the lenses to obtain the desired result.

In the early days of the nineteenth century (about 1830) Sir G. B. Airy worked out mathematically the theory of the camera-obscura lens, and also turned his attention in a very thorough manner to the errors of astigmatism, and curvature of the field, to be met with in simple lens combinations. His work, however, seems to have been lost sight of for some time after the use of lenses for photographic work had become common.

Later on, Petzval and Von Seidel independently solved the problem as to the nature of the material required for a lens (*i.e.* its physical properties of refraction and dispersion of light), and also the theoretical form of the perfect lens.

In photographic work we endeavour to obtain on a flat surface a correct representation of a view in which the objects occupy many different planes, so that the lens

must be such that rays starting from the various points of the object are able to converge to a series of points in the plane of the plate, these points being arranged in a similar manner to the points of the object, so that a perfectly flat image is formed. This problem was investigated by Gauss, who showed how the action of the lens system could be predicted when its focal and other chief points are known, and he further showed how these points could be determined in quantities depending on the form, material, and distances apart of the lenses. Of course no system of lenses absolutely fulfils all these conditions: the object is to devise such a system that the deviations from the theoretical ideal shall be as small as possible.

Such work as this was of the utmost importance, for the early lenses were mainly the outcome of a large amount of experimental work combined with little if any mathematical work.

For some time the Petzval combination lens was the only example of a theoretical lens (see p. 15).

When, later on, Abbé and Schott undertook to construct a lens suitable for this work, they had the very great advantage of having a definite aim in view.

Photographic Lenses.—The various kinds of doublet lenses used in photographic work may be classed as follows:—

I. *The Rapid Rectilinear.*—So called since it is so corrected that spherical aberration is reduced to a minimum, and straight lines in the object are represented by straight lines in the image.

II. *The Portrait Lens.*—Originally due to Petzval. A lens so constructed as to work at a very large aperture and to give a soft definition over a very small area.

III. *The Wide-angle Lens.*—A system by means of which it is possible to take a photograph of an extended object when the distance which the camera can be placed from the object is limited. Such lenses are of short focus

and are slow in action. It must be remembered that all three classes of lenses are rectilinear.

There is still another system of lenses which is of great use in obtaining views of inaccessible objects, I refer now to the *Telephoto-lenses*. In all lenses of this class there are two systems of lenses, the front one being positive, having a large aperture and short focus, the hinder one negative and of less focal length than the front.

The general idea of the principle of this system of lenses can be obtained from the following diagram. The positive lens $A B$ would bring the light to a focus at C , but the negative lens $E F$ causes these rays to diverge slightly,

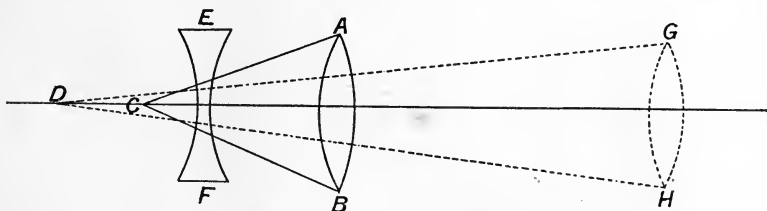

Fig. 37.

and they so come to a focus at D . Hence they appear to behave as if they proceed, not from $A B$ but from a new position, $G H$, *i.e.* the apparent focal length of $A B$ is increased, and the image obtained magnified. The distance G to D , or more exactly the perpendicular distance of D from the straight line joining G to H , is known as the equivalent focal length of the lens system. This diagram does not show the actual lenses used; for this see p. 129.

Terms in General Use.—After briefly considering one or two terms which we have constantly to use with respect to photographic lenses, these various systems of lenses will be considered, for that purpose reference will be made to some of the best-known lenses.

The lens used should always have a focal length at least equal to the diagonal of the plate which it is intended the image shall cover. Thus for a half-plate ($6\frac{1}{2}$ " by $4\frac{3}{4}$ ") a lens of 8" focal length is required, while for a quarter-plate ($4\frac{1}{4}$ " by $3\frac{1}{4}$ "), one having focal length of $5\frac{1}{4}$ " is suitable. This is an important point to remember if errors of perspective are to be avoided, for the longer the focus of the lens, the better and more truthful will be the picture produced.

The focal length of a lens may be ascertained by focussing some very distant object on the screen, in which case the rays of light from the object to the lens may be considered parallel, and then the focal length may be taken as the distance of the screen from the diaphragm, if the lens is of symmetrical construction.

The well-known relationship $\frac{1}{v} + \frac{1}{u} = \frac{1}{f}$, in which u = distance of object from lens, v = distance of image from lens, and f = focal length, may be made use of in the following simple way:—

Let some object, the exact distance of which from the screen can be measured, be focussed; then it can be shown that the focal length is equal to

$$\frac{\text{size of object}}{\text{size of image}} \times \text{distance of screen from object.}$$

$$\left(\frac{\text{size of object}}{\text{size of image}} + 1 \right)^2$$

for the ratio of the size of the object to the image will depend upon their relative distances from the lens, and will

be $\frac{u}{v}$.

So that above may be written $\frac{u}{v}(u+v)$

$$\frac{u}{\left(\frac{u}{v} + 1\right)^2}$$

$$\text{that is } \frac{(u)(\cancel{u+v})}{\cancel{v}} \times \frac{\cancel{v^2}}{(\cancel{u+v})^2} = \frac{uv}{u+v}$$

$$= \frac{1}{\frac{1}{u} + \frac{1}{v}} = \frac{1}{\frac{1}{f}} = f.$$

This method is particularly useful, since the only measurements required are distance of screen from some fixed object, the length of this object, and the length of the image formed on the screen.

It is as well to bear in mind that no great advantage accrues from using a lens larger than is necessary for the particular sized camera, in fact it may be a distinct disadvantage, owing to loss of brightness in the picture due to reflections in the camera.

The *circle of illumination* of the lens should be known, because if it only just covers the plate when the camera is horizontal, when the camera is tilted it may be unable to do so. If the circle of illumination is known, then the amount of movement that can be given to the lens is also known, and likewise the largest size of plate which can be used with the lens.

The rapidity of the lens depends upon the amount of light which can pass through it to the sensitive plate; this must of course depend upon the size of the stop used and the distance of the stop from the plate. The ratio,

$$\frac{\text{Diameter of largest stop giving the required degree of sharpness}}{\text{Focal length of the lens,}}$$

is known as the intensity ratio, and this is a gauge of the speed at which the lens works, so that the larger the denominator of this ratio, the slower the lens. Thus, suppose the diameter of stop is $\frac{1}{2}$ " and the focal length of the lens 8", then $\frac{1/2}{8} = \frac{1}{16}$ —i.e. this system has what is known as an *intensity* of $f/16$. The f values of

the stops may thus be found by dividing their diameter into the focal length of the lens. A little thought will make it quite apparent that the intensity of light upon the plate must depend directly upon the area of the stop used, *i.e.* upon the square of the diameter, and *inversely* upon the square of the distance of the plate from the stop *i.e.* $\frac{1}{(\text{focal length})^2}$. Now in the in-

tensity ratio the square root of these quantities is used. Hence, in order to compare the times required for two intensities, the ratio between their squares must be taken. Thus a lens working at $f/16$ requires, not twice but four times the exposure of one working at $f/8$.

Such an intensity as $f/16$ would be found quite high enough for general landscape and architectural work.

Since the photographic value of the light received depends upon its intensity, and in all good lenses the intensity depends only upon the stop used and the focal length of the lens, it should be apparent that all such lenses, when working at the same f value, have the same speed.

The term *Depth of Focus* is frequently used with reference to lenses. Scientifically speaking there is no such thing as depth of focus for a lens system. The position of the image as measured from the lens alters as we alter the distance of the lens from the object, and hence two objects at different distances cannot be equally in focus on the screen at the same time. Of course when the distance of the objects from the lens is very great compared with the focal length of the lens, the difference in definition may become so slight as to be practically imperceptible. Hence we may define this "Depth of Focus" as the ability which the lens possesses of rendering the images of objects situated at different distances from the camera equally sharp on the focussing screen.

A short focus lens is of course far less influenced by a slight difference in position of objects than a long focus

lens, when used in a camera at the same distance from the objects, but it must at the same time be remembered that at a greater distance from the objects the long focus lens will be no more affected than the short focus lens is in its present position, and the resulting photograph, which may be on the same scale, will be a much better one as regards perspective.

The required amount of definition can, however, be given without increasing the distance, by simply adjusting the diaphragm, so as to reduce the aperture of the lens. It must be mentioned here that want of distinctness in a photograph may add to its pictorial value, and a want of definition in one part of the photograph may be lost sight of if the definition of the whole subject is suitably lowered (see diffusion of focus, p. 125).

It must be remembered that if we have two lenses of equal focal length and intensity, then the depth of focus must be the same for each. Lenses which are of the same focal length but of different intensity have different depths of focus, the one with the smaller intensity having the greater depth, but of course if the faster lens is stopped down to the same intensity, then they will both have the same depth of focus.

While dealing with this subject, it might be of interest to mention the principle upon which the action of the *fixed focus cameras* depends.

For this purpose, without going into any proof of the formula used, let us assume that the distance beyond which all objects may be considered in focus depends upon three things—the focal length of the lens used, the intensity of the lens, and the degree of distinctness which is aimed at.

It can be shown that the distance varies directly as the intensity, and also directly as the square of the focal length. With respect to the degree of distinctness, it is generally agreed that good clear results are not to be obtained if the

circle of least confusion has a greater diameter than $\frac{1}{1000}$ ". In this case the distance in feet beyond which all objects may be regarded as in focus is given by the formula $8.3 I f^2$, in which I =intensity ratio and f is the focal length in inches of the lens used. Thus, suppose the intensity I is equal to $\frac{1}{8}$, and the focal length of lens 6", then the distance will be equal to $\frac{8.3 \times 6^2}{8} = 37.5$ feet.

From this it is apparent that the greater the intensity, the greater the distance which the camera must be placed from the objects to get uniform clearness, in other words, the smaller the stop used, the shorter will be the distance beyond which all things may be regarded as in focus.

The Rapid Rectilinear Lens.

—The Rapid Rectilinear (R. R.) lens is the most useful for general purposes.

From the diagram this can be seen to consist of two compound lenses, one at each end of the tube, the stops being placed between these lenses.

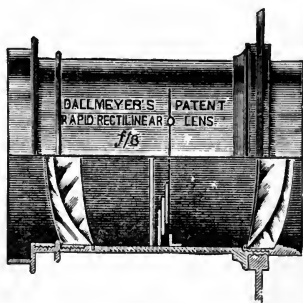

Fig. 38.

Such lenses are the best to employ for all kinds of outdoor work, whether landscapes, architecture, or instantaneous effects.

All the best classes of these lenses are so made that the front or back lens may be used by itself, and in some cases, when these lenses have different focal lengths, it is possible to obtain from the same standpoint three pictures graded in size.

Another rapid rectilinear lens which works well at a large aperture ($f/5.6$) is that known as the "Ross Homocentric." The name implies that ideal definition can be produced by this lens, each point of the object being represented by a corresponding point in the image, and

certainly very fine results can be obtained with lenses of this type.

The construction of this lens is shown in the accompanying diagram (39).

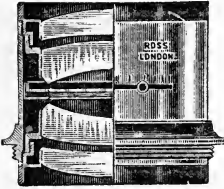

Fig. 39.

Portrait Lenses.—The lenses required for portraiture are of much more rapid action, and the great bulk of these are still of the ordinary or Petzval construction.

These lenses give a soft definition over a small area, and in some the back combination consists of two lenses, the distance between which can be altered by unscrewing the back. When screwed up tight, the definition is at its best, and a softening of definition is produced by slightly unscrewing.

The diagram shows a very rapid type of portrait lens which works at an aperture $f/2.24$. Such a lens is especially useful in the photography of small children.

The softening of the definition of the image produces such fine results in portraiture that a special lens has been invented which enables this kind of work to be carried out with the least possible amount of inconvenience. When an object is put out of focus with an ordinary lens, the form of the object is also to some extent altered, but this new lens gives diffusion of focus without in any way diminishing the beauty of the form.

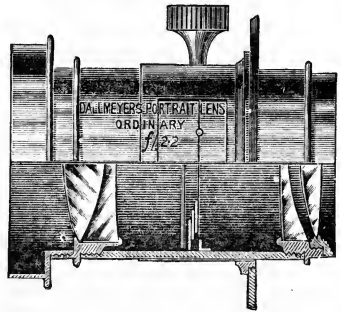

Fig. 40.

It is known as the Dallmeyer-Bergheim lens, and, as can be seen from the diagram, it consists of two simple lenses, the front one positive (converging), and the back negative

(diverging), the stops being in front of the positive lens. The fact that only two single lenses are included renders this combination more rapid than it otherwise would be, since the loss of light is less.

The screw with the milled head is for altering the distance between the two lenses, and thus it is apparent that the focal length of this lens can be altered considerably. There is in fact no limit to the size of the image that can be produced: if the necessary amount of camera extension can be had, the same lens can be used for obtaining pictures from cabinet to life size.

The focussing, so as to obtain the required result so far as diffusion goes, can only be learned by practice. It is best to focus some object sharply on the screen, this object being placed an inch or two farther off than the object it is intended to photograph. That good results can be obtained with this lens may be seen by consulting *Photography*, January 31st, 1903.

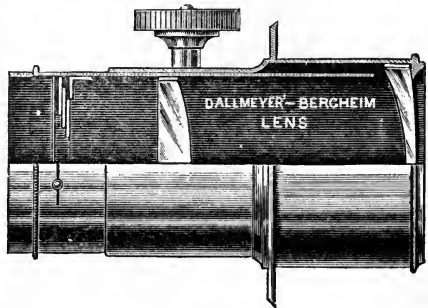

Fig. 41.

Arrangements have also been made by means of which the necessary diffusion of focus with the ordinary portrait lens can be obtained by the operator while he is looking at the image on the screen. The method of doing this is illustrated in the next diagram (42), which is an illustration of a Cooke portrait lens adapted for this work. By means of the pulleys shown, a certain amount of rotation can be given to part of the lens, and the necessary diffusion obtained. The diaphragm can also be worked in a similar manner, so that it is not necessary to come to the front of the camera during any part of the focussing operations.

When the required degree of diffusion has once been obtained it can be repeated at pleasure by noting the position of a pointer on a fixed scale.

The pleasing results which can be obtained by a judicious use of diffusion is well illustrated in Plates II.-V. The

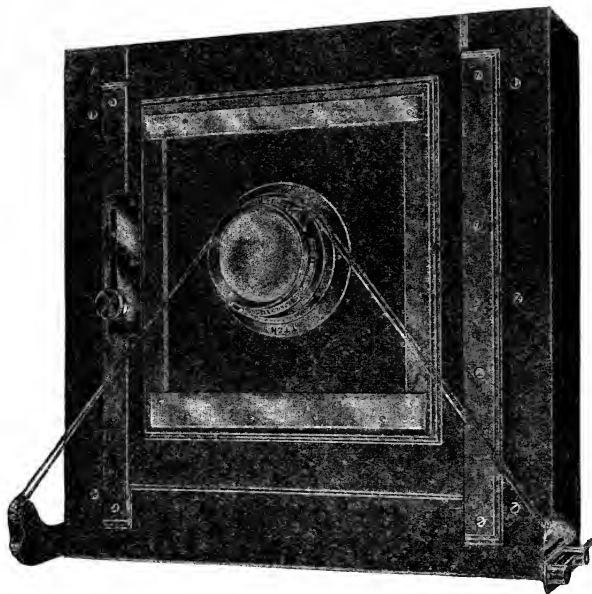

Fig. 42.

first of these shows the result when a book illustration is prepared from a photograph obtained with a Cooke lens, the object being perfectly in focus, so that its image is extremely clear cut and sharp, all its details being clearly brought out. The next three illustrate prints obtained with increasing degrees of diffusion.

When held in the hand and closely examined, it is quite



Plate II.

Portrait obtained with 12-inch Cooke lens working at f 3.5. Sharp definition.

.....

PLATE III.



Plate III.

Portrait obtained with same lens, showing first diffusion effect.



Plate IV.

Portrait obtained with same lens, showing second diffusion effect.

1 2 3 4 5 6 7 8 9 10 11 12 13 14 15 16 17 18 19 20 21 22 23 24 25 26 27 28 29 30 31 32 33 34 35 36 37 38 39 40 41 42 43 44 45 46 47 48 49 50 51 52 53 54 55 56 57 58 59 60 61 62 63 64 65 66 67 68 69 70 71 72 73 74 75 76 77 78 79 80 81 82 83 84 85 86 87 88 89 90 91 92 93 94 95 96 97 98 99 100



Plate V.

Portrait obtained with same lens, showing third diffusion effect.

AMERICAN

possible that the balance of favour will still rest with the first plate, but when placed 6 or 8 feet from the eye and viewed in a good light, it must be admitted by even the most ardent adherent to the older idea that a good portrait should be sharply defined, that although the picture loses somewhat in detail owing to diffusion, yet it certainly gains a good deal in general artistic value.

One of the most pleasing applications of the rapid portrait lens to other branches of photography is the production of pictures of town life by night.¹

Wide-angle Lens.—Sometimes it is found when using an ordinary R. R. lens that it is impossible to place the camera sufficiently far from the object to obtain all that is desired on the plate. It may be that it is not possible to quite take in the whole height of a tall building or the whole width of some extended scene. Then it is that it becomes necessary to employ a wide-angle lens.

This diagram shows an ordinary form of R. R. wide-angle lens working at $f/16$. This lens can be used with the smallest stop, so as to include angles up to nearly 100° . The front combination can be used by itself as a complete lens and then has about twice the focal length of the original compound lens.



Fig. 43.

The next diagram shows a special stigmatic lens of slightly greater focal length than the preceding. It works, however, much more rapidly, giving good definition at $f/6$. On the other hand, the field is not so extended (about 85°), but each combination can be used as a

¹ An excellent series of such pictures appeared in *Photography and Focus*, March 16th, 1909. These pictures were taken by means of a Dallmeyer 2B portrait lens at $f/3.3$, by exposures of $\frac{1}{4}$ to 4 or 5 seconds, according to subject and the kind of plate used.

separate lens, the front requiring about four times, and the back twice the exposure required by the complete lens, at the same diameter of the stop.

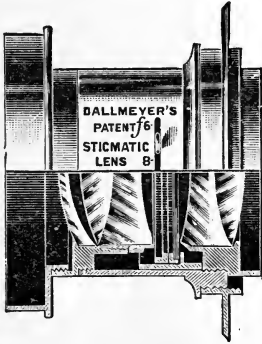

Fig. 44.

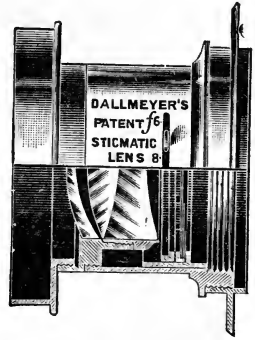

Fig. 45.

Fig. 44 shows complete lens as used for Rapid or Wide-Angle Work. Fig. 45 Front Combination used as a Single Lens.

The ordinary wide-angle lens should not be used even for architectural work, where one of longer focus can be employed. The reason for this will be obvious if a picture of objects situated in different planes, taken by such a lens, is examined. The objects in the foreground will appear exaggerated in size, and those in the distance diminished.

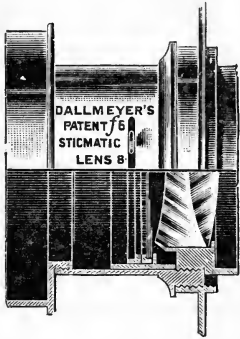

Fig. 46.

Back combination used as single lens.

In order to obtain correct ideas of the objects portrayed, photographs should be viewed from a distance equal to that of the focal length of the lens used; and since the distance of distinct vision for ordinary eyesight is about 10", it can easily be seen that while a view taken with a lens of 8" focus may appear quite satisfactory, it is by no means so certain

that all views taken with a lens of 4" focal length will be equally satisfactory.

Telephoto Lenses.—Sometimes it is impossible to get sufficiently near an object, such as some piece of architecture, in order to obtain a good detailed picture of it with an ordinary R. R. lens. Or it may be that it is found that some distant objects, when looked at on the focusing screen, appear much too small to be of use in a photograph.

Then it is that a telephoto attachment becomes of use. The diagram (47) shows a rapid rectilinear lens with a back telephoto attachment.

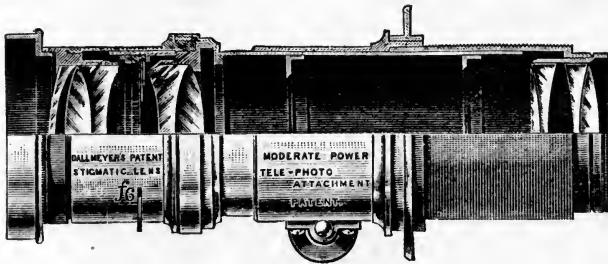

Fig. 47.

In most cases the negative back attachment used is one having a focal length of about half that of the positive lens to which it is attached.

It is necessary to explain here that the actual distance between the lens and the screen is usually referred to as "the back focal length" when speaking of telephoto lenses; the term, equivalent focal length, has already been explained (see p. 118).

It ought to be remembered, when taking a distant view by means of a lens with a telephoto attachment, that a hazy atmosphere will render the photograph somewhat indistinct, and it is therefore best to choose a clear and not over-hot day for such work; even then it will be

found to be a great advantage to use some yellow screen (see screens, p. 166).

It is somewhat difficult at first to get accustomed to the use of such lens combinations, and the time of exposure usually is a great source of worry to the beginner.

The necessary information is, as a rule, supplied with the better class of lens, and if one is careful to keep to the brands of plates which have been thoroughly mastered, little difficulty should be experienced with distant views; the photography of near objects will perhaps require somewhat more practice.

The camera extension, when such lenses are used, is often very considerable, and every precaution must be taken to avoid vibration, since, as the exposures are necessarily long, any vibration will detract from the value of the photograph. It is also necessary to take especial pain in focussing, if distinctness is aimed at, and with most lenses it is also advisable to use a rather small stop, and of course increase the length of the exposure proportionately. All photographs obtained by this means should be developed as slowly as possible, using a weak developer, and one which gives great density and clear shadows. Lenses have been constructed which can be used either as telephoto attachments to other lenses or by themselves.

Such a lens is the Adon, which is composed of two achromatic combinations, the front being a positive lens of $4\frac{1}{2}$ " focal length, and the back a negative lens of focal length $2\frac{1}{4}$ ". (In the more recent Adon these dimensions are slightly altered.) These are mounted in an aluminium setting, and can be separated very considerably. Pictures of very different sizes can therefore be taken by this lens, and it can be used with plates of various sizes up to 15 by 12".

This lens gives good results when used for portraiture with a large aperture, and on account of its small size

and weight is likely to be of great use when large camera extensions are used in ordinary landscape views.

The new Adon requires about 8" camera extension for infinity, is of 20" focal length, and works at $f/10$. The correct exposure may be ascertained by the ordinary rules for any lens working at $f/10$.

Attach the lens to the camera and rotate the front cell to the right until the line engraved infinity on the inner tube is exactly opposite the arrow on the outer tube. This adjustment should not again be touched, focussing



Fig. 47A.

being effected by the rack and pinion on the camera. On fixed extension cameras, focussing may be effected by the spiral adjustment on the Adon. It is, however, preferable to focus by the camera.

The Busch "Bis Telar" is another lens which can be used by itself as a tele-objective.

The diagram (48) shows the construction of this lens, which is made in five different sizes, having focal lengths from 8" to 22" inclusive, while the camera extensions required for objects at infinity range only from $4\frac{1}{8}$ " to $11\frac{1}{2}$ " respectively.

Thus for a half-plate the lens has an equivalent focus of 16", but the camera requires an extension of only $8\frac{1}{4}$ " for objects at infinity. Since this lens works at $f/7$, it can readily be seen that the exposure required is sufficiently short for this lens to be used for practically all classes of subjects. .

A very useful device for those who wish to keep the weight of their photographic apparatus as small as possible, and yet be able to obtain good-sized pictures of more distant objects, is the extension lens which can be obtained in connection with the ordinary Cooke lenses.

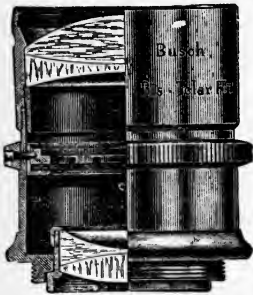

Fig. 48.

These extension lenses are intended to replace the back lens of the Cooke lens.

Thus, suppose the ordinary lens to be in use with a half-plate camera, and therefore to have a focal length of 8"; then by means of one of these extension lenses its focal length can be brought up to about 12.3".

It must of course be borne in mind when using these extension lenses that the rapidity of the lens system is in all cases altered. In the above case, the ordinary lens works at $f/5.6$, while the lens with the extension works at $f/11$. In other words the latter combination requires about four times the exposure of the original lens. Further, it is necessary to note that such additional lenses are not intended to enable one to use a larger-sized plate, such as can be done with a lens of focal length equal to that of the new combination, but simply to give a more detailed representation of some particular object or objects. As a rule these extension lenses increase the linear dimensions of the images 50 per cent. as compared with those obtained with

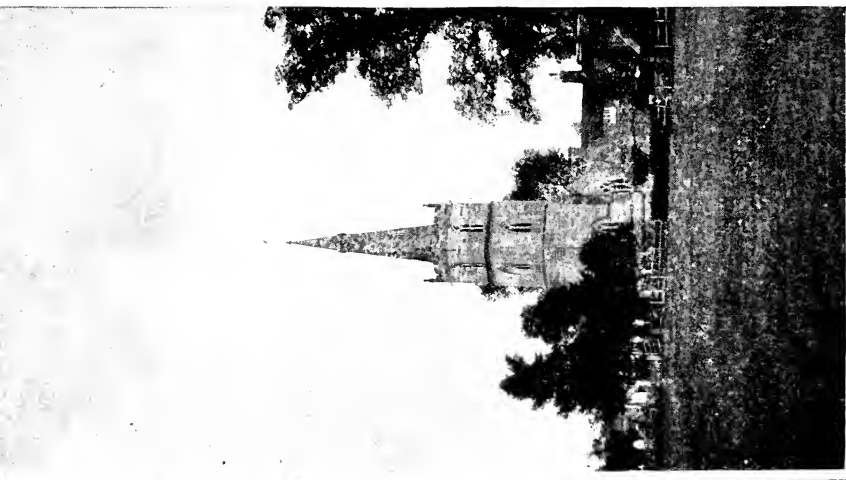

Fig. 49.

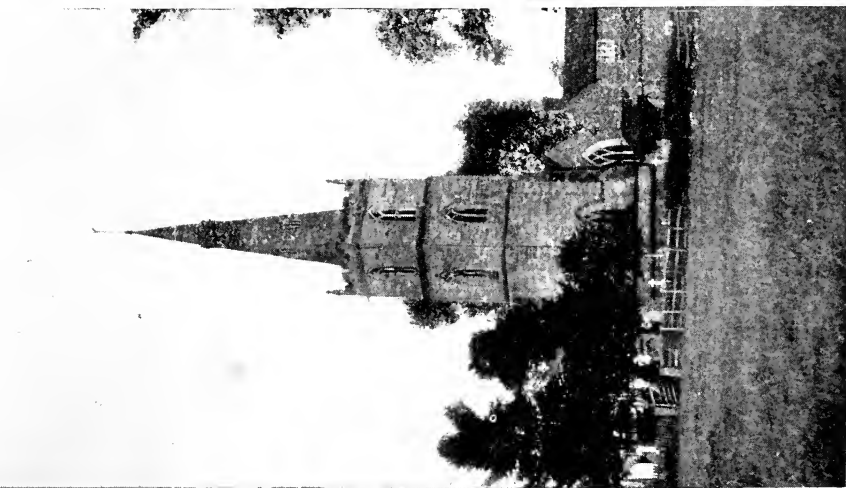

Fig. 50.

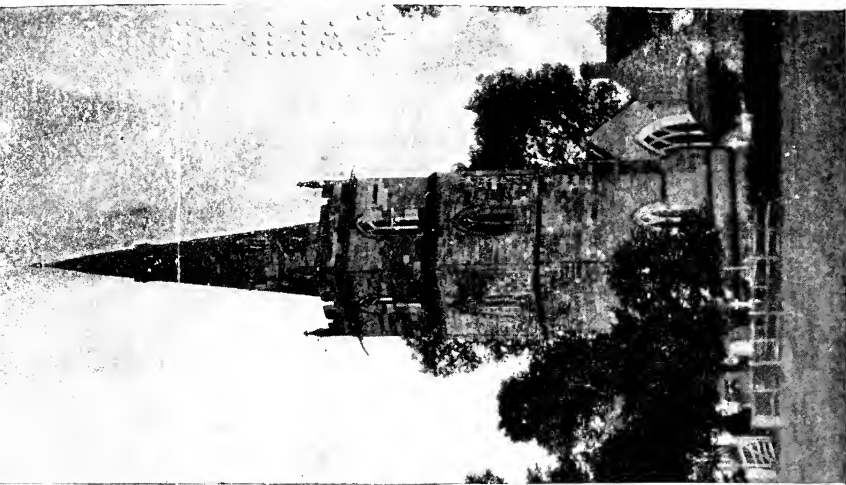

Fig. 51.

Fig. 49 represents the view taken with the ordinary 6-inch IV. Cooke lens. Fig. 50 view with 50 per cent. extension lens; and Fig. 51 with 100 per cent.

the ordinary lens, but the Cooke extension lenses increase the dimensions to 50 or 100 per cent., as desired.

The next three illustrations show the relative sizes of view obtained by the normal lens and the lens with attachments.

CAMERA APPLIANCES

Early Form of Camera.—As the art of photography has become more and more popular, various kinds of cameras have been constructed, until now it is possible to obtain cameras specially adapted for practically every kind of photographic work. For the sake of comparison we here introduce, with the necessary description, the illustration of the camera which was in vogue when the first edition of this book appeared some forty years ago (1874). It will require but a glance at this illustration to see what

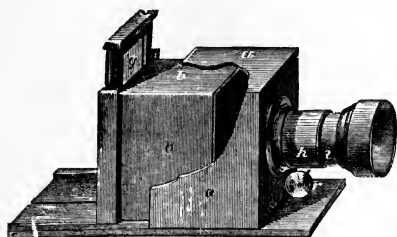

Fig. 52.

great advances have been made in camera construction since that time.

“The dark chamber is converted into a small box (Fig. 52), the back part of which is movable, and contains

a ground-glass slide *g*. If the back of the camera *o* is moved to and fro, it is easy to find the exact situation of the image of an object placed before the lens *l*. In order to determine this distance with the necessary accuracy, photographic lenses are supplied with a rackwork motion *r* in the frame of the lens; but this addition is by no means necessary.”

The Pinhole Camera.—Before proceeding to discuss any of the more modern camera appliances, we will first direct our attention to that very simple piece of apparatus which, while being inexpensive, is still most effective in those cases in which one has unchanging conditions and unlimited

time at one's disposal. We refer to the pinhole camera.

As is generally known, this instrument is so called, since the image formed on the plate is produced by light entering the dark chamber through a small circular hole, usually from $\frac{1}{30}$ " to $\frac{1}{100}$ " in diameter.

The formation of the image is illustrated in the accompanying diagram (53), and it will be readily recognized that the size of the image $g' a' f'$ bears the same relation to the size of the object $g a f$ that the distance of the pinhole ' o ' from the screen ($o a'$) does to the distance of the object from the pinhole.

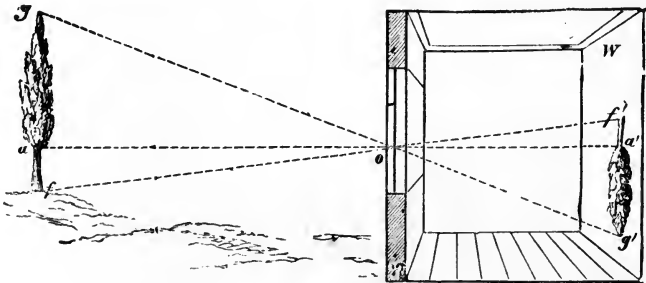

Fig. 53.

The distance $o g'$ is much greater than the distance $o a'$, and therefore while it is possible to obtain photographs with the same pinhole for very varying distances of screen from pinhole, yet, unless that distance is suitably chosen, the centre of the plate is likely to be over exposed when the edges have received the correct amount of exposure. Still, there is a fairly wide range over which practically uniformly good results may be obtained.

Lord Rayleigh¹ has shown, as the result of theory and experiment combined, that for light from the most photo-active part of the spectrum the best results are to be obtained when $d^2/f=10^{-5} \times 6''$. In this d =the diameter

¹ See *Phil. Mag.*, xxxi., pp. 87 et seq., 1891.

of the hole and f = the distance of the screen from the hole. Thus, suppose screen is distant from the hole 10", so that $f = 10$, then, since $d^2/f = \frac{6}{100,000}$, $d^2 = \frac{6}{10,000}$, from which $d^2 = \frac{1}{1666}$, *i.e.* $d = \frac{1}{41}$ " very nearly. To give this in a general form so as to be used for light of other wavelengths, we have distance (d) = r^2/λ , where r = radius of pinhole and λ = wave-length of the light being used.

This can be shown as follows :—

Let us assume that in order to obtain the greatest amount of concentration of light we must arrange the position of the screen with reference to the pinhole, so

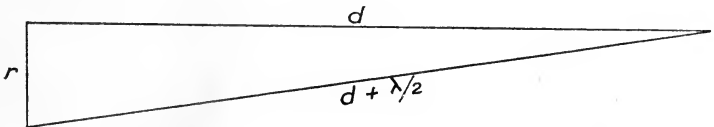

Fig. 54.

that the distance a ray has to travel from the centre of the pinhole to the plate may differ from that which a ray entering at the edge of the hole has to travel to reach the same spot by $\lambda/2$, then by the property of the right-angled triangle we have $r^2 = (d + \lambda/2)^2 - d^2 = d\lambda + \lambda^2/4$, which will be approximately = $d\lambda$, since $\lambda^2/4$ is very small; so that $d = r^2/\lambda$.

To illustrate this, let us suppose screen is 10 inches from pinhole, and light of wave-length 0.000017" to be the most active, then $r = \sqrt{0.000017 \times 10} = \sqrt{0.00017} = 0.013$ ", *i.e.* the diameter of the hole should be $\frac{26}{1000}$ ", *i.e.* about $\frac{1}{40}$ ".

Sir William de Abney has pointed out that, if it were not for diffraction, the smaller the hole the better would be the definition, yet for each working distance there is

a minimum useful size. He gave a formula by which this minimum size can be calculated. It is as follows :
 aperture = $0.008 \sqrt{d}$. Thus suppose $d=10$ inches, then $\sqrt{10}=3.16$, and $3.16 \times 0.008=0.025+$. So that in this case the least diameter of the hole giving good results would be $\frac{1}{40}$ " about. (Compare the three results which are obtained by different formulæ and have been worked out.)

In practice it is not necessary to provide different apertures for each different focal distance, on account of the wide range over which good results can be obtained.

The pinholes should be circular in section, and could be made with suitable needles in thin metal sheets, the rough edges being filed off, if the holes are punched. The great disadvantage of this photographic apparatus is the very long exposure which it is necessary to allow.

To find the length of exposure the f value may be calculated from $\frac{\text{aperture}}{\text{distance of screen}}$; thus, if aperture = $\frac{1}{40}$ " and distance of screen = 10", the f ratio is $1/40/10=f/400$.

Now suppose it is found that $f/8$ requires $\frac{1}{20}$ second, then $f/400$ will require $\frac{1}{20} \times 2500$ seconds = 125 seconds, *i.e.* 2 minutes 5 seconds.

In such a camera there is, of course, no distortion, but only fixed objects can be photographed by means of it.

It is, of course, very difficult to see the image on the screen; perhaps the best means of judging the amount to expect on the plate is to have a slightly larger hole to replace the pinhole (one about $\frac{1}{4}$ " diameter will do); then turn the camera round, remove the screen and look through the new aperture. The amount now visible when the eye is close to the hole will be approximately that included in the picture. A good idea of the amount included may also be obtained by calculation (see p. 135) if the distance of the object is known.

In our further consideration of the camera it will

perhaps be best to deal with some of the leading types now in use, pointing out the special features in each case.

Stand Cameras.—This type of camera is still a great favourite, notwithstanding its bulkiness and weight. It is, of course, better adapted for the photography of fixed objects than the hand camera, although most of these latter can now be arranged as stand cameras if desired.

By means of the stand camera larger direct photographs of any particular object can be taken than with the ordinary hand cameras, but it is doubtful whether this is a distinct advantage, since a good small scale photograph can most easily be enlarged to the required size.

A good stand camera should possess a long extension (over 20" for a $\frac{1}{2}$ -plate camera), so that it can be used either with a long focus lens or a telephoto attachment. Some cameras are provided with triple extension for this purpose, but there are also double extension models of sufficient range. Then the bellows of the camera should be such that, when not fully extended, or when the front is raised, no portion of the image is prevented from falling upon the plate. The square bellows cameras are, of course, made for this purpose, but there are good models of less cumbersome make which answer the same purpose. Until quite recently the backs of the better-class cameras were so arranged that they could be swung backwards or forwards, in order that the plate might be kept in a vertical position when it was found necessary to tilt the baseboard to obtain the complete image on the screen. It seems likely that this method will be superseded by the method of rising and swing front, as adopted in the newer Sanderson models.

With such cameras, owing to the great covering power of modern lenses, it is possible to photograph most difficult subjects without tilting the base. The axis of the lens can be raised to a higher level than the top of the plate, and it can then be swung into any desired position, the camera

in the meantime being kept perfectly rigid with its base-board horizontal, thus avoiding faulty pictures due to want of verticality in the plate. It can be readily understood that the more or less parallel perpendicular lines in any object, *e.g.* a church tower, would not appear as such in any picture produced upon a plane which was itself out of the erect position; the swing back, and now the rising and swing front, are designed to avoid this error.

A good camera is so built that it is perfectly rigid when at full extension, and the rack and pinion by which the base-board is extended works smoothly and easily. There may also be a further rack and pinion by means of which the back is racked forward on the base-board so that the camera can be used with a short focus wide angle lens if desired.

The front must be so arranged that the lens is capable of a side-to-side motion.

The back of the camera should be made so that the plate can be used with its long side vertical or horizontal as required, and the double dark slides should fit easily into the back, the whole being absolutely light-tight when the plate is ready to be exposed.

The stand, while being made as light as possible, should be absolutely rigid, and a turntable likewise be provided with it, so that the camera can be swung round in a horizontal plane to point in any desired direction. Lastly, the whole should be easily packed in a relatively small space, and also easily and quickly unpacked and arranged when required for use.

Some arrangement such as a small spirit level or other suitable contrivance should be attached to the back of the camera in order that the back may be in such a position that the plate to be exposed is held in a vertical plane. Of course the wood of the camera should be such that it does not warp or crack, and so admit the light. Special precautions in this respect are necessary in cameras de-

signed for work in the tropics, and in many instances it is found advisable to construct these of teak.

All stand cameras are provided with a ground glass focussing screen. If the camera is of the $\frac{1}{2}$ -plate size, it is a good plan to draw in pencil on this screen the size of a picture post card and $\frac{1}{4}$ plate, so that there can be no doubt whether the whole of any view will be included

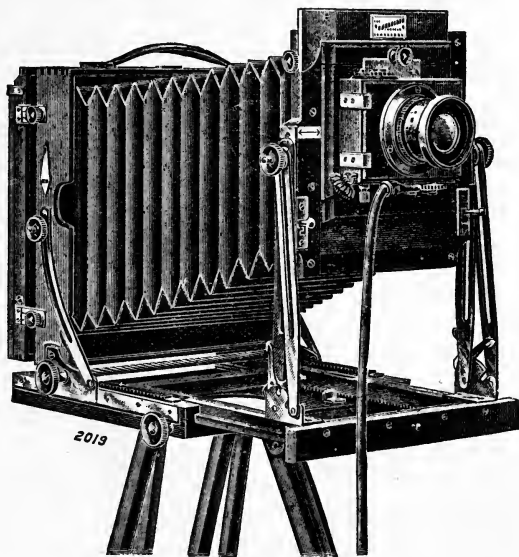

Fig. 55.

in a picture. Of course, the dark slides can be easily adapted so as to be used with either $\frac{1}{2}$ or $\frac{1}{4}$ plates as desired.

The accompanying illustration shows a camera (the "Sanderson") in which many of the points mentioned are embodied.

The following diagram illustrates the way in which by means of the Sanderson patent swing front the necessity for tilting the camera has been overcome. By this means

not only can the front be raised or lowered, but the lens can be swung upwards and downwards if necessary. Added to all this it makes possible very large extensions on a relatively short and therefore more rigid base-board.

Hand Cameras.—Even more popular than the ordinary stand camera are the small cameras, which can be used either with or without a stand as desired. Such cameras are known by the general name “Hand Cameras.”

This class of camera has been called into existence by the very rapid progress photography has made as a hobby among all classes of people, and the desire which has thus been established for obtaining photographs as mementoes of places of interest visited.

Hence the first consideration in the construction of the hand camera is

usually the smallness of the space into which it can be packed. Some of the older forms of box cameras, by means of which much very good work has been and still is being done, have suffered somewhat on account of their bulkiness.

In such cameras the distance of the plates from the lens was so arranged that all objects beyond a relatively short distance could be considered as equally well in focus.

In some cases additional lenses completed the outfit, these lenses being required when the objects were at a less

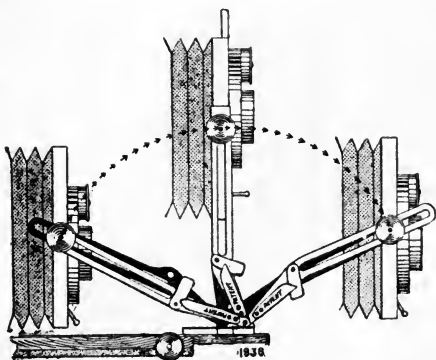

Fig. 56.

The Camera front is here shown only in three different positions, but of course the front can be stopped at any point of the arc shown by arrow-heads, and at the same time can be raised or lowered to any position within that arc.

distance from the camera than that for which the principal lens was suitable.

The better-class hand cameras are no longer of this "fixed focus" type, and, owing to the care with which they are constructed, one can scarcely admit they have lost much in rigidity by the change. On the other hand, any form of collapsible camera must necessarily be less bulky when closed, than one of the box type adapted to lenses of equal focal length.

So much movement is indeed now desired, that the Sanderson hand camera possesses the same patent universal swing front as previously described.

Another point which has to be considered in the construction of the hand camera is the ease with which it can be manipulated. Much snap-shot work is done by means of these cameras, and it is apparent that many of the best pictures would be lost if preliminary setting-up arrangements took up any considerable length of time.

Should a hand camera be made so that it can be extended by means of bellows, it is important to ensure that the front can be made perfectly rigid.

Then, of course, some arrangement should be attached by means of which it is possible to see at a glance the exact extent of the picture which would appear on a developed plate if exposure is made at any instant.

If the camera is adapted only for the use of plates, then the carriers should be made as light as possible, and at the same time the process of filling the carriers should be made so simple that if necessary they can be loaded in the dark. Then, again, some detachable arrangement might be provided by means of which a dozen slides, or perhaps twenty-four films, can be loaded at one time. When this is done the process of changing the slides or films after exposure offers no difficulty, even to a mere beginner.

For snap-shot and other rapid work it is necessary that some form of shutter should be supplied, and for very

rapid exposures the focal plane shutter is perhaps the favourite.

The principle of this shutter is simply that by the movement of a dark blind or blinds immediately in front of the sensitized surface of the plate, the whole plate is left exposed to the light passing through the lens usually for a very small fraction of a second, although the blinds can be arranged for time exposures if necessary. In the focal plane shutter supplied with the Ross Panros Camera there are two short blinds winding from one roller on to another without any strain beyond the tension of the springs. One blind begins to move first, and after an interval sufficient to attain the desired aperture the second blind, which is automatically released, follows. The mechanism connected with the two blinds then becomes so locked that the distance between the blinds, *i.e.* the aperture, remains constant during the whole time the blinds are in motion. The increase or decrease of the width of the aperture is controlled by a milled head, and the actual speed of the blinds increases automatically as the aperture is decreased.



Fig. 57.

Another important feature of these blinds is that they are self-closing, one blind overlapping the other and remaining in this position during the next setting of the shutter, so that should the slide of the plate-holder have been withdrawn, no light will reach the film or sensitized plate.

This camera being supplied with a focussing hood, it is also arranged that the focal plane blind can be opened for focussing purposes.

The illustration (fig. 57) will make the essential parts more clearly understood.

This shows the camera attached to a tripod stand, with pneumatic ball release, such as is used with it when a time exposure is desired. The small knob to be seen immediately above the junction of the tube with the camera is the

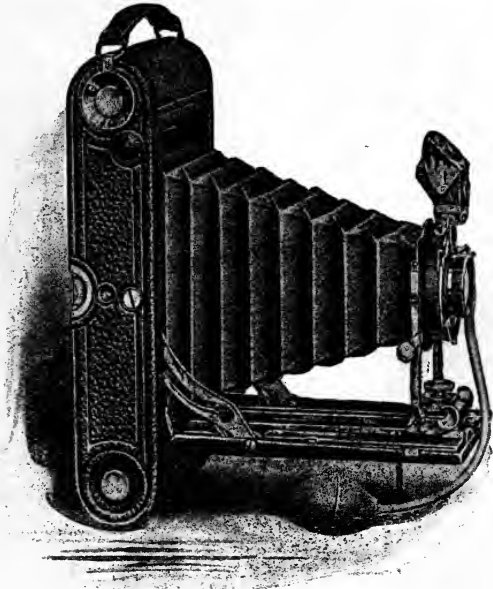

Fig. 58.

release used for the blinds when short exposures are given. The milled head and butterfly nut are the only permanent projecting parts. The finder seen on the top can be laid flat down when not in use.

The diagram also shows the compactness of the camera and the rigidity of its front. While not possessing the same degree of movement as the front of the Sanderson hand camera, the lens board has a fair rise and fall, indeed, sufficient for all ordinary circumstances. The speed

obtained with such appliances as these ranges from time to $\frac{1}{10000}$ second.

Among hand cameras of the ordinary type, in which the shutter employed is not a focal plane blind, none are better known than the Kodak cameras.

These are sold in different sizes and at very varying prices, and some of them are sufficiently small to be easily carried in the coat pocket, their shape being suitable for this, as can be seen from the accompanying pictures of two extended for use. (Figs. 58 and 59.)

These cameras (at least the more expensive ones) can be used with plates or roll films.

Reflex Cameras. — Another hand camera which may be noted is the Reflex. In the older forms these cameras were of the box type, and so suffered under the great disadvantage of being decidedly cumbersome. This objection has been removed quite recently by the production of Houghton's Folding Reflex, a camera which

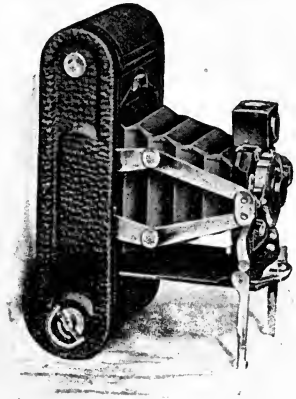

Fig. 59.

when closed is no more bulky than many folding hand cameras of the ordinary type. The next two pictures illustrate this camera, the first with the hood raised and opened ready for use, and the second closed for carrying. The release of the shutter is arranged on the right-hand side, so that by gently pressing with the thumb the shutter is released and the mirror left in position for the next exposure. When opened the side struts lock, and the camera becomes perfectly rigid. A small lever locks the extended camera in position, so that it is practically impossible for it to become partially closed by accident. Like all the better-class reflex models the image can be seen in the

ground glass, right up to, and immediately after, the exposure.



Fig. 60.

The Naturalist Camera.

—A camera has been devised to enable a telephoto lens to be used for relatively short exposures. This is known as the Naturalist's Camera, because it is very useful for obtaining photographs of insects, etc., which would be disturbed if one attempted to obtain a photograph at too close quarters. Under favourable circumstances the exposure required for the type of instrument shown in the next illustration may be as short as $\frac{1}{150}$ second, so that absolutely



Fig. 61.

sharp pictures can be obtained in most cases. In fig. 62 the projection at the top is the viewing apparatus. In one form of this camera the image is projected by the lens upon an inclined mirror, and thence it is deflected at an angle of 45° into the special eye-piece. The field lens of this eye-piece has one surface ground. This consequently serves as a focussing screen and gives a fixed plane, accurately registering with the surface of the plate. The image is viewed through the eye lens, and

this not only serves as a magnifier for focussing purposes, but it also acts as a hood keeping external light from the

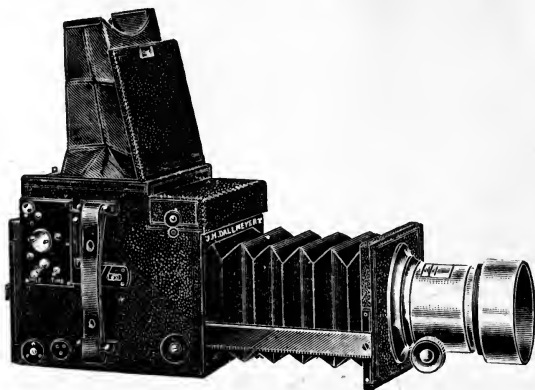

Fig. 62.

field lens, and so makes it possible to focus accurately even in very bright light.

Toy Cameras.—Among the class of hand cameras we might mention one or two instances of what may be looked upon as toy cameras. Many of these, although very small in bulk, are fitted with first-class lenses and are capable of producing photographs which, when enlarged, make quite satisfactory pictures.

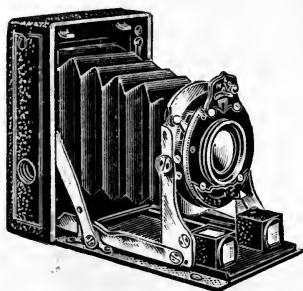

Fig. 63.

The Bebe Camera of Watson's is one of these. This camera is $3\frac{1}{2}$ " by $2\frac{1}{2}$ " by 1", and the size of the print is $2\frac{3}{4}$ " by $1\frac{3}{4}$ ".

The accompanying illustration shows the compact nature of this little instrument.

Another of a somewhat different appearance is the "Ticka," a tiny camera which looks like a silver watch (see fig. 64). Like the others in which spools of films are used, it can be loaded and

unloaded in daylight. If desired it can be fitted with an

Anastigmat lens which works at $f/6.5$ with a focal plane shutter.

Panoramic Cameras. — Several cameras have been invented for obtaining a panoramic view. The angle included in the view varies, some

of the better-class models being able to produce pictures extending over nearly 150° .

In the type shown in fig. 65 the film is arranged in a curved manner at the back of the camera. When a button is pressed the lens swings round, and an

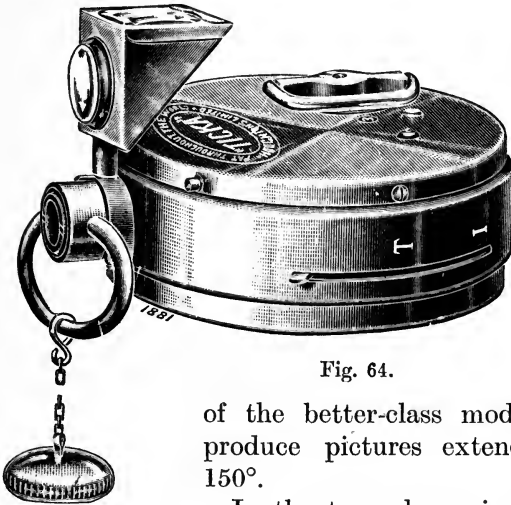

Fig. 64.

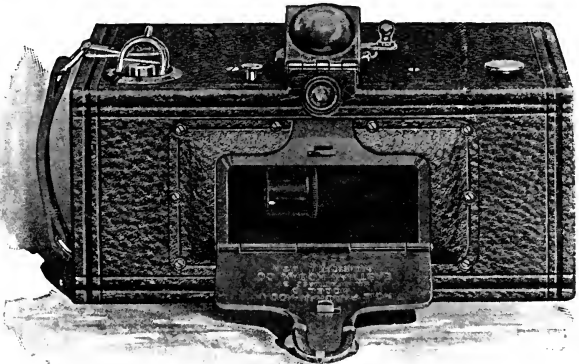

Fig. 65.

image is projected over the whole length of the exposed section of the film.

Stereoscopic Cameras.—The ordinary photograph as obtained by any of the above-mentioned cameras does not, after all, give impressions which are so true to nature as those obtained by the double lens system in the stereoscopic camera.

In the pictures produced by means of these cameras the images of the near objects should be very sharply defined—in fact, as far as possible every object must stand out sharp.

No branch of photography, with the exception of the cinematograph, has in the last year or two afforded so much pleasure to the general public as the stereoscopic.

Many excellent cameras are now made which enable such photographs to be obtained with the minimum amount of trouble. Such an one is that shown in fig. 66. This can be used with films or plates, and can take either single pictures or stereoscopic pictures, each single picture being $3\frac{1}{4}'' \times 3\frac{1}{4}''$.

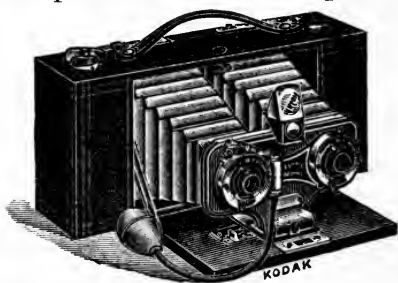

Fig. 66.

Of course it is essential when viewing the two pictures that the one seen by the *Right* eye should be the picture obtained by the *Right* lens.¹

A little observation will make it quite clear that if prints are made direct from the negative the right-hand one is that obtained with the left lens. Hence in order that the objects may appear in their true relative positions, the positives must be transposed, and this often is a stumbling-block for beginners.

The two views thus obtained, which at the first glance

¹ Readers interested in this special branch of photography will find a detailed account in the *Photographic Annual* for 1910-11.

seem to be absolutely alike, when looked at through the instrument form one picture, which appears no longer plane but solid.

The two pictures which are seemingly alike are, in fact, different. If we look at a cube with the right eye, we see rather more of the right side ; if we look with the left eye, we see something more of the left side, taking for granted that the head is not moved. The pictures of the right and of the left eyes are combined with each other and give the impression of solidity.

If we close one eye, the impression of solidity is far weaker ; the objects appear plane or flat. This may not be readily credited, because men do not often seek an explanation of what they see, but look at objects much too hastily. But it can be easily ascertained that such is the fact if a bottle be placed before a wall, or in front of an upright book. If we then look at them with both eyes, we readily perceive the distance of the bottle from the wall or book, but directly we close one eye the bottle and the book appear to be almost contiguous, and it is only by moving the head on one side that we clearly distinguish the distance between them.

Accordingly, the use of both eyes is necessary for a perception of solidity. It is only in this manner that we come to the conviction that space has not only height and breadth, but also depth. One-eyed persons only receive this impression by turning the head on one side. If objects are very remote, the difference between the views which the right eye and the left eye have of them is very inconsiderable ; and, accordingly, such remote objects appear flat and without solidity, and it is only when we change our position and observe them from different sides that we become acquainted with their solidity. This is therefore purely an affair of experience. Every person will recognize a distant house as a solid object, because we know from experience that a house is solid ; but that we

actually see it as a flat surface is proved by the deception produced by theatrical decorations, where the remote background, if properly painted, often produces an extremely natural effect; but we perceive this background to be flat directly we move the head on one side. When this is done, a solid object presents a different appearance, but a flat surface remains unchanged.

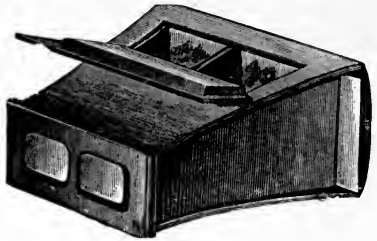

Fig. 67.

The Stereoscope.—Wheatstone was impressed by the fact that the solid impression made by an object is caused by the combination of the different views of it by the right and left eye. Accordingly, he tried to substitute for a single picture a view of the right side of an object for the right eye, and of the left side for the left eye. He obtained in this manner a perfectly solid impression, though the double picture occasioning it is no solid at all. Some people, indeed, are able to see stereoscopic pictures as solids without using an instrument. But most persons require an apparatus which renders it possible for both eyes to see in the same place the two separate pictures. This apparatus is the stereoscope (fig. 67). Its most essential features are, the two pictures on the slide and the partition in the interior of the box which prevents the right eye seeing the picture on the left, and *vice versa*; and, further, the lid, which is generally provided with a mirror which can be either shut or opened, so as to exclude or let the light into the box; and, lastly, the two lenses at the top.



Fig. 68.

These lenses are represented in the diagram (fig. 68); they are two halves of one lens, and work in the same manner. We are indebted to Brewster for the construction of this instrument.

If in the fig. (69) we consider the points a and a' to represent the same point in the view on the stereoscopic pictures obtained, and $L L$ the two lenses of the viewing apparatus, the blending of the images to form one can be understood.

The two corresponding points $a a'$, which belong to the right and left images, appear therefore in common to both eyes at a'' —that is, at the same place—and consequently our two eyes see only one image instead of two.

Now, every one who wishes to see an object (for instance, writing) clearly and distinctly, holds it at a definite distance from his eye. This distance is the distance of clear vision. In the case of good eyesight it is eight inches; with far-sighted persons it is more, and with short-sighted persons less. In the case of stereoscopic vision, the image appears remoter or nearer, according as it is removed from or approached towards the two lenses. If the image is near the lenses, it appears when viewed through them nearer and smaller. In the opposite case it appears farther and larger. But every

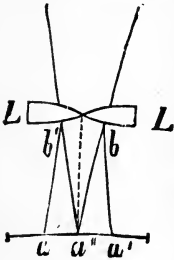

Fig. 69.

one wishes to see the image at the distance of clear vision, therefore stereoscopes must have movable lenses, in order that persons may adapt the position of the object to the eye—that is, that they may vary the distance of object and lens until the image appears clearest. If such focussing arrangements are absent, the instrument is only adapted for eyes of average power of vision, and requires an effort in eyes of a different calibre. Persons are often met with whose eyes are not of equal strength, one being short and the other long-sighted. There can be no satisfactory stereoscope for such persons: for if the distance of the lenses is adapted for one eye, it does not suit the other.

Nevertheless, such persons can obtain a tolerable

stereoscopic effect if they hold a suitable eyeglass before one eye.

A great hindrance to viewing stereoscopic pictures on paper was the shape of the Brewster stereoscopic box, which is closed all round and only open at the top. This aperture only admits an insufficient amount of light to the picture, which is commonly left in the shade on one side.

This defect was removed in the American stereoscope, which dispenses with any box. Lenses are fitted in a frame *g g* (fig. 70), which may be held by a handle; the partition *b* serves to separate the field of view of the two lenses. The object is placed on the cross-board *d d*, and this board can be easily slid to and fro, so that the proper position of the image with reference to the eye may be found.

But the American stereoscope is only suitable for paper pictures. The beautiful

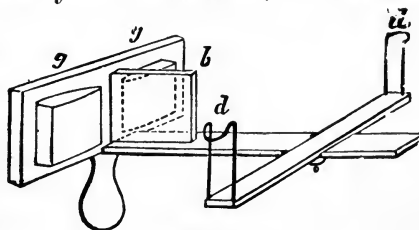

Fig. 70.

transparent stereoscope pictures on glass can only be viewed with stereoscopes of the Brewster type, as they must be seen by transmitted light, and all front light excluded, or the effect will be destroyed.

Double pictures drawn by the hand can also be viewed through the stereoscope. It is evident that the preparation of such pictures only succeeds in very simple subjects. It would be very difficult to represent stereoscopically a complicated object—for example, a man, a landscape, or a machine. Photography, which can produce with the greatest ease pictures of the most complicated objects from any point preferred, rendered this possible. It is only since the invention of photography that the stereoscope, which was formerly a philosophical instrument, has become a favourite instrument with the public. Not-

withstanding their small form, the pictures of these instruments make a clearer and more intelligible impression than single pictures of the same object in a larger form. A single picture of a machine, or of complicated architecture (for example, the choir of the Cologne Cathedral), is often a hopeless maze of details. But in the stereoscope the confused masses are directly defined ; they become distinct in perspective, and the eye perceives with great clearness the interior structure. In this respect the stereoscopic pictures are of equal value to the magic lantern in imparting instruction.

Very much more elaborate forms of stereoscope have come into use during the last few years, and it is no uncommon thing for arrangements to be made for two hundred views, on paper or glass, to be examined in succession, the change from one view to the next being made by simply turning a milled head which projects from one side of the apparatus.

Enlarging Cameras.—The small photographs obtained by means of the hand camera can be enlarged to any desired size, and the apparatus required for this can be arranged so that the work can be carried out either by the aid of daylight or by artificial light. If the degree to which it is desired to extend the enlargement is relatively small, then there is a great deal to recommend the daylight enlarger.

The simplest of this class are usually of a fixed focus type and are made for one degree of enlargement only, but some of the daylight enlargers are so arranged that they can be easily set for enlarging $\frac{1}{4}$ plate photographs into any ordinary size up to 12 by 10.

Again, some enlargers of this type are also capable of being used for the purpose of enlarging other sizes (*e.g.* $\frac{1}{2}$ plates as well as $\frac{1}{4}$ plates).

It is not the usual practice to try to obtain enlarged negatives by this means, although, of course, this can be

done, but the enlarged photograph is made on bromide paper, and this forms a very expeditious method of getting

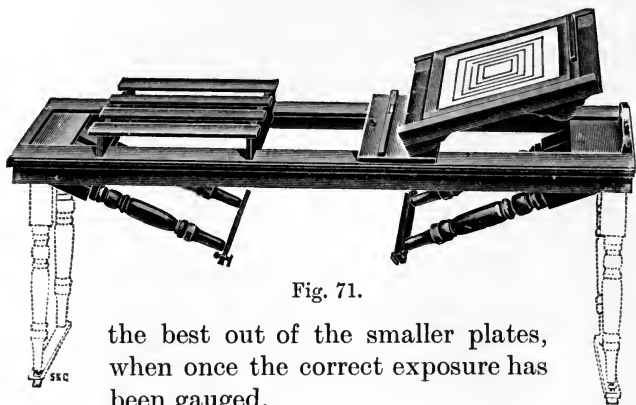

Fig. 71.

the best out of the smaller plates, when once the correct exposure has been gauged.

Any daylight enlarger can, if necessary, be used with artificial light, but if photographs can only be enlarged

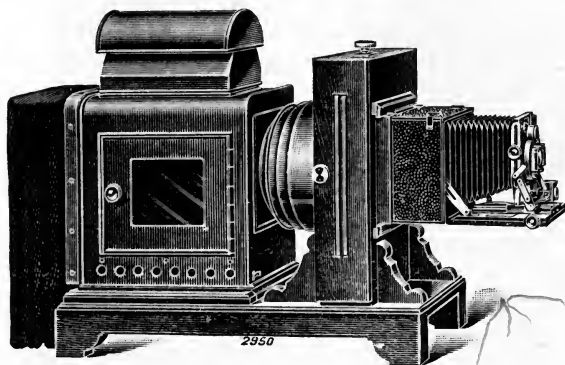

Fig. 72.

during the long winter evenings, it is far better to do this by means of an enlarging lantern.

By using this instrument it is possible to obtain any reasonable degree of enlargement, and this method has

the distinct advantage over daylight enlarging, that it is subject to a much greater degree of control.

When an enlarging lantern is used it is necessary, or at least advisable, to have some form of enlarging easel which can be placed so that the plane of the paper which is to be exposed is at right angles to the length of the lantern—*i.e.* parallel to the plate which is being enlarged.

Fig. 71 shows an arrangement of this nature.

Lanterns are also made which can be used in connection with a given class of camera, the camera lens taking the place of the enlarging lens. Fig. 72 shows an example of this.

There is still one further camera appliance that demands a brief mention, although it cannot be claimed that it is of much interest except to the professional photographer. This is the studio camera and its stand. These stands must be absolutely rigid,

and the attachment of the camera to the stand is such as to ensure that the whole arrangement is as far as possible non-vibratory.

Fig. 73 shows a camera on its stand. When the height of the stand is altered this is done by turning the wheel, which can be seen behind the stand in the illustration.

Mention has already been made of the necessity for some form of shutter in connection with the lens when

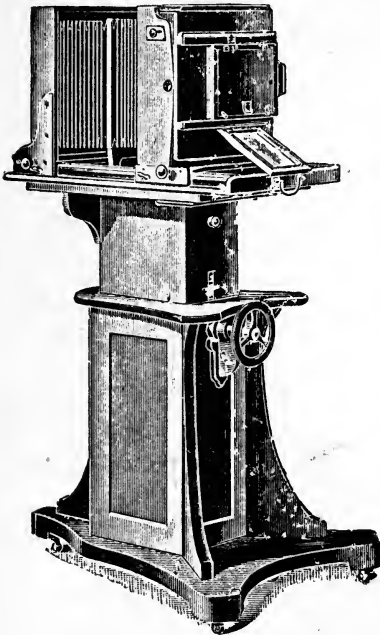

Fig. 73.

very short exposures are to be made. One kind of focal plane shutter has already been briefly described. Other shutters may be divided into two classes: (*a*) those which work in front of the lens or immediately behind it, and (*b*) those which are placed between the components of the lens system.

The Thornton-Pickard (see fig. 74) is perhaps the best known of the class (*a*). This shutter can be used for time or instantaneous exposures and can be fitted either in front of or behind the lens. In the latter case a loose panel is supplied to which the flange of the lens can be screwed.

One of the Thornton-Pickard shutters, known as the Fore-ground Shutter, is especially constructed so as to give more exposure to the foreground than the sky. This is a very useful one for obtaining cloud effects, and, in fact, for all landscape and seascape photography.

Other well-known shutters are to be found among the various kinds of sector shutters, such as the Goerz, the Unicum, and the Koilos.

Whatever kind is used, it should as far as possible be free from all vibration when in action. It should be possible to obtain a fair range of speeds, and the marked speeds ought to be accurate, or, at least, if they are too high, all the speeds should be affected in the same proportion.

The mechanism of the shutter, too, should be such that the liability to get out of order with proper use is reduced to a minimum, and the adjustments required should be of an easily understood nature. If required for such work as the photography of animals, it should make no noise



Fig. 74.

when being set or released. Lastly, so far as it is possible the movement of the shutter should be so arranged that the plate receives an evenly distributed illumination. Many of the shutters are regulated pneumatically, the principle of the system being a plunger fitted loosely within a cylinder so that there is a leak of air between the two. This cylinder is in connection with the parts causing the shutter to move ; the alterations of speed are, however, not made by altering the rate at which the air leaks out, but by the length of the travel in the cylinder. The slower the speed the longer the distance travelled. Some interesting work has recently been done on the testing of photographic shutters, for which the reader is referred to the original paper.¹

¹ *Journal Phys. Soc.*, Vol. xxi., 7, pp. 788 *et seq.*

DRY PLATES, FILMS AND PAPERS

THE ordinary dry plates may be divided into groups according to their sensitivity to the action of light, those which are least sensitive being termed slow, and then with increasing degrees of rapidity we have medium, rapid and very rapid plates.

The Emulsion for Dry Plates.—In all these plates a gelatine coating is used, ammonium bromide and potassium iodide being dissolved up in distilled water with the gelatine. A second solution is made of silver nitrate in distilled water, to which is added sufficient ammonium hydrate to dissolve the precipitate first formed.

The second solution is added to the first either in the cold state if slow plates are required, or the first is kept at a temperature of about 120° F. while the second solution is added as when more rapid plates are required. The rapidity of the plates depends to a large extent upon the relative amounts of gelatine, bromide, iodide and nitrate present, but it also depends upon the treatment which the solutions undergo before and after mixing.

A digestion of the solutions at about 130° F. for about one hour will greatly increase the speed of a plate over one similarly coated, but the gelatine, etc., of which has not been digested at such a high temperature.

For ordinary photographic purposes the slow plates will be found quite satisfactory; it is quite possible in good lights with lens aperture $f/16$ to use these for making snapshots of objects. Of course, for focal plane work and the photography of rapidly moving objects it is better to use some of the more rapid varieties.

No attempt, however, will be made to describe any

particular make of plates or papers, the object of this chapter being to give such information as may be of general interest to the worker, and at the same time make clear some of the more important facts in this branch of the work.

Backed Plates: Halation.—Sometimes, when photographing the interior of a church or other building in which dark masses of shadow necessitate a long exposure, it is found on developing the plate that the high lights have spread out considerably beyond their proper boundaries, and have consequently blotted out much of the surrounding detail. The effect so produced is called *Halation*. This is due to the fact that the very bright light has not been completely absorbed by the film, but some has been able to pass through it and has then been reflected from the back of the plate at such an angle that it reaches the under surface of the film, and, owing to the length of the exposure, this produces such an effect on the chemicals contained, that it helps to blot out the image which should be produced by the direct action of the light.

There are means by which such a plate can be reduced locally by the application of some reducing agent, or the high lights may be reduced to a certain extent by placing the negative in alcohol after it has been fixed, and gently rubbing the parts with either a very soft piece of linen or a plug of cotton wool.

It is far better, however, to avoid the error than to try to remedy it, and this can be done by employing what are known as backed plates. Such plates can be prepared at home if desired, but it is better to buy them already backed, as the increase in cost is not great and the chance of failure less.

Whatever the nature of the colouring matter used in the backing, which is placed as a coating on the back of the sensitive plate, it must be such that it absorbs the light which passes through the film, and so prevents its reflection

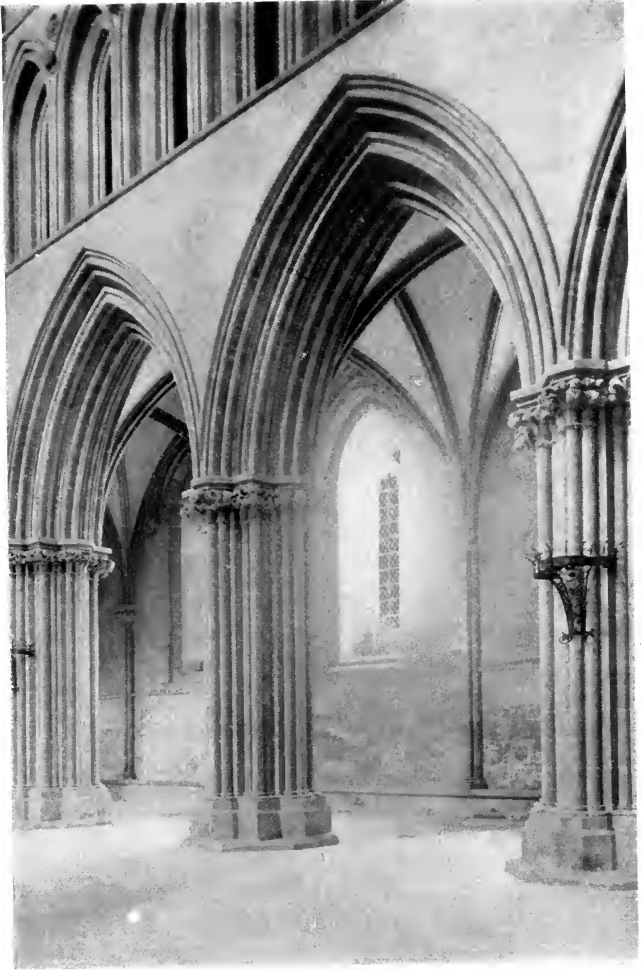

Fig. 75.

Photograph obtained with ordinary unbacked plate. Note halation effect.



Fig. 76.

Photograph obtained with Ilford Rapid Chromatic backed plate.
Note absence of halation effect.

back to the under surface of neighbouring parts of the film. As it is the photographically active rays which must be absorbed, the backing must be of a reddish brown or black colour. Again, the refractive index of the material used should be the same as that of the glass, if it is to have a maximum effect in preventing reflection of the light.

The advantage of using such backed plates is well illustrated in figs. 75 and 76.

Fig. 75 shows the *halation* effect due to the action of the excess of light which has passed through the window. The surrounding details are almost entirely obliterated. Not only that, but the brighter portion of the window has even produced a reversal effect—*i.e.* a positive instead of a negative has appeared on developing the plate. Fig. 76 shows the result obtained when an Ilford Rapid Chromatic Backed Plate is used for obtaining the same photograph. Here all the details of the window and its immediate neighbourhood are quite distinct.

Backing adds greatly to the effectiveness of plates when used in astronomical work. Any fine dark markings on a brightly illuminated area, *e.g.*, the surface of the moon, tend to become so weakened in detail by halation as to be very indistinctly seen.

When a ray of light which has passed through the sensitive film and the glass plate at any angle other than the normal, meets the air, a portion of the ray is reflected again into the glass, and strikes against the lower surface of the film, as previously stated.

The amount of light so reflected gradually increases with the angle of incidence until the critical angle is reached, at which point there is total reflection. The point upon the film where the ray falls may be considered as the point of emission, and as the rays radiate in all directions around this point, they thus form a circle in the plane of the sensitive film.

This halation circle is often evident in the photographic negatives of stars when made on unbacked plates.

Orthochromatic Plates.—The silver salts contained in the film of the sensitive plate are much more strongly affected by light of some colours than that of others, and the light which has the greatest effect upon the human eye has not the greatest effect upon the film of the ordinary photographic dry plate.

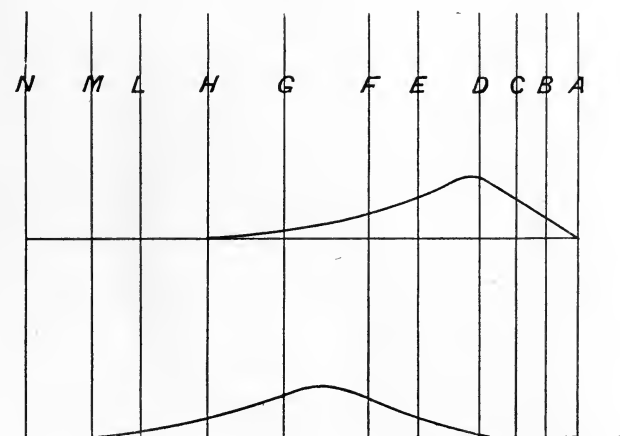

Fig. 77.

Suppose that in fig. (77) the base line in each case represents the spectrum. The vertical lines *N* to *A* will then represent certain fixed dark lines (Fraunhofer lines, see p. 42) which are visible in the solar spectrum. *A* being at the extreme end of the red and *H* at the extreme end of the violet, thus *L M N* are in the ultra-violet region. The other lines lie as follows: *B* in the red, *C* in the orange, *D* in the yellow, *E* in the bluish green, *F* at the beginning of the blue, and *G* between the blue and the violet.

The upper curve represents the relative degrees of sensitivity of the human eye to light of various colours, the lower curve that of the ordinary photographic plate. A glance at this diagram shows that the ordinary plate is not sensitive to rays of less refrangibility than the yellow, that the blue to violet rays have the maximum action upon the plate, and that the action of the violet end of the visible spectrum by far exceeds that of the remaining portion.

Hence it is that if one endeavours to photograph black letters upon a red surface, using for this purpose an ordinary dry plate, no letters will be visible upon the developed plate, the light reflected from the red and the black having apparently the same amount of action upon the sensitive film.

If the coloured objects are to be represented properly, *i.e.* if each colour is to have its proper light value, some means must be taken to make the effect of the various coloured lights upon the plate correspond as nearly as possible in their relative intensity to the effect which those lights have upon the eye.

As this is the case, some method has to be devised for enabling the plate to record the action of the rays from the red end of the spectrum, and at the same time to tone down the effect produced by rays from the violet end.

The first of these changes can be brought about by the action of certain dyes upon the film. The dye can be added to the emulsion when the plates are being made and such plates will keep for a long time, or if greater colour sensitiveness is required, the colouring matter may be prepared in very dilute solution with ammonia, and the plates immersed in this solution. The plates, however, do not keep well when so treated.

Such special colour-sensitive plates can be bought as orthochromatic, isochromatic, panchromatic plates, etc.

A brief mention here of some of the red sensitizing

properties of the more commonly used dyes will be of interest.

Some Dyes for Red Sensitizing.—The cyanin dyes are all useful as colouring agents for silver chloride and silver bromide, and they render these compounds sensitive to the rays of the red end of the spectrum.¹

The absorption spectrum of all the cyanins is characterized by two well-marked bands, the one lying towards the red known as the α band, and that nearer the blue as the β band.

The relative distance between these two bands remains nearly constant under different conditions in solutions of the dyes and also in dyed dry films; on the other hand, the form of the bands, their intensity, and their position in the spectrum, depends upon the nature of the medium in which the dyes are dissolved. Thus solutions in quinoline, alcohol, and benzene show an intense α band, but the β band is only very faintly indicated. In dilute solutions in water, the β band is broad, and the α band only appears as a light shadow.

As the concentration is increased the β band shows a tendency to spread out, either in both directions, or towards the blue end of the spectrum only.

In the case of dyed dry films the bands appear of almost equal intensities, but dyed collodion films always show an approximation to the spectrum obtained with solutions in alcohol, while stained gelatine films are more like water solutions with respect to their action upon light. The bands seem to approach nearer the red end of the spectrum when a solvent of high dispersive power is used.

It is of particular interest to note that all the cyanin dyes sensitize photographic plates in a similar manner to the effect shown by the absorption spectrum of the dyes in the dried films.

On account of the high dispersive power of silver bromide,

¹ Baron A. von Hübl, *Journal of Photography*, March 1906.

the cyanin bands are shifted some distance towards the red and are at the same time drawn somewhat apart.

For certain unknown reasons the α band sometimes fails, and then, of course, the dye is of no use as a red sensitizer. Von Hübl suggests that the unsatisfactory action of such dyes in plates prepared with dyed emulsions as compared with that of bathed plates may perhaps be due to this.

*Dicyanin*¹ is a remarkable sensitizer in the extreme red when used with collodion emulsion. The sensitiveness is low and does not extend into the green, so that dark green light may be used with plates bathed in this dye.

Pinaverdol is especially adapted for sensitizing dry plates or films to orange, yellow and green.

In the case of *orthochrome T* the makers claim that the sensitizing action reaches to the *C* line of the spectrum, while *pinachrome* renders films sensitive to line *B*, and faster than those dyed with orthochrome.

Pinacyanol forms a blue solution when dissolved in alcohol, but the addition of water when the bath is prepared, changes the colour of this solution to purple. Like dicyanin, this dye does not sensitize for green rays, yet films dyed by pinacyanol are very fast and their sensitiveness extends far into the red.

Cyanin is a blue dye, and films dyed with it are sensitive far into the red. They are, however, very slow and are very liable to fog, hence great care must be taken to use suitable developers with plates sensitized by means of this dye. Many other dyes are used—*e.g.* *Erythrosine*, *Rose Bengal*, *Eosin*, *Alizarin Blue S.*, etc., all of which have the power to increase the sensitiveness of the plates to the rays from the red end of the spectrum.

The theory of the action of dyes in this connection has been the subject of some amount of controversy. Vogel considered that coloured light is absorbed by the dye and that this light is transferred to the silver salt in the

¹ W. A. Scoble, *Photographic Journal*, May 1906.

neighbourhood for a much longer period of time than would be the case if the dye were absent. If this explanation were correct, then the action of the dye would be purely a physical one.

On the other hand, Abney considers that the action must be looked upon as purely chemical. By his theory the colouring matter is supposed to undergo photo-chemical oxidation, and it is further assumed that it acts as a reducing agent, thus assisting in the reduction of the silver salts.

According to Vogel's theory the best sensitizers for the red and orange rays should be found among the green and blue dyes. While many of the dyes in common use help to bear out the truth of this theory, there are several well-known exceptions to the rule, for red, yellow and violet dyes or colouring matters, as well as certain resins and colourless organic substances, have been found useful in this respect.

Even when plates are thus specially prepared it is still found that the light of the violet end of the spectrum has relatively too great an effect upon the film, hence it is that some *suitable* screen must be used with the lens when such plates are exposed. These screens are specially prepared by the various makers, and although any lemon-yellow screen which is not too dark answers well, it is better to obtain the screen recommended with the plates.

It can be seen that if too much of the blue light is cut off, those parts which are coloured blue will be represented as too low in intensity, and the photograph will then err in the opposite direction to those obtained with ordinary plates.

It must be remembered that the exposure must be greatly increased when using a screen. Thus, if a fourfold yellow screen is used, the exposure should be four times the length that would be allowed with plates of the same rapidity, when not using a colour screen. Of course when the sun is near the horizon, so that the light received from it has a



Fig. 78.—Ordinary Plate. Compare the appearance of the foliage with that in fig. 79.



Fig. 79.—Ilford Panchromatic Plate. Note the cloud effects, and the clearness of the distant view.



Fig. 80.—Ordinary Plate. Note the effect produced by the various coloured objects.



Fig. 81.—Ilford Panchromatic Plate. Note the effect produced by the various coloured objects.

Scarlet Tiger.

Yellow Underwing.
Large Tortoiseshell.

Clouded Yellow.

Frittillary.

Empress.

Cinnabar.

Speckled Wood.
Garden Tiger.

C. Spot Burnet.
Cream Spot Tiger.

much larger proportion of yellow rays than when it is higher in the sky, orthochromatic plates can be used without a screen, and the pictures obtained will be distinctly better than those got with ordinary plates. On the other hand, for ordinary purposes no benefit is derived from the use of such plates unless the screen is employed.

The employment of screens is, however, quite a simple matter, for they can be obtained so as to fit on the front of the lens, and the cap of the screen can then be used if desired to time the exposure, instead of the ordinary lens cap. When not in use, colour screens should be kept in a light-tight case, as unnecessary exposure to light only tends to alter the light value of the screen.

The result of using orthochromatic plates with suitable colour screens is well illustrated in figs. 78, 79, 80, and 81.

The importance of the orthochromatic plate and colour-filter in astronomical work is clearly shown by the following statement by R. J. Wallace :¹—

“The new era in photographic science, opened by the introduction of the (so-called) isochromatic plate and its accompanying colour filter, was pregnant with significance to astronomers in general throughout the world, for that hitherto while the application of photography to the recording of results could be attained only by the possession of an expensive correcting lens, the simple combination of a colour filter and isochromatic plate not only fulfilled all requirements, but did so more perfectly.”

Care must be taken not to over-develop orthochromatic plates, for then the high lights will be partly obliterated in the attempt to bring out the details in the shadows.

Now that plates are being used which are sensitive to red light, the ordinary dark-room lamp or lantern which supplies red light must not be used when developing the plates, in fact, as little light of any kind should be used as it is possible to work with, and then it ought to be of

¹ *Astrophysical Journal*, xxvii. 2, 1908.

a yellowish green tint, since it is by this light that one is enabled to see the most with the least amount of light. This is the more convenient, since some Panchromatic plates are less sensitive to green than to any other light.

Orthochromatic plates can be used without a screen, and the results then obtained will compare favourably with the best of those with ordinary plates. It is, however, for the more difficult subjects that these plates are especially adapted.

They can be used for obtaining "cloud effects," and with a suitable screen, cloud and sky, as well as trees, etc., can be photographed at one and the same time, thus dispensing with the use of cloud negatives.

Then, again, in ordinary landscape effects the results obtained are far more pleasing, for the different shades of green produce different effects upon the plate, and clumps of trees are not represented as a rule by one uniform tint in which a large proportion of the detail is lost to sight.

Perhaps it is in hazy weather that the landscape photographer feels the greatest benefit from these plates. When using ordinary plates any haze renders distant objects very indistinct, and, in fact, a slight fog is sometimes quite sufficient to make it impossible to obtain a distant view. With orthochromatic plates and a suitable screen, while the whole plate may clearly indicate the conditions under which the exposure was made, the distant objects are quite clearly visible.

Even in portraiture such plates will be found useful. The light from some shades of red hair produces an effect upon the ordinary plates very much the same as black hair, and thus such hair appears much too dark in the photograph, while, of course, shades of yellow and red in the clothing will also appear disproportionately dark.

Photography by Invisible Rays of Light.—A very interesting development in the employment of invisible

light rays for photographic purposes has been brought forward by Prof. R. W. Wood.¹

It is a well-known fact that a landscape takes on quite a new aspect when viewed through tinted glass, as only a relatively small range of light rays from the objects are enabled to reach the eye through the glass. Some objects which do not reflect rays of such wave length as to be transmitted through the glass will therefore appear quite dark, while others which reflect such rays will appear much brighter by contrast. It seems quite probable that the sensitivity of the human eye to certain spectrum colours has become so developed because we are thus enabled to perceive the greatest amount of contrast between objects commonly observed.

Prof. Wood's experiments are interesting, since they show us in one instance, how our surroundings would appear if the retina of our eye was sensitive to the invisible ultra-violet rays, and in another, if it was sensitive to the infra-red rays.

In order to do this, care has to be taken that only those invisible rays from one end of the spectrum should be allowed to act upon the photographic plate during its exposure.

The screen used for photography with ultra-violet rays must, of course, be opaque to all visible light, and yet able to transmit ultra-violet light of wave lengths 3000-3200.

Glass of course is out of the question, since this is opaque to these rays.

Quartz lenses are usually employed when working with ultra-violet rays, but quartz is transparent to ordinary light.

To overcome this difficulty, Prof. Wood deposited a thin film of metallic silver on the quartz lens. This renders the lens quite opaque to ordinary light, but allows

¹ *Photo Journal*, Oct. 1910, and *Journal Astronomical Society*, Jan. 1910.

sufficient ultra-violet to pass through for the purpose of experiment.

It is much easier to arrange a suitable screen for the infra-red. A sheet of very dense cobalt glass which transmits light of wave-lengths 7100-7600 is employed, but since this allows some green and blue rays to pass through, it has to be supplemented by a cell containing a solution of bichromate of potash. By this means, rays of shorter wave length are cut out.

In the photographs of landscapes, when only ultra-violet rays are allowed to act upon the plate, the sky appears brighter than a sheet of white paper arranged so as to appear on the same photograph. On the other hand, when infra-red rays are used, the sky appears darker than the paper.

A very curious feature about the ultra-violet photographs is that no shadows appear on the developed plates, even when the exposure has been made in full sunlight.

In infra-red photographs the sky appears darker than the foliage and the shadows are quite black. With reference to the sky, it is noticed in Wood's photographs, that in the region of the zenith the sky appears quite black, but that it gradually becomes lighter towards the horizon. This is interesting as affording a visible illustration of the difference in the scattering of light produced by our atmosphere at varying altitudes above the horizon. On account of these effects the general appearance of a landscape containing dense masses of foliage is very similar to that obtained by ordinary photography when the trees are loaded with snow.

Dr Kenneth Mees¹ has pointed out that every small patch of cloud is distinctly visible in these infra red photographs, and has suggested that on this account they may prove useful in meteorological observations.

Chinese white, when photographed by ultra-violet rays,

¹ *Knowledge*, Jan. 1911.

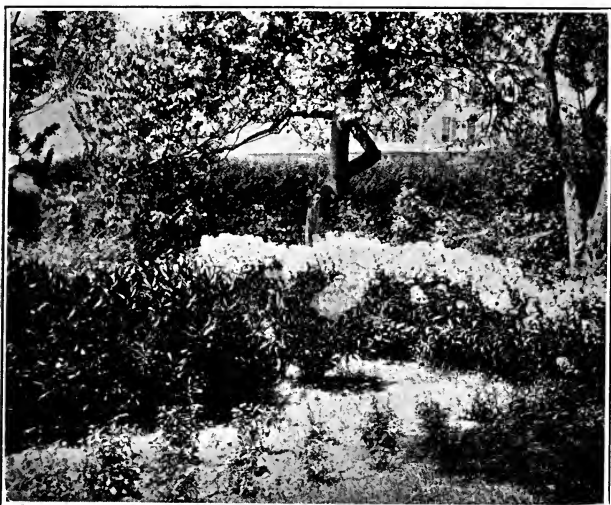

Fig. 81*a*.—Photograph obtained with ordinary lens. Note white phlox.



Fig. 81*b*.—Photograph obtained when using a quartz lens which passes ultra-violet rays.
Note.—White phlox now appears darker than leaves.



Fig. 81c.—Photograph obtained by using infra-red rays only. Note the appearance of willow tree, and the gradual lighting of sky towards horizon.

appears quite black, and even slight traces of it, which are invisible to ordinary eyes, make their presence known in this way.

Prof. Wood has already obtained some peculiar photographs of the moon by the use of ultra-violet rays, and from the results obtained, he suggests that it may ultimately be possible to obtain by this means information as to the nature of the rocks comprising the moon's surface.

Working at $f/8$, the exposure required for a landscape in bright sunlight, when making use of infra-red rays, is ten minutes. With ultra-violet light the time varies according to the thickness of the silver film employed, and ranges from 3 or 4 seconds up to $\frac{3}{4}$ minute. Of course the photograph of the full moon requires a much longer time—2 minutes.

Lantern Plate.—One other type of plate deserves mention, although it is not, as a rule, exposed in a camera like the other varieties: this is the Lantern plate. These are made in one standard size and are very much less rapid than ordinary photographic plates.

The emulsion with which they are coated contains either some soluble chloride (sodium chloride being frequently used) and silver nitrate, or else, in addition to the above, ammonium bromide and dilute hydrochloric acid. The plates are usually exposed to artificial light while in register with the negative the positive of which it is thus desired to produce. For this purpose they can be placed in an ordinary printing frame with the film against the film of the negative, and exposure then made to some lamp or gas-light of known candle power, the frame being held at a fixed distance from the light.

Full particulars as to exposure, etc., are usually issued by the makers with each batch of plates, the speed of the plates being stated in some well-known unit. *E.g.* The

Wratten Lantern plate has an average speed of $1\frac{1}{2}$ Watkins, and the makers advise that the exposure behind a normal negative may be taken as 1000 candle-meter seconds divided by the Watkins speed of the plate.

Thus 1000 divided by $1\frac{1}{2}$ gives about 670, and this would be taken as meaning that at a distance of 1 metre from a 10-candle-power light, 67 seconds' exposure would be required.

Films.—Lastly, for those who wish to carry about with them the means of obtaining a large number of photographs, and yet not be bothered with cumbersome parcels, the sensitive films, either in the flat or roll form will recommend themselves.

Films can be now obtained with which the camera can be loaded in the daylight for exposure, and they can be taken out again in the daylight after being exposed. These films are rolled up with a strip of black paper in such a way that a good length of the black paper must be unrolled before the edge of the film is exposed.

Again, some films are not continuous, but the sensitive film is made in sections to alternate with translucent paper. By this means it is possible to focus for the object before the exposure is made.

Exposure Meters.—The most important step in the production of a good photograph is to decide upon the correct exposure to be given.

It must be clearly understood that no care in the developing can make up for any deficiency in this respect. This point will be referred to in more detail later on.

There is no necessity for amateurs who have barely a good working knowledge of the subject to make mistakes in this respect at the present day. Various kinds of exposure meters are upon the market at very reasonable prices, which indicate the correct exposure for plates of different speeds for certain lens apertures, the calculation being usually based upon the length of exposure

required to darken a small section of sensitized paper to a fixed tint.

When such a meter is used care must be taken to ensure that the exposure of the meter has been made at that place in which the densest shadows occur, otherwise the plate will almost certainly be under-exposed.

The fig. (82) shows the appearance of a meter issued with Wellcome's Photographic Exposure Record; the shaded portions are fixed permanently to the cover of the book, the unshaded part can be rotated on the central axis.

An illustration will make clear how this meter is intended to be used. Suppose the month to be January, the time 12 noon, and the sun to be shining brightly, then the light value from the given monthly tables is $1/3$.

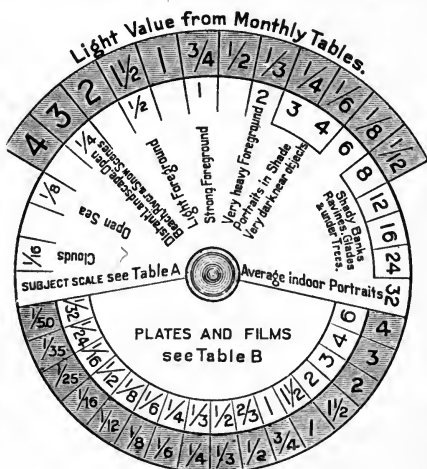
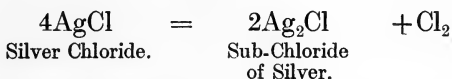

Fig. 82.

Next, suppose the view to be taken includes a very heavy foreground. By placing the tips of the fingers on the movable part this can be rotated until very heavy foreground is just in line with $1/3$, as in illustration. Again, if the plates used are Imperial Sovereign, then a reference to the speed table, Col. 1, gives $1/6$ as factor for this brand. On looking at the meter, $1/6$ (plate speed) will be seen to be opposite $1/8$, and these figures, which in the actual meter are in red, indicate the time in seconds which a correct exposure should take when the stop used is $f/8$. Exposure for stops ranging from $f/5.6$ to $f/32$ can also be read off direct without any calculation.

Change in Silver Salts due to Action of Light.—The processes of change which the active salts in the sensitive film undergo when exposed to light in order that a latent image of the object may be produced, have formed the subject for much scientific research.

One theory which was proposed by Fischer in 1814, and extended by Wetzlar in 1834, is that the silver chloride forms a sub-salt, and the reaction taking place can be represented by the equation



The existence of these sub-salts has, however, never been definitely proved.

Others have put forward an oxychloride theory: thus Dr Hodgkinson, who examined the darkened product, found that it consisted of an oxychloride of silver Ag_4OCl_2 .

Abney has also found that silver chloride does not darken in a vacuum after several months if kept dry, and Carey Lea says it does not darken in air or oxygen if these are dry.

On the other hand, silver chloride will darken under petroleum, and in this case no free oxygen or moisture is present.

Then there is the molecular strain theory, which states that no chemical action actually takes place, the action of light being of too short duration. The particles of silver chloride are considered as being made less stable without actually undergoing any decomposition.

An intense strain is set up in the molecules and the amount of this strain is proportional to the intensity of the light received. This strain would render the silver compound much less stable, and in the presence of a reducing agent those molecules in which the strain is greatest would be first reduced to metallic silver.

According to this theory, the recovery of a latent image would always be possible, and would only be a matter of time.

The Explosion Theory.—F. F. Renwick, in a recent letter to the *British Journal of Photography*, has brought forward an "Explosion" theory of the formation of the latent image.

This theory is based upon the observation made by Dr W. Scheffer that a silver bromide grain on exposure to light violently throws off some part of its substance. Should this take place in the case of the photographic plate, the surrounding gelatine would of course be ruptured by the passage of the particles. Renwick makes the suggestion that the silver bromide grains in the emulsion are encompassed by a complete meshwork of gelatine, and in the unexposed plate these can only be attacked by developers either through the very minute channels left, or by diffusion through the substance of the gelatine itself. When the plate is exposed, the meshwork of gelatine is broken up to some extent, larger sized channels being formed, and the developer thus obtains readier access to the grains of silver bromide. The "explosion" theory is useful in enabling one to grasp the meaning of the "ripening" process. According to this theory, a ripened grain would be one which is in the most highly explosive condition: in other words, the crystallisation of which has, during the cooking process, reached the limit of stable equilibrium, so that any energy derived from outside sources is bound to bring about disintegration.

Skerry¹ considers the action of light on the photographic plate to take place in three stages: (1) a molecular change, with the formation of a product whose development is very rapid but is greatly hindered by oxidizers, which is itself untouched by oxidizers, and is probably

¹ *Photographic Journal*, 47, pp. 170-173, 1907.

soluble in the fixing bath ; (2) a partial breaking up of the haloid forming a rapidly developable product which is prevented from development by oxidizers and is insoluble in the fixing bath until oxidized ; and (3) a complete breaking up of the haloid with the liberation of the halogen, forming an undevelopable product which is not acted upon by oxidizers and is insoluble in the fixing bath. The last of these products appears at the latest about the beginning of the reversal period.

Sheppard and Mees,¹ who have investigated this question from the standpoint of the electron theory, consider that the photographic process consists in the passage of ionized silver to the metallic state, with a suboxidation stage probably intermediate. "Ripening" seems due (*a*) to the formation of resonating systems or clumps of halides, and (*b*) to the formation of an intermediate reduction product, and the function of the gelatine is to assist in both of these. On exposure, light is absorbed and electrons are set free which ionize the haloid and the surrounding air ; the gelatine having a high dielectric constant conserves the electrons ; and the gas, according as it removes the electrons, or not, may reduce the sensitiveness ; electrons may be emitted either from the halide or from the sensitizers used. The gelatine combines with the free halogen, and the ionization of the halide leads to chemical reduction, probably a half halide of the form Ag_2X is produced in solid solution with the halide present, this being the *latent image*.

According to W. D. Bancroft² only those rays of light which are absorbed by the film have the power to produce any chemical action upon the contained silver salts ; further, all the absorbed rays have not equal powers in this direction.

The presence of a depolarizer increases, or, it may be,

¹ *Roy. Soc. Proc.*, Ser. A, 78, pp. 461-472, 1907.

² *Journ. Phys. Chem.*, 12, pp. 209-278 and pp. 318-376, 1908.

renders possible the action of the light, and the ability which some substances possess of being easily oxidized, and others of being easily reduced, depends on the depolarizer. He considers that sensitizers are either direct or indirect polarizers and are light sensitive, also that they are either reducing agents, or become such when acted upon by light.

Reversal or Solarization.—Bancroft has also published some lengthy papers dealing with the reversal of the photographic image, or, as it is sometimes called, "solarization" ¹

Briefly, his views upon this subject may be expressed as follows :

The reversal of the photographic image is due primarily to a change in the silver salt, which is independent of the nature of the medium in which it is imbedded ; the readiness with which the reversal takes place is, however, markedly dependent upon the nature of the gelatine or collodion. It is much easier to obtain a reversal with a gelatine than with a collodion plate. The grain of the emulsion, too, is important in this connection, for reversal takes place much more readily with a coarse-grained emulsion than with a fine-grained one. When pure silver bromide is used reversal is difficult to obtain. A great variety of causes can bring about this action ; thus it can be produced by *prolonged exposure of the sensitive plate to light*, by the antagonistic action of light of different colours, by exposure to white light followed by immersion in a solution of an oxidizing agent and exposure to the spectrum, by the use of stained plates, by partial development and subsequent treatment with silver nitrate, *by the action of white light during development, by the very slow development of an under-exposed plate*, by the addition of thio-carbimide, etc., to the developer, by very short and intense exposures,

¹ *Journ. Phys. Chem.*, 13, pp. 181-250 and pp. 269-331, 1909 ; 13, pp. 1-90, 1909, pp. 449-468, 1909.

with subsequent short exposure to diffused light, or by kathode rays followed by sunlight.

Bancroft also finds that the stronger the developer, and the more prolonged the development, the easier it is to obtain a reversed image. On the other hand, the very slow development of an over-exposed plate will produce a normal image.

The *latent reversed image* is more readily destroyed by bromine, nitric acid, ammonium persulphate, chromic acid, etc., than the latent normal image.

Silver nitrate and potassium nitrate apparently prevent solarization when added to the film before exposure, although it also is probable that the rapid reduction of the silver salts in the presence of these halogen absorbers masks the solarization.

According to Eder there are three images on an undeveloped over-exposed plate, viz., a latent normal image, a latent reversed image, and a normal silver image.

According to Lüppo Cramer the latent reversed image consists of a reduction product of silver bromide, but, according to others, there is no such thing as a latent reversed image, the phenomena being due to the regeneration of silver bromide.

The developable image consists of silver bromide and an α -silver sub-bromide which acts as a catalytic agent, causing the developer to reduce the silver bromide; this α -silver sub-bromide can be reduced by light to a β -silver sub-bromide which is also reduced by the developer but has no catalytic properties. Solarization occurs when the α sub-bromide has been changed in the high lights very largely to the β sub-bromide and this change has not taken place to any great extent in the shadows. The photo-chemistry of the sub-haloids of silver has also been investigated by A. P. H. Trivelli,¹ who traces out the suc-

¹ Trivelli also deals with the problems of solarization in the following papers:—*Zeitschr. Wiss. Phot.*, 6, pp. 197-216, 237-257, 273-299, 1908;

cessive formation by the action of light of sub-haloids from the normal haloid by removal of one atom of the halogen at a time.

The normal haloid is considered by him to be of the form $\text{Ag}_{2n}\text{H}_{2n}$ and not AgH , thus the formula of silver bromide according to his theory becomes Ag_8Br_8 .

A Peculiar Effect of Chemicals upon Normal Latent Image.

—The following peculiar effect of chemicals upon the normal latent image has been noted by E. Demole.¹ If a plate has been exposed under a negative and then immersed for some minutes in a 1 per cent. solution of potassium ferricyanide, then rinsed and developed in a hydroquinone developer, great over-exposure is then found to have no effect at all in accelerating the development or as regards the final result. Further, when the development is carried out under the action of the light of a candle instead of that from the red lamp a negative is obtained instead of a positive. Such a result can be produced even when only very short exposures are given, although a longer exposure renders the result obtained more vigorous.

Thus he found that a Lumière plate (blue label) was sufficiently exposed for ordinary development by 1 second exposure under a negative to an arc lamp at 50 cms. distance. When ferricyanide and candle-light were used, exposures ranging from 1 to 170 seconds were found to give negatives, but with 180 seconds the plate showed a positive which became a negative, with 7 minutes a positive only but not clear in the whites, while with 14 minutes' exposure it produced a perfect positive. He explains this action on the assumption that an oxybromide is formed which is comparatively difficult to reduce by the

Konink. Akad. Wetensch. Amsterdam Proc., 11, pp. 2-29, 1908; *Konink. Akad. Wetensch. Amsterdam Proc.*, 11, pp. 730-747, 1909; *Zeitschr. Wiss. Phot.*, 6, pp. 438-442, Dec. 1908.

For further work on solarization, see article by G. A. Perley, *Journ. Phys. Chem.*, 13, pp. 630-658, Nov. 1909.

¹ *Comptes Rendus*, 144, pp. 565-567, March 1907.

developer alone, but which becomes more reducible when acted upon by white light, but still less so than the surrounding silver bromide which has not been affected by the oxidation process.

Development of the Image.—In order to render the image visible upon the photographic plate it is subjected to the action of some kind of developing agent. It may be advisable to consider the ingredients of some well-known developer and point out the object of adding the various chemical compounds.

For this purpose let us select the *pyro-soda* developer. This contains, as its name indicates, pyrogallol—*i.e.* pyrogallic acid which is the principal reducing agent present. The object of using this is to reduce the silver salts, *i.e.* silver bromides, to metallic silver, which is the essential process in the formation of the visible image. Were this reducing agent used alone with the necessary alkali, its action would be so rapid that it would be impossible to control and no satisfactory result could be expected. On this account some controlling agent is necessary, and potassium bromide is usually chosen for this purpose. The presence of this substance, by tending to prevent the action of the reducer from being too rapid, greatly reduces the chance of producing a general fogging of the plates, and also hinders the production of flat negatives.

The following experiment,¹ due to A. and L. Lumière and A. Seyewetz, well illustrates the importance of potassium bromide in preventing fog :—

Exposed and unexposed plates are placed in the same developer composed of 1000 grams water, 5 grams diamidophenol, and 30 grams of anhydrous sodium sulphite, the temperature of the developer being 18° C.

In one or two minutes fog begins to appear upon the unexposed plate, while it does not commence in the case

¹ *Zeitschr. Wiss. Photo.*, 5, pp. 392-394, Nov. 1907.

of the exposed plate for ten minutes. When the same developer is used at 25° C, the exposed plate begins to fog after $2\frac{1}{2}$ minutes, and in ten minutes is just as fogged as the unexposed plate. It is also noticed that the shorter the exposure to light, the more intense is the fog. The explanation given is, that the exposed plate forms potassium bromide in the developer, and this acts as a restrainer retarding the fog. If this amount of restrainer be added to the developer, the unexposed plates are found to fog no more rapidly than exposed plates. Old plates seem to lag in this production of potassium bromide, for both exposed and unexposed soon fog when placed in the developer.

The necessary alkali, also called the accelerator, which is used so as to help on the action of the reducer, is, as a rule, sodium carbonate. Lastly, sometimes sodium sulphite, which is a more easily oxidizable substance than pyrogallol, is added, as this salt helps to keep the developer from deteriorating.

Such a developer as the above can be varied in composition to suit the special case in hand. Thus if plates are under-exposed, the amount of bromide used should be decreased, and in exceptional cases it may even be advisable to omit it altogether.

On the other hand, if over-exposure is feared, the developer could be changed by putting in less carbonate of soda and increasing the amount of bromide.

It was a very common practice some years since to use ammonia as the accelerator with pyrogallol, because of the excellent detail which it gives, this has now been very largely discontinued owing to the tendency of this solution to bring about a general fog, especially when used for under-exposed plates.

As it is an alkali which is required with pyrogallol, it might be supposed that caustic soda or caustic potash would do equally well, but it is found inadvisable to use

these with pyrogallol, although, if desired, they may be used with hydroquinone, which also requires an alkaline solution.

With reference to the carbonate of soda, which is the alkali often used, it should be remembered that, as given in ordinary formulæ, it is the crystalline form which is generally understood, although some formulæ give particulars for the dry powder as well. The anhydrous form is much more powerful in action, since the loss in weight which takes place when the crystals change to a powder is due to the loss of the water of crystallization.

It is always advisable to use the developer at normal strength for all properly exposed plates, unless it is desired to produce a soft negative. When this is the case the developer should be somewhat diluted. The diluted developer will, of course, be slower in its action than the normal.

Hydroquinone is another well-known developer, and is especially useful when greater density is required. Hence this developer is often used when making transparencies and lantern slides. It should be remembered when using hydroquinone that negatives developed in that substance lose more than usual in density when undergoing fixing.

This developer is somewhat slow in its action, especially at low temperatures, and it is often found better to use a combination consisting of hydroquinone and *metol*. The latter is an extremely active developer, and the compound developer is a very useful one where delicate soft negatives are required.

It is peculiar that *metol* brings out the details first and afterwards increases the density of the negative; such a developer is very handy where the object aimed at is to obtain excellent detail rather than strong contrasts.

These two developers belong to the non-staining class, and can therefore be used for the development of bromide papers, etc., as well as plates.

Metol is often used also in combination with pyrogallol, especially in the development of hand camera plates. This reducer is found to be a very rapid one and to give good results so far as detail is concerned.

A very favourite developer in use with bromide papers is the *ferrous oxalate*. This developer, which is produced by the reaction of ferrous sulphate and potassium oxalate, has no fogging effect upon plates or paper—*i.e.* it only reduces the silver bromide in those parts which have been exposed to light. On this account it is extremely good for very slow developing, as it does not tend to produce any marks on the prints or plates. The slowness of this developer is often looked upon as one of its chief drawbacks, the other being its want of keeping properties.

The papers or plates developed with ferrous oxalate must not be placed into plain water directly after removal from the developer, or brown stains will almost certainly appear, owing to the precipitation of oxide of iron on the papers or films.

In order to overcome this difficulty, a clearing bath is used. This generally consists of a very weak solution of acetic acid, although oxalic acid, which is much more effective but has the disadvantage of being poisonous, is also sometimes used for this purpose.

This developer should not be used in dishes which have been employed for any of the pyro developers, otherwise black stains will be sure to occur on the papers.

Among the other well-known developers are *ortol*, *rodinal*, *glycin*, *eikinogen*, and *rytol*. Each of these have their own special qualities which recommend them to the user, but it would be out of place to enter into details here.

There is perhaps no branch of practical photography in which such great improvements and changes have taken place during the last twenty years as in the development of the negative. During the infancy of photography the worker had to prepare the developer for himself,

and each person had some particular wrinkle of his own in this direction. Necessarily, therefore, very indefinite ideas were sometimes obtained from accounts given of this or that developer, as certain alterations were prescribed for correcting faults in the exposure, etc., for it was believed that by careful developing, incorrect exposure could be very largely rectified.

Constant Density Ratio.—It was Hurter and Driffield who were responsible for the earlier work upon the laws which govern the densities of the photographic plates, or, in other words, the quantity of silver which can be deposited under certain conditions by the action of the developer. Their researches formed the turning-point in the method of dealing with this question.

They came to the conclusion, *that the relationship existing between the densities and the light intensities is determined by the exposure, and that it cannot be altered by modifying the constitution of the developer or by the time occupied by developing the plate.* This is often spoken of as the law of "Constant density ratios," and it can be imagined that such a law was not at first considered as of very great importance by the practical photographers of the time. Their opposition was very largely based upon wrong ideas, for ammonia and a soluble bromide being then commonly used in developers (their proportions being arranged to suit the plate), the density ratios obtained were quite irregular and could not be controlled.

To understand the meaning of "Constant density ratio," let us imagine that a strip of plate has been exposed for a certain definite time—say one second—to a given source of light, that a second strip has been exposed for two seconds to the same source of light, and that both are developed for five minutes. On measuring the densities of the strips at the end of this time suppose that the second is 1.6 times as dense as the first.

Now expose similarly two other strips and carry on

the development for ten minutes. The actual density of the strips will be found to have somewhat increased, but it will be an increase in the same proportion—*i.e.* the second will still be 1.6 times as dense as the first.

On the other hand, the opacity of the strips will be greatly changed by the extra development, and the increase in this will not be proportionate; the opacity of the strip which had the longer exposure will increase much more rapidly than that of the other strip.

It must not be understood from the foregoing that no control is possible with the developer, as that is absolutely incorrect. Control can be effected when developing, but it should be done by altering the length of time the developer acts, and not by altering the ingredients—that is to say, no alteration in the composition of the developer can alter the gradations in the negative; these are due to the exposure to light.

All the various types of plates that are required for different purposes—such as a fairly dense negative for platinotype work, a much denser one for P.O.P., a thinner one for carbon, and a thin and somewhat flat negative for enlarging—may be readily produced by an alteration in the time the developer is allowed to act, if the correct exposure has been made.

Mees and Sheppard have carried out further researches in this direction, and have come to the conclusion that there are two distinct classes of photographic plate so far as speed of development is concerned. One of these gives the same speed no matter what developer is used, while the other class is much faster with such developers as pyro-soda, hydroquinone, etc.

Factorial Development.—The next great step made in scientific development was due to Watkins, who introduced the system of “Factorial development.”

This may be looked upon as an outcome of the work of Hurter and Driffield, for it is based upon the fact that the

time which elapses between pouring the developer upon the plate, and the first appearance of the image, bears a certain definite relation to the total time required for the particular developer in use. This automatically rectifies, to a certain extent, the influence of the temperature of the developer upon the speed of development.

There are, however, drawbacks to this method. In the first place a light is required in order to be able to note the first appearance of the image, and this is not possible with some of the orthochromatic plates; then, again, the personal equation comes in, for some persons are able to distinguish an image relatively much earlier than others, and so, of course, the calculated time of full exposure will in some cases be incorrect. In some cases, too, this system has been found to fail for temperatures between 45° F. and 60° F.

The following examples of factors taken from Watkins' table will help to make the method understood:—

Hydroquinone	5	Metol-hydroquinone	14
Ortol	10	Eikinogen	9
Rodinal	30	Pyro-soda	4-15
Metol	30	Glycin soda	8

Suppose that the image can be first seen in 20 seconds when using metol, then, since the factor for metol is 30, the total time of development to obtain a negative of average vigour will be 20×30 sec.=10 min. The higher the temperature the more rapidly will the development take place, and each particular developer has its own "temperature coefficient"—*i.e.* the factor by which the time of development must be increased or decreased, by a decrease or increase of 18° F. or 10° C. in the temperature from the normal 60° F.

The Time Thermometer.—Watkins has quite recently brought out a simple instrument for overcoming this temperature difficulty.

His invention is based upon a discovery he made that the table of times and temperatures calculated by the formulæ due to Ferguson, Houdaille, and others, could be accurately represented by a logarithmic scale of figures representing time placed in contact with an even division scale of temperatures.

The instrument is known as the *Time Thermometer*, and it is used for indicating directly the time required to complete development for any one group of developers. It is like an ordinary chemical thermometer in appearance, but no temperatures are marked upon the scale; the height the mercury rises in the tube indicates direct the time for development. Of course the expansion of the logarithmic time scale has been carefully adjusted by the makers to fit the particular thermometer to the temperature coefficient of the developer used. The pattern on the market has a fixed scale, and is devised for that group of developers having a temperature coefficient 1.9 about, and it can also be used for the Kodak tank developer.

One side is marked for dish development with ordinary dilution, the time being $6\frac{1}{2}$ minutes at 60° F. The other side of the mercury tube is marked for tank development with diluted developer, and is set for 24 minutes at 60° F.

Watkins' idea is that the thermo-developers should be issued so as to require $6\frac{1}{2}$ minutes at 60° F., different dilutions of the developer to be then indicated by certain code letters given to the plates. Thus he classes the plates by the code letters :

VQ.	Q.	MQ.	M.	MS.	S.	VS.
1	$1\frac{1}{3}$	$1\frac{3}{4}$	$2\frac{1}{4}$	3	4	5

and the figures under are the drams of Watkins' time developer required in 3 ozs. of water for dish, or 10 ozs. for tank development.

The complete Thermo-time system of Watkins can therefore be stated as follows: "Allow for the variation of the plate by altering the dilution of the developer, and for the temperature by altering the time of development."

The tank development above referred to, is based directly upon the fact that the only control we have over the quality of the negative produced, is the length of time the developer is allowed to act upon the exposed plate, and it is found by experience that if in twenty-four minutes a certain developer at a certain temperature will produce a perfect negative in a plate or film for which correct exposure has been allowed, then it will also produce the most satisfactory results if allowed to act upon under-exposed or over-exposed plates or films for the same length of time.

For developing roll films the Kodak Developing Tank is perhaps one of the best known. By its means one can avoid finger marks, scratches, stains and patches upon the negatives obtained, and, of course, uneven development is impossible.

Again, when using this apparatus no dark room is necessary, as the operations can be carried out in daylight or gaslight as desired.

All that has to be done when using this tank is to enclose the exposed film, with the aid of a covered box supplied with the outfit, in a light-tight celluloid band, and immerse it in the tank of developer, where it should be left for the necessary time, then removed, fixed, washed and dried in the usual manner.

A similar tank developing apparatus can also be obtained for use with plates, but, of course, a dark room of some kind is necessary for removing the plates from their holders and placing them in the tank.

Daylight development without the aid of any particular form of tank has been practised for some time to a limited extent. The method adopted is either to stain the sensitive films to a non-actinic colour, or else to stain

the developer so that the light will not affect the plate when once it is safely in the solution.

Whichever of these methods is adopted, some device such as a suitable changing bag, or a dark room, is required when the plate is introduced into the developer.

The introduction of *tabloid developers* and other photographic chemicals has been a great boon to those who prefer to develop their own plates or films, and are in the habit of carrying camera appliances with them on their holiday or other excursions. The outfits of this kind now supplied by several makers are so complete that the entire requirements of the photographer, so far as chemicals are concerned, can be comfortably carried in the coat pocket.

The new Rytol tabloids of Burroughs Wellcome & Co. are a good illustration of these developers. The tabloids are easily soluble in cold water, and one tabloid of Rytol makes four ounces of developer.

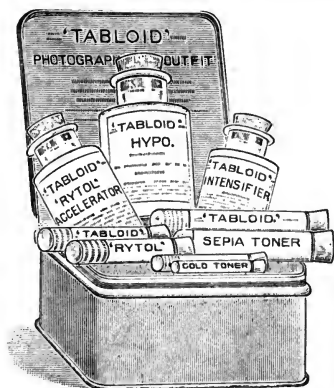

Fig. 83.

Not only are there tabloids for developing, but there are others for fixing, intensifying and reducing plates or films, and toning tabloids for P.O.P. and bromide papers. A good idea of the compact nature of the tabloid outfit can be obtained from fig. 83.

Intensification.—Sometimes it is found desirable to intensify a negative which is too thin for the purpose for which it is intended. During the process of intensification the opacity of the negative is increased either by the increase in the amount of silver deposited, or by the addition of some other more or less opaque substance to the exposed

parts of the sensitive film. It should be remembered that intensification is of practically no use unless sufficient details are visible on the negative. Again, the plate should be properly fixed and thoroughly washed so as to remove all traces of hypo before any attempt at intensification is made, otherwise stains are almost certain to result.

The *mercurial intensifier* is one of those most commonly used. Mercuric chloride is used to bleach the negative; by its action a white compound of the chlorides of silver and mercury is formed, and then this is subsequently blackened by the action of some other reagent.

Dilute ammonia has frequently been used for this purpose, and although the results obtained by its action are of a somewhat uncertain nature, a dark brown colour is produced which renders the negative very suitable for obtaining good prints.

Some form of ordinary developer may be used to bring up the image after bleaching has proceeded to the desired extent, for if the negative only requires a slight degree of intensification it should be immersed for a short time only in the mercurial solution, while on the other hand, if much intensification is desired, bleaching should be proceeded with until the whole film appears white when looked at from the back.

The great disadvantage of this intensifier is that it is a most violent poison, and hence should only be used with extreme precautions.

Another favourite method of intensification is that carried out by means of the *uranium intensifier*. By this method a solution containing potassium ferricyanide and some salt of uranium, usually the nitrate, is applied to the negative. The result of this is that a deep orange red deposit is formed upon the ordinary silver image, and so the opacity of the negative is greatly increased. Here, again, the slightest trace of hypo will be found to cause stains or a kind of red fog. When using this method great care must be taken

to withdraw the negative from the solution when the intensification has proceeded far enough, otherwise the deposit will most probably form on parts of the film where its presence is not desired—in fact, this action may take place at the beginning unless the plate has been most carefully washed, and this represents the great difficulty to be met with in this process.

Should the intensification be carried slightly too far a thorough washing in hard water will be found to reduce it somewhat, and to remove any slight traces of stain. There are several other methods of intensification in general use, but the one which, on account of its simplicity, will appeal most strongly to the beginner is that in which the *Chromium Tabloid Intensifier* is used.

By the action of this intensifier, chromium is added to the original silver image, and the process can be repeated until the desired degree of opacity has been obtained.

All that is necessary is to immerse the plate in a solution obtained by dissolving one of the tabloids in two ounces of water, and to leave it in this solution until it has assumed a general buff tint. Next, the plate must be thoroughly washed (if running water is used fifteen minutes will usually be found sufficient), and then redeveloped with any ordinary developer.

All these processes may be carried out in daylight, and the result will be found quite satisfactory as compared with those obtained with other more difficult and expensive means.

Reduction of Negatives.—Should a negative be found to be over-dense it can to a certain extent be reduced, but there is always more risk attached to this process than to the preceding, for a negative which has been over-reduced must be considered as spoilt, since if it be intensified again it will be found that a negative having quite false gradations has been produced.

However, judiciously used, reducing processes may be of

service, and there are several well-known methods open to the experimenter.

First, there are mechanical or physical methods in which methylated spirit or some prepared solution is rubbed over the parts it is required to reduce, until the desired effect has been obtained. A very soft piece of wash-leather is most suitable for this purpose, and the result achieved is entirely due to friction. Then there are various chemical reagents which by their action upon the fixed plate can reduce the opacity which has been produced by the deposit of silver in the film. Some of these will be found useful for one kind of plate, others for plates of a different type. Thus, the *Ferricyanide* reducer, which is composed of a dilute solution in water of potassium ferricyanide, will be found very useful when it is required to reduce the shadows in greater proportion than the lights, while *ammonium persulphate* reducer acts more on the lights than the shadows, and *ferric chloride* will be found to act fairly uniformly.

No matter what care is taken with these supplementary processes, an error in the exposure, or even in the development, can never be absolutely rectified, although, of course, a very great amount of improvement in the printing properties of the negative may be obtained.

Fixing of Negative.—Before either of the above processes are tried upon a negative, it must be properly fixed.

When the developing process is complete, there exists side by side with the dark metallic silver deposit a quantity of unchanged silver bromide. This silver bromide would not only interfere with the value of the plate for printing purposes, but would also darken gradually when exposed to light. It must therefore be removed from the film, and for this purpose a solution must be employed which has the power of dissolving it, while leaving the silver untouched. The substance which is used for this purpose is commonly known as *Hypo* or hyposulphite of sodium,

although it should be properly described as sodium thiosulphate. The plate is immersed in a solution of this salt until all traces of the unchanged silver bromide have disappeared, and then it should be thoroughly washed, in running water if possible, so as to remove all traces of the "Hypo."

It is a very common practice with those who have a room set apart as a dark room, to keep a dish of hypo made up, and to use this over and over again even after it is somewhat discoloured.

A. and L. Lumière and Seyewitz ¹ have shown that if it is desired to avoid staining negatives on gelatine bromide plates, not more than 100 plates (9 × 12 cm.) should be fixed in one litre of a 15 per cent. solution of sodium hyposulphite. [The plate can be easily compared with English makes by remembering that 1 inch = 2·54 cm.]

If the bath contains 1·5 per cent. of sodium bisulphite, then not more than 50 such plates should be fixed.

As a practical test for the exhaustion of the bath, a drop of it may be placed on a piece of paper, which should then be exposed to light and warm air, noting whether the spot turns brown or not.

Printing of Positive.—When a satisfactory negative has been produced the next object of the photographer is to obtain positive prints from the negative, and it is often desirable to have means at hand for doing this under very diverse conditions of lighting, etc.

Thanks to the enterprising character of those engaged in the manufacture of photographic appliances, there are at the present time papers on sale which will answer the purpose for all ordinary conditions, and there is no longer any need for the individual experimenter to indulge in the needless expense incurred by sensitizing papers at home. On the other hand, there are many processes which offer themselves to the more enterprising as a means of carrying

¹ *Photo. Journ.*, Feb. 1907.

on experimental work, and of producing results which have a more pleasing effect, and certainly appeal more to the artistic eye than the more rigidly correct prints obtained with ordinary P.O.P. or bromides.

Some of these, such as *the Carbon process* and the *Gum Bichromate Printing*,¹ depend upon the action of light on bichromates in contact with a colloid substance and a pigment on paper (see p. 81).

The *Ozobrome*² process is another which differs from the ordinary carbon process in that the worker is independent of daylight for printing—in fact, this is often spoken of as the evening carbon process, since no direct action of light is required.

By this method a number of copies in carbon can be obtained from one bromide print without using a negative, and in the end the original bromide print, if it has been carefully handled, may still remain unimpaired.

For the ordinary worker there are papers which can be used for obtaining prints by daylight (P.O.P.), and others which it is best to employ when a reliably constant source of artificial light can be obtained.

Toning and Fixing.—P.O.P. is the contraction commonly used for Gelatino-Chloride printing-out paper. This is paper coated with an emulsion in gelatine of silver chloride and other silver salts. These papers, when exposed under a negative, become darkened by the action of the light which passes through, and thus a positive image of the object is obtained. These images, of course, if exposed to light after removal from beneath the negative, would soon be lost sight of, since the whole sensitized surface would gradually become darkened. Hence some means must be taken to fix the print, and for this purpose hypo is again used,

¹ See J. C. S. Mummery, *Photo. Journ.*, 1904, and C. Wille, *Photo. Journ.*, 1908 (May).

² T. Manly, *Photo. Journ.*, 1908 (June). Booklet by Ozobrome Ltd., Kentish Town, N.W.

but before this is done it is usual to alter the appearance of the image by "toning" it in a bath containing gold chloride. When immersed in a suitable bath made up of *chloride of gold*, distilled water and *ammonium sulphocyanide*, a quantity of the gold is deposited on the image and the tone or appearance changes.

Many persons now adopt a *combined toning and fixing bath*, and if proper precautions are taken, very satisfactory results may be obtained by this method. It will be found advisable to immerse the prints in a fixing bath after removal from the combined bath if permanence is desired. After fixing, the prints must be thoroughly washed in running water so as to remove every trace of hypo.

It might be mentioned that the Gold Toning is also arranged for by the tabloid makers, and that such methods are to be recommended to a beginner, as the difficulty of obtaining pure chemicals in absolutely correct quantities has thus been overcome.

Phosphate Paper.—A relatively new form of sensitized paper known as *Phosphate Paper* can be used either in weak daylight [5 seconds at about 6 feet from a window] or artificial light, and when developed, fixed and washed [but without the action of gold], the results obtained are similar to those with P.O.P.

Metol is recommended as the developer for these papers, and an acid fixing bath composed of hypo, 3 oz.; metabisulphite of potash, $\frac{1}{4}$ oz.; and water to make up 20 ounces is employed for one minute only.

Bromide and Gaslight Papers.—This Phosphate paper is not so well known as the *bromide* and *gaslight* papers, which have been for some time in common use for obtaining positive prints by artificial light. The gaslight are much less sensitive than the bromide papers, and no dark room is required for their development. As their name indicates, bromide papers are made sensitive to the action of light by the presence of a gelatino bromide emulsion similar to

that employed in the manufacture of plates, but far less rapid. The paper, however, must be carefully preserved from the action of white light, otherwise on developing, a dirty greyish appearance will result, and no good whites will appear in the print. Such a result will also occur if the paper has been greatly over-exposed under the negative, or it may take place, as also happens in the case of the plate, by employing a too strong developer.

Many varieties of bromide and gaslight papers can now be purchased ; and since full instructions are issued by the makers as to the exposure, development and subsequent manipulations so as to avoid fogs, stains and other imperfections, no more will be here said, than to mention the fact, that in order to obtain good results from this class of prepared paper great care must be taken and every precaution adopted to ensure absolute cleanliness in the baths used.

The negatives which give best results with bromide papers are comparatively thin plates, full of detail, and it is necessary that the plates should be developed and fixed in such a manner as to avoid stains.

It is possible to tone bromide prints so as to obtain good red, green, and blue colours, as well as such intermediate tints as brown and sepia.

Platinotype.—Lastly, a brief mention must be made of *Platinotype* paper, which is used for obtaining prints, perhaps the most permanent form of all, since in them the image consists of metallic platinum, and platinum does not oxidize, and is practically unaffected by sulphur and chlorine. This paper was invented by Willis in 1873, improved in 1878, and again in 1880. At one time the platinum was added to the paper in the process of development, but it is now upon the prepared paper itself. The paper must be kept absolutely dry.

There are several modifications of this paper, but as a rule it is sensitized with a mixture of ferric oxalate and a

platinum salt. When the paper is exposed to light, which should be done under a negative in the shade, the ferric salt is changed to a ferrous salt and a slight change in colour results. When it is subsequently acted upon by a solution of potassium oxalate, the ferrous oxalate is dissolved, and at the same time the platinum salt is reduced and metallic platinum deposited where the ferrous oxalate was previously situated. There is absolutely no control with the platinum paper, and therefore it is well to lower the paper face downwards into the developer, as this gives the iron salts a better chance to escape.

After development in this way the print must at once be placed in a clearing bath of dilute pure hydrochloric acid (1 in 60), and it should be passed in succession through at least three different baths of this clearing solution; the last bath should be quite free from any yellow tinge due to the presence of any platinum or iron salts which have been removed.

The prints must then be carefully washed, and may be dried between blotting paper if desired.

Fine black tones are obtained by means of this paper, and sepia tones can also be produced by several methods—*e.g.* the introduction of chloride of mercury into the oxalate developer. By such means a fine range of colours is obtainable from a dark rich sepia to a golden brown, but at the same time it should be noted that the permanence of such prints is not so great as those of the black tone. In gold toning, a combination takes place between the gold and the metal present forming the image, but the platinum actually replaces the other metal, so that the image is rendered absolutely permanent.

Cyanotype.—There are some less commonly used processes for obtaining prints which depend upon the action of light upon iron salts. As a rule they depend upon the conversion of a ferric salt into a ferrous salt by the action of light in the presence of organic matter such as paper.

The best known of these is the *Blue* or *Cyanotype* process. The paper, which must be kept in the dark and in a dry place, is sensitized by a mixture of potassium ferricyanide and a ferric salt. Such paper should be exposed under a negative in direct sunlight if possible until the parts which have received the most light—*i.e.* those under the more transparent parts of the negative—have passed through a deep blue to a somewhat red colour. To complete the print it is washed in changes of warm water until the ground is quite white; the image in a deep blue colour will then remain on the paper.

Such paper is, of course, much more useful for copying photographs of plans, etc., than for ordinary pictorial photography.

ART IN PHOTOGRAPHY

Pictures to illustrate Solids.—In considering briefly this important section of our work, let us first of all examine a few of the details which govern the general appearance of a picture.

Let the simplest case be taken ; for example, a cube or a cylinder. Let representations of these be drawn, and figures will be obtained nearly identical with those marked *X* and *S* in the diagram. Now, these figures are flat like the paper, while the originals are solids. It may be said that picture and solid agree ; but it is not so. Let a blind man be questioned, who knows the bodies by touch only, and the difference will be apparent. Now, the cube can be moulded in marble or plaster, and then the

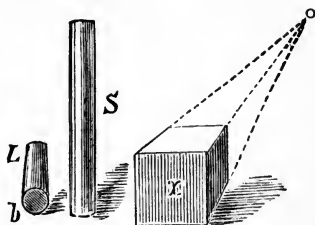

Fig. 84.

deception—for such it is—can be carried to greater lengths. The wood of the cube or of the cylinder can be imitated by painting. The eye will readily pronounce such imitation to be wood. The blind man, who feels both, will say : The form agrees, but not the mass—one cube, that of wood, feels warm ; the other, that of stone, cold.

The principles that apply to these two objects apply to all objects and their representations. No one of them is a perfectly true copy of the object. When the surface representation makes on our eye the impression of a solid object, this is an illusion by which our eye suffers itself to be deceived.

If two rectangles *A* and *B* are drawn on paper, both appear as plane figures. But directly one of them, *B*, is shaded with thinner or thicker lines, the rectangle no longer appears flat, but cylindrical. Thus, by imitating the gradation of light and shade, we have produced a deception for our eye. This division of light and shade is one of the most important means of producing an appearance of solidity.

Perspective.—But there is another and a more important means of deception—perspective.

If we observe the cube (fig. 84), the faces of which are equal, we perceive that these faces appear of very different length. The surface turned towards our eye

appears a square, while the others are shortened in a marked degree, the surface appearing quite irregular, the parallel lines running together and converging to one point *o*, called the vanishing point.

The same thing happens with all other bodies : a human arm hanging

down or a standing column *S* (fig. 84) appears at their full length, but the lying column *L*, and the arm extended towards us, appear foreshortened. Their dimensions are contracted ; in short, we see, instead of the shaft of a column, only its circular base *b*, and this, again, appears sometimes round, when its full surface is turned towards us, at others an ellipse, which it is not in fact, and in this case the parallel sides of the column converge. The track of a railroad viewed in perspective presents the same features. The fact that we do not feel this deception—for such it is—to be one, results from habit.

We know from experience that the arm extended towards us is longer than it appears, in perspective, to our eye, and also that the rails which appear to run together are parallel. We are continually correcting the

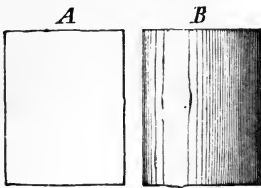

Fig. 85.

errors of our sense of sight. The eye gives us a false representation of objects, and the painter takes advantage of this circumstance. He represents the lying column Lb , and the sides of the cube, as falsely as we see them—that is, “foreshortened” in their dimensions, with their parallel lines converging—and everyone is deceived by this.

It is the task of the artist as of the photographer to represent perspective correctly—that is, as it appears to our eye. If this is not the case, the picture appears incorrect.

Perspective teaches us the laws of foreshortening.

Our eye is a camera obscura with a simple landscape lens. It is known from optics that the image of any point lies on the straight line drawn from the point to the optical centre of the objective, at the place where this

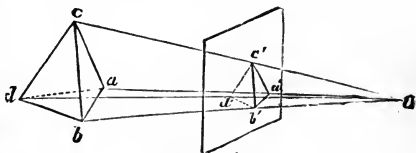

Fig. 86.

line, named the principal radius, cuts the plane of the image—the ground-glass screen of the camera or the retina of our eye. The image of a straight line is the place where the rays from each point of the line, passing through the optical centre, cut the ground-glass screen. Now, these rays form a plane, and this plane cuts the flat screen in a straight line. Therefore the image of a straight line is to our eyes another straight line, and the image of a plane triangle another plane triangle. If the flat figure is parallel to the retina, by well-known stereometric laws the image is like the original. Let the reader imagine a glass slab placed perpendicular to the axis of his eye; then the rays or pencils of light issuing from this object $a b c d$ will cut it so as to form a figure $a' b' c' d'$ (fig. 86). If such a figure is drawn for a given point of intersection, this drawing, if brought to a proper position

and distance from the eye, will produce on it exactly the same impression as the object itself. This is the secret of the solid appearance of plane pictures properly constructed. A picture made in the manner just described is named a drawing in perspective. It is evident that such a drawing must be viewed under the same conditions as those in which it was designed.

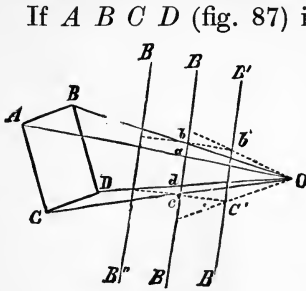

Fig. 87.

If $A B C D$ (fig. 87) is the outline of a house, B the picture plane, O the point of intersection of the rays, and $a b c d$ the image of the points $A B C D$, the eye must be brought exactly to the point of intersection O if the representation in perspective $a b c d$ is to produce the same impression as the object.

If the picture is brought nearer to the eye (for example, to B'), it is evident that the rays will intersect at a very different angle from those issuing from the object $A B C D$; accordingly, they cannot produce a correct impression. The same thing would be the case if the picture were removed further from the eye (e.g. to B''). Therefore every drawing in perspective must be viewed from the point of intersection of the rays adopted as the basis of its construction if it is to produce a correct impression.

Now, photography is a drawing in perspective whose point of sight is in the objective. Accordingly the inspecting eye must be brought to the same distance as the objective—that is, to the focal distance. If this is not done, the impression is untrue.

We have lenses with a focal distance of only four inches, and even less; and at such a distance it is impossible to see a drawing with the unaided eye. To do this it must be held at the distance of at least eight inches, and that is the reason why photography in such

cases produces an untrue impression. This is often the case with views taken with lenses of great aperture.

Effect of Distance.—There are other abnormal appearances which accompany portrait taking. Thus, the same object gives an entirely different picture according as it is viewed from a greater or less distance. Let the reader conceive a pillar with the outline $A B C D$, let it be viewed from P ; in this case the faces $A B$ and $C D$ will

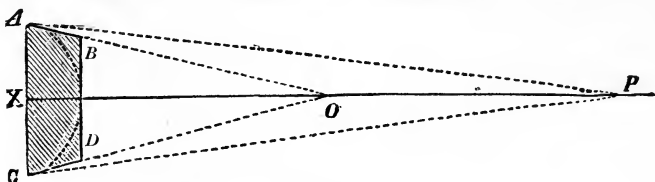

Fig. 88.

be perfectly seen. Now let the spectator approach nearer to the object—for example, to O . From this position nothing is any longer seen of the faces; the entire character of the picture becomes changed. If, instead of a pillar, a human face be thought of, it is evident that the cheeks will contract if we approach the object, and the face appear too narrow in proportion to its height.

The accuracy of this conclusion is proved by the following illustrations. The two representations (fig. 89) of the head of Apollo were taken at the distance of 47 and 112 inches. The bust was placed perfectly upright, also the photographic apparatus, and the directing line was most carefully arranged.

The contrast is obvious. The whole figure appears in I. slimmer, the chest almost contracted; on the other hand, the same model II. appears with full cheeks and square shoulders. That this slimness is by no means a mere deception of the eye may be ascertained by measurement.¹

¹ In the original photograph, where the two busts stand out from a black background, this difference is still more marked.

The distances between the eye and the point on the chest marked by a cross are exactly equal in both busts—the greatest breadth of chest, including the arms, amounts in I. to 56 millimetres, and in II. to 59 millimetres. Quite independently of this glaring difference,

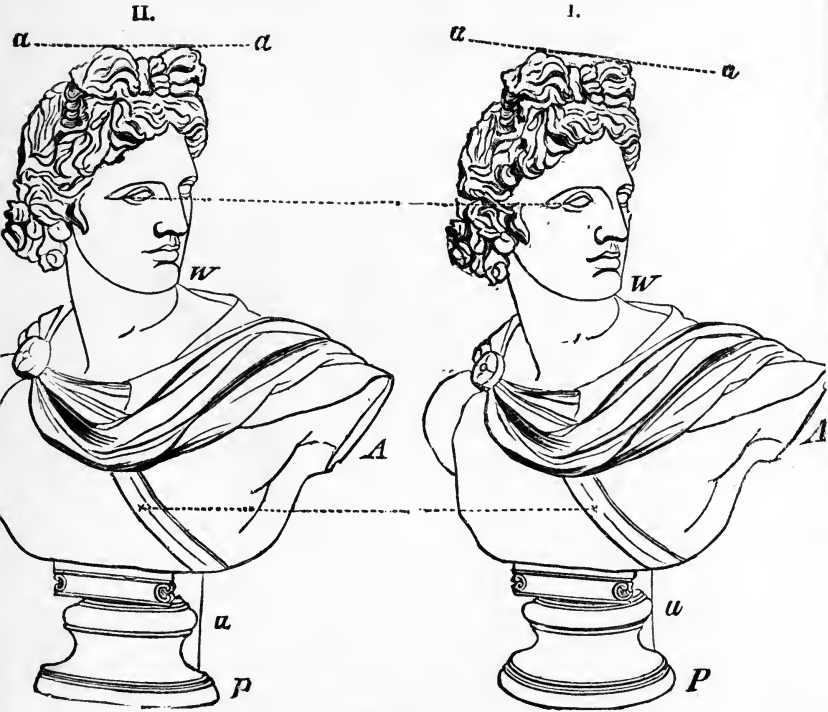

Fig. 89.

there are other marked distinctions between the two heads which strike a careful observer. Let a line *a a* be drawn across the top of the hair—in II. it is horizontal, in I. it inclines to the right.

Next let attention be directed to the pedestal. The curves in I. are strongly inclined and in II. are quite horizontal.

Let the ends of the arms $A A$ be next considered. In I. the side surface is scarcely seen and in II. it is very apparent. In like manner it is clearly seen that the back pedestal at u stands out more in II. than in I. In II. the head stands more between the shoulders (let the angle of the neck be observed at W); in I. it rises up more; therefore the whole form appears in I. to raise up the head. In II. the head appears somewhat bent forward; and yet the figure was immovable, the lenses employed free from flaw, the direction and height were the same in both. Nothing was different but the distance.

If four heads taken at different distances are placed beside each other, it is seen how with the increase of distance the form becomes fuller and more thickset; how the hair sinks more and more; how the ellipses of the pedestal become flatter; how the chest increases in width, and the stumps of the arms stand out.

Thus, therefore, we see very different views of the same object at different distances; just as the same portrait placed in different lights expresses an entirely different character.

It may be objected that these are small matters, and that it is indifferent whether the statue looks a little too thin or too stout. To many this may appear unimportant in the case of Apollo—most persons do not know in the least how he looks. But it is a different matter in the photography of portraits, when the personality of the customer himself is in question. Persons quite untutored in art have a very quick eye for their own physiognomy—a line, a wrinkle, an outline, a curl, are in this case criticised, and differences that would not be at all remarked in the picture of Apollo become very striking. It is therefore the duty of the photographer to attend to the effects of distance.

Now, many persons would perhaps wish to know which distance is the best; which gives the most correct picture.

We might reply that this depends on the individuality of the person. Painters in general recommend for the drawing of an object a distance that is twice its own length; accordingly, for a man six feet in height, a distance of about twelve feet; for his bust, about five feet. The painter, however, has here greater freedom; he can add, omit, and alter at his pleasure. In photography this is only partially possible.

Very fine results in portraiture can, however, now be produced with the telephoto lens. The Adon is a lens which can be used for this purpose, and this lens can be attached directly to the camera.

Besides the advantage as to proportion which one

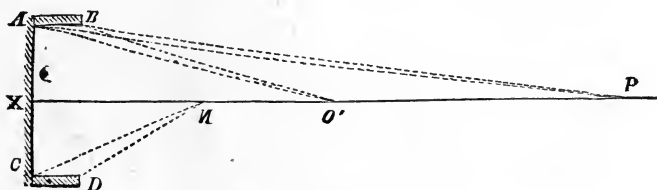

Fig. 90.

obtains, especially when the space is limited, a diffused effect can be obtained by using a large stop, so that the large aperture may admit the necessary rays and bring about diffusion of focus.

The appearance of hollow bodies is as much altered by distance as that of solids.

If $A B C D$ (fig. 90) is the inside of a box, we should see the side $A B$ much more foreshortened from the distance P than from O' or N ; therefore, its picture taken at short distances will show it wider in proportion to its height than if taken from a more distant point. The same thing occurs if we imagine $A C$ to be the trunk, and $C D$ the lap or the feet of a seated person. In that case the lap appears much larger in relation to the trunk, and the feet of a standing person appear longer from the shorter

distance. Let the reader observe, for instance, the foot of the Apollo in I. (fig. 89), which is much more prominent than in II. Lastly, let CD (fig. 90) be supposed to be the carpet or ground; this will appear wider—that is, rising higher—seen from N . Therefore, if the same person is taken from different positions, P and O' , so that the height of the body remains the same in both pictures, in that one taken at the shorter distance the prominent parts—lap, hands, and feet—appear wider, and the ground or chair more inclined than in the picture taken from P .

Effect of Height of Eye.
—Very important changes result from an alteration in the height of the spectator's eye.

If a standing person is looked up to, so that the head of the spectator is lower than the head of the object, the latter appears thrown back. If the head of the spectator is on a level with the head of the object, the latter appears perpendicular; if the spectator is higher, the head of the object appears inclined forward.

The three accompanying diagrams, taken from photographs, will make this evident. The first shows the view taken on the same level, the second taken from above, the third from below.

Similar differences occur in viewing a landscape from



Fig. 91.

a high and from a low position, as may be seen from the three illustrations on next page. The dotted horizontal line shows the height of the eyes of the spectator (his horizon). The first picture gives a view as a person sitting on the ground would see it; the milestone on the left appears unusually high, towering to the sky, and the men appear taller, but the ground looks contracted (foreshortened). The second

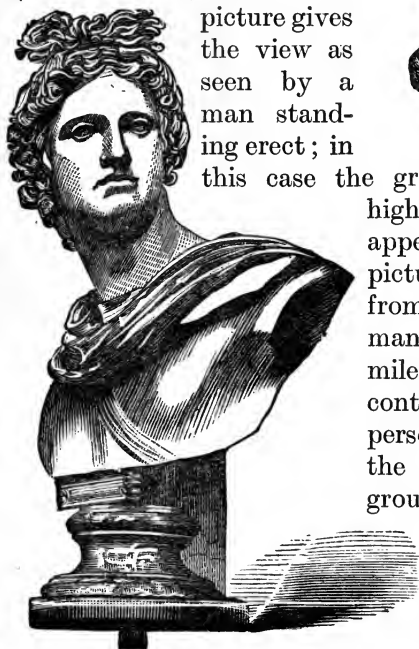

Fig. 93.



Fig. 92.

picture gives the view as seen by a man standing erect; in this case the ground widens out, rising higher, and the milestone appears lower. In the third picture, which gives the view from twice the height of the man, the figures and the milestone appear small and contracted. They appear persons who are smaller than the spectator, while the ground widens out and rises considerably in the picture. These examples show how important is the choice of position both in photo-



Fig. 94.



Fig. 95.



Fig. 96.

graphy and painting, and how an incorrect choice produces quite an abnormal picture.

General Hints.—The art in photography is more often than not left to take care of itself. Of course one could scarcely expect such a pleasant pastime as photography to be the monopoly of the limited number of persons who are gifted with the artist's eye, but there are many ways in which a worker with an average amount of taste and common sense can often greatly improve upon the views obtained by one who is absolutely careless as to pictorial effect, and only aims at correct exposure and what is commonly known as a good print.

The unfortunate part about the matter is, that relatively speaking so few artists have taken an active interest in this subject.

With the average amateur photographer such details as the amount of foreground or sky which will best suit a certain landscape are too often left to be arranged when the print is taken, and this not by any means because it is always impossible to make the necessary adjustments of the camera before exposing the plate.

Then, again, a stream or road has very different appearances when viewed from different standpoints, and when they occur in the foreground of a view, they may often by a good selection of position for the camera be utilized as a means of introduction to the principal subject of the photograph, rather than appearing, as is too often the case, a great counter-attraction for the attention of the observer.

If possible the camera should be so arranged that the road or stream appears to run in a sinuous or zigzag line from the front edge in a more or less diagonal manner, thus leading the eye gradually into the picture up to the object round which the chief interest centres.

There is no need for the sinuous line to appear absolutely unbroken—in fact, a better effect is often attained when it

breaks, and the river or other object is lost sight of, if the reappearance takes place in such a position as to carry the eye forward.

This method of introducing the eye to the picture is considered the best when the subject is one in which the perspective is very deep.

In all pictures there should be some means of introduction, just as there should also be some object to which the attention is naturally drawn, and the line of introduction should lead the eye from object to object of increasing interest until the climax is reached; then it should not happen that the attention has to be suddenly withdrawn, or that one has, as it were, to retrace the path along the line of entry, but some means of exit should be present, in the shape of some more or less vacant patch in the background, by which the eye may remove its attention from the picture.

In landscape views in which there are openings through trees, or skies with plenty of well-defined cloud and clear spaces, try to arrange that only one of these clearer spaces shall be at all prominently brought to the notice of the observer—in other words, if possible allow only one means of exit from the picture.

The exit should also be so carefully placed that the eye must first traverse the whole of the detail before reaching it.

Another point of the utmost importance is the relative position in the picture of the most prominent object. One thing should be kept in mind—that is, it certainly should not, as a rule, occupy the central position in the view.

As a general rule there will be several objects in the view, and the relative positions of these in the picture plane will greatly influence the value of the picture from an artist's standpoint. There should be what is usually spoken of as a good balance of the parts.

This does not mean that the picture plane should be

divided into equal sections and the objects arranged according to such a plan, far from it; such a scheme is always to be avoided. In doing so a practical plan of construction often adopted is to consider which points in the picture may be regarded as weak, which as strong. It is agreed that the centre is the weakest point of all, so this position should be avoided except in productions of a formal character. On the other hand, points which lie so that their relative distances from the sides are in the ratios 1 : 2 or 2 : 3 may be regarded as strong points, and in such a position should the most important object of the picture be placed. A picture should balance about a horizontal line through its centre, and also about a vertical line through the same point.

The vertical balance—*i.e.* balance about the vertical line—is the more important, and we may look upon this as similar to an ordinary pair of scales, in which similar masses placed at the same distance from the pivot have the same balancing power.

Carrying the analogy yet further, of course, it can be understood that a prominent object near the central line can be balanced by a much less prominent object at a greater distance from that line.

The further an object is from the centre, and the more isolated it is, the greater power of attraction will it necessarily have, and this should be borne in mind.

Care must be taken not to make the system of balancing about the centre too apparent, as this will most certainly detract from the value of the picture. In good pictures where a balance about the centre has been adopted, the artist often displays a great amount of ingenuity in attempting to hide the scheme.

There are many who will argue that in the ordinary photographic work one cannot be bothered as to the pictorial result, but even in portraiture a little attention to these matters will prove that the time has been well spent.

When a photograph is being taken in which there appear a large number of lines running in any particular direction, it is well to arrange so that objects the lengths of which lie in a direction at right angles to the others may break the monotony of such a view.

A good plan, and one frequently adopted, is to place the camera so that the objects of interest lie along one of the diagonal lines of the picture, balancing in the remaining spaces suitable objects of minor importance.

Such a plan as this can be readily followed when the portrait of one person only is required.

Another method is to group the objects so that a series of pyramids is formed. Such a grouping gives an impression of physical stability to the picture, and might with advantage be adopted in the photography of groups at a picnic or some similar occasion.

Lastly, in suitably chosen subjects, details arranged so as to lead the eye in a circular manner through the picture have a very good effect and give an impression of continuity.

For those who undertake the photography of objects for scientific purposes, or merely to obtain records of events, the above remarks are not intended, since in such instances the main object is to secure exactness as to the relative positions of certain objects, and details of construction, irrespective of the pictorial effect.

Those enthusiasts in photographic work who have not had the advantage of good training in art are advised, more especially if they may claim good artistic taste, to carefully study some good book on the composition of pictures, and to supplement that study by the critical examination of such masterpieces of art which they will there find specified, as illustrating the various points tending to produce a good picture.

SOME EARLY APPLICATIONS OF PHOTOGRAPHY

Meteorological Instruments.—Meteorological observations require a daily reading of the barometer and thermometer. To economize this reading, and yet to receive a perfectly safe register of the state of the thermometer and barometer at each minute, photography was soon turned to account. Let the reader imagine behind the tube of a thermometer *R* (fig. 97) or barometer,

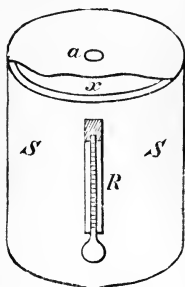

Fig. 97.

revolves round its axis *a* by means of clockwork. Let sensitive paper be wrapped round this drum, and the whole be enclosed in a cylinder *S*, which has only a small slit behind the thermometer through which the light can penetrate. The upper part of the thermometer will let the light through, while the thread of quicksilver will stop the light. Therefore the strip of paper above the quick-silver will blacken, and the limit of the blackening

on the paper will rise and fall with the mercury. Now the time can be marked beforehand on the paper. As the drum revolves once in twenty-four hours, the strip of paper need only be divided perpendicularly into twenty-four parts, and the first part be moved opposite the thermometer directly the clock strikes twelve, after which the whole may be allowed to revolve. Thus when suitable arrangements for lighting are made the blackened strip will show the height of the thermometer at all times of the day. In the same manner the height of the barometer can be registered by photography.

Neumeyer's Deep-sea Apparatus.—Professor Neumeyer

employed a similar instrument to determine the temperature in the depths of the sea. As there is no light producing chemical action at those depths, Neumeyer sent down a light-producing apparatus. This consisted of a galvanic battery and a Giesler's tube—that is, a tube in which very attenuated nitrogen gas is enclosed, and through which the electric current is passed. The tube then gives out a faint light. But this faint light has a powerful chemical action, because it contains many of the invisible ultra-violet rays (see p. 168), and in three minutes it effects the blackening of the paper. Neumeyer also attempted to determine with his apparatus the direction of the oceanic currents. For this purpose the apparatus had attached a vane like that of a weathercock, which could move the instrument in any direction whilst suspended. If any currents exist, they will turn the apparatus so that the vane is parallel to their direction. A magnetic needle was enclosed in the apparatus, and moved over a disc of sensitive paper; this magnetic needle pointed, of course, to the magnetic north, and the luminous tube above it fixed its position on the sensitive paper, which was firmly fastened to the box. Therefore, it can be easily seen what situation the apparatus has assumed with reference to the magnetic needle.

Stein's Heliopictor and other Apparatus.—Medical science soon made great use of photography, both as a means of obtaining pictures of interesting anatomical preparations and phenomena of short duration, and in giving exact anatomical views of the different organs. The interior of living organs can be disclosed by ophthalmoscopes, otoscopes, and laryngoscopes, and the image seen by the eye with these instruments successfully photographed. Dr Stein, of Frankfort-on-the-Maine, did good service in this branch, not only as a practical photographer, but also by the construction of suitable apparatus.

The apparatus devised by him for photographing the

interior of the ear (fig. 98) consists of three parts: 1st, the ear-funnel *A*; 2nd, the illuminating apparatus *B*; 3rd, the photographic apparatus *D*, with the lenses *C*. These parts are placed together, as may be seen in the accompanying diagram. The instrument is fastened by a ball and socket joint to a suitable stand, in order to give it the proper direction, according to the position of the sun. The ear-funnel *A* is a conical tube about $1\frac{1}{2}$ inches in length, to push aside the small hairs which interrupt the view; it is made of vulcanized india-rubber. The illuminating apparatus *B*, which is easily closed by a cover at *a d*, consists of two metal tubes, soldered together at a right angle at *b c*, of which one is provided with parallel, the other with curved sides.

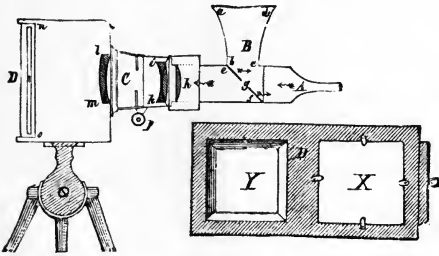

Fig. 98.

At the place where the two tubes unite is a perforated metallic mirror (*eg f*), inclined at an angle of 45° .

The photographic apparatus consists of a double objective *C* and a small camera, two inches deep. The ground-glass screen *X*, and the dark slide *Y*, are fitted in a frame *D*, easily moved. A plano-convex lens is placed at *h*, between the objective and the illuminating apparatus. According to the position of the sun, bright cloud, or any other source of light, the apparatus *B* can be moved by turning round on its axis; so that, in conjunction with the joint of the stand, the apparatus can be turned easily and steadily in all directions.

The rays which penetrate into the tube *B* are thrown by the perforated plane mirror *ef* through *A* on the drum of the ear. Reflected thence, they pass at *g* the perforated plane mirror, and the image of the drum of the ear is

thrown by the lenses on the ground-glass slide *n o*. The image is focussed either by shifting the objective by means of the screw at *p*, or by moving the lens at *h*, according as an enlarged image or one of life-size is desired. During the photographic process, an assistant must pull the ear muscle backwards and upwards, in order to give a proper direction to the funnel in the tortuous aperture of the ear. The exposure in the sunlight, if a good collodion was employed, lasted half a second; under bright clouds on a clear day, from five to ten seconds, according to the intensity of the light. The exposure was effected by opening and closing a shutter at *c d*.

In order to render photography more accessible to physicians and scientific investigators, Dr Stein constructed an ingenious instrument called the "heliopictor," with which wet-plate photographs could be taken without any dark room.

The heliopictor was a kind of dark slide which could be placed at the back of any camera. Dubroni, of Paris, first constructed such developing boxes. This box, a section of which is given in the diagram fig. 99, contained a glass vessel *K*, into which a silver solution could be poured through a stop-cock, not visible in the figure. The glass plate to be prepared was coated with collodion, then brought through the door *T* into the box, and placed on the aperture *O* of the vessel *K*. The door *T* was then closed, and the plate thus pressed by the spring *a* watertight against *K*. After this, the box was turned over to the right, the silver solution flowed over the plate and rendered it sensitive. The course of this operation could be observed through a yellow glass slide *S*, which admits no light having any chemical action upon the sensitized plate. After the plate had been properly sensitized, the

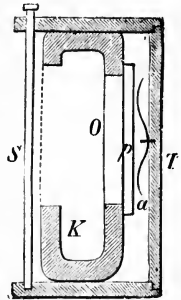

Fig. 99.

box was again placed upright, and brought into the camera in place of the ground-glass slide, *S* was drawn up, and thus the plate exposed. Then the silver solution was drawn off through a stopcock, and a solution of green vitriol poured in instead ; by tilting the box this flowed over the plate and developed the picture. The development could be watched through the yellow slide *S* : when it was completed the picture was taken out and fixed.

Stein improved his developing box by substituting a vulcanized india-rubber vessel, easily taken out and cleaned, for the glass receiver. He also introduced the method of filling and emptying the receiver by means of a stopcock, Dubroni having employed pipettes. Both apparatus were described in detail in the *Photographischen Mittheilungen*, Jahrgang X., Nr. 117, 118.

Microscopic Photographs and Pigeon Post.—Some years ago jewellery and toys were offered for sale in Paris, containing small lenses in place of jewels. If these were held before the eye, small transparent pictures, some of them portraits, and other writings, were visible. These little pictures were the so-called microscopic photographs on glass. Such a picture is by no means the representation of a microscopic object, but of a large-sized object, only it is so small that a microscope is required to see it. The production of these photographs does not differ from that of others ; it only requires an instrument forming images of microscopic minuteness, and this is effected by employing small lenses of very short focal length. In using these a direct photograph is not taken, but in the first place a photographic negative is prepared with an ordinary camera from the object chosen ; after this, with the help of the small lens, microscopic positives on glass are obtained with the ordinary collodion process. These are then cut, and a small lens fastened on them, and then they are mounted in metal. Such pictures are in themselves little else than toys, which have, however, been put to a

bad purpose, for indecent photographs have been thus placed in the hands of unsuspecting persons—a fact that speedily brought this branch of photography into discredit. But there are circumstances in which such microscopic photographs can be of extraordinary value. Simpson in England called attention to the fact that, by the help of photography, the contents of whole folios can be concentrated within a few square inches, and that the substance of books filling entire halls, when reduced by microscopic photography, can be brought within the compass of a single drawer—a circumstance which, with the enormous increase of material that has to be stored by our libraries, may be of importance. Of course, either a microscope or a magic lantern, would be required to read such microscopic works.

Microscopic photographs have obtained great importance in promoting pigeon despatches. During the siege of Paris, in 1870, the blockaded city held communication with the world outside by means of balloons and carrier pigeons. The first mode of communication was used almost exclusively for political objects; the second only admitted the transmission of very light letters. Letters, however condensed, could scarcely have been sent more than two or three at a time by a pigeon. In this case, microscopic photography presented a valuable means of concentrating many pages on a collodion film of only one square inch, and so light that more than a dozen packed in a quill could be sent by one pigeon. Dagron, at Paris, who first prepared microscopic photographs, also was the first to prepare these pigeon despatches. All the correspondence which had to be diminished was first set up in type, and printed together on a folio page. A microscopic photograph was made of this folio page, contained in about the space of $1\frac{1}{2}$ square inches. The collodion film of the picture was then removed from the glass by pouring a collodion over it which contained

castor oil in solution. The collodion soon dries, and can then be separated from the glass, carrying the film of the picture with it. Such films contained in some cases as many as 1500 despatches. At the place of arrival the films were unrolled and then enlarged by the help of a magic lantern; a number of writers thereupon set to work to copy the enlarged despatches, and ultimately forwarded them to their respective addresses. Thus Paris corresponded, by the aid of photography, for six months with the outer world, and even poor persons were able to let their relatives know that they still lived.

Pyro-Photography.—An ordinary photograph is, as paper, very combustible, and exposed to injury from corrosive substances. Encaustic images on porcelain and glass do not participate in this exposure to injury, and therefore attempts have been made to prepare fire-proof photographs, especially for the decoration of glass and porcelain. Success has crowned these efforts in several cases. One of the simplest processes was that of W. Grüne at Berlin.

Grüne found that the collodion image—which, as we have seen, consists of minute parts of silver—is capable of manifold changes, and that, moreover, it is easily transferable, by means of the elastic collodion film, to other bodies. The film, with the picture, can be removed from the glass, placed in different solutions, and then transferred to curved surfaces, etc. If the collodion picture is placed in a metallic solution, a chemical change ensues. Assuming the solution to contain chloride of gold, then the chlorine passes over to the silver, of which the picture consists, chloride of silver is formed, and metallic gold is precipitated as a fine blue powder on the picture. Thus a gold picture is obtained.

With certain precautions this can be transferred to, and burnt into porcelain. By this means a dull image is obtained, which can be rendered brilliant by polishing.

Grüne employed this method to produce gold ornaments on glass and porcelain. Drawings and patterns of various kinds were photographed; the image obtained was changed into one of gold, then burnt in, and thus the most beautiful and complicated decorations could be produced without the assistance of the porcelain painter.

If a silver picture be plunged into a solution of platinum instead of a solution of gold, a platinum image is obtained. This assumes a black colour on being burnt into the porcelain. In this manner black portraits, landscapes, etc., have been produced on porcelain.

Pictures of this kind can be prepared in other colours than black. For example, if the photograph is dipped in a combined solution of gold and platinum, the gold and platinum are precipitated on the picture. The image thus obtained, if burnt in, presents a very agreeable violet tint.

Solutions of uranium, of iron, and of manganese effect precipitates on a collodion picture, modifying its colour, and, when burnt in, produce different brownish or blackish tints. There are other means of producing such pyro-photographs. Details will be found in the chapter on the photo-chemistry of the chromium compounds.

The so-called Magic Photography.—Closely connected with Grüne's process for producing pictures on porcelain is what was called magic photography. Some years ago small sheets of white paper were offered for sale which, on being covered with blotting-paper and sprinkled with water, displayed an image as if by magic. The white sheets of paper, to all appearance a blank, were photographs which had been bleached by immersion in a solution of chloride of mercury. If a photograph not containing gold be immersed in a solution of chloride of mercury, a part of the chlorine passes over to the silver of the picture, and changes the brown silver particles into white chloride of silver, which is invisible on the white paper. At the same

time subchloride of mercury (mercurous chloride), which contains less chlorine than the chloride of mercury, is precipitated. This body is also white, and therefore invisible on the white paper. Now there are several substances which colour this white subchloride of mercury black. Among these are ammonia and hypo-sulphite of soda. If, therefore, the invisible picture is moistened with one of these substances, it is coloured black and becomes visible. In the magic photographs formerly sold there was hypo-sulphite of sodium in the blotting-paper; this was dissolved on moistening the paper, the solution penetrated to the picture and made it visible.

Quite a different kind of magic photograph was offered for sale some years later—the magic cigar-holders. These contained a small sheet of paper between the cigar and the mouthpiece, which was exposed to the action of the cigar smoke; with continued smoking an image became visible on the sheet of paper, which contained a magic photograph of the kind described above. The image was brought out by the vapour of ammonia which is contained in the smoke, which has also the property of colouring the magic photographs black.

These magic photographs were introduced at Berlin by Grüne, but their principle was known before, as J. Herschel had produced similar ones in 1840.

Scamoni's Heliographic Process.—Scamoni, a heliographer of the Russian Imperial State Paper Office, observed that a photographic negative does not form a plane surface, but appears in relief, the transparent places—shadows—being deeper than the opaque. But the difference is very slight. Scamoni tried to increase it by treating the freshly taken and developed picture with pyrogallic acid and solution of silver. In this manner fresh silver was precipitated on the picture, which has the property of attracting and retaining silver separated chemically. The relief was considerably

increased by this strengthening process. It can be augmented by a treatment with solutions of chloride of mercury and iodide of potassium, which transform the metallic silver into more bulky compounds. A relief was ultimately obtained nearly as high as the incisions of an engraved plate are deep. If now a collodion positive be taken of a negative from a linear drawing, and treated as above described, we have all the requisites for producing from it an engraved copper plate. The relief-like photographic plate is then brought into an electrotype apparatus. This produces on the plate a coherent copper precipitate, which is in low relief where the plate shows high relief—that is, where there are strokes or outlines. Thus a copper plate is obtained from which impressions can be taken as well as from one that has been engraved. This process was used to reproduce drawings like copper plate.

Maps were prepared in this manner, in which the original could be photographically enlarged or diminished, also writings on an enlarged and diminished scale. Scamoni thus reduced a page of the illustrated journal, *Ueber Land und Meer*, to sheets of one inch in width, on which the print was perfectly legible through the microscope.

Photography and the Sand-blast Process.—Tilghmann, at Philadelphia, made the observation, during his residence at the watering-place Longbranche, that the windows exposed to sea wind became quickly dim. He found that this was occasioned by fine sand, which the wind drove against the window; this gave him the idea of making ground glass by blowing sand against it, and he succeeded perfectly. He covered a glass surface with an iron screen, in which figures and letters were cut, and kept this in a current of air and sand. In a short time the exposed parts of the glass were ground, and thus a picture of the figures produced on the glass. A blast of a pressure of only four inches of water and a period of ten minutes are required for this work. If the air pressure is stronger, or

steam is used to convey the sand, at a pressure of 60 to 120 lbs. to the square inch, the effect is wonderful. Sand blown with such power through a narrow pipe bores deep holes into the hardest stones, and even into glass. The process has been used to bore stone and metal plates. Figures cut in a cast-iron screen placed over a stone surface can be deeply engraved in the stone in a short time. The iron plate is also affected, but much more slowly than the stone slab. A cast-iron plate $\frac{3}{16}$ of an inch thick is only reduced $\frac{1}{16}$ of an inch in the same time that a cut 300 times deeper is made in marble. India-rubber endures the sand stream almost as well as iron. Marble, protected by a perforated screen of india-rubber, may be cut 200 times as deep as the screen is thick without perceptibly affecting the india-rubber.

With the pressure of 100 lbs. such a sand stream can penetrate in one minute $1\frac{1}{2}$ inches deep into granite, 4 inches into marble, and 10 inches into soft sandstone.

The circumstance that soft bodies can be used as shields has led to elegant applications of this method in the industrial arts. For example, if glass be covered with lace pattern and a sand-blast be directed on it, the glass becomes ground in the meshes, and a copy of the lace is obtained on glass. In the same manner, painting with a gum colour upon glass can be produced clear on an unpolished ground by the sand-blast. This circumstance led immediately to the application of photography. If a gelatine picture is produced on glass by the transfer process, the surface of the glass at all the dark spots of the picture is protected by a layer of gelatine. If now a sand stream is allowed to operate upon it, it roughens the glass only at the uncovered places; thus a picture is formed. If the gelatine picture is a negative, the shadows are dim. A plate ground in this manner may be used for printing with printer's ink. The metal plates of Talbot's heliographic process may be etched by the sand-blast instead of by

acids, which often eat sideways into the fine strokes, making them too wide. The sand, in consequence of its direction being at right angles to the plate, cannot widen the lines, and therefore the incisions may be carried to a great depth, and then the plates may be used with letter-press.

Tilghman suggested that a gelatine positive should be produced upon a cake of resin; that this should be blown upon and deeply hollowed out.

A cast in plaster from this would form a mould for a type-metal cast, which could be used for printing.

Animated Photography—Marey's Pistol.—Instantaneous photography could not fail to derive impetus from the introduction of the more highly sensitive gelatine plates. Not only were they more convenient and easy to work with; they also made it possible to obtain instantaneous images even under an unfavourable light, giving them in detail instead of as mere silhouettes. Attempts to photograph flying birds even proved successful. Marey, of Paris, constructed a "photographic pistol" for this purpose. It was simply a photographer's camera of somewhat peculiar form, resembling a revolver. The object glass was in the barrel, and a small sensitized plate was adjusted in the revolving chamber. If the instrument was pointed at a



Fig. 100.



Fig. 101.

flying bird and the spring pressed, a mechanism was released by which the revolving chamber turned once round in a second of time, in twelve distinct jerks; and at each of the twelve pauses a spring-shutter opened for $\frac{1}{700}$ of a second. This is enough to produce an

image of the flying bird on the highly sensitive gelatine plate, which thus records twelve succeeding positions of the wings: these are of great value in the study of wing-

action. The pictures were, of course, minute, but photography enables us to make enlargements of such minute images with the greatest ease. Figs 100 and 101 are examples of these enlargements.

The instantaneous photographs of horses in movement by Muybridge, of San Francisco, done in 1879, were executed not with dry plates, but with wet plates under particularly favourable conditions of daylight.

PHOTOGRAPHY IN NATURAL COLOURS

Historical Development.—The first attempts to make coloured photographs date a long way back. Professor Seebeck of Jena, as early as 1810, found that chloride of silver, when exposed to the solar spectrum, became coloured in a corresponding manner. This observation, published in Goethe's "Farbenlehre," ii. p. 716, passed unnoticed, until, in the year 1841, after the discovery of the daguerreotype, experiments in the same direction were made by Sir John Herschel. He took paper saturated with chloride and nitrate of silver, let a powerful solar spectrum fall upon it, and obtained immediately, like Seebeck, a coloured image of the spectrum, agreeing, however, only imperfectly with the original. Becquerel, in 1848, was more successful. He ascertained that the solution of nitrate of silver in Herschel's experiments had a disturbing effect, and he worked with chloride of silver alone. He employed silver plates, which he plunged in chlorine water. A white film of chloride of silver was thus formed on the plates, and, on exposure to the solar spectrum, an image was obtained, the colours of which agreed very closely with those of the spectrum. Becquerel observed that the duration of the action of the chlorine water was very important, and he preferred at a later date to chlorinate the plates by the electric current. For this purpose he suspended them in hydrochloric acid from the copper pole of a galvanic battery. The current decomposes this acid into chlorine and hydrogen. The chlorine passes to the silver plate, and forms chloride of silver. This method enables the operator to produce a film of chloride

of silver of any thickness, according to the duration of the current. The brownish subchloride of silver is thus produced, and this is chiefly sensitive to coloured light. This sensitiveness is, however, not great : it suffices to fix a powerful spectrum, but it requires a very long exposure to obtain pictures in the camera obscura ; and all such pictures, unfortunately, darken in the light. Becquerel found that the sensitiveness was increased by heating the plates. This observation was turned to account by his successor, Nièpce de St Victor (the nephew of Nicophore Nièpce, see p. 21), who made numerous attempts from 1851 to 1867 to produce coloured photographs, accounts of which he communicated to the Paris Academy.

He worked, like Becquerel, with silver plates, which he chlorinated by immersion in a solution of the chlorides of iron and copper, and then heated them strongly. He thus obtained plates which appeared ten times more sensitive than Becquerel's, and allowed him to copy in the camera obscura, engravings, flowers, church windows, etc. He relates that he not only obtained the colours of objects in his pictures, but that gold and silver retained their metallic splendour, and the picture of a peacock's feather the lustre of nature.

Nièpce de St Victor introduced a further improvement, by covering the plate of chloride of silver with a peculiar varnish, consisting of dextrine and a solution of chloride of lead. This coating made the plate still more sensitive and durable. At the Paris Exhibition of 1867, Nièpce exhibited various coloured photographs, which lasted about a week in a subdued daylight (they were shown in half-closed boxes). Other persons who paid attention to coloured photographs at this time were Poitevin at Paris, Dr Zenker¹ at Berlin, and Simpson and Sir W. de Abney in London. The two former investigators reverted to

¹ Those who take a special interest in the historical part of matter are referred to Dr Zenker's "Lehrbuch der Photochromie." Berlin, 1868.

the older process, as employed by Seebeck and Herschel, *i.e.* they prepared pictures on paper, only the preparation of this paper was peculiar. Paper saturated with salt was made sensitive in a solution of silver, like the photographic positive paper previously described, then washed to remove the solution of silver, and afterwards exposed to the light in a solution of subchloride of tin. By this means violet subchloride of silver is formed from the white chloride of silver. The subchloride of tin only operates as a reducing medium. This paper is in itself little sensitive to coloured light; but if it be treated with a solution of chromate of potash and sulphate of copper, its sensitiveness increases considerably, so that it is easy to copy with it transparent coloured pictures. Nevertheless, the colours are never so vivid as in the original, the red tones showing themselves the strongest. After printing, the pictures are washed with water, to make them less sensitive to light. In this condition they showed tolerably well in a subdued light, but no means were found to make them perfectly durable. Hypo-sulphite of sodium could not be used, as it destroys the colours immediately.

With reference to the action of light upon the salts of silver, mention must be made of the observations and experiments of Carey Lea (1887). He found that the halogen compounds of silver are not only capable of changing colour when acted upon by light, but may also be caused to do so by chemical action alone. These particular salts he named *Photo Salts*, and he found that with a red variety of the chloride he could obtain the best results. With the aid of this salt Lea was able to obtain a photograph of the spectrum colours with the exception of the yellow and green. This active chloride can be produced from the ordinary variety by the action of a reducing agent.

Certain chemical compounds when mixed with this salt

were found to modify, or sometimes completely change it, so far as the action of light upon it is concerned. Thus, the addition of the chlorides of lead and tin so alters it, that when exposed to white light the colour becomes lighter instead of darker, as is usually the case. Again, when sodium salicylate is added, the sensitivity is greatly increased.

An interesting fact with respect to those early attempts of E. Becquerel is that the colours which he succeeded in obtaining were produced by the action of stationary light waves upon the silver salts in the sensitive film, although the phenomenon was apparently not so interpreted by Becquerel.

In 1868 Zenker developed the theory that the polished metal surface on which the sensitive film was placed formed a reflecting body by means of which the incident light was thrown into a series of stationary undulations. In the loops of these waves the chemical action due to light is a maximum, the silver salts are decomposed and an extremely thin layer of silver is deposited.

The thickness of the film will in all cases be many times the wave-length of the light, hence many of these layers will occur at definite distances apart throughout the substance of the film; the distance apart of the various layers will, of course, depend upon the wave-length of the incident light.

When such a film is made to reflect light, the colours visible will be the same as those to which the plate was originally exposed—that is, provided white light is used to illuminate the plate when it is used as a reflector. The theory of this has also more recently been developed by Lord Rayleigh.¹

Lippmann's Colour Photographs.—The first real practical application of this theory is due to Lippmann, and the method of obtaining photographs in natural colours which

¹ *Phil. Mag.*, 5, 26, p. 256, 1888.

we shall now consider is very generally known as Lippmann's Colour Photography.¹ This process was placed before the French Academy of Science in 1891.

Lippmann makes use of a film of mercury as the reflecting surface in the place of the polished silver surface as used by Becquerel. The photographic plate he uses is of the ordinary kind, but having a fine-grained film. This plate is placed in an especially constructed dark slide, in which an arrangement has been made in order that the mercury can be poured in so as to be in contact with the sensitive film while the exposure is taking place. Since this thin layer of clean mercury is to act as a reflecting surface for the incident light, it can readily be seen that the film side of the plate must be turned towards the camera back—*i.e.* away from the lens. Great care must be taken to ensure the absolute cleanliness of the glass surface before exposing, and when the slide is removed from the camera it is also as well to dust the film with a camel-hair brush which has been moistened with alcohol, as this will tend to remove any adhering mercury. Develop and fix in the ordinary way, but be careful not to carry either process too far. After well washing the plate, it is bleached with mercuric chloride, and then either re-developed with amidol or else blackened with a 10 per cent. solution of sodium sulphite, after which it should be washed and dried. A systematic series of researches on this subject have recently (1908) been carried out by H. E. Ives, and a brief mention will now be made of some of the more interesting of his results.

¹ Those wishing to trace the historical development of this process will find the following list of references useful:—(1) Lippmann, *Comptes Rendus*, 112, 274, 1891; (2) Lippmann, *Journ. de Physique*, 3, 97, 1894; (3) Wiener, *Annalen der Physik*, 69, 488, 1899; (4) Neuhaus, *Die Farbenphotographie nach Lippmann's verfahren*, 1898; (5) Valenta, *Die Photographie in Natürlichen Farben*, 1894; (6) Lehmann, *Beiträge zur Theorie und Praxis der directen Farbenphotographie*, 1906; (7) Ives, *Astrophysics Journal*, 27, 5, 1908.

He finds that the smaller the grain of the silver particle, the more minute is the variation in the stationary wave which can be recorded by the plate.

It necessarily follows that the thicker the film, the greater will be the possible number of layers deposited ; and from this again results the greater purity of the reflected light. It is quite possible to obtain with the aid of the microscope photographs of the sections of the film, and so be able to count the number of laminae of deposited silver actually present. In some photographs of such films obtained by Neuhaus only seven or eight layers could be counted, but Ives has succeeded in obtaining photographs showing many more layers.

There is a large amount of light lost at each lamina on account of the reflection and absorption which there takes place. As this is the case, the effect of each lamina depends very largely upon its distance from the surface, becoming rapidly less as this distance increases. This is what one would expect even if the layers were all equally well formed, but as a matter of fact they are not so, for the layers themselves also rapidly become less marked. This does not agree with the theory as worked out by Lehmann, for he found by calculation that the laminae should become more marked as their distances from the mirror are increased. He explained the want of agreement between theory and practice by assuming that the reflected light loses its powers of interference after a short distance.

Ives has found that the purity of the reflected light is greatly increased when the amount of silver bromide used is diminished—in other words, as the grain becomes finer. He ascertained that this increase is most marked when quantities of silver nitrate between 0.18 gm. and 0.09 gm. are used for every gram of gelatine.

The following is Ives' method of preparation :—

A. Gelatine, 1 gram ; water, 25 c.c.

B. Gelatine, 2 grams ; potassium bromide, 0·25 gram ; water, 50 c.c.

C. Silver nitrate, 0·3 gram ; water, 5 c.c.

A and *B* are heated until the gelatine melts, after which it is allowed to cool to 40° C. *C* is then added to *A*, which in turn is added to *B*, the latter process being done slowly, the mixture being stirred meanwhile ; the sensitizer is then added, and the resulting mixture carefully filtered. After the plates are coated and the film has set, they are washed for fifteen minutes, and then allowed to dry.

His experiments tend to show that whether the reflected light is viewed from the film or the glass side of the plate, no increase in the purity takes place for any increase in the thickness of the film used beyond a thickness of about thirty wave-lengths.

It is found that the coloured light reflected by the layers of silver deposited in the film increases in intensity with an increase in the length of exposure, until a stage is reached when the diffusely reflected light can no longer be noticed ; after that stage very little change in the intensity takes place, although the exposure may be increased considerably.

In the less exposed parts the film appears when viewed by reflected light like an ordinary negative—that is, a positive can be seen, caused by the diffusely reflected light. With further exposure the film tends to lose this appearance and become black, and behaves in much the same way as unsilvered glass.

When viewed by transmitted light the plate appears greenish in the very slightly exposed parts, a kind of yellowish brown in parts which have received a moderate amount of exposure, and in those parts where the film has been sufficiently exposed to cause a disappearance of the diffuse light produced by reflection, the plate appears quite clear, just like a piece of yellow glass.

Therefore Ives concludes that the behaviour of the silver

deposit is in all respects just as if the particles of silver were first of all separate and so produce a scattering of the light, but with longer exposure become fused together into a homogeneous mass.

Ives also found that the effect of varying the length of time for development depends upon whether the plate is viewed from the film or glass side. Greatly increased development causes fog, and this decreases the purity if the plate is viewed from the film side. When viewed from the glass side no effect whatever is noticed in cases of long development unless the films used are thin, in which case there is a diminution in the purity of the colours. He recommends that plates for this work should be developed until a fog just begins to appear.

The small effective number of laminæ (twenty to thirty at most) appears due not to the small number actually formed, as has often been assumed, but to the mode of action of the developer. Some developers, such as ferrous oxalate, or hydroquinone, can be used without any trace of fog until development has proceeded with great uniformity quite through the film. The deposit obtained with these developers is black and opaque, so that the reflected light is such as to render the colours very dull. Hence it becomes necessary to bleach with mercury chloride, and the resulting loss of reflecting power is more than compensated by the increase in effective laminæ. The deposit in such cases is so transparent that absorption becomes practically negligible, and all the laminæ may be considered as acting with equal effect. On this account, when monochromatic light is photographed, and the plates are treated as described, the result is that the reflected light from the plate is a narrow bright line when examined spectroscopically, and not, as is usual in such cases, a diffuse band.

In such plates increased thickness of film results in a larger number of laminæ being formed, and the limiting

thickness of the film is only reached when it is no longer practicable to flow and dry a thicker one. A point to be remembered, however, is that the greatly increased exposures necessary on account of the opacity and slow speed of thick films makes it much more difficult to obtain satisfactory results when working with them.

Up to the present we have been supposing the plate to be illuminated by monochromatic light ; let us now see what is the result when the source of light is such that when analysed spectroscopically it either gives two or more distinct lines, or else broad bands of colours. In such cases there will, of course, be regions in the film where the waves will by interference strengthen the effect, and in others the effects will be much diminished.

Lippmann has developed the theory of the reflecting elements of the film by assuming that minute reflecting particles are distributed throughout the film. On his theory, white is produced owing to the continuous irregular distribution of the particles. Experiments which have been carried out by Ives indicate that when a plate with a fairly coarse grain is used, if over-exposure be carefully guarded against, and the plate is subsequently developed with pyrogallic acid, there is apparently a very close approach to a condition of separate reflecting particles. On the other hand, with complex radiations, and also with over-exposure, there must in either case be a certain amount of fusing together and a consequent loss of luminosity.

Schutt¹ brought forward the idea that the action of light merely causes a periodic change in the refractive index, and this idea more nearly fits in with the reflection obtained when the plate has been developed with hydroquinone and then bleached.

From such considerations as these it appears quite evident that when the object is to keep the luminosity as

¹ *Ann. d. Physik*, 57, p. 533, 1896.

high as possible, it is best to use a developer like pyrogallie acid. This gives a deposit which, while being fairly transparent, is yet highly reflecting; on the other hand, where there is a complex arrangement of colours to be reproduced, it is best to work with a deep-acting developer, such as hydroquinone, and then bleach so as to obtain a transparent deposit.

The production of good whites has always been a difficult matter by this process, and has been the subject of much discussion. According to Lippmann's theory white is produced as the result of light being reflected from particles of silver which are densely but irregularly distributed throughout the film, so that in such a region regular-spaced laminæ would be entirely wanting. Cajal, on the other hand, came to the conclusion that white can be produced only by the use of amidol as developer, and the subsequent use of an intensifier, since, in his opinion, it is due to a mirror-like surface being formed on the film. Others, however, have been able to obtain very satisfactory whites without the use of amidol.

There is sometimes, especially with under-exposed plates, a greenish tint to be seen in the whites. Lehmann considered this to be due to the formation of a rapidly damped stationary vibration of a wave-length equivalent to the mean wave-length of the incident light. He endeavoured to correct this by using a screen having three maxima of transmission, viz., red, green and blue, since on short exposures white will be produced as the result of a mixture of these three colours; but there are serious objections to such a practice.

Ives finds that the brightest whites are obtained by using an emulsion containing four times the amount of silver used for pure colour work, or twice that quantity which has been commonly used by other investigators, a fact which tells very strongly in favour of the theory of scattered reflecting particles. He also finds that *Isocol*

is the best sensitizer to use in this work, since it imparts a practically uniform sensitivity extending from deep red to blue and violet.

There are no gaps or maxima in the sensitivity curve of this substance, although it gradually increases in strength towards the violet. Absorbing solutions of wool black, cobalt sulphocyanate, and iron sulphocyanate reduce the action in the blue, green and yellow to that in the deep red, and by this means very satisfactory isochromatic action is obtained from red to ultra-violet.

In the actual photography of coloured objects fairly coarse-grained isochromatic emulsion should therefore be used. Ives found that a film about $\frac{1}{200}$ mm. in thickness will give very good colours, but success depends very largely upon correct exposure and development; very little deviation will render the colours weak. No exact data can be given as to time of exposure, experience alone must be the guide; thus, working at $f/3.6$ on sunlit objects, it is necessary to give exposures ranging from $1\frac{1}{2}$ to 5 minutes. Under the very best conditions as to light and with a lens working at $f/6$, we must therefore allow at least 4 minutes for an exposure.

When the plate has been developed and fixed in dilute hypo-sulphite of soda, in which it is not allowed to remain too long, it is next necessary to arrange it so that it can be viewed by light reflected from the silver particles in the film, for when viewed in the ordinary way no colours can be seen. Now, in the photograph of any coloured object there will be a few layers of laminæ, behind which will come a diffuse deposit, so that arrangements must be made to exclude all light except that coming in the direction to be regularly reflected by the laminæ, since if light reflected from the diffuse deposit is also obtained, the colours will be very much weakened, for they will then be mixed with a certain amount of white light. If the film be made excessively thin, there is, of course, the ad-

vantage that there will be very little diffuse deposit, and the resulting colours will appear all the more brilliant, and will also be less affected by the conditions of illumination ; this, however, has the great disadvantage that while it is satisfactory so long as monochromatic light is used, the same is far from being the case when the light consists of complex colours.

The plates are made ready for viewing by cementing on to the film side by means of canada balsam a thin glass prism, of very small angle, so as to destroy surface reflections, and the back of the glass is covered with asphaltum varnish. Parallel light should be used, if possible, to illuminate the plate, and all side-lights should be cut off—*i.e.* the parallel beam should strike the plate so that the light may reach the eye at a slight angle from the vertical. If held in the hand and lighted by light coming through a hole in a shutter facing a clear sky, an ideal arrangement would be obtained.

The mercury trough as an adjunct to the dark slide has formed a great drawback to this method, and various attempts have been made to obtain similar results by other means.

Thus Krone relied for his results upon the reflection which takes place at the gelatine-air surface, and dispensed entirely with the mercury. Colours obtained by this method, however, are very dull and poor. Lehmann flowed the emulsion upon a polished metal plate previously coated with collodion. In this case the polished metal forms the reflecting surface, and the film could be stripped after being exposed, and then floated on to glass.

By this method pure colours can be reproduced, but in those cases in which the laminæ system lies close to the surface of the film near the reflecting surface, failure takes place, since that space is occupied by the collodion. It can readily be seen that a silver mirror in close contact is open to the same objection. Ives has found that the

following method succeeds well :—A glass plate is heavily silvered and is then flowed with a thick solution of celluloid in amyl acetate. When this varnish is dry the plate is placed under water ; this slowly works under the coating of celluloid, lifting it from the glass and bringing with it the silver. This flexible silver mirror is immediately laid, silver surface down, on a wet Lippmann plate and allowed to dry there. When dry the gelatine film will have the silver surface in optical contact with it. The plate may then be exposed at any time, and only an ordinary dark slide will be required. After exposure the celluloid film is stripped from the gelatine, taking with it most of the silver ; the plate is then developed, and after a thorough washing, any silver which remains can be removed by a mop of wet cotton wool. This works well for all types of colours, but has a disadvantage that sometimes proves troublesome, viz., some of the best sensitizers are apt to lose their power during the slow drying. Erythrosine is found to act perfectly, while pinacyanol and pinaverdol are likely to fail.

The Three-colour Process.—Another process by which many attempts have been made to obtain photographs in natural colours is that known as the *Three-colour Process*.

In 1867 we find that C. Cros patented a process of three-colour heliochromy, in which three negatives were taken—one with red, another with yellow, and the third with blue light. The positives obtained from these negatives were to be thrown into register so as to form one picture by means of suitable apparatus, the positives having previously been dyed with proper care as to correct tint.

In the next year L. Ducos du Hauron brought forward a very similar process, and also one which in principle was very like that now known as the *Joly* process.

Ducos du Hauron, in his patent of 1868, outlined a process of preparing a three-colour screen consisting of bands of the three primary colours in juxtaposition which was

to be placed before the sensitive plate when making the exposure. The importance of this was not recognized until Joly in England and MacDonough in America applied it in practice. This they did within a short time of one another.

In 1881 Cros described a process very nearly the same as the later ones based on the Young-Helmholtz theory of colour vision. Thomas Young (1807) and V. Helmholtz (1852) assumed that there are three primary light colours to which three different kinds of nerves in the retina respond. These three primary colours are red, green, and blue. Every colour in the spectrum was assumed to excite all the kinds of fibres, but some of them very feebly and others strongly. Thus, while red light excited the fibres sensitive to red most, yet those sensitive to blue and green were also feebly excited.

This theory was afterwards (1861) elaborated by Clerk Maxwell, who put forward the idea that all colours could be produced from the three primary colours—red, green, and blue.

F. E. Ives of Philadelphia made use of this theory, and obtained three negatives, using respectively red, green, and blue colour screens. These negatives he developed and fixed in the ordinary manner, and then obtained three positives as transparencies.

In order that it might be possible to view all three positives at the same time and in register, he invented a special apparatus which he named the *Kromskop*.

The diagram (102) will illustrate the principle on which the action of this instrument depends.

A represents the position of a piece of red glass on which the positive made from the negative obtained with the red screen is placed. Similarly *B* and *C* represent positions of blue violet, and green glass with the suitable positive. *E* shows the position of the eye, and the arrows the direction of incident white light. *L*, *M*, *N* are three plane

mirrors placed at 45° with the direction of the incident light. Of course the tops of the mirrors L and M must be transparent in order that the positives at B and C may be of use.

It is so arranged that the distance $A L + L E = B M + M E = C E$, the three images then combine at the eye to form one.

When suitably lighted and with proper screens some

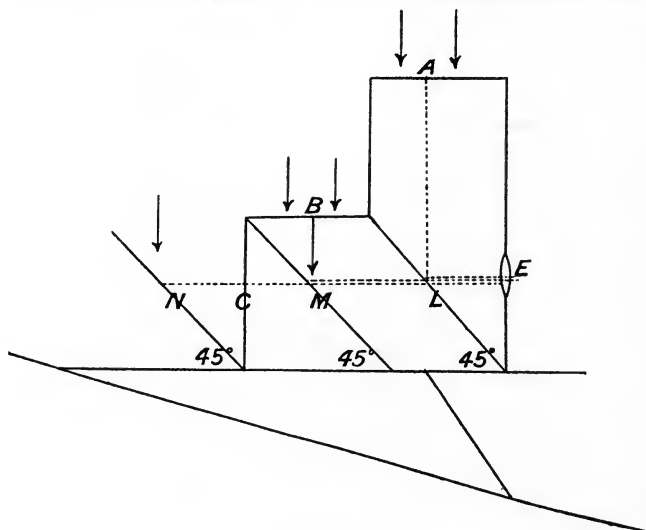

Fig. 102.

excellent results are obtained by this means. This apparatus can be arranged so as to be used as a stereoscope if desired. Ives also devised a triple lantern with suitable lenses and coloured glasses in order that a combined picture could be thrown upon a screen.

The Sanger-Shepherd Process may be regarded as the modern representative of the three-colour process.

Three-colour record negatives are taken, the same brand of plate being used for all three. These negatives may be taken in any ordinary camera if a suitable arrangement

is made for the colour screens to be held in front of the lens, and a dark slide is used which will hold the three plates. Sanger-Shepherd, however, supplies a dark slide with repeating back in which all three negatives can be taken upon one plate.

This is illustrated in diagram (103). The three screens—blue, green, and red—which are seen on the right are clipped in a frame to the front of the dark slide, which stands next. They are then placed with the plate in the repeating-back case of the camera, and are passed one after another in front of the single opening seen in the

figure. By this means it is absolutely certain that light of one colour only reaches any third of the plate, and the result is that by this means three negatives of the object can be obtained which differ only in their respective densities.



Fig. 103.

The three negatives are illustrated by the figure to the left of the illustration.

Cameras with repeating backs are, of course, inconvenient, and, in fact, impossible when the object it is desired to photograph is moving, for, of course, in whatever form the camera is made three exposures must be made. This has been one great drawback in three-colour photography.

Several attempts have therefore been made to produce a camera in which all three negatives can be exposed at the same time. E. T. Butler has devised one in which the principle involved is the same as that of the Ives Kromskop¹ (p. 241). Others have been invented by Sir

¹ See also description by Dr Mees, *Journ. of Photog.*, July 1908.

Wm. de Abney and Sanger-Shepherd. In order that any such camera may be of real use for landscape work, or, indeed, for use in general work where the three-colour process is employed, it must be so arranged that the three images fall on one plate so that they may be developed simultaneously. The images on the plate must also all three be of the same size for the same objects at whatever distance from the camera these objects are situated, so that it may be possible to obtain complete register. Then, lastly, if the images are all taken at the same time on one and the same plate, there is bound to be a slight stereoscopic effect, and this must be reduced to a minimum.

It should be remembered that in this work, in which exposure is made through colour filters, longer time has to be allowed than when exposing without a filter.

Thus with lens working at $f/8$, each of the three plates, if of the rapid-colour plate type, as supplied by Sanger-Shepherd, require an exposure of about a second if the light is good.

The plates are developed in the ordinary manner, metal being used in preference as the developer, and great care must be taken to exclude all light while developing.

Most beautiful lantern slides can be made by this process. The first step is to make a black lantern slide by using the negative obtained with the red filter. This slide is then converted into a greenish blue transparency by the action of a special solution. The positives from the green

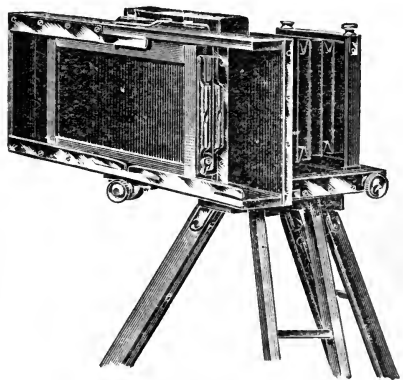

Fig. 104.

A Camera with repeating back is here shown.

and blue filter negatives are printed upon a specially prepared celluloid film coated with gelatine containing silver bromide. These are sensitized by immersion in a solution of bichromate of potash for three minutes. They may also be obtained ready for use together with a special case in which they may be stored. The two prints are obtained by making exposures under the two negatives, the celluloid side of the film being placed in contact with the negative and the exposure continued until all the details are apparent as a brownish yellow image. The film is now removed from the frame and immersed in warm water, when the unexposed gelatine will be dissolved and a white image left. The two prints after this treatment are next fixed in clean hypo-sulphite of soda in order that the silver bromide may be removed and a transparent low relief in clear gelatine will remain. Next it is necessary to stain these prints; that from the negative obtained with a green filter is stained a pink colour in a bath containing a special dye, and that from the blue violet is stained yellow.

Suitable dyes for this purpose are on the market. The necessary detailed instructions are supplied with the plates and dyes.

The films are dried after being stained, and finally mounted in superposition on the blue transparency. It is, of course, absolutely essential that the three positives should be in exact register. The films are kept in position by means of binding strips, and the mask and ordinary cover-glass are next placed on and the whole bound together in the usual manner.

Wood's Process.—In an article to the *Philosophical Magazine* for April 1899, R. W. Wood describes a process by which diffraction gratings can be used to enable one to obtain a coloured photograph from three negatives. A diffraction grating may consist of a piece of plane glass on which is ruled or photographed a large number of lines

(for this purpose 2000-3000 to an inch) at equal distances apart. The principle on which Wood's process depends is described by him as follows : " If a diffraction grating of moderate dispersion and a lens be placed in the path of a beam of light coming from a linear source, and the eye be placed in any one of the spectra formed to the right or left of the central image, the entire surface of the grating will appear illuminated with light of a colour depending on the part of the spectrum in which the eye is placed. If one part of the grating has a different spacing from the rest, the spectrum formed by this part will be displaced relatively to the first ; and if the eye be placed in the overlapping part of the two spectra, the corresponding portions of the grating will appear illuminated in different colours."

In a simple way this may be explained by remembering that the amount of diffraction depends upon the closeness of the lines, and by using gratings of different rulings it can be arranged so that any two colours may be made to overlap, since, *e.g.*, red will be diffracted by one grating just to the same extent as green by the other. When such a thing as this occurs with red and green colours, the result will be that the eye will receive yellow light, while if, in addition, a third grating is used by which blue violet light is diffracted to the same extent as red and green respectively by the other two, and then all three spectra are made to overlap, the light received by the eye will be white. Again, if different parts of a picture are represented by lines of a fineness corresponding to that required to show a given colour, that colour will be visible in the picture when viewed from a suitable standpoint.

In practice Wood took three negatives, using red, green, and blue screens respectively. From these negatives three positives are made on ordinary lantern slides ; and in this connection it is important to remember that albumen-coated plates must be used, since the warm water used in subsequent development would dissolve a gelatine

film. When the positives are dry they are coated with a bichromated gelatine and allowed to dry in a subdued light.

Three diffraction gratings, 2000 lines to 1 inch for red, 2400 lines per inch for green, and 2750 for blue-violet, are placed over these positives and an exposure to the sun made for thirty seconds. When the plates are afterwards washed in warm water diffraction gratings of great brilliancy are formed directly on the film surface.

Three sheets of thin glass sensitized with bichromated gelatine are placed under the three positives and prints taken from them.

The portions of each plate on which the light has acted bear the impression of the corresponding grating, and this impression varies in distinctness according to the density of the different parts of the positives. When these three plates so obtained from the positives are superimposed, placed in front of a lens and illuminated by a narrow source of light, a correctly coloured picture is seen if the eye is placed in the correct position. This method, however, did not allow of perfect registration of the three slides.

Wood found that it was not necessary to use three separate plates, but that the three gratings could be obtained on a single film. Thus the final process becomes an exposure, through the transparency made from the negative obtained with the red screen, of a piece of glass coated with bichromated gelatine, over which is laid a grating of 2000 lines to the inch. A second exposure is made of the same bichromated film through a grating 2400 lines per inch and the transparency obtained with green negative; finally a third exposure is made with grating 2750 lines and blue-violet transparency. When this bichromated plate has been washed and dried it becomes the coloured photograph. The reason for this is that where reds occur in the original only spacings of the red

grating appear, and so on; where yellows, spacings of both green and red, and where white, all three spacings are superimposed.

One great advantage of this method is that it is possible by a single exposure to obtain a new positive when one positive has been made.

The apparatus for viewing the pictures consists of a cheap double convex lens mounted on a simple frame, at the other end of which is a small screen which is so perforated as to bring the eye into the correct position for obtaining the desired colour effect. Wood found that when a lens of proper focal length was used, it was possible to view the picture by both eyes, since similar overlapping spectra are then formed on each side of the central image.

Before leaving this three-colour method of obtaining photographs in their natural colours, we will briefly mention a process brought out by *Lumière* in which three-colour filters—viz., blue-violet, green, and orange—are required. Three negatives are obtained using the three different screens, and from these negatives three prints are made on special paper which has been coated with bichromated gelatine and glue. These prints are developed in the ordinary manner with water, and when dry are dyed.

The print obtained from the green negative is dyed red, that from the blue-violet is dyed yellow, and the orange print is dyed blue. The dyes are so prepared that the prints should remain in the dyes about twelve hours, the excess of colour being afterwards removed by washing before drying the prints. It is possible so to correct any colours, since if not sufficiently transparent, washing may be continued until the proper stage is reached, while any deficiency in colour can be rectified by a longer immersion in the dye. These three prints are then stripped from their paper supports and mounted in superposition on a temporary paper support, great care being taken to ensure

that the three are in perfect register. Adhesion is secured in this process by a gelatine mountant, and each film must be allowed to dry in its new position on the temporary mount before trying to mount another.

When all the three films are mounted in their proper positions, they are stripped as one from the paper and transferred to a permanent glass support.

All these methods, however, have been more or less overshadowed by the success which has been attained in the last few years with colour photography in which only one exposure is necessary and in which only one plate is used.

Autochrome Process.—In the front rank among these is the Autochrome process of Lumière. The manufacture of this plate has been so improved, and the method of developing so simplified, that it is now possible with just ordinary precautions and practice, to obtain most satisfactory results of very difficult subjects.

The plate consists essentially of a glass support on which a layer of very minute coloured starch grains is coated. These starch grains are only about $\frac{1}{1800}$ to $\frac{1}{2000}$ inch in diameter, and before they are used for coating the plates are dyed, some violet, some green, and some an orange red. After dyeing, they are mixed together until the mixture assumes a neutral tint. They are then applied to the plate so as to form a very thin but complete coating. When looked at through a microscope such a plate would seem to be covered with a transparent screen composed of innumerable coloured dots. If the plate is held up to the light and viewed as a transparency, the starch grains give it a slightly pink tint.

When the plate has been so coated, a layer of waterproof varnish is next placed on it, and lastly a highly sensitive panchromatic film.

As it is desired that the light should pass through the starch grain screen before impinging on the sensitive film,

it can be seen that the plate must be placed in the dark slide so that the film side is away from the lens.

To better understand the action of this screen, let us imagine that in one small spot there are three grains adjacent—one red, one green, the other violet. Now suppose light of any one of these colours to fall upon such a spot, then it will only be transmitted by the coloured starch which is of its own colour, and behind that grain the film will be affected, so that on developing we shall find in that position a microscopic black dot. The film will not be affected at all behind the other two grains. Hence, when viewed by transmitted light, the colours of these two grains will mingle and the result will be a colour complementary to that to which the film was exposed. Were it not possible to alter this by some simple means the whole process would of necessity be a failure; fortunately it is quite possible and easy to transform the negative into a positive, so that no such false rendering of colours takes place.

Since the autochrome plates are sensitive to all rays, great care must be taken to have a safe lamp for the dark room. This can be obtained by special Virida papers, supplied by Lumière. Even then precautions must be taken so that the plate shall not be exposed directly to the light until it is immersed in the developer.

As the plate must be exposed with its film side away from the lens, it is necessary to see before placing the plate in the dark slide that its glass surface is perfectly clean.

A special piece of black cardboard is supplied with the plates, and this should be put in contact with the film, and the plate and cardboard then placed together in the slide, so that the film may be kept free from scratches.

The focussing screen of the stand cameras must also be arranged so that its rough side is outwards.

A special colour filter is necessary when using these plates, which may be placed either in front of or behind

the lens if the focussing screen is arranged as described. It need hardly be added that the lens itself should contain no trace of coloration.

The exposure required by these plates is long compared with that for ordinary plates; thus under the best conditions, with a lens working at $f/8$, they require about one second. On this account the camera must have a firm support.

Full particulars as to the speed of the plates, and also full working directions, are supplied with the plates.

The new method of development as recommended by Lumière is as follows :—

Make up the stock solution used for developing, by dissolving 15 gms. of Quinomet in 1000 c.c. of warm water, add to this 100 gms. of anhydrous sodium sulphite, then 32 c.c. of ammonium hydrate of specific gravity 0.920; lastly, add 6 gms. of potassium bromide. This developer can be bought ready mixed in a concentrated form, when all that is necessary is to use one ounce of developer to 4 ounces of water.

This quantity of developer can be used for one $\frac{1}{2}$ -plate. If the exposure is correct, develop for just two and a half minutes, the temperature of the bath being about 60° F. For reversing the image the stock solution is composed of 1000 c.c. of water, 2 gms. of permanganate of potash, and 10 c.c. of sulphuric acid.

When the negative is removed from the developer it should first of all be rinsed in running water and then placed in about 3 ounces of the reversing solution. After it has been placed in this it should be taken into daylight. The plate gradually becomes transparent and the colours will be visible. The plate should be quite transparent at the end of three or four minutes, when it should be removed from the bath and washed in running water for about half a minute. After this it is necessary to redevelop the plate. This may be done in full daylight, making use for this

purpose of the solution saved from the first development. When the high lights are sufficiently darkened, which should take about three or four minutes, the plate is washed for four minutes and immediately placed on one side to dry. It is not necessary to use a fixing solution unless the plate is intensified, which is sometimes done after the second development, when, owing to over-exposure, the image is too transparent, and the colours are lacking in brilliance.

It is found that varnishing the film not only protects it, but also adds greatly to the transparency. Special varnish is supplied for this purpose, which can be applied cold by flowing it over the plate in the usual manner.

There is one great drawback to the autochrome plate. Every coloured photograph must be obtained by a fresh exposure. This, of course, renders it absolutely impossible in many instances to get two exactly similar photographs of the same object. Then, again, the image of the object only appears in its natural colours when viewed by transmitted light, and for this purpose white light should be used as the means of illumination.

The Thames Colour Plate.—The Thames Colour Plate can also be used for obtaining a coloured photograph in one exposure. These plates have been on the market for just about two years, the first trade circular being issued in October 1908. This circular commenced with the following paragraph :—“ The Thames Colour Plate is for use in *any* camera, to obtain without additional apparatus, at one operation, on one plate, a photograph of the scene or object in all its natural colours. It consists of a screen of the primary colours laid down in minute regular-shaped patches of pure transparent colour with mathematical accuracy ; and a sensitive surface.”

The screen mentioned can be best understood by examining one with a pocket lens. It will then be seen that there are a very large number of circles, some of which are coloured red and the others coloured green,

while the spaces between these circles are coloured blue. These circles are so small that it takes about 70,000 of them to cover a square inch, yet they are very large compared with the starch grains of the Lumière autochrome plate, and so, while the Thames screen has the advantage in the regularity and precision of its coloured spaces, the Lumière scores on account of the minuteness of the coloured particles.

It will be seen that the principle of the action of light upon this plate is precisely the same as that already explained in the case of the Lumière plate.

When taking a photograph with the Thames plate the coloured screen should be placed in the dark slide so that the film side is turned away from the lens; the special panchromatic plate should next be placed upon this, so that the film of the plate is on the film of the screen, and then the whole covered with a piece of black paper.

By this "separate" method there is, however, a great gain to the beginner, since, if on development the negative is found to be unsuitable owing to incorrect exposure, a second negative can be taken, and the loss is confined to the price of the panchromatic plate, as the screen can, of course, be used with a fresh plate.

The plates are, however, supplied with the coloured screen and sensitive emulsion on one and the same plate. This is not to be recommended for beginners, since a failure involves the loss of both plate and screen. There is, of course, in this a saving of time for those who are become expert with the plates, since the film being actually attached to the coloured screen, perfect registration must exist between the two.

In the "separate" method the negative must be used to obtain a positive, and then this bound in register with the coloured screen. This is not at all a difficult matter, for on looking at the screen it will be seen that at one end there is a single cross scratched and a double cross at the

other end. These are photographed quite plainly on the negative, so that if the colour screen which was used in the exposure is used with the positive made from the negative, all that is necessary is to place the screen and plate so that the crosses are in superposition. But a little thought will make it quite apparent that even these registration marks are not at all necessary. The screens being mechanically made, so that the circles and spaces are all of a definite fixed size, a little patience will enable one to obtain perfect register with a colour screen not used with the plate, since there must be many hundreds of such positions and a very slight movement will produce the required result. In such cases, however, great care must be taken to note the true value of the colours of the object, so as to be certain when the best position is obtained. Unless the beginner has a good eye for colour the more mechanical method is to be recommended.

One very great advantage of the "separate" method is that by its means it is possible to obtain duplicates of the photograph—in fact, the same negative can be used for obtaining any desired number of positives, each of which when bound in register with a colour screen will give a photograph in natural colours. When it is desired to use the negative for this purpose, it should be developed and fixed just like an ordinary negative. Any plate which gives good density like a lantern plate can be used for obtaining a positive by contact with the negative.

The "separate" method may cause a little inconvenience in those cases in which the usual dark slides will not accommodate the two thicknesses of glass, but this is not an insurmountable difficulty nor one which it is very expensive to overcome.

The "Combined" plate should be developed and reversed in much the same manner as the autochrome plates. Full instructions for these operations are issued with the plates.

There is one other point to remember in using these plates—that is, although the film is sensitive to the action of all light, yet the action of the blue-violet is still greater than that of other colours, hence a colour filter must be used so as to diminish this action to the level of the others. A yellow filter for this purpose is supplied at a cheap rate with the plates.

The “separate” negatives obtained by this means when looked at through a pocket lens will show a definite structure for the silver deposits, those brought about by the green and red lights being in circles, while those due to blue are irregular patches of the same shape as the spaces between the circles. These negatives may be used just like ordinary negatives for obtaining bromide or P.O.P. prints, for the positives so obtained will be found not to be by any means rendered useless owing to the presence of the screen pattern on the plate.

Jouglà Omnicolore Plates.—There is yet another process very similar to the two just described by which coloured photographic plates of natural objects can be obtained. This is by means of the *Jouglà Omnicolore Plates*. The coloured screen in this case consists of an enormous number of microscopic lines crossing one another so as to give rise to small squares. These lines are of three colours, blue-violet, green, and red, and are ruled by a mechanical process so that the squares are exactly touching each other, and there are neither blank spaces through which white light can act upon the sensitive film, nor yet do any of the colours overlap. The film used with this screen is, of course, one which is sensitive to all the rays of the spectrum. In all cases when using this kind of plate it is well to remember that the best results are obtained when the plate has been exposed to no light whatever, until such chemical operations have been performed upon the plate as to render the light harmless. Thus the makers recommend that the following operations should be accomplished in

complete darkness :—Opening the boxes, putting the plate into the dark slide, the first development, and the washing and immersion in the dissolving bath.

The plates should be placed in the dark slide, as has already been described for the autochrome plates. A special colour filter must also be used with the plates, and it might be pointed out in this connection that it is essential that in all cases these colour screens should be suited to the plates for which they are intended. Many of the cases of failure in which a false tint can be seen to dominate the whole photograph are due to the fact that an unsuitable screen (filter) has been used. The screen can be used with these plates either in front of or behind the lens, the focussing screen being arranged with its rough side outwards.

The exposure required with these plates is much longer than for ordinary plates; thus a well-lighted object requires from one to two seconds when using a lens working at $f/8$ in the middle of a summer day.

The following method of treating the exposed plates is recommended by the makers. The stock solution for the first development contains :—

Distilled water	. . .	1000 c.c.
Metol	4 gms.
Anhydrous sodium sulphite		50 gms.
	[or double quantity of crystallized]	
Hydroquinone	. . .	2 gms.
Anhydrous potassium carbonate	30 gms.
Potassium bromide	. . .	1 gm.
1 per cent. solution of sodium hypo-sulphite	15 c.c.

100 to 150 c.c. of this solution should be in readiness in the developing dish; the room should then be made totally dark, and the plate taken out of the camera, its film care-

fully brushed to remove any dust, and then placed into the dish. The development which takes place in this solution must be allowed to continue for five minutes, and, of course, produces a negative. Before commencing this it is necessary to have prepared a second bath in which the deposited silver can be dissolved. The stock solution for this is :—

Distilled water	.	.	1000 c.c.
Bichromate of potash	.	.	8 gms.
Sulphuric acid	.	.	12 c.c.

After developing, the negative should be washed for about twenty seconds and then put into a second dish containing about 100-150 c.c. of the second stock solution. The plate having been placed in this bath, while still in total darkness, the subsequent operation should be carried out in ordinary daylight if possible. The plate should be rocked while in this bath and should be kept in it about two minutes. It should then be removed and washed for about half a minute in order to get rid of the bichromate. After this operation place the plate again into the first bath which was used to develop it, and leave it there for about three minutes. In the second development all the bromide of silver which up to that time has been unattacked will turn black, and the negative will by this means be transformed into a positive. After this second development, and washing it in running water for half a minute, the plate may be fixed if desired by placing it for three or four minutes in a bath of the following composition :—

Water	.	.	.	1000 c.c.
Sodium hypo-sulphite	.	.	.	120 gms.
Sodium meta-bisulphite	.	.	.	30 gms.

After this it should be washed in running water for twenty to thirty minutes before drying. All the various baths should be used at an even temperature of about 65° F.

Although the silver which forms the image in the negative is removed when the plate is placed in the second bath, and the remaining silver bromide is reduced during the second development, and so no fixing should be required after reversal of the image, yet it is often better to run the risk of obtaining a slightly weakened photograph in order to be quite certain that all the unreduced silver bromide may have been removed.

The plates may be varnished so as to preserve their films, and it is also important that they should not be exposed to sunlight more than is necessary, on account of the action of the sun's rays upon the colouring matter contained. The same applies, only in a much greater degree, to the colour-filters used. These should be kept in special light-tight cases, and only exposed to light when required for use, as any change in their tint would greatly modify the results obtained.

Joly's Process.—J. Joly, in 1895, brought out a process in which the screen used was built up of red, green, and violet-blue lines alternate with one another. These lines were ruled with aqueous inks upon a glass support which had been previously coated with a thin layer of gelatine. This screen was a difficult one to produce on a commercial basis. A Chicago firm acquired Joly's patents and made an endeavour to produce such screens with 300 lines to the inch, but the cost of production was so high that the firm very quickly gave up the enterprise.

Still, as an example of the attempts which have been made to obtain coloured photographs by the exposure of only one negative, this process deserves mention.

The same procedure as to exposure and development applies to this method as to those already described. In the negative the different tints of the object photographed will be seen to have produced lines which vary in their degrees of opacity. Like the Thames Colour Plate, it was necessary to view the positive obtained by this

process through a coloured viewing-screen, but it differed from that plate in that the same screen was not used both for taking and viewing. The tints of the colours used in the two screens were slightly different, since those of the taking-screen were adapted to the plate, while those of the viewing-screen were suited to the eye, the reason for this being that the plates used were not sensitive to the various colours in the same relative degrees as the eye.

The number of lines per inch in the viewing-screen must be exactly the same as in the taking plate.

The viewing-screen had of course to be so adjusted that the colours were in perfect register with the corresponding lines on the positive, then the two plates could be bound together.

The plate so produced had to be viewed by transmitted light, and unless its image was projected upon a screen, the observer had to stand so that the rays of light which passed through the plate in a direction at right angles to its surface reached his eye, otherwise an incorrect colour rendering was the result.

The *Dufay Dioptrichrome Plate* is the result of still another attempt to supply the photographer with a means of obtaining photographs in natural colours.

The important difference between this and other screen plates lies in the method adopted to prepare the three-colour screen.

Warner-Powrie Process.—An interesting addition to colour photography has recently¹ been made by the combined efforts of Miss Warner and Mr Powrie of Chicago, and is known as the Warner-Powrie process. The method adopted by these inventors is the same in principle as the Joly process, but has not the same drawbacks from a commercial standpoint.

The coloured screen is obtained by calling in the aid of the bichromated colloid process, and a ruled grating

¹ *Photographic Journ.*, Jan. 1908.

in which the dark lines are double the width of the transparent intervening spaces. It has been found practicable to use such a grating with 600 lines per inch, hence much finer than anything attempted in the Joly process. When being used to prepare a screen, the grating is placed in the printing-frame, and the sensitive plate laid in contact with it. Exposure is then made to an arc light. The plate is then removed, developed in the usual way, and the line images in the insoluble colloid dyed up with green colouring matter. In this way one-third of the surface of the plate has been covered with green lines, and two-thirds still remain transparent. The plate is again coated with sensitized bichromated colloid, and the grating arranged so that the lines of the grating are in register with the green lines; and great care is required for this, since the lines of the grating are double the width of the coloured lines on the plate. After exposure and development as before, the red colour is applied to the plates.

The blue is finally added by a repetition of these methods, except that exposure is made through the glass of the screen, and then on developing and dyeing up it is found that the blue automatically fills up the remaining spaces. This screen is on the market, and is known as the *Florence Heliochromic Screen Plate*. This screen plate is coated with a panchromatic emulsion, and thus a means is provided of obtaining a coloured photograph by making an exposure, just as would be done in the case of any orthochromatic plates.

Two varieties of plates are to be provided; those for obtaining negatives in colour will have the lines running in a lengthwise direction, while those intended for the production of coloured positives are to have lines running parallel to the shorter side of the plate, thus enabling one to automatically place the plates in the correct position when obtaining a colour positive from a colour negative.

The negatives obtained can be made use of to obtain a set of positives for three-colour work as follows:—

In making one of these positives a panchromatic plate is placed in a special printing-frame with its sensitive film upwards; a thin sheet of glass or celluloid is then placed in contact with this film, and on this is placed the negative with its film side down. The glass side of the negative is placed facing the light. Exposure must be made to monochromatic light, and so the arc light, if used, must be filtered through a suitable screen. Suppose green light is in use; then, if the arrangements are so made that the rays of light are parallel and striking the surface of the negative at right angles, since only one-third of the screen-plate filter-surface consists of green bands, only one-third of the sensitive film will be affected. Now, when the source of light, or printing-frame, is moved a little to one side, so that the light strikes the face of the negative obliquely, a fresh part of the sensitive film of the positive will be exposed, and by making the exposure with the light, first on one side then on the other, after placing it in the central position, a full-tone positive in any one of the three colour sensations can be produced. The amount of movement made for the above need not be at all accurate. If three sources of parallel light can be used at once, then when two are arranged, one on the right, the other on the left, so that their light strikes the plate at small angles with the vertical, and the third placed directly in front of the plate, only one exposure is necessary.

In this manner all three positives can be produced by using suitable light-filters. The negative may, if desired, be also used for printing a colour positive, in which case a positive screen plate must be used in the place of the panchromatic plate, and the negative must be illuminated by white light. The film of the negative should be in contact with the glass of the positive plate,

and three exposures made, or three parallel beams of white light used. No cross-line pattern appears on the positive, owing to the exposure through the two screens.

There are some interesting applications of the use of a bichromated gelatine and suitable dyes, in order to obtain a coloured print on paper.

Pinatype Process.—One of these, the *Pinatype Process*, depends upon the fact that certain dyes are not so easily washed out from bichromated gelatine when it is soft, as when it has been hardened by the action of light.

In this process three negatives are obtained, as is usual, by means of orthochromatic plates and the proper filters. Next, since the dyes used have a selective action upon the gelatine, only adhering to the unexposed parts, positives must be made from these negatives. Good lantern-slide plates will do for this purpose, but of course enlarged positives could be made if desired.

Under these positives, plates coated with gelatine which has been sensitized by means of a two per cent. solution of a bichromate salt are exposed. The plates so obtained are washed so as to free them from the bichromate, and then dyed as follows:—

The plate obtained by using the transparency made with negative produced with red filter is stained blue, that with green filter is dyed red, and that with blue filter, yellow.

When the plates are thoroughly stained, gelatinized paper is well soaked in water, and then squeegeed to one of the dyed plates and left ten or fifteen minutes. The blue-dyed plate is used first, the yellow one next, and lastly the red. If it is found that any one colour is too faint, it can be strengthened by again squeegeeing the print on the corresponding dyed plate, or if it is found to be too strong, then some of the dye may be removed by squeegeeing the paper down to a gelatine-coated plate.

The dyed print plates can be used for obtaining coloured pictures on paper over and over again.

After the print is finished it is advisable to immerse it in a fixing bath, since this hardens the gelatine and makes the colours more permanent.

Transparencies in colour can be made if desired. In this case a glass is coated with a bichromated gelatine, and this when dry is exposed under one of the positives, washed, and stained up in the corresponding dye; the plate again coated and exposed under a second transparency, washed and stained; and similarly for the third, unless it is desired to make the yellow image on a second prepared plate, and to use this as the cover glass.

Imbibition Process.—Another process somewhat similar in principle is known as Sanger Shepherd's *Imbibition Process*. The positives for this are printed upon a celluloid film coated with gelatine containing silver bromide, the gelatine being sensitized with potassium bichromate. Thus, in this process, use is made of the relief surface of hardened gelatine obtained by developing such a film after it has been exposed under one of the three negatives.

When the positive film has been exposed and developed in warm water, the white bromide of silver which remains is removed by hyposulphite of soda. Three positives are made, one from the negative obtained with the red colour-filter, one with the green, and one with the blue. These are next dyed up; the print from the green negative being placed in a pink dye, the one from the red in a blue dye, and that from the blue in a yellow dye. Now it is known that if a gelatine relief stained with a suitable dye-stuff is squeegeed in contact with a damp sheet of gelatinized paper, the dye will leave the harder gelatine surface and adhere to the softer gelatine coating on the paper. Hence after this operation the positives are squeegeed in the following order on to the surface

of a sheet of paper which is covered with a thin coating of gelatine; pink-dyed positive, yellow-dyed positive, and lastly the blue-dyed positive: all three being of course in perfect register a colour photograph is obtained.

BOOK ILLUSTRATIONS

WE have already dealt at some length with a few of the methods employed to produce illustrations for books. These can be found in the chapter on the "Photographic Importance of the Chromium Compounds," and will be found to include many of the processes which were in use some few years since. In the present chapter it is proposed to deal with one or two of the up-to-date processes, paying special attention to the part played by photography in such cases.

Process Studio.—In any process works the studio now forms one of the most important departments. In this studio there must be ample room for the large cameras which are used, and also for the arrangement of the stands upon which the objects or copy to be photographed are placed. Next, there must be a good supply of dark rooms, which it is absolutely essential to keep scrupulously clean.

It is now the usual custom to obtain the necessary illumination of the object which is to be photographed, by means of powerful arc lamps. Such a lamp is illustrated in fig. 105. This lamp is suitable for use with voltages of between 100 and 150, and currents of between 10 and 12 amperes.

One of these lamps is arranged on either side of the copy and so adjusted as to secure an absolutely uniform intensity of light.

The cameras in use in such establishments are sufficiently different from those in common use to justify a few words in their explanation.

The front of such a camera is shown in fig. 106, the optical attachments not being in position; in fig. 107 the

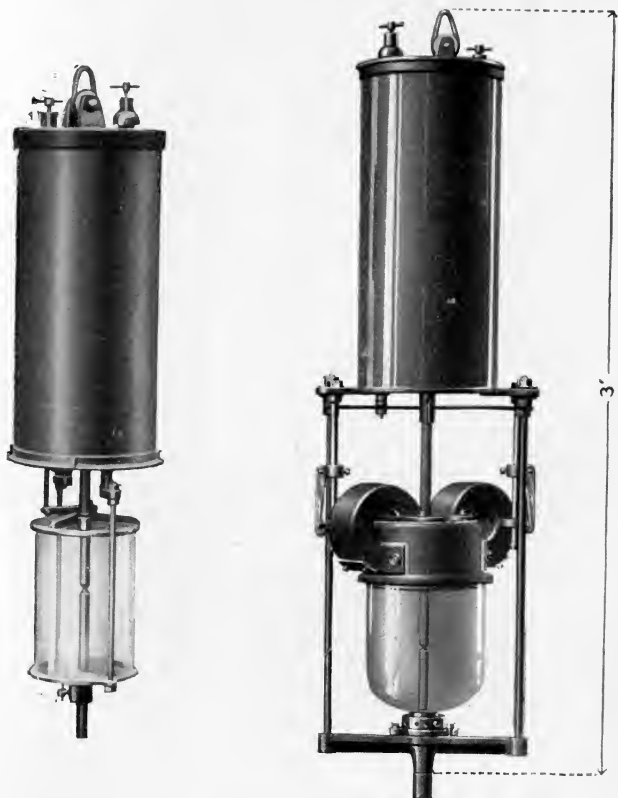

Fig. 105.
Types of Lamp used in the Process Studio.

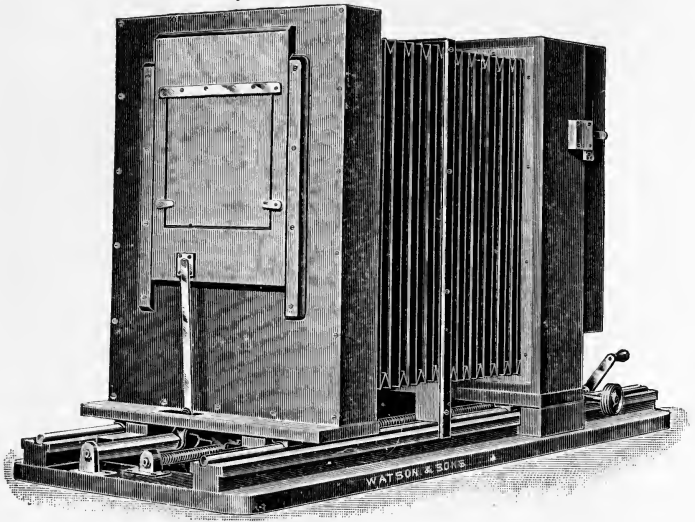

Fig. 106.

Process Studio Camera—Front.

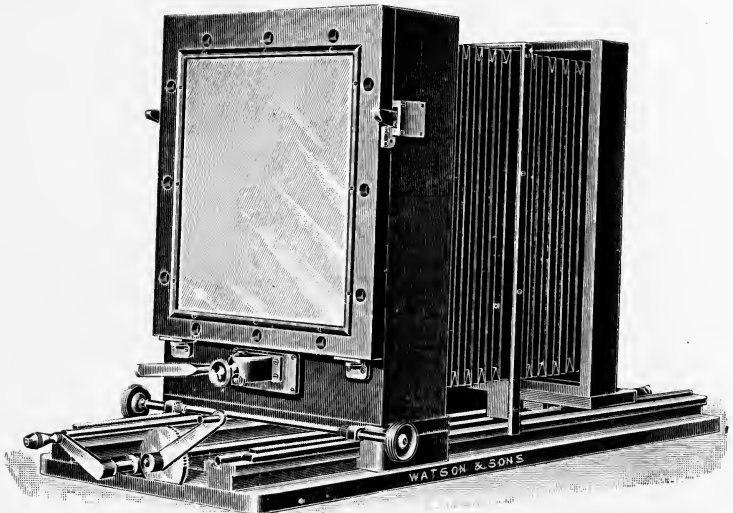

Fig. 107.

Process Studio Camera—Back.

back of the camera is illustrated. All such instruments must be made of exceptionally well-seasoned wood, and the greatest care is always taken in the construction, so as to ensure the parallelism of the front and back parts of the camera. The rising front of the camera can be worked from the back by means of the attachments shown in the two figures. In the branch of photography for which these cameras are designed it is customary to work with wet plates, hence the dark slide is of special construction, some provision usually being made to avoid damage done by drainings from the wet plate. Then again it is often necessary to use a ruled screen through which the light must pass before reaching the sensitized plate, thus arrangements for holding this screen have to be made in the camera back.

The peculiar appearance of the camera front is due to the fact that it is usual to reverse the image of the object before allowing it to fall upon the plate. The lens is therefore detached from the camera, and an arrangement made so that the light, after passing through the lens, is allowed either to fall upon a plane mirror, the plane of which is placed at 45° with the path of the rays of light, or to pass through a special reversing prism.

This of course brings about a considerable loss of light and necessitates a longer exposure. To lessen the ill effects of this, prisms and lenses have been constructed of special glass, which allows a large amount of the ultra-violet light given out by the arc lamps to be transmitted to the plate.

The stands to which the camera and copying easel are attached must be so constructed as to annul as far as possible any ill effects due to vibration. It was a very common practice to overcome this difficulty by the adoption of swinging stands, but these are being largely superseded by strongly constructed stands, the bed portion of which rests on spiral springs to obviate any

vibration. The camera carriage attached to such a stand is so arranged that the camera can be used direct for copying, or can be turned into a position at right angles to this direct position when it is necessary to use a prism. Such a stand without the camera is shown in fig. 108.

Half-Tone Process.—We will now try to trace the steps by which a process-block for a half-tone illustration is prepared.

It will be necessary first of all to explain what is meant by a half-tone illustration. In making a block from a photograph or other picture in which there is a well-marked gradation of light and shade, it is necessary to break up the half-tones and lights into distinct parts by dots or stipple, so as to be able to reproduce them in the press, and the best means of doing this furnished food for thought for many workers until the line screens were invented. It will be instructive to consider the attempts made in this direction, and it will be well to do so by referring to them in their historical order.

The idea appears to have originated with Fizeau 1842, but it was Fox Talbot who was the real father of the process. He used what he called a photographic veil, which was composed of two or more thicknesses of crape or gauze. His work on photographic engraving appeared in 1852. In 1854 Pretsch made use of the reticulation of the gelatine for the same purpose.

Berchtold, between the years 1854 and 1859, was the first to make use of crossed rulings. His method was somewhat analogous to that afterwards adopted by Meisenbach, in that he used a single line-screen with equal parallel spaces and lines, but in his case the ruling was applied directly to the print. In 1860 Asser used starch, and in 1865 J. W. Swan used gelatine mixed with charcoal or other fine powder of a chemically inert nature, and in the same year specifications were also published by

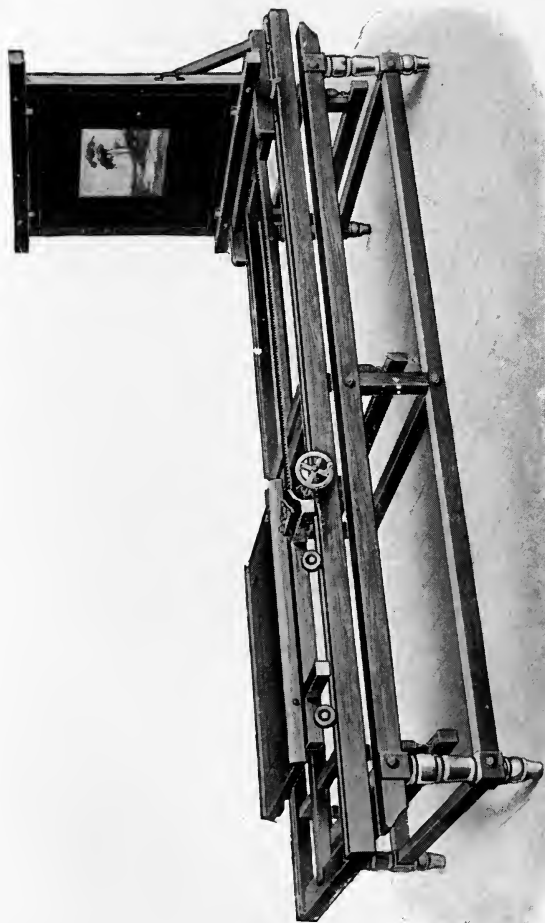

Fig. 108.

Copying Easel and Stand as used in the Process Studio.

E. and J. Bullock for methods of obtaining a grain. J. W. Swan was also one of the first to use a cross line screen for photo-engraving. About the same time (1867) similar methods were being experimented upon in Berlin and Paris, but in all cases the results obtained were very crude, on account of the coarseness and irregularity of the rulings.

In 1873 Mr Woodbury patented a process in which use was made of a screen for producing half-tone blocks ; this screen was obtained by photographic reductions of nets. In 1882 Meisenbach brought out his method of using a single line-screen, this screen being turned during the process of exposure into a position at right angles to its original position. The screen was kept for half the exposure in one position, and for the other half in the other position. This proved to be a very great advance upon any of the previous attempts, and in fact has formed the basis on which all modern ruled screens have been developed.

The great defect of the early cross-line methods was that they were all placed in contact with the object which was being photographed. As this was the case, it will be readily understood that the diffusion and diffraction effects, upon which the screens which are now applied at a short distance in front of the sensitive film rely for their success, were entirely absent. A good many of the more recent improvements in ruled screens have been due to the ingenuity of Max Levy.

The modern screen consists of a net-work of lines, the fineness of the lines varying in different screens. A system of equidistant parallel lines is ruled on each of two pieces of glass, these pieces of glass being afterwards cemented together in such a manner that the parallel lines cross one another.

The distance which the screen is placed from the film is very important, and is a question which must be

settled by experience ; it is the rule, however, to place the finer screens nearer the plate, also the less the camera extension the nearer the plate must the screen be placed.

As before stated, the fineness of the lines varies very much in different screens. The better the paper on which the print is to be made and the more finished the picture it is desired to produce, the finer must be the screen ruling. For the very rough kind of illustrations in common use in some newspapers, screens with 60 to 80 lines per inch are quite fine enough, while for good book illustrations, screens having from 150 to 200 lines to the inch must be used, and these by no means represent the finest grade of this kind of work.

A good deal of controversy has taken place on the theory of the action of these ruled screens. The most generally accepted view is that each little space of clear glass which lies between four of the crossed lines of the screen, acts in forming an image upon the plate just as does a pinhole in the pinhole camera.

This explanation is questioned by some authorities, but space does not permit of a detailed account here.¹

Some idea of the building up of the picture from the effects of the light received through the little spaces of the screen may be obtained by looking carefully at a half-tone illustration through a small hand-lens (see fig. 109).

In the high lights it will be seen that there are a number of very tiny dots, any suitable neighbouring four of which will be easily recognized as forming the corners of a square. In the half tones these dots become larger and spread out into the square, while in the darker shadows it may be almost impossible to pick out the individual black dots, and unless a more powerful lens is used, all that appears is an even black tone with here and there a clear white dot.

¹ *Photographic Journ.*, Feb. 1908, p. 77.



60

Line Screen.—Will print well on almost any cheap paper.



120

Suitable for illustrated weeklies, advertisements in trade papers and work of not too fine a nature.



133

More used than any other screen being fine but printable on any coated paper used in good magazine or commercial work.



150

Requires good paper and ink, and best conditions in printing.

The correctness with which this half-tone dot is formed depends not only on the fineness of the screen used, but also on the size of the diaphragm and the camera extension.

The copy for reproduction with the half-tone process may of course be a photo or even a wash drawing. It is, however, often necessary to touch up the copy by working upon it in colour; this may either be done by hand brush work, or as is now more often the case by what is technically known as the air brush. This air brush consists of a mechanically worked pump which is used to force tiny jets of colour from a very small hole. The size of the jet can be varied by altering either the air pressure or by valves, and the effect on the plate can be changed by altering the distance of it from the jet.

The glass which is used as a support for the film of the negative must be perfectly clean. The collodion which is required for coating the plate can be purchased already prepared. The sensitizing bath for this work should contain not less than forty grains of silver to every ounce of distilled water, and it is very important that the silver bath should be kept up to its proper strength. After coating the plates with collodion, they are immersed two or three minutes in the silver bath, after which they are ready for use.

This preparation of the sensitive plate must of course be performed in a specially darkened room. The amount of light admitted may be much in excess of that allowed when dry plates are used, since these wet plates are not so sensitive to light, but great care must be taken to admit only such light as is chemically inactive. This is done by covering up all sources of light with a suitable yellow screen.

The negative is developed with ferrous oxalate developer, and fixed by means of potassium cyanide. The negative must next be intensified, after which it is rinsed and then dried.

As the collodion film is so extremely delicate when dry, it is often found advisable to protect it by giving it a coat of varnish.

The next process is the preparation of the zinc or copper plate from the negative so obtained.

Zinc plates suitable for this work can be obtained either in large sheets from which plates can be cut as required, or plates the exact size may be purchased if desired.

Both the copper plates and the zinc plates must be quite clean before they are coated. It is usual to use pumice powder for this purpose with the zinc plates, and charcoal or very fine whiting for the copper plates.

Nearly all the line work is done on zinc plates, but much of the half-tone work is done on copper; again, the coating used for the plates is usually one of albumen for line work, while fish glue is substituted for this when the plate is for half-tone work.

Before the plate can be successfully coated it must be given a slight grain in order that the coating solution may flow evenly over its surface. For this purpose the plate is placed in a solution composed of about a pint of water, a half ounce of saturated solution of alum, and about a dram of nitric acid. When removed from this solution, in which it should have been kept about five minutes, the large wooden tray in which the operation is performed being rocked to and fro, the cleaned surface of the plate should have a fine frosted appearance.

After removal from this bath the plate should be carefully rinsed, any impurities sticking to the cleaned surface being removed by means of a little mop of cotton wool.

Suppose now the plate is to be coated with albumen, then for this purpose the whites of eggs are used, and this is made sensitive to light by the addition of a solution in water of ammonium bichromate, to which ammonium

hydrate has been added drop by drop until the whole turns a bright yellow colour. When this prepared albumen is poured over the plate, the plate must be whirled so as to get an even layer, and it is usual to coat and whirl the plate twice. The coating is dried by whirling it over a not too hot flame or stove. It may be taken for granted that it is not being heated too much if it can be held in the hand. The film on the plate is now sensitive to light, hence the operations must be performed in a yellow light.

The printing-frames used for exposing these prepared zinc and copper plates to light under the negative have to be of an especially strong construction, for it is absolutely essential that the prepared plate and the film of the negative should be in intimate contact. A printing-frame of this description is shown in fig. 110.

A thick piece of plate glass is first placed in such a frame, then the negative from which it is desired to obtain a print on the prepared metal, then the metal sheet, and lastly a backing of paper, the whole being finally firmly screwed together. The time required for an exposure will of course depend upon the light, the negative, and the nature of the subject, *i.e.* whether line or half-tone; and it may vary from a minute or two up to half an hour.

When the print on albumenized metal comes out of the frame, it is just possible to distinguish a very faint outline of the image. It is at once rolled up with some special transfer ink which has been thinned down with turpentine, and when a uniform coating is obtained it is dried.

The next operation is the development of the image; this is done by placing the plate into a dish containing cold water and working upon the prepared surface with a small mop of cotton wool. By this means all the parts which have been unacted upon by light will be

dissolved away, and the ink covering the albumen on which the light has acted will represent the image. When all the details are apparent the development is complete; the plate should then be rinsed and placed on one side to dry.

Should some of the lines of the negative be missing upon the zinc, then it is a clear proof that there has not been satisfactory contact in the printing-frame. If the finer lines wash out when the plate is being developed, then the exposure has not been sufficiently prolonged; on the other hand, if a good portion of the surface refuses to part with the ink so that the finer details are covered up, then the exposure has been too long.

The plate has finally to be *etched* by means of a dilute solution of nitric acid, but albumen does not resist the action of this acid to a sufficient extent to enable one to at once proceed with the etching. It is, therefore, necessary to first "bake in" the plate with a very fine bitumen powder.

When glue is used in the place of albumen the various processes in the preparation and printing are very similar to those just described. The plate is first of all placed on a whirler, a small quantity of the glue is poured into the middle of the plate, which is then whirled round so that the superfluous glue is carried off as the whirling goes on. It must be very specially remembered in this case, however, that if the glue is allowed to get too hot during the drying processes it will be found impossible to develop the print. After exposure the metal plate is placed in an aniline dye so that its subsequent development with water can be easily watched. In order that the glue may be able to resist the etching it must be turned into a kind of enamel. This is done by simply burning in the glue, by holding the plate over a gas flame or hot plate. During this process care must be taken not to char the glue. The dye now also burns away and the plate goes to a very white tint. Afterwards on

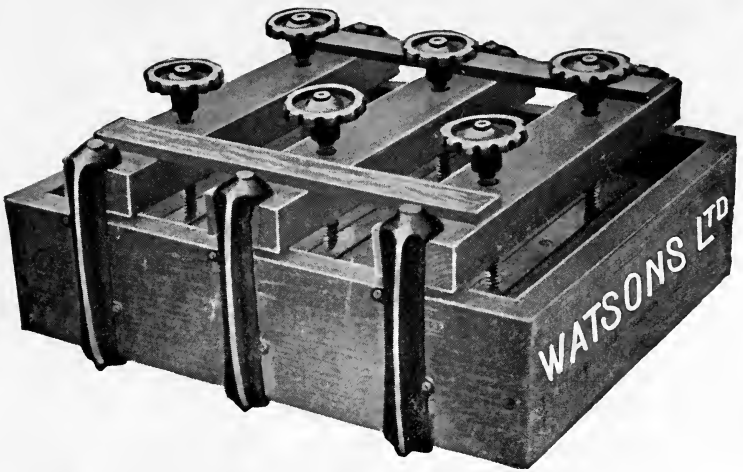

Fig. 110.
Printing Frame as used in preparing zinc and copper plates.

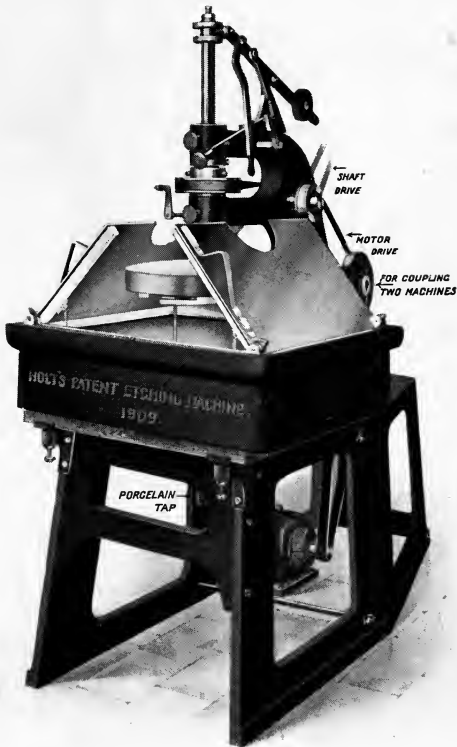

Fig. 111.
The Holt Etching Machine.

cooling, the copper first assumes a pale yellow colour and finally becomes almost chocolate coloured.

There is often a slight scum of glue which it is necessary to get rid of at the end of this "burning in" process. This is done by subjecting the plate to a cleansing solution composed of one dram of chromic acid, one dram of sulphuric acid, and a pint of water. The plate is then ready to be etched. Should it, however, be desired to make any portion a solid black, then the corresponding part of the plate must be suitably painted before the etching is commenced.

This, as before stated, is done by subjecting the plate to the action of dilute nitric acid. Formerly this process was performed by placing the plate in a trough containing the acid and rocking to and fro for a few minutes, the operation being repeated until a satisfactory result was obtained.

At the present day, however, when so much depends upon saving time, it is not surprising that machinery should have been called in to help in this direction. One of the most recent and likewise most satisfactory of these machines is that shown in fig. 111. This "Holt Etching Machine" occupies the extremely small floor space of about 16 square feet, and requires only $\frac{1}{8}$ horse-power when in motion. The part at the top of the table, with raised lids, contains the etching solution, and this solution is kept in constant motion by means of paddles attached to a motor-driven spindle. These paddles are so arranged that the acid is kept in constant motion, but the plates which are placed in the bath remain in precisely the same position the whole time. The "floating board" upon which the plates are placed measures 26 inches by 20 inches. This board rises automatically to the surface when the machine is opened, and by closing the lids the board with the plates is forced beneath the etching fluid. The machine is simultaneously set in motion causing the disc

to revolve rapidly. The acid can be removed from the bath by means of the tap seen beneath the table. The whole operation of etching by this process takes only about two minutes, and it will be found that the plates have been etched quite evenly with a good direct downward etch. It is worth noting that there are no metallic parts of the machine in contact with the acid.

Scientific Diagrams—Line Drawings.—For the reproduction of scientific diagrams, and all other drawings in which the picture is built up of distinct lines and dots, it is not necessary to use the half-tone screen. Such illustrations are known as line drawings. Since this is so, a word or two on the preparation of such copy will be useful. The paper used should have a pure white, smooth surface, so that the amount of reflection may be just correct. As these drawings have often to be sent through the post, it is advisable to use cards of medium thickness so as to avoid errors, etc., due to doubling up the copy. It is, of course, by this time understood that some colours can be photographed with much shorter exposure than others, hence whatever colour is adopted should be used throughout the drawing. The best substance to use for drawing the lines is Chinese ink; this gives a good black line which does not increase the difficulty of the photographer by giving an undue amount of reflection. If it is wished to shade in any part of the drawing, this must be done by strong fine lines which must always be kept quite distinct from one another. Should these lines be placed so close together that the amount of white shown is very small, then, if as is usually the case, a reduced photograph of the copy is taken, a solid black tone will be the result. When dotted lines are used, each dot must be separate and distinct, while again in cross-hatching, the lines when running in the same direction must be carefully drawn so as to be separate throughout their entire length. On this account they must not be drawn too closely to-

gether, and great care must be taken not to smudge the ink from one line to another. As far as possible it is also best to avoid trying to erase any marks, since such attempts usually produce effects resulting in smudges which look very bad in the illustration.

When the design of a border is very complicated, it is not always necessary to draw the whole of the border. If sufficient is drawn to enable the printer to easily see the order of the design, he will be able to make up the complete border if a rough drawing of it be submitted at the same time.

The Three-colour Process.—One of the most instructive and interesting of the processes used for book illustration is that known as the “*three-colour process.*” This is more particularly so from our standpoint, since the success of the process depends upon the correct use of ortho-chromatic plates and colour-screens, and in the last year or two colour photography has also played a very important part in this work. The spectrum colours, red (vermilion), green (emerald green), and violet (blue violet), are often spoken of as *primary light colours*, since by the combination of these three colours it is possible to produce any of the various tints.

Now we must consider that while the sum of the three primary light colours produces white light, we have quite a different matter to deal with in the case of pigment colours. When one colour is printed on the top of another, we perform in reality a subtraction process so far as the light reflected is concerned.

The so-called primary pigment colours which are used in the colour process are secondary, so far as the light reflected by them is concerned, for each is built up of two primary light colours. Thus, magenta or crimson is composed of the primary colours red and violet, primrose yellow consists of green and red, and lastly blue or cyan-blue is built up of green and violet.

Now suppose a pull from a yellow block has been made on pure white paper, then, instead of the three primary light colours being reflected in equal proportions, only a mixture of green and red results. When on the top of this a magenta colour is printed, since this can reflect only red and violet, the green from the layers beneath will be suppressed.

Finally, should a blue be printed on the top of the other two colours, the result would be simply a deep black, for this blue can only reflect the green and violet rays, and the substance on which it is placed has absorbed these rays, so no reflection of light takes place.

This is what would happen if the pigment colours used were perfect, and each was printed to its full strength.

Printers' inks, however, leave much to be desired, although with the best obtainable some excellent results are now produced with only three workings, in fact, so much so, that it is very seldom that a large number of workings are now resorted to, although in days gone by this was the method adopted to produce coloured illustrations.

A good ink for this purpose must not only be of the correct colour and body, but the pigments which produce that colour must be of a sufficiently transparent nature to allow the effects of former workings to be seen.

In order to ensure the building up of effects, the reflecting power of the colours should be as high as possible.

If white light is spectroscopically examined after passing through a very thin layer of an ideal coloured printing ink, only two-thirds of the spectrum should be visible, the light rays producing the colours making up the remaining third having been absorbed by the ink.

The three regions absorbed by the three ideal inks should of course just make up the complete spectrum without any overlapping. We may thus consider that

the yellow pigment absorbs the blue rays, the magenta pigment absorbs the green, and the cyan-blue absorbs the red.

Let us now briefly trace the processes necessary for the production of a three-colour illustration of some subject which can only be viewed for a relatively short time.

Two methods of obtaining a representation of the "colour value" of the subject are open to us. The first is to use orthochromatic plates and take three photographs—one using a red screen and a plate which has been sensitized for red rays; a second using a green screen with a suitably sensitized plate; and a third using a violet screen, also with a special plate. This would necessitate three exposures, and although even when using colour filters the time of exposure is very small, still the colour value of the subject depends upon the light which it receives, and this is liable to alter owing to atmospheric changes.

Until the invention of the autochrome plates the above was the method adopted. Now, when it is possible to obtain such excellent representations of nature by the Lumière autochrome process, it is much better to take a photograph, using one of those plates. Then from this plate, under conditions in the studio which can be perfectly regulated, the three necessary negatives are obtained by the use of the proper plates and colour-screens (filters).

These colour-filters must be of the proper value to ensure the best results, and this is by no means an easy matter to arrange.

It is assumed that the camera has been arranged with a suitable half-tone screen when used in the preparation of the three negatives.

Blocks are prepared from the three half-tone negatives in the manner already described. The negative prepared with the red filter will be employed for the block which will be used to print the colours reflecting all the rays of

the spectrum except the red, that is, green and violet. The negative obtained with the green filter will similarly be used for the block intended for printing with the magenta ink, while the positive block made from the negative photographed when employing the blue filter will be used to obtain the yellow.

The reason for this is as follows. The light received by the plate sensitized for red light is obtained through a red filter, hence only the red rays of light proceeding from the copy produce any deposit on the plate. When this plate is used for printing on the prepared copper, those portions of the glue which are under the parts of the negative affected by red rays will be uninfluenced by exposure to light, and will be dissolved away when the plate is developed. Hence the image obtained is not one of the red part of the object, but of those parts which emit other rays than the red, viz., the green and violet.

When all three blocks are ready the printing must be first of all performed with the yellow ink, next with the red, and lastly with the blue. The six accompanying illustrations will show how the picture appears after each of these operations, and will also make clear that very beautiful work can be produced by the use of inks of three colours only.

Collotype.—One other method of producing very beautiful pictures, but without the aid of the half-tone screen, must be briefly mentioned: this process is known as *Collotype*. Negatives are prepared from nature as previously described, but without the half-tone screen, and then prints are made from these upon films of bichromated gelatine which have been placed upon plate glass and dried. Such a film is found to have the ability to take up ink just in proportion to the action of the light upon it during the exposure. The negatives for this kind of work must possess well-marked gradations from the deepest shadows

Black Impression
of
Yellow Plate.
Fig. 112



1st Working,
Yellow.
Fig. 113



2nd Working,
Red.
Fig. 114



BLOCKS BY
JOHN SWAIN & SON, LTD.
LONDON.

The above impressions shew the order of



Shewing
Progressive Red
over Yellow.

Fig. 112a



3rd Working,
Blue.

Fig. 113a



Finished Print.

Fig. 114a

ng when printing from Tri-Colour plates.

to the highest lights, and must be by no means hard ; also all negatives must be reversed.

In the preparation of the prepared glass plate an oven must be used in which the film can be dried while the plate is kept in a level position, and also kept absolutely free from dust particles. It is the practice to give the plate glass a preliminary coating of albumen or some similar substance in order to hold the sensitive film down on the plate during the printing operations. Before putting on the sensitive coating of bichromated gelatine the plate is placed in a horizontal position, warmed to a temperature just over 100° F. After coating with the albumen it is again dried, artificial heat being used, the temperature for this operation being varied to suit the particular kind of gelatine employed

The plates are ready for use as soon as the gelatine is dry, but, on the other hand, with care they may be kept well over a week without undergoing any deterioration. Of course the drying must be done in the dark room, and if kept the plates must be left in the dark.

The collotype plate itself is to be used in printing, hence great care has to be taken in order that only that part of the gelatine which is necessary to form the picture remains on the plate. For this reason, previous to the exposure the negative must be masked in such a way that no light will penetrate to the gelatine through the negative except it goes through the picture. The printing-frame for collotype plates must be of the strong heavy kind already described. A paper mask is first laid on the thick plate glass, then the negative carefully placed on the mask, and lastly, the collotype plate placed upon the negative and the frame firmly closed.

It is generally best to allow the exposure to take place in diffused light. When the exposure is complete, the image will appear on the plate as slightly brown upon a yellow ground.

To develop the image all that is necessary is to remove the unnecessary parts of the bichromated gelatine by the continued application of cold water.

The collotype plate so obtained must next be prepared for the printing-press by first removing from its back any stray gelatine, and then subjecting it to the so-called "etching process," which must not be confused with the "etching" already dealt with in connection with zinc and copper plates.

In this case the surface of the plate is exposed to the action of a solution made up of one ounce gelatine, 2 ounces water, and 2 drops of ox gall, for about half an hour.

When this solution has been removed by means of a sponge, the plate is placed upon the bed of the press and the film dried with a soft cloth, after which it can be inked up by using leather rollers slowly and with gentle pressure. If the plate has been properly prepared, shadows will first take the ink and then the half-tones, while the high lights should remain almost, if not entirely, free from it. It is usual to make use of a second roller with ink slightly less thick, and rolled with less pressure and more quickly, as this is found to be a very effective manner of removing surplus ink. After placing upon the plate the necessary mask, it is now ready for the printing process.

It can readily be conceived that paper suitable for this process must be of the very best quality and have a smooth surface. The frontispiece shows an illustration prepared by this process.

ASTRONOMICAL PHOTOGRAPHY

Introductory.—Writing to the *New Princeton Review*, vol. iii. No. 3, 1887, C. A. Young said: “Probably it would not be too much to say that the instruments of ‘the New Astronomy,’ the camera, the spectroscope, and the bolometer, either or all of them, can possibly increase the range and power of astronomical research as did the telescope. But their effect is already so powerful that a transformation of the science is going on before our eyes, fairly comparable, in kind at least, with that which occurred in Galileo’s time. Fifty years ago the main strength of astronomical investigation converged upon the positions and motions of the heavenly bodies; the meridian circle and the micrometer were the principal instruments, and the theoretical astronomer confined his discussions to the equations of motion.

“Observations and work of this sort no longer occupy the proportion of time and thought as formerly. Questions relating to the physical phenomena of the heavenly bodies, to their temperature and brilliance, their chemical constitution, and the condition of the matter of which they are composed, are now under examination. . . . It is certainly not too much to say that inquiries of this sort receive to-day fully as great an expenditure of labour, time, and thought as the older work of position observation, and they are pursued with even a heartier zest. Among the newer methods of astronomy, photography just now occupies the most conspicuous place.”

How true these words of Young have proved to be

will be seen by a perusal of the following very brief account of the use of photography in this branch of science.

Why Photography is useful in Astronomical Work.—There are several very important reasons why the use of photography has become so general in astronomical studies. In the first place, the sensitive plate will accomplish in an extremely short time that for which an artist would require many hours, and the astronomical objects are often such as very rapidly alter in detail. Hence this seems the only reasonable way of obtaining a series of views showing the changing appearances of the heavenly body concerned.

Then again, although, even after all the necessary precautions are taken, the photographic plate will not be absolutely panchromatic, yet it will be free from bias and will not suffer in any way from optical illusions such as only, too often, affect the work of the observer; while lastly, it may fairly be said that it would be next to impossible to represent by any other means the minute details and delicate shades of difference in nebulae and comets.

But perhaps one of the most important applications is due to the fact that the action of light upon the plate has a cumulative effect. When a person looks through a telescope, all the stars which can be seen by its aid become visible at once; no amount of careful, continued watching will help the observer to see more stars; on the other hand, the eyes may tire and so even less be seen. Now, with a sensitive plate, just the reverse is true. Each beam of light received adds its portion to the general effect, and so although the light received from a faint star may not visibly affect the plate if only exposed for one minute, quite a different result may be obtained if the exposure is doubled.

Thus it is that by the aid of photography many millions

of stars have been discovered, which are too dim to be seen even with the most powerful telescopes.

Telescopes employed in Astronomical Work.—The telescopes used in astronomy are of two distinct kinds, Reflecting and Refracting. The former is generally known as a reflecting telescope or a reflector; this is much the simpler of the two, and as a rule much less expensive. It consists essentially of a concave mirror turned towards the object, and this mirror forms in the air space in front of itself an inverted image of the object.

To use this for photographic purposes it is apparent that in order to record the image, either the plate must be somehow or other supported in front of the reflector, or else a small reflector must be arranged so as to throw the rays out to one side, or to reflect them back through a hole in the centre of the large mirror.

In the former instance the telescope is known as a Newtonian Reflector, and in the latter as a Cassegrain Reflector.

With both types the centre of the main reflector is of course quite useless so far as the formation of the image is concerned. One of the largest reflectors yet constructed is the 60-inch at the Mount Wilson Solar Observatory, U.S.A.

The Mount Wilson 60-inch Reflector.—This instrument can be arranged as a Newtonian and as a Cassegrainian for purposes of direct photography; and as a modified Cassegrain type — Cassegrain-coudé — for spectroscopic work.

When arranged as a Newtonian, it can also be used for spectroscopic work, with a spectrograph carried at the Newtonian focus. The focal length is then 299 inches. When used as a Cassegrainian for direct photography, it has an equivalent focal length of about 100 feet, and when used for spectroscopic work its equivalent focal length is about 80 feet.

Even these very large dimensions are dwarfed by those obtained when this telescope is arranged as a Cassegrain-coudé for spectroscopic work. The spectrograph used is of very large size, and is mounted on stationary piers in an underground pit, which can be kept at an absolutely constant temperature, a very necessary arrangement where such large apparatus is used, if distortion of the image is to be reduced to a minimum. In this case the equivalent focal length reaches 150 feet.

The large 60-inch paraboloidal mirror of this telescope has a focal length of 299 inches, is $7\frac{5}{8}$ inches in thickness at the edges, $6\frac{7}{8}$ inches in thickness at the centre, and weighs 1900 lbs.

All the mirrors are polished approximately flat on their backs, and when in use are silvered on their back as well as on their front surfaces, so as to ensure a symmetrical temperature effect.

So as to avoid any ill-effects due to the strain inevitable when such large masses are moved, a good portion of the weight is borne, not on the axis, but by a float in mercury. At the upper end of the polar axis is a large flange to the lower side of which is bolted this float, which is a very rigid hollow disc of steel boiler plate, 10 feet in diameter, 2 feet deep, weighing 8600 lbs. To the upper side of the flange of the polar axis is bolted the fork between the arms of which the great tube of the telescope swings in declination on nickel steel trunions 7 inches in diameter. The fork itself is made of cast-iron and weighs 10,400 lbs. These enormous parts are clamped firmly together by twelve nickel steel bolts, each $2\frac{1}{2}$ inches in diameter and 3 feet long, so as to give great strength and rigidity at a region of the mounting where the greatest tendency to flexure occurs.

The float dips into a cast-iron trough which nearly fits the float, leaving a space of $\frac{1}{8}$ inch only all round. This

space is filled with mercury, 650 lbs. of that element being required for this purpose.

The immersed part of the float gives a displacement of about 50 cubic feet of mercury, thus carrying about $21\frac{1}{2}$ tons of the moving parts of the telescope in the fluid, and relieving 95 per cent. of the weight on the large bearings of the polar axis.

The whole mounting is so designed that the centre of weight of the moving parts is vertically above the centre of flotation. The telescope is, owing to this system of flotation and the care which has been given in finishing the driving clock, the clock connections, etc., able to follow the motions of the stars with exquisite smoothness and accuracy, although the moving parts weigh nearly 23 tons.

The tube of the telescope is a skeleton one, octagonal in shape, and is constructed so as to ensure very great rigidity.

The entire building and dome are planned so as to close air tight if necessary. In the early morning, after a night's work, the dome of the building is closed and not opened again until sunset, so enclosing 120,000 cubic feet of cool night air. It is believed that this provision, together with the complete sun protection of the dome and building, will reduce the rise in temperature within the structure during the day to a very few degrees. This protection from daily temperature changes should be sufficient for the telescope mounting, and for the smaller mirrors. To further protect the large mirror during the day a small refrigerating plant supplies air at a constant temperature, such as is expected at night; this circulates through a jacket enclosing the entire lower end of the telescope tube.

The necessity for all these precautions arises from the fact that it is important to preserve the best optical figure on the large mirror.

An error in the figuring of the mirror is about three

times as injurious as a similar error in the figuring of a lens. Any flexure or distortion of the mirror damages the image infinitely more than the same distortion of a lens. So sensitive is a mirror in this respect that even slight temperature differences, which would have no effect upon a lens, would render photographs obtained by the mirror useless.

For a given size a *refracting telescope* furnishes more light, and it also has the larger undistorted field. In the case of a refracting telescope which has been designed for the purpose of viewing the heavenly bodies, the rays most effective in vision, namely, the yellow, green, and light blue, are brought as nearly as possible

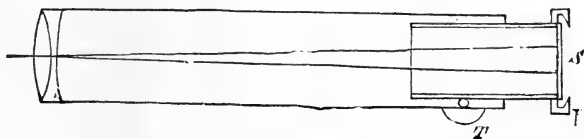

Fig. 116.

to the same focus. The extreme violet rays, which have the greatest actinic value, and also the extreme red rays, deviate a considerable amount from this visual focus. The result of this is, that when such an instrument is used for photographic purposes without proper correction, only a more or less blurred image is obtained.

The Arrangements of Telescope for Photography.—The mode of preparing astronomical pictures differs little from that of ordinary photographs. An ordinary photographic apparatus could be used for this purpose, were it not that it gives too minute images of very remote objects, such as the stars. The size of the picture is in direct proportion to the focal length of the lens; therefore, in taking astronomical photographs, by converting an astronomical telescope into a photographic camera, lenses are used the focal length of which is very long.

The accompanying figure shows a telescope of this kind adapted to photographic purposes. The objective, *O*, remains in its place; the eye-piece, which would be fixed at the other end of the tube, is taken away, and an apparatus, *V* (Fig. 116), is substituted for it, which is identical with the hinder part of a photographic camera. It contains a ground-glass slide, *S*, which, after the image has been focussed, can be exchanged for a sensitive plate. The focussing is effected by a rackwork motion at *T*.

But now a difficulty occurs through the motion of the stars, which necessitates the telescope following this movement. For this purpose, the stand of the telescope is furnished with a driving-clock, which causes it to revolve in the direction of the course of the stars, so that the telescope is what is called equatorially mounted. Fig. 117 shows an arrangement of this kind.

The oblique support of the telescope resting on the foot is parallel to the axis of the earth. The polar axis of the telescope is turned completely round in this support once in twenty-four hours.

The telescope, *d d*, is not fixed immediately on this axis, but on an axis *c*, at right angles to it; it can be turned round the latter (the declination axis) in all directions perpendicular to the axis, *c i*. The movement of the two axes allows any star to be brought into the field of the telescope.

Historical Survey.—When Arago, in August 1839, announced to the French Academy of Sciences the invention of Daguerre, he also proposed that this method of obtaining pictures should be made use of for photographing the moon, and also for getting more complete representations of the solar spectrum than could then be made in any other way.

However, only one daguerreotype appears to have been taken of the sun in France for a period of about twenty years. This was taken by Fizeau and Foucault in 1845.

In 1840 Dr J. W. Draper of New York obtained a daguerreotype of the moon, and a few years later he also obtained one of the solar spectrum.

In 1850 the first star photographs, and the first really

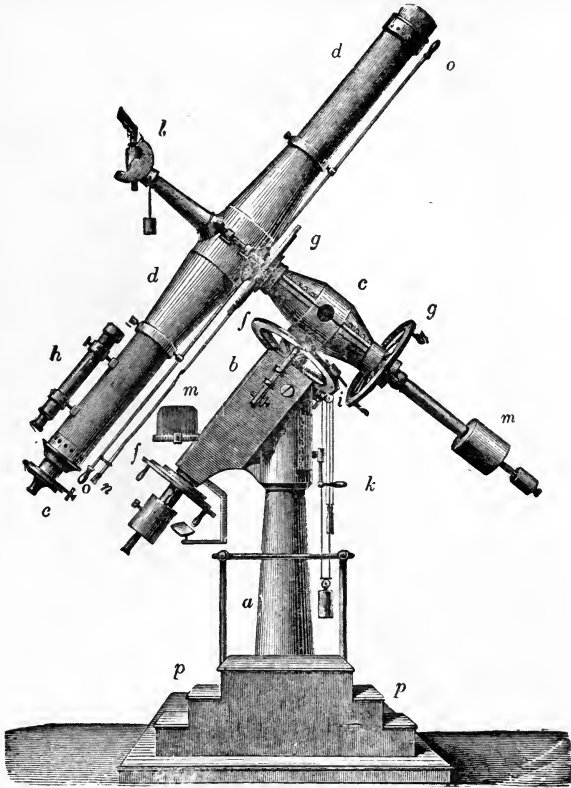

Fig. 117.

valuable photographs of the moon, were made by Bond at Cambridge.

The first attempt in Germany to employ photography for astronomy was made by Berkowsky at the Königsberg Observatory, in the year 1851, by the help of Bessel's noted heliometer, during a total eclipse of the sun. He

obtained a daguerreotype the beauty of which was much lauded, and which showed very well the remarkable phenomena that appear during an eclipse of the sun—flamelike formations that stand out from the darkened disc of the sun, called protuberances. In the year 1860, Warren de la Rue in England, and Secchi at Rome, undertook an expedition to Rivabellosa, in Spain, to observe the eclipse of the sun, and both obtained interesting views on collodion plates. In 1868, the government of the North German Confederation equipped an expedition to observe the eclipse of August 18th, and sent Dr Fritzsich, Messrs. Zencker, Tiele, and Vogel to take photographs. Another photographic expedition was sent out by the English Government to India. Besides these, the German, English, Austrian, and French Governments sent out expeditions for the ocular observation of the phenomenon.

The Photography of Solar Eclipses.—Obstacles were, no doubt, encountered by these expeditions, nevertheless they produced results that finally settled the question about the nature of the protuberances, and moreover gained experience that materially lessened the labour of subsequent photographic observers.

Aden was one of the points where the eclipse was first visible. As previously stated, England had also equipped a photographic expedition, which stationed itself at Guntoor in India. The eclipse was observed an hour later in India than at Aden. The same protuberances appeared in the Indian photographs as in those at Aden, but they present a very different form, which seems to show that these prominences are not compact bodies, but formations of a cloud-like nature; and this supposition was converted into certainty by Jansen's observations with the spectroscope, made simultaneously.

Jansen showed that in a total eclipse the protuberances display bright lines in the spectroscope. As this is the property of gaseous bodies only, the question as to

the nature of the protuberances was solved. Jansen determined at the same time the exact position of these bright lines, and discovered that the gaseous substance was glowing hot hydrogen. He subsequently made the discovery that an eclipse was by no means necessary in order to detect the bright lines of the protuberances. They are seen on clear days if the slit of a spectroscope be directed on the sun's rim, and the changeable nature of these protuberances can every day be observed by the appearance and disappearance of these bright lines. Zöllner of Leipzig even detected with the spectroscope a sudden burst of gas, also the sudden breaking away of gas clouds from their substratum, and their dispersion, all in the space of a few minutes.

We add a copy of the Aden photographs, taken from Herr Schellen's work on spectral analysis. The first view (Fig. 118) gives us the eastern rim of the sun; the western was covered by clouds. It is easy to recognize in it the large, horn-like protuberance, which has an elevation of 184,000 miles, and gives an idea with what immense force masses of gas are projected from the surface of the sun. It shows, further, the remarkable protuberance to the left, in which the masses of gas appear like powerful jets of flame driven sideways by a tempestuous wind; a light region surrounding the protuberances forms the glowing hot stratum of vapour permanently surrounding the rim, named chromosphere.

The second view (Fig. 119) gives a representation of the total eclipse as it was observed in India. Besides the protuberances seen at Aden, there is another on the western rim of the sun, which was quite covered by clouds at Aden.

Photography was soon applied to the observation of total eclipses on a more magnificent scale. Thus, on the 7th of August 1869, hundreds of photographers were actively employed in observing the total eclipse of

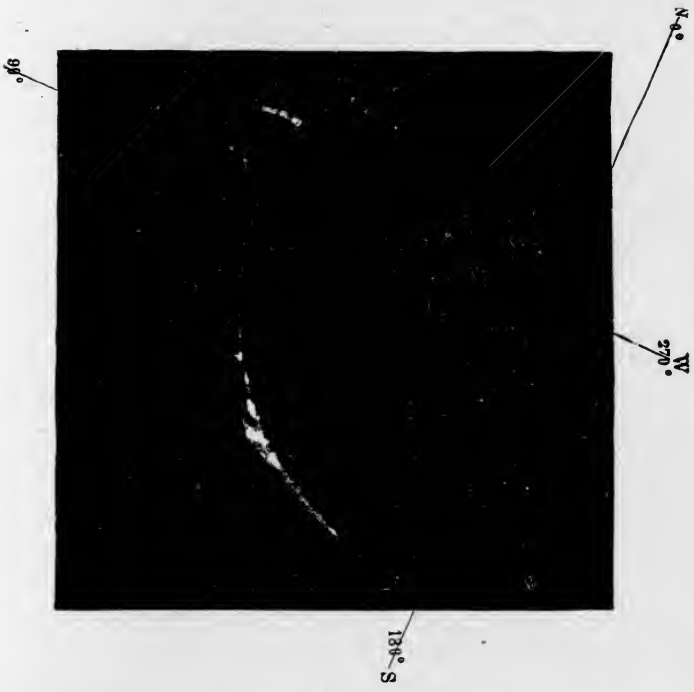
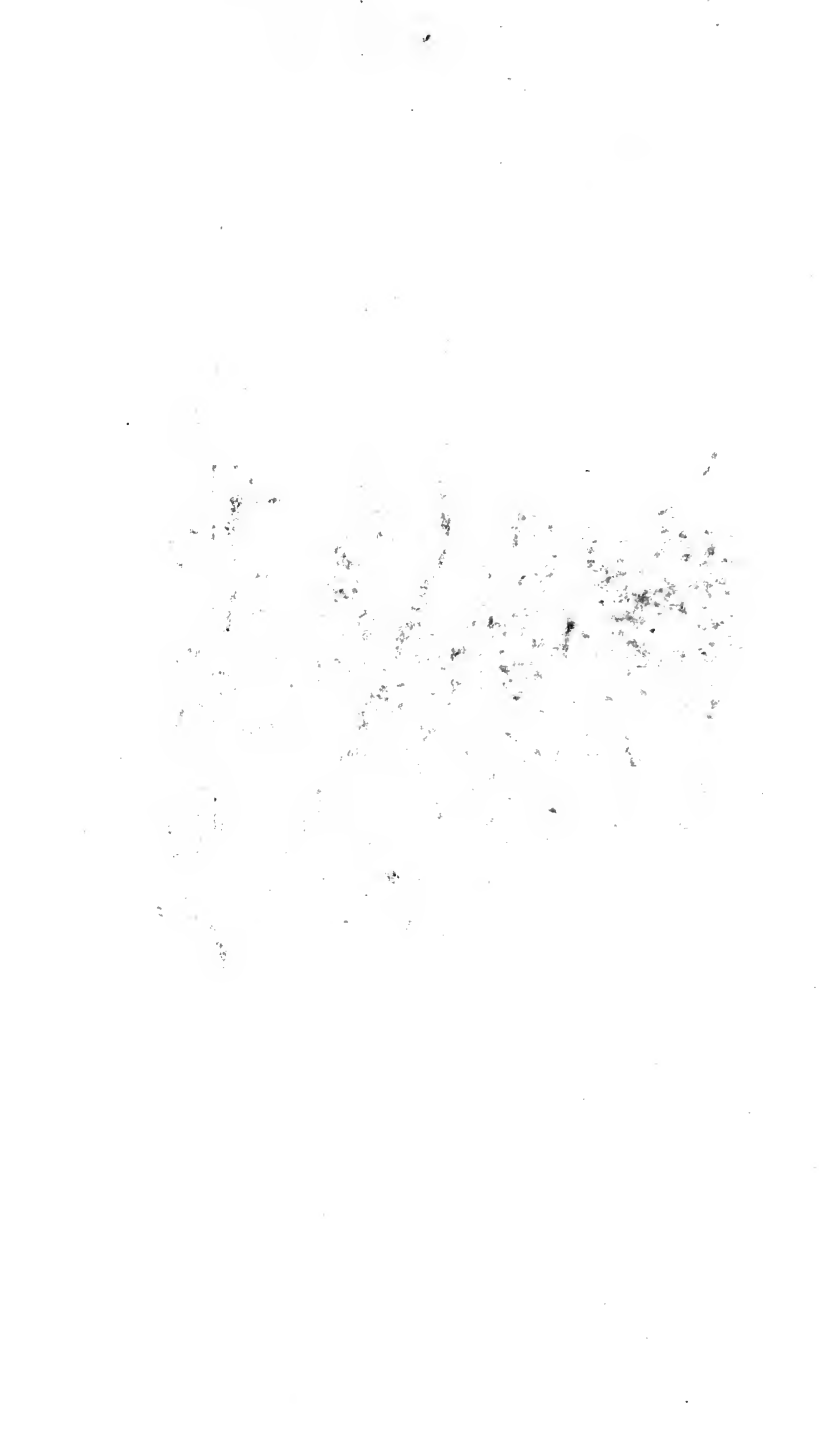

Fig. 118.

Early photograph of E. edge of Sun's Disc, taken at Aden during a solar eclipse.



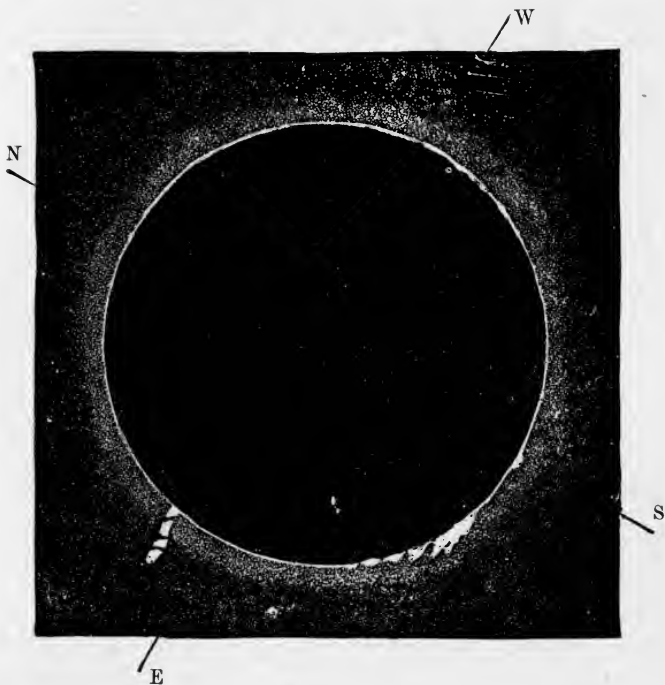

Fig. 119.
Early photograph of edge of Sun's Disc, taken at Guntoor, in India,
during a total eclipse.

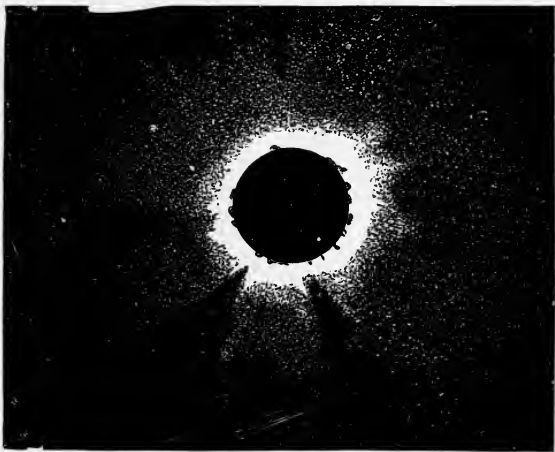

Fig. 120.

Photograph of Corona obtained during eclipse of sun in 1870.

the sun at Iowa, in North America, and more than thirty telescopes were set up to retain the phenomenon. By these observations, the question respecting the nature of the protuberances was finally set at rest, and the only question that remained related to the corona. By corona is meant a kind of nimbus of white light surrounding the sun when totally eclipsed. Many observations of total eclipses have been undertaken to decide its nature. A very beautiful view of the corona was obtained by Whipple, at Shelbyville in Kentucky, August 7th 1869. The feeble light of this phenomenon renders a much longer exposure necessary than in the case of the protuberances. At Shelbyville, the exposure for the corona lasted forty-two seconds, whereas five seconds sufficed to take the protuberances. Nor was the nature of the corona as yet determined.

In 1870 an English expedition, conducted by Lockyer, was sent to Catania to observe the corona, and Dr Vogel accompanied it. Unfortunately, owing to the unfavourable weather, the observations were only partially successful. However, a detachment of the expedition, conducted by Brother, in Syracuse, succeeded in obtaining a good view of the corona, and the illustration (Fig. 120) is copied from this photograph.

The black prominences round the sun's disc give the situation of the protuberances which were visible on the day of the eclipse. We call attention to the fact that they are not visible in the photograph of the corona. To take a view of the corona requires an exposure eight times as long as for the protuberances. During this long exposure the images of the protuberances received too much light, and have therefore become paler instead of brighter, so that their outline becomes confounded with the less bright parts.

To show to what an extent these solar-eclipse expeditions have grown, and also to give the reader an opportunity

to consult an up-to-date account and so obtain at first hand information as to the employment of photography on such occasions, it may be mentioned that to view the total solar eclipse which took place on August 30th, 1905, no fewer than five English expeditions went to various parts of the countries round the Mediterranean, where the eclipse was visible. Thus, Professors Callendar and Fowler went to Castellón de la Sierra, Spain; Sir William Christie was in charge at Sfax, Tunis; J. Evershed at Pineda de la Sierra, Spain; H. F. Newall at Guelma, Algeria; Professor H. H. Turner at Aswan; and lastly, L. Becker, at Kalaa-es-Senam, Tunis. A full account (extending over nearly 100 pages) of these various expeditions has been published by the Royal Astronomical Society, from the Proceedings of the Royal Society.

Daily Photographs of Sun's Disc.—Photography is applied to other important purposes in astronomy besides taking pictures of eclipses. Views of the sun are taken daily. The observation of centuries has established that the sun is continually changing: spots appear, increase, and disappear. All these phenomena were at an earlier date explained as openings in the cloudy luminous atmosphere of the sun, which was supposed to surround its dark central mass. These sun-spots follow the revolution of the sun's body round its axis, and experience manifold changes during this time. It is only by means of these spots that the duration of the sun's revolution has been determined. Recent observations have established that the number of the spots increases and decreases periodically, and that this period is connected with the magnetic phenomena of our earth.¹ These circum-

¹ For further information on this point see the various papers by E. W. Maunder, published in the monthly notices of the Royal Astronomical Society, *e.g.* Great Magnetic Storms, 1875-1903, and their association with Sunspots as recorded at Greenwich (LXIV. No. 3; LXV. Nos. 1 and 6). Also apparent influence of the earth on the numbers and areas of sunspots in the cycle 1889-1901 (A. S. Maunder, LXVIII. No. 7)

stances have led to a closer study of the spot formations, and photography has offered a valuable aid for this purpose. It gives at a particular moment a faithful view of the sun's surface, and photographs taken daily give us the most exact representation of the spots, their size and number. A comparison of the views during one month affords an instructive survey of the changes on the sun's surface, relating more faithfully than words the history of the central body of our planetary system. Lewis Rutherford, of New York, who made valuable contributions to astronomical photography, took a great number of these views at the photographic observatory built at his own expense.

These views, taken on successive days, exhibit mani-

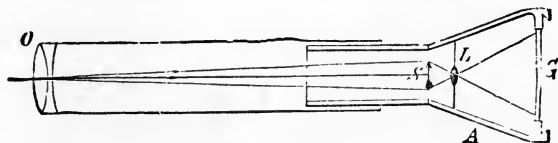

Fig. 121.

fold groups of spots, often of considerable size ; and the change in their form and position is thus accurately recorded (the latter consequent upon the revolution of the sun). These impressions are not prepared, as were the pictures of the eclipse, in the principal focus of the telescope, but in an additional apparatus (fig. 121) which answers the purpose of a magnifying apparatus. This contains a small lens L , which projects on the ground glass, G , an enlarged image of the small representation of the sun, S , produced by the great lens, O .

In this manner Rutherford obtained directly a picture of the sun about two inches in diameter. This enlarging apparatus is not to be recommended in the case of eclipses ; for the brightness of the image produced by the great telescopic lens is materially weakened by the

enlargement. When the image is twice the size, the weakening of the light is fourfold; when it is three times as great, the weakening is ninefold, and so on. In views of the unclouded sun this is of no consequence, for its light is so intense that it bears a considerable enlargement, and yet remains bright enough to give a view on a momentary exposure. The protuberances, however, give out much less light, and if their image were magnified they would become so faint that a longer exposure would be required than the duration of the eclipse.

*The Spectro-heliograph.*¹—Our knowledge of the sun has in the last few years been greatly augmented by means of the spectro-heliograph. This instrument enables photographs of the sun to be taken in which use is made of monochromatic light only.

The spectro-heliograph was first systematically employed for purposes of solar research in 1892.

As will be seen from the following account, the function of the instrument is the photography of the invisible gases surrounding the sun, which are commonly spoken of as the solar atmosphere.

The principle of this apparatus can be readily grasped by a study of fig. 122, which represents a plan of the essential parts.

The whole of the parts here shown, with the exception of the plate G, are on a moving platform, which is so arranged that the primary slit A can move across an image of the sun formed in that position by means of a telescope. The slit A need not be of any very special construction, in fact, the ordinary spectroscopic slit will do very well for this purpose.

The whole may really be looked upon as a spectroscope having the ordinary collimator and telescope, but with a

¹For further information on this subject see (a) "Monthly Notices," *R. A. S.*, vol. lxxv. No. 5, pp. 473 *et seq.*; (b) *Nature*, Nov. 4 and Nov. 11, 1909; (c) *Astrophysics Journal*, Sept. 1908.

plane mirror C so arranged in the path of the parallel beam of light that the telescope can be used in a position parallel to the collimator. In the place of the eye-piece of the telescope the slit F is substituted. B is the ordinary lens used in the collimator; D is a prism or prisms for obtaining the spectrum of the light which passes through the slit A; E is a simple lens or a camera lens by means of which an image of the spectrum is formed in the plane of the secondary slit, F; G represents the photographic plate, which remains in a fixed position.

The primary slit moves across the image of the sun,

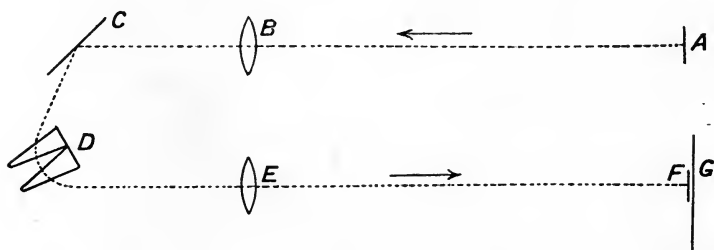

Fig. 122.

and the ordinary sunlight which passes through that slit is made parallel by the lens B. It is then reflected by the plane mirror, C, through the prisms, D, by which its spectrum is obtained.

The second slit, F, can be so arranged that only light of one distinct colour, corresponding to some particular line on the spectrum, passes through.

Then, since all the parts from A to F are fixed with respect to one another, whatever spectral line is arranged to fall on F at the beginning of the exposure will continue to do so until the end.

The photographic plate, G, must be placed as nearly in contact with the slit F as is convenient, and of course be carefully shielded from all other sources of light.

The primary slit, and the whole of the spectroscopic arrangements, move in a horizontal plane at right angles to the rays of light coming from the telescope, so each portion of the sun's image passes across the primary slit and an image of the sun as formed by some particular line of the spectrum will be produced on the sensitive plate.

It could be arranged that the image of the sun should move at a definite rate across the primary slit, the plate being made to move at a corresponding rate across the secondary slit.

In this case of course the spectroscopic part would be stationary ; this would be useful if the latter parts are so massive that their motion would cause the telescope to vibrate.

The lines which are most frequently used for this purpose are the " K " line of calcium and the " H " lines of hydrogen.

Photographs obtained by the " K " line show sunspots surrounded and frequently covered with vast clouds of calcium vapour, which there attain an elevation of several thousands of miles, but which must not be confused with the solar prominences, for the latter reach a much greater altitude. These cloud-like masses of calcium vapour are called calcium flocculi.

The next three illustrations will show the great change which is seen in the photographs when obtained by means of the spectroheliograph as compared with direct photographs.

The first (fig. 123) shows a reproduction of a direct photograph of an insignificant group of sunspots obtained under the excellent atmospheric conditions of the dry season at Mount Wilson Observatory.

The next (fig. 124) shows an enormous calcium flocculi occupying the same region of the sun, its form is, however, by no means remarkable, and certainly gives no indication of the phenomena brought to light by the H_{α} photograph as shown in fig. 125.

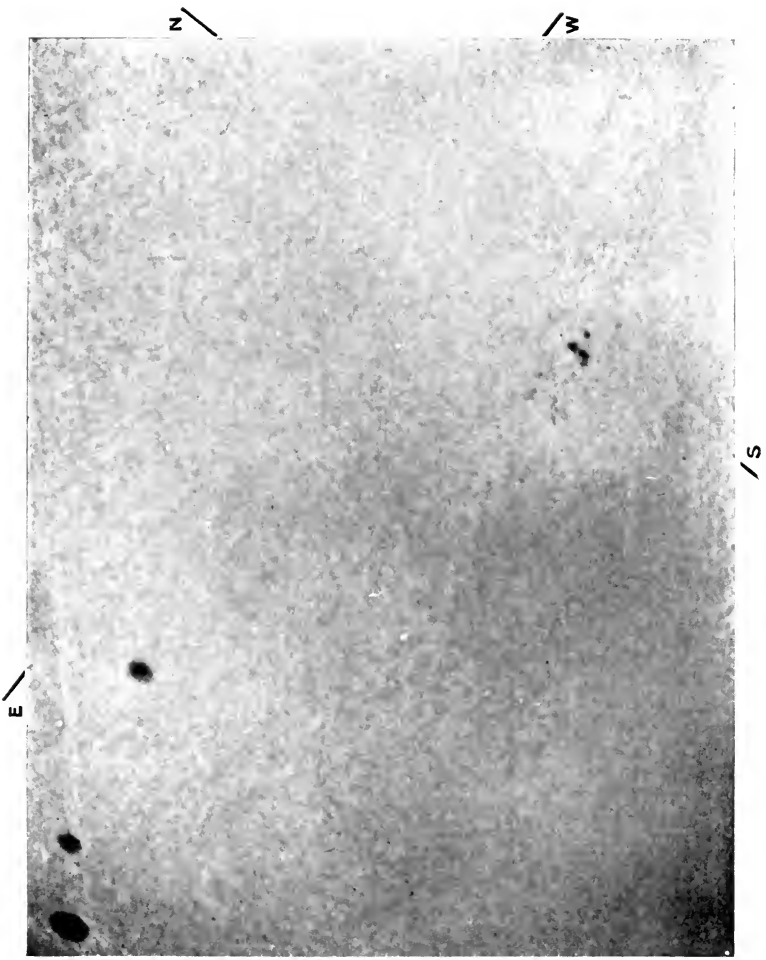

Fig. 123.

Direct photograph of small group of Sunspots, obtained at Mount Wilson Observatory, U.S.A.

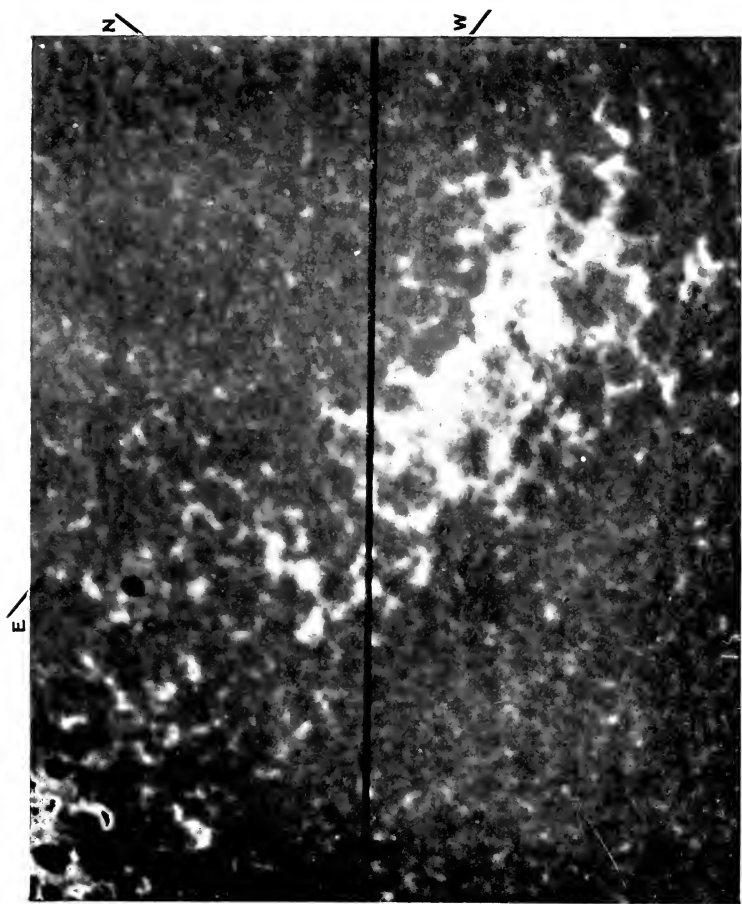

Fig. 124.

Photograph of same region as in Fig. 123, but using only "K" line of calcium.
Mount Wilson Observatory, U.S.A.



Fig. 125.

Photograph of same region as in Fig. 124, obtained by means of the H α line.
Mount Wilson Observatory, U.S.A.

In the solar physics laboratory at Kensington the image of the sun as formed on the plate of the primary slit is just over 2 inches in diameter, and the primary slit has a length of 3 inches. The jaws of the secondary slit are $3\frac{1}{2}$ inches in length and are slightly curved, the curvature corresponding to that of the "K" line of calcium.

It is usual to arrange a needle or some similar object at the secondary slit so as to form a datum line on the photograph.

When a photograph of the sun's limb is required the amount of light available is so reduced that the time of exposure must be at least sixty times that required for a disc photograph.

Sometimes photographs are taken of the solar prominences by this means, then it becomes necessary to cover the sun's image with a metal disc, and to give the moving platform a greater degree of motion as well as a much slower rate. It is usual to subsequently expose the same plate, after removal of the disc, so as to obtain a composite picture showing disc and limb with prominences.

Spectro-heliograph Work at Mount Wilson.—Of all the workers in this sphere of astronomical work Professor Hale of the Mount Wilson Observatory, U.S.A., is perhaps the foremost. He has, by means of photographs obtained in this manner, made extremely careful measurements of the daily motion in longitude of the calcium flocculi, and by these measurements has redetermined the times of the sun's rotation.

He has likewise investigated their distribution in latitude and longitude, and the forms of these flocculi at different levels.

By this means he has come to the conclusion that these calcium flocculi do not indicate the existence of currents in the solar atmosphere.

He has similarly observed the hydrogen flocculi, and finds that, while these occupy the same general regions of

the sun's disc, they are distinguished from the calcium flocculi by several important peculiarities.

In the first place most of them are dark where the corresponding calcium flocculi are bright; then again they seem to obey a different law of rotation, for although the sunspots, faculæ, and calcium flocculi all seem to show the polar retardation, this is not the case with the hydrogen flocculi. Lastly, and this is the most interesting fact of all, they exhibit a very decided definiteness of structure, which, as Professor Hale's photographs clearly show, is indicated by radial or curving lines, or by some such distribution of the minor flocculi as is exhibited by iron filings when placed in a magnetic field. This is shown in the accompanying plate, which is a reproduction of a photograph taken at the Mount Wilson Observatory.

This was first recognized at Mount Wilson in 1903. For the purpose of these observations, the hydrogen lines $H\alpha$, $H\beta$, $H\gamma$, $H\delta$ are used. It is with the $H\alpha$ lines since April 30, 1908, that the real advance in obtaining photographs showing definite structure has been made.

By observation of the spot photographs it is found that the spots in the northern hemisphere of the sun seem to indicate a cyclonic disturbance or vortex in which the motion is often, although not invariably, in a counter-clockwise direction (see fig. 126).

In conjunction with these observations, a more extended *study of sunspot spectra*, in comparison with the ordinary solar spectra, has brought many interesting facts to light.

The great object in arranging apparatus for furthering the spectroscopic study of the sun has been to devise some means of employing a long-focus spectroscope, in conjunction with a long-focus telescope.

The method of overcoming this difficulty at the Mount Wilson Observatory is as follows :—

Two adjustable plane mirrors, each one foot in thickness, are so arranged that they can reflect a beam of sunlight

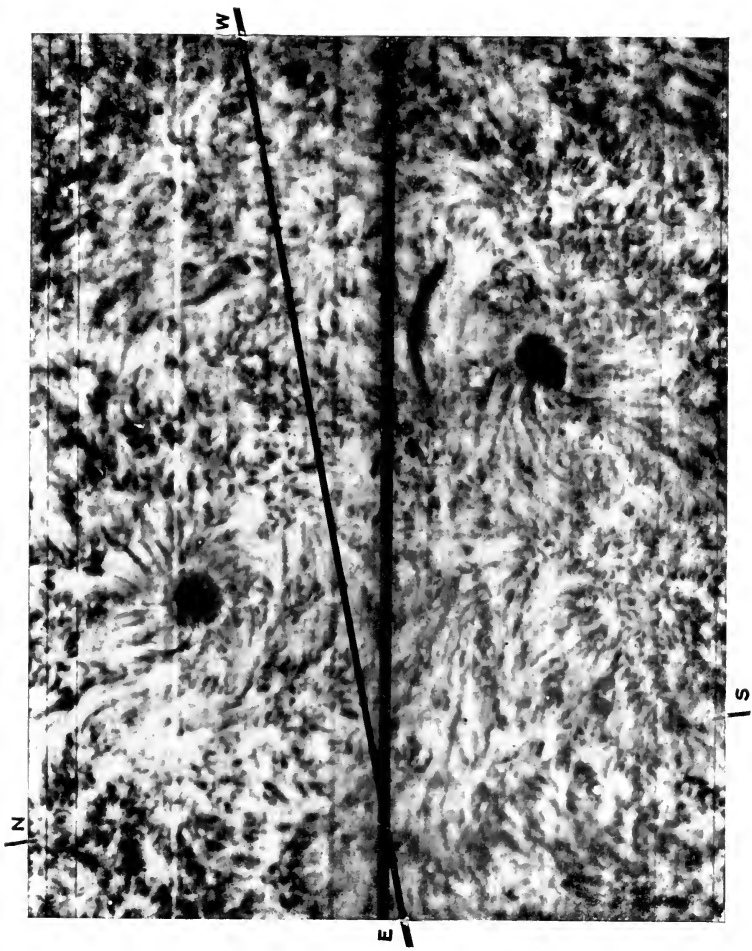

Fig. 126.

Photograph of Sunspots by means of $H\alpha$ lines. Mount Wilson Observatory, U.S.A.

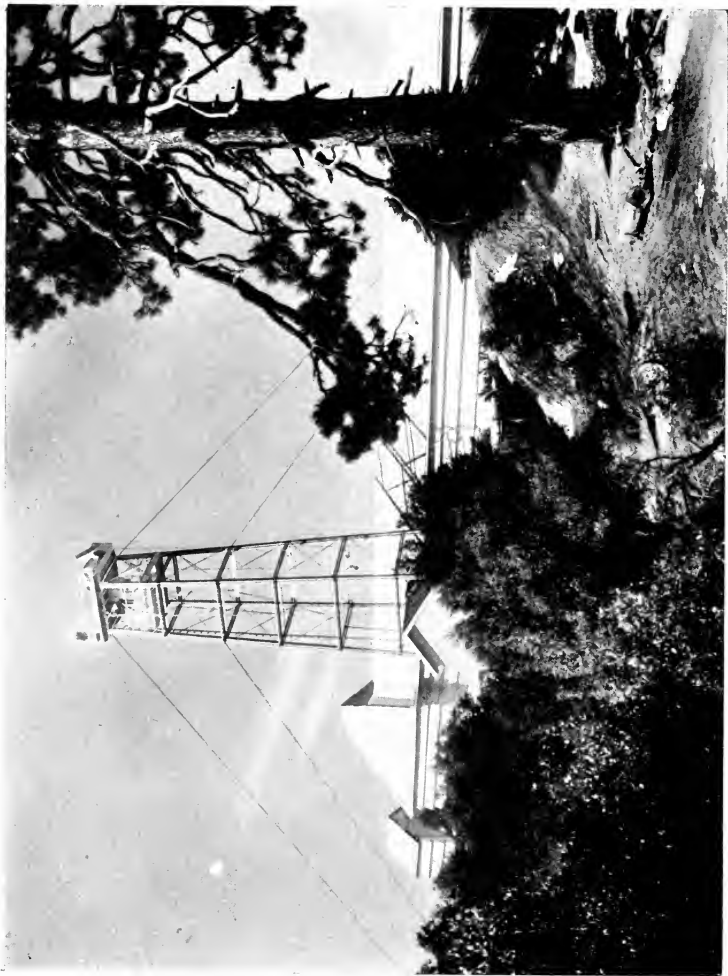

Fig. 127.

The Tower Telescope, Mount Wilson Observatory, U.S.A.

down the large telescope which is placed in a vertical position.

Unlike an ordinary telescope, this Tower Telescope, as it is called, has no tube, but the objective is simply held in position on the top of a light steel framework tower. (See fig. 127.)

A 12-inch objective of 60 feet focal length lies in a horizontal position on the top of this tower, and the sunlight is reflected into it from the second of the two plane mirrors. The first of these mirrors is mounted as a coelostat, and is rotated by an accurate driving clock at such a rate as to counteract the sun's apparent motion.

An image of the sun, 6.6 inches in diameter, is formed on the slit of the spectroscop 60 feet below, and 3 feet above the level of the ground.

The portion of the sun's image which it is desired to examine is allowed to fall on the slit, and the light of that portion passes through the slit, and descends vertically into a well about 30 feet deep. At a distance of 30 feet from the slit a 6-inch objective is placed, and the rays passing through that are rendered parallel. They then fall upon a Rowland plane grating, ruled 14,438 lines to the inch, and by means of this the light is broken up into a series of spectra.

The rays are returned through the same objective, and the spectra formed are thus brought to a focus close to the slit.

When the grating is inclined at a very small angle, the images of the spectra fall a little to one side of the slit and can there be photographed. By this means portions of the spectrum 17 inches in length can be photographed at one operation.

When spot spectra are being photographed, only light from the darkest part is allowed to fall on the slit. At the end of the exposure that portion of the slit is covered, and light from the photosphere at a little distance from the

spot is allowed to fall on the slit on either side. By this means the spot spectrum is obtained between two strips of the ordinary solar spectrum, and a comparison of the lines obtained can then be made.

The exposure required for sunspots may last from a few minutes to over one hour, and is from 5 to 20 times as long as that required for the solar spectrum.

The spectrum of a sunspot was first examined by Lockyer as far back as 1866, and he found that many of the lines of the solar spectrum were widened where they crossed the sunspots. Since that time the observations of these widened lines have been carried on in a systematic manner. Among the chief workers in this field have been Young and Mitchell, who worked with the 23-inch Princeton refractor, and a powerful grating spectroscope. They found that many of the lines in the sunspot spectrum really became doublets.

Mitchell afterwards made a special study of these doublets. With the Tower Telescope and spectroscope just described these widened and doubled lines have been photographed, and Professor Hale and his staff have investigated the question as to the cause of this, by comparison with results obtained under known conditions in the laboratory at Pasadena, which is attached to their observatory.

By this means they have arrived at the conclusion that the doubling of the lines is due to the presence of a magnetic field in the sunspot regions, in fact, that in this they are in such cases dealing with what is known as the *Zeeman effect*. Not only have they done this, but by comparison with the known magnetic conditions in the laboratory experiments, they have been able to measure the strength of the magnetic field which causes the doubling of the lines. The strongest fields which they have yet measured by means of these photographs of sunspots is about 4500 gauss. They also find that the

field decreases so rapidly upwards that it could not have any appreciable effect on the higher regions of the sun's atmosphere. If this interpretation is correct, it would appear impossible that any combination of sunspots can be responsible for the magnetic storms which occur on the earth.

In one series of Hale's photographs a large hydrogen flocculus is shown which appears to be on the point of being drawn into a sunspot. He, therefore, concludes that sunspots are centres of attraction, drawing toward them the hydrogen of the solar atmosphere.

This subject is of such great importance that another Tower Telescope is being constructed which will have a focal length of 150 feet, and a spectrograph of 75 feet focal length will be used in connexion with that telescope. By its aid it is hoped that spectra of much smaller sunspots will be examined, as a focal image of the sun 16 inches in diameter will be so obtained.

Photography of Stars.—The solution of other important astronomical problems has been attempted with the help of photography; for example, the production of pictures of the stars.

The object of such pictures is the representation of the constellations, or the relative position of the stars. It always has been one of the principal objects of astronomy to determine the position of the fixed stars.

The photographic process is of great importance for this purpose, because it offers advantages in the facility of its application and correctness of its results. Many readers may inquire why so much trouble is taken to determine with the greatest accuracy the positions of thousands and millions of fixed stars. The answer is that the fixed stars are not stationary, as their name implies; nothing is stationary in nature, and hence such study is never at an end. No doubt the fixed stars change their position so slowly that the builders of the

pyramids, four thousand years ago, beheld the constellations much as we do. It is only the finest astronomical measurements that show any change within a limited number of years. However, the study of the proper movement of the fixed stars has now begun, and requires very accurate measurements carried on for generations.

Another interesting point comes into consideration in connection with this subject. On the one hand, the fixed stars are not without movement; on the other, their distances from the earth are very various, the nearest being enormously great. The photographer who wishes to take a graphic view of an object, will always try to take it from different points. Two views of a moderately remote object taken from two points only two inches apart, appear different to the eye, and produce, when viewed in a special manner, a stereoscopic effect. No distance on earth is great enough to give different pictures of the same constellation; nevertheless, within the space of one year we describe a circle round the sun having a diameter of 184 millions of miles, so that in half a year we are 184 millions of miles from our present position. This enormous distance is in certain cases just sufficient to show a change in the relative position of certain stars, though not to the naked eye. By this means the distance of the nearest fixed stars has been determined, amounting to billions of miles.

By careful comparative measurements of positions of neighbouring stars, continued for years and centuries, a change can be proved to exist, and the proper movement of the stars can be calculated. The distance of the stars can be deduced by carefully collating the yearly recurring changes in the positions of the stars. It is evident that photography, which affords the means of fixing these positions, must be of the greatest value for both these astronomical problems.

Photography of the stars was first introduced nearly

sixty years ago by Professor Bond, of Cambridge, Massachusetts, but it was Mr Lewis Rutherford, of New York, who did much to perfect the method. He constructed a photographic objective of 11 inches diameter and about 13 feet focus. This objective shows a considerable focal difference; that is, the violet and blue rays have a different focus from the yellow and red. If a clear image of the star is focussed, the sensitive plate would be adjusted to the focus of the yellow rays, and the focus of the chemically operative blue rays would fall beyond the sensitive plate, and an indistinct picture would result. The plate must therefore be adjusted to the focus of the blue rays; but this is not so easy to find. After it has been found approximately, it is corrected by taking different photographs of a star, changing the position of the plate each time. The point is determined at which the best and sharpest picture is obtained, and, by continual repetitions of the attempts, the chemically active focus of a lens of 13 feet focal length can be accurately determined to within $\frac{1}{150}$ of an inch. It is well known that all heavenly bodies have the same focus, on account of their great distance.

No photographic objective gives a correct picture with a large surface. Accordingly, to obtain the accuracy required by astronomy, the surface to be devoted to the image can only be very small, or about $1\frac{1}{2}$ degrees in diameter. Any remaining distortions are controlled and corrected by photographing a very correct scale, and comparing the picture with the original. A field of $1\frac{1}{2}$ degrees, or three times the moon's diameter, embraces the well-known constellation of the Pleiades.

Rutherford's telescope was arranged as in fig. 116; it was moved by clockwork, so as to exactly follow the movement of the stars.

The views of large stars taken with it, after a short exposure, all appear as small round points which can

only be seen through a magnifying glass. In the case of a long exposure their size depends on the more or less strong vibrations of the atmosphere, which occasion the flickering of the stars. Stars of the ninth magnitude could be photographed with an exposure of eight minutes with wet plates; the light of these stars is ten times weaker than that of the faintest which can be detected on a clear night by the naked eye, and their images are very small points. It would be difficult to distinguish these small points from dirt spots on the plate. To do this, Rutherford made use of an ingenious device. He brought the telescope, after the first exposure of eight minutes, into a slightly different direction, and made a second exposure of eight minutes, while the clockwork continued to operate, and move the telescope correctly in this second direction.

In this manner two closely adjacent images are obtained of every star on the plate, the distance and relative position being in all the same. These double images can be easily found on the plate and distinguished from accidental spots. If the telescope stops, it is evident that the images of the stars make a movement on the plate, the bright stars describing a line. This line is of great importance to determine the direction from east to west on the plate. For faint stars which leave no line a third exposure is necessary to determine this direction. This is done after the clockwork of the telescope has been stopped for some minutes.

Rutherford took numerous views of the stars, and they will serve as important means of comparison, after the lapse of centuries, in order to discover what change has taken place in the position of the fixed stars.¹

In the last few years photography has proved a very useful servant to the astronomer, in the preparation of

¹ Details respecting Rutherford's observatory are contained in the "Photographischen Mittheilungen," Jahrg. 1870. Berlin: Oppenheim.

the star catalogues, for the plates can be exposed under favourable circumstances and their examination carried out at leisure.

Photographs of the Moon.—But another heavenly body invites us specially to study it by the help of photography; that is, our nearest neighbour, the moon. The unassisted eye recognizes its uneven surface (“mountains in the moon”) and the varying shades of its ground (moon spots). Its surface appearing as a rigid, almost vitreous, waterless, airless waste, contains a thousand problems.

Warren de la Rue tried to take photographic pictures of this singular body, which is so near to our earth and yet so different; he succeeded in obtaining, with the help of a telescope, a small view of the moon, which he enlarged to 24 inches diameter with an enlarging apparatus.

The moon gives out less light than the sun. It is therefore taken to the best advantage in the principal focus of the telescope. In the most favourable case, three-quarters of a second sufficed for exposure, but it was rare to obtain sharp negatives, owing to the disturbance of the atmosphere, and to obtain a sharp image of the moon was a test of patience. After Warren de la Rue, Rutherford was celebrated for his moon-pictures; his improved telescope, set up expressly for photographic purposes, gave a still sharper image of the moon than that of De la Rue.

Some years ago Schmidt, at Athens, maintained that an extinct volcano observed by Mädler is no longer to be found, and he thereby proved the possibility of changes on the apparently rigid surface of the moon. If a photograph of the moon's surface could have been taken when Mädler observed the volcano, we should now be certain about this point, which is still doubtful.

Spectrography.—But the sun and its eclipses, the

moon, and stars are not the only objects of astronomical photography. Its province extends further, since the discovery of spectrum analysis.

When it was discovered that the wonderful lines intersecting the sun's spectrum were occasioned by glowing substances of different kinds, and that each element shows invariably the same lines, so that the presence of certain spectral lines establishes the presence of certain elements, it became necessary to possess an exact map of the countless lines of the solar spectrum. Then, by comparing this map with the spectrum of a flame or of a star, it could be at once seen what substances give these lines. Kirchhoff, one of the discoverers of spectrum analysis, and Angström have prepared such maps of the solar spectrum. Their labour would have been materially simplified had Rutherford published his photograph of the spectrum a year earlier.

Rutherford's photograph only shows the lines of the chemically active part of the spectrum—from green to violet—but it does this with wonderful clearness. Many lines that appear faint to the naked eye show themselves strong and sharp in the picture; nay, lines are discovered in the photograph of the spectrum which Kirchhoff did not see at all in the spectrum itself.

The causes of this phenomenon may be twofold: either the eye is not sensitive to certain rays of light—as we know it is not influenced by the ultra-violet rays, which have a strong photographic effect—or it is possible that changes take place in the sun: that at certain times fresh substances come to its surface, and thereby new lines become apparent.

The photograph of the spectrum may be taken with the aid of an ordinary spectroscope, seen in fig. 128. This consists of a tube *A*, which has a fine slit *F*, through which the light penetrates, and at the other end a lens, which makes all the rays from the slit parallel, and con-

ducts them to the prism *P*. The rays are then refracted and pass into the tube *B*, and can be observed through its narrower end. If the object is to photograph the spectrum thus seen, a photographic camera is placed light-tight on the tube *B*, its eye-piece is drawn a little out, and then the image of the spectrum appears upon the ground-glass screen.

Fig. 129 shows a modern spectrograph which can be used either with prisms or with a grating. The prisms

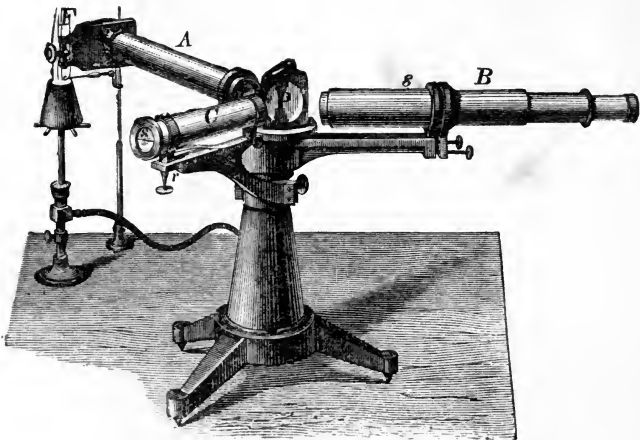

Fig. 128.

are automatically kept correctly set. In the case of the grating, means of rotation with rackwork and division are supplied.

The camera takes a half-plate, and the spectrum runs the long way of the plate, and in this way six spectra can be taken, one above the other.

The Presence of Water in Atmosphere of Mars.—Spectroscopic photographs of the light received from the moon show most distinctly the absorption lines due to the water vapour in the earth's atmosphere.

This has always been of peculiar interest, since by comparison of this spectrum with those obtained of the light received from the planets Jupiter, Saturn, etc., it becomes possible to ascertain whether there is water vapour in their atmospheres.

Before the introduction of photography this method of comparison was at its best a very doubtful procedure, for the observer had to carry in his memory a picture

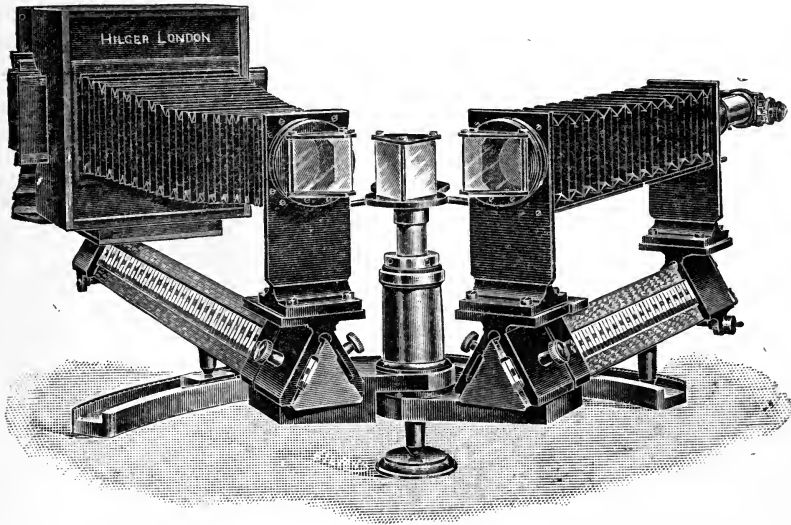

Fig. 129.

of the spectrum of the moon, and in this way compare it with that of the planets, and since the absorption would be only one of degree, no definite conclusions could be arrived at.

Now, Slipher, at Lowell Observatory, has taken striking comparison spectra of Jupiter, Saturn, Uranus, and Neptune, with the moon, and these can, of course, be examined with ease, and accurate determinations of the relative values of the absorption bands can be made.

The plates used by Slipher¹ for this purpose were "Seed 23," which he sensitized to the lower spectrum by bathing them for 3 or 4 minutes in a bath made up as follows :—

Water, 8 ounces.
Dicyanin, 45 minims.
Pinaverdol, 75 minims.
Pinacyanol, 25 minims.
Ammonia, 120 minims.

After removing the plates from this bath they are washed in water, or rinsed in alcohol and dried in a current of warm air. He finds that this combination of dyes produces a plate which is sensitive in a fairly uniform manner to the prismatic solar spectrum down to $\lambda 7000$, where it begins to weaken. It is just sensitive enough in the region about line A to record that line.

The importance of this method of sensitizing will be understood when it is mentioned that almost all the dark lines observed in the solar spectrum below line C are due to absorption in the earth's atmosphere.

Previous observations which have been made with a view to settling the question as to the presence of water vapour in the atmosphere of Mars have been greatly hampered by the fact that they have been of necessity confined to the rainband which is visible in the spectrum round about the D line ; but this plate gives the " a " band, which is situated midway between the oxygen bands A and B.

This double band is due to the absorption of light by the water vapour in the air. It is by far the strongest of the group of lines due to water vapour, being visible when there is but a very small amount of moisture in the path of the light, and is even conspicuous when the rainband is not visible.

¹ *Astrophysical Journal*, Dec. 1908.

This "a" band is reinforced in the spectrum of Mars, due of course to absorption taking place in its atmosphere, and since this band in the spectrum of the moon has been found to be due to absorption brought about by water vapour in the atmosphere of the earth, and it appears identical in the two spectra except in respect to intensity, the reasonable conclusion is that the spectrograph has revealed the presence of water vapour in the atmosphere of Mars.

Spectroscopic Binaries.—It may be mentioned that one of the earliest results of the employment of photographic methods for observing the spectra of the stars was the discovery of a class of double stars (binaries), which have accordingly been designated "spectroscopic binaries." Such binaries are often divided into two classes, (1) those in which the spectra of both stars can be photographed and measured, and (2) those in which only one star is sufficiently bright to produce a spectrum which can be photographed.

In the first of these two classes the difference between the movements of the component stars in the line of sight is indicated by a shift of the lines of the spectra relative to one another.

In the stars of the second class the determination of the orbital motion depends upon the measurement of the variable radial motion of the bright component in the line of sight relative to the earth; this necessitates that the spectrum of the star shall be compared with the spectrum of some suitable artificial source of light, that the amount of shift of certain lines due to the radial motion may be measured. The first spectroscopic binary to be discovered was ζ Ursæ Majoris. This binary was first proved to be so in 1889; it belongs to the first-mentioned class. In 1890 Dr Vogel announced that the star Spica (α Virginis) is a spectroscopic binary of the second class.

Laboratory Work.—A good illustration of how the work in the laboratory may be made to supplement that in the observatory is to be found in the work of Prof. Fowler on the comparison of the spectrum of α Ceti with that of titanium oxide.

Prof. Fowler has carefully examined the spectrum of that oxide, and by comparison with a spectrum of α Ceti obtained by Slipher, has come to the conclusion that nearly all the characteristic flutings observed in the spectra of the Anturian type of stars are produced by the absorption due to titanium oxide. This kind of work would have been next to impossible were it not for the help of photography.

Attempts have been made to solve other important problems by the help of photography. Thus, Dr Zencker hoped to be able to trace the *path of shooting stars* by means of it. Unfortunately, these were found to give out too little light to produce, while they lasted, an impression on the photographic plates then in use.

With the much more rapid plates now in use, the trails of meteors are sometimes recorded. Professor Turner has worked out at some length the question as to the information which can be obtained from such trails.¹

Transit of Venus.—The transit of Venus affords a grand problem for photography.

In determining the distance of heavenly bodies, the diameter of the earth's orbit is taken as a base line; therefore the knowledge of the exact length of this base is assumed. Now, this amount has only hitherto been determined by approximation, and is in round numbers one hundred and eighty millions of miles.

Many efforts have been made to determine this distance more accurately. It is, however, a problem of great difficulty. Let it be conceived that there are at two opposite points of the earth, a and b (fig. 130), two

¹ See "Monthly Notices," *R. A. S.*, vol. lxvii. No. 9, pp. 562 *et seq.*

observers who look with telescopes at a star x , and measure the angles which the rays xa , xb make with the line ab : it can be determined from both angles and the line ab (which is easily found) what is the distance of the star from a or b . This is the trigonometrical method, and it gives reliable results, if the distance of the star is not too great; thus, for example, the distance of the moon, which is about thirty of the earth's diameters, is easily ascertained. If the star to be measured is too remote,



Fig. 130.

the rays ax and bx are nearly parallel, no difference exists between the two angles at a and b , and the trigonometrical method is useless. This is the case with the sun, which is ninety-three millions of miles from the earth. We can therefore only ascertain its distance by indirect methods.

According to a law discovered by the celebrated astronomer Kepler, the squares of the periods of revolution of the planets vary as the cubes of their distances from the sun. Thus, if the period of the earth's revolution is U , and that of Venus u , the distance of the earth E , that of Venus e , according to this law,

$$U^2 : u^2 = E^3 : e^3.$$

If the cube root is extracted from both, we have—

$$\sqrt[3]{U^2} : \sqrt[3]{u^2} = E : e, \text{ hence,}$$

$$\sqrt[3]{U^2} - \sqrt[3]{u^2} : \sqrt[3]{u^2} = E - e : e.$$

But $E - e$ is the distance between the earth and Venus. When this has been determined, three terms of the proportion are known; for the periods of the revolutions of Venus and the earth are accurately known. Then, by simple rule of three, the fourth term, e , can be found; that is, the distance of Venus from the sun. If to this is

added the distance of the earth from Venus, we obtain the distance of the earth from the sun, which was required.

Thus the determination of our distance from the sun depends on that of our distance from Venus, which must be taken at the moment when Venus is between the earth and the sun. But Venus is only visible at the moment when it is between the sun's disc and the earth. This is only exceptionally the case—twice in every century—and then it appears as a small black point on the sun's disc, which, however, continually changes place, on account of the earth's movement and its own. This circumstance renders simultaneous measurements at two different and remote points of the earth very difficult, and therefore the idea has been entertained of using photography as an auxiliary. If by its help, and in the manner described above, a sun picture is taken during the transit of Venus, the distance of Venus from the sun's centre can be easily measured upon it. The centre of the sun is a fixed point which can be assumed to be stationary.

If the earth is supposed to be at *E* (fig. 131), Venus at *V*, and the sun at *S*, the observer at *a* will see Venus below the centre of the sun, while an observer at *b* will see Venus above it. Accordingly, Venus will present a different position to the sun's centre on photographs taken at various points of the earth.

Now, the position of the centre of the sun is very accurately known. The sun's diameter subtends an angle of about 30 minutes, so that if divided into 30 parts, each part would represent an angle of one minute. It is only necessary therefore to measure how many of such parts Venus is distant from the sun's centre, to find at



Fig. 131.

once the angular distance of Venus from this point or $m a V$. If this angle is subtracted from the angle which the line $a b$ makes with the direction of the sun's centre $m a b$, the remainder will give the angle $V a b$, which Venus makes with the line $a b$, which gives all the data necessary to calculate the distance of Venus, and, from that, the distance of the central body which forms the foundation and base of all astronomical measurements.

The determination of this angle by photography is of special value, as this measurement can easily be made at any convenient time, whereas direct measurements can only be made while the phenomenon is visible, and hence many errors are introduced in the excitement of the moment. Measurements of this kind require apparatus of the most accurate description, and the adoption of many precautions.

Parallax of Eros.—Besides the great disadvantage of the long interval between transits of Venus across the sun's disc, this method has been considered far less accurate than that of measuring the distance of Mars or one of the brighter minor planets when in opposition. For this purpose too, only one observing station is necessary, and the positions with reference to certain stars can be measured on the photographs, and from this the angle subtended by the earth's radius at the planet (parallax), and so its distance can be determined. Since the discovery of Eros that heavenly body has been made use of in determining the distance of the sun in this way. Photographs were taken during its opposition 1900-1901, and these have been made the basis of calculations for finding the solar parallax. Some account of the results obtained can be seen in the monthly notices of the Royal Astronomical Society for April 1907.

Moon's Position relative to Stars.—Professor Turner¹ has suggested a method of photographing the moon

¹ R.A.S. Notices, Nov. 1903.

with the surrounding stars. He considers that if this be carried out at a number of observatories over a long continued period of time, some very definite information may be so obtained of the figure of the earth.

Another method for obtaining such photographs has been brought forward by E. H. Wade.¹

Nebulæ and Comets.—Mention must also be made of the excellent service rendered by photography in the work on nebulæ and comets.

Every one is more or less familiar with the beautiful photographs which have been obtained of the various well-known nebulæ, but it may be as well to mention just one fact which has been brought out in this manner.

The nebula in Orion is of such enormous extent that one can scarcely grasp the dimensions of it, and at the same time it is by no means of a compact, regular form. Yet no change has been observed in the outlines even of the less conspicuous parts since photographic records were first taken some thirty years ago.

In the photography of comets it must be remembered that these heavenly bodies have such a large proper motion that the telescope must be made to follow them by moving it by hand. The stars therefore make short trails on the plate owing to this, and these trails of course indicate the direction in which the comet is moving among the stars.

In 1908 there was a small comet which was at times just visible to the naked eye. Although relatively few persons actually saw this comet, a very large number became more or less acquainted with it through current literature. It was discovered by Mr Morehouse of the Yerkes Observatory on September 1, 1908, and hence is usually spoken of as Morehouse's Comet, although it is officially designated Comet c, 1908.

When discovered it appeared as a very conspicuous

¹ R.A.S. Notices, Dec. 1905.

object with a long tail. Great changes in the structure of its tail were observed on September 16, October 1, and October 16, and these were accompanied with great fluctuations in the brilliancy of the comet.

At all the principal observatories series of photographs were taken, and from these many important facts with respect to the nature of these heavenly bodies have been learned. These photographs show clearly that the process of tail formation is of an intermittent and not continuous nature. In no previous comet has the motion of the matter forming the tail been so clearly traced.

The behaviour of the nucleus, and the phases through which the comet passed as parabolic envelopes of matter appeared on the side towards the sun; the sweeping round of the matter to produce the beautiful fan-shaped tail, and finally the break-up of the tail into fleecy masses, can all be clearly observed in the photographic records. Professor E. E. Barnard¹ has combined a number of the photographs taken at intervals of one hour or so, and has thus obtained beautiful stereoscopic effects.

The comet of course appears as a brilliant object suspended in space among the stars; but while he believes that a great many of the stereoscopic details give incorrect ideas of what was taking place at the time, yet he considers much can be learned of the general structure of such bodies by this means.

Jupiter's Eighth Satellite.—Lastly, the brilliant and patient work of Mr Melotte of the Royal Observatory, Greenwich, as a result of which he discovered the eighth satellite of Jupiter, is still another success due to photography. Let us for a moment try to understand the difficulty of discovering the existence of such a small heavenly body as this satellite, which is equivalent in brightness to a star of the seventeenth magnitude.

Stars are classed in magnitude according to their

¹ See R.A.S. Notices, June 1909.

brightness, stars of the first magnitude being 2.5 times as bright as stars of the second, those of the second 2.5 times as bright as those of the third, and so on; hence a star of the first magnitude is about 100 times as bright as a star of the fifth magnitude, and 250 times as bright as one of the sixth, which is the faintest star ever visible to the naked eye.

This little satellite, being only of the seventeenth magnitude, can easily be seen to be about $\frac{1}{25,000}$ the brightness of these just visible stars, thus it must have required not only considerable skill, but a great deal of patience in deciphering the photographic records which contain the first evidence of its existence, since, although it changed its position among the neighbouring stars, the very faint impression was so indistinct as to make it quite probable that it was due to some flaw in the film. However, at the end of February 1908, Melotte was certain of the existence of the satellite, and it was then found that it could be traced back to January 27th on the photographic plates.

The orbit of the satellite was then calculated by Messrs Crommelin and Cowell from the records which had been obtained, and so soon as Jupiter was again in a favourable position (January 1909), and the sky was dark, and the night bright, Mr Melotte succeeded in again obtaining a photograph of the eighth satellite.

Its position was found to be very close to that indicated by the above-named astronomers, and it has been thus proved that this very small satellite of Jupiter is a very distant one, with retrograde motion and a very eccentric orbit. This brilliant success in astronomical research is one of the latest triumphs in that branch of science due to the help of photography in recording the positions and motions of the heavenly bodies.

Effect of a Brief Exposure of Plates to Light when they are used for photographing Faint Spectra.—R. W. Wood has

found that the exposure of the sensitive plate to a very faint light tends to shorten the time of exposure required for the reproduction of very faint spectra of stars.¹

He explains this action on the part of light as follows : Let the abscissæ in the diagram (132) be units of time during which the plate is exposed, and the ordinates

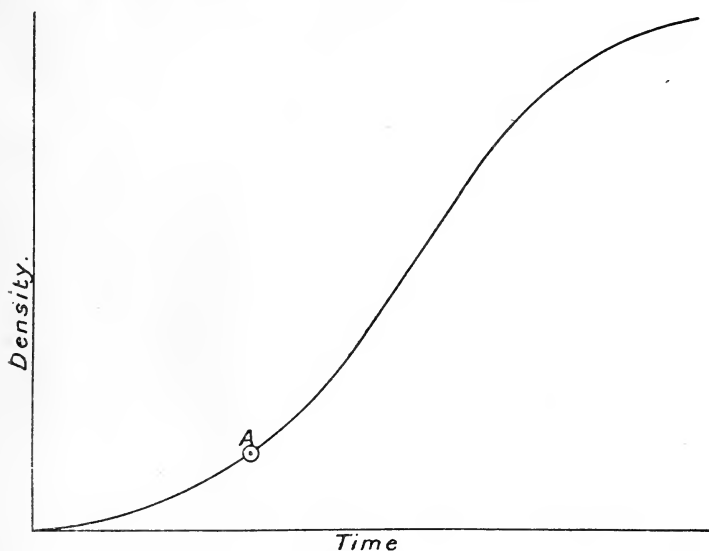

Fig. 132.

represent the image density which results from this exposure.

At first it will be seen that the increase in density takes place very slowly as time proceeds. This continues until the point A is reached, after which the density increases very rapidly with further exposure.

Now the preliminary short exposure to a very weak source of light is most effective if the density is carried

¹ *Astrophysical Journal*, xxvii. 5, 1908.

to point A, and then exposure to the faint spectrum can be made at that period when the increase in density takes place most rapidly.

To find out just what is the best preliminary exposure to give, turn down an ordinary gas jet until its yellow tip is only three or four millimetres high; hold the plate a certain distance from it covered with a sheet of black paper. If now the black paper is gently and gradually drawn aside so as to expose strips in which the exposure will vary by two seconds, the results can be compared on development. Wood finds that glycin is the best developer to use, and he prefers a rather strong developer which he uses for some fifteen to twenty minutes.

The best results are obtained by the exposure which produces a faint image; this is obtained in four seconds, with the small gas jet previously mentioned at a distance of about two metres, but of course this will depend upon the plate used. According to Wood, it is immaterial whether the exposure to the faint source of light is made before or after exposure to the weak stellar spectrum or nebula.

On the other hand, R. J. Wallace and H. B. Lemon¹ contend that no practical advantage is gained by either a preliminary or supplementary exposure in so far as stellar photography is concerned.

Colour of Light from Stars.—Schwarzschild has suggested that the difference between the visual magnitude of a star and that obtained from ordinary photographic plates should give an accurate measure of the star's colour. He named this difference the "*Farbentönung*."

The method of determining the colours of the stars by the eye has proved very unsatisfactory. Parkhurst and Jordan² have now made use of photographic means to obtain the visual magnitude of stars.

¹ *Astrophysical Journal*, xxix. 2.

² *Ibid.*, xxvii, 3, 1908.

Pairs of plates are used, one being ordinary and the other isochromatic. The former plate has a maximum of sensitiveness at about a wave-length of $\lambda 4000$, while in the case of the latter the maximum sensitiveness occurs about $\lambda 5550$ in the plates used, therefore it follows that a star giving a maximum radiation in the blue or violet will produce a more marked effect upon the former, while one the maximum for which occurs in the yellow or red will appear stronger upon the latter. The more intense the colour of the star, the greater will be the difference of magnitude on the two plates, so that by this means a measure of the colour intensity can be obtained quite as accurately as the measure of the magnitude. The magnitudes are obtained from these plates by measuring the diameters of the discs under the microscope, and reducing the results by means of the formula:— $\text{magnitude} = a - b \sqrt{D}$, in which D = diameter of the disc, a = a constant for each plate depending on the exposure, and found for each plate by using the visual magnitude of the white stars; b = a constant depending upon the emulsion and conditions of development. It is also found that definite colour intensities correspond in general to definite spectral types, and this of course furnishes a means of determining the spectra of stars which are too faint for ordinary spectroscopic analysis.

MICRO-PHOTOGRAPHY AND PROJECTION APPARATUS

The Solar Microscope.—Photography as an auxiliary to, or substitute for the art of drawing, appears nowhere to greater advantage than in the representation of microscopic objects. This was investigated in the very earliest days of photography, for Wedgwood and Davy attempted to fix on sensitive silver paper the images which they produced by means of the so-called solar microscope. The construction of this instrument is shown in the accompanying figure.

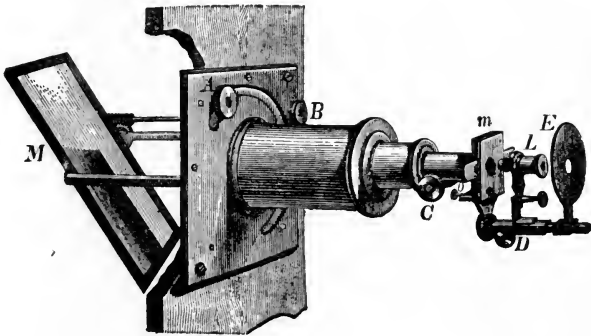

Fig. 133.

The microscopic preparation is inserted at *m*. The small lens *L* projects an enlarged image of this minute object on a suitably placed screen.

The rackwork at *D* serves to regulate the distance of the lens from the object *m*, and thereby to focus the object sharply upon the screen. *E* is a diaphragm by which the edges of the image are cut off, so that a clearly

defined picture may be produced on the screen. The tube BC contains the lenses which concentrate the light.

It must be remembered that in enlarging the image as is here done, the actual amount of light received on any particular part of it will be very greatly diminished. In fact, if it is enlarged three times, the light on any particular part is diminished to one-ninth its original value; if enlarged fourfold, to one-sixteenth, and so on, the light received being inversely proportional to the square of the linear magnification. With such a diminution of brightness it would be extremely difficult to distinguish anything by the unaided eye, if care were not taken to throw a very strong beam of light upon the object. The system of lenses in BC answers this purpose, concentrating on the microscopic object the sun's rays which are reflected by the mirror M into the tube B . When this apparatus was made use of for obtaining microphotographs, the room into which the image was projected had to be completely dark, so all that was necessary was to expose the photographic plate in the exact position in which the image on the screen appeared well defined.

Such a piece of apparatus as the above, presented too large a number of difficulties to be surmounted ever to become very generally used, the chief perhaps being that a special room was required for its use.

The Microscope.—The ordinary microscope can, however, be used in a much simpler manner, and with a little practice good results are obtained. For this purpose it is essential that the stand should be perfectly rigid, of a large type, and provided with a rotating and centering stage; and further, a very good fine adjustment should be possible, so that perfectly well defined images can be produced

These properties are possessed by such instruments as shown in fig. 134.

To produce photographs with the help of such a

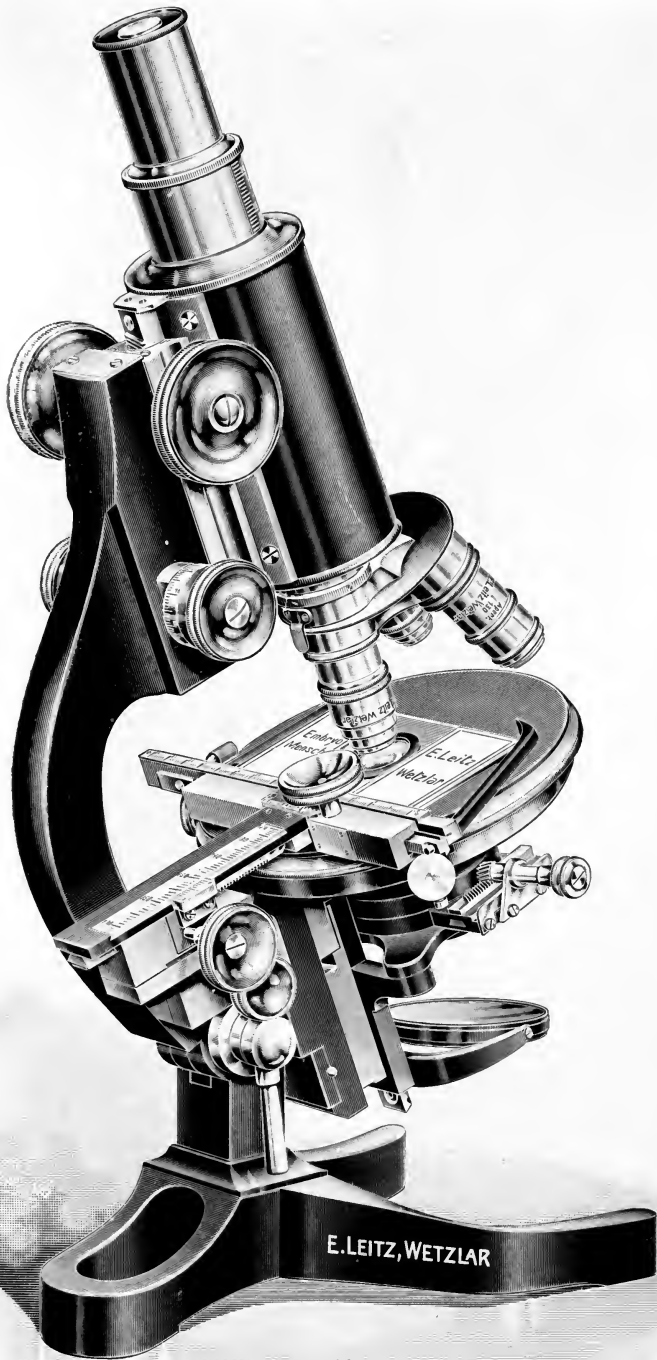

Fig. 134.

A modern Microscope, with attachments.

microscope, a camera, properly supported, can be placed directly on the eye-piece. This camera does not require a lens like the ordinary photographic camera. The eye-piece of the microscope serves this purpose, and this is inserted through a light-tight sleeve into the front of the camera. It is necessary, in these operations, that all light not emitted from the object should be excluded. If the reflector at the bottom of the microscope is used by itself, many rays pass by the sides of the object, and fall upon the lenses, bringing about reflections that materially disturb the clearness of the image. Hence it becomes advantageous to use in such work the substage condenser, by means of which the rays of light are concentrated on the object; in addition to this, an iris diaphragm will often be found extremely useful.

The lenses used for microscopic objectives are either achromatic or what are known as apochromatic. Such lenses differ from one another in that the apochromatic lenses are so constructed that a very much higher order of colour correction is obtained in them than in the case of the achromatic lenses.

On the other hand, the superiority of apochromatic lenses in micro-photographic work is only very apparent when the preparation to be photographed is unstained, and extremely minute details are required, such as can only be resolved with light of short wave-length. Hence it is that the cheaper achromatic lenses are much more frequently used in conjunction with stained preparations, autochrome plates, or orthochromatic plates and colour screens.

The method by which the image is formed in the microscope will be understood by referring to fig. 135; rs is the small object of which it is desired to obtain an enlarged image; $S R$ represents the enlarged image projected by means of the objective. This is when

viewed through the eye-piece, again magnified so that a still greater image $S' R'$ is produced. It will be seen from the figure that rays of light from r , after passing through the lens $a b$, converge to R . R is therefore the image of r as formed by lens $a b$; similarly the light from s converges to form an image at S , and so with all points, between r and s .

Again considering the rays from r , it will be seen that they diverge after passing R , and that as the result of these diverging rays passing through the lens $c d$ it appears to the eye, behind that lens, as if these rays actually proceeded from R' . Thus $S' R'$ is the apparent image of the object $s r$ as seen by the eye after the light has passed through the lenses $a b$ and $c d$.

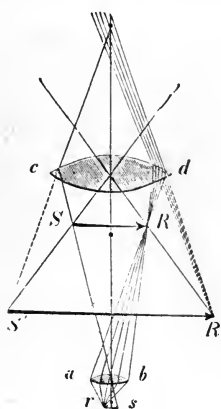

Fig. 135.

Camera Attachments.—Since microscopic work forms such an important part in biological studies, special camera attachments for microscopes are now made, as it is much more convenient to obtain a photograph of a preparation, and from this

make a lantern slide, which can be projected so as to be visible at the same time to a larger number of persons than it would be possible to allow to separately view the image as formed in the microscope. Again there are instances where the object under observation is undergoing change so rapidly that it would be impossible to keep a good record of its varying appearances by any other process than the photographic. Of course direct representation of the object on the screen by micro-attachments to the lantern are to be preferred when possible, but this process reaches a practical limit when the strong light required for the

higher magnifications is accompanied by sufficient heat to injure the specimen. The next two figures show one of these cameras as made by Leitz, the first arranged with the microscope placed horizontally, the other with the vertical arrangement.

It will be noted from fig. 136, that in this position the mirror is detached. It is as well to note that for all purposes in which the amount of magnification desired

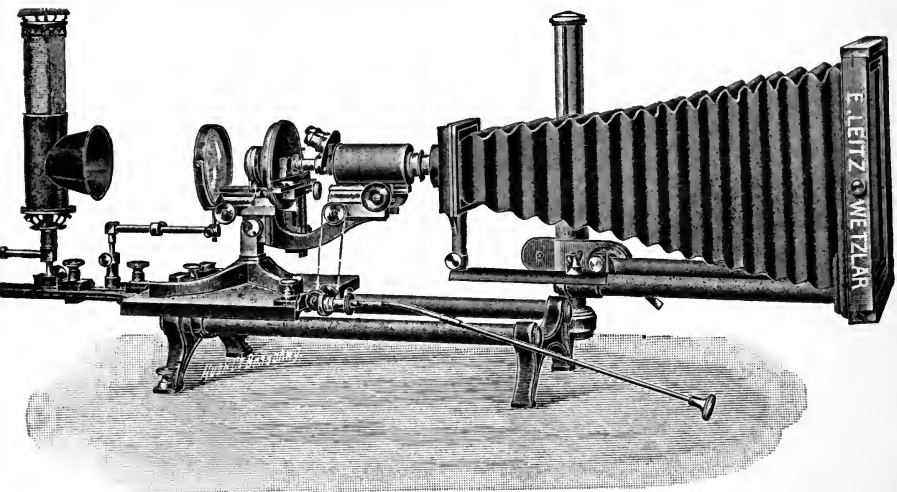

Fig. 136.

requires a greater camera extension than 25 cms., the horizontal position should invariably be adopted. The reason for this will be understood when it is remembered that in this kind of work it is of the utmost importance that even the slightest vibratory movement be avoided. It is preferable that the camera and the microscope should be arranged as shown in the figures, so that should any small disturbance take place, both may be affected in a similar degree, and distortion of the image may be avoided as much as possible. For those familiar with the microscope the arrangements as shown in the figures

are sufficiently distinct not to require any detailed explanation. The following points may, however, be of interest.

After the dark slide is placed in the camera, before

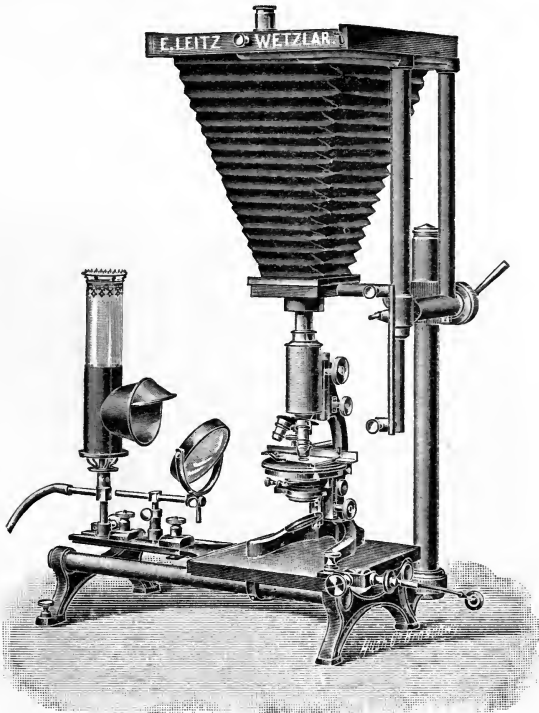

Fig. 137.

exposing the plate, cut off the light by means of black paper. This must be carefully performed by covering the mirror with the paper in one case, and placing the paper between the lamp and the illuminating lens in the other. When ready to expose the plate remove the obstruction. It is of course impossible to give any absolute rule as to the amount of exposure required,

since this will depend upon the plates used, the source of light, the magnification, and the nature of the preparation. It is a good plan before commencing actual work to expose a plate for two seconds, then gradually push in the slide a half inch at a time, allowing one second to elapse between each operation and the next. In this way, strips of the plate will have been exposed two, three, four seconds, and so on, and if the plate has been previously marked, the correct time of exposure can be accurately gauged by noting which strip has just sufficient density when developed.

The carrier of the camera front is fitted with a rack-and-pinion movement for conveniently focussing photo-micrographic and photographic objectives attached directly to the camera front. These lenses are attached by a threaded flange to a small wooden lens board which slides into a fork forming part of the camera front. This slide may be replaced by another fitted with a double-tube sleeve, which serves to establish the optical connection between camera and microscope by means of a short single socket which slips over the end of the draw-tube of the microscope.

When the camera is in the horizontal position, focussing is done by means of the side attachment (see fig. 136). By this means it is possible to observe the image on the camera-screen during the focussing operations.

During the preliminary arrangements very great care must be taken to ensure that the screen of the camera is evenly illuminated, otherwise some parts of the image will receive correct exposure, and others incorrect.

If the outlines of the image are not absolutely clear, and the details not well marked, proceed as in ordinary photographic work, *i.e.* stop out some of the light. This should be done gradually until the required degree of sharpness is obtained, as much illumination as possible being retained, on account of the length of exposure

required when the beam of light is small. Besides, a very narrow source of light is apt to produce coloured fringes due to diffraction. The source of light is movable, and its distance from the illuminating lens will depend upon the magnification which is required. For low magnifications it is not necessary to use a substage condenser, and in this case the lamp may be placed at the extreme end of the apparatus, the lens being situated about 15 cms. in front of it. When the higher powers are used an Abbé condenser becomes an essential addition to the apparatus, and now the lamp and lens are gradually moved nearer this condenser until its back lens is uniformly and brightly illuminated. It may sometimes be found advisable to interpose a ground-glass screen between the lamp and camera, especially so if any structure of the source of light, such as filaments of an electric lamp, or meshes of an incandescent mantle, are visible on the screen.

In such cameras as those just described, it must be remembered that there is a large amount of metal-work, and that the correct adjustment depends upon this metal-work support. It can therefore be easily understood that if the best results are desired, it is imperative that the temperature of the room should be kept as nearly constant as possible after focussing and during the exposure.

In the photographs of some microscopic preparations it is desired to make the contrasts as strongly marked as possible; for this purpose it is necessary to use coloured filters with the apparatus, unless the preparation itself is of such a nature as to transmit only those colours which are best adapted for the plate used. A number of such coloured filters are supplied with the apparatus.

The accompanying figure (138), which represents the transverse section of the leaf of the tea-plant, has been taken with a ground green glass disc in the apparatus.

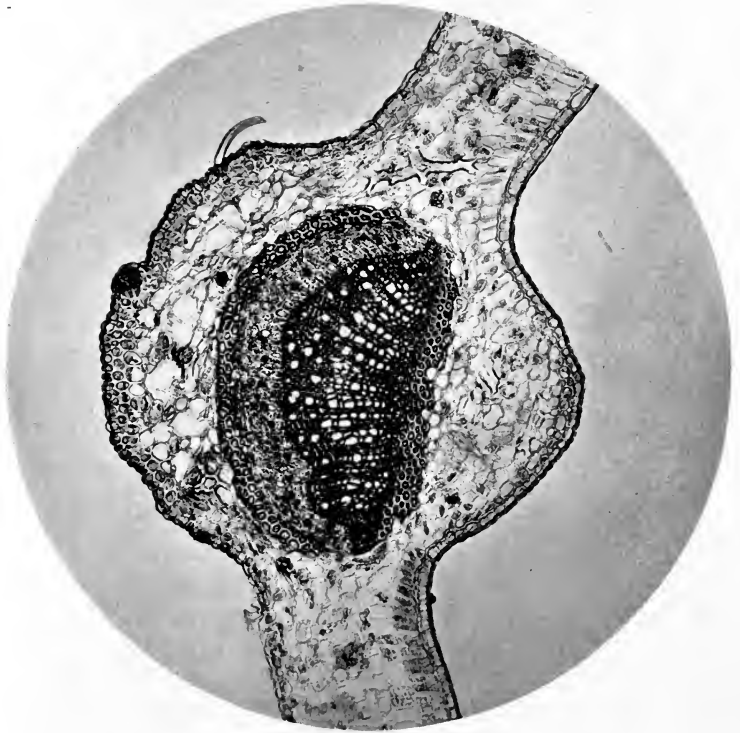

Fig. 138.

Transverse Section Tea Leaf. Magnification, 125 diameters.



Fig. 138a.—Arrangement of camera with microsummar lens, when used for photographing opaque objects.



Fig. 139.

Armadillo Embryo in Spirit. Magnification, 1·5 diameters.

The microscopic attachments used were achromatic objective number 4, and eye-piece I. An arc lamp was used for source of light, and the illuminating apparatus was shut to 7 mm. The camera extension was 32 cm.; silver eosine plates were used, and the exposure allowed was 3 minutes.

It is sometimes necessary to photograph relatively large opaque objects, and the next figure shows how this can be done. The result of such an experiment is seen in fig. 139, which represents the photograph of an armadillo embryo in spirit. It has been magnified $1\frac{1}{2}$ diameters. The lens used was a microsummar of 80 mm. focal length, and the exposure lasted five minutes with a silver eosine plate.

A section of a microsummar is shown in fig. 140. These objectives have an aperture of $f/4.5$, and are specially corrected for chromatic, spherical, and astigmatic dispersion.

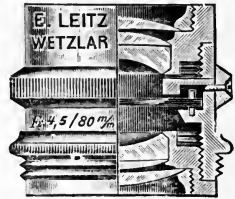

Fig. 140.

By means of such an arrangement it is well to remember that it is possible to obtain many degrees of magnification with the same objective; the shorter the camera extension the smaller will be the image.

Should stereoscopic photographs of any particular preparation be desired, all that is necessary is to move the object aside so that the second image on the screen may be displaced by an amount equal to the distance between the pupils of the eyes, that is, about 6.5 cm., and the apparatus allows of such displacement being made.

Of course any good brand of photographic plate will do for this work, but with stained preparations it is essential that some variety of orthochromatic dry plate should be used. No special remarks are necessary as to the management of the plates after exposure, but it

is wise to work with a slow developer so as to be better able to watch the development and to secure the required amount of contrast. If prints are made, choose some paper with a good glossy surface so as to bring up the details of the image to the best advantage.

Cameras for Microphotography in Metallurgical Work.— There is one important branch of micro-photography, viz. the metallurgical, in which one is concerned very largely with opaque specimens. Fig. 141 shows the usual laboratory arrangement for this kind of work. *A* is the arc lamp, *B* and *D* are condensers, *C* is the cooling trough, *E* diaphragm, and *F S* the microscope. Although the beam of light is passed through a trough to lower its heating power, it is still not passed directly through the microscope, but it is reflected so that it ultimately passes forward in a direction parallel to its original course ; in other words, the camera and microscope are parallel to, but not in the same straight line as the beam of light in the right-hand part of the apparatus. By means of such instruments it is possible to obtain very fine photographs of the surface appearance of metals, and also their intimate structure after undergoing any desired treatment. This is clearly illustrated in the next two figures.

The first of these shows a specimen of carbon steel containing 0.89 per cent. carbon, which has been heated to 1000° C., and then allowed to cool. The magnification in this case is 960 diameters. The second shows the surface structure of a silver cupellation bead, and the magnification is 120 diameters.

Quite recently a very neat form of apparatus suitable for a lecture-room bench has been devised by Messrs Leitz. It has the great advantage over the one just described that it does not take up more than one-half the space.

The stand consists of an upright which carries the tube and appliances for illuminating the object. Above this the stage can be seen. This may be raised or lowered

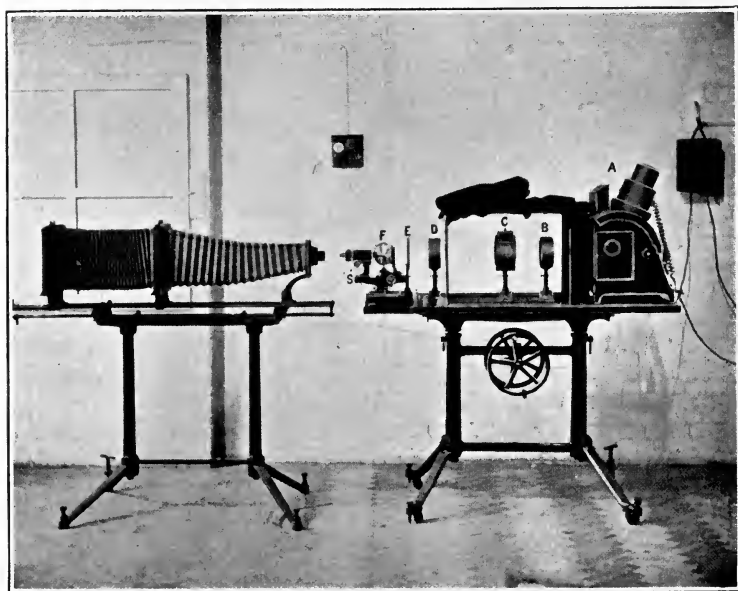

Fig. 141.

Laboratory apparatus for obtaining photographs of Metallurgical Specimens.

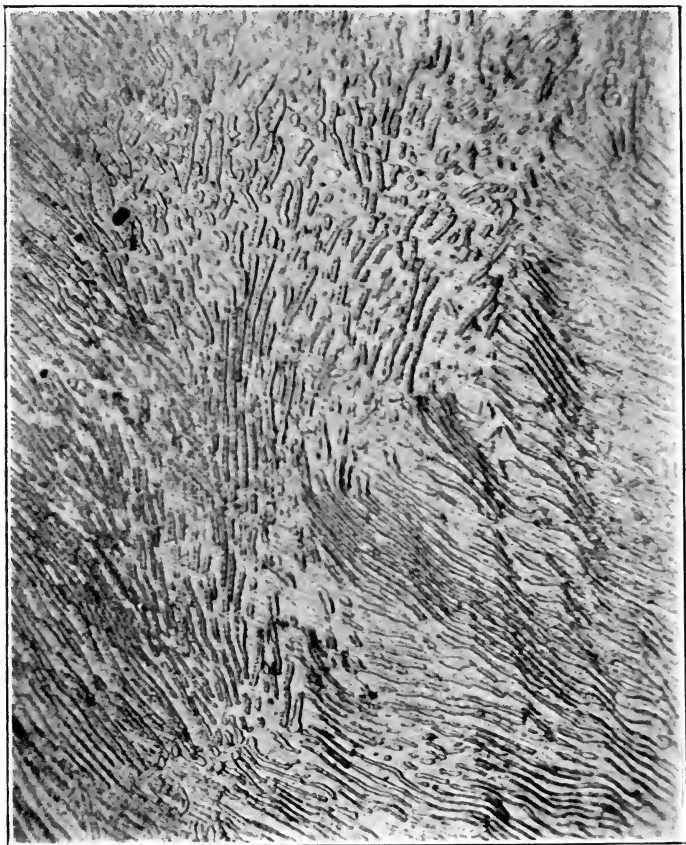

Fig. 142.

Photograph of specimen of Carbon Steel. Magnification, 960 diameters.



Fig. 143.

Photograph showing Surface Structure of Silver Cupellation Bead.
Magnification, 120 diameters.

by means of a rack and pinion, and for slow motion a micrometer is provided. The lamp in this case is an electric arc, the carbons of which can be adjusted by means of screws.

The carrier marked S_2 (fig. 145), which can be moved along the slide, is fitted with an iris diaphragm and lenses, for illuminating the object. The lamp employed here is of a special make, and has been found to work excellently

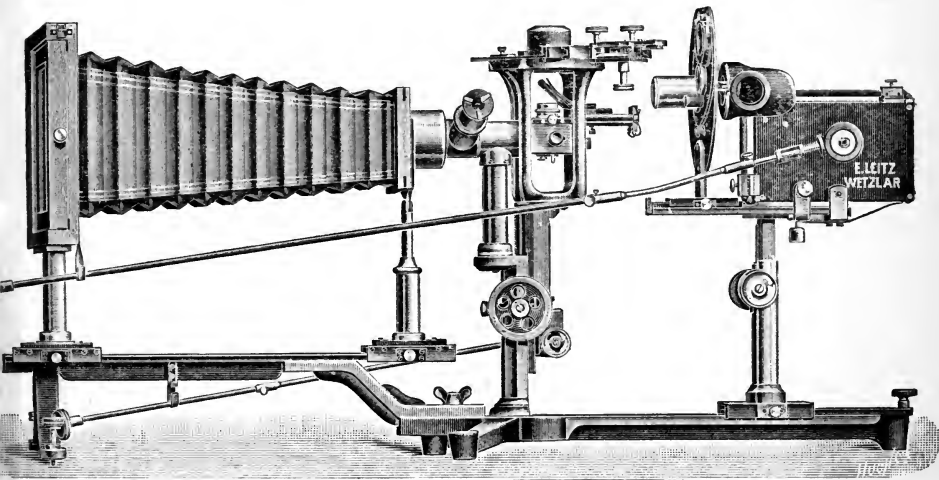

Fig. 144.

in this connection, and also in the optical projection lantern. It requires a continuous current of about 4 ampères, and so can easily be fed from the lighting circuit by placing it in series with a suitable resistance. The state of the carbons can be watched from time to time through a dark glass window. But the special feature is that the two carbons are placed in directions at right angles to one another, the positive being in a horizontal position along the line of projection, and the negative in a vertical position. By this means the uniformity in the amount of light is ensured, and this of course is extremely

important when photographs are being taken. The gap can be regulated when the image is being observed, by means of the attachment shown beneath the camera front.

The camera itself is adapted for the use of plates which measure 7 inches by 5 inches; the greatest distance by which the focussing screen can be separated from the eye-piece is 28 cms., *i.e.* about 11 inches.

There is a very useful mechanical stage which can be attached to the stage *T* after the removal of the stage rings. By means of certain attachments to this stage, together with vernier scales, the exact position of any point of interest in a specimen of metal can be located, and it is thus possible to make a record of any points of special interest, and be able to return to them at any time.

By means of the next figure a much clearer idea of the arrangements of the stage and the attachments to the lamp will be obtained.

This diagram represents the arrangement of the apparatus when using a high-power magnification. The lamp (fig. 144) is placed in its lowest possible position, and then moved along the bench (fig. 144) until it is as far as possible from the stand. The iris diaphragm *I* (fig. 145) is next placed in position. The two pencils at right angles to one another in the extreme right of the figure represent the positions of the carbons of the electric arc lamp; the carrier S_2 , having been moved towards the lamp, the iris diaphragm is closed down until it has only a very tiny aperture.

To arrange the parts of the stage it is first necessary to loosen the screw *r*, so as to be able to lower the tube *B*. When this tube has been moved as far down as possible, retighten the screw *r*. The knob R_1 is used for withdrawing the slide which holds the objective *O*. This should be made use of when it is wished to place in a fresh objective. Now refer to fig. 144; note the side projection between the camera and the stage. This is

the eye-piece which should be used in focussing the object, before trying to do so by means of the camera screen. The eye-piece tube can be moved up and down, and is fitted with a prism, which deflects the rays transmitted by the objective into the eye-piece when the tube is pushed in. When it is wished to allow the rays to pass direct into the camera attachment, all that is necessary

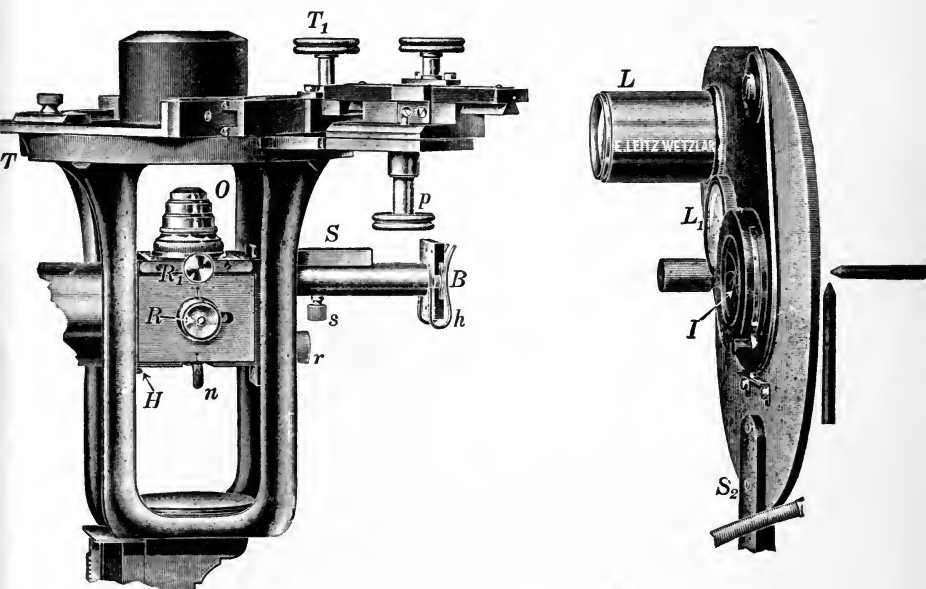

Fig. 145.

is to withdraw the tube of the eye-piece so as to move the prism out of the path of the rays.

Perhaps it is a bit difficult to understand the directions in which the small beam of light travels in its course through the apparatus, but a reference to fig. 146 may help to remove some of the difficulties.

Let us imagine that the source of light is extremely small and is situated at *B*. Then the thick black lines *J* would represent the position of the iris diaphragm.

The lens L_1 is situated inside the tube B , fig. 145, and its position can be regulated by means of the small knob s . When the adjustments are being made this knob should be moved until an image of the diaphragm is formed at E , midway above the upper face of the prism P , which itself can be adjusted by means of the milled head R (fig. 145). It is of extreme importance that the width of the pencil of light proceeding from the prism P may be properly regulated; this may be done by altering the distance of P from L_1 . This distance should be greater

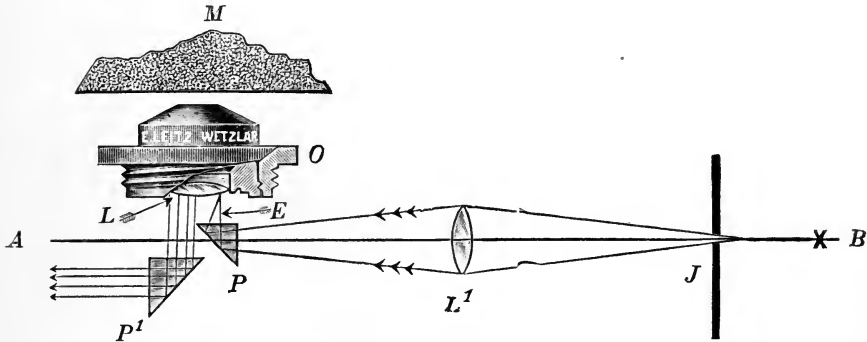

Fig. 146.

with high than with low powers. P is also of extreme importance, because it can be so arranged as to intercept any light reflected by the lens L , which, if allowed to pass through the second prism P_1 would cause irregularity of illumination of the screen.

After the light has passed through P it proceeds through the objective O and illuminates the object; it then returns through the objective O , enters the prism P_1 , and is by this deflected into the camera. Should it be necessary to adjust the prism P_1 , this can be done by means of the pin n (fig. 145). Both this pin and the milled head R are provided with index marks, so that the prisms can always be reset in the same initial positions.

Should the image as viewed on the screen appear at all distorted, it may be taken as a clear indication that the prisms P and P_1 are not properly adjusted.

The clips to be seen on the tube B (fig. 145) are for the purpose of holding any light filters which may be required. If desired, a shutter can be attached to the carrier S_2 when the apparatus is used for obtaining photographs. It may be as well to add that an eye-piece as well as objective is used in this instrument when taking a photograph; the eye-piece is attached by means of a fitting which is put in the sleeve at the end of the camera. The final focussing is done by means of the lower attachment beneath the camera (fig. 144).

The lens L , as shown in figs. 144 and 145, is for use when it is desired to work with low magnifications; for this purpose it is also necessary to raise the lamp, and move it as near as possible to the stand. The object is illuminated by the light reflected from the glass plate, which is attached to the slider S (fig. 145) for this purpose.

Lantern Slides.—The permanent records obtained by means of microphotography can be made of much more extended use by preparing lantern slides from the photographs. The lantern slides should, if properly prepared, show much better gradations than ordinary prints obtained from the same negative. To prepare the lantern slide, the sensitized plate should be placed in the printing-frame with its film side to the film side of the negative. This of course should be done in the dark room. The exposure is best carried out by artificial light, the plate being placed at a definite distance from the light and so arranged that the light strikes it as nearly vertically as possible. The development and fixing of lantern slides is carried out in the same manner as that of ordinary plates, but it is well to remember that the success depends upon the light transmitted by the slides, so it is better to avoid developing too far.

It is of course necessary to protect the film of the slides; this is done by placing a plain glass slide on the film and fastening the two together by black binding, which is sold for the purpose. It is as well to place a small white circle of paper on one side of the slide, so that the operator may know which face of the slide should be placed towards the light.

Projection Apparatus.—It will give us a good idea of the development which this method of projecting images upon a screen has undergone, during the last thirty or

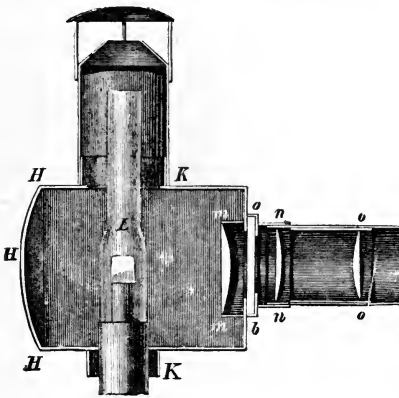

Fig. 147.

forty years, by comparing the account and illustration of a lantern used for projection purposes, given in the edition of this book which appeared in 1874, with one of the best projection lanterns of the present day. Of course it is well known that there are still sold a great many lanterns fitted with oil lamps, similar in principle to the one here described, but when the following was written such lamps were practically the *only* ones in general use.

Early Form of "Magic Lantern."—"The magic lantern serves for the production of enlarged images by means of lenses. Instead of a simple lens, a system of lenses *n n o o* (fig. 147) is employed for enlarging, which gives more sharply defined images. The object is painted or photographed on glass plates, which are placed in the slide *a b*, and brightly illuminated by the lamp *L*. The concave mirror *H* and the lens *m m* are employed to concentrate the lamplight on the object that has to

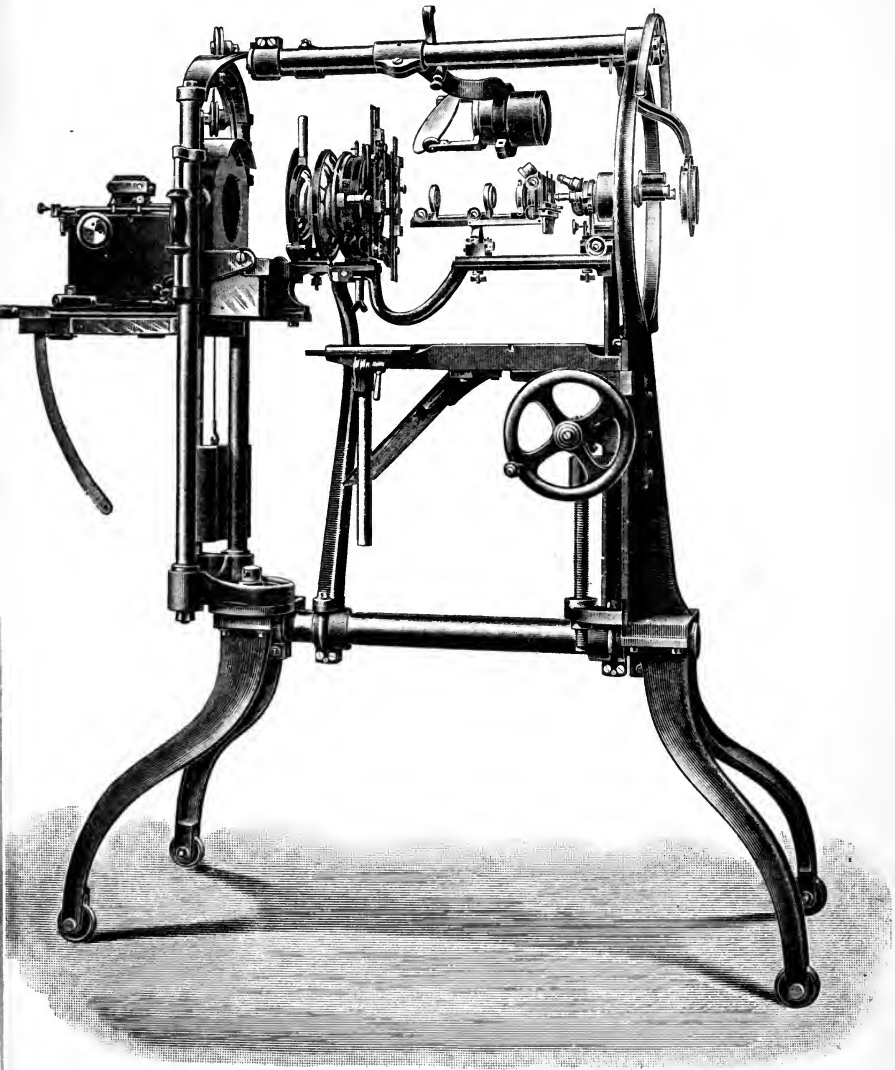

Fig. 148.

be enlarged. The images obtained vary in size with the distance of the screen from the lens.

This instrument was formerly nothing but a plaything, but it has latterly become an important auxiliary in instruction. Photographs of microscopic preparations, of animals, plants, minerals, landscapes, national types, and architecture, may be in this manner more faithfully represented than by maps, which are in general very imperfectly designed."

Universal Projection Apparatus.—We will not consider next one of the many excellent lanterns fitted with lime-light or arc-light lamps, nor even a biunial or triple lantern, such as are in frequent use not only where dissolving views are exhibited, but also for many other purposes; but we will briefly describe a projection apparatus suitable for projecting not only images of slides, but also images of apparatus and experimental arrangements, etc., upon the screen.

Such a piece of apparatus is that known as *the universal projection apparatus*. (Fig. 148.)

This picture gives a good idea of the general appearance of the apparatus. The frame, which is of great rigidity, is an iron one, and the parts of the frame are connected by means of steel tubes. While the instrument is in use it is enclosed in a light-tight screen, so that the rest of the room can be kept in complete darkness if desired. The lamp used is one of the simple arc lamps previously described, and is especially suited for this kind of work, since it regulates itself automatically, and the light is always perfectly centred; besides, from the arrangement of the carbons, the lighting capacity of the lamp is increased enormously.

Let us now examine a few of the many uses to which this apparatus may be put. It will be seen on looking at the illustration, p. 337, that the instrument is there shown with an attachment for projecting images of microscopic

preparations. Fig. 149 shows this in a diagrammatical manner; the part to the right of *D* represents the special attachment for this purpose. The dotted lines show the directions taken by a beam of light. The stands on *B*₁ carry an iris diaphragm, a lens, and condensers, by the suitable arrangement of which it is possible to properly illuminate the object for the microscopic projection.

This arrangement, together with a suitable camera attachment, could, if desired, be made use of to obtain

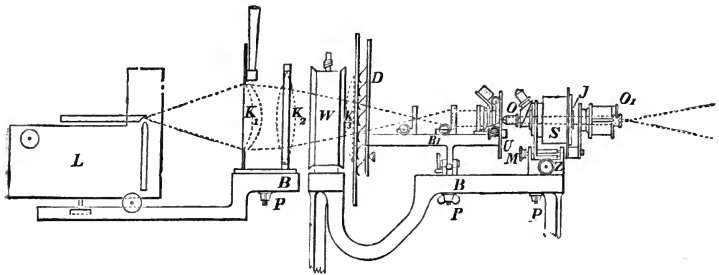

Fig. 149.

micro-photographs, but of course it is not intended for that purpose.

It must be borne in mind that it is necessary to invert a lantern slide if we want the image on the screen to appear the right way up; the reason for this is self-apparent from the following figure, which represents the projection of ordinary lantern slides. (See fig. 150.)

D represents the lantern slide carrier, which in this case is of a special type. The slides are placed in the carrier one above the other, the lower one being the one in use.

When this is removed by gently pulling it in a downward direction, the other slips into position. The large bend in the part *B-B* is to give space for the hand, while this operation is being performed. *Q*₁ represents

the lantern objective which is used for projecting the images upon the screen.

The lamp with the attached condensers can be moved down between the vertical supports (see fig. 148), so that by means of a mirror the light may be sent up through a condenser lens situated on the stage, but kept covered when not in use. Slides and sections up to 21 cm. diameter can be placed on this lens, and images of them projected upon the screen.

Then again, the lamp and attachments may be tilted

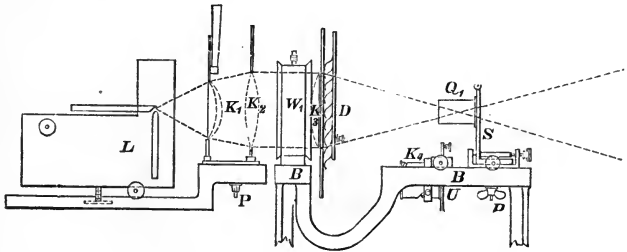

Fig. 150.

downwards 45° from the horizontal by means of the handle attached to it. There is no fear that the lamp may be given a wrong tilt, since it can only rest in the proper position. This is extremely useful for projecting the images of opaque objects. The method by which this is accomplished is made clear by fig. 151.

Images of objects placed on X in the illuminated area are reflected by the mirror G through the attached projection apparatus.

It is also possible by another adjustment of the lamp to project images of objects which must be kept in a vertical position. For this purpose, the specimen is so placed at the side that it may be illuminated by the lamp and reflected in the mirror.

Such a piece of apparatus as the one just described is of the greatest importance for demonstrations, which

are given to a large number of students. Although it appears from just a casual glance at the diagrams

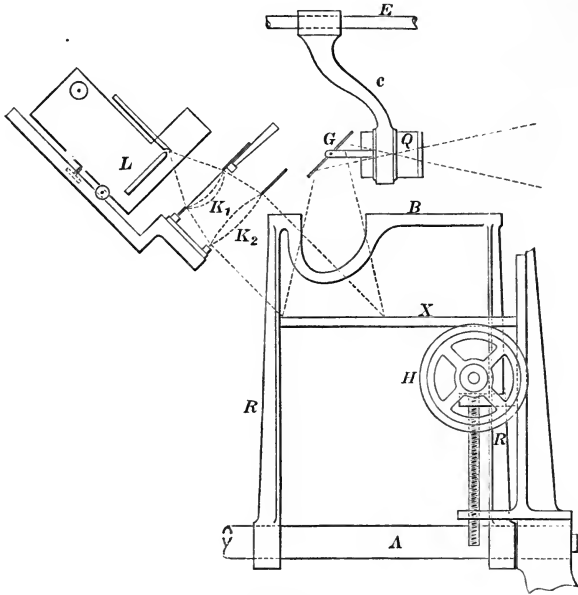

Fig. 151.

and illustrations to be of a somewhat complex nature, it is extremely simple to manipulate, and it takes but very little practice to enable one to obtain uniformly good results with it.

RÖNTGEN-RAY PHOTOGRAPHY

Introductory.—In these days of electric trams and trains, everybody is more or less familiar with the sparking which takes place, when, owing to the presence of dirt or some other cause of break in the electric circuit, the current is obliged to jump across a small air-gap. Now, the power of the electric current to complete a circuit in which the conductors are separated by an air gap depends upon what is known as the voltage, and not on the actual quantity of electricity which is passing through the circuit. Unless the voltage is very much higher than that used for lighting or traction purposes (about 200 volts), it requires but an extremely small gap in the circuit to cause the current to cease altogether. Thus, a voltage of over 30,000 is necessary to enable it to jump across an air-gap of one inch. A method has long been known by means of which it is possible to obtain a relatively small current at a very high voltage, by the use of a few simple cells and a suitable transformer. This is very important, for in Röntgen-ray work it is necessary to have such an apparatus, since a simple trial will be sufficient to convince one that the voltage obtainable with a few accumulators in series, is of no use for sending a discharge through a vacuum tube.

The Ruhmkorff Coil.—The transformer used for this purpose is what is familiarly known as a “coil,” or, more correctly, as an induction coil; it is also sometimes spoken of as *Ruhmkorff’s* coil. With the help of even cheap forms of this coil, we can obtain a voltage of some tens of thousands by using only a few accumulators in the primary circuit, while with larger and more expensive

varieties even greater changes than this can be brought about.

The action of such a coil depends on two or three well-known principles. One of these may be stated thus: If we have two circuits lying quite close to one another, but not in absolute contact, and a current of electricity be sent round one of these circuits, then, at the moment the circuit is completed an instantaneous current passes round the other circuit in the opposite direction, owing to what is called the inductive action of the first or primary current. The induced current is usually called the secondary current.

Again, when the primary current is stopped, *i.e.* at the moment when the circuit is broken, an induced current instantly excited in the secondary circuit in the same direction as the primary.

Consequently, if arrangements are made for quickly closing and opening the primary circuit alternately, then an alternating current will be induced in the secondary circuit.

In the Ruhmkorff coil the primary circuit passes round a core of soft iron, which, of course, becomes a magnet when the current is made, and loses its magnetism when the break of the current takes place.

Outside this primary coil is a secondary coil which consists of many thousands of turns of fine wire all very carefully insulated. This wire is not wound in one layer from end to end of the coil, then another on the top of this and so on, but is in separate sections perpendicular to the axis of the coil, these sections being separated from one another by partitions which are made of very good insulating material. In this way it is possible to ensure that no two consecutive layers shall be at such a great difference of potential as to cause a breakdown in the insulation, and a consequent short circuiting due to sparking across from layer to layer. The primary current is obtained by a battery of a few accumulators, or from

the main lighting circuit, by using a suitable resistance in series.

An arrangement of some sort is necessary to make and break the primary current at regular intervals.

When this is done, a change of the magnetic field due to the core of the coil is constantly taking place, and a powerful current at a very high voltage is thus excited in the secondary circuit.

For further details as to the action of this coil the reader

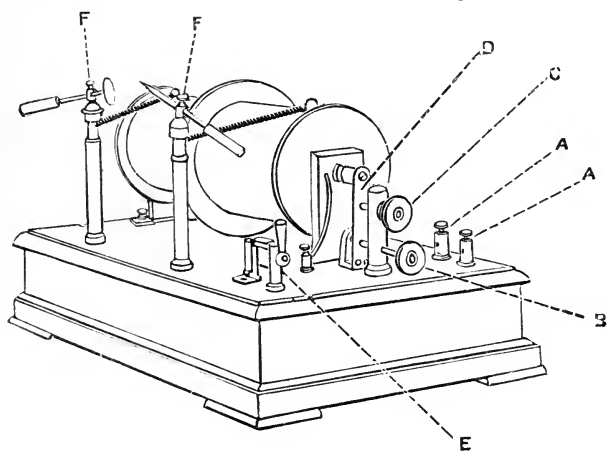

Fig. 152.

is referred to any one of the well-known text-books on magnetism and electricity.

The general external appearance of the instrument is seen in the following diagram.

A A are the primary terminals, to which the wires from the accumulators or other suitable source of electricity must be fastened.

F F are the secondary terminals to which wires from the electrodes of the tube must be attached. Care must of course be taken to connect the kathode or negative

electrode of the tube to the negative secondary terminal when using a Röntgen-ray tube.

E is a switch by means of which the primary circuit can be broken or reversed at will. This switch should always be kept open until all the connections are made and the work is ready to be started. In the diagram it is shown in the "cut off" position.

D is the hammer by means of which the alternate make and break of the primary current is arranged.

The screw *C* is for the purpose of regulating the distance of the hammer from the soft iron core, so as to ensure the most easy and uniform action of the coil.

The screw *B* alters the pressure upon the point of the screw *C* of the spring to which the hammer *D* is attached. When turned to the right, this screw lessens the pressure, and so makes the amount of current passing through the primary circuit less. On this account, if it is desired to obtain a brighter glow in the tube, increase the current in the primary circuit by turning screw *B* slightly to the left.

When working properly the coil should make a minimum amount of noise. The sparks should be sharp and snappy when the coil is used for radiographic purposes. Great care must always be taken not to touch any part of the secondary circuit while the coil is in action, otherwise a very unpleasant shock may be experienced. The kind of coil which is very extensively used by Röntgen-ray workers in our hospitals and elsewhere is shown in fig. 153.

Coils of this type are made in several different sizes, which are capable of giving sparks from four inches to eighteen inches in length in air at ordinary atmospheric pressure. It requires a coil capable of giving at least an 8-inch spark to get satisfactory results in X-ray work.

When a discharge of electricity is sent through a vacuum tube, the appearance of the discharge depends

upon several conditions ; thus, it alters with an alteration of the pressure of the residual gas, with the current passing through the tube, and likewise with the nature of the gas contained in the tube.

The Röntgen-rays.—The fact that the colour of the light emitted during the discharge can be varied by altering the nature of the contained gas is made use of in the well-known Geissler tubes, which are so much used for exhibition purposes.

It was not until November 1895 that Röntgen, at the Institute of Physics in the University of Wurzburg,

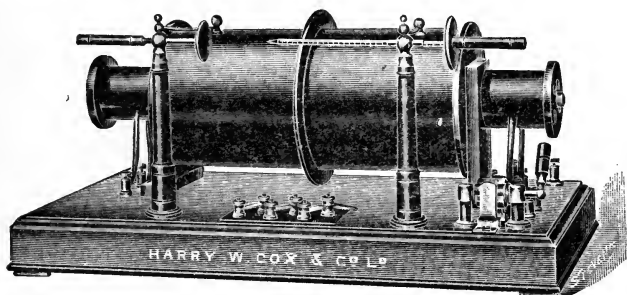

Fig. 153.

Bavaria, when working with vacuum tubes in which the pressure was so low that a bright green phosphorescence could be seen on their glass walls, noticed some very peculiar phenomena taking place in the neighbourhood of these tubes.

A screen covered with a barium-platino-cyanide preparation became luminous when held near such a tube. Such screens made of chemically prepared vellum and having one side covered with barium-platino-cyanide are mounted in wooden frames and can be bought ready for use. When using such a screen, the prepared side should be turned away from the object.

The tube could be covered with a sheath of thin,

black cardboard, and yet he found that the rays could penetrate, in fact from his experiments he came to the conclusion that all substances are in varying degrees transparent to the rays emitted under such conditions. He further discovered that these rays have the power to affect a photographic plate in the same manner as does ordinary light, and a somewhat brief notice was given by him of their use in obtaining a photograph of the bones of the hand.

To obtain a shadow of the bones of the hand, all that is necessary is to place the hand between the prepared screen and the Röntgen tube. Since the flesh is less dense than the bones, the rays can the more readily pass through the former, and the shadow thrown by the latter appears dark by comparison.

Other materials for use on the screen have been tried from time to time. Thus, Edison obtained good results by using tungstate of calcium, mixed with a small quantity of tungstate of manganese; hydrated potassium platino-cyanide has been used by others, but the barium-platino-cyanide is still the substance most generally used.

The first attempts to use Röntgen-rays for photographic purposes were greatly handicapped by the want of a suitable tube. The tubes used in the earlier work had such a wide region from which the rays were generated that the photographs obtained by their use were all more or less lacking in definition.

The Focus-tube.—This defect was removed by the invention by H. Jackson of the "focus-tube," in which the kathode or negative electrode is concave in shape, and the rays sent out from this strike upon a platinum-faced aluminium anode or positive electrode, arranged at an angle of 45° with their path from the kathode. The anode is placed a short distance beyond the centre of curvature of the kathode. The reason for placing it in that position is because, when working with the lower

vacua, the rays do not come to a focus quite so soon as when using the higher vacua, and the object is to make the area of the anode struck by the kathode rays as small as possible. At the same time it is just as well that the rays should not be brought to a focus on the anode, as the amount of heat generated is so great that the anode is soon melted at the place struck.

Gardiner¹ has carried out some experiments in which the kathode rays are deflected by a weak magnet, so that different parts of the anti-kathode come under their influence. In this way the time of usefulness of the tube is lengthened, and it is found that the photographs obtained do not suffer any lack of distinctness.

When the anode is struck by the rays from the kathode, the so-called X or Röntgen-rays are produced, and the part of the bulb facing the anode then becomes of a bright green colour.

From recent experiments made by Dr Kaye,² it appears that the 45° position of the anti-kathode enjoys no real advantage over any other position relative to the direction of the kathode-rays. He found that the fluorescence of the bulb, which is due to the secondary kathode rays from the anti-kathode, increases very markedly as the deviation from the normal incidence increases, but that the Röntgen-rays do not show any corresponding order of variation.

According to his researches, it would appear that the ideal Röntgen-ray tube should have a concave tantalum (this he preferred to aluminium) kathode, directly facing, and parallel to, a heavy bowl or trough-shaped tantalum anti-kathode.

The kathode should be cooled in some manner, as this greatly reduces the tendency of the bulb to harden when it has been in use for a long time.

The reason tantalum is preferred for use in such tubes

¹ *Röntgen Soc. Journ.*, 5, pp. 80-81, May 1909.

² *Roy. Soc. Proc.*, Ser. A, 83, pp. 189-194, Jan. 7, 1910.

is that its melting-point is very high, and that the sputtering so common with electrodes in vacuum tubes is reduced to a minimum when this metal is used.

A modern form of Röntgen tube is shown in fig. 154.

The electrodes marked + are the anodes, and it will be seen that, unlike ordinary vacuum tubes, there are two instead of only one of these on the main tube. It has been found in practice that the tube which is very frequently in use tends to become what is known as "hard," that is, it becomes more difficult to obtain a supply of

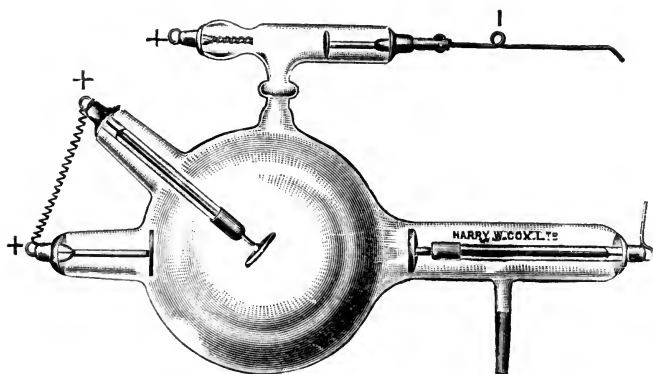

Fig. 154.

Röntgen-rays from it, owing to the vacuum becoming higher as the work continues.

These bianodic tubes are used in order to diminish this effect. It is perhaps better to speak of the target at which the kathode rays are shot, and the Röntgen-rays are generated, as the anti-kathode, and the other positive electrode as the anode.

It will be seen from the figure that the anti-kathode shields the anode from bombardment by the kathode rays and thus helps to prevent its disintegration.

The kathode (-) is made of aluminium

The small vacuum tube at the top of the figure is an

accessory which is found very useful in reducing or increasing the hardness of the tube, as may be required. It contains a suitable substance which has the power of lowering the resistance of the tube when a current is passed through it. Many methods have been tried by various experimenters for decreasing the hardness of a tube; one method, that of heating the tube very gradually with a bunsen flame, until the glass becomes soft, being perhaps a favourite. Auxiliary side tubes containing platinum have also been used, as when such a tube is heated the contained platinum gives off a gas and so lowers the vacuum.

These accessory tubes are much easier to manipulate, much safer, and also more reliable, as, after a Röntgen-tube has been heated up a few times, its hardness can no longer be reduced by that means, and then the tube must be laid on one side for some months before it can be used again with the same sized coil.

If the vacuum is too high, the adjustable spark-point, at the top right of the figure, should be moved so that it is within about one-half inch of the bottom point, and the current then turned on for a few seconds. This causes a very small quantity of gas to be driven from the smaller to the main tube, and in this way the hardness of the tube is diminished. The distance between these two points may be arranged so that sparking takes place when the hardness reaches a certain degree, and then of course the tube will regulate itself automatically. Should the tube be very hard, and a great change be desired, then the wire from the kathode should be removed and connected to loop 1 on the auxiliary tube. The current should then be turned on and allowed to run for a few seconds, taking great care not to prolong this, as the tube will by so doing become too soft to be of use.

If it is desired to increase the hardness quicker than can be done by constant use, then the top point must be

moved as far as possible from the lower, and the connecting wire from the anode (+) of the main tube moved to the positive terminal (+) on the small upper tube, the other connecting wire being still connected with the kathode. If the current is turned on for a few seconds, the hardness of the tube will increase, and work may then be resumed with the connecting wire attached to the anode of the main tube.

Sometimes a very much stronger current through the tube is required, so as to produce X-rays of sufficient strength for use beneath an X-ray couch, when taking a

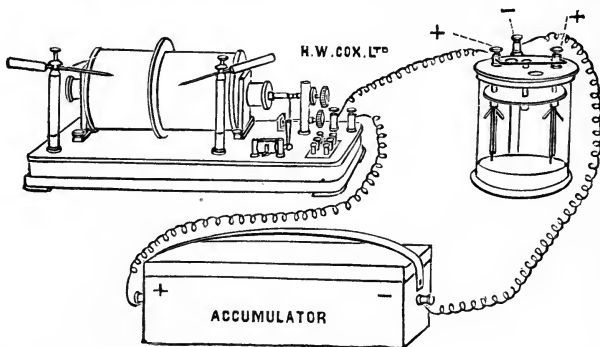

Fig. 155.

photograph with the plate placed above the body on the couch.

In such cases, it is usual to dispense with the ordinary interrupter attached to the coil, by screwing it into light contact with the core, and in its place to use an electrolytic interrupter in series with the battery in the primary circuit, as is shown in figs. 155 and 156.

When this is done, the current through the tube is so great that the ordinary anti-kathode would soon be melted. To avoid the risk of this it is kept cool by water.

A tube suitable for such purposes is shown in fig. 157.

Photographs by Röntgen-rays.—In the photographs

obtained by the X-rays no camera appliances are required. The plate, suitably shielded against the access of ordinary light, should be placed as near as possible to the portion

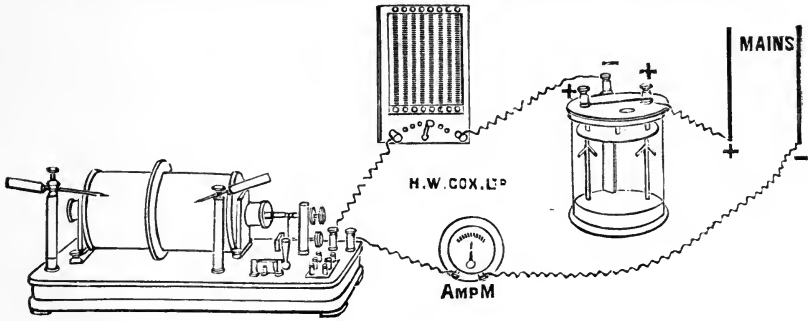

Fig. 156.

of the body which it is desired to photograph, and the rays turned on for the necessary length of time, the object in all cases being between the tube and the sensitive film.

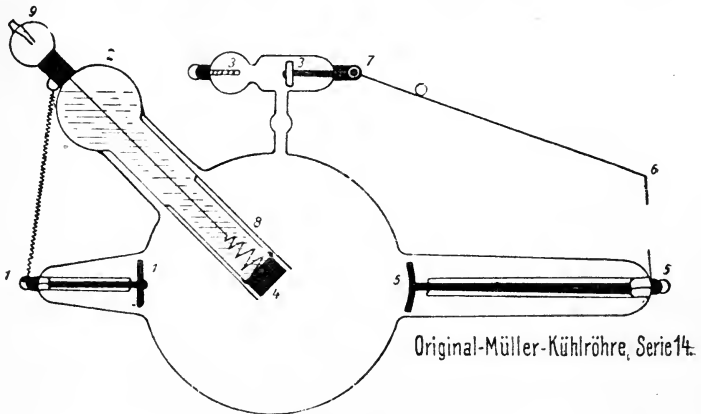

Fig. 157.

Great care should be taken to prevent the fogging of plates by the X-rays; the safest plan is to bring into the room only the plate it is desired to expose, and to allow the X-rays to act only during the actual time of exposure.

Lead-lined boxes are sometimes used to protect the plates while they are in the room where the X-rays are working; these are useful and reliable if the lead-lining is of sufficient thickness. It should be at least 1.5 mm. thick.

It is customary to enclose the sensitive plate when required for exposure in a light-tight black envelope, and to dispense with the usual dark slide. The plates, if purchased in the necessary black envelope, are always placed with their films towards the plain side of the envelope, and this should therefore be placed towards the object being radiographed.

If this is not done and the overlapping gummed parts are placed toward the object, marks on the developed plate will indicate the presence of the gum, etc. The tube should always be at a sufficient distance from the plate to ensure as small an amount of distortion as possible. The distance will vary with the object being radiographed, but it is rarely advisable to place the tube less than 12 to 18 inches from the plate when photographs of parts of the human body are required.

Sometimes it is found advisable to use a barium platino-cyanide screen to intensify the effects. In this case, a dark slide of some form or other must be used, for the screen must be so placed as to be in actual contact with the film during exposure. Of course when the ordinary wooden dark slide is used, and is placed in position, it is not necessary to open it in order to make the exposure, for wood is sufficiently transparent to the rays. It may be well to remember that with reference to these rays, bone is the most opaque substance in the human body; the blood is much more opaque than the flesh, hence anæmic patients need less exposure than full-blooded persons.

The liver and stomach are fairly opaque to the rays, and it is noticed that the muscles, when tense, are more opaque than when they are relaxed.

When making exposures in which a radiograph of the bones of a bandaged limb is required, it is well to bear in mind that ordinary strapping plaster and iodoform are by no means very transparent to the rays; ordinary bandages of course offer little obstruction to the passage of the rays.

Any good brand of fast plate or film is suitable for this work, and many specially prepared plates are now on the market. In this branch of photographic work as in all others it is as well for workers to keep to brands with which they are familiar; those who have no preference will find the Ilford X-ray plate give very satisfactory results. When a good many copies of a radiograph are required at a very short notice, a special form of X-ray paper is sometimes used instead of a plate.

This paper is really a very rapid bromide paper, and a large number of such papers may be placed on one another and exposed at the same time, since the rays can very readily pass through many layers of paper.

When films or papers are used in the place of plates, care must be taken to keep them quite flat, otherwise the image obtained will be distorted.

One great drawback to X-ray photography as compared with screen-work has been the length of time required for an exposure.

This has now been overcome by the employment of a coil giving a very intense discharge for a very small fraction of a second. The value of such an appliance as this cannot be over estimated in certain classes of work in which it is essential to make the exposure extremely short.

Such an X-ray set of apparatus is shown in fig. 158.

The three tubes in the top right-hand corner of the illustration are called "rectifiers." These are placed in series with the Röntgen-ray tube in the secondary circuit, so as to ensure that the current may pass through that tube in one direction only.

By means of this apparatus radiographs of the thicker parts of the body can be obtained in the fraction of a

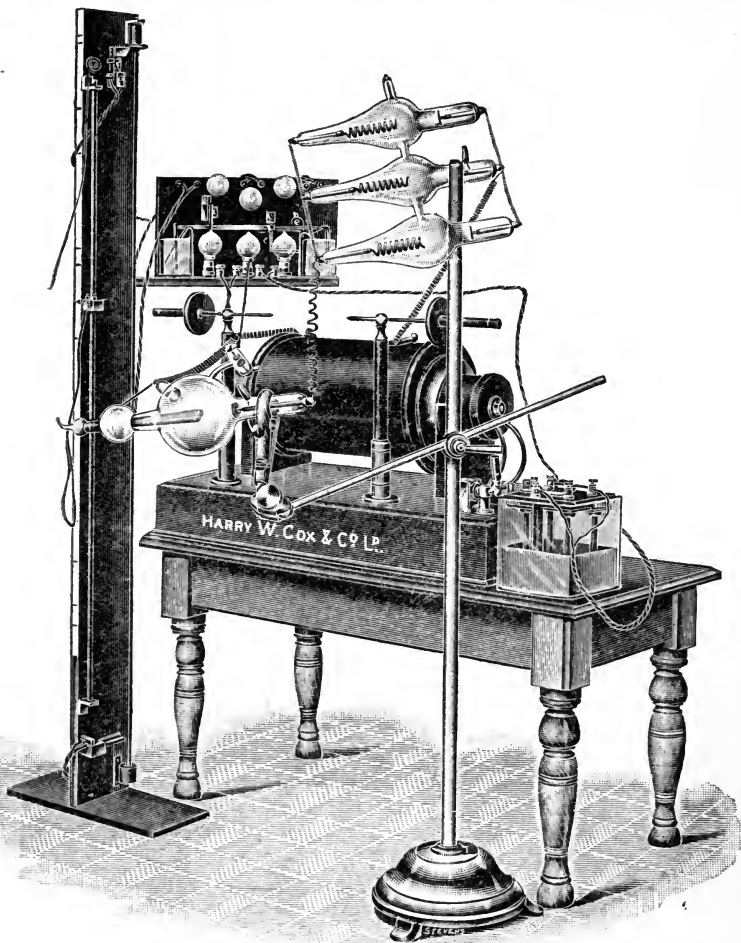

Fig. 158.

second. The coil used gives a spark fourteen inches in length, and is so made as to obtain a very heavy discharge

without any danger of the insulation breaking down. The current is made and broken under oil by an automatic timing switch, so that it is possible to time the exposure in hundredths of a second. In the figure, the stand to the left shows an arrangement in which, by means of a trigger, the operator causes a weight to fall, and this quickly makes and breaks the current by the aid of the oil switches.

In the negative obtained, the more dense parts, *e.g.* the bones in the hand, will appear white on a dark background.

The amount of exposure required is governed by many circumstances, such as the nature of the subject, the hardness of the tube, the size of the coil, the primary current, and the distance of the tube from the plate.

Hard tubes require shorter exposures than soft tubes, but negatives obtained by hard tubes are very apt to be thin. To radiograph the bones of the hand, Messrs Cox recommend an exposure of five to ten seconds, when using a 10-inch coil and the ordinary break, while with the same coil, twenty to thirty seconds exposure is necessary to obtain a successful negative of the ankle bones. The thorax under the same conditions requires still longer, and the pelvis must be exposed for about one minute.

When a larger current is sent through the tube, by using an electrolytic break in place of the hammer break, these times are of course in all cases considerably reduced.

The nature of the photographs obtained with a tube depends to a very great extent on the hardness of the tube. This is very clearly shown in the three figures (159, 160, 160A).

The first of these is taken with a soft tube, that is one in which the vacuum is not a sufficiently high one, and it can be at once seen that even the less dense parts throw quite a distinct shadow, and consequently there is a lack of good definition.

The second shows what definition and distinctness can



Fig. 159.
Photograph to illustrate effect obtained with a
soft tube.



Fig. 160.
Photograph to illustrate effect obtained with tube
under *best* conditions.

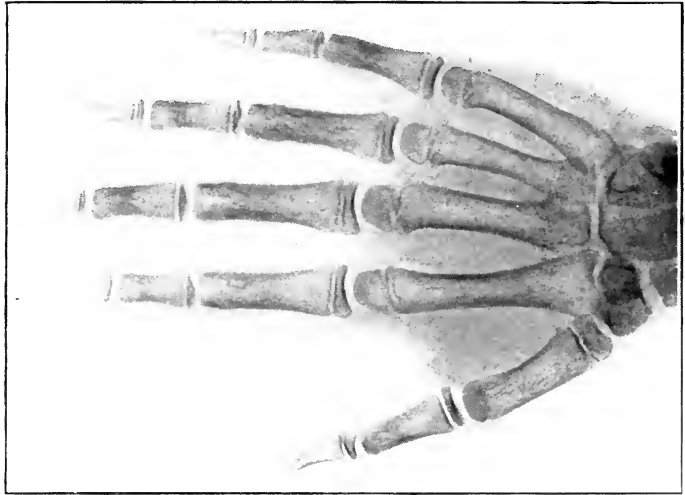

Fig. 160A.
Photograph to illustrate effect obtained with a
hard tube.



be got when a tube is working under the best conditions as to degree of hardness, and there can be no hesitation in saying in which of the three illustrations those qualities are the most clearly marked.

The last shows the result obtained with a very hard tube, that is one in which the vacuum has been pushed as high as it is possible to obtain radiographs with, and here it is apparent that even the more dense parts are relatively transparent to the rays, hence the radiograph obtained is far from satisfactory.

These photographs were all taken with the same tube (Cox Record). The different effects were obtained by altering the time of exposure, thus Fig. 159 had an exposure of 2 seconds, Fig. 160 of 7 seconds, and Fig. 160a of 30 seconds. The results correspond to those which would be obtained with soft, correct, and hard tube respectively. A 10 inch Cox coil with the Cox Radial break, was used. The voltage was 100, primary current 1 ampere, current through the tube $\frac{1}{2}$ milliampere, and the equivalent spark gap was $3\frac{1}{2}$ inches. Similar effects would be obtained by correct exposure with tubes requiring about 2, $3\frac{1}{2}$, and $5\frac{1}{2}$ inch gaps respectively. The photographs were obtained on Ilford plates, placed at a distance of 15 inches from the tube.

Great care must be observed on the part of the operator, so as to shield himself and also the patient from the access of the rays, as very dire consequences may result from carelessness in this respect. The necessity for such precaution has been made apparent to every reader by the numerous cases of victims, suffering from Röntgen-ray dermatitis, which have been recorded in our daily papers.

Any ordinary developer may be used for these negatives, but it should be clearly understood that the negatives ought not to be over-developed, and it is best to use weak developers.

One very important use of radiography is the localisation of foreign bodies, such as bullets, in the human body.

Appearances in this respect are very deceptive. If one photograph only is taken it is next to impossible, owing to the great penetrating power of the rays, to ascertain the exact position of the object; in fact, it is sometimes difficult to even roughly fix its position with reference to the bones. To do this, stereoscopic views are taken, and pieces of apparatus, such as the *Mackenzie-Davidson localisers*, have been invented in order to perform this operation in a proper scientific manner.

Reversal by Röntgen-rays.—Röntgen-rays can produce the phenomena of solarisation or reversal of the image on a photographic plate in the same manner as an over exposure of the plate on the camera to very bright objects such as the sun.

Experiments on this cause of reversal have been carried out by M. Chanoz.¹ He partly covered a sensitive plate with a steel watch-spring, 0.12 mm. thick, the whole being wrapped in black paper. The plate is exposed to the action of the rays, an arrangement being made by means of a lead screen so that strips of the plate could be exposed for varying lengths of time. When the exposed plate is developed, it is found that the density obtained is by no means proportional to the length of the exposure.

In the strips which are exposed for under two minutes, the parts under the spring are much more transparent than the rest.

With further exposure the density of the strip gradually becomes more uniform, and by the time the exposure has reached ten minutes, the part under the spring is the denser. By an increase in the length of exposure beyond this point, the density once more becomes uniform, and when the plate has been under the action of the rays for a period of between 1½ and 2 hours, the part under the steel

¹ *Comptes Rendus*, 146, pp. 172-174, Jan. 27, 1908.

spring is once again less dense than the other part of the plate.

This experiment shows that in some respects at least the Röntgen-rays can produce similar effects on the photographic plate to those produced by ordinary visible light.

PHOTO-TELEGRAPHY

EVERYONE is more or less familiar with the fact that it is now possible to take a photograph in Manchester or Paris, and transmit a copy of that photograph by telegraphy to London. Such pictures were first of all sent to the *Daily Mirror* in the latter part of 1907. Two or three methods of accomplishing this task have been in use since that time.

The first method which came into practical use was one devised by Prof. Korn of Munich. His system depends for its success upon the variation in the electrical resistance of a selenium cell when acted upon by a more or less powerful light. Suppose the photographs to have been taken upon a film, then certain parts of that film, when developed, will more easily transmit light than others. Now let this film be placed round a transparent cylinder, and a source of light so arranged that by means of a lens or system of lenses the rays are focussed on the film. Then more or less light will pass through the film and transparent cylinder to be reflected by the right-angled prism upon the selenium cell, according as to whether a less dense or more dense part of the photograph is in the path of the light (see fig. 161).

The resistance of the selenium cell varies according to the degree of illumination, and so the current passing through the circuit in which the cell is will also vary, as the amount of light received by the cell changes. The axis on which the cylinder is placed rotates and at the same time gradually rises, so that the whole length of the film comes in time in the path of the rays.

The next step is to have at the receiving station some

arrangement on the electric circuit, by means of which a source of illumination can be made to act upon a second film also placed on a cylinder, the rotation of which is

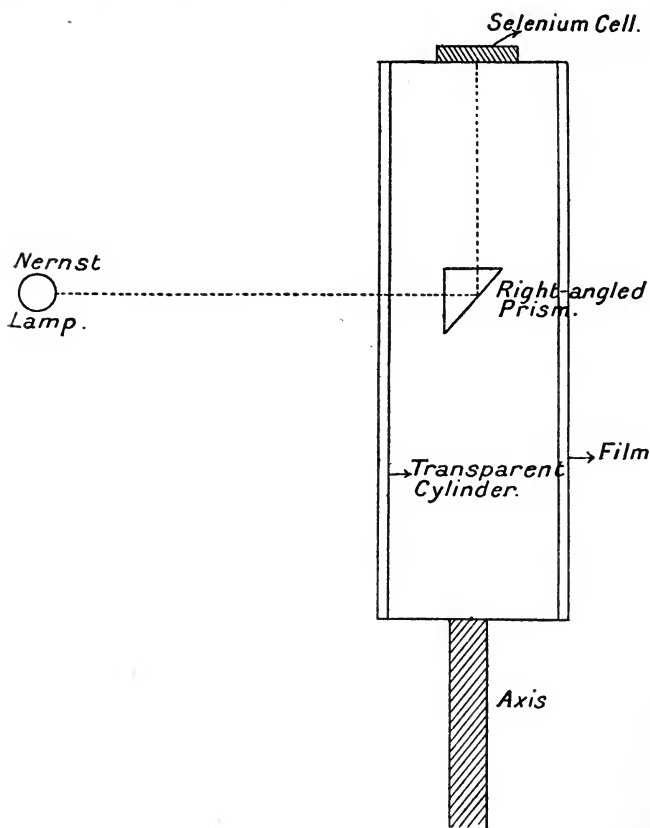

Fig. 161.

synchronized with that of the cylinder at the transmitting station. In practice these cylinders are driven by motors, and are so geared as to rotate about twelve times per minute.

In the receiving circuit is a thin piece of foil which is

attached to two fine silver wires which are free to move laterally in a strong magnetic field when the current received passes through the silver wires. The stronger the current the more movement will this piece of foil exhibit.

It is so arranged that the amount of light which has access to the prepared film on the receiving cylinder shall be gauged entirely by the degree of movement of the foil, and hence by the amount of current passing through the circuit, which in its turn depends upon the resistance of the selenium cell, or, in other words, on the density of the photographic film on the transmitting cylinder.

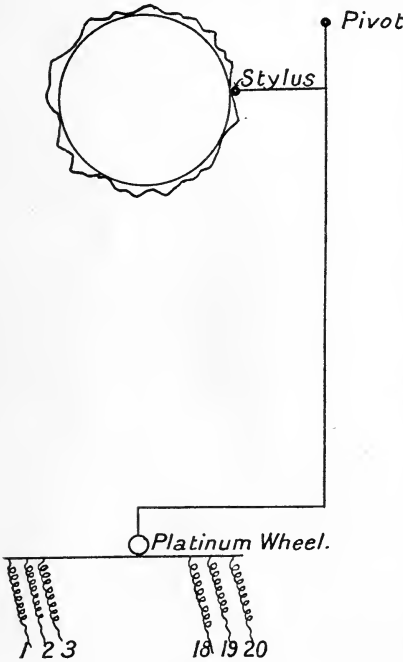

Fig. 162.

To send a picture by this method takes from ten to twelve minutes, hence as the cylinder rotates twelve times per minute there will be one hundred and forty - four lines in the photograph received, which lines form a spiral

thread round the film on the receiving cylinder. When this film is developed and laid open, the picture will become apparent owing to the varying thicknesses of the lines on the film.

Fig. 163 shows a photograph transmitted by the Korn process.

Another method in which the carbon process plays an



Fig. 163.

Photograph transmitted by the Korn Process.

important part has now come to be known as *Belin's* method. In reality this method is very much the same as one, the basis of which was first proposed by Amstutz in 1885, and patented 1891.

The sending apparatus consists essentially of a carbon process photograph prepared with extra thick tissue, so that the picture obtained possesses great relief. Just as in the previously described method, so in this, the cylinder or drum to which this photograph is attached is made to rotate by means of a motor.

A sapphire stylus is pressed against the print, and this stylus is attached to a movable arm having a pivot slightly above the point where the stylus joins it. The arm ends in its lower part with a small platinum wheel. It can readily be seen from the diagram that a very small movement of the stylus would result in a much more considerable one in the case of the wheel. Now, this wheel is so arranged that by the movement of it, caused by the stylus moving over the uneven surface of the picture, it can pass backwards and forwards over a tiny rheostat composed of twenty copper strips carefully insulated from each other. Each of these strips is in connection with a different resistance coil. On account of this arrangement, as the cylinder with the picture revolves, and the platinum wheel is moved, changes of current will be experienced at the receiving station, which can be made use of to form the picture.

A nernst lamp is used to throw a beam of light on to the mirror of an oscillograph, the turning part of which moves in oil. The mirror of this instrument turns about its axis in proportion to the amount of current sent by the transmitter, hence it is able to cast the spot of reflected light more or less to one side of a graduated scale of tints. The light emerging from this tinted scale is converged by a lens, so that it is brought to a focus upon a piece of bromide paper wrapped round the receiving cylinder, which, of

course has been synchronized with the transmitting cylinder.

It is possible to obtain more detail by this method than by Korn's, for the lines are somewhat closer together than in that process. The time of transmission is, however, considerably greater, being about twenty-two minutes.

In this method too, a certain amount of current always flows through the circuit. Belin used batteries of forty to fifty cells, but the process can be worked quite satisfactorily by a very much smaller number.

A third method, which is due to Mr Thorne Baker of the *Daily Mirror*, is one which, owing to its simplicity and dispatch, is likely to come to the front. It is known by the name of the *Telectograph process*, and has been in use since July 1909, for transmitting pictures from Manchester to London, and also from Paris to London.

To better understand the principle which underlies this method, let us consider the following simple experiment.

Soak a piece of white blotting-paper with a solution of potassium iodide in water. Place wires which are connected to the terminals of an electric cell on this wet paper, so that the points of the wires are a short distance apart. If the distance is not too great a current will pass through the wires, as the wet paper is a conductor if a poor one. When this takes place a brown mark will appear where the positive wire touches the paper. This brown mark is really produced by a tiny deposit of iodine, which has been set free by the action of the electric current upon the potassium iodide present. A method based upon this simple experiment has been in use for a considerable time for telegraphic writing.

If now we turn to the account given on p. 266 of the half-tone process, we shall be able to understand how it is possible for a picture to be composed of separate dots or lines of varying densities and yet not appear harsh or in any degree wanting in gradation. Now, if it can be

arranged that the photograph used at the transmitting station is broken up like this half-tone process, and the receiving apparatus can be arranged so that the marks on the recorded image shall occupy the same relative positions, we have at once a means of adapting the above electrolytic process for the purpose of photo-telegraphy.

Thorne Baker's method of doing this is as follows: At the transmitting station a metal drum is made to rotate under an iridium stylus. Printed in fish-glue upon this drum is a half-tone photograph prepared on lead foil. Every time the iridium stylus comes in contact with a clear part of the metal foil, a current passes through the wires to the receiver. This receiver consists of a rotating metal drum round which is placed chemically prepared paper, and over which a platinum stylus traces. Hence, when the current passes, a black or coloured dot or mark appears on the paper. The current will of course be interrupted for a time, the length of which will depend upon the width of the fish glue line.

The width of the mark should of course depend on the duration of the current. A practical difficulty has been met with in connection with the marks obtained, on account of the very large number of signals which must be sent through per second, and the capacity of the line for long-distance wires. While each signal mark should be distinct and clearly defined, it was at first found that when messages are transmitted long distances, the marks obtained tail off into one another and a hopeless blur results.

This difficulty has, however, been overcome by the introduction of a shunt circuit at the receiving station. This shunt circuit comprises two batteries, a variable resistance, and a variable condenser. By a suitable arrangement of the elements of this shunt circuit it is possible to obtain faithful copies of half-tone photographs by the telectograph method. In fact, as many as three

hundred sharply defined marks can be recorded per second.

In practice, the receiving drum is made to rotate a little quicker than the drum on which the photograph to be transmitted is placed. The speed of rotation is about thirty per minute.

As the receiving drum completes its rotation before the transmitter, it is stopped by a steel check and is obliged to wait until the other drum has caught it up. When the transmitting drum has completed its turn, a transitory current is sent to the receiving instrument ; this is led into a relay which actuates an electro-magnet, and this magnet removes the check.

By this arrangement, no matter how much one drum gets out of step with the other, the fault is limited to each rotation, for both drums must always start on a new rotation at the same instant. The great advantage of this method over the two previously described, is that while in those cases it is necessary to develop the film or bromide paper before one is able to tell whether a satisfactory picture has been received, by this method the picture can be watched as it is being gradually built up.

The telephone lines need then only be held until the operation of receiving the picture is completed, when the teletograph method is employed, so the expense incurred by holding the lines until the photograph has been developed is avoided.

Fig. 164 shows a photograph which has been transmitted by this process.

Portable sets of apparatus have been constructed by Sanger-Shepherd, and it is believed that a much more extended use will be made of this method of transmitting photographs. Some attempts have been made to send photographs by the aid of wireless telegraphy, and, although we can only look upon this as being in a more



Fig. 164.

Photograph transmitted by the Thorne Baker Telectograph Process.

or less experimental stage, already some amount of real progress has been made. The results obtained, so far as detailed photographs are concerned, are very far from satisfactory, but plans, line sketches, and similar matter can be transmitted. For more detailed accounts of the technical parts of this interesting subject, the reader is referred to *Nature*, August 1910, pp. 220-226.

ANIMATED PHOTOGRAPHY

No branch of photography has given more pleasure to the general public during the last year or two than that connected with the production of a continuous series of pictures representing the movements taking place in the world around us. Negatives for such a series are obtained by exposing a roll of films in a specially constructed camera. The positives formed from these films are projected in series upon a screen by means of a special lantern apparatus, in which the films are made to pass at a fixed rate, of so many per second, across the beam of light.

The origin of this process is by no means certain, although the credit for it is generally given to Friese-Greene and Evans, who in 1889 patented a process, or rather a machine, for obtaining photographs of this kind on celluloid.

There were, however, several inventions prior to that time which had for their object the representation of movements, some of these inventions dating back as far as 1860.

In the same year as that in which Friese-Greene and Evans patented their process, Muybridge gave an exhibition of moving pictures at the Photographic Convention which was held at St James's Hall. In order to obtain the necessary photographs for this purpose, he employed a number of cameras, which were so arranged that the object, the movements of which were to be photographed, should pass in front of the cameras in succession. In its progress it came in contact with strings which released the shutters of the cameras. By this means a number of silhouettes were obtained, and

prints made from these were placed round a glass disc, which was made to rotate.

Many important patents followed after that of Friese-Greene and Evans, such as that of Edison's kinetoscope, and Lumière's cinématographe, the year 1895 being especially prolific in this respect.

The first apparatus required for the production of films to illustrate movements is a camera in which the film can be exposed so as to obtain the negative, and many such instruments are on the market. Some of these, intended for the production of standard-sized films, are costly, but the amateur has also been catered for, a complete amateur outfit being supplied by Messrs Hughes, Kingsland, under the name of "La Petite," for about £10.

The size of the films used for this outfit is only $\frac{1}{2}$ -inch, instead of the standard size, $1\frac{3}{8}$ -inch.

The same camera is used for printing the positive film as was used in obtaining the negative.

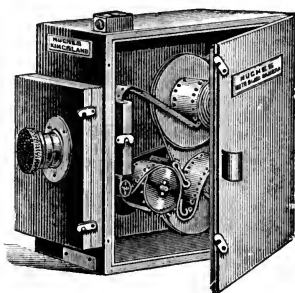

Fig. 165.

A more expensive form of camera, in which standard-sized films can be exposed, is shown in fig. 165. This camera has an adjustable focal plane shutter which renders possible a variety of exposures ranging from $\frac{1}{10}$ to $\frac{1}{1500}$ part of a second. By a slight modification it can also be used as a printing-machine for making positives.

Messrs Hughes recommend the following exposures with this "Moto Bijou" camera when the light is good. For slowly moving objects, such as a man walking, wrestlers, street scenes, etc., the lens aperture being $f/8$, the shutter open full, *i.e.* three inches, an exposure of ten sections of film per second. When exposing for running horses, or objects moving at similar rates of speed, using lens

aperture $f/6.5$ and shutter slot $1\frac{1}{2}$ inches, fifteen exposures should be made per second.

For very rapidly moving objects, such as cyclists racing, trains in motion, etc., use an aperture $f/4$, with shutter opening one inch, and make twenty to twenty-five exposures per second.

It is absolutely essential that the films used should be accurately perforated, and fit the sprocket wheels both in the camera and projecting machines, otherwise it would be impossible to obtain steady projections.

For projecting the standard-sized films a lantern with some form of cinematograph attachment is required. The object of the attachment is of course to move the film across the field in such a manner that an observer sees upon the screen a reproduction of the movements represented upon the film. This is sometimes done by a series of sprocket wheels which move intermittently and so cause the film to be dragged across the field of view in a somewhat unpleasant, jerky manner. Other models provide an ingenious arrangement of cog-wheels, and a piston rod and plunger, which at every revolution gently pushes the film forward over the extent of one of the small photographs.

It is usually arranged that the picture remains before the eye some four or five times as long as the period of change, so that the tendency for any "flicker" may be reduced to a minimum. Some form of shutter which usually revolves on a steel spindle is supplied, because in some films, particularly those in which light objects occur on a dark background, the rapid movement of the film produces a sort of rain effect. This can be eliminated by a properly arranged shutter, and the entire picture thus made more sharply defined.

The critical frequency at which flicker appears has been shown by Porter to be proportional to the log. of intensity of illumination. Lehmann's experiments and

Porter's equations lead to the conclusion that the frequency of change of picture should lie between 38 and 46.8 per second. This is not possible in practice, since the strength of film does not allow the necessary speed, and the frequency employed lies between 15 and 25. Helmholtz has shown that there is a change in the critical frequency with change of the proportion of the light to the dark interval, and it appears from Marbe's experiments that beyond a certain frequency reduction of the dark interval is accompanied by a decrease in the critical frequency. Taking the value 25 for the frequency, the exposure interval should be ten times longer than the time of motion of the picture. This, however, gives $1/275$ second for dark interval, which is too short, and in practice the ratio is reduced from 10 to 4 or 5.

When coloured light is employed the critical frequency is less than for white light, the order of the colours with respect to frequency being the same as that given by König's curve of sensitiveness of the eye for the spectrum colours.

Some machines are made so that the effect can be reversed at will by simply turning the handle in the reverse direction. These cause a great deal of amusement, and enable much more to be got out of any set of films.

These large instruments can take films varying from 500 to 2000 feet in length. As a rule, however, films beyond about 800 feet in length are cumbersome, and are very apt to tire the eye, even if the action is smooth and free from flicker. The next two figures (166, 167) show (*a*) a combination which can be used for exhibiting pictures of still life and also animated photographs, and (*b*) a reversing machine. In the latter, the lantern is not shown. In the second picture the film can be seen in position. The film track in these projection instruments is so arranged that nothing touches the film except at the edges, thus increasing the length of time the films can be used.

The films are pulled down by a Cam movement, by means of which they are moved the exact distance desired.

A handy little camera and viewing apparatus for drawing-room purposes is known as the Kinora camera.

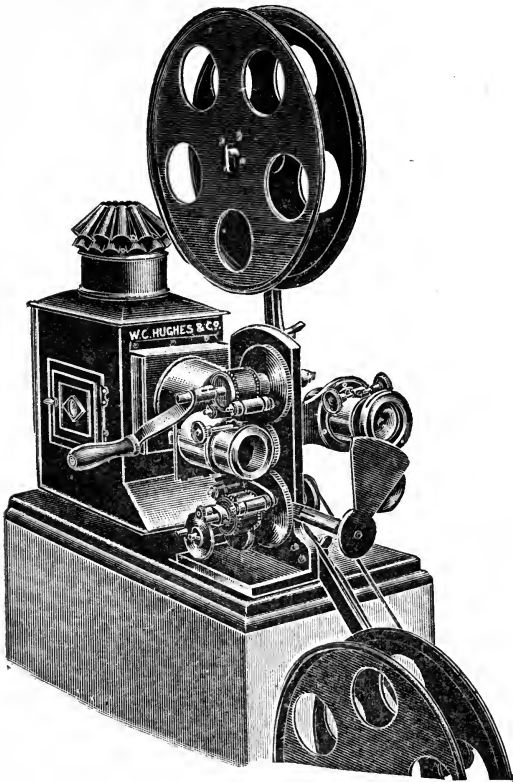

Fig. 166.

This camera is arranged for taking photographs upon a film which is about 50 feet in length, at the rate of about fifty per second. This quantity of film is sufficient to record more than seven hundred and fifty exposures.

When the film has been exposed and developed, bromide

prints are made, and these are mounted in consecutive order around a cylinder, so that they stand out like the leaves of a book.

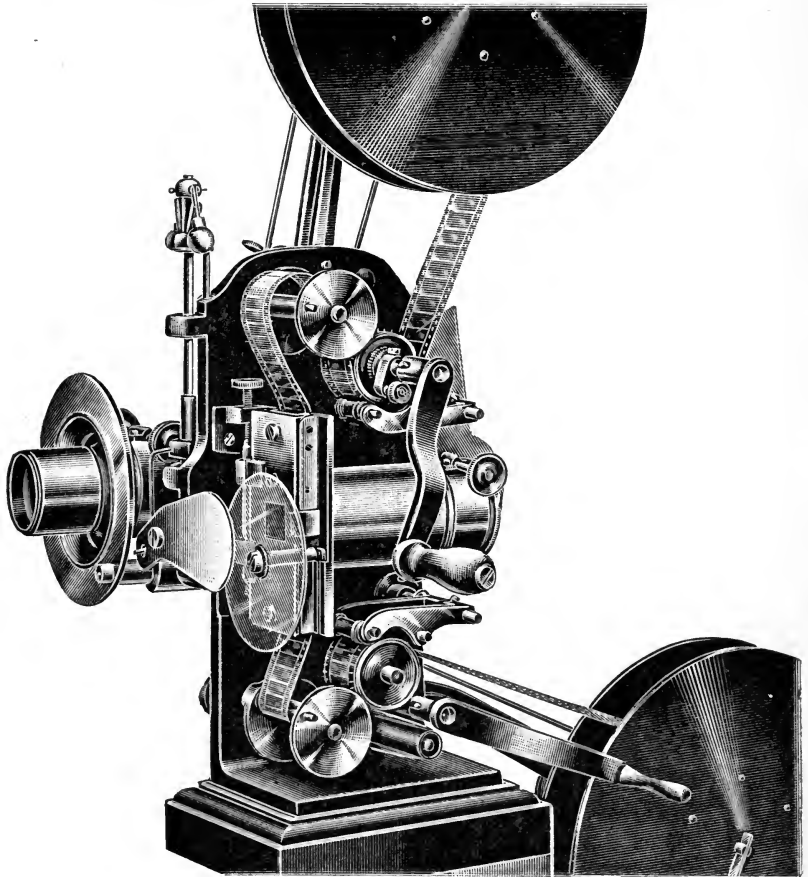

Fig. 167.

This cylinder is slowly revolved in a special apparatus, the prepared prints being held back by a stop, and so made to snap past the eye, just as the leaves of a book do when the finger is drawn across their edges.

In this way an apparently moving scene is witnessed. This little piece of apparatus can be obtained in a much more elaborate form in which the reels carrying the photographs are operated by clockwork. The pictures in the Kinora can be viewed by day or night without employing any special form of illuminating apparatus. A reflecting mirror is supplied which projects the light into the apparatus. Stock reels of many interesting up-to-date events can be purchased for use in the kinora, just as one can obtain films for use with the Cinematograph.

M. Bull has invented an ultra-rapid cinematograph camera, by means of which clear-cut stereoscopic views may be obtained of such rapid movements as the flight of a fly.¹ As already stated, in the ordinary cinematograph the motion of the film is jerky, and the same applies to the camera, the film being at rest for a relatively long period compared with the time during which it is in motion. This would be impossible if the rate at which the film moved across the field was extremely rapid, such as it is in the case of the ultra-rapid cinematograph, in which the mean speed of the film is somewhere about 130 feet per second. The movement of the film in such a case must be continuous, and a sharp image is obtained by means of an extremely short exposure, the electric spark being used for this purpose. Of course M. Bull has to arrange that the fly or other insect, the flight of which is to be studied, will pass across the field of view during the very short time exposures are being made. He has found no little difficulty in doing this, as some classes of insects do not move off the instant they are liberated, and so by the time they enter the field the exposure is over. By an ingenious contrivance by which the insect in its flight moves a minute mica door, thus setting in motion the mechanism operating the shutter, he has, however, overcome this difficulty.

¹ An account of this appeared in *La Nature*, April 30, 1910.

Of course, it would be absolutely impossible to appreciate the details of these movements if the positives were passed through the apparatus for viewing at the same rate (1500-2000 per second) as that at which the negatives were obtained.

Instead of doing this, they are passed through an ordinary cinematograph projection apparatus at the rate of about fifteen per second, which as a general rule is found to be sufficiently slow to enable the movements to be easily followed.

Sometimes, however, even this is too fast, and then it is arranged that only two or three views are seen per second, but when this is done, arrangements are made to make the exposure much longer in proportion to the period of change than is usually the case, so that although the changes are made less frequently, the motion may still appear continuous.

Such developments as the above are of extreme interest to the scientific world, since by means of such apparatus it becomes possible to follow, by the aid of the camera, movements so rapid that their details escape our notice, and then reproduce these movements at a rate which can enable the student at his leisure to make observations otherwise impossible.

Of course the converse operation is also possible. A series of photographs can be prepared, which shows the changes taking place in some object, such as a developing bud, during a relatively long period of time, and then these can be reproduced through the projection apparatus at such a rate that the whole growth, which actually took days to complete, can be observed in a few minutes.

It is also possible in some cases to obtain colour films of movements, and when this becomes more generally extended and perfected, the results obtained will be even more instructive and entertaining than they are at present.

INDEX

- ABBÉ & SCHOTT, on lenses, 117
 Abney, action of chromium compounds, 92
 Abney camera, three-colour, 243
 " colour photography, 228
 " latent image, 70
 " pinhole camera, 136
 " red sensitisers, 166
 Accelerator, 181
 Achromatic lenses, 113
 Action of chromium compounds on
 glue, 81
 " hydrogen peroxide on
 plate, 74
 " light on asphalt, 8
 " " on glass, 67
 " " on the halogens, 59
 " " having low actinic
 value, 68
 " " (coloured) on the
 photographic plate,
 43
 " " on silver salts, 174
 " " on the visual purple,
 71
 Action of metals on plate, 73
 " pith on plate, 75
 " sunlight, 1
 " ultra-violet light, 46, 169
 Aden photographs, 290
 Adon, the, 130, 206
 Airy, work on lenses, 116
 Albert process, 93
 Alberti's show box, 6
 American stereoscope, 153
 Ammonia as accelerator, 181
 Ammonium persulphate reducer, 192
 " sulpho cyanide, 195
 Amstutz, photo-teleggraphy, 363
 Angström, solar spectrum maps, 306
 Aniline printing, 94
 Animated photography, 225, 368
 Aperture, 110
 Aplanatic lens, 111
 Apochromatic lenses, 323
 Arago and Daguerre's discovery,
 12, 287
 Archer's experiments, 23
 Art in photography, 199
 Asphalt, photo-lithography, 101
 Asser, " " 98
 " half-tone process, 266
 Astigmatism, 111
 Astronomical photography, 281
 Autochrome process, 248
 BACK focal length, 129
 Backed plates, 160
 Baker, Thorne, telectograph process,
 364
 Bancroft's work, 176
 Barbaro, treatise on perspective, 6
 Barium-platino-cyanide screen, 346
 Barnard, E. E., stereoscopic work, 316
 Barrel-shaped distortion, 113
 Bebe camera, 147
 Becquerel, colour photography, 227
 " Becquerel rays, 75
 Belin, photo-teleggraphy, 363
 Bennett, dry plates, 34
 Berchtold, half-tone screen, 266
 Berkowsky, astronomical photo-
 graphy, 288
 Bianodic tubes, 349
 Bleaching of linen, 3
 Blue Bengal light, 47
 Bond, astronomical photography,
 288, 303
 Book illustration, 264
 Böttcher, gun cotton, 22
 Bouguer, action of sunlight, 51
 Brewster, stereoscope, 151
 Bromide papers, 195
 Bull, camera, 374
 Bullock, E. & J., half-tone screen, 267
 Bunsen, chemical power of light, 53
 Burnett, salts of uranium, 65
 Burning-in process, 273
 Busch Bis-Tellar, 131
 Butler, camera, 242

- CAJAL's researches, 236
 Calcium flocculi, 296
 Camera appliances, 134
 " attachments for micro-
 photography, 324
 " obscure, 6
 Carbon process, 194
 Chanoz' experiments, 358
 Chemical action of light, 47
 " effects " 2
 Chinese ink, 274
 Chloride of gold, 195
 Chromatic aberration, 113
 Chromium compounds, 78
 " tabloid intensifier, 191
 Chromo-lithography, 97
 Circle of illumination, 120
 " least confusion, 111
 Cloud effects, 168
 Coating of a plate, 25
 Collodion, 22, 25
 Collotype, 278
 Colour of light from stars, 319
 Combined toning and fixing, 195
 Conjugate focus, 107, 111
 Constant density ratio, 184
 Controlling agent, 180
 Converging lenses, 108
 Cooke portrait lens, 125
 Copper plate engraving, 9, 82
 Corona, the, 291
 Cox, Rontgen Ray apparatus, 356
 Cros patent, 239
 Cyanin, 165
 Cyanotype process, 197

 Dagron's micro-photography, 219
 Daguerre's experiments, 10, 24
 Daguerreotype, 14
 Dallmeyer-Bergheim portrait lens,
 124
 Dark slide for wet plates, 26
 Davy's experiments, 4, 321
 Daylight development, 188
 Demole, on latent normal image, 179
 Depth of focus, 121
 Developing tank, kodak, 188
 " process, 180
 " wet plate, 63
 Dicyanin, 165
 Diverging lenses, 108
 Draper, daguerreotypes, 14, 288
 Driffield and Hurter, 184
 Dry plates, 32

 Dubroni's developing box, 217
 Dufay dioptichrome plate, 258
 Dyes for red sensitising, 164

 Early applications of photography
 214
 " form of camera, 134
 Eder, latent image, 178
 Edison's kinetoscope, 369
 Edridge-Green, theory of colour
 vision, 71
 Effect of blue sky, 53
 " " distance, 203
 " " grey clouds, 54
 " " height of eye, 207
 " " white clouds, 54
 Emulsion, 33
 " for dry plates, 159
 Enlarging camera, 154
 " easel, 155
 " lantern, 155
 Eosin, 165
 Erythrosine, 165, 239
 Etching, 272, 280
 Ether, the, 36
 Extension lenses, 132
 Explosion theory, 175
 Exposure meters, 172

 FACTORIAL developing, 185
 Fading of coloured fabrics, 2
 Farbentönung, 319
 Faraday, 67
 Fast colours, 2
 Faults in lenses, 115
 Ferric chloride reducer, 192
 Ferricyanide reducer, 192
 Ferrous oxalate developer, 183
 Films, 172
 Fischer's theory, 174
 Fixed focus cameras, 122, 141
 Fixing, 15, 17, 192, 194
 Fizeau, 266, 287
 Flare spot, 115
 Flash light, 48
 Fleming's Experiments, 77
 Flicker, 370
 Florence heliochromic screen plate,
 259
 Fluorescence, 47
 Fluorescence, 47
 Focal length, 107, 119
 Focal lines, 112
 " plane shutter, 143

- Focus tube, 347
 Foreground shutter, 157
 Foreshortening, 201
 Foucault, 287
 Fowler's experiments, 311
 Fraunhofer's lines, 41
 Friese-Greene and Evans, 368

 GAFFIELD'S experiments, 67
 Gardiner's experiments, 348
 Gaslight papers, 195
 Gauss, on lenses, 117
 Gelatine relief, 85
 Goertz shutter, 157
 Grune's researches, 220
 Gum bichromate printing, 194

 HALATION, 160
 " circle, 162
 Hale, Prof., *Astronomical Work*, 297
 Half-tone process, 266
 Halogen compounds of silver, 59
 Hand cameras, 141
 Hauron's process, 239
 Heliography, 9, 101
 Herschel, 17, 65, 222, 227
 Hodgkinson's theory, 174
 Holt Etching machine, 273
 Hübl, von, *Red Sensitisers*, 165
 Hydrogen flocculi, 297
 Hydrokinone, 182
 Hypo, 15, 192

 IMBIBITION process, 262
 Indelible ink, 4
 Infra red rays, 40, 169
 Insolubility of asphalt in turpentine, 9
 Intensifying process, 28, 189
 Intensity ratio, 120
 Isocol, 236
 Ives, F. E. apparatus, 240
 " H. E. researches, 231

 JACKSON'S focus tube, 347
 Jansen's observations, 289
 Joly process, 239, 257
 Jordan, 320
 Jougla Omnicolore plates, 254
 Jupiter's eighth satellite, 316

 KAYE'S researches, 348
 Kepler, camera obscura, 6

 Kinora camera, 372
 Kirchoff, spectrum, 43, 306
 Kodak camera, 145
 Koilos shutter, 157
 Korn, Prof. photo-telegraphy, 360
 Kratochvila, daguerreotype, 65
 Kromskop, 240
 Krone's work, 238

 LANTERN plates, 171
 " slides, 335
 Latent reversed image, 178
 Lea, Carey, 33, 174, 229
 Leaf print, 18
 Legrady's experiments, 75
 Lehmann, 232, 370
 Leitz, apparatus, 325
 Lemon, H. B., 319
 Lenses, 104
 Levy, Max, half-tone screen, 267
 Lichtdrucke, 93
 Lichtpaus, 18
 Light and shade, 200
 " waves, 36
 Line drawings, 274
 Lippman, colour photography, 230
 Lithography, 96
 Lockyer, 291, 300
 Lumière, 180, 193, 247, 248
 " cinematographie, 369
 Lüppo Cramer, latent reversed image, 178

 MACKENZIE-DAVIDSON localiser, 358
 Magic photography, 221
 Manly, ozobrome, 194
 Marey's pistol camera, 225
 Marion's work, 92
 Maunder, astronomy, 292
 Maxwell, Clerk, 240
 Mees, 170, 185
 Melotte, 316
 Meniscus lenses, 108
 Mercurial intensifier, 190
 Mercury vapour, 11
 Metallurgical photography, 330
 Meteorological instruments, 214
 Metol, 182
 Microscope, the, 322
 Microscopic photography, 218
 Microphotography, 321
 Microsummar lens, 329
 Mitchell, 300

- Modern screen for half-tone, 267
 Molecular strain theory, 174
 Moncetz, 70
 Moonlight photography, 44
 Moon's position relative to stars, 314
 Morehouse's comet, 315
 Morse, 14
 Moser, 58
 „ rays, 74
 Mothay, Tessie de, 93
 Mount Wilson Reflector, 283
 Mummy, 194
 Muybridge's photographs, 226, 368

 NATURALIST'S camera, 146
 Nebulæ and comets, 315
 Negative, 19
 Neuhaus' researches, 232
 Neumeier's deep-sea apparatus, 214
 Nicophore Niépce, 8
 Niépce de St Victor, 21, 228
 Normal haloid, 179
 „ latent image, 179

 OBERNETTER, 94
 Oleograph, 97
 Orthochromatic plates, 162
 Orthochrome *T*, 165
 Osborne, 88
 Otsuki's experiments, 74
 Ozobrome process, 194

 PANORAMIC camera, 148
 Parallax of Eros, 314
 Parkhurst, 320
 Pea sausage, 102
 Perspective, 200
 Petzval, 15, 116
 Photography, astronomical, 282
 „ by invisible rays, 168
 „ of solar eclipses, 289
 „ of sun's disc, 292
 „ of stars, 301
 „ of moon, 305
 „ of faint spectra, 317
 „ in natural colours, 227
 Photographic action of sunlight, 51
 „ importance of the chromium compounds, 78
 Photographic lenses, 117
 Photo-telegraphy, 360

 Photo-lithography, 98
 „ zincography, 100
 „ electric effect, 77
 „ salts, 229
 Phosphate paper, 195
 Phosphorescent substances, 76
 Physical changes, 2
 „ „ produced by light, 57
 Pictures to illustrate solids, 199
 Pigeon post, 218
 Pinachrome, 165
 Pinacyanol, 165, 239
 Pinatype process, 261
 Pinaverdol, 165, 239
 Pincushion distortion, 113
 Pinhole camera, 134
 Plano-convex lens, 111
 Platinotype, 196
 Player's experiments, 76
 Poitevin's discoveries, 90, 228
 P.O.P., 29, 194
 Ponton's experiments, 79
 Porcelain decorations, 101
 Porta, 6
 Porter, 370
 Portrait lens, 15, 124
 Positive, 19
 Pretsch engravings, 83
 „ half-tone screen, 266
 Printers' inks, 276
 Printing of paper money, 10
 „ of positive, 193
 Process camera, 264
 „ stands, 265
 „ studio, 264
 Projection apparatus, 336
 Pseudo-photographic effects, 72
 Pyro, 23
 Pyro-photography, 220
 Pyro-soda, 180

 RADIOACTIVE substances, 72, 75
 Rainbow, 41
 Rapid rectilinear lens, 123
 Rayleigh, 135, 230
 Rectifiers, 354
 Reducing agent, 180
 Reduction of negative, 191
 Reflex cameras, 145
 Refraction of light, 40, 114
 Renwick, explosion theory, 175
 Retouching, 29
 Reversal, 177

- Reversal by Rontgen Rays, 358
 Ripening, 175
 Röntgen Rays, effect of, 69
 " " photography, 342,
 346
 Roscoe, 55
 Rose Bengal, 165
 Ross homocentric lens, 123
 " Panos camera, 143
 Ruhmkorff coil, 342
 Russell, 72
 Rutherford, 293, 303, 305
 Rytol tabloids, 189
- SACHSE, 13
 Saeland, 73
 Sand blast process, 223
 Sanderson camera, 138
 Sanger Shepherd, 241, 366
 Scamoni, heliographic process, 222
 Scheffer, 175
 Schönben, 22
 Schott, 117
 Schutt, 235
 Schwarzschild, 319
 Scientific diagrams, 274
 Screen half-tone, 266
 " yellow, 166
 Seebeck's researches, 227
 Seidel von, 116
 Senefelder, 96
 Sensitivity of human eye, 162
 " " ordinary photo plate,
 162
 Seyewetz, 180, 193
 Sheppard and Mees, 176, 185
 Shutters, 157
 Simpson, 219, 228
 Silver oxy-chloride, 174
 Skerry, 175
 Slipper, 303, 311
 Solarisation, 177
 Solar microscope, 321
 Solomon's lamp, 49
 Sound waves, 39
 Spectrography, 306
 Spectroheliograph, 294
 Spectroscopic binaries, 310
 Spectrum, 41
 Spherical aberration, 110
 " lenses, 108
 Square bellows camera, 138
 Stand cameras, 138
 Stein's heliopictor, 215
- Stereoscope, 151
 Stereoscopic camera, 149
 Studio camera, 156
 Swan, J. W., 266
- TABLOID developer, 189
 Talbot, 81
 Telephoto lenses, 118, 286
 Telescopes, 283, 286
 Thames colour plate, 251
 Thornton-Pickard shutter, 157
 Three-colour process, 239, 275
 Tighlmann, 223
 Time thermometer, 186
 Toning, 31
 " and fixing, 194
 Tower telescope, 299
 Toy cameras, 147
 Transit of Venus, 311
 Transparencies in colour, 262
 Trivelli, 70, 178
 Turner, 311
- ULTRA-rapid cinematograph camera,
 374
 " violet light, 40, 169
 Unicum shutter, 157
 Universal projection apparatus,
 338
 Uranium intensifier, 190
- VERTICAL balance, 212,
 Vignetting, 31
 Villard, 68
 Virida papers, 249
 Vogel, 165, 310
 Voigtlander, 15
 Vojtěch, 9
- WALLACE, 167, 319
 Warner-Powrie process, 258
 Warren de la Rue, 305
 Water in atmosphere of Mars, 307
 Watkins, 185
 " factor table, 186
 Wedgwood's experiments, 4, 321
 Welcome's exposure record, 173
 Wet plate 24
 Wetzlar, 174
 Wheats'one, 151
 White Bengal light, 47
 " silhouette, 5
 Wide-angle lens, 127

- Willis, 94, 196
Wollaston, 42
Wood, 169, 244, 317
Woodbury half-tone screen, 267
Woodbury type, 88
Young, 300
- Young-Helmholtz theory of colour
vision, 240
ZEMAN effect, 300
Zenker, 228, 311
Zincography, 97
Zollner, 290



14 DAY USE
RETURN TO DESK FROM WHICH BORROWED
LOAN DEPT.

This book is due on the last date stamped below, or
on the date to which renewed.
Renewed books are subject to immediate recall.

~~24 May '65~~ 9

REC'D LD

MAY 10 '65 10 PM

JUN 11 1977

REC. CIR. JUN 14 '77

DEC 11 1977

REC. CIR. DEC 7 '77

LD 21A-60m-3,'65
(F2336s10)476B

General Library
University of California
Berkeley

YC 13794

-414/121

TR

145

G3

THE UNIVERSITY OF CALIFORNIA LIBRARY

