

UC-NRLF



QB 32 936

CONTEMPORARY
MATHEMATICAL SERIES



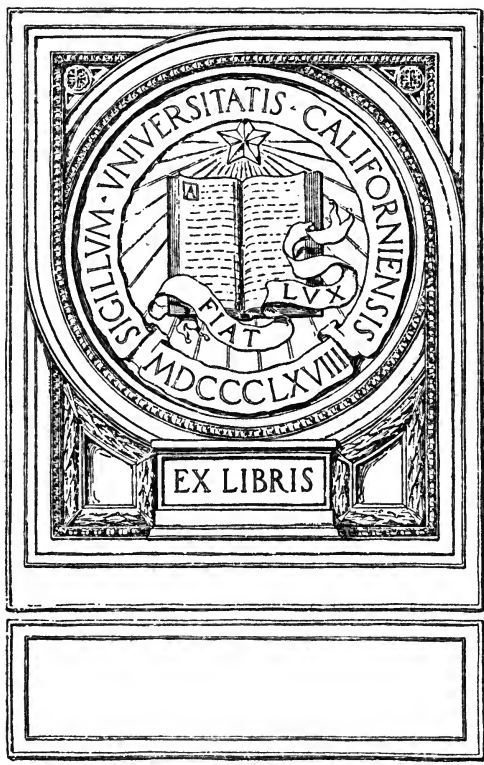

EX LIBRIS

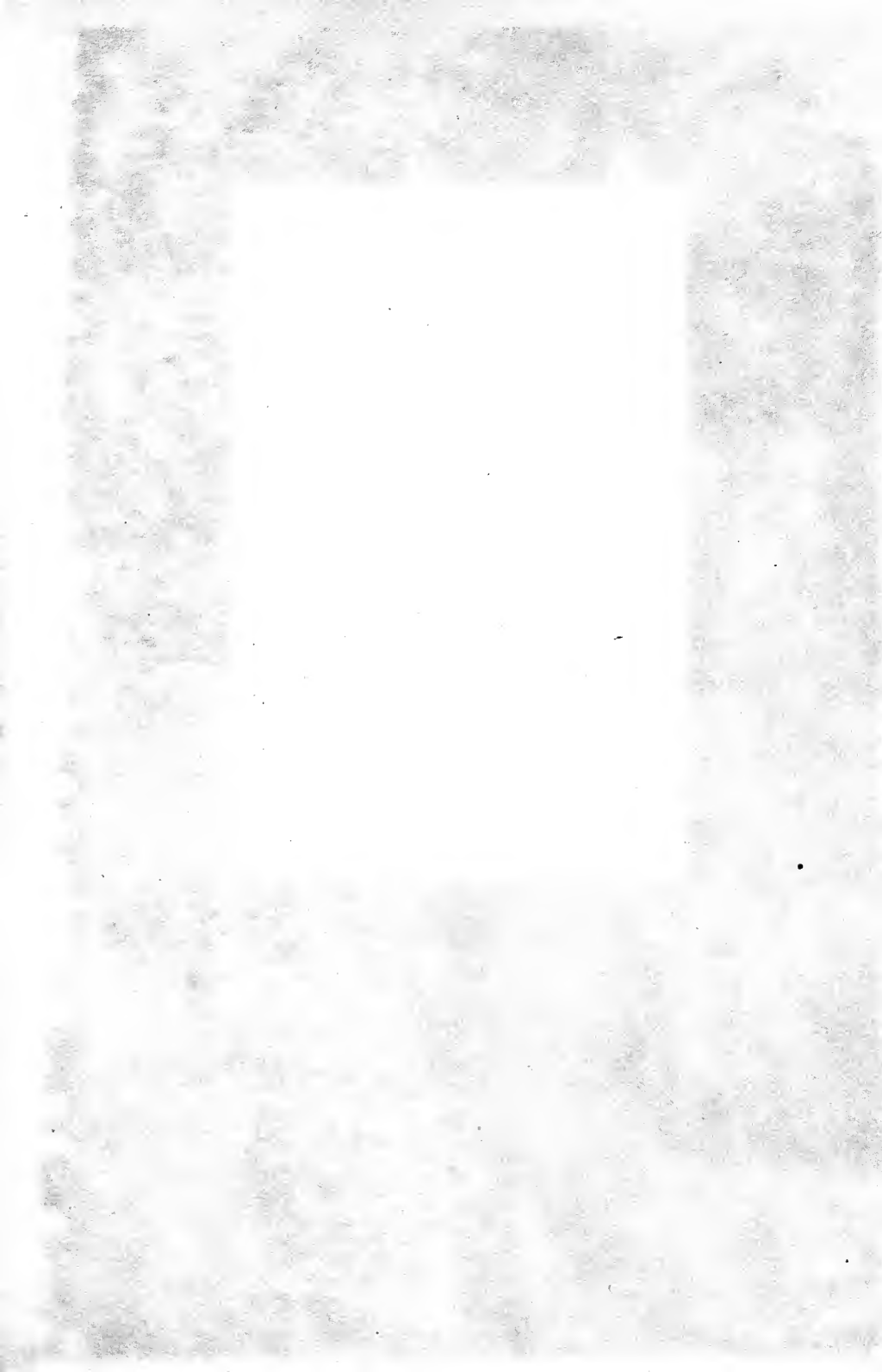



THE
AEROPLANE

THE AEROPLANE.

CHARLES GRIFFIN & CO., LTD., PUBLISHERS.

SECOND EDITION, Revised. In Large 8vo. Cloth. Pp. i-x + 131.
Many Illustrations. 10s. 6d. net.

THE PROBLEM OF FLIGHT.

A TEXT-BOOK OF AERIAL ENGINEERING.

By HERBERT CHATLEY, B.Sc. ENG. (LOND.).

Professor of Civil Engineering, Tong Shan Engineering College, N. China.

CONTENTS:—The Problem of Flight—The Helix—The Aëroplane—The Airplane—Dirigible Balloons—Form and Fittings of the Airship—Appendices—INDEX.

“An epitome of the knowledge available on the subject.”—*Scotsman*.

In Crown 8vo. Cloth. Pp. i-viii + 83. Illustrated with Diagrams. 3s. net.

THE FORCE OF THE WIND.

By HERBERT CHATLEY, B.Sc. ENG. (LOND.).

“Could not well be more terse or pointed.”—*Symon's Meteorological Magazine*.

In Handsome Cloth. Illustrated. Pocket Size. Pp. i-xi + 179.
2s. 6d. net.

A COMPENDIUM OF AVIATION AND AEROSTATION.

Balloons, Dirigibles, and Flying Machines.

By LIEUT.-COL. H. HOERNES.

Translated and Supplemented with Facts of Interest to English readers—*i.e.*, details regarding British Dirigibles, Aeroplanes, Flying Grounds, etc.—with an Introduction and Biographical Sketch of the Author by J. H. LEDEBOER, Editor of *Aeronautics*.

CONTENTS:—Introduction—The Air—The Wind—Resistance of the Air—Spherical Balloon—Aerial Motors—Propellers—Dirigible Balloons—Machine of the Future—Theory of the Aeroplane—The Aeroplane—Orthicopter—Helicopter—Conclusion—Aero Clubs—Flying Grounds—Hangars.

“A very readable popular handbook.”—*Nature*.

In Handsome Cloth. Fully Illustrated.

AERO ENGINES.

With a General Introductory Account to the Theory of the Internal Combustion Engine.

By G. A. BURLS, M. INST. C. E., ETC.

GENERAL CONTENTS:—Weight, Cycles; Power and Efficiency of Internal Combustion Engines—Aero Engines, Necessity for Lightness, etc., etc.—Horizontal Engines—Radial Engines—Diagonal or “Vee” Engines—Vertical Engines—Rotary Engines—Aero Engines of 1914—INDEX.

FIFTH EDITION, Revised and Enlarged. Pp. i-xxiii + 639. With 243 Illustrations.
Large 8vo. Handsome Cloth. 25s. net.

A TEXT-BOOK ON GAS, OIL, & AIR ENGINES.

By BRYAN DONKIN, M. INST. C. E., M. INST. MECH. E.

Revised throughout by T. GRAVES SMITH. With important New Matter by Prof. BURSTALL.

“A very much up-to-date classic.”—*Daily Telegraph*.

In Demy 8vo. Handsome Cloth. Pp. i-xi + 176. With 130 Illustrations.
6s. net.

CARBURETTORS, VAPORISERS, & VALVES, USED IN INTERNAL COMBUSTION ENGINES.

By EDWARD BUTLER, M. I. MECH. E.

“Mr Butler writes with an intimate practical knowledge of his subject, and the book is one we have every pleasure in recommending.”—*Mechanical Engineer*.

LONDON: CHARLES GRIFFIN & CO., LTD., EXETER STREET, STRAND.

THE GREAT
AIRCRAFT

Frontispiece.

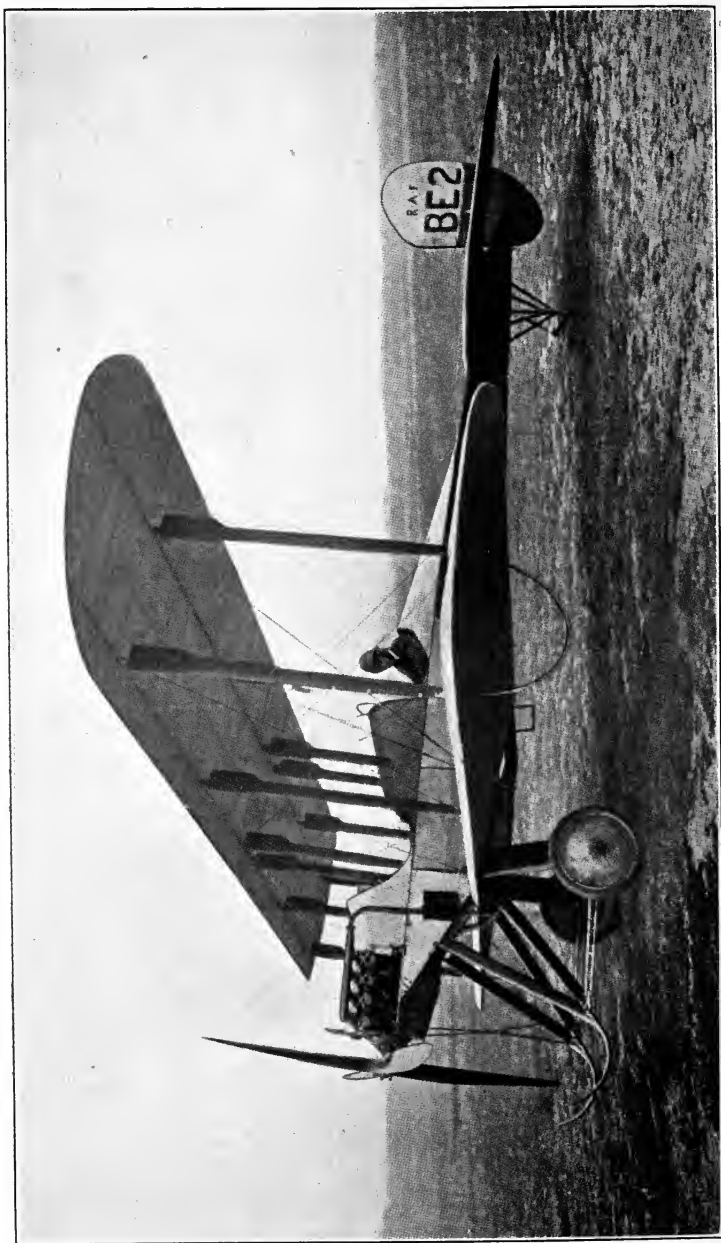

B. E. 2 (July 1913).

THE AEROPLANE.

A CONCISE SCIENTIFIC STUDY.

BY

A. FAGE, A.R.C.Sc.,

ROYAL EXHIBITIONER;

AERONAUTICS RESEARCH SCHOLAR OF THE IMPERIAL COLLEGE OF SCIENCE AND TECHNOLOGY ;
ASSOCIATE FELLOW OF THE AERONAUTICAL SOCIETY.

With Frontispiece and 58 other Illustrations.



LONDON:
CHARLES GRIFFIN & COMPANY, LIMITED
EXETER STREET, STRAND.

1915.

[*All Rights Reserved.*]

TL670
F3

7. 2010
6. 2010

PREFACE.

THIS book has been written to meet the requirements of engineers who are desirous of an introduction to the study of aeronautics. The fundamental principles of mechanics are unalterable, although the many interpretations and practical applications of such laws are the fruit of scientific labour. The new science of aeronautics, which has necessitated a fuller understanding of the dynamics of the air, must now be regarded as a branch of engineering, although each step forward into the realm of aeronautical research seems but to reveal an ever-increasing unexplored region. The many unsound theories often advanced by well-intentioned people, who have had little opportunity to traverse the paths of aeronautical research, rather tend to confuse a new reader. The reports of the several aeronautical laboratories have been drawn upon in the preparation of this book, and, as far as possible, no controversial matter has been discussed. Moreover, sketches and descriptions of aeroplane construction, which are of minor importance compared with a full understanding of the underlying principles of aeronautics, have only been considered briefly. The author is greatly indebted to Mr L. Bairstow of the National Physical Laboratory for his helpful criticism and encouragement, and to Mr A. Landells, who kindly assisted in the laborious task of reading the proofs.

A. F.

TEDDINGTON, *May* 1915.

CONTENTS.

CHAPTER I.

WINDS.

	PAGES
Atmospheric Winds—Wind Velocity—Pitot and Static Pressure Tube—Pitot and Suction Tube—A Comparison of Forces acting upon Similar Bodies—Pressure upon Square Plates—Air Resistance of Smooth Wires	1-7

CHAPTER II.

STREAM-LINE BODIES AND STRUTS.

Stream-Line Bodies—Energy Considerations—The Nature of Stream-Line Flow—Imperfect Stream-Line Bodies in a Viscid Fluid—Comparison of Body Forms—Struts	8-14
--	------

CHAPTER III.

AEROPLANE WINGS.

Definition of Lift and Drag.—Section I. : AN AERODYNAMIC CONSIDERATION OF AEROPLANE WINGS :—Nature of the Air Flow around a Wing—Principle of the Dipping Front Edge—Pressure Distribution around the Wing-Tips—The Lift, Drag, and Centre of Pressure Curves of a Modern Wing—Relative Importance and Interdependence of the Two Surfaces of a Wing—Camber of the Wing—The Wings of a Variable-Speed Machine—Position of the Maximum Ordinate—Aspect Ratio—Leading and Trailing Edges—Dihedral Angle—Biplane Wings—Aerodynamic Behaviour of a Wing which has a Reflex Curvature towards the Trailing Edge—Section II. : THE DESIGN AND CONSTRUCTION OF A WING :—Front or Main Spar—Aeroplane Fabric	15-30
--	-------

CHAPTER IV.

CONSTRUCTION OF AN AEROPLANE.

The Aeroplane—Aeroplane Undercarriage or Chassis—The Hydro-Aeroplane—Bristol 80 H.P. Tractor Biplane—The Sopwith Bat-Boat—Sopwith Hydro-Aeroplane—Avro Biplane—Avro Hydro-Aeroplane—Blériot Monoplane—Nieuport Monoplane—Vickers Biplane—Wight Hydro-Aeroplane—Farman Biplane—Grahame-White Biplane	31-50
---	-------

CHAPTER V.

THE EQUILIBRIUM OF AN AEROPLANE.

	PAGES
Horizontal Flight—Equilibrium Conditions—Performance Curves—Comparisons of Similar Machines—Inclined Flight—Gliding Flight—Climbing—Starting—Alighting—Turning—Motion of a Hydro-Aeroplane on Water—Behaviour of Aeroplane in a Regular Wind	51-70

CHAPTER VI.

STABILITY OF AN AEROPLANE.

Introduction—Definition of Stability—Automatic Stability—Longitudinal Stability—A Gust Problem—Longitudinal Instability—Lateral Stability—Spiral Instability—Yawing and Rolling Oscillations—Gusts	71-88
--	-------

CHAPTER VII.

THE AERIAL PROPELLER.

Description of a Propeller—Propeller Terms—Performance of a Propeller—A Propeller Theory—Flow of Air around a Propeller—The Position of a Propeller—Balance of a Propeller—Gyroscopic Action—Design of an Aerial Propeller—Calculation of Stresses in the Propeller	89-113
---	--------

CHAPTER VIII.

AERONAUTICAL ENGINES.

The Otto, or Four-Stroke Cycle—The Two-Stroke Cycle—Magnetos—Carburettors—Compression Ratio—Horse-Power—Volumetric Efficiency—Heating Value of Fuel—Considerations of η —Mechanical Efficiency—Engine Cooling—The Ratio $\frac{\text{Engine Weight}}{\text{H.P.}}$ —Piston Speed—Engine Weight—General Remarks—Classification of Aeronautical Engines—The Salmson Engine—Gnome Engine—Green Engine	114-134
---	---------

INDEX	135-136
-----------------	---------

THE AEROPLANE.

CHAPTER I.

WINDS.

Atmospheric Winds.—A regular wind is one which has a constant velocity (speed and direction of course), and such an ideal wind is a convenient standard for the comparison of atmospheric winds. The artificial wind of a research wind channel may be regarded as the nearest approximation to a regular wind. The fluctuations of the speed of the wind in the wind channel at the National Physical Laboratory are easily maintained within one-half per cent. of the mean wind speed.

The range of speed variation of a “steady” atmospheric wind is roughly proportional to the mean speed of the wind, and positive and negative speed fluctuations of 25 per cent. of the mean speed, with occasional speed excursions of 35 per cent., are to be expected, so that a steady wind of a mean speed of 20 miles per hour will probably have a speed range of 13 miles per hour to 27 miles per hour. A steady wind also has fluctuations of direction, although no definite connection appears to exist between the speed and the direction fluctuations. Low surface winds are usually of a “gusty” nature, chiefly due to the eddy motion created by obstacles.

A horizontal eddy—that is, a revolving roller of air with a horizontal axis—may be encountered at the horizontal edge of a high vertical cliff, if the general wind impinges directly upon the face of the cliff, whilst a well-defined vertical edge of such a cliff will favour the formation of a vertical eddy. If the fluctuations of the wind velocity are much greater than the range of the normal gust excursions of a steady wind, the wind is said to be “squally.”

The most dangerous winds encountered in England are

termed Line Squalls, and they are usually accompanied by a sudden fall of temperature, a rise of pressure, a veer of the general wind direction, and a squall of hail, rain, or snow. Line squalls, so called because they advance with the characteristic line front of a tidal wave, traverse the surface of the country at a great speed. These squalls, which would have a disastrous action upon air-craft, are probably formed by the spreading of the upper cold air layers before a rising warm air current.

On account of surface irregularities, ground winds are of an entirely different character from the winds of the upper atmospheric regions. The speed and steadiness of a surface wind increase with the height above the earth's surface, until the wind velocity reaches a more or less limiting value. There is evidence to show that the gustiness of surface winds is due to the effect of the ground, and it is convenient to assume that gustiness disappears, and the limiting velocity is reached, in the air strata which are removed from ground influences. The upper layers probably have a regular periodic motion.

A surface wind blowing in from the sea has its velocity continuously diminished as it passes inland, on account of the retarding influences of surface friction and obstacles.

The experience of balloonists and pilots has proved the existence of vertical atmospheric currents. The formation of clouds, as is well known, depends upon the rising of warm moist air currents into the colder upper regions, although the absence of clouds does not necessarily imply the absence of ascending air currents. Occasionally, the velocity of these ascending currents is sufficiently great to support large hailstones. A cumulus cloud is generally the cap of an ascending air current, and a cumulus sky may be regarded as a danger-signal indicating the prevalence of ascending and descending air currents. Rising currents, chiefly formed by the local heating of the earth's surface by the sun's rays, are always accompanied by descending air currents. The low-pressure centre of a cyclonic disturbance is also partial evidence of the existence of an ascending current, and, conversely, the high-pressure core of an anticyclone indicates the presence of a descending air current.

There are no well-pronounced atmospheric signs to indicate

the presence of descending air currents, although the bright fine weather which occasionally follows a rainy period is probably due to descending currents. Cyclonic and anticyclonic motions have no resemblance to those perfect columns of rotating air, the product of the imagination. Moreover, most eddies are of short duration, as the low pressure of the core can only be maintained in most exceptional circumstances. Horizontal eddies, which are certainly dependent upon peculiarities of the earth's surface, are of less frequent occurrence than vertical eddies.

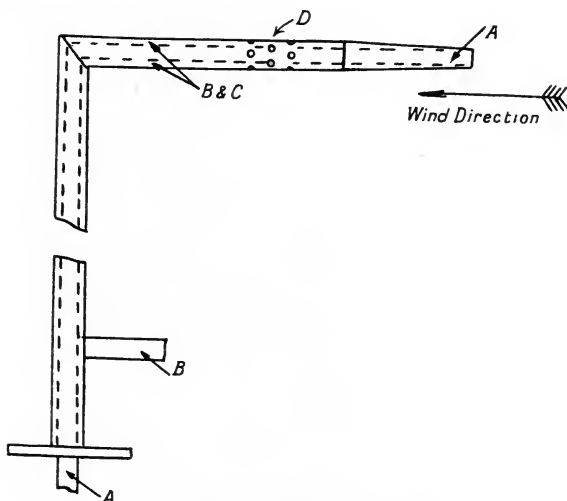

FIG. 1.—Pitot tube.

Wind Velocity.—*Pitot and Static Pressure Tube.*—The velocity of the wind may be determined very accurately by a Pitot and Static Pressure tube. A sketch of such a tube is given in fig. 1. The inner tube or Pitot tube A faces the wind, and is surrounded by a concentric tube B. The annular space C between the two concentric tubes is connected to the outside air by a series of small holes D.

To measure the velocity of the wind, the tube A is connected to one end of a sensitive tilting water gauge and the annular space B to the other end of the gauge, and the pressure difference is balanced by a head of water. Adopting consistent units, let

v = velocity of the wind,
 ρ = density of the air,
 p = static or barometric pressure of the air,
 h = head of water.

Now, it has been proved experimentally that the pressure reading of the annular space equals p , and the pressure reading of the Pitot tube equals $(p + \frac{1}{2}\rho v^2)$.

Hence, when the pressures have been balanced by the head of water, we have

$$\left(\frac{1}{2}\rho v^2 + p\right) - p = h,$$

and $\therefore \frac{1}{2}\rho v^2 = h.$

Pitot and Suction Tube.—Fig. 2 is a sketch of a Pitot and Suction tube commonly employed upon an aeroplane. If p_1 be the pressure at the mouth E of the suction tube F, then, adopting the same notation as formerly,

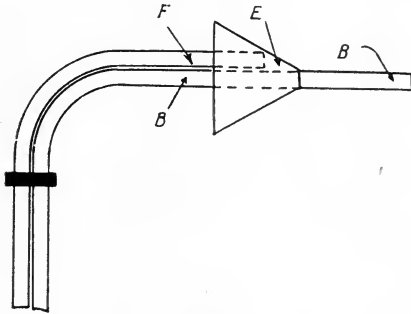

FIG. 2.

$$\left(\frac{1}{2}\rho v^2 + p\right) - p_1 = h.$$

It has been experimentally established that the difference of the pressure readings of the two tubes F and B is proportional to $\frac{1}{2}\rho v^2$, and hence,

$$h = K\left(\frac{1}{2}\rho v^2\right),$$

where K is the constant for the instrument.

Also

$$\frac{1}{2}\rho v^2 + p - p_1 = K\left(\frac{1}{2}\rho v^2\right),$$

and $\therefore (p - p_1) = (K - 1)\left(\frac{1}{2}\rho v^2\right).$

We see, then, that the difference between the static pressure and the pressure in the cone at the point E is proportional to v^2 .

A Comparison of Forces acting upon Similar Bodies.—

Let two similar bodies A and B be similarly situated in two different fluids. For the body A let L represent a linear dimension, F represent a force, and V represent the velocity of the body relatively to the fluid. Also let ρ_A = density, and ν_A = coefficient of kinematic viscosity of the fluid surrounding body A. The coefficient of kinematic viscosity is equal to the ordinary coefficient of viscosity divided by the density of the fluid.

Then for the body B let l represent a similar dimension, and f the force corresponding to the force F of the body A, also v the velocity of the body relatively to the fluid. Assume ρ_B to be the density, and ν_B the coefficient of kinematic viscosity of the second fluid.

$$\text{Now, if} \quad \frac{VL}{\nu_A} = \frac{vl}{\nu_B},$$

$$\text{then} \quad \frac{F}{f} = \frac{K\rho_A L^2 V^2}{K\rho_B l^2 v^2} = \frac{\rho_A L^2 V^2}{\rho_B l^2 v^2}$$

if we ignore the compressibility of the fluids. This statement may be deduced from a mathematical discussion of dimensional equations.

Moreover, the flow around the body A will be exactly similar to the flow around the body B, and the photographs of the flows, when taken upon plates of the same size, will be exactly the same.

Application of the Preceding Discussion to the Case of Air.—

For the same fluid $\rho_A = \rho_B = \rho$, say, and $\nu_A = \nu_B = \nu$, say; and if we make $vl = VL$, and also ignore compressibility, then

$$\frac{F}{f} = \frac{K\rho L^2 V^2}{K\rho l^2 v^2} = \frac{L^2 V^2}{l^2 v^2}$$

When the wind speed is above 125 miles an hour, compressibility effects, although very small, may have to be considered. The accurate determination of air forces acting upon full-sized machines may be deduced from the results of experiments upon models, if the product of the linear dimension and the velocity for the machine is the same as that of the model.

Pressure upon Square Plates.—The pressure upon a square plate may be written at $P = KV^2$, where P is in lbs. per square foot, and V is in feet per second.

The dependence of the value of K upon the value of vl is clearly shown in fig. 3, so that if we required the pressure upon a square plate of side 8 feet, when the wind velocity was 50 feet per second, the value of K would then be $\cdot 00153$, and the pressure in this case would be $\cdot 00153 \times 2500 = 3\cdot 82$ lbs. per square foot. The values of K given by the graph would need to be modified under abnormal temperature and pressure conditions.

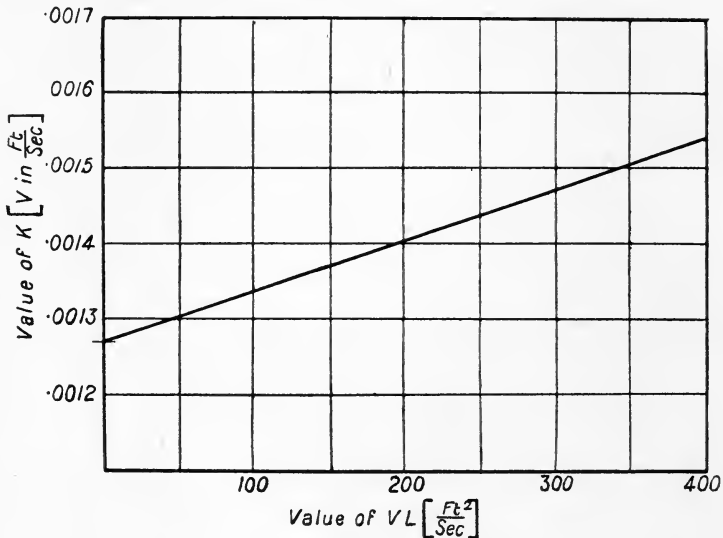

FIG. 3.

The Air Resistance of Smooth Wires.—The resistance of a wire or rope can be conveniently expressed by the equation $F = kDV^2$,

where F = force per unit length of the wire,
 D = diameter of the wire,
 V = velocity of the wind.

k is not a constant, but a function of (DV) , *i.e.* the product of the diameter of the wire and the wind velocity, and also of the density of the air.

The resistances at several wind speeds of a large number of smooth wires have been determined in the wind channel at the National Physical Laboratory, and fig. 4 gives the values

of k , i.e. $\frac{F}{DV^2}$ plotted against the corresponding values of DV . These experimental results have been reduced to 15.6° C. temp. and 760 mms. pressure. We see, then, that k is not a constant but a function of DV . From a practical point of view the most useful portion of the curve is that between $DV = .5$ to $DV = 2.5$. Owing to instability of air flow, the values of k for the portion of the curve ranging from $DV = .14$ to $DV = .40$ were difficult to determine. However, the errors in these values of K are

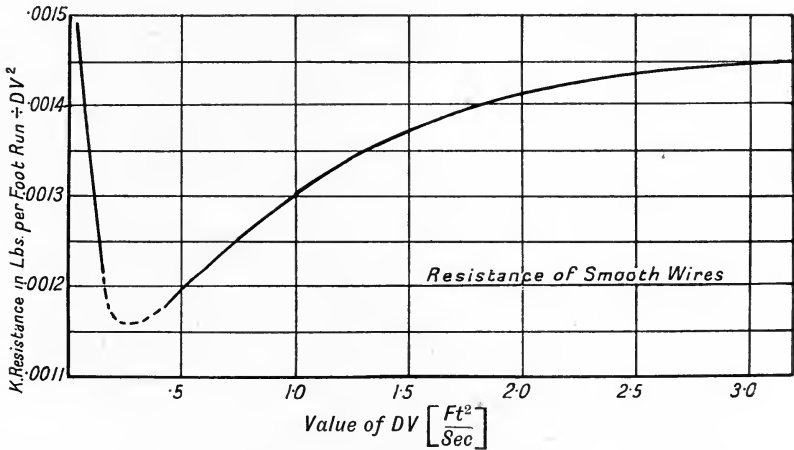

FIG. 4.

considered to be within 10 per cent. of the correct values. The resistance of a wire is not appreciably influenced by a small lateral vibration. The following example illustrates the use of the curve. Suppose that it is desirable to know the resistance per foot run of a 0.1-inch diameter tie wire if the machine has a speed of 81.5 miles per hour.

$$\text{Now, } D = \frac{1}{120} \text{ feet,}$$

$$V = 81.5 \text{ miles per hour} = 120 \text{ feet per second,}$$

$$\text{and } \therefore DV = 1.$$

From the curve when $DV = 1$ the value of k is .001304,

$$\text{and } \therefore R = .001304 \times \frac{1}{120} \times (120)^2 = .1565 \text{ lbs. per foot.}$$

CHAPTER II.

STREAM-LINE BODIES AND STRUTS.

Stream-Line Bodies.—At the outset, it is convenient to define a stream-line body as one which has a gradual change of curvature along any section, and it may be of interest to examine briefly the nature of the flow of an inviscid fluid, *i.e.* one possessing no viscosity, around such a stream-line body.

We may assume the fluid in the vicinity of the body to be divided into a large number of imaginary tubes, graphically represented in fig. 5. Now, imagine any one of these tubes, say, A B C D E, to be isolated from its fellows. Then the reaction upon the walls of this tube due to the centrifugal component of the curvilinear path of the flow, will be as represented by the arrows. If the area of the cross section of the tube at A is equal to the area at B, and the pressures at these sections are also equal, there will be no momentum communicated to the inviscid fluid during its flow through the tube. Naturally, in view of the general static pressure of the fluid, *i.e.* the pressure existing in the stream before the introduction of the body, no tensile stress can exist between the adjacent walls of neighbouring tubes.

From fig. 5 we see that the tubes are crowded together in the vicinity of *c*, and the contraction in the sectional area of each tube is accompanied by an increase of the velocity of flow. In the immediate neighbourhood of the extremities of the body where the stream-lines widen out, the motion of the fluid is actually slower than the general velocity of the stream. Since the increase of velocity across a section of any tube is only achieved at the expense of the pressure energy of the fluid, it follows that the pressure of the fluid within the region of *c* is low. Also, as the pressure of the inviscid fluid at any

point within a stream-line tube is not affected by its boundary conditions, we may anticipate, upon the basis of the foregoing remarks, that the pressure distribution over the stream-line body of fig. 5 is as is indicated by the arrows.

Energy Considerations.—By the aid of fig. 5, we will endeavour to examine the mutual transference of energy between the stream-line body and the fluid. It is immaterial whether we consider the body to move through the fluid or the fluid to flow past a stationary body.

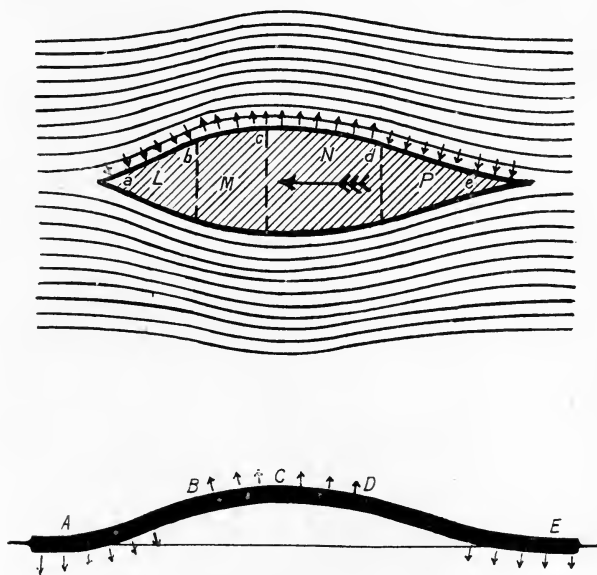

FIG. 5.

The pressure at any point of the surface of the portion L of the body is greater than the static pressure, and therefore the nose of the body does work upon the fluid in contact with it. The fluid which flows over the advancing surface of M gives energy to the body, because the pressure over this area is less than the static pressure of the fluid. The surface of N is also under suction, but the fluid is now receding relatively to the body, and so takes energy from the body. Lastly, the pressure on the surface of P is greater than the static pressure, and hence the fluid does work upon the body. Briefly, the two portions of the body L and N continuously give energy to the fluid, whilst the two remaining portions M and P con-

tinuously receive the energy back again, a balance of the energy account indicating a perfect stream-line motion.

The Nature of Stream-Line Flow.—The well-defined stream-lines of fig. 5 are an expression of the perfect harmony which exists between the molecules of the fluid, each distant molecule appearing to be perfectly cognisant of the nature of its future path around the body. A stream-line body acts sympathetically on the fluid, and the approaching stream-lines are gently coaxed to assume shapes which are more or less characteristic of the smooth contours of the body. Eddying and impact motions, which are opposed to a continuity of flow, cannot exist in a stream-line motion. It is thus apparent that sudden changes of curvature in the "body lines" should be avoided if discontinuity of flow, which in a viscid fluid will be accompanied by the formation of a "dead-water" region, is to be discouraged. Further, it should be noted that the direction and magnitude of the motion at any point in an inviscid fluid, flowing around a perfect stream-line body, is only a function of the position of the point relatively to the body, and is entirely independent of time.

Imperfect Stream-Line Bodies in a Viscid Fluid.—Most of the energy which has been taken from an imperfect stream-line body to form eddies is of a rotational nature, a form which is not favourable to any subsequent return of the energy to the body. The high resistance of bodies of imperfect form may be attributed to two disadvantageous conditions: firstly, an excess of pressure upon the surface of presentation of the body; secondly, by virtue of the viscous drag exerted by the stream, at the "surface of discontinuity," upon the mass of dead water there is a diminished pressure in the neighbourhood of the tail of the body. By the "surface of discontinuity" we mean the region separating the mass of dead water from the surrounding non-eddying fluid. Fig. 6 shows clearly a "surface of discontinuity" at the tail of a badly designed strut. The expression "surface of discontinuity" is but a convenient name: the "surface" is rather a stratum, which in all probability is a region of turbulent motion.

On the basis of the foregoing remarks, a stream-line body may be conveniently defined as one which, in its motion through a fluid, does not give rise to a surface of discontinuity.

Practical experience is, however, entirely opposed to the existence of such a body.

Generally, the motion around an ordinary body may be regarded as composed of two currents, which flow in opposite directions. The wake current of the dead-water region has a general translational motion of the same direction as the body, and superposed on the wake current is a rotational motion, the

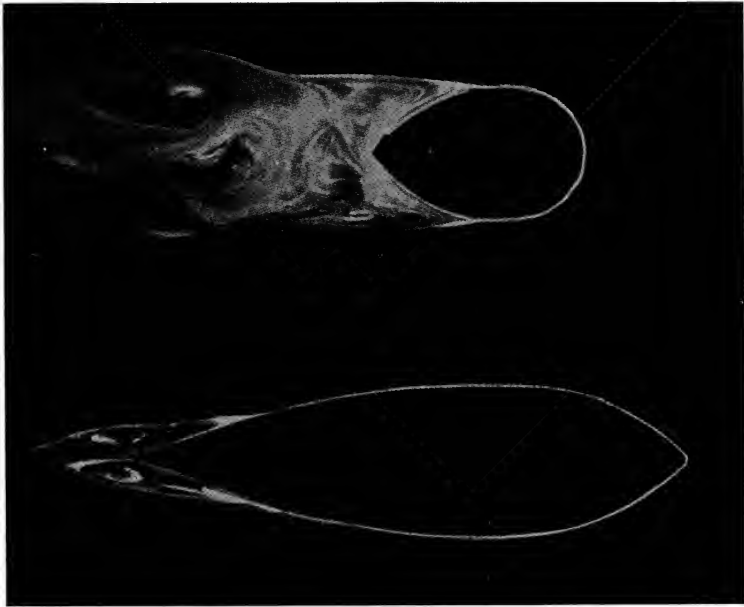

FIG. 6.

magnitude of which is determined by the frictional drag at the surface of discontinuity. It is evident that equilibrium of the fluid can only be satisfied by a flow in the opposite direction to the wake current. Hence the counterwake current which always surrounds the wake current.

Comparison of Body Forms.—The study of the flow of fluid around bodies has been greatly facilitated by the aid of photography. A contrast between a good and a bad type of flow is afforded by fig. 6. Both bodies are models of struts of which the sections B and C are shown in fig. 7. The eddying motion in the region of the tail of strut B, defined clearly in fig. 6, is

accompanied by a great increase in the resistance of the strut (see Table I.). The flow around the low resistance strut C, of fig. 6, is characterised by an almost complete absence of eddying motion. Blunt tails should be avoided if the elimination of eddying motion is desired, although a blunt nose may be used, without introducing great disadvantages, upon a body which has some approximation to a stream-line form. It is probable that once eddying motion has commenced, the shape of that portion of the body within the disturbed region has but a small influence upon the total resistance of the body. Care should be taken that the advantages of a good stream-line tail are

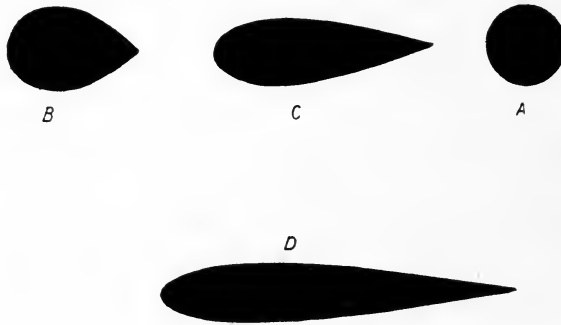

FIG. 7.—Sections of struts.

not diminished by an imperfectly shaped nose or a badly designed "middle region." The economical advantages of the employment, where possible, of bodies approximating to the stream-line form are well demonstrated in the following section.

Struts.—In a comparison of the relative merits of struts of different sectional shapes, it is reasonable to consider that equal lengths of different struts should be just capable of supporting the same end load. Adopting this standard of comparison, the relative linear scales of different strut sections may be found. The maximum thickness of each strut, fig. 7, has been calculated from a constant value, [$\cdot 05$ (inch)⁴], of the least moment of inertia of the section. It is of great importance to realise that any saving in the resistance greatly increases the lifting capacity of a machine. Thus, assume a "theoretical machine," without struts, to have a gliding angle of 1 in 6, *i.e.* the ratio of the lift

to the drag in steady flight is 6. Introducing struts of total weight w and resistance r will increase the resistance of the machine by $\frac{1}{6}[w+6r]$ (see Chapter V.), assuming the gliding angle to remain unaltered. The total increase of resistance is least when $(w+6r)$ is a minimum, and hence the quantity $(w+6r)$ may be regarded as a criterion of the total worth of a strut. In such a machine, a saving of 15 lbs. in the resistance of the struts increases the carrying capacity by 90 lbs.

Table I. has been constructed from data taken from the *Report of the Advisory Committee for Aeronautics, 1911-12*. The sections of the struts are shown in fig. 7. The weight of the wood is taken as 43 lbs. per cubic foot. It may be noted that the total length of the struts employed in a biplane approximates to 100 feet. The table, when studied in conjunction with fig. 6, should enable the student to understand more fully the dependence of the usefulness of a strut upon the shape of its section.

TABLE I.

Type of Strut.	Maximum Thickness for Equal Strength.	Resistance of 100 Feet of Strut at 60 Miles per Hour.	Weight of 100 Feet of Strut.	Equivalent Weight of Struts of Equal Strength in a Wind of 60 Miles per Hour ($w+6r$).
	Inches.	lbs.	lbs.	
A.	1.005	93.0	23.4	581.0
B.	.990	54.0	29.0	353.0
C.	.718	10.6	45.5	109.0
D.	.677	9.2	58.5	113.0

Manufacturers should endeavour to make struts of symmetrical cross section, because small deviations from symmetry are usually accompanied by wide divergences from symmetry in the crosswind and drag forces (see fig. 8). The direction of the crosswind force acting upon a strut occasionally depends upon a critical type of flow, the nature of which is further dependent upon the "fineness ratio" of the strut, *i.e.* upon the ratio of the length of the cross section to the maximum thickness. The crosswind force occasionally acts in the opposite direction to that anticipated from the angle between the wind direction and the axis of the section of the strut. Again referring

to fig. 8, the value of θ at which a critical breakdown of air flow occurs, increases with the fineness ratio. When the wind blows directly upon the nose of the strut, the smaller the fineness ratio the larger the resistance of the strut, if due regard be taken of any alteration in the sectional area of the strut. Further, when a strut of low fineness-ratio is inclined at small angles to the wind direction, that is, θ is small, the crosswind force usually acts in a negative direction. Positive values of θ and the positive direction of the crosswind force are shown in fig. 8. When struts which have a fineness ratio greater than

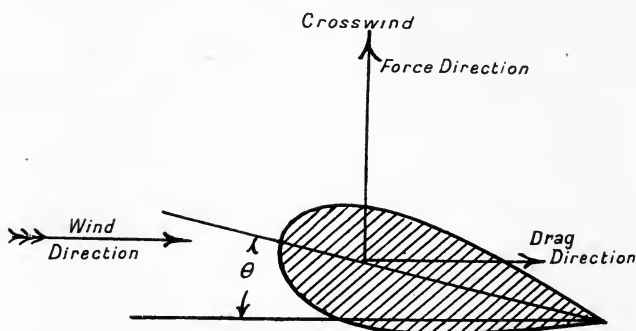

FIG. 8.

5 are acted upon by a cross wind, they may be regarded as the equivalent of positive vertical fins—that is, the crosswind forces act in positive directions for positive values of θ . Struts of small fineness ratio, that is, $2\frac{1}{2}$ –5, have uncertain fin action in cross winds. The fin action of such struts may vanish in strong, gusty side winds. The resistance of a strut of fineness ratio less than $2\frac{1}{2}$ is very high, and the fin effect, if present, will probably have an action opposite to that which may be anticipated from the direction of the wind. It appears, then, that a strut of fineness ratio less than $2\frac{1}{2}$ has nothing to recommend it.

The chief woods employed in the manufacture of struts are spruce and ash. Hollow steel tubes, surrounded with wood of good stream-line form, are also in common use. The struts of the future will probably be constructed of steel.

CHAPTER III.

AEROPLANE WINGS.

THIS branch of aeronautics may be studied most conveniently in two sections: (a) an aerodynamic consideration of wings, (b) a mechanical consideration of wings. We are greatly indebted to experimental research for its contributions to the science of aeronautics. Certainly most of our present knowledge of the aerodynamic properties of aeroplane wings has been gained from the results of laborious experiments made upon

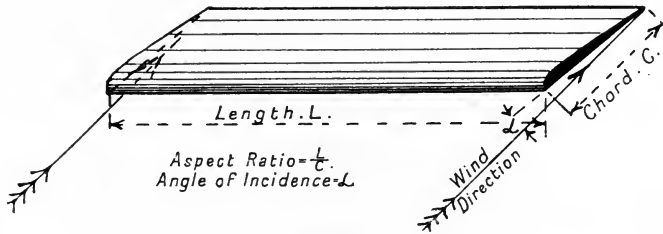

FIG. 9.

small models. Hence, as is most fitting, the greater proportion of the matter of the first section of this chapter has been compiled from the reports of the big aeronautical laboratories, and more especially from the *Annual Reports of the Aeronautical Section of the National Physical Laboratory*. The second section, which deals with wing stresses and wing construction, should be of interest to the designer and workman.

Fig. 9 will be of service in explaining some of the terms employed in this chapter.

Definition of Lift and Drag.—The total air force acting upon the wings of an aeroplane, when the machine is flying normally, may be resolved into two components: (a) a force acting at right angles to the general wind direction and to the plane of

the wing, which is called the "Lift" component, and (b) a force acting along the general wind direction, which is called the "Drag" component.

SECTION I.—AN AERODYNAMIC CONSIDERATION OF AEROPLANE WINGS.

Nature of the Air Flow around a Wing.—We can conceive that by virtue of the larger number of "flow paths" afforded by the configuration of the wing-tips, the air flow at the end of the wing is of an entirely different nature from that which exists at the middle portion of the wing. The deviation of the behaviour of a wing which has this three-dimensional type of flow at its ends from that of a similarly constructed wing in which the two-dimensional flow at the middle is assumed to extend to the wing-tips is said to be due to "end effects." The nature of the flow around the middle portion of the wing,



FIG. 10.

i.e. the two-dimensional flow region, has been experimentally investigated, and we will now discuss, as briefly as possible, the salient features of this research. Fig. 10 is a sketch of a section of a wing of a modern aeroplane. Firstly, we will consider the distribution of pressure around the upper and lower surfaces of such a wing. By "pressure" we shall mean the difference between the pressure at the point on the wing and the pressure of the undisturbed air of the same locality—that is, the pressure that would be indicated by a barometer.

When the wing has an ordinary or "normal flight" angle of incidence there is a positive pressure upon its lower surface, and a negative pressure upon its upper surface, and both these pressures have a maximum value in the vicinity of the leading edge. Also, the numerical values of both these pressures considerably diminish as we travel towards the trailing edge, and some idea of the nature of this pressure gradient will be realised from the following illustration. Thus, when an aeroplane travels at 60 miles per hour, the pressure normal to the

chord at the leading edge of the wing is of the order of 35 lbs. per square foot, whilst the pressure at the trailing edge may be only 2 lbs. per square foot. Under these circumstances we should expect the average normal pressure upon the wing to be about 10 lbs. per square foot. With such a distribution of pressure the point of intersection of the line of the resultant force with the chord of the section, conveniently called the centre of pressure of the section, is well forward of the middle of the chord.

Principle of the Dipping Front Edge.—We will now discuss a phenomenon commonly known as the “Principle of the Dipping Front Edge.” Referring to fig. 10, we see that the region in the neighbourhood of A faces the wind, whilst the area around B is sheltered from the wind, and we, in ignorance, would naturally expect a positive pressure at A and a negative pressure at B. We have just read, however, that such is not the case: the pressure at A is most decidedly negative, whilst that at B is positive. Photographs which illustrate the flow of air around model wings show that the wind is deflected upwards as it approaches the leading edge of the wing, so that although the surface of A faces the general wind direction, this surface is screened from the general wind. It is this upward deflection of the air which is responsible for the formation of a general low-pressure region above and a high-pressure region below the wing. The efficient results of a well-designed wing depend chiefly upon the “suction” over the top surface, and, obviously, the greater the suction the greater the lifting force in a direction normal to the chord. Usually the angle of incidence is small, so that the force normal to the chord approximates closely to the lift on the wing. Furthermore, since the negative pressure on the upper surface, in the region of the leading edge, is much greater than that at the trailing edge, the resultant force along the chord due to the pressures on the upper surface of the wing acts in an upwind direction. The lower surface does not materially affect the numerical value of the upwind force. It would appear, then, that the direction of the resultant force upon an efficient wing is between the normal to the chord and the normal to the wind direction, and the smallness of the angle between the direction of the resultant force and a normal to the wind direction may be regarded as a criterion of the

aerodynamic efficiency of the wing. Roughly speaking, about 60 per cent. of the wing area may be considered to be subjected to the two-dimensional flow which has been described above.

Pressure Distribution around the Wing-Tips.—The nature of the air flow in the neighbourhood of the wing-tip, usually about 40 per cent. of the wing area, has also been investigated at the National Physical Laboratory. The distributions of pressure upon the upper and lower surfaces of sections, which were situated at several distances along the wing, were found. The distribution of negative pressure upon the upper surface of a

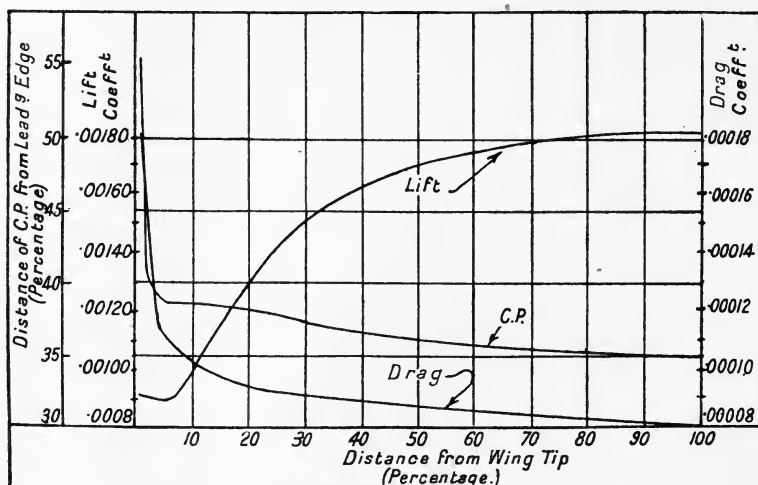

FIG. 11.

section alters progressively as we approach the tip of the wing, until at the tip section we have the greatest suction in the neighbourhood of the trailing edge. The undesirable increase of drag which is introduced by such a distribution of pressure should be quite clear, as the force component parallel to the chord, which has an upwind direction for a middle section, has a downwind direction at the tip section. The portion of the wing in the immediate neighbourhood of the tip is almost completely under suction, and therefore the flow over the lower surface reduces by a small amount the value of the lift developed by the flow over the upper surface. It is of interest to note that any movement of the position of the maximum suction upon the upper surface towards the trailing edge will

also be accompanied by a similar backward movement of the centre of pressure of the wing section. Table II., compiled from data taken from a paper dealing with this subject, may illustrate more clearly the relative contributions of the various sections of the wing towards the lift, drag, and centre of pressure of the complete wing. The values of Table II. have been plotted in fig. 11.

TABLE II.

Lift upon the wing = KAV^2 ,

Drag „ „ „ = kAV^2 ,

where K and k are constants, when the angle of incidence of the wing has a constant value.

The values of K and k in the table have been calculated on the understanding that

A the area is in square feet,

V the velocity is in miles per hour,

and the angle of incidence of the wing = 4° .

Section.	Distance of the Section from the Wing-Tip, expressed as a Percentage of the Total Length of the Wing.	Lift Coefficient K .	Drag Coefficient k .	$\frac{L}{D}$.	Position of the Centre of Pressure from the Leading Edge. Percentage of Chord.
	Tip Section				
A.	1.1	.00093	.000182	5.1	55.5
B.	5.6	.00089	.000110	8.1	38.5
C.	16.8	.00123	.000096	12.8	38.5
D.	33.4	.00158	.000090	17.6	36.9
E.	100.0	.00184	.000080	23.0	35.0
	Body End of Wing				

Direct force measurements made upon the complete wing gave the following results :—

Lift coefficient for complete wing = .001600,

Drag coefficient „ „ = .000107,

and $\therefore \frac{\text{Lift}}{\text{Drag}} = 15.$

Distance of the centre of pressure behind the leading edge was 35.9 per cent. of the chord length.

The Lift, Drag, and Centre of Pressure Curves of a Modern Wing.—The curves of figs. 12 and 13, which are typical of almost

all efficient aeroplane wings, have been constructed from values taken from a report on research work performed at the National Physical Laboratory. Fig. 10 is a sketch of a section of this particular wing. By the "centre of pressure" we shall mean the point of intersection of the line of the resultant force with the chord of the section.

At an angle of incidence of 15° , *i.e.* at the point C, we observe

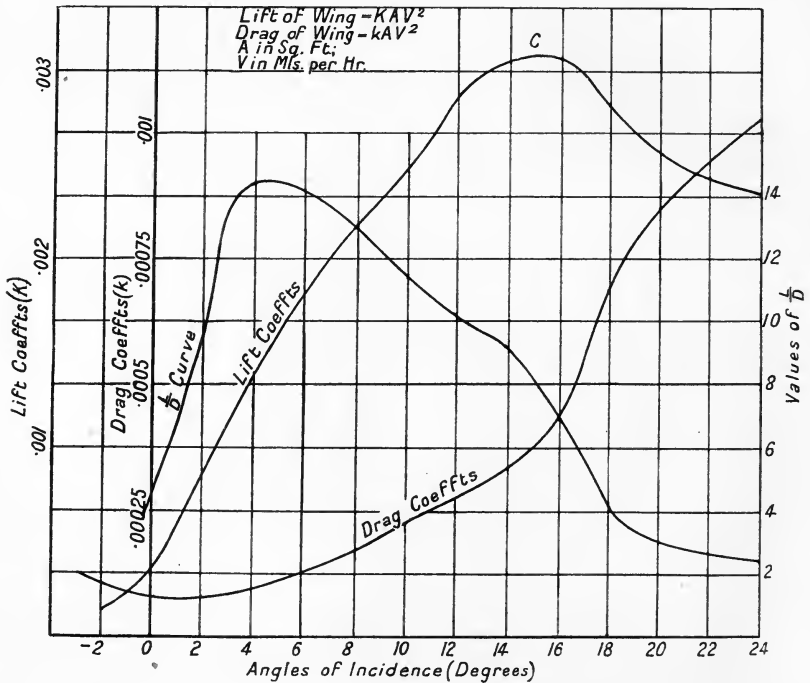

FIG. 12.

a big falling-off in the value of the lift coefficient and a marked increase in the value of the drag coefficient. Both these phenomena are the result of a breakdown in the character of the air flow, which results in the sudden alteration of the pressure distribution over the upper surface. The angle at which this breakdown in flow takes place is appropriately called the "critical angle." At angles of incidence greater than the critical angle, the negative pressure upon the upper surface tends to become uniform, so that now the negative pressure upon this surface contributes but a small upwind force com-

ponent in the direction of the chord. The increase of drag may be thus partly explained.

The value of the critical angle, and the changes of force occurring at it, are a function of the position of the maximum ordinate. The ratio $\frac{L}{D}$ has its maximum value when the angle of incidence is equal to 4.5° .

The best angle of incidence is that which makes the ratio $\frac{\text{Lift of the wings}^*}{\text{Drag of the machine}}$ a maximum, so that the curve of body

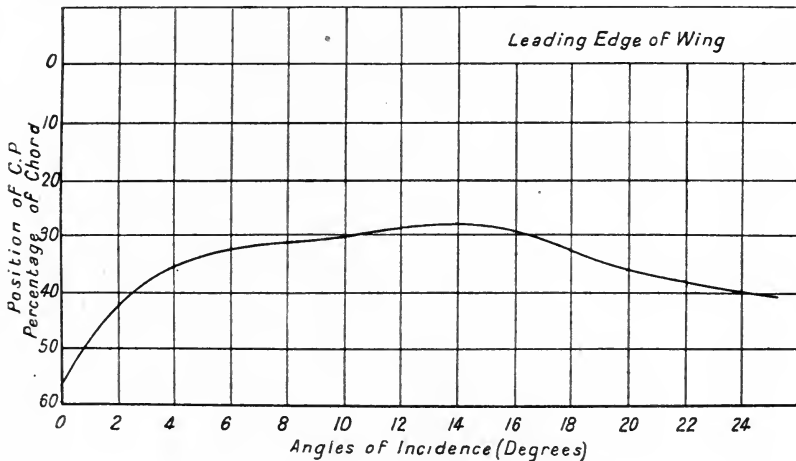

FIG. 13.

resistance must be estimated before the best normal flying angle of incidence can be assigned.

It is desirable that the lift coefficient at the normal angle of incidence should be large, and, to ensure a good manœuvring speed range, the ratio of the lift coefficient at 15° to that at 4.5° should also be large. It is scarcely necessary to add that this wing should never have an angle of incidence greater than the critical angle of 15° .

Relative Importance and Interdependence of the Two Surfaces of a Wing.—The negative pressures upon the top surface of a wing are much greater, numerically, than the positive pressures upon the lower surface, and hence the greater part of the resultant force normal to the chord is contributed by

* The lift of the other parts of an aeroplane is usually almost negligible.

the pressures upon the upper surface. The force in the direction of the chord depends not only upon the pressures upon a surface, but also upon the projected area of the surface upon a plane which is normal to a chord of the wing. The importance of the upper surface, which has the greater projected area, by virtue of its greater camber, is still further increased.

Generally, we may say that the upper surface of an efficient wing supplies, at least, three-quarters of the total lift. Moreover, the pressure distribution over the upper surface is practically unaffected by changes made in the camber of the lower surface—that is, if the lower surface is not given a convex curvature. The converse is not true, however: the pressure distribution over the lower surface is affected by alterations in the camber of the upper surface, but the forces contributed by the lower surface are small, and hence a considerable percentage change in these forces does not greatly affect the resultant wing forces. Further, the structural advantages of a wing with a flat or slightly concave camber would probably outweigh the small aerodynamic advantages which would be derived by cambering still further the lower surface.

Camber of the Wing.—The camber of a section is measured by the ratio of the length of the maximum ordinate, which can be drawn from a point of the section upon the chord, to the length of the chord. Generally speaking, as the camber of the upper surface decreases, the angle of incidence of the chord of the wing, at no lift and at maximum lift, becomes greater, and also the rate of decrease of the lift coefficient with the angle of incidence, in the region beyond the critical angle, is much less marked.

The Wings of a Variable-Speed Machine.—The following characteristics of a wing are of the greatest importance to the designer:—

- (a) The maximum value of $\frac{L}{D}$ obtainable from the wing.
- (b) The lift coefficient corresponding to this maximum value of $\frac{L}{D}$.
- (c) The ratio between the lift coefficient at the maximum value of $\frac{L}{D}$, and the lift coefficient at the critical angle.

It is of interest to observe that wings which have a high maximum value of $\frac{L}{D}$, usually have a low lift coefficient at

the angle of incidence which makes the value of $\frac{L}{D}$ a maximum.

Fortunately, however, the ratio which this lift coefficient bears to that at the critical angle is small. The wings of a variable-speed machine should have these characteristics. Perhaps a little further explanation may make this statement clearer. Usually, a machine flies normally at the angle of incidence

which makes $\frac{\text{Lift}}{\text{Drag}}$ for the machine a maximum. In horizontal

flight the lift, which is equal to the weight of the machine, has a constant value, and hence $(K_\alpha V^2)$ is a constant where K_α = lift coefficient of the machine at an angle of incidence of the wings equal to α , and V is the velocity of the machine. The maximum angle of incidence suitable for safe flight is dependent upon the value of the critical angle; and if the ratio of the lift coefficient

at the maximum value of $\frac{L}{D}$ to that at the critical angle has

a low value, the lift coefficient K_α will have a large available range in value. Further, if $(K_\alpha V^2)$ must be constant, V^2 also has a large range in value.

It has been found that a wing which has an upper surface camber of .055, and its lower surface only slightly cambered, gives a lift coefficient of about .0013 at an angle of incidence of about 3.5° , and a value of 14 for the corresponding value

of $\frac{L}{D}$. When using this lift coefficient the velocity should be

measured in miles per hour. The average camber of the upper surface of the wing of a modern aeroplane is of the order of .08.

The Position of the Maximum Ordinate.—If the maximum ordinate is placed too close to the leading edge of the wing, low values of the critical angle and the lift coefficient at the critical angle are encouraged. We have already seen that it is advantageous to have a high value of the critical angle, and also a high value of the lift coefficient, at this angle. The maximum ordinate may be shifted forward from the middle of the chord to within a distance of 0.2 of the chord from the nose without greatly influencing the behaviour of the wing at small angles

of incidence, say from 0° to 8° . It has been the practice of wing designers to place the maximum ordinate at a distance of one-third of the chord from the leading edge, although it is probable that the more stable type of flow which would result by the placing of the maximum ordinate at a distance of three-eighths of the chord from the leading edge, would more than compensate for any slight decrease in the maximum value of $\frac{L}{D}$. It is of theoretical interest to know that the values of the lift and drift coefficients at angles of incidence greater than the critical angle are greatly dependent upon the position of the maximum ordinate.

Aspect Ratio.—A consideration of the influence of the aspect ratio upon the values of the lift and drag coefficients of a wing (see fig. 9).

Imagine a wing of constant section to be cut by a series of parallel planes which are perpendicular to the length of the wing, and suppose the flow at each of these sections to be photographed. Then if the photographs are exactly similar, the flow around the surface of the wing is two-dimensional. Obviously, if the flow over the surface of the wing were strictly two-dimensional, both the lift and drag coefficients would be independent of the aspect ratio. It is only by preventing an inherent feature of the modern wing—that is, the lateral escape of the air at the wing-tips—that we may hope to approximate to a uniform two-dimensional type of flow. The maximum value of $\frac{L}{D}$ decreases considerably with a decrease of the aspect ratio of a wing. Recent researches at the National Physical Laboratory indicate that a fall of 35 per cent. in the maximum value of $\frac{L}{D}$ is quite probable when the aspect ratio is diminished from 8.0 to 3.0. This great fall in the maximum value of $\frac{L}{D}$ is largely due to the increase in the drag coefficient, which is accompanied by only a slight decrease in the lift coefficient. The limit to the maximum practical value of the aspect ratio must be assigned by a consideration of the weight and the strength of the wing. Obviously, the weight of a wing must be some function of its aspect ratio.

The Leading and Trailing Edges.—The popular notion that aerodynamic advantages may accrue from a thick leading edge has not been substantiated by research. It is even probable that the aerodynamic efficiency of the wing, as measured by the maximum value of $\frac{L}{D}$, may decrease as the nose of the wing becomes thickened. When the nose of the wing is decidedly thick the lift coefficient, although not greatly affected at the normal flight angles of incidence, has a tendency to remain constant at large inclinations of the wing. The thick leading edge certainly has structural advantages, and is not accompanied by any great aerodynamic disadvantages. Moreover, a slight thickening in the neighbourhood of the trailing edge, if reasonably performed, will not greatly interfere with the aerodynamic properties of the wing.

The Dihedral Angle.—The wings of many aeroplanes are not in the same plane, but are slightly inclined upward from the shoulder to the tip, or, to use the technical expression, the wings have a dihedral angle. The dihedral angle is measured by the angle between the lateral axis of the wing and the plane of XOY (see fig. 36, Chapter VI.). Usually the dihedral angle is small, and such a small angle difference does not have any appreciable effect upon the lift and drag forces of the wing. The dihedral angle between the wings has a great influence on the lateral stability of the machine.

Biplane Wings.—We now wish to consider the interaction which takes place between the two superposed wings of a biplane. The wings may be arranged in a "normal" position, so that the chords of each wing are parallel and the longitudinal axis OX of the machine is normal to the plane passing through the leading edges, or the wings may be staggered, in a positive direction, by a forward displacement in the direction of the chord of the top wing relatively to the lower wing, the wings still remaining parallel. The lifting capacity of a wing, and also to a lesser extent the drag, is diminished by the presence of a neighbouring wing.

A popular spacing of biplane wings is to make the gap between the wings equal to the chord. With such a spacing, and at the usual angles of incidence, the lift coefficient of each wing is approximately 80 per cent. of the value of the lift coefficient of

the single wing, and we may roughly assume that the drag coefficient of either wing is unaffected by the presence of the other. If, now, the top wing is staggered a distance of 0.4 of the chord length forward of the lower wing, an improvement of about 5 per cent. in the value of the lift coefficient may be introduced. A similar improvement is also found in the ratio of $\frac{L}{D}$.

Aerodynamic Behaviour of a Wing which has a Reflex Curvature towards the Trailing Edge.—The navigation of an aeroplane would be greatly facilitated if the position of the centre of pressure of the wings was not influenced by the angle of incidence. This desirable condition may be obtained by giving to that portion of the wing in the neighbourhood of the trailing edge a reversed or “turned-up” curvature of the correct amount.

A stationary position of the centre of pressure can, however, only be obtained at the expense of the other desirable properties of the wing. Thus the maximum value of the ratio $\frac{L}{D}$ may be reduced more than 10 per cent., whilst a diminution of about 25 per cent. in the value of the maximum possible lift may result. Also, since an increase in the curvature at the trailing edge of the wing will increase the angle of incidence necessary to produce a given lift, such a wing could not be employed upon a variable-speed machine.

SECTION II.—THE DESIGN AND CONSTRUCTION OF A WING.

In the previous section we were entirely concerned with a theoretical discussion of the aerodynamic properties of a wing; we will now study an aeroplane wing from a more practical standpoint.

The framework, or skeleton of a wing, is commonly built up of two main spars, *i.e.* the front and rear spars, which are connected together by equally spaced transverse ribs. The curvatures of the upper and lower surfaces of any rib decide the shape of the section of the wing in that neighbourhood. The front ends of the ribs are connected to a “nose” or leading edge spar. The fabric, sufficiently stretched to give an even

surface, is fastened to the upper and lower surfaces of the ribs and spars. The shoulder end of the front or main spar is firmly connected to the body of the machine, but occasionally, to enable warping duties to be performed, the shoulder end of the rear spar has a swivelling connection to the body. Wire bracing is extensively employed to stiffen the wing, and tie wires connect several points in the lower surfaces of the spars to the lower portion of the body. The wings of a biplane are further stiffened by a system of strut bracing. We will now consider in greater detail the several parts of a wing, and the contributions of each part towards the efficient construction of the wing.

Front or Main Spar.—Designers endeavour to arrange that the whole of the drag of the wings shall be taken by the forward pull of the lift wires. Usually the tie wires are connected to points in the front spar, which are an appreciable distance, say 2 inches, below the neutral axis of the spar—a factor which should not be omitted in stress calculations.

The weight of the machine, minus the weight of the wings, is chiefly carried by the lift wires; but although the bending moment at the connection between the front spar and the body may consequently be small, the spar with the shoulder connection is under a great compressive force. The calculation of the stresses in any part of an aeroplane should be made for the particular manœuvre which imposes a maximum stress upon that part. Thus the stress calculations for the front spar should be made when the centre of pressure of the wing is nearest the leading edge, and the wing forces are also a maximum. Warping a wing increases the loading upon it, and the wing loading during a *vol piqué*, although difficult to estimate, is probably very great. Further, side gusts may introduce stresses much greater than the calculated stresses, although such contingencies may be adequately provided for by the choice of a reasonable factor of safety. The spar stresses due to bending are greater than those due to direct compression. Great attention should be given to the initial straining of the wires—or “timing,” to use the technical term,—as any interference with the previous alignment of the points of attachment of the wires to the spar, consequent upon the application of the load, may introduce great stresses in the spar.

The breaking of any tie wire endangers the wing, and this especially applies to the end wire. As may be expected from the great difficulty of calculating the maximum stresses possible, a spar should be allowed a very large factor of safety. A few sections of typical spars are given in fig. 14. Although at the present time ash is the material chiefly employed in the making of spars, it is extremely likely that in the future wood will be superseded by metal. The rear spar, which may take only a small percentage of the total load of the wing, is usually smaller in section than the front spar, although a good deal of the foregoing discussion on the front spar is equally true for the rear spar.

The ribs are commonly made of French poplar, spruce,

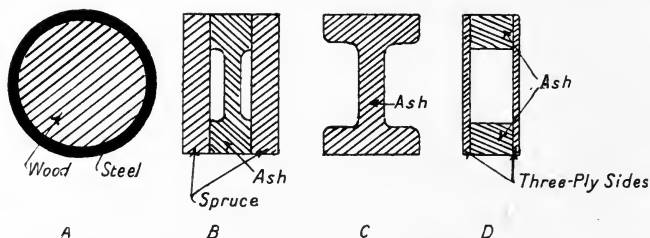

FIG. 14.—A, Bristol; B, Sopwith; C, Grahame-White; D, Martin Handasyde.

Honduras mahogany, and occasionally of cotton wood, a light wood which does not readily split. The ribs may be rigidly connected to the spars, but some makers affirm that a loose fit between the ribs and spars prevents any excessive fatigue of the material of the wing structure during an excessive warp. The ties, usually made from piano-wire, should be efficiently connected at their ends, and should have a factor of safety of at least 12.

Aeroplane Fabric.—Linen, of a fine, closely-woven texture, is employed as a covering for the upper and lower surfaces of aeroplane wings. It is most essential that an aeroplane fabric should possess strength, lightness, and durability. The weight of aeroplane fabric is about 4 ounces per square yard, and its strength varies from about 80 lbs. per inch in the warp direction, to 110 lbs. per inch in the weft direction. The warp threads of a fabric are those stretched lengthwise in the loom, and crossing at right angles these long threads are the shorter weft

threads. The fabric is attached to the structure of the wing so that the weft threads take the greater strain—that is, the warp threads are in the direction of the ribs. No great difficulty is experienced in the production of a strong and light linen, but a linen which is at the same time airtight and unaffected by moisture has yet to be manufactured. Airtightness and watertightness are obtained, and also a taut surface given to the wing, by coating the linen with a chemical preparation termed “Dope”. Almost all the dopes now on the market contain cellulose acetate in solution, the chief solvents being tetrachlorethane, methyl alcohol, and acetone. The first coat of dope penetrates the threads of the linen and fills the interstices between the threads, and, as the drying proceeds, the gelatinous substance remaining contracts and brings the threads more closely together. Usually four or five coats of dope are applied to the surface of the linen, the increase of weight due to the dope being about 40 per cent. of the weight of the undoped linen. It is desirable that the coating of dope should remain airtight and watertight after long periods of weathering, and should not in any way weaken the fabric. Needless to say, the doped fabric should be non-inflammable. As a rule, doping increases the strength of the fabric by about 20 per cent. The fabric now used in aeroplane construction is sufficiently strong to support any load which the wings may have to bear. If the fabric is punctured, say, by a bullet, its strength is diminished, a cut of length $\frac{3}{4}$ inch causing a reduction of strength of at least 50 per cent. of the strength of the undamaged fabric.

We have read on a previous page that the maximum positive pressure upon the lower surface, and the maximum negative pressure upon the upper surface, occur on areas very close to the leading edge of the wing.

It would follow, then, that the greatest possible pressure which the fabric may have to bear would occur at a point of maximum suction upon the upper fabric when there is a leak at a point of maximum positive pressure in the lower fabric, assuming the remainder of the fabric to be airtight. The value of the maximum pressure in this hypothetical case, when the machine has a normal flying speed of 70 miles per hour, does not greatly differ from 20 lbs. per square foot.

Moreover, assuming the existence of such a leak, the sudden

flattening out of the machine after a steep dive, when the speed of the machine is probably of the order of 100 miles per hour and the angle of incidence of the wings about 12° , imposes a maximum stress of 100 lbs. per square foot upon the fabric. Ordinarily, the initial tensions of those threads of the fabric which are transverse to the line of flight have negligible values. Also any small initial tensions in the longitudinal threads of the fabric, such as are introduced during the construction of the wing, are greatly reduced by subsequent weathering. It is assumed then, that, in the absence of initial tensions in the longitudinal threads, the whole of the pressure upon the fabric is transmitted to the framework of the wing at the areas of attachment of the fabric to the ribs. The transverse spacing between the ribs is only a small fraction of the chord length (about $\frac{1}{3}$ th), so that during flight the greater proportion of the strain in the bulging fabric is taken by the transverse threads.

At the expense of a small sacrifice of accuracy, the calculation of the stresses in the fabric is facilitated by the reasonable assumption that the transverse fibres support the whole of the pressure upon the fabric. It is comforting to know that, with the abnormal pressure of 100 lbs. per square foot, the value of the maximum stress in the fabric is much less than the limiting stress which would cause the rupture of an unwounded fabric. The fabric of the upper wing of a biplane is more severely stressed than the lower, the upper wing usually carrying a load which is about 30 per cent. greater than the load upon the lower wing. In view of the great air load on the fabric, an efficient connection of the fabric to the ribs is of the greatest importance. The fabric may be fixed to the ribs with small brass tacks and washers, although a more efficient method is to tack upon the outside of the fabric strips of cane or wood. A great improvement is effected by sticking the fabric to the ribs before tacking, and connecting the portions of the upper and lower fabrics, which are in the neighbourhood of the ribs, by knotted sewing, and covering the exposed portions of the sewing with tape. Should such a wing be tested to destruction, it is highly probable that the main spar would fracture before there would be any failure of the attachment of the fabric to the ribs.

CHAPTER IV.

CONSTRUCTION OF AN AEROPLANE.

The Aeroplane.—The author does not desire to consider the general details of the present-day machines, but a broad outline of the construction and function of the several aeroplane parts should be of some interest to the reader. Prominence has been given, when possible, to the good points of any particular type of machine.

The classification of modern aeroplanes favours two groups : (1) monoplanes, (2) biplanes. A monoplane is a machine with a single pair of wings or main planes, whilst a biplane, as its name implies, has two superposed pairs of wings. Multiplaned machines have been constructed, although the successful development of these machines probably belongs to the future. The aeroplane is a heavier-than-air machine, and a prolonged sustentation in the air of such a machine is only possible by virtue of the lift on the wings, the lift depending upon the configuration and the speed of the wings relatively to the air.

The biplane, with its elaborate system of wing bracing, is usually more strongly constructed than the monoplane, and the additional wing area is in favour of a much larger carrying capacity. Biplanes, as a rule, are slower than monoplanes, although a slow speed is not essentially a characteristic of a biplane.

The planes at the tail of an aeroplane may be divided into two groups : (1) those fixed in the machine—such planes are essentially stabilisers ; (2) those capable of partial rotations. The rudder, a vertical plane capable of rotation about a vertical axis, partially controls the yawing or turning of the machine. The elevator, a plane turning about a lateral axis, regulates the pitching of the machine. The terms “horizontal” and

“vertical” in this connection are not strictly accurate. “Lateral” and “longitudinal” are correct (see diagram, fig. 36, Chapter VI.). The position and the size of the rudder have an important bearing on the lateral stability of the machine. Similarly, the elevator should be regarded as a longitudinal stabiliser. Usually, the leading plane which is fitted to some biplanes has both a directive and stabilising action upon the machine.

At present there are two methods of controlling transverse equilibrium :—

(1) The employment of flaps or ailerons, that is, auxiliary horizontal surfaces which are capable of partial rotation. Fig. 20 gives a general idea of the position and the size of a wing flap. The flaps are cross-connected so that a downward rotation of one flap is accompanied by an upward rotation of the other.

The yawing and rolling moments which are greatly dependent upon the differences of the drags and lifts of the two wings respectively, are affected by the flap action. If necessary, the yawing moment may be modified by rudder action.

It is conceivable that the air flow around a wing may, for certain positions of the flap, be of an extremely irregular, if not actually unstable, character. The adoption of wing flaps cannot be safely advocated until their reliability has been proved by an extensive research.

(2) Warping the wings, that is, the angle of incidence of one wing may be increased relatively to the other. Warping is performed by a slight rotation of the rear spar about its attachment to the body, and the various wing sections have small rotations about the main spar. There is a growing tendency nowadays to substitute wing flaps for the wing warp. A brief summary of the disadvantages of the wing warp is given below.

(a) The self-warping of the wings imparts a continuous flicking motion to the warping lever. During a long flight, the constant attention to the warping lever imposes a great strain on the pilot.

(b) Great attention must be given to the adjustment of warping wings.

(c) Warping may introduce stresses in the material of the wings. Certainly, warping cannot be recommended from a mechanical standpoint.

(d) "Flapped" wings may be easily dismantled and again set up.

The wings, rudder, elevator, and stabilising fins are fixed in their correct relative positions by a framework of wood which is known as the body or fuselage. The body also contains the engine, propeller, control levers, and seating accommodation. Finally, the aeroplane is completed by the chassis or undercarriage which supports the fuselage when the machine is on the ground.

A consideration of aeroplane wings from a mechanical standpoint has already been given in Chapter III.

The Aeroplane Undercarriage or Chassis.—At the present time the reliability of an aeroplane engine is a factor of uncertain amount, so that the pilot may not always be able to choose a convenient and safe landing-place. The undercarriage, which should not be of cumbrous proportions, must be sufficiently strong to withstand the abnormal stresses of a sudden and, maybe, violent landing. The following points dealing with the construction of an undercarriage should be considered by the designer:—

(1) The machine has to attain its flying speed rapidly, so that the ground resistance when the machine is running along the ground should be small.

(2) Suitable devices to absorb landing and rolling shocks must be fitted.

(3) The machine must be efficiently steered when on the ground, and also the alighting speed must be braked. It has been found that a rim, or a tyre, or a band brake, which acts directly upon the main wheels, readily keeps the machine under control when running on the ground.

(4) The stability of the machine at high ground speeds demands attention. When alighting, the machine should have no tendency to pitch forward on to its nose. Such a disaster may be prevented by fitting a leading wheel or skid.

A simple construction of undercarriage facilitates the repair of accidental breakages, and also minimises weight and head resistance. When the machine rests upon the ground, the main wheels support most of the weight, so that the rear skid or wheel bears only a comparatively small load. An uncomfortable "rebounding" landing is the result of placing the C.G.

(centre of gravity) of the machine some distance behind the axis of the main wheels. The pitching moment called into play by the reaction of the ground upon the wheels increases the angle of incidence of the wings, and the increased lift causes the machine to ascend again. Moreover, if the main chassis wheels are placed nearly under the C.G. of the machine, the loading upon the rear skid will be small, so that no undue strengthening of the framework, entailing additional weight, is necessary.

The hubs of the wheels should be sufficiently strong to resist side strains. For reasons of decreased resistance, and probably also from strength considerations, wheels with dished steel sides are preferable to ordinary spoked wheels. A broad wheel base is necessary to ensure that the machine when running on the ground may have sufficient stability.

The working of a land steering gear should not be dependent on air pressures, which are a function of the velocity of the machine. Also steering should not be dependent upon the propeller slip stream. A pivoted rear skid, when operated from the wheel or foot-bar which works the rudder, allows ground steering to be performed efficiently.

Shock absorbers are largely manufactured from rubber cable, a material which has good lasting qualities and a high ultimate stress. Ordinary steel springs and rubbers both dissipate and store the energy of landing and rolling shocks. The stored energy is afterwards imparted to the machine as minor shocks. Some absorbers do not greatly diminish the energy which is subsequently given to the machine, although by increasing the time of impact the magnitude of the blow is diminished. The real shock absorber—a dashpot, for instance—would dissipate most of the energy, and only a small fraction of the original energy of the blow would exert a disturbing influence upon the machine. Rubber cable dissipates energy quite rapidly, and has, therefore, a “dashpot” action.

Ash is largely employed in the construction of an undercarriage of an aeroplane. The advantages of ash are (i.) lightness, (ii.) strength, (iii.) cheapness, (iv.) hardness, (v.) a capacity to withstand bending and torsional stresses, (vi.) facility with which a damaged portion may be replaced. Nevertheless, the great advantages of metals—of which strength, the use of strong welded joints and connections, and almost

complete indifference to weather conditions, may be mentioned—encourage us to anticipate that the undercarriage of the future will be constructed exclusively of metal.

The Hydro-Aeroplane.—A hydro-aeroplane has been defined as an air-borne craft capable of floating on water. Such a machine must be made sufficiently strong to resist the severe buffeting of a rough sea, although its flying capacity is affected adversely by any undue weight and head resistance. The double-float machine is probably the more seaworthy class of hydro-aeroplane, and is fairly efficient in rough water. The floats should not be too far apart, otherwise the lifting of one float out of the water due to excessive rolling causes the machine to suddenly swing round; and, moreover, the unbalanced forces called into action by the reduction of the resistance of the rising float, and the increase of the resistance of the falling float, are greatly assisted by the leverage between the two floats. On the other hand, when the two floats are close together, the behaviour approximates to that of a single-float machine. The water resistance of the floats appears to be practically independent of their distance apart. To prevent the float driving into the water when the machine alights, and also to keep the nose of the float well out of the water when the machine is at rest on the water, it is desirable that the centre of buoyancy of the float, when the longitudinal axis of the machine is horizontal, should be well forward of the position of the centre of gravity of the machine. The total buoyancy of the floats should be almost equal to twice the weight of the fully-loaded machine. Whilst the float is rising from the water the free access of air to the bottom of the step should not be hindered. The tendency to hop—a characteristic of most floats when running along the surface of the water at high speeds and small buoyancy—is due to the inherent instability of a machine partly supported on a small area. Any tendency to dip the nose of the float under water, when the machine is travelling at high speeds, may be minimised by a low position of the line of the propeller thrust. Floats must be sufficiently strong to resist the severe wave blows experienced during an enforced alighting on a rough sea. The bow of a float, where great buoyancy is required, should not be too narrow, otherwise when alighting the required “pick up” off the water is not

attained. If bows of the floats are too bluff, the machine has to traverse a long distance on the water before the planing speed is reached. Long and narrow floats with flared sides at the step are very serviceable upon a rough sea. To enable the float to obtain a greater lift, by a partial utilisation of the energy of the bow waves, concave mudguards are fitted from the bow to the bottom of the step. The mudguards also favour the admittance of air to the bottom of the step. Seaworthiness may be increased with a sacrifice of "getting off" efficiency by transverse rounding of the bottom of the float. A low position of the C.G. of the machine is in favour of good floating stability, but may have a disturbing influence upon the behaviour of the machine in flight. A low position of the

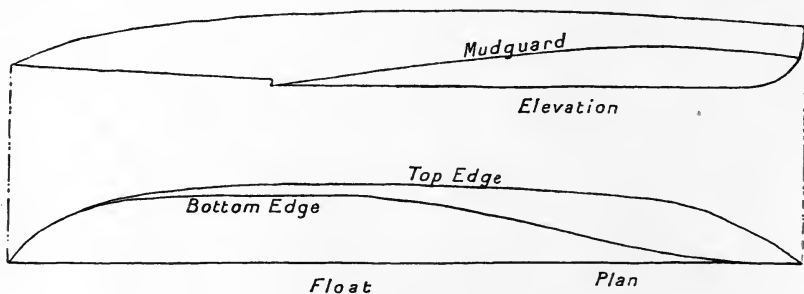

FIG. 15.

wings enhances the possibility of damage by a rough sea. A sketch of a good float is shown in fig. 15.

It is thought that descriptions of one or two of the modern machines may be of some interest to the reader. Technical details of construction are omitted, so that the descriptions are necessarily of a brief character.

THE BRISTOL 80 H.P. TRACTOR BIPLANE (TWO-SEATER)

(see fig. 16).

Weight, light = 440 kilos = 970 lbs.

Range of flight = 5 hours.

Speed = 120 to 56 kms. per hour = 75 to 35 miles per hour.

Useful weight carried, including pilot and passenger (160 kilos), with petrol and oil (155 kilos)—Total = 315 kilos = 695 lbs.

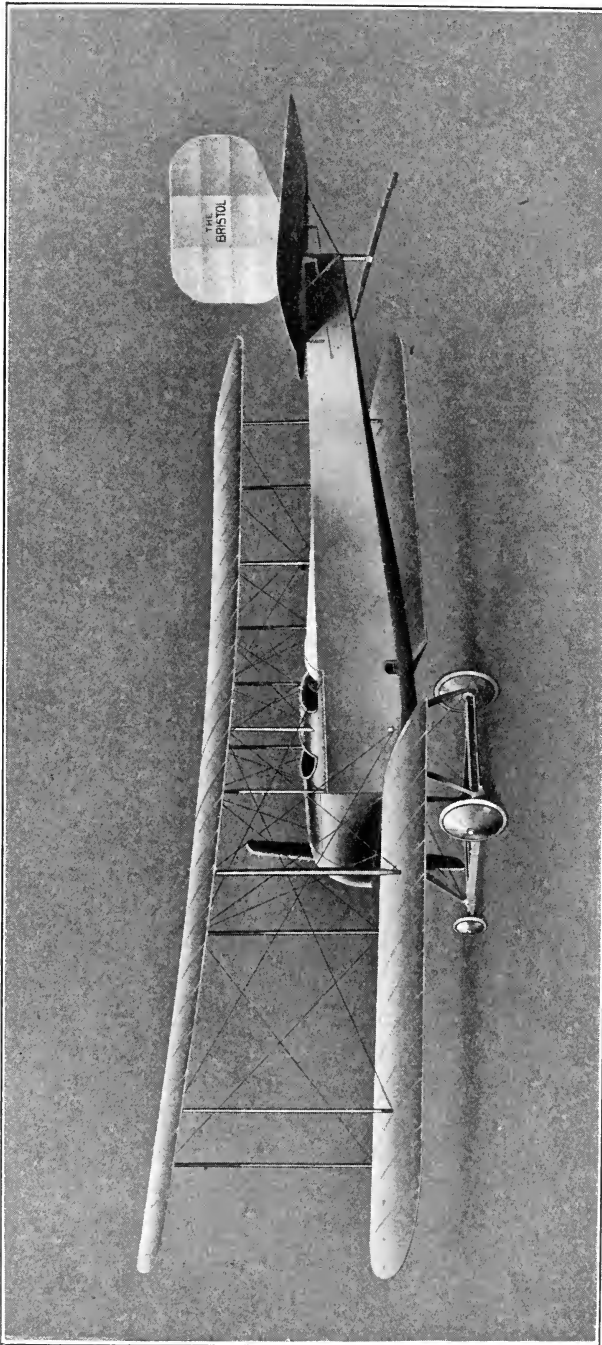

FIG. 16.—Bristol 80 H.P. two-seater biplane.

Dimensions :—

Length over all	= 8·9 metres = 29·2 feet.
Span	= 11·5 metres = 37·8 feet.
Chord	= 1·85 metres = 6·1 feet.
Total area	= 39 square metres = 362 square feet.

Fuselage.—The fuselage is of a special design adapted to offer a minimum resistance at the flying speed of the machine. It is flat-sided in section in order to provide the vertical surface necessary for directional stability, and is built up of longitudinal members of ash with cross members and struts of spruce, which are connected by steel joints and strongly braced with steel piano-wire.

Wings.—The wings are exceptionally light and strong. Special compression ribs are provided for the internal bracing of the wings. The upper and lower wings are separated by twelve struts of stream-line section, braced together with stranded steel cable.

Engine.—An 80 H.P. Gnome engine (Monosoupape type) is mounted in front of the fuselage. To prevent any oil being thrown back on the pilot, the engine is entirely enclosed in an aluminium shield. The propeller boss is so designed that it is the forward continuation of the lines of the aluminium shield, so that the head resistance is thereby greatly diminished.

The seats for the pilot and passenger are in tandem, the passenger, in front, being situated directly over the centre of gravity of the machine, which arrangement enables the machine to be flown either with or without a passenger. The suspension of the seat allows the height and the angle to be adjustable.

Wind Shield.—The top of the fuselage is covered in by a curved sheet of three-ply wood, designed to deflect the air upwards from the passenger's face. The fuselage is covered with fabric which is laced on, and which can be easily removed.

Tail and Empennage.—The empennage, which has a non-lifting plane as a directive organ, ensures the longitudinal stability of the machine. The plane is arranged at a negative angle and placed midway between the upper and lower surfaces of the fuselage. The levers for the elevator and rudder are of the best-quality steel.

Landing Chassis.—The chassis is of the combined skid and wheel type, in which the skids are connected to the fuselage by stream-line struts of very ample dimensions, with pin joints to give the whole structure more flexibility. At the forward end, the skids carry two small wheels journalled on one axle, sprung with rubber cord. They form therefore a resilient member to counteract any tendency of the machine to tip forward, and also to effectively protect the propeller on uneven ground. The machine runs upon a pair of wheels, 66 cms. in diameter, which have wide hubs and stout gauge spokes. The wheels are journalled upon a stout tubular axle which is sprung from the skids by rubber cord. The tail is protected by a tail skid.

Control Gear.—The main control of the machine consists of a hand-wheel mounted on a vertical lever. The longitudinal movement controls the tail plane, and a rotation of the wheel actuates the warping of the wings by means of wires passing round suitably arranged pulleys. The rudder is operated by foot-levers. All the moving parts of the control are of brass or other non-magnetic material, and all the control wires are duplicated.

The coverings of the wings, tail, rudder, and fuselage are treated with dope, which gives them a smooth taut surface. Upon the instrument board are usually fitted an air-speed indicator, altimeter, engine tachometer, inclinometer, watch, trip watch, petrol gauge, and communicator between pilot and passenger. Fig. 17 is an illustration of a "Bristol" 80 H.P. "Scout."

THE SOPWITH BAT-BOAT.

This machine, a photograph of which is shown in fig. 18, is a particular type of hydro-aeroplane, the pilot and passenger sitting in the boat.

Weight, light	=2200 lbs.
Useful load	=1000 lbs.
Maximum speed	=70 miles per hour.
Minimum speed	=40 miles per hour.

Dimensions :—

Span of upper wing	=54 feet.
Span of the lower wing	=44·5 feet.
Chord of the wings	=6·75 feet.
Total area of the wings	=600 square feet.

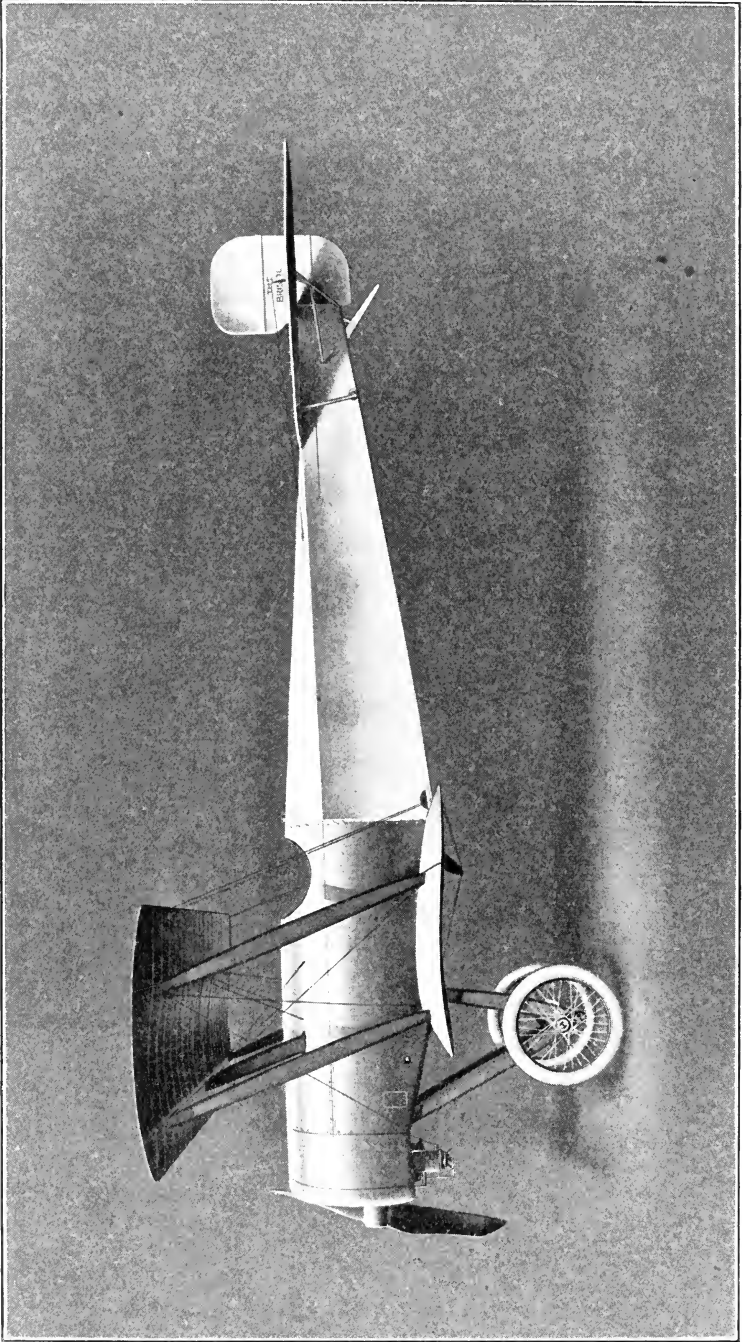

FIG. 17.—Bristol 80 H.P. single-seater "Scout" biplane.

The main wing spars are made of spruce. The fuselage is made chiefly of mahogany. The pilot's and passenger's seats are arranged side by side in the roomy cockpit of the boat. The machine is driven by a 200 H.P. Canton-Unné engine. The main petrol tank has a capacity sufficient for four and a half hours' flight, and is situated in the boat behind the occupants. Petrol is forced from this tank to a smaller service tank between the engine and the radiator, whence it is fed by gravity to the engine. Two compressed air self-starters are carried



FIG. 18.

under the seats, so that the engine may be started by the pilot without the necessity of swinging the propeller.

The four tail booms and their struts are made of spruce. The rudder is of the balanced type, and, to allow sufficient rudder movement, the elevator is divided. The lower wings have a well-pronounced dihedral angle which allows the machine to roll considerably on the water. Floats at the wing-tips are also fitted. The boat is built up of two skins of mahogany over ash stringers. It is of the single-stepped type, and air is admitted to the bottom of the step by sheet-brass channels screwed to the sides of the boat. A wheel mounted on a single tube controls the aileron and elevator movements, whilst the rudder is actuated by a pivoted foot-lever. A complete set of

instruments is mounted on the instrument board in front of the pilot, and a wireless set driven by a motor-cycle engine is mounted in front of the passenger's seat.

SOPWITH 100 H.P. TRACTOR HYDRO-AEROPLANE
(see *fig. 19*).

The floats of this machine are of the single-step type. The float has five watertight compartments, each fitted with a neat

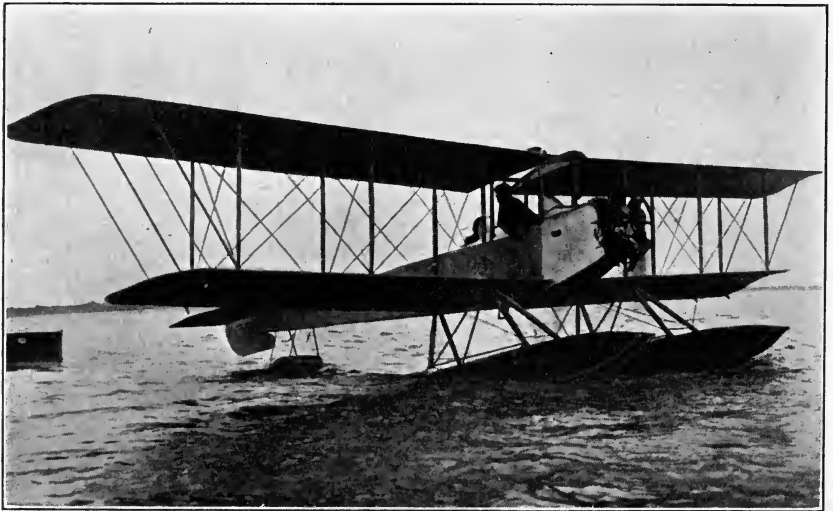

FIG. 19.—Sopwith 100 H.P. tractor hydro-aeroplane.

inspection door. The doors are screwed down on rubber seatings with butterfly nuts, thus ensuring a watertight joint. A 100 H.P. Anzani engine is mounted on this machine.

80 H.P. AVRO BIPLANE (see *fig. 20*).

The main planes are staggered, giving the pilot an extremely good view forward and downward. The fuselage is made narrow for the same reason. The engine is carried on fore-and-aft bearings, but at the same time a well-rounded streamline nose is obtained, which gives the machine an exceptionally clean appearance. The chassis is extremely light, but at the

same time strong, and the machine starts from, or lands on, rough ploughed ground in an easy manner. The centre skid is placed well forward, and thus protects the propeller and minimises the possibility of the machine turning over during alighting. When an 80 H.P. Gnome Monosoupape engine is mounted, the maximum speed may be about 90 miles an hour. A machine of this type has climbed at the rate of 550 feet per minute, when carrying a three hours' fuel supply and a passenger.



FIG. 20.—Avro biplane (1914 type).

THE "AVRO" HYDRO-AEROPLANE.

A 100 H.P. "Avro" hydro-aeroplane is illustrated in fig. 21.

The good characteristics of the "Avro" hydro-aeroplane are:—

(a) The floats are mounted well forward, so that the tendency of the machine to overturn on alighting is reduced. The machine is easily manageable on the water in a wind, as the tail float rests on the water and a water rudder is provided.

(b) The main floats are sprung internally by rubber cord suspension, giving a very large range of action and a certain amount of "give," both laterally and longitudinally.

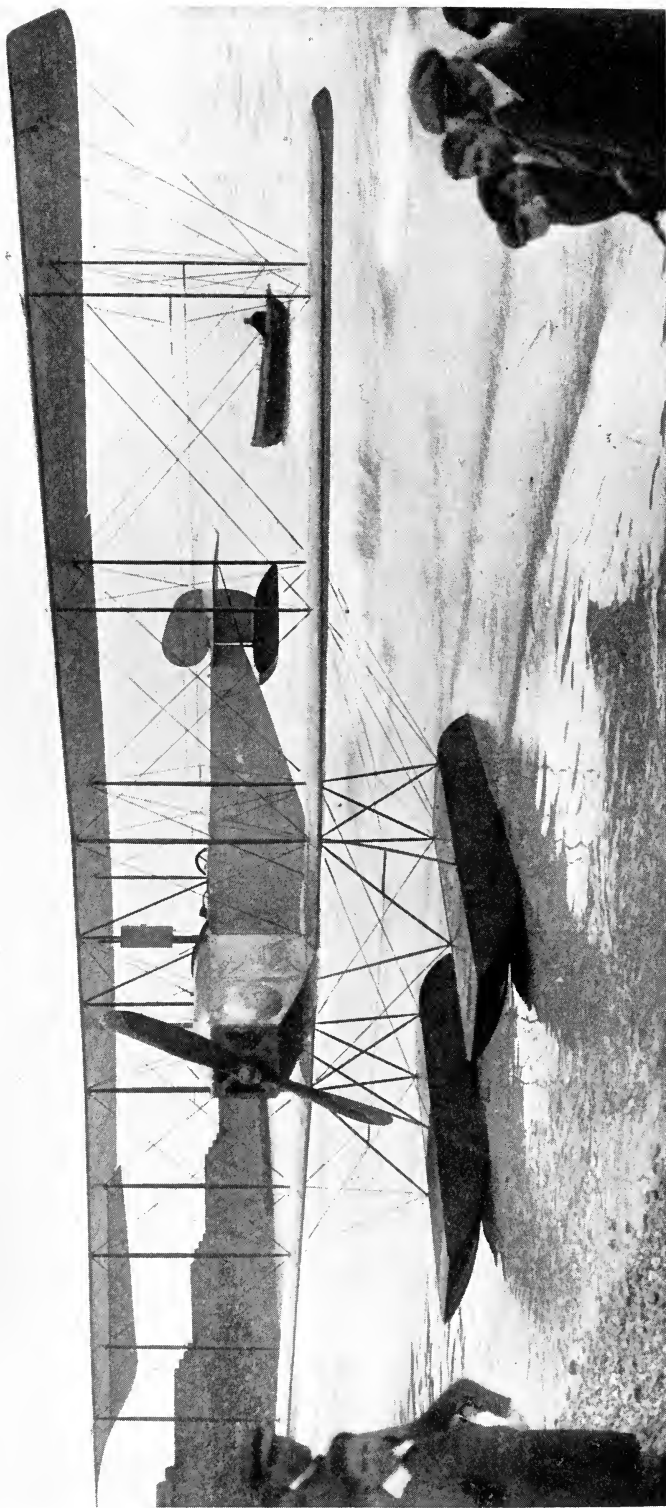

FIG. 21.—100 H.P. "Avro" waterplane.

(c) The engine is fitted up with a crank starting gear, enabling it to be started by the observer.

(d) The passenger and pilot are well protected from the weather, and they have an exceptionally easy means of egress and access. The engine is very neatly mounted, and shielded to offer the minimum of head resistance.

(e) The bottom wings are made shorter than the top wings in order to give an uninterrupted air space and a greater water clearance laterally. The ailerons on the top plane are very large, giving a powerful lateral control.

(f) The floats are very durable, and are rendered absolutely watertight by a covering of stout rubber-proofed cloth.

THE BLÉRIOT SINGLE-SEATER MONOPLANE.

Span of the wings = 29.3 feet.

Area of the wings = 194 square feet.

Weight, light = 618 lbs.

Useful load = 309 lbs.

The main spars are made of ash. The fuselage is constructed of ash and spruce, and the landing gear of ash and steel. Lateral control is obtained by warping the wings. An 80 H.P., seven-cylinder, Gnome engine is carried. The propeller, of the Integral type, is mounted in front of the machine.

NIEUPORT SINGLE-SEATER MONOPLANE (*see figs. 22 and 23*).

Span of the wings = 29 feet.

Chord of the wings = 6 feet.

Area of the wings = 155.5 square feet.

Maximum speed = 84 miles per hour.

Weight, light = 595 lbs.

Useful load = 352 lbs.

The main spars are made of steel. The fuselage is constructed of ash and spruce, and the landing gear of steel. A 60 H.P. Le Rhône engine is mounted in front of the pilot. The propeller is of the Régy type.



FIG. 22.—Nieuport single-seater monoplane.



FIG. 23.—Nieuport.

VICKERS TWO-SEATER BIPLANE.

Span of the upper wing	=38 feet.
Span of the lower wing	=38 feet.
Area of wings	=400 square feet.
Maximum speed	=70 miles per hour.
Minimum speed	=40 miles per hour.
Weight, light	=850 lbs.
Useful load	=850 lbs.

The main spars are made of steel. The fuselage and landing gear are also constructed of steel. Lateral control is by the aileron system. A 100 H.P. Gnome engine, with nine cylinders, is mounted at the rear of the pilot.

THE "WIGHT" HYDRO-AEROPLANE.

A two-seater machine built by Samuel White of Cowes, Isle of Wight.

Span of the upper wing	=63 feet.
Span of the lower wing	=59 feet.
Chord	=6.5 feet.
Gap	=5.6 feet.
Area of the wings	=735 square feet.
Weight, light	=2600 lbs.
Useful load	=900 lbs.
Maximum speed	=72 miles per hour.
Minimum speed	=35 miles per hour.

The main spars are made of spruce. The fuselage and landing gear are also constructed of spruce. Lateral control by the aileron system. The machine is driven by a 200 H.P. Canton-Unné engine mounted at the rear of the pilot. A doubled cambered wing section is an interesting feature of this machine. The two main floats are unusually long and are provided with three steps. These floats are built up of three-ply wood on a strong framework of elm. Each float is divided into six watertight compartments, and the whole is strengthened by a longitudinal partition extending throughout the length.

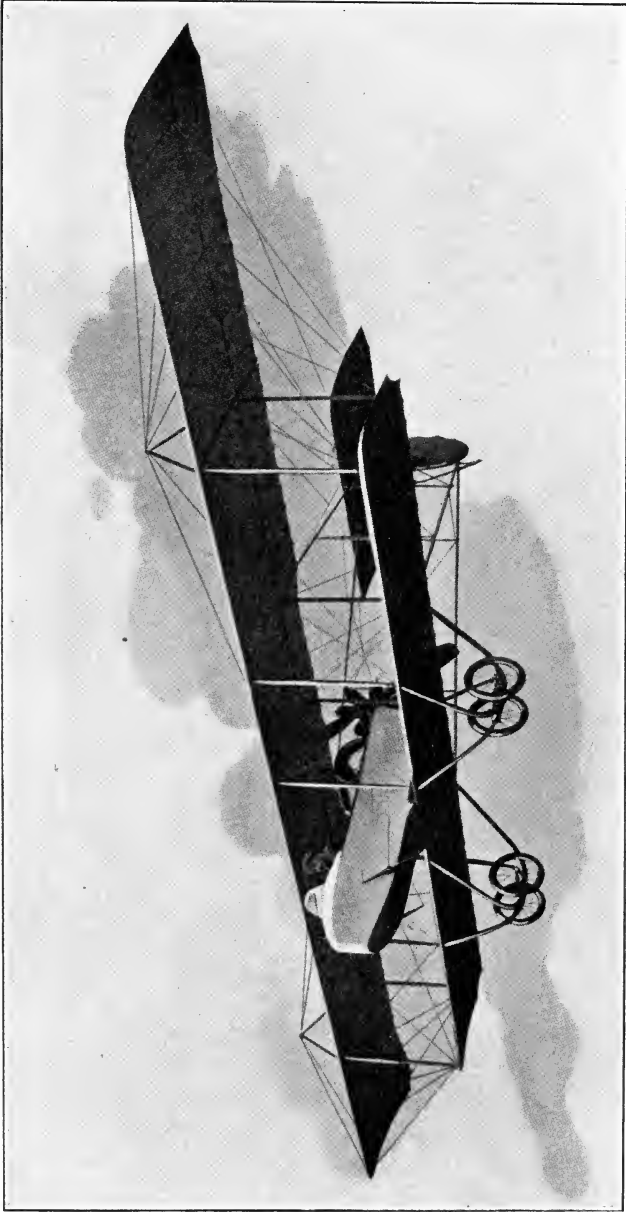

FIG. 24.—Henri Farman.

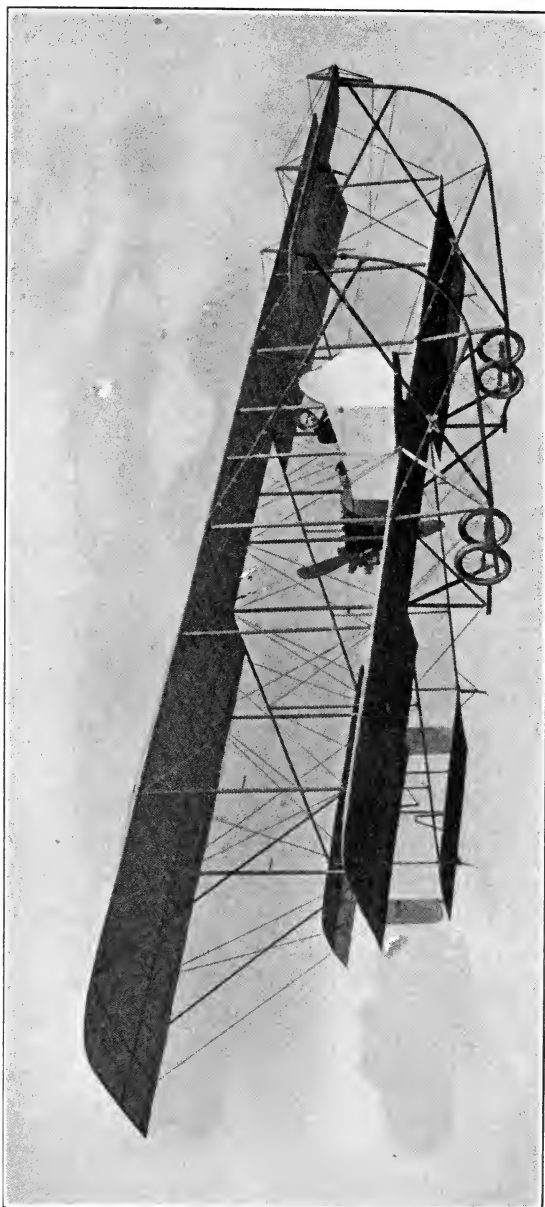

FIG. 25.—Maurice Farman.

THE FARMAN TWO-SEATER BIPLANE (*fig. 24*).

Span of the upper wing	= 50.8 feet.
Span of the lower wing	= 32.8 feet.
Area of wings	= 560 square feet.
Weight of the machine, light	= 1320 lbs.
Useful load	= 660 lbs.

The main wing spars and the fuselage are made of spruce, and the landing gear is constructed of ash and steel. The lateral control is by the aileron system. The machine is driven by a 70 H.P. Renault engine mounted at the rear of the pilot. An automatic machine-gun may be mounted at the forward end of the nacelle—that is, just in front of the passenger's seat, the pilot occupying the rear seat.

THE GRAHAME-WHITE TWO-SEATER BIPLANE.

Span of the upper wing	= 37 feet.
Span of the lower wing	= 35 feet.
Chord	= 5 feet.
Gap	= 6 feet.
Area of the upper wing	= 183 square feet.
Area of the lower wing	= 175 square feet.
Weight of the machine, light	= 1000 lbs.
Useful load	= 550 lbs.
Maximum speed	= 80 miles per hour.
Minimum speed	= 42 miles per hour.

The main wing spars are made of spruce, and the fuselage is constructed of ash, hickory, and spruce. The landing gear is of steel. Lateral control by the aileron system. A 100 H.P. Gnome engine is mounted at the rear of the pilot. The tanks have a capacity of 45 gallons of petrol and 9 gallons of lubricating oil—that is, sufficient for a flight of about five hours' duration.

CHAPTER V.

THE EQUILIBRIUM OF AN AEROPLANE.

Horizontal Flight.—An aeroplane in ordinary linear flight—that is, a horizontal, a gliding, or a climbing flight—is symmetrical about a vertical plane passing through the longitudinal axis, so that we need only consider its longitudinal equilibrium. If the planes of a machine are fixed relatively to each other, flight is only possible at one particular angle of incidence of the wings. To enable a machine to adopt several flying positions, an elevator—a movable plane capable of rotation about an axis perpendicular to the plane of symmetry—is fitted. In the following discussion we shall assume, and quite rightly, that the position of the centre of gravity of a machine is unaffected by the elevator position. The main functions of the tail are (*a*) to control the attitude, and (*b*) to damp out longitudinal oscillations. It is assumed that in normal flight the tail does not contribute to the total lift of the machine.

The following nomenclature is adopted throughout this chapter :—

W =weight of the machine.

A =area of the wings.

α =angle of incidence of the wings.

L =lift of the machine—that is, the air force acting on the machine in a direction normal to the wind direction, and to the plane of the wing.

D =drag of the machine—that is, the air force acting on the machine in the direction of the wind.

H =propeller thrust, or the tractor pull.

K_α =lift coefficient of the machine, when the wings have an angle of incidence α .

k_α =drag coefficient of the machine, when the wings have an angle of incidence α .

U = speed of the machine in the direction of the longitudinal axis.

R = total air force acting on the machine. The propeller thrust is, of course, an air force, although we shall take R to be exclusive of the propeller thrust. Hence R is the resultant of L and D .

Equilibrium Conditions of a Machine in Horizontal Flight.—

(1) W , H , L , and D are in equilibrium. Hence, if the propeller thrust acts in the direction of flight, the condition (1) may be rewritten as :—

(a) Lift of the wings, L = weight of the machine, W ,
and $\therefore W = L = K_a AU^2$.

(b) Drag of the machine, D = propeller thrust, H ,
and $\therefore H = D = k_a AU^2$.

(c) The algebraic sum of the moments of W , H , L , and D about the centre of gravity of the machine is zero.

Considering equation (a), if the angle of incidence α be constant, then K_a will also be constant, and since A and W are constants of the machine, the speed of the machine in horizontal flight will be constant for a particular value of α . The speed of a machine in horizontal flight only depends, then, upon the angle of incidence of the wings—that is, upon the position of the elevator. To alter the horizontal flight speed of a machine, an alteration of the propeller thrust must be accompanied by a change in the angle of incidence of the wings.

Briefly, in any one machine, the speed of horizontal flight, the propeller thrust, and, consequently, the engine-power, are dependent wholly upon the angle of incidence of the wings.

The drag or total resistance of a machine may be regarded conveniently as composed of—

(a) The resistance of the wings.

(b) The sum of the resistances of the remaining portions of the machine, which we shall call the body resistance.

Unless otherwise stated, we are to assume that the forces L , D , R , and H are measured in pounds, the area A in square feet, the velocity U in miles per hour, and K_a and k_a , the lift and drag coefficients, are measured in the corresponding units. Hence, $L = K_a AU^2$ lbs., and $D = k_a AU^2$ lbs.

It is occasionally convenient, especially for the purposes of comparison, that the lift and drag coefficients should have absolute values, in which case we write the lift $L = K_a^1 \rho A U^2$ and the drag $D = k_a^1 \rho A U^2$, where ρ is the density of the air. K_a^1 and k_a^1 are absolute coefficients—that is, their values are independent of the system of units employed, so long as the units are themselves dynamically consistent. Thus, if we use the foot-pound-second system, and the velocity is in feet per second, then the area should be in square feet, and the density should be in pounds per cubic foot, and the force is then in poundals. Similarly, if we use the centimetre-gramme-second system and the velocity is in centimetres per second, the area should be in square centimetres, and the density in grammes per cubic centimetre, and the force is then in dynes.

The following example may illustrate the preceding discussion. An aeroplane travels at 60 miles per hour, and has a wing area of 250 square feet. If the angle of incidence is 5° , and the *absolute* coefficient of lift at this angle is $\cdot 31$, what is the lift on the wings?

The lift $L = K_a^1 \rho A U^2$.

We are given $K_a^1 = 0\cdot 31$, $A = 250$ square feet, $U = 88$ feet per second, and $\rho = 0\cdot 076$ lb. per cubic foot.

Hence, lift $= \cdot 31 \times 0\cdot 076 \times 250 \times (88)^2$ poundals

$$= \frac{\cdot 31 \times 0\cdot 076 \times 250 \times (88)^2}{32\cdot 2} \text{ lbs.} = 1425 \text{ lbs.}$$

The value of K_a may easily be found from K_a^1 . From the above, lift $= K_a A U^2 = K_a \times 250 \times (60)^2$ pounds. But the lift is also equal to $K_a^1 \times 0\cdot 00236 \times 250 \times (88)^2$ pounds.

$$\begin{aligned} \text{and} \quad \therefore K_a &= K_a^1 \times 0\cdot 00236 \times \left(\frac{88}{60}\right)^2 = 0\cdot 00510 K_a^1 \\ &= 0\cdot 00510 \times 31 = 0\cdot 00158. \end{aligned}$$

“Performance” Curves.—Most of the curves of fig. 26 were obtained experimentally at the Royal Aircraft Factory, and they have been taken from the *Report of the Advisory Committee for Aeronautics* (1912–13).

Curve 1 of fig. 26 gives the relation between the wing resistance, angle of incidence, and the speed in horizontal flight of a constant-weight machine. The weight of this particular

machine is 1650 lbs., and the area of its wing surface 372 square feet. From the curve it is seen that when the speed of the machine is 60 miles per hour, the wings have a resistance of 97 lbs. and an angle of incidence of slightly less than 4° .

Now, the drag D_w of the wings may be written in the form $D_w = ({}_1k_a) \cdot A \cdot U^2$, and therefore

$$({}_1k_a) = \frac{97}{372 \times (60)^2} = 0.000072 \quad (\alpha = 4^\circ \text{ approximately}).$$

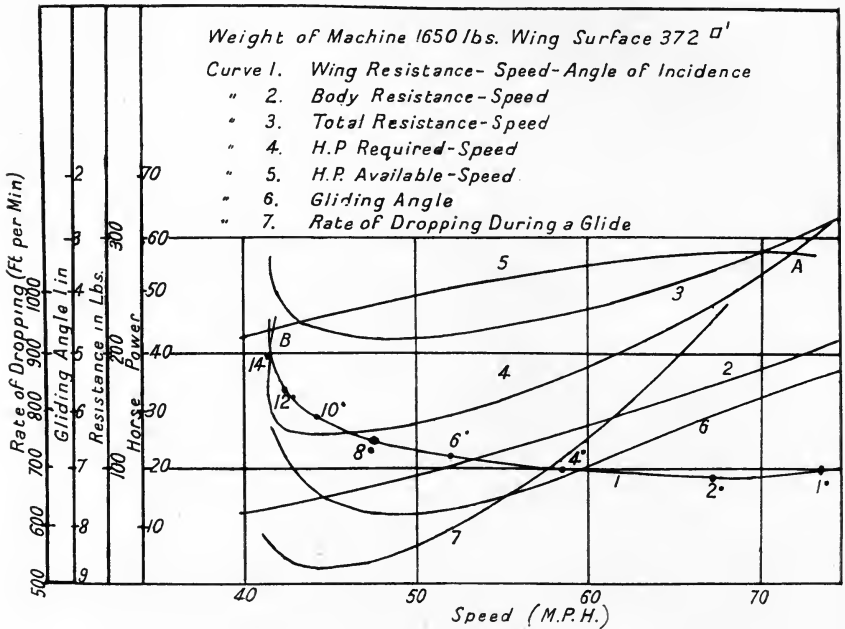

FIG 26.

Also, if the machine be supported entirely by the lift on the wings,

$$W = K_a A U^2, \text{ and therefore}$$

$$K_a = \frac{1650}{372 \times (60)^2} = 0.00123 \quad (\alpha = 4^\circ \text{ approximately}).$$

Since $D_w = \left(\frac{{}_1k_a}{K_a}\right) W$, the resistance of the wings is a minimum at the angle of incidence which makes $\left(\frac{K_a}{{}_1k_a}\right)$ a maximum. From curve 2 we see that the body resistance R_b is practically

proportional to the square of the speed. The body resistance at 60 miles per hour is 137 lbs., and consequently, if we assume the body-resistance law to be $R_b = cU^2$, the value of the constant c is equal to $\frac{137}{(60)^2}$, that is, 0.038. The body resistance may be materially diminished by the adoption, where possible, of stream-line forms and also by the elimination of unnecessary wires, etc.

The following comparisons of two similar machines—that is, machines built to the same drawing but to different linear scales—are instructive :—

Case I.—Assumption $\left\{ \begin{array}{l} \text{Linear scale of machine A} = 2 \text{ linear} \\ \text{scale of machine B.} \\ \text{Weight of A} = \text{weight of B.} \end{array} \right.$

Then, at similar horizontal flying attitude—

Speed of B is double the speed of A.

Thrust of B is equal to the thrust of A.

Power of engine B is double the power of engine A.

Case II.—Assumption $\left\{ \begin{array}{l} \text{Linear scale of A} = \text{linear scale} \\ \text{of B.} \\ \text{Weight of A} = 4 \text{ weight of B.} \end{array} \right.$

Then, at a similar horizontal flying attitude—

Speed of A is double speed of B.

Thrust of A is four times thrust of B.

Power of engine A is eight times the power of engine B.

A few remarks on the stresses in similar machines may not be out of place. Stresses in like parts of similar machines vary as the linear dimensions when such stresses are entirely dependent on the dead-weight of the machine, and from this point of view the smaller machine is the stronger. The stresses in similar *wings* due to equal loading at similar points are proportional to the reciprocal of the square of the linear dimension. Generally speaking, the smaller machine is the stronger.

The speed of a machine in horizontal flight may be increased (a) by decreasing the wing area, the other factors—such as the weight of the machine, the angle of incidence of the wings, etc.—remaining constant ; (b) by increasing the weight of the machine, the other factors, with the exception of the propeller thrust,

remaining constant. The first method is to be preferred, and nearly all the modern high-speed monoplanes have small wing areas.

From the data of curve 3 of fig. 26—that is, the curve of total resistance—we may calculate the “horse-power required” curve. Thus the total resistance of the machine at 60 miles per hour is 235 lbs., so that the horse-power required will be

$$\frac{235 \times 88 \times 60}{33,000} = 37.6.$$

The high speed of horizontal flight, which occurs at a small angle of incidence of the wings of a constant-weight machine, is only attained if the engine run at a high power, see curve 4, fig. 26. Moreover, a small angle of incidence is not to be encouraged, as should such a machine be struck by a downward vertical gust, the relative wind may strike the wings upon the upper surface.

From curve 4 we see that the smallest horse-power is required at a speed of 44.5 miles per hour, and then the angle of incidence is 10° . What may be occasionally required is the most economical speed for a journey of a certain distance, see fig. 27. Let us assume that the machine is carrying a Chenu engine, in which the fuel consumption per horse-power hour has the constant value of .54 lbs., and that the machine carries such a large supply of fuel that the consumption of a portion of this fuel will not appreciably affect the weight of the machine. The fuel-consumption-speed curve has been constructed for a distance of 200 miles. The distance taken does not affect the shape of the curve.

From curve 4, fig. 26, it is seen that when the machine travels at 60 miles per hour the horse-power required is 37.6. Also, the time taken to perform the journey is $\frac{200}{60}$ hours, so that the fuel consumption is $\frac{200}{60} \times 37.6 \times .54 = 67.5$ lbs. In this way the curve of figure 27 has been constructed, from which it follows that with this engine the total fuel consumption, over any distance, is a minimum when the aeroplane has a speed of 50 miles per hour approximately.

The following curve, fig. 27, cannot be exceptionally accurate,

because the weight of the machine is not constant during a flight ; and, further, the fuel consumption per horse-power hour is not a constant but a function of the horse-power.

Generally speaking, a high velocity consistent with safety is desirable, and the greatest speed attainable in horizontal flight is the speed beyond which a diminution in the angle of incidence becomes dangerous. To facilitate starting and climbing, the horse-power of an engine is greater than the power necessary to

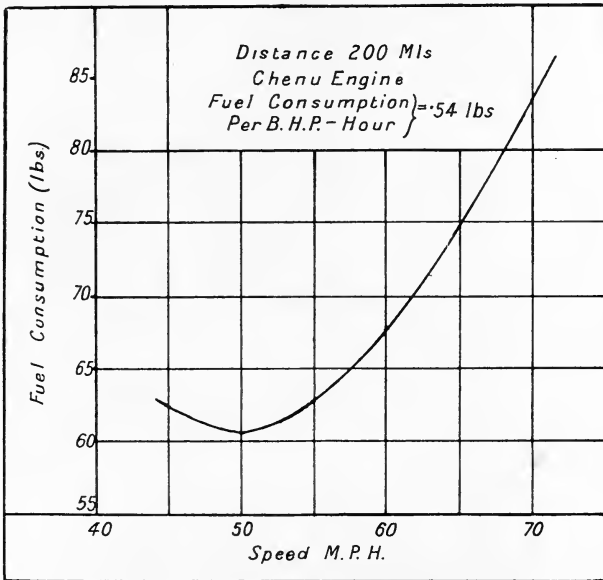

FIG. 27.

maintain the normal speeds of horizontal flight, so that in horizontal flight the engine is eased down.

It is desirable that the normal speed of the engine should approximate to the value designated by the engine designer as the best. Theoretically, the maximum efficiency of the propeller and its gearing should be given at the normal speed of the engine. Usually, however, the propeller runs at a rotational speed greater than that corresponding to its maximum efficiency. Curve 4, the "horse-power required" curve, and curve 5 (fig. 26), the "horse-power available" curve, cut at two points A and B: so that when the engine is running all out, horizontal flight may be maintained at two different

angles of incidence and the two different corresponding translational speeds. If an aviator desire horizontal flight at full engine-power, he would prefer the upper speed limit A—that is, if the angle of incidence corresponding to the upper speed is well within the safety limit. From curve 4 we see that horizontal flight at the various speeds ranging from 72 to 42 miles per hour may be obtained by a throttling of the engine, and the necessary adjustment of the elevator position. A vertical distance between the “horse-power available” curve and the “horse-power required” curve gives the horse-power available for climbing at any angle of incidence of the wings.

This particular machine will climb most rapidly when the angle of incidence of the wings is equal to $6\frac{1}{2}^\circ$ approximately. If the machine is flying horizontally with the engine at full power, so that the speed is 72 miles per hour (see point A of curve 4, fig. 26), climbing may be performed by a simple manipulation of the elevator to increase the angle of incidence of the wings. A well-designed machine enables climbing to be performed by the operation of the elevator alone, the power of the engine remaining unaltered. If the horizontal flight speed be less than 72 miles per hour, or greater than 42 miles per hour, the engine has a reserve of power, and occasionally a good reserve of power is necessary to facilitate rapid climbing. Nevertheless a storage of excess engine-power during a horizontal flight entails a burden of excess engine weight.

Inclined Flight.—The steady flight of an aeroplane is said to be inclined when the direction of its forward motion is not horizontal, and the slope of the flight path is measured by the tangent of the angle between the direction of forward motion and the horizontal. Also when an aeroplane is in steady inclined flight, the angle of incidence of a wing is measured by the angle between a chord of the wing and the direction of the relative wind.

When the direction of the propeller thrust passes through the centre of gravity of the machine, the angle of incidence of the wings in an equilibrium position of the machine depends only upon the position of the elevator, and is independent of the magnitude of the propeller thrust.

As before, the *condition of equilibrium* is that the forces acting upon the machine, L, D, W, H, must be in equilibrium,

and this statement includes the fact that the algebraic sum of the moments of these four forces L , D , W , H , about any point, say the centre of gravity of the machine, must be zero.

In the following two sections the equilibrium of a machine during an inclined flight has been considered, firstly, when the propeller thrust passes through the C.G., and secondly, when the propeller thrust does not pass through the C.G. of the machine.

Case I.—When the direction of the propeller thrust passes through the centre of gravity of the machine. Assume the elevator to be locked in position. Now H and W always pass through the centre of gravity of the machine, so that, for equilibrium, R , the resultant of the air forces L and D , must also pass through the centre of gravity (fig. 28). An increase of the value of the propeller thrust does not introduce any

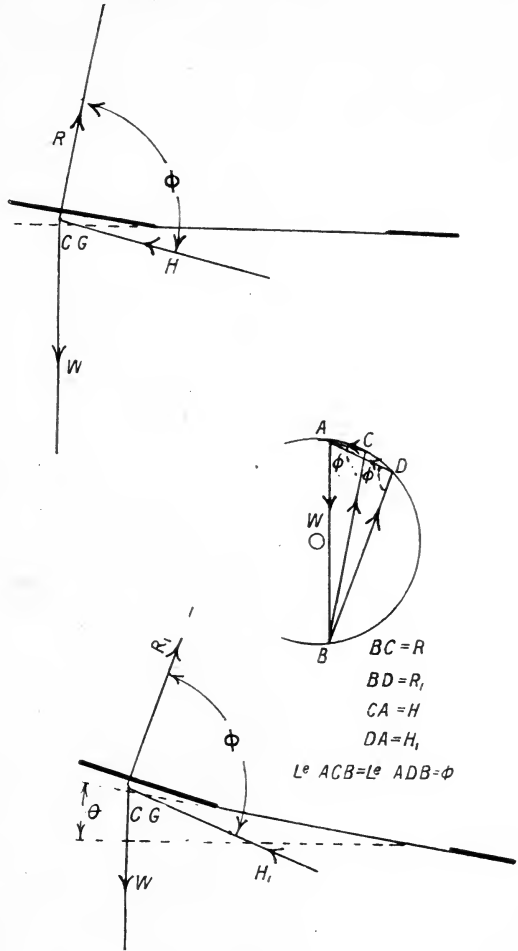

FIG. 28.

moment about the C.G., so that the machine has no tendency to turn about a lateral axis, and hence in an equilibrium position the direction and the point of application of the resultant of the lift and drag forces, both taken relatively to the machine, are constants, and thus the angle of incidence of the wings has also a constant value. The new value of the propeller thrust

H_1 introduces a new air force R_1 , so that H_1 , R_1 , and W are represented in magnitude and direction by the sides of a triangle

taken in order (see fig. 28). It follows, then, that if the elevator position be fixed, variations in the magnitude of the propeller thrust will produce alterations in the slope of the flight path, and different speeds of the machine along the flight path, but no alteration of the angle of incidence of the wings.

Case II.—When the direction of the propeller thrust does not pass through the centre of gravity of the machine. In this case, any alteration of the propeller thrust must be accompanied by a slight alteration of the elevator position, if equilibrium is to be maintained.

Let the fig. 29

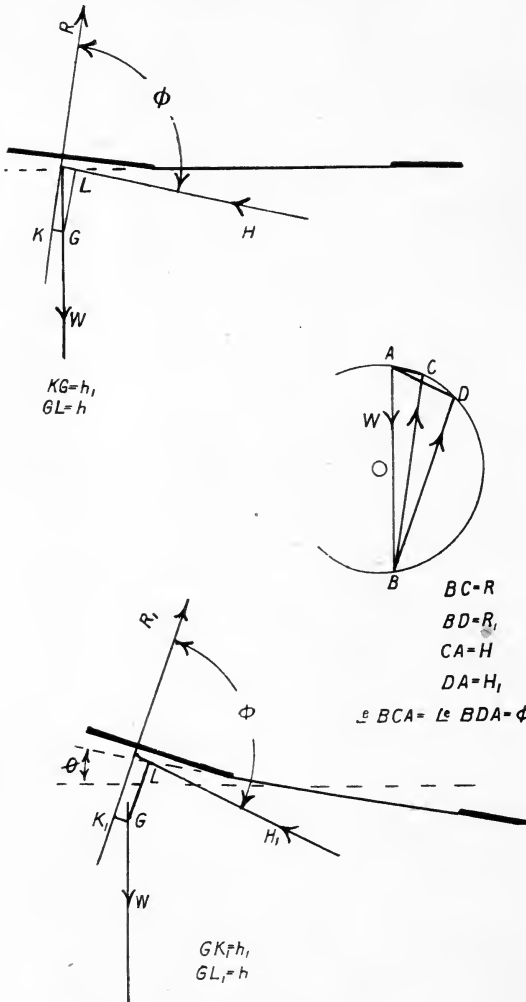

FIG. 29.

represent an equilibrium position, then

(a) R , W , and H may be represented in direction and magnitude by the sides of a triangle taken in order.

(b) $Rh_1 = Hh$; and $\therefore \frac{h}{h_1} = \frac{R}{H}$.

Now imagine the elevator locked in position, and the propeller thrust increased to H_1 . Assume for the new equilibrium position that the angle of incidence of the wings remains constant, and the angle of the flight path has been increased by θ , so that, according to the condition (a), R_1 is the new value of the air force.

Also, condition (b) now gives $H_1 \cdot h = R_1 \times h_1$;

and therefore
$$\frac{R_1}{H_1} = \frac{h}{h_1} = \frac{R}{H},$$

that is
$$\frac{R}{R_1} = \frac{H}{H_1}.$$

Also, since $H_1 > H$, it follows from fig. 29 that $\frac{H_1}{H} > \frac{R_1}{R}$, and therefore $\frac{R}{R_1}$ cannot equal $\frac{H}{H_1}$.

Hence the initial assumption that the angle of incidence of the wings remains constant is proved to be incorrect, and any alteration of propeller thrust must be accompanied by a slight alteration of the elevator position, if the machine is to remain in equilibrium.

It is hardly necessary to add that the flight path of a machine is not necessarily in the same direction as the propeller axis. The magnitude and direction of the minimum propeller thrust necessary to sustain a machine during a horizontal flight may be easily obtained if (a) the point of application of the propeller thrust be at the centre of gravity, (b) the angle of incidence of the wings be constant. Under these circumstances R will have a constant direction relatively to the aeroplane passing through the centre of gravity. In fig. 30 AB represents the weight of the machine,

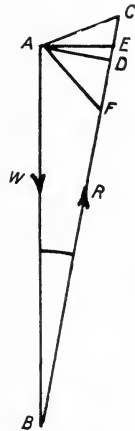

FIG. 30.

and BC the constant direction of R . Obviously the direction and magnitude of the minimum thrust is represented by the line DA , the angle ADB being a right angle. It is usually arranged that the direction of the propeller thrust shall be horizontal when the machine is flying horizontally at its normal speed, and in this attitude of the machine the direction of

R does not greatly deviate from the vertical, so that the thrust employed, AE, is not much greater than the minimum thrust AD. If the angle DAB be equal to zero, the forward speed of the machine will be zero, so that equilibrium is only possible when the propeller, which now operates as a helicopter, supports the weight of the machine.

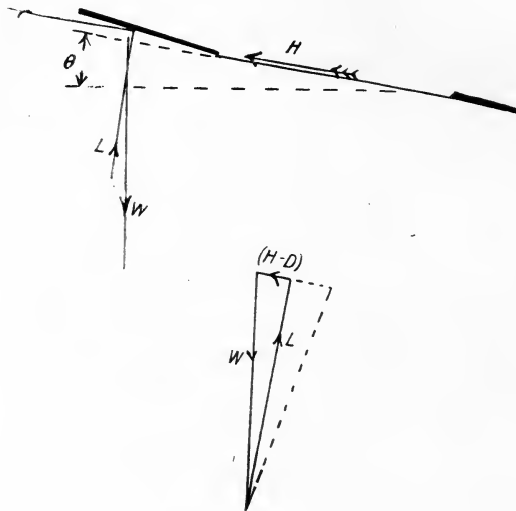

FIG. 31.

Assuming the propeller thrust to act parallel to the longitudinal axis of the machine, it is seen easily from fig. 31 that

- (a) For a climb θ is positive, and $\therefore H > D$.
- (b) Horizontal flight $\theta = 0$, and $\therefore H = D$.
- (c) For a fall θ is negative, and $\therefore H < D$.
- (d) For a glide $H = 0$ and $\therefore \theta = \tan^{-1}\left(\frac{D}{L}\right)$.

Gliding Flight.—If the engine of an aeroplane suddenly stop, the machine will commence to glide, and the slope of the glide path will be $\left(\frac{D}{L}\right)$. Hence the gliding angle has its minimum value at the angle of incidence which makes the ratio $\frac{D}{L}$ for the machine a minimum; or, in other words, the angle of incidence corresponding to the minimum drag of horizontal flight. The

same gliding path may be followed at two different angles of incidence, the two speeds of the machine corresponding to these angles. This statement is a corollary of a previous statement that, if the propeller thrust be constant, horizontal flight may be maintained at two definite angles of incidence, the machine having the corresponding speeds. At any angle of incidence, the gliding angle is the ratio of the total resistance of the machine in horizontal flight to the weight of the machine. According to the curve 3 (fig. 26), when the angle of incidence of the wings is equal to 6° , the total resistance of the machine in horizontal flight is 215 lbs. This machine would therefore have a gliding angle of $\frac{215}{1650}$, that is, 1 in 7.7, at the same angle of incidence of the wings. As the gliding angle of a modern machine is small, the gliding speed is not greatly different from the speed of horizontal flight, the angle of incidence of the wings remaining unaltered.

Thus

Let U_H = speed of the machine in horizontal flight.

U_G = speed of the machine in gliding flight.

θ = angle of glide.

K_α = lift coefficient at the angle of incidence α .

$$\text{In horizontal flight } W = L = K_\alpha A U_H^2 \quad . \quad . \quad (1)$$

$$\text{In gliding flight } W \cos \theta = L_1 = K_\alpha A U_G^2 \quad . \quad . \quad (2)$$

And \therefore from equations (1) and (2)

$$\cos \theta = \left(\frac{U_G}{U_H} \right)^2 .$$

When the gliding angle is equal to $\tan^{-1} \left(\frac{1}{7.7} \right)$,

$$U_H = 52 \text{ miles per hour.}$$

And $U_G = .99 U_H,$

so that $U_G = .99 \times 52 = 51.5 \text{ miles per hour.}$

Curve 6 (fig. 26) gives the relation between the angle of gliding, the speed of gliding, and the angle of incidence of the wings, and it is seen that a small diminution in the value of a small angle of incidence is sufficient to cause the flight path to approach the vertical rapidly. A high-speed machine in which the wings have a small area, and also a small angle of incidence,

has a strong tendency to dive with a diminution of the angle of incidence. If the propeller axis of such a high-speed machine be below the centre of gravity, a sudden stoppage of the engine is accompanied by an automatic decrease of the angle of incidence of the wings, the unfavourable condition for a rapid steep dive.

Consider A and B to be two exactly similar machines which are equal in all respects. If B be now more heavily loaded, by placing a weight at its centre of gravity, then the gliding slopes of both machines are still the same, but the machine B will glide at a greater speed than A. The distance fallen in one second depends upon the angle of gliding and the speed of gliding, and thus the angle of incidence which gives the minimum gliding angle may not give the minimum rate of falling. Curve 7 (fig. 26) may easily be constructed. Thus, when the angle of incidence of the wings is equal to 6° the gliding angle is 1 in 7.7, and the speed of gliding is 4590 feet per minute, so that the distance fallen in one minute is 596 feet. The fall per minute is a minimum when the angle of incidence is equal to 10° approximately, and the corresponding speed is 44.5 miles per hour.

Climbing.—When a machine climbs with uniform velocity, H, D, L, and W are in equilibrium.

That this is so may be readily seen from work considerations.

Adopting the usual notation (see fig. 31), let the machine have a uniform velocity of U feet per second.

Hence,

Work done by the engine in unit time = HU foot-lbs.

Work done against gravity in unit time = $U \sin \theta \cdot W$ foot-lbs.

Work done against wind resistance in
unit time = $U \cdot D$ foot-lbs.

And $\therefore H \cdot U = U \cdot \sin \theta \cdot W + U \cdot D$,
and $H = W \sin \theta + D$ (1)

Furthermore, the lift L does no work, because the velocity of the machine in the direction of L is zero. The lift L merely supports $W \cos \theta$ the component of the weight,

and $\therefore W \cos \theta = L$ (2)

Equations (1) and (2) are the equilibrium equations when the forces are resolved along, and perpendicular to the direction of the wind. If U_c be the uniform speed of climbing a slope of inclination θ , and U_H be the horizontal speed corresponding to the same setting of the elevator, then $U_c = U_H \sqrt{\cos \theta}$, and as the value of θ is fairly small, U_c is not greatly different from U_H . A glance at curves 4 and 5 of fig. 26 shows that the aviator may alter the angle of the climbing path by operating the elevator. Thus if the engine is running all out, and the machine is in horizontal flight at the angle of incidence given by the point A, the machine will climb if the angle of incidence be increased, although the engine-power remains constant. The machine climbs most rapidly when the angle of incidence of the wings is equal to $6\frac{1}{2}^\circ$, so that an increase of an angle of incidence which has a greater value than $6\frac{1}{2}^\circ$ will cause the machine to climb more slowly. The maximum limit of the angle of incidence should be that corresponding to the maximum rate of climbing.

Starting.—Initially the elevator is placed in a position which corresponds to a small angle of incidence of the wings, and also small head resistance. When the machine has a sufficiently great ground speed, the pilot adjusts his elevator so that the wings may have a large angle of incidence. The machine now rises, and with the disappearance of the ground friction, coupled with the fact that the wings have a large angle of incidence and that the engine is working at full power, the machine continues to ascend. When a sufficient altitude has been reached, the elevator is adjusted to give the correct angle of incidence for horizontal flight, usually an operation of skill. Obviously, starting and also alighting are most efficiently performed in a head wind.

Alighting.—Firstly, the rate of falling of the machine must be reduced to a minimum. When the engine is running, the descent is easily regulated by a combined use of the elevator and throttle. When the engine is out of action, the angle of incidence of the wings should give the gliding angle which corresponds to the minimum rate of falling.

When the machine is approaching the ground the aviator adjusts either the elevator or the engine, or both, according to his particular fancy, so as to flatten out the flight path.

The ground speed of the machine is gradually diminished by the ground friction of the wheels and skids, and may be further checked by an increase of the angle of incidence of the wings.

Turning.—It is of the greatest importance to realise that the action of the rudder is only effective when the machine has an adequate keelplate. The term “keelplate” includes all the portions of the machine which are capable of offering resistance to lateral motion. Thus, wings which have a dihedral angle assist the keelplate action. To the first order of approximation a turn of the rudder of an aeroplane which has

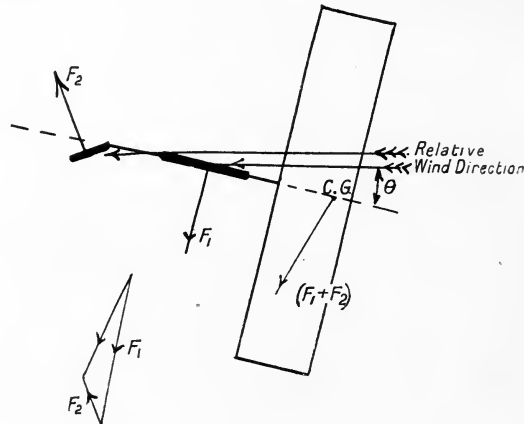

FIG. 32.

no keelplate—an imaginary aeroplane of course—would result in an equal deflection of the longitudinal axis of the machine, with no appreciable alteration in the direction of motion of the centre of gravity of the machine. Briefly, the rudder action on such a machine would be primarily a turning action, and secondarily, a side-slip. A deflection of the rudder of an aeroplane introduces a force at the centre of gravity of the machine, which tends to damp out the original motion. We shall now consider how the keelplate of an up-to-date machine facilitates turning. Fig. 32 represents the forces acting on the machine when the turning action has just commenced, so that the rudder action has had sufficient time to rotate the machine through a small angle about a normal axis. When the rotation of the machine about its normal axis is com-

pleted the algebraic sum of the moments of the two forces F_1 and F_2 about the centre of gravity is equal to zero, and we are left with a force (F_1+F_2) acting at the centre of gravity. This force curves the trajectory of the centre of gravity until the centrifugal force thus introduced just balances the centripetal force. Obviously the greater (F_1+F_2) , the smaller is the radius of the turn. Ordinarily, the area of the keelplate is large, and its centre of pressure is fairly close to the centre of gravity of the machine, whilst a rudder of small area is placed a long distance from the centre of gravity. If the centre of pressure of the keelplate area coincide with the centre of gravity of the machine, then at the commencement of the turn the angle between the relative wind direction and the longitudinal axis of the machine will be theoretically equal to the angle through which the rudder has been turned. The component of the force (F_1+F_2) , which acts in the direction of the longitudinal axis, increases the head resistance, and hence the machine will drop unless the angle of incidence of the wings is increased by the operation of the elevator. It is apparent that any tendency to drop is minimised by the use of a high keelplate: the component of (F_1+F_2) along the longitudinal axis is then above the centre of gravity and its moment increases the angle of incidence of the wings. The above discussion, although interesting and instructive, is not wholly applicable to modern machines. Moreover, a good many machines which have small keelplate areas are not entirely dependent upon the action of the rudder to enable them to turn.

Generally, when a machine turns, the outside wing, which moves at a greater speed than the inside one, rises relatively to the latter, and the machine heels over or banks. The lift component of the air force acting on the wings has now a lateral component which must be added to the centripetal force due to the keelplate action. Furthermore, the increased drift of the outside wing has a tendency to turn the machine in the opposite direction, and such an antagonistic tendency can only be balanced by a suitable manipulation of the rudder. If the machine has an appreciable bank, the vertical component of the lift will be less than the weight. Also when the rudder is deflected for a turn the longitudinal component

of $(F_1 + F_2)$ increases the drag. To counteract the disastrous consequences of the reduced lift and increased drag, the elevator and engine are adjusted, prior to a turning manœuvre, to the conditions which, under ordinary circumstances, would favour

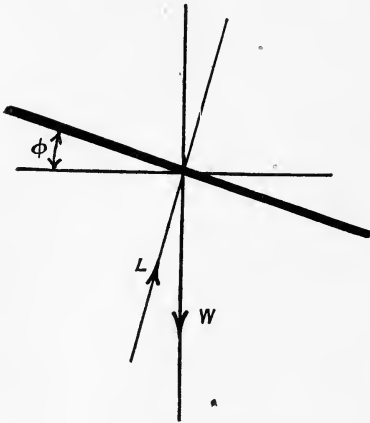

FIG. 33.

climbing. Turning at a small elevation, unless skilfully performed, is a dangerous operation. At the commencement of this article we ignored the rolling action due to the difference between the relative wind speeds of the wings, and it is now of theoretical interest to consider the banking angle of a machine which has no keelplate.

We shall adopt the bold assumption that the machine turns without dropping. Then, if the turning speed U be uniform, and the angle of bank, ϕ , a constant, we have, if r be the radius of the turn (see fig. 33),

$$L \cos \phi = W \quad . \quad . \quad . \quad (1)$$

$$L \sin \phi = \frac{WU^2}{rg} \quad . \quad . \quad . \quad (2)$$

And $\therefore \tan \phi = \frac{U^2}{rg}$; if ϕ be small, $\phi = \frac{U^2}{rg}$.

To keep this theoretical angle of bank within reasonable limits, it is desirable that the turning speed of the machine shall not be too great. Owing to the keelplate action of a well-constructed machine the angle of bank is much less than $\left(\frac{U^2}{rg}\right)$.

The gyroscopic action of the propeller has also to be considered during turning operations. Thus, imagine an aeroplane to be driven by a left-handed tractor, then the gyroscopic action of the propeller during a left-handed turn will cause the machine to dive. Similarly, a right-handed turn of this machine will increase the angle of incidence of the wings.

Motion of a Hydro-Aeroplane on the Water.—At any time

during the motion of the machine on the surface, the forces acting are shown in fig. 34, where

W = weight of the machine.

H = propeller thrust.

L = lift on the wings.

D = drag of the machine (including air resistance of the floats).

B = buoyancy of the floats.

F = water resistance of the floats.

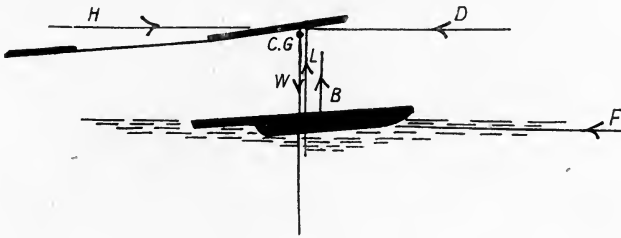

FIG. 34.

The curves of fig. 35 are taken from *The Report of the Advisory Committee for Aeronautics, 1912-13*.

The dependence of the water resistance F of the float upon the area of the wetted surface, and the square of the speed through the water, clearly accounts for the well-defined shape of curve 3.

The Behaviour of an Aeroplane in a Regular Wind.—We shall assume that for any arbitrarily fixed position of the controls, and any arbitrarily fixed value of the propeller thrust, an aeroplane is in stable flight and moving with a velocity U through still air. Now, imagine the dead calm of the atmosphere to be instantaneously converted into a regular wind of velocity u (U and u are not necessarily horizontal). Then, if the position of the controls and the value of the propeller thrust have remained unaltered, the aeroplane, after some time, will be in the same flying configuration, relatively to the air, as formerly, so that the new velocity of the machine relatively to the ground is $(U+u)$. An illustration may further enlighten the reader. Imagine a portion of the atmosphere to be enclosed in an exceedingly large railway carriage. Then once the carriage has attained a uniform velocity, the bodies in and the air of the compartment are not acted upon by any force due to the

movement of the carriage, so that a man in the compartment regards the air of the compartment as stationary. An aeroplane flying in the compartment would appear to the man to be manœuvring in a dead-calm air. A spectator outside the compartment knows that the compartment, man, and the aeroplane have the additional velocity of the train; and, furthermore, he regards the air of the compartment as a wind

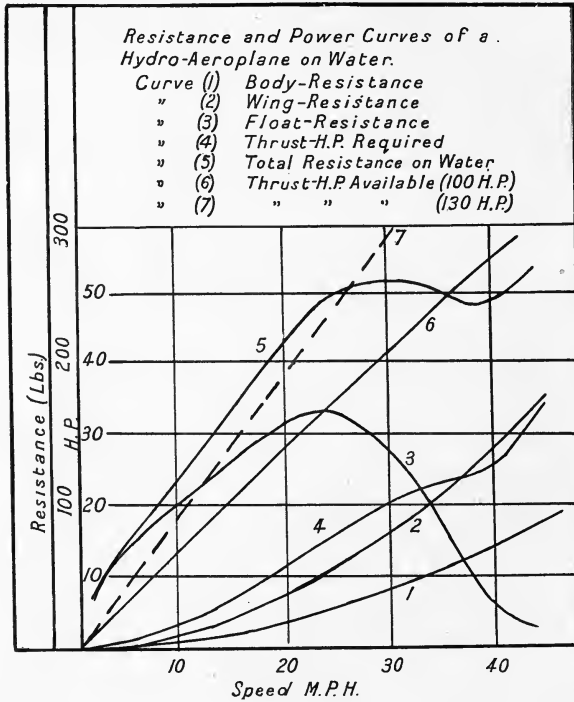

FIG. 35.

of uniform velocity. The velocity of the aeroplane to the spectator standing by the track (that is, its velocity relatively to the earth) will be different from the apparent velocity to the man in the compartment—or, in other words, the velocity of the machine relatively to the air in the compartment—by the velocity of the train.

Hence to an observer on the earth, the gliding angle of a machine in a horizontal following wind will appear to be less than the gliding angle of the same machine in a horizontal head wind.

CHAPTER VI.

STABILITY OF AN AEROPLANE.

Introduction.—At present but little is known of the stability of an aeroplane, and in view of the extreme difficulty of the subject, which necessitates a limited number of investigators, rapid progress in the future is not to be expected. Mathematical ability coupled with a sound engineering experience must be the equipment of one who wishes to further develop the present knowledge of aeroplane stability. The successful designer of the future will be able to predict the probable behaviour of his machine, no matter in what adverse circumstances the machine may be placed.

F. W. Lanchester, one of the pioneers of aeronautical research, has done a great deal of useful stability work, although he was undoubtedly handicapped by the lack of experimental evidence and the general apathy of the scientific world towards the study of aeronautics. Later much excellent work has been done by Bryan, Crocco, Ferber, Bairstow, and others. Bairstow, who has had the advantages of aeronautical research work at the National Physical Laboratory, has written many admirable papers upon the mathematics of stability. The author has endeavoured to present the subject in the light of the teaching of Bairstow, although the present chapter can only be regarded as an introduction, so that the student who desires a deeper study should turn to the original papers.

Definition of Stability.—Bairstow has proposed the following definition of a stable machine :—

“A stable machine is one which from any position in the air into which it may have got, either as a result of gusts or the pilot’s use of controls, shall recover its correct flying position and speed when the pilot leaves the machine to choose its own

course, with free or fixed controls, according to the character of the stability."

The definition presumes a sufficient height above the ground to enable the machine to perform the necessary righting manœuvres. In view of the possible action of gusts when the machine is near the ground, it would appear that a slightly stable machine, which can only right itself by virtue of a great fall, is not all that is desirable. In such a case the pilot would need to operate the controls, so that a combination of the skill of the pilot and the stability characteristics of the machine would secure safety in quite a limited range of action. It is the general impression that the pilot's final corrective manœuvres may be occasionally necessary even if the machine be itself inherently stable. The degree of stability of a machine is dependent, more or less, upon the presence of the desirable aerodynamic qualities which are conducive to the safety of the machine. The relative importance of these "desirable" characteristics will be greatly influenced by the weather conditions, and the various complications of aeroplane manœuvres. The ideal machine enables all safety manœuvres to be successfully performed in an "air-worthy" manner, irrespective of the vagaries of the weather. If a stable aeroplane be moving in a uniform manner relatively to the air, and, as a result of a small external temporary disturbance—say, a gust—the machine is made to adopt a new configuration relatively to the air, then the forces and reactions acting upon the machine will tend to restore the original motion. In an unstable machine the new external forces would introduce other forces which encourage a further departure from the initial flying conditions. A machine which has no tendency to return to its original condition, or depart from its slightly displaced new condition, is said to be neutral.

A machine which possesses small instability continually tends to depart from its normal flying condition, the continual application of correcting manœuvres entailing a great strain upon the pilot.

An inherent characteristic of a stable machine is the maintenance of speed, although a sufficient height of the machine above the ground is required. A machine which is over-stable is insensitive to control, and is difficult to manage in gusty weather in consequence of the tendency of the machine to lie

in the direction of the relative wind—that is, to adopt an altered attitude relatively to the earth with each new direction of the relative wind. Hence a stable machine turns into the relative wind, and such good “weathercock” stability is only obtained when the longitudinal position of the centre of gravity is well forward of the longitudinal position of the centre of pressure of the machine, when the longitudinal axis of the machine faces down the wind. To prevent discomfort to the pilot, weathercock or directive stability should not be too pronounced.

A machine which possesses good inherent stability does not encourage the development of large oscillations, as the damping forces become more effective with large and rapid oscillations. Moreover, inherent stability is attained without the aid of any moving parts and depends upon the correct size and position of the several fins and surfaces. The resistances offered by the wings, keelplate, tail, rudder, and fins of a stable machine readily damp out any oscillations. Great inherent stability is not desirable in gusty weather, the big initial disturbances imposing great discomfort upon the pilot.

Automatic Stability.—The automatic devices are only called into play after the oscillations have started, and there is a lag between the cause and the corrective action, so that “hunting” of the machine may be a disastrous consequence. Although automatic stability may be a great aid to the pilot, it should not be regarded as a substitute for inherent stability. It would appear that “automatic controllability” would be a more appropriate term than “automatic stability.” Automatic devices should be capable of being rapidly thrown out of action to enable the pilot to perform easily extreme manœuvres.

A serviceable machine for gusty weather should have a small stability factor, with good damping and small restoring couple, so that the pilot can effect a ready recovery after the action of a gust. If the periodic disturbances due to wind gusts synchronise with the periods of the machine, big, and maybe dangerous, oscillations may be set up.

Dynamical stability is dependent upon all the forces acting upon a moving body, whereas statical stability is only concerned with the forces acting upon a stationary body. Generally, the motion of an aeroplane may be considered to be one main translational velocity upon which is superposed small trans-

lational and angular velocities. A machine, when slightly displaced from its normal flying position, oscillates, and hence, if the general direction of the wind remain unaltered, each portion

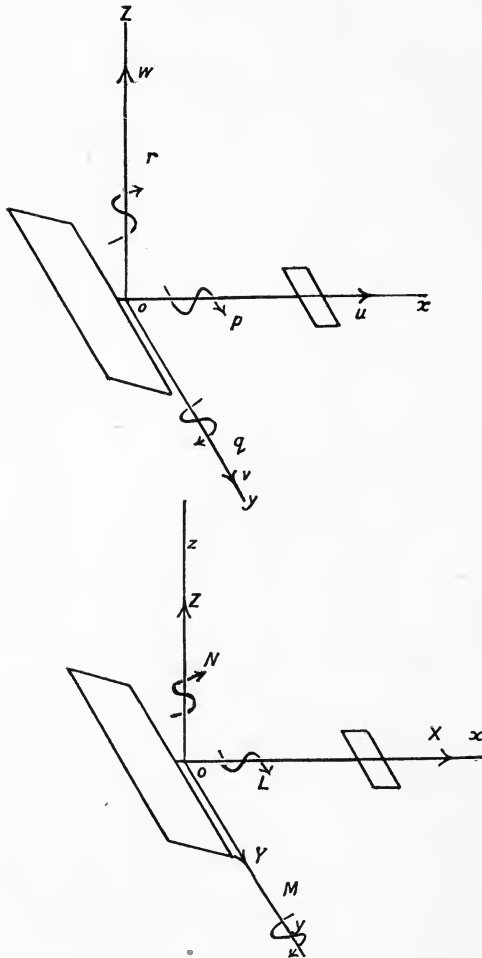

FIG. 36.

of the machine will have a new velocity relatively to the air. The forces acting on the machine at any instant are thus a function of the motion of the machine, so that when speaking of the stability of an aeroplane we mean dynamical stability. It is possible for a body which is statically stable to be dynamically unstable. Thus, the well-known experiment of producing unstable oscillations in a pendulum by the action of a succession of small impulses of the same period as the natural period of the pendulum is a case of dynamical instability. Nevertheless, a pendulum is always statically stable.

Before proceeding with a study of longitudinal and lateral stability, it may be advisable to define the various oscillations common to an aeroplane. Fig. 36 gives a sketch of the three principal axes OX, OY, and OZ, of an aeroplane. These axes, at right angles to each other, pass through the centre of gravity of the machine, and are fixed in the machine.

of the machine will have a new velocity relatively to the air. The forces acting on the machine at any instant are thus a function of the motion of the machine, so that when speaking of the stability of an aeroplane we mean dynamical stability. It is possible for a body which is statically stable to be dynamically unstable. Thus, the well-known experiment of producing unstable oscillations in a pendulum by the action of a succession of small impulses of the same period as the natural period of the pendulum is a case of dynamical instability. Nevertheless, a pendulum is always statically stable.

Before proceeding with a study of longitudinal and lateral stability, it may be advisable to define the various oscillations common to an aeroplane.

The following nomenclature has been adopted at the National Physical Laboratory :—

TABLE III.

Axis.	Name of Axis.	Translational Velocity along Axis.	Rotational Velocity about Axis.	Name of Force Acting along the Axis.	Symbol of Force.	Name of Motion which takes place about Axis.	Symbol for Angle of Rotation.	Name of Moment about Axis.	Symbol of Moment.
<i>x</i>	Longitudinal	<i>u</i>	<i>p</i>	Longitudinal	X	Rolling	ϕ	Rolling	L
<i>y</i>	Lateral	<i>v</i>	<i>q</i>	Lateral	Y	Pitching	θ	Pitching	M
<i>z</i>	Normal	<i>w</i>	<i>r</i>	Normal	Z	Yawing	ψ	Yawing	N

The air forces X, Y, and Z, and the air moments L, M, and N are functions of $p, q, r, u, v, w, \theta, \phi, \psi$. The rigid mathematical discussion of the stability of an aeroplane is one of great difficulty, as the general equations of motion for oscillations about a state of steady motion give rise to a linear differential equation of the eighth order. If the steady motion does not involve rotation, the equation may be split into two fourth order linear differential equations, one equation dealing with symmetrical or longitudinal oscillation, and the second equation with asymmetrical or lateral oscillation. It is not intended to enter upon a mathematical discussion of stability, and only the general results of the mathematics are touched upon.

Longitudinal Stability.—We are here concerned with displacements and oscillations in the plane XOZ. It has been fairly well established that longitudinal stability is only possible when the wings and the tail of the machine form an upward dihedral angle or V. The longitudinal stability depends chiefly upon the position and size of the tail, and in the normal equilibrium position the wings have a much greater loading per square foot than the tail. In most machines any lowering of the position of the centre of gravity does not appear to have much effect upon the longitudinal stability of the machine. We have already seen that in addition to the static righting moment which acts upon a stable machine by virtue of a new disturbed position, there is, in addition, a dynamic righting moment due to the oscillatory motion. The longitudinal oscillations are damped out by the dynamic action of the tail,

and it is of importance that the area of the tail, the distance of its centre of pressure from the centre of gravity of the machine, and the moment of inertia of the machine about the lateral axis should be suitably chosen.

Some notion of the behaviour of the dynamic righting forces upon the longitudinal stability of a machine may be gleaned from the following discussion, and the non-mathematical student should endeavour to understand these pages.

The three motions which primarily affect the longitudinal stability of a machine are (1) an alteration of the longitudinal velocity U along OX , (2) an introduction of a normal velocity w along OZ , (3) an introduction of an angular velocity q about OY . An alteration in any or all of these three motions will affect the values of (a) the longitudinal air force X , (b) the normal air force Z , (c) the pitching moment M .

In the following investigation, the machine is assumed to have each of the above motions separately, and the approximate effects upon X , Z , and M have been calculated. Furthermore, the calculations indicate the behaviour of gusts, since the imparting of any velocity to a machine has practically the same action as would be obtained by allowing a gust of equal and opposite velocity to impinge upon the machine.

Assume initially that the machine is moving in horizontal flight, with a velocity $-U_0$. The minus sign is used because of the direction of the X axis (see fig. 36).

For convenience, we shall write $-U_0 = U$.

Since the machine is in steady horizontal flight,

$$v=0, w=0, p=0, q=0, r=0, L=0, M=0, N=0, Y=0.$$

In longitudinal stability we are only concerned with the changes in X , Z , and M by changes in the values of u , v , q . A suffix 0 indicates initial conditions.

Then we may write

$$Z_0 = \text{lift} = K_1 \cdot A \cdot U^2 \alpha_0 = -W,$$

where

A = area of the wings,

α = angle of incidence,

K_1 is a constant.

Also

$$X_0 = \text{drag} = k_1 \cdot A \cdot \alpha_0 \cdot U^2,$$

where

k_1 is a constant.

Case I.—To find the alterations in the values of X , Z , and M , if the forward velocity U be increased to $(U+u)$, where u is small. The new value of Z is

$$\begin{aligned} K_1 \cdot A \cdot \alpha_0 (U+u)^2 &= K_1 \cdot A \cdot U^2 \cdot \alpha_0 \left[1 + \frac{2u}{U} \right] \\ &= Z_0 \left[1 + \frac{2u}{U} \right]. \end{aligned}$$

And \therefore increase in the value of Z is equal to $\frac{2u}{U} Z_0$.

Similarly, the increase in the value of X is equal to $\frac{2u}{U} X_0$.

U has a value ranging from 50 feet per second to 150 feet per second. Moreover, since the ratio of X_0 to Z_0 gives the gliding angle for a particular angle of incidence (about one-sixth), the increases in Z and X may be found when the constants of the machine are known.

As the direction of the wind undergoes no change, the pitching moment M will remain zero.

Case II.—To find the alterations in the values of X , Z , and M if a small normal velocity w be imparted to the machine. A small upward velocity w reduces the angle of incidence of the wings by

$$\tan^{-1} \left(\frac{w}{U} \right), \text{ that is } \left(\frac{w}{U} \right) \text{ since } w \text{ is small.}$$

The new value of the drag is

$$\begin{aligned} X &= k_1 A (U^2 + w^2) \left(\alpha_0 - \frac{w}{U} \right) \\ &= k_1 A U^2 \alpha_0 - k_1 A U^2 \frac{w}{U}. \end{aligned}$$

And \therefore increase in the value of the drag is equal to $-k_1 A U^2 \frac{w}{U}$,

that is $-\frac{X_0}{\alpha_0} \frac{w}{U}$.

Similarly, the value of the lift is

$$\begin{aligned} Z &= K_1 \cdot A \cdot [U^2 + w^2] \left[\alpha_0 - \frac{w}{U} \right] \\ &= K_1 A U^2 \alpha_0 - K_1 \cdot A \cdot U^2 \frac{w}{U}. \end{aligned}$$

And \therefore increase in the value of the lift is equal to $-\frac{Z_0}{a_0} \frac{w}{U}$.

In modern machines the value of a_0 ranges from $\frac{1}{7}$ to $\frac{1}{20}$ rads.

The pitching moment M chiefly depends upon the elevator and tail planes, although the pitching moment due to movement of the centre of pressure of the wings and fin action of the body has also to be considered. High-speed machines, which probably have a small angle of incidence of the wings, have very large tails to counterbalance any pitching moment due to pitching introduced by the displacement of the centre of pressure of the wings. Usually the area of the tail is about one-tenth the area of the wings, and with such an aeroplane the pitching moment due to the wings is small compared with that due to the tail.

Assume the pitching moment due to the wings to be zero.

The normal force acting upon the tail is equal to $\left[-K_1 \cdot \frac{A}{10} \cdot \frac{w}{U} \cdot U^2\right]$, that is $\frac{-Z_0 \cdot w}{10 \cdot U \cdot a_0}$ approximately.

The leverage d of this force from the C.G. of the machine may be assumed to be 15 feet approximately.

Thus, the increase in the value of

$$M = \frac{+Z_0 \cdot w \cdot 15}{10 \cdot U \cdot a_0}.$$

During a *vol-piqué* the angle of incidence of the wings is small, and even a small variation in such a small angle would appreciably affect the position of the centre of pressure of the wings, so that a slight modification of the above discussion may be necessary.

Case III.—To find the alterations in the values of X , Z , and M if a small angular velocity q be imparted to the machine. The variation in the value of Z is chiefly produced by the action of the tail.

As before, $Z_0 = K_1 \cdot a_0 \cdot AU^2$.

The new angle of incidence of the tail = $\frac{q \cdot d}{U}$, where d = dis-

tance of the centre of pressure of the tail from the C.G. of the machine.

Force acting on the tail

$$\begin{aligned} &= \frac{d \cdot q}{U} \cdot K_1 \cdot A_1 (U^2 + l^2 q^2) \quad (\text{where } A_1 = \text{area of tail}) \\ &= \frac{d \cdot q}{10U} \frac{Z_0}{\alpha_0} = \frac{15}{10} \cdot \frac{Z_0 \cdot q}{U \cdot \alpha_0} \end{aligned}$$

And \therefore increase in the value of Z is equal to $\left[\frac{15 \cdot Z_0 \cdot q}{10 \cdot U \cdot \alpha_0} \right]$.

The dependence of X upon a small pitching velocity q is probably very small.

The variation of M depends upon the action of the wings, tail, and the fin area of the body.

As before, the increase of Z due to tail action

$$= \frac{15 \cdot Z_0 \cdot q}{10 \cdot U \cdot \alpha_0}$$

And \therefore increase in M

$$= \frac{-15 \times 15 \cdot Z_0 \cdot q}{10 \cdot U \cdot \alpha_0} = \frac{-22 \cdot 5 \cdot Z_0 \cdot q}{U \cdot \alpha_0}$$

If the movement of the centre of pressure of the wings be large, the increase in M may even be

$$3 \left[-22 \cdot 5 \frac{Z_0 \cdot q}{U \cdot \alpha_0} \right]$$

It is not a difficult matter to design a machine which shall be longitudinally stable. If such a stable machine suffer a slight disturbance whilst it is in flight, the trajectory of its C.G. is a damped oscillatory curve of a slow period, say, 20 seconds.

In addition to this slow-period oscillation there is a much quicker longitudinal oscillation, usually heavily damped, about the lateral axis OY of the machine.

Comparatively slow oscillations may be anticipated by the pilot, and the correct manœuvres performed.

Longitudinal stability also depends upon the inclination of the flight path to the horizontal, and a modern aeroplane is usually more stable when gliding than when climbing.

Also, it is important to realise that longitudinal stability increases with the speed of the machine. Nevertheless, a high speed is not conducive to comfort, unless the machine has been especially designed for speed—that is, the wings should have small area and a normal angle of incidence.

A Gust Problem.—It is a matter of common experience that a pilot of a variable-speed machine prefers to travel at his lowest speed in gusty weather. We have already seen that the increases in X and Z due to a vertical gust are greater by about three to ten times those due to a horizontal gust of the same magnitude. Moreover, a horizontal gust does not alter the value of M .

In a variable-speed machine the lift is a constant, and therefore $U^2 a_0$ is constant approximately where the value of a_0 ranges from $\left(\frac{1}{7} \text{ to } \frac{1}{20}\right)$.

Now, the increases in the values of X , Z , and M , due to a downward vertical gust, vary as $\frac{w}{a_0 U}$, that is, as wU , and hence the effect of a vertical gust increases with the speed of the machine. It is to minimise the effect of vertical gusts that the pilot prefers to travel at his lowest speed. It appears that the velocity of a gust is not a function of its direction.

Longitudinal Instability. — Generally speaking, a machine which is longitudinally unstable will, as the motion proceeds, rise, fall, and pitch with increasing violence.

Longitudinal instability may be divided into three sections: (a) catastrophic instability, (b) rapid oscillations, (c) phugoid oscillations.

(a) *Catastrophic Instability.*—The steady flight of a machine, under certain conditions, may be completely changed by the action of a powerful vertical gust. The pitching moment may be sufficiently great to cause the machine to turn over upon its back, so that the new flight attitude may be upside down. Catastrophic instability is avoided by ensuring that for any position of the controls there shall be only one flying attitude, relatively to the wind, which makes the pitching moment about the centre of gravity of the machine zero.

(b) *Rapid Oscillations.*—It has been shown mathematically

that rapid oscillations are almost entirely dependent upon air forces and couples, and that they are comparatively uninfluenced by gravity. These rapid oscillations very rarely persist, and in some cases give rise to a dead-beat motion.

(c) *Phugoid Oscillations*.—These oscillations are of a comparatively slow period. The amplitude of successive oscillations may be diminished if a sufficiently large tail and elevator are fitted to the machine, whilst the oscillations are increased if the machine has a large moment of inertia and a small tail area.

Lateral Stability.—The study of lateral stability is one of great complexity, and many difficult problems have yet to be solved before a machine possessing lateral stability, or rather, lateral stability of known amount, can be constructed. Lateral stability is chiefly affected by (i.) an introduction of a rolling moment p about the longitudinal axis OX; (ii.) an introduction of a yawing moment r about the normal axis OZ; (iii.) an introduction of a lateral velocity v along OY.

The above motions will produce changes in the values of (a) the lateral force Y, (b) the yawing moment N about the axis OZ, (c) the rolling moment L about the longitudinal axis.

Adopting the same procedure as with longitudinal stability, we shall superpose each of the above motions upon the steady motion of the machine, and note roughly the changes in L, N, and Y. Briefly, a study of the lateral stability of a machine in linear flight is concerned with changes in L, N, Y due to small changes in p , r , and v .

Case I.—Alterations in the Values of Y, L, and N due to a Small Side-Slip of Velocity v .—The value of Y will depend upon the area of the body, rudder, vertical fins, etc., and also upon the dihedral angle of the wings, supposing such to be present.

The total area A, affected by a side-slip, is about 70 square feet.

$$\text{Increase of Y} = -K_1 \cdot A_1 \cdot \frac{v}{U} (U^2 + v^2) = -K_1 \cdot A_1 \cdot v \cdot U.$$

The increase of L depends mainly upon the dihedral angle, and the increased lift on one wing, due to a side wind, is accompanied by a decreased lift on the other wing.

Referring to fig. 37, let

β = half of the dihedral angle.

α_0 = angle of incidence of the wings.

The relative wind now veers through an angle of $\left(\frac{v}{U}\right)$

and

$$\therefore \text{Angle BGC} = \frac{v}{U}.$$

$$\text{Angle AGB} = \alpha_0.$$

$$\text{Angle EAD} = \beta.$$

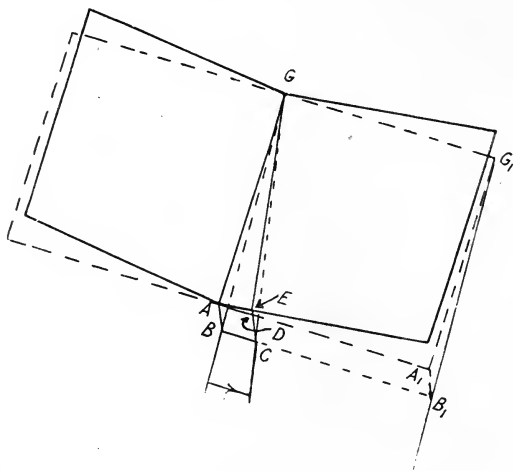

FIG. 37.

Hence the new angle of incidence = angle EGC = $\frac{ED + DC}{GC}$

$$= \frac{AD \cdot \beta + BG \cdot \alpha_0}{BG} = \alpha_0 + \frac{BG \cdot \frac{v}{U} \cdot \beta}{BG} = \alpha_0 + \beta \cdot \frac{v}{U}.$$

Similarly, the angle of incidence of the second wing is equal to $\alpha_0 - \beta \frac{v}{U}$.

Now, as before, the lift = $Z_0 = K_1 \alpha_0 A U^2$,

and \therefore increase of lift on the first wing = $K_1 \cdot \frac{\beta v A U^2}{U} \frac{1}{2} = \frac{Z_0 \cdot \beta \cdot v}{2 \cdot U \cdot \alpha_0}$

while decrease of lift on the second wing = $+\frac{Z_0 \cdot \beta \cdot v}{2 \cdot U \cdot \alpha_0}$.

Hence, rolling moment $L = \frac{Z_0 \cdot \beta \cdot v}{2U \cdot \alpha_0} \times d$ approximately,

where d = length of one wing.

The variation of the yawing moment with a side-slip depends upon the area and position of the centre of pressure of the rudder with respect to the centre of gravity, and is rather difficult to determine.

Case II.—The Variations of L, N, and Y with a Small Rolling Velocity p .—A roll increases the angle of incidence of the falling wing and diminishes the angle of incidence of the rising wing.

Assume that b = breadth of the wings.

Now consider an element of the wing, of area ($b \Delta y$), at a distance y from the longitudinal axis.

Increased lift in the falling element due to a rolling velocity p

$$= K_1 \cdot \frac{py}{U} U^2 (b \, dy).$$

And \therefore the increase of lateral force due to this element

$$= K_1 \frac{py}{U} (b \cdot dy) U^2 \cdot \beta = \frac{Z_0 b \, dy}{\alpha_0 A} \cdot \beta \cdot \frac{py}{U},$$

so that increase of lateral force Y due to the wings

$$= 2 \int \frac{Z_0 b \, dy}{\alpha_0 A} \beta \cdot \frac{py}{U} = \frac{2Z_0 \cdot p \cdot \beta}{\alpha_0 \cdot A \cdot U} \int y \, dy \cdot b = \frac{Z_0 \cdot p \cdot \beta}{\alpha_0 \cdot U} \times \frac{d}{2} \text{ approx.,}$$

since
$$\int y b \, dy = \frac{A}{2} \times \bar{y} = \frac{A}{2} \times \frac{d}{2}.$$

From the previous working it is obvious that the increase of rolling moment

$$\begin{aligned} &= -2 \int \frac{Z_0 (b \, dy) y p \times y}{\alpha_0 \cdot A \cdot U} = \frac{-2Z_0 p}{\alpha_0 U \cdot A} \int y^2 b \, dy \\ &= -\frac{Z_0 \cdot p \cdot d^2}{3 \cdot \alpha_0 U} \text{ approximately,} \end{aligned}$$

since
$$\int y^2 b \, dy = \frac{A}{2} \times \frac{d^2}{3}.$$

We may write $X_0 = k_1 A U^2 \alpha_0$ approximately.

Hence the increased drag in the element ($b \, dy$) of the falling wing

$$= \frac{k_1 \cdot py}{U} (b \cdot dy) U^2 = X_0 \frac{b \cdot dy}{A} \frac{py}{U \alpha_0}.$$

And \therefore increase in the yawing moment due to rolling

$$\begin{aligned} &= 2 \int \frac{X_0 p y b \cdot dy}{A \cdot U \cdot a_0} y = \frac{2 \cdot X_0 p}{A \cdot U \cdot a_0} \int y^2 b dy. \\ &= \frac{X_0 \cdot p}{U \cdot a_0} \times \frac{d^2}{3}. \end{aligned}$$

The rolling of the body and the rudder has a small effect upon the yawing moment.

Case III.—**Variations in Y, L, N due to a Small Yawing Velocity r .**—Working upon the same lines as previously, we have:—

Increase of lift of element $b dy$ of wings due to yawing velocity r

$$= K_1 \cdot a_0 \cdot 2yr \cdot U \cdot b dy = Z_0 \frac{b dy 2yr}{A \cdot U}.$$

Increase of lateral force on element due to yawing velocity r

$$= \frac{Z_0 b dy 2yr}{A \cdot U} \beta.$$

Hence, increase of Y due to wings

$$= -2 \int \frac{Z_0 b dy 2yr}{A \cdot U} \beta = -\frac{4Z_0 \cdot \beta \cdot r}{A \cdot U} \int b dy \cdot y = -\frac{Z_0 \beta \cdot r}{U} \cdot d.$$

The rudder will also influence the value of Y. Stability conditions are not greatly affected by the value of the lateral force due to yawing.

Increase of rolling moment L due to the wings

$$= 2 \int \frac{Z_0 b dy 2yr \times y}{A \cdot U} = \frac{4Z_0 \cdot r}{A \cdot U} \cdot \int y^2 b dy = \frac{2Z_0 r \cdot d^2}{3U}.$$

The yawing moment due to yawing is partly due to the wings, and partly to the action of the body and the rudder.

The part due to the wings is easily seen to be

$$-2 \int \frac{2y^2 \cdot r \cdot X_0}{U \cdot A} \cdot b dy,$$

that is,
$$\frac{-4 \cdot r \cdot X_0}{U \cdot A} \int y^2 b dy = \frac{-2 \cdot X_0 \cdot r \cdot d^2}{3 \cdot U}.$$

When the position of the centre of pressure of the body and rudder is known, the yawing moment due to the yawing of these portions of the machine may be easily found.

The centre of pressure of the keelplate, vertical longitudinal fins, rudder, etc., should be above the longitudinal axis passing through the centre of gravity. The dihedral angle, if suitably chosen, largely assists the lateral stability. It is worthy of note, that the dihedral angle $A'AA''$ (see fig. 38) gives much greater rolling and yawing moments, due to rolling and yawing, than the "equivalent" fin AB. A consideration of one case—

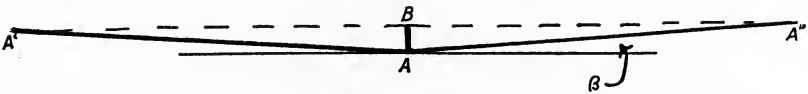

FIG. 38.

that is, rolling due to rolling—may be regarded as typical of the rest.

Assume, as before, that the angular velocity of rolling = p . Increase of rolling moment due to the dihedral angle of the wings

$$= \frac{-Z_0 \cdot p \cdot d^2}{a_0 \cdot U \cdot 3} \text{ approximately} \quad (1)$$

Now, the height of the equivalent fin = $d \cdot \beta$,
and the area of the equivalent fin = $\frac{A}{2} \cdot \beta$.

Hence, increase of rolling moment due to an element dA of this fin, when the distance of the element from the longitudinal axis = z ,

$$= -K_1 \frac{z^2 p}{U} dA \cdot U^2 \times z.$$

And \therefore increase of rolling moment due to the equivalent fin

$$\begin{aligned} &= \int -K_1 \frac{z^2 p}{U} dA \cdot U^2 z = \frac{-K_1 U^2 \cdot p}{U} \cdot \int dA \cdot z^2 \\ &= -\frac{K_1 \cdot U^2 \cdot p}{U} \times \frac{A}{2} \beta \times \frac{d^2 \cdot \beta^2}{3} = -\frac{Z_0 \cdot p \cdot d^2 \cdot \beta^3}{a_0 \cdot 6 \cdot U} \quad (2) \end{aligned}$$

Expression (2) is very much less than expression (1). The other cases may be worked out similarly.

The position of the C.G. of the machine has very little

influence upon the lateral stability, chiefly because of the important behaviour of the wings. The lateral oscillations of an aeroplane, and also any skidding, are readily damped out by the dynamic action of the wings, rudder, tail, keelplate, vertical fins, etc., and the magnitude of the dynamic righting moment of any one of these parts depends upon its area, position, and the rapidity of the oscillation. If a machine side-slip inward during turning, a righting moment, due to the skidding, is introduced if the lateral position of centre of pressure of the machine as a whole is above the position of the centre of gravity. If the moments of inertia of the machine about the longitudinal and normal axes be small, the yawing and rolling oscillations will be rapid and the damping will be heavy. Nevertheless, if the period of an oscillation be large the pilot has ample time to perform the correct manœuvre to swamp the oscillation. A machine which has great lateral stability in calm weather may be exceptionally dangerous and uncomfortable in gusty weather. On the other hand, if a machine has indifferent lateral stability the pilot, with the aid of controls, may introduce the necessary righting couples. The management of such a machine imposes a severe strain upon the pilot. Nevertheless an indifference to yawing, and possibly to rolling, is regarded favourably in many aeronautical circles. Machines usually side-slip inwards when turning, so that a rolling moment, tending to reduce the banking, is called into play. But the rolling moment due to the yawing, or turning, tends to increase the banking. The banking must not be excessive if spiral instability is to be avoided.

Spiral Instability (a Spiral Glide).—A spirally unstable machine will probably be fitted with a large rudder. Imagine such a machine to be performing a right-handed turn. Then the increased lift upon the left wing, and the decreased lift on the right wing, give the machine a bank. Incidentally, the yawing couple due to the drag forces tends to diminish the turn. Initially, the centrifugal force of the turn has caused a side-slip outwards, but now, by virtue of the bank, gravity causes the machine to side-slip inwards. A large turning moment is now given to the machine by the action of the side-slip upon the large rudder, and thus the banking increases. After a time the rolling moment due to side-slipping will tend

to increase the banking. Hence, as the motion proceeds, the banking increases and the radius of the turn diminishes, so that a recovery becomes hopeless.

The conditions favourable to the elimination of spiral instability are :—

- (a) Rolling due to side-slipping, great. Hence, a good dihedral.
- (b) Yawing due to side-slipping, small. This moment is greatly dependent upon the rudder.
- (c) The rolling due to yawing, small. Negative wing-tips may favour this condition.
- (d) Yawing due to yawing, great.

Big Yawing and Rolling Oscillations.—A large vertical longitudinal fin in the front of the machine produces another form of instability.

Imagine such a machine to side-slip towards the left. The air pressure upon the large leading fin gives the machine the bank for a right-hand turn, and also a right-hand yawing moment. Under the action of gravity the machine now side-slips to the right. A reverse motion will then occur, so that finally big unstable yawing and rolling oscillations are set up in the machine.

Much lateral stability work remains to be done, such as the effect of negative wing-tips, turned-up wing-tips, turned-down wing-tips, and it is possible that the near future may see startling changes in the design of machines.

Gusts.—In the preceding stability work, the calculations have been based upon the assumption that the direction of any gust is along a principal axis of the machine, but the gusts which a pilot encounters are not so well defined. Nevertheless, any gust may be resolved along the three well-defined directions, and the separate effect of each of these gusts upon the behaviour of the machine ascertained. The assumption that a gust strikes each part of the machine simultaneously is not correct, although, if the machine be of reasonably small size, theoretical calculations upon such an assumption are of great practical value. We have already seen that the initial effect of a gust is to change the velocity of the machine relatively to the air. The new air forces impart a

linear acceleration to the centre of gravity and angular accelerations about the three principal axes of the machine, but these linear and angular accelerations are not uniform. Further, the time-action of a gust is very small. A pilot is only conscious of changes of acceleration, and the body sensations caused by the variable linear and angular accelerations inform the pilot that his machine has been deflected from its course, although, should he be in a cloud, and therefore unable to see the ground, he will have no sense of the new flight path of the machine.

CHAPTER VII.

THE AERIAL PROPELLER.

THE many propeller theories now in existence, some of a more or less conflicting nature, and not a few of an unsound character, rather tend to confuse the elementary reader. Obviously, any theory which is not substantiated by experimental evidence is valueless to the practical engineer. It is not the author's intention to adhere rigidly to any one of these theories, although the problem has been treated in an exceedingly interesting, if not absolutely exact, manner by S. Drzewiecki, who appears to have further developed the excellent work of F. W. Lanchester. A research upon propellers which have been constructed upon the Drzewiecki assumptions, indicates that, although his method is not accurate, the discrepancy between the actual behaviour of a propeller and the assumed behaviour is of no great importance. In fact, this theory may be accepted with modifications, and is quite as sound as many of our so-called "engineer's theories." In any case, it is to be hoped that the following remarks may aid the student considerably to appreciate the aerodynamical behaviour of a propeller.*

Description of Propeller.—Fig. 39 is an engineer's drawing of the blade of an aerial propeller. The line through A, perpendicular to the plane of the paper, is called the axis of the propeller, and the horizontal line AB may be conveniently termed the axis of the blade. Imagine the surfaces of cylinders, which have the axis of the propeller as their common axis, to cut the blade. The developments of the sections of the blade so cut are shown in the figure, $O_1, O_2, O_3 \dots$ being the points

* It should be noted that a propeller is an air screw which pushes, a tractor being an air screw which pulls. At the time the book was written it was customary to use the general term propeller.

of intersection of the cylinders with the axis of the blade, whilst $C_1C_1, C_2C_2, C_3C_3 \dots$ are the lines of intersection of the surfaces of the cylinders with the plane containing the propeller axis and the blade axis. $D_1D_1, D_2D_2, D_3D_3 \dots$ are the developments of the lines of intersection of the surfaces of the cylinders with the horizontal plane passing through the axis of the blade. We should now be able to picture in our mind's eye the true shape of the propeller blade.

Propeller Terms.—Next, it is desirable to have a clear conception of the several “propeller” expressions, so that we may immediately proceed to the study of some experimental curves.

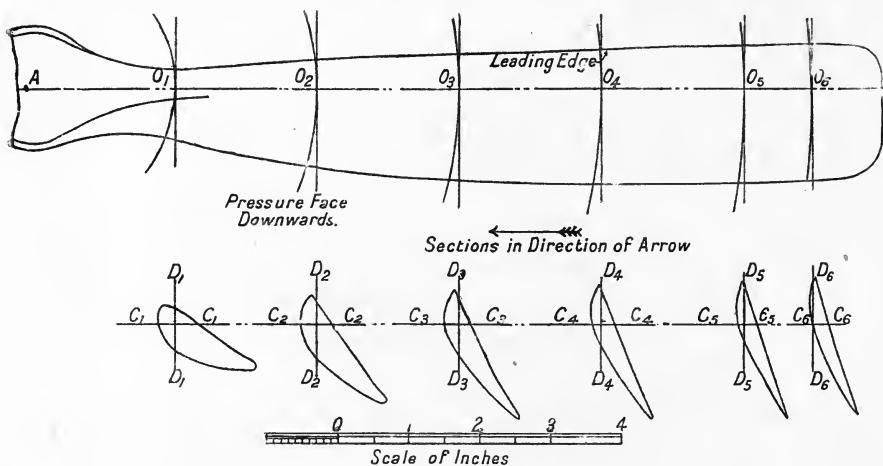

FIG. 39.

The time-honoured marine terms “pitch” and “slip,” although adhered to when speaking of aerial propellers, have undergone slight changes in their meanings.

By “pitch” of an aerial propeller we shall mean the axial advance of the propeller during one revolution, when the thrust has a zero value. The various elements of a marine propeller usually have the same pitch, but this is not the case for the aerial propeller, which is generally designed from different considerations.

It is better to determine the pitch of an aerial propeller experimentally, rather than from theoretical considerations, and the term “pitch” should then strictly be termed the “experimental mean pitch” of the propeller.

The "slip-ratio" of a propeller will be defined as $\left[1 - \frac{V}{np}\right]$, where V is the translational speed of the propeller, n is the rotational speed, and p is the pitch.

The author does not wish to discuss the physical meaning of "slip-ratio," but prefers rather to regard it as a convenient non-dimensional expression which greatly facilitates a concise presentment of the performance of a propeller. "Efficiency" has the usual meaning, that is, the ratio of the useful work done—the product of the thrust and translational speed—to the total work expended: $2\pi \times \text{torque} \times \text{rotational speed}$.

Discussion of the Performance of a Propeller.—Propellers may be most favourably compared when they drive the same aeroplane at the same forward speed—that is, when they develop the same thrust at the same translational speed. The large number of variables which influence the behaviour of a propeller renders the exact appreciation of the experimental performance of the propeller a more or less difficult matter. A model of the propeller shown in fig. 39 has been tested by F. H. Bramwell and the author, and the anticipated performance of the full-size propeller, as deduced from these experiments, is given in figs. 40–43.

The pitch of the propeller = 8.1 feet.

Diameter of the propeller = 8.0 feet.

A static test of a propeller—that is, a test when the translational speed of the propeller is zero—has little practical value. From these static curves (figs. 40 and 41) we see that the thrust and the H.P. of the propeller approximately vary as the square of the rotational speed. The curves of figs. 42 and 43 completely define the performance of the propeller at a translational speed of 50 miles per hour. It should be noted that the thrust and torque of a propeller, at the same slip, practically vary as the square of the translational speed, or, what is the same thing, as the square of the rotational speed. A maximum efficiency of 68 per cent. is reached at a slip of 24 per cent., and the slip may vary from 18 per cent. to 32 per cent. without any appreciable variation in the efficiency of the propeller. The following simple calculation shows how a small increase in the rotational speed of the propeller greatly increases the thrust of the propeller, with no appreciable alteration in the efficiency. Thus

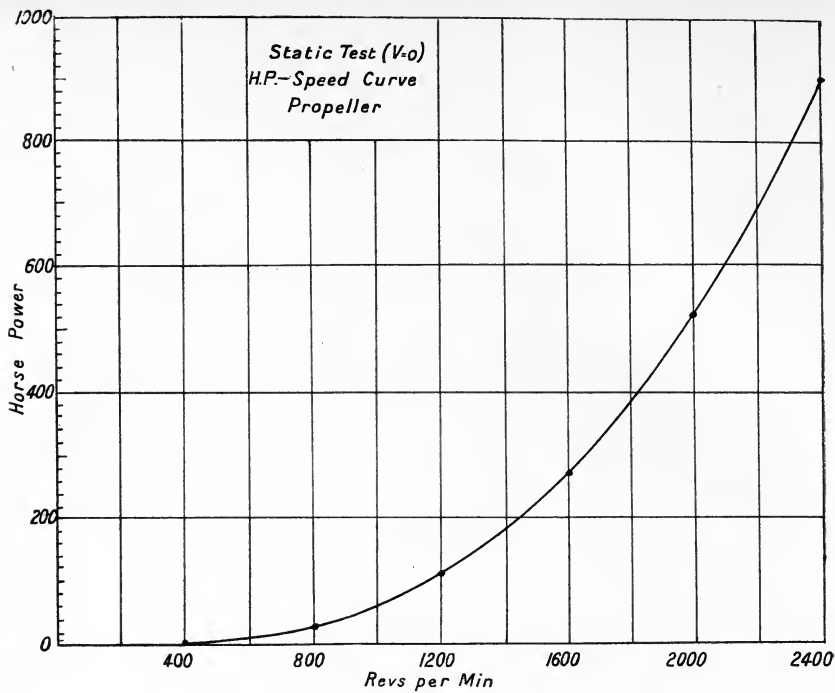

FIG. 40.

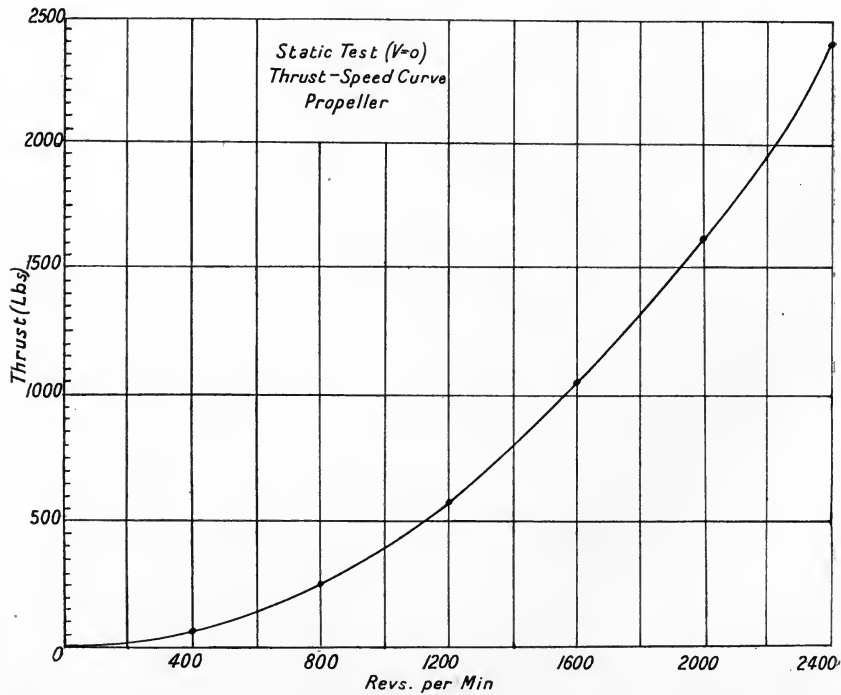

FIG. 41.

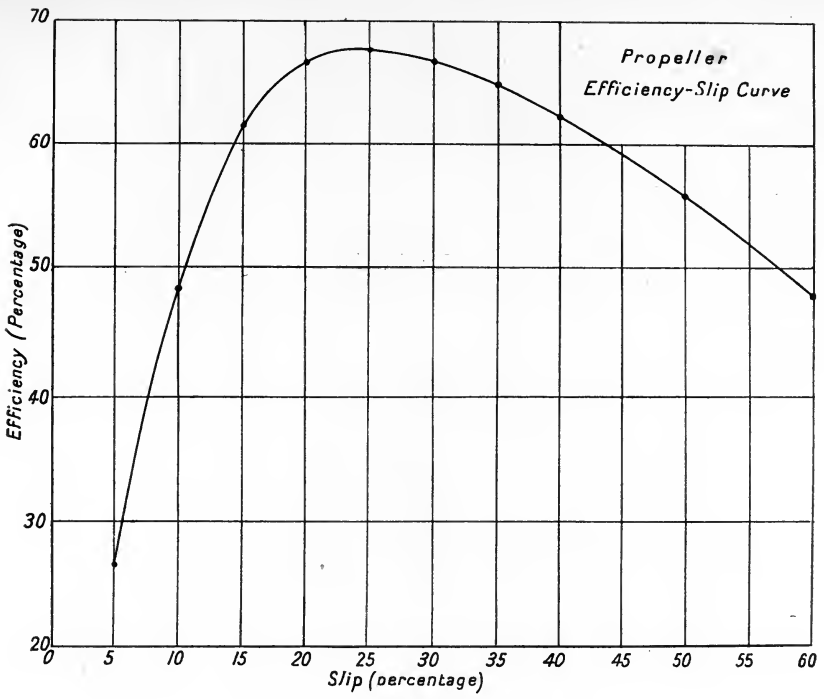

FIG. 42.

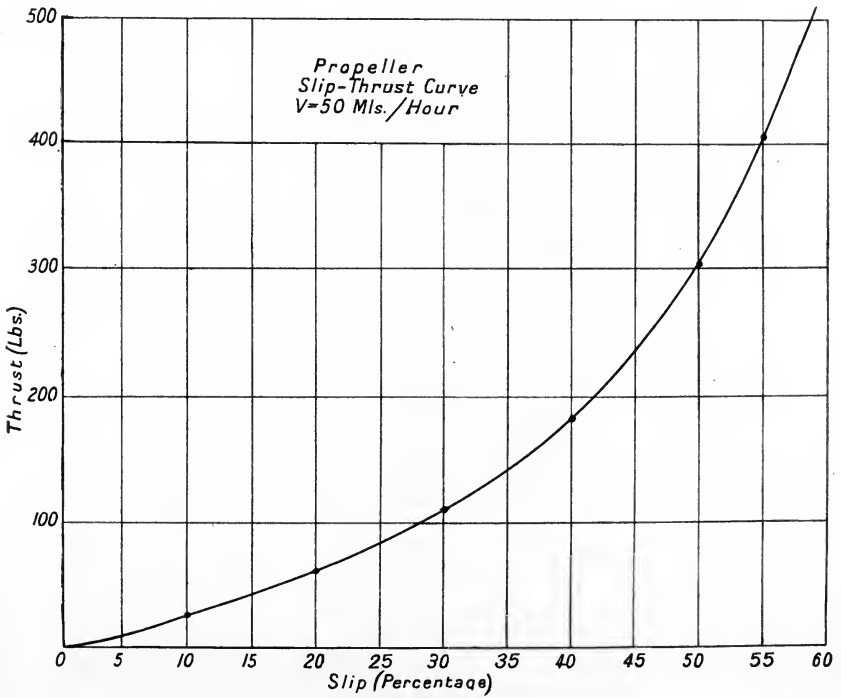

FIG. 43.

we shall assume that to drive an aeroplane at 50 miles per hour, our propeller must have a thrust of 237 lbs. and a rotational speed of 970 revolutions per minute. Hence slip of the propeller = 44 per cent. A glance at the curves shows that when the rotational speed is 970 revolutions per minute, the thrust is only 222 lbs. If, by slightly opening the throttle valve of the engine, we increase the speed of our propeller to 990 revolutions

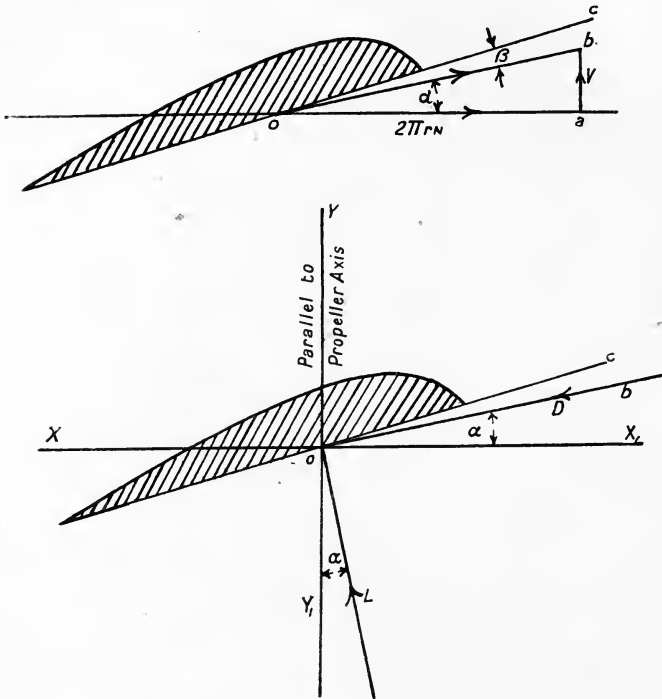

FIG. 44.

per minute, so that the slip is now 45 per cent., we enable the propeller to give the required thrust of 237 lbs.; and, further, the efficiency remains practically unaltered. In other words, reasonable discrepancies between designed and calculated values are not of great importance, as a small variation in the engine speed is sufficient to bring the thrust up or down, as the case may be, to the required value.

A Propeller Theory.—We may now consider the flow of air around an element of a blade, which is at a distance r feet from the propeller axis. The good aerofoil contour of such an element,

or, rather, of the development of the section made by an imaginary cylinder of radius r , is shown clearly in fig. 44. In fact, we may consider the blade of a propeller to be an aerofoil of such suitable configuration as enables it to glide in a helical path. If the rotational speed of our propeller be represented by n revolutions per minute, and its translational speed by V feet per minute, any element of the blade will have a forward translational velocity (in the direction of the propeller axis) of V feet per minute, and also a translational velocity of $2\pi rn$ in the direction OX_1 , where OX_1 is at right angles to OY and also to the axis of the blade (see fig. 44). The element is therefore moving through the air in the direction ob with a velocity of V_1 , where

$$V_1 = \sqrt{(V^2 + (2\pi rn)^2)}.$$

We should now recognise that we are on familiar ground, and we will call β —that is, the angle between the chord of the element and the wind direction—the angle of attack of the section. Also the wind forces D and L , which act upon the element, have their usual signification. For our present purpose, it is convenient to resolve the resultant force upon the section into the two directions OX and OY . The component of the resultant force in the direction OY will then be $[L \cos \alpha - D \sin \alpha]$, whilst the component in the direction OX is $[L \sin \alpha + D \cos \alpha]$. The useful work done by the section will then be $[L \cos \alpha - D \sin \alpha]V$, and this work is accomplished by a work expenditure of $[L \sin \alpha + D \cos \alpha]2\pi r \cdot n$. The efficiency of the element is represented by

$$\eta = \frac{V[L \cos \alpha - D \sin \alpha]}{2\pi rn[L \sin \alpha + D \cos \alpha]}.$$

If the ratio $\frac{D}{L}$ be represented by $\tan \phi$, the efficiency is concisely represented by the expression—

$$\frac{V}{2\pi rn} \cot(\phi + \alpha).$$

The importance of the function ϕ is clearly demonstrated by such an expression; and to ensure a small value of $\tan \phi$, the section should have a good shape and should be inclined to

the wind direction at the best value of the angle of attack β . Moreover, if for the arbitrary values of V and n , the values of L and D for each section are known, we may, by integration, obtain the thrust, torque, and efficiency of the propeller.

It has been thought desirable to summarise the prominent features of the foregoing remarks :—

(a) Each element of the blade has an aerofoil shape.

(b) The air flow around each element is assumed to be uninfluenced by the presence of the neighbouring portions of the blade.

(c) The forces upon each element are due to the resultant of the axial and circumferential velocities of the element, and the air into which the element moves is *assumed* to be *motionless*.

(d) Since $\tan a = \frac{V}{2\pi rn}$, where V and n are arbitrary constants for all the elements of the blade, the value of a for each element will depend upon the distance of the element from the axis of the propeller.

(e) Under such conditions the efficiency, thrust, and torque of a propeller may be determined theoretically when the aerodynamic properties of the elements are known.

A series of experiments was conducted at the National Physical Laboratory by F. H. Bramwell and the author to ascertain the degree of accuracy of the foregoing assumptions, and also to afford a comparison between the calculated and experimental values of the various factors which define the performance of a propeller. In the light of this research, the hypothesis, that the air flow around the blade element is not influenced by the presence of adjacent elements, is not strictly accurate. Furthermore, the value of the best angle of attack of an aerofoil may undergo a change when a section of the aerofoil is employed in the construction of a propeller blade. Nevertheless, in the hands of a skilled designer, this theory, although not accurate, furnishes a convenient basis for the design of a propeller. Experimental evidence rather encourages the adoption of the theory, if the working conditions of the propeller are not greatly different from those upon which the design has been based. We found that the calculated values of the efficiencies were less than the experimental values, and these discrepancies were chiefly due to the non-agreement of

the torque values. The calculated and experimental values of the thrusts were not greatly different. We anticipate that the discrepancy between the calculated and experimental values is mainly due (*a*) to the initial motion of the air into which the propeller moves, and (*b*) to the radial velocity of that portion of the air in the neighbourhood of the blades, such a velocity being partly attributed to centrifugal force.* The frictional contact between the air and the blades must influence the character of the air flow, and it is a matter for surprise that we found the calculated and experimental values in such close agreement.

A brief survey of the tests performed upon a large number of model propellers reveals the astonishing fact that the maximum efficiencies of almost all the propellers lie within a range of 60 per cent. to 75 per cent.

The Flow of Air around a Propeller.—The air which is drawn in at the front of the propeller is discharged in practically a cylindrical jet. The axial velocity of the discharged air increases from the tip of the blade to a short distance inwards, and then gradually decreases until the velocity has a zero or small negative

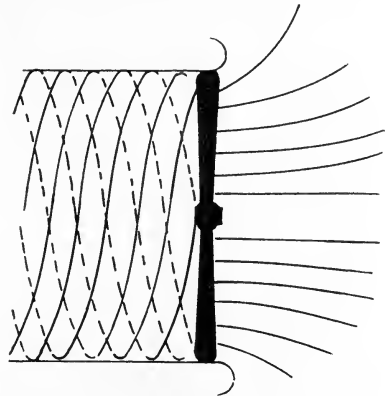

FIG. 45.

value in the neighbourhood of the boss of the propeller. The rotational motion of the discharged air has the same direction as that of the propeller. When this motion is superposed on the translational motion, the usual spiral flow results (see fig. 45). The area of a cross section of the discharged stream is less than the area of a section of the incoming air column, and it is assumed to be equal to the area swept out by the propeller blades. The calculation of the thrust of the propeller from the axial momentum of the discharged air can only be performed when we know the distribution of velocity across the area of the discharged stream, and is therefore a matter of great difficulty. Furthermore, our ignorance of the

* No account was taken of the eddying flow at the tip of the blade.

nature and magnitude of the rotational motion renders the exact calculation of the torque, and therefore of the propeller efficiency, an impossibility.

The thrust T of a propeller may be represented by $\Sigma(mv)$, where m = the mass of an elemental volume of air in the discharge stream. Every particle of this volume is supposed to be moving with the same axial velocity v .

The kinetic energy of translation wasted by the discharge stream = $\Sigma\left(\frac{1}{2}mv^2\right)$.

Similarly, the torque $Q = \Sigma(m \cdot r^2 \cdot \omega)$, where m = the mass of an elemental volume of air in the discharge stream. Every particle of this volume is supposed to be moving with an angular velocity ω about, and also to be at a distance r from the axis of the propeller.

The kinetic energy of rotation dissipated in the discharge stream = $\Sigma\left(\frac{1}{2}mr^2\omega^2\right)$.

It would follow, then, that to develop a given thrust, it is advantageous to discharge a large mass of air at small axial and rotational velocities.

The kinetic energy of rotation is only a fraction of the total kinetic energy of the discharged stream.

It is supposed that the air which is in the region of the high-speed propeller tips does not undergo any significant change in density.

The Position of the Propeller.—The position of the propeller upon the machine is usually determined by constructional exigency. In monoplanes, the propeller—or, more correctly, the “tractor screw”—is conveniently placed at the front of the machine. At the same translational speed of a machine, by virtue of the viscous drag exerted upon the air by the aeroplane wings, the tractor screw has a greater velocity of entry into the air than a propeller situated at the rear of the wings. Now, to get the necessary thrust, a propeller works with a slip-ratio well above the value which corresponds to the maximum efficiency of the propeller. Consequently if the speed of the machine and the thrust of the propeller be the same, a shift of the airscrew from the front of the wings to the back will necessitate the airscrew running at a greater slip, and hence at a smaller

efficiency (see figs. 42 and 43). Furthermore, the wings which are situated in the slip stream of a tractor screw have a greater lifting capacity and also, unfortunately, a greater drag. It is credible that if these forces have a large value, a sudden failure of the engine will greatly interfere with the equilibrium of the machine. We may venture to assume that the efficiency of a tractor screw will be increased by the near presence of the aeroplane body and wings, but the inevitable increase of head resistance of the machine will tend to counteract this advantage. With the advent of a reliable make of engine, the utilisation of the energy in the discharge stream for navigation and stabilising purposes will be worthy of serious consideration. When flying, the reaction torque of the air upon the propeller, which will be transmitted to the machine, is usually counterbalanced by a wing warp of the requisite amount combined with a judicious employment of the rudder. Two similar propellers symmetrically situated, but rotating at the same speed in opposite directions, introduce no disturbing torque upon the machine.

The Balance of the Propeller.—A simple calculation may demonstrate the importance of the employment of a well-balanced propeller. Thus, assume that a propeller of weight 30 lbs. and diameter 8 feet has a rotational speed of 1200 r.p.m. Assume, further, that its C.G. is displaced a distance of $\frac{1}{16}$ inch from the propeller axis.

The centrifugal force due to this eccentricity

$$= \frac{mv^2}{rg} = \frac{30 \times 1600\pi^2}{32 \times 120} = 125 \text{ lbs. approximately.}$$

An unbalanced force of this magnitude and period may introduce unpleasant, if not dangerous, oscillations in the machine.

The Gyroscopic Action of a Rotary Engine and its Propeller.

—Before we proceed to the study of the gyroscopic behaviour of a rotary engine and propeller upon an aeroplane, we shall discuss briefly some principal features of gyroscopic action. When an extraneous couple acts on the machine, the axis of rotation of the propeller and engine, if the engine be a rotary one, tends to place itself in line with the axis of this couple, so that the direction of the rotation of the engine and propeller is the same as that of the applied couple. Thus, assume an aeroplane, which is driven by a right-handed tractor

—that is, the tractor has a clockwise direction of rotation when it is viewed from the pilot's seat—is to turn to the right, so that the applied air couple acts about a vertical axis. In this case the machine will tend to dive. Further, to consider another illustration, let us assume that the applied air couple tends to turn the nose of the machine downwards. Then, due to the influence of the rotating propeller and engine, the machine will tend to make a horizontal left-handed turn. The mathematics of gyroscopic action is simple, if we accept the following statement. The magnitude of the gyroscopic couple is equal to the angular momentum of the rotating masses multiplied by the angular velocity of the precessional movement. In the above illustrations we have dealt with two precessional movements—firstly, one of pitching; secondly, one of turning. Now, for a practical illustration, let us imagine our machine to precess to the right with an angular velocity of $\frac{2\pi}{16}$ radians per second—that is, one turn in 16 seconds; also that

The weight of the rotary engine	=200 lbs.
The weight of the propeller	= 30 lbs.
Radius of gyration of the engine	= .8 foot.
Radius of gyration of the propeller	=2.5 feet.
Rotational speed of engine and propeller	=1200 r.p.m.

Angular momentum of engine

$$= \left[\frac{200 \times .64 \times 40\pi}{32} \right] = 160\pi \text{ (Ft.-lb.-sec. units).}$$

Angular momentum of propeller

$$= \left[\frac{30 \times 6.25 \times 40\pi}{32} \right] = 234\pi.$$

The angular velocity of turning = $\frac{2\pi}{16}$ radians per second.

Hence the pitching couple exerted upon the machine due to the gyroscopic action of the engine and propeller

$$= [160\pi + 234\pi] \frac{\pi}{8} \text{ lbs.-feet} = 490 \text{ lbs.-feet.}$$

Also suppose the area of the elevator is 20 square feet, and that its C.P. is situated at a distance of 15 feet from the point about which the machine turns. To balance such a couple the pressure of the air on the elevator in a direction normal to the longitudinal axis of the machine will need to be $\frac{490}{300} = 1.6$ lbs. per square foot. Such an air-pressure loading cannot be considered of great magnitude, especially as the pilot has already anticipated the required elevator position for such a turn. Furthermore, the inertia of the machine, and the damping action of the wings and tail, must tend to minimise the disturbing influence of the gyroscopic couple.

Design of an Aerial Propeller.—The following design presumes a knowledge of the matter of the foregoing pages, and the author hopes that this treatment of the subject may familiarise the reader with the aerodynamical behaviour of a propeller. The design has been based upon the teachings of F. W. Lanchester and Drzewiecki, but only in so far as their theories have been substantiated by experimental evidence. The non-mathematical student should glean some useful information from the various conclusions and observations which are interspersed amongst the “troublesome” calculations.

Data necessary for the Design of a Propeller.*—(a) The thrust of the propeller at the known translational speed of horizontal flight.

(b) The rotational speed of the propeller when the machine is in horizontal flight. This speed will be a function of the speed of the engine and the type of gearing employed.

(c) The diameter of the propeller. This is determined, more or less, from a consideration of constructional exigencies. We shall assume that the following data have been supplied to the designer:—

The “propeller” to be of the tractor type.

Translational speed of machine, and therefore of the tractor = 65 miles per hour.

Pull of the tractor screw = 385 lbs.

Rotational speed of the tractor = 1100 r.p.m.

The diameter of the tractor must not be greater than 10

* This design would need to be modified in the case of the helicopter.

feet. Hence take the diameter as 9 feet. This will allow a clearance of 6 inches.

Use the same notation as previously. (Also see fig. 44.)

The lift upon an aerofoil = $K_a \times \text{area} \times (\text{velocity of wind})^2$, where K_a = lift coefficient at an angle of incidence equal to α .

Let l_1 = chord length of a blade section at a radius r .

The lift upon a unit length of the blade, assuming any cross section of this unit length to have the same shape and size as that of the cross section of the blade at a radius r

$$= K_a \times l_1 \times V_1^2 = K_a \times l_1 [V^2 + (2\pi r n)^2].$$

Similarly the drag $D = k_a \times l_1 \times V_1^2 = k_a l_1 [V^2 + (2\pi r n)^2]$.

As before, the thrust contributed by such a unit length of the blade

$$\begin{aligned} &= K_a l_1 V_1^2 \left[\cos \alpha - \frac{D}{L} \sin \alpha \right] \\ &= K_a l_1 \frac{V^2}{\sin^2 \alpha} \times \frac{1}{\cos \phi} \cos (\alpha + \phi), \end{aligned}$$

where $\frac{D}{L} = \tan \phi$.

In like manner the torque for such a unit length

$$= \frac{K_a \cdot l_1 \cdot V^2}{\sin^2 \alpha} \times \frac{1}{\cos \phi} \left[\sin (\alpha + \phi) \right] r.$$

From the above two expressions it would appear advantageous to make ϕ as small as possible.

The values of α for the elements of the blade may be directly calculated from the expression, $\tan \alpha = \left[\frac{V}{2\pi r n} \right]$,

which gives $\alpha = \tan^{-1} \left[\frac{5720}{2\pi \times 1100 \times r} \right] = \tan^{-1} \left[\frac{.828}{r} \right]$.

In the light of the researches conducted upon aerofoils of multiform sections, the best angle of attack, *i.e.* β , for the aerofoil sections suitable for propeller-blade construction may be taken as 4° . It should be remembered that by "angle of attack" we mean the angle between the wind direction and the direction of the line fixed upon the aerofoil section which

gives the wind direction when there is no lift upon the section. The calculated values of $(\beta+a)$, i.e. $(\alpha+4^\circ)$, are given in Table IV.

TABLE IV.

Section.	Radius. Feet.	$\tan \alpha$.	α . Degrees.	$\alpha+4^\circ$. Degrees.
1	4.0	.207	11.7	15.7
2	3.5	.241	13.6	17.6
3	3.0	.276	15.4	19.4
4	2.5	.331	18.3	22.3
5	2.0	.414	22.5	26.5
6	1.5	.552	28.9	32.9
7	1.0	.828	39.6	43.6

Adopting a suitable linear scale, we then design what appears to be a good plan form, taking great care that the blade widths at radii $2\frac{1}{2}$ feet, 3 feet, $3\frac{1}{2}$ feet, 4 feet have the maximum widths consistent with a suitable plan form. From the known values of $(\beta+a)$ we may also draw, in position, the lines which will eventually become the "no-lift" lines of the various sections. Now select some good aerofoil sections, of which the aerodynamical properties are known, and sketch them in position about the no-lift lines. Such sections may be found in the *Annual Reports of the Advisory Committee for Aeronautics* and the published works of Eiffel. Also a designer may, if he so wish, have aerofoil sections tested at the National Physical Laboratory.

The following points should be borne in mind :—

(1) The chord lengths of the sections have already been fixed by the plan form.

(2) The sections at radii 4 feet, $3\frac{1}{2}$ feet, 3 feet, and probably $2\frac{1}{2}$ feet, should be good aerofoil shapes.

(3) The maximum ordinate of each section should be situated at a distance from the nose of the section of about one-third the chord.

(4) Sections at the boss of the propeller should be designed chiefly from considerations of strength.

(5) That the centre of area of each section, which may be decided upon quite accurately without calculation, should be as nearly as possible on the blade axis.

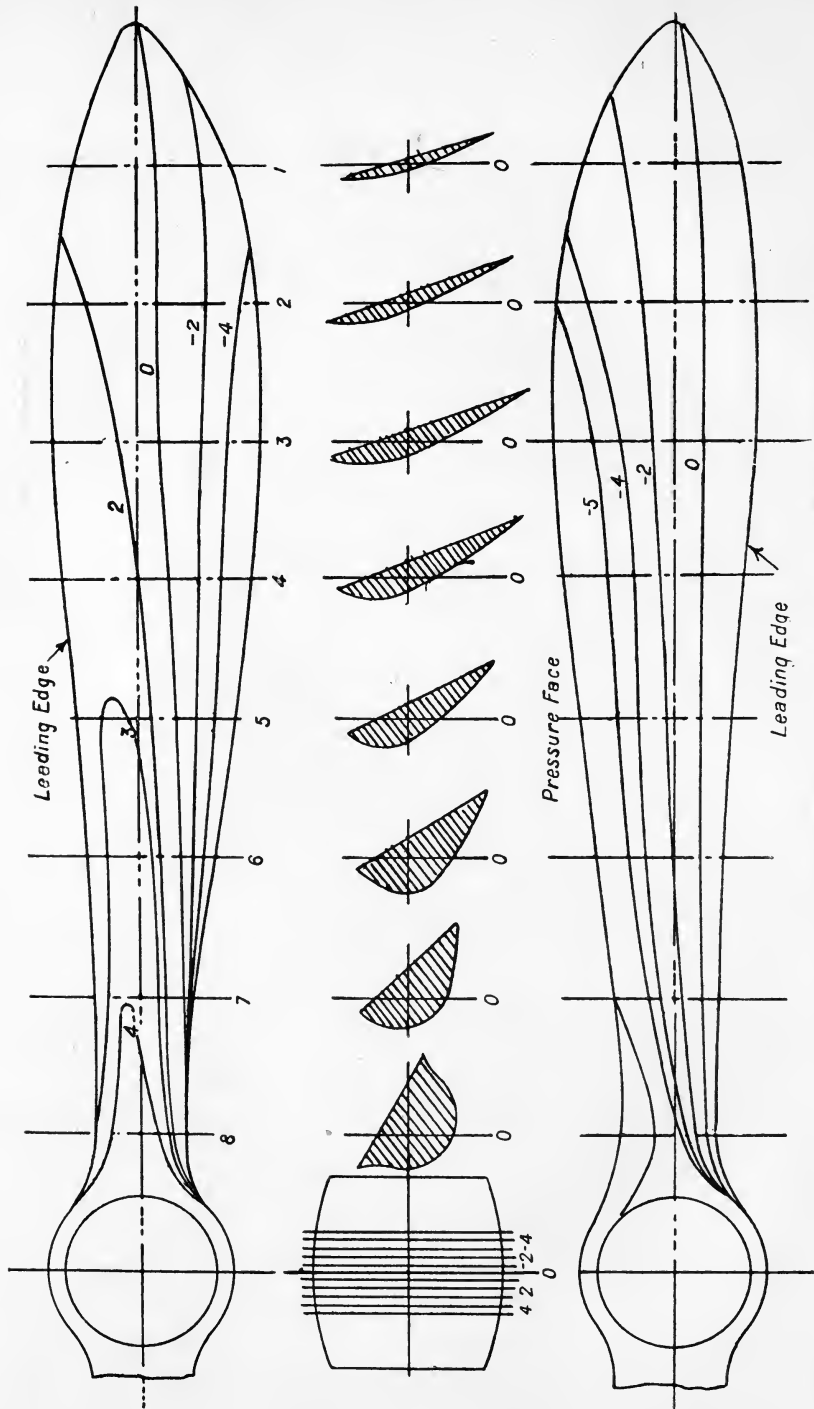

FIG. 46.—Design for propeller. Scale 1" = 8".

(6) That the centres of pressure of the various sections should be so placed with respect to the blade axis that the resultant air pressure on the blade passes through the blade axis. Fig. 47 gives a good distribution of the centres of pressure on the several sections of a blade.

The conditions (5) and (6) may be occasionally antagonistic.

From these sections we may now construct the contour lines of the plan form (see fig. 46). After "fairing" the contour lines it may be necessary to "refair" the sections. By such a tentative method of fairing—that is, constructing the contour lines of the plan form from the sectional shapes, and *vice versa*—we obtain eventually a smooth blade surface. Whilst fairing we should have constantly in mind the conditions above stated. Also, the contour lines should not suddenly undergo any great

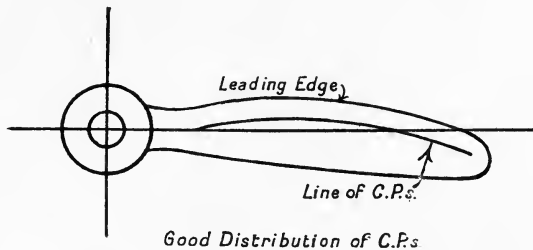

FIG. 47.

changes of curvature, otherwise the propeller blades may, by virtue of their great twist, present an unsightly appearance. The success of the above operation, like all fairing processes, depends greatly upon the experience and the practical instinct of the designer. A study of the characteristics of the many aerofoil sections which have been tested at the big aeronautical laboratories should enable the designer to approximate with some accuracy to the aerodynamical properties of those sections, the shapes of which have been slightly modified by the fairing. It has been the author's experience that the fairing of the blade surfaces, if well performed, does not greatly alter the shapes of the blade sections. Further, the author ventures to suggest that a deduction of the aerodynamical properties of the blade sections after fairing—the alterations of the sections must be small—may be productive of better results than the utilisation of data, which, although accurate for the initial

blade sections, cannot be applicable to the sections of the finished propeller.

Table V. gives the aerodynamical properties of aerofoils having the same shapes as the several blade sections.

Let the scale of blade widths be

1 inch represents k feet.

TABLE V.

Section.	Length of Chord of Section. Feet.	$\frac{L}{D}$	ϕ . Degrees.	Lift Coefficient K at Maximum $\frac{L}{D}$. Ft.-lb.-sec. units.
1	$0.87k$	14	4.1	.000775
2	$1.07k$	14	4.1	.000825
3	$1.15k$	13	4.5	.000875
4	$1.05k$	11	5.2	.000950
5	$0.95k$	9	6.3	.001000
6	$0.8k$	9	6.3	.000500
7	$0.72k$	4	14.0	.000250

Now, from the two expressions,

$$T = \frac{K_a \cdot l \cdot V^2}{\sin^2 \alpha} \times \frac{1}{\cos \phi} \cos(\alpha + \phi),$$

$$Q = \frac{K_a \cdot l \cdot V^2}{\sin^2 \alpha} \times \frac{r}{\cos \phi} \sin(\alpha + \phi),$$

we may calculate the values given in the following table:—

TABLE VI.

Section.	T. Lbs. per foot-length.	Q. Lbs.-ft. per ft.-length.
1	$144.5k$	$164.0k$
2	$138.0k$	$154.0k$
3	$122.0k$	$132.5k$
4	$83.0k$	$90.0k$
5	$51.5k$	$56.5k$
6	$12.7k$	$13.5k$
7	$2.4k$	$1.8k$

If the values of T —that is, the thrust upon unit length of the blade, assuming the distribution of thrust over this unit length to be uniform and of the same magnitude as the actual thrust distribution on the blade section at radius r —be plotted

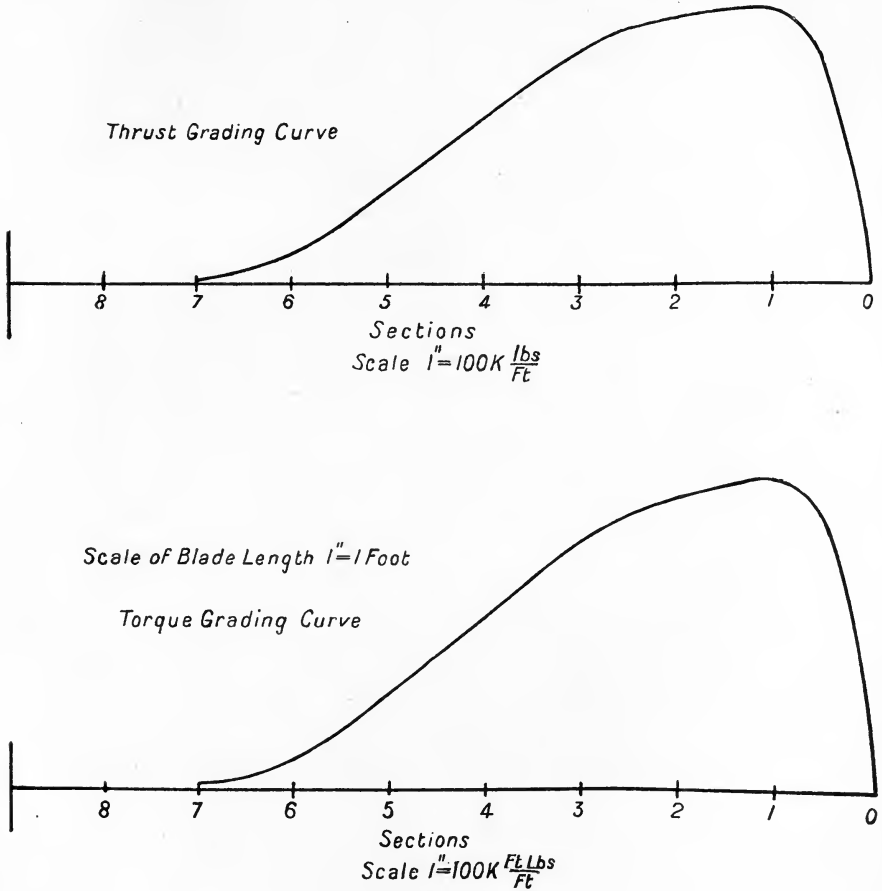

FIG. 48.

against r , we obtain the "thrust grading curve" (fig. 48). The area of this curve gives the total thrust contributed by the blade. A study of the curve confirms a remark made formerly, that the portion of the blade between the radii 1 foot and 2 feet is of small aerodynamical importance, since it only contributes about 6 per cent. to the total thrust of the blade, whilst the remainder of the blade from $r=2$ feet to the tip,

contributes 94 per cent. Integrating the area of the thrust grading curve, we find that the thrust contributed by a single blade = $289k$ lbs. The value of k may be deduced from the expression $289k \times n = \text{thrust of propeller}$, that is 385 lbs., where $n = \text{number of blades}$.

Aerodynamically, a four-bladed propeller is probably more efficient than a two-bladed one, but the former is more difficult to make, and is usually weaker at the boss. Other advantages of a four-bladed propeller are: (a) good balance, (b) small interference forces are introduced by the action of side gusts upon the blades.

We shall assume a two-bladed propeller, and, therefore, $k = \frac{2}{3}$, so that the linear scale of blade widths becomes—1 inch represents $\frac{2}{3}$ ft.

Similarly, integrating the area of the torque grading curve (fig. 48), we find that the torque of the propeller

$$= 318 \times k \times 2 = 424 \text{ lbs.-feet.}$$

$$\text{The propeller efficiency} = \left[\frac{V \cdot T}{2\pi Qn} \right] 100 \text{ per cent.}$$

$$= \frac{100 \times 65 \times 88 \times 385}{2\pi \times 424 \times 1100} \text{ per cent.} = 75 \text{ per cent.}$$

It is anticipated that the calculated torque may be about 5 per cent. greater than the actual working torque, and, therefore, in all probability the working efficiency of the propeller may have the high value of 80 per cent. In ordinary flight, the propeller may run at a greater slip than that corresponding to the maximum efficiency, and then small variations from the rotational speed will be accompanied by appreciable variations in the value of the thrust, although the efficiency may remain practically unaltered. By altering the torque of the engine the pilot may allow for any small discrepancy between the calculated and the actual behaviour of the propeller.

Calculation of the Stresses in the Propeller.—A propeller blade is usually under the combined action of (a) a twisting couple, (b) a bending moment, (c) the direct tension due to centrifugal force, and obviously a rigid calculation of the stresses at any point of the blade would be one of complex difficulty. However, from the independent calculations of the centrifugal

and bending stresses some approximation to the stresses at any section of the blade may be obtained.

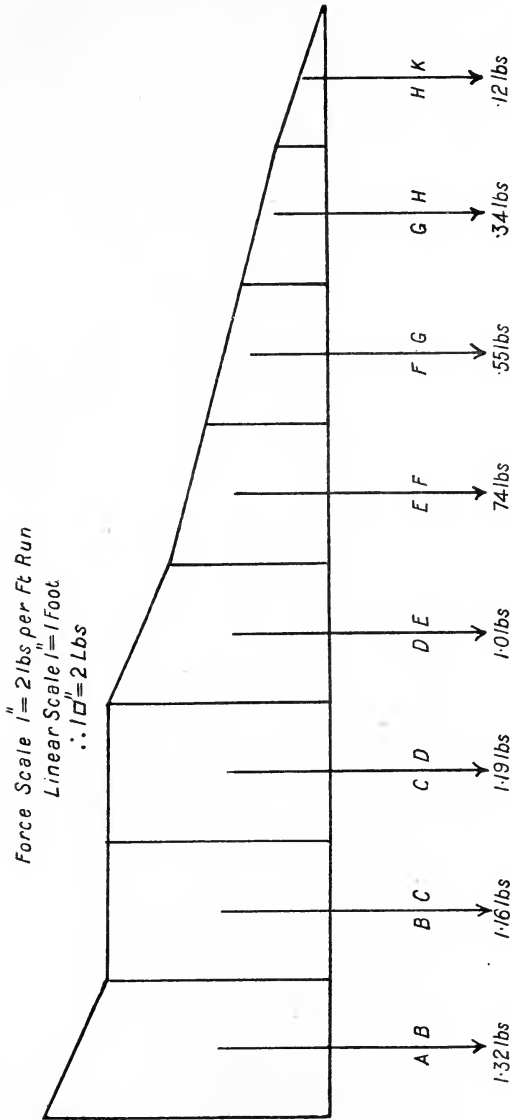

Diagram for W.R. Values
 Fig. 49.

We shall ignore the stresses due to the twisting couple, because in a well-designed propeller these should be quite small. The calculation of the centrifugal stresses (see Table VII. and fig. 49)

is a matter of small difficulty, and the student should readily understand the method adopted.

In this calculation the weight of the wood was taken as 35 lbs. per cubic foot.

TABLE VII.

Section.	Area of Section. Sq. ins.	Values of w . Lbs. per foot.	Values of W . Lbs.	Values of r . Feet.	Values of rW . Foot-lbs.
0	0	0			
1	1.99	0.48	0.12	4.17	0.50
2	3.55	0.86	0.34	3.72	1.30
3	5.40	1.31	0.55	3.23	1.78
4	6.72	1.63	0.74	2.73	2.05
5	9.60	2.38	1.00	2.23	2.23
6	9.60	2.38	1.19	1.75	2.08
7	9.30	2.26	1.16	1.25	1.48
8	12.30	3.00	1.32	0.74	1.00

w is the weight of a foot-length of the blade in lbs. when the sectional area is assumed to be constant, and the same as at the section under consideration.

W = weight in lbs. of a portion of the blade between any two consecutive sections.

TABLE VIII.

Section.	Centrifugal Force acting across Section. Lbs.	Stress (tensional). Lbs. per square inch.
1	205	105
2	745	210
3	1485	275
4	2340	345
5	3260	340
6	4120	430
7	4740	510
8	5150	420

Calculation of Stresses due to Air Pressure upon the Blade.

—Assumptions :—

(1) The calculation to obtain the bending moment at a section, assumes the resultant air forces over the elements of the blade to be parallel, and also in the same plane.

(2) Afterwards, when calculating the stresses, the bending moment was assumed to act about an axis parallel to the chord passing through the C.G. of the section.

The value R (see Table IX.) gives the total load per foot-length of the blade, assuming the distribution of load over the unit length to have the same magnitude as the actual load distribution at the section at radius r .

Hence $R = \sqrt{\left(T^2 + \left(\frac{Q}{r}\right)^2\right)}$, and makes an angle ψ with the direction of T, where $\psi = \tan^{-1}\left(\frac{Q}{Tr}\right)$.

A study of columns 3 and 4 of Table IX. justifies the two assumptions previously made. Column 3 gives the angle at any section between the direction of R and the direction of translational motion of the blade. The angular change in the direction of R as we pass from section 1 to section 5 is only 13° .

Column 4 gives the angular displacement of the direction of R forward of the normal to the chord of the section, and it is seen that R is practically normal to the chord of the section.

TABLE IX.

Section.	R. Lbs. per foot.	Column 3. ψ . Degrees.	Column 4. Degrees.
1	100.0	15.8	0.1
2	97.0	17.7	0.1
3	66.5	20.0	0.6
4	60.5	23.5	1.2
5	39.0	28.7	2.2
6	10.7	35.3	2.4
7	2.0	37.0	3.4

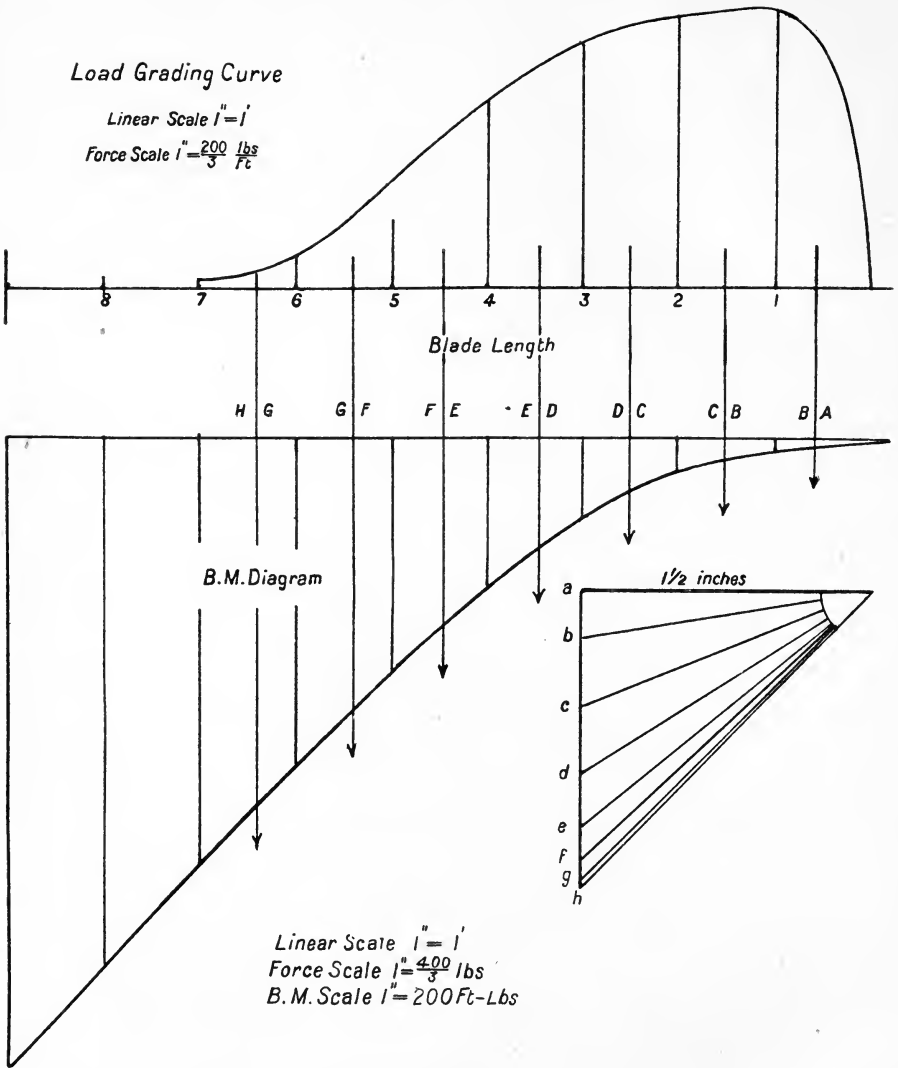

FIG. 50.

We may now construct a load grading curve from which the bending moment at any section may be calculated (see fig. 50).

TABLE X.

Section.	Bending Moment at Section M. Inch-lbs.	$\frac{Y}{I}$ for Section Compression. [Inch] ⁻³ .	$\frac{Y}{I}$ for Section Tension. [Inch] ⁻³ .	Maximum Compression. Lbs. per sq. in.	Maximum Tension. Lbs. persq.in.
1	72	8.4	5.60	607	407
2	442	4.2	2.80	1865	1240
3	1080	1.77	1.18	1914	1280
4	1950	1.08	0.72	2108	1410
5	3050	0.57	0.38	1740	1145
6	4240	0.41	0.27	1735	1145
7	5460	0.39	0.26	2130	1420
8	6720	0.25	0.17	1680	1120

The maximum stresses at the sections may be approximated to, by adding the centrifugal and bending moment stresses (see Table IX.).

TABLE XI.

Section.	Maximum Compressive Stresses due to Bending and Centrifugal Force. Lbs. per sq. in.	Maximum Tensile Stress due to Bending and Centrifugal Force. Lbs. per sq. in.
1	502	512
2	1655	1450
3	1639	1555
4	1763	1755
5	1400	1485
6	1305	1575
7	1620	1930
8	1260	1540

The best woods for the construction of a propeller are (1) walnut, (2) Honduras mahogany, (3) spruce. Spruce, when in tension, is the weakest of the three, but it retains its shape well. Mahogany has a tendency to warp, and walnut is a very heavy wood. Assuming a working load for mahogany and walnut of 2000 lbs. per square inch, we see that the above stresses are well within the safety limit.

CHAPTER VIII.

AERONAUTICAL ENGINES.

THE author presumes that the reader has some knowledge of internal combustion engines, and hence only the first few pages are devoted to a general study of petrol engines. A detailed and complete study of the petrol engine may readily be obtained from the many excellent text-books entirely devoted to this subject.* The author has endeavoured to treat the subject more especially from an aeronautical standpoint, and, as far as possible, prominence has been given to the essential characteristics of the aerial engine.

The Otto, or Four-Stroke Cycle.—An indicator diagram, taken from a four-cycle engine, is shown in fig. 51. With such an engine, the whole cycle of operations in each cylinder repeats itself after four strokes of the piston—that is, two revolutions of the crankarm. At the commencement of the cycle the inlet valve, usually of the poppet type and operated by a cam, is opened, and, as the piston descends, a mixture of petrol vapour and air is sucked from the carburettor into the cylinder. When the crankarm has slightly passed the lower dead centre the inlet valve closes, and the rising piston compresses the charge. Just before the end of the compression stroke an electric spark fires the mixture, but no appreciable combustion occurs until the piston reaches the top of the cylinder. At this point, however, the combustion proceeds very rapidly, and the piston descends under the pressure of the burning gases, the work performed upon the piston appearing as a turning moment about the crankshaft. When the piston has almost reached the bottom of the cylinder, the exhaust valve opens, and an escape

* *Aero Engines*, by G. A. Burls, M.Inst.C.E.; London: C. Griffin & Co., Ltd., 1915.

of the products of combustion occurs, the pressure within the cylinder falling to approximately that of the atmosphere. During the fourth stroke the remaining exhaust gases, with the exception of the gases which will eventually remain in the clearance space, are expelled into the atmosphere.

The Two-Stroke Cycle Petrol Engine.—We will now consider very briefly the two-stroke engine—that is, an engine which has one working stroke during each complete revolution of the crankarm. An indicator diagram from this type of engine is

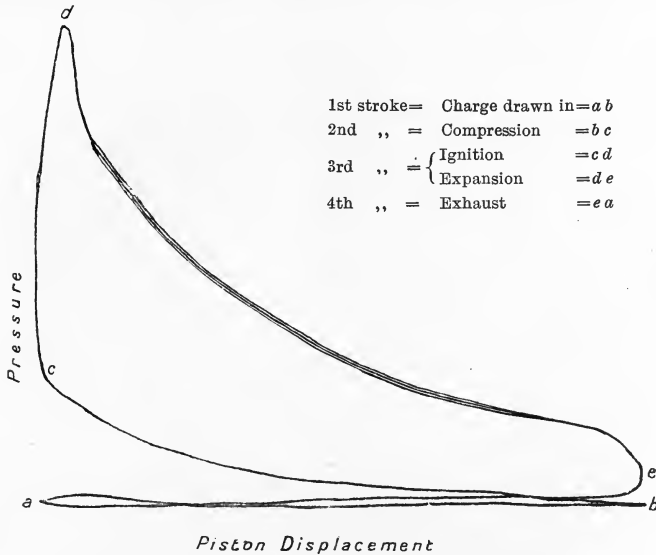

FIG. 51.—Indicator diagram of four-stroke engine.

given in fig. 52. Imagine the piston at the top of its stroke, and that the petrol mixture in the combustion space has just been ignited. When the descending piston is near the end of its working stroke, it uncovers an exhaust valve and allows the products of combustion to escape into the atmosphere. During the further descent of the piston a port connected to the crankcase is opened, and a fresh mixture, which has been slightly compressed in the crankcase by the descending piston, is allowed to flow into the cylinder. The inflowing gases are deflected upwards, usually by baffle plates, and drive the burnt gases out through the exhaust port. At the commencement of the return stroke the piston first closes the port connected

to the crankcase, and afterwards the exhaust port, so that the further rise of the piston compresses the gases into the combustion space. Further, at the end of the second stroke the uncovering of a port enables a fresh charge of mixture to pass from the carburettor into the crankcase.

Magnetos.—High-tension magnetos are largely employed to ignite the charge of an aerial engine, and these are quite reliable at the ordinary speeds of rotation. To diminish the possibility of misfiring of the charge of a high-speed aerial engine, the employment of two synchronised magnetos is to

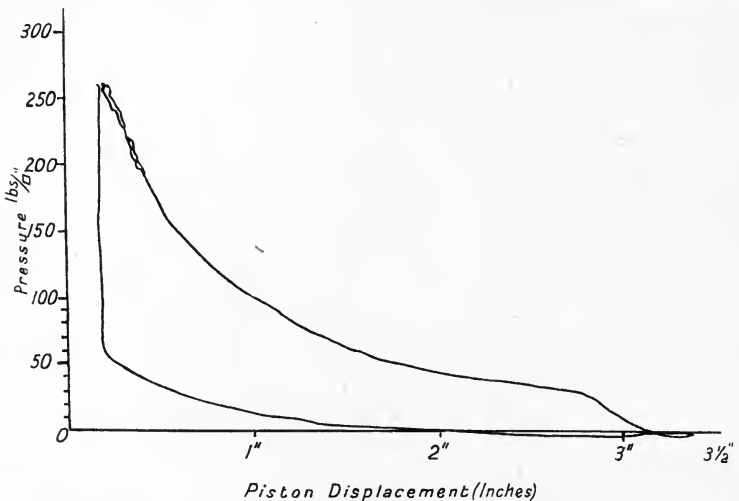

FIG. 52.—Indicator diagram of two-stroke engine.
Mean pressure=62·81 lbs. per square inch. Speed of engine=900 r.p.m.

be recommended, even although the weight of the engine is thereby slightly increased.

Carburettors.—A sketch of a jet carburettor is shown in fig. 53. The petrol, which passes through a pipe G to the small tank K, is maintained at a constant level, normally a little below the jet, by means of a float A and a needle valve B. The air drawn in at C passes a constriction D on its way to the cylinder. The pressure of the air surrounding the jet at D is therefore lower than atmospheric pressure, and the petrol is projected or sucked into this air, partly as a fine spray and partly as a vapour. The area of the petrol orifice may be regulated by the needle valve L. If we assume the area of the petrol

orifice is adjusted to give the correct mixture strength at low engine speeds, the mixture, as regulated by the needle valve, would be too rich at any higher speed. This disadvantage is partly overcome by fitting an air inlet valve *F*. The area of this inlet opening and the air flow depend upon the difference between the suction pressure at *F* and the atmospheric pressure. This extra air, which mixes with the mixture flowing up the pipe *E*, tends to make the mixture strength more or less independent of the speed of the engine.

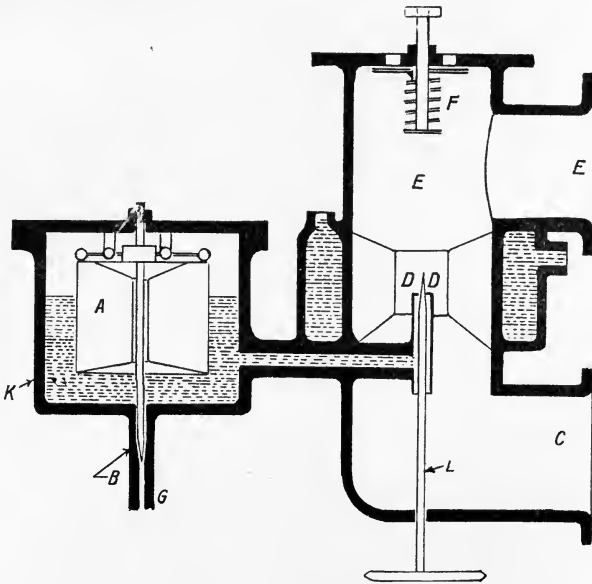

FIG. 53.—Carburettor.

The weight of the petrol flowing from the orifice depends upon :—

- (a) The pressure of the air at *D*.
- (b) The area of the petrol orifice.
- (c) The viscosity of the petrol.
- (d) The difference of head *h* between the petrol in the tank and the petrol orifice.

Assume—

V = velocity of the air at *D*.

ρ = density of the air at *D*.

V_1 = velocity of the petrol in the pipe at *D*.

ρ_1 = density of the liquid petrol in the pipe.

Then the available head which produces the flow of the

$$\text{petrol} = \frac{V^2 \rho}{2} - gh\rho_1.$$

The resistance to the flow of petrol in the pipe = KV_1 approximately.

K is a constant, and depends upon (1) the viscosity of the petrol, (2) the shape and size of the petrol jet and pipe.

The "carburettor equation" will then be

$$\frac{V^2 \rho}{2} - gh\rho_1 = \frac{V_1^2 \rho_1}{2} + KV_1.$$

If the petrol jet area be large, V_1 may be small, and therefore KV_1 will be more important than $\frac{\rho_1 V_1^2}{2}$.

It is desirable that KV_1 may be negligibly small, because K, which depends upon the viscosity of the petrol, is a factor of uncertain amount.

Assume that in a particular carburettor $h=0$ and KV_1 is negligibly small. The above equation then reduces to $V^2 \rho = V_1^2 \rho_1$.

Now let A = area of the air orifice at D,

A_1 = area of the petrol orifice,

then the weight ratio of the air to petrol

$$= \frac{A \rho V}{A_1 \rho_1 V_1} = \frac{A}{A_1} \sqrt{\frac{\rho}{\rho_1}}.$$

If such a carburettor were fitted to an aerial engine, we see that the petrol-air ratio, which is proportional to $\sqrt{\frac{\rho_1}{\rho}}$, would be dependent upon the height of the machine in the air.

Dependence of the Performance of a Petrol Engine upon the Compression Ratio r .—The percentage of the heat of combustion which is wasted by the escape into the atmosphere of the exhaust gases may be reduced by increasing the compression ratio r . This may be demonstrated by the aid of a hypothetical diagram, see fig. 54.

Thus, assume the charge to be drawn into the cylinder at atmospheric pressure P and absolute temperature t_0 . At the end of the adiabatic compression, $pv^\gamma = \text{a constant}$, the volume, pressure, and temperature are $\frac{V}{r}$, Pr^γ , and $t_0 r^{\gamma-1}$ respectively.

The rise of temperature due to the complete combustion of the

mixture, say t , may be assumed to be independent of the compression ratio. The state of the mixture at C (see diagram) is then represented by a volume $\frac{V}{r}$, a temperature $(t_0 r^{\gamma-1} + t)$, and a pressure $P r \left[r^{\gamma-1} + \frac{t}{t_0} \right]$. After adiabatic expansion to the original volume V , the temperature and pressure become $t_0 \left[1 + \frac{t}{t_0 r^{\gamma-1}} \right]$ and $P \left[1 + \frac{t}{t_0 r^{\gamma-1}} \right]$. We may now complete our imaginary cycle by cooling the volume V of the products of combustion to the

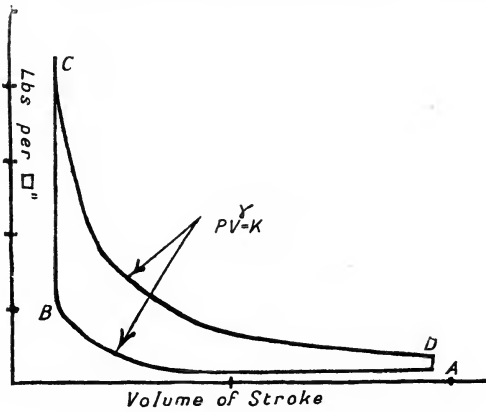

FIG. 54.

initial temperature and pressure. Such an ideal cycle does not consider (a) the thermal losses due to conduction and radiation through the cylinder walls, and (b) the changes, with temperature, of the properties of the working substance.

The efficiency of this cycle = $\frac{\text{Work done}}{\text{Heat taken in}}$

$$= \frac{\text{Heat taken in} - \text{Heat given out}}{\text{Heat taken in}} = \frac{K_v t - K_v \left[t_0 + \frac{t}{r^{\gamma-1}} - t_0 \right]}{K_v t}$$

$$= 1 - \left(\frac{1}{r} \right)^{\gamma-1}$$

where K_v = specific heat at constant volume.

The value of γ for air = 1.408.

The temperature of the products of combustion at D, that is, at the commencement of the exhaust stroke, is $\left[t_0 + \frac{t}{r^\gamma - 1} \right]$, and therefore a large value of the compression ratio encourages an economical use of the fuel. The maximum value of r is limited, however, by the maximum pressure reached during the combustion of the working substance, a large value of r greatly increasing the size, weight, and initial cost of the engine.

From the point of view of fuel economy, the employment of a heavy, strong engine, which has a large compression ratio, is to be encouraged. To prevent pre-ignition of the petrol mixture, the temperature at the end of the compression stroke should be less than 700°C . Pre-ignition is encouraged by the presence of hot particles of carbon or drops of lubrication oil on the cylinder walls, and for this reason the cylinders of aerial engines are thoroughly examined and cleaned at frequent periods. Compression ratios common in aerial engines vary from $3\frac{1}{2}$ –5.

The Horse-Power developed by an Engine.—The work done per stroke is the product of the thermal efficiency of the engine and the heat of combustion supplied at each working stroke.

Let the thermal efficiency of the engine be denoted by η . Also if V = stroke volume in cubic feet,

let λV = volume of the mixture drawn in per stroke, measured at the pressure and temperature of the atmosphere, and h = heating value of a cubic foot of this mixture measured at the same temperature and pressure,

then the work done during the working stroke = $\eta \cdot \lambda \cdot V \cdot h$, and the mean effective pressure during the stroke = $\eta \cdot \lambda \cdot h$.

The Volumetric Efficiency λ .—The value of the volumetric efficiency is always less than unity, and this may be chiefly attributed to the following causes:—

(a) The incoming mixture has its temperature increased by contact with the hot cylinder walls and valves, and also by further contact with the high-temperature exhaust gases of the clearance spaces.

(b) The pressure within the cylinder is lower than the atmospheric pressure.

(c) By virtue of the drop of pressure at the supply valve, usually about 2 lbs. per square inch, work is done upon the mixture as it passes from the supply pipe to the cylinder. This

work is proportional to the square of the mixture velocity at the valve opening, and may be lessened by an increase in the area of the valve opening.

(d) To enable the frictional resistance of the valve and pipes to be overcome, work is performed upon the incoming mixture, and this work increases the temperature of the mixture.

A Consideration of h .—The heating value h of a cubic foot of the mixture depends partly upon its density, and therefore upon the temperature and pressure. The fluctuation of h with the altitude of the engine is a question of importance. The pressure of the air at a height of x feet $= P_0 e^{-\frac{x}{26250}}$, where P_0 is the pressure at the earth's surface. It follows, then, that at a height of 5000 feet the pressure may be reduced by about 18 per cent. Usually the air is warmed before passing through the carburettor, so that any fall of temperature with altitude is of less consequence. Assuming that the absolute temperature of the air varies as (pressure)²⁸—that is, the ordinary adiabatic relation,—the fall in the absolute temperature at a height of 5000 feet would be about 7 per cent. Now, h varies as the ratio of pressure to absolute temperature, and hence the value of h at a height of 5000 feet would be about 13 per cent. less than its value at the earth's surface.

Considerations of η .—We may express the thermal efficiency of an actual engine by $R \left[1 - \left(\frac{1}{r} \right)^{\gamma} \right]$, where R , the relative efficiency, is defined as the ratio of the actual efficiency of the engine to the efficiency of an ideal engine working with the same compression ratio. We shall base the following investigation into the dependence of η upon the size of the engine, upon the assumption that the heat loss furnishes a criterion of the work wasted per stroke. The losses due to conduction of heat through the cylinder walls of similar engines are proportional to the area, whilst the radiation losses are a function of the cylinder volume. Hence, in similar engines, the heat losses may be conveniently expressed by $a_1 L^2 + b_1 L^3$, where a_1 and b_1 are constants and L is the linear scale of the engine. The ratio of the heat dissipated during the working stroke to the total heat of combustion is then proportional to $\frac{a_1}{L} + b_1$. If R_0 represent the relative

efficiency of an engine of which the cylinder walls are impervious to heat flow (this is not an ideal engine), the relative efficiency of a similarly designed engine, but with conducting walls, may be expressed by $R_0 \left[1 - \frac{a}{L} - b \right]$. The experimental value of R_0 is about .8. It is apparent, then, that the proportionally greater heat loss during the working stroke of a small engine will affect adversely the value of η .

Mechanical Efficiency.—The frictional losses in similar engines which are run at the same piston speed are proportional to area, since the pressure between similar parts and the velocity of rubbing between these parts have constant values. The pump losses are also proportional to area, and hence both the frictional and pump losses of similar engines may be accounted for by a constant reduction from the mean effective pressure. The mechanical efficiency of an engine depends greatly upon the workmanship and the method of lubrication employed. It is a matter of common experience that an engine gives smoother running and a higher mechanical efficiency when it has been “warmed up,” and this is probably due to the lower viscosity of the lubricant at the higher temperature. Forced lubrication ensures a steady supply of lubricating oil at a constant temperature, with the maintenance of an oil film of sufficient viscosity between the bearing surfaces, and these advantages more than compensate for the additional cost of the engine. The feeding-in of lubricating oil by centrifugal force, a characteristic of many air-cooled engines, is usually a most wasteful process, and does not encourage a uniform supply of lubricant to the vital working parts of the engine.

Engine Cooling.—The necessity for efficient cooling of the cylinder walls is manifest when we consider that a temperature of 2000° C. is probably reached during the combustion of the petrol mixture. The pre-ignition of a fresh charge can only be prevented if the temperature of the cylinder walls be below 700° C. The temperature and density of the gas have maximum values at the commencement of the working stroke, and to keep the temperature of the inside of the cylinder walls within safe limits, by the maintenance of a great heat flow, the cooling of the cylinder head must be very efficient. Usually air-cooling depends upon the position and speed of the engine, and hence

cannot ensure uniform cooling of the working parts. Moreover, any unequal expansion of the cylinder walls, due to a lack of uniformity in cooling, introduces frictional losses between the piston and cylinder walls.

The lightness of air-cooled engines is only attained with a sacrifice of reliability, and, furthermore, in rotary engines such as the Gnome, to overcome the air resistance created by the rotating cylinders, there is a further sacrifice of the engine-power.

Dependence of the Ratio $\frac{\text{Engine Weight}}{\text{Horse-power}}$ upon (a) Size of Cylinder, (b) Piston Speed.—We now propose to compare the performances of engines built from the same drawings but to different linear scales when running at the same piston speed. Assume, further, that the same strength of mixture is employed, and that similar engines have the same efficiency. The latter assumption will need further qualification.

The horse-power of a four-cycle petrol engine is equal to
$$\frac{\text{Mean effective pressure} \times \text{Piston area} \times \text{Piston velocity}}{4 \times 33,000}$$

Under the above conditions, the horse-powers of similar engines will vary as area—that is, as L^2 . It is interesting to note that the Royal Automobile Club Taxation Rule is $\text{H.P.} = 4D^2$, where D , the bore, is measured in inches.

The inertia forces of the rotating masses vary as $\frac{\text{Mass} \times (\text{Piston velocity})^2}{\text{Linear dimension}}$ —that is, as L^2 ; and those of reciprocating masses vary as $(\text{Mass} \times \text{Acceleration})$ —that is, as L^2 ; and therefore the stresses in like parts of similar engines, due to inertia forces, have constant values. In addition, the stresses in like parts due to the gas pressures have also constant values, and hence from such considerations similar engines have the same factor of safety.

Under the above conditions, the ratio $\frac{\text{Weight}}{\text{Horse-power}}$ then varies as L .

The foregoing discussion needs to be modified if we consider the decrease in the efficiency of a small engine due to the proportionally greater heat loss during the working stroke.

The data furnished below were obtained from a test upon a 72.5 H.P. Renault engine. We desire to find the probable

values of (a) $\frac{\text{Weight}}{\text{Horse-power}}$ ratio, and (b) $\frac{\text{Fuel}}{\text{B.H.P. hour}}$ ratio, of an engine of the same B.H.P. and piston speed, but a larger number of smaller cylinders.

THE FIRST RENAULT ENGINE.

Bore = 3.8 inches. Stroke = 4.75 inches. No. of cylinders = 8.

$$\text{B.H.P.} = 72.5. \quad \frac{\text{Weight of engine}}{\text{B.H.P.}} = 5.25 \text{ lbs.}$$

Piston speed = 1420 feet per minute. Efficiency $\eta = .77$.

Mean effective brake pressure = 76.4 lbs. per square inch.

Petrol consumption per B.H.P. hour = .665 lb.

THE SECOND RENAULT ENGINE.

For the purpose of illustration we shall assume that the bore of each cylinder = $\frac{3.8}{2} = 1.9$ inches, and since the cylinders are similar the stroke = $\frac{4.75}{2} = 2.375$ inches.

The value of η may be expected to be about .50, and \therefore Mean effective brake pressure ($\eta \cdot \lambda \cdot h$)

$$= \frac{.50}{.77} \times 76.4 = 49.5 \text{ lbs. per square inch.}$$

$$\text{H.P. per cylinder} = \frac{49.5 \times \pi(1.9)^2 \times 1420}{4 \times 4 \times 33,000} = 1.51,$$

so that the number of cylinders = $\frac{72.5}{1.51} = 48$.

$$\text{The ratio } \frac{\text{Weight of engine}}{\text{B.H.P.}} = \frac{5.25}{8} \times \frac{1}{2^3} \times \frac{48}{1} = 3.9 \text{ lbs.}$$

$$\text{Fuel used by the engine} = \frac{.75}{.50} \times .665 = 1 \text{ lb. per B.H.P. hour.}$$

We thus see that the saving of $\left[\frac{5.25 - 3.9}{5.25} \right] 100 = 25.7$ per cent. in the $\frac{\text{Weight of engine}}{\text{B.H.P.}}$ ratio is only accomplished by the large increase of $\left[\frac{1 - .665}{.665} \right] 100 = 50$ per cent. in the $\frac{\text{Petrol}}{\text{B.H.P. hour}}$ ratio.

(b) **Piston Speed.**—An increase in the piston speed V will be accompanied by a rise in the temperature of the engine, since the heat of combustion has less time to escape from the cylinder. Also, if the cylinder be very hot η has a high value and λ a low value. The maximum value of the piston velocity is limited by a consideration of the inertia stresses of the reciprocating and rotating masses, and, obviously, these stresses have to be taken in conjunction with those dependent upon the pressure of the burning gas. The whipping of the connecting rod of a high-speed engine may introduce large bend-

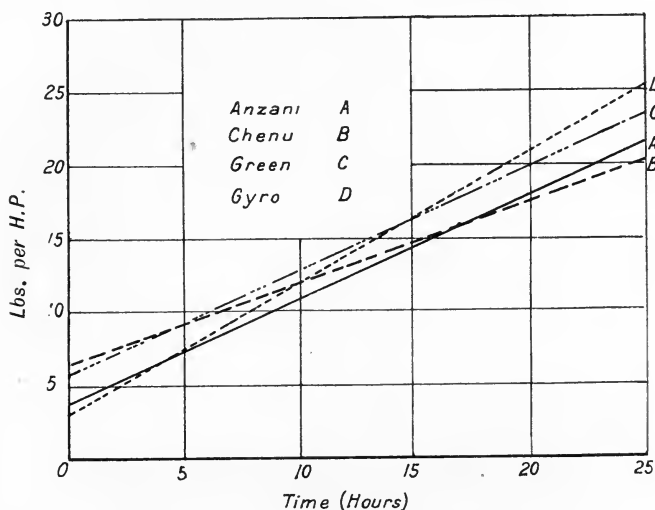

FIG. 55.

ing-moment stresses. Furthermore, the great wear and tear between the moving parts of a high-speed machine are not favourable to smoothness nor reliability of running.

The Weight of an Engine.—By the weight of an engine we mean the sum of the weights of all the parts, such as flywheel, silencer, fuel and lubrication reservoirs, cooling water, radiators, piping, etc., which are essential for a prolonged run. The weights of fuel and of lubricating oil carried by an aeroplane are not included in the engine weight. A factor of great importance to the aeronaut is the sum of the weights of the engine and of the fuel and lubricating oil which must be carried for a flight of known duration. The curves of fig. 55 have been

plotted from the data of Table XII., and give for several well-known engines the sum of the weights of the engine and of the fuel and lubricating oil consumed during a flight of known time. The weights are measured per B.H.P. of the engine. From these curves it is apparent that the fuel economy is practically unimportant for a short-distance flight, whilst on the other hand, a strong, heavy engine, with a good fuel and oil economy, is most suitable for a long-distance one.

TABLE XII.

Name of Engine.	Weight of Engine. Lbs.	B.H.P. at 1200 Revolutions per Minute.	Weight of Engine per B.H.P. Lbs.	Fuel Consumption per B.H.P. Hour. Lbs.	Oil Consumption per B.H.P. Hour. Lbs.
Anzani	200	54·6	3·67	·526	·180
Green .	375	64·4	5·82	·590	·110
Gyro. .	160	52·2	3·06	·720	·170
Chenu .	466	73·1	6·38	·542	·005

It is of the greatest importance that the lightness of an engine should not be due to a weakening of the engine parts, but the design should be such as to favour a minimum number of light efficient working parts. The saving of weight which may be achieved by rotating the cylinders, and so adopting air cooling, has been dealt with elsewhere; although the detrimental effects of such a practice must not be ignored. Undue lightness in the piston and cylinder greatly interferes with the heat flow, so that pre-ignition may probably result from the high temperatures of these parts. An economic distribution of the stresses in the working parts by a judicious use of hollow shafts and rods, H-section connecting rods, etc., is a favourable method of reducing engine weight. Also, where possible, simply constructed engine parts should be employed.

Some idea of the materials employed in the construction of the principal parts of an aeronautical engine is given in Table XIII.

TABLE XIII.

Name of Engine Part.	Material and Design.
Cylinder	Cast iron (stationary engines). Nickel steel (rotary engines). <i>Nickel steel to be preferred.</i>
Cylinder jacket	Jacket may be : (a) integral with the body ; (b) steel, shrunk or welded on, nickel-plated or copper electrolytically deposited on the inside ; (c) aluminium. (a) is not to be recommended because of the unequal expansion of the cylinder and jacket.
Piston	Pressed steel. Steel. Semi-steel. Cast iron.
Piston rings	Cast iron.
Connecting rods	H-section chiefly—nickel steel, special steel, chrome vanadium steel, nickel chrome steel.
Crankshaft	Nickel chrome. Chrome vanadium steel.
Main bearings	Nickel steel. Special steel.
Crankcase	White metal between each crank. Ball bearings.
	Aluminium alloy.

General Remarks.—A water-cooled engine, if at the front of the machine, should be enclosed in a good stream-line casing, so that the power expended in overcoming air resistance, which may be considerable at a high velocity, may be reduced to a minimum. The air-cooling of an engine introduces a large air resistance, so that a reduction in the useful H.P. of the engine is inevitable. In the absence of a flywheel, the non-uniformity of torque of a well-balanced stationary motor may give rise to unpleasant vibrations.

The absence of chattering amongst the working parts of the valve mechanisms, and a silent exhaust-gas escape, are inestimable qualities of a land engine, but in view of the great noise created by the rotating propeller they are, more or less, of small importance in an aeronautical engine.

Where possible, the burnt gases and unburnt oil should be exhausted at a convenient place, so that the motor and machine may not present an unduly dirty appearance. The valves and vital working parts of the engine must be cleaned

frequently, so that accessibility to these parts is a factor to be considered.

The following classification of aeronautical engines has been suggested by J. S. Critchley, M.I.M.E. :—

Class (A).—Engines which retain the approved design of the automobile motor, but which have slight modifications in favour of an increase of reliability and mechanical strength, and a reduction of weight. This is the largest class, and includes the following well-known engines: (*a*) Green, (*b*) Wolseley, (*c*) E.N.V., (*d*) Mercédès, (*e*) Renault, (*f*) Gobron-Brillie, (*g*) Korting Brothers, (*h*) N.A.G., (*i*) Austro-Daimler, (*j*) Curtiss.

Class (B).—Engines characterised by a star-wise or a radial arrangement of cylinders. Engines of this class are: (*a*) Anzani, (*b*) R.E.P., (*c*) Salmson, (*d*) Sturtevant.

Class (C).—The design of this class of engine is essentially a complete departure from that of the preceding classes. These engines have the star-wise disposition of the cylinders of Class (B), but the cylinders themselves rotate, the crankshaft remaining stationary. The important rotary engines are: (*a*) Gnome, (*b*) Burlat, (*c*) Gyro, (*d*) Clerget.

Class (A).—A popular design of this class is the diagonal or V type of motor, in which the centre lines of the cylinders make 90° with each other. Furthermore, compactness and lightness are favourable characteristics of the V type of engine. The balance of an eight-cylinder V type of engine is thoroughly satisfactory, when the connecting rods of two opposite pistons are connected to the same pin of the crankshaft.

Class (B).—The economic distribution of stress is one of the fundamental reasons for the adoption of a star-wise arrangement of cylinders. Constancy of torque and smoothness of running are achieved by an increase in the number of cylinders. Also, by connecting all the pistons to the same crankpin, the crankarm and pin are continuously under maximum stress, and the efficient use of this material is ensured. When the cylinders are arranged in a vertical plane, the successful lubrication of the set of cylinders below a central horizontal plane is a matter of great difficulty. These lubrication difficulties may be successfully overcome by rotating the lower set of cylinders through 180° , about an imaginary axis passing through the crankshaft. We have now a two-throw crank

engine—that is, the two cranks are 180° apart—and the balance of such an engine is less perfect than when the cylinders were arranged uniformly in a vertical plane.

It is worthy of notice that a uniform series of impulses can only be obtained during a complete engine cycle—that is, two revolutions of the crankshaft—when the engine has an odd number of cylinders.

Class (C).—The motors of this class were designed to meet the special requirements of aeronautical engines. Undoubtedly the small value of the ratio $\frac{\text{Engine weight}}{\text{H.P.}}$ and the compactness

of this type of engine have only been achieved with a sacrifice in other important factors, such as fuel and oil economy, cooling, and, to a lesser extent, reliability. Nevertheless, the balance of these engines is exceptionally good, and the revolving cylinders perform adequately the functions of a flywheel. The Gnome engine, the most popular rotary engine, is described on p. 131.

Particulars of several well-known aeronautical engines are given in Table XIV.

TABLE XIV.

	Anzani.	Austro-Daimler.	Gnome.	Green.	Renault.	Salmson.	Wolsley.
Type	Radial	Vertical	Rotary	Vertical	V	Radial	V
Form of cooling	Air	Water	Air	Water	Air	Water	Water
Horse-power	100	120	100	100	100	200	30
Revs. per minute	1250	1200	1200	1200	1800	1250	1200
Number of cylinders	10	6	9	6	12	14	8
Bore	105 mms.	130 mms.	110 mms.	140 mms.	96 mms.	120 mms.	5 inches
Stroke	145 mms.	175 mms.	150 mms.	152 mms.	140 mms.	140 mms.	7 inches
Material	Cast iron	Cast iron	Steel	Steel	Cast iron	Steel	Steel
Method of attaching jacket	Electrolytic	..	Rubber ring	..	Brazed	Jointed
Material of jacket	Copper	..	Copper	..	Copper	Copper
Method of working of valves } Inlet	Auto	Rockers and push rods	Piston	Rockers	Direct	Copper Rockers and push rods	Copper Rockers and push rods
Method of working of valves } Exhaust	Rockers and push rods	Rockers and push rods	Rockers and push rods	Rockers	Direct	Rockers and push rods	Rockers and push rods
Carburettor	Zenith	A.D.	Gnome	Zenith	Claudel
Magneto	Gibaud	Bosch	Bosch	Bosch	..	Bosch	Bosch
Lubrication	Pump	Forced	Pump	Fully forced	Forced to crankshaft bearings and splash	Pump	Forced to crankshaft bearings and splash

The Salmson Engine (Canton-Anné System).—This engine is water-cooled. The water circulation is maintained by a centrifugal pump driven by gearing, which draws the water through the radiators and forces it through the cylinder jackets

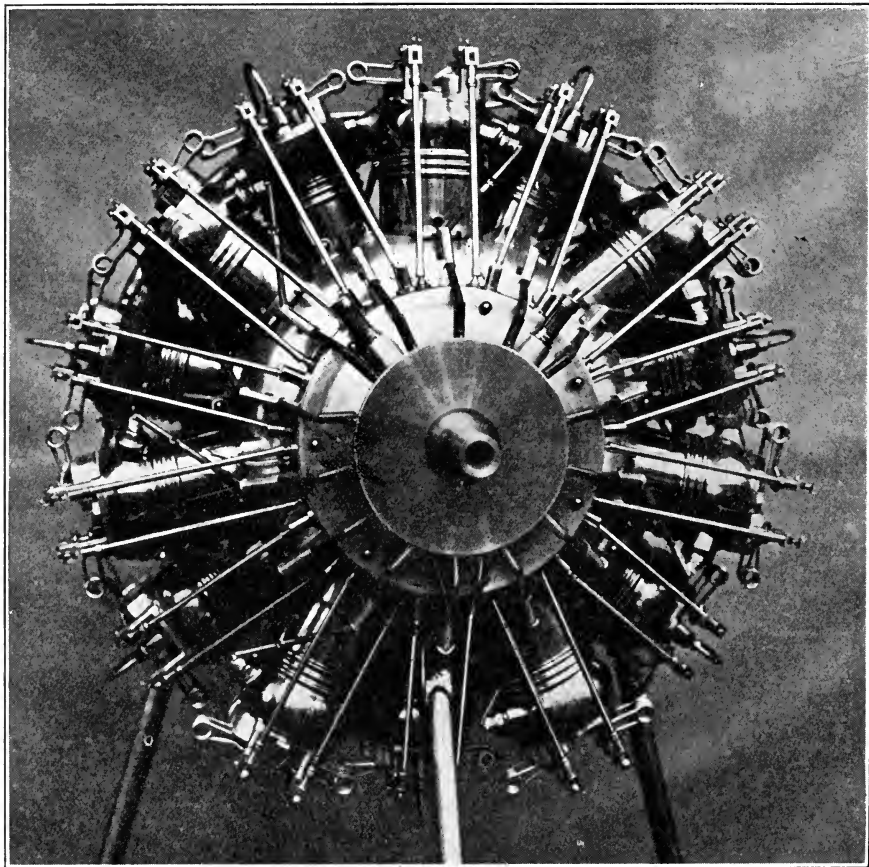

FIG 56 —200 H.P. Salmson engine.

from bottom to top. When the engine is in motion the momentum and perfect balance of the moving parts are sufficient to keep the engine running steadily, even when the propeller is removed.

The cylinders are of forged steel, machined all over. The water jackets are of spun copper, brazed on. The bottoms of the cylinders have two openings in which the valve bodies are

fixed. The pistons are of cast iron of a special quality, and are each fitted with three rings, and the resulting slight increase of weight is fully compensated for by the greater reliability of the engine.

The connecting rods are made from high-grade steel, machined all over, fitted with phosphor-bronze bushes. The connecting rods are connected to a central collar, which is carried on a crankpin by two ball-bearings. By means of a patent planetary gearing all the pistons have exactly the same stroke.

The casing is in two parts: one carries the brackets for fixing the engine, and the other the valve gear. These two parts, when bolted together, hold the cylinders in position, but in such a manner that the clamping of the cylinders does not produce any distortion.

The valves are of special steel, and are all mechanically operated. They are of large dimensions, and are held on their seats by double springs. These springs are so designed and arranged that their active parts are practically isolated from the hot parts of the cylinders. The valves are operated by means of push rods and rocking levers, bushes of tempered steel being fitted between the parts in contact.

The carburettor is automatic, and placed below the centre of the engine. A special heater is interposed between the carburettor and the induction pipe.

Ignition is obtained by a high-tension magneto, situated at the back of the engine.

Efficient lubrication is assured by a double oil-pump situated at the lower part of the engine. The first pump forces the oil under pressure into two single feeds, one of which leads to the centre of the crankshaft, which is hollow, and conducts the oil to the principal parts to be lubricated; the second to the valve gear. The oil which collects at the lower part of the engine is taken up again by the second pump and returned to the tank. The cylinders are arranged in such a way that the oil which flows along the walls cannot flood the lower cylinders.

The consumption of petrol is about $\cdot 6$ of a pint per B.H.P. hour, that of oil about 0.025 lb. per B.H.P. hour.

The number of revolutions may be varied from 300 r.p.m. to 1350 r.p.m.

The Gnome Engine.—This engine is the design of Laurent-

Sequin, and it is manufactured by the Gauthier Company. Each cylinder, with its radiator fin, is machined out of a solid bar of steel. The lower end of the cylinder fits in a corresponding hole in the crank chamber, and projects a short distance into the inside of the latter. The projection is provided with a groove, and a split locking-ring inserted in this groove completes the attachment of the cylinder to the crankcase. The hollow,

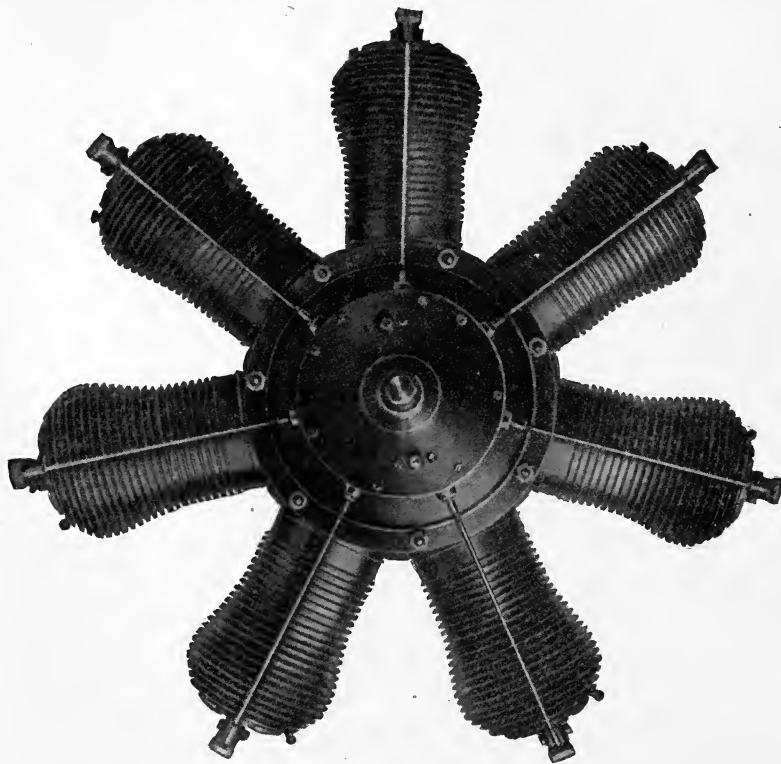

FIG. 57.—50 H.P. Gnome engine.

fixed crankshaft has a single throw, to which only one connecting rod is attached. The remaining connecting rods work on pins let through the big end of the main connecting rod. The explosive mixture is led from the carburettor through the hollow shaft into the crankcase, whence it is admitted into the cylinders by means of an automatic inlet valve placed in the head of the piston. The exhaust valves are on the cylinder head. A drip-feed lubricator is provided, which delivers the

oil into the centre of the crankcase, whence the lubricant is distributed to the cylinders by centrifugal force.

The 60 H.P. and also the 80 H.P. engines have each 7 cylinders.

The 100 H.P. engine may have either 9 or 14 cylinders.

The 160 H.P. engine has 14 cylinders.

The 200 H.P. engine has 18 cylinders.

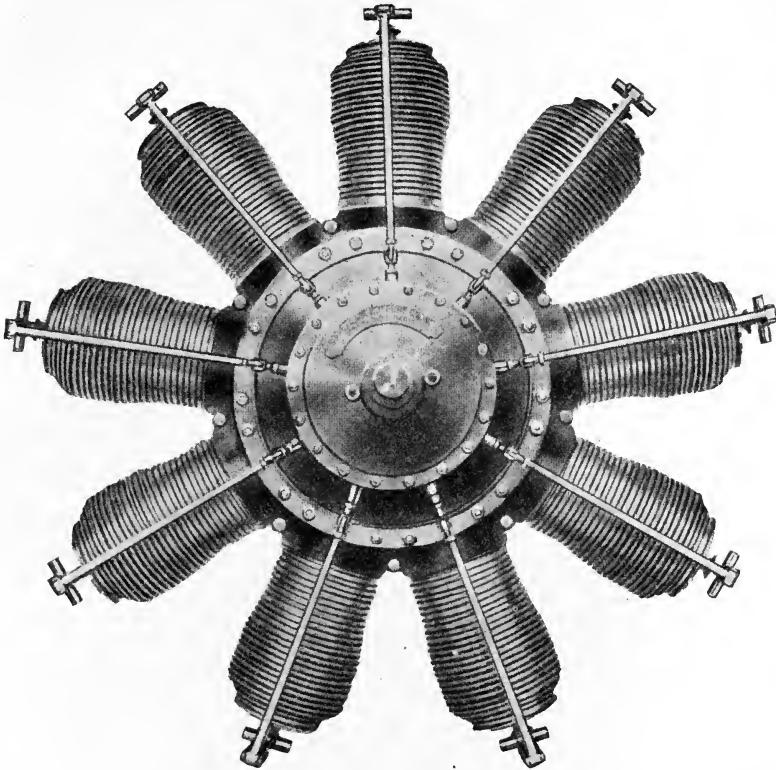

FIG. 58.—100 H.P. Gnome Engine.

The Green Engine.—The following is a brief description of the Green engine tested in the Alexander Prize Competition, 1911:—

The engine had four separately mounted cast-steel cylinders, machined inside and out, of 140 mms. bore, with a stroke of 146 mms. The water jacket consisted of a thin copper helmet, the joint with the cylinder at its lowest end was made by a rubber ring fitted into a groove in the cylinder, so that the

expansions of the cylinder and the jacket were independent. The cylinders were mounted on an aluminium crankcase. The valves were of the mushroom spring-closed type. Each valve was enclosed in a small dome, which had an orifice through which the valve was actuated by the end of a short tappet pin. The cam-shaft was carried in bearings in a small oil-tight horizontal casing, divided into halves, and was rotated by an encased vertical spindle situated in the front of the engine. This spindle was driven by a pair of worm-wheels from the crankshaft. The rocking levers were pivoted in extensions of the cam-shaft case, and their striking ends were provided with adjusting screws, and the ends operated by the cams with rollers.

The carburettor was of the Zenith make, with a separate float chamber.

The circulation in the jackets was maintained by a water-circulating pump, and the water was delivered to two spiral-tube radiators, placed obliquely, one on each side of the engine. The tubes were arranged two deep, and were staggered.

The main oil channel was cast solid with the crankcase, and oil was forced from this by a small-gear pump through leads at right angles, communicating directly with each of the hollow columns through which the holding-down bolts pass, and thence to the main bearings and the crankshaft, the latter being hollow. By this system it was possible to dispense with the use of separate pipes. The crankcase did not hold any appreciable quantity of oil, but the oil was pumped directly from an oil tank placed immediately under the crankcase.

INDEX.

- ABSOLUTE coefficients, 53.
Aerodynamic consideration of aeroplane wings, 16.
Aeroplane, behaviour of in a regular wind, 69.
 construction of, 31.
Ailerons, 32.
Air flow around a wing, 16.
 resistance of smooth wires, 6.
Airscrew (*see* Propeller), 89.
Alighting, 65.
Angle of incidence, 15.
Anzani engine, 128, 129.
Aspect ratio, 15, 24.
Atmospheric winds, 1.
Austro-Daimler engine, 128, 129.
Automatic stability, 73.
Avro biplane, 42.
 hydro-aeroplane, 43.
Axes of body, 75.
- BAIRSTOW, L., 71.
Balance of propeller, 99.
Biplane wings, 25.
Blériot monoplane, 45.
Body axes, 75.
 forms, comparison of, 11.
Bramwell, F. H., 91, 96.
Bristol 80 H.P. biplane, 36.
Bryan, G. H., 71.
Burlat engine, 128.
- CAMBER of a wing, 22.
Carburettor, 116.
Catastrophic instability, 80.
Centre of pressure, 19.
Chassis, 33.
Chord of a wing, 15.
Clerget engine, 128.
Climbing, 64.
Coefficient of kinematic viscosity, 5.
Comparison of forces acting upon similar bodies, 5.
 of body forms, 11.
 of similar machines, 55.
Compression ratio of an engine, 118.
Cooling of an engine, 122.
Crocco, 71.
Curtiss engine, 128.
- DIHEDRAL angle, 25.
Dipping front edge, 17.
Dope, 29.
Drag, definition of, 15.
 of wing—angle of incidence curve, 19.
Drzewiecki, S., 89, 101.
- END effects, 16.
Energy considerations, 9.
Engine weight, 125.
 material and design of, 127.
Engines, classification of, 128.
E.N.V. engine, 128.
Equilibrium of an aeroplane, 51.
- FABRIC, 28.
Farman biplane, 50.
Ferber, 71.
Fineness ratio, definition of, 13.
Flaps of wing, 32.
Four-stroke cycle, 114.
- GLIDING flight, 62.
Gnome engine, 128, 129, 131.
Gobron-Brillie engine, 128.
Grahame-White biplane, 50.
Green engine, 128, 129, 133.
Gust problem, 80.
Gusts, 87.
Gyro engine, 128.
Gyroscopic action, 99.
- HEATING value of fuel, 121.
Horizontal flight, 51.
Horse-power of an engine, 120.
Hydro-aeroplane, 35.
 motion on water of a, 68.
- IMPERFECT stream-line bodies in a viscid fluid, 10.
Inclined flight, 58.
Instability, longitudinal, 80.
- KORTING BROTHERS' engine, 128.
- LANCHESTER, F. W., 71, 101.
Lateral stability, 81.
Leading edge, 25.
Lift, definition of, 15.

- Lift of a wing—angle of incidence curve, 19.
- Line squalls, 2.
- Longitudinal instability, 80.
stability, 75.
- MAGNETOS, 116.
- Maximum ordinate, position of, 23.
- Mechanical efficiency of engine, 122.
- Mercédès engine, 128.
- N.A.G. engine, 128.
- Nieuport monoplane, 45.
- OTTO cycle of an engine, 114.
- PERFORMANCE curves of an aeroplane, 53.
- Phugoid oscillations, 81.
- Pitch of an airscrew, 90.
- Pitching, 75.
- Pitot and static pressure tube, 3.
and suction tube, 4.
- Pressure distribution around a wing-tip, 18.
upon square plates, 5.
- Propeller, balance of, 99.
calculation of stresses in a, 108.
description of, 89.
design of, 101.
flow of air around a, 97.
gyroscopic action of, 99.
performance of, 91.
position of, 98.
terms, 90.
theory, 94.
- RAPID oscillations of an aeroplane, 80.
- Ratio of engine weight to horse-power, 123.
- Reflex curvature towards the trailing edge, 26.
- Relative importance of the two surfaces of a wing, 21.
- Renault engine, 124, 128, 129.
- R.E.P. engine, 128.
- Resistance of smooth wires, 6.
- Rolling oscillations, 75, 87.
- SALMSON engine, 128, 129, 130.
- Shock absorbers, 34.
- Slip, 90.
- Sopwith Bat-boat, 39.
- 100 H.P. hydro-aeroplane, 42.
- Spar, main or front, 27.
- Spiral glide, 86.
instability, 86.
- Stability, automatic, 73.
definition of, 71.
lateral, 81.
longitudinal, 75.
- Starting, 65.
- Stream-line bodies, 8.
flow, 10.
- Struts, 12.
material of, 14.
- Sturtevant engine, 128.
- THERMAL efficiency of engine, 121.
- Trailing edge, 25.
- Turning, 66.
- Two-stroke cycle, 115.
- UNDERCARRIAGE of an aeroplane, 33.
- VARIABLE-SPEED machine, 22.
- Vickers biplane, 47.
- Volumetric efficiency of an engine, 120.
- WARPING, 32.
- Wight hydro-aeroplane, 47.
- Wind velocity, 3.
- Winds, 1.
- Wing, air flow around, 16.
design and construction, 26.
- Wings, 15.
of a biplane, 25.
- Wires, air resistance of smooth, 6.
- Wolsley engine, 128, 129.
- Woods used for struts, 14.
- YAWING oscillations, 75, 87.

**CHARLES GRIFFIN & COMPANY,
LIMITED.**

**A SELECTION FROM
CHARLES GRIFFIN & CO.'S
Scientific and Technical Publications.**

FULL DETAILED CATALOGUE ON APPLICATION.



MESSRS. CHARLES GRIFFIN & COMPANY'S PUBLICATIONS may be obtained through any Bookseller in the United Kingdom, or will be sent on receipt of a remittance to cover published price and postage. To prevent delay, Orders should be accompanied by a Cheque or Postal Order crossed "UNION OF LONDON AND SMITH'S BANK, Chancery Lane Branch."

Telephone—
1634 City.

LONDON:

Telegrams—
Explanatus.

12 EXETER STREET, STRAND.

M.T. 32. 2-xiv.

GRIFFIN'S ENGINEERING PUBLICATIONS.

SCIENCE AND INDUSTRY: THEIR CO-OPERATION. By S. R. ILLINGWORTH, A.R.C.Sc. &c. In Pocket Size, Leather,	net.	1s 6d
DESIGN OF STRUCTURES (Bridges, Roofs, &c.). By S. ANGLIN, C.E. FIFTH EDITION, Revised,		16s 0d
THE DESIGN OF BEAMS, GIRDERS, AND COLUMNS in Machines and Structures. By W. H. ATHERTON,	net.	6s 0d
BRIDGE CONSTRUCTION (Practical Treatise on). By Prof. C. FIDLER, M.Inst.C.E. FOURTH EDITION, Revised,		30s 0d
REINFORCED CONCRETE (Principles and Design). By R. and R. COULSON,	At Press.	
CONSTRUCTIONAL STEELWORK. By A. W. FARNSWORTH,	net.	10s 6d
DOCK ENGINEERING. By BRYSSON CUNNINGHAM. SECOND EDITION. With Folding Plates and other Illustrations,	net.	30s 0d
HARBOUR ENGINEERING. By BRYSSON CUNNINGHAM. In Large 8vo. Cloth. Profusely Illustrated,	net.	16s 0d
DOCK AND HARBOUR ENGINEER'S REFERENCE BOOK. In Pocket Size, Leather. Fully Illustrated. By BRYSSON CUNNINGHAM.	net.	7s 6d
HYDROGRAPHIC SURVEYING. By Commander S. MESSUM, R.N.,	net.	12s 0d
COAST EROSION AND PROTECTION. By E. R. MATTHEWS,	net.	10s 6d
HYDRAULIC POWER AND HYDRAULIC MACHINERY. By Prof. H. ROBINSON, M.Inst.C.E. THIRD EDITION, Revised,	net.	25s 0d
MODERN PUMPING AND HYDRAULIC MACHINERY. By ED. BUTLER, M.I.Mech.E.,	net.	18s 0d
PUMPING MACHINERY (Steam and Water Pressure). By HENRY DAVEY, M.Inst.C.E. SECOND EDITION,	net.	21s 0d
WATER SUPPLY: Selection of Sources and Distribution. By R. E. MIDDLETON, M.Inst.C.E., &c. With Plates and other Illustrations,	net.	8s 6d
SEA WATER DISTILLATION. By FRANK NORMANDY,	net.	6s 0d
THE THEORY OF THE STEAM TURBINE. By ALEX. JUDE. SECOND EDITION,	net.	18s 0d
GAS, OIL, AND AIR ENGINES. DONKIN, GRAVES SMITH, and BURSTALL. FIFTH EDITION,	net.	25s 0d
INTERNAL COMBUSTION ENGINES. By C. W. ASKLINS and E. ROESLER, M.E.,	net.	12s 6d
EVOLUTION OF THE INTERNAL COMBUSTION ENGINE. By EDWARD BUTLER,	net.	8s 6d
THE GAS TURBINE (Construction and Working of Two Actual Machines). By H. HOLZWARth and A. P. CHALKLEY,	net.	7s 6d
SUCTION GAS PLANTS. By Prof. C. A. SMITH. SECOND IMPRESSION,	net.	5s 0d
OIL MOTORS: Their Development, Construction, and Management. By G. LIECKFELD. In Handsome Cloth. Fully Illustrated,	net.	15s 0d
BOILERS, LAND AND MARINE. By T. W. TRAILL. FOURTH EDITION, net.	10s 6d	
STEAM BOILERS: Their Defects, Management, and Construction. By E. D. MUNRO. FOURTH EDITION,	net.	4s 6d
SMOKE ABATEMENT. By WM. NICHOLSON, Chief Smoke Inspector to the Sheffield Corporation. With 59 Illustrations,	net.	6s 0d
LUBRICATION AND LUBRICANTS. By L. ARCHBUTT and R. M. DEELEY. THIRD EDITION, Thoroughly Revised,	net.	25s 0d
EMERY GRINDING MACHINERY. By R. B. HODGSON, A.M.Inst.C.E. Fully Illustrated,	net.	5s 0d
INVESTIGATIONS ON THE POWER REQUIRED IN ROLLING MILLS. By J. PUPPE,	net.	12s 6d
LOCOMOTIVE ENGINEERING. By W. F. PETTIGREW, M.Inst.C.E. THIRD EDITION, Revised throughout. New Illustrations,	net.	21s 0d
LOCOMOTIVE COMPOUNDING AND SUPERHEATING. By J. F. GAIRNS,	net.	8s 6d
LIGHT RAILWAYS at Home and Abroad. By W. H. COLE, M.Inst.C.E.,	net.	16s 0d
MECHANICAL DRAWING. By J. E. JAGGER, M.Sc. SECOND EDITION, net.	7s 6d	
MECHANICAL ENGINEERING FOR BEGINNERS. By R. S. McLAREN. Cloth. With 126 Illustrations. SECOND EDITION,	net.	5s 0d
BONUS TABLES: for the Calculation of Wages on the Bonus System. By H. A. GOLDING, A.M.Inst.M.E.,	net.	7s 6d
THE CALCULUS FOR ENGINEERS AND PHYSICISTS. By Prof. R. H. SMITH, A.M.Inst.C.E., &c. SECOND EDITION,	net.	7s 6d
MEASUREMENT CONVERSIONS (English and French). 43 Graphic Tables or Diagrams on 23 Plates. By Prof. R. H. SMITH, A.M.Inst.C.E., &c.,	net.	7s 6d
MATHEMATICS AND MECHANICS. By C. A. A. CAPITO, M.Sc.,	net.	12s 6d
PRACTICAL CALCULATIONS FOR ENGINEERS. By C. E. LARARD, A.M.Inst.C.E., &c., and H. A. GOLDING, A.M.Inst.M.E. THIRD EDITION, At Press.		
ELEMENTARY GRAPHIC STATICS. By W. J. CRAWFORD, D.Sc.,	net.	2s 6d
CALCULATIONS ON THE ENTROPY-TEMPERATURE CHART. By W. J. CRAWFORD,	net.	2s 6d
THE EFFECTS OF ERRORS IN SURVEYING. By HY. BRIGGS, M.Sc. In Crown 8vo. Cloth,	net.	5s 0d
VALVES AND VALVE GEARING. By CHARLES HURST. SIXTH EDITION, Revised and Enlarged,	net.	9s 0d

LONDON: CHARLES GRIFFIN & CO., LTD., EXETER STREET, STRAND.

GRIFFIN'S ENGINEERING PUBLICATIONS—Continued.

SCIENCE AND INDUSTRY: THEIR CO-OPERATION. By S. R. ILLINGWORTH, A.R.C.Sc., &c. In Pocket Size, Leather,	1s 6d
THE THERMO-DYNAMIC PRINCIPLES OF ENGINE DESIGN. By L. M. HOBBS,	4s 6d
ENGINEERING DRAWING AND DESIGN. By S. H. WELLS, Wh.Sc., &c. FIFTH EDITION. Vol. I.—Practical Geometry, Plane, and Solid,	4s 6d
Vol. II.—Machine and Engine Drawing and Design,	4s 6d
CIVIL ENGINEERING PRACTICE. By F. NOEL TAYLOR. 1,086 Illus.,	25s 0d
THE MAIN DRAINAGE OF TOWNS. By F. NOEL TAYLOR. Fully Illus.,	12s 6d
MODERN DESTRUCTOR PRACTICE. By W. F. GOODRICH. Fully Illus.,	15s 0d
ROAD MAKING AND MAINTENANCE. By THOMAS AITKEN. SECOND ED.,	21s 0d
DUSTLESS ROADS: TAR-MACADAM. By J. WALKER SMITH,	10s 6d
MODERN ROAD CONSTRUCTION. By FRANCIS WOOD, M.Inst.C.E.,	4s 6d
PETROL MOTORS AND MOTOR CARS. Comprising the Designing, Construction, and Working of Petrol Motors. By F. STRICKLAND. SECOND ED. <i>At Press.</i>	
MOTOR CAR MECHANISM AND MANAGEMENT. By W. P. ADAMS. Part I.—The Petrol Car. THIRD EDITION,	5s 0d
Part II.—Electrical Cars,	5s 0d
CARBURETTORS, VAPORISERS, AND DISTRIBUTING VALVES. By ED. BUTLER,	6s 0d
COMPENDIUM OF AVIATION. By Lieut.-Col. HOERNES. Pocket Size,	2s 6d
THE PROBLEM OF FLIGHT. By Prof. H. CHATLEY. SECOND EDITION,	10s 6d
THE FORCE OF THE WIND. By Prof. HERBERT CHATLEY, B.Sc. In Crown Svo. Cloth. Illustrated,	3s 0d
STRESSES IN MASONRY. By Prof. HERBERT CHATLEY, B.Sc. In Crown Svo. Cloth. Fully Illustrated,	3s 6d
BUILDING CONSTRUCTION IN EARTHQUAKE COUNTRIES. By A. MONTEL,	8s 6d
CENTRAL ELECTRICAL STATIONS (Design, Organisation, and Management). By C. H. WORDINGHAM, A.K.C. SECOND EDITION,	24s 0d
ELECTRICITY METERS. By H. G. SOLOMON,	16s 0d
TRANSFORMERS. By Prof. H. BOHLE and Prof. D. ROBERTSON,	21s 0d
ELECTRIC CRANE CONSTRUCTION. By C. W. HILL, A.M.I.C.E.,	25s 0d
ELECTRICAL PHOTOMETRY. By Prof. H. BOHLE, M.I.E.E. Fully Illus.,	10s 6d
ELECTRIC SMELTING AND REFINING. By Dr. W. BORCHERS. Translated by W. G. McMILLAN, F.I.C. SECOND EDITION,	21s 0d
ELECTRO-METALLURGY. By WALTER G. McMILLAN, F.I.C., F.C.S. THIRD EDITION, Revised and Enlarged by W. R. COOPER. Demy Svo.,	12s 6d
ELECTRICAL PRACTICE IN COLLIERIES. By Prof. D. BURNS, M.E. Cloth. FOURTH EDITION, Revised. With numerous Illustrations <i>At Press.</i>	
ELECTRICITY IN MINING. By SIEMENS BROS., Ltd.,	10s 6d
WIRELESS TELEGRAPHY. By GUSTAV EICHORN, Ph.D.,	8s 6d
TELEGRAPHIC SYSTEMS, and Other Notes. By ARTHUR CROTH, of the Engineer-in-Chief's Department, G.P.O. Illustrated,	5s 0d
ELECTRICAL RULES AND TABLES (A Pocket-book of). By JOHN MUNRO and Professor JAMIESON. NINETEENTH EDITION, Revised. Pocket size. Leather,	8s 6d
ELECTRICAL THEORY AND THE PROBLEM OF THE UNIVERSE. By G. W. de TUNZELMANN,	15s 0d
THE THEORY OF STATICS. By G. UDNY YULE. SECOND EDITION,	10s 6d

WORKS BY W. J. MACQUORN RANKINE, LL.D., &c.

CIVIL ENGINEERING (A Manual of). TWENTY-FOURTH EDITION,	16s 0d
A MANUAL OF APPLIED MECHANICS. EIGHTEENTH EDITION,	12s 6d
A MANUAL OF MACHINERY AND MILLWORK. SEVENTH EDITION,	12s 6d
A MANUAL OF THE STEAM ENGINE AND OTHER PRIME MOVERS. SEVENTEENTH EDITION,	12s 6d
A MECHANICAL TEXT-BOOK: A Simple Introduction to the Study of Mechanics. By Prof. RANKINE and C. E. BAMBER. FIFTH EDITION,	9s 0d
USEFUL RULES AND TABLES: For Architects, Builders, Engineers, Founders, Mechanics, Shipbuilders, Surveyors, &c. EIGHTH EDITION,	10s 6d

WORKS BY PROF. A. JAMIESON, M.Inst.C.E.

STEAM AND STEAM ENGINES (Advanced). SEVENTEENTH EDITION,	10s 6d
APPLIED MECHANICS AND MECHANICAL ENGINEERING. Vol. I.—Applied Mechanics, 6s. Vol. II.—Strength of Materials, 5s. Vol. III.—Theory of Structures, 6s. Vol. IV.—Hydraulics, 5s. Vol. V.—Theory of Machines, 7s 6d.	
HEAT ENGINES: STEAM, GAS, AND OIL (Elementary Manual of). THIRTEENTH EDITION, Revised and Enlarged,	3s 6d
MAGNETISM AND ELECTRICITY (Practical Elementary Manual of). NINTH EDITION, Revised and Enlarged,	3s 6d
APPLIED MECHANICS (Elementary Manual of). NINTH EDITION, Revised and Greatly Enlarged,	3s 6d

LONDON: CHARLES GRIFFIN & CO., LTD., EXETER STREET, STRAND.

FIFTH EDITION, Revised. In Large 8vo. Pp. i-xxiv + 511. With 255 Diagrams, Examples, and Tables, and a Chapter on Foundations. 16s.

THE DESIGN OF STRUCTURES:

A Practical Treatise on the Building of Bridges, Roofs, &c.

By S. ANGLIN, C. E.,

Master of Engineering, Royal University of Ireland, late Whitworth Scholar, &c.

CONTENTS.—Stresses and Strains.—Elasticity and Fatigue of Materials.—Properties of Materials as used in Structures.—Mechanical Laws relating to Stresses on Structures.—External Loads on Beams (supporting Forces).—Bending Moments for Fixed Loads.—For Moving Loads.—Shearing Forces on Beams.—Centre of Gravity and Moment of Inertia of Plane Surfaces.—Internal Stresses on Beams, Columns, and Long Struts.—Braced Girders.—Bollmann Truss.—Trapezoidal Truss.—Fink Truss.—Warren Girders.—Lattice Girders.—Linville Trusses.—Braced Girders with Curved Flanges.—Cranes.—Framework.—Arches.—Roofs.—Deflection of Girders.—Camber of Girders.—Connections.—Riveted Joints.—Punching, Drilling, and Rivetting.—Bridges, Loads, and Stresses; Foundations and Piers; Superstructure; Suspension Bridges.—Movable Bridges, Weight.—Wind Pressure on Structures.—Lifting Tackle.—Specifications.—Foundations of Buildings.—INDEX.

"We can unhesitatingly recommend this work not only to the Student, as the BEST TEXT-BOOK on the subject, but also to the professional engineer as an EXCEEDINGLY VALUABLE book of reference."—*Mechanical World*.

In Large Crown 8vo. Pp. i-xiv + 236. With 201 Illustrations. 6s. net.

AN INTRODUCTION TO THE DESIGN OF BEAMS, GIRDERS, AND COLUMNS IN MACHINES AND STRUCTURES,

With Examples in Graphic Statics.

By WILLIAM H. ATHERTON, M.Sc., M.I.MECH.E.

CONTENTS.—Introductory.—Applied Forces and Reactions.—Equilibrium of a Beam.—Stress, Strain, and Elasticity.—Strength of Rectangular Beams.—Applications.—Non-rectangular Beams.—Shearing Action in Beams.—Diagrams of Shearing Force and Bending Moment Strength of Rolled Joists.—Moment of Inertia.—Numerical Applications.—Experiments on Beams.—Deflection of Beams.—Types of Girders.—Braced Girders.—Stress Diagrams.—Strength of Columns.—INDEX.

"A very useful source of information. . . . A work which we commend very highly."—*Nature*.

FOURTH EDITION, Thoroughly Revised. Royal 8vo. Pp. i-xxx + 456. With 239 Illustrations in the Text, and 13 Lithographic Plates. Handsome Cloth. Price 30s.

A PRACTICAL TREATISE ON BRIDGE CONSTRUCTION:

Being a Text-Book on the Construction of Bridges in Iron and Steel.

FOR THE USE OF STUDENTS, DRAUGHTSMEN, AND ENGINEERS.

By T. CLAXTON FIDLER, M. INST. C. E.,

Late Prof. of Engineering, University College, Dundee.

CONTENTS.—Definitions.—The Opposition and Balance of Forces.—Bending Strain.—Graphic Representation of Bending Moments.—Comparative Anatomy of Bridges.—Combined or Composite Bridges.—Theoretical Weight of Bridges.—Deflection.—Continuous Girders.—Theoretical Strength of Columns.—Design and Construction of Struts.—Strength and Construction of Ties.—Strength of Iron and Steel and Stress in Bridges.—Load on Bridges.—Movable Load.—Parallel Girders.—Parallel Girders, Weight of Metal.—Parabolic Girders, Polygonal Trusses, and Curved Girders.—Suspension Bridges and Arches, Flexible and Rigid Construction.—Bowstring Girders.—Rigid Arched Ribs.—Continuous Girders and Cantilever Bridges.—Wind Pressures and Wind Bracing.—INDEX.

"The new edition of Mr. Fidler's work will again occupy the same CONSPICUOUS POSITION among professional text-books and treatises as has been accorded to its predecessors. SOUND, SIMPLE, AND FULL."—*The Engineer*.

LONDON: CHARLES GRIFFIN & CO., LTD., EXETER STREET, STRAND.

THIRD EDITION, *Thoroughly Revised and Enlarged.* Pp. i-xvi + 227.
 With 60 Plates and 71 other Illustrations. Handsome Cloth. 25s. net.

HYDRAULIC POWER AND HYDRAULIC MACHINERY.

By HENRY ROBINSON, M.INST.C.E., F.G.S.,

FELLOW OF KING'S COLLEGE, LONDON; PROF. EMERITUS OF CIVIL ENGINEERING,
 KING'S COLLEGE, ETC., ETC.

CONTENTS—Discharge through Orifices.—Flow of Water through Pipes.—Accumulators—Presses and Lifts.—Hoists.—Rams.—Hydraulic Engines.—Pumping Engines.—Capstans.—Traversers.—Jacks.—Weighing Machines.—Riveters and Shop Tools.—Punching, Shearing, and Flanging Machines.—Cranes.—Coal Discharging Machines.—Drills and Cutters.—Pile Drivers, Excavators, &c.—Hydraulic Machinery applied to Bridges, Dock Gates, Wheels and Turbines.—Shields.—Various Installations.—Meters.—INDEX.

"The standard work on the application of water power."—*Cassier's Magazine.*

Second Edition, Greatly Enlarged. Pp. i-xiv + 336. With Frontispiece,
 12 Plates, and 279 other Illustrations. 21s. net.

THE PRINCIPLES AND CONSTRUCTION OF PUMPING MACHINERY (STEAM AND WATER PRESSURE).

With Practical Illustrations of ENGINES and PUMPS applied to MINING,
 TOWN WATER SUPPLY, DRAINAGE of Lands, &c., also Economy
 and Efficiency Trials of Pumping Machinery.

By HENRY DAVEY, M.INST.C.E., M.INST.MECH.E., &C.

CONTENTS—Early History of Pumping Engines—Steam Pumping Engines—Pumps and Pump Valves—General Principles of Non-Rotative Pumping Engines—The Cornish Engine, Simple and Compound—Types of Mining Engines—Pit Work—Shaft Sinking—Hydraulic Transmission of Power in Mines—Electric Transmission of Power—Valve Gears of Pumping Engines—Water Pressure Pumping Engines—Water Works Engines—Pumping Engine Economy and Trials of Pumping Machinery—Centrifugal and other Low-Lift Pumps—Hydraulic Rams, Pumping Mains, &c.—INDEX.

"By the 'one English Engineer who probably knows more about Pumping Machinery than any OTHER.' . . . A VOLUME RECORDING THE RESULTS OF LONG EXPERIENCE AND STUDY."—*The Engineer.*

In Medium Svo. Cloth Pp. i-xvi + 473. With 345 Illustrations. 18s net.

MODERN PUMPING AND HYDRAULIC MACHINERY.

By EDWARD BUTLER, M.I.MECH.E.

CONTENTS.—Introductory Remarks.—Early Direct-acting Steam Pumping Engines.—Waterworks Pumping Engines, Rotary Class.—Waterworks Pumping Engines, Direct-acting Duplex Class.—Differential Non-rotative Pumping Engines.—Mine, Pumps, Force Pumps, and Sinking Pumps.—Suction and Delivery Valves.—Boring Appliances for Artesian Tube Wells.—Artesian Well or Borehole Plunger and Air-lift Pumps.—Appliances for Raising Petroleum from Artesian or Borehole Wells.—Boiler-feed and General Service Pumps.—Injectors, Jet Pumps, and Ejectors.—Vacuum and Condenser Pumps.—Hydraulic Power Pumps, Ram Pumps, and Steam, Air, and Gas-power Displacement Pumps.—Fire Pumps and High-speed Plunger Pumps.—Variable-delivery Pumps and Variable Transmission by Hydraulic Power.—Masseault, Rotary, Oscillating, and Wind-power Pumps.—Low-lift and High-lift Centrifugal Pumps.—Hydraulic Power Wheels.—INDEX.

"This work is a veritable encyclopædia . . . with excellent and abundant diagrams."—*Times Engineering Supplement.*

LONDON: CHARLES GRIFFIN & CO., LTD., EXETER STREET, STRAND.

In Medium 8vo. With over 800 Pages and over 1000 Illustrations.
Cloth. 25s. net.

A MANUAL OF CIVIL ENGINEERING PRACTICE,

Specially Arranged for the Use of Municipal and County Engineers.

By F. NOEL TAYLOR, CIVIL ENGINEER.

CONTENTS.—Ordnance Maps.—Chain Surveying.—Surveying with Angular Instruments.—Levelling.—Adjustment of Instruments.—Mensuration of Areas, Volumes, &c.—The Mechanics of Engineering, &c.—Beams.—Pillars, Stanchions and Shafting.—Design of Structure.—Arches.—Graphic Statics.—Materials of Construction.—Engineering Foundations.—Brickwork and Masonry.—Walls.—Constructional Carpentering.—Road Materials.—Road Construction.—Reinforced Concrete Construction.—Masonry Bridges and River Work.—Hydraulics.—Land Drainage.—Pumping Machinery and Stations.—The Use of Water-Power.—Main Drainage.—Sewage Disposal.—Royal Commission on Sewage Disposal.—Salford Sewage Works.—Sanitation, House Drainage and Disinfection.—Refuge Disposal.—Waterworks, Preliminary Considerations and Sources of Supply.—Construction, Filtration and Purification.—Water-works.—Distribution.—Chimneys, Brick and Steel.—Steel Construction; Stanchions, Rivets and Bolts.—Steel Construction; Beams and Girders.—Combined Structures in Iron and Steel.—Specification.—Electric Tramways.—Appendix.—INDEX.

"A veritable *vade mecum* . . . would prove an acquisition to the library of any Municipal Engineer."—*Surveyor*.

In Medium 8vo. Pp. i-xi + 313. With over 350 Illustrations. Cloth. 12s. 6d. net

THE MAIN DRAINAGE OF TOWNS.

By F. NOEL TAYLOR, Civil Engineer.

CONTENTS.—Maps, Plans, Sections, and Preliminary Considerations.—Principles of Hydraulics and Hydrostatics.—Calculations in reference to Design of Sewage Works.—Practical Construction, Trenches, and Tunnels.—Forms of Sewers.—Ventilation of Sewers.—Manholes, Lampholes, Storm Overflows, etc.—Pumping Sewage.—House Drainage.—Sewage Disposal from a Theoretical Standpoint.—Sewage Disposal Works.—Special Constructions.—TABLES.—INDEX.

"The Author may be congratulated on the production of a work that can safely be placed in the hands of students, and which will serve as a useful guide to the municipal engineer."—*Times*.

In Medium 8vo. Cloth. Pp. i-xvi + 278. With 116 Illustrations. 15s. net.

MODERN DESTROYER PRACTICE.

By W. FRANCIS GOODRICH, Assoc. Inst. C.E.,
F.I. San. Engrs., &c.

CONTENTS.—Some Alternative Methods of Refuse Disposal.—Representative Types of British Destroyers.—Systems of Charging Destroyers.—Destroyers combined with Sewage Works.—With Electricity Works.—Refuse Destruction in U.K.—Site.—Specifications.—Design and Operation.—Operative Costs.—Residuals.—Foreign and Colonial Practice.—INDEX.

"Well illustrated and thoroughly up-to-date . . . should be in the hands of every engineer who is responsible for destroyer design or maintenance."—*Surveyor*.

MODERN SEWAGE PURIFICATION.	G. B. KERSHAW.	[See page 23.
SEWAGE TREATMENT.	DUNBAR and CALVERT.	[,, 23.
TRADE WASTE WATERS.	WILSON and CALVERT.	[,, 23.
PRACTICAL SANITATION.	DR. GEO. REID.	[,, 23.
SANITARY ENGINEERING.	FRANCIS WOOD.	[,, 23.

LONDON : CHARLES GRIFFIN & CO., LTD., EXETER STREET, STRAND.

SEVENTEENTH EDITION. Thoroughly Revised and Re-set Throughout, and Greatly Enlarged. Large Svo. Cloth. Profusely Illustrated. Nearly 1000 Pages. 25s. net.

A MANUAL OF
MARINE ENGINEERING:
 COMPRISING THE DESIGNING, CONSTRUCTION, AND
 WORKING OF MARINE MACHINERY.

By **A. E. SEATON, M.I.C.E., M.I.Mech.E., M.I.N.A.**

CONTENTS.—General Introduction.—Resistance of Ships and Indicated Horse-power Necessary for Speed.—Marine Engines, their Types and Variations of Design.—Steam used Expansively.—Steam used after Expansion.—Turbines.—Efficiency of Marine Engines.—Engines, Simple and Compound.—Horse-power: Nominal, Indicated, and Shaft or Brake.—General Design and the Influences which effect it.—The Cylinder and its Fittings.—The Piston, Piston-Rod, Connecting-Rod.—Shafting, Cranks and Crank-Shafts, &c.—Foundations, Bedplates, Columns, Guides, and Framing.—Condensers.—Pumps.—Valves and Valve Gear.—Valve Diagrams.—Propellers.—Sea-Cocks and Valves.—Auxiliary Machinery.—Boilers, Fuel, &c.; Evaporation.—Boilers; Tank Boiler Design and Details.—Water-Tube Boilers.—Boilers; Construction and Detail.—Boiler Mountings and Fittings.—Fitting in Machinery.—Starting and Reversing of Engines, &c.—Weight and other Particulars of Machinery relating thereto.—Effect of Weight, Inertia, and Momentum; Balancing.—Materials used by the Marine Engineer.—Oil and Lubricants, Engine Friction.—Tests and Trials, their Objects and Methods. APPENDICES.—The Diesel and other Oil Engines, also Lloyd's Rules relating to.—Valve Gear.—Cottrell's Method of Constructing Inertia Curves.—Spare Gear, and B.O.T. and other Rules.—Boilers: B.O.T., Lloyd's, Admiralty, &c., &c., Rules relating to.—Electric Light, Rules.—Safety Valves, Rules.—Testing Materials, Rules, &c., &c.—INDEX.
 "A monumental work . . . up-to-date."—*Marine Engineer.*

ELEVENTH EDITION, Thoroughly Revised Throughout and Enlarged.
 Pocket-Size, Leather. 8s. 6d.

A POCKET-BOOK OF
MARINE ENGINEERING RULES AND TABLES,
 FOR THE USE OF
Marine Engineers, Naval Architects, Designers, Draughtsmen,
Superintendents and Others.

With various Lloyd's, B.O.T., Bureau Veritas, and German Government Rules.

By **A. E. SEATON, M.INST.C.E., M.I.MECH.E., M.I.N.A.,** AND
H. M. ROUNTHWAITE, M.I.MECH.E., M.I.N.A.

GENERAL CONTENTS.—Horse-powers.—Efficiency.—Resistance and Propulsion of Ships.—Triple *v.* Compound Engines.—Ratios of Cylinders.—Equivalent Mean Pressures.—Piston Speed.—Revolutions.—Stroke.—Diameter of Cylinders.—Ports, Pipes, and Passages.—Liners, Ends, and Covers.—Valve Boxes and Covers.—Cylinder Joints.—Relief Valves.—Receiver Safety Valves.—Drain Valves.—Receiver Columns.—Clearance.—Studs and Bolts.—Pistons and Rods.—Connecting-Rods.—Shafting.—Thrust Blocks.—Stern Tubes.—Bearings.—Framing.—Condensers.—Air Pumps.—Circulating, Feed, Bilge Pumps.—Levers and Links.—Slide Valves.—Valve Gear.—Reversing Gear.—Propellers and Paddles.—Sea Valves.—Pipe Arrangements.—Balancing, etc. of Engines.—Fuel and Combustion.—Evaporation.—Boilers, Material, Mounting.—Furnaces.—Internal Combustion Engines.—Chains and Ropes.—Strength of Material.—Bending Strains.—Expansion of Metals.—Melting Points.—Weight of Machinery, etc., etc.—INDEX.
 "The best book of its kind, both up-to-date and reliable."—*Engineer.*

In Large Svo. Handsome Cloth. With Frontispiece, 6 Plates,
 65 other Illustrations, and 60 Tables. 12s. 6d. net.

THE SCREW PROPELLER
 And other Competing Instruments for Marine Propulsion.

By **A. E. SEATON, M.INST.C.E., M.I.MECH.E., M.I.N.A.**

CONTENTS.—Early History of Marine Propellers.—Modern History of Propellers.—Resistance of Ships.—On Ship, Cavitation and Racing.—Paddle Wheels.—Hydraulic Propulsion.—The Screw Propeller: Thrust and Efficiency.—Various Forms of Propeller.—Number and Positions.—Blades, Number, Shape, etc.—Details of Screws.—Pitch of the Screw.—Materials.—Trials and Experiments.—INDEX.
 "Contains all that is useful to know about the screw propeller. . . . Thoroughly up-to-date."—*Steamship.*

LONDON: CHARLES GRIFFIN & CO., LTD., EXETER STREET, STRAND.

FIFTH EDITION, Revised and Enlarged. Pp. i-xxiii + 639. With 243 Illustrations. Large 8vo, Handsome Cloth. 25s. net.

A TEXT-BOOK ON GAS, OIL, AND AIR ENGINES.

BY BRYAN DONKIN, M.INST.C.E., M.INST.MECH.E.

Revised throughout by T. GRAVES SMITH. With important New Matter by Prof. BURSTALL.

CONTENTS.—*Part I. : Gas Engines.*—General Description of the Action and Parts of a Gas Engine.—Heat “Cycles” and Classification of Gas Engines.—History of the Gas Engine.—The Atkinson, Griffin, and Stockport Engines.—The Otto Gas Engine.—Modern British Gas Engines.—Modern French Gas Engines.—German Gas Engines.—Gas Production for Motive Power.—Utilisation of Blast-furnace and Coke-oven Gases for Power.—Theory of the Gas Engine.—Chemical Composition of Gas in a Cylinder.—Utilisation of Heat in a Gas Engine.—Explosion and Combustion *Part II. : Petroleum Engines.*—Discovery, Properties, and Utilisation of Oil.—Oil Testing, Carburetters, Early Oil Engines.—Working Methods.—The Priestman Engine.—Other British Oil Engines.—American Gas and Oil Engines.—French and Swiss Oil Engines.—German Oil Engines.—Applications of Gas and Oil Engines. *Part III. : Air Engines.*—Appendices.—INDEX.

“A very much up-to-date classic.”—*Daily Telegraph.*

In Handsome Cloth. Pp. i-x + 303. With Plate and 178 Illustrations. 12s. 6d. net.

Internal Combustion Engines and Gas Producers.

BY C. W. ASKLING, M.E., AND E. ROESLER, M.E.

CONTENTS.—The Method of Working of Internal Combustion Engines Compared with that of Other Heat-engines.—The Production, Preparation, Composition, and Qualities of the Fuels mostly employed in Gas or Oil Engines.—Producers with Accessories: General Principles of Design.—General Rules for the Care of Suction-gas Plants.—Producer Plants Built for Gas-power Purposes.—Principal Power-cycles of Internal Combustion Engines.—Gas Engines.—Oil Engines.—The Humphrey Gas Pump.—On Combustion.—Calculation of the Cylinder Dimensions.—The Working Economy of Combustion Engines.—Some Installations.—Reduction Factors.—INDEX.

“Internal combustion engineers will do well to add this volume to their library of text-books.”—*Gas and Oil Power.*

In Demy 8vo. Pp. i-xiv + 237. With Illustrations. 8s. 6d. net.

EVOLUTION OF THE INTERNAL COMBUSTION ENGINE.

BY EDWARD BUTLER, MECHANICAL ENGINEER.

GENERAL CONTENTS.—Introductory.—Caloric Engines—Constant-pressure Engines—Free-piston Engines.—Non-compression Engines.—Compression of Mixture.—Four-stroke Engines.—Removal of Inert Gases.—Two-stroke Engines.—Compound Explosion Engines, The Thermo-dynamics of Int. Comb. Engine.—Difficulties of the Turbine Principle.—Valves.—Mixing and Governing and Carburetting.—Ignition.—Starting and Reversing—Evolution of the Internal Combustion Engine.—Industrial Oil and Gas Engines.—Large-power Engines.—High-speed Engines.—Rotary and Revolving Cylinder Engines.—Single-sleeve or Liner Valves.—Cooling and Lubricating.—INDEX.

“The Author’s experience gives him excellent qualifications for the task he has undertaken. . . all who are interested in the practical working of combustion engines will find this volume interesting and worthy of a place on their bookshelf.”—*Mechanical Engineer.*

LONDON : CHARLES GRIFFIN & CO., LTD., EXETER STREET, STRAND.

By **ANDREW JAMIESON, M.Inst.C.E., M.Inst.E.E.**

SEVENTEENTH EDITION, Revised. With over 800 Pages, over 400 Illustrations, and 12 Plates. 10s. 6d.

A TEXT-BOOK ON
STEAM & STEAM ENGINES,
INCLUDING TURBINES AND BOILERS.

Specially arranged for the use of Engineers qualifying for the Institution of Civil Engineers, the Diplomas and Degrees of Technical Colleges and Universities, Advanced Science Certificates of British and Colonial Boards of Education, and Honours Certificates of the City and Guilds of London Institute, in Mechanical Engineering, and for Engineers generally.

GENERAL CONTENTS.—Early Forms of Steam Engine.—Temperature, Thermometry Pyrometry.—Quantity of Heat, Thermal Units, Tables, Calorimeters, Specific Heats of Gases and Steam.—Diffusion, Radiation, etc., of Steam, Ebullition of Water.—Nature of Heat, Conversion of Work into Heat, First Law of Thermodynamics, The B.T.U.—Sensible and Latent Heats of Water and Steam, Temperature and Pressure of Steam.—Pressure and Vacuum Gauges.—Evaporation and Condensation.—Jet and Surface Condensers.—Work.—Generation of Steam in a Closed Vessel.—Boyle's Law, Watt's Diagram of Work.—Charles's Law.—Absolute Zero.—Adiabatic Expansion.—Heat Engines, Carnot's Principle.—Entropy and Thermodynamics.—Lap and Lead of a Valve, Admission, Cut-off, etc.—Zeuner's Valve Diagrams.—Behaviour of Steam in a Cylinder.—Loss between Boiler and Cylinder.—Steam Jacketing.—Superheated Steam.—Cushioning.—Compounding.—Watt's, Crosby, and other Indicators, Indicator Diagrams.—Nominal and Indicated H.P., Brake H.P., Apparatus for finding H.P.—Crank, Connecting-rods, and other Moving Parts, Effect of Inertia of; Crank Effect Diagrams.—Stationary Engines.—Corliss Valve Gear.—Lubrication.—Willans' Engine.—Marine Engines.—Paddle Wheels.—The Screw Propeller, Pitch, Angle, Slip, Thrust, etc., etc.—Triple-Expansion Engines, Quadruple-Expansion Engines.—DETAILS OF ENGINE: Valves, Pistons, Crossheads, Bearings, etc., etc.—Pumps.—STEAM TURBINES: Definition, Types, Speed of Rotor, Steam Consumption, Stresses, Balancing, etc., etc.—Mathematical Explanation of Heat Units, Work done, etc., etc., as expressed for Ideal Steam Engines, with Special Reference to Turbines.—Examples of Types of Turbines.—BOILERS: Vertical, Horizontal; Cornish; Lancashire; Water Tube; Belleville; Yarrow, etc., etc.—Forced Draught.—Mechanical Stokers.—Materials in Boiler Construction.—Joints, Stays, etc.—The Locomotive Engine, Injectors, Compounding, Efficiency, etc.—APPENDICES.—INDEX.

. Contains many Board of Education and City and Guilds Questions and Answers also all the Inst. C.E. Exams. ever set, in *The Theory of Heat Engines*, up to time of publication.

"The best book yet published for the use of students."—*Engineer*.

"We consider the volume a splendid text-book for all readers."—*Marine Engineer*

NINETEENTH EDITION. Leather, Pocket Size, with 810 pages. 8s. 6d.

A POCKET-BOOK OF
ELECTRICAL RULES AND TABLES

FOR THE USE OF ELECTRICIANS AND ENGINEERS.

By **JOHN MUNRO, C.E., & PROF. JAMIESON, M.Inst.C.E., F.R.S.E.**

GENERAL CONTENTS.—Electrical Engineering Symbols.—B. of T. Standards of Measurement.—Units of Measurement.—Weights and Measures.—Testing.—Conductors.—Dielectrics.—Telegraphy.—Telephony.—Radio or Wireless Telegraphy.—Electro-chemistry and Metallurgy.—Röntgen Rays.—Batteries.—Dynamos and Motors.—Transformers.—Lighting.—Wiring Rules (Lighting and Tramways).—Miscellaneous.—Magnetic Measurements.—Logarithms.—INDEX.

"WONDERFULLY PERFECT. . . . Worthy of the highest commendation we can give it."—*Electrician*.

LONDON: CHARLES GRIFFIN & CO., LTD., EXETER STREET, STRAND.

By ANDREW JAMIESON, M.Inst.C.E., M.Inst.E.E.

INTRODUCTORY MANUALS.

THIRTEENTH EDITION, Revised and Enlarged. Pp. i-xvi + 425. 3s. 6d.

**AN ELEMENTARY MANUAL OF
HEAT ENGINES: STEAM, GAS AND OIL.**

Specially arranged for First Year Students under all Boards of Education, City and Guilds of London Institute, Colonial and other Engineering Students.

ABRIDGED CONTENTS.—Elementary Mensuration.—Weights and Measures.—Thermometry.—Heat.—Evaporation.—Ebullition.—Work.—Pressure and Temperature of Steam.—Properties of Gases.—The Parts of a Steam Engine.—Valves and their Setting.—Indicators.—Single and Compound Engines.—Details of Engines.—Valves and Fittings.—Condensers.—Crank Shaft, Bearings, etc., etc.—Boilers and Boiler Mountings.—Locomotives.—Turbines.—Gas Engines.—Oil Engines.—APPENDICES.—INDEX.

"This is the best elementary manual, and is indispensable."—*Steamship*.

TENTH EDITION, Thoroughly Revised and Enlarged. Pp. i-xix + 452. 3s. 6d.

**AN ELEMENTARY MANUAL OF
APPLIED MECHANICS.**

Specially arranged to suit those preparing for the Institute of Civil Engineers; Royal Institute of British Architects; City and Guilds of London Institute; British and Colonial Boards of Education, and all kinds of First-Year Engineering Students.

ABRIDGED CONTENTS.—Force.—Matter.—Scale and Vector Quantities.—Work, Units of Work.—Moment of a Force, Couples, etc., etc.—Practical Applications of the Lever, Balance, etc., etc.—The Principle of Work, Work Lost, Useful Work.—Pulleys, Blocks, etc., etc.—Wheel and Compound Axle.—Graphic Demonstration of Three Forces in Equilibrium.—Cranes.—Inclined Planes.—Friction.—Bearings.—Driving Belts.—Winch or Crab.—Jib Cranes.—Screws, Spiral, Helix, etc.—Whitworth Standard.—Backlash in Wheel and Screw Gearings.—Endless Screw and Worm Wheel, etc.—Screw-Cutting Lathe.—Hydraulics.—Hydraulic Machines.—Motion and Velocity.—Energy.—Properties of Materials.—Stresses in Chains, Shafts, etc., etc.—Universal Joints, Sun and Planet Wheels.—Reversing Motions.—Measuring Tools.—Limit Gauges.—APPENDICES.—INDEX.

"No better book on the subject has hitherto been published."—*Railway Official Gazette*.

EIGHTH EDITION, Thoroughly Revised and Enlarged. Pp. i-xv + 398. 3s. 6d.

**A PRACTICAL ELEMENTARY MANUAL OF
MAGNETISM AND ELECTRICITY.**

Specially arranged for the use of Science Teachers and Students in Great Britain and the Colonies, and for other Electrical Students.

ABRIDGED CONTENTS.—Magnets, Natural, Permanent.—Methods of making Magnets.—Lines of Force.—Molecular Theory of Magnetisation.—Magnetic Induction.—The Earth as a Magnet.—Mariners' Compass.—Units of Measurement.—Electrical Units.—Electro-Magnetism.—Magnetic Field due to a Current.—Solenoid.—Galvanometers.—Polarity due to Current.—Magnetisation by Electric Current.—Electro-dynamics.—Electro-magnetic Induction.—Ohm's Law.—Primary Batteries.—Conductors and Resistance.—Polarisation of a Cell.—Electrolysis.—Static Electricity.—Positive and Negative Electrification.—Conductors and Insulators.—Induction.—Charges on a Surface.—Frictional Machines.—Potential.—Condensers.—Leyden Jar.—Gold Leaf Electroscope.—Volts-meters.—APPENDICES.—INDEX.

LONDON: CHARLES GRIFFIN & CO., LTD., EXETER STREET, STRAND.

By **ANDREW JAMIESON, M.Inst.C.E., M.Inst.E.E.**

In Five Volumes. Large Crown 8vo. Each quite complete in itself,
and sold separately.

A TEXT-BOOK OF
**APPLIED MECHANICS
AND MECHANICAL ENGINEERING.**

Specially arranged for the use of Engineers qualifying for the Institute of Civil Engineers, the Diplomas and Degrees of Technical Colleges and Universities, Advanced Science Certificates of British and Colonial Boards of Education, and Honours Certificates of the City and Guilds of London Institute, in Mechanical Engineering, and for Engineers generally.

VOLUME I. NINTH EDITION, Revised and Enlarged. Pp. i-xviii + 400. 6s.

APPLIED MECHANICS.

CONTENTS.—Definitions of Matter and Work.—Diagrams of Work.—Moments and Couples.—Principle of Work applied to Machines.—Friction of Plane Surfaces.—Friction of Cylindrical Surfaces and Ships.—Work absorbed by Friction in Bearings, etc.—Friction usefully applied by Clutches, Brakes, and Dynamometers.—Inclined Plane and Screws.—Velocity and Acceleration.—Motion and Energy.—Energy of Rotation and Centrifugal Force.—APPENDICES.—INDEX.
"Indispensable to all students of engineering."—*Steamship*.

VOLUME II. EIGHTH EDITION, Revised and Enlarged. Pp. i-xviii + 314. 5s.

STRENGTH OF MATERIALS.

CONTENTS.—Stress and Strain, and Bodies under Tension.—Strength of Beams and Girders.—Deflection of Beams and Girders.—Strength of Shafts.—Strength and Elasticity of Materials.—Testing.—Stress-Strain Diagrams and Elasticity of Materials.—Strength and Elasticity of Columns.—APPENDICES.—INDEX.

"The author is to be congratulated upon the care he bestows in keeping his works systematically up to date."—*Practical Engineer*.

VOLUME III. EIGHTH EDITION, Thoroughly Revised. Cloth.

Pp. i-xviii + 260. 5s.

THEORY OF STRUCTURES.

CONTENTS.—Framed Structures.—Roof Frames.—Deficient Frames.—Cranes.—Beams and Girders.—APPENDICES.—INDEX.

"We heartily recommend this book."—*Steamship*.

VOLUME IV. EIGHTH EDITION, Revised. Pp. i-xvi + 324. 5s.

HYDRAULICS.

CONTENTS.—Hydrostatics.—Hydraulic Machines.—Efficiency of Machines.—Hydraulic Appliances in Gas Works.—Hydrokinetics.—Water Wheels and Turbines.—Refrigerating Machinery and Pneumatic Tools.—APPENDICES.—INDEX.

VOLUME V. EIGHTH EDITION, Revised. Pp. i-xx + 526. 7s. 6d.

THEORY OF MACHINES.

CONTENTS.—Locs and Point Paths.—Kinematic Pairs, Links, Chains, etc.—Crank and Parallel Motions.—Chains and Peaucellier Mechanisms, etc.—Kinematics, Centres, and Relative Velocities.—Miscellaneous Mechanisms.—Reversing and Return Motions, etc.—Efficiency of Machines.—Wheel Gearing and Electric Driving.—Friction and Wedge Gearing, with Power Transmitted.—Teeth of Wheels.—Cycloidal Teeth.—Involute Teeth, Bevel and Mortice Wheels, etc.—Friction and Strength of Teeth in Gearing.—Belt Rope and Chain Gearing.—H.P. Transmitted by Belt and Rope Gearing.—Inertia Forces of Moving Parts and Crank Effort Diagrams of Reciprocating Engines.—APPENDICES.—INDEX.

"So well known that we need only commend it to new readers as one of the most lucid and instructive text-books extant."—*Electrical Review*.

LONDON : CHARLES GRIFFIN & CO., LTD., EXETER STREET, STRAND.

WORKS ON ELECTRICAL ENGINEERING, TELEGRAPHY, ETC.

- CENTRAL ELECTRICAL STATIONS : Their Design, Organisation, and Management.** By CHARLES H. WORDINGHAM, A.K.C., M.Inst.C.E., M.I.Mech.E. SECOND EDITION, Revised. In large 8vo. Cloth. Profusely Illustrated. 24s. net.
- ELECTRICITY METERS.** By HENRY G. SOLOMON, A.M.Inst.E.E. In large Crown 8vo. Handsome Cloth. With 334 pages and 307 Illustrations. 16s. net.
- TRANSFORMERS.** By Prof. HERMANN BOHLE, M.I.E.E., and Prof. D. ROBERTSON, B.Sc., of Bristol. In large 8vo. Profusely Illustrated. 21s. net.
- ELECTRICAL PHOTOMETRY AND ILLUMINATION.** By Prof. HERMANN BOHLE, M.I.E.E. In Large 8vo. Cloth Fully Illustrated. 10s. 6d. net.
- ELECTRIC CRANE CONSTRUCTION.** By CLAUDE W. HILL, A.M.Inst.C.E., M.I.E.E. In Medium 8vo. Fully Illustrated. 25s. net.
- TELEGRAPH SYSTEMS AND OTHER NOTES.** By ARTHUR CROTCH, of the Engineer-in-Chiefs' Department, G.P.O. In Large Crown 8vo. Cloth. Illustrated. 5s. net.
- WIRELESS TELEGRAPHY.** By GUSTAV EICHHORN, Ph.D. In Large 8vo. Profusely Illustrated. 8s. 6d. net.
- ELECTRICITY IN MINING.** By SIEMENS BROTHERS DYNAMO WORKS, Ltd. In Crown Quarto. Cloth. 10s. 6d. net.
- ELECTRICAL PRACTICE IN COLLIERIES.** By D. BURNS, M.E., M.Inst. M.E. Crown 8vo. FOURTH EDITION, Revised. Cloth. With Numerous Illustrations. *At Press.*
- ELECTRIC SMELTING AND REFINING.** By Dr. W. BORCHERS and W. G. McMILLAN, F.I.C. SECOND EDITION, Revised and Enlarged. Illustrated. 21s. net.
- TREATISE ON ELECTRO-METALLURGY.** By W. G. McMILLAN, F.I.C., and W. R. COOPER, M.A., B.Sc. THIRD EDITION, Revised and Enlarged. 12s. 6d. net.
- ELECTRICAL THEORY AND THE PROBLEM OF THE UNIVERSE.** By G. W. de TUNZELMANN, B.Sc. In Large 8vo. Cloth. 15s. net.
- MAGNETISM AND ELECTRICITY (An Elementary Manual of).** By Prof. A. JAMIESON, M.Inst.C.E., M.I.E.E. EIGHTH EDITION. 3s. 6d.
- ELECTRICAL RULES AND TABLES (A Pocket-book of).** By JOHN MUNRO, C.E., and Prof. JAMIESON, M.Inst.C.E., M.I.E.E. NINETEENTH EDITION. 8s. 6d.

GRIFFIN'S NAUTICAL SERIES.

*** For further information regarding these Volumes consult Index.*

- A MANUAL OF ELEMENTARY SEAMANSHIP.** By D. WILSON-BARKER. SIXTH EDITION, Revised and Enlarged. Profusely Illustrated. Price 6s.
- NAVIGATION, PRACTICAL AND THEORETICAL.** By D. WILSON-BARKER and WILLIAM ALLINGHAM. THIRD EDITION, Revised. Fully Illustrated. Price 3s. 6d.
- MARINE METEOROLOGY, for Officers of the Merchant Navy.** By WILLIAM ALLINGHAM. Very fully Illustrated. Price 7s. 6d.
- PRACTICAL MECHANICS, Applied to the Requirements of the Sailor.** By THOS. MACKENZIE. THIRD EDITION, Revised. Price 3s. 6d.
- A MANUAL OF TRIGONOMETRY.** By RICHARD C. BUCK. FOURTH EDITION, Revised and Corrected. Fully Illustrated. Price 3s. 6d.
- A MANUAL OF ALGEBRA.** By RICHARD C. BUCK. SECOND EDITION. Price 3s. 6d.
- LATITUDE AND LONGITUDE : How to Find them.** By W. J. MILLAR, C.E. SECOND EDITION, Revised. Price 2s.
- LEGAL DUTIES OF SHIPMASTERS.** By BENEDICT W. GINSBURG. THIRD EDITION, Very Thoroughly Revised. Price 5s.
- A MEDICAL AND SURGICAL HELP. For Shipmasters and Officers in the Royal Navy.** By W. JOHNSON SMITH. FOURTH EDITION. Revised by ARNOLD CHAPLIN (of the P. & O. S. N. Coy.). Price 5s. net.

OTHER WORKS OF INTEREST TO SAILORS.

- NOTES ON THE PRACTICAL DUTIES OF SHIPMASTERS.** By Capt. W. HARRY WILKES. Price 2s. 6d. net.
- DEFINITIONS IN NAVIGATION AND NAUTICAL ASTRONOMY.** By P. GROVES SHOWELL. Price 2s. 6d. net.
- ENGLISH-SPANISH AND SPANISH-ENGLISH SEA TERMS AND PHRASES.** By Fleet-Paymaster GRAHAM-HEWLETT. Pocket Size. Price 3s. 6d. net.
- HYDROGRAPHIC SURVEYING.** By Commander S. MESSUM. With Coloured Plates and Numerous other Illustrations. Price 12s. net.
- THE PREVENTION AND TREATMENT OF DISEASE IN THE TROPICS.** By E. S. CRISPIN, M.R.C.S. In Cloth. Price 1s. net.

LONDON : CHARLES GRIFFIN & CO., LTD., EXETER STREET, STRAND.

MINING AND GEOLOGICAL WORKS.

For further particulars of these Volumes, refer to Index.

Ore and Stone Mining.	FOSTER AND COX,	Net 28s. 0d.
Elements of Mining and Quarrying.	FOSTER AND COX,	Net 7s. 6d.
Methods of Air Analysis.	J. S. HALDANE,	Net 5s. 0d.
The Air of Mines.	CADMAN AND HALDANE,	<i>At Press.</i>
Text-Book of Coal-Mining.	H. W. HUGHES,	Net 24s. 0d.
Practical Coal-Mining.	G. L. KERR,	Net 12s. 6d.
Elementary Coal-Mining.	G. L. KERR,	3s. 6d.
Treatise on Mine-Surveying.	B. H. BROUGH,	Net 6s. 0d.
Effects of Errors in Surveying.	H. BRIGGS,	Net 5s. 0d.
Theodolite Surveying and Levelling.	J. PARK,	Net 7s. 6d.
Mining Geology.	Prof. JAS. PARK,	Net 6s. 0d.
Text-Book of Geology.	Prof. JAS. PARK,	Net 15s. 0d.
Modern Mine Valuation.	M. H. BURNHAM,	Net 10s. 6d.
Mining Law of British Empire.	C. ALFORD,	Net 8s. 6d.
Mine Accounts and Book-Keeping.	J. G. LAWN,	10s. 6d.
Mining Engineers' Report Book.	E. R. FIELD,	3s. 6d.
Spanish-English and English-Spanish Mining Terms.	E. HALSE,	Net 10s. 6d.
Prospecting for Minerals.	Prof. S. H. COX,	5s. 0d.
Mineralogy of Rarer Metals.	CAHEN AND WOOTTON,	Net 6s. 0d.
Shaft-Sinking in Difficult Cases.	J. RIEMER,	Net 10s. 6d.
Blasting : and Use of Explosives.	O. GUTTMANN,	10s. 6d.
Testing Explosives (New Methods).	C. E. BICHEL,	Net 6s. 0d.
Electrical Practice in Collieries.	Prof. BURNS,	<i>At Press.</i>
Electricity in Mining.	SIEMENS BROS.,	Net 10s. 6d.
Cyaniding Gold and Silver Ores.	JULIAN AND SMART,	Net 21s. 0d.
Cyanide Process of Gold Extraction.	Prof. J. PARK,	Net 8s. 6d.
Getting Gold.	J. C. F. JOHNSON,	3s. 6d.
Gold Seeking in South America.	THEO. KASSNER,	4s. 6d.
Bibliography of Mineral Wealth and Geology of China.	C. WANG,	Net 3s. 0d.
Sampling and Assaying of Precious Metals.	E. A. SMITH,	Net 15s. 0d.
Stratigraphical Geology and Palæontology.	ETHERIDGE,	34s. 0d.
A Text-Book of Geology.	Prof. J. PARK,	Net 15s. 0d.
Geology for Engineers.	Lieut.-Col. SORSBIE,	Net 10s. 6d.
Aids in Practical Geology.	Prof. G. COLE,	10s. 6d.
Open Air Geology.	Prof. G. COLE,	8s. 6d.
The Earth : Its Genesis and Evolution.	A. SWAINE,	Net 7s. 6d.

LONDON : CHARLES GRIFFIN & CO., LTD., EXETER STREET, STRAND.

WORKS BY
SIR CLEMENT LE NEVE FOSTER, D.Sc., F.R.S.

SIXTH EDITION. Pp. i-xxx+799. With Frontispiece and 712 Illustrations.
Price 28s. net.

ORE & STONE MINING.

By SIR C. LE NEVE FOSTER, D.Sc., F.R.S.,

LATE PROFESSOR OF MINING, ROYAL COLLEGE OF SCIENCE.

REVISED, AND BROUGHT UP-TO-DATE

By PROF. S. H. COX, Assoc.R.S.M.,

PROFESSOR OF MINING, ROYAL COLLEGE OF SCIENCE.

GENERAL CONTENTS.

INTRODUCTION. Mode of Occurrence of Minerals.—Prospecting.—Boring.—Breaking Ground.—Supporting Excavations.—Exploitation.—Haulage or Transport.—Hoisting or Winding.—Drainage.—Ventilation.—Lighting.—Descent and Ascent.—Dressing—Principles of Employment of Mining Labour.—Legislation affecting Mines and Quarries.—Condition of the Miner.—Accidents.—Index

"We have seldom had the pleasure to review a work so thorough and complete as the present one. Both in manner and in matter it is FAR SUPERIOR TO ANYTHING ON ITS SPECIAL SUBJECT HITHERTO PUBLISHED IN ENGLAND."—*Athenæum*.

"Not only is this work the acknowledged text-book on metal mining in Great Britain and the Colonies, but that it is so regarded in the United States of America is evidenced by the fact that it is the book on that subject recommended to the students in most of the mining schools of that country."—*The Times*.

SECOND EDITION, Revised. In Crown 8vo. Pp. i-xviii+323. Handsome Cloth. With nearly 300 Illustrations. Price 7s. 6d. net.

THE ELEMENTS OF MINING AND QUARRYING.

An Introductory Text-Book for Mining Students.

By SIR C. LE NEVE FOSTER, D.Sc., F.R.S.,

Late Professor of Mining at the Royal College of Science.

Revised by Prof. S. H. Cox, A.R.S.M., &c.

GENERAL CONTENTS.—INTRODUCTION.—Occurrence of Minerals.—Prospecting.—Boring.—Breaking Ground.—Supporting Excavations.—Exploitation.—Haulage or Transport.—Hoisting or Winding.—Drainage.—Ventilation.—Lighting.—Descent and Ascent.—Dressing, &c.—INDEX.

"A remarkably clear survey of the whole field of mining operations."—*Engineer*.

"Rarely does it fall to the lot of a reviewer to have to accord such unqualified praise as this book deserves. . . . The profession generally have every reason to be grateful to Sir C. Le Neve Foster for having enriched educational literature with so admirable an elementary Text-book."—*Mining Journal*.

In Crown 8vo. Handsome Cloth. Pp. i-xii+300. 8s. 6d. net.

MINING LAW OF THE BRITISH EMPIRE.

By CHARLES J. ALFORD, F.G.S., M.Inst.M.M.

CONTENTS.—The Principles of Mining Law.—The Mining Law of Great Britain.—British India.—Ceylon.—Burma.—The Malay Peninsula.—British North Borneo.—Egypt.—Cyprus.—The Dominion of Canada.—British Guiana.—The Gold Coast Colony and Ashanti.—Cape of Good Hope.—Natal.—Orange River Colony.—Transvaal Colony.—Rhodesia.—The Commonwealth of Australia.—New Zealand, &c.—INDEX.

"Cannot fail to be useful . . . we cordially recommend the book."—*Mining World*.

LONDON: CHARLES GRIFFIN & CO., LTD., EXETER STREET, STRAND.

WORKS ON COAL-MINING.

FIFTH EDITION, Revised and Greatly Enlarged. Pp. i-vii+563.
With 4 Plates and 690 Illustrations. Price 24s. net.

A TEXT-BOOK OF COAL-MINING :

*FOR THE USE OF COLLIERY MANAGERS AND OTHERS
ENGAGED IN COAL-MINING.*

BY HERBERT WILLIAM HUGHES, F.G.S.,
Assoc. Royal School of Mines, General Manager of Sandwell Park Colliery.

GENERAL CONTENTS.—Geology.—Search for Coal.—Breaking Ground.—Sinking.—Preliminary Operations.—Methods of Working.—Haulage.—Winding.—Pumping.—Ventilation.—Lighting.—Works at Surface.—Preparation of Coal for Market.—INDEX.

"Quite THE BEST BOOK of its kind . . . as PRACTICAL in aim as a book can be . . . The illustrations are EXCELLENT."—*Athenaeum*.

"We cordially recommend the work."—*Colliery Guardian*.

"Will soon come to be regarded as the STANDARD WORK of its kind."—*Birmingham Daily Gazette*.

FIFTH EDITION, Thoroughly Revised and Greatly Enlarged. Re-set throughout. Large Crown 8vo. Handsome Cloth. Pp. i-xi+778.
With 755 Illustrations. 12s. 6d. net.

PRACTICAL COAL-MINING :

**A MANUAL FOR MANAGERS, UNDER-MANAGERS,
COLLIERY ENGINEERS, AND OTHERS.**

With Worked-out Problems on Haulage, Pumping, Ventilation, &c.

BY GEORGE L. KERR, M.E., M.INST.M.E.

CONTENTS.—Sources and Nature of Coal.—Search for Coal.—Sinking.—Explosives.—Mechanical Wedges, Rock Drills.—Coal Cutting by Machinery.—Transmission of Power.—Modes of Working.—Timbering Roadways.—Winding Coal.—Haulage.—Pumping.—Ventilation.—Safety Lamps.—Rescue Apparatus.—Surface Arrangements, Coal Cleaning, etc.—Surveying, Levelling, and Plans.—INDEX.

"AN ESSENTIALLY PRACTICAL WORK, and can be confidently recommended. No department of Coal-Mining has been overlooked."—*Engineers' Gazette*.

THIRD EDITION, Revised. In Crown 8vo. Handsome Cloth.
Pp. i-vii+225. 3s. 6d.

ELEMENTARY COAL-MINING :

**FOR THE USE OF STUDENTS, MINERS, AND OTHERS
PREPARING FOR EXAMINATIONS.**

BY GEORGE L. KERR, M.E., M.INST.M.E.

CONTENTS.—Sources and Nature of Coal.—Exploration and Boring for Coal.—Breaking Ground.—Explosives, Blasting, &c.—Sinking and Fitting of Shafts.—Modes of Working.—Timbering Roadways.—Winding and Drawing.—Haulage.—Pumping and Drainage.—Ventilation.—Cleaning and Sorting Coal.—Surveying, &c.

"An abundance of information conveyed in a popular and attractive form. . . Will be of great use to all who are in any way interested in coal mining."—*Scottish Critic*.

LONDON : CHARLES GRIFFIN & CO., LTD., EXETER STREET, STRAND.

THIRTEENTH EDITION, Revised. Pp. i-xvi + 372. With
Numerous Diagrams. Cloth. 6s. net.

A TREATISE ON MINE-SURVEYING:

*For the use of Managers of Mines and Collieries, Students
at the Royal School of Mines, &c.*

By BENNETT H. BROUGH, Assoc.R.S.M., F.G.S.

CONTENTS.—General Explanations.—Measurement of Distances.—Miner's Dial.—Variation of the Magnetic Needle.—Surveying with the Magnetic Needle in the Presence of Iron.—Surveying with the Fixed Needle.—The German Dial.—The Theodolite.—Traversing Underground.—Surface-Surveys with the Theodolite.—Plotting the Survey.—Calculation of Areas.—Levelling.—Connection of the Underground and Surface-Surveys.—Measuring Distances by Telescope.—Setting-out.—Mine-Surveying Problems.—Mine Plans.—Applications of the Magnetic Needle in Mining.—Photographic Surveying.—Bibliography.—INDEX.

"Its CLEARNESS OF STYLE, LUCIDITY OF DESCRIPTION, and FULNESS OF DETAIL have long ago won for it a place unique in the literature of this branch of mining engineering, and the present edition fully maintains the high standard of its predecessors. To the student, and to the mining engineer alike, ITS VALUE is inestimable. The illustrations are excellent."—*The Mining Journal*.

In Handsome Cloth. Pp. i-xi + 179. Fully Illustrated. 5s. net.

THE EFFECTS OF ERRORS IN SURVEYING.

By HENRY BRIGGS, M.Sc.

CONTENTS.—Introduction.—Analysis of Error.—The Best Shape of Triangles.—Propagation of Error in Traversing.—Application of the Methods of determining Average Error to certain Problems in Traversing.—Propagation of Error in Minor Triangulation.—Summary of Results.—APPENDIX.—INDEX.

"Likely to be of the highest service to surveyors . . . it is a most able treatise."—*Engineer*.

SECOND EDITION. In Crown 8vo. Pp. i-xii + 320. Handsome Cloth.
Fully Illustrated. 7s. 6d. net.

A HANDBOOK ON THEODOLITE SURVEYING AND LEVELLING.

For the use of Students in Land and Mine Surveying.

By PROFESSOR JAMES PARK, F.G.S.

CONTENTS.—Scope and Object of Surveying.—Theodolite.—Chains and Steel Bands.—Obstacles to Alignment.—Meridian and Bearings.—Theodolite Traverse.—Co-ordinates of a Station.—Calculation of Omitted or Connecting Line in a Traverse.—Calculation of Areas.—Subdivision of Land.—Triangulation.—Determination of True Meridian, Latitude, and Time.—Levelling.—Railway Curves.—Mine Surveying.—INDEX.

"A book which should prove as useful to the professional surveyor as to the student."—*Nature*.

JUST PUBLISHED. In Medium 8vo. Fully Illustrated. Pp. i-xi + 160.
10s. 6d. net.

MODERN MINE VALUATION.

By M. HOWARD BURNHAM, B.Sc., M.A.I.M.E.,
Late H.M. Inspector of Mines for the Transvaal.

CONTENTS.—Preliminary Considerations.—Block Calculations.—Bases of Sound Valuation.—Sampling.—Explanation of Sinking Fund Table (XXII).—APPENDIX.—INDEX.

"One of the best volumes of its kind that we have seen."—*Mining World*.

LONDON: CHARLES GRIFFIN & CO., LTD., EXETER STREET, STRAND.

Griffin's Metallurgical Series.

Standard Works of Reference for Metallurgists, Mine-Owners, Assayers, Manufacturers, and all interested in the development of the Metallurgical Industries.

EDITED BY

Sir W. ROBERTS-AUSTEN, K.C.B., D.C.L., F.R.S.

In Large 8vo, Handsome Cloth. With Illustrations.

For further particulars refer to Index.

- INTRODUCTION to the STUDY of METALLURGY. By the EDITOR. 18s. net.
- GOLD (The Metallurgy of). T. K. ROSE. 21s.
- LEAD (The Metallurgy of). H. F. COLLINS. 21s. net.
- SILVER (The Metallurgy of). H. F. COLLINS. *At Press.*
- IRON (The Metallurgy of). T. TURNER. 16s. net.
- STEEL (The Metallurgy of). F. W. HARBORD and J. W. HALL. 36s. net.
- ALLOYS. EDWARD F. LAW. SECOND EDITION. *At Press.*
- ANTIMONY. C. Y. WANG. 12s. 6d. net.
- SAMPLING and ASSAYING of PRECIOUS METALS. E. A. SMITH. 15s. net.

OTHER METALLURGICAL WORKS.

- THE NON-FERROUS METALS. W. GOWLAND. *At Press.*
- MODERN COPPER SMELTING. D. M. LEVY. 10s. 6d. net.
- CAST IRON, in the Light of Recent Research. W. HATFIELD. 10s. 6d. net.
- METALLIC ALLOYS. G. H. GULLIVER. 10s. 6d. net.
- MICROSCOPIC ANALYSIS of METALS. OSMOND and STEAD. 8s. 6d. net.
- TEXT-BOOK of ASSAYING. J. J. and C. BERINGER. 10s. 6d.
- METALLURGICAL ANALYSIS and ASSAYING. MACLEOD and WALKER. 12s. 6d. net.
- QUANTITATIVE METALLURGICAL ANALYSIS TABLES. J. J. MORGAN. 4s.
- ELECTRIC SMELTING. BORCHERS and McMILLAN. 21s. net.
- ELECTRO-METALLURGY. McMILLAN and COOPER. 12s. 6d. net.
- INTRODUCTION to PRACTICAL METALLURGY. T. TURNER. 3s. net.
- ELEMENTARY METALLURGY. A. H. SEXTON. 6s.
- GENERAL FOUNDRY PRACTICE. McWILLIAM and LONGMUIR. 15s. net.
- LECTURES on IRONFOUNDING. T. TURNER. 3s. 6d. net.
- BLAST FURNACE PRACTICE. J. J. MORGAN. 1s. 6d. net.
- NOTES on FOUNDRY PRACTICE. J. J. MORGAN. 2s. 6d. net.

Also Works on Petroleum.

LONDON : CHARLES GRIFFIN & CO., LTD., EXETER STREET, STRAND.

SECOND EDITION, Revised Throughout. In Medium 8vo. With Numerous Plates, Maps, and Illustrations. Pp. i-xxiv + 460. 2ls. net.

CYANIDING GOLD & SILVER ORES.

A Practical Treatise on the Cyanide Process; its Application, Methods of Working, Design and Construction of Plant, and Costs.

BY H. FORBES JULIAN,

Mining and Metallurgical Engineer; Specialist in Gold; Late Technical Adviser of the Deutsche Gold und Silber Scheide Anstalt, Frankfurt-on-Maine.

AND EDGAR SMART, A.M.I.C.E.,

Civil and Metallurgical Engineer.

CONTENTS.—Early History of the Cyanide Process.—Preliminary Investigations.—Crushing.—Weighing and Measuring.—Percolation and Leaching.—Principles involved in Dissolution and Precipitation of Metals.—Dissolution of the Gold and Silver.—Temperature Effects.—Absorption of Air by Solutions.—Action of Various Cyanide Solutions.—Sources of Loss of Cyanide.—Precipitation.—Precipitation by Zinc.—Electrical Precipitation.—Other Methods of Precipitation.—Cleaning-up, Refining, and Smelting.—Applications of the Cyanide Process.—Double Treatment.—Direct Treatment of Dry Crushed Ore.—Crushing with Cyanide Solution.—Slimes.—Dissolving the Gold and Silver in Slimes.—Extraction by Successive Washings.—Agitation and Natural Settlement.—Filter Presses.—Vats.—Essential Parts of a Cyanide Plant (Construction).—Piping, Cocks, Launders, and Buildings.—Handling Material.—Ropes and Gears for Haulage.—Belt Conveyors.—Pumps.—Spitzlutte and Spitzkasten.—Cost of Plant.—Cost of Treatment.—Complete Plants.—Roasting.—INDEX.

"A handsome volume of 400 pages which will be a valuable book of reference for all associated with the process."—*Mining Journal*.

FIFTH ENGLISH EDITION. In Large Crown 8vo. With 22 Plates and many Illustrations in the Text. Handsome Cloth. Pp. i-xiv + 347. 8s. 6d. net.

THE CYANIDE PROCESS OF GOLD EXTRACTION.

A Text-Book for the Use of Metallurgists and Students at Schools of Mines, &c.

BY JAMES PARK, F.G.S., M.INST.M.M.,

Professor of Mining and Director of the Otago University School of Mines; late Director Thames School of Mines, and Geological Surveyor and Mining Geologist to the Government of New Zealand.

Thoroughly Revised and Greatly Enlarged. With additional details concerning the Siemens-Halske and other recent processes.

CONTENTS.—The McArthur-Forrest Process.—Chemistry of the Process.—Laboratory Experiments.—Control, Testing, and Analysis of Solutions.—Appliances and Plant for Cyanide Extraction.—Actual Extraction by Cyanide.—Production and Treatment of Slimes.—Cyanide Treatment of Concentrates.—Leaching by Agitation.—Zinc Precipitation and Treatment of Gold Slimes.—Application of the Process in Different Countries.—The Siemens-Halske Process.—Other Cyanide Processes.—Antidotes for Cyanide Poisoning.—INDEX.

"Deserves to be ranked as amongst the BEST OF EXISTING TREATISES."—*Mining Journal*.

In Crown 8vo. Handsome Cloth. Pp. i-vii + 63. 3s. net.

A BIBLIOGRAPHY OF THE MINERAL WEALTH AND GEOLOGY OF CHINA.

By C. Y. WANG, M.A., B.Sc., M.Am. Inst. Min. Eng., M. Iron & Steel Inst.

CONTENTS.—MINERALS (including Mining and Metallurgy).—Coal.—Iron.—Gold and Silver.—Minerals in General.—Mining Industry in General.—GEOLOGY.—General.—Petrology.—Palaeontology.

LONDON: CHARLES GRIFFIN & CO., LTD., EXETER STREET, STRAND.

GRIFFIN'S METALLURGICAL SERIES.

FOURTH EDITION, Thoroughly Revised Throughout. With 51 Folding Plates, Comprising 112 Figures, over 500 Illustrations in the Text, and nearly 80 Photo-Micrographs of Steel Sections. Large Svo. Two Volumes. In all 1000 pages. Handsome Cloth. 36s. net.

With Additional Chapter on The Electric Smelting of Steel.

THE METALLURGY OF STEEL.

BY F. W. HARBORD, Assoc.R.S.M., F.I.C.,

AND J. W. HALL, A.M. INST. C.E.

Vol. I.—Metallurgy.

Vol. II.—Mechanical Treatment.

(N.B.—These Volumes are not Sold Separately.)

ABRIDGED CONTENTS.—The Plant, Machinery, Methods and Chemistry of the Bessemer and of the Open Hearth Processes (Acid and Basic).—The Influence of Metalloids, Heat Treatment, Special Steels, Microstructure, Testing, and Specifications.—The Mechanical Treatment of Steel comprising Mill Practice, Plant and Machinery.

The *Engineers* say, at the conclusion of a review of this book:—"We cannot conclude without earnestly recommending all who may be interested as makers or users of steel, which practically means the whole of the engineering profession, to make themselves acquainted with it as speedily as possible, and this may be the more easily done as the published price, considering the size of the book, is extremely moderate."

THIRD EDITION, Revised and Enlarged. Pp. i-xvi+463. With 120 Illustrations. 16s. net.

THE METALLURGY OF IRON.

BY THOMAS TURNER, Assoc.R.S.M., F.I.C.,

Professor of Metallurgy in the University of Birmingham.

General Contents.—Early History of Iron.—Modern History of Iron.—The Age of Steel.—Chief Iron Ores.—Preparation of Iron Ores.—The Blast Furnace.—The Air used in the Blast Furnace.—Reactions of the Blast Furnace.—The Gaseous Products of the Blast Furnace.—The Fuel used in the Blast Furnace.—Slags and Fluxes of Iron Smelting.—Properties of Cast Iron.—Foundry Practice.—Wrought Iron.—Indirect Production of Wrought Iron.—The Poddling Process.—Further Treatment of Wrought Iron.—Corrosion of Iron and Steel.

"A THOROUGHLY USEFUL BOOK, which brings the subject UP TO DATE. OF GREAT VALUE to those engaged in the iron industry."—*Mining Journal*.

. For Professor Turner's "*Lectures on Iron-Founding*," &c., see page 67 *General Catalogue*.

In Medium Svo. Handsome Cloth. With 166 Illustrations. 15s. net.

The Sampling & Assay of the Precious Metals :

Comprising Gold, Silver and Platinum, in Ores, Bullion and Products.

By ERNEST A. SMITH, A.R.S.M., M. INST. M.M.,

Deputy Assay Master of the Sheffield Assay Office; Late of the Royal School of Mines.

CONTENTS.—Introduction.—Design and Equipment of Assay Offices.—Furnaces and Appliances.—Precious Metal Ores.—Valuation of Ores.—Sampling of Ores.—Preparation of Samples for Assay.—Fluxes and Principles of Fluxing.—Assay Operations—(a) Roasting; (b) Fusion; (c) Scorification; (d) Cupellation.—Systems of Working.—Assay of Gold and Silver Ores.—Of Complex Ores.—Calculating and Reporting Results.—Special Methods of Ore Assay.—Bullion.—Valuation of Bullion.—Sampling of Bullion.—Assay of Gold, Silver, and Base Bullion.—Of Auriferous and Argentiferous Products.—Assay Work in Cyanide Mill.—Platinum and the "Platinum Metals."—Assay of Platinum in Ores, Bullion and Products.—APPENDICES.—INDEX.

"Unique . . . the book should be added to the Mining Engineer's Library."—*Mining World*.

LONDON : CHARLES GRIFFIN & CO., LTD., EXETER STREET, STRAND.

In Medium Svo. Handsome Cloth. Pp. i-xii+250. With 19 Plates (2 Coloured), and 69 other Illustrations. 16s. 6d. net.

LECTURES ON MODERN COPPER SMELTING

By DONALD M. LEVY, M.Sc., A.R.S.M.,

Assistant Lecturer in Metallurgy University of Birmingham.

ABBREVED CONTENTS.—Historical.—Price and Cost of Production and Statistics.—Uses of Copper as Metal and Alloy.—Effect of Impurities.—Compounds.—Ores.—Preliminary Treatment.—Sampling.—Concentration.—Principles of Copper Smelting.—Smelting.—Reverberatory Smelting Practice.—Blast Furnace Practice.—Bessemerising of Copper Matces.—Purification and Refining of Crude Copper.—Casting.—INDEX.

"A welcome addition to existing literature on the subject."—*Chemical Trade Journal*.

In Medium Svo. Handsome Cloth Pp. i-xiii + 248. With Frontispiece and 164 Illustrations, including many Photo-Micrographs. 16s. 6d. net.

CAST IRON IN THE LIGHT OF RECENT RESEARCH.

By W. H. HATFIELD, B.Met., A.M.I.Mech.E.

CONTENTS.—INTRODUCTION.—The Non-Carbon Alloys and Cast Iron from the Standpoint of the Equilibrium Diagram.—Influence of Silicon.—Of Phosphorus.—Of Sulphur.—Of Manganese.—Of Other Elements.—Of Casting Temperature.—Shrinkage and Contraction.—Growth of Cast Iron under Repeated Heatings.—Effect of Superheated Steam upon Cast-iron Fittings.—Malleable Cast Iron.—Heat Treatment of Cast Iron.—Decarburisation of Cast Iron without further Fusion.—Mechanical Properties of Cast and Malleable Cast Iron.—Furnaces and Slags.—APPENDICES.—INDEX.

"A valuable addition to Griffin's noted metallurgical publications."—*Mining Magazine*.

SECOND EDITION. In Crown Svo. Handsome Cloth. Pp. xxvii+409. Thoroughly Revised and very greatly Enlarged. With many New, and in all 310 Illustrations. 10s. 6d. net.

A HANDBOOK ON METALLIC ALLOYS:

Their Structure and Constitution.

By GILBERT H. GULLIVER, B.Sc., F.R.S.E.

CONTENTS.—Methods of Investigation.—The Physico-Chemical Equilibrium of Mixed Substances.—Binary Alloys in which no Definite Chemical Compounds are formed.—Do, which show Evidence of the Formation of Definite Chemical Compounds.—Transformations in Completely Solid Metals.—Alloys.—Equilibrium Conditions in Metallic Mixtures.—The Structures of Metals and Alloys.—The Bronzes, Brasses and other Alloys of Copper.—Steel and other Alloys of Iron.—Alloys of more than two Metals.—The Microscope in Engineering Practice.—INDEX.

"This book offers most exhaustive information, and is profusely illustrated."—*Metals Industry*.

SECOND EDITION, Thoroughly Revised. Pp. i-xvii+313. With 195 Photo-Micrographs, Diagrams, and Figures. 8s. 6d. net

THE MICROSCOPIC ANALYSIS OF METALS.

By FLORIS OSMOND AND J. E. STEAD, D.MET., F.R.S.

REVISED AND CORRECTED BY L. P. SYDNEY.

CONTENTS.—PART I. Metallography considered as a Method of Assay.—PART II. The Science of Polishing.—PART III. The Microscopic Analysis of Carbon Steels.—APPENDICES.—INDEX.

LONDON: CHARLES GRIFFIN & CO., LTD., EXETER STREET, STRAND.

THIRD EDITION, Thoroughly Revised, Enlarged, and Re-set Throughout.
Three Volumes, with Valuable Bibliography, New Maps,
Illustrations, &c. 50s. net.

IN THREE VOLUMES.
A TREATISE ON
PETROLEUM.

By SIR BOVERTON REDWOOD, BART.,
D.Sc., F.R.S.E., Assoc. Inst. C.E., F.I.C.

CONTENTS.—SECTION I.: Historical Account of the Petroleum Industry.—SECTION II.: Geological and Geographical Distribution of Petroleum and Natural Gas.—SECTION III.: The Chemical and Physical Properties of Petroleum and Natural Gas.—SECTION IV.: The Origin of Petroleum and Natural Gas.—SECTION V.: The Production of Petroleum, Natural Gas, and Ozokerite.—SECTION VI.: The Refining of Petroleum.—SECTION VII.: The Shale Oil and Allied Industries.—SECTION VIII.: The Transport, Storage, and Distribution of Petroleum.—SECTION IX.: The Testing of Crude Petroleum, Petroleum and Shale Oil Products, Ozokerite, and Asphalt.—SECTION X.: The Uses of Petroleum and its Products.—SECTION XI.: Statutory, Municipal, and other Regulations relating to the Testing, Storage, Transport, and Use of Petroleum and its Products.—BIBLIOGRAPHY.—APPENDICES.—INDEX.

"It is indisputably the most comprehensive and complete treatise on petroleum, and this statement is true, no matter on what branch of the industry a test of its merits is made. It is the only book in existence which gives the oil man a clear and reliable outline of the growth and present-day condition of the entire petroleum world. . . . There is a wonderfully complete collection of plates and illustrations."—*Petroleum World*.

THIRD EDITION, Revised. Pp. i-xix+340. Price 8s. 6d. net.

A HANDBOOK ON PETROLEUM.
FOR INSPECTORS UNDER THE PETROLEUM ACTS,

And for those engaged in the Storage, Transport, Distribution, and Industrial Use of Petroleum and its Products, and of Calcium Carbide. With suggestions on the Construction and Use of Mineral Oil Lamps.

By CAPTAIN J. H. THOMSON,
H.M. Chief Inspector of Explosives.

AND SIR BOVERTON REDWOOD, BART.,

REVISED BY MAJOR A. COOPER-KEY AND SIR BOVERTON REDWOOD.

CONTENTS.—Introductory.—Sources of Supply.—Production, Refining, etc.—Commercial Products.—Flash Point and Fire-Test.—Testing.—Legislation.—Precautions.—Oil Lamps.—Calcium Carbide.—Appendices.—INDEX.

"A volume that will enrich the world's petroleum literature, and render a service to the British branch of the industry. . . . Reliable, indispensable, a brilliant contribution."—*Petroleum*.

In Pocket Size. Strongly Bound in Leather. Fully Illustrated.

THE PETROLEUM TECHNOLOGIST'S POCKET BOOK.

By SIR BOVERTON REDWOOD, Bart., D.Sc., &c.,
And ARTHUR EASTLAKE, M.I.M.E., A.M.I. Mech. E., &c.

SYNOPSIS OF CONTENTS.—PART I.: General Information about Petroleum (Origin, Occurrence, Prospecting, acquiring Land, Raising, Storage, Refining, etc.). PART II.: Geological (Identification of Rocks, Angle of Dip, Maps, Oil-bearing Areas, Oil per acre, Bitumens, etc.). PART III.: Physical and Chemical (Specific Gravity, Analysis of Gas, Viscometry, Calorific Value, Flash Point, Distillation, Candle Power, etc.). PART IV.: Production (Drilling, Casing, Water, Raising Oil, Plugging, Cost of Drilling, etc.). PART V.: Storage and Transport (Tanks, Flow of Gas in Pipes, Pipe Lines, Pumping, Railway Cars, Barrels, etc.). PART VI.: Uses (Liquid Fuel, Air required, Oil Engines, Natural Gas, Asphalt, etc.). PART VII.: Weights and Measures (English and Foreign). PART VIII.: Miscellaneous and Glossaries. PART IX.: Crude Petroleum (Statistics of Production, Asphalt, Oil Shale, Ozokerite, Natural Gas).

LONDON: CHARLES GRIFFIN & CO., LTD., EXETER STREET, STRAND.

Griffin's Local Government Handbooks.

WORKS SUITABLE FOR MUNICIPAL AND COUNTY
ENGINEERS, ANALYSTS, AND OTHERS.

For further particulars of the following, see Index.

- Civil Engineering Practice.** By F. NOEL TAYLOR. With over 800 Pages and over 1,000 Illustrations. Cloth. 25s. net.
- The Main Drainage of Towns.** By F. NOEL TAYLOR. Pp. i-xi + 313. With over 350 Illustrations. 12s. 6d. net.
- Practical Sanitation: A Handbook for Sanitary Inspectors and others.** By GEO. REID, M.D., D.P.H. SEVENTEENTH EDITION, Thoroughly Revised. 6s.
- Sanitary Engineering.** By FRANCIS WOOD, A.M.Inst.C.E. THIRD EDITION, Revised. Pp. i-xv + 306. 8s. 6d. net.
- Modern Methods of Sewage Purification.** By G. BERTRAM KERSHAW, Engineer to the Sewage Commission. Fully Illustrated. 21s. net.
- The Principles of Sewage Disposal.** By Prof. DUNBAR of Hamburg. Translated by H. T. CALVERT, M.Sc. 15s. net.
- Trade Waste Waters.** By H. WILSON, M.D., and H. T. CALVERT, Ph.D. Fully Illustrated. 18s. net.
- Trades' Waste: Its Treatment and Utilisation.** By W. NAYLOR, F.C.S., A.M.Inst.C.E. 21s. net.
- Modern Destructor Practice.** By W. F. GOODRICH, A.M.Inst.C.E. Pp. i-xvi + 278. 15s. net.
- Water Supply: Selection of Sources and Distribution.** By REGINALD E. MIDDLETON, M.Inst.C.E., M.Inst.Mech.E., F.S.I. Crown 8vo. 8s. 6d. net.
- Water Analysis for Sanitary and Technical Purposes.** By H. B. STOCKS, F.I.C., etc. 4s. 6d. net.
- Calcareous Cements: Their Nature, Preparation, and Uses.** By GILBERT REDGRAVE, Assoc.Inst.C.E., and CHAS. SPACKMAN, F.C.S. SECOND EDITION. 15s. net.
- Handbook for Cement Works Chemists.** By F. B. GATEHOUSE, F.C.S. 5s. net.
- Road Making and Maintenance.** By THOS. AITKEN, A.M.Inst.C.E. SECOND EDITION. Fully Illustrated. 21s. net.
- Dustless Roads: Tar-Macadam.** By J. WALKER SMITH. Fully Illustrated. 10s. 6d. net.
- Central Electrical Stations: Their Design, Organisation, and Management.** By C. H. WORDINGHAM, A.K.C., M.Inst.C.E. SECOND EDITION. 24s. net.
- Transformers.** By HERMANN BOHLE, M.I.E.E., and Prof. DAVID ROBERTSON, B.Sc. Pp. i-xiv + 356. Profusely Illustrated. 21s. net.
- Electrical Photometry and Illumination.** By Prof. H. BOHLE. Pp. i-xi + 222. Profusely Illustrated. 10s. 6d. net.
- Electricity Meters.** By HENRY G. SOLOMON, Assoc.M.Inst.E.E. In Medium 8vo, Handsome Cloth. Profusely Illustrated. 16s. net.
- Gas Manufacture (The Chemistry of).** By W. J. A. BUTTERFIELD, M.A., F.I.C., F.C.S. With Illustrations. FOURTH EDITION, Revised. Vol. I., 7s. 6d. net. Vol. II., in preparation.
- The Calorific Power of Gas.** By J. H. COSTE, F.I.C., F.C.S. Illustrated. 6s. net.
- Smoke Abatement.** A Manual for Manufacturers, Inspectors, Engineers, and others. By WILLIAM NICHOLSON. Fully Illustrated. 6s. net.
- Fire and Explosion Risks. The Detection, Investigation, and Prevention of Fires and Explosions.** By Dr. VON SCHWARTZ. Cloth. 16s. net.
- Milk: Its Production and Uses.** With Chapters on Dairy Farming, The Diseases of Cattle, and on the Hygiene and Control of Supplies. By EDWARD F. WILLOUGHBY, M.D., D.P.H. 6s. net.
- Flesh Foods: With Methods for their Chemical, Microscopical, and Bacteriological Examination.** By C. AINSWORTH MITCHELL, B.A., F.I.C. Illustrated. 10s. 6d.
- Foods: Their Composition and Analysis.** By A. WYNTER BLYTH, M.R.C.S., F.C.S., and M. W. BLYTH, B.A., B.Sc. SIXTH EDITION, Thoroughly Revised. 21s.

LONDON: CHARLES GRIFFIN & CO., LTD., EXETER STREET, STRAND

In Large 8vo. Cloth. Pp. i-xxiii + 271. With 147 Illustrations.
15s. net.

A MANUAL OF

THE PRINCIPLES OF SEWAGE TREATMENT.

BY PROF. DUNBAR,

Director of the Institute of State Hygiene, Hamburg.

ENGLISH EDITION BY HARRY T. CALVERT, M.Sc., Ph.D., F.I.C.,
Chief Chemical Assistant, West Riding of Yorkshire Rivers Board.

ABRIDGED CONTENTS.—HISTORICAL DEVELOPMENT OF THE SEWAGE PROBLEM.—Growth of River Pollution.—Legal Measures of Central and Local Authorities.—Rise and Development of Methods of Sewage Treatment.—Earlier Views, their Object and Utility. PRESENT POSITION OF SEWAGE TREATMENT.—The Characteristics of Sewage.—Objects of Precipitation Works.—Description for the Removal of Suspended Matters.—Methods for the Removal of Putrescibility.—The Disinfection of Sewage.—Supervision and Inspection of Sewage Disposal Works.—The Utility and Cost of the various Methods of Sewage Treatment.—INDEX.

"We heartily commend the book as a peculiarly fair and impartial statement of the present position of the sewage problem."—*Lancet*.

In Medium 8vo. Cloth. Pp. i-xiii + 356. With Tables, Illustrations
in the Text, and 36 Plates. 21s. net.

MODERN METHODS OF

SEWAGE PURIFICATION.

A Guide for the Designing and Maintenance of Sewage Purification Works

BY G. BERTRAM KERSHAW, F.R.S.I., F.R.M.S., F.G.S., &c.,

Engineer to the Royal Commission on Sewage Disposal.

CONTENTS.—Introduction.—Historical.—Conservancy Methods, &c.—Sewerage Systems.—Rainfall, Storm Water.—Variations in Flow of Sewage.—Classification and Composition of Sewages.—Considerations to be observed in selecting the Site for Sewage Disposal Works.—Preliminary Processes.—Disposal of Sludge.—Land Treatment of Sewage.—Contact Beds.—Percolating Filters.—Trades' Wastes.—Miscellaneous.—Precipitation Works in Actual Operation.—INDEX.

"A large and comprehensive work . . . replete with information."—*Journal Royal Sanitary Institute*.

In Handsome Cloth. Pp. i-xiii + 256. With 59 Illustrations. 6s. net.

SMOKE ABATEMENT.

A Manual for the Use of Manufacturers, Inspectors, Medical Officers of
Health, Engineers, and Others.

BY WILLIAM NICHOLSON,

Chief Smoke Inspector to the Sheffield Corporation.

CONTENTS.—Introduction.—Legislation (General).—Do. (Local).—Foreign Laws.—Smoke Abatement.—Boilers, Furnaces and Kilns.—Dwelling-house Smoke.—Chimneys.—Smoke Preventers and Fuel Savers.—Waste Gases from Metallurgical Furnaces.—INDEX.

"We welcome such an adequate statement on an important subject."—*British Medical Journal*.

See also—

THE MAIN DRAINAGE OF TOWNS, . . .	page 6.
AND MODERN DESTRUCTOR PRACTICE, . . .	„ 6.

LONDON : CHARLES GRIFFIN & CO., LTD., EXETER STREET, STRAND.

SECOND EDITION. *In Large 8vo. Handsome Cloth. Beautifully Illustrated. With Plates and Figures in the Text. 21s. net.*

ROAD MAKING AND MAINTENANCE:

A Practical Treatise for Engineers, Surveyors, and Others.

By THOS. AITKEN, M.Inst.C.E.,

Member of the Association of Municipal and County Engineers; Member of the Sanitary Inst.; Surveyor to the County Council of Fife, Cupar Division.

WITH NUMEROUS PLATES, DIAGRAMS, AND ILLUSTRATIONS.

CONTENTS.—Historical Sketch.—Resistance of Traction.—Laying out New Roads.—Earthworks, Drainage, and Retaining Walls.—Road Materials, or Metal.—Quarrying.—Stone Breaking and Haulage.—Road-Rolling and Scarifying.—The Construction of New, and the Maintenance of existing Roads.—Carriage Ways and Foot Ways.

"The Literary style is EXCELLENT. . . . A COMPREHENSIVE and EXCELLENT Modern Book, an UP-TO-DATE work. . . . Should be on the reference shelf of every Municipal and County Engineer or Surveyor in the United Kingdom, and of every Colonial Engineer."—*The Surveyor*.

In Handsome Cloth. Fully Illustrated. 10s. 6d. net.

DUSTLESS ROADS. TAR MACADAM.

By J. WALKER SMITH,

City Engineer, Edinburgh.

CONTENTS.—Necessity for Improved and Standard Road Construction.—Tar.—Standardisation of Matrix.—Aggregate for Macadam.—Different Modes of Preparing and Laying.—Mechanical Mixing.—Effects of Wear, Density, Porosity, Distribution of Weight.—Scavenging; Watering and Maintenance.—Camber; Gradient, Noiselessness, Hygienic Advantages.—Rolling.—Traactive Effort.—Statistics.—Tar Spraying on Ordinary Macadam Surfaces.—APPENDICES.—INDEX.

"The book is in every respect up-to-date and very suggestive. It is practical in the best sense of the term."—*County and Municipal Record*.

In Crown 8vo. Cloth. Pp. i-xi + 137. With 25 Illustrations, Coloured Map, and a Chart. 4s. 6d. net.

MODERN ROAD CONSTRUCTION.

*A Practical Treatise for the Use of Engineers, Students,
Members of Local Authorities, &c.*

By FRANCIS WOOD, M.Inst.C.E., F.G.S.

CONTENTS.—Introductory.—Macadam Roads.—Wear of Roads.—Effect of Traffic on Roads.—Tarred Roads.—Bitumen.—Methods of Using Tar and Bitumen.—Rollers and Rolling.—Paving.—Cost of Maintenance of Roads.—APPENDICES.—INDEX.

"A little volume that should find its place on the shelf of every road and highway surveyor and engineer in the Local Government world."—*Municipal Journal*.

LONDON: CHARLES GRIFFIN & CO., LTD., EXETER STREET, STRAND.

TECHNOLOGICAL WORKS.

- Chemistry for Engineers and Manufacturers.** By B. BLOUNT, F.I.C., and A. G. BLOXAM, F.I.C. Vol. I.—SECOND EDITION, 14s. Vol. II.—SECOND EDITION, 16s.
- Oils, Fats, Butters, and Waxes.** By ALDER WRIGHT and MITCHELL. SECOND EDITION. 25s. net.
- Physico-Chemical Tables.** By J. CASTELL-EVANS, F.I.C. Vol. I.—Chemical Engineering, 24s. net. Vol. II.—Physical and Analytical Chemistry, 36s. net.
- Quantitative Inorganic Analysis.** By Dr. J. W. MELLOR. 30s. net.
- Water Analysis for San. and Tech. Purposes.** By H. B. STOCKS. 4s. 6s. net.
- Methods of Air Analysis.** By J. S. HALDANE, M.D., LL.D., F.R.S. 5s. net
- The Principles and Practice of Brewing.** By Dr. W. J. SYKES. THIRD EDITION, Revised by A. R. LING, F.I.C. 21s. net.
- Technical Mycology.** Dr. F. LAFAR. SECOND EDITION. In Two Vols. Vol. I., 15s. net. Vol. II., 24s. net.
- Micro-Organisms and Fermentation.** By ALFRED JÖRGENSEN. FOURTH EDITION, Completely Revised. Translated by S. H. DAVIES, B.Sc. 15s. net.
- Ferments and their Actions.** By C. OPPENHEIMER. Translated by C. A. MITCHELL, B.A. F.I.C. In Cloth. 7s. 6d. net.
- Peat ; its Use and Manufacture.** By BJÖRLING and GISSING. 6s. net.
- Commercial Peat ; its Uses and its Possibilities.** By F. T. GISSING. 6s. net.
- Paper Technology.** By R. W. SINDALL, F.C.S. SECOND EDITION, Revised. 12s. 6d. net.
- Stationery Testing.** By H. A. BROMLEY. Fully Illustrated. 2s. 6d. net.
- The Clayworkers' Handbook.** By A. B. SEARLE. SECOND EDITION. 6s. net.
- British Clays, Shales, and Sands.** By A. B. SEARLE. Illustrated. 7s. 6d. net.
- Ceramic Literature.** Compiled, Classified, and Described by M. L. SOLON. 42s. net.
- Art of the Goldsmith and Jeweller.** By T. B. WIGLEY. SECOND EDITION. 7s. 6d. net.
- Smoke Abatement.** By WM. NICHOLSON. With Illustrations. 6s. net.
- Calcareous Cements.** By G. R. REDGRAVE and CHARLES SPACKMAN, F.C.S. SECOND EDITION. 15s. net.
- Handbook for Cement Works' Chemists.** By FRANK B. GATEHOUSE, F.C.S. In Handsome Cloth. 5s. net.
- Gas Manufacture.** By W. J. A. BUTTERFIELD. Vol. I., 7s. 6d. net. Vol. II. *Shortly.*
- Calorific Power of Coal Gas.** By J. H. COSTE, F.I.C. 6s. net.
- The Examination of Fuel.** By J. H. COSTE and E. R. ANDREWS. *At Press.*
- Acetylene.** By F. H. LEEDS and W. J. A. BUTTERFIELD. SECOND EDITION. 8s. 6d. net.
- Fire and Explosion Risks.** By Dr. VON SCHWARTZ. In Cloth. 16s. net.
- Enamelling on Iron and Steel.** By JULIUS GRÜNWARD. Cloth. Illustrated. 6s. net.
- Technology of Iron Enamelling and Tinning.** By JULIUS GRÜNWARD. 6s. net.
- The Chemistry of the Colloids.** By Dr. V. PÜSCHL. Translated by Dr. H. HODGSON. 3s. 6d. net.
- Celluloid ; its Manufacture, Application, and Substitutes.** From the French of MASSELOX, ROBERTS, and CILLIARD. By Dr. H. H. HODGSON. 25s. net.
- Chemistry of India Rubber.** By C. O. WEBER, Ph.D. THIRD IMPRESSION. With many Illustrations. 16s. net.
- The Manufacture of Rubber Goods.** By ADOLF HEIL and Dr. W. ESCH. Translated by E. W. LEWIS, A.C.G.I. In Cloth. Illustrated. 10s. 6d. net.
- Glue, Gelatine, and their Allied Products.** By THOMAS LAMBERT. In Large Crown 8vo. Fully Illustrated. 5s. net.
- Leather Trades Chemistry.** By S. R. TROTMAN, M.A., F.I.C. In Handsome Cloth. Fully Illustrated. 15s. net.
- Ink Manufacture.** By C. A. MITCHELL, B.A., F.I.C., and T. C. HEPWORTH. In Cloth With Plates and Illustrations. 7s. 6d. net.
- Inorganic Chemistry.** By A. DUPRÉ and WILSON HAKE. THIRD EDITION. 6s. net.
- Elements of Chemical Engineering.** By J. GROSSMANN, Ph.D. SECOND EDITION. 3s. 6d. net.
- Outlines of Quantitative Analysis.** By A. H. SEXTON, F.I.C. FIFTH EDITION. 3s.
- Outlines of Qualitative Analysis.** By A. H. SEXTON, F.I.C. FOURTH EDITION. 3s. 6d.

LONDON : CHARLES GRIFFIN & CO., LTD., EXETER STREET, STRAND.

THE FERMENTATION INDUSTRIES.

THIRD EDITION. In Handsome Cloth. Fully Illustrated. 21s. net.
PRINCIPLES AND PRACTICE OF BREWING.
 FOR THE USE OF STUDENTS AND PRACTICAL MEN.
 By WALTER J. SYKES.

REVISED BY ARTHUR R. LING, F.I.C., F.C.S.,

Editor of the Journal of the Institute of Brewing.

CONTENTS.—Physical Principles Involved.—The Chemistry of Brewing.—The Microscope.—Vegetable Biology.—Fermentation.—Water.—Barley and Malting.—Arrangement of Brewery Plant.—Quantities of Materials.—Fermentation.—Antiseptics.—Flings.—Characteristics of Beer.—Diseases of Beer.—INDEX.

"A thorough and comprehensive text-book . . . up-to-date . . . a standard text-book."—*Brewers' Journal*.

In Large 8vo. Complete in Two Volumes.

Each Volume Complete in Itself, and Sold Separately.

TECHNICAL MYCOLOGY:

The Utilisation of Micro-organisms in the Arts and Manufactures.

By DR. FRANZ LAFAR,

Prof. of Fermentation-Physiology and Bacteriology in the Technical High School, Vienna.

TRANSLATED BY CHARLES T. C. SALTER.

Vol. I.—SCHIZOMYCETIC FERMENTATION. 15s. net.

Vol. II.—EUMYCETIC FERMENTATION. 24s. net.

NOTE.—Part I. of Vol. II. was issued separately at 7s. 6d. Copies of Part II., Vol. II., have, therefore, been bound up to enable those possessing Part I. to complete their copies. The price of Vol. II., Part II., is 18s. net.

"The first work of the kind which can lay claim to completeness in the treatment of a fascinating subject. The plan is admirable, the classification simple, the style is good, and the tendency of the whole volume is to convey sure information to the reader."—*Lancet*.

FIFTH EDITION. In Demy 8vo. Revised Throughout. Pp. i-xi + 489.
 With 101 Illustrations. In Cloth. 15s. net.

MICRO-ORGANISMS AND FERMENTATION.

By ALFRED JÖRGENSEN.

TRANSLATED BY SAMUEL H. DAVIES, M.Sc.

CONTENTS.—Microscopical and Physiological Examination—Biological Examination of Air and Water—Bacteria—Moulds—Yeasts—The Pure Culture of Yeasts on a Large Scale.—INDEX.

"The student taking up this subject would do well to work through this book first and then take Lafar's."—*Brewing Trade Review*.

In Crown 8vo. Handsome Cloth. Price 7s. 6d. net.

FERMENTS: AND THEIR ACTIONS.

A Text-book on the Chemistry and Physics of Fermentative Changes.

By CARL OPPENHEIMER, Ph.D., M.D.

TRANSLATED BY C. AINSWORTH MITCHELL, B.A., F.I.C., F.C.S.

CONTENTS.—Introduction.—Definition of Ferment.—Chemical Nature of Ferment.—Influence of External Factors on Ferments.—Mode of Action.—Physiological Action.—Secretion of Ferments.—Ferments and the Vital Processes.—A. THE HYDROLYTIC FERMENTS: Proteolytic Ferments.—Trypsin.—Bacteriolytic and Hemolytic.—Proteolytic Vegetable Ferments.—Coagulating Ferments.—Saccharifying Ferments.—Animal Diastases.—Enzymes of the Disaccharides.—Ferments which decompose Glucosides.—Lactic Acid Fermentation.—B. THE OXIDISING FERMENTS: Alcoholic Fermentation.—Biology of do.—The Oxydases.—Acetic, Oxalic, and similar Fermentations.—Bibliography.—INDEX.

"Such a veritable *multum in parvo* has never yet appeared."—*Brewers' Journal*.

LONDON: CHARLES GRIFFIN & CO., LTD., EXETER STREET, STRAND.

In Cloth. Pp. i-xxxii + 778. With 2 Coloured Plates and 206 other Illustrations. 30s. net.

A TREATISE ON QUANTITATIVE INORGANIC ANALYSIS,

With Special Reference to the Analysis of Clays, Silicates, etc.

BY J. W. MELLOR, D.Sc.

PART I. General :—Introduction.—Weighing.—Measurement of Volumes.—Volumetric Analysis.—Colorimetry and Turbidimetry.—Filtration and Washing.—Heating and Drying.—Pulverisation and Grinding.—Sampling.—The Reagents. **PART II. Typical Silicate Analyses—Clays** :—Volatile Matters.—Opening up Silicates.—Determination of Silica.—The Ammonia Precipitate.—Iron.—Titanium.—Calcium and Magnesium.—The Alkalies.—Abbreviated Analysis and Analytical Errors.—Electro-Analysis. **PART III. Glasses, Glazes, Colours, and Complex Silicates** :—Analysis of Glass, Glazes, Enamels and Colours.—Determination of Arsenic.—Antimony.—Tin.—Lead.—Bismuth and Mercury.—Copper and Cadmium.—Zinc.—Manganese.—Cobalt and Nickel. **PART IV. Special Methods—Bases** : Determination of Molybdenum.—Tungsten, Columbium, and Tantalum.—Gold and Selenium.—Aluminium and Beryllium.—Special Methods for Non-Compounds.—Chromium, Vanadium, and Uranium.—Zirconium, Thorium, and the Rare Earths.—Barium, Strontium, Calcium, and Magnesium.—Alkalies and their Salts. **PART V. Special Methods—Acids and Non-Metals** : Carbon.—Water.—Boron Oxide.—Phosphorus.—Sulphur.—The Halogens.—Rational Analysis of Clays.—APPENDICES.—INDICES.

“Will at once take its place in scientific literature as the standard work on the subject.”
—*Chemical News*,

In Demy 8vo, Cloth. Fully Illustrated.

CLAY AND POTTERY INDUSTRIES,

Being Vol. I. of the Collected Papers from the County Pottery
Laboratory, Staffordshire.

BY SEVERAL AUTHORS.

EDITED BY J. W. MELLOR, D.Sc.

In Imperial 8vo. Strongly and Elegantly Bound in Half Leather.
Enclosed in Case. Pp. i-xviii + 660. £2 2s. net.

CERAMIC LITERATURE

Compiled, Classified, and Described by M. L. SOLON,
President of the English Ceramic Society.

An Analytical Index to the Works Published in all Languages on the History and the Technology of the Ceramic Art; also to the Catalogues of Public Museums, Private Collections, and of Auction Sales in which the Description of Ceramic Objects occupy an important place; and to the most important Price Lists of the Ancient and Modern Manufactories of Pottery and Porcelain.

“A work of inestimable value to all serious study of Ceramics.”—*Burlington Magazine*.

LONDON : CHARLES GRIFFIN & CO., LTD., EXETER STREET, STRAND.

In Demy 8vo. Handsome Cloth. Pp. i-vii + 171. With Many Tables.
6s. net.

The Theory and Practice of Enamelling on Iron and Steel.

By JULIUS GRÜNWARD,

Technical Chemist and Works' Manager.

CONTENTS.—Introduction.—The Raw Materials.—The Mixing, Dissolving, and Application of Enamel.—Heating and Pickling Goods in the Rough.—Correct laying on.—Baking Enamelled Ware.—Decoration of Enamelled Objects.—Photo-Ceramics in their Application to Enamels.—General and Statistical Chapter.—The History of Enamels and their Uses.—INDEX.

“Combines the theory and practice of enamelling in a most effective manner.”—*Iron and Steel Trades' Journal*.

In Demy 8vo. Uniform with the above. 6s. net.

The Technology of Iron Enamelling and Tinning.

By JULIUS GRÜNWARD.

Translated by H. H. HODGSON, M.A., B.Sc., Ph.D.

CONTENTS.—The History of the Enamels and their Technology.—Economic Significance of the Sheet-Iron Enamelling Industry.—Chemical Technology of the Enamelling Industry.—Enamel Manufacture and the Function of Clay in the Enamel.—Purple of Cassius.—The Examination of Enamels for Cast Iron.—The Stiffening of Enamels when ground Moist by means of Vehicles.—Heating and Pickling of Rough Iron Wares.—The Pickling Process.—Chemical Composition of an Enamel.—Tinning.—Tin Recovery.—Danger of Lead Compounds.—Tin Disease.—Procedure in an Enamel Works.—Educational Training of Managers for Enamel Works.—INDEX.

In Medium 8vo. Handsome Cloth. Illustrated. Pp. i-xix + 359. 25s. net.

CELLULOID.

ITS MANUFACTURE, APPLICATIONS, AND SUBSTITUTES.

Translated from the French of MASSELOU, ROBERTS, and CILLARD.

By H. H. HODGSON, M.A. (Camb.), B.Sc. (Lond.), Ph.D. (Heidelberg).

CONTENTS.—Composition, Origin, Properties.—Nitrocellulose.—Commercial Nitration Processes.—Bleaching of Cellulose.—Drying.—Steeping.—Staining of Celluloid.—Rolling, Compression.—Cutting and Dressing.—Tubes.—Waste.—Analyses.—Mechanical Tests.—Inflammability.—Precautions in Celluloid Works.—INDEX.

In Large 8vo. Handsome Cloth. Pp. i-xiv + 251. With Plates and
Illustrations. 7s. 6d. net.

The Manufacture of Ink.

Handbook of the Production and Properties of Printing,
Writing, and Copying Inks.

By C. A. MITCHELL, B.A., F.I.C., F.C.S., & T. C. HEPWORTH.

CONTENTS.—Introduction.—Carbon and Carbonaceous Inks.—Tannin Materials for Inks.—Nature of Inks.—Manufacture of Iron Gall Inks.—Logwood, Vanadium, and Aniline Black Inks.—Coloured Writing Inks.—Examination of Writing Inks.—Early Methods of Manufacture.—Manufacture of Varnish.—Preparation and Incorporation of the Pigment.—Coloured Printing Inks.—Copying Inks.—Marking Inks.—Safety Inks and Papers.—Sympathetic Inks.—Inks for Special Purposes.—English Patents.—INDEX.

“Thoroughly well arranged . . . and of a genuinely practical order.”—*British Printer*.

LONDON: CHARLES GRIFFIN & CO., LTD., EXETER STREET, STRAND.

PAINTS, COLOURS, DYEING, AND THE TEXTILE INDUSTRIES.

- TREATISE ON COLOUR MANUFACTURE (Preparation, Examination, and Application of Pigments).** By GEORGE ZERR and Dr. RUBENCAMP. English Edition by Dr. C. MAYER, of Burgdorf. Profusely Illustrated. 30s. net.
- TESTS FOR COAL-TAR COLOURS IN ANILINE LAKES.** By GEORGE ZERR. Translated by Dr. C. MAYER. In Medium 8vo. Cloth. 10s. 6d. net.
- PAINTING AND DECORATING. A Complete Practical Manual.** By W. J. PEARCE. FOURTH EDITION, Revised and Enlarged. Profusely Illustrated, and with many Plates in Colours. 12s. 6d.
- IDEAS AND STUDIES FOR STENCILLING AND DECORATING.** By A. DESAINT. In Medium Quarto. With Designs in Colour and Colour Scheme.
- PAINTERS' COLOURS, OILS, AND VARNISHES.** G. H. HURST, F.C.S. FIFTH EDITION, Revised and Enlarged. By NOEL HEATON, B.Sc., with Chapter on Varnishes by M. B. BLACKLER. 10s. 6d. net.
- PAINTERS' LABORATORY GUIDE.** By G. H. HURST, F.C.S. In Crown 8vo. Cloth. With Illustrations. 5s.
- A MANUAL OF DYEING.** By E. KNECHT, Ph.D., CHR. RAWSON, F.I.C., and R. LOEWENTHAL, Ph.D. SECOND EDITION, Thoroughly Revised and Rewritten. 45s.
- SYNTHETIC DYESTUFFS, and the Intermediate Products from which they are Derived.** By J. C. CAIN, D.Sc., and J. F. THORPE, Ph.D. SECOND EDITION, Revised. With 7 Folding Tables. 16s. net.
- DICTIONARY OF DYES, MORDANTS, AND OTHER COMPOUNDS.** By CHR. RAWSON, F.I.C., W. M. GARDNER, F.C.S., and W. F. LAYCOCK, Ph.D. In Large 8vo. Cloth, Library Style. 16s. net.
- SPINNING AND TWISTING OF LONG VEGETABLE FIBRES (Flax, Hemp, Jute, Tow, and Ramie).** By H. R. CARTER. With Plates and Illustrations in the Text. 16s. net.
- THE COTTON WEAVERS' HANDBOOK.** By H. B. HEYLIN. In Cloth. Fully Illustrated. 6s. net.
- BUYERS AND SELLERS IN THE COTTON TRADE.** By H. B. HEYLIN. With Chronological and Statistical Chart. 8s. 6d. net.
- TEXTILE FIBRES OF COMMERCE (Occurrence, Distribution, Preparation, and Uses).** By W. I. HANNAN. In Cloth. With Illustrations. 9s. net.
- BLEACHING AND FINISHING OF COTTON.** By S. R. TROTMAN, M.A., and E. L. THORP, M.I.Mech.E. 16s. net.
- TEXTILE PRINTING.** By E. KNECHT, Ph.D., and J. B. FOTHERGILL. With 13 Plates and 86 Patterns in the Text. 36s. net.
- TEXTILE PRINTING.** By C. F. S. ROTHWELL, F.C.S. With Illustrations. 21s.
- DYEING AND CLEANING.** By FRANK J. FARRELL, M.Sc. In Cloth; With 76 Illustrations. THIRD EDITION. Enlarged. 5s. net.
- BLEACHING AND CALICO PRINTING.** By GEORGE DUERR, Assisted by WM. TURNBULL. Cloth. 12s. 6d.

LONDON: CHARLES GRIFFIN & CO., LTD., EXETER STREET, STRAND.

In Medium 8vo. Handsome Cloth. Pp. i-xvi + 615. With 13 Plates and 80 Illustrations, also 86 Patterns inset in Text. 36s. net.

The PRINCIPLES & PRACTICE of TEXTILE PRINTING

By E. KNECHT, PH.D., AND J. B. FOTHERGILL.

CONTENTS.—Part I. Introduction.—Part II. Methods of Printing.—Part III. Preparation of Cloth for Printing.—Part IV. Preparation of Printing Colours.—Part V. Treatment of Goods after Printing.—Part VI. Mordants.—Part VII. Styles of Printing: (a) Direct; (b) Dyed; (c) Insoluble Azo-Colour; (d) Discharge; (e) Resist or Reserve; (f) Raised; (g) Printing of Linings; (h) Metal Printing; (i) Crepon or "Crimp."—Part VIII. Finishing of Printed Calicoes.—Part IX. Wool and Half Wool Printing. Part X. Silk and Half Silk Printing.—INDEX.

"This important book . . . fills an admitted gap in textile literature very systematically."—*Journal of Society of Dyers and Colourists*.

In Medium 8vo. Handsome Cloth. Pp. i-xi + 347. With 131 Illustrations. 16s. net.

THE BLEACHING AND FINISHING OF COTTON.

By S. R. TROTMAN, M.A., F.I.C., AND E. L. THORP, M.I.MECH. E.

CONTENTS.—Structure of Cotton Fibre.—Constituents of Cotton Fibre.—Cotton Testing.—Carbohydrates.—Water.—Bacteria in Bleaching.—Cotton Piece Goods.—Steeping.—Transmission of Cloth.—Alkali Boiling.—Soap.—Soap Making.—Organic Solvents.—Keirs.—Washing Machines.—Bleaching and Bleaching Powder.—Bleaching and Scouring Apparatus.—Sodium Hypochlorite and Electrolytic Bleaching Solutions.—Other Bleaching Agents.—Souring Acids and Souring Apparatus.—Processes.—Coloured Goods.—Stains and Discolourations.—Finishing and Materials Used.—Mangling, Drying, and Conditioning.—Stiffening and Mangles.—Auxiliary Machines and Processes.—Stenters.—Beetling.—Calendering.—Finishing Processes.—INDEX.

"Deserves the attention of practical bleachers, and we can recommend it to them with confidence."—*Textile Mercury*.

In Medium 8vo. Cloth. Pp. i-xvi + 360. With 161 Illustrations. 16s. net.

THE SPINNING AND TWISTING OF LONG VEGETABLE FIBRES

(FLAX, HEMP, JUTE, TOW, & RAMIE).

A Practical Manual of the most Modern Methods as applied to the Hackling, Carding, Preparing, Spinning, and Twisting of the Long Vegetable Fibres of Commerce.

By HERBERT R. CARTER, of Belfast, Ghent, and Lille.

CONTENTS.—Long Vegetable Fibres of Commerce.—Rise and Growth of the Spinning Industry.—Raw Fibre Markets and Purchase of Materials.—Storing and Preliminary Operations of Batching, Softening, Knifing, Breaking, and Cutting.—Hackling by Hand and Machine, Cost and Speed of Machining.—Sorting, and Management of Hackling Dept.—Preparing Department.—Sliver Formation.—Tow Carding and Mixing.—Preparing, Drawing and Doubling, and Tow Combing.—Gill Spinning.—Rope Yarn.—Binder Twine.—Trawl Twine and Shoe Threads.—The Flax, Hemp, Jute, and Ramie Roving Frame.—Dry and Demy-See Spinning of Flax, Hemp, Jute, and Ramie.—The Wet Spinning of Flax, Hemp, and Ramie Yarns.—Flax, Hemp, Jute, and Ramie Waste Spinning.—Yarn Reeling, Winding, Drying, Cooling, and Bundling.—Manufacture of Threads, Twines, and Cords.—Rope Making.—Weight of Ropes.—Mechanical Department: Repairs.—Fluting.—Hackle-Setting.—Wood Turning.—Oils and Oiling.—Mill Construction: Heating, Lighting, Ventilation, and Humidification.—Boilers, Engines, etc.—Power Transmission.—INDEX.

"THE WHOLE SUBJECT IS EXHAUSTIVELY AND ABLY DEALT WITH by Mr. Carter, and the letterpress is illustrated by an ABUNDANCE of EXCELLENT PLATES. The book is THE WORK of a TECHNICAL EXPERT, who can put his knowledge into plain English, and it is WORTH the ATTENTION of ALL concerned with the industries treated of."—*The Dyer and Calico Printer*.

LONDON: CHARLES GRIFFIN & CO., LTD., EXETER STREET, STRAND.

A TEXT-BOOK OF PHYSICS.

By **J. H. POYNTING**, Sc.D., F.R.S.,
Professor of Physics, Birmingham University,
And **Sir J. J. THOMSON**, M.A., F.R.S.,
Professor of Experimental Physics in the University of Cambridge.
In Five Volumes. Large 8vo. Sold Separately.

INTRODUCTORY VOLUME. FIFTH EDITION, Revised. Fully Illustrated.
10s. 6d.

PROPERTIES OF MATTER.

CONTENTS.—Gravitation.—The Acceleration of Gravity.—Elasticity.—Stresses and Strains.—Torsion.—Bending of Rods.—Spiral Springs.—Collision.—Compressibility of Liquids.—Pressures and Volumes of Gases.—Thermal Effects Accompanying Strain.—Capillarity.—Surface Tension.—Laplace's Theory of Capillarity.—Diffusion of Liquids.—Diffusion of Gases.—Viscosity of Liquids.—INDEX.

"We regard this book as quite indispensable not merely to teachers but to physicists of every grade above the lowest."—*University Correspondent*.

VOLUME II. FIFTH EDITION. Fully Illustrated. Price 8s. 6d.

SOUND.

CONTENTS.—The Nature of Sound and its chief Characteristics.—The Velocity of Sound in Air and other Media.—Reflection and Refraction of Sound.—Frequency and Pitch of Notes.—Resonance and Forced Oscillations.—Analysis of Vibrations.—The Transverse Vibrations of Stretched Strings or Wires.—Pipes and other Air Cavities.—Rods.—Plates.—Membranes.—Vibrations maintained by Heat.—Sensitive Flames and Jets.—Musical Band.—The Superposition of Waves.—INDEX.

"The work . . . may be recommended to anyone desirous of possessing an **UP-TO-DATE STANDARD TREATISE ON ACOUSTICS**."—*Literature*.

VOLUME III. FOURTH EDITION, Revised. Fully Illustrated. Price 15s.

HEAT.

CONTENTS.—Temperature.—Expansion of Solids.—Liquids.—Gases.—Circulation and Convection.—Quantity of Heat; Specific Heat.—Conductivity.—Forms of Energy; Conservation; Mechanical Equivalent of Heat.—The Kinetic Theory.—Change of State; Liquid, Vapour.—Critical Points.—Solids and Liquids.—Atmospheric Conditions.—Radiation.—Theory of Exchanges.—Radiation and Temperature.—Thermodynamics.—Isothermal and Adiabatic Changes.—Thermodynamics of Changes of State, and Solutions.—Thermodynamics of Radiation.—INDEX.

"Well up-to-date, and extremely clear and exact throughout. . . . As clear as it was possible to make such a text-book"—*Nature*.

VOLUME IV. IN THREE PARTS—TWO BOUND VOLUMES.

ELECTRICITY & MAGNETISM.

PARTS I. & II. In Cloth. Pp. i-xiv + 246. Price 10s. 6d.

STATIC ELECTRICITY AND MAGNETISM.

CONTENTS.—Common Phenomena.—Quantity of Electrification.—"Inverse Square" Systems.—Electric Strain produced in a Field.—Force on a Small Charged Body in the Field.—Potential.—Energy in Electrified Systems.—Measuring Potential and Capacity.—Dielectric, Specific Inductive Capacity, Residual Effects.—Spec Ind. Capacity and Refractive Index.—Stress in Dielectric.—Alteration in Dielectric under Strain.—Pyro- and Piezo-electricity.—Magnetic Actions.—Molecular Hypothesis of Magnets.—Magnets other than Iron.—Inverse Square Law.—Magnetic Fields.—Induced Magnetism.—Permeability.—Measurements of Susceptibility and Permeability.—Terrestrial Magnetism.—Magnetism and Light.—INDEX.

PART III.—Is in the Press.

VOLUME V. **LIGHT**—Is in Preparation.

LONDON: CHARLES GRIFFIN & CO., LTD., EXETER STREET, STRAND.



UNIVERSITY OF CALIFORNIA LIBRARY,
BERKELEY

**THIS BOOK IS DUE ON THE LAST DATE
STAMPED BELOW**

Books not returned on time are subject to a fine of 50c per volume after the third day overdue, increasing to \$1.00 per volume after the sixth day. Books not in demand may be renewed if application is made before expiration of loan period.

JUL 25 1922

4 Apr '50
LIBRARIAN'S USE

JUN 14 1953

21 Nov 54
PB

NOV 7 1954

20 APR '59

REC'D LD

APR 23 1959

327976

TA670

Fage

F3

UNIVERSITY OF CALIFORNIA LIBRARY

