

508.3

L87

ALLAN HANCOCK FOUNDATION
PUBLICATIONS

Los Angeles OF
THE UNIVERSITY OF SOUTHERN CALIFORNIA

FIRST SERIES

ALLAN HANCOCK PACIFIC EXPEDITIONS

VOLUME 3
1936-1944



THE UNIVERSITY OF SOUTHERN CALIFORNIA PRESS
LOS ANGELES 7, CALIFORNIA

1944

ALLAN HANCOCK FOUNDATION
PUBLICATIONS

ALLAN HANCOCK PACIFIC EXPEDITIONS

VOLUME 3
1936-1944

THE UNIVERSITY OF SOUTHERN CALIFORNIA PRESS
LOS ANGELES 7, CALIFORNIA
1944

CONTENTS

	PAGES
1. Mosses of the G. Allan Hancock Expedition of 1934, Collected by Wm. R. Taylor, by William Campbell Steere. (Plate 1).....	1- 14
2. Myxophyceae of the G. Allan Hancock Expedition of 1934, Collected by Wm. R. Taylor, by Francis Drouet. (Plates 2-3).....	15- 32
3. Lichens of the G. Allan Hancock Expeditions of 1934, Collected by Wm. R. Taylor, by Carroll William Dodge.....	33- 46
4. Plankton Diatoms of the Gulf of California Obtained by the G. Allan Hancock Expedition of 1936, by W. E. Allen. (1 figure).....	47- 60
5. Plankton Diatoms of the Gulf of California Obtained by Allan Hancock Pacific Expedition of 1937, by E. E. Cupp and W. E. Allen. (1 map and Plates 4-15).....	61-100
6. Phycomycetes Recovered from Soil Samples Collected by W. R. Taylor on the Allan Hancock 1939 Expedition, by F. K. Sparrow, Jr. (Plates 16-17).....	101-114
7. Field Observations on the Algae of the Gulf of California, by Elmer Yale Dawson.....	115-120
8. A Review of the Genus Rhodymenia with Descriptions of New Species, by Elmer Yale Dawson. (Plates 18-30).....	121-182
9. Some Lichens from the American Tropics Collected by Wm. R. Taylor, by Joyce Hedrick.....	183-188
10. The Marine Algae of the Gulf of California, by Elmer Yale Dawson. (Plates 31-77).....	189-454
Index.....	455-464

Corrections

- p. 130. under (5) for 1923 read "1922"
- p. 131. under (7) after Pugill. Alg. Yemens, read "(1850)"
- p. 135. under (18) for pls. 50-51 read "pl. 50"
- p. 136. under (22) for Plate 23 read "Plate 22"
- p. 137. under (24) for Plate 26 read "Plate 25"
- p. 138. under (25) for 1884 read "1885"
- p. 139. under (31) for Plate 25 read "Plate 24"
- p. 141. under (34) for Plate 24 read "Plate 23"
- p. 151. under Agardh, J. G., for historia read "historiam"; after De Algis Novae Zelandiae marinis, read "Lunds Univ. Arsskrift VIII"; for 1884 read "1885"; for 1896 read "1894"; for continuata read "continuatio"; under Kuetzing, F. T., for 1849-1869 read "1845-1871."

THE HANCOCK PACIFIC EXPEDITIONS

VOLUME 3

NUMBER 1

MOSSES
OF THE G. ALLAN HANCOCK EXPEDITION
OF 1934, COLLECTED BY WM. R. TAYLOR

(WITH ONE PLATE)

by

WILLIAM CAMPBELL STEERE

OF THE
DEPARTMENT OF BOTANY
AND THE HERBARIUM
OF THE
UNIVERSITY OF MICHIGAN



THE UNIVERSITY OF SOUTHERN CALIFORNIA PRESS
LOS ANGELES, CALIFORNIA
1936

7

REPORTS ON THE COLLECTIONS OBTAINED BY THE HANCOCK PACIFIC EXPEDITIONS OF
VELERO III OFF THE COAST OF MEXICO, CENTRAL AMERICA, SOUTH AMERICA, AND
GALAPAGOS ISLANDS IN 1932, IN 1933, IN 1934, AND IN 1935.

MOSSES
OF THE G. ALLAN HANCOCK EXPEDITION
OF 1934, COLLECTED BY WM. R. TAYLOR

By WILLIAM CAMPBELL STEERE

THE UNIVERSITY OF SOUTHERN CALIFORNIA PUBLICATIONS

THE HANCOCK PACIFIC EXPEDITIONS

VOLUME 3, NUMBER 1

ISSUED FEBRUARY, 1936

THE UNIVERSITY OF SOUTHERN CALIFORNIA PRESS

LOS ANGELES, CALIFORNIA

COPYRIGHT 1936

BY

THE UNIVERSITY OF SOUTHERN CALIFORNIA

MOSSES OF THE G. ALLAN HANCOCK EXPEDITION
OF 1934, COLLECTED BY WM. R. TAYLOR

(WITH ONE PLATE)

By WILLIAM CAMPBELL STEERE

Department of Botany and the Herbarium of the University of Michigan

Considering the fact that most of Dr. Taylor's collecting was done in the immediate vicinity of the seashore, since he was engaged primarily in the collection of marine algae, it is not surprising that his series of bryophytes is not a large one. However, the smallness of the collection is well compensated for by the unusual significance and interest of the material. Among the thirty-three species here reported, two, *Fissidens Hancockiana* from Colombia and *Barbula Taylorii* from the Galapagos Islands, are proposed as new, whereas many others represent new records for the areas considered, and consequently add much to our knowledge of their geographical distribution. Since six of the nine mosses from the Galapagos Islands represent new reports for the area, it is obvious, as already pointed out by Mr. Bartram (1933), that a full bryological exploration of these Islands will appreciably extend the list of moss species, and probably reveal new and interesting forms, as well.

FISSIDENTACEAE

FISSIDENS MOLLIS Mitt., Jour. Linn. Soc., Bot. 12:600. 1869.

On red sandstone at the bottom of a forest stream, in rather less than two feet of water. Bahia Honda, Panama (west coast); February 21, 1934; *W. R. Taylor No. 1100*.

Since this material was growing eighteen to twenty-four inches below the surface of the water during the dry season, and must consequently be much more deeply submerged during the rainy season, it seems to represent a completely aquatic phase of the species. Such a habitat is all the more noteworthy, because of the relative scarcity of aquatic species in the section *Bryoidium*.

Distribution: Cuba; Jamaica; Trinidad; Panama; western South America.

Fissidens (Semilimbidium) **Hancockiana**, sp. nov.

Plate 1, figures 1-3.

Planta 5-10 mm. alta, erecta, atro-vel pallido-viridis, vetustate fuscescens; folia 13-25 juga (pares 2-5 infima valde minores), lanceolata, apicibus acutis serrulatis; vaginarum laminae marginatae, foliis 2/5 breviores; costa crassa tenuiter vel haud flexuosa, percurrentis; marginis cellulae perlongae angustaeque, hyalinae sed aetate decolorantes; cellulae ceterae parvae, 5-7 μ diametro, mamillosae papilla centrali singulari, ita ut marginem crenulato-denticulatum simulans et areolas obscurans; cellulae apicium ultimae laevigatae et valde maiores, haud papillosae; lamina inferior haud decurrens. Autoica; antheridia sub perichaetio; archegonia in cauli primo terminalia, vel in gemmis axillaribus, vel in ramosis axillaribus perbrevis aut elongatis; fructus singularis vel nonnunquam duplex; seta vetustate rubra, 2-4 mm. longa, flexuosa; capsula subobliqua vel horizontalis; urnula 0.6-0.7 mm. longa; cervix stomatosa; operculum rostratum urnulam aequilongum.

Plants of small to medium size, 5-10 mm. high, erect, somewhat caespitose, stiff, increasing in size each year by a resumption of growth at the apex of the stem, or through the development of axillary, dorsal, easily separated innovations, or both, the old stems finally becoming prostrate, bearing several erect secondary branches; dark to yellowish-green, turning reddish-brown with age, the stem and costa becoming red even in rather young plants; leaves in 13-25 pairs, the lowest 2-5 pairs smaller than the others, 1.0-1.5 mm. long, 0.2-0.3 mm. wide, oblong-lanceolate, tapering rather gradually to a straight or very slightly falcate acute and serrulate apex, with a conspicuous border on the sheathing laminae, extending slightly beyond their juncture, the sheath reaching about three fifths of the way to the apex; terminal leaves only slightly or not at all larger than the others, all with a stout, rarely slightly flexuous costa which is percurrent or very nearly so; the cells of the border are very long and narrow, hyaline or pale yellow, becoming colored in old leaves; the remaining cells small, 5-7 μ in diameter, each cell mamillate, with a single high, central papilla, so that the unbordered leaf-margin is crenulate-denticulate and the areolation somewhat obscure, except at the serrulate apex where the cells are about twice as large and not papillose; inferior lamina ceasing abruptly at the base, not at all decurrent. Autoicous; the antheridia in a very short, bud-like

branch immediately below the perichaetium; archegonia numerous, their position exceedingly variable, terminal on the main stem, or in axillary buds on the dorsal side of the stem, or on very short to elongated axillary branches which bear rhizoids at their base and are easily detached, all types often on the same plant; sporophytes single or not infrequently 2 from each perichaetium, stages of widely differing ages often occurring on the same plant, or even from the same perichaetium; seta yellow, becoming red shortly after maturation of the capsule, 2-4 mm. long, quite variable in length, flexuose; capsule inclined, slightly asymmetric, the urn 0.6-0.7 mm. long, its cells mamillate and projecting, their angles strongly thickened, the neck stomatose; lower half of the peristome teeth red and conspicuously incurved, the upper half pale and suddenly erect; operculum conic and long rostrate, as long as the urn; calyptra small, shed very early; spores smooth, small, 12 μ in diameter.

On clay soil, Port Utria, Choco, Colombia; February 14, 1934; *W. R. Taylor No. 1081* (type specimen, in the U. S. N. Herbarium).

This species possesses a combination of characters which serves to distinguish it rather easily from the species most closely related to it. The principal diagnostic characters are the long stems, with an unusually large number of leaf-pairs, the red stem and costa, the serrulate leaf-apex consisting of enlarged, smooth cells, the peculiar growth-habit, and the character of the inflorescence, including the variable position of the archegonia.

DICRANACEAE

CAMPYLOPUS INTROFLEXUS (Hedw.) Brid., *Bryol. Univ.* 1:472. 1826.

On thin soil, near Wedemann place, inland on Santa Maria (Charles or Floreana) Island, Galapagos Islands; January 28, 1934; *W. R. Taylor No. 1001*.

Distribution: An exceedingly widely distributed species, reported from the southern United States, Mexico, West Indies, Central and South America, the Galapagos Islands, Africa, and Australasia.

LEUCOBRYACEAE

LEUCOBRYUM MARTIANUM (Hornsch.) Hampe; *C. Müll., Linnaea* 17:317. 1843.

On trunk of palm, Bahia Honda, Panama (west coast); February 21, 1934; *W. R. Taylor No. 1093*.

Distribution: West Indies; northern South America.

This is apparently the first record for Central America.

OCTOBLEPHARUM ALBIDUM Hedw., Descr. Musc. Frond. 3:15. 1792.

On humus and rotting wood, Bahia Honda, Panama (west coast); February 21, 1934; *W. R. Taylor Nos. 1108, 1122*.

Distribution: Widely distributed throughout tropical regions; Galapagos Islands.

OCTOBLEPHARUM PULVINATUM (Dozy et Molk.) Mitt. Journ. Linn. Soc., Bot. 12:109. 1869.

On trunk of tree, Gorgona Island (off Narino), Colombia; February 12, 1934; *W. R. Taylor No. 1020*.

Distribution: West Indies; Central and South America.

CALYMPERACEAE

CALYMPERES DISCIFORME C. Müll., Linnaea 21:183. 1848.

On trees, in forest, Bahia Honda, Panama (west coast); February 21, 1934; *W. R. Taylor Nos. 1107, 1121*.

Distribution: Santo Domingo; northern South America.

This seems to be one of the first reports of this species from Central America.

CALYMPERES DONNELLII Aust., Bot. Gaz. 4:151. 1879.

On trunk of tree in dense forest, Gorgona Island (off Narino), Colombia; February 12, 1934; *W. R. Taylor No. 1023*.

Distribution: Florida; West Indies; Guatemala; Panama.

This collection apparently represents a southern extension to the known geographical range of the species.

SYRRHOPODON INCOMPLETUS Schwaegr. Suppl. 2(2):119. 1824.

On trees in forest, Bahia Honda, Panama (west coast); February 21, 1934; *W. R. Taylor Nos. 1109, 1111*.

Distribution: Florida; West Indies; Central and South America; Galapagos Islands.

POTTIACEAE

Barbula (Hydrogonium) **Taylorii** Bartram et Steere sp., nov.

Plate 1, figures 6-8

Planta sterilis, perennis, aquatica, simplex vel leviter ramosa; caules 2-4 cm. longi, paralleli, debiles, supra frondosi, infra nudi; folia triseriata, acyclica, madidata squarroso-potentia, exsiccata pa-

tentia et languide crispa, concava, lineali-lanceolata, 2 mm. longa, 0.2-0.3 mm. lata, apice acuta, valde concava; folii margo aequus, integer; costa robusta, percurrents, superficiei dorsalis parte superiori papillosa; cellularum basalium saepta aliquantulum crassa, elongata vel rectangularia; cellulae superiores quadrangulares, saeptis crassis, tenuiter papillosae, $7-8 \times 9-10 \mu$ longae margine, costam versus maiores; antheridia, archegonia et fructus ignota.

Sterile; plants dark green, perennial, simple to sparsely branching, in deep tufts, aquatic; stems 2-4 cm. long, closely approximated, parallel, lax, green and leafy above, becoming reddish-brown and leafless below, more or less covered with a thin felt of tangled white radicles, which become reddish with age; leaves in three ranks which are spirally arranged on the stem, disappearing below or with only the stout costa remaining, squarrose-spreading when moist, spreading and slightly crispate when dry, especially the apical leaves, concave, linear-lanceolate, about 2 mm. long and 0.2-0.3 mm. wide at the broadest part, tapering gradually to an acute, very concave apex; leaf-margin plane to slightly recurved, entire except for the papillae borne by the marginal cells; costa stout, up to 50μ in diameter half way up the leaf, consisting of greatly elongated cells in the basal portion and of rectangular cells in the upper half, distinctly papillose on the dorsal side above and less conspicuously so on the ventral surface above, percurrent or nearly so, in cross-section showing mostly 4-6 guide cells, with a broad dorsal stereid band and a narrower ventral one, the outermost cells on both sides differentiated, but not as large as the guide cells; basal cells with somewhat thickened walls, without papillae, those at the extreme basal margin linear, the others somewhat elongated to rectangular, passing very gradually in the upper part of the leaf into thick-walled, finely papillose, four-angled or rounded cells which are smaller and wider than long at the margin, $7-8 \mu \times 9-10 \mu$, but become progressively somewhat larger and occasionally longer than wide toward the costa. Antheridia, archegonia and fruit unknown.

In the spring at "Baroness von Wagner's" place, associated with *Callicostella pallida* (Hornsch.) Jaeg., Santa Maria (Charles or Floreana) Island, Galapagos Islands; January 28, 1934; *W. R. Taylor No. 1014* (type specimen, in the U. S. N. Herbarium).

The only other American species of *Barbula* in this section is *B. Ehrenbergii* (Lor.) Fleisch. var. *mexicana* Thér., which has been

reported from Mexico and British Honduras. *B. Taylorii* differs from this species in the following respects: the leaf is of quite different form, being much narrower, the basal cells are more conspicuously differentiated, the upper cells and costa are papillose, and the apex is more acute (Pl. 1, fig. 9).

BARBULA REPLICATA Tayl., Hook. Jour. Bot. 15(C):49. 1846.

On shallow soil, near Wedemann place; inland on Santa Maria (Charles or Floreana) Island, Galapagos Islands; January 28, 1934; *W. R. Taylor No. 1002*.

Distribution: Ecuador; Peru; Bolivia.

This is a new record for the Galapagos Islands.

HYMENOSTOMUM sp.

On shallow soil, inland on Santa Maria (Charles or Floreana) Island, Galapagos Islands; January 28, 1934; *W. R. Taylor No. 1006*.

These specimens, although sterile, have the characteristic leaf shape and structure of the genus *Hymenostomum*, of which no members have yet been reported from the Galapagos Islands.

BRYACEAE

BRYUM ARGENTIUM Hedw. var. LANATUM B. et S., Bry. eur. 6(9):7. pl. 41. 1839.

On shallow soil, associated with *Campylopus introflexus* (Hedw.) Brid., near Wedemann place, inland on Santa Maria (Charles or Floreana) Island, Galapagos Islands; January 28, 1934; *W. R. Taylor No. 1010*.

Distribution: Cosmopolitan in the warmer parts of the earth.

This species has apparently never before been reported from the Galapagos Islands.

BARTRAMIACEAE

PHILONOTIS TENELLA (C. Müll.) Besch., Ann. Sci. Nat., Bot. VI. Ser. 3:207. 1876.

On tree in dense, wet forest, Gorgona Island (off Narino), Colombia; February 12, 1934; *W. R. Taylor No. 1024*.

Distribution: Florida; West Indies; Central and South America.

ORTHOTRICHACEAE

MACROMITRIUM MUCRONIFOLIUM (Hook. et Grev.) Schwaegr.,
Suppl. 2(2):61. pl. 170. 1826.

On the trunk of a tree, inland on Santa Maria (Charles or Floreana) Island, Galapagos Islands; January 28, 1934; *W. R. Taylor No. 1003*; on tree in dense, wet forest, Gorgona Island (off Narino), Colombia; February 12, 1934; *W. R. Taylor No. 1022*.

Distribution: Florida; West Indies; Central and South America.

MICROMITRIUM FRAGILE (Mitt.) Jaeg., Ber. St. Gall. Nat. Ges.
1872-73:157. 1874.

On tree in forest, Jicarita Island, Panama (west coast); February 20, 1934; *W. R. Taylor No. 1088-a*.

Distribution: Mexico; Central America; Guadalupe; tropical South America; Galapagos Islands.

HELICOPHYLLACEAE

HELICOPHYLLUM TORQUATUM (Hook.) Brid., Bryol. Univ. 2:771.
1827.

On humus and decaying roots, Jicarita Island, Panama (west coast); February 20, 1934; *W. R. Taylor No. 1088*.

Distribution: Throughout the American tropics.

RHACOPILACEAE

RHACOPILUM TOMENTOSUM (Sw.) Brid., Bryol. Univ. 2:719. 1827.

On tree trunk, among hepatics, Santa Maria (Charles or Floreana) Island, Galapagos Islands; January 28, 1934; *W. R. Taylor No. 1007*.

Distribution: Throughout tropic and subtropic America.

This is a new record for the Galapagos Islands.

PTEROBRYACEAE

ORTHOSTICHOPSIS TETRAGONA (Sw.) Broth., Engl.-Prantl, Pflanzenfam. 1(3):805. 1906.

On tree in forest, Bahia Honda, Panama (west coast); February 21, 1934; *W. R. Taylor No. 1098*.

Distribution: Mexico; West Indies; Central and tropical South America.

METEORIACEAE

METEORIOPSIS PATULA (Sw.) Broth., Engl.-Prantl, Pflanzenfam. 1(3):825. 1906.

On tree in forest, Bahia Honda, Panama (west coast); February 21, 1934; *W. R. Taylor No. 1104*: on tree, mixed with hepatics, near Wedemann area, inland on Santa Maria (Charles or Floreana) Island, Galapagos Islands; January 28, 1934; *W. R. Taylor No. 1012*.

Distribution: Mexico; West Indies; Central and South America.

This is the first record of the species from the Galapagos Islands. Mr. Bartram (1. c.) has suggested that *Meteoriopsis Anderssonii* (C. Müll.) Broth., which has long been known from the Galapagos Islands, probably represents this species or a form of it.

NECKERACEAE

NECKEROPSIS DISTICHA (Hedw.) Fleisch., Laubmfl. Java 3:879. 1907.

On trees in forest, Cabita Bay, Cape Corrientes, Choco, Colombia; February 13, 1934; *W. R. Taylor No. 1026*.

Distribution: Florida; Mexico; West Indies; Central and South America.

NECKEROPSIS UNDULATA (Palis.) Broth., Engl.-Prantl, Pflanzenfam. Ed. II. 11:187. 1925.

On trees, Cabita Bay, Cape Corrientes, Choco, Colombia; February 13, 1934; *W. R. Taylor No. 1056*: Bahia Honda, Panama (west coast); February 21, 1934; *W. R. Taylor Nos. 1113, 1119*.

Distribution: Florida; West Indies; Central and South America.

PILOTRICHACEAE

PILOTRICHUM AMAZONUM Mitt., Jour. Linn. Soc., Bot. 12:387. 1869.

On tree in forest, Bahia Honda, Panama (west coast); February 21, 1934; *W. R. Taylor No. 1112*.

These specimens, which bear antheridia, are noteworthy for the large numbers of peculiar green propagula produced on the ultimate branches.

Distribution: Guatemala; South America.

PILOTRICHUM BIPINNATUM (Schwaegr.) Brid., Bryol. Univ. 2:263. 1827.

On tree in dense forest, Cabita Bay, Cape Corrientes, Choco, Colombia; February 13, 1934; *W. R. Taylor No. 1030*.

Distribution: West Indies; South America.

HOOKERIACEAE

CALLICOSTELLA PALLIDA (Hornsch.) Jaeg., Ber. St. Gall. Nat. Ges. 1875-76:353. 1877.

On dead wood, associated with *Taxithelium planum* (Brid.) Mitt.; Bahia Honda, Panama (west coast); February 21, 1934; *W. R. Taylor No. 1102*.

Distribution: West Indies; Central and South America.

CYCLODICTYON ALBICANS (Sw.) Broth., Engl.-Prantl, Pflanzenfam. 1(3):935. 1907.

In the spring at "Baroness von Wagner's" place, intermixed with *Barbula Taylorii*; Santa Maria (Charles or Floreana) Island, Galapagos Islands; January 28, 1934; *W. R. Taylor No. 1011*.

Distribution: Mexico; West Indies; Central and South America.

HOOKERIOPSIS DIFFUSA (Wils.) Jaeg., Adumb. 2:253. 1874-75.

On moist clayey soil, associated with *Taxithelium planum* (Brid.) Mitt.; Cabita Bay, Cape Corrientes, Choco, Colombia; February 13, 1934; *W. R. Taylor No. 1075-a*.

Distribution: Panama; Cocos Island.

LEPIDOPILUM FLEXIFOLIUM (C. Müll.) Mitt., Jour. Linn. Soc., Bot. 12:375. 1869.

A few isolated plants of this species were found in a tuft of *Acroporium pungens* (Hedw.) Broth.; Cabita Bay, Cape Corrientes, Choco, Colombia; February 13, 1934; *W. R. Taylor No. 1037*.

Distribution: Trinidad; South America.

SEMATOPHYLLACEAE

ACROPORIUM PUNGENS (Hedw.) Broth., Engl.-Prantl, Pflanzenfam. Ed. II. 11:436. 1925.

On decaying wood in forest, Cabita Bay, Cape Corrientes, Choco, Colombia; February 13, 1934; *W. R. Taylor No. 1036*.

Distribution: Antilles; Panama; tropical South America.

TAXITHELIUM PLANUM (Brid.) Mitt., Jour. Linn. Soc., Bot. 12:496. 1869.

On decaying wood and moist soil, Cabita Bay, Cape Corrientes, Choco, Colombia; February 13, 1934; *W. R. Taylor No. 1075-b*: Bahia Honda, Panama (west coast); February 21, 1934; *W. R. Taylor No. 1101*.

Distribution: Widespread throughout the American tropics.

SEMATOPHYLLUM CAESPITOSUM (Sw.) Mitt., Jour. Linn. Soc., Bot. 12:479. 1869.

On moist soil, Cabita Bay, Cape Corrientes, Choco, Colombia; February 13, 1934; *W. R. Taylor No. 1074*.

Distribution: Florida; Mexico; West Indies; Central and South America; Africa.

HYPNACEAE

VESICULARIA AMPHIBOLA (Spruce) Broth., Engl.-Prantl, Pflanzenfam. 1(3):1094. 1908.

On soil, Cabita Bay, Cape Corrientes, Choco, Colombia; February 13, 1934; *W. R. Taylor Nos. 1039, 1044*.

Distribution: Florida; West Indies; Central and South America.

RHACOPILOPSIS TRINITENSIS (C. Müll.) E. G. Britt. et Dixon, Jour. Bot. 60:88. 1922. [*R. Pechuelii* (C. Müll.) Card. Rev. Bryol. 40:19. 1913].

On tree in forest, Bahia Honda, Panama (west coast); February 21, 1934; *W. R. Taylor No. 1110*. (Pl. 1, figs. 4-5)

Dr. Taylor's specimens of this species, which is as unusual in its appearance as in its geographical distribution, differ rather sharply from the several collections in the Herbarium of the New York Botanical Garden. Although the serrate, dimorphic, asymmetric leaves with well-marked and frequently inflated alar cells allow it to be placed in no other genus, these plants are smaller and more lax than the others examined, and possess, in addition, attenuate branches. Both dorsal and ventral leaves are narrower than the descriptions and illustrations would indicate (for instance, those of Brotherus, 1925), and the ventral leaves have conspicuously recurved margins, instead of plane margins (figs. 4 and 5). *Rhacopilopsis trinitensis* is known to vary widely, however, as demonstrated by its ample synonymy. It seems advisable to wait until more American

material becomes available for comparison before considering the creation of a new species to fit these specimens.

The rather constant presence of a row of two or three suddenly inflated hyaline or occasionally colored alar cells in this genus suggests that its affinities may be with the Sematophyllaceae rather than with the Hypnaceae.

Distribution: Trinidad; French and British Guiana; Angola, Congo; Madagascar.

LITERATURE CITED

BARTRAM, E. B.

1933. Mosses of the Templeton Crocker Expedition collected by John Thomas Howell and lists of the mosses known from the Galapagos Islands and from Cocos Island. Proc. Calif. Acad. Sci. IV. Ser. 21:75-86.

BROTHERUS, V. F.

1925. Musci. In Engler und Prantl, Die natürlichen Pflanzenfamilien. Ed II. 11:473, fig. 757.

EXPLANATION OF PLATE

Figs. 1-3. *Fissidens Hancockiana* sp. nov.

Fig. 1. Fruiting plant, x 20.

Fig. 2. Whole leaf, x 63.

Fig. 3. Detail of leaf-apex, showing areolation, x 450.

Figs. 4-5. *Rhacopilopsis trinitensis*.

Fig. 4. Dorsal side of stem, x 40.

Fig. 5. Ventral side of stem, x 40.

Figs. 6-8. *Barbula Taylorii* sp. nov.

Fig. 6. Upper part of plant, x 18.

Figs. 7-8. Leaves, x 40.

Fig. 9. *Barbula Ehrenbergii* var. *mexicana*.

Fig. 9. Leaf, x 40.



STEERE: HANCOCK EXPEDITION MOSSES

THE HANCOCK PACIFIC EXPEDITIONS

VOLUME 3

NUMBER 2

MYXOPHYCEAE
OF THE G. ALLAN HANCOCK EXPEDITION
OF 1934, COLLECTED BY WM. R. TAYLOR

(WITH TWO PLATES)

by

FRANCIS DROUET

OF THE
DEPARTMENT OF BOTANY
UNIVERSITY OF MISSOURI



THE UNIVERSITY OF SOUTHERN CALIFORNIA PRESS
LOS ANGELES, CALIFORNIA

1936

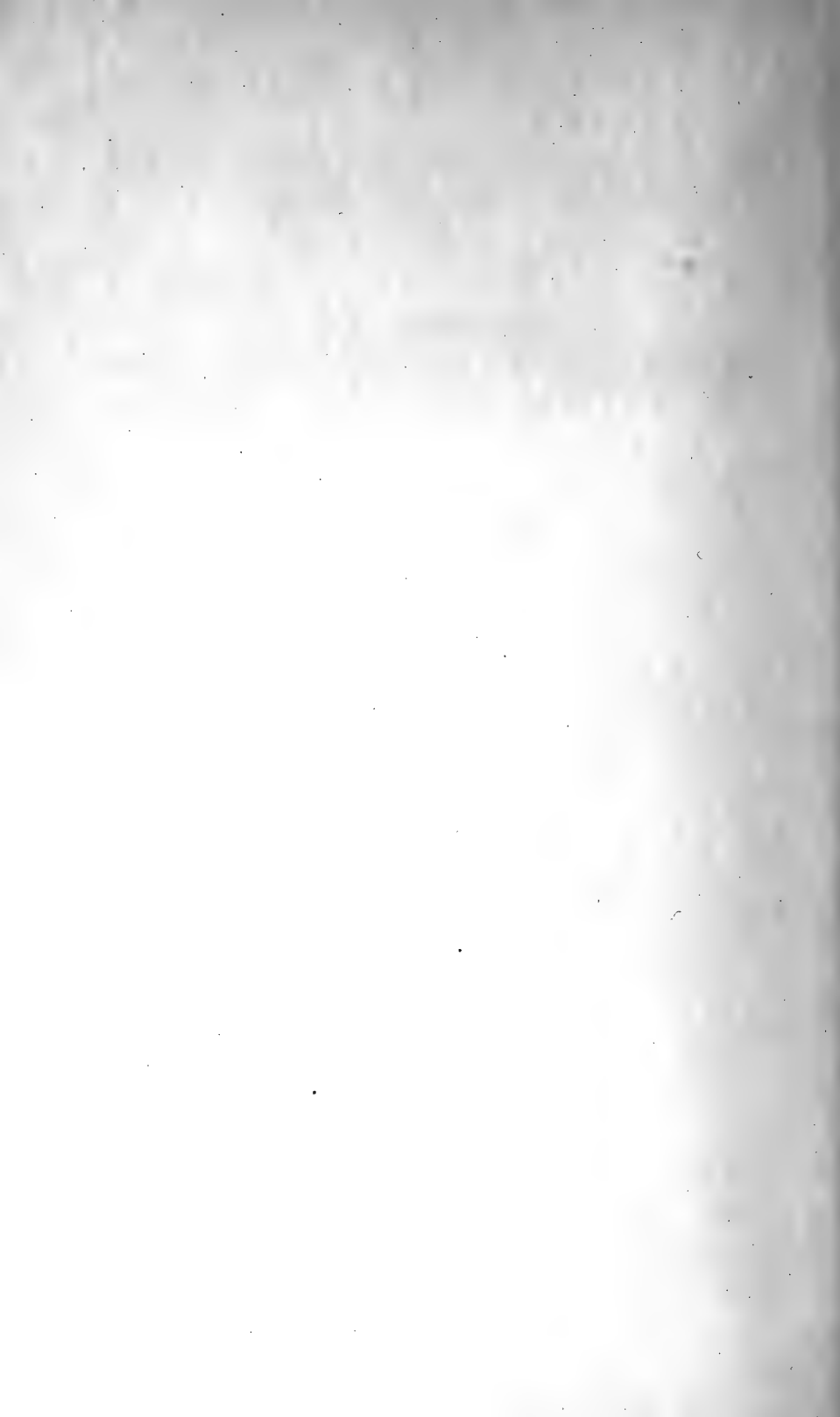

7

REPORTS ON THE COLLECTIONS OBTAINED BY THE HANCOCK PACIFIC EXPEDITIONS OF
VELERO III OFF THE COAST OF MEXICO, CENTRAL AMERICA, SOUTH AMERICA, AND
GALAPAGOS ISLANDS IN 1932, IN 1933, IN 1934, AND IN 1935.

MYXOPHYCEAE
OF THE G. ALLAN HANCOCK EXPEDITION
OF 1934, COLLECTED BY WM. R. TAYLOR

By FRANCIS DROUET

THE UNIVERSITY OF SOUTHERN CALIFORNIA PUBLICATIONS
THE HANCOCK PACIFIC EXPEDITIONS
VOLUME 3, NUMBER 2
ISSUED NOVEMBER, 1936

THE UNIVERSITY OF SOUTHERN CALIFORNIA PRESS
LOS ANGELES, CALIFORNIA

COPYRIGHT 1936
BY
THE UNIVERSITY OF SOUTHERN CALIFORNIA

MYXOPHYCEAE
OF THE G. ALLAN HANCOCK EXPEDITION OF 1934,
COLLECTED BY WM. R. TAYLOR

(WITH TWO PLATES)

By FRANCIS DROUET

Department of Botany, University of Missouri

The Myxophyceae listed here were found in thirteen samples of marine algae collected by Dr. William Randolph Taylor on the Galapagos Islands (Archipelago de Colon) and the Revilla Gigedo Islands, and on the Pacific coast of Mexico and Costa Rica, during the G. Allan Hancock Expedition of 1934. These samples consist principally or entirely of blue-green algae; as the other marine plants collected are examined, it is expected that more epiphytic Myxophyceae will be found and reported. The phycological literature of the general region has been listed or summarized by Robinson (Proc. Amer. Acad. 38(4): 79-82. 1902), Howe (Mem. Torr. Bot. Club 15: 4-7. 1914), and Setchell and Gardner (Proc. Calif. Acad. Sci., ser. 4, 19(11). 1930). The myxophycean flora has not been exhaustively treated by any one author; the largest number of species (22) reported for any one area is listed by Setchell and Gardner (*ibid.*) for Guadalupe Island, Baja California, and for the Revilla Gigedo Islands, Colima. Original material cited in the list below is to be distributed, on behalf of Captain G. Allan Hancock, to The University of Southern California, the United States National Herbarium, the Herbarium of the University of Michigan, my personal collection, and possibly other depositories. Professor Taylor has been most generous in allowing me to study this material and in offering numerous welcome suggestions during the writing of this report.

CHROOCOCCACEAE

CHROOCOCCUS TURGIDUS (Kützing) Nägeli, Gattungen einzelligen Algen, p. 46, 1849; Geitler, Rabenh. Kryptogamenfl. 14: 228. 1930.

Forma cellulis praecipue 8μ ad 12μ crassis, tegumentis evidenter lamellosis. Fig. 16.

ECUADOR: Galapagos Islands, in an inland salt pool, north end of Isabela (Albemarle) Id., near Albemarle Point, *No. 123*, January 12.

var. SUBMARINUS Hansgirg, Oesterr. bot. Zeitschr. 39: 6. 1889; Geitler, Rabenh. Kryptogamenfl. 14: 230. 1930.

Forma cellulis sine tegumentis 15μ ad 30μ crassis, aerugineis vel luteolis vel violaceis; tegumentis crassis, haud evidenter lamellosis.

ECUADOR: Galapagos Islands, with *Calothrix pilosa* Harv. about the edge of a brackish lagoon near high water level, Albemarle Point, Isabela Id., *No. 96*, January 12.

GOMPHOSPHAERIA APONINA Kützing, Algae exsiccatae, Dec. XVI, No. 151. 1836; Geitler, Rabenh. Kryptogamenfl. 14: 245. 1930.

Forma cellulis vulgo 3μ ad 6μ latis, 6μ ad 10μ longis. *Fig. 10*.

ECUADOR: Galapagos Islands, salt pool at north end of Isabela Id., near Albemarle Point, *No. 123*, January 12; and in an inland salt lagoon, Fernandina (Narborough) Id., *No. 155*, January 14.

MERISMOPEDIA GLAUCA (Ehrenberg) Nägeli *forma* MEDITERRANEA (Nägeli) Collins, Phycotheca Boreali-Americana No. 1651; Geitler, Rabenh. Kryptogamenfl. 14: 264. 1930.

Cellulae 6μ latae. *Fig. 1*.

COSTA RICA: Port Culebra, tide pools, *No. 535*, February 24.

Individuals were rare and intermingled with other algae. Geitler (*ibid.*) suggests that this form and *M. Gardneri* Setchell (Univ. Calif. Publ. Bot. 2: 239. 1906) are morphologically identical.

JOHANNESBAPTISTIA PRIMARIA (Gardner) J. deToni, Noterelle di nomenclatura algologica. I. Alcuni casi di omonimia (Missoficee), p. 6. 1934.

Cyanothrix primaria Gardner, Mem. N. Y. Bot. Gard. 7: 31. 1927.

Cyanothrix Willei Gardner, *loc. cit.*

Nodularia ? fusca W. R. Taylor, Papers from Tortugas Lab. Carnegie Inst. Washington 25: 48. 1928.

Johannesbaptistia Willei (Gardner) J. deToni, *loc. cit.*

Johannesbaptistia Gardneri Frémy, Bull. Soc. Hist. nat. Afr. Nord 26(4): 95. 1935.

ERRATA

P. 17, insert following line 35 —

maria is described as having cells 10 to 15 μ wide and C. Willei as

P. 23, line 7 —trato should be strato

P. 25, line second from bottom of page — *monile* should be *monilis*



Filamenta uniseriata, recta aut flexuosa, 8μ ad 23μ crassa, vel variis algis permixta vel in stratum aerugineum mucosumque aggregantia; cellulis discoideis, 4μ ad 17.5μ latis, 2μ ad 6μ longis; protoplasmate pallide aerugineo-caeruleo, saepe olivaceo aut brunneo aut etiam aureo-brunneo, homoganeo aut paulum granuloso; cellula apicali saepius depresso-conica; tegumento homoganeo aut rarius circum cellulis binas adjacentes tenui lamelloso, 1.5μ ad 6μ crasso, conspicua delimitato, chlorozincico iodurato non caerulescente. *Fig. 3 et 4.*

FLORIDA: Dry Tortugas, among other filamentous algae, Long Key, *W. R. Taylor*, July 1925 (original material of *Nodularia ? fusca* *W. R. Taylor*, in the private collection of Professor Taylor). PORTO RICO: San Juan, Lake Tortuguero, *N. Wille No. 830b* (type of *Cyanothrix primaria* Gardner, in Herb. N. Y. Bot. Gard.), *830e* (type of *C. Willei* Gardner, in Herb. N. Y. Bot. Gard.), *844e*, *849c*, February 5, 1915. ECUADOR: Galapagos Islands, bottom muck in the center of an inland salt pool, north end of Isabela Id. near Albemarle Point, *No. 123*, January 12; bottom sample from an inland salt lagoon, Fernandina Id., *No. 155*, January 14. Professor l'Abbe Frémy reports collections also from DUTCH WEST INDIES: Buen Ayre, Oranjepan, *Hummelink*, and from ALGERIA: Southern Oran, Aïn Ouarka, *Mme. Gauthier-Lièvre*.

This puzzling and recently discovered alga appears to be widely distributed in saline and subsaline pools along tropical coasts. Originally described from Porto Rico by Professor Gardner in 1927, the species has already within a space of eight years accumulated the astonishing array of synonymy displayed above. Professor Frémy (*ibid.*) has reviewed this synonymy in his excellent article. There is no adequate reason to discard the binomial *Johannesbaptistia primaria* (Gardner) J. deToni.¹

As Professor Frémy has already pointed out, Professor Gardner separated his two species of *Cyanothrix* primarily on the basis of size of cells and filaments. The original publication gives us to understand, however, that Professor Gardner felt at the time of writing that he may have been dealing with a single variable species. *Cyanothrix pri-* having cells 6 to 6.5μ wide. The macroscopic appearance of the type

¹I am indebted to Professor W. R. Taylor and Dr. M. A. Howe for the use of the various specimens of *Johannesbaptistia* cited here, and to Professor N. L. Gardner and Professor l'Abbe P. Frémy for the use of certain literature otherwise unavailable to me.

specimens in the Herbarium of the New York Botanical Garden and the fact that they are both numbered 830 indicate that these original specimens were made up from the same sample, and it was to be expected that the two species described should be found mixed together.

During examination of the material from the Galapagos Islands, it early became evident that many individuals fall between the limits of measurement originally ascribed to the two species. Though filaments were none too abundant in either *No. 123* or *No. 155*, I measured the width of cells of one hundred filaments in the former sample to ascertain to what extent the size of cells might vary. Since the shapes of cells in all filaments were essentially similar—all disc-shaped, and circular in end-view and narrowly rectangular or ellipsoidal in optical side-view—I assumed the linear measurement of width to be a fair index of size for such a comparative study. A similar plan was proposed for the type material from Porto Rico, but here the filaments were so much more rarely encountered than in

<i>Width of cells²</i> <i>in microns</i>	<i>Number of filaments in</i> <i>our No. 123 from the</i> <i>Galapagos Islands</i>	<i>Number of filaments in</i> <i>Wille No. 830b and 830e</i> <i>from Porto Rico</i>
4.0-4.5 μ	3	
4.5-5.5 μ	9	2
5.5-6.5 μ	10	6
6.5-7.5 μ	42	10
7.5-8.5 μ	17	12
8.5-9.5 μ	7	10
9.5-10.5 μ	9	10
10.5-11.5 μ	3	7
11.5-12.5 μ		6
12.5-13.5 μ		5
13.5-14.5 μ		4
14.5-15.5 μ		3
15.5-16.5 μ		3
16.5-17.5 μ		2
<i>Total</i>	100	80

² Filaments in which the width of cells varied measurably are listed in the table above according to the width of the largest cells.

our own material that in the end I was forced to be satisfied with observing only eighty individual filaments. The table above shows the distribution of these measurements of cell-width in the material from both the Galapagos Islands and Porto Rico.

It is readily to be seen from the above table that there can be no distinction between *Cyanothrix primaria* and *C. Willei* as described by Professor Gardner on the basis of cell-width; and in neither the type specimens nor in our own material can I find other morphological differences. I therefore follow Professor Frémy in considering that we are dealing here with a single species in which cell-size varies within wide limits. That the range in size is not the same in different habitats, as shown in the table above, is to be expected, since the size of the individual so often depends upon the nature of the environment. Professor Frémy has found the range in width of cells in the collections from Algeria and Buen Ayre to extend from 5.4μ to 16.3μ . In Professor Taylor's material of *Nodularia ? fusca* from the Dry Tortugas, the range is from 6.5μ to 10.3μ .

Variation in size of cells within the same filaments also occurs in all the collections seen, as shown in *Fig. 4*, drawn from the type material of *Cyanothrix primaria*, where the cells range from 9μ wide at one end of the filament to 13μ at the other end. Such gradation in size of cells from one end of the filament to the other is especially noticeable in those filaments which contain the largest cells. Filaments with large cells in the middle and small cells at the ends have also been observed. Obtusely conical apical cells as shown in *Fig. 3 and 4* are found in all of the material seen and are well depicted in Professor Frémy's figures.

Professor Frémy suggested (*ibid.*) that *Nodularia ? fusca* W. R. Taylor should be placed in the genus *Johannesbaptistia*. Professor Taylor obligingly sent me a part of his original material from Long Key, Dry Tortugas, for comparison with our material from the Galapagos Islands and with the type of *C. primaria* from Porto Rico. The collection agrees in every respect with the type and the Galapagos specimens, even to the brown-colored protoplasm in many filaments and the rare occurrence, as noted in Professor Taylor's diagnosis (*loc. cit.*), of evident sheaths about pairs of adjacent cells (see *Fig. 3*). In this material the filaments are more abundant and as a rule of greater length than in the Galapagos or Porto Rico collections.

Professor Frémy recorded some excellent observations, well illustrated, and duplicated in our material, on the fragmentation of filaments of *Johannesbaptistia* by the death and disintegration of cells within the filaments. This mode of vegetative reproduction reminds one forcibly of production of hormogonia among the Oscillatoriaceae. It, together with the uniseriate arrangement of cells in the filament, leads Professor Frémy to suggest that *Johannesbaptistia* is closely related to the genus *Oscillatoria* and should be placed at least tentatively between that genus and *Lyngbya* in a natural scheme of classification. Professor Frémy also compares filaments of *Johannesbaptistia* with filaments of a species of *Lyngbya* in which the cells are separated from each other. It has been my experience that separation of cells in any filaments of the Homocysteeae is also accompanied by other pathological characteristics—loss of pigment, change in shape of cells, and production or loss of protoplasmic granules. In filaments of *Oscillatoria* or *Lyngbya* with separated cells, the cylindrical sheath about the trichome is always, as I have observed it, distinctly limited from and of a firmer consistency than the more recently formed jelly between the cells—if indeed such jelly can be demonstrated. We may as rightfully transfer at once to the Hormogoneales any of the Entophysalidaceae or Pleurocapsaceae as soon as a filament has been seen to break into segments because of death and disintegration of a cell within a filament. It is to be remembered that as yet *Johannesbaptistia primaria* is known in only the few bits of preserved material listed above and that the complete life-history of the organism is possibly not represented in any of these. Observation of one tiny aggregation of filaments in our No. 123 from the Galapagos Islands leads me to suppose it wholly probable that when more favorable material presents itself in the future—perhaps a collection containing an abundance of filaments aggregated into a gelatinous stratum—divisions of the cells in planes other than at right angles with the axis of the filament may be observed. The above I suggest as a possibility, as likely to be found correct as the impossibility of division of cells in several planes implied when the genus *Johannesbaptistia* is placed in a taxonomic scheme between *Oscillatoria* and *Lyngbya*. I suggest that *Johannesbaptistia primaria* (Gardner) J. deToni be allowed to stand appended to the Chroococcaceae until further and more elucidating studies have been made.

RIVULARIACEAE

CALOTHRIX PILOSA Harvey *ex* Bornet & Flahault, Ann. Sci. nat. VII, Bot. 3: 363. 1886.

Forma trichomatibus 10μ ad 20μ (etiam ad 26μ) crassis; filis 10μ ad 40μ crassis. *Fig. 17.*

PORTO RICO: On rocks, etc., littoral, *M. A. Howe*, May 1903 (Phyc. Bor.-Amer. No. 1167, in Herb. Missouri Bot. Gard.). MEXICO: Revilla Gigedo Islands, 'drifted ashore,' Sulphur Bay, Clarion Id., No. 57, January 5. ECUADOR: Galapagos Islands, about the edge of a brackish lagoon near high water level, Albarmarle Point, Isabela Id., No. 96, January 12; about the edges of an inland salt lagoon, Fernandina Id., No. 154, January 14.

This species, characterized by intercalary heterocysts, attenuate ends of the trichomes, hemispherical terminal cells, and symplocoid habit, was first described and figured by Harvey (Smiths. Contrib. Knowl. 10: 106. 1858) from Key West, Florida. Bornet and Flahault (*ibid.*), with whose *Révision des Nostocacées hétérocystées* nomenclature in this group of Myxophyceae begins, cite specimens in European herbaria from Tortola (Leeward Islands), Guadeloupe, the Red Sea, the Friendly Islands, and Mauritius. Geitler (Rabenh. Kryptogamenfl. 14: 612. 1931) cites Dr. Howe's specimen from Porto Rico (Phyc. Bor.-Amer. No. 1167) as typical of this species. Our material agrees in every respect with this specimen, with the exception in the Mexican material (No. 57) of the greater breadth of some of the trichomes.³

³ In the Phycotheca there is a specimen, No. 859 (specimen examined in the Herbarium of the Missouri Botanical Garden), from Point Carmel, Monterey County, California, *W. A. Setchell*, June 10, 1901, distributed under the name *C. pilosa* Harv. The trichomes end in distinct colorless hairs; the heterocysts are basal and often multiseriate; and the mode of branching is usually quite *Dichothrix*-like, though scytonemataceous branching is by no means rare. I have not had the opportunity to examine the type of *Dichothrix seriata* Setchell & Gardner (Univ. Calif. Pub. Bot. 6: 473. 1918), but from the description and figures I gather that Phyc. Bor.-Amer. No. 859 might well be placed in that species. The habit of the mass of filaments is reminiscent of *Scytonema fuliginosa* Tilden, American Algae No. 629 (specimen examined in the Herbarium of the Missouri Botanical Garden) from Hawaii, recently redescribed as the type of the scytonemataceous genus *Tildenia* Kossinskaja (Not. Syst. Inst. Crypt. Hort. Bot. Princip. U. S. S. R. 4: 85. 1926); but the absence of colorless terminal hairs in the Hawaiian material prevents our placing Phyc. Bor.-Amer. No. 859 here. Poljansky (Bull. Jard. Bot. Princip. de l'U. S. S. R. 1928: 17) places No. 859 in *Calothrix dura* Harv., a species according to Bornet and Flahault (*ibid.*) synonymous with *C. pilosa* Harv. The same Russian author transfers *C. pilosa* Harv. to the genus *Tildenia*. This latter transfer appears to me unjustifiable, inasmuch as the button-like terminal cells of Phyc. Bor.-Amer. No. 1167 and of our own material appear in rare instances to be true heterocysts. I am indebted to Dr. J. M. Greenman for the privilege of examining the specimens cited above.

OSCILLATORIACEAE

Schizothrix Hancockii⁴ *sp. nov.*

Stratum expansum, pulvinatum, subaeriale, carneo-durum, non calce impregnatum, ad tria centimetra altum, externe luteo-olivascens vel luteo-aerugineum, interne griseo- ad luteoli-aerugineum, superficie planum; filamentis internis tortuosis, praecipuus dense intricatis, parce pseudoramosis, vulgo 5μ ad 7μ crassis, superne caespitosis, saepe parallelis, plus minusve tortuosis; vaginis cylindraceis, tenuibus, firmis aut ad superficiem pulvini plus minusve diffluentibus et crasioribus, hyalinis, non lamellosis, chlorozincico iodurato caerulescentibus; trichomatibus dilute aerugineis, intra vaginam singulis aut rarissime binis, 3μ ad 4μ crassis, ad genicula paullo constrictis; articulis diametro trichomatis 1- ad 2-plo longioribus, 3μ ad 8μ longis; dissepimentis haud conspicuis, non granulatis; protoplasmate homogeneo aut subtiliter granuloso; cellula apicali rotundata; calyptra nulla (v. in form.). *Fig. 15.*

Hab.: ad lapides planes littorales, MEXICO: Revilla Gigedo Islands, Braithwaite Bay, Socorro Id., *No. 4*, January 2-4. (*Type in the U. S. National Herbarium*).

This alga is placed in the section *Hypeothrix* near *H. cyanea* Nägeli (in Kützing, *Species Algarum*, p. 269. 1849), to which it appears to be most closely allied. Unfortunately *H. cyanea* is an ill-described form for which we are not at present certain of the original specimens or the type locality. According to Professor Taylor's notes, our alga was found in great abundance on 'smooth littoral rocks,' forming rounded or extended cushions often several centimeters in breadth. These cushions were 'firm-fleshy, nearly as tough as a *Laminaria* stipe,' the 'surface soft but particularly smooth.' The toughness of the mass appears to be due to the fact that the filaments in the interior are very compactly intertwined. On the surface the filaments are somewhat less tortuous, often parallel, and always either caespitose or repent, never forming symplocoid fascicles. False branching is more common than can be demonstrated with facility because the filaments are so contorted that the branching is as a rule obscured by the presence of other filaments. The sheaths are thin and well-defined, especially in the

⁴ Named in honor of Captain G. Allan Hancock, through whose generosity this expedition was made possible.

interior of the mass where few healthy trichomes are to be found; on the surface, the sheaths are often definitely diffuent. More than one trichome within a sheath are rarely observed. In careful dissections of material preserved in formalin, the closed ends of the sheaths may be seen.

f. *submersa*, forma nov.

Forma typica similis sed trato subsphaerico vel depresso-sphaerico, submerso, gelatinoso; filamentis phormidioideis, vaginis totum diffluentibus.

Hab.: lapidibus in aquam subsalsam submersis affixa, MEXICO: Oaxaca, tide pools, Tangola-Tangola Bay, No. 557, February 28-March 1. (Type in U. S. National Herbarium).

The specimen cited consists of filaments which exhibit the same tortuous habit of growth encountered in the typical subaerial *S. Hancockii*, but here the sheaths are always entirely diffuent into an amorphous hyaline mucus which becomes bright blue when treated with chlor-zinc-iodine. The trichomes are morphologically identical with those of the type of *S. Hancockii*. I interpret the f. *submersa* as an ecological form which can be distinguished taxonomically only when the plant mass is produced beneath the surface of the water.

HYDROCOLEUM COMOIDES (Harvey) Gomont, Ann. Sci. nat. VII, Bot. 15: 335. 1892.

Forma trichomatibus 15μ ad 20μ crassis, ad genicula constrictis, intra vaginam praecipue singulis, ad apices attenuatis et truncatis, dissepimentis evidenter granulatis. Fig. 7.

MEXICO: Revilla Gigedo Islands, abundant in certain tide pools, Braithwaite Bay, Socorro Id., No. 22, January 2-4; high warm tide pools, Sulphur Bay, Clarion Id., No. 65, January 5. ECUADOR: Galapagos Islands, in higher tide pools, Wenman Id., No. 85, January 11.

Our material is somewhat reminiscent of *Lyngbya aestuarii* (Liebm.) Gom., especially since most of the filaments contain single trichomes. The trichomes are all distinctly constricted at the dissepiments, however, and the sheaths are conspicuously mucous; here and there a filament is found containing more than one trichome, and frequent false branching occurs. The material at hand exhibits the characteristic form of the colony: caespitose mats bearing short erect glutinous tufts.

HYDROCOLEUM CANTHARIDOSMUM (Montagne) Gomont, *ex Ann. Sci. nat.* VII, Bot. 15: 336. 1892.

Forma trichomatibus 19μ ad 24μ , etiam ad 27μ crassis, apicibus attenuatis et fere truncato-capitatis; dissepimentis non granulatis. *Fig. 9.*

MEXICO: Oaxaca, in intertidal pools, Tangola-Tangola Bay, *No. 556*, February 28 - March 1. COSTA RICA: Port Culebra, tide pools, *No. 535*, February 24.

Setchell and Gardner (*Proc. Calif. Acad. Sci.*, ser. 4, 19: 123. 1930) reported this alga previously from Guadalupe Island, Baja California.

MICROCOLEUS TENERRIMUS Gomont, *Ann. Sci. nat.* VII, Bot. 15: 355. 1892.

Forma trichomatibus 1.5μ ad 1.8μ crassis, ad genicula constrictis, ad apices tenuibus et acuto-conicis; cellulis diametro 2- ad 5-plo longioribus, etiam cellula apicali ad 8-plo longiori; vaginis amplis, chlorozincico iodurato non caerulescentibus. *Fig. 11 and 12.*

ECUADOR: Galapagos Islands, bottom of an inland salt lagoon, Fernandina Id., *No. 155*, January 14.

This sample does not contain the species in abundance, yet typically developed filaments were seen in sufficient numbers to make certain their identity. For geographic distribution of this species, see Frémy, *Bull. Soc. Linn. Normandie ser. 7*, 7: 181-184. 1924.

LYNGBYA EPIPHYTICA Hieronymus *in* Kirchner, *Schizophyceae*, p. 67, in Engler & Prantl, *Natürl. Pflanzenfam.* 1(1a). 1898; Lemmermann, *Ark. f. Bot.* 2(2): 103. 1904; Geitler, *Rabenh. Kryptogamenfl.* 14: 1038. 1932.

Forma filamentis epiphyticis, tenuibus; trichomatibus 1μ ad 1.5μ crassis, ad genicula non constrictis; cellulis pallide aeruginis, diametro 1- ad 2-plo longioribus; vaginis tenuissimis, hyalinis, chlorozincico iodurato non caerulescentibus. *Fig. 8.*

ECUADOR: Galapagos Islands, on *Hydrocoleum* in higher tide pools, Wenman Id., *No. 85*, January 11.

A similar but apparently colorless form which is possibly of bacterial nature is epiphytic on the larger blue-green algae of several other samples. It is equally possible that the lack of color is due to

the method of drying the specimens. Morphologically the plants referred to *Lyngbya epiphytica* here cannot be separated from specimens from both fresh and salt water collected at Woods Hole, Massachusetts. Setchell and Gardner (*ibid.*) have reported the species from Guadalupe Island, Baja California.

LYNGBYA GRACILIS Rabenhorst var. **monilis** (Setchell & Gardner),
comb. nov.

Phormidium monile Setchell & Gardner, Proc. Calif. Acad. Sci. ser. 4, 19: 119. 1930.

Caespites ad sesquicentimetra alti, floccosi, lubrici, siccitate sordide aerugini aut lutei, variis algis affixi, filis elongatis saepe parallelis, rectis aut flexuosis, 7μ ad 8μ crassis; vaginis conspicuis, arctis, non diffluentibus, chlorozincico iodurato caerulescentibus; trichomatibus dilute aeruginiis, torulosi, etiam moniliformibus, 2.5μ ad 6μ (vulgo 3.5μ ad 4μ) crassis, apice non attenuata; articulis quadratis vel diametro ad duplo brevioribus, 1.25μ ad 6μ longis, protoplasmate tenui granuloso farcti; cellula apicali rotundata, diametro saepe crassiore quam trichomate, membranam superne paululum incrassatam praebente. *Fig. 2.*

MEXICO: Baja California, Guadalupe Island, *Herbert L. Mason No. 95*, [April 1925] (Type in Herb. Calif. Acad. Sci.); Revilla Gigedo Islands, on *Hydrocoleum comoides* in tide pools above high water, Braithwaite Bay, Socorro Id., *No. 22*, January 2-4; high warm tide pools, Sulphur Bay, Clarion Id., *No. 65*, January 5. COSTA RICA: on *H. cantharidosmum* in tide pools, Port Culebra, *No. 535*, February 24.

After a thorough examination of the original material from Guadalupe Island upon which Professors Setchell and Gardner based *Phormidium monile*,⁵ I do not have the slightest doubt as to the identity of our own specimens. I propose here to establish this form as a variety of the more widely distributed *Lyngbya gracilis* Rabenh., with which Professor Geitler (Rabenh. Kryptogamenfl. 14: 1040. 1932) considers *L. Menegheniana* (Kütz.) Gom. synonymous. Morphologically the var. *monile* is separated from the typical variety by the smaller size of the trichomes and the reaction of the sheaths to

⁵ I am under obligation to Dr. J. T. Howell of the California Academy of Sciences at San Francisco for permission to examine the type specimen of this interesting alga.

chlor-zinc-iodine. Like the typical variety, it is epiphytic on other algae, and at least in early stages of growth can be seen attached to the substratum otherwise than by a basal cell. The sheaths, as the authors of *P. monile* assert, are "conspicuous, . . . distinct, not diffuent." Such characteristics are so pronounced in our material and in the type specimen that we cannot find justification for retaining in the genus *Phormidium* this form so closely related morphologically to *Lyngbya gracilis*. Phormidioid layers of parallel filaments of many long-established species of *Lyngbya* are often encountered where the filaments are numerous or where the plant mass is exposed at times to the atmosphere.

LYNGBYA SEMIPLANA (C. Agardh) J. Agardh *ex* Gomont, Ann. Sci. nat. VII, Bot. 16: 138. 1892.

Forma trichomatibus 7μ ad 7.5μ crassis. *Fig. 13.*

MEXICO: Revilla Gigedo Islands, rare and mixed with *Hydrocoleum comoides*, etc., in high warm tide pools, Sulphur Bay, Clarion Id., No. 65, January 5.

LYNGBYA VERSICOLOR (Wartmann) Gomont, Ann. Sci. nat. VII, Bot. 16: 147. 1892.

Forma filis intricatis tortuosisque; trichomatibus ad genicula haud aut non constrictis, dissepimentis pellucidis, non granulatis; articulis plus minusve 3μ crassis, ad 6μ longis; vaginis hyalinis, chlorozincico iodurato caerulescentibus, ad 2μ crassis. *Fig. 6.*

ECUADOR: Galapagos Islands, bottom muck in the center of an inland salt pool, north end of Isabela Id., near Albemarle Point, No. 123, January 12.

OSCILLATORIA LAETEVIRENS Crouan *ex* Gomont, Ann. Sci. nat. VII, Bot. 16: 226. 1892.

A forma typica protoplasmate haud luteolo sed pallide aerugineo-caeruleo differt. *Fig. 5.*

MEXICO: Revilla Gigedo Islands, forming blue-green strata on *Calothrix pilosa* 'drifted ashore,' Sulphur Bay, Clarion Id., No. 57, January 5.

The lack of the characteristic yellowish-green color of the protoplasm is due probably to the method of drying the material; however, the shapes of the cells are beautifully preserved.

SPIRULINA TENERRIMA Kützing *ex* Gomont, Ann. Sci. nat. VII, Bot., 16: 252. 1892.

Forma trichomatibus haud 0.4μ crassis, spiris 1.4μ ad 1.5μ crassis, anfractibus regulariter 1μ distantibus. *Fig. 14.*

ECUADOR: Galapagos Islands, abundant in bottom muck of an inland salt pool, north end of Isabela Id., near Albemarle Point, *No. 123*, January 12.

The exact taxonomic relationship between this species and *S. socialis* Gardner (N. Y. Acad. Sci., Sci. Surv. Porto Rico 8(2): 272. 1932) and between *S. socialis* and *S. subtilissima* Kützing (*Phycologia generalis*, p. 183. 1843) has not been too clearly defined.

EXPLANATION OF PLATE

PLATE 2.

- Fig. 1. *Merismopedia glauca* f. *mediterranea*. x 1000.
Fig. 2. *Lyngbya gracilis* var. *monilis*. x 1500.
Fig. 3. *Johannesbaptistia primaria*, a typical filament. x 1000.
Fig. 4. *J. primaria*, a filament showing gradation in width of cells. x 1000.
Fig. 5. *Oscillatoria laetevirens*. x 800.
Fig. 6. *Lyngbya versicolor*. x 800.
Fig. 7. *Hydrocoleum comoides*, showing two trichomes within a sheath. x 600.
Fig. 8. *Lyngbya epiphytica* on a filament of *Hydrocoleum comoides*. x 2500.
Fig. 9. *Hydrocoleum cantharidosmum*. x 600.

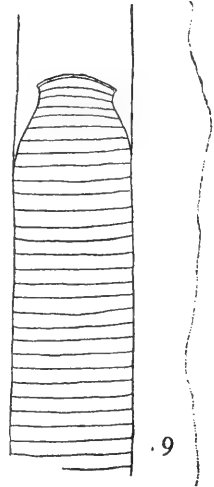
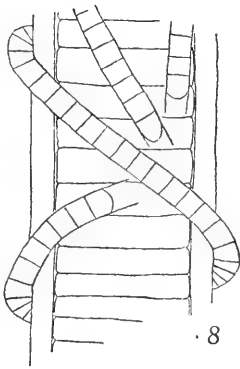
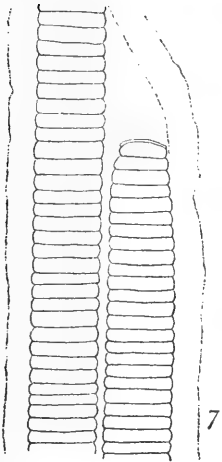
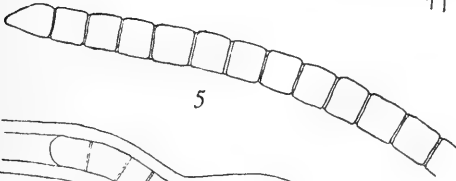
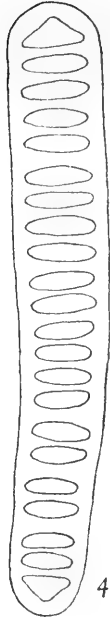
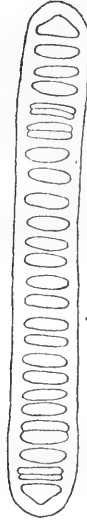
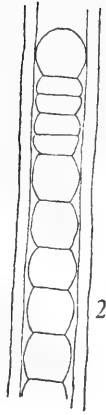
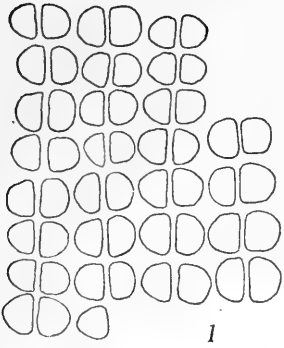

EXPLANATION OF PLATE

PLATE 3

- Fig. 10. *Gomphosphaeria aponina*. x 1000.
Fig. 11. *Microcoleus tenerrimus*, end of a single trichome. x 2000.
Fig. 12. *M. tenerrimus*, end of a typical filament. x 1000.
Fig. 13. *Lyngbya semiplena*. x 1500.
Fig. 14. *Spirulina tenerrima*. x 2000.
Fig. 15. *Schizothrix Hancockii*, a filament showing false branching. x 1500.
Fig. 16. *Chroococcus turgidus*. x 1000.
Fig. 17. *Calothrix pilosa*. x 900.

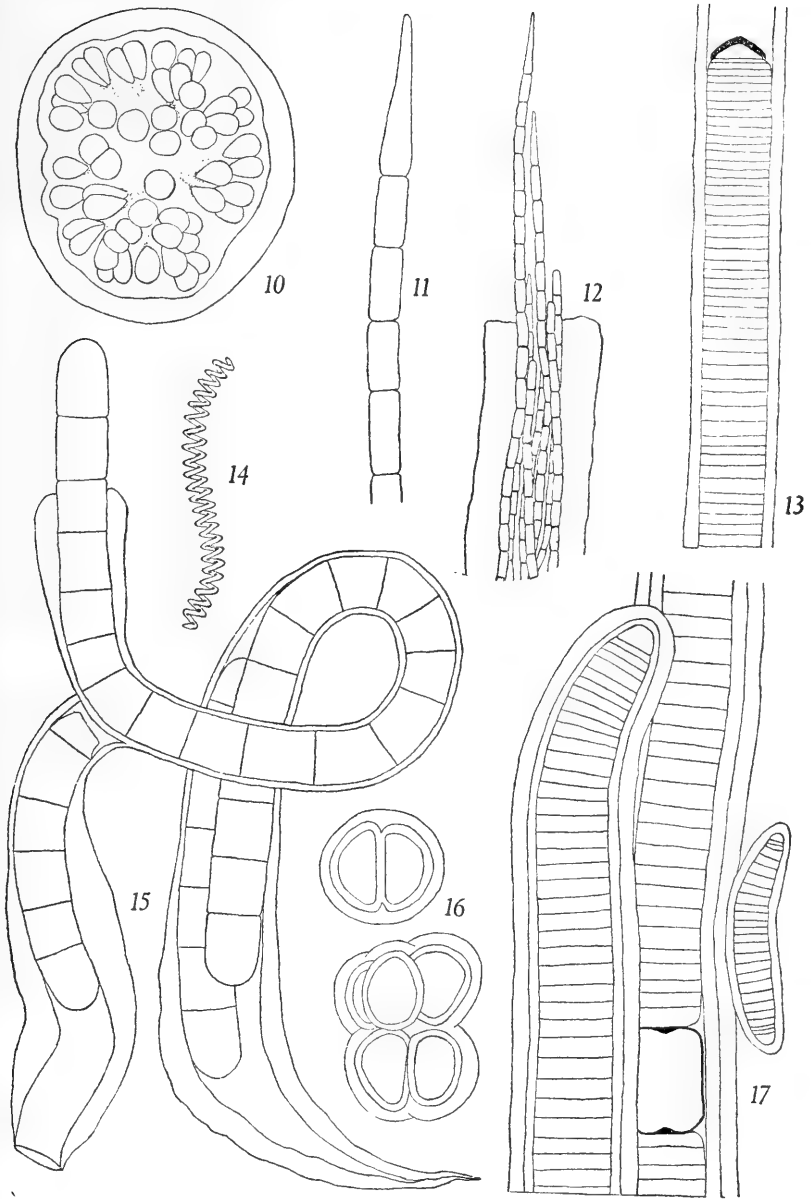

87

THE HANCOCK PACIFIC EXPEDITIONS

VOLUME 3

NUMBER 3

LICHENS
OF THE G. ALLAN HANCOCK EXPEDITION
OF 1934, COLLECTED BY WM. R. TAYLOR

by

CARROLL WILLIAM DODGE

MYCOLOGIST TO THE MISSOURI
BOTANICAL GARDEN AND
PROFESSOR IN THE HENRY SHAW
SCHOOL OF BOTANY OF
WASHINGTON UNIVERSITY



THE UNIVERSITY OF SOUTHERN CALIFORNIA PRESS
LOS ANGELES, CALIFORNIA

1936

REPORTS ON THE COLLECTIONS OBTAINED BY THE HANCOCK PACIFIC EXPEDITIONS OF
VELERO III OFF THE COAST OF MEXICO, CENTRAL AMERICA, SOUTH AMERICA, AND
GALAPAGOS ISLANDS IN 1932, IN 1933, IN 1934, AND IN 1935.

LICHENS
OF THE G. ALLAN HANCOCK EXPEDITION
OF 1934, COLLECTED BY WM. R. TAYLOR

By CARROLL WILLIAM DODGE

THE UNIVERSITY OF SOUTHERN CALIFORNIA PUBLICATIONS
THE HANCOCK PACIFIC EXPEDITIONS
VOLUME 3, NUMBER 3

THE UNIVERSITY OF SOUTHERN CALIFORNIA PRESS
LOS ANGELES, CALIFORNIA

COPYRIGHT 1936
BY
THE UNIVERSITY OF SOUTHERN CALIFORNIA

LICHENS OF THE G. ALLAN HANCOCK EXPEDITION OF 1934, COLLECTED BY WM. R. TAYLOR

By CARROLL WILLIAM DODGE

Mycologist to the Missouri Botanical Garden

Professor in the Henry Shaw School of Botany of Washington University

Our knowledge of the geographical distribution of the lichens of tropical America is very fragmentary, usually depending upon collectors who were primarily interested in other groups, frequently flowering plants, and described by persons with little or no field experience in the American tropics. Our knowledge of the lichen flora of the Galápagos Archipelago and of the coastal regions of the Pacific, south of California, is even more fragmentary. Since Darwin collected a few lichens in the Galápagos a century ago, collectors have occasionally visited the islands and returned with lichens collected incidentally in connection with other work. The collections of Snodgrass and Heller (Robinson, 1902) and of Stewart (1912), both identified by Farlow, were the most extensive. Stewart gives brief ecological notes on the commoner species. Svenson, on the Astor expedition of 1930, brought back six specimens from Santa Cruz (Indefatigable) Island and one from Tower Island, studied by the writer and published in Svenson (1935). J. T. Howell of the Templeton Crocker expedition 1932 (cf. Linder, 1934) returned with one species (previously reported from Chatham Island) and *Dictyonema sericeum* from Santa Cruz (Indefatigable) Island. The present collection adds about a score to the Galapagos list of 51, and five new stations in the archipelago.

Linder (1934) has summarized the previous collections of lichens in the Revilla Gigedo Archipelago, listing 18 species, exclusive of Roccellaceae. The present expedition added seven new species and one new locality to this list. Except for Barro Colorado Island in Gatun Lake where one specimen was taken, all the other localities have probably never been visited by a botanist.

No novelties are reported at this time, as the groups which the author has studied intensively are poorly represented and in some of the larger more difficult genera the material is inadequate, a

species being represented by a fragment unintentionally collected with another species. Some of the fragments of rock have half a dozen species in various stages of development, intimately intermingled. Some of these seem to be species recently and excellently described by Malme, but material has not been available for comparison. Only more field experience and careful monographing of these difficult genera can show whether some of the specimens cited below are correctly referred.

DERMATOCARPACEAE

PSOROGLAENA CUBENSIS Müll. Arg., *Flora* 74:381. 1891.

On rock, Islet, Gardner Bay (Gardner Island) near Española (Hood) Island (cf. Stewart, 1912), Galápagos Islands; January 31, 1934; *W. R. Taylor No. 872*.

This microthalline species might be easily overlooked as very young thalli since the thallus is scarcely larger than apothecia of some saxicolous lichens.

Distribution: previously reported only from Cuba.

GRAPHIDACEAE

Three sterile fragments evidently belong to this family but more certain determination is impossible at present.

On shrub (?) near Black Beach Anchorage, Santa María (Charles or Floreana) Island, Galápagos Islands; January 17, 18, 30, 1934; *W. R. Taylor No. 856*; (2 fragments) Port Utria, Choco, west coast of Colombia; February 15, 1934; *W. R. Taylor No. 880*.

CHIODECTONACEAE

CHIODECTON SANGUINEUM (Sw.) Vainio, *Acta Soc. pro Fauna Flora Fenn.* 7 (2):143. 1890 [often cited *Étude Lich. Brésil. Thèse Univ. Helsingfors* 2:143. 1890].

Inland trail, Santa María (Charles or Floreana) Island, Galápagos Islands; January 1934; *W. R. Taylor No. 901*.

Distribution: ubiquitous in the lower elevations in the American tropics.

ROCELLACEAE

ROCELLA BABINGTONII Mont., *Ann. Sci. Nat. Bot.* III. 18:305. 1852.

On trees, Black Beach Anchorage, and inland near Wittmer place, Santa María (Charles or Floreana) Island, Galápagos Islands; Jan-

uary 17, 18, 30, 1934; *W. R. Taylor No. 875h*; Bartholomew Island near San Salvador (James) Island, Galápagos Islands; January 23, 1934; *W. R. Taylor No. 862*; Islet, Gardner Bay (Gardner Island) near Española (Hood) Island, Galápagos Islands; January 31, 1934; *W. R. Taylor No. 870*; Tangola-Tangola Bay, Oaxaca, west coast of Mexico; February 28—March 1, 1934; *W. R. Taylor No. 892*.

The thallus becomes a very bright red with calcium hypochlorite and the soralia remain uncolored. The specimen from Bartholomew Island is smaller, rather more yellowish in color, and the soralia become red, while the thallus is unchanged. Until more material is available from the Pacific coast of tropical America and an opportunity is afforded to compare material critically with the types of species and varieties usually referred to *R. Babingtonii*, it seems wiser not to describe it as new.

Distribution: Darbishire reports this species from Valparaiso, Chile, to California, and from Santo Domingo, Aruba and Curaçao, in the Caribbean.

ROCCELLA DECIPIENS Darb., *Biblioth. Bot.* 9:42. *pl. 20, f. 92, 93*, 1898.

On rocks, Isabel Island, west coast of Mexico; March 3, 1934; *W. R. Taylor No. 896*.

Distribution: previously reported only from southern California.

ROCCELLA DIFFICILIS Darb., *Biblioth. Bot.* 9:49-50, *pl. 19, f. 89*, 1898.

On rocks, high ground near shore, Albemarle Pt., Isabela (Albemarle) Island, Galápagos Islands; January 12, 1934; *W. R. Taylor No. 854*.

Distribution: reported from Pt. Loma, California, to Isla San Lorenzo and Payta, Perú.

ROCCELLA PORTENTOSA (Mont.) Darb., *Biblioth. Bot.* 9:29-31. *pl. 7-II, f. 27-41*. 1898.

On rocks, Islet, Gardner Bay (Gardner Island) near Española (Hood) Island, Galápagos Islands; January 31, 1934; *W. R. Taylor No. 871*; Bartholomew Island near San Salvador (James) Island, Galápagos Islands; January 23, 1934; *W. R. Taylor No. 862a*.

Distribution: Chiloe and Coquimbo, Chile, to the Galápagos Islands.

ROCCELLA sp.

On trees, Tenacatita Bay, Jalisco, west coast of Mexico; March 2, 1934; *W. R. Taylor No. 902*.

This sterile fragment may be referable to *R. Babingtonii*. It appears to be a broken thallus which is regenerating.

THELOTREMACEAE

LEPTOTREMA MASTOIDEUM Müll. Arg., *Flora* 70:400. 1887.

Santa María (Charles or Floreana) Island, Galápagos Islands; January 1934; *W. R. Taylor No. 903*.

Distribution: Originally described from Paraguay.

LEPTOTREMA sp.

On rock with *Caloplaca Muelleri* (Vainio) Zahlbr., Islet, Gardner Bay (Gardner Island) near Española (Hood) Island, Galápagos Islands; January 31, 1934; *W. R. Taylor No. 874f*.

Too immature for certain determination.

COENOGONIACEAE

COENOGONIUM SUBVIRESCENS Nyl., *Flora* 57:72. 1874.

Trunks of living trees in forest, Barro Colorado Island, Gatun Lake, Canal Zone; February 17, 1934; *W. R. Taylor No. 881*.

Distribution: common at low elevations in the rain forests of tropical America.

COLLEMACEAE

LEPTOGIUM AZUREUM (Sw.) Mont. ap. Webb., *Hist. Nat. îles Canaries* 3 (1):129. 1840.

Gorgona Island off Marino, west coast of Colombia; February 12, 1934; *W. R. Taylor No. 876*; Cabita Bay, Cape Corrientes, Choco, west coast of Colombia; February 13, 1934; *W. R. Taylor No. 904*.

Distribution: common in rain forest at lower elevations throughout tropical America.

LEPTOGIUM DENTICULATUM Nyl., *Ann. Sci. Nat. Bot.* V. 7:302. 1867.

Growing over hepatics, Cabita Bay, Cape Corrientes, Choco, west coast of Colombia; February 13, 1934; *W. R. Taylor No. 878*.

Distribution: this or closely related species and varieties are common in the rain forest at lower elevations throughout tropical America.

? *LEPTOGIUM MARGINELLUM* (Sw.) S. F. Gray, Nat. Arrang. Brit. Pl. 1:401. 1821.

Santa María (Charles or Floreana) Island, Galápagos Islands, *W. R. Taylor No. 865*.

A few fragments with tiny coralloid immature apothecia suggest this species.

STICTACEAE

Pseudocyphellaria xantholoma (Del.) Dodge, n. comb.

Sticta Mougeotiana var. *xantholoma* Del., Hist. Lich. Gen. *Sticta* 63-65, pl. t, f. 14. 1822.

Type: not stated, specimens from Réunion (Île Bourbon) and Mauritius (Île de France), *Bory de St. Vincent* and Cayenne, French Guiana, mentioned. The following description is based on Costa Rican material as it is more fully developed.

Thallus 4 cm. high, irregularly pinnately lobed, ultimate divisions more or less dichotomous and truncate, sinuses deep and rounded but not excised, margins elevated, slightly sorediate, shining rugose or slightly scrobiculate, Brussels brown to bister, glaucescent toward the base; below densely rhizinose, clove brown or darker with abundant minute yellow pseudocyphellae. Upper cortex 60-70 μ , apparently the highly gelified remains of a tomentogenous layer, dark brown; the rest a pseudoparenchyma of hyaline cells with highly gelified walls, the protoplast nearly spherical, 2-3 μ in diameter; the algal layer about 30 μ thick, of compact colonies of *Nostoc* up to 20 μ in diameter; the medulla variable in thickness, 60-100 μ , of compact periclinal hyphae about 4-5 μ in diameter, thickwalled; lower cortex about 30 μ , consisting of an inner zone of thickwalled brown periclinal hyphae about 10 μ thick, a hyaline zone of very gelified pseudoparenchyma with very small protoplasts, and an outer tomentogenous zone about 10 μ thick which gives rise to a very dense branched mass of rhizinae, uniformly distributed not in tufts as other species.

As I have been unable to see the types, I am not sure of the identity of this species although the material fits Delise's description and figures. It is the species commonly but erroneously referred to *Sticta Mougeotiana* and *S. aurigera*, also described by Delise from Réunion, Mauritius, and Madagascar.

Costa Rica: San Jose; Quebradillas, 7 km. n. of Santa Maria de Dota; *Standley 42950*; ? Cartago; Pejivalle, 900 m., *Standley and J. Valerio* (fragments unnumbered).

Ecuador: Galápagos Islands, Santa María (Charles or Floreana) Island; January 1934; *W. R. Taylor No. 905*.

PSEUDOCYPHELLARIA AURATA (Ach.) Vainio, Acta Soc. pro Fauna Flora Fenn. 7(1):183. 1890 [often cited Étude Lich. Brésil, Thèse Univ. Helsingfors 1:183. 1890].

Inland trail, Santa María (Charles or Floreana) Island, Galápagos Islands; January 1934; *W. R. Taylor No. 906*.

Distribution: widespread in American tropics.

STICTINA WEIGELII var. *BEAUVOISII* (Müll. Arg.) Hue, Nouv. Arch. Mus. IV. 3:96. 1901.

Bahía Honda, south coast of Panamá; February 22, 1934; *W. R. Taylor No. 887*.

Distribution: widespread at lower levels in the tropics and sub-tropics.

ACAROSPORACEAE

ACAROSPORA PELTASTICA Zahlbr., Beih. Bot. Centralbl. 13:161. 1902. On rock, Islas Secas, south coast of Panama; February 22, 1934; *W. R. Taylor No. 889*.

Distribution: previously reported from California and Arizona.

? *ACAROSPORA NIGROMARGINATA* Bouly de Lesdain, Lich. Mexique 16. 1914.

On rock, Gorgona Island off Marino, west coast of Colombia; February 12, 1934; *W. R. Taylor No. 877*.

Distribution: previously reported from Mexico.

LECANORACEAE

HAEMATOMMA PUNICEA (Ach.) Mass., Atti. I. R. Ist. Veneto III. 5:253. 1860.

On bark, Bahía Honda, south coast of Panamá; February 21, 1934; *W. R. Taylor No. 885*.

Distribution: common in American tropics.

PERTUSARIACEAE

PERTUSARIA sp.

On bark, Bahía Honda, south coast of Panamá; February 21, 1934; *W. R. Taylor No. 885a*.

Fragment sterile.

PARMELIACEAE

PARMELIA CRISTIFERA Tayl., London Jour. Bot. 6:165. 1847.

Inland trail, Santa María (Charles or Floreana) Island, Galápagos Islands; January 28, 1934; *W. R. Taylor No. 868*.

Distribution: common in American tropics.

PARMELIA LATISSIMA Fée, Suppl. Essai Cryptog. Écorc. Officin. 119. 1837.

Port Utria, Choco, west coast of Colombia; February 14, 1934; *W. R. Taylor No. 879*.

Distribution: common in American tropics.

PARMELIA TINCTORUM Despr. ap. Nyl., Flora 55:547 note. 1872.

Near Wittmer place, inland, Santa María (Charles or Floreana) Island, Galápagos Islands; January 28, 1934; *W. R. Taylor No. 907*.

Distribution: common in American tropics.

? PARMEËIA SOYAUXII Müll. Arg., Linnaea 63:32. 1880.

On rock, Islet, Gardner Bay (Gardner Island) near Española (Hood) Island, Galápagos Islands; January 31, 1934; *W. R. Taylor No. 874a*.

Distribution: previously reported from Brazil.

PARMELIA sp. [perhaps near *P. crinita* Ach.].

Near Wittmer place, inland, Santa María (Charles or Floreana) Island, Galápagos Islands; January 28, 1934; *W. R. Taylor No. 908*.

Too fragmentary for certain determination.

PARMELIA sp. [suggesting *P. tinctorum* Despr. but no reaction with calcium hypochlorite].

On slopes of ridge above Braithwaite Bay, Socorro Island, Revilla Gigedo Islands; January 2-4, 1934; *John Garth, com. W. R. Taylor No. 909*.

Too fragmentary for certain determination.

USNEACEAE

RAMALINA ALLUDENS Nyl., Bull. Soc. Linn. Normandie II. 4:130. 1870.

Jicarita Island south of Coiba Island, south coast of Panamá; February 20, 1934; *W. R. Taylor No. 883*.

Distribution: usually at 1000-1500 m., Mexico and Central America.

RAMALINA COMPLANATA (Sw.) Ach., Lichenogr. Univ. 599. 1810.

On slopes of ridge above Braithwaite Bay, Socorro Island, Revilla Gigedo Islands; January 2-4, 1934; *John Garth*, com. W. R. Taylor No. 910.

Distribution: originally described from Jamaica, this species has been reported frequently from Mexico and the West Indies southward.

RAMALINA DASYPOGA Tuck., Am. Jour. Arts & Sci. II. 28:203. 1859.

Near Wittmer place, and inland trail, Santa María (Charles or Floreana) Island, Galápagos Islands; January 28, 1934; *W. R. Taylor* No. 911.

Distribution: Cuba.

This may be the "*Alectoria sarmentosa*" of earlier reports, as it resembles it in habit and both species are usually found sterile. *Alectoria* is a subarctic genus coming southward along the mountains to Mexico.

Distribution: Cuba and Costa Rica, probably more widespread but mistaken for the coarser *R. Usnea* or even *Alectoria* or *Usnea*.

RAMALINA SUBASPERATA Nyl., Flora 59:411. 1876.

Islet, Gardner Bay (Gardner Island) near Española (Hood) Island, Galápagos Islands; January 31, 1934; *W. R. Taylor* No. 3.

Distribution: Cuba.

RAMALINA SUBCALICARIS Nyl., Bull. Soc. Linn. Normandie II. 4:138. 1870.

On slopes of ridge above Braithwaite Bay, Socorro Island, Revilla Gigedo Islands, west coast of Mexico; January 2-4, 1934; *W. R. Taylor* 851; Islas Secas near Bahía Honda, south coast of Panamá; February 22, 1934; *W. R. Taylor* No. 888.

Distribution: previously reported from Mexico.

RAMALINA SUBFRAXINEA Nyl., Bull. Soc. Linn. Normandie II. 4:139. 1870.

Islet, Gardner Bay (Gardner Island) near Española (Hood) Island, Galápagos Islands; January 31, 1934; *W. R. Taylor* No. 869; on trees, Tenacatita Bay, west coast of Mexico; March 2, 1934; *W. R. Taylor* No. 893.

Distribution: previously reported from Colombia.

RAMALINA USNEA (L.) Howe, var. USNEOIDELLA (Nyl.) Howe, Bryologist 17:81. 1914.

Santa María (Charles or Floreana) Island, Galápagos Islands; January 28, 1934; *W. R. Taylor No. 897*.

Distribution: from Mexico and West Indies southward, widespread but not common.

RAMALINA PUIGGARIII Müll. Arg., Flora 64:83. 1881.

Black Beach Anchorage and near Wittmer place, inland, Santa María (Charles or Floreana) Island, Galápagos Islands; January 17, 18, 30, 1934; *W. R. Taylor No. 858* and *912*; Academy Bay, Santa Cruz (Indefatigable) Island, Galápagos Islands; January 20, 1934; *W. R. Taylor No. 861*.

Distribution: previously reported from Brazil and the Galápagos Islands.

RAMALINA INTERPONENS Nyl., Bull. Soc. Linn. Normandie II. 4:141. 1870.

Islet, Gardner Bay (Gardner Island) near Española (Hood) Island, Galápagos Islands; January 31, 1934; *W. R. Taylor No. 873*.

Distribution: previously reported from Colombia.

RAMALINA sp.

On rock, Albemarle Pt., Isabela (Albemarle) Island, Galápagos Islands; January 12, 1934; *W. R. Taylor No. 855b*.

Too immature for determination.

USNEA sp.

On slopes of ridge above Braithwaite Bay, Socorro Island, Revilla Gigedo Islands, west coast of Mexico; January 2-4, 1934; *John Garth*, com. W. R. Taylor.

CALOPLACACEAE

? CALOPLACA MALMEANA Zahlbr., Cat. Lich. Univ. 7:156. 1930.

Caloplaca brachysporum Malme, Ark. f. Bot. 20(9):34. 1926.

Sulphur Bay, Clarion Island, Revilla Gigedo Islands; January 5, 1934; *W. R. Taylor No. 852*.

Distribution: previously reported from Minas Geraes, Brazil.

CALOPLACA DISSIMILIS (Malme) Zahlbr., Cat. Lich. Univ. 7:115. 1930.

On rocks, Tangola-Tangola Bay, Oaxaca, west coast of Mexico; February 28-March 1, 1934; *W. R. Taylor No. 890a*.

Distribution: previously reported from Brazil.

CALOPLACA ELEGANS (Link) Th. M. Fr., Lichenogr. Scand. 168. 1871.

On rocks, Santa María (Charles or Floreana) Island, Galápagos Islands; January 17, 1934; *W. R. Taylor No. 859*; Petatlan Bay, Guerrero, west coast of Mexico; March 2, 3, 1934; *W. R. Taylor No. 895*.

Distribution: reported from many regions in the temperate and tropical zones.

CALOPLACA FERNANDEZIANUM Zahlbr., K. Svensk Vetensk. Akad. Handl. 57(6):46. 1917.

On rock, Sulphur Bay, Clarion Island, Revilla Gigedo Islands; January 5, 1934; *W. R. Taylor No. 852a*.

Distribution: Juan Fernandez and Valparaiso, Chile.

CALOPLACA MUELLERI (Vainio) Zahlbr., Cat. Lich. Univ. 7:248. 1931.

On rock with other lichens, Islet, Gardner Bay (Gardner Island) near Española (Hood) Island, Galápagos Islands; January 31, 1934; *W. R. Taylor No. 874b*.

Distribution: Brazil and Argentina.

CALOPLACA RUGULOSA (Nyl.) Zahlbr., Cat. Lich. Univ. 7:263. 1931.

On rock, Santa María (Charles or Floreana) Island, Galápagos Islands; January 17, 1934; *W. R. Taylor No. 859a*.

Distribution: Chile and Argentina.

CALOPLACA sp. sterile thallus.

Sulphur Bay, Clarion Island, Revilla Gigedo Islands; January 5, 1934; *W. R. Taylor No. 852b*.

TELOSCHISTACEAE

TELOSCHISTES EXILIS (Michx.) Vainio, Acta Soc. pro Fauna Flora Fenn. 7(1): 115. 1890 [also cited Étude Lich. Brésil, Thèse Univ. Helsingfors 1:115. 1890].

Inland trail, Santa María (Charles or Floreana) Island, Galápagos Islands; January 28, 1934; *W. R. Taylor No. 865*.

Distribution: widespread in tropical America.

TELOSCHISTES FLAVICANS (Sw.) Norm., *Nyt Mag. Naturvidensk.* 7:229. 1853.

Inland trail, Santa María (Charles or Floreana) Island, Galápagos Islands; January 28, 1934; *W. R. Taylor, No. 913*; Academy Bay, Santa Cruz (Indefatigable) Island, Galápagos Islands; January 20, 1934; *W. R. Taylor, No. 914*.

Distribution: widespread in tropical America.

BUELLIACEAE

? BUELLIA MONTEVIDENSIS Malme, *Ark. f. Bot.* 21(14):31. 1927.

On rock, Sulphur Bay, Clarion Island, Revilla Gigedo Islands, west coast of Mexico; January 5, 1934; *W. R. Taylor No. 852a, 915*.

? BUELLIA UMBRINA Malme, *Ark. f. Bot.* 21(14):37-38. 1927.

On rock, Islet, Gardner Bay (Gardner Island) near Española (Hood) Island, Galápagos Islands; January 31, 1934; *W. R. Taylor No. 874g*.

Distribution: reported previously from southern Brazil.

BUELLIA XANTHINULA (Müll. Arg.) Malme, *Ark. f. Bot.* 21(14):25. 1927.

On rock, Islet, Gardner Bay (Gardner Island) near Española (Hood) Island, Galápagos Islands; January 31, 1934; *W. R. Taylor 874d*; on rock, Santa María (Charles or Floreana) Island, Galápagos Islands; January 17, 1934; *W. R. Taylor No. 859a*.

Distribution: previously reported from Brazil and Paraguay.

PHYSICIACEAE

PYXINE BRACHYLOBA Müll. Arg., *Bull. Soc. Bot. Belgique* 32:131. 1893.

On rocks, Tangola-Tangola Bay, Oaxaca, west coast of Mexico; February 28-March 1, 1934; *W. R. Taylor No. 890*.

Distribution: previously reported from Costa Rica.

PHYSCIA ADGLUTINATA (Flke.) Nyl., Mem. Soc. Imp. Sci. Nat. Cherbourg 5:107. 1857.

On rock, Albemarle Pt., Isabela (Albemarle) Island, Galápagos Islands; January 12, 1934; *W. R. Taylor No. 853*.

Distribution: widespread in tropical America.

PHYSCIA AEGILATA (Ach.) Nyl., Ann. Sci. Nat. Bot. IV. 15:43. 1862.

On rock, Albemarle Pt., Isabela (Albemarle) Island, Galápagos Islands; January 12, 1934; *W. R. Taylor No. 855*; near Wittmer place, Santa María (Charles or Floreana) Island, Galápagos Islands; January 28, 1934; *W. R. Taylor No. 867*.

Distribution: widespread in tropical America.

PHYSCIA ALBA (Fée) Müll. Arg., Rev. Myc. 9:23. 1887.

Jicarita Island south of Coiba Island, south coast of Panamá; February 20, 1934; *W. R. Taylor No. 884*; Islet, Gardner Bay (Gardner Island) near Española (Hood) Island, Galápagos Islands; January 31, 1934; *W. R. Taylor No. 874e*.

Distribution: widespread in tropical America.

PHYSCIA MINOR (Fée) Vainio, Acta Soc. pro Fauna Flora Fenn. 7(1):149. 1890 [also cited Étude Lich. Brésil, Thèse Univ. Helsingfors 1:149. 1890].

On bark, Jicarita Island, south of Coiba Island, south coast of Panamá; February 20, 1934; *W. R. Taylor No. 884a*.

Distribution: previously reported from Brazil.

PHYSCIA PICTA (Sw.) Nyl., Syn. Meth. Lich. 1:430. 1860.

On rock, Gorgona Island off Marino, Colombia; February 12, 1934; *W. R. Taylor No. 877b*.

Distribution: common at lower levels in American tropics.

PHYSCIA SOREDIOSA (Vainio) Lynge, Vidensk.-Selsk. Kristiania Skr. Math. Naturv. Kl. 1924(16):27. 1925.

On rock, Gorgona Island off Marino, Colombia, February 12, 1934; *W. R. Taylor No. 877a*; on trees called "white birches" near Black Beach Anchorage, Santa María (Charles or Floreana) Island, Galápagos Islands; January 17, 18, 30, 1934; *W. R. Taylor No. 858*.

Distribution: widely distributed in tropical America.

ANAPTYCHIA PODOCARPA (Bel.) Trev. var. CONFERTA Vainio, Ann. Acad. Sci. Fenn. A 6(7):61. 1915.

Inland trail, Santa María (Charles or Floreana) Island, Galápagos Islands; January 1934; *W. R. Taylor No. 916*.

Distribution: previously reported from Guadeloupe.

ANAPTYCHIA sp.

Inland trail, Santa María (Charles or Floreana) Island, Galápagos Islands; January 1934; *W. R. Taylor No. 917*.

This sterile fragment, evidently not one of the common species, is too small for certain determination.

LITERATURE CITED

Linder, D. H.

1934. The Templeton Crocker Expedition of the California Academy of Sciences 1932. No. 18. Lichens. Proc. Calif. Acad. Sci. IV. Ser. 21:211-222. *pl. 8.*

Robinson, B. L.

1902. Flora of the Galápagos Islands. Proc. Am. Acad. Sci. 38:77-269. *pl. 1-3.*
Lichens by W. G. Farlow, p. 83-89.

Stewart, Alban

1911. Expedition of the California Academy of Sciences to the Galápagos Islands. 1905-1906. II. A botanical survey of the Galápagos Islands. Proc. Calif. Acad. Sci. IV. Ser. 1:7-288. *pl. 1-19.* Bibliography by M. A. Day with additions by Alban Stewart, p. 246-248.
1912. Notes on the lichens of the Galapagos Islands. Proc. Calif. Acad. Sci. IV. Ser. 1:431-446.

Svenson, H. K.

1935. Plants of the Astor Expedition. 1930 (Galápagos and Cocos Islands). Am. Jour. Bot. 22:208-277. *pl. 1-9.* Lichens by C. W. Dodge, p. 221.

THE HANCOCK PACIFIC EXPEDITIONS

VOLUME 3

NUMBER 4

PLANKTON DIATOMS
OF THE GULF OF CALIFORNIA OBTAINED BY
THE G. ALLAN HANCOCK EXPEDITION OF 1936

(WITH ONE FIGURE)

by

W. E. ALLEN

SCRIPPS INSTITUTION OF OCEANOGRAPHY
UNIVERSITY OF CALIFORNIA
LA JOLLA, CALIFORNIA



THE UNIVERSITY OF SOUTHERN CALIFORNIA PRESS
LOS ANGELES, CALIFORNIA

1937

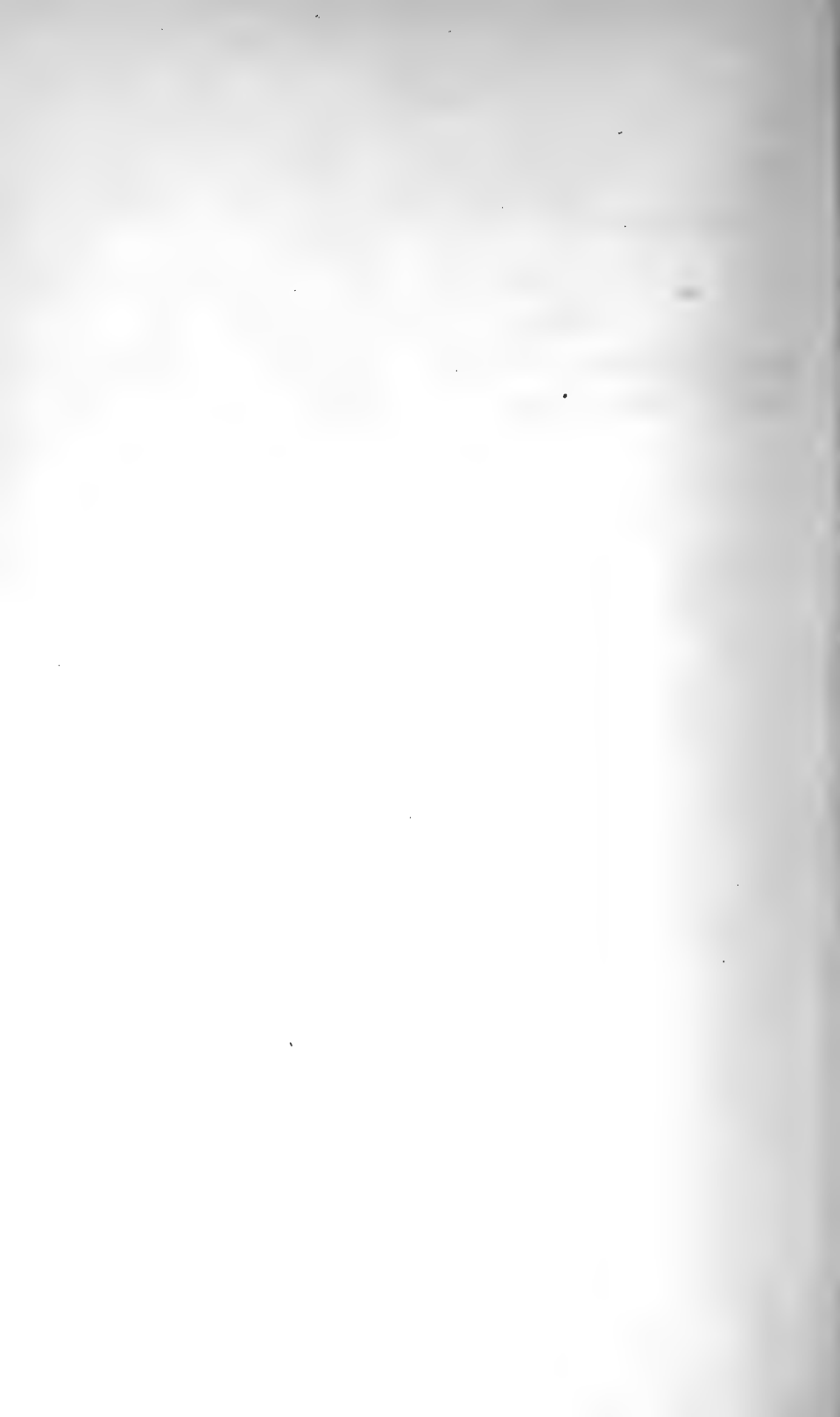

REPORTS ON THE COLLECTIONS OBTAINED BY THE HANCOCK PACIFIC EXPEDITIONS OF
VELERO III OFF THE COAST OF MEXICO, CENTRAL AMERICA, SOUTH AMERICA, AND
GALAPAGOS ISLANDS IN 1932, IN 1933, IN 1934, IN 1935, AND IN 1936.

PLANKTON DIATOMS
OF THE GULF OF CALIFORNIA OBTAINED BY
THE G. ALLAN HANCOCK EXPEDITION OF 1936

By W. E. ALLEN

THE UNIVERSITY OF SOUTHERN CALIFORNIA PUBLICATIONS

THE HANCOCK PACIFIC EXPEDITIONS

VOLUME 3, NUMBER 4

ISSUED MAY, 1937

PRICE 75 CENTS

THE UNIVERSITY OF SOUTHERN CALIFORNIA PRESS

LOS ANGELES, CALIFORNIA

PLANKTON DIATOMS
OF THE GULF OF CALIFORNIA OBTAINED BY THE
G. ALLAN HANCOCK EXPEDITION OF 1936

By W. E. ALLEN
Scripps Institution of Oceanography
University of California
La Jolla, California

INTRODUCTION

The Gulf of California has attracted the attention of seafaring people, oceanographers, geographers, and geologists for a long time. Its peculiarities of form and its situation are alone sufficient to demand notice. In addition, its connective relation between the outlet of one of the large drainage systems of North America and the ocean, through an arid region for hundreds of miles, suggests many problems in numerous fields. Furthermore, some observers say that the resemblance of certain organisms in the Gulf to some of those characteristic of Atlantic seas suggests important problems in its geological history.

Notwithstanding such stimuli to attention and interest, very little authentic information about the Gulf is in existence. We know that its general dimensions are over seven hundred miles in length, about sixty miles in width, and that its depth exceeds a thousand meters in more than one half of its length, but we do not know details of differences (cyclical or noncyclical) in physical, chemical, and biological conditions which exist within its extent.

Many people have known about the opportunities for investigators in these waters, but few have tried to do anything about it. Captain G. Allan Hancock is one of those who has really done something about it. In February and March of 1936 he added the surface collecting of microscopic plankton organisms (mainly diatoms in this case) to his other scientific observations and investigations. This report gives the more important results of study of the collections obtained at that time.

Diatoms are microscopic plants which may be found in water or in wet spots almost anywhere. Sometimes they appear as brown, slimy masses of velvety material under the drip from a leaky hydrant.

Whether in sea water or fresh water, those living attached to a solid surface of any kind are called sedentary forms. Other kinds live afloat in sea water or fresh water, and are called plankton forms. The plankton kinds collected in this series were all obtained by dipping six gallons of water from the surface of the Gulf and filtering it through fine-meshed (200 meshes to an inch) bolting silk. The specimens caught on the silk were preserved in ordinary formaldehyde.

These 1936 catches were especially important because it was the first time that any had been made in the Gulf in late winter or early spring, the season at which microscopic plants as well as other plants are likely to show increased growth and abundance in nature. In the ocean off southern California there is a wide range of differences in times of greatest abundance of plankton diatoms in different years, but there are more years in which largest abundance occurs in spring than there are showing largest abundance at some other season. Therefore, it is reasonable to suppose that the Gulf of California tends to yield in large abundance at that season.

Taking Cape San Lucas as the outer limit, eighty catches were made in the Gulf, thirty-seven while northbound, forty-three southbound. The round trip occupied a little more than a month, involving important time differences in the sampling of different sections and localities. For convenience in discussion, three sections may be designated, i.e., southern, south of 25°N ; middle, from 25°N to 27°N ; and northern, north of 27° . In respect to time, each of these three sections differs from the others, not only as to the dates of sampling, but also in the total time elapsed between the taking of the first and last samples in the section. All of the catches in the northern section were taken within two weeks of each other, while those in the southern section were taken in two periods three weeks apart. Furthermore, the two weeks of operation in the northern section were midway between the periods of operation in the southern section, and there is no means of knowing how conditions in the one compared with those in the other at that time. This point of time difference is stressed, not because of any unusual deficiency in the series, but because it cannot be ignored when catches are repeated at certain stations at intervals no longer than these.

If collections had been made only on a continuous trip in one direction, this particular kind of comparison of the localities would not be suggested by the records, at least not strongly. If collections in all

three sections had been taken at exactly the same time, one might think that the differences in abundance of diatoms were due to the northern section being a relatively shallow part of the Gulf from which depths were progressively greater to and through the southern section. Or he might think that differences in abundance were related to increasing distance southward from the influence of the Colorado River drainage. With time differences so prominent as they are in this series it is easy to see that direct comparison of productivity in different sections of the Gulf may lead to wrong conclusions as readily as to right conclusions. It is also evident that production in the southern section over the four and one-half weeks' period may be badly represented by catches taken only at the beginning and end. Not a little of the importance of the evidence of this series lies in the fact that it helps to direct attention to the hazards of assuming the constancy of conditions in nature in periods for which direct observations are lacking. Still, it should be understood that rare or discontinuous observations of natural phenomena are better than none at all, provided they are not used to reach or support conclusions transcending the range of their evidence.

THE NORTHERN SECTION

In lack of information from a detailed survey of the Gulf of California it is possible to make only roughly suggestive comments on certain features of its topography and their significance. The evidence at hand indicates that the northern section in this series is a rather steeply descending trough extending from the region of relatively level floor (depth 250 meters or less) above Angel de la Guardia Island (or from about Lat. $29^{\circ} 30'$) to the twenty-seventh parallel of latitude where a considerable unevenness in bottom topography indicates a southern termination of at least part of the trough. In this section there is not much evidence of land drainage of water from the side of the trough and there seems to be no great extent of shoals or marginal lagoons or swamps. Superficially, there seems to be little opportunity for Pacific Ocean waters to exert direct influence on the conditions of organic productivity of the section. Presumably, the direct influence of the Colorado River drainage should be much greater (although probably greatly changed in the future as a result of diversion projects). Apparently, there is no dependable basis upon

which to attempt to evaluate or to describe the influences of air drainage in the region, although there must be considerable importance in transportation of dust or soil particles alone. Therefore, the hydrographic and biologic conditions of the northern section should be essentially resultants of the combined influence of the river, the ocean, and atmospheric phenomena. Although the gradient in the upper sixty miles of the section is well established, the trough is partly filled by Angel de la Guardia, Tiburon, and other islands, and it lacks the appearance of a broad, open, south tilted basin characteristic of the remainder of the Gulf.

Twenty-five stations were occupied in the northern section, more than one catch being made at several of them. The total of catches was thirty-eight. (See Figure 1 for route and location of stations in the section.) Of these catches only seventeen were too small to be significant, and seven of them were at six stations fairly near shore in the southwest part of the section. The other ten were at stations irregularly distributed up to and in the neighborhood of Angel de la Guardia Island. Five stations yielded six large catches, two between Angel de la Guardia Island and the west shore of the Gulf, three just south of Tiburon Island, and one in mid-Gulf about seventy miles to the southeast of the latter. The first five were taken in relatively shallow water, the last at a point where the depth was more than a thousand meters. Such a distribution of large catches suggests that the northern section as a whole has a tendency to good productivity. Nine of the catches of moderate significance were scattered along the route in the section. Six others were obtained at two stations at the north end of Angel de la Guardia Island.

While the locations of these catches of moderate importance were such as to support the suggestion from larger catches that the section as a whole is productive, at least on certain occasions, consideration of the three large catches at Tiburon Island leads to the idea that the region of these islands is more than ordinarily favorable for production of plankton diatoms as far as the Gulf is concerned. Perhaps the islands mark the most favorable point of mixing of river, Gulf, and ocean influence. In 1921 (Allen, 1923) this section was visited in April and again in June by the expedition of the California Academy of Sciences. On both occasions large catches were found not only near Angel de la Guardia Island but also at points much farther up in the Gulf, one (at Georges Island) being only about ten

miles from Georges Bay at the northeast end of the Gulf. As far as series taken at different seasons and in different years may be regarded as comparable, the 1921 series supports the 1936 evidence that the upper third of the Gulf is a productive region for plankton diatoms. In addition, it points to a strong influence of the Colorado River in favor of productivity. No other collections from this section are on record.

MIDDLE SECTION

Twelve stations were occupied in the middle section. From them eighteen catches were taken. Only four of these were so small as to be negligible. Since they were taken more than two weeks earlier than the other fourteen, it is not certain that their insignificance indicated real differences. In fact, the probability is to the contrary, because later catches of larger size were taken so nearly at the same locations that they suggest a time difference rather than a locality difference.

However, no catch was really large. Of the seven showing moderate size (10,000 cells or more per liter), one was in Concepcion Bay and five at two stations in mid-Gulf a little north of the latitude of Topolobampo Bay. The remaining catches, showing only thousands of cells per liter, were all near the western shore of the Gulf, two in Concepcion Bay. The one fairly large catch in Concepcion Bay suggests favorable influence of land and shallow water, but the five in mid-Gulf were larger than that, and two others nearly equal. Apparently, the favorable condition in mid-Gulf may be due to ocean influence to an appreciable extent. At any rate, it is true that these better catches of moderate size were made south of the low cross-ridge which interrupts the continuity of outward slope of the floor of the Gulf, and it was almost at the point of beginning of the part of the Gulf which appears to slope continuously to the ocean. In 1921, some large catches were made by the expedition of the California Academy of Sciences in this section in April and June, notably near Carmen Island (Allen, 1923). In November, 1935, only four months before the 1936 catches were taken in mid-Gulf, the Templeton Crocker Expedition of the California Academy of Sciences obtained a large catch near Topolobampo Bay (Allen, in press). Although obtained in different years, the fact that large abundance has been found at three different seasons of the year in this section of the Gulf indicates that it tends to be productive of ocean pasturage.

SOUTHERN SECTION

Twenty-four catches were obtained at eighteen stations in the southern section, all but two of them being taken near shore. Ten were from the vicinity of Espiritu Santo Island, six near San Josef Island, two near Ceralbo Island, and the others around the shore toward Cape San Lucas. None were large and only three showed numbers of thousands per liter. At the station about fifteen miles east of Ceralbo Island two catches were taken, one of small size, the other nearly 20,000 diatom cells per liter. No series of collections known to the Scripps Institution has yet shown large abundance of plankton diatoms in this section, sometimes called the "Cape Region" by former observers.

OCEAN CATCHES

After leaving the Gulf, twelve catches were taken on the northward run in the Pacific Ocean near the west shore of the peninsula of lower California. Except for one catch of moderate size about forty miles northwest of Magdalena Bay, all were too small to have much statistical significance, although one catch of the six taken near Cerros Island showed nearly 10,000 cells per liter, a number suggesting the possibility of good production in the locality at times.

GENERA AND SPECIES

Fifty species belonging to twenty-six genera were recorded for the Gulf. A number of other species were present, but their exact identification was not possible within the time available for study of the material, even when the specimens bore enough distinguishing characters. Inasmuch as these totals are about the same as those usually found along the coasts of southern California and Lower California in series of catches of similar extent, it may be supposed that such representation is about normal. In the preceding November the Templeton Crocker Expedition of the California Academy of Sciences of 1935 (Allen, in press) had found a like representation of genera and species along the ocean coast of Lower California. As a matter of interest rather than a matter of recognizable significance the following lists (Table I) of species on the two sides of the peninsula are arranged in opposite columns for comparison.

Comparison of lists from the two coasts taken by the same expedition cannot be made because the November cruise had too few stations in the Gulf and the February-March cruise had too few stations in the ocean. However, the accompanying table helps to show that no essential difference in representation of genera and species of plankton diatoms is observable as yet between Gulf waters and ocean waters. A long series of collections from each would probably show complete identity as to names listed. Indeed, one of the striking features of phytoplankton occurrence in the Gulf as exhibited so far is the likeness of the catches to those obtained in the neighboring ocean. This likeness goes so far as to show the same scanty representation of certain species commonly occurring in small numbers in widely different regions of the ocean. Excellent examples of species commonly noticed but never in large numbers are *Planktoniella sol* (Wall.) and *Rhizosolenia setigera* Btw.

TABLE I

PLANKTON DIATOMS OF LOWER CALIFORNIA PENINSULA

<i>Ocean Coast, November, 1935</i>	<i>Gulf Coast, February-March, 1936</i>
Asterionella japonica Cl.	Achnanthes sp. Actinoptychus undulatus (Bail.) Asterionella japonica Cl. Asteromphalus heptactis (Breb.) Bacteriastrium sp.
Bacteriastrium sp.	
Biddulphia mobiliensis (Bail.)	Cerataulina bergonii Perag. Chaetoceros affinis Laud. atlanticus (Schütt) coarctatus Laud. compressus Laud. concaivicornis Mangin. constrictus Gran curvisetus Cl. debilis Cl. decipiens Cl. didymus Ehr. eibenii (Grunow) laciniosus Schütt laeve Leud-Fort. lorenzianus Grun. messanensis Castr. peruvianus Btw. radicans Schütt socialis Laud. spp. tetrastichon Cl.
Chaetoceros affinis Laud.	
atlanticus (Schütt)	
compressus Laud.	
concaivicornis Mangin.	
constrictus Gran	
curvisetus Cl.	
debilis Cl.	
decipiens Cl.	
didymus Ehr.	
eibenii (Grunow)	
laciniosus Schütt	
laeve Leud-Fort.	
lorenzianus Grun.	
messanensis Castr.	
peruvianus Btw.	
radicans Schütt	
socialis Laud.	
spp.	
tetrastichon Cl.	

Corethron criophilum Castr.	Corethron criophilum Castr.
Coscinodiscus spp.	Coscinodiscus spp.
Dactyliosolen sp.	Dactyliosolen sp.
Ditylum brightwelli (West)	
Eucampia zoodiacus Ehr.	Eucampia zoodiacus Ehr.
Guinardia flaccida (Castr.) Perag.	Guinardia flaccida (Castr.) Perag.
Hemiaulus hauckii Grun.	Hemiaulus hauckii Grun.
Leptocylindrus danicus Cl.	Leptocylindrus danicus Cl.
Lithodesmium undulatum Ehr.	Lithodesmium undulatum Ehr.
Navicula spp.	Navicula spp.
Nitzschia longissima (Breb.) Ralfs.	Nitzschia longissima (Breb.) Ralfs.
seriata Cl.	seriata Cl.
Planktoniella sol (Wallich)	Planktoniella sol (Wallich)
	Pleurosigma sp.
	Pseudoeunotia doliolus (Wall.)
Rhizosolenia alata Btw.	Rhizosolenia alata Btw.
calcar avis Schultz	calcar avis Schultz
delicatula Cl.	delicatula Cl.
fragillissima Berg.	fragillissima Berg.
semispina (Hensen) Gran	semispina (Hensen) Gran
Rhizosolenia setigera Btw.	Rhizosolenia setigera Btw.
stolterfothii H. Perag.	stolterfothii H. Perag.
styliformis Btw.	styliformis Btw.
Skeletonema costatum (Grev.)	Skeletonema costatum (Grev.)
Stephanopyxis sp.	Stephanopyxis sp.
Thalassionema nitzscooides Grun.	Thalassionema nitzscooides Grun.
Thalassiosira condensata Cl.	Thalassiosira condensata Cl.
deciens (Grun.)	deciens (Grun.)
rotula Meunier	rotula Meunier
Thalassiothrix frauenfeldii (Grun.)	Thalassiothrix frauenfeldii (Grun.)
heteromorpha (?) Karst.	heteromorpha (?) Karst.
longissima Cl. & Grun.	longissima Cl. & Grun.

An interesting point in respect to occurrence of species is the relatively high abundance of a species not yet satisfactorily named at the Scripps Institution, although it has been seen often in Institution collections for nearly twenty years. For some years it was recorded in Institution lists as *Thalassiothrix acuta* Karst. on the assumption that it was enough like that species to carry the name without confusion. More recently it has been decided to list it as *T. heteromorpha* Karst. because its characteristics are more nearly those of the latter species. On a few occasions the form has reached large abundance in oceanic catches, mostly in the Gulf of Santa Catalina off southern California. But in all of those instances it was associated with other forms showing larger numbers. In mid-Gulf in this series, at a point a little south of the latitude of Guaymas, a large catch (143,000 cells per liter) was taken which consisted almost entirely of this species. A moderately large catch (12,000 cells per liter) was obtained three days later in Concepcion Bay and it was also nearly exclusive of

other forms. Of course, the evidence is too little to support an explanation of the peculiarities involved in these occurrences, but there is a suggestion that the Gulf may be more favorable to this species at certain times and places. Possibly a different form of statement is preferable, i.e., that this species may have been better able than others to meet the obligatory conditions. A good explanation of the peculiarities of occurrence of this form there and then would surely contribute largely to solution of the perennial problem of why abundance of plankton diatoms increases at a particular time and of why any certain species leads in abundance at that particular time. For the catch in mid-Gulf one might be content to suppose that the sample merely chanced to be taken from a center of propagation of this species. For the catch taken under much different conditions in the narrow, shallow bay, this supposition may not appear so acceptable, especially when one considers the possibility of explaining both of them in the same way. My own belief is that causes of change in abundance or in lead of abundance in nature do not operate uniformly or steadily, and that the results of their operation are not predictable in detail. In a case like this, the population in mid-Gulf may have been preponderant because of its physiological readiness to take advantage of the first favorable opportunity, while the population of the bay may have been holding its leading place merely because of greater tolerance, or greater capacity for endurance for bay conditions. But it is still true that in both cases *T. heteromorpha* may have had more representatives on the ground ready to meet prosperity when it approached. It seems probable that the Gulf offers good opportunities for solving certain parts of the general problem of occurrence of abundance and changes in abundance.

CONDITION OF SPECIMENS

Following the Scripps Institution practice of the last several years, records were kept of numbers in poor and in good condition. This series in the Gulf of California was remarkable for the relatively small numbers of specimens in poor condition. In some series studied at the Institution many catches (some very large) have shown much more than half of the specimens to be in poor condition (the frustules empty or the contents disintegrating), but in this series no catch of significant size showed as many as ten per cent of the speci-

mens to be in poor condition. Apparently, no great numbers were being devoured by copepods or other diatom feeders. The good condition of the diatom populations at so many stations also indicates that the plants were physiologically ready to take advantage of favorable external influences. Therefore, it is probable that very large abundance might have been found a little later in numerous localities where combinations of environmental conditions encouraged increase of population.

TEMPERATURE

In general, it appears that the temperature tended to be progressively lower toward the head of the Gulf, a large number of the moderately large and large catches being taken at about 15°C. Still, the largest catch was made in a moderately high temperature of 19.4°C just south of Tiburon Island. In 1921 (Allen, 1923) most of the large catches were taken at temperatures near 20°C, but some were made in water showing about 29°C. There can be no reasonable doubt that temperatures have great influence on welfare and productivity of plankton diatoms, but the relationships are too obscure to appear as direct correlations in series of this kind. For one thing, it ought to be more generally understood and recognized that a temperature taken at the time of sampling a population of micro-organisms bears no necessary relation to the immediate characteristics exhibited by it. The temperature having most significant influence in causing the visible condition of the sample must have appeared at some time (possibly some place) preceding that of the sampling. The temperature taken at the time and place of sampling should be regarded only as an aid to understanding the general status of the environment. It should not be used for attempts to establish direct correlations.

SUMMARY

1. There is ample indication that the Gulf of California provides excellent opportunities for different kinds of phytoplankton investigations.
2. It appears probable that the more productive areas of the Gulf lie between 25°N and 30°N, and that conditions are more favorable for phytoplankton production and maintenance toward the north in that territory.

3. The Gulf of California supports essentially the same forms of phytoplankton as are found in the neighboring ocean.

4. There is some indication that production is better near islands in the Gulf of California, but there was one notable exception.

5. The occurrence of one species in nearly pure culture in mid-Gulf suggests the possibility of influences especially favorable to it.

6. Satisfactory explanations of some of the phenomena of occurrence of plankton diatoms in the Gulf of California can not be given until thorough studies are made of physical, chemical, meteorological, and general biological conditions there.

LITERATURE CITED

ALLEN, W. E.

1923. Observations on surface distribution of marine diatoms of Lower California in 1921. Proc. Calif. Acad. Sci., vol. 12, pp. 435-45.
1937. The Templeton Crocker Expedition to the Gulf of California in 1935—the phytoplankton. In press.

FIGURE 1

Map to show route followed in making the collections and order of magnitude of catches (by symbols).

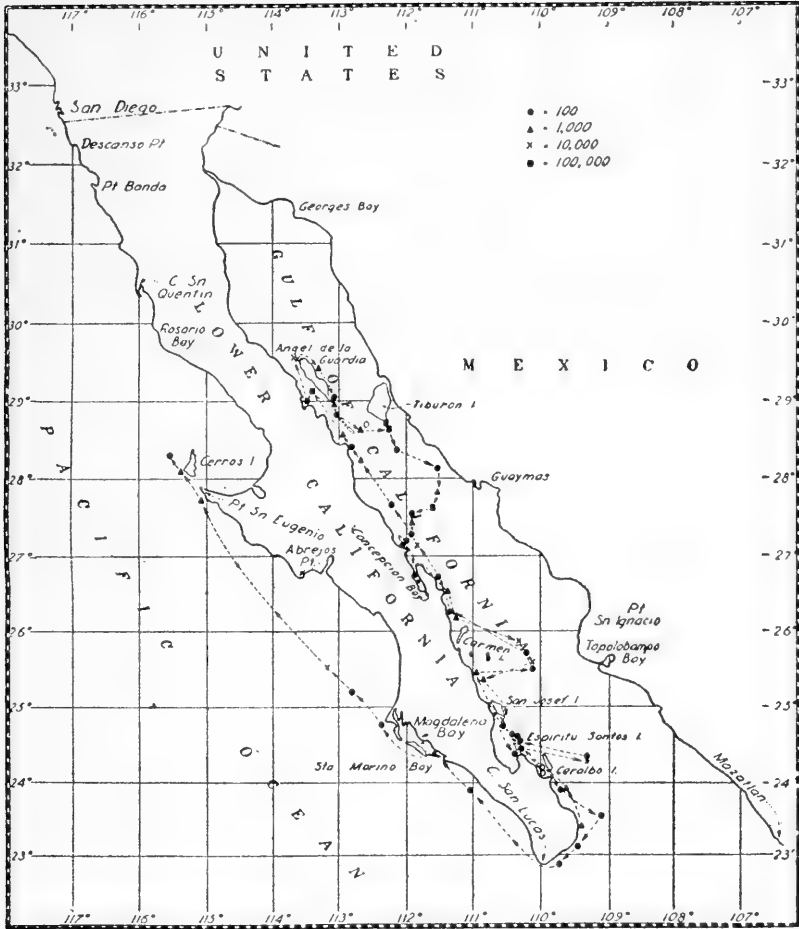

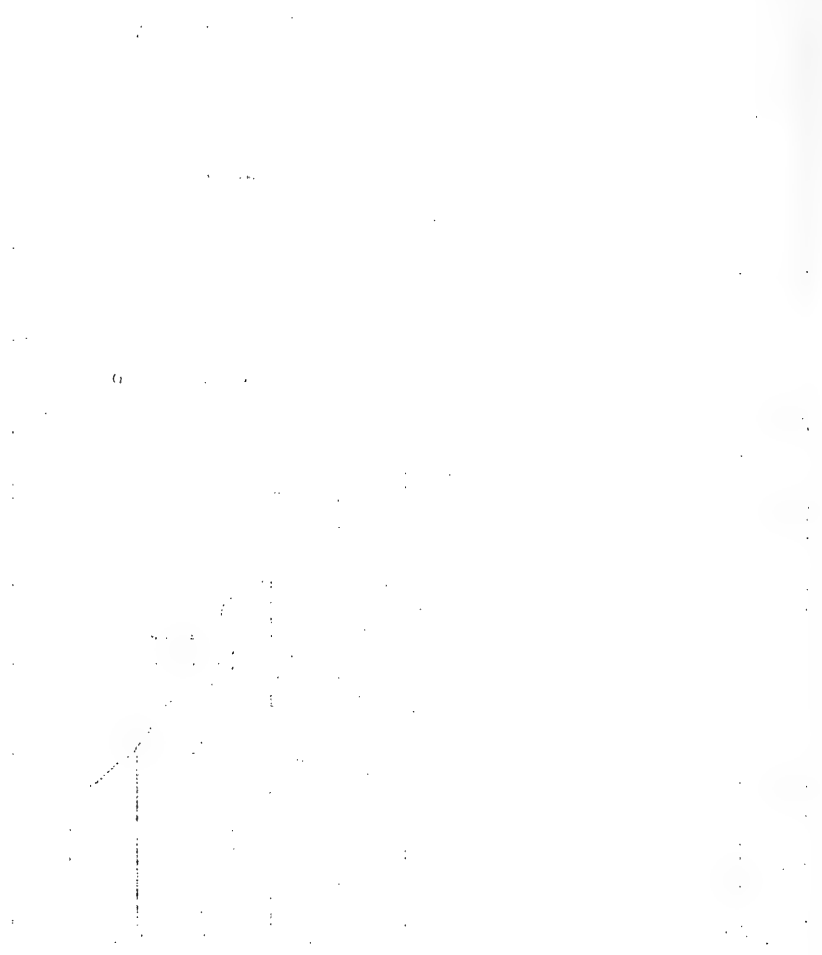

37
ALLAN HANCOCK PACIFIC EXPEDITIONS

VOLUME 3

NUMBER 5

PLANKTON DIATOMS OF THE GULF OF
CALIFORNIA OBTAINED BY ALLAN
HANCOCK PACIFIC EXPEDITION OF 1937

(WITH 12 PLATES)

BY

E. E. CUPP and W. E. ALLEN

SCRIPPS INSTITUTION OF OCEANOGRAPHY, UNIVERSITY OF CALIFORNIA
LA JOLLA, CALIFORNIA



THE UNIVERSITY OF SOUTHERN CALIFORNIA PRESS
LOS ANGELES, CALIFORNIA

1938



REPORTS ON THE COLLECTIONS OBTAINED BY ALLAN HANCOCK PACIFIC EXPEDITIONS OF
VELERO III OFF THE COAST OF MEXICO, CENTRAL AMERICA, SOUTH AMERICA, AND GALA-
PAGOS ISLANDS IN 1932, IN 1933, IN 1934, IN 1935, IN 1936, IN 1937, AND IN 1938.

PLANKTON DIATOMS OF THE GULF OF
CALIFORNIA OBTAINED BY ALLAN
HANCOCK PACIFIC EXPEDITION OF 1937

By E. E. CUPP and W. E. ALLEN

THE UNIVERSITY OF SOUTHERN CALIFORNIA PUBLICATIONS

ALLAN HANCOCK PACIFIC EXPEDITIONS

VOLUME 3, NUMBER 5

ISSUED AUGUST, 1938

THE UNIVERSITY OF SOUTHERN CALIFORNIA PRESS

LOS ANGELES, CALIFORNIA

PLANKTON DIATOMS OF THE GULF OF CALIFORNIA
OBTAINED BY
ALLAN HANCOCK PACIFIC EXPEDITION OF 1937*

(WITH 12 PLATES)

E. E. CUPP and W. E. ALLEN

Scripps Institution of Oceanography, University of California
La Jolla, California

Our knowledge of biological conditions in the Gulf of California, although still very limited, is being increased from time to time. Until 1937, only three series of phytoplankton samples had been collected in the Gulf, one in 1921, between April 7 and July 11, by the Expedition of the California Academy of Sciences (Allen, 1923); a second in November, 1935, by the Templeton Crocker Expedition on the *Zaca* (Allen, in press); and a third by the Allan Hancock Expedition of 1936, from February 8 to March 26 (Allen, 1937). A fourth series of collections, to be discussed in the present paper, was made by the Allan Hancock Expedition of 1937, between March 1 and April 4.

In 1937, seventy-three phytoplankton samples were collected, seven on the southward run in the open ocean from Point San Eugenio to Cape San Lucas, sixty-six in the Gulf. (Map 1) Several catches were collected farther north in the Gulf than any previous samples and more were collected on the eastern side of the Gulf. Most of the collecting was done on the northward run along the west side of the Gulf. In 1921, samples were collected as far north as Georges Bay; in 1936, to the north end of Angel de la Guardia Island; and in 1935, only as far as Topolobampo Bay.

The method of collecting was the same as that used in 1936. A measured quantity of water (13 liters for catches 1 to 35, 8 liters for catches 36 to 73) was simply dipped from the surface and filtered through a net of No. 25 silk bolting cloth (200 meshes to the inch). A small quantity of formalin was used as the preservative. In the laboratory counting was done by use of a Sedgwick-Rafter counting cell. Records were kept of cells in good condition and of cells in poor condition. The designation "poor condition" was used to indicate cells in which no chromatophores or chromatophore material remained.

* Contributions of the Scripps Institution of Oceanography. New Series, No. 14.

For convenience in making comparisons, the same geographical division of the Gulf into three sections has been used as in the discussion of the 1936 series, namely, the southern section, south of 25° N. latitude; the middle section, between 25° N. and 27° N. latitude; and the northern section, north of 27° N. latitude.

Toward the preparation of this report Professor Allen contributed the microscopic examination and Dr. Cupp contributed the general discussion, the taxonomic discussion, and the illustrations of prominent species.

TOPOGRAPHY OF THE GULF

Certain features of the topography of the Gulf were discussed in the paper by the junior author dealing with the 1936 series. Only a brief review of the salient points need be repeated here. The northern section, according to available information, appears to be a more or less steeply descending trough extending from the comparatively level floor (250 meters deep or less) above Angel de la Guardia Island to 27° N. latitude. Here the bottom is uneven and at least part of the trough seems to terminate. There is little evidence of land drainage from the side of the trough and probably there is little direct influence exerted by ocean waters on the productivity of this section. The Colorado River drainage should have considerable influence. The trough is partly filled by Angel de la Guardia, Tiburon, and other islands. The remainder of the Gulf, south of 27° N., is characterized by a broad, open, south tilted basin. Ocean waters would naturally be expected to have considerable influence upon productivity in the middle section of the Gulf, and to be of major importance in the southern section.

NUMERICAL ABUNDANCE OF DIATOMS

Far larger numbers of diatoms were present in the samples collected during the present Expedition than in the 1921 or 1936 series. Sixteen of the sixty-four catches (25%) in the Gulf had over 100,000 cells per liter, ten of these over 1,000,000 cells. The largest catch was recorded as having over 5,000,000 cells per liter. In 1921, nineteen catches out of a total of 117 (16+) had over 100,000 cells per liter but none reached 1,000,000 cells. The largest abundance recorded in the series was 592,720 cells per liter. In the 1936 Hancock Expedition

only five catches out of eighty (6.3%) had over 100,000 cells per liter, with the largest catch estimated at 217,476 cells. Fourteen catches in 1937, three in 1921, and eleven in 1936, yielded no cells.

NORTHERN SECTION

Three regions in the northern section were particularly noteworthy for their high diatom productivity. The first and largest of these three was found on the west side of the Gulf to the north of Angel de la Guardia Island, between $29^{\circ}30'N.$ and $30^{\circ}N.$ latitude; the second region off the southeastern part of Tiburon Island on the east side of the Gulf in $28^{\circ}49'N.$ latitude, $112^{\circ}16'W.$ longitude; and the third region on the east side of the Gulf from $27^{\circ}56'N.$ (off Guaymas) south to $27^{\circ}31'N.$ latitude. (Shaded areas on Map 1)

Nine catches in the first named region to the north of Angel de la Guardia contained over 100,000 cells to the liter with five of these having over one million cells. The largest catch in the entire series was taken a few miles northwest of the Island on March 22. It was estimated that the yield from this one catch was 5,058,800 cells per liter. Of this number, 4,945,000 cells (4,460,000 in good condition, 485,000 in poor condition) belonged to the one species, *Chaetoceros radicans*. This species predominated in all of the nine large catches.

In the three catches off Tiburon Island, one gave nearly 2,000,000 cells per liter, one nearly 3,000,000 cells, and the third 408,000 cells. *Chaetoceros species* was most abundant in the two largest, *Chaetoceros socialis* in the third. A catch to the south of the Island ($28^{\circ}41'N.$ latitude, $112^{\circ}27'W.$ longitude) had 12,125 cells per liter.

In the third region, two catches off Point Doble contained 1,021,750 and 1,950,140 cells with *Chaetoceros compressus* and *C. species* predominating, respectively. The third large catch in this region was estimated to have 3,300,500 cells per liter, with 2,465,000 of these *Chaetoceros radicans*.

Table 1 (pp. 66 and 67) gives the data for all the catches over 100,000 cells per liter taken in the northern section of the Gulf.

No large catches were taken in the Gulf north of $30^{\circ}N.$ One sample had 7,875 cells per liter, four between 1,000 and 3,000, two between 125 and 250, and one had no cells. Two other catches on the east side of the Gulf opposite the Angel de la Guardia region of abundance showed no cells. Three catches taken near the west side of

the Gulf around 27°30'N. contained fewer than 1,000 cells per liter. One catch of 50,375 cells was taken southeast of Las Animas Point (28°49'N. latitude, 113°13'W. longitude), a catch of 27,951 cells a little south of the San Lorenzo Islands, and one of 19,375 cells on the east side of the Gulf in latitude 27°8'N., longitude 110°27'W. All other catches contained fewer than 10,000 cells per liter and most of them fewer than 1,000 cells.

No other Expedition has gone so far north in the Gulf as did the 1937 one. In 1921 (April 26), two catches were taken on the eastern side of the Gulf about ten miles southwest of Georges Bay. One of these contained 4,428 cells, the other 196,621 (*Chaetoceros species* 66,976 cells, *Leptocylindrus danicus* 63,700 cells) showing that a large production does occur in this region at times. North of San Luis Island, near the western side of the Gulf just south of 30°N. latitude, two catches were made on April 28, one containing 207,284, the other 220,078 cells per liter. Again *Chaetoceros species* predominated.

In 1921, as in 1937, the region around Angel de la Guardia Island was highly productive. On that Expedition a number of catches were taken near the southern end of the Island as well as to the north. In the latter part of April, early May, and again toward the last of June large catches were taken near the southern end or south of the Island. The largest of these, estimated to contain 572,317 cells per liter, was collected on June 25. *Chaetoceros species*, *C. compressus*, and *C. radicans* were abundant. In the larger catches of April and May *Thalassionema nitzschioides* was the leading species in number of cells. Toward the north of the Island a catch of 592,720 cells (*Chaetoceros debilis* and *Thalassionema nitzschioides*) was taken on May 1 and one of 118,152 cells (*Chaetoceros species* and *C. didymus*) on June 29. Near the southeastern point of Tiburon Island two catches of over 100,000 cells per liter were collected on July 4. This region would appear to be a productive one in 1921 as well as in 1937 although the catches were taken three months later in 1921. *Chaetoceros species*, *C. curvisetus*, and *Cerataulina bergonii* were most numerous. The third region mentioned as being highly productive in 1937 was represented by only two very small catches taken on July 10 and 11 in 1921.

In the 1936 series two catches, one of 205,296 cells per liter, the other of 115,484 cells, were taken between Angel de la Guardia and the coast of Lower California on March 2. *Chaetoceros debilis*, *Nitzschia seriata*, and *Chaetoceros curvisetus* predominated. Three

catches of 217,476 cells, 118,860 cells, and 95,577 cells per liter were collected just south of Tiburon on March 10 and 11. *Chaetoceros species*, *C. debilis*, *C. compressus*, *C. curvisetus*, and *C. constrictus* were present in largest numbers. One large catch (143,724 cells) was taken in mid-Gulf about seventy miles southeast of Tiburon on March 12. Almost the entire catch was made up of *Thalassiothrix heteromorpha* (?).

Middle Section

With two exceptions, the middle section of the Gulf (25°N. to 27°N. latitude) was a region of very low diatom productivity in 1937. One catch of 29,337 cells per liter was made in Concepcion Bay on March 15. *Nitzschia seriata*, *Chaetoceros species*, and *C. curvisetus* were most abundant. The other large catch, taken off Topolobampo Bay on March 31, contained 512,000 cells per liter. Here *Skeletonema costatum*, *Nitzschia seriata*, and *Eucampia zoodiacus* were most numerous. Nine of the seventeen catches in this section yielded no cells. The remaining six were all very small.

In 1921, large catches were found in the Carmen Island region on May 19 and 23 (480,610 cells and 264,385 cells) and on June 13 and 14 (338,156 cells and 450,740 cells). *Chaetoceros species* and *C. compressus* were most abundant. One catch of 85,645 cells (*Rhizosolenia stolterfothii*, *Chaetoceros debilis*, and *C. decipiens*) was taken in San Nicolas Bay on May 17, and one of 142,920 cells (*Chaetoceros species*, *Bacteriastrum elongatum*, and *Thalassionema nitzschioides*) on April 13 in mid-Gulf off San Nicolas Bay.

Four catches at two stations in mid-Gulf a little north of the latitude of Topolobampo Bay and one in Concepcion Bay were the only catches of moderate size in the middle section during 1936. Of these the largest was only 39,396 cells per liter, the smallest 11,970 cells. *Chaetoceros species* was most prominent in the mid-Gulf catches, *Thalassiothrix heteromorpha* (?) in the Concepcion Bay catch. These catches were all taken between March 14 and March 19.

The Templeton Crocker Expedition of the California Academy of Sciences of November, 1935, collected six plankton samples in the middle section of the Gulf. One of these, taken a short distance southwest of Topolobampo Bay on November 16, was a large catch of 106,019 cells per liter. Of these, 82,316 cells belonged to the one species, *Chaetoceros curvisetus*. The other five catches were small.

Numerical Abundance and Predominant
Cells per Liter in the Northern

Date	Catch No.	Region	Numerical Abundance Cells per Liter		
			Good Condition	Poor Condition	Total
March 20	37	Angel de la Guardia Island	171,250	30,250	201,500
	38		456,375	10,750	467,125
21	39		860,750	97,875	958,625
	40		1,211,250	63,250	1,274,500
22	41		4,570,800	488,000	5,058,800
	42		2,690,000	174,000	2,864,000
	43		2,822,500	292,750	3,115,250
23	44		1,153,500	153,250	1,306,500
	45		67,875	39,000	116,875
27	57	Tiburon Island	2,905,500	84,750	2,990,250
28	58		361,250	46,750	408,000
	59		1,800,050	64,500	1,864,550
29	61	Off Guaymas and south to 27° 31' N.	933,500	88,250	1,021,750
30	62		1,804,590	145,550	1,950,140
	63		2,271,500	1,029,000	3,300,500

I
Diatoms in Catches Greater than 100,000
of the Gulf of California in 1937

<i>Predominant Species</i> <i>Cells per Liter</i>			
<i>Name</i>	<i>Good Condition</i>	<i>Poor Condition</i>	<i>Total</i>
Chaetoceros radicans	146,250	19,250	165,500
curvisetus	16,750	4,250	21,000
Chaetoceros radicans	446,875	8,125	455,000
debilis	3,625	375	4,000
Chaetoceros radicans	847,500	97,500	945,000
Nitzschia seriata	2,625	0	2,625
Chaetoceros radicans	1,188,750	62,500	1,251,250
species	4,750	375	5,125
Pseudoeunotia doliolus	5,125	0	5,125
Chaetoceros radicans	4,460,000	485,000	4,945,000
Pseudoeunotia doliolus	21,500	0	21,500
Chaetoceros radicans	2,580,000	130,000	2,710,000
debilis	41,500	29,500	71,000
Chaetoceros radicans	2,652,500	277,500	2,930,000
debilis	108,500	10,750	119,250
Chaetoceros radicans	1,103,750	148,750	1,252,500
debilis	27,875	3,625	31,500
Chaetoceros radicans	64,500	35,750	100,250
debilis	750	3,250	4,000
Chaetoceros species	711,000	30,000	741,000
socialis	709,500	0	709,500
Skeletonema costatum	480,000	0	480,000
Chaetoceros compressus	394,500	15,000	409,500
Chaetoceros socialis	104,500	8,250	112,750
Skeletonema costatum	110,500	0	110,500
Chaetoceros species	54,000	16,000	70,000
Chaetoceros species	439,500	18,000	457,500
Skeletonema costatum	451,500	0	451,500
Chaetoceros compressus	307,500	0	307,500
socialis	292,500	10,500	303,000
Chaetoceros compressus	361,250	0	361,250
species	161,250	6,250	167,500
radicans	127,500	28,500	156,000
Chaetoceros species	817,500	75,000	892,500
debilis	223,500	28,500	252,000
Asterionella japonica	201,000	4,550	205,550
Skeletonema costatum	146,250	15,000	161,250
Chaetoceros radicans	1,645,000	820,000	2,465,000
species	241,000	112,000	353,000
compressus	190,000	30,000	220,000

TABLE 1
Numerical Abundance and Predominant Species of Diatoms in Catches Greater than 100,000
Cells per Liter in the Northern Section of the Gulf of California in 1937

Date	Catch No.	Region	Numerical Abundance Cells per Liter			Predominant Species Cells per Liter			
			Good Condition	Poor Condition	Total	Name	Good Condition	Poor Condition	Total
March 20	37	Angel de la Guardia Island	171,250	30,250	201,500	Chaetoceros radicans curvisetus	146,250 16,750	19,250 4,250	165,500 21,000
	38		456,375	10,750	467,125	Chaetoceros radicans debilis	446,875 3,625	8,125 375	455,000 4,000
21	39		860,750	97,875	958,625	Chaetoceros radicans Nitzschia seriata	847,500 2,625	97,500 0	945,000 2,625
	40		1,211,250	63,250	1,274,500	Chaetoceros radicans species Pseudoeunotia doliolus	1,188,750 4,750 5,125	62,500 375 0	1,251,250 5,125 5,125
22	41		4,570,800	488,000	5,058,800	Chaetoceros radicans Pseudoeunotia doliolus	4,460,000 21,500	485,000 0	4,945,000 21,500
	42		2,690,000	174,000	2,864,000	Chaetoceros radicans debilis	2,580,000 41,500	130,000 29,500	2,710,000 71,000
23	43		2,822,500	292,750	3,115,250	Chaetoceros radicans debilis	2,652,500 108,500	277,500 10,750	2,930,000 119,250
	44		1,153,500	153,250	1,306,500	Chaetoceros radicans debilis	1,103,750 27,875	148,750 3,625	1,252,500 31,500
	45		67,875	39,000	116,875	Chaetoceros radicans debilis	64,500 750	35,750 3,250	100,250 4,000
27	57	Tiburon Island	2,905,500	84,750	2,990,250	Chaetoceros species socialis	711,000 709,500	30,000 0	741,000 709,500
						Skeletonema costatum Chaetoceros compressus	480,000 394,500	0 15,000	480,000 409,500
28	58		361,250	46,750	408,000	Chaetoceros socialis Skeletonema costatum Chaetoceros species	104,500 110,500 54,000	8,250 0 16,000	112,750 110,500 70,000
						Chaetoceros species Skeletonema costatum Chaetoceros compressus socialis	439,500 451,500 307,500 292,500	18,000 0 0 10,500	457,500 451,500 307,500 303,000
29	61	Off Guaymas and south to 27° 31' N.	933,500	88,250	1,021,750	Chaetoceros compressus species radicans	361,250 161,250 127,500	0 6,250 28,500	361,250 167,500 156,000
						Chaetoceros species debilis Asterionella japonica Skeletonema costatum	817,500 223,500 201,000 146,250	75,000 28,500 4,550 15,000	892,500 252,000 205,550 161,250
30	62		1,804,590	145,550	1,950,140	Chaetoceros radicans species compressus	1,645,000 241,000 190,000	820,000 112,000 30,000	2,465,000 353,000 220,000
	63		2,271,500	1,029,000	3,300,500				

SOUTHERN SECTION

The southern section (south of 25°N. latitude) is a region of low diatom productivity at least in the seasons during which samples have been collected in four different years. In 1937, one catch of 20,713 cells per liter was collected on March 4 off Gorda Point (23°2'N. latitude, 109°30½'W. longitude-Gorda Banks), and one of 14,707 cells on March 8 southeast of San Josef Island. *Chaetoceros compressus* predominated in the first, *C. radicans* in the second. No other catch of the thirteen made in this section had as many as 10,000 cells. Two contained no cells. One catch made farther south along the coast of Mexico (22°16'N. latitude, 106°W. longitude) on April 2 yielded 55,125 cells per liter (47,250 cells *Nitzschia seriata*).

In 1921, two catches in this section yielded over 100,000 cells per liter. One of these was taken on April 12 southwest of Espiritu Santo Island. *Chaetoceros species* was listed as predominating. The other was collected on June 9 northwest of the same Island. *Thalassionema nitzschioides* and *Chaetoceros species* were most abundant. One catch, taken south of Espiritu Santo on April 11, had 22,656 cells per liter. No other sample yielded as many as 10,000 cells per liter. Three of the twenty-five contained no cells.

Fifteen of the twenty-five samples collected by the Templeton Crocker 1935 Expedition in this section during November contained no cells. The largest catch was one of 532 cells.

None of the twenty-four catches of the 1936 series was large. Only one sample had over 3,000 cells per liter, six had none. The largest catch, 19,824 cells per liter, was taken about fifteen miles east of Ceralbo Island. *Chaetoceros compressus* was the important species numerically in this sample.

OCEAN CATCHES

Seven catches were made on the southward run to the Gulf. The largest, 919,962 cells per liter, was collected off Point San Juanico (26°14'N. latitude, 112°28'W. longitude). A second large catch was taken north of Cape San Lazaro (25°10'N. latitude, 112°19'W. longitude). The estimated number of diatoms was 331,297 cells per liter. In both cases *Chaetoceros costatus* was the leading species (855,128 cells in the first sample, 211,584 cells in the second) with *C. curvisetus* second in abundance. The other five catches were small, one nearly

10,000 cells, the others less than 1,500 cells per liter. Allen (1934) mentions *Chaetoceros costatus* as a prominent species south of Point Abrejos in April, 1931. About 2,000,000 cells per liter were recorded for one catch.

GENERA AND SPECIES OF DIATOMS

Sixty-seven species of diatoms distributed among thirty-one genera were found in the samples from the Gulf during the routine counting. In the entire series sixty-nine species in thirty-two genera were recorded. Of this number, fourteen species were of considerable importance, seven reached sufficiently large numbers to be given rank as of major importance. The one most abundant species, *Chaetoceros radicans*, was more than five and one-half times more numerous than any other species.

Forty-one of the sixty-seven diatoms found in the Gulf were neritic species. Five were tychopelagic (semibottom living littoral diatoms that have been broken away from their substratum), fifteen were oceanic, and six were unclassified. Northerly and southerly temperate neritic species were present in equal numbers. Table 2 lists all species of diatoms according to their habitat groups and indicates the most important species.

TABLE 2

SPECIES OF DIATOMS

OCEANIC

ARCTIC

1. *Chaetoceros atlanticus* Cl. (and boreal) (Fig. 22)
2. *decipiens* Cl. (and boreal)
3. *Thalassiothrix longissima* Cl. and Grun. (Fig. 40)

TEMPERATE

1. *Asteromphalus heptactis* (Bréb.) Ralfs (Fig. 6)
- *2. *Bacteriastrum elongatum* Cl. (southerly) (Fig. 21)
3. *Chaetoceros peruvianus* Brightw. (and tropical)
4. *Corethron hystris* Cl. (Fig. 7)
5. *Hemiaulus hauckii* Grun. (and tropical)
6. *Rhizosolenia alata* Brightw. (Fig. 18)
7. *alata* f. *indica* (Perag.) Osten.
 (south temperate or subtropical) (Fig. 19)
8. *bergonii* Perag. (Fig. 11)
9. *styliformis* var. *longispina* Hust. (northerly) (Fig. 15)
10. *Thalassiothrix frauenfeldii* Grun. (Fig. 41)

TROPICAL

1. *Rhizosolenia acuminata* (Perag.) Gran (and subtropical) (Fig. 20)
- *2. *calcar avis* Schultze (perhaps neritic) (Fig. 17)

NERITIC

ARCTIC

1. *Biddulphia aurita* (Lyng.) Bréb. and God. (also littoral) (Fig. 37)

TEMPERATE

Northerly

- *1. *Chaetoceros approximatus* Gran and Angst
- ‡2. *compressus* Laud. (Fig. 25)
3. *concavicornis* Mang. (or oceanic arctic) (Fig. 23)
- †4. *constrictus* Gran (Fig. 27)
- ‡5. *debilis* Cl. (Fig. 31)
- ‡6. *radicans* Schütt (Fig. 32)
- ‡7. *socialis* Laud. (Fig. 33)
8. *subsecundus* (Grun.) Hust.
9. *Lauderia borealis* Gran (Fig. 8)
- *10. *Leptocylindrus danicus* Cl. (Fig. 9)
11. *Nitzschia longissima* (Bréb.) Ralfs
12. *pungens* var. *atlantica* Cl. (or southerly) (Fig. 45)
- †13. *seriata* Cl. (or oceanic arctic) (Fig. 44)
14. *Rhizosolenia fragilissima* Bergon
15. *imbricata* var. *shrubsolei* (Cl.) Schröd. (Fig. 14)
- *16. *setigera* Brightw. (Fig. 16)
17. *stolterfothii* Perag. (Fig. 13)
- †18. *Skeletonema costatum* (Grev.) Cl. (Fig. 2)
- *19. *Thalassionema nitzschioides* Grun. (Fig. 39)
20. *Thalassiosira decipiens* (Grun.) Jörg. (Fig. 3)

Southerly

- †1. *Asterionella japonica* Cl. (Fig. 42)
2. *Cerataulina bergonii* Perag. (Fig. 38)
3. *Chaetoceros affinis* Laud. (Fig. 28)
- ‡4. *costatus* Pav. (†if in Gulf only) (Fig. 29)
- †5. *curvisetus* Cl. (Fig. 30)
- *6. *didymus* Ehr. (Fig. 26)
- †7. *laciniosus* Schütt
- *8. *lorenzianus* Grun. (Fig. 24)
9. *simplex* Osten.
10. *Dactyliosolen mediterraneus* Perag.
11. *Ditylum brightwellii* (West) Grun. (Fig. 35)
- †12. *Eucampia zodiacus* Ehr. (Fig. 34)
13. *Guinardia flaccida* (Castr.) Perag. (Fig. 10)
- *14. *Lithodesmium undulatum* Ehr. (Fig. 36)
15. *Planktoniella sol* (Wall.) Schütt (Fig. 5)
- *16. *Pseudoeunotia doliolus* (Wall.) Grun. (and littoral) (Fig. 43)

- †17. *Rhizosolenia delicatula* Cl. (Fig. 12)
- 18. *Schröderella delicatula* (Perag.) Pav. (ocean only)
- 19. *Stephanopyxis turris* (Grev. and Arn.) Ralfs
(and subtropical) (Fig. 1)
- 20. *Thalassiosira rotula* Meun. (Fig. 4)
- *21. *Thalassiothrix mediterranea* Pav. (given as *T. heteromorpha* Karst.
by Allen, 1937)

TYCHOPELAGIC

- 1. *Actinoptychus undulatus* (Bail.) Ralfs
- 2. *Licmophora abbreviata* Agardh
- 3. species
- 4. *Pleurosigma* species
- 5. *Surirella* species

UNCLASSIFIED

- 1. *Bacteriastrum* species
- 2. *Biddulphia* species (ocean only)
- ‡3. *Chaetoceros* species
- *4. *Coscinodiscus* species
- 5. *Navicula* species
- 6. *Rhizosolenia* species
- 7. *Triceratium* species

* Moderately abundant in at least some catches

† Abundant species

‡ Species of major importance

In comparing the diatom species with the list published for the 1936 Expedition to the Gulf, we find nine species present in 1936 not listed in 1937, twenty-three species present in 1937 that were not listed in 1936. (Table 3)

TABLE 3

Species Present in 1936, Absent in 1937:

- 1. *Achnanthes* species
- 2. *Chaetoceros coarctatus* Laud.
- 3. *danicus* Cl.
- 4. *Corethron criophilum* Castr.
- 5. *Dactyliosolen* species
- 6. *Rhizosolenia semispina* Hensen
- 7. *styliformis* Brightw.
- 8. *Stephanopyxis* species
- 9. *Thalassiosira condensata* Cl.

Species Present in 1937, Absent in 1936:

- 1. *Bacteriastrum elongatum* Cl.
- 2. *Biddulphia aurita* (Lyng.) Bréb. and God.
- 3. species (ocean only)

4. *Chaetoceros approximatus* Gran and Angst
5. *costatus* Pav.
6. *subsecundus* (Grun.) Hust.
7. *Corethron hystrix* Cl.
8. *Dactyliosolen mediterraneus* Perag.
9. *Ditylum brightwellii* (West) Grun.
10. *Lauderia borealis* Gran
11. *Licmophora abbreviata* Agardh
12. species
13. *Nitzschia pungens* var. *atlantica* Cl.
14. *Rhizosolenia acuminata* (Perag.) Gran
15. *alata* f. *indica* (Perag.) Osten.
16. *bergonii* Perag.
17. *imbricata* var. *shrubsolei* (Cl.) Schröd.
18. species
19. *styliformis* var. *longispina* Hust.
20. *Schröderella delicatula* (Perag.) Pav. (ocean only)
21. *Stephanopyxis turris* (Grev. and Arn.) Ralfs
22. *Suirella* species
23. *Triceratium* species

The species of diatoms found in the Gulf are not notably different from those found in the ocean outside the Gulf off Lower California or particularly different from those found at La Jolla.

CONDITION OF SPECIMENS

As customary with all phytoplankton collections studied at the Scripps Institution, record was kept of cells in good condition and of cells in poor condition. In 1936, the Gulf series was notable for the relatively small number of cells in poor condition. Allen reported that no catch of significant size showed as many as 10 per cent of the specimens in poor condition. While the same statement cannot be made for the 1937 series, in most cases the number of cells in poor condition was low for the major catches. Half of the catches of over 10,000 cells per liter had more than 10 per cent of the cells in poor condition, half less than 10 per cent. One catch, taken south of Guaymas, with a total of 3,300,500 cells had 1,029,000 in poor condition. The large catches taken north of Angel de la Guardia Island all had fewer than 10 per cent of the cells in poor condition.

SUMMARY AND CONCLUSIONS

1. Seventy-three surface samples of phytoplankton were collected between March 1 and April 4, 1937, by the Allan Hancock Expedition

to the Gulf of California. Seven of these were taken in the open ocean off Lower California, sixty-six in the Gulf.

2. In the northern section of the Gulf (north of 27° N. latitude) three regions were notably productive of diatom growth:

- a. the west side of the Gulf to the north of Angel de la Guardia Island, between $29^{\circ}30'$ and 30° N. latitude;
- b. the east side of the Gulf off the southeastern part of Tiburon Island;
- c. the east side of the Gulf between $27^{\circ}56'$ and $27^{\circ}31'$ N. latitude.

3. Regions *a* and *b* were also highly productive in 1921 and 1936, indicating that these localities may be peculiarly favorable for diatoms.

4. The high productivity of the upper third of the Gulf may very probably be due, in large part, to the influence of the Colorado River.

5. The middle section of the Gulf (between 25° and 27° N. latitude), except for one catch in Concepcion Bay and one off Topolobampo Bay, was poor in diatom growth. The favorable influence of land and shallow water may account, at least in part, for the higher catch in Concepcion Bay. Productivity around Carmen Island, unlike that in 1921, was poor in 1937.

6. The southern section of the Gulf (south of 25° N. latitude) is a region of low diatom productivity according to results from four Expeditions.

7. Sixty-seven species of diatoms distributed among thirty-one genera were present in the samples from the Gulf.

8. Neritic species of northerly and southerly temperate habitats predominated.

9. *Chaetoceros radicans*, *C. species*, *Skeletonema costatum*, *Chaetoceros compressus*, *C. socialis*, and *C. debilis* were the most prominent species. *Chaetoceros radicans* occurred in very large numbers in nine catches taken off Angel de la Guardia Island.

10. The species of diatoms found in the Gulf vary little from those in the open ocean off Lower California or at La Jolla.

11. While the percentage of cells in good condition was not so high as in 1936, a remarkably large percentage were in good condition.

12. Much more information as to physical, chemical, and meteorological conditions in the Gulf is needed before we can properly interpret the results of these diatom studies.

LITERATURE CITED

ALLEN, W. E.

1923. Observations on surface distribution of marine diatoms of Lower California in 1921. *Proc. Calif. Acad. Sci.*, vol. 12, pp. 437-42.

1937. Plankton diatoms of the Gulf of California obtained by the G. Allan Hancock Expedition of 1936. *The Hancock Pacific Expeditions, The Univ. So. Calif. Publ.*, vol. 3, pp. 47-59.

In Press. The Templeton Crocker Expedition to the Gulf of California in 1935—the Phytoplankton. *Hancock Expedition of 1936. Hancock Pacific Expeditions, The*

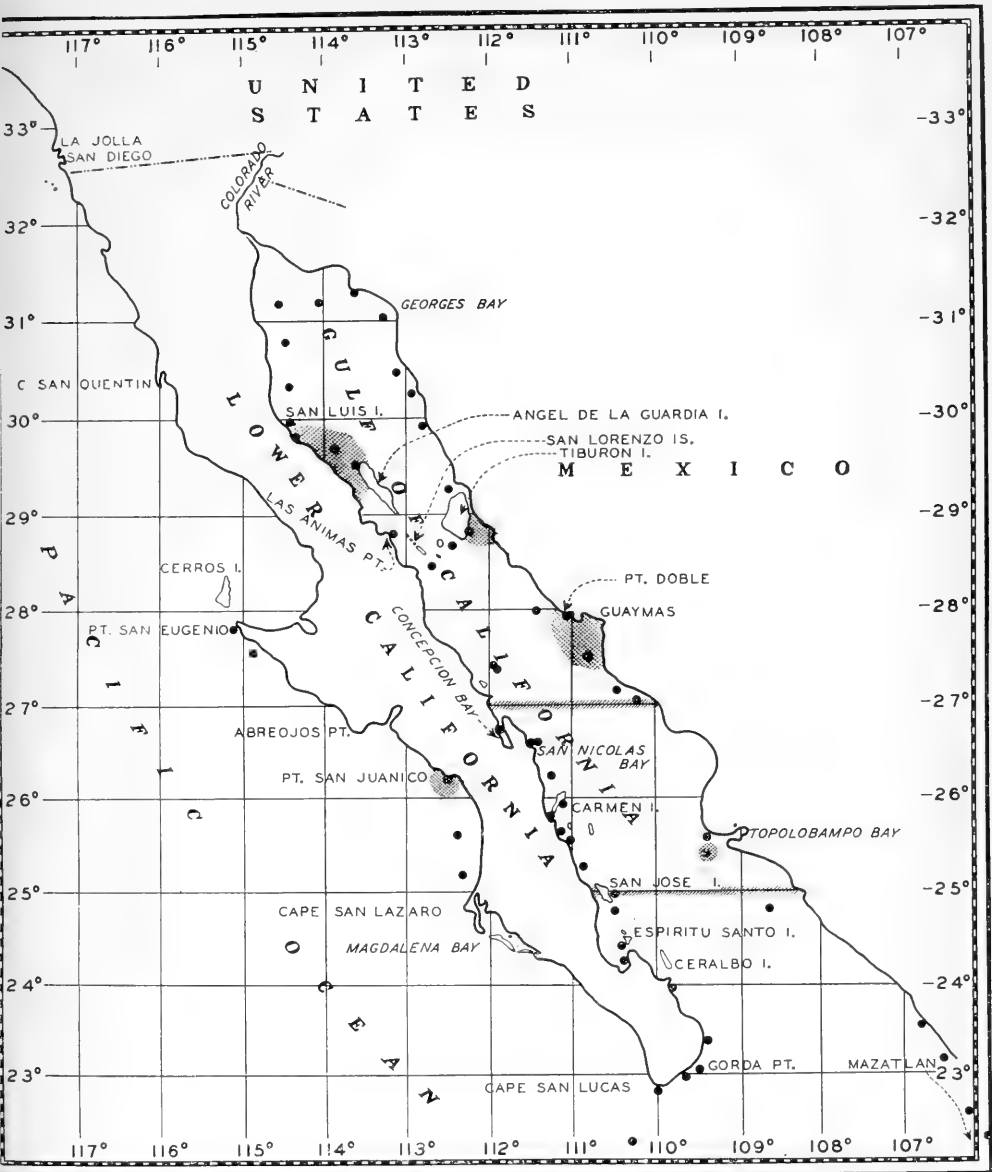

MAP 1

Region visited by the Allan Hancock Expedition of 1937.

● = Locations of Phytoplankton samples.

Shaded areas = Regions of greatest abundance of diatoms.

PLATE 4

- Fig. 1. *Stephanopyxis turris* (Grev. and Arn.) Ralfs. Part of a chain.
1a. Mantle structure.
- Fig. 2. *Skeletonema costatum* (Grev.) Cl. Part of a chain.
2a. Part of a more slender chain.
2b. Sketch to show arrangement of connecting threads between cells.
- Fig. 3. *Thalassiosira decipiens* (Grun.) Jörg. Part of a chain.
3a. Valve view indicating arrangement of sculpturing.
- Fig. 4. *Thalassiosira rotula* Meun. Part of a chain.
- Fig. 5. *Planktoniella sol* (Wall.) Schütt. Valve view of cell with old wing-like expansion.
5a. Valve view of cell developing new wing-like expansion.
5b. Normal cell with arrangement of sculpturing on valve indicated.
5c. Girdle view of a normal cell.
- Fig. 6. *Asteromphalus heptactis* (Bréb.) Ralfs. Valve view with arrangement of areoles indicated in one sector.

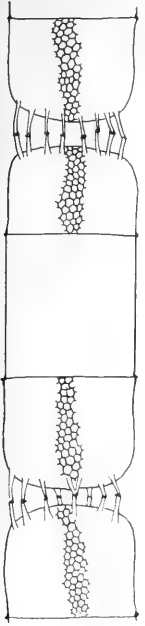

1
10μ

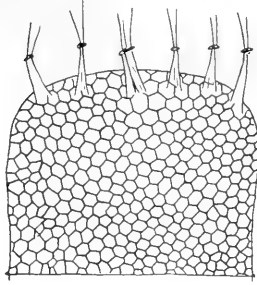

1a

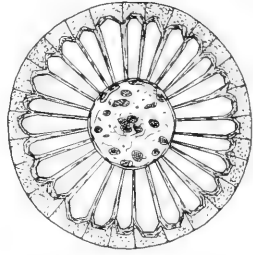

5

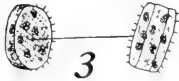

3

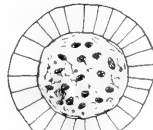

5a



5c

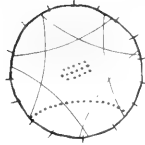

3a

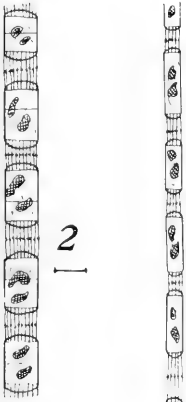

2

2a

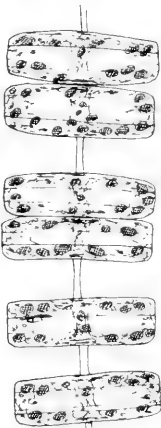

4

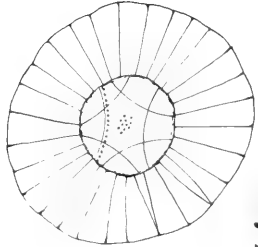

5b

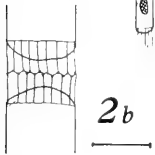

2b

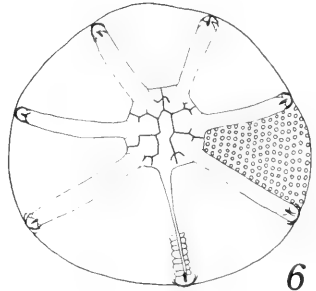

6

PLATE 5

- Fig. 7. *Corethron hystrix* Cl.
7a. A cell in process of division.
- Fig. 8. *Lauderia borealis* Gran. (Possibly *L. annulata* Cl.)
- Fig. 9. *Leptocylindrus danicus* Cl. Part of a chain.
- Fig. 10. *Guinardia flaccida* (Castr.) Perag.

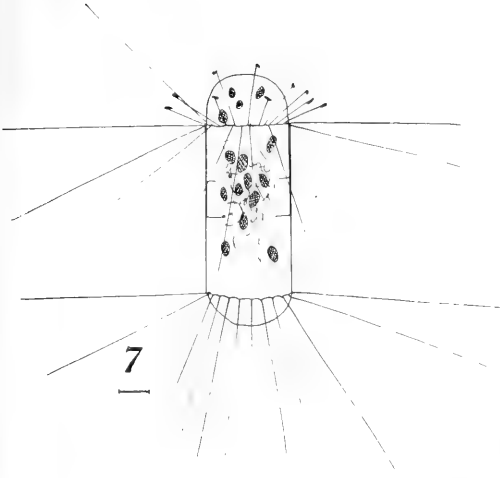

7

9

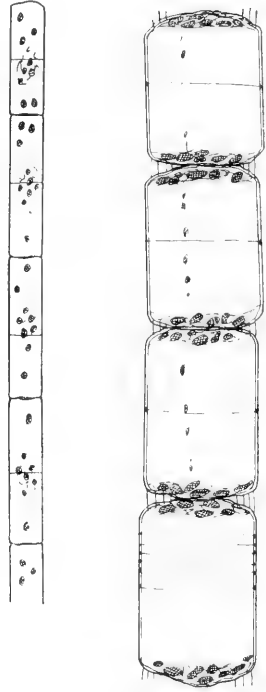

8

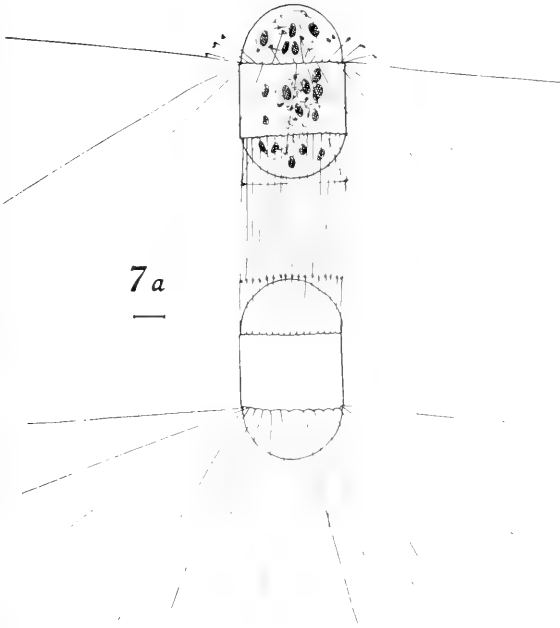

7a

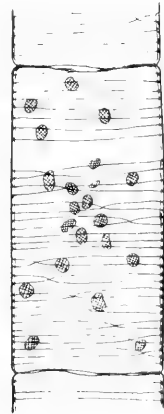

10

PLATE 6

- Fig. 11. *Rhizosolenia bergonii* Perag.
11a. Apex of cell.
- Fig. 12. *Rhizosolenia delicatula* Cl.
- Fig. 13. *Rhizosolenia stolterfothii* Perag.
- Fig. 14, 14a. *Rhizosolenia imbricata* var. *shrubsolei* (Cl.) Schröd.
- Fig. 15, 15a. *Rhizosolenia styliiformis* var. *longispina* Hust.
- Fig. 16. *Rhizosolenia setigera* Brightw.

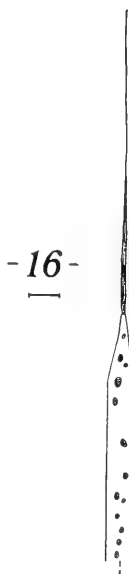
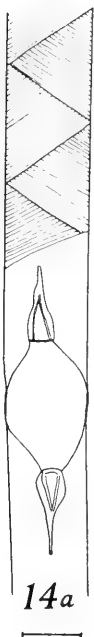
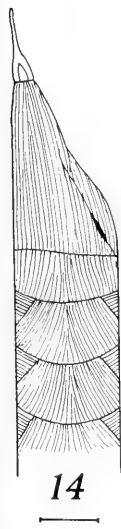
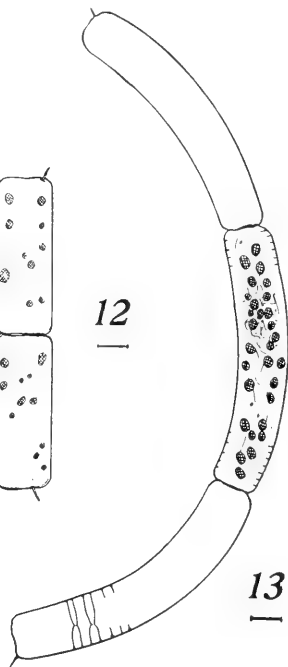
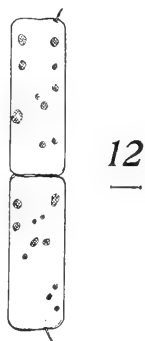
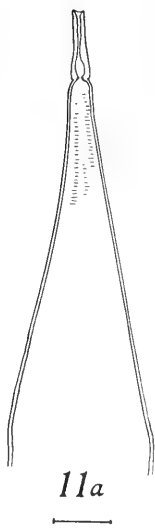
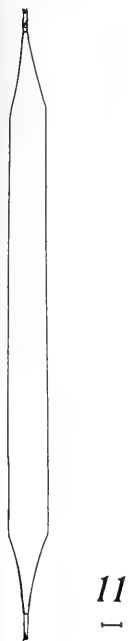

PLATE 7

- Fig. 17. *Rhizosolenia calcar avis* Schultze.
17a. A more slender cell.
17b. Apex of cell more highly magnified.
- Fig. 18. *Rhizosolenia alata* Brightw. Entire cell.
18a. End of another cell.
- Fig. 19. *Rhizosolenia alata* f. *indica* (Perag.) Osten.
- Fig. 20. *Rhizosolenia acuminata* (Perag.) Gran.
20a. Apex of cell more highly magnified.

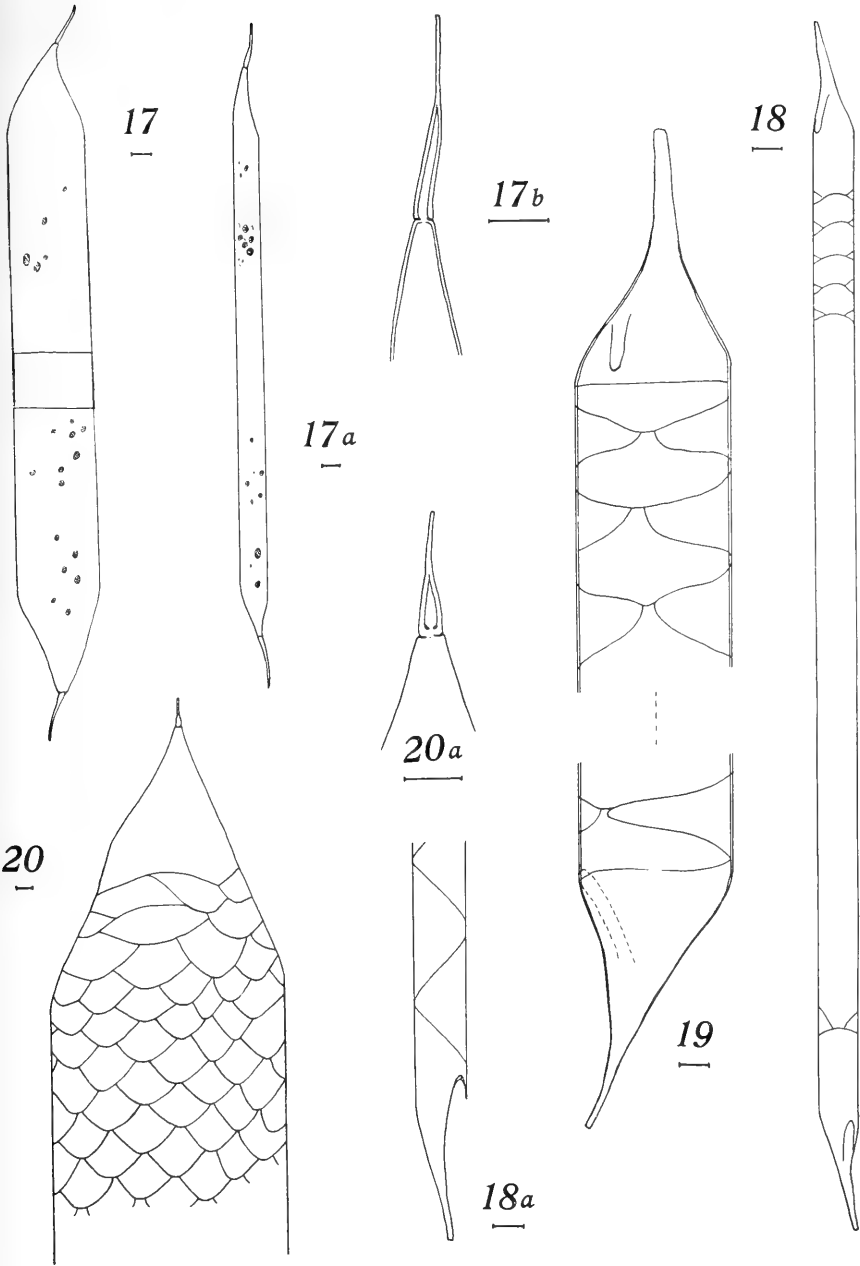

PLATE 8

Fig. 21. *Bacteriastrum elongatum* Cl.

Fig. 22. *Chaetoceros atlanticus* Cl. (var.?)

Fig. 23. *Chaetoceros concavicornis* Mang.

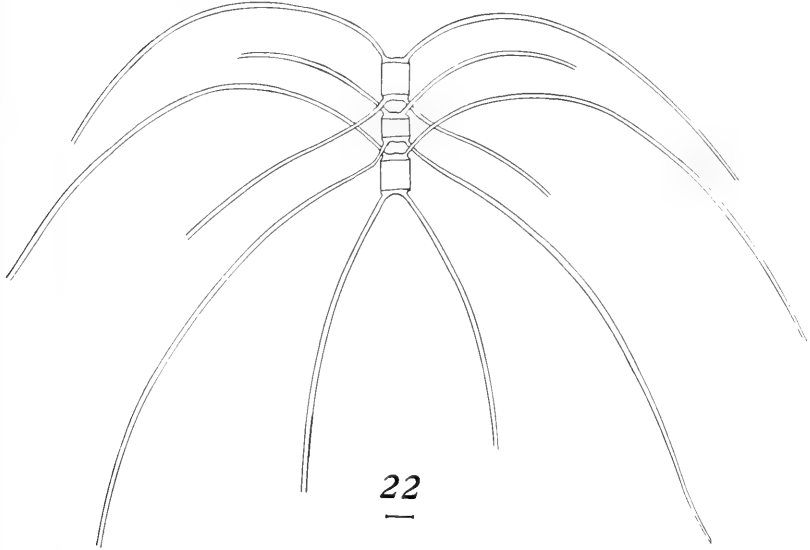
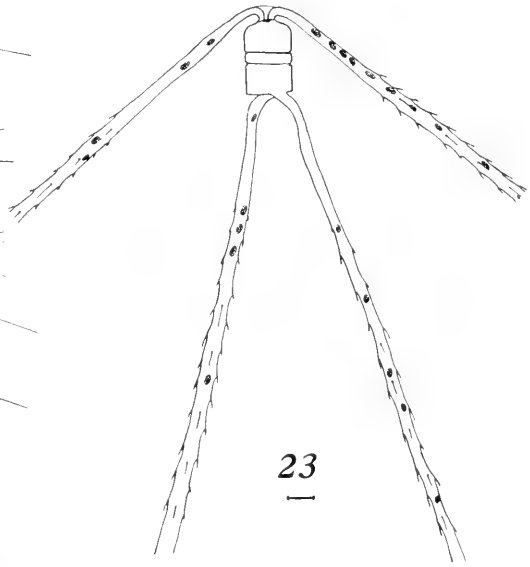
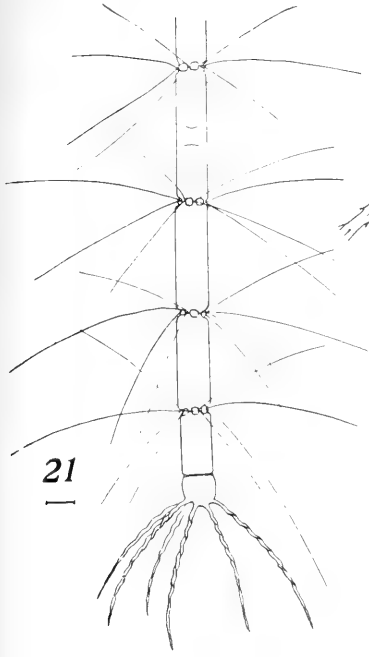
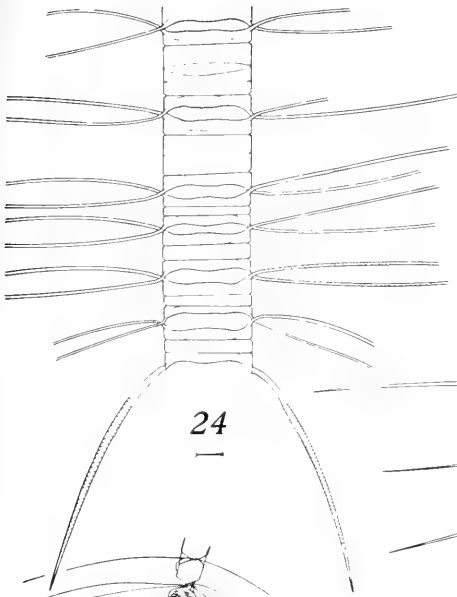

PLATE 9

Fig. 24. *Chaetoceros lorenzianus* Grun.

Fig. 25. *Chaetoceros compressus* Laud.

Fig. 26. *Chaetoceros didymus* Ehr.



24

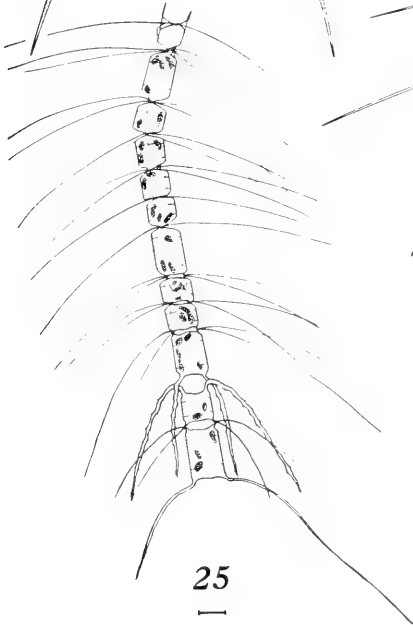

25

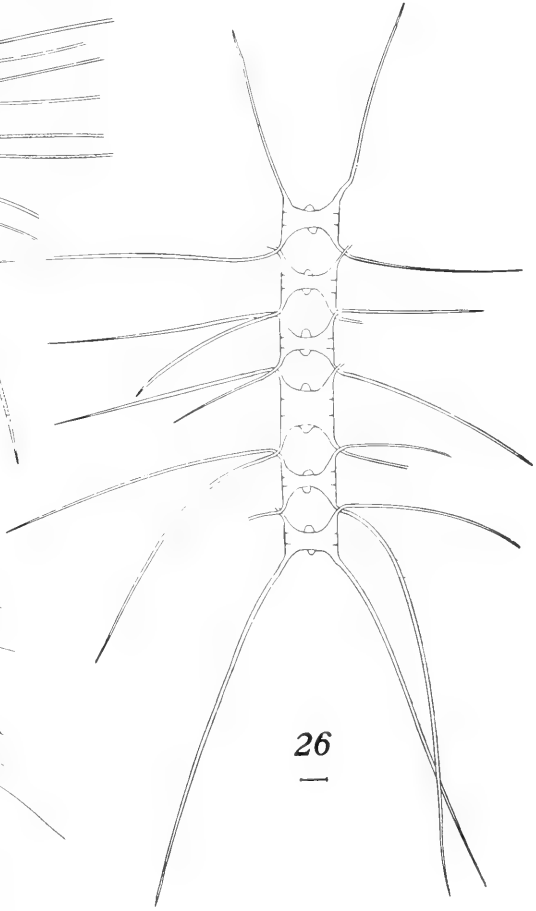

26



PLATE 10

Fig. 27. *Chaetoceros constrictus* Gran.

Fig. 28. *Chaetoceros affinis* Laud.

Fig. 29. *Chaetoceros costatus* Pav.
29a. Enlarged view.

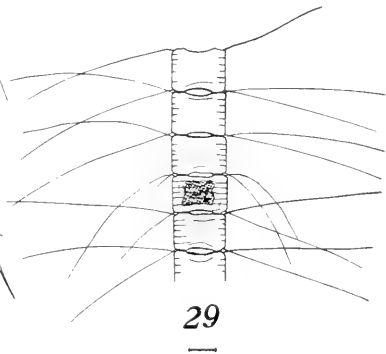
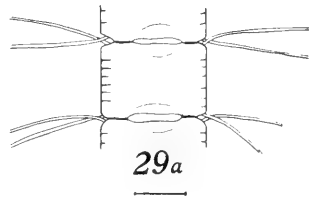
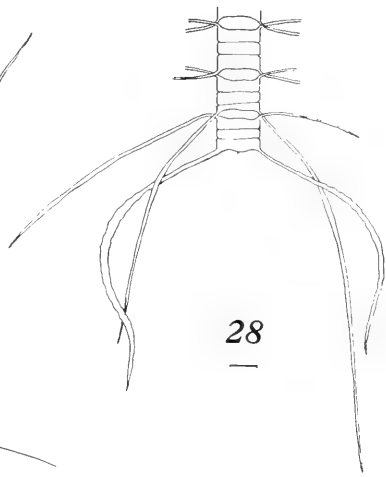
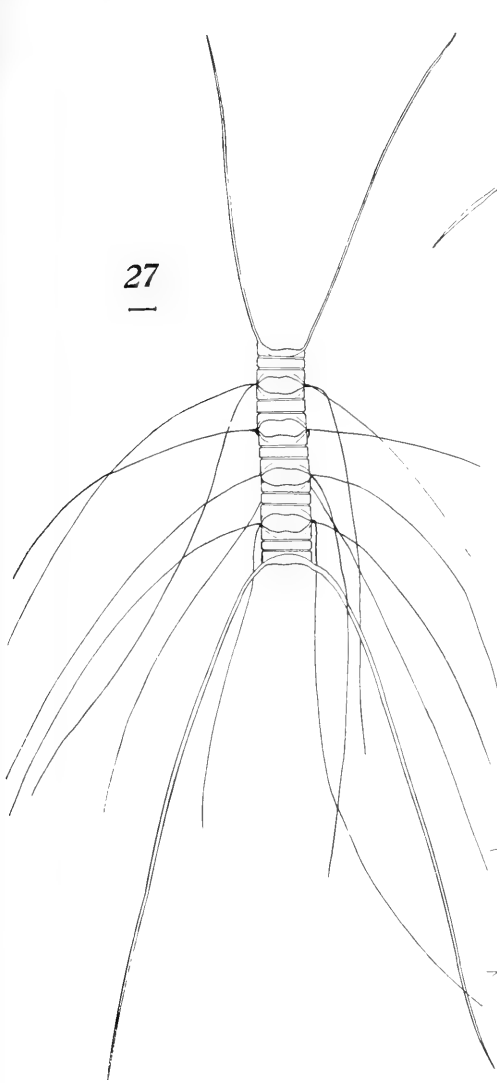
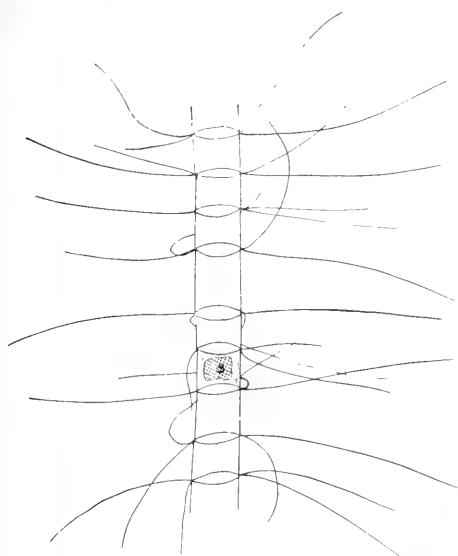
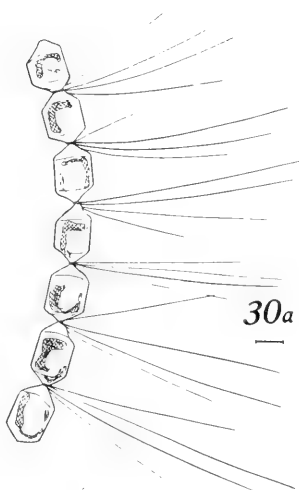

PLATE 11

- Fig. 30. *Chaetoceros curvisetus* Cl. Broad girdle view of chain.
30a. Narrow girdle view of chain.
30b. Broad girdle view of chain with two resting spores.
- Fig. 31. *Chaetoceros debilis* Cl.



30



30a

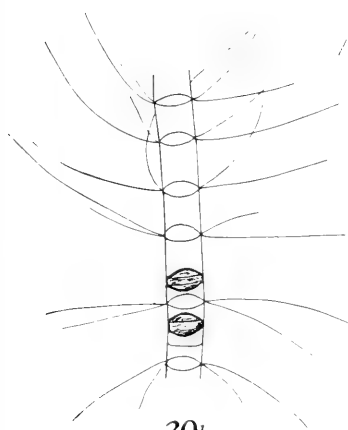

30b

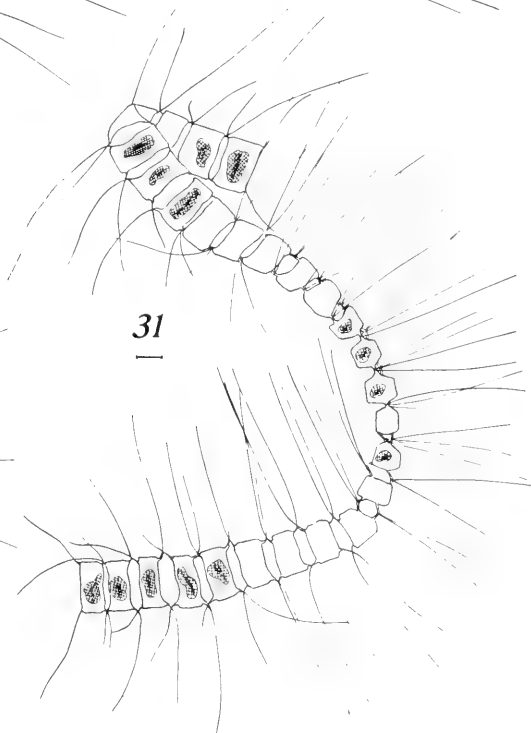

31

PLATE 12

Fig. 32. *Chaetoceros radicans* Schütt.

32a. Part of chain more highly magnified. Upper part, narrow girdle view; lower part, broad girdle view.

32b. Valve view of a cell.

Fig. 33. *Chaetoceros socialis* Laud.

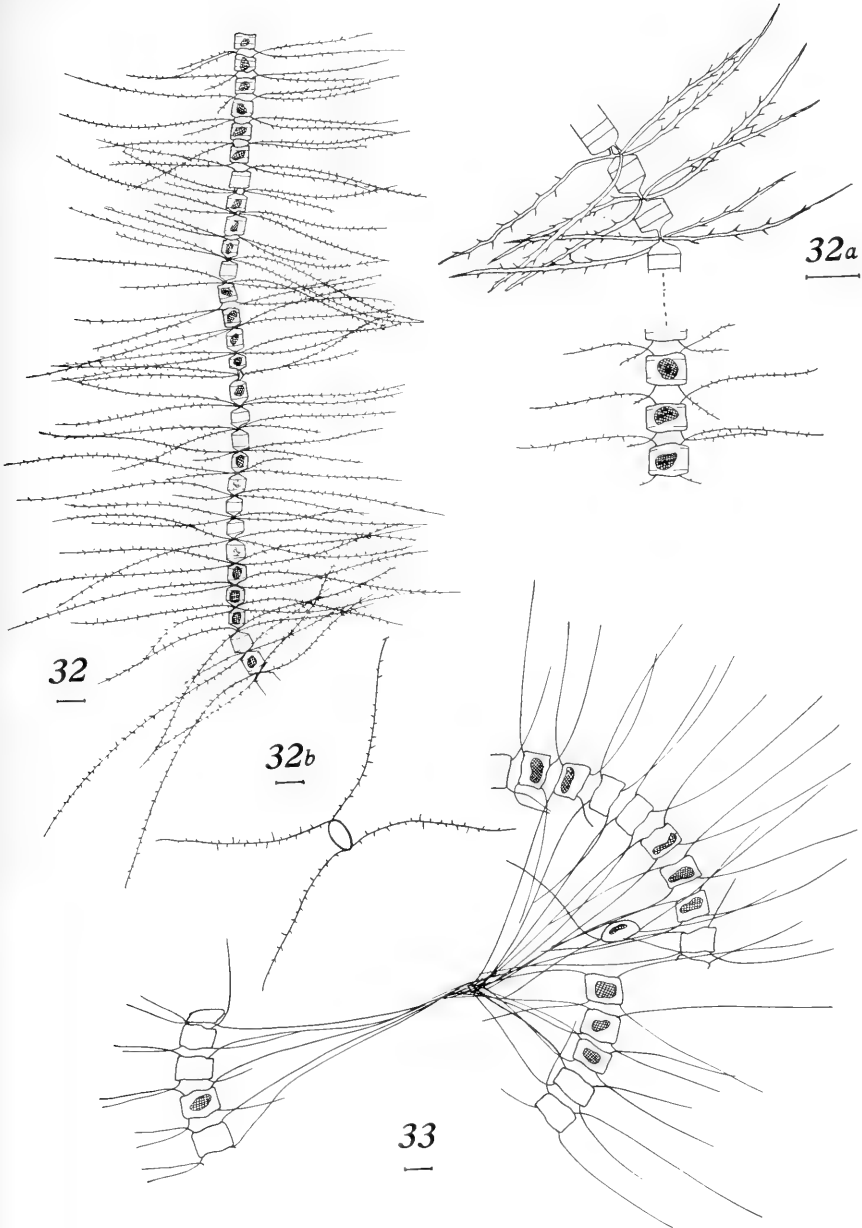

PLATE 13

- Fig. 34, 34a, 34b. *Eucampia zodiacus* Ehr. Parts of three different chains.
Broad girdle view.
- Fig. 35. *Ditylum brightwellii* (West) Grun.
- Fig. 36, 36a. *Lithodesmium undulatum* Ehr. Two views of the same chain.
- Fig. 37. *Biddulphia aurita* (Lyng.) Bréb. and God. Broad girdle view.
- Fig. 38, 38a. *Cerataulina bergonii* Perag. Two views of the same chain.

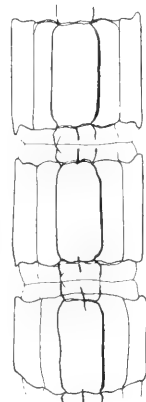
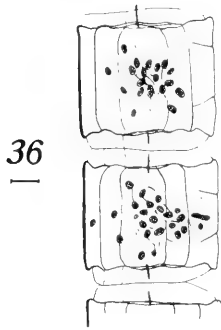
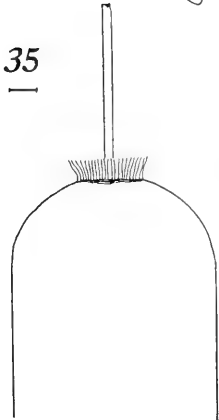
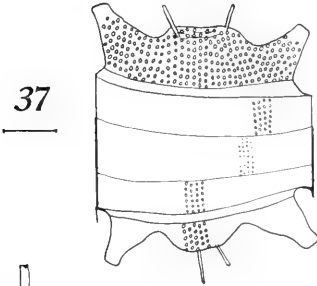
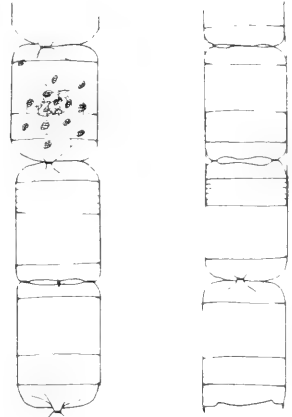
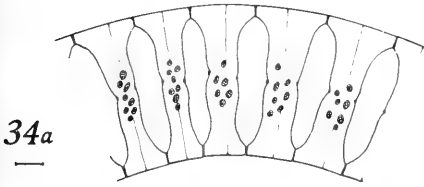
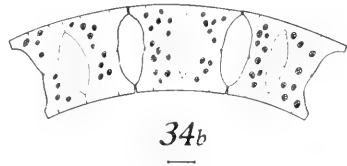
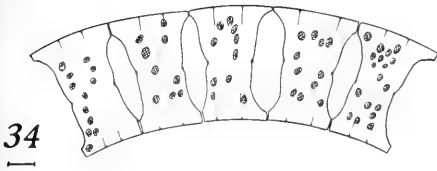

PLATE 14

- Fig. 39. *Thalassionema nitzschioides* Grun. Chain.
39a. Girdle view of a cell.
- Fig. 40. *Thalassiothrix longissima* Cl. and Grun. Entire cell.
40a. Part of the cell more highly magnified. Girdle view.
- Fig. 41. *Thalassiothrix frauenfeldii* Grun. Girdle view.
41a. Colony.
41b. Another colony.

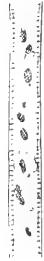
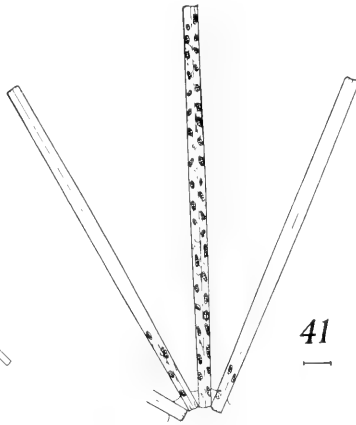
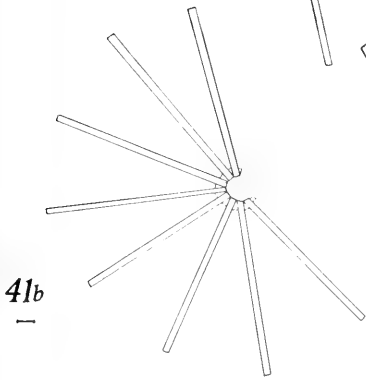
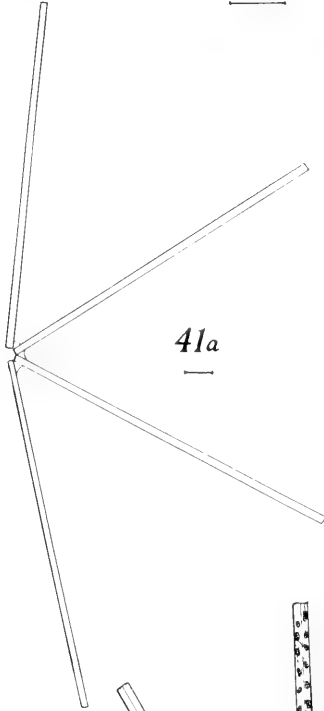
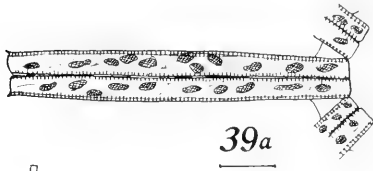
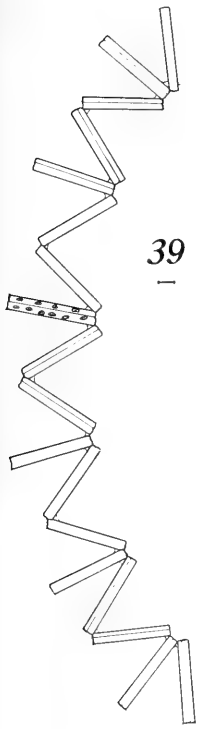
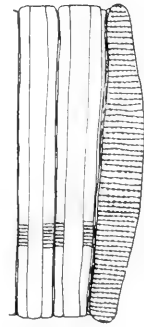
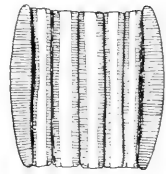
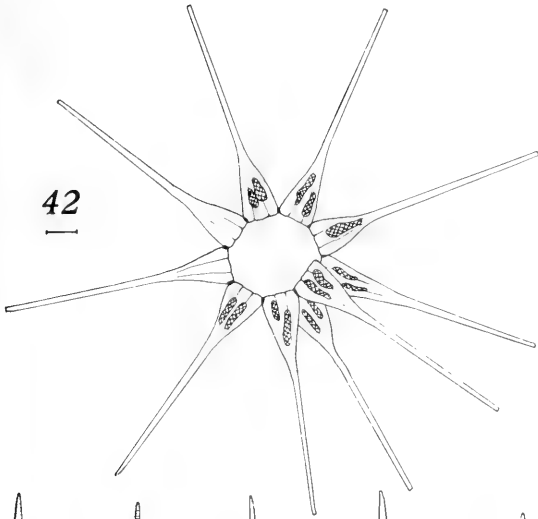

PLATE 15

- Fig. 42. *Asterionella japonica* Cl.
- Fig. 43. *Pseudocunotia doliolus* (Wall.) Grun. Colony.
- Fig. 43a. Part of colony more highly magnified. End cell in valve view, others in girdle view.
- Fig. 44. *Nitzschia seriata* Cl. Four-celled chain.
- 44a. Valve view of a cell.
- 44b. Girdle view of a cell.
- Fig. 45. *Nitzschia pungens* var. *atlantica* Cl. Girdle view of a chain.
- 45a. Valve view of a chain.
- 45b. Valve view of a cell.
- 45c. Girdle view of a cell.





ALLAN HANCOCK PACIFIC EXPEDITIONS

VOLUME 3

NUMBER 6

PHYCOMYCETES RECOVERED FROM SOIL
SAMPLES COLLECTED BY W. R. TAYLOR ON
THE ALLAN HANCOCK 1939 EXPEDITION

(WITH TWO PLATES)

BY

F. K. SPARROW, JR.



THE UNIVERSITY OF SOUTHERN CALIFORNIA PRESS
LOS ANGELES, CALIFORNIA

1940



REPORTS ON THE COLLECTIONS OBTAINED BY ALLAN HANCOCK PACIFIC EXPEDITIONS OF
VELERO III OFF THE COAST OF MEXICO, CENTRAL AMERICA, SOUTH AMERICA, AND
GALAPAGOS ISLANDS IN 1932, IN 1933, IN 1934, IN 1935, IN 1936,
IN 1937, IN 1938, AND IN 1939.

PHYCOMYCETES RECOVERED FROM SOIL
SAMPLES COLLECTED BY W. R. TAYLOR ON
THE ALLAN HANCOCK 1939 EXPEDITION

(WITH TWO PLATES)

By F. K. SPARROW, JR.

THE UNIVERSITY OF SOUTHERN CALIFORNIA PUBLICATIONS
ALLAN HANCOCK PACIFIC EXPEDITIONS
VOLUME 3, NUMBER 6
ISSUED OCTOBER 8, 1940

THE UNIVERSITY OF SOUTHERN CALIFORNIA PRESS
LOS ANGELES, CALIFORNIA

PHYCOMYCETES RECOVERED FROM SOIL SAMPLES
COLLECTED BY W. R. TAYLOR ON THE ALLAN
HANCOCK 1939 EXPEDITION*

(WITH TWO PLATES)

F. K. SPARROW, JR.

Through the kindness of Professor W. R. Taylor soil samples were obtained from certain Central and South American localities visited by him during the 1939 Allan Hancock Expedition. Water cultures were prepared from each of these samples and "baited" with appropriate substrata. Although the extreme dryness of the soil samples when received undoubtedly restricted greatly the variety and number of fungi still in a viable condition, they nonetheless yielded species of exceptional interest. Indeed, one of these, *Monoblepharella Taylori*, was found to be unique among plants in the behavior of the egg after fertilization.

All the fungi recovered are known to possess a resting spore stage resistant to unfavorable environmental conditions, such as drought, which would be fatal to the vegetative parts. It is easy, therefore, to understand how they survived the vicissitudes to which they were necessarily exposed from the time of their collection until they reached—some months later—the more congenial habitat of a battery jar of sterile water provided with bits of substrata.

The samples were collected into clean new boxes by careful methods, using ordinary precautions against the possibility of mixture. They were not, however, collected or stored under strictly aseptic conditions. The collection boxes were taped shut immediately after collection and remained unopened until they reached the laboratory. Pieces of soil were then cut out with a sterile scalpel from the middle of each sample and placed in jars of sterile water containing bits of "bait."

The following fungi were recovered:

* Paper from the Botany Department, University of Michigan, No. 720.

Chytridiales

1. *Rhizopodium carpophilum* (Zopf) Fischer

Parasitic on oospores of *Achlya* sp.¹ Sandy bank of a stream ("Site I"). Caledonia Bay, Panama; April 26, 1939.

A species hitherto known only from the Eastern United States, Western Europe, and Japan.

Blastocladales

2. *Allomyces javanicus* Kniep

Mud from a roadside watering trough on the road from Curacas to La Guaira, Venezuela; April 11, 1939.

According to F. T. Wolf (1939), no epigynous species of *Allomyces* have been reported from the Western Hemisphere. In connection with the present record, it might be mentioned that this species has also been isolated from soil from Texas, where it was found associated with *Blastocладиella simplex* Matthews.

The gametophyte differs from that formed by subcultures of Kniep's Javanese material in the occasional formation in water cultures of extraordinarily long, cylindrical female gametangia.

3. *Allomyces moniliformis* Coker and Braxton

Soil from a paddy field on the road to Pitch Lake from Port of Spain, Trinidad, B.W.I.; April 18, 1939.

This rare species has hitherto been known only from the Eastern United States (two collections) and Mexico (Wolf, 1939).

4. *Allomyces* sp. indet.

Soil from a spring on a hillside above the village of Bahia Honda, Panama; March 28, 1939.

So far, this isolate, which resembles in its sporophyte phase *A. javanicus* and *A. arbuscula*, has failed to produce a gametophyte. It is possibly *A. anomala* Emerson, inedit., an unpublished species which, according to Wolf (1939), is to include short-cycled species lacking both a gametophyte and "Cystogenes" phase.

¹ Attempts are being made to obtain normal material of this fungus for purposes of identification.

Monoblepharidales

5. *Monoblepharella* n. gen.

Mycelium, contents, zoosporangia, zoospores, oogonia, antheridia, and antherozoids as in *Monoblepharis*, the egg after fertilization emerging from the oogonium and by means of the persistent flagellum of the male gamete undergoing a period of swarming, after which it encysts and becomes a thick-walled oospore; the oospore upon germination forming the vegetative mycelium.

Mycelium, sporangia, zoosporis, oogonium, antheridia, antherozoideis simili *Monoblepharis*; ova inseminata postice uniciliata, natantia; oosporis in aqua liberis, germinatio formati mycelio.

Monoblepharella Taylora comb. nov.

Monoblepharis Taylora Sparrow,² in *Mycologia* 31:737. 1939.

Mycelium well developed, consisting of tenuous, flexuous branched hyphae 2—5 μ in diameter, the contents reticulately vacuolated; sporangia narrowly siliquiform with a tenuous wall, variable in size, 35—65 μ long by 5—9 μ in diameter, with a very narrow (2.5—4 μ) base, occurring singly or in pairs at the tips of the hyphae or after sympodial branching of the hypha appearing lateral; zoospores ovoid or somewhat cylindrical, 7—9 μ long by 4.5—5 μ wide, the posterior cilium 2—3 times the length of the body; oogonium at first terminal or after sympodial branching of the supporting hypha often appearing lateral, clavate or obpyriform with rounded apex and narrow cylindrical base, 15—17 μ long by 8—10 μ wide, tapering to 2—3 μ at the base, the contents at maturity forming one or occasionally up to 6 eggs containing numerous large refractive globules; antheridium usually hypogenous, several often developed in basipetal succession, consisting of a cylindrical segment of the suboogonial hypha and a beaklike lateral outgrowth 8—10 μ long by 4—5 μ wide, antherozoids two to five, strongly amoeboid, posteriorly uniciliate, ovoid when swimming and about 5 μ long by 3 μ wide, escaping through a pore formed at the tip of the beak; zygote broadly ovoid to nearly spherical, 10—13 μ long by 8—10 μ wide, posteriorly uniciliate, free swimming, the contents bearing numerous large refractive globules; oospore formed free in the water, spherical, 8—11 μ in diameter, with a slightly thickened, light brown, smooth wall, contents bearing globules, upon germination forming a mycelium.

² A Latin, but not an English, description has been previously published in *Mycologia*.

In soil, from a paddy field on the road from Port of Spain to Pitch Lake, Trinidad, B.W.I., April 18, 1939; from sandy soil on the bank of a stream ("Site I"), Caledonia Bay, Panama, April 26, 1939; dry bed below waterfall, 9 miles from Madden Dam, Panama, Canal Zone, March 31, 1939.

After a careful consideration and study of the genus *Monoblepharis* it has seemed advisable to segregate *M. Taylori* in a genus of its own. The remarkable behavior of the zygote is unlike anything observed in *Monoblepharis*, or, indeed, in the Fungi or Algae, and well warrants generic distinction. It is possible that *M. ovigera* and *M. regignens* may in the future be found to possess this same type of sexual reproduction, in which case they too might be included in *Monoblepharella*. While *Monoblephariopsis* already exists for their accommodation, this genus is founded on fungi known only from the imperfect stage. Since *Monoblepharella* is based on a species with both perfect and imperfect stages, it would, rightly, take precedence.

The thallus and sporangia of *M. Taylori* resemble in superficial aspect those of *Monoblepharis regignens* and *M. ovigera*. The mycelium, which forms a lustrous, pearly gray halo around the substrate, is composed of delicate, moderately branched hyphae 2—3 μ in diameter. Near the base, where the plant is anchored by a system of holdfasts to the substrate, the hyphal axes may attain a diameter of 5 μ . Catenulate series of swellings are formed on the hyphae of some, but not all, isolates. It is suspected that these are due to an extraneous parasitic organism. However, no reproductive phase has ever been observed which would substantiate this idea. The contents of the hyphae are characteristically disposed in a rich network, or reticulum, within which may be seen moving along the long axis somewhat coarse refractive granules of irregular size. A preliminary cytological examination of these hyphae shows the minute nuclei to be disposed at more or less regular intervals.

Occasionally both nonsexual and sexual reproductive organs may be formed simultaneously on the same plant (pl. 17, fig. 10). However, at room temperature (20-21°C.) a preponderance of zoosporangia is produced, whereas at 30°C. the formation of sexual organs occurs in abundance.

The zoosporangia are ordinarily produced at the periphery of the colony at the tips of delicate, sparingly branched hyphae. By subsequent sympodial branching of the hypha they come to appear lateral. The dif-

ference in width of the sporangium and its attendant hypha is so striking that the former frequently appears as though it were a long, slender fusiform or siliquiform highly refractive conidium lying free in the tangled mycelial complex. The sporangia vary from $35\text{--}65\mu$ long by $5\text{--}9\mu$ wide, the base generally tapering to $2.5\text{--}4\mu$. The zoospores are fully matured before discharge and emerge (pl. 17, fig. 9) through a small pore formed upon the deliquescence of the sporangial apex, in the same manner as in species of *Monoblepharis* (Sparrow, 1933). They are ovoid or somewhat cylindrical, $7\text{--}9\mu$ long by $4.5\text{--}5\mu$ wide, and possess a single long posterior cilium. The internal organization is exactly like that found in *Monoblepharis*.

Oogonia and antheridia are frequently formed on somewhat shorter branches of the thallus than are the zoosporangia. The clavate or obpyriform oogonium, $15\text{--}17\mu$ long by $8\text{--}10\mu$ wide, with a narrow base $2\text{--}3\mu$ in diameter, may, like the sporangium, be at first terminal but, after sympodial branching of the hypha, appears lateral. Both oogonium and antheridium develop in the same manner as do those of *Monoblepharis sphaerica* (Sparrow, 1933), i.e., the rudiment of the terminal oogonium is formed first. After this is delimited, another, more proximal segment is separated from the supporting hypha by a cross wall. In most cases this basal segment before its delimitation has formed a short branch beneath the oogonium which continues to increase in size as maturation proceeds. The mature oogonium is thin walled and apparently without a prominent receptive papilla, although further observations are needed on this point. The contents of the large, broadly ellipsoidal egg are made highly characteristic and conspicuous by the possession of numerous large, colorless, refractive globules (pl. 16, fig. 1), embedded in the clear cytoplasm. Although in most cases only a single egg is formed in the oogonium, 2—6 have occasionally been found (pl. 17, fig. 8). The mature antheridium, which may be formed singly or in basipetal series beneath the oogonium, consists of a cylindrical portion and a large, lateral, beaklike outgrowth, $8\text{--}10\mu$ long by $4\text{--}5\mu$ wide, formed from the previously mentioned branch. About 2—5 strongly amoeboid, posteriorly unciliated antherozoids, 5μ long by 3μ wide, are produced which escape through a pore formed at the tip of the beak. These may creep about after discharge or, like the zoospores which they resemble in all but size, swim about in the medium. The early stages in the process of fertilization are like those found in *Monoblepharis*. The antherozoid after reaching the apex of the fully mature oogonium be-

comes strongly amoeboid. Its contents become watery and spread over the oogonial apex (pl. 16, figs. 1-4). Numerous small vacuoles appear and disappear so rapidly as to give an appearance of cytoplasmic "boiling." The cilium waves feebly above the body of the sperm and, as the cytoplasm of the male gamete gradually sinks into the ooplasm, becomes more hyaline in appearance. During absorption of the male gamete the ooplasm expands and for a short time fills the oogonium (pl. 16, figs. 5, 6). In none of the many cases of fertilization observed was the body of the male gamete completely engulfed by the ooplasm. There always remained a small, papillalike part at the apex, from which protruded the cilium of the antherozoid (pl. 16, fig. 6). The remainder of the male gamete could be detected for a time as a more slightly granular material in the anterior part of the egg, but it was soon lost to view. Almost instantly after the absorption of the major part of the antherozoid, the papillalike residue of this structure on the surface of the egg started to increase in size (pl. 16, fig. 7). This marked the initiation of evacuation of the zygote from the oogonium. More definite evidence of emergence could then be seen in the migration of the large, conspicuous globules into the enlarging papilla (pl. 16, figs. 8-10). These continued to flow out with the cytoplasm of the zygote. Meanwhile, the cilium remained passive and, as the zygote continued to ooze out, slowly assumed a lateral position with respect to the orifice of the oogonium. The completely emerged zygote was at first somewhat pyriform, with the cilium nearly basal and extending at a right angle or more to the long axis of the body (pl. 16, fig. 11). It then rounded off (pl. 16, fig. 12), remained quiescent for a few seconds, and then began to rock gently. A trembling movement of increasing intensity was soon initiated, which frequently carried it away somewhat from the oogonial orifice (pl. 17, fig. 1). Lateral vibration of the hitherto quiescent cilium then occurred, and vacuoles appeared in the anterior part of the now more ovoid body (pl. 17, fig. 2). After a few violent tugs, accompanied by rapid vibration of the dark-appearing cilium, rotation of the zygote on its long axis as well as forward progression was initiated, and it slowly swam off. Under poor environmental conditions the zygote may fail to emerge, and the oospore is formed in the oogonium (pl. 17, fig. 7).

After a period of motility of unknown duration, frequently punctuated by periods of quiescence and strong amoeboid crawling (pl. 17, fig. 3), the zygote comes to rest. Its cilium is apparently absorbed (pl. 17, fig. 4), and the body becomes surrounded by a thickened wall (pl. 17,

fig. 5). The globules persist for a time, but eventually these are absorbed and the oospore undergoes a period of rest, far removed from the oogonium. The precise duration of encystment is not known. Fully mature oospores dried for three weeks on cover slips have germinated when placed in water. It will also be recalled that the soil samples from which the fungus was isolated had been dry at least two months before they were obtained for study. It is probable, therefore, that the oospore can remain viable in the soil during ordinary periods of tropical drought.

Upon germination, a single small pore is formed in the oospore wall, through which a hypha emerges (pl. 17, fig. 6). The latter elongates indefinitely, branches, makes contact with bits of organic material, and re-establishes the fungus. Reproductive organs of either type may be formed, or the mycelium may continue its vegetative growth.

Monoblepharella Taylori presents among other features a type of sexual reproduction of unusual interest. So far as now known, sexuality in those unciliated Phycomycetes where one or both the gametes are free swimming may be isogamous (*Olpidium*, *Synchytrium*, *Blastocladiella variabilis*), anisogamous (*Allomyces javanicus*, *A. arbuscula*), or oogamous (*Monoblepharis*). In this series one type of sexual reproduction has not as yet been found, namely, that in which a free-swimming egg is fertilized out in the water by a motile sperm. When *M. Taylori* was first discovered, it was thought that it might possess this sort of reproduction. A close examination, however, revealed otherwise, for it is not the egg that is ciliated and motile, but the *zygote*. It seems highly probable, therefore, that there exists in nature an oogamous organism of this group in which both gametes are motile.

6. Phycomycete of unknown affinities.

Sandy bank of a stream ("Site I"), Caledonia Bay, Panama; April 26, 1939.

Only a few thalli and mature sporangia of this fungus were found. All attempts to multiply it failed, and hence little is known of its life history or affinities.

The plant consists at maturity of two well-defined parts: a distal, more or less spherical body, 70—200 μ in diameter with a broad discharge tube 15—30 x 50—60 μ long, and, continuous with it, a trunklike basal stalk, 50—220 μ long x 25 μ wide, from the tip of which emerges a series of sparsely or richly branched holdfasts. Occasionally the stalk is lacking and the holdfasts arise directly from the body. The two parts are

separated by a cross wall. The contents of the swollen apex and tube become segmented—apparently by successive division—into an extremely large number of roundish or somewhat angular spores about 10μ in diameter. The cytoplasm of these bodies consists of a granulated matrix, within which are embedded a few bright granules. No spore discharge was ever witnessed. The frequent finding of columns of motionless spores in the medium seemed to indicate that they were set free upon the disintegration of the wall of the discharge tube.

In its superficial aspect the fungus resembles a species of *Blastocladiella*. An even closer resemblance to the recently described *Rhizidiomyces bivellatus* (Nabel, 1939) is found not only in the presence of a discharge tube but in the occasional lack of a stalk. Nabel's fungus was discovered in soils collected in Haiti, Venezuela, Mexico, and Yugoslavia.

LITERATURE CITED

NABEL, K.

1939. Über die Membran niederer Pilze, besonders von Rhizidiomyces bivellatus nov. spez. Archiv f. Mikrobiol. 10 (4): 515-541.

SPARROW, F. K., JR.

1933. The Monoblepharidales. Ann. Bot. London. 47: 517-542.

WOLF, F. T.

1939. A study of some aquatic Phycomycetes isolated from Mexican soil. Mycologia 31:376-387.

EXPLANATION OF PLATES

All figures were drawn from living material with the aid of the camera lucida.
The absolute scale is given on each plate.

PLATE 16

Stages in the fertilization of the egg of *Monoblepharella Taylora*
and the emergence of the zygote.

FIGS. 1, 2. Emergence of the last of four antherozoids from the
antheridium.

FIGS. 3-6. Absorption of the antherozoid by the egg. In Fig. 6
all but a small portion of the male gamete and its
cilium has sunk into the ooplasm. The cilium has as-
sumed a lateral position.

FIG. 7. Beginning of emergence of the zygote.

FIGS. 8-10. Further stages in emergence.

FIG. 11. Completely emerged, somewhat ellipsoidal zygote
resting at the mouth of the oogonium.

FIG. 12. Zygote assumes a more spherical shape and moves
away from the orifice of the oogonium.

ERRATA: Plates 16 and 17 are transposed.
With this correction, all references to both
plates are accurate.

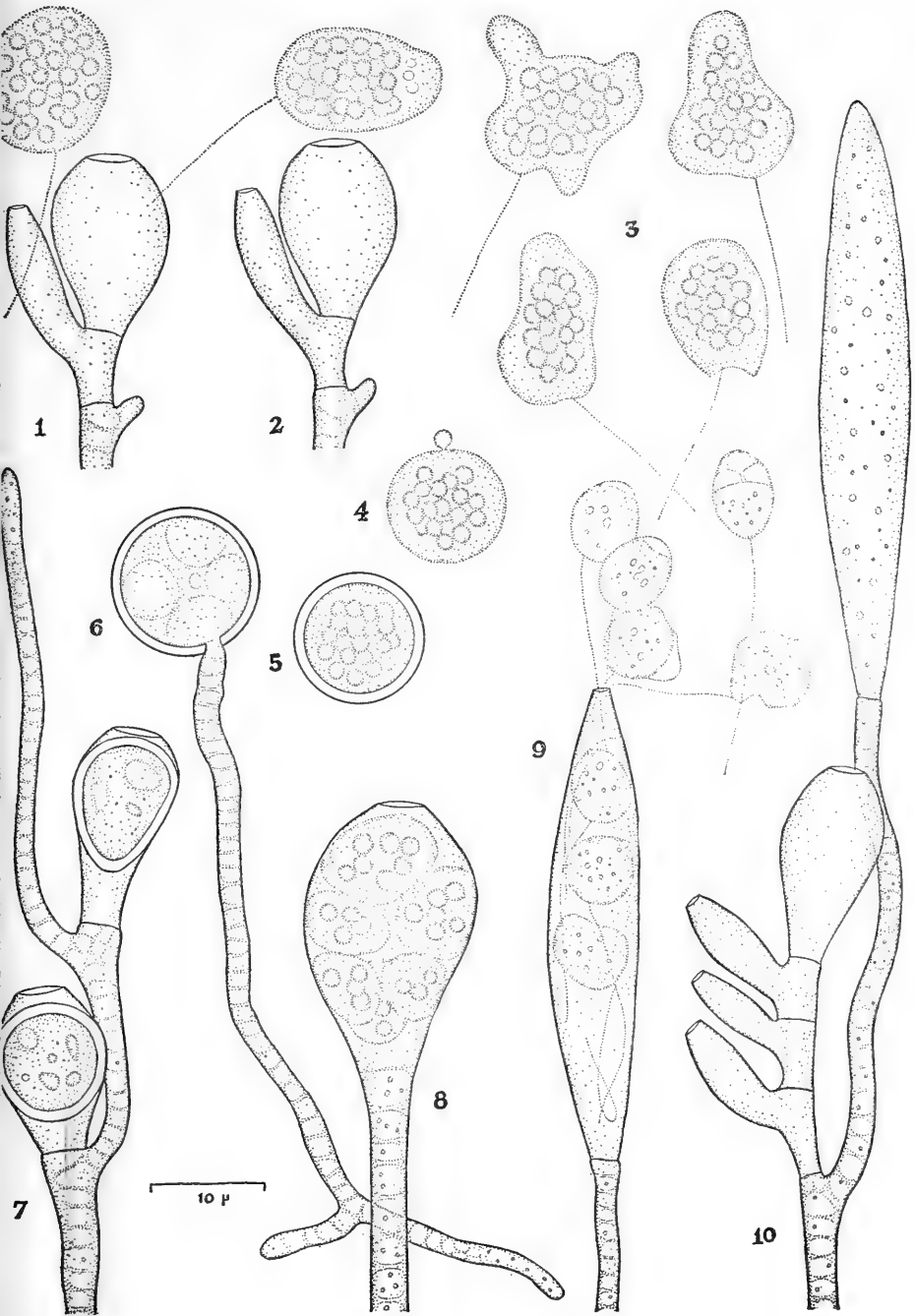
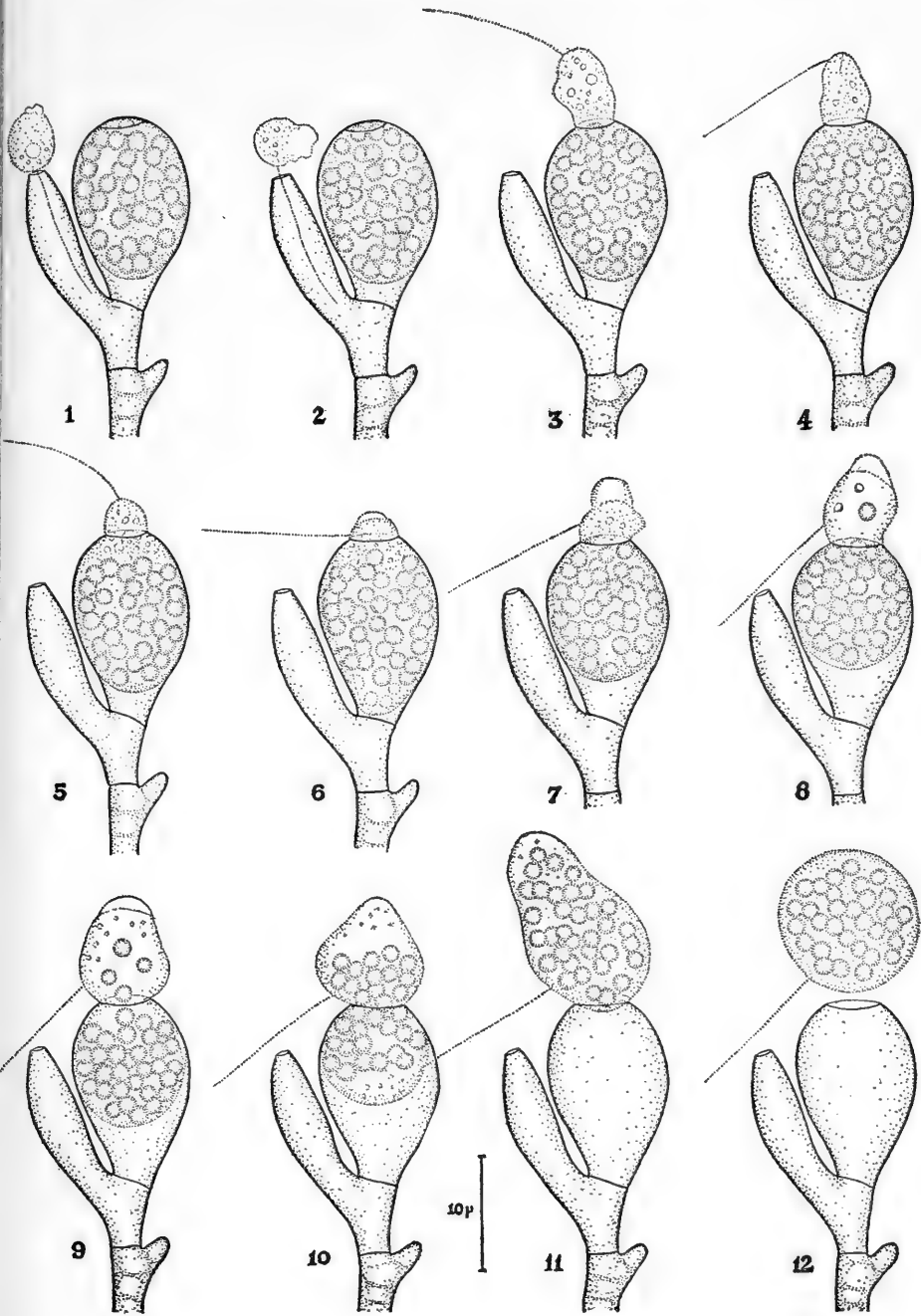

PLATE 17

- FIGS. 1, 2. Final stages in the escape of the zygote. In Fig. 2 the body has started to rotate on its long axis, and the cilium is in motion.
- FIG. 3. Amoeboid changes of shape undergone by the zygote during temporary periods of rest.
- FIG. 4. Zygote at rest. The body has become rounded and the cilium condensed into a small droplet.
- FIG. 5. Mature oospore free in the water.
- FIG. 6. Germinated oospore. The full length of the hypha is not shown.
- FIG. 7. Two oospores formed within the oogonium. Occurring commonly under poor environmental conditions.
- FIG. 8. Unusually large oogonium containing six eggs.
- FIG. 9. Discharging zoosporangium. A mature zoospore with the typical internal structure assumed during motility is shown in the upper right figure.
- FIG. 10. Portion of a hyphal tip bearing an immature zoosporangium and an empty oogonium beneath which are several antheridia.
- Figures inked in by Richard Higgins.





ALLAN HANCOCK PACIFIC EXPEDITIONS

VOLUME 3

NUMBERS 7, 8

FIELD OBSERVATIONS ON THE ALGAE OF
THE GULF OF CALIFORNIA

A REVIEW OF THE GENUS RHODYMENIA
WITH DESCRIPTIONS OF NEW SPECIES

(THIRTEEN PLATES)

BY

ELMER YALE DAWSON

DEPARTMENT OF BOTANY, UNIVERSITY OF CALIFORNIA



THE UNIVERSITY OF SOUTHERN CALIFORNIA PRESS
LOS ANGELES, CALIFORNIA

1941



REPORTS OF THE COLLECTIONS OBTAINED BY ALLAN HANCOCK PACIFIC EXPEDITIONS OF
VELERO III OFF THE COAST OF MEXICO, CENTRAL AMERICA, SOUTH AMERICA,
AND GALAPAGOS ISLANDS IN 1932, IN 1933, IN 1934, IN 1935,
IN 1936, IN 1937, IN 1938, IN 1939, AND IN 1940.

FIELD OBSERVATIONS ON THE ALGAE OF
THE GULF OF CALIFORNIA

By ELMER YALE DAWSON

THE UNIVERSITY OF SOUTHERN CALIFORNIA PUBLICATIONS
ALLAN HANCOCK PACIFIC EXPEDITIONS
VOLUME 3, NUMBERS 7, 8
ISSUED APRIL 21, 1941

THE UNIVERSITY OF SOUTHERN CALIFORNIA PRESS
LOS ANGELES, CALIFORNIA

FIELD OBSERVATIONS ON THE ALGAE OF THE GULF OF CALIFORNIA

ELMER YALE DAWSON

Department of Botany, University of California

It was during the Allan Hancock Expedition of 1940 that the author had an opportunity to obtain information on the condition of the winter algal flora of the Gulf of California.

Our collections were made between January 18 and February 16, and ranged between Gorda Banks, off the Cape of Baja California, and Rocky Point, Sonora. In July, exactly six months after the Expedition visited Turner's Island, near Tiburon Island in the upper Gulf, a return trip was carried out by automobile and fishing dory to the same location to observe the seasonal change in the marine flora of that particular station.

Before entering upon detailed observations on the flora of the Gulf of California, conspicuous general differences from that of the California coast should be stressed. Some of the factors controlling these differences will be discussed.

Taking the Gulf as a whole, as observed at fully twenty-five different shore stations, the most conspicuous feature was the paucity of seaweeds as compared to the abundance on the rocky shores of California. In many of the more southern localities in the Gulf, the fine rocky places one would expect to find covered with plant life are almost sterile. In the places which do have an abundant rock cover, a great difference exists in the size of the plants. In the Gulf, though many species may occur in a given area, the impression of paucity is due mostly to the absence of the genera of large and conspicuous brown algae, the Kelps and the Fucoids. In short, the marine flora of the Gulf is rich in species but is largely a flora of miniature plants, the great bulk being made up of species of *Sargassum*.

As might be expected, the contrast in abundance is less conspicuous in the upper Gulf. The richest algal flora was found among the northern islands from San Esteban to Angel de la Guardia. The greatest number of species collected occurred at Puerto Refugio and at Turner's Island. The abundance of both species and individuals in these regions of the

northern island group may be controlled by two principal sets of conditions: (1) those of substratum, and (2) those of water movement.

It was observed throughout the upper two thirds of the Gulf, as in other marine areas, that shallow, sandy, or muddy bays and shores are relatively poor in algae as compared to rocky shores, which provide firm bases for holdfast development. Regions of abundant sedimentation are unsatisfactory, as shown by the decreasing richness of development both toward the mouth of the Colorado River and along the coastal plains at Bahia Gonzaga and Bahia Tepoca, where alluvial sedimentation occurs during the rainy season. (The former yielded only 34 species on shore and 8 by dredge, the latter 22 species on shore and 22 by dredge.)

As to the effect of water movement, one may best note the way in which the northern island group blocks the Gulf to general mass movement, leaving only narrow channels for the passage of the tremendous volume of tidal water. The daily rise and fall of tides in the upper Gulf is spectacular, as much as 32 feet in some places. The continuous movement of water through the channels is very rapid, and thorough aeration of the relatively sediment-free water apparently takes place. This greater purity of the flowing water seems favorable to algal growth, and we find, as compared to the above figures, the striking totals of some 80 species collected at Turner's Island and 130 from Puerto Refugio. On the other hand, in the quiet water of the sandy or mucky bays and harbor lagoons around Guaymas, where renewal is minor and sediment accumulation continuous, the number of species is low. Across the Gulf from Guaymas and to the south, little could be determined except that the winter flora is very inconspicuous and the summer flora, according to accounts by the natives, relatively abundant.

In the perennially warm, tropical waters around La Paz, the algal flora is of a very different type from that found farther up the Gulf, where the water is subject to periodic heating and cooling of a much greater degree. The tropical algae are smallest in quantity and species; the rocky shores in most places are almost completely bare of plant life. The tropical water of the Gulf is not calcareous in nature, such as is that of the Caribbean region, and, though corals are plentiful in the lagoons, they are of an individual rather than of a reef-building nature. Thus, under conditions which in other such warm localities might yield an abundance of calcareous green algae, almost none are found. Only a few emaciated specimens of *Halimeda* turned up in the dredge.

In order to secure midsummer data on the algal situation in the Gulf to compare with the midwinter data already on hand, the author decided

to revisit, in July, one of the richest algal habitats known there, the reef at Turner's Island. Without the *Velero III* at this time marine collecting in Mexico from a land approach presented quite a different problem.

Bahia Kino is a broad bay of almost continuous beach. For a marine botanist it yields little to excite enthusiasm, but on this occasion it contributed to one problem in particular, that of the development of *Sargassum* in the Gulf.

The first *Sargassum* material found in fresh, wet condition on the beach at Kino Bay could easily be separated into two forms. Both had been capable of continued life and growth while floating and drifting in the open sea. One clearly gave evidence of morphological modification under these free-floating conditions; the other, less strikingly.

Sargassum was again encountered on the south of Tiburon Island, where a species approaching fertility was found to be abundant on a cobble shore, attached firmly to rocks by broad, discoid holdfasts.

On Turner's Island, where in January great masses of *Sargassum* 3-6 feet long covered large areas of the lower littoral shore, a striking change had taken place. These had all disappeared, and there remained only occasional remnants of disintegrating fronds, below which were numerous young shoots springing from the spreading holdfast region and just beginning a new season's development. Two species of young *Sargassum* were found, both in about the same stage of development and indicating that a complete seasonal cycle occurs annually at that locality. In one of these, destruction of the mature plants is accomplished most probably by gradual disintegration in accordance with increasing water temperatures. The other seemed to be one which breaks off to take on the floating habit. These detached pieces may live and grow actively for a considerable time before being cast up on the beaches, where they are destroyed by myriads of beach isopods which consume them completely at each low-tide period.

The observations thus far have shown the *Sargassum* flora to be largely annual in development, either entirely from sporelings or from perennial bases. However, the various species follow through their developmental cycles in different seasonal order. Thus, in January at Guaymas two species were in full reproductive condition; at Tepoca Bay to the north another species had reached only the earlier stages, and maturity was not due for some months. The same conditions were found to the south at Agua Verde Bay, though the stages were still younger at that time. In July, on the other hand, Turner's Island specimens were just beginning a new cycle, and those on the south of Tiburon Island were

very near to the end of one. Beach-drift specimens at the same time must be considered separately, for it seems that the suspended state may prolong the life of such plants after they have left the original habitat, and thus create an overlap in the cycle whereby one generation continues to linger as a floater, while the succeeding one proceeds in its development.

Aside from the interesting changes in the *Sargassum* vegetation of Turner's Island as observed at the two seasonal extremes, there were other changes of an equally pronounced nature. In January about fifty species were collected on the reef, and in July about the same number was found. However, the expression of the flora of the reef was strikingly different at the two seasons. During the winter, *Colpomenia* had been dominant over a great part of the cobble shore, associated with an abundance of *Padina* and *Codium*. All of these were gone by summer, together with *Gigartina*, the greater part of the jointed corallines, and many small rock-cover types. Over everything grew clumps of *Dictyota*, a large species six to ten inches high, forming the great bulk of the plant life. Some species which had been encountered in mature stages in January were recognizable in July in their juvenile stages, but others were apparently absent or greatly reduced in number.

It seems certain that this great change is due primarily to the widely contrasting seasonal temperature relations. A comparison with the situation on our California coast reveals no such temperature extremes. In January the open sea at Turner's Island measured between 60 and 64 degrees F., while in July this same water had warmed to 88 degrees. Insolation in the summer is exceedingly severe and, no doubt, produces much higher temperatures on the surfaces of exposed plants at low tide and in small pools. On Tiburon Island, in the bays along the shore, temperature figures as high as 92 were common.

Some mention may be made of the deepwater collections secured by the Hancock Expedition, since they far exceed all previous ones from the region. The immediately sublittoral dredging yielded a great number of species not found in any of the shore stations; indeed, the hauls from 6-16 fathom depths were among the most productive collections made. In deeper water, 11-22 fathoms, a number of genera of membranaceous red algae were secured, and even in a 30-40 fathom haul several species came up, though it was suspected that a part of these may have been detached pieces from lesser depths. Conspicuous among the deepwater specimens were certain crustaceous corallines which were usually the only representatives of the plant kingdom. On the Gorda Banks off the Cape of Baja

California a great number of a single species of *Lithothamnium* were secured from between 53 and 75 fathoms. Besides the corallines, one species of *Schizymenia* was brought up from a 55-76 fathom haul off Isla Partida in the upper Gulf. This record is surprising in view of the fact that abundant phytoplankton through most of the upper Gulf greatly diminishes the penetration of light to these depths.

Entirely aside from the preceding considerations, two algal discoveries merit particular mention here. Two species of brown algae turned up most unexpectedly and serve very well to initiate a consideration of distributional problems in the Gulf. One, *Zanardinia*, is a member of the *Gutleriales*. *Zanardinia prototypus* (Nardo) Nardo (commonly known as *Zanardinia collaris* (Ag.) Crouan) is the single species of the Mediterranean genus which has had, until the present, no unquestionable records of a distribution far outside that general region. Beautifully fringed, actively growing specimens, which were collected in several localities from Turner's Island north, show exceedingly close resemblance to the Mediterranean species and may prove to be identical. The species in the Gulf is probably ephemeral, with a short period of vegetative growth during the cooler seasons. It was found nowhere during the summer.

The other very peculiar species is an *Ishige*, one which is at present best referred to *Ishige foliacea* Okam. This has been known until now to have a purely eastern Asiatic distribution. The two forms, *I. Okamurae* Yendo and *I. foliacea* Okam., are very abundant along the coasts of China and Japan but have not been recorded elsewhere, in so far as the author knows. Reproductive stages are unknown in spite of the abundance of the plant. The Gulf material also is quite sterile. The finding of this Japanese element in the flora of the Gulf is somewhat less startling than the discovery of *Zanardinia* but is nevertheless remarkable. It is plentiful on most of the rocky reefs in the northern part of the Gulf, where it had attained a size of about two inches in January. It was encountered in July on Tiburon Island in greater luxuriance and thus would seem to be long lived, quite unlike *Zanardinia*. Only the flattened form is present; whereas in the far eastern habitat both the flat and cylindrical forms are found in close association. This one form is, however, widespread in the Gulf area and apparently of broad ecologic tolerance.

Other species of similar interest and importance are being found from time to time as the investigations proceed. These will receive appropriate mention with the accounts which are to follow of various algal genera and families as they occur in the Gulf of California.



REPORTS ON THE COLLECTIONS OBTAINED BY ALLAN HANCOCK PACIFIC EXPEDITIONS OF
VELERO III OFF THE COAST OF MEXICO, CENTRAL AMERICA, SOUTH AMERICA,
AND GALAPAGOS ISLANDS IN 1932, IN 1933, IN 1934, IN 1935,
IN 1936, IN 1937, IN 1938, IN 1939, AND IN 1940.

A REVIEW OF THE GENUS RHODYMENIA
WITH DESCRIPTIONS OF NEW SPECIES

(THIRTEEN PLATES)

By ELMER YALE DAWSON

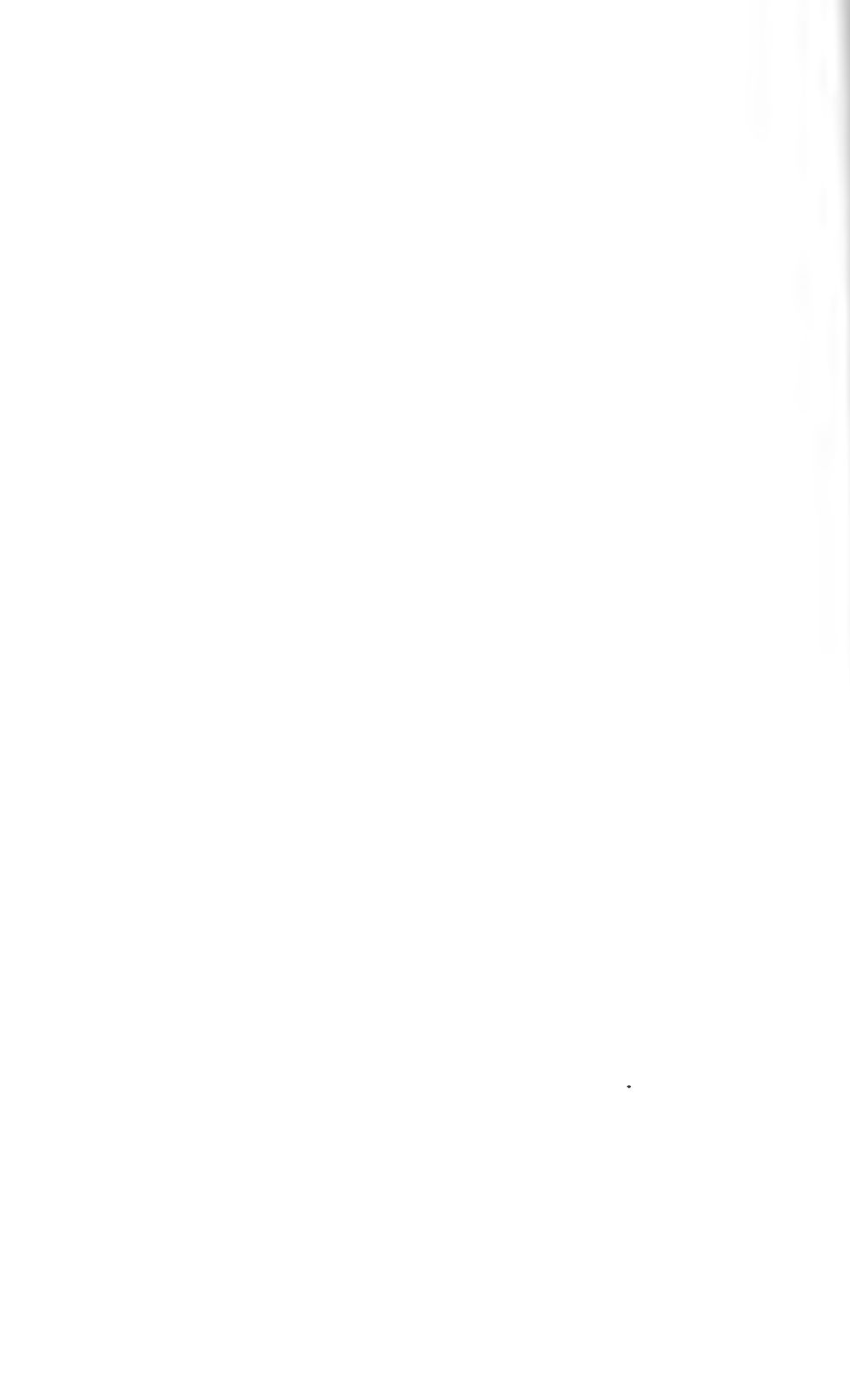

A REVIEW OF THE GENUS RHODYMENIA
WITH DESCRIPTIONS OF NEW SPECIES

(THIRTEEN PLATES)

ELMER YALE DAWSON

Department of Botany, University of California

In attempting to determine the species of *Rhodymenia* collected on the Allan Hancock Expedition of the *Velero III* to the Gulf of California in January, 1940, it was found that the Rhodymenias of the Pacific Coast of North America were very imperfectly known, specimens having been referred to species such as *Rhodymenia palmetta* and *R. corallina* on little more basis than a general resemblance in size and shape. In working over the very considerable variety of specimens available in the Herbarium of the University of California, it soon became clear that a review and re-assembling of the species of the whole genus were necessary in order to proceed with any certainty in the study of the species of the Gulf of California. The following is a summary of the work as carried on thus far, both in assigning described species to places in a systematic scheme and in proposing new ones.

Acknowledgment is due Dr. W. A. Setchell for his generous help in the research and for preparing the Latin diagnoses of this paper; also to Captain Allan Hancock and to Dr. T. Harper Goodspeed, through whose expeditions material has been made available.

The genus *Rhodomenia* was founded by Greville in 1830 and illustrated by a series of drawings of *Rhodomenia palmetta* (Greville, Alg. Brit., 84, pl. XII (1830)). He apparently regarded *R. palmetta* as typical of his genus, and we may consider it the type, although no actual specimen was designated. Greville places some 10 species in his genus, several of which are now segregated into other genera such as *Gigartina*, *Kallymenia*, and *Calliblepharis*. Kuetzing (Sp. Alg., 778 (1849) included *Rhodomenia*, *Gracilaria*, and the members of some other genera under *Sphaerococcus*.

J. G. Agardh reconstituted the genus (Sp. Alg. II, 375 (1851)), revising the spelling to *Rhodymenia* as suggested by Montagne (Cryp. Brasil., 42-55 (1839)). This spelling was adopted as preferred in 1912 in the International Rules of Botanical Nomenclature of the Congress of Vienna (1905) and of Brussels (1910), and the generic name *Pal-*

maria Stack. (Tent. mar. crypt., 54 (1809)) was rejected. The genus as Agardh understood it has been accepted almost to date. A modification of his arrangement of species (J. G. Agardh, Epicr., 328-332 (1876)) has not been attempted since his time, even though a very considerable number of new species have been described (cf., e.g., De Toni, Syl. Alg. IV, II:509 (1900),—Kylin, Die Florideenord. Rhodymen., 1-48 (1931),—et al.).

After an investigation, both macroscopical and microscopical, of all the immediately available specimens referable to the genus *Rhodymenia*, it has seemed best to follow Agardh, but to institute further a new section *Pertusae* and to reduce the genus *Dendrymenia* Skotts. (Bot. Ergeb. schwed. Exped. nach Patagon. IX Rhodophyceae, p. 16 (1923)) to subgeneric status. Agardh's method of separating the sections on tetrasporic characters has been carried a little further and, based on the occurrence of tetraspores, scattered or in sori; and, under the latter, whether the cortex is nemathecioid or nonnemathecioid, the new section *Pertusae* is established as equivalent with Agardh's sections *Palmatae*, *Palmettae*, and *Clinophora*.

In establishing *Dendrymenia* as a subgenus account has been taken of the branching habit of the stipe and of the occurrence of stolons. The specimens included are those which show a sympodial branching of the erect stipe in addition to the production of decumbent branches. In sections *Palmettae* and *Clinophora* branching of the stipe frequently occurs to produce stolons, and in cases in which the stoloniferous region of the stipe gives rise to blades through the branching of these stolons, the distinction from *Dendrymenia* may be very difficult to interpret. This condition seems to make a generic separation undesirable but does allow the suggestion of a fifth section for the genus—*Dendrymeniae*.

The genus embraces about 54 species, of which 14 are described in this article. Of the total number, the occurrence of tetraspores, which are highly important in distinguishing the members from one another and in arranging them in the sections, is unknown for about 26 species. Cystocarps are unknown in even a larger number, and thus the arrangements proposed here are only suggestive and are subject to change at any time upon the discovery of new and pertinent facts. Several new species are provisionally described from sterile material; others, from a single specimen. These, like many of the already described species, are incomplete, and their determination even as to the genus may be regarded at present as no more than tentative.

Of the 54 species listed here, 27 have been studied from actual, preserved material. The rest are interpreted from the literature, but it is hoped that additional, authentic specimens may be available as the work on this genus continues.

KEY TO THE SPECIES OF RHODYMENIA

- A. Plants sessile, or with unbranched stipes, or with only stoloniferous branching from the base subgenus *Eurhodymenia*
- I. Tetraspores never in sori, dispersed over surface of frond in unmodified cortical layer Sec. 1. PERTUSAE
- Frond simple or branched from near base of stipe, without marginal proliferations; blade undivided or with few, irregular, broad lobes
- Frond up to 60 cm. high, perforated, 150-200 μ thick;
type:—Kamchatka *R. pertusa*
- Frond up to 25 cm. high, unperforated, 250-300 μ thick;
type:—Washington *R. stipitata*
- Frond dichotomously divided into more or less cuneate segments
- Apex of the segments rather broad, blunt, notched; margins entire
- Fronds gelatinous, adhering to paper; type:—Peru *R. peruviana*
- Fronds not gelatinous; type:—Japan . *R. cuneifolia*
- Apex of segments attenuated; margins entire or foliiferous; type:—New Zealand *R. sanguinea*
(*R. lanceolata*)
- Of doubtful affinity; apex of segments often multifid; fronds coriaceous; margins entire, denticulate, or proliferating; type:—Red Sea *R. erythraea*
- II. Tetraspores in irregularly shaped sori, often slightly raised and in cross section showing modification of the cortical layers to produce a nemathecoid structure . . Sec. 2. PALMATAE
- Fronds dichotomous, not showing a palmatifid branching form
- Tetraspores in vermicular sori; margins entire or proliferous; type:—Borneo *R. indica*
- Tetraspores arranged in broadly anastomosing, hiero-

- glyphic sori; margins entire; type:—East Indies . . .
 *R. Setchellii*
 Fronds expanded palmately or flabellately, not strictly dichotomous, sometimes various in *R. palmata* and *R. palmatiformis*
- Frond-margins more or less undulate-cripsed or folded
 Frond-margins bearing spinules; type:—Japan . . .
 *R. spinulosa*
 Frond-margins entire
 Fronds broadly membranaceous, erect; type:—
 Japan *R. punctata*
 Fronds linear, irregularly lobed, crenulated, decumbent; type:—Japan *R. coacta*
- Fronds plane throughout
 Blade in cross section showing a distinct line between cortex and medulla; type:—Patagonia
 *R. palmatiformis*
 Blade in cross section showing a more gradual change in cell size from cortex to medulla; type:—Atlantic coast of Europe *R. palmata*
- III. Tetraspores in rounded sori usually confined to frond-apices or proliferations; cortical layer not distinctly modified by tetraspores Sec. 3. PALMETTAE
- Atlantic and Mediterranean species
 Fronds dichotomo-flabellate
 Fronds with prominent stipe; type:—England . . .
 *R. palmetta*
 Fronds largely sessile; type:—Mediterranean . . .
 *R. corallicola*
 Fronds dichotomous but not flabellate, the segments linear, not spreading; type:—Mediterranean *R. ligulata*
- Eastern Pacific species
 Plants large, 10-25 cm. high; segments 3-6 mm. broad; type:—Peru *R. Howeana*
 Plants smaller, 4-12 cm. high; segments 2-3 mm. broad; type:—California *R. californica*
- Western Pacific species
 Segments very narrow; type:—Japan . . . *R. liniformis*
 Segments not strikingly narrow

- Blades mostly as broad at apex or broader than below; type:—Australia *R. foliifera*
 Blades attenuated toward apex; type:—New Zealand *R. novazelandica*

IV. Tetraspores in rounded sori as in Sec. *Palmettae*; cortical layers modified in tetrasporic areas to give a more or less nemathecioid structure; some modification is present, though it may be obscure Sec. 4. CLINOPHORA

Stipes prominent, long

- Tetraspores in sori below apices of fronds; type:—"in mari australi" *R. linearis*
 Tetraspores largely covering lobulate proliferations of the upper frond-segments; type:—California
 *R. lobulifera*

Stipes neither long nor absent

- Habit erect; segments narrow, little branched, not spreading; type:—Australia *R. stenoglossa*

Habit spreading; branches variously dichotomous

- Branches adhering to each other at places of contact by rootlike disks or by fusion; type:—Japan
 *R. intricata*

Branches not adhering or fusing

- Foliations, when present, submarginal, often almost superficial; type:—So. Africa *R. capensis*

Foliations, when present, marginal

Segments with blunt apices

- Frond-apices proliferating again and again; type:—Tasmania *R. prolificans*

Frond-apices nonproliferous

- Segments 2-3 cm. broad; base of blade broad, cuneate; type:—Falkland Isl.
 *R. Schmittii*

- Segments usually less than 1 cm. broad; base of blade narrow; type:—
 East Indies *R. australis*

- Segments narrowed at apices and acute except in cases of lobing of tetrasporic blades; type:—California *R. attenuata*

SPECIES STERILES

<i>R. divaricata</i>Gulf of California	<i>R. pacifica</i>California
<i>R. rosea</i>Gulf of California	<i>R. palmettiformis</i>California
<i>R. occidentalis</i>West Indies	

SPECIES INQUIRENDAE

<i>R. dichotoma</i>New Zealand	<i>R. anastomosans</i>E. Indies
<i>R. adnata</i>Japan	<i>R. rhizoidifera</i>E. Indies
<i>R. javanica</i>Java	<i>R. epimenioides</i>N. Zealand
<i>R. cinnabarina</i>Indian Ocean	<i>R. mamillaris</i>Martinique
<i>R. cuneifolia</i> (Hook. f. & Harv.) Taylor	
(<i>Phyllophora cuneifolia</i> Hook. f. & Harv.).....Falkland Islands	

B. Stipes truly sympodially branched in addition to basal stoloniferous branching; tetraspores as far as known confined to sori below frond-apices Subgenus *Dendrymenia*

V. Sec. 5. DENDRYMENIAE

Plants low, 3-5 cm. high

Blades mainly dichotomous, usually ending in a bilobed apex; type:—New Zealand *R. leptophylla*

Blades showing a tendency toward palmate, often ending in a 4-6 lobed flabellum; type:—Hawaii *R. leptophylloides*

Plants longer than 5 cm.

Blades conspicuously flabellate, broadly cuneate from the stipe, or lower segments spreading almost at right angles

Flabella each with an individual stalk, branching from the main stipe

Basal parts possessing numerous, branched stolons; stipes proliferous below; blades not over 150 μ thick; type:—California *R. rhizoides*

Basal parts imperfectly known; blades 150-400 μ thick; type:—Gulf of California *R. Hancockii*

Blades sessile

Blades developing at point of union with the stipe so as to form an amplexicaul structure at each branch; type:—Chile *R. Skottsbergii*

Blades merely sessile or somewhat decurrent, not amplexicaul; type:—Chile *R. flabellifolia*

Fronds not conspicuously flabellate, mainly dichotomous, narrowly cuneate from the stipes

Stipes from a discoid holdfast without stolons; type:—

California *R. arborescens*

Stipes with branched stolons augmenting the simple holdfast

Segments blunt at apices; ultimate segments long

Fronds and stipes lobulate-proliferous; tetrasporic apices usually expanded into short, broad lobes; type:—California *R. lobata*

Fronds and stipes nonproliferous; tetraspores unknown; types:—Chile *R. corallina*

Segments with palmate, polydigitate apices, the ultimate segments very short, acute; type:—New Zealand *R. palmipedata*

Subgenus EURHODYMENIA nom. nov.

Section 1. *Pertusae* nom. nov.

Tetrasporic material of only one species was available as a basis for organizing this section, but as far as the descriptions can be interpreted, 7 species can pretty definitely be assigned to it. The even distribution of tetraspores over the frond is reasonably distinctive, since members of Sec. *Palmatae* which have large tetrasporic areas bear them in broken, irregular arrangement. In any case, if *Rhodymenia pertusa* can be taken as at all representative of this type of tetraspore production, a definite difference can be realized in the cross-sectional appearance of tetrasporic fronds between sections *Pertusae* and *Palmatae*. This difference is best shown by the illustrations (figs. 1-4) but may be expressed briefly as: showing an essentially unmodified cortex in Sec. *Pertusae*; showing a nemathecially modified cortex in Sec. *Palmatae*.

- (1) RHODYMENIA PERTUSA (Post. et Rupr.) J. Ag., Sp. II (1851), p. 376; Epicr., p. 329; *Porphyra pertusa* Post. et Rupr., Illust. Alg. (1840), p. 20, tab. XXXVI.

Plate 18, Figs. 1-2

Distribution.—The type specimen from Kamchatka; in the Arctic Ocean; Greenland; Spitzbergen; North Japan; Bering Sea; Coast of North America south to Puget Sound, Washington.

- (2) RHODYMENIA STIPITATA Kylin, Mar. Red Algae of Friday Harbor (1925), p. 41, fig. 23.

"This species is nearly related to *Rhodymenia pertusa*, but it differs in having a thicker, non-perforated blade. The cystocarps are somewhat larger, but not so densely scattered in *R. stipitata* as in *R. pertusa*."—Kylin.

Distribution.—The type specimen from San Juan Island, Washington, on piles of Friday Harbor docks; British Columbia.

- (3) RHODYMENIA PERUVIANA J. Ag., Sp. II (1851), p. 378, Epic., p. 329; Howe, Mar. Alg. Peru (1914), p. 126, fig. 40.

Distribution.—The type specimen "ex oris Peruviae meridionalis." According to Howe, not since collected and probably not occurring within the present limits of Peru.

- (4) RHODYMENIA CUNEIFOLIA Okam., Notes on Algae from Pac. Coast of Tiba Pref. (1934), p. 17, pl. VII (1).

"The nearest ally of the present plant is *R. peruviana* Howe from which it differs in its more widely cuneate segments, by not having deeply lobed apical segments and in not being gelatinous." Okamura quoted the authority of *R. peruviana* as Howe instead of J. Agardh.

As Taylor recently suggested, *Phyllophora cuneifolia* may prove to be a *Rhodymenia*, in which case Okamura's species will have to yield to priority.

Distribution.—Provs. Kadusa, Bosyu (Bay of Tateyama) Tiba Pref., Japan.

- (5) RHODYMENIA SANGUINEA Harv., in Hook., Fl. N. Zeal., vol. II (1855), p. 248; De Toni et Forti, Alghe di Australia, Tasmania, e Nuova Zelanda (1923), p. 30, tab. IV (VII), figs. 1-3.

"This is a large species, to 14 inches high, fronds deeply divided. The tetraspores are scattered over the laciniae, not in irregular sori as in *R. palmata*."—Harvey.

Distribution.—The type specimen from Foveaux Strait, New Zealand.

- (6) RHODYMENIA LANCEOLATA Harv., in Hook., Flor. N. Zeal., vol. II (1855), p. 248.

"Possibly a form of the preceding but is softer in substance and has a more highly developed cortex. The tetraspores as in *R. sanguinea*."—

Harvey. Both this and the preceding species are said to have acute, attenuated apices which distinguish them from all others.

Distribution.—The type specimen from Port Cooper, Bank's Peninsula, New Zealand.

- (7) RHODYMENIA ERYTHRAEA Zanard., *Plant. Mar. Rubr. enum.* (1858), p. 276; Piccone, *Algol. Eritrea* (1884), p. 328; *Rhodymenia palmata* Mont., *Pugill. Alg. Yemens*, p. 8 (excl. synon.) non aliorum.

Of this species we have only a description. The best we can do is to interpret it according to the two suggestive statements it contains: "Appearance wholly like *R. palmata*. Tetraspores scattered over the whole surface." More material from the Red Sea may eventually establish this species as a definite entity.

Distribution.—The type specimen from the Red Sea at Hodeida; also on the coast of Yemen.

Section 2. **Palmatae** J. Ag. p. p. (*Epicr.*, 329 (1876); *Palmaria* Stackh., *Tent. mar. crypt.*, 69 (1809))

Of this section the tetrasporic material available of *R. palmata* and the descriptions and illustrations of fertile specimens of other species within the group establish fairly well certain morphological relationships among the 7 species at present included. Two features of tetrasporic plants are distinctive: the sorus, present as an irregular, cloudlike, disconnected, or convoluted body, definitely limited and distinct from the portions of the frond in which tetraspores are not being produced; the frond, somewhat thickened in the soral regions because of extra cell division and growth stimulated by the tetrasporic development in the cortical layers. At the maturity of spores, their enlargement and consequent displacement of the surrounding cells cause an irregularity in the otherwise smooth outline of the frond-surface. The cortical layer, which in sterile fronds may be only 2 or 3 cells thick, increases by periclinal divisions to from 4 to 7 in tetrasporic fronds. This increase in the cortex causes the cells to appear more or less in strings or anticlinal rows, but the displacement or pushing aside of these by the enlarging spores destroys much of the regularity. The appearance of the spore, however, imbedded in the thickened cortex, surrounded by these rows or strings of cells gives the impression of a nemathecium (plate 18, figs. 3-4), and in both section *Palmatae* and section *Clinophora* the term "nemathecial" will be used to describe this condition.

- (8) RHODYMENIA INDICA Web. v. Bosse, Liste des Algues du Siboga (1928), p. 460, fig. 196.

No specimens have been seen, but the tetrasporic sori described as "worm like" would seem sufficiently distinctive for identification. Mme. Weber found it near to certain forms of *R. palmata* and thought it to be a connecting type between the northern forms and the southern ones now known under the name *R. palmatiformis* Skottsb.

Distribution.—The type from the coast of Borneo at a depth of 40-50 m.

- (9) RHODYMENIA SPINULOSA Okam., Icones Jap. Algae (1934), vol. VII, no. IV, p. 33, pl. 318, figs. 1-6.

"The present plant shows a close affinity with *R. punctata* Okam. from which it differs in having marginal spinules."—Okamura.

Distribution.—The type from Tainan, Taiwan (Aoki), Japan.

- (10) RHODYMENIA PUNCTATA Okam., Icones Jap. Algae (1929), vol. VI, no. 2, p. 13, pl. 258.

Okamura gives ample description and illustration of this Japanese species. His figure of the tetraspores shows the characteristics of this section very well.

Distribution.—The type from Prov. Tosa, Japan.

- (11) RHODYMENIA COACTA Okam. et Segawa, in Segawa, Mar. Alg. Susaki (1935), p. 84, pl. 20.

This plant is easily distinguished from its allies by the decumbent, matted habit of the crisped fronds.

Distribution.—The type from Shikineshima, Prov. Idsu, Japan.

- (12) RHODYMENIA PALMATIFORMIS Skottsb., in Kylin & Skottsb., Subant. und Antarkt. Meeresalgen (1919), p. 21, figs. 11, 12; *R. palmata* (L.) Grev. quoad plantam australem; *R. palmata* et *palmetta*, Reinsch, Meeresalg. Sudgeorg. (1890), p. 379; *R. georgica* Reinsch, l.c.?

This species was established to embrace all the southern forms of a somewhat heterogeneous assemblage which had previously been identified with the northern species *R. palmata*. Skottsb. says: "These are similar to certain forms of the variable *R. palmata*; I have, however, found no southern forms which can be identified with a northern form."

Skottsb. figures a cross section of the frond to illustrate his idea of the sharp line of demarcation between the medulla and the cortex. In our

sections made from one of Skottsberg's specimens this distinction is not so prominent as he indicates. However, were material available other than the single specimen which is very difficult to expand after drying, this point might be verified.

Distribution.—Subantarctic; coast of Chile; Patagonia; Falkland Islands; South Georgia.

- (13) RHODYMENIA PALMATA (L.) Grev., Alg. Brit. (1830), p. 93; Harv., Phyc. Brit. tab. 217; J. Ag., Sp. II (1851), p. 376, Epic., p. 329.

Plate 18, Figs. 3-4

This species shows the greatest morphological variation to be found within the genus. Compared to other more sharply defined species of less widespread distribution, it must be considered a heteromorphic "macrospecies" of broad ecologic tolerance. The tetrasporic arrangement seems, however, to place it conclusively within the section J. G. Agardh named for it, and within that the species is distinct except for similarities to *R. palmatifomis* of the Southern Hemisphere, whose forms have only recently been distinguished from *R. palmata*.

Distribution.—Cooler waters of the coasts of the North Pacific and North Atlantic.

- (14) RHODYMENIA SETCHELLII Web. v. Bosse, Liste des Algues du Siboga (1928), p. 462, pl. XI, figs. 6-8.

It is now to be questioned whether this species is really a *Rhodymenia*, for Mme. Weber states that she sees great resemblance between this species and *Faucheia Gardneri*, which has been more recently placed as *Fryella Gardneri* (Setch.) Kylin. Certain morphological characters mark the genus *Fryella* as distinct; but, since we cannot be certain as to whether Mme. Weber may have overlooked these or not, we can only leave the species for further inquiry. Cystocarps were lacking in her specimens, and these will, no doubt, prove decisive when found. Mme. Weber states also that in structure *Faucheia Mortensenii* W. v. B. resembles very closely both *Rhodymenia setchellii* and *Faucheia Gardneri*.

Distribution.—The type from Taruna, East Indies.

Section 3. *Palmettae* J. Ag. (Epicr., 330 (1876))

J. G. Agardh defined this section as containing those species in which the tetraspores are located in distinct sori in the frond-apices, and in which the cortical layer is scarcely modified by the presence of sori. This

analysis has been verified by cross sections of tetrasporic sori in European material of *R. palmetta* (figs. 5-6) which showed the soriferous frond only slightly thicker than the sterile, and the cortical layer of small, oval cells entirely unmodified except through displacements by the enlarging tetraspores. There is apparently no stimulation to extra cell division in the cortex and hence no strings or rows of cells in which the tetraspores are imbedded as in Sec. *Palmatae* (figs. 3-4). Tetraspores may also be borne on lateral lobules proliferating from the upper segments.

- (15) RHODYMENIA PALMETTA (Esp.) Grev., Alg. Brit. (1830), p. 88, pl. XII; *Fucus palmetta* Esper, Icon. Fuc. (1800), p. 84, pl. XL.

Plate 18, Figs. 5-6

This assemblage is another one which has caused considerable confusion in the treatment of the Pacific Coast species of *Rhodymenia*. Numerous specimens with only superficial resemblance have been referred to this species. In the type locality it is rather polymorphic, a fact which has allowed a broad basis for the interpretation of forms. Fertile material is rare; not only in this species but throughout the section cystocarps are largely unknown. We must depend then upon gross morphology for specific taxonomic characters; and, since this section contains so many forms of similar habit, separation is difficult.

When more complete collections are available and the extent of variation in *Rhodymenia* in response to the environment is more fully understood, rearrangements will undoubtedly be necessary. The section *Palmatae* is the most difficult section of the genus to interpret because it seems to be a center of variation in which the variants are distinguished with difficulty and about which the morphological differentiation into other sections of the genus radiates. It is a fortunate coincidence that this median species was illustrated by Greville as the type of the genus.

Distribution.—Coasts of England and France; the Mediterranean.

- (16) RHODYMENIA CORALLICOLA Ardiss., Florid. Ital., II (1868-1878), p. 55, pl. IX (ex synonym.).

Distribution.—The Mediterranean.

- (17) RHODYMENIA LIGULATA Zanard., Saggio (1843), p. 46; J. Ag., Sp. II (1851), p. 382; *Sphaerococcus ligulatus* Kuetz., Tab. Phyc. XVIII, t. 96.

Distribution.—The Mediterranean.

(18) RHODYMENIA HOWEANA sp. nov.

R. corallina Howe, Mar. Alg. Peru (1914), p. 124, pls. 50-51;
? *Sphaerococcus palmettoides* Bory, Voy. Coquille, Bot. Crypt.
(1829), p. 173.

Plate 19, Fig. 9

Frons usque ad 15 cm. alta, e disco simplici, stolonibus paucis; stipitibus brevissimis 0.4-0.5 cm., gracilibus superne in laminis copiose dichotomis expansis, membranaceo-gelatinosis; segmentis laminarum 1-1.5 cm. longis, 3-5 mm. latis, plus minusve 100 μ crassis, laesis proliferationes angustas apicibus rotundis frequenter emarginatis emittentibus; marginibus integris; tetrasporangiis in sori orbicularibus in partes apicales segmentorum sitis et transformationes negligentes stratorum corticalium efficientibus, cruciatis, elongato-ovoideis; cystocarpiis super superficies medias partes laminarum sparsis, hemisphericis, non-rostratis.

Fronde membranous-gelatinous, to 15 cm. high from a simple hold-fast with few accessory stolons; subterete portion of stipe very short, 0.4-0.5 cm., slender, expanding into an abundantly dichotomous frond; segments 1-1½ cm. long, 3-5 mm. broad, about 100 μ thick, when injured producing narrow proliferations, with rounded apices often conspicuously notched; margins entire; tetraspores in rounded sori in apices of ultimate segments, causing little modification of the cortical layers, cruciate, long-oval; cystocarps scattered over mid-portions of the fronds, hemispherical, not beaked.

Sterile and Tetrasporic Types.—In beach drift, La Punta, near Callao, Peru, R. E. Coker # 29 & 30, Jan. 25, 1907.

Cystocarpic Type.—In the surf, Lobos de Tierra, Peru, R. E. Coker # 149a, April 2, 1907. In Herb. Univ. Calif.: ster. 198881, tetr. 199622, cyst. 199608. All specimens received from Marshall A. Howe.

Now that the true identity of *Rhodymenia corallina* is established and that species is arranged under Sec. *Dendrymeniae*, it is not at all difficult to distinguish *R. Howeana* in which, according to Howe, the subterete stipe is only 0.4-0.5 cm. long. The habit of this species is very distinct from *R. corallina* in the manner of segmentation of the frond as well as in the nature of the stipe.

(19) RHODYMENIA CALIFORNICA Kylin, Die Florideenord. Rhodymen. (1931), p. 21, fig. 22.

This is apparently one of the commoner and more variable species along the Californian coast. Kylin describes it very briefly from material collected at Monterey. In the Herbarium of the University of California there are, however, specimens from several localities which indicate something of the variations of the species and allow a fuller account.

Rhodymenia californica is easily distinguished from *R. palmettiformis* by the very short or almost absent stipe. It shows little tendency toward a palmate type of division, and the dichotomous segments are conspicuously of a uniform width, 2.5-4 mm. Plants do not average so small as Kylin's types, but more commonly are 6-8 cm. high. The thickness of the blades averages between 125 and 150 μ .

Distribution.—Specimens have been seen from San Diego, Laguna Beach, Anaheim Landing, San Pedro, Carmel Bay, and Monterey, California.

- (20) RHODYMENIA LINIFORMIS Okam., Icon. of Jap. Algae, vol. VII (1934), no. IV, p. 34, pl. 318, figs. 7-14.

"Plant belonging under the section *Palmettae* De Toni in the vicinity of *R. palmetta* or *R. ligulata*."—Okamura.

Distribution.—The type from Enoshima, Japan.

- (21) RHODYMENIA FOLIIFERA Harv., Phyc. Austr. (1863) V: Syn. p. xl, n. 508; J. Ag., Epic., p. 331; Kylin, Die Florideenord. Rhodymen. (1931), p. 21, Taf. 7, fig. 17.

The type was not figured with the description of the species, but Kylin gives a photograph of "one of Harvey's original specimens." There is a remarkable resemblance between this illustration and some specimens of *R. californica*. Harvey says, "Near *R. palmetta* but remarkably different when in fruit."

Distribution.—Australia; Tasmania; New Zealand.

- (22) RHODYMENIA NOVAZELANDICA sp. nov.

Plate 23, Fig. 30

Frons e disco simplici, 6-10 cm. alta, stipitata, ramos proxime usque ad 1.5 cm. super discum emittentibus, iis mox decumbentibus aut laminas producentibus; laminis anguste cuneatis, dichotomis, segmentis angustis, 1.5-2.5 mm. latis, apicibus attenuatis obtusis rotundatis, 100-160 μ crassis, cellulis corticalibus superficie elongatis; sori tetrasporangiiferis parvis, apicalibus in segmentis ultimis transformationes negligentes corticales efficientibus. Cystocarpiis nondum visis.

Fronds from a simple, discoid holdfast 6-10 cm. high, stipitate, producing stoloniferous branches from immediately above the holdfast to 1½ cm. above, these turning down or developing blades; blades dichotomous, narrowly cuneate, the segments narrow, 1.5-2.5 mm. broad, with attenuated, rounded apices, 100-160 μ thick with elongated cortical cells; tetrasporic sori small, in apices of ultimate segments, causing only minor modification of cortex. Cystocarps unknown.

Type.—Littleton, New Zealand, R.M. Laing # 1113; Herb. Univ. Calif. 96238.

Section 4. *Clinophora* J. Ag. (Epicr., 331 (1876))

This section is maintained as founded by J. G. Agardh to embrace those species having rounded tetrasporic sori located below the apices of the frond-segments and having nemathecially modified cortical layers (figs. 7-8). The sori may also occur in lobulate proliferations as in *R. lobulifera*, but their position and appearance are essentially the same.

The nemathecial condition may be less conspicuous than in Sec. *Palmatae* or even somewhat obscure, but wherever there is more than a simple displacement of the cortical cells by the developing spores, the species has been assigned to this group. Where specimens are not available, the arrangement and interpretation are according to J. G. Agardh.

- (23) RHODYMENIA LINEARIS J. Ag., Symb. I (1841), p. 13; Sp. II, p. 379; Epicr., p. 331; *Sphaerococcus linearis* Kuetz., Tab. Phyc. XVIII, tab. 91, figs. c-d (ex oras chilensibus ?); Kylin, Die Florideenord. Rhodymen., p. 20, tab. 6.

Distribution.—Coast of "New Holland"; Tasmania; New Zealand.

- (24) RHODYMENIA LOBULIFERA sp. nov.

Plate 26, Fig. 36

Frons usque ad 20 cm. alta, e disco simplici, stolonifera; stipitibus conspicuis, 2-7 cm. longis, compressis, in laminis dichotomis, aliquando, primo palmatis, flabellato divisis; segmentis 1.5-3.5 cm. longis, 3-5 mm. latis, vulgo leviter ad apicem attenuatis; tetrasporangiis cruciatis, in lobulis parvis, lateralibus, pedicellatis productis, nemathecioidibus (cellulis corticalibus in parte sterili sphericis, in tetrasporangiifera elongatis in ordinibus anticlinis); cystocarpiis in proliferationibus segmentorum terminalium gracilibus, ramosis sitis.

Fronds to 20 cm. high from a simple holdfast, with stolons; stipes conspicuous, 2-7 cm. long, compressed, expanding cuneately into dichotomous, sometimes at first palmate, flabellately divided blades; segments $1\frac{1}{2}$ - $3\frac{1}{2}$ cm. long, 3-5 mm. broad, usually slightly attenuated to apex; tetraspores produced in small, lateral, pedicellate lobules, causing nemathecial modification of the cortex, the cortical cells spherical in sterile material, anticlinally elongated in tetrasporic; cystocarps produced on slender, branched proliferations of the terminal segments.

Sterile Type.—San Pedro Harbor, Calif., cast ashore, May 27, 1911, N. L. Gardner 2442; Herb. Univ. Calif. 274155.

Tetrasporic and Cystocarpic Types.—San Pedro, Calif., Dec. 20, 1907, N. L. Gardner 1847; Herb. Univ. Calif. 372021.

This species may be distinguished by its very prominent, long, gradually tapering stipes and the development of both types of reproductive bodies on lobules proliferating from the ultimate segments.

Other specimens from Carmel Bay and Bolinas, California, are referred here.

- (25) RHODYMENIA STENOGLOSSA J. Ag., Till. Alg. System. VII (1884), p. 50; Kylin, Die Florideenord. Rhodymen. (1931), p. 21, tab. 7.

Distribution.—Australia and the southern coasts of the East Indies.

- (26) RHODYMENIA INTRICATA (Okam.) Okam., Icon. of Jap. Algae, vol. VI, no. 4 (1930), p. 23, pl. 267; *Phyllophora intricata* Okam., Icon. of Jap. Algae, vol. IV, no. 7, p. 129, pl. 182.

According to Okamura's illustrations, this species is best referred to Sec. *Clinophora*. His figure of the tetrasporic cross section clearly indicates long, anticlinal rows of cells surrounding the tetraspores.

Distribution.—Prov. of Iyo, Kii, Idzu, Sagami, Iwaki, and Echigo, Japan.

- (27) RHODYMENIA CAPENSIS J. Ag., Anal. Algol. II (1894), p. 58; Kylin, Die Florideenord. Rhodymen., p. 21, tab. 8.

De Toni lists this species under Agardh's Sec. *Palmettae*, whereas the description clearly indicates the arrangement of the tetraspores in a nemathelial, cortical layer. On the basis of the description of this feature it is best to refer *R. capensis* to Sec. *Clinophora*.

Distribution.—Cape of Good Hope, South Africa.

- (28) RHODYMENIA PROLIFICANS Zanard., Phyc. Austral. nov. (1874), p. 499, n. 21.

This species has not been seen but for the present may be retained in Agardh's Sec. *Clinophora*, to which it was referred by De Toni.

Distribution.—The type from "Georgetown," Tasmania.

- (29) RHODYMENIA AUSTRALIS (Sond.) Harv., Phyc. Austral. (1860), tab. 146; J. Ag., Epicr., p. 332; *Rhodymenia australis* Sond., in Botan. Zeitung. (1845), p. 56; *Acropeltis australis* J. Ag., Sp. II, p. 609; Kuetz., Tab. Phyc., vol. XIX, t. 34, figs. c-e.

Plate 18, Figs. 7-8

Distribution.—Southern East Indies; Australia; New Zealand.

- (30) RHODYMENIA SCHMITTII Taylor, Mar. Alg. from Southeast. South America (1939), p. 148, pl. II, fig. 2.

Distribution.—The type from Port Stanley, Falkland Islands.

- (31) RHODYMENIA ATTENUATA sp. nov.

Plate 19, Figs. 10-11; Plate 25, Fig. 35

Frons brevi-stipitata, super basem stolonifera superne (1 cm. super discum) expansa; segmentis divaricatis, laminam linearem exteriorem rotundatam praebentibus, angustis, 1.5-2.5 mm. latis, ultimis frequenter longioribus, in plantis sterilibus ad apices acutos attenuatis, in plantis tetrasporangiiferis iterum ad apices latiores expansis; soris tetrasporangiiferis rotundatis, parvis in partibus apicalibus aut in proliferationibus eorum parvis, in nematheciiis; plantis cystocarpiiferis conspicuore stipitatis stoloniferentibusque usque ad 1-1.5 cm. super basem, stipites secundarias laminarum expansarum praebentibus; cystocarpiis in segmentis terminalibus aut in proliferationibus angustis eorum, laxe sparsis, vulgo urceolatis.

Fronds short-stipitate, with stolons branching from above base, expanding usually about 1 cm. above holdfast; segments spreading, giving the plant a rounded outline, narrow, 1.5-2.5 mm. broad, the ultimate ones often longer, attenuated to acute apices in sterile plants, in tetrasporic plants again expanded to broader apices; tetraspores in small rounded sori in the expanded apices of the ultimate segments or on small proliferations from these, causing a nemathecoid modification of the cortex; cystocarpic plants more conspicuously stipitate, with stoloniferous branches 1-1½ cm. above the base, providing secondary stipes for the expanded blades; cystocarps borne on the terminal segments or on narrow proliferations from these, rather sparse, mostly urn shaped.

Tetrasporic Type.—On rocks in sheltered places in the lower littoral zone, Whites Point, west of San Pedro, Calif., Dec. 23, 1912, N. L. Gardner 2534; Herb. Univ. Calif. 276284.

Cystocarpic Type.—Cast ashore, Pebble Beach, Carmel Bay, Calif., Jan., 1917, N. L. Gardner 3611; Herb. Univ. Calif. 372081.

Sterile Type.—San Pedro, Calif., Oct. 21, 1896, A. J. McClatchie 1264; Herb. Univ. Calif. 96226.

The following species of the subgenus EURHODYMENIA are uncertain of placement because of sterile material or inadequate descriptions of the types.

(32) RHODYMENIA PALMETTIFORMIS sp. nov.

Plate 22, Fig. 29

Frons 4-10 cm. alta, e disco simplici pauca, valde stipitata, stipitibus aliquando paulum super discum ramiferis aliquando stoloniferis; laminis variabilibus, e stipite supero complanata gradatim expansis, dichotomis, interdum in segmentis ultimis angustis, sed vulgo in apicibus late-lobatis 1.5-3 cm. latis expansis, frequenter paululum palmatis, 100-150 μ crassis. Tetrasporangiis cystocarpiisque nondum visis.

Fronde 4-10 cm. high, several from a simple, discoid holdfast, prominently stipitate; stipe sometimes branching just above holdfast, sometimes stoloniferous; blades variable, expanding gradually from the flattened upper stipe into dichotomies, sometimes ending in narrow ultimate segments but commonly tending to expand into a broad-lobed apex, 1.5-3 cm. across, often somewhat palmate, 100-150 μ thick. Tetraspores and cystocarps unknown.

Type.—Washed ashore, La Jolla, San Diego Co., Calif., Mrs. E. Snyder No. 692 in Collins, Holden, and Setchell, *Phycotheca Boreali-Americana* (1900) Fasc. XIV, sub. *R. corallina* (Bory) Grev. (from set in Herb. W. A. Setchell).

Cast ashore, Carmel Bay, Monterey Co., Calif., W. A. Setchell 1572, Dec. 31, 1896.

There is some overlapping of *R. palmettiformis* and *R. californica* with respect to the external morphology of the stipe; this may be somewhat shorter in the former and longer in the latter, causing confusion in the distinction. The frequently expanded terminal segments seem, however, to be a feature of *R. palmettiformis* alone.

Like *Rhodymenia palmetta*, *R. palmettiformis* is a conspicuously stipitate species in which the stipe may even superficially resemble that of some members of Sec. *Dendrymeniae*. However, upon comparison of many forms of *Dendrymenia* with those of the other subgenus, *Eurhodymenia*, it is seen that the branching may occur in the latter a short distance up from the holdfast, on account of the development of potential blade-producing stolons at that point. In Mrs. Snyder's specimen mentioned above there is a distinct branching of the stipe just above the holdfast, indicating that branching is stoloniferous rather than truly sympodial. In one collection from San Pedro, California specimens which

are tentatively placed under *R. palmettiformis* do show occasional branching of the stipe in its upper parts, a feature which would seem to place them in *Dendrymenia*. The aspect of the plants, however, is not dendrymenoid in the sense herein interpreted.

(33) RHODYMENIA DIVARICATA sp. nov.

Plate 23, Fig. 31

Frons 4-5 cm. alta, estipitata, e basi in dichotomiis irregularibus expansis, segmentis late divaricatis, angulis latis; segmentis vulgo 2-3 mm. latis, brevibus, ultimis brevissimis, lobiformibus, apicibus rotundatis, plus minusve 250 μ crassis, superficie corticis cellulis parietibus tenuibus leviter angulatis composita; tetrasporangiis cystocarpiisque nondum visis.

Fronde 4-5 cm. high, essentially stipeless, expanding from the base into irregular dichotomies, the divisions spreading, with wide axillary angles; segments mostly 2-3 mm. broad, short, the ultimate segments very short, lobelike, with rounded apices, about 250 μ thick, with a cortex of thin-walled, slightly angular cells as seen in surface view. Tetraspores and cystocarps unknown.

Morphologically this species is nearest to *R. californica*, from which it is distinguished by its strongly divaricate nature, by the less regular dichotomies, and by the irregularly lobed appearance of the ultimate segments.

Type.—Dredged in 2-3 fms., mud bottom, Guaymas Bay, Sonora, Mex., January 22, 1940, E. Y. Dawson 53 of Allan Hancock Expedition to the Gulf of California—1940; Herb. Allan Hancock Foundation, AHF no. 1.

Other specimens from sand and coralline bottom in 6-11 fms. off Mejia Isl., Puerto Refugio, Angel de la Guardia Island, Gulf of Calif., E. Y. Dawson 257, Jan. 28, 1940.

(34) RHODYMENIA ROSEA sp. nov.

Plate 24, Figs. 32-33

Frons erecta usque ad 7 cm. alta, sessilis, e disco simplici oriens, e basi directe expansa, laete rosea; ramificatione primaria irregulariter dichotoma, marginibus laminarum sparse denticulatis et in segmentis prolificantibus, iisdem basim angustis et frequenter dichotomis; segmentis 2-3 mm. latis, apicibus rotundatis, plus minusve 100 μ crassis, corticibus acute delimitatis; cellulis corticalibus superficie parietibus tenuibus et acute angulatis. Tetrasporangiis cystocarpiisque nondum visis.

Fronde bright rose, erect to 7 cm. high, nonstipitate, from a simple holdfast, expanding directly from the base; primary branching irregularly

dichotomous, the margins of the blades sparsely denticulate and proliferating into segments which are narrowed at the base and frequently dichotomous; segments 2-3 mm. broad, with rounded apices, about 100 μ thick, with a sharply delimited cortex; cortical cells in surface view thin walled and sharply angular. Tetraspores and cystocarps unknown.

Type.—Dredged off Mejia Isl. in 6-11 fms., Puerto Refugio, Angel de la Guardia Island, Gulf of Calif., Mexico, Jan. 22, 1940, E. Y. Dawson 266 of Allan Hancock Expedition to the Gulf of California, 1940; Herb. Allan Hancock Foundation, AHF no. 2.

This species is distinguished from all East-Pacific species of *Rhodymenia* by the following combination of characters: angular-celled cortex; denticulate, proliferating margins; lack of stipe; and brilliant color. The morphological habit resembles that of the West Indian species *R. occidentalis*.

- (35) RHODYMENIA OCCIDENTALIS Boerg., Mar. Alg. Dan. West Indies, II (1920), p. 387, figs. 371-372.

Distribution.—West Indies.

- (36) RHODYMENIA PACIFICA Kylin, Die Florideenord. Rhodymen. (1931), p. 21, tab. 9.

Plate 20, Fig. 14

Kylin describes this species very briefly, but the photograph of the type shows sufficiently well the typical characters of the species as it occurs in California. Fertile material has not yet been found.

Distribution.—Coast of California.

Species *Inquirendae*

- RHODYMENIA DICHOTOMA Harv., in Hook., Fl. Antarct. vol. I (1845), p. 186, tab. LXXII, fig. 1; Laing, Mar. Alg. Subantarct. N. Zeal. (1909), p. 510, pl. XXIV, fig. 3; Laing, Trans. of N.Z. Inst., vol. 57 (1926), p. 157.

In 1909 Laing expressed the opinion that he had specimens which seemed to agree with Harvey's type in the British Museum. In 1926, however, he says, concerning this species, "A doubtful species."

Distribution.—New Zealand.

- RHODYMENIA ADNATA Okam., Icon. Jap. Alg., vol. VII: 4 (1934), p. 35, pl. 318.

Distribution.—Gulf of Tateyama, Japan.

RHODYMENIA JAVANICA Sond., in Zollinger, Syst. Verzeichniss I (1854-55), p. 4.

Distribution.—Java, East Indies.

RHODYMENIA CINNABARINA (Dies.) J. Ag., Symb. Cont. I (1841), p. 447; Sp. II, p. 382; *Halymenia cinnabarina* Dies. ms.

Distribution.—Indian Ocean, Herb. Diesing.

RHODYMENIA ANASTOMOSANS Web. v. Bosse, Alg. de l'Exp. dan. aux îles Kei (1926), p. 150, fig. 39.

Distribution.—Kei Islands, East Indies.

RHODYMENIA RHIZOIDIFERA Web. v. Bosse, *ibid.*, p. 151, figs. 40-43.

Distribution.—Kei Islands, East Indies.

RHODYMENIA EPIMENIOIDES Harv., in Hooker, Bot. of Ant. Voyage II: 2 (1855), p. 248.

Distribution.—"Otago Harbor," New Zealand.

RHODYMENIA MAMILLARIS Mont., Pl. Cell. exot., cent. III (1838-45), n. 58; J. Ag., Sp. II, p. 381.

Distribution.—On the coast of the Island of Martinique.

Subgenus **DENDRYMENIA** (Skotts.) comb. nov.

Section 5. **Dendrymeniae** nom. nov.

In consequence of the results of the investigations into *Rhodymenia flabellifolia* (Bory) Mont. and *Dendrymenia flabellifolia* (Bory) Skotts., which are discussed and illustrated under *R. flabellifolia* and *R. Skottsbergii*, it has seemed best to regard *Dendrymenia* of Skottsberg as a subgenus of *Rhodymenia*. This subgenus and section embrace those species which show typically a multiple-branched stipe-system in addition to the stoloniferous branching of the bases and lower stipes. Otherwise the morphology corresponds roughly to either Sec. *Palmettae* or Sec. *Clinophora*.

(37) RHODYMENIA LEPTOPHYLLA J. Ag., De. Alg. Nov. Zeal. marinis (1877), p. 20, n. 167; *Rhodymenia linearis* Harv., in Hooker, Bot. of Ant. Voyage II: 2 (1855), p. 248 partim; Kylin, Die Florideenord. Rhodymen. (1931), p. 20, tab. 6, fig. 15.

Distribution.—New Zealand.

(38) RHODYMENIA LEPTOPHYLLOIDES sp. nov.

Plate 20, Fig. 18; Plate 27, Fig. 39

Frons gregaria, 3-5 cm. alta e disco simplici, stipitibus sympodiale ramosis, 1-2.5 cm. longis et laminis parvis composita; laminis e stipite cuneatis, semel atque iterumque furcatis nonnumquam leviter flabellatis, segmentis 2-3 mm. latis, apicibus rotundatis; stipitibus aliquando ramos deflexos in stolonibus transformantes producentibus et ex iis invicem ramis laminiferentibus fortasse orientis; segmentis 120-160 μ crassis, medullis cellulis magnis tenuiparietalibus, 2-3 stratosis, corticibus cellulis parvioribus et inter medullis et corticibus stratis cellularum magnitudinis intermediarum; superficie cellulis ovatis, approxime in seriebus longitudinalibus; tetrasporangiis cystocarpiisque nondum visis.

Plants gregarious, 3-5 cm. high, from a simple, discoid holdfast; frond composed of a sympodially branched stipe, 1-2.5 cm. long, and a small blade; blades cuneate from the stipe, once or twice forked, sometimes slightly flabellate, the segments 2-3 mm. broad with rounded apices; stipes sometimes producing deflexed branches which form semiprostrate, stoloniferous structures from which blade-bearing branches may arise; segments 120-160 μ thick, composed of a medulla of 2-3 layers of large, thin-walled cells and a cortical region of much smaller cells between which there is a gradation in cell size; surface cells ovate, somewhat longitudinally arranged. Tetraspores and cystocarps unknown.

Type.—Black Point, off Diamond Head, Oahu, Hawaiian Islands, March 24, 1910, Miss Minnie Reed 1152; Herb. Univ. Calif. 622237.

This species is very closely related to *R. leptophylla*, with which it forms a very distinct group within the subgenus *Dendrymenia*. Future investigations may reveal a less broken distribution of these forms, and they may possibly prove identical. At present, however, since this species shows a tendency toward a flabellate form of the blades while those of *R. leptophylla* are no more than once forked, and since they are found in such widely separated geographical areas, a specific distinction is probably justified.

(39) RHODYMENIA SKOTTSBERGII sp. nov.

Dendrymenia flabellifolia Skotts. p.p., in Bot. Ergeb. schwed. Exped. nach Patagon. IX. Rhodophyceae (1923), p. 16, fig. 3 d-f, non *Sphaerococcus flabellifolius* Bory.

Plate 21, Figs. 21-23; Plate 27, Fig. 40

Frons e disco simplici, 7 cm. alta, supra basem implicata et ramoso stolonifera; laminis irregulariter dichotomo-flabellatis, nodos quosque stipitum ramosorum terminantibus internodio quoque stipitum e lamina succedente oriente, per augmen-

tum basium laminarum amplexicaulibus; segmentis patentibus, flabella lata formantibus, apicibus rotundatis, 4-5 mm. latis; tetrasporangiis cystocarpiisque nondum visis.

Frond 7 cm. high from a simple discoid holdfast above which branched stolons grow down to form a loose tangle around the base of the stipe; blades irregularly dichotomo-flabellate, terminating each joint of the sympodially branched stipe which arises by branching successively from the surface of the base of each previously developed blade, forming by continued growth an amplexicaul structure in the region of each branch (figs. 21-23); segments spreading almost at right angles to the stipe, forming a broad flabellum; apices rounded, 4-5 mm. broad. Tetraspores and cystocarps unknown.

Type.—Chile, Prov. Concepcion, west shore of Concepcion Bay; 10 km. north of Talcahuana; rocks at upper low tide level, Jan. 4, 1936, James West 5078d of Univ. of Calif. Bot. Gard. Exped. to the Andes, 1935-1936; Herb. Univ. Calif. 543963. This specimen is apparently identical with Skottsberg's less mature specimens from Valparaiso (St. 41, 2.9.08).

It was the best of good fortune that the specimen collected by James West in Chile was available in the Herbarium of the University of California. Without this specimen the confusion which has long surrounded *Rhodymenia flabellifolia* would undoubtedly have continued. Skottsberg in 1923, working on the Patagonian Rhodophyceae, attempted to clarify the situation, but the material he used for comparison was very young, and his specimens were referred to *R. flabellifolia* (Bory) Mont. His synonymy is correct in that Howe's specimen, named *R. flabellifolia* (Mar. Alg. Peru (1914)), is of the same species as Bory's type, since it corresponds in all essentials with Bory's figure. Careful comparison of West's specimen with Skottsberg's figures shows that it is identical with the material of Skottsberg's own collection which he illustrated as *Dendrymenia flabellifolia*, but is quite a different plant from the species as re-established by Howe. Close relationship in several morphological characters is to be found between *R. Skottsbergii* and *R. flabellifolia* (Plate 21), but the former differs very strikingly in the amplexicauline development of the bases of the blades around each successive branch of the stipe. In *R. flabellifolia* there is frequently a decurrent growth of stipe and blade at their points of junction but never the amplexicaul character. The specimen at hand has a more coriaceous texture to the frond as well. Reproductive bodies are unfortunately absent, but the external mor-

phology of this species is so outstanding that it need not be confused with any other members of the *Rhodymenia* assemblage.

As shown in Plate 21, the sympodial method of growth is essentially the same in *R. Skottsbergii*, *R. flabellifolia*, and *R. corallina*, indicating close relationships among these South American species. This character is not so easily identified in other members of Sec. *Dendrymeniae*, but may prove to be similarly present as more and better material is available. Rather than to segregate all of these typically rhodymenioid species into another genus (*Dendrymenia*), it has seemed best to keep them within *Rhodymenia* but to give them separate section status.

(40) RHODYMENIA RHIZOIDES sp. nov.

Plate 20, Fig. 16; Plate 26, Fig. 37

Frons 12-15 cm. alta, pauca e disco primario per stolones laxe implicatas basi stipitis prolificantes obscurando; stolonibus copiose ramosis, superne compressis, aliquando proliferentibus; lamines late flabellatis, e basi late cuneatis, segmentis 4-5 mm. latis, apicibus rotundatis (iis in spec. typ. plus minusve laceratis prolificantibusque) plus minusve 140 μ crassis, cellulis medullaribus 2-3 stratis, magnis ad cellulares parvas corticales gradatim parvioribus; tetrasporangiis cystocarpis nondum visis.

Fronde 12-15 cm. high, several from a primary discoid holdfast obscured by the loose tangle of branched stolons proliferating from the lower parts of the stipes, these creeping and frequently giving rise to erect branches which develop blades; stipes abundantly branched, compressed above, sometimes somewhat proliferous; blades broadly flabellate, broadly cuneate from the stipe; segments 4-6 mm. wide, with rounded apices (these somewhat lacerated and slightly proliferous in the type) about 140 μ thick, composed of 2-3 layers of large medullary cells showing gradation in size from the small cells of the cortical region; tetraspores and cystocarps unknown.

Type.—San Diego, Calif., June 1924, N. L. Gardner; Herb. Univ. Calif. 377902.

(41) RHODYMENIA HANCOCKII sp. nov.

Plate 20, Fig. 20; Plate 26, Fig. 38

Frons partibus basalibus intimis ignota, ramosa, teres, stipitibus abrupte in laminas stricte regulariter dichotomas, flabellate expansis, segmentis inferis fere angulis rectis patentibus; segmentis 4.5-7 mm. latis, apicibus rotundatis, 150-400 μ crassis, interne pluristratis, cellulis gradatim e centro ad superficiem parvioribus. Tetrasporangiis cystocarpis nondum visis.

Lowest basal parts unknown; fronds composed of branched, terete stipes expanding abruptly into quite regularly dichotomous, flabellate blades, these with the lower segments almost at right angles to the ultimate stipes; segments 4.5-7 mm. broad, with rounded apices, 150-400 μ thick, composed of many layers of cells showing gradation in size from the small cells of the cortical region to the large ones of the medulla. Tetraspores and cystocarps unknown.

Type.—Dredged in 21 fms., west side of bay, shell bottom, Puerto Refugio, Angel de la Guardia Island, Gulf of Calif., Jan. 27, 1940, E. Y. Dawson 252 of Allan Hancock Expedition to the Gulf of California, 1940; Herb. Allan Hancock Foundation, AHF no. 3.

This species from the Gulf is distinguished from *R. rhizoides*, with which it shows similarities, by the stouter, more extensively terete stipe, thicker blades, and more regular dichotomies of the segments. No stolons are known from the material, since the lower parts of the stipes are absent, possibly because of the raking action of the dredge.

- (42) RHODYMENIA FLABELLIFOLIA (Bory) Mont., Voy. Bonite (1844-46), p. 105; *Sphaerococcus flabellifolius* Bory, Voy. Coquille, Atlas (1826), pl. 17; Howe, Mar. Alg. Peru (1914), p. 124, pl. 49; *Dendrymenia flabellifolia* Skotts. p.p., Bot. Ergeb. schwed. Exped. nach Patagon., IX Rhodophyceae (1923), p. 16 (ex. illustr.).

Plate 21, Figs. 24-27

There has been less confusion surrounding this species than has attended Bory's other species, *R. corallina*, but presumably only because fewer specimens of sundry collections and localities could be found to resemble his figure. Indeed this species is very unique in the genus and should be confused with no other members. *R. flabellifolia* has been definitely re-established upon specimens obtained by Coker at Lobos de Tierra, Peru (Howe, lit. cit.). As discussed under *R. Skottsbergii*, with which it was associated by Skottsberg, *R. flabellifolia* can readily be recognized by the conspicuous, usually stout, much-branched stipe which bears sessile, flabellate blades without any amplexicaul structure.

Distribution.—West coast of South America; Galapagos Archipelago.

- (43) RHODYMENIA LOBATA sp. nov.

Plate 19, Figs. 12-13; Plate 28, Fig. 41

Frons e disco simplici fere non-stolonifera, 20-25 cm. alta, stipiti gracili compressa, 10-15 cm. usque ad laminam primam; segmentis vulgo 3 mm. latis, ultimis 1-2.5 cm. longis, angulis inter segmenta 30° et 40° divergentibus, apicibus

rotundatis, aliquando in regione segmentorum inferiorum et stipitum superiorum prolificantibus, plus minusve 100 μ crassis; cellulis medullaribus 2-3 stratosis, cellulis corticalibus parvis, plus minusve 2 stratosis; tetrasporangiis in lobis curtis ultimis abrupte expansis 2-plo latioribus quam segmentis et soros rotundatos formantibus, lobis fertilibus plus minusve 200 μ crassis, stratis corticalibus per divisiones accessorias irregularesque in nematheciis transformatis; tetrasporangiis cruciatis; cystocarpiis nondum visis.

Fronds from a simple disk attachment with almost no stolon development, 20-25 cm. high, from a slender, compressed, branched stipe which reaches 10-15 cm. before expanding to the blades; segments mostly 3 mm. broad, the ultimate ones 1-2 $\frac{3}{4}$ cm. long with angles of between 30 and 45 degrees, with rounded apices, somewhat proliferous in region of lower segments and upper stipes, about 100 μ thick, of 2-3 layers of medullary cells covered by about 2 layers of small cortical cells; tetraspores in rounded sori at apices of the ultimate segments, each sharply expanded into a short lobe at least twice as broad as the segment, this lobe about 200 μ thick and showing considerably modified cortices in which accessory and irregular cell divisions convert them into nemathecioid layers containing the cruciate tetraspores; cystocarps unknown.

Type.—Cast ashore, Pebble Beach, Carmel Bay, Calif., Jan., 1917, N. L. Gardner 3612; Herb. Univ. Calif. 372025.

Extensively branched stipes, thin fronds, and narrow angles of the dichotomies distinguish this species from other *Rhodymenia* species of the North Pacific coasts. Its nearest relative may be *R. arborescens*, from which it is distinguished by its thinner blades, longer, more slender stipe, and less abundant segmentation of the upper fronds.

- (44) RHODYMENIA CORALLINA (Bory) Grev., Alg. Brit. (1830), p. xlvi; *Sphaerococcus corallinus* Bory, Voy. Coquille, Atlas (1826), tab. 16.

Plate 21, Fig. 28; Plate 29, Fig. 42

Bory's original figure shows a large, erect-appearing plant with a branched, terete stipe, the blades from this stipe being themselves individually short stipitate. Moreover, he indicates an extended, abundantly dichotomous blade with long segments divided by narrow angles. Agreement with these points is found in specimens of three collections from the region of South America in which this species was first found. The only point of confusion remaining is in Bory's portrayal of the holdfast. He does not indicate the presence of branched stolons around the holdfast, but we may assume that his specimen either did not have a really complete

base or was immature in the development of the base, the stolons not yet having appeared. Our specimens, in particular those of Stork and Horton from Peru, show abundant stolons at the base. Since, however, such a close resemblance exists between specimens of modern collections and Bory's figure, we may best consider these South American plants as representative of his species and redefine *Rhodymenia corallina* as a South American member of the subgenus *Dendrymenia*, characterizing it as described above.

Distribution.—Coasts of Peru and Chile; Southern Argentina ? (a mutilated specimen).

(45) RHODYMENIA PALMIPEDATA sp. nov.

Plate 20, Fig. 17; Plate 24, Fig. 34

Frons 6 cm. alta, pauca e disco simplici, per stolonium explicationem confusa; stipitibus sympodialiter ramosis, inferne teretibus, superne compressis et in laminas angustas expansis; segmentis laminarum inferne 1-1.5 mm. latis, iis ultimis palmatis, brevissimis, acutis, palmipedes simulantibus; laminis plus minusve 200-250 μ crassis; medullis 5-6 stratosis, cellulis magnis compositis et corticibus 2-stratosis, cellulis parvis et transformationibus inter se forma magnitudinique abruptis; tetrasporangiis cystocarpiisque nondum visis.

Fronds several, to 6 cm. high, from simple holdfasts which are somewhat confused by the development of stoloniferous proliferations, of slender, sympodially branched stipes, terete below, becoming compressed above and expanding into narrow blades; segments 1-1½ mm. broad below, terminating in a palmate arrangement of very short, acute ultimate segments resembling the digits of a webbed foot; blades about 200-250 μ thick, of 5-6 layers of large medullary cells covered by 2 layers of small cortical cells and with a fairly abrupt change in cell size. Tetraspores and cystocarps unknown.

Type.—Akaroa, New Zealand, R. M. Laing 1098, Sept., 1902; Herb. Univ. Calif. 96189.

The branched stipe together with the peculiar sharp-pointed ultimate segments distinguish this species from all other South Pacific Rhodymenias.

(46) RHODYMENIA ARBORESCENS sp. nov.

Plate 20, Fig. 19; Plate 30, Fig. 43

Frons usque ad 12 cm. alta, e disco pauca, stolonibus deutibus; stipitibus, primo semiteretibus, mox compressis, crassis, rigidis, in segmentis laminarum angustis transientibus, iis 2-3 mm. latis; laminis multuplo dichotomis, cuneatis, segmentis, superne gradatim angustioribus, medio plus minusve 450-500 μ crassis;

medullis plus minusve 6 stratosis, corticibus quibusque plus minusve 8 stratoso, subcorticibus cellulis gradatim magnitudine e cellulis medullibus usque ad cellulas corticales; tetrasporangiis cystocarpiisque nondum visis.

Fronds up to 12 cm. high, several from a discoid holdfast, without stolons; stipes branched, semiterete at first, soon compressed, thick, rigid, expanding gradually into the narrow segments of the blade, these 2-3 mm. broad; blades multidichotomous, cuneate in outline, the segments becoming shorter and narrower above, about 450-500 μ thick in the mid-portions, of about 6 layers of medullary cells bordered by about 8 layers of cortical and subcortical cells through which there is a gradual transition in cell size from the smallest to the largest; tetraspores and cystocarps unknown.

Type.—Growing on a barnacle, cast up on shore, Laguna Beach, Orange Co., Calif., N. L. Gardner 2562, Feb. 2, 1913; Herb. Univ. Calif. 274046.

LITERATURE CITED

AGARDH, J. G.

1841. In *historia Algarum Symbolae*—Linnaea XV—Hallae.
1851-1863. *Species, genera et ordines Algarum*, II: 1-3. Lundae.
1876. *Species, genera et ordines Algarum*, III (Epicrisis system. Florid.). Lipsiae.
1877. *De Algis Novae Zelandiae marinis*. Lundae.
1884. *Till Algernes Systematick VII*—Lunds Univ. Arsskrift. tom XXI—Lundae.
1896. *Analecta Algologica—Continuata II.*—Lunds Univ. Arsskrift. N.F. II, Bd 7. Lundae.

ARDISSONE, F.

- 1868-1878. *Le Floridie italiane descritte ed illustrate*, I-II. col. Milano e Firenze.

BOERGESEN, F.

1920. *Marine Algae of the Danish West Indies*, Vol. 2—*Dansk Botanisk Arkiv Udgivet af Dansk Botanisk Forening*, Bd 3, Nr 1f—Copenhagen.

BORY DE S. VINCENT, J. B.

1826. *Voyage de la Coquille, Histoire naturelle Botanique, Atlas*. Paris.
1827-1829. *Voyage de la Coquille, Botanique, Cryptogamie*. Paris.

DE TONI, G. B., et FORTI, A.

1922. *Alghi di Australia, Tasmania, e Nuova Zelanda—Memorie R. Inst. Veneto*, XXIX: 3. Venezia.

ESPER, E. J. C.

- 1797-1800. *Icones fucorum*, col. Norimb.

GREVILLE, R. K.

1830. *Algae Britannicae*, Edinburgh.

HARVEY, W. H.

1845. In *Hooker, Flora Antarctica I*, London.
1849-1851. *Phycologia britannica*, 3 vol. London.
1855. In *Hooker, Botany of the Antarctic Voyage II: part II*. London.
1858-1863. *Phycologia australica*, 5 vol. London.

HOWE, M. A.

1914. *Marine Algae of Peru—Memoirs of the Torrey Botanical Club*, XV. New York.

KUETZING, F. T.

1849. *Species Algarum*, Leipzig.
1849-1869. *Tabulae Phycologicae, Cent. I-XIX*. Nordhausen.

KYLIN, H.

1925. Marine red Algae of Friday Harbor—Lunds Univ. Arsskrift. N. F. II, Bd 21. Lund.
1931. Die Florideenordnung Rhodymeniales—Lunds Univ. Arsskrift. N. F. II, Bd 27, Nr 11. Lund.

KYLIN, H., and SKOTTSBERG, C.

1919. Subantarktischen und Antarktischen Meeresalgen, II Rhodophyceen—Wissenschaftliche Ergebnisse der Schwedischen Südpolar-Expedition, 1901-1903, Bd IV: lief. 15. Stockholm.

LAING, R. M.

1909. Marine Algae of the Subant. Islands of New Zeal.—Subantarctic Islands of New Zealand, Article XXII. Wellington.
1926. A List of New Zealand Marine Algae—Trans. of the New Zeal. Inst. 57.

MONTAGNE, J. F. C.

- 1838-1845. Des Plantes Cellulaires exotiques nouvelles, Cent. I-V—Extrait des Ann. des Sci. nat. II: 8. Paris.
1839. Cryptogamae brasiliensis seu plantae cellulares—Extrait des Ann. des Sci. nat. II: 12.
1844-1846. Voyage Autour du Monde exécuté pendant les années 1836 et 1837 sur la corvette la Bonité, Crypt. cell.—Paris.
1850. Pugillus Algarum Yemensium quas collegerunt annis 1847-49 clarr. Arnaud et Voysiere—Ann. Sci. Nat., XIII (Bot.), p. 236-248.

OKAMURA, K.

- 1928-1934. Icones of Japanese Algae, Vol. VI-VII. Tokyo.
1934. Notes on Algae dredged from the Pacific Coast of Tiba Pref.—Records of Oceanographic works in Japan, VI: 1.

PICCONE, A.

1884. Contribuzioni all'Algologia eritrea—Nuova Giorn. bot. ital. XVI.

POSTELS, A., and RUPRECHT, F. J.

1840. Illustrations Algarum Oceani Pacifici imprimis septentrionalis. Petropoli.

REINSCH, P. F.

1890. Zur Meeresalgenflora von Süd-Georgien—Extr. a. d. Deutsch. Polar Exped. II: 15.

SEGAWA, S.

1935. On the Marine Algae of Susaki, Prov. Idzu—Scientific Papers of the Inst. of Algol. Research, Fac. of Sci., Hokkaido Imp. Univ., I: 1.

SKOTTSBERG, C.

1923. Botanische Ergebnisse d. Schwedischen Expedition nach Patagonien und dem Feuerlande 1907-1909. IX. Rhodophyceae—Kungl. Sv. Vet. Akad. Handl., Bd 63. Stockholm.

SONDER, G. O.

1845. *Nova Algarum Genera et Species quas in itinere ad oras occidentalis Novae Hollandiae, collegit L. Preiss*—*Bot. Zeit.* 3: 49-57.
- 1854-1855. In Zollinger, *Systematisches Verzeichniss der im indischen Archipel in der Jahren 1842-48 gesammelten sowie der aus Japan empfangenen Pflanzen, Algen, Heft I.* Zurich.

STACKHOUSE, J.

1809. *Tentamen marino-cryptogamicum*—*Memoires de la Société Impériale des Naturalistes.* Moscou.

TAYLOR, W. R.

1938. *Alg. Coll.* by "Hassler," "Albatross," and Schmitt Exped., II. Mar. Alg. from Uruguay, Argentina, Falk. Isl., and Str. of Magellan—*Papers of Mich. Acad. Sci., Arts and Letters, Vol. XXIV: I.*

WEBER VAN BOSSE, A.

- 1913-1928. *Liste des Algues du Siboga*—*Siboga Expedition, LIX: a, b, c, d, Leiden.*
1926. *Algues de l'Expedition danoise aux îles Kei*—*Saertryk af Vidensk. Medd. fra Dansk naturh. Foren, Bd 81.*

ZANARDINI, G.

1843. *Saggio di classificazione naturale delle Ficee con nuovi Studi sopra l'Androsace degli antichi.* Venezia.
1858. *Plantarum in mari rubro hucusque collectarum enumeratio*—*Memorie R. Istituto Veneto, VII: parte II.* Venezia.
1874. *Phyceae Australasicae novae vel minus cognitae*—*Flora.*

EXPLANATION OF PLATES

PLATE 18

- Figs. 1-2. *Rhodymenia pertusa*, cross sections of a tetrasporic frond to show unmodified cortex. x 120
- Figs. 3-4. *R. palmata*, cross sections of a tetrasporic frond to show the nemathecial modification of the cortex. x 130
- Figs. 5-6. *R. palmetta*, cross sections of (5) a tetrasporic and (6) a sterile frond. x 140
- Figs. 7-8. *R. australis*, cross sections of (7) a sterile and (8) a tetrasporic frond. x 135



1

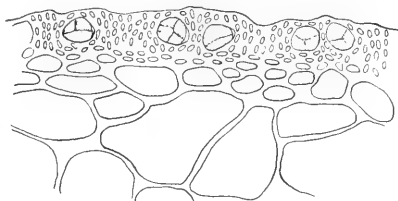

3

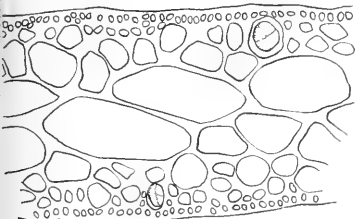

2

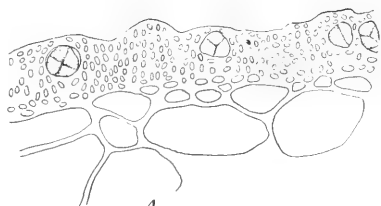

4

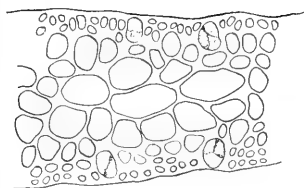

5

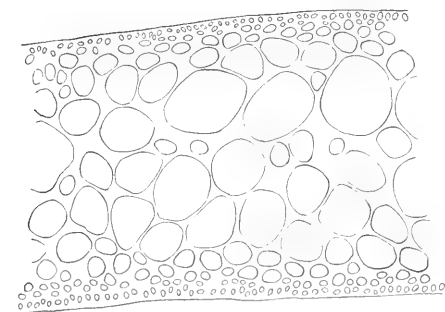

7

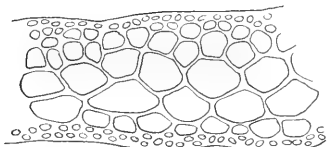

6

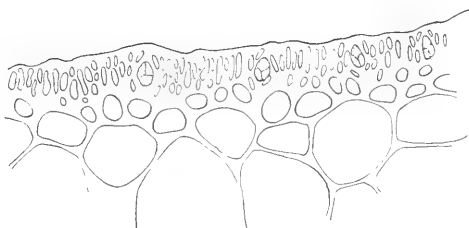

8

PLATE 19

- Fig. 9. *Rhodymenia Howzeana*, median section through a mature cystocarp. x 150
- Fig. 10. *R. attenuata*, portion of a frond bearing cystocarps. x 5
- Fig. 11. *R. attenuata*, median section through a mature cystocarp. x 60
- Figs. 12-13. *R. lobata*, cross sections of (12) a sterile and (13) a tetrasporic frond. x 150

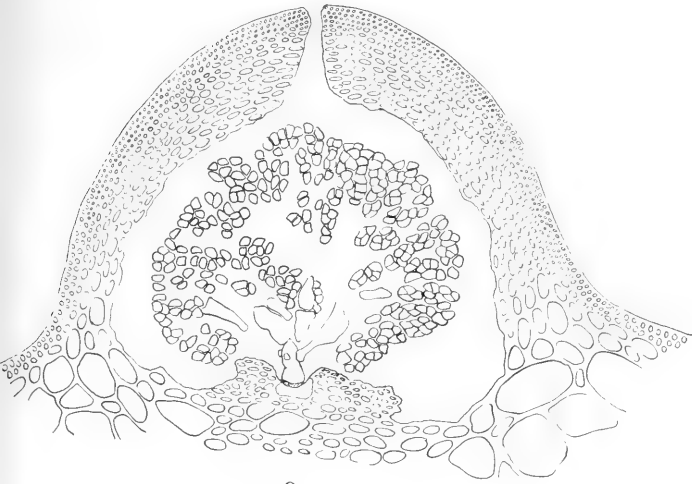

9



10

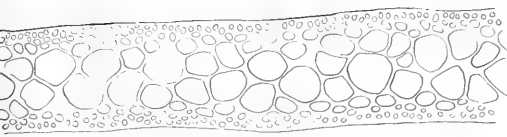

12

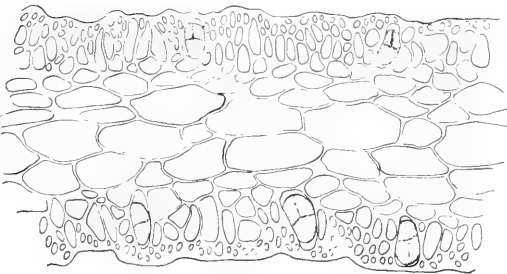

13



11

PLATE 20

Cross sections of sterile fronds

- Fig. 14. *Rhodymenia pacifica*. x 120
Fig. 15. *R. californica*. x 140
Fig. 16. *R. rhizoides*. x 160
Fig. 17. *R. palmipedata*. x 160
Fig. 18. *R. leptophylloides*. x 210
Fig. 19. *R. arborescens*. x 110
Fig. 20. *R. Hancockii*. x 125

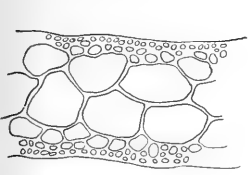

15

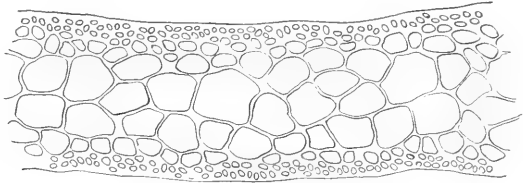

16

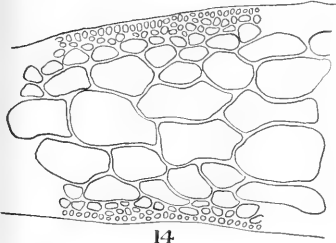

14

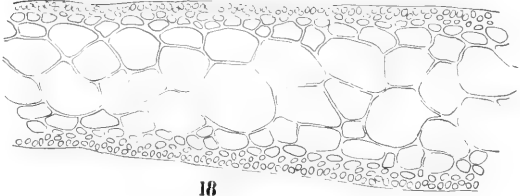

18

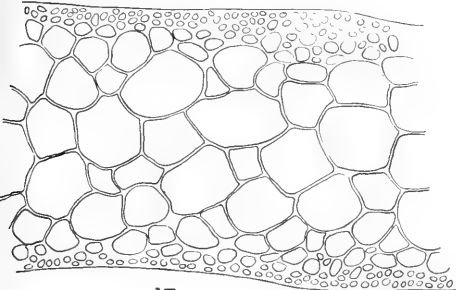

17

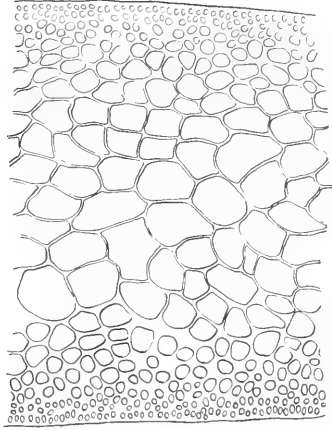

19

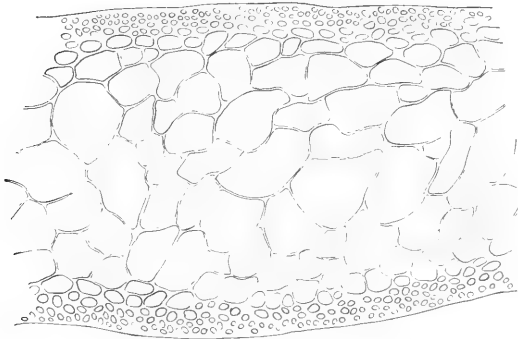

20

PLATE 21

- Fig. 21. *Rhodymenia Skottsbergii*, detail of the region of growth showing the sympodial method of branching. x $2\frac{1}{2}$
- Fig. 22. The same enlarged. x 8
- Fig. 23. *R. Skottsbergii*, detail of the amplexicaul structure of the branches as derived from the development shown in figs. 21-22. x 5
- Figs. 24-25. *R. flabellifolia*, apices of a specimen from the Galapagos Islands, showing sympodial growth analogous with figs. 21-22. x 10
- Figs. 26-27. *R. flabellifolia*, apices of a specimen from Chile. x 10
- Fig. 28. *R. corallina*, sympodial apex. x 8

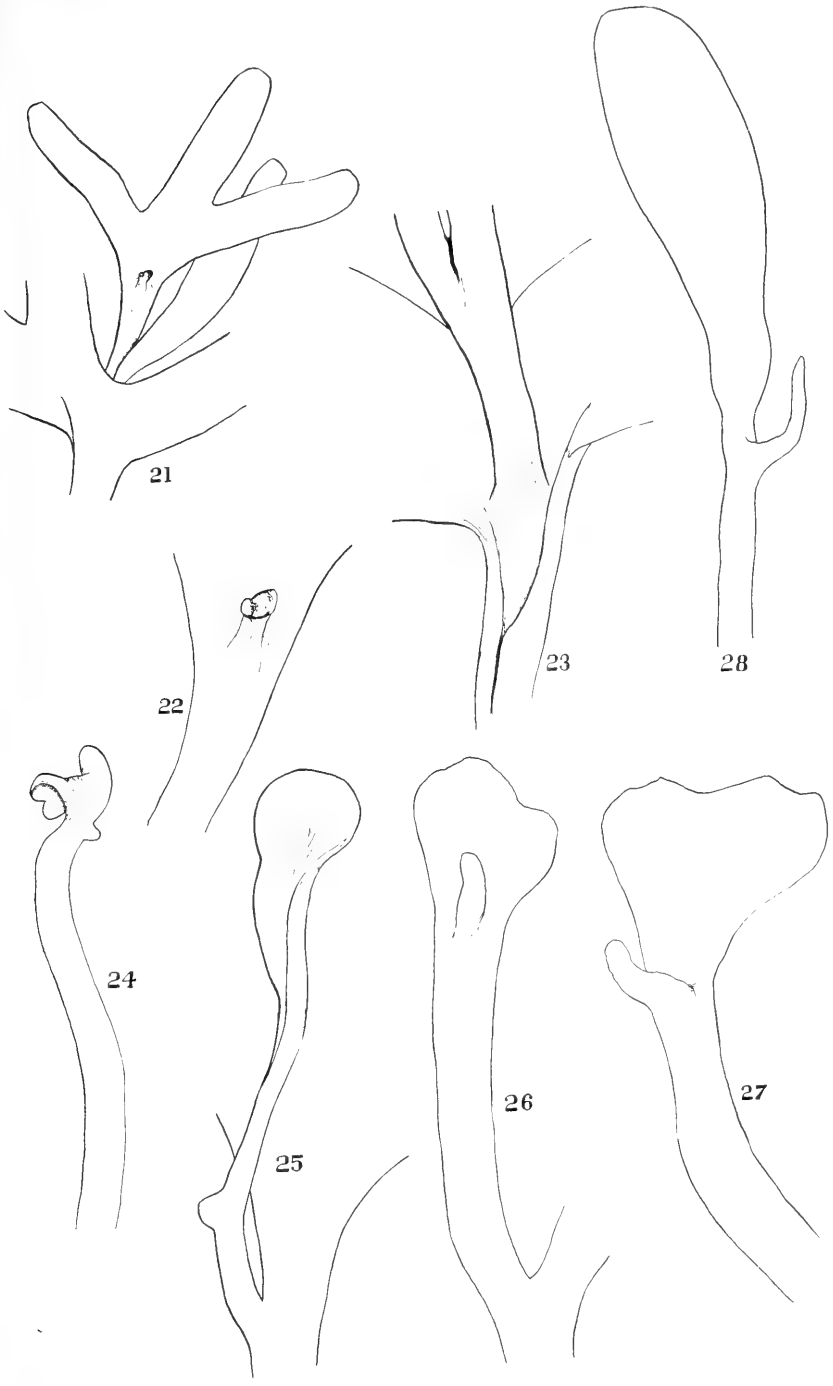

PLATE 22

Fig. 29. *R. palmettiformis*. A photograph of the type material.

Fig. 30. *R. novazelandica*. A photograph of part of the type material.



PLATE 23

Fig. 31. *R. divaricata*. A photograph of a specimen from the type collection.

Figs. 32-33. *R. rosea*. Photographs of 2 specimens from type collection.

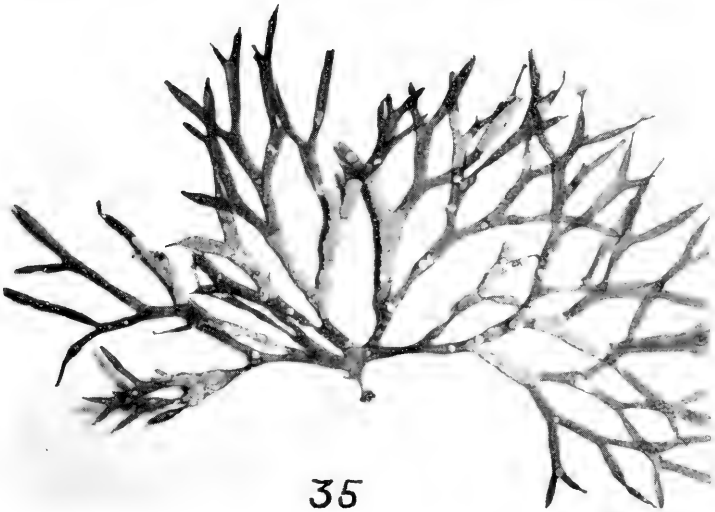

PLATE 24

- Fig. 34. *R. palmipedata*. A photograph of the type specimen.
- Fig. 35. *R. attenuata*. A photograph of a specimen from the type collection.



34 *A. Karua*



35

PLATE 25

Fig. 36. *R. lobulifera*. A photograph of the type specimen.



36

PLATE 26

Fig. 37. *R. rhizoides*. A photograph of the type specimen.

Fig. 38. *R. Hancockii*. A photograph of the type specimen.

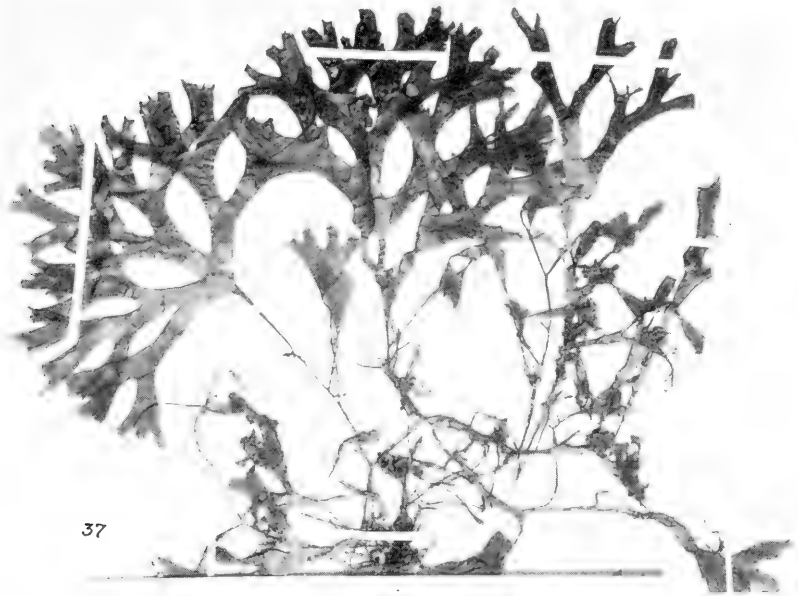

37

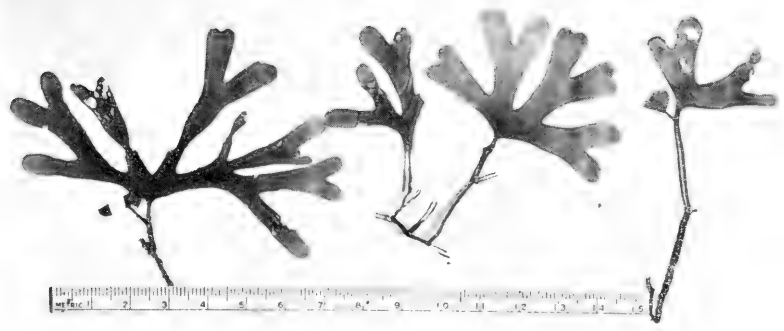

38

PLATE 27

Fig. 39. *R. leptophylloides*. A photograph of the type material.

Fig. 40. *R. Skottsbergii*. A photograph of the type specimen.

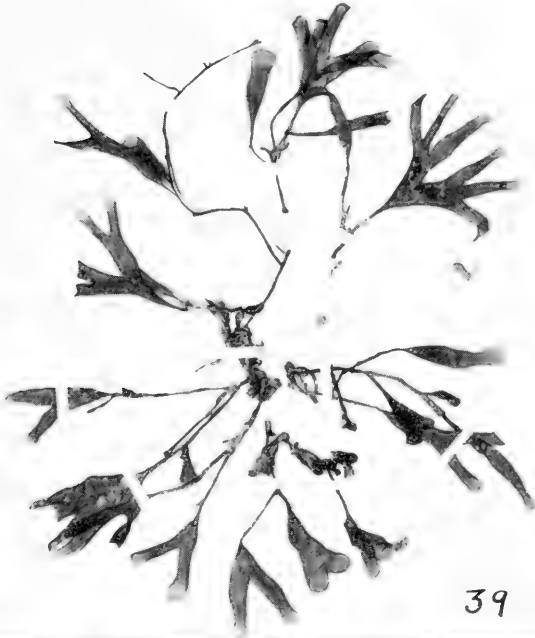

39

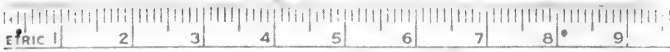

40

PLATE 28

Fig. 41. *R. lobata*. A photograph of the type specimen.



PLATE 29

Fig. 42. *R. corallina*. A photograph of a typical specimen from Peru.



42

PLATE 30

Fig. 43. *R. arborescens*. A photograph of the type specimen.



43

ALLAN HANCOCK PACIFIC EXPEDITIONS

VOLUME 3

NUMBER 9

SOME LICHENS FROM THE AMERICAN TROPICS COLLECTED BY WM. R. TAYLOR

BY

JOYCE HEDRICK



THE UNIVERSITY OF SOUTHERN CALIFORNIA PRESS
LOS ANGELES, CALIFORNIA

1942



REPORTS ON THE COLLECTIONS OBTAINED BY ALLAN HANCOCK PACIFIC EXPEDITIONS OF
VELERO III OFF THE COAST OF MEXICO, CENTRAL AMERICA, SOUTH AMERICA,
AND GALAPAGOS ISLANDS IN 1932, IN 1933, IN 1934, IN 1935,
IN 1936, IN 1937, IN 1938, IN 1939, IN 1940, AND IN 1941.

SOME LICHENS FROM THE AMERICAN
TROPICS COLLECTED BY WM. R. TAYLOR

By JOYCE HEDRICK

THE UNIVERSITY OF SOUTHERN CALIFORNIA PUBLICATIONS
ALLAN HANCOCK PACIFIC EXPEDITIONS
VOLUME 3, NUMBER 9
ISSUED DECEMBER 30, 1942

THE UNIVERSITY OF SOUTHERN CALIFORNIA PRESS
LOS ANGELES, CALIFORNIA

SOME LICHENS FROM THE AMERICAN TROPICS COLLECTED BY WM. R. TAYLOR*

JOYCE HEDRICK

The specimens upon which this report is based were collected by Wm. R. Taylor, botanist with the Allan Hancock Expedition of 1939. Lichens were obtained at stops made off the west coast of Mexico, on Clarion and Socorro islands; along the west coast of Costa Rica, at Port Parker near Salinas Bay and at Golfo Dulce; along the west coast of Panama, at Bahia Honda, and the south coast at Islas Secas near Puerto Neuvo; and at the western end of Tortuga Island in the Caribbean Sea north of Venezuela.

There has been little published on the lichens from these specific regions. *The Flora of Costa Rica* by Durand and Pittier in 1891-96 gives two lists of lichens prepared by J. Müller. The first enumerates 214 species and the second 281. Part I, *Foliose and Fruticose Lichens of Costa Rica*, by Dodge appeared in 1933 with discussions of 73 species and varieties. Lichens collected on the Galapagos Islands by Snodgrass and Heller were reported by Robinson in 1902. Stewart in 1912 published *Notes on the Lichens of Galapagos Islands*. Linder in 1932 presented the lichens of the Templeton Crocker Expedition of the California Academy of Sciences, 1932, mainly from Guadalupe Island, Lower California, and other islands off the west coast of Mexico. In 1936 Dodge reported on the lichens of the Allan Hancock Expedition of 1934. Svenson in 1935 listed the lichens of the Astor Expedition of 1930.

In the present account 23 species in 15 genera are listed. Two species, *Monoblastia lutescens* and *Minksia saxicola*, are described as new. Seven other species in the list are not found in the papers mentioned above.

PYRENULACEAE

Monoblastia lutescens n. sp. Thallus crustaceus uniformis effusus haud limitatus, continuus laevigatus aut parte inaequalis, laeviter lutescens. Perithecia circ. 0.3-0.6 mm. lata, dimidiata alte hemisphaerico-convexa, parte superficialia, ostiolo minute umbilicato concolore thallo. Paraphyses persistentes ramoso-convexae. Asci cylindricae, 6-8-spori.

* Papers from the Herbarium of the University of Michigan.

Sporae incolores simplices ellipsoideae aut oblongae, 44-60 x 21-28 μ , membrana crassiuscula laevigata.

Thallus crustose, uniform, widespread, continuous, smooth or becoming partly rough, light yellow; perithecia small, 0.3-0.6 mm. across, dimidiate, above hemispherical convex, partly superficial, the ostiole minute, terminal; colored like the thallus; paraphyses persistent, netlike interwoven; asci cylindrical; spores 6-8, hyaline, nonseptate, ellipsoid or oblong, 44-60 x 21-28 μ , with thick smooth wall.

On tree bark, Port Parker, Costa Rica, March 24, 1939, Wm. R. Taylor, 39-718. Type deposited in the herbaria of the Allan Hancock Foundation and of the University of Michigan. *M. lutescens* can be distinguished from *M. palmicola* Riddle, which has a white thallus, asci with 2-4 spores, and spores 30-50 x 16-20 μ .

Anthracothecium canellae-albae (Fée) Müll. Arg.—On bark of trees, Port Parker, Costa Rica, March 24, 1939, Taylor, 39-717.

TRYPETHELIACEAE

Trypethelium aeneum (Eschw.) Zahlbr.—On tree branches, Chochua Bay, coast of Mexico, March 21, 1939, Taylor, 39-715; on bark of trees, Islas Secas, Panama, March 27, 1939, Taylor, 39-728.

ARTHONIACEAE

Arthothelium spectabile Mass.—On bark of trees, Port Parker, Costa Rica, March 24, 1939, Taylor, 39-720.

Arthothelium macrothecum (Fée) Mass.—On bark of trees, Port Parker, Costa Rica, March 24, 1939, Taylor, 39-721.

GRAPHIDACEAE

Graphis scripta (L.) Ach.—On bark of trees, Port Parker, Costa Rica, March 24, 1939, Taylor, 39-719.

CHIODECTONACEAE

Minksia saxicola n. sp.—Thallus crustaceus, uniformis, pallido aut laeviter glaucescens, hypothallo indistincto. Apothecia thallo immersa, aggregata, vulgo rotundata aut elongata, disco nigro, 0.05-0.1 mm. lato. Paraphyses ramosae. Asci clavati, 96 x 32 μ , 4-8-sporei. Sporae incolores, oblongae, murales, 33-40 x 9-15 μ , 9-11 transverse septatae et 1-2 longitudinale septatae, cellulis cubicis.

Thallus thin to moderately thick, smooth to minutely chinky and becoming powdery, ashy to greenish gray, brighter green when moist, hypothallus indistinct; apothecia minute to small, 0.05-0.1 mm. across, round to elongated, several to many immersed in round to irregular thal-loid warts, the disk flat, black; hypothecium brown, the apothecial wall scanty and not well defined; paraphyses hyaline below to brownish above, branched; asci broadly clavate, $96 \times 32 \mu$, the wall somewhat thickened above; spores 4-8, hyaline, oblong, $33-40 \times 9-15 \mu$, muriform, 9-11-septate transversely and 1-2-septate longitudinally, the cells cubical.

On maritime rocks, Tortuga Island, April 13, 1939, Wm. R. Taylor, 39-731. Type deposited in the herbaria of the Allan Hancock Foundation and of the University of Michigan. The species previously described in this genus were growing on wood. *M. caesiella* Müll. Arg. and *M. candida* Müll. Arg. have a whitish thallus and spores $20-28 \times 6.5-7 \mu$. *M. irregularis* Müll. Arg. has a yellowish white thallus and spores, one in each ascus, $65 \times 23 \mu$. *M. saxicola* is found on rocks, has a greenish white thal-lus and spores $33-40 \times 9-15 \mu$, which separate it from the other species.

ROCCELLACEAE

Roccella Babingtonii Mont.—On twigs, Tortuga Island, April 13, 1939, Taylor, 39-733.

COENOGONIACEAE

Coenogonium linkii Ehrh.—On twigs in forest, Golfo Dulce, Costa Rica, March 26, 1939, Taylor, 39-726.

COLLEMACEAE

Leptogium denticulatum Nyl.—Specimen sterile; so identification doubtful—on twigs in forest, Golfo Dulce, Costa Rica, March 26, 1939, Taylor, 39-725.

LECANORACEAE

Lecanora varia (Ehrh.) Nyl.—On bark of trees, Port Parker, Costa Rica, March 24, 1939, Taylor, 39-722.

PARMELIACEAE

Parmelia latissima Fée.—On trees, Islas Secas, Panama, March 27, 1939, Taylor, 39-727.

Parmelia sulphurata Nees. & Flot.—On trees, Bahia Honda, Panama, March 28, 1939, Taylor, 39-729.

USNEACEAE

Ramalina complanata (Sw.) Ach.—On twigs of trees, Tortuga Island, April 13, 1939, Taylor, 39-730, 39-735.

Ramalina Usnea (L.) Howe.—On trees, Tortuga Island, April 13, 1939, Taylor, 39-732, 39-734, 39-736.

CALOPLACACEAE

Caloplaca elegans (Link) T. Fries.—On broken old coral near shore, Sulphur Bay, Clarion Island, March 16, 1939, Taylor, 39-713.

Caloplaca Malmeana Zahlbr.—On rocks near shore, Sulphur Bay, Clarion Island, March 16, 1939, Taylor, 39-710.

Caloplaca diphocia phaea (Tuck.) Zahlbr.—On rocks, Sulphur Bay, Clarion Island, March 16, 1939, Taylor, 39-712.

Caloplaca murorum (Hoffm.) T. Fries.—On lava rocks near shore, Soccoro Island, March 18, 1939, Taylor, 39-714.

BUELLIACEAE

Buellia parasema (Ach.) T. Fries.—On bark of trees, Port Parker, Costa Rica, March 24, 1939, Taylor, 39-716.

Buellia xanthinula (Müll. Arg.) Malme.—On shale along shore, high above the tide line, Port Parker, Costa Rica, March 25, 1939, Taylor, 39-724.

PHYSICIACEAE

Physcia alba (Fée) Müll. Arg.—On rocks, top of peak, Sulphur Bay, Clarion Island, March 16, 1939, Taylor, 39-711.

Physcia aegilata (Ach.) Nyl.—On bark of trees, Port Parker, Costa Rica, March 24, 1939, Taylor, 39-723.

LITERATURE CITED

DODGE, C. W.

1933. The Foliose and Fruticose Lichens of Costa Rica. I. *Annals Missouri Botanical Garden*, 20: 373-467.
1936. Lichens of the G. Allan Hancock Expedition of 1934, collected by Wm. R. Taylor. *Allan Hancock Pacific Exped.*, 3(3): 33-46.

DURAND, TH. et PITTIER, H.

- 1891-96. *Primitiae Florae Costaricensis* Bruxeles, Jardin Botanique de L'etat. Lichens by J. Müller, 1: 49-95, 3: 122-173.

LINDER, DAVID H.

1934. The Templeton Crocker Expedition of the California Academy of Sciences, 1932. *Proc. Calif. Acad. Science*, 21: 211-224.

ROBINSON, B. L.

1902. Flora of the Galapagos Islands, Lichens by W. G. Farlow. *Proc. Am. Acad. Science*, 38: 83-89.

STEWART, ALBAN

1912. Notes on the Lichens of the Galapagos Islands. *Proc. Calif. Acad. Science*, 1: 432-446.

SVENSON, H. K.

1935. Plants of the Astor Expedition, 1930. Lichens by C. W. Dodge. *Am. Jour. Bot.*, 22: 221.



87
ALLAN HANCOCK PACIFIC EXPEDITIONS

VOLUME 3

NUMBER 10

THE MARINE ALGAE OF THE
GULF OF CALIFORNIA

(FORTY-SEVEN PLATES)

BY

ELMER YALE DAWSON

DEPARTMENT OF BOTANY, UNIVERSITY OF CALIFORNIA



THE UNIVERSITY OF SOUTHERN CALIFORNIA PRESS
LOS ANGELES, CALIFORNIA

1944

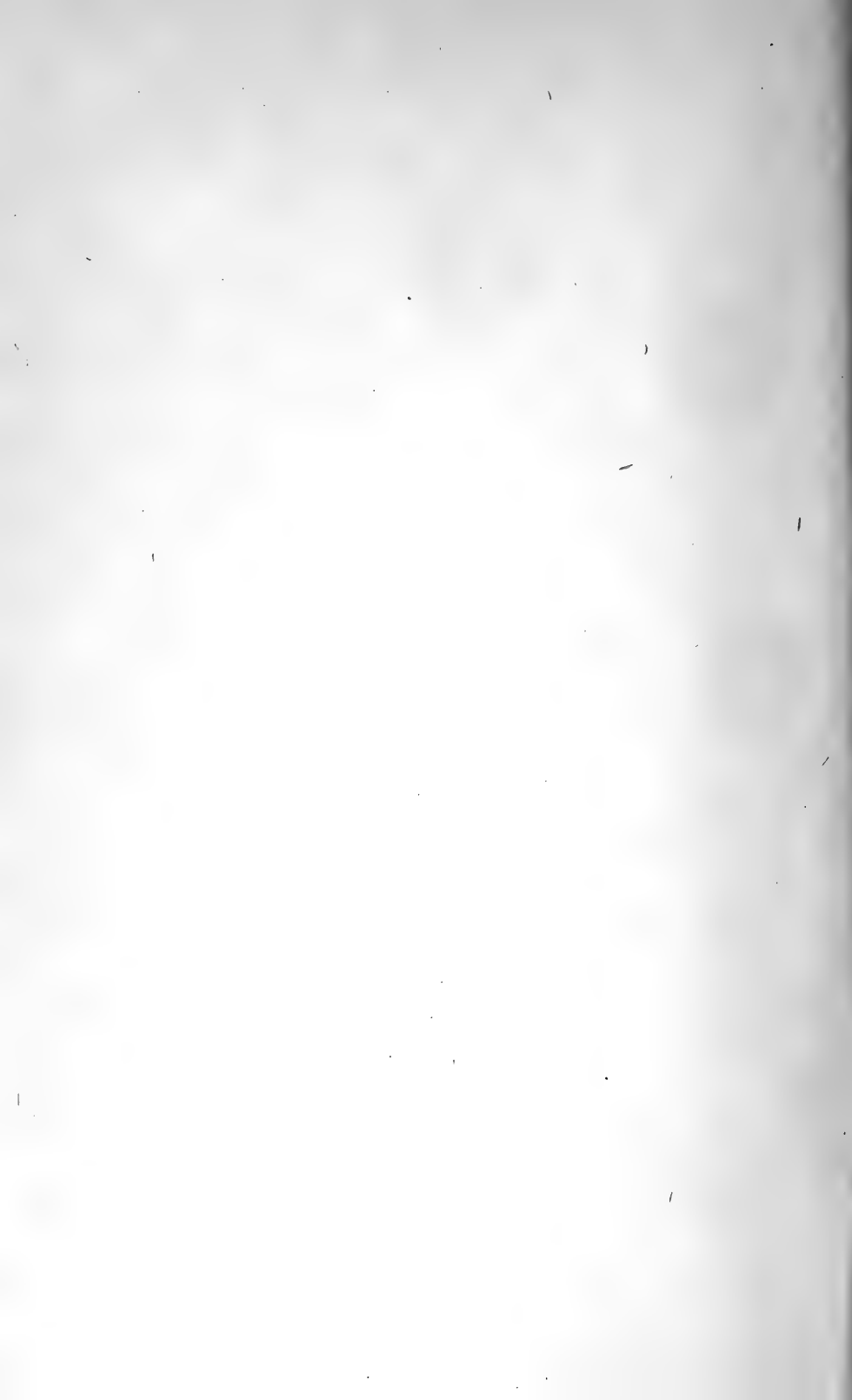

REPORTS ON THE COLLECTIONS OBTAINED BY ALLAN HANCOCK PACIFIC EXPEDITIONS OF
VELERO III OFF THE COAST OF MEXICO, CENTRAL AMERICA, SOUTH AMERICA,
AND GALAPAGOS ISLANDS IN 1932, IN 1933, IN 1934, IN 1935,
IN 1936, IN 1937, IN 1938, IN 1939, IN 1940, AND IN 1941.

THE MARINE ALGAE OF THE
GULF OF CALIFORNIA
(FORTY-SEVEN PLATES)

By ELMER YALE DAWSON

327100

C

...

DEDICATED TO THE MEMORY OF

WILLIAM ALBERT SETCHELL

*Professor Emeritus of Botany
of the
University of California*

Foremost American phycologist of this century; a scientist of rare wisdom and breadth of understanding; a teacher who endeared himself to thousands; a man of unforgettable personality; a prince of good fellows.

It was the author's very great privilege to have been among Professor Setchell's closest associates during the last years of his life, and to have been his last and youngest pupil. It was with him, under his guidance, and inspired by his great understanding and kind helpfulness that this work was done. By the younger of his friends and associates during more recent years he was known as "Uncle Bill," and by our adoption into his family of friends we fortunate ones gained a treasured intimacy with this great man. He will not be forgotten, for, as his life has been an inspiration, so his memory will be a shrine.

—at the time of his death,
April 5, 1943

THE UNIVERSITY OF SOUTHERN CALIFORNIA PUBLICATIONS
ALLAN HANCOCK PACIFIC EXPEDITIONS
VOLUME 3, NUMBER 10
ISSUED JULY, 1944

THE UNIVERSITY OF SOUTHERN CALIFORNIA PRESS
LOS ANGELES, CALIFORNIA

CONTENTS

INTRODUCTION	189
HISTORICAL SUMMARY	189
RECENT COLLECTIONS OF THE AUTHOR	190
GENERAL NATURE OF THE GULF OF CALIFORNIA	192
ECOLOGIC CONSIDERATIONS	195
GENERAL ASPECTS OF THE ALGAL FLORA	198
CHLOROPHYCEAE	201
PHAEOPHYCEAE	220
RHODOPHYCEAE	251
GENERAL SUMMARY AND CONCLUSIONS	337
ACKNOWLEDGMENTS	338
TABLES	
I. TEMPERATURE DATA, SCRIPPS, 1939	339
II. OXYGEN DATA, SCRIPPS, 1939	341
III. STATION LOCATIONS, SCRIPPS, 1939	343
ALGAL COLLECTION STATIONS	
ALLAN HANCOCK EXPEDITION, 1940	353
DAWSON, JULY, 1940	356
PRINCIPAL ALGAE FOUND AT TURNER'S ISLAND	
JANUARY, 1940	357
JULY, 1940	357
LIST OF NEW NAMES AND COMBINATIONS	358
LITERATURE CITED	344
EXPLANATION OF PLATES	359



THE MARINE ALGAE OF THE GULF OF CALIFORNIA

(FORTY-SEVEN PLATES)

ELMER YALE DAWSON
Department of Botany, University of California

INTRODUCTION

HISTORICAL SUMMARY

The first alga known to have been taken and preserved from the Gulf of California is a specimen of *Wurdemannia miniata* collected in 1860 by Edward Palmer on the shore of Carmen Island. In 1890 T. S. Brandegee and Walter E. Bryant of the third expedition of the California Academy of Sciences to Lower California collected a considerable number of specimens, particularly of *Sargassum*. These, however, received no mention in print until thirty-four years later. It was not until 1895 that any account of algal material from this region came into press, that published by M. Paul Hariot being the first (*Algues du Golfe de Californie recueillies par M. Diguët*). Five marine and two fresh-water species were recorded. The collection consisted mainly of crustaceous corallines which have, since Hariot's work of 1895, been re-examined and reported on by other authorities on the Corallinaceae: Foslie, Heydrich, and Lemoine.

The year 1904 marked the first collection in the northern Gulf, made by D. T. MacDougal at San Felipe Bay. In 1911 G. J. Vives gathered a number of beach-drift specimens at La Paz, and these together with MacDougal's material found their way to Marshall A. Howe, who published that year an account of the combined 24 species (*Phycological Studies V*).

The most important publication to date on the marine algae of this region was made by W. A. Setchell and N. L. Gardner in 1924 (*New Marine Algae from the Gulf of California*). These authors had at hand a far greater quantity of material than the aggregate of previous collections, and their account includes designations of 144 species and varieties of which 111 were described as new. The bulk of the collection was composed of specimens secured by Ivan M. Johnston on the expedition of the California Academy of Sciences to the Gulf of California in the summer of 1921, but the old collections of Brandegee and Bryant were included in the study as well as a collection made in 1917 by Dr. and Mrs. Marchant.

In Phycological Contributions VII, 1924, Setchell and Gardner presented the name *Meneginiella Brandegeei* for an undated specimen of Brandegee's collection from La Paz.

N. L. Gardner published in 1927 (New Rhodophyceae from the Pacific Coast of North America VI) two new species from a collection of D. T. MacDougal made at Puerto Libertad, Sonora, in November, 1923. Another small collection was made by MacDougal in May of the same year, some specimens of which are mentioned for the first time in the present account.

In the quantity of material secured by J. T. Howell of the 1932 *Zaca* Expedition of the California Academy of Sciences are some specimens taken from the waters of the Cape region of Lower California. These are included in the present paper.

Waldo L. Schmitt obtained in 1938 a few algae from dredgings off the Cape of Lower California. These were accounted for by W. R. Taylor in 1939 (Marine Algae of the Presidential Cruise of 1938).

In addition to the author's extensive collections made in the winter and summer of 1940 and described below, material from this report has been made available by several other contributors. Principal among these other collections is that made by Dr. Francis Drouet and Mr. Donald Richards of the Field Museum Expedition to Sonora in the winter of 1939. E. F. Ricketts of Pacific Biological Laboratories contributed some samples from Puerto Refugio obtained in April, 1940. A few were brought in by J. Wyatt Durham of the Scripps Institution of Oceanography Expedition of the Fall of 1940. Lastly, a small but valuable collection was made by Dr. John Poindexter of Stanford University at Punta Peñasco, Sonora, in the spring of 1941.

All of the above-mentioned collections from the Gulf of California, excepting part of those of Diguët and those of Schmitt, have been examined in the preparation of this report.

RECENT COLLECTIONS OF THE AUTHOR

In January of 1940 the writer was given the unique opportunity of accompanying the Allan Hancock Expedition from The University of Southern California as marine botanist. It was a splendid chance to visit the Gulf of California in winter and with such equipment as would be most effective in securing an unprecedented quantity of algal material. Winter collections had not been secured from the area before, and, moreover, a visit had never been made by an investigator primarily in-

terested in the marine algae. The general environmental conditions were still unrecorded for the plants of this large area, and seasonal changes not only had escaped investigation but had never been considered. Though over a hundred species of algae were recorded from the Gulf, collection localities were scattered, and the absence of winter collections suggested strongly that further exploration would be very fruitful.

Five weeks of cruising on the 195-foot twin Diesel *Velero III* allowed us to make 90 collection-station records, from over half of which algal material was obtained. The whole length of the Gulf was traversed, from San Jose del Cabo, Lower California, to Punta Peñasco (Rocky Point), Sonora.

For the detailed analysis of this expedition, the cruise charts, and complete station records, the reader is referred to Volume 1, nos. 1, 2, 3, of this series.

The splendid dredging equipment afforded by the *Velero III* permitted the carrying out of extensive sublittoral collecting, much of which was exceedingly profitable from the phycological point of view. Deep-water dredgings were made mostly off the bow of the *Velero* by means of the ship's dredge, while shallower areas were dredged by means of a motor dredge launch. A glass-bottomed skiff was used for inshore raking, grappling, and diving. The small dredge boat, being best suited for work over the most excellent sublittoral vegetation areas, yielded the most interesting sublittoral algal collections. Much of this material has never been taken in any other way.

The low tides of late January, 1940, made available some of the richest shore stations under optimum collecting conditions. Later, during February, in spite of relatively higher tides, the exceptional fall of ordinary tides made all shore stations in the northern Gulf profitable. Brief descriptions of the littoral and sublittoral stations together with accessory data are to be found on pp. 353-356.

In July, 1940, in order to study the seasonal change in the algal flora, a return trip was made to Turner's Island, the only island station visited in January by the Hancock Expedition which could be reached without unreasonable difficulty. Turner's Island is 25 miles seaward from Kino on the Sonora coast and may be reached by small boat owing to the safety afforded by the shores of Tiburon Island which extend far out into the Gulf. The trip was made in three days by outboard motor attached to a one-ton fishing dory. We crossed the channel between Tiburon Island and the mainland, followed the south shore, and then crossed to the reef

at the north end of Turner's Island. A week in mid-July was chosen in which the lowest tides of the summer season were predicted. The impossibility of mooring a small boat at high tide made it necessary that all specimens be thrown together in large jars and preserved in formalin, to be segregated, sorted, and spread after the return to the laboratory. A stay of several days would have been valuable, but the difficulties of the trip did not allow it.

GENERAL NATURE OF THE GULF OF CALIFORNIA

Just as the Galapagos Archipelago has long been recognized as a unique land area of the eastern Pacific, so more recently the Gulf of California has gained attention as an almost equally unique marine area. On this account, frequent expeditions from learned institutions have made their way into the "Sea of Cortez" to investigate both the extraordinary oceanography of the region and the plant and animal inhabitants of its islands and its waters. The phycologist, however, has been wholly dependent upon herbarium specimens brought back from the region. Indeed, until 1939 no part of the living marine flora of the Gulf of California had ever been seen by phycologists.

One would perhaps suppose that so interesting an area, being relatively near the large cities of the California coast, might have become well explored by means of overland routes. The Gulf of California, however, is far less accessible than the distance alone might imply. Even today there is no satisfactory road to any point on the Gulf from any point in the United States; indeed, there are few roads of any kind. Even if one reaches the few accessible points, relatively little can be done, for the Gulf is a sea of islands; and without the cruising facilities of an ample ship and adequate dredging equipment the waters are not likely to yield a large part of their inhabitants.

The Gulf of California is one of those few marine areas in the world so set apart from the ocean at large that its whole nature is at variance with comparable parts of the greater mass. Over 600 miles long, with fully 2,000 miles of coastline and a large number of islands, it constitutes a very considerable part of the Pacific coast of North America and one which is fast fulfilling the expectations stated by Setchell and Gardner nearly twenty years ago: "It seems likely that there will be found to be an exceedingly rich marine flora in the Gulf of California when it shall have been carefully and thoroughly explored." The purpose of this paper, however, is not only to describe the variety and abundance of marine plant

life in this region but to show wherever possible how the nature of the vegetation reflects directly the peculiar conditions existing in this body of water.

The southwestern limit of the Gulf is taken as Cape San Lucas, the outjutting rocks of the extreme tip of Lower California forming a geographic point of division between the two parallel coasts of the peninsula. It is not possible to establish an eastern boundary, for no known collections of algae have been made on the mainland coast of Mexico between Mazatlan and the mouth of the Rio Mayo. On the chart of collection stations a 300-mile blank exists without a single record, and, instead of attempting to extend the treatment southward across this unknown region, the collections at Rio Mayo are taken as representing the southernmost samples known from the eastern Gulf coast.

Geographically, the Gulf of California extends through ten degrees of latitude and is, for this reason alone, subject to a very considerable range of variation in climate. The southern waters lie below the Tropic of Cancer and, as will be shown below, are influenced by temperature conditions entirely unlike those acting upon the northern waters. Actually, the Gulf forms a marine pocket reaching deeply into the western side of Mexico. Surrounded as it is by barriers to the tempering influences of the Pacific winds, the waters of much of this marine area are subjected to much greater climatic extremes than are the waters along the outer coast of Lower California. On the west is the backbone of the peninsula, a largely unbroken chain of mountains 6,000 to 10,000 feet high, barring the access of winds which would cool the heated air of summer and stay the falling temperatures of winter. On the north and east lies the great Sonoran desert mass, flanked by the North American cordillera. The summers of this whole country are notoriously hot and snow falls on the cactus-studded desert in winter. The upper half or more of the Gulf, therefore, confined by these remarkable barriers, is subjected to conditions much as a large inland lake would be, and the temperatures of its surface waters vary directly with these seasonal climatic conditions.

Aside from the unusual temperature conditions existing in the region, another remarkable feature is present which both directly and indirectly has considerable influence on the distribution of the marine plants. Nowhere else on the Pacific coast do the tidal conditions compare with those at the head of the Gulf. The great length and relatively narrow proportions of the Gulf result in the development of a tidal bore which reaches tremendous volume in its northern regions. Twice a day the great influx

of tidal water sweeps up the gradually narrowing channel of the Gulf and causes an increasingly greater tidal range toward the Colorado river. At Puerto Refugio the spring range is 11.8 feet, at Tepoca Bay 17.2 feet, and at the mouth of the river 31.5 feet. These figures merely represent the average differences between high and low water at the time of new or full moon, and, since the author's visits to the Gulf were made during times of maximum tidal difference in the winter and summer of 1940, proportionally greater ranges were observed at all the stations visited. Puerto Refugio, in particular, exhibited a most striking rise and fall of the water level. A reef on the north side of the bay, exposed to a height of at least 15 feet at lowest ebb, was completely submerged at high water. At San Felipe on the Lower California coast quite near to the upper extremity of the Gulf, large fishing boats were observed late in July of 1938 to be high and dry in a basin far above the reach of the high water of that particular time. Yet, these boats are floated in on the crest of one high-water tide and floated out again on another such crest.

Two thirds of the way up the Gulf lie a group of large islands and an outjutting peninsula of land which together serve as a very decided hindrance to the movement of water up and down the Gulf. Above this narrow "bottleneck" is a large water area connected to the southern water mass and the ocean at large only through these straits. Consequent upon the tremendous movement of tidal water in and out of the northern area, very strong currents develop in the channels between the islands. On either side of San Esteban Island the currents are so powerful that anchorage is impossible and must be sought in protected bays of the south-facing shore. The significance of these currents in regard to the general distribution of algal populations will be taken up in a consideration of the oxygen relations of these plants.

No discussion of general water movement in the Gulf is complete without mention of the nature of wave action. Here again is a factor playing an exceedingly important role in the oxygen relations of marine algae. Unlike the outer coast, where powerful surf is the rule, the action of waves in the Gulf of California is contrastingly slight. Except at times of heavy winds and general storminess, the waters are essentially calm and small waves prevail, breaking directly on the shore. Commonly there is scarcely more than a strong lap of water on the beaches; and, wherever protection is afforded, little more than a gentle surge. Toward the southern limits of the Gulf, however, increasingly heavy wave action is present, reaching full proportions in the Cape district, where the collector, instead

of being able to work casually at the water's edge when choosing desirable specimens, must scan and pick hurriedly from exposed rocks or sustain frequent immersions.

ECOLOGIC CONSIDERATIONS

Setchell, in a series of papers (1915, 1920, 1922) on the temperature relations of marine algae, has shown the primary importance of temperature in ecologic and distributional considerations of these plants. He recognized that the ranges of temperature to which marine plants are subjected are in general much narrower than are those of land plants. Also, in contrast to terrestrial plants, whose various parts are subjected to quite different temperatures at a given time, the marine plants are completely surrounded by a medium of uniform temperature. The problems of temperature for marine plants, thus, are relatively simple, and the ease with which temperature can be measured makes some interesting correlations possible.

The seasonal variation in the temperature of surface waters along the outer coasts of California and Mexico does not exceed 10° C. and is usually considerably below that figure. This coincides with Setchell's general thesis as to temperature amplitudes in ocean waters (1915, 1920). In the Gulf of California, however, we have not only latitudinal temperature differences from south to north but exceptionally pronounced seasonal differences far exceeding those known for any other waters of our coasts (see p. 339). From winter to summer, amplitudes of temperature variation may reach as high as 25° to 28° C. Records made on the *Velero* cruise, January 20-30, 1940, showed a gradual decrease in temperature of surface water from San Jose del Cabo, 23° C., to San Felipe, 14° C. Scripps Institution data obtained over the same course from February 13 to March 19, 1939, showed a range from 21.5° in the south to between 15° and 17° in the north. A recording of the *Zaca* Expedition at San Jose del Cabo, August 4, 1932, gave 26° - 27° for surface water. The writer's surface readings for July 18, 1940, were 31° on the reef at Turner's Island and 32° - 33° along shore and in bays of adjacent Tiburon Island. The highest temperature known to have been measured is a figure of 36° C. obtained by the author in shore waters of Concepcion Bay, Lower California, in mid-July, 1934.

As soon as the extent of these seasonal temperature changes was realized, it was strongly suspected that investigation would reveal a marked seasonal alternation in the marine floras of northern parts of the Gulf.

With this in mind, careful attention was given to collection localities to which return trips at other seasons might be made feasible. After the return of the Hancock Expedition it was found that one of the richest algal stations visited during the winter season could be reached from the Sonora side of the Gulf. This was Turner's Island, a tiny, rocky island off the south end of Tiburon, within 25 miles, in direct line, of the fishing village of Kino. A return visit to this island at the height of the warm-water season of midsummer confirmed completely the suspicions regarding seasonal alternation of the floras.

In attempting to explain the general distribution of algal types and floras in the Gulf, the author is fully aware that in the present account only suggestions can be made. Ecologic data are still exceedingly scanty. Even so easily recorded a fact as temperature is available for only a small part of the year, and that almost entirely from measurements in the open sea. Fortunately, Sverdrup and the Scripps Institution staff have made available a series of oxygen values showing the concentration of oxygen in the sea water of the Gulf of California at 53 stations and at many depths.

Unlike terrestrial plants, which live in a partly atmospheric partly subterranean environment, the algae, in their aquatic medium, are subject to different primary environmental factors. Next to temperature, oxygen is probably the most significant primary factor. In contrast with land plants, when marine algae carry on photosynthesis the CO_2 removed from sea water is immediately replaced by the dissociation of bicarbonates and carbonic acid. This buffering action of sea water prevents any deficiency in the CO_2 content which might be limiting to photosynthesis. The oxygen supply, therefore, except when photosynthesis is proceeding at an adequate rate, becomes a critical factor, and its availability in the sea water of different habitats becomes significant as a factor in the general development and distribution of marine vegetation.

From the oxygen data at hand (see p. 341) we find values in surface waters ranging from 5 to 9 milliliters per liter from south to north in the Gulf. These differences are attributable to a number of climatic and oceanographical factors.

The solubility of oxygen varies inversely with the temperature. Thus, the warmer waters of the southern regions contain much less oxygen at saturation than do the colder northern waters (in winter). The extreme seasonal temperature differences at Turner's Island serve as an instance in which the solubility of oxygen in 15°C . winter water is approximately 35 per cent greater than in the 31° summer water.

The oceanographical factors affecting aeration, mixing, and diffusion are highly significant in regard to the concentration of oxygen in surface and subsurface waters. In shore water the degree of wave action is a factor of particular importance. In the narrow Gulf waters general surface agitation is relatively low and the absence of strong wave action is in marked contrast to the situation on the outer Pacific coast. In wave-beaten water the oxygen concentration may reach high supersaturation values, which are from all indications very favorable to the development of algae. In the Gulf of California the wave action is much reduced or essentially absent, and, though no data are available on the oxygen content of Gulf shore water, the relative paucity of vegetation as compared with the outer California coasts may in part be accounted for by this more limited oxygen supply.

It will be noted from Table II that in the region of the island mass toward the head of the Gulf there are definitely higher oxygen concentrations than anywhere southward in the Gulf. The occurrence of narrow channels between the islands causes rapid movement of tremendous volumes of tidal water and mixing of rougher, more broken surface waters. This undoubtedly provides for some additional aeration. Of greater importance is the oxygen supply already present in the water at the north which is involved in the movement. A study of the soundings in the upper Gulf reveals that the region north of the island mass is essentially shallow. Very little of the water is deeper than 300 meters, and a great part of it is under 100. The Scripps data show that southern Gulf waters over depths of 1,500 meters or more may be as low in oxygen at 300 meters as .15 ml. per liter. In the northern region the lowest figure given for 300 meters is 1.10 ml. per liter. The lower concentrations in surface waters of southern parts of the Gulf can partly be explained, therefore, by upwellings of deep waters very low in oxygen. According to this interpretation the distinctly higher concentrations in all of the northern waters are attributable to the absence of any such deep waters, and high residual concentrations at all of the comparatively slight depths.

A comparison of the data on oxygen values with the relative luxuriance of vegetation shows a very significant correlation. The greatest concentrations of algae, as to both kinds and quantity, are to be found on the reefs bathed by the highly oxygenated waters of this northern region, particularly those reefs bordering the channels between the islands and lying in the paths of the ever-moving tidal currents.

On the southwestern side of the Gulf, at Agua Verde Bay, it was notable that on rocky reefs ideally suited for the growth of algae as far as

substratum is concerned, and where temperature conditions in February were apparently satisfactory, an extreme paucity of algal vegetation existed. The same paucity was observed at Escondido Bay. Determinations of oxygen values in the vicinity of these two localities show that the surface oxygen content is low, first because of generally higher surface temperatures, but principally because of definite upwellings of adjacent abyssal waters with a negligible oxygen supply. Moreover, wave action and general water movement are exceptionally slight in both of these quiet, well-protected bays. It seems, therefore, possible, and even probable, that at these localities the development of marine vegetation is limited by oxygen deficiency.

GENERAL ASPECTS OF THE ALGAL FLORA

It has already been pointed out that the waters of the southern region of the Gulf of California are essentially tropical in nature. Like most tropic waters, their littoral flora, as revealed by collections at San Gabriel Bay, Espiritu Santo Island, are dominated by widely distributed warm-water elements and are very scanty in bulk. Although San Gabriel Bay is the only well-known station of its kind in the Gulf, its flora may undoubtedly be considered typical of many such bays of the warm waters of the southwestern Gulf coast and islands. The temperature of surface waters varies less than 10° C. annually, and a uniform flora of diminutive plants is prevalent. On the bottoms of the shallows grow large coral heads, in and about which may be found *Dictyosphaeria*, *Gelidiella*, and *Caulerpa*. Both *Caulerpa racemosa* and *C. sertularioides* are abundant and often form thick mats. Several other warm-water genera are present, *Hydroclathrus*, *Wurdemannia*, and *Jania* being frequent. *Sargassum* was not encountered here, though it is known to occur in the general region of La Paz.

One who is not familiar with tropical marine floras but has seen the rich algal growths of cool, northern latitudes would be immediately impressed by the relative paucity of vegetation. Almost all tidal rocks are completely barren, for very few plants of the southern Gulf seem to tolerate exposure at low tides. On the whole, considering its poverty and the dominance of tropical elements, the San Gabriel Bay flora shows almost no characters in common with floras known for the northern part of the Gulf.

The shore flora of Guaymas harbor and near-by bays is moderately well known for the winter season through the studies made on the *Velero* cruise. The vegetation is not particularly rich or varied, but certain

characteristic and conspicuous elements are worthy of mention for comparison with the floras farther north. Two species are prevalent and especially conspicuous: *Sargassum sinicola* and *Padina Durvillaei*. This *Sargassum* is here and in other localities accompanied by one or several other less abundant species. *Padina Durvillaei*, however, is the only member of the genus anywhere abundant in our region. It is apparently a common plant south along the Mexican coast all the way to Central America. In the Gulf it occurs at all the northern stations, often in great abundance. Tropical elements such as were found at San Gabriel Bay are absent or very obscure. *Codium simulans* and *Gracilaria compressa* are occasional. Small rock-cover species begin to be conspicuous in this region but do not reach the rich development of those of the island reefs to the north.

The first rich winter vegetation is encountered on the south shores of the islands of the large northern group. All of the prevalent plants of the Guaymas area are present and many others in addition. *Colpomenia*, *Gigartina*, *Gelidium*, *Gracilaria*, *Hypnea*, *Laurencia*, *Lomentaria*, *Centroceras* are common fleshy genera. The articulated corallines, *Corallina* and *Amphiroa*, are abundant and form, with various crustaceous *Lithophyllum* species, dense covers over shore rocks. A list of species collected at Turner's Island is given on p. 357.

Having been acquainted with the flora of the coast of California, the author was struck with the peculiar appearance of this vegetation. The entire aspect is at variance with floras a few hundred miles northwest on the California coast. The most obvious differences are in regard to the "Kelps." The Laminariales are not represented in any part of the Gulf of California. These plants, so conspicuous and important a part of the California marine flora, are utterly lacking from these shores as are most of the other larger brown algae. The order Fucales is represented only by *Sargassum*, which is, however, the dominant brown alga of the Gulf. Other fucoids such as *Fucus*, *Pelvetia*, *Halidrys*, and *Cystoseira*, so commonplace to Californians, apparently do not occur.

It is well known that the larger brown algae, particularly the Laminariales, are characteristic of cool or cold waters, rarely extending into warm seas. On the outer coast of Lower California there is evidence of their extension perhaps as far south as Magdalena Bay, where rising summer temperatures undoubtedly become limiting for the development of critical phases in the life cycle. In the Gulf of California temperature conditions during the winter season are in general quite in accord with

the requirements of the kelps, at least through most of the northern regions, but the extremes of midsummer transform all surface waters into tropical ones. There seems little question that conditions are adequate for dispersal and introduction of these plants into the Gulf, but they have not become established because they have not been able to survive the unfavorable seasons.

The richest development of algae in the Gulf is found on the reefs of islands lying in the northern regions in the path of the rapidly moving, more highly oxygenated water of those parts: San Esteban Island, Pond Island, Puerto Refugio, Turner's Island, and Tepoca Bay, Sonora. Possible ecologic explanations have already been discussed.

The shore vegetation of Turner's Island reef was as luxuriant in January as was that of any other station. Collecting was again done in July, under identical tidal conditions, exactly six months after the winter visitation. The most significant observations have already been described (Dawson, 1941, pp. 117-118). Here, it need only be repeated that with the temperature increase of 15° C. there occurs a profound change in the vegetation. Many winter elements apparently disappear completely or are present only as juvenile forms. Some obscure elements of the winter flora attain very rich and dominant development. Other entirely new elements appear. The summer and winter floras are of more or less comparable bulk but are of utterly different composition. Further mention of specific cases may be found under *Dictyota Johnstonii* and by referring to the list of species from Turner's Island on p. 357.

The sublittoral floras of the Gulf as known from dredgings at a limited number of stations appear to be exceedingly varied and apparently often very rich. A large proportion of the sublittoral species were obtained only by dredging, and the infrequent duplication of species in different hauls suggests how incomplete our knowledge of these plants is. At Puerto Refugio, for instance, five dredge hauls were made in different parts of the small bay. Each one yielded a number of species not found in any of the others. Many such dredge hauls, in fact, have brought to light unique samples of species unknown elsewhere.

CHLOROPHYCEAE*

Family **Ulvaceae**

Genus **ULVA** Linnaeus

Ulva dactylifera S. & G.

Setch. & Gard., 1920, p. 272, pl. 21, fig. 1; 1924, p. 717.

This species may be identified by its expanded, thick, laciniate fronds composed of cells appearing vertically elongated in cross section. Thus far, *Ulva dactylifera* has been collected only in warm waters in the Gulf area: San Marcos Island, Tortuga Island, La Paz, Eureka, Espiritu Santo Island. On the outer coast it is recorded from San Roque, near Turtle Bay, and from exposed rocks, uppermost littoral in southern California. The author's recent collections are of plants found growing on a sandy substratum in warm oyster-culture pools at San Gabriel, Espiritu Santo Island, D. 617, Feb.

J. 11a, San Marcos Island, June; J. 31, Tortuga Island, June; Brand. 9, 30, La Paz; M. 5, Eureka, May.

Ulva angustata S. & G.

Setch. & Gard., 1920, p. 264, pls. 22, 26, fig. 1.

D. & R. 3152, on rocks between tide marks, 3292, on rocks in shallow water, 3159, in tidal stream, near Guaymas, Dec.

These specimens seem to agree in general with Setchell and Gardner's concept of *Ulva angustata*. The cells are quadrate in cross section. The fronds resemble those of *Ulva teniata* in form, but the lower parts are not

* The general scheme of classification used is that found in Okamura, 1936, pp. 1-5. He has employed the most modern systems, notably those of Kylin for the Phaeophyceae and Rhodophyceae.

Abbreviations used preceding numbers in the designation of collection data are as follows:

Brand.=collections of T. S. Brandegee of the California Academy of Sciences Expedition to Lower California in 1890.

M.=collections of Dr. and Mrs. Marchant, mostly at Eureka, south of La Paz, and at Guaymas in 1917.

J.=collections of Ivan Johnston, Expedition of the California Academy of Sciences to the Gulf of California in 1921.

H.=collections of John Thomas Howell of the *Zaca* Expedition of the California Academy of Sciences to the Galapagos Archipelago in 1932.

D. & R.=collections of Dr. Francis Drouet and Donald Richards of the Field Museum Expedition to Sonora in the winter of 1939.

D.=collections of the author during the year 1940. All collection data for these numbers are to be found in the Appendix.

AHF=Allan Hancock Foundation type or isotype specimen to be found in the Foundation Herbarium.

dentate. Our specimens are generally shorter and somewhat broader than the type, and frequently have less conspicuous undulation of the margins.

Ulva rigida Ag.

C. Agardh, 1822, p. 410; Setch. & Gard., 1920, p. 269; 1924, p. 717.

On upper littoral rocks at Turner's Island an abundance of this small, crisp, tufted species was found. It was noted in the upper littoral at other stations in the northern part of the Gulf, but apparently collecting of it was neglected. This species may be distinguished from young plants of *Ulva lactuca*, which often resemble it, by the thicker fronds and the vertical elongation of cells in cross section. The small, ruffled blades do not expand broadly as in *U. lactuca*.

D. 114, Turner's Island, Jan.

Ulva lactuca L.

Linnaeus, 1753, p. 1163; Setch. & Gard., 1920, p. 265; 1924, p. 717.

Twenty-one collections of this cosmopolitan species are present from various localities and habitats in the Gulf, from La Paz to Punta Peñasco. It is distinguished from the other three Gulf species by its broadly expanded fronds and quadrate cells in cross section.

Genus ENTEROMORPHA Link

For the most part, Setchell and Gardner, 1924, can be followed in the identification of the Gulf species or forms of *Enteromorpha*. Our specimens of *E. acanthophora* correspond closely with the material they examined. This species is quite distinct in habit from any others from the region.

Enteromorpha Marchantae, on the other hand, should certainly be considered nothing more than a form of *E. intestinalis*. I cannot confirm the distinctions made in the original description. Since *Enteromorpha* "species" are so often merely form names, it is difficult to justify the addition of more names for minor shape differences in these variable and undoubtedly much hybridized plants.

Enteromorpha prolifera in the Gulf is usually much finer in habit than *E. compressa* and shows more fine proliferations as well as cells in more or less longitudinal series. It seems best here to follow Collins in listing *E. tubulosa* as a synonym or variety of *E. prolifera*. The Gulf ma-

terial can, as Setchell and Gardner indicate, only doubtfully be referred to this form-name (*E. tubulosa*), though some of the specimens at hand may very well fall under *E. prolifera*. The forms which best correspond with *E. compressa* are common and fairly consistent in morphology.

***Enteromorpha acanthophora* Kütz.**

Kützling, Tab. Phyc. VI, pl. 34; Setch. & Gard., 1924, p. 715, pl. 16, fig. 43, pl. 38.

Considerable variation in size and proliferation is present among the many collections of this species, which may best be recognized by the abundance of short, spinelike proliferations, longer in lax specimens, shorter in smaller forms with larger tubes.

D. & R. 3140, 3423, 3288, 3365, 3156, 3139, 3427, on rocks in tidal water, various shore stations near Guaymas, Dec.; D. 40, Guaymas Bay, Jan.; J. 39, lower littoral rocky beach, Los Angeles Bay, June; D. 374, dredged from 22 meters, Tepoca Bay, Feb.; D. 418, in lagoon, Pond Island, Feb.; D. 470, dredged in 30-36 meters, near Guaymas, Feb.; D. 604, shallow lagoon, San Gabriel Bay, Espiritu Santo Island, Feb.

***Enteromorpha compressa* (L.) Grev.**

Greville, 1830, p. 180, pl. 18; Setch. & Gard., 1920, pp. 251-252; 1924, p. 716.

This species may be distinguished by its smooth, slender tubes of even diameter, which are nonproliferous and little branched.

Abundant in tidal water about Guaymas, both floating and attached: D. & R. 3261, 3282, 3321, 3312, 3280, 3428, 3244, 3429, 3245, 3241, 3143, 3154, 3153, Dec.; D. 56, 65, Jan.; D. 87, dredged in 12-20 meters, outside Guaymas Bay, Jan.; D. 152, dredged in 4-32 meters, off Tiburon Island, Jan.; D. 526, high rock pool, Agua Verde Bay, Feb.; Brand. 17, La Paz.

***Enteromorpha intestinalis* (L.) Link**

Link, 1820, p. 5; Kützling, Tab. Phyc. VI, pl. 31; Setch. & Gard., 1920, p. 252. *Enteromorpha Marchantae* Setch. & Gard., 1924, p. 716, pl. 16, figs. 40-42.

The forms which best fall under this name are of larger tube-diameter than the others known from the Gulf, to 15 mm. in diameter. The tubes

are irregularly inflated and constricted in age, nearly smooth in younger stages and in dredged specimens.

The type specimen of *Enteromorpha Marchantae* (loc. cit.) is a plant nearly identical with D. & R. 3279 from pools in a tidal flat, Playa Miramar, Guaymas, December. Both consist of numerous, irregularly inflated and constricted tubes averaging 4-5 mm. in diameter. Those of Marchant's specimen are younger and shorter than Drouet's.

D. 625, dredged in 34-50 meters over fine, gray sand off Gorda Point, Lower California, Feb.; D. 150, dredged in 4-32 meters off Tiburon Island, Jan.

Enteromorpha prolifera (Muell.) J. Ag.

J. Agardh, 1883, p. 129, pl. 4, figs. 103, 104; Setch. & Gard., 1924, p. 715. *Enteromorpha tubulosa* Setch. & Gard. (not of Kützing), 1924, p. 716.

The specimens placed here have the most slender, hairlike tubes of the known Gulf species.

Floating or on rocks in tidal water, D. & R. 3155, 3249, 3146, Guaymas, Dec.; M. 4, Guaymas, May; J. 49, along beach at La Paz, April.

Family **Chaetophoraceae** Genus **ENTOCLADIA** Reinke **Entocladia condensata** S. & G.

Setch. & Gard., 1924, p. 718, pl. 12, figs. 4, 5.

This species was detected by Setchell and Gardner on various species of *Codium* in the Johnston collection. It has again been found in the terminal membrane of *Codium simulans*, D. 439, San Esteban Island, February, and in *Codium MacDougalii*, MacDougal, Port Libertad, May, 1923.

According to Setchell and Gardner, *Entocladia condensata* is similar to *E. codicola* growing on the utricles of *Codium fragile* on the coast of California, but the cells are much larger throughout and the whole plant is more condensed. It is apparently quite widely distributed in a number of different species of *Codium* in the Gulf.

As to the members of the genus as a whole as they occur in the Gulf, Setchell and Gardner say: "We have represented in the three species apparently the extremes of variation in the matter of the formation of the thallus. In *Entocladia condensata* the whole plant is practically a solid

parenchymatous disk, with only a few peripheral short free filaments. In *E. Polysiphoniae* there is no indication of a central parenchymatous disk. The filaments are all free, more or less crooked and distorted, and the branching is alternate or at times secund, usually arising from the center of the cells. Between these two extremes we have *E. codicola* with a slight central disk, *E. mexicana* and *E. cingens*. In all cases the reproductive cells are merely vegetative cells enlarged and more or less metamorphosed. In *E. Polysiphoniae* those of the central part of the thallus are enlarged to almost spherical, whereas those near the margin may only be slightly swollen. This condition does not seem to be the case in the other species."

Entocladia Polysiphoniae S. & G.

Setch. & Gard., 1924, p. 718, pl. 13, fig. 18.

Growing in the membrane of *Polysiphonia Marchantae*, Bryant 7, La Paz; M. 50b, Guaymas Bay, May. Not again detected.

Entocladia mexicana S. & G.

Setch. & Gard., 1924, p. 719, pl. 19, fig. 57.

Growing within the membrane of *Chaetomorpha antennina*, J. 49b, La Paz; within the membrane of *Valoniopsis Hancockii*, D. 215, Puerto Refugio, Jan.

Genus PRINGSHEIMIA Reinke Pringsheimia Marchantae S. & G.

Setch. & Gard., 1924, p. 720, pl. 12, fig. 8.

Growing on various species of *Laurencia*, M. 68, La Paz, May. Not again detected.

Family Valoniaceae Genus DICTYOSPHERIA Decaisne Dictyosphaeria Versluysii W.-v. B.

Weber-van Bosse, 1913, p. 64, pl. II, fig. 6.

Specimens from the tropical waters of the southern Gulf agree very well with the figure and description given by Madame Weber of this species. The plants grow attached to coral heads in shallow lagoons, are solid in structure throughout, and are made up of very large cells 1.2 to 1.8 mm. in diameter. Unfortunately, specimens were not preserved in

liquid, and the internal structure of the cells cannot satisfactorily be studied. The wide extension in the distribution of this tropical Australasian species must, therefore, remain tentative.

D. 599, growing in shaded places on coral heads in shallow lagoon and in oyster-culture ponds, San Gabriel Bay, Espiritu Santo Island, Feb.

Genus **CLADOPHOROPSIS** Børgesen
Cladophoropsis robusta S. & G.

Setch. & Gard., 1924, p. 714, pl. 13, fig. 16.

J. 135, growing on rocks in the upper sublittoral, Tortuga Island, June. Not again collected.

According to Setchell and Gardner, this species may readily be distinguished from all other known species of *Cladophoropsis* by the large diameter and by the great length of the segments between the branches.

Genus **VALONIOPSIS** Børgesen
Valoniopsis pachynema (Martens) Børg.

Børgesen, 1934, p. 10, figs. 1, 2. *Valonia confervoides* Harvey, Alg. Ceylon Exsicc. no. 73 (nomen nudum); J. Agardh, 1887, p. 100.
Bryopsis pachynema Martens, 1866, p. 24, pl. IV, fig. 2.

Comparison of our specimens was made with an original specimen of Martens' collection from Sumatra in the Herbarium of the University of California. The correspondence is remarkably close, especially with D. 214. Børgesen's description also conforms satisfactorily to our plants.

The species is widespread in the Gulf and moderately common on middle and lower littoral rocky shores. Collections have been made in both winter and summer, the plant apparently tolerating a considerable range of temperature. It is known from warmer seas in many parts of the world.

D. 682, south shore of Tiburon Island, July; D. 126, Turner's Island, Jan. (young specimens); D. 694, July (mature specimens); D. 614d, occasional in oyster-culture ponds, San Gabriel Bay, Feb.; D. 71, Guaymas harbor, Jan.; D. & R. 3236, cave north of Cabo Arco, near Guaymas, Dec.; D. 217, Puerto Refugio, Jan.

In the winter collections it is peculiar that the specimens were usually found associated with a small species of sponge.

Valoniopsis Hancockii sp. nov.

Plate 31, Fig. 9

Frondes caespitosae supra arenam repentes; filis coenocyticis iis erectis 300-400 μ diam. ramellis curtis lateralibusque ad bases septatas abrupte constrictis; apicibus late rotundatis; membranis translucidis nitentibusque.

Plants caespitose, creeping, forming small, tangled masses of filaments over loose substrata of sand and small algae, apparently without attachment organs when mature; filaments coenocytic with only occasional cross walls, these mostly at points of branching; prostrate parts very crooked, 125-250 μ in diameter; ascending filaments straighter, 300-400 μ diam., with occasional short lateral branches, these of about the same diameter as the parent filament but sharply constricted at the septate bases; apices broadly rounded; membrane transparent and shiny; chloroplasts dark green, minute, unevenly distributed in dried specimens causing blotched appearance of the filaments.

TYPE: Dawson 215, on rocky shore in lower littoral zone, Puerto Refugio, Angel de la Guardia Island, Jan. 27, 1940. Herb. AHF no. 4.

D. 293 from the same locality is composed mostly of the irregular prostrate, creeping filaments, none of the short, erect parts being branched. These examples are surely the same as D. 215 and undoubtedly represent immature plants.

Awaiting further collections and observations of this plant in the field, it is here tentatively described as a new species of the hitherto monotypic genus *Valoniopsis*. The specimens at hand resemble in several ways, but are not the same as, *V. pachynema*, which occurs with the present species at Puerto Refugio and is conspicuously different in both the fresh and the dried state. It seems to conform to Børgesen's genus better than to any other. The plants are much more slender and more widely branched with more extensive horizontal parts than *V. pachynema*. The lateral branches of the erect filaments are sharply constricted at the septum, a character which the other species does not possess.

Family **Cladophoraceae**Genus **CHAETOMORPHA** Kützing
Chaetomorpha antennina (Bory) Kütz.

Kützing, 1849, p. 379; Tab. Phyc. III, tab. 60; Setch. & Gard., 1920, p. 203; 1924, p. 713.

This species, which is found more abundantly along the southern coast of Mexico to Costa Rica and Panama, was collected in the Gulf only in

July at the peak of the warm-water season. Very thick tufts of half-mature plants were taken from rock pools at Turner's Island, D. 710, and from a rocky point just north of Kino, D. 660. These examples, though young, are typical of the species and show the characteristically long basal cell.

***Chaetomorpha aerea* (Dillw.) Kütz.**

Kützling, 1849, p. 379; Collins, 1909, pp. 324, 325; Setch. & Gard., 1920, p. 200, pl. 14, figs. 9-11. *Conferva aerea* Harvey, 1846-51, pl. XCIXb.

Two collections seem possibly referable to this species reported from the coast of California. D. 285 from Puerto Refugio is young. The plants were scraped from rock surfaces and consist of short tufts of filaments about 350 μ thick. The basal cell is short and those above as long as broad. D. 368 from Tepoca Bay was dredged and consists of only a few stray filaments 200-240 μ in diameter, likewise with cells only slightly longer than broad. The former collection agrees with Collins' description of the typical species, and with the figure of Harvey as far as the cell shape is concerned. The latter collection is probably the detached state of the same species, called by Collins *Chaetomorpha aerea* forma *Linum* (Muhl.) Collins. Setchell and Gardner (loc. cit.) have not recognized this form, not having found any Pacific coast specimens agreeing with Collins' description.

Genus LOLA Hamel

***Lola lubrica* (S. & G.) A. et G. Hamel**

A. & G. Hamel, 1929, p. 1094; G. Hamel, 1930, p. 118, fig. 37, 1-5.
Rhizoclonium lubricum Setch. & Gard., 1920, p. 185, pl. 9, fig. 5a-b.

The several collections from the Gulf correspond precisely to the descriptions both of Setchell and Gardner and of Hamel. The specimens were taken in thick masses, usually floating, resembling, as Hamel says, masses of *Spirogyra*. The filaments in ours are 25-45, 28-35, 30-50 μ in diameter in various specimens. Hamel reports lateral rhizoids rare or not present. Only unbranched filaments without rhizoids have been observed in the Gulf material. The texture, whether lubricous or not, cannot well be determined from material in the dried state.

D. & R. 3266, 3263, 3271, floating in tidal stream near Guaymas, Dec.; D. & R. 3300, in shallow water along shore of bay near Guaymas,

Dec.; D. 613b, in oyster-culture pond, San Gabriel Bay, Espiritu Santo Island, Feb.

Genus **CLADOPHORA** Kützing
Cladophora Rudolphiana (Ag.) Kütz.

Kützing, 1843, p. 268; Harvey, 1846-51, pl. LXXXVI; Collins, 1909, p. 336; Setch. & Gard., 1920, p. 218; Taylor, 1937, p. 87, pl. 5, figs. 2-4, pl. 6, fig. 2.

Two collections which show main filaments about 50 μ in diameter and with very long cells fall best into this old European species reported by Collins and by Taylor from the east coast of North America. Setchell and Gardner, 1920, do not report having seen any specimens comparing with the typical species from the Pacific coast, but give *Cladophora Rudolphiana* f. *eramosa* Gardner. D. & R. 3273 is more like this lax form, having longer, simpler branches than D. & R. 3425a, which corresponds rather well with Collins' description and with Harvey's figures. Our specimens are not of large plants; D. & R. 3275 is up to 5 cm. high.

D. & R. 3273, on rocks in tidal creek near Guaymas, Dec.; D. & R. 3425, attached to drifting *Gracilaria*, Empalme, Dec.

Cladophora microcladioides Collins

Collins, 1909a, p. 17, pl. 78, figs. 2, 3; Setch. & Gard., 1920, p. 212, pl. 13, fig. 2.

Several collections of this distinct species have recently been made in the Gulf and extend the range of this plant still farther south on the Pacific coast. The figures of Collins and of Setchell and Gardner are sufficient to identify it, the curved secund ramuli easily setting it apart from others of our region. Plants of different collections vary considerably in size and diameter.

This species is sublittoral in the Gulf, no specimens being known from shore stations except as drift.

D. 147, in 4-32 meters off Tiburon Island, Jan.; D. 348, in 22 meters, Punta Peñasco, Feb.; D. 51, in 3-4 meters, Guaymas Bay, Jan.; D. 380, in 22 meters, Tepoca Bay, Feb.; D. & R. 2928, washed up on beach, Kino, Nov.

Cladophora albida (Huds.) Kütz.

Kützing, 1843, p. 267; Harvey, 1846-51, pl. CCLXXV; Collins, 1909, p. 336.

This species is easily distinguished from others of our region by its very slender filaments and small size. Collins gives the following characters: plants soft, dense, pale green; filaments 21-30 μ diam.; segments 4 to 5 diameters long, delicate; branching irregular; ramuli long, patent, blunt.

Growing with *Cladophora microcladioides*, cast up on beach at Kino, D. & R. 2928a, Nov.

Cladophora delicatula Montagne

Montagne, 1850a, p. 302; Kützing, Tab. Phyc. VI, pl. 1, fig. 2; Collins, 1909, p. 337.

A single collection of a mass of filaments from the tidal flats of Rio Mayo, D. & R. 3207, December, agrees well both with the description of this species given by Collins and with the figure of Kützing. The filaments are about 50 μ in diameter below, with cells about four diameters long. Above, the filaments are 25-35 μ broad and with shorter cells, 1.5-2.5 times as long, often somewhat constricted.

Cladophora graminea Collins

Collins, 1909a, p. 19, pl. 78, fig. 6; Setch. & Gard., 1920, p. 211.

One specimen of this coarse, erect species, corresponding excellently with Collins' figure and description, was collected in a rock pool on the shore of Tiburon Island, D. 677, July. It is distinguished by its erect habit and coarse texture, main branches about 300 μ in diameter, and very long cells up to 30 diameters long below.

Other specimens tentatively to be referred here: D. & R. 3147, on tidal rocks, Guaymas, 3229, in tide pools near Guaymas, 3134a, on tidal rocks at entrance to Guaymas harbor, Dec.; D. 70, in shallow water along shore of Guaymas Bay, Jan.; D. 271, dredged in 12-22 meters, Puerto Refugio, Jan.

These latter collections are robust, coarse, erect plants perhaps of *Cladophora graminea*. The branching, however, is more secund and the cells generally shorter than described for that species. They may prove to be of a distinct entity when more ample collections are at hand and more information is available as to the appearance of *C. graminea* in nature in the Gulf. For the present, it seems best to set them off in this way.

Cladophora trichotoma (Ag.) Kütz.

Kützing, 1849, p. 414; Howe, 1911, p. 492; Setch. & Gard., 1920, p. 210, pl. 16, fig. 2.

A fragmentary specimen from La Paz, in the Herbarium of the New York Botanical Garden, ex. herb. C. L. Anderson, was doubtfully identified with this species by M. A. Howe. It was not considered worth while to re-examine this specimen. The record must remain a questionable one for our area until confirmed by ample material.

Cladophora MacDougallii Howe

Howe, 1911, p. 491, pl. 33, fig. 7; Collins, 1912, p. 96; Setch. & Gard., 1920, p. 214.

The type specimen was taken in San Felipe Bay by D. T. MacDougal in February, 1904. No specimens referable to this species have appeared in recent collections. Collins considers it very near to or the same as California specimens of *Cladophora ovoidea*, but Setchell and Gardner prefer to consider the two distinct. From other Gulf species it is said to be distinguished by its rather large diameter, 135-310 μ in main branches, 75-110 μ in ultimate lateral ramuli, and by its short cells, mostly 1.5-2.5 times as long as broad, somewhat constricted at the septa.

Cladophora hesperia S. & G.

Setch. & Gard., 1924, p. 713, pl. 13, fig. 17.

A comparison of D. 653 with the type of this species indicates that the two are the same. The plants collected by the writer were, like the type, growing in a dense, thin mat on rock surfaces. They are 1-1.5 cm. high, abundantly branched, and in all respects conform to the description and illustration given by Setchell and Gardner.

Brand. 21, growing in muddy habitat at the southern extremity of Lower California; D. 653, on middle littoral rock surfaces, rocky point north of Kino, July.

D. 602f from San Gabriel Bay, Espiritu Santo Island, is only a scrap of a specimen but perhaps should be referred here. It is more lax than the typical species but is of the same size and habit.

Cladophora tiburonensis sp. nov.

Plate 31, Figs. 1-3

Frondes caespitosae, 3-4 mm. altae, matta fibrarum multicellularum ramosarum affixae; filis erectis superne circa 25 μ diam., stricte, subdichotomo usque ad secundo ramosis; cellulis 4-5 plo. diam. longioribus; zoosporangiis circa 40 x 70 μ amplis.

Plants 3-4 mm. high, forming small, dense tufts on rock surfaces, crustaceous corallines, etc., attached by a spreading mat of multicellular, branched, creeping filaments, bright green; individual fronds erect, with a stupose axis, about 60 μ diam. below, ultimate branches about 25 μ diam.; branches strict, subdichotomous to secund, gradually decreasing in diameter to the extremities, but these + — blunt; cells mostly 4-5 diameters long, occasionally much longer below; mature and empty zoosporangia present, the cells short and swollen, about 40 to 70 μ in dimensions, conspicuous beside the slender cells of the sterile branches.

TYPE: Dawson 132, scraped from rock pools at low tide, Turner's Island near Tiburon Island, Jan. 24, 1940. Herb. AHF no. 5.

The erect, stiff habit of this minute plant, resembling *Cladophora graminea* in all but size, sets it apart from any known Pacific coast species. The presence of zoosporangia and its encrustation with diatoms and other minute epiphytes indicate its maturity.

Family Bryopsidaceae

Genus BRYOPSIS Lamouroux

Bryopsis plumosa var. *pennata* (Lam.) Børg.

Børgesen, 1913, p. 117. *Bryopsis pennata*, Vickers, 1908, p. 30, pl. LII.

The specimens at hand agree closely with Vickers' figures. Only a single collection is available, but specimens were obtained in luxuriant abundance. The plants are 3-4 cm. high, forming very thick, rounded tufts on rock surfaces. This species was not present at the time of the winter expedition and is apparently a warm-water annual.

D. 688, lower littoral reef-rocks, Turner's Island, July.

Family Caulerpaceae

Genus CAULERPA Lamouroux

Caulerpa van Bosseae S. & G.

Setch. & Gard., 1924, p. 704, pl. 13, figs. 13-15.

Bryant 1 (AHF no. 72), islands of San Jose and Espiritu Santo; D. 214, lower littoral rocky shore, Puerto Refugio, Jan.

The latter specimens are large and vigorous, measuring several centimeters in extent, of somewhat larger diameter than the type throughout (500-800 μ). They grow in loose, spreading tangles over broken shell in rock pools.

***Caulerpa racemosa* var. *uvifera* (Turn.) W.-v. B.**

Weber-van Bosse, 1898, pp. 360, 362, pl. XXXIII, figs. 6, 7.

One collection of very abundant material made at San Gabriel Bay, Espiritu Santo Island, agrees with the figures given by Madame Weber. The plants were growing in mats several centimeters thick and sometimes a meter or more in extent on the sand bottom of abandoned oyster-culture ponds at the head of the lagoon. Here, the absolutely quiet water was about 25° C. and abounded with these plants and schools of small tropical fish.

D. 600, Feb.

***Caulerpa racemosa* var. *chemnitzia* (Esper) W.-v. B.**

Weber-van Bosse, 1898, p. 376, pl. XXXI, figs. 5-8.

A few rather dwarfish, immature specimens were collected on the rocky shore of Agua Verde, D. 541, February. They show in general the characters delineated by Madame Weber for the above variety, and, though not entirely satisfactory, this designation will probably serve best for the present material, which may not be at all typical. The plants form mats about 7 cm. wide, thickly branched, the erect branches bearing assimilating laterals which are very irregular as to both arrangement and length.

***Caulerpa pinnata* f. *pectinata* (Kütz.) W.-v. B.**

Weber-van Bosse, 1898, pp. 290-291, pl. XXIV, fig. 3.

The few specimens at hand correspond sufficiently well with the figures of both Kützting (Tab. Phyc. VII, tab. 5) and Madame Weber to be designated under the above name. The plants have long, spreading, prostrate rhizomes with a few erect, pinnate branches up to 4.5 cm. high.

D. 269, dredged in 12-22 meters over sand and coralline bottom, Mejia channel, Puerto Refugio, Jan.

***Caulerpa sertularioides* (Gmel.) Howe**

Howe, 1905, p. 576. *Fucus sertularioides* Gmelin, 1768, p. 151, tab. 15, fig. 4. *Caulerpa plumaris* Weber-van Bosse, 1898, pp. 294-295.

This species is strictly a lagoon dweller in the quiet, warm waters of the southern part of the Gulf. It is found growing on the sand bottoms of the shallow bays and lagoons, and was collected several times by means

of a long-handled rake from a skiff. The only form thus far known is that which has been called *C. sertularioides* f. *longiseta* (J. Ag.) Weber-van Bosse (Børgesen, 1913, p. 133).

D. 563, on sand bottom with coral clumps, shallows of San Gabriel Bay, Espiritu Santo Island, Feb.; D. 574, dredged in 6-12 meters, same locality; D. 618, abundant on mucky bottom of oyster-culture ponds, forming extensive mats with *C. racemosa* var. *uvifera*, same locality.

Family **Codiaceae**

Genus **HALIMEDA** Lamouroux

Halimeda discoidea Decaisne

Decaisne, 1842a, p. 102; Howe, 1907, pp. 495-500, pl. 25, figs. 11-20, pl. 26; 1911, p. 492; Setch. & Gard., 1920, p. 177, pl. 13, fig. 3; 1924, p. 704.

This species is reported thus far only from the warm waters of the southern part of the Gulf. Three very early collections were made at La Paz. H. 724, dredged in 40 meters off San Jose del Cabo, August; D. 519, dredged in 30-40 meters over sand bottom at Puerto Refugio (the most northern locality).

Halimeda discoidea is here near or at the northern boundary of its potential area. None of the specimens collected are of the size and vigor of examples from Central America and other parts of the Pacific. It has already been suggested that low calcium content of the Gulf sea water may in part account for their scanty development.

Genus **CODIUM** Stackhouse

In 1924, when Setchell and Gardner wrote their account of the Gulf species, only a few collections were available, and nothing was recorded on the ecology of the various species or of their appearance in nature. Since the preservation of material by drying destroys much of the normal aspect of these plants, unless one has some experience with the species of a particular region it is difficult to visualize the nature of the plants from the dried specimens. The recent experience of the author in the field and the somewhat more extensive collections have made possible a revision of the several Gulf *Codium* species from a different point of view.

The author considers utricle shape-characters of secondary importance in distinguishing the species at hand, for considerable variation due to age and habitat may occur in the same plant. Indeed, utricles of various ages,

shapes, and sizes may occur side by side in the same part of a plant. The species of the Gulf of California, as recognized in this paper, are distinguished first by their gross morphology and habit, secondarily by utricle characters. Since gross morphology is modified by age, we must consider the possibility that small plants such as have been placed under the name *Codium cervicorne* may likely be young stages of a species like *C. simulans*. A plant collected in summer such as that named *C. unilaterale* may be a more aged form of a plant similar to that named *C. Brandegeei*. A floating plant such as *C. amplivesiculatum* may be a growth form of *C. unilaterale* or *C. longiramosum* from the same station. *C. anastomosans* was described from immature material but has juvenile characters which suggest its possible distinctness. All of these problems must be investigated in the field before any of the specific determinations given here can be confirmed. However, with the information at hand, the following modifications in nomenclature seem justified.

A re-examination of the type of *Codium simulans* and of *C. Brandegeei* indicates that these two plants are essentially indistinguishable. Setchell and Gardner saw similarities between the two but stated no points of distinction. The type of *C. Brandegeei* is a fragmentary specimen with no positive data as to either locality or date. It does, however, match *C. simulans* and other comparative specimens so closely that its synonymy here can be stated with certainty. *Codium unilaterale* is an entity which is recognized by Setchell in recent study notes as being closely related to *C. simulans*. The plant was collected in the summer and is undoubtedly an older growth form of this species, exhibiting the same fundamental characters merely in a somewhat larger, more expanded form. On the other hand, the type of *C. cervicorne*, though future investigation alone can verify this, shows every evidence of being the juvenile form of the same species. In all these plants the utricles are of the same shape, the size varying directly with that of the specimens. Thin end-walls in the utricles of *C. unilaterale* are conspicuous but may not be of genetic importance.

Codium unilaterale is one of that remarkable set of specimens collected in July, 1921, by Johnston (74) in the lagoon at Pond Island. Pond Island's "rattlesnake harbor" is only about 150 yards long, the whole island being less than a square mile in area. In this lagoon Johnston collected several specimens which Setchell and Gardner segregated under three names, *C. unilaterale*, *C. amplivesiculatum*, and *C. longiramosum*, by reason of the strikingly different appearance of the dried plants. In February, 1940, the author collected in the same lagoon specimens which

seem to be either *Codium anastomosans* or juvenile examples of *C. sinicola*. Now, it seems remarkable indeed that four species of *Codium* should be growing side by side in that very small area. True, at present there is no way by which we can show that they are genetically related, and at least tentatively these specimens must remain separately designated, but it is strongly suspected that at Pond Island, inside and outside the lagoon, there are situations which will, upon investigation, reveal much as to the influence of environment on the growth forms of these *Codia*. It is probably to be expected that at that time further changes in the present nomenclatorial concepts will become necessary.

Most of the recent collections of *Codium* are of young plants, few of them having attained a sufficiently mature stage of development to allow them to be matched satisfactorily with the older specimens collected in the spring and summer. A large number of the author's specimens are small plants resembling the types of either *C. cervicorne* or *C. anastomosans*. In some instances it is impossible to draw any lines of distinction. *C. anastomosans* is, however, here left separate, awaiting verification of the permanency of its caespitose, clumping habit which may prove distinctive.

***Codium simulans* S. & G.**

Setch. & Gard., 1924, p. 706, pl. 14, figs. 21, 22, pl. 31. *Codium unilaterale* Setch. & Gard., 1924, p. 710, pl. 15, figs. 30, 31, pl. 36. *Codium Brandegeei* Setch. & Gard., 1924, p. 712, pl. 14, figs. 25, 26, pl. 30. *Codium cervicorne* Setch. & Gard., 1924, p. 712, pl. 14, figs. 19, 20, pl. 32b. *Codium tomentosum*, Howe, 1911, p. 493 (not of Stackhouse).

The species here understood as *Codium simulans* is probably the commonest member of this genus in the Gulf, and its growth-forms are responsible for the several names given in synonymy. With regard for seasonal and other ecological variation, all of the specimens listed under the several names can reasonably be considered as being of a very close genetic relationship. With the exception of the somewhat larger utricles with thin end-walls in *C. unilaterale*, a difference perhaps to be expected in such larger specimens, there are no points with which the utricles can be used to distinguish them. From all indications of the collections at hand, *C. cervicorne* is probably a young form of this plant, not yet having developed the distinctive branching habit of the larger specimens. The type

specimens of *C. simulans* and *C. Brandegeei* are quite indistinguishable in all respects. The latter name is based on a single, imperfect specimen from La Paz, likewise the type locality of *C. cervicorne*.

D. 439 from the south shore of San Esteban Island, February, seems to be most like the *C. Brandegeei* type in all respects. Though diameter relations are difficult to interpret in the dry specimens, part of this collection grades into the more robust-appearing plants of D. & R. 3411, 3231 from Guaymas, December, 2926, Kino, November, and D. 109, Turner's Island, January. These specimens were evidently dried slowly and retained more of their original size and form. The dichotomous branching is less regular than is common in the other specimens referred to *C. simulans*, but the plants are not fully mature and in other respects there is considerable similarity.

D. 74, Guaymas, January, is another plant closely related here but showing more divaricate branching. The terminal portions of the branches are shriveled to slender proportions from rapid drying and give the specimens a peculiar appearance. Young specimens present in the collection resemble the type of *C. cervicorne*: D. 107, Turner's Island, D. 310, Gonzaga, D. 396, Tepoca Bay. Nothing short of a study of these plants in the field will be able to establish them in their proper relation to one another.

Codium conjunctum S. & G.

Setch. & Gard., 1924, p. 706, pl. 15, figs. 32, 33, pl. 32a.

Specimens matching the type have not been rediscovered. This is a small, caespitose species which in bearing slender branches is apparently distinct from the others of the Gulf.

J. 16, Tortuga Island, June.

Codium amplivesiculatum S. & G.

Setch. & Gard., 1924, p. 709, pl. 15, figs. 28, 29, pl. 35.

The type specimen is highly distinctive in appearance from anything else known. (See the general discussion of *Codium*.)

J. 74 (AHF no. 67), floating in Pond Island lagoon, July.

Codium longiramosum S. & G.

Setch. & Gard., 1924, p. 710, pl. 15, fig. 27, pl. 37.

The very long, unbranched, cylindrical segments set this specimen off from any others known. (See general discussion of *Codium*.)

J. 74b, floating in Pond Island lagoon, July.

Codium cuneatum S. & G.

Setch. & Gard., 1924, p. 708, pl. 16, figs. 24, 25, pl. 34. *Codium reductum*
Setch. & Gard., 1924, p. 707, pl. 14, figs. 23, 24, pl. 33.

Specimens given two different names were collected by Johnston in virtually the same locality. Smith Island, the type locality of *C. cuneatum*, is immediately opposite Los Angeles Bay, the locality for *C. reductum*, and only a short distance off shore. In habit and general aspect, though differing somewhat in branching proportions, the two type specimens are certainly of the same species, and it seems best to consider them as such in this account. Fresh specimens would undoubtedly confirm the decision more fully, though it seems clear enough that *C. reductum* is but a less regularly flabellately branched growth form of *C. cuneatum*.

In the original account the description of *C. reductum* immediately precedes that of *C. cuneatum*, but the type specimen of the former is fragmentary and very much inferior to that of the latter. Hence, according to the International Rules, it is permissible to retain the name bearing the fullest description of the plant.

Codium anastomosans S. & G.

Setch. & Gard., 1924, p. 711, pl. 16, figs. 36, 37.

Plants collected in January and February which match quite perfectly the type of this species are closely branched, + — hemispherical clumps, the branches smaller in diameter than those of *C. conjunctum*. The species is here maintained with due realization that the type specimen is probably an immature plant without gametangia, and that further comparative work is essential before it can be substantiated.

J. 84e, Puerto Refugio rocks, June.

D. 109a, Turner's Island, Jan., and 396a, Tepoca Bay, Feb., are mixed in with other juvenile specimens which seem to belong somewhat more probably to *Codium simulans*. *C. anastomosans*, as interpreted here, is of darker color when dry and is attached to the substratum at more than one point.

Codium MacDougalii sp. nov.

Plate 53, Fig. 1

Frondes 8-10 cm. altae, essentialiter cylindricae, disco 1 cm. lato affixae; ramis irregulariter usque ad 4-plo furcatis, inferne constrictis, latioribus in partibus mediis, usque ad 11-13 mm. tumefacientibus; utriculis longis, gracilibus, 1100 μ longis, superne 125-200 μ latis; gametangiis angustis, fusiformibus, 250-300 μ longis, 70-90 μ latis.

Thallus 8-10 cm. high, essentially cylindrical, attached by a disk about 1 cm. broad; one to several erect axes arising from the holdfast; branches irregularly forked, narrow below and constricted at the junctions, broadest in midportions above, swollen to as much as 11-13 mm.; utricles long, slender, about 1100 μ long in upper swollen parts, mostly 125-200 μ diam., shorter and narrower below but of same proportions; end-wall very thick, 50-75 μ , laminate, smooth, dome shaped; gametangia mostly narrow fusiform, 250-300 μ long, 70-90 μ broad.

TYPE: MacDougal, Port Libertad, Sonora, May 4, 1923. Isotype, Herb. AHF no. 6.

This is one of the most outstanding species of the Gulf of California, distinct at once from any of the other Pacific coast species, and one of the few known in which the branches are swollen above. The utricles are notably long and narrow, and the end-walls very thick. In Setchell's study notes there is a statement that he has considered this plant near to *Codium contractum* Kjellm. of northeast Asia, another species with swollen upper branches.

An additional collection of this plant was recently made by Dr. Poin-dexter at Punta Peñasco, near the type locality, March, 1941. His specimens are largely immature, but some show very well the broad, swollen upper portions of the branches.

PHAEOPHYCEAE

Family Ectocarpaceae

Genus **ECTOCARPUS** Lyngbye

Ectocarpus Mitchellae Harv.

Harvey, 1852, p. 142, pl. 126; Saunders, 1898, pl. 21, figs. 1, 2; Setch. & Gard., 1925, p. 428.

The collections from the Gulf agree in all essential particulars with this species as delineated by Saunders. In the description by Setchell and Gardner, the plants from the Pacific coast have not been separated satisfactorily from those of the Atlantic coast (Taylor, 1937, p. 111). The present specimens are 2-4 cm. high and vary from green to olivaceous brown upon drying. Only plurilocular gametangia are present.

D. 358, 363, growing on *Sargassum*, Punta Peñasco, Feb.; D. 644, growing on young *Sargassum*, *Ralfsia*, etc., in rock pools, middle littoral, San Jose del Cabo, Feb.; H. 717, Santa Maria Bay (outer coast), Aug.

Ectocarpus confervoides f. variabilis Saunders

Saunders, 1898, p. 155, pl. 23; Setch. & Gard., 1925, p. 414, pl. 46, fig. 7; Phyc. Bor. Amer., no. 1737.

D. 747, densely tufted, .5-1.0 cm. high, on disintegrating *Sargassum* fronds, lower littoral, Turner's Island, July.

Ectocarpus mucronatus Saunders

Saunders, 1898, p. 152, pl. 19; Setch. & Gard., 1925, p. 429.

The present collections have uniformly sessile, ovoid, short-acuminate plurilocular gametangia and conform in all other essentials to *Ectocarpus mucronatus* as described and figured by Saunders. The type is from San Pedro, California, and the Gulf collections extend the range into a new area.

D. 358a, plants .8-2.5 cm. high, attached to the bladders of *Sargassum*, upper sublittoral, Punta Peñasco, Feb.

Ectocarpus Bryantii S. & G.

Setch. & Gard., 1924, p. 720, pl. 17, fig. 45.

According to Setchell and Gardner, *Ectocarpus Bryantii* and *E. gonodoides* are evidently closely related and both have near affinities in the

pusillus group of Sauvageau (1895). Both species differ from all others recognized by Setchell and Gardner in the method of branching and in the lack of hairs terminating the erect filaments.

Bryant 3a, growing on *Codium simulans*, La Paz. Not again detected.

Ectocarpus gonodioides S. & G.

Setch. & Gard., 1924, p. 721, pl. 17, fig. 44.

According to Setchell and Gardner, the small tufts of this species remind one of the genus *Gonodia* (*Myriactis*), but the penetrating part, which extends relatively deeply into the host, is composed of slender, almost colorless, slightly branched, closely intertwined filaments, which, however, do not coalesce or form a false parenchyma as in the case of some species of *Gonodia*.

J. 47e, growing on *Codium cuneatum*, Smith Island, July. Not again detected.

Ectocarpus sonorensis sp. nov.

Plate 31, Fig. 5

Frondes usque ad 10 cm. altae; filis primariis usque ad 50 μ diam., cellulis 1.25-1.50-plo diam. longioribus; ramificatione semierecta, moderate remota; ramulis superne usque ad 12 μ attenuatis; ramis ultimis usque ad apicem acutam elongato-subulatis; ramellis spinuliformibus superne numerosis; gametangiis plurilocularibus gracilibus, usque ad 400 μ longis, 20-25 μ latis, in extensionem cellularum vegetativarum terminantibus, pedicellis 2-cellularibus suffultis.

Plants large, light green abundantly and finely branched, to 10 cm. high; main filaments up to 50 μ in diam., of thin-walled cells 1.25-1.5 times as long as broad; branching semi-erect, rather distant; ramuli gradually attenuating from 40 μ to 12 μ diam., ultimate branches elongate-subulate, to a sharp point, in terminal parts bearing numerous short, spine-like ramelli; chloroplasts pale, thin, nongranular, apparently lining the walls; plurilocular gametangia developing in same position and orientation as short vegetative branches of upper parts of the plant, uniformly borne on a 2-celled pedicel, slender, to 400 μ long, 20-25 μ wide, ending in a pointed extension of vegetative cells 30-120 μ long; zoosporangia unknown.

TYPE: D. & R. 3281 (Field Museum, Chicago; isotype, AHF no. 7), on rocks in tidal stream, 3 km. east of Guaymas, December 15, 1939.

Its large size and branching habit, together with the peculiarities of its plurilocular gametangia, identify this species as a very distinctive one from our coasts.

Ectocarpus Hancockii sp. nov.

Plate 31, Fig. 4

Frondes 4-6 mm. altae, dense caespitosae; filis erectis non crebro ramosis, circa 20 μ diam., cellulis 2-3-plo diam. longioribus; gametangiis plurilocularibus lateralibus, sessilibus, 125-175 μ longis, 28-32 μ latis, anguste lanceolato-conicis.

Plants 4-6 mm. high, forming dense tufts on surface of rocks or crustaceous coralline algae, attached by a mat of cells and basal filaments from which the erect filaments arise abundantly, the latter infrequently branched, about 20 μ diam., not constricted, commonly blunt-tipped, with cells mostly 2-3 diam. long; plurilocular gametangia abundant, lateral, sessile, 125-175 μ long, 28-32 μ broad, narrowly lanceolate-conical; zoosporangia unknown.

TYPE: D. 133, on rock and crustaceous coralline surfaces, middle littoral, Turner's Island reef off Tiburon Island, Jan. 24, 1940. Herb. AHF no. 8.

This species differs in several respects from any other known from the Pacific coast. Its small size, saxicolous habit, commonly unbranched filaments, and long slender, sessile gametangia are characters which in combination mark this plant as very distinct.

Family **Myrionemataceae**Genus **COMPSONEMA** Kuckuck**Compsonema immixtum** S. & G.

Setch. & Gard., 1924, p. 724, pl. 17, fig. 49; 1925, p. 487.

J. 58b, growing on *Colpomenia sinuosa* f. *deformans*, Isla Partida, July. Not again detected.

Family **Ralfsiaceae**Genus **RALFSIA** Berkeley**Ralfsia pacifica** Hollenberg ms.

Ralfsia verrucosa Setch. & Gard. (at least in part not of J. Agardh), 1925, p. 497.

Thallus very dark brown to blackish, 400-800 μ thick, coriaceous, 2-10 cm. in extent, firmly adhering to substratum throughout. The Gulf specimens were examined by Dr. Hollenberg, and, though all are sterile, he finds them satisfactorily referable to this unpublished species.

On rocks with crustaceous corallines, lower littoral: D. 397a, Tepoca Bay, Feb.; D. 468, San Esteban Island, Feb.; D. 757a, Turner's Island, July; D. 318a, Gonzaga Bay, Jan.

Ralfsia californica S. & G.

Setch. & Gard., 1925, p. 497, pl. 36, fig. 22.

Unfortunately, the material is sterile, but it is a thin species which seems to correspond in most respects with *R. californica*. Fertile material will be required to establish this determination.

D. 619, on rocks with crustaceous corallines in quiet water of shallow lagoons, San Gabriel Bay, Espiritu Santo Island, Feb.; D. 479c, Puerto San Carlos, near Guaymas, Feb.; D. 130a, reef at Turner's Island, Jan.

Ralfsia Hancockii sp. nov.

Plate 31, Figs. 6, 7; Plate 54, Fig. 2

Frondes leves, crustosae, irregulariter lateque lobatae, usque ad 6 cm. diam. prorsum per rhizinas pluricellulares ad substratum arcte adhaerentes, in partibus sterilibus 175-200 μ crassae; cellulis stratorum 2-3 basaliu horizontaliter elongatis et iis ramos assurgentes ad directionem marginium producentibus; partibus fertilibus 150-175 μ crassis, inferne hypothallo 3 stratos compacto cellulis cubicis et superne paraphysibus gracilibus et sporangiis unilocularibus compositis; paraphysibus 150-175 μ longis, gracilibus, clavatis, 7-9 μ diam., sporangiis unilocularibus 90-110 μ longis, 20-30 μ diam.

Thallus flat, smooth, crustose, irregularly and broadly lobed, to 6 cm. in diameter, bister brown, firmly adhering to the smooth rock substratum throughout, largely by means of small, branched, pluricellular rhizoids; sterile vegetative portions 175-200 μ thick; cells of basalmost 2-3 layers elongated horizontally, these leading into branching, assurgent rows in the direction of the margins, the cells averaging about 12 by 25 μ in dimensions; fertile portion 150-175 μ thick, of slender paraphyses and unilocular sporangia from a compact, 3-tiered hyperthalllic layer of quadrangle cells; paraphyses 150-175 μ long, slender, clavate, 7-9 μ diam. at thickest outer ends, of cells much longer than broad below, mostly at least 1.5 times as long as broad above; unilocular sporangia clavate, with a narrow basal stalk, 90-110 μ long, 20-30 μ in diameter.

TYPE: D. 640, growing over bare rock surfaces in middle littoral, San Jose del Cabo, Feb. 16, 1940. Herb. AHF no. 9.

This species is very distinct among those of our region in its light brown color, its thick, adherent thallus of assurgent cell rows, and in the length and slender proportions of the paraphyses.

Family **Elachistaceae**Genus **GONODIA** Nieuwland**Gonodia Johnstonii** S. & G.

Setch. & Gard., 1924, p. 722, pl. 17, figs. 46, 47; 1925, p. 506.

J. 11b, growing on *Sargassum lapazeanum*, San Marcos Island, June. Not again detected.**Gonodia Marchantae** S. & G.

Setch. & Gard., 1924, p. 723, pl. 17, fig. 48; 1925, p. 506.

M. 22a, growing on the fronds of *Sargassum horridum*, Eureka, May. Not again detected.

According to Setchell and Gardner, *Gonodia Marchantae* differs from *G. Johnstonii* in the character of the basal penetrating portion, the former having few narrow filaments and the latter having a dense, copious, pseudoparenchymatous base. Two or three cells in the lower part of the free filaments are usually asymmetrical in *G. Marchantae* and not so in *G. Johnstonii*. Neither species has hairs or any indication of having had them, a prominent character as figures by Thuret and Bornet in *Etudes Phyc.* pl. 7, figs. 2-6, for *Elachista pulvinata*, and mentioned by Yendo as 'paraphysibus paucioribus' in *Myriactis Sargassi* (Nov. Alg. Japon., 1920, p. 3). *G. Marchantae* is close to *G. pulvinata* in character of the basal penetrating portion. *G. Johnstonii* in general resembles *G. moniliformis* but is much smaller throughout.

Family **Sphacelariaceae**Genus **SPHACELARIA** Lyngbye**Sphacelaria furcigera** Kütz.Kützing, *Tab. Phyc.* V, p. 27, pl. 90; Setch. & Gard., 1924, p. 724, pl. 19, fig. 58.

Gametophytic specimens were detected on Marchant's collections of *Sargassum* (22) and provisionally identified by Setchell and Gardner as *Sphacelaria furcigera*. Propagulum-bearing specimens, which seem satisfactorily to correspond to those of this species as figured by Kützing, have recently been observed growing on *Sargassum*.

D. 686b, growing on old, lower stems of *Sargassum Camouii*, Tiburon Island, July.

Sphacelaria brevicorne S. & G.

Setch. & Gard., 1924, p. 725, pl. 19, figs. 59, 60.

Brand. 59 on *Sargassum*, La Paz; D. 598b, on and among encrusting algae in coral heads, San Gabriel Bay, Espiritu Santo Island, February.

In describing this species Setchell and Gardner say: "*Sphacelaria brevicorne* has very close affinity in *S. cornuta* Sauv. (1901, p. 132, repr.) the type locality of which is New Caledonia. Unfortunately, we have no fruit on ours. We are basing the distinction from *S. cornuta* largely on the differences in the character of the propagula."

D. 589b is undoubtedly of this same species but even more closely resembles *S. cornuta*. The propagulum-rays are 3-4 celled and often markedly acute, rather than "short, blunt, and of two cells," as stated in the original description of *S. brevicorne*. Some, however, are identical with the Setchell and Gardner figure. The plants are about 3 mm. high, somewhat larger than those of the Brandege collection, but it is not unlikely that the latter specimens are younger, the propagula not fully mature, this accounting for the shorter rays and the smaller size of the whole plants. For the present, the specimens on hand will be placed under the name given to them by Setchell and Gardner, although this may be relinquished in favor of *S. cornuta* as a fuller knowledge of our species is developed.

Sphacelaria Hancockii sp. nov.

Plate 31, Fig. 8

Fronde caespitosae, 8-12 mm. altae, inferne dense superne sparse ramosae; ramis omnibus erectis strictisque; filis 35-60 μ diam.; pilis copiosis, 500-1000 μ longis; propagulis tribuliformibus, 75-90 μ latis, 100-110 μ longis, pedicellis 2-3 cellularibus suffultis et radiis inconspicuis, quibusque cellula rotunda singula aut leviter protrudente aut non protrudente compositis; zoosporangiis gametangiisque nondum visis.

Erect filaments forming brown tufts on rock surfaces, 8-12 mm. high, attached by a small, dense mat of rhizomes, densely branched from the base, sparsely and irregularly above; all branches erect and strict; filaments 35-60 μ in diam.; segments as broad as high, with vertical partitions only; hairs abundant, 500-1000 μ long, of up to 10 cells, about 15 μ in diam.; propagula tribuliform, 75-90 μ broad, 100-110 μ long, on 2-3-celled pedicels; rays inconspicuous, each of one rounded cell, little projecting or not at all; zoosporangia and gametangia unknown.

TYPE: D. 643, on rocks in middle littoral, entangled with *Cladophora*, *Ectocarpus*, *Ceramium*, etc., San Jose del Cabo, Feb. 16, 1940. Herb. AHF no. 10.

D. 703, on rocks in middle littoral, Turner's Island, July.

This species is very near to *Sphacelaria novae-caledoniae* Sauv. (1914, p. 141, fig. 34) in morphology, but is not known to be parasitic or epiphytic as is that species. It is considerably larger, with filaments mostly 40-50 μ in diameter, none as slender as 20 μ . The propagulae are, however, very similar. Sauvageau does not mention the presence of hairs in *S. novae-caledoniae*.

Family Cutleriaceae

Genus CUTLERIA Greville

Cutleria Hancockii sp. nov.

Plate 54, Fig. 1

Frondes dimorphae; gametophyticae 4-6 cm. altae, 100-140 μ crassae, laminis complanatis, membranaceis, flabellatis, 3-6 cm. latis, marginibus trichothallico crescentibus; sporophyticae crustosae, per rhizinas pluricellulares ramosas laxae affixae, usque ad 2 cm. diam., multilobatae, marginibus integris, in superficie supera 20-30 μ revolutis; divisione cellulari marginali crescentes.

Gametophytic plants 4-6 cm. high, with flat, membranous, flabellate blades with broadly rounded margins, prostrate at first and attached by numerous rhizoidal outgrowths from the under side, soon erect; flabella 3-6 cm. broad, with marginal trichothallic growth, somewhat lacinate in outer, submarginal parts, 100-140 μ thick, of large, thin-walled, + — rectangular, colorless, medullary cells 100-125 μ in greatest length, bordered on either side by a single cortical layer of very small, brick-shaped cells rich in chromatophores, 5 by 12 μ in cross section, nearly quadrate in surface view but with rounded corners; gametangia unknown; sporophytic thallus thin, crustose, light brown, loosely attached by branched, pluricellular, nonmoniliform rhizoids to articulated corallines and other semiloose substrata, spreading to 2 cm., multilobed; lobes 2-5 mm. broad, rounded; margins entire, turned back 20-30 μ on upper surface; growth by marginal cell division; surface cells quadrate, 6-8 μ in dimension; growing together with gametophytic plants in January.

TYPE: (gametophyte) D. 111, lower littoral on rocky reef, Turner's Island off Tiburon Island, Jan. 24, 1940. Herb. AHF no. 11a.

TYPE: (sporophyte) D. 164, lower littoral on rock-shingle beach, southwest shore of Tiburon Island opposite Turner's Island, Jan. 25, 1940. Herb. AHF no. 11b.

D. 318, sporophytes and gametophytes, rocky shore, Willard's Island, Gonzaga Bay, Jan.; D. 410, gametophytes, rocky shore, Pond Island, Feb.

The collections of this plant from the Gulf were first identified as *Zanardinia prototypus* (Nardo) Nardo (Dawson, 1941, p. 119), a species which they resemble very closely. The discovery and investigation of an "*Aglaozonia*" among the collections led, however, to the conclusion that the plant belongs to *Cutleria*, a genus whose sporophyte stage has long been known as *Aglaozonia*. *Zanardinia*, on the other hand, does not have dissimilar gametophytes and sporophytes. Close correspondence in general aspect was found also with *Cutleria adspersa* (Roth) De Not. Sauvageau (1899, p. 298-301) has compared *Cutleria adspersa* and *Zanardinia prototypus* (*Z. collaris*), which differ very little in the nature of the sterile gametophytes and has pointed out the slight distinctions. Since, however, the sporophyte is present also in the Gulf collections, comparison could be made on two bases. Hamel (1931-1939, p. 325) discusses the gametophyte of *C. adspersa* together with its sporophyte, known as *Aglaozonia melanoidea*. The latter plant is characterized by its very dark color and firm attachment to rock surfaces. Its size reaches several (4-8) cm. The *Aglaozonia* stage from the Gulf, which in one case was found growing directly at the base of the *Cutleria* gametophyte, and which is without question the sporophyte of that plant, is not dark in color, is not firmly attached to the substratum, and reaches only 1.5-2 cm. in extent. Though little can be found to distinguish the gametophyte of our species from *Cutleria adspersa*, except perhaps the thin appearance of the cortical cells in cross section, the presence of a distinctive type of sporophyte seems sufficient to establish this plant as a species new to science.

It is remarkable in being the first member of the order Cutleriales to be positively recorded from the Pacific coast of America.

Apparently it is an ephemeral plant, and no specimens were found in July, 1940, although special search was made at the precise spot from which examples were taken in January. This fact would indicate a winter annual development. All gametophytes found in January were in excellent, fresh, rapidly growing condition, all with fine trichothallic marginal fringes.

Cutleria adspersa (Roth) De Not has been reported in Japan, but as yet no sporophyte *Aglaozonia* stage has been mentioned. The Japanese plant may perhaps be the same as ours, but evidence is at present incomplete.

Family **Dictyotaceae**Genus **DICTYOTA** Lamouroux**Dictyota crenulata** J. Ag.

J. Agardh, 1847, p. 7; Setch. & Gard., 1924, p. 730, pl. 18, figs. 50, 51.

A collection taken from beach drift at San Jose del Cabo, D. 629x, February, is identical with that previously reported from the Gulf, name-ly, Brand. 24, from La Paz. Taylor (1939, p. 8) has reported it from off Punta Gorda in 12-20 meters, Waldo Schmitt, 7, July, 1938.

The author's specimens average 10 cm. high, are finely but conspicuously denticulate and richly proliferous with sporelings as mentioned by Setchell and Gardner (loc. cit.).

Dictyota hesperia S. & G.

Setch. & Gard., 1924, p. 731, pl. 18, figs. 52, 53.

D. 713, 718, middle littoral rocks, Turner's Island, July.

The present specimens compare well with the type from Tortuga Island, J. 32 (AHF no. 71), and with the cotype from San Marcos Island, J. 5, both collected in June. The species seems to be a summer annual, since it was not found at the Turner's Island station in January. Its smaller size, 3-5 cm., and narrower segments, 1-1.5 mm., serve to distinguish it from the much more abundant *Dictyota Johnstonii* of the same habitat.

Dictyota Johnstonii S. & G.

Setch. & Gard., 1924, p. 730, pl. 18, figs. 54-56, pl. 39.

J. 4, lower littoral rocks, San Marcos Island, June; J. 81 (AHF no. 70), Isla Partida, July; D. 95, rocky reef, Turner's Island, January, D. 740, July; D. 659, middle littoral rocks north of Kino, July; D. 686, cobblestone beach, south shore of Tiburon Island, July; D. 155, dredged in 4-32 meters off south shore of Tiburon Island, Jan.

The winter and summer collections at Tiburon Island in 1940 have revealed much concerning the seasonal development of this species. January collections on the reef at Turner's Island and off the shore of Tiburon Island yielded a few plants, mostly very young. At that season individual plants were only occasional and formed no conspicuous colonies. The surface temperature in January was 15.5-16° C. In July, when the first low-tide collections were made on the shore of Tiburon Island, the

great abundance of this species was the most conspicuous feature of the vegetation. Together with *Padina Durvillaei* and *Ishige foliacea*, *Dictyota Johnstonii* made up the bulk of the vegetation, far surpassing the young *Sargassum* plants in quantity. On the reef at Turner's Island the change in the vegetation from that of January was even more pronounced. *Sargassum*, which had been so conspicuous and abundant, was gone, as were *Colpomenia* and *Gigartina*. Quantities of *Dictyota Johnstonii* clung to almost every rock, and the alga was the dominant member of the summer flora. Many plants were over 15 cm. high, and everywhere the growth was very dense.

Though we have such a record from only a single locality, it seems safe to say that *D. Johnstonii* is a very abundant, sometimes dominant, summer annual, reaching its highest development at the peak of the warm-water summer season. The water temperature on the reef at Turner's Island was 31° C. by July 18, an increase of 15.5 degrees over the temperature in January. Johnston's specimens are also large, vigorous plants and probably are indicative of this species' abundance in other localities in the upper Gulf.

Dictyota Vivesii Howe

Howe, 1911, p. 497, pl. 27.

One collection from the waters of the Cape region compares favorably with Howe's illustration of Vives' plant from La Paz. The divaricate habit, smaller size, and shorter segments distinguish this species from *Dictyota Johnstonii*. Furthermore, the latter plant is thus far known only from the coasts of the northern third of the Gulf of California.

Though Howe does not mention anything in regard to the habitat of Vives' plants, we may assume, perhaps, that they were cast up as were most of his collections. Further collecting will verify whether it is confined to the tropical waters of our coast.

D. 623, dredged in 34-50 meters off Gorda Point, south of La Paz, Feb.

Genus **NEUROCARPUS** Weber & Mohr *Neurocarpus zonarioides* (Farlow) Howe

Farlow, 1899, p. 73; Howe, 1914, pp. 69-70; Setch. & Gard., 1924, p. 728; 1925, pl. 95.

This species was first collected in the Gulf by Johnston on high sublittoral (lower littoral) rocks at Tortuga Island. These specimens, col-

lected in June, are 8 to 12 cm. high and with broad segments (5-8 mm.). In February, 1940, the author found specimens cast up in abundance on the beach near San Jose del Cabo. They are up to 16 cm. high and with only a few broad segments from the basal parts, the upper parts being very abundantly branched into narrow segments about 1 mm. in width. So little do the upper parts of these plants resemble the more typical broad segments of *N. zonarioides* that they were at first suspected of being of a different species. A careful examination of the lower parts and younger segments showed convincingly, however, that the plants should be placed here. They have woody, stupose axial parts and are apparently over-mature.

Poindexter has recently collected at Punta Peñasco, Sonora, March, 1941, several specimens which correspond closely with Johnston's Tortuga Island material.

Genus **PADINA** Adanson
Padina Durvillaei Bory

Bory, 1826, pl. 21, fig. 1; Setch. & Gard., 1924, p. 729.

The numerous collections of this species by Marchant, Brandege, Bryant, and Johnston (S. & G. loc. cit.) showed that it is abundant and widely distributed in the lower littoral and upper sublittoral belts throughout the Gulf of California during the months April to June. The present collections (which include specimens obtained in November, December, January, February, March, April, and July) allow us to conclude that this plant is perennial in the Gulf and is adaptable to great variations of water temperature known to exist in its habitats.

The species is to be found at almost all shore stations, but grows most abundantly in large colonies on the smooth rock and sand bottoms of shallow bays and lagoons. E. F. Ricketts, Pacific Biological Laboratories, Pacific Grove, California, makes the following statement of observations at Puerto Refugio, April 2, 1940: "Very common flat alga; acres of the littoral were choked with this form."

Development of new fronds from the perennial bases apparently begins in late fall and becomes most rapid by about December. January and February collections are of maturing specimens, mostly with fresh, full, nonlacerated margins. Collections from late July to early November are largely lacerated and covered with other organisms, and are obviously old. Some early December collections show many very young fronds, no old ones. Specimens collected near Guaymas, December 22, show great increase in growth over those collected three weeks earlier.

The species is widespread along the whole coast from Costa Rica to the head of the Gulf of California and is evidently a plant developing long-lived annual fronds, often from perennial bases, though rapid winter growth from sporelings probably accounts for by far the greater number of plants. Fruiting material is most abundant in spring and summer.

D. 538, Agua Verde Bay, Feb.; D. 386, Tepoca Bay, Feb.; D. 309, Gonzaga Bay, Jan.; D. 139, Tiburon Island, Jan.; D. 681, July; D. 89, Turner's Island, Jan.; D. 748, July; D. 413, Pond Island, Feb.; D. 281d, Puerto Refugio, Jan.; D. & R. 3137, Guaymas, Dec. 2, 3391, Dec. 22, 3239, Dec. 6, 3324a, Dec. 21, 2930, Nov. 10; D. 66, Guaymas, Jan.; H. 1, San Jose del Cabo, Aug.; Poindexter, Punta Peñasco, March.

Padina mexicana sp. nov.

Plate 52, Fig. 2

Frondes complanatae, expansae, resupinatae, late flabellatae, 1.5-4 cm. latae integrae stipite basali non insigniter distincta, basim arcte et prorsum per rhizinas numerosas e superficie infera orientes affixae, calce incrustatae, candido-calcareo-fuscae, zonatae; laminis prope margines revolutas 2 stratosi, aetate provecta 4-6 stratosi; pilis tantum in superficie supera; tetrasporangiis in superficie supera, in lineis interruptis aut in gregariis sparsis zonas interpilae occupantibus.

Thallus flat, expanded, resupinate, broadly flabellate, 1.5-4 cm. broad, entire, without a recognizable basal stipe, attached at base and throughout by numerous rhizoids from the under surface, these holding the plants firmly to dense tufts of articulated corallines (*Jania*, *Amphiroa*) rather heavily calcified, of a light chalky, gray-brown color, zonate, but noncalcified piliferous lines parallel with the margins; lamina of 2 cell layers near the revolute margins, of 4-6 layers in older parts, the cells of the outer layers in cross section about half as long as the inner, though this is not so definite in the lower layer; hairs on upper side only; tetrasporangia borne on upper surface in broken lines or scattered in groups in interpilar zones, covered with a thin indusium; antheridia and oogonia unknown.

TYPE: D. 725, middle and lower littoral, Turner's Island reef, off Tiburon Island, July 18, 1940. Herb. AHF no. 12.

This species is near to *Padina Vickersii* in color and structure, but differs from that and other related species in its remarkable habit of growing firmly attached by its whole under surface to the irregular coralline substrate. Overlapping laminae become firmly adherent to each other by the same rhizoidal development. It is in striking contrast with *P. Durvillaei* in all its specific characters.

Padina mexicana is a rather short-lived summer annual, appearing only with the warm-water season. It was found fairly abundant in July

in rock pools measuring 31° C., growing with *Amphiroa* and *Jania*, but was not seen at all in January at the same station.

Family **Sporochnaceae**

Genus **NEMACYSTUS** Derb. & Sol.

Nemacystus Brandegeei (S. & G.) Kylin

Kylin, 1940, p. 49. *Meneghiniella Brandegeei* Setch. & Gard., 1924, p. 5; 1925, p. 549, pl. 47, fig. 11, pl. 49, fig. 16.

Kylin did not have examples of this species when he wrote his revision of the Chordariales, and he was able to judge the systematic position of this plant only from the published description and figures, the latter quite inadequate for his purpose. A reinvestigation of the type specimen together with another specimen of recent collection confirms Kylin's opinion. Setchell, in a marginal note in his personal copy of the *Melanophyceae* (S. & G., 1925), had also reached the conclusion that the species belonged to the genus *Nemacystus* of Derbès and Solier, but this was never published.

The genus as delimited by Kylin includes those plants having a single central axis-strand, growth in length by means of an apical cell rather than by intercalary division, and in the presence of vegetative hair-branches clothing the whole of the thallus surface.

Recent collections of *Sargassum* leaves show this species is epiphytic. Only a single example was found, this at the northernmost station in the Gulf, whereas the type came from La Paz in the southern region.

Brand. 24, cast up at La Paz; D. 359, on a *Sargassum* leaf dredged in shallow water near shore at Punta Peñasco, Sonora, Feb.

Family **Scytosiphonaceae**

Genus **COLPOMENIA** Derb. & Sol.

Colpomenia sinuosa (Roth) Derb. & Sol.

Derbès & Solier, 1856, p. 11, pl. 22, figs. 18-20; Setch. & Gard., 1925, p. 539, pl. 45, figs. 82-86.

To avoid added confusion, though Sauvageau (1927, p. 350) has questioned the occurrence of true *Colpomenia sinuosa* on the Pacific coast of North America, the name is here used by which the plants under consideration have long been known and may most readily be recognized.

From the material now at hand it is clear that several forms or varieties of this species are abundant perennial inhabitants of the shores of the

Gulf of California. At least three different entities are present, and, following the practice of Setchell and Gardner (loc. cit.), they are here identified as forms. In the case of plants known as *C. sinuosa* f. *deformans* this treatment would seem hardly justifiable if based only on specimens of the Gulf of California, since the forma *deformans* as found in the Gulf is strikingly distinct from the other forms. Indeed, f. *deformans* is so sharply defined and so different in shape and texture that the author was at first inclined to place it in the genus *Scytosiphon*. However, it does have a small, bullate, colpomenioid basal portion from which tiny, hollow projections arise, pushing outward and expanding into the long, hollow sacs of the mature frond. Sections at the narrowest point of the stipelike portion indicate a hollow structure throughout, unlike *Scytosiphon*. These specimens are, to the author's knowledge, the most extreme of any referred to *C. sinuosa* f. *deformans*.

Within the Gulf there are relatively few specimens which can be satisfactorily identified with *C. sinuosa* f. *typica*. Some examples are perfectly smooth, but the greater number are slightly to very strongly tuberculate, all gradations being present in young as well as in old plants.

Colpomenia sinuosa f. *tuberculata* (Saunders) S. & G.

Saunders, 1898, p. 164, pl. 32; Setch. & Gard., 1924, p. 725.

On almost every rock-shingle beach or in stony places bordering bays and lagoons, these plants are to be found growing in abundant colonies attached to the stones. Plants 10-14 cm. in diameter are frequent in some localities.

Colpomenia sinuosa f. *expansissima* is undoubtedly a form of *C. sinuosa* f. *tuberculata*, which has achieved very extensive development in a detached, floating condition in warm water. This form was described by Setchell and Gardner in 1924 from specimens collected by Johnston, floating on San Francisquito Bay, Lower California.

D. 422, Pond Island, Feb.; D. 307, Gonzaga, Jan.; D. 220, Puerto Refugio, Jan.; D. 351, dredged in 6-20 meters, Punta Peñasco, Feb.; D. 384, Tepoca Bay, Feb.; D. 636, Feb. (young); D. 90, Turner's Island, Jan.; J. 26, San Francisquito Bay, June; J. 117, Los Angeles Bay, May; M., Brand., La Paz, May.

Rosenvingea intricata (J. Ag.) Børg.

Plate 52, Fig. 1

Børgesen, 1914, pp. 181-183. *Encoelium intricatum*, Kützing, Tab. Phyc. IX, tab. 5.

This plant is here reported for the first time from our coasts. It is evidently an inhabitant of the warm waters of shallow bays and lagoons in many parts of the world.

Growing in middle littoral, in quiet water of shallow, silty bays and lagoons, on substrata of loose gravel or coarse sand and broken shell: D. 306, Willard's Island, Jan.; D. 385, Tepoca Bay, Feb.; D. 424, Pond Island, Feb.; D. 606, San Gabriel Bay, Espiritu Santo Island, Feb.

Genus **HYDROCLATHRUS** Bory

Hydroclathrus clathratus (Bory) Howe

Howe, 1920, p. 590; Setch. & Gard., 1924, p. 727. *Hydroclathrus cancellatus* Harvey, 1859, tab. 98.

Thus far, specimens of this tropical species have been found only in the warm waters of the southern part of the Gulf. When found they are only occasional.

Brand. 11, cast ashore at La Paz; M. 12, Eureka; D. 598d, growing in coral heads on bottom of shallow lagoon, San Gabriel Bay, Espiritu Santo Island, Feb.; D. 608, among other algae on rock shingle, same locality.

Family **Chnoosporaceae**

Genus **CHNOOSPORA** J. Ag.

Chnoospora pacifica J. Ag.

J. Agardh, 1847, p. 7; Kützing, Tab. Phyc. IX, tab. 86; Setch. & Gard., 1924, p. 728.

M. 16, Eureka; Brand. 39, cast ashore at La Paz.

This species has not again been encountered, and its absence from all the recent collections as well as from those of Johnston suggests that it may be of strictly tropical distribution and limited to the warm waters of the southern extremity of the Gulf. The type was collected by Liebmann at St. Augustine, near Acapulco much farther south on the coast of Mexico.

Family **Ishigeaceae**

Genus **ISHIGE** Yendo

Ishige foliacea Okam.

Plate 53, Fig. 2

Okamura, in Segawa, 1935, pp. 65, 66; Okamura, 1936, p. 239, figs. 130, 131; Yendo, 1907, p. 155, pl. II, figs. 1-8.

This peculiar brown alga may be distinguished from all others on our coast by its dichotomous, complanate fronds, 4-7 cm. high, composed of a medullary tissue of tangled hyphal cells and a cortex of rows of antically arranged cubical cells.

As to the systematic position of the plant Segawa says: "*Ishige* Yendo was put by Yendo under the Fucaceae in his 'Fucaceae of Japan,' but recently zoospores have been observed by different authors and the new family has consequently been established.

"Of the establishment of the new family Okamura is of the opinion that *Ishige* may be put in the Chnoosporaceae, though *Chnoospora* has a parenchymatous structure in the inner layer instead of a filamentous one. Apart from this difference of structure of the frond, uniseriate gametangia alone are known in *Chnoospora*, while in *Ishige*, zoosporangia only. So, until the true nature of both kinds of reproductive organs of both genera is fully known, it certainly seems best, at present, to place *Ishige* in a family of its own."

Ishige foliacea Okam. was separated from *I. Okamurai* Yendo by Okamura. It had been considered by Yendo a foliose type of the more or less cylindrical *I. Okamurai*. These plants were first described from Japan and are known to be common on the warmer coasts of that country as well as along the coast of China, to Amoy and southward. Up to the present record it has not been known outside of Far Eastern habitats.

On the coast of Japan and China both foliose *Ishige foliacea* and the more or less cylindrical *Ishige Okamurai* grow together in the same localities. In the Gulf of California, on the other hand, only the former has been found. The Gulf plants are identical in structure and in external morphology with Japanese plants of *I. foliacea*, and the summer collections show in some sections cortical cell rows which seem to bear zoosporangia as figured by Okamura (1936, fig. 131). Fronds vary in width from 1 to 5 mm., the narrowest ones being found in July, the broad ones in February.

This plant seems to be perennially abundant on many reefs and rock-shingle beaches of the upper half of the Gulf. In winter it was found plentiful in the middle littoral zone at all of the shore stations visited between San Esteban Island and Tepoca Bay. In summer it competes with *Dictyota Johnstonii* as the most conspicuous rock cover on the south shore of Tiburon Island.

D. 190, Puerto Refugio, Jan.; D. 313, Gonzaga Bay, Jan.; D. 388, Tepoca Bay, Feb.; D. 446, San Esteban Island, Feb.; D. 680, south shore of Tiburon Island, July.

Family **Desmarestiaceae**
Genus **DESMARESTIA** Kjellm.
Desmarestia filamentosa sp. nov.

Plate 76

Frondebis cylindraceis, inferne lente compressis; stipitibus 1.5-2 mm. diam., 5 cm. usque ad laminam primam; ramis totaliter oppositis et copiosis, gradatim et successive magnitudine decrescentibus; ramulis ultimis gracillimis flaccidisque, 80-100 μ diam.; corporibus reproductivis ignotis.

Fronds cylindrical, or somewhat compressed in older parts, to 5 dm. high, with profuse, opposite branching throughout, from a stipe about 5 cm. long below the first branches, pale greenish brown when dry; main axis 1.5-2 mm. diam. with 4-5 orders of branches gradually reduced in size, the ultimate ramuli very slender and flaccid, 80-110 μ diam., each producing by trichothallic growth from its tip a slender, monosiphonous hair of short, swollen cells about 40 μ diam., in a catenate series; reproduction not seen.

TYPE: Dredged in 15 fathoms, Puerto Refugio, Angel de la Guardia Island, March 20, 1937. Herb. AHF no. 64.

This species is similar in general form and structure to *Desmarestia media* (Ag.) Grev. from Alaska and Puget Sound. It also resembles *D. compressa* (Reinsch) Skottsberg from the Antarctic region.

Desmarestia mexicana sp. nov.

Plate 77

Frons membranacea, 9-15 dm. alta, ad 18 cm. lata, e disco simplici, 8-10 cm. longe stipitata, simpliciuscula vel e stipite ramosa; frons e stipite cuneatim dilata, simpliciuscula, costata, dentata.

Fronds from a small discoid holdfast giving rise to a slender, compressed, usually branched stipe 8-10 cm. long, 2-3 mm. wide, the several branches expanding gradually into large, broad, thin, membranous blades 9-15 dm. long, up to 18 cm. wide, of a pale greenish brown color when dry; blades unbranched, with a slender mid-vein from which opposite, lateral veins branch at regular intervals, these breaking up into fine veinlets; margins with regularly spaced, broad, low teeth, the abruptly sharp points directed upward; blades commonly lacerate above, the apical parts unknown.

TYPE: Dredged in 15 fathoms, Puerto Refugio, Angel de la Guardia Island, March 20, 1937. Herb. AHF no. 65.

The two *Desmarestia* species here described from Puerto Refugio are remarkable in being the southernmost representatives of the genus on our

coasts. Hitherto, San Diego, California, had marked the southern limits of this cold-water genus, and to find two species in the Gulf of California is indeed unexpected. The waters of Puerto Refugio at 15 fathoms' depth, however, are quite as cold in March and earlier as some of our more northern Pacific waters, 13-14°C., and therefore allow environments acceptable to the members of this genus. The presence of *Desmarestia*, on the other hand, does not seem in accord with the complete absence of members of the Laminariales. Yet, considering the poorly explored nature of the sublittoral waters of the Gulf, some even of these may remain to be found as more extensive exploration is carried out.

Family Laminariaceae

Genus **MACROCYSTIS** C. Agardh

Macrocystis pyrifera (Turner) Ag.

C. Agardh, 1820, p. 47; Setch. & Gard., 1924, p. 728.

J. 78, caught in the log line of vessel between Espiritu Santo Island and La Paz, April.

"A single specimen about 3 feet long was brought aboard the ship, but no specimens were found growing attached within the Gulf"—Johnston.

Family Sargassaceae

Genus **SARGASSUM** C. Agardh

J. Agardh, 1889, pp. 32-34; Setch. & Gard., 1925, p. 711; Setchell, 1937, pp. 127-158.

The Sargassa of the Gulf of California, as determined from a study of almost every specimen known to have been collected in that area, may be arranged under four major type-groups according to leaf-shape, costation of the leaf, and cryptostomata. These characters mark off groups of species with reasonable distinctness, and, with few exceptions, these groups seem to be natural, the members of each showing close mutual relationship.

All of the Sargassa of the Gulf fall under J. G. Agardh's subgenus *Eusargassum*. Further arrangement according to his system, that is, under his groups *Zygocarpicae*, *Acanthocarpicae*, *Malacocarpicae*, etc., is too confusing to be attempted, since when the sexuality of the various species is taken into consideration the characters used as a basis for Agardh's broader classifications are too unreliable. Therefore, in this paper, the

plants are placed under the four natural groups, each designated by the name of the principal or most expressive species of the group.

A considerable reduction in the number of species proposed by Setchell and Gardner has been necessary, as well as the addition of three new ones. From the specimens at hand in 1924 these authors were largely justified in proposing the names they did. The material was often fragmentary, the importance of the sexual nature was not so well understood as at present, and little or nothing was known about the native habitats of the various species or of seasonal disturbances. The present collections and records help considerably toward clearing up some of the problems surrounding this genus as it occurs in the Gulf, but the work is still in a preliminary state.

KEY TO THE SPECIES OF SARGASSUM IN THE
GULF OF CALIFORNIA

- I. Leaves without a midrib (sometimes dimly costate in *S. Johnstonii* and *S. lapazeanum*)
 - A. Johnstonii group: leaves very narrow, semiterete to flattened (branching usually abundant, loose, spreading; vesicles elliptical, long-apiculate; cryptostomata usually frequent) *S. Johnstonii*
 - B. Lapazeanum group: leaves expanded, asymmetrical.
 1. Vesicles mostly long-apiculate *S. acinacifolium*
 2. Vesicles with foliaceous crest or extension
 - a. Vesicles mostly only cristate; upper leaves less than 1 cm. long *S. lapazeanum*
 - b. Vesicles with prolonged foliaceous extension; upper leaves large, more than 1.5 cm. long.
 - (1) Lower leaves usually less than half as long as broad *S. asymmetricum*
 - (2) Lower leaves almost as broad as long *S. MacDougalii*
- II. Leaves with a midrib
 - A. Sinicola group: cryptostomata abundant and usually conspicuous on leaves of upper parts of plants; vesicles mostly spherical; known holdfasts parenchymatous or of short, coarse rhizomes.
 1. Plants not lax, with short internodes and short lateral branches; color dark gray-brown; base a solid parenchymatous disk or cone *S. Camouii*

2. Plants usually lax, with + — long internodes and + — long lateral branches; color brown; base so far as known of coarse, short, woody rhizomes.
 - a. Receptacles spinose or terminally dentate in both sexes; stems strongly muricate in oogonial plants *S. horridum*
 - b. Receptacles smooth or nearly so in both sexes; stems usually smooth *S. sinicola*
- B. Herporhizum group: cryptostomata absent or inconspicuous on leaves of upper parts of plants; vesicles apiculate (see also *S. sinicola* for some specimens); holdfasts of long, loosely developed rhizomes.
 1. Leaves dentate to very strongly so; dentations more or less evenly spaced *S. Brandegeei*
 2. Leaves slightly and irregularly dentate or merely with uneven margins; plants drying very dark *S. herporhizum*

I. The *Johnstonii* Group

Plates 32, 33

Leaves ecostate, very slender, expanded to filiform; branching loose, secondary mostly bifarious; vesicles elliptical, with long apiculae or linear, foliar extensions; cryptostomata usually frequent.

The plants of this group are especially distinct from all others as regards leaf-structure. The very slender, flattened to cylindrical leaves give the plants a delicate, stringy appearance. They bear fairly numerous, large cryptostomata which appear like eruptions on the surface. These characters are generally reliable, especially when combined with the elliptical vesicles which are almost universally tipped with a medium to long apicula or flattened, linear, leafy extension. Sometimes the vesicles are slender and the apicula is several times as long as the bladder. More commonly the apicula and bladder are of about equal length.

Antheridial and oogonial specimens are present in the collections, but the receptacles are not markedly different, showing about the same degree of branching and no recognizable difference in diameter. The antheridial receptacles frequently have, however, a noticeable denticulation of the tips and the surface, while thus far all oogonial receptacles have been found to be smooth. The specimens available show to some degree evidence of the more general association of vesicles with oogonial "inflorescences" (Setchell, 1937) and of modified leaves with antheridial "inflorescences"

(pl. 32). There are frequent instances elsewhere, as will be shown later, in which this feature is very obvious. It often causes considerable difference in appearance of the fruiting parts of the two sexes. In two collections we have plants of both sexes from the same locality, and it is thus possible to make some statement regarding sexual variation. The plant called *Sargassum Johnstonii* f. *laxius*, for instance, is an antheridial plant from the same collection as that named *S. Johnstonii* f. *gracile*, an oogonial plant.

The species *Sargassum guardiense* was distinguished principally because of its heteroclyte cyme and short apiculae. The type plant is oogonial, and vesicles, as might be expected from the foregoing, are to be found associated closely with the receptacles in the inflorescences. The observations that these often emerge from receptacular tissue gave rise to the idea that this plant was distinct from *S. Johnstonii*. D. 476, however, is a collection including both sexes, the oogonial plant of which is identical in this respect with the type of *S. guardiense*. The antheridial plant shows no such emergence of vesicles from receptacular tissue, and, furthermore, the vesicles are not so important an element of the inflorescence as are the leaves, evidence again of the above-mentioned idea of the inflorescence associations. This heteroclyte cyme character is, then, clearly one of sexual variation in these plants and cannot be relied upon to separate species. *Sargassum guardiense* S. & G. thus falls in as synonymous with *S. Johnstonii*, and we have only the one species and its variety as constituting this first group.

***Sargassum Johnstonii* S. & G.**

Plate 32, Figs. 1-15; Plate 33, Figs. 1, 2, 17-22

Setch. & Gard., 1924, p. 737, pl. 20, fig. 72, pl. 21, fig. 80. *Sargassum guardiense* Setch. & Gard., 1924, p. 732, pl. 19, fig. 64.

Basal parts unknown; plants long and stringy, 1-2 m., with terete, smooth primary axes usually continuous from the base; secondary branching bifarious, at intervals of 3-10 cm., alternate and open below, more closely spaced and sometimes almost opposite above, the branches of more or less equal length, forming a fairly symmetrical branch system densely crowded with fructiferous ramuli; leaves narrowly lanceolate to linear, 1.25-2.25 cm. long, 1-2.5 mm. wide, expanded, ecostate or rarely dimly costate, with sparsely denticulate margins; cryptostomata not abundant but fairly conspicuous; vesicles smooth, narrowly elliptical, 5-9 mm. overall, merging below gradually into a pedicel somewhat shorter than the

body of the vesicle, above into a long apicula which is often somewhat flattened or even resembles a leaf-remnant; receptacles known for both antheridial, oogonial and intersex plants; antheridial receptacles cylindrical, once to several times branched, smooth except frequently for small, scattered teeth, more often associated with leaves than vesicles in the inflorescences; oogonial receptacles little different in size and shape from antheridial ones but with little or no evidence of denticulations, usually associated with vesicles in an inflorescence in such a compact way that it may be termed a heteroclyte cyme.

This is a common species in the lower littoral and upper sublittoral at many stations. E. F. Ricketts says that in April this species is the commonest one below the *Padina Durvillaei* belt at Puerto Refugio.

D. 355, 357a, Punta Peñasco, Feb.; Poindexter, March; J. 71, Georges Island, April; D. 476, Puerto San Carlos near Guaymas, Feb.; D. & R. 2914, Kino, Nov.; J. 2, Puerto Refugio, June; D. 551, cast up at Agua Verde Bay, Feb.

Sargassum Johnstonii f. *gracile* S. & G.

Plate 33, Figs. 3-16

Setch. & Gard., 1924, p. 738, pl. 21, fig. 76. *Sargassum Johnstonii* f. *laxius* S. & G., p. 737, pl. 21, figs. 75, 81.

This form is like the species but more slender and lax throughout, with fewer and longer, more stringy branches; leaves not much flattened, usually filiform with relatively more abundant and conspicuous cryptostomata; vesicles with long cylindrical apiculae.

Growing in upper sublittoral or lower littoral: D. 340, Punta Peñasco, Feb.; M. 28, 28a, Guaymas; D. 63, Guaymas, Jan.

II. The *Lapazeanum* Group

Plates 34-37

Plants from slender, short stipes, attached by an essentially parenchymatous, discoid, semirhizomatous holdfast; leaves ecostate, expanded, unsymmetrical.

Most members of this group are easily distinguished from other Gulf species by their unsymmetrical, ecostate leaves. The group as a whole is rather sharply defined. The members show close mutual relationship in the gradation in size and shape of leaves and vesicles from *Sargassum lapazeanum* to the long-vesicled floating form of *S. MacDougalii*.

Sargassum lapazeanum represents a small-leaved, short-vesicled species found thus far at Guaymas, San Marcos Island, Tortuga Island,

La Paz, and Turner's Island. It has characteristically very small, broad, unsymmetrical leaves, and vesicles with a conspicuous, irregularly toothed crest which may extend into a margin around the edges of the bladder. The small size of the upper leaves and the shortness of this crest distinguish this plant from the other members of the group.

The receptacles of *Sargassum lapazeanum* are quite distinctive, being variously and rather conspicuously dentate in both sexes. The antheridial receptacles are commonly smaller in diameter and more openly branched. In both cases the heteroclyte character is more or less conspicuous. The variation is of such a nature as easily to include the obviously similar specimens given the names *S. Bryantii* and *S. insulare* in the 1924 account. The former has somewhat flattened receptacles, but the type specimen is oogonial. From the study of the sexual dimorphism of receptacles in these plants it is clear that the above character used to distinguish *S. Bryantii* is one of sexual variation. The heteroclyte cyme condition is also variable, and the gradient is such that it seems impossible to set apart the type specimen of *S. insulare* from the two afore-mentioned species. The names *Sargassum Bryantii* and *S. insulare* become synonymous with *S. lapazeanum*.

Sargassum acinacifolium is represented by three mature specimens, two oogonial (Brand. 2, Guaymas; J. 75, San Francisquito Bay, June) and one sterile (MacDougal, Port Libertad, May). This species may be distinguished fairly well on the basis of the vesicles, most of which have merely a simple apicula about 0.6 as long as the bladder, unflattened or not conspicuously so. The smoothness of the oogonial receptacles seems generally reliable as does also the branching habit, which is much more deliquescent than in the two following members of the group. These characters are sufficient for present segregation and they may be found to hold, though relationship with the other members of the group is very close.

The other two members of the group, *Sargassum asymmetricum* and *S. MacDougalii*, are distinguished from the foregoing by a branching habit in which the primary branches are percurrent and the secondary branches distinct, by the vesicles with prolonged, foliaceous extensions, and by the large upper leaves, more than 1.5 cm. long. Reproductive material is present only in *S. asymmetricum*, specimens of which were collected in January at Turner's Island and at Puerto Refugio. The characters of the antheridial receptacles of this species are very much in accord with those of *S. lapazeanum*, having the same branching structure and denticulations. The vesicles are, however, very different in the occurrence

of a markedly foliaceous extension 1-3 times as long as the bladder. The upper leaves are large, strongly one-sided on most specimens, and boldly dentate.

A specimen collected in December by MacDougal at Puerto Libertad is recognized as the same as D. 383 from Tepoca Bay and D. & R. 3392 from Guaymas. These three examples, though immature and sterile, have leaves on the lower parts of the primary stems sufficiently different from the other species of this group that it seems well to distinguish the species *Sargassum MacDougalii*. The proposal is tentative, however, awaiting the collection of more mature material. The nature of the branching, the parenchymatous holdfast, and the short, slender stipe as well as the general character of the leaves are in perfect congruity with the *lapazeanum*-complex.

A comparative study of juvenile specimens of the several species of this group suggests strongly that distinctive characters are evident in the early developmental stages of these plants.

***Sargassum lapazeanum* S. & G.**

Plate 34, Figs. 1-34

Setch. & Gard., 1924, p. 733, pl. 20, fig. 74. *Sargassum Bryantii* S. & G., 1924, p. 733, pl. 21, fig. 83. *Sargassum insulare* S. & G., 1924, p. 735, pl. 20, figs. 67, 68, pl. 21, fig. 78.

Fronds 4.5-6 dm. high, arising from a solid, parenchymatous disk; stipe about 1 cm. long; primary branches terete, smooth, becoming confused above in the secondary branches which are equally long; leaves 0.5-1.25 cm. long, essentially ecostate, asymmetrical, widest above the middle, with very short petioles, the basal half of the upper margin smooth and concave, the remainder of the blade sharply dentate, cryptostomata usually quite abundant and conspicuous; vesicles ellipsoidal, 4-6 mm. long overall, the bladder 1.5-3 mm. crowned or rimmed by foliar remnants which form a crest; receptacles in 2-4 times closely branched, usually more or less heteroclyte inflorescences, the antheridial receptacles somewhat more broadly branched and smaller in diameter than oogonial, variously and quite abundantly denticulate in both sexes.

M. 21, 24, cast ashore, Eureka, May; Bryant 5, La Paz; M. -, Guaymas, Aug.; J. 20, Tortuga Island, June; J. 10, 11, San Marcos Island, June; D. 712, lower littoral rocky reef, Turner's Island, July (all young but seem to have the juvenile characters of this species); D. 746 from same locality seems to be very old, dying or mostly disintegrating specimens of the same species.

Sargassum acinacifolium S. & G.

Plate 37, Figs. 1-26

Setch. & Gard., 1924, p. 724, pl. 21, fig. 82.

Basal parts not positively known, probably a parenchymatous disk-holdfast; branches terete, smooth, deliquescent above; leaves 12-16 mm. long, asymmetrical, the upper margin concave and smooth, the lower margin and apex coarsely dentate, ecostate, cryptostomata absent; vesicles subspherical to ellipsoidal, smooth, with a simple apicula about 0.6 as long as the bladder, commonly unflattened, on pedicels shorter than the diameter; oogonial receptacles 2 to 3 times forked, nearly cylindrical, smooth, or more or less denticulate toward the apices.

J. 75, high sublittoral rocks, San Francisquito Bay, June; Brand. 2, Guaymas?; MacDougal, Port Libertad, Sonora, May 4, 1923; D. 678, lower littoral on cobblestone beach, south shore of Tiburon Island, July (young specimens but apparently with the juvenile characters of this species).

Sargassum asymmetricum sp. nov.

Plate 36, Figs. 8-18

Frondes axi primaria curta (1 cm. longa) gracilique, a rhizomatibus crassis discum efficientibus oriente; ramis primariis teretibus, levibus, strictis, percurrentibus, minime 6 dm. longis; foliis ecostatis, plerumque valde asymmetricis, dentatis, 2-2.5 cm. longis, infernis parvissimis, 3-6 mm. longis; cryptostomatibus inconspicuis; vesiculis ellipsoideis, cum extensionibus foliaceis dentatisque, 1-3-plo longioribus coronatis.

Primary axial stems terete, smooth, strict, percurrent, unbranched to at least 6 dm., from a slender stipe 1 cm. long, attached to a small, knotty disk of short, thick rhizomes, 1-1.5 cm. across; leaves ecostate, usually strongly asymmetrical by means of a smooth, concave upper side, dentate or almost lobed at times, 2-2.5 cm. long, the lowermost very small, 3-6 mm., blunt-lanceolate to almost triangular in shape; cryptostomata small, inconspicuous, but present; vesicles ellipsoidal with usually dentate, foliaceous extensions, 1-3 times as long as bladder; antheridial inflorescences about 1 cm. long, more or less heteroclyte, of 2-4 times branched receptacles which are terminally dentate; oogonial receptacles unknown.

TYPE: D. 156, on rocks in lower littoral, Tiburon Island (opposite Turner's Island), Jan. 25, 1940. Herb. AHF no. 13.

D. 221, on rocky shore, Puerto Refugio, Jan.; D. 314, rocky shore, Gonzaga Bay, Feb. (juvenile specimens); Poindexter, Punta Peñasco, March.

Sargassum MacDougalii sp. nov.

Plate 35, Figs. 1-8; Plate 36, Figs. 1-7; Plate 37, Figs. 27-30

Frondes axi primaria gracili, 1 cm. longa, a disco parenchymatico, affixa; ramis primariis paucis, teretibus, levibus, usque ad 5 dm. continuis; foliis ramorum primariorum ecostatis, asymmetricis, 4-8 mm. longis, 0.6 usque ad quam latis quam longis, acute-denticulatis, cryptostomatibus deuntibus; foliis superis usque ad 2 cm. longis; vesiculis ellipticis extensionibus foliaceis coronatis.

Primary stems several, terete, smooth, continuous as main axes to at least 5 dm., from a slender stipe 1 cm. long, attached by a small parenchymatous disk-holdfast; leaves of lower parts of primary branches ecostate, asymmetrical, small, 4-8 mm. long, 0.6 to nearly as broad as long, lower halves of upper sides smooth, concave, the remainder of blade sharply denticulate especially at apices; cryptostomata absent; upper leaves the same but longer and larger, to 2 cm.; vesicles elliptical with dentate foliar extensions about as long as the bladder; mature plants with receptacles unknown.

TYPE: MacDougal (U.C. 615657; isotype AHF no. 14), Puerto Libertad, Sonora, December, 1923.

D. 383, rocky shore, Tepoca Bay, Feb.; D. & R. 3392, in deep rock pools, Punta San Pedro, near Guaymas, Dec.

D. & R. 3287 and 3311, cast up on shore near Guaymas, December, are very probably of this species, but due to prolonged floating habit have become very lax and all parts attenuated.

III. The *Sinicola* Group

Plates 38, 39

Leaves expanded, symmetrical, costate, irregularly and more or less strongly dentate or dentate-serrate, usually with abundant cryptostomata; vesicles mostly spherical, often with cryptostomata.

The largest and most variable assemblage of *Sargassum* forms in the Gulf of California is that which falls under the above characterization.

The spiny receptacles of *Sargassum horridum* and *S. Marchantae* were among the first subjects to be investigated in this group. They were soon found to belong to the same entity, *S. horridum* being a spiny oogonial plant, *S. Marchantae*, a spiny antheridial plant. Since the former name appears first in the 1924 account, according to article 56 of the International Rules, it is here adopted. Both plants were of the same collection, Eureka, Lower California.

The macrospecies, *Sargassum sinicola*, probably the commonest and most widespread in the region, has, on the whole, smooth receptacles,

though occasional spiny oogonial ones may occur. In general, the oogonial receptacles are shorter and more robust than the antheridial; yet in some cases almost the opposite was found to be true. All the specimens here referred to *S. sinicola* are fundamentally indistinguishable in general appearance and morphology. The leaves, variable in size, are basically the same in shape, dentation, and cryptostomata. The vesicles are nearly always spherical and rather large, a form peculiar to this group (see pls. 38 and 39).

In this complex, variation in the inflorescences seems generally to uphold the observations mentioned above, that oogonial inflorescences show closer association with modified vesicles and antheridial with leaves. However, here again, definite exceptions have been observed in some plants.

As evidenced by specimens collected and observed cast up on the beach at Kino in July (see below), the floating habit has considerable influence on the gross morphological appearance of plants. A prolonged life in the floating condition may account for the undulate, crisped leaves and for modification of receptacular parts. It is undoubtedly the cause of the lighter, yellowish color of these specimens.

Apparently, differences in the age of plants or the luxuriance of growth also determines to some degree the extent of branching of the receptacles. The name *Sargassum cylindrocarpum* S. & G. was given to one bearing much-branched, only slightly spiny receptacles. *S. sinicola* was first used to apply to a form with less abundantly branched, smooth receptacles. In no particular does it seem possible with the knowledge at hand to distinguish the type specimen of the latter from that of *S. polyacanthum* f. *americanum* S. & G.

Sargassum paniculatum (det. W. A. Farlow) appears on the label of a specimen from Guadalupe Island outside of the Gulf. This plant has been referred to *S. californicum* (Grun.) Setchell. The leaves are shorter but of the same proportions in this example, and the antheridial receptacles are very slender, but again its basic nature and aspect do not suggest its distinctness from certain plants referred here to *S. sinicola*.

The collections made in the summer of 1940 between Kino and Turner's Island include both *Sargassum sinicola* (in the broader sense) and a species which is here named *Sargassum Camouii* after the French-Mexican fisherman who guided and navigated us to the island. On the beach at Kino, both were cast up and could easily be distinguished by their contrasting color, *S. sinicola* a light, shiny yellow brown, *S. Camouii* a dull gray brown. On the south shore of Tiburon Island, *S. Camouii* was found growing, attached by woody, basal disk or cone holdfasts to the cobble-

stones (pl. 35, fig. 9). The plants lacked any form of rhizome; and the lower parts of the stems were rough, thick, and gnarled, the upper parts mostly muricate. No mature specimens were present.

At Turner's Island the dark *Sargassum Camouii* was not found; indeed, only very young *Sargassum* plants were present. Some of these proved to be immature plants of *S. sinicola* (a species collected at the same station in January). These showed stiff tangles of short rhizomes as basal holdfasts (pl. 35, fig. 10).

Speculation in regard to the *Sargassum sinicola* problem in this region suggested that, since young plants are present in midsummer, old floating plants being cast up at the same time, and mature, attached plants in January, at least in this particular locality a marked seasonal development of this species occurs.

On the south shore of Tiburon Island, *Sargassum Camouii* was found nearly mature in both January and July. This species, then, has different seasonal development from that of *S. sinicola*; and the observation suggests that, when more extensive field investigations can be made, the seasonal development may prove specifically distinctive in these species and in others as well.

***Sargassum horridum* S. & G.**

Plate 38, Figs. 1-4

Setch. & Gard., 1924, p. 734, pl. 20, figs. 65, 66. *Sargassum Marchantiae* S. & G., 1924, p. 735, pl. 19, fig. 63.

Basal parts unknown; branches and branchlets muricate in oogonial plants, smooth and terete in antheridial plants; leaves linear-lanceolate, acute, midrib percurrent, margins irregularly serrate-dentate to doubly serrate; cryptostomata numerous and conspicuous; vesicles spherical, 4-8 mm. in diam., short-pedicellate; receptacles sexually dimorphic; oogonial decomponently ramose, decidedly spinose; antheridial less abundantly branched, more slender, merely finely spinulose.

M. 17, 22, Eureka, Lower California.

Bryant 7, from the islands of San Jose and Espiritu Santo, and J. 77, from between Ceralbo and Espiritu Santo Island, April, are sterile but seem to belong here.

***Sargassum sinicola* S. & G.**

Plate 35, Fig. 10; Plate 38, Figs. 5-11; Plate 39, Figs. 1-11

Setch. & Gard., 1924, p. 736, pl. 20, fig. 73. *Sargassum cylindrocarpum* S. & G., 1924, p. 738, pl. 21, fig. 77. *Sargassum polyacanthum* f.

americanum S. & G., 1924, p. 736. *Sargassum paniculatum* of S. & G., 1924, p. 740, 1925, p. 721, pl. 46, fig. 5. *Sargassum californicum* (Grun.) Setchell, 1937, p. 129.

The type of *Sargassum sinicola* is a fragment of the upper reproductive part and shows only the special characters of that portion of the plant. A study of entire and fragmentary plants of all Gulf collections has been made to derive the above synonymy. Considering the very wide variation included in this species-complex, no attempt is made here to reach a positive determination of the limits of the species and its varieties, but only to discuss the variations and something of their significance. Thus it may be possible to segregate examples of this complex species from examples of the other, more sharply defined species of the region.

With few exceptions, the proportionately long, narrow, dentate leaves, with conspicuous cryptostomata, the smooth branches and vesicles, together with the basal holdfast of short, coarse, branched, and knotted rhizomes will distinguish this macrospecies. It is usually very much more lax in habit than *Sargassum Camouii*. Vesicles may sometimes have a small apicula (D. & R. 3141). Leaves may sometimes be large, broad, and with inconspicuous cryptostomata (D. 135).

D. 135, Turner's Island, Jan.; D. 738, July; D. 426, Pond Island, Feb.; D. & R. 3355, 3354, 3141, Guaymas, Dec.; M. 29, 30, 31, Aug.; Mexia, 1945, Brand. 5, 3, 1; D. 676b, Kino, July; D. & R. 2927, Nov.; J. 15, Concepcion Bay, June; M. 20, 26, 27, 11, 23, Eureka, May; Bryant 6, La Paz; Brand. 37, 13, 27; D. 357, Punta Peñasco, Feb.; Poin-dexter, March.

A peculiar form of this species with receptacles bearing both oogonial and antheridial conceptacles has been collected twice at Punta Peñasco, Sonora (pl. 39, figs. 6, 7).

Sargassum Camouii sp. nov.

Plate 35, Figs. 9, 11-13

Frondes usque ad 6 dm. altae, axi primaria e disco solido parenchymatico aut cono orientes; ramis primariis asperis; foliis 4-6 cm. longis, lineari-lanceolatis, 6-12-plo longioribus quam latis, costa percurrente, irregulariter dentatis, cryptostomatibus numerosis, parvis; vesiculis sphericis, muticis, 3-4.5 mm. diam.

Plants to at least 6 dm. high, from a solid parenchymatous disk or cone-holdfast; stems rough, usually muricate, coarse and woody below; leaves 4-6 cm. long, linear lanceolate, 6-12 times as long as broad, with percurrent midrib, irregularly dentate, dark-colored, with numerous small cryptostomata which are not conspicuous on dried specimens; gen-

eral habit erect and compact, not lax, internodes very short; vesicles spherical, smooth, 3-4.5 mm. in diam.; receptacles (oogonial) 1-3 times branched, + — cylindrical, somewhat spiny.

TYPE: D. 686a, growing attached to cobblestones on rocky south shore of Tiburon Island, July 17, 1940.

It is unfortunate that most of the specimens of this collection were lost on the return open-boat voyage to the mainland. Only a single plant lacking the holdfast was saved. Field notes, however, verify the recollection that the holdfast of this species is as described above, and this is substantiated by a mature specimen with holdfast among J. Wyatt Durham's material. These specimens are from a bay 10 miles N.W. of Guaymas, October 30, 1940. They agree well with those from Tiburon Island, and represent fully mature plants with abundant receptacles.

D. 158, Tiburon Island, Jan.; D. 463, San Esteban Island, Feb. (probably this species but has undulate leaves); M. 18, 25, Eureka (perhaps the same). Herb. AHF no. 15.

IV. The *Herporhizum* Group

Sargassum herporhizum and *S. Brandegeei* form a compact, easily recognizable group because of the outstanding features of their attachment organs. In both species attachment of adult plants is by means of loose, spreading rhizomes which grow around pebbles and through the generally loose substratum upon which the plants are found. When basal parts are present, these plants need not be confused with species of other groups, for this character together with the absence of conspicuous cryptostomata distinguishes them readily.

Sargassum herporhizum S. & G.

Plate 40, Figs. 1-12

Setch. & Gard., 1924, p. 739, pl. 20, figs. 69-71.

Only two collections of this species are thus far known: J. 72 from Georges Island, April, and J. 55, San Pedro Martir Island, April. These plants are distinct from *S. Brandegeei* in their smaller leaves whose margins are entire or only sparsely denticulate. *S. Brandegeei* is characterized by very bold dentations of the margins.

Sargassum Brandegeei S. & G.

Plate 40, Figs. 13-26

Setch. & Gard., 1924, p. 736, pl. 21, fig. 79.

Plants attached primarily by a parenchymatous disk, but branching

immediately above this soon gives rise to numerous decumbent rhizomes which develop clasping hapteres and form a loose, spreading, holdfast tangle about the substratum; branches and branchlets terete, smooth, without cryptostomata; branching rather dense in the upper parts; leaves 15-25 mm. long, 4-8 mm. wide, apices blunt, base cuneate, margins deeply serrate, cryptostomata absent; vesicles spherical, small, 2-3 mm. diam., smooth, apiculate or crowned by a rudiment of a leaf, supported by pedicels mostly shorter than their diameter, occupying positions of leaves toward the base of ramuli, or scattered among the receptacles; receptacles in short, dense racemes, with short, distinct pedicels below but with sessile branches above, mostly blunt.

Brand. 4, cast ashore, Guaymas?; MacDougal, Puerto Libertad, Dec.; D. 383, Tepoca Bay, Feb.; D. 141, dredged at Tiburon Island, Jan.; D. 157, on rock-shingle beach in lower littoral, south shore Tiburon Island, Jan.; D. 462, San Esteban Island, Feb.; D. & R. 3393, in deep rock pools, Guaymas, Dec.

Sargassum Liebmanni J. Ag.

J. Agardh, 1889, p. 91, pl. 5; Setchell, 1937, p. 130, pl. 28, figs. 1-3.

Setchell, in the above-mentioned paper, has discussed this species so fully that little more need be said here. Reviewing a cotype specimen of Liebmann's collection from St. Augustine, Mexico, together with Mexican and Costa Rican specimens identified with it by Setchell, it seems unlikely that any of the plants of the Gulf of California can be included under that name. Setchell has identified H. 2 and H. 5 from San Jose del Cabo as *Sargassum Liebmanni*, but, since these specimens are only fragments and badly encrusted with foreign matter, it seems undesirable to include them as positive records of this species in our area. Rather it is better to suggest that it may be found in the warm waters of the southern coasts of the eastern side of the Gulf and should be looked for there.

RHODOPHYCEAE

Family **Porphyridiaceae** Kylin, 1937a

Genus **GONIOTRICHUM** Kützing

Goniotrichum elegans (Chauvin) Le Jolis

Le Jolis, 1863, p. 103; Børgesen, 1915, p. 4, fig. 2. *Goniotrichum Alsidii* (Zanard.) Howe, 1914, pp. 75, 76; Setch. & Gard., 1924, p. 741.

Filaments microscopic, monosiphonous, attached by one unmodified, basal cell, pseudoramose, with a thick gelatinous wall.

Frequently found with other minute algae in various collections throughout the Gulf.

The name *Goniotrichum elegans* has been chosen, following the arguments of Børgesen. Zanardini's name *G. Alsidii*, though antedating that of Chauvin, should not be used, for as Børgesen says: "it seems impossible, judging from Zanardini's description and figure to say quite certainly which species of *Goniotrichum* we have to deal with." In any case, there should be no difficulty in recognizing the present entity in our region.

Family **Bangiaceae**

Genus **ERYTHROCLADIA** Rosenvinge

Rosenvinge, 1909, p. 72; Kylin, 1925, p. 9, fig. 3 c-g. *Erythrotrichia polymorpha* Setch. & Gard. (not of Howe), 1924, p. 741.

Specimens epiphytic on *Polysiphonia*, D. 402a, Pond Island, February, correspond precisely with Kylin's figure (loc. cit.). The *Erythrotrichia polymorpha* of Setchell and Gardner is undoubtedly a summer example of this species. The disks are older, larger, and more extensively spread than in the winter example. No young disks are present. The absence of any erect filaments on such material does not suggest its identity with Howe's Peruvian plant, which has abundant, long filaments characteristic of the genus *Erythropeltis*.

Erythrocladia irregularis Rosenv.

Rosenvinge, 1909, p. 72; Kylin, 1925, p. 9, fig. 3 a, b.

Specimens growing on the surface of *Dictyota*, D. 718, Turner's Island, July, seem to correspond most nearly to the figures of this species. They are not the same as *Erythrocladia subintegra* and have more of an irregular structure when young. They had best be referred here awaiting further investigation.

Genus **ERYTHROTRICHIA** Aresch.
Erythrotrichia californica Kylin

Kylin, 1941, p. 3, fig. 1 A-D.

The examples at hand are 1000-1500 μ high and 20-40 μ in diameter, showing no cellular, basal disk. Though somewhat smaller than plants examined from Monterey, California, this is perhaps due to their scantiness and immaturity. It seems best to refer the Gulf plants to the Californian species rather than to *Erythrotrichia Kylinii* from farther north, which is also closely related here.

D. 686b, epiphytic on *Sphacelaria*, Tiburon Island, July.

Erythrotrichia carnea (Dillw.) J. Ag.

J. Agardh, 1883, p. 15; Rosenvinge, 1909, p. 67, fig. 8.

Several examples of this minute epiphytic red alga have been identified from various collections in the Gulf of California. It may be recognized by its slender, unbranched filaments, 16-24 μ diam., of cells slightly longer than broad, attached only by the basal cell and a few minute rhizines.

Genus **ERYTHROPELTIS** Schmitz
Erythropeltis discigera (Berthold) Schmitz

Schmitz, in Engler & Prantl, 1896, p. 313. *Erythrotrichia discigera*,
 Kylin, 1937, p. 44, fig. 19 A-C.

Spreading disks of an epiphytic red which seems referable to this species were detected on the fronds of *Sphacelaria* D. 686, Tiburon Island, July. Short, erect filaments are present arising from the disks which encircle the fronds of the host. Very close similarity is seen with the figures of Kylin, especially as to the appearance of the short, erect filaments. Since the material is scanty and the erect filaments perhaps not fully developed, the present identification must be considered tentative.

The predominance of the spreading disk over the very short, erect filaments suggests that this plant should best be distinguished under Schmitz' genus. Setchell, in a recent manuscript, has considered this treatment most advisable and has included *Erythrotrichia polymorpha* Howe and *E. pulvinata* Gardner in this genus. By distinguishing the genus *Erythropeltis* from *Erythrotrichia* because of its spreading basal disks, the present species is set well apart from *Erythrotrichia californica* and *E. carnea* here recorded from the Gulf. From *Erythrocladia* it is distinct in possessing erect portions.

Genus **PORPHYRA** J. Agardh**Porphyra perforata** J. Ag.

J. Agardh, 1883, p. 69; Hus, 1902, pl. XX, figs. 4a-10; Phyc. Bor. Amer., no. 682.

Specimens agreeing very well with certain forms of this species as they occur on the coast of California and the outer coast of Lower California were collected from an abundance of material on the upper littoral rocks at Agua Verde Bay, D. 539, February. The plants are greenish rose colored when dry, up to 16 cm. high and with lanceolate fronds. The habitat is also typical of the species. Our material is probably nearest to what Setchell and Hus called *Porphyra perforata* f. *segregata* (loc. cit.).

Porphyra Thuretii Setchell & Dawson nom. nov.

Porphyra leucosticta Hus (not of Thuret) 1902, p. 199, pl. XX, figs. 1a-3b; Howe, 1911, p. 499; Phyc. Bor. Amer., no. 376.

Fronds from a small, distinct disk, bearing a short but distinct stipe with cordate base expanding into a broader or narrower oblong membrane, 7-70 cm. long, 2-25 cm. broad, margins somewhat undulate, monostromatic, cells once and a half to twice as broad as high (in transverse section), surface jelly and jelly between cells thin, very readily soluble in dried plants; monoecious, spermatangia forming small elongated patches among the dark-colored cystocarps, the fruit at first marginal, gradually developing over the whole frond, compact, no vegetative cells mixed with the reproductive cells; vegetative frond 25-50 μ thick, cystocarpic 25-50 μ thick, spermatangial 30-50 μ thick; each cystocarp (simple) forming 8 spores (in two tiers); spermatangia (simple) forming 64 spermatia arranged in two spherical groups in each spermatangium; color pinkish.

TYPE: W. A. Setchell 5161 (Univ. Calif., Herb.), Pacific Grove, California.

Specimens are also known in California from Santa Cruz and from Monterey Bay, on rocks or sometimes epiphytic, March to May.

Hus has already called attention to the fact that the Pacific coast specimens referred by him to *Porphyra leucosticta* Thuret differed from the European and N. E. Atlantic coast specimens in being more definitely stipitate, in being a much lighter shade of red, and in the arrangement of the spermatia within the spermatangium. Although the type specimen of Thuret has not been studied, in view of these differences and the wide discontinuity in distribution it seems best to bestow upon the California

plant another specific name and to dedicate it to that Prince of Phycologists, Gustav Thuret.

The specimen from the Gulf of California referred by Howe (loc. cit.) to this species has been re-examined, and his statements can here be confirmed. It is undoubtedly very closely related if not identical with the plants of the outer California coast. He also noted a difference from the European plants, but followed Hus in his determination. Howe's plant was collected at San Felipe Bay by MacDougal, February, 1904, and described as follows: "Thallus monoecious; antheridia in spots and streaks adjoining sporocarps, both unmixed with vegetative cells; carpospores 8; spermatia 64; thallus disintegrating and deliquescing when dried specimens are soaked in fresh water."

Resembling the true *Porphyra leucosticta*, *P. Thuretii* also seems to be a spring annual.

In relationship, *P. Thuretii* seems closer to the distromatic species as regards the smaller number of spermatia and carpospores. Rosenvinge (1909) says that the number of spermatia in *P. leucosticta* is often smaller than 64 from each mother cell, and that "the carpogonia produce 4 and 8 spores in two layers."

We are here considering *Porphyra leucosticta* and *P. Thuretii* as two monostromatic species, closely related taxonomically, but widely separated geographically.

Family Chantransiaceae

The plants of this family are small, even to microscopic, and unless they occur in quantity on a given host or other substrate, most of them are very easily overlooked. Consequently, many more species may be expected in the Gulf of California than have thus far been detected.

It has been considered advisable to use the genus *Rhodochorton* in the more expanded sense (Drew, 1928) in the designation of the species thus far known from the Gulf.

Genus **RHODOCHORTON** (Naegeli) Drew

Rhodochorton microscopicum (Naeg.) Drew

Plate 41, Fig. 3

Drew, 1928, p. 163. *Callithamnion microscopicum* Kützing, Tab. Phyc. XI, pl. 58, fig. 2.

A large number of plants were found growing on a *Polysiphonia* taken on shore at Turner's Island, D. 737, July. They are 30-50 μ high exclusive of the long terminal hairs.

Rhodochorton arcuatum Drew

Drew, 1928, p. 165, pl. 37, figs. 1-3.

Specimens growing on the surface of *Sphacelaria* are quite identical with the figure given by Drew. The plants are hairless, about 50 μ long, and consist of a few short branches of barrel-shaped cells. The plants may be recognized further by the reclining position of the main branch in relation to the host, always ascending at an acute angle (see Drew description, p. 165).

D. 686d, on *Sphacelaria furcigera*, Turner's Island, July.

Rhodochorton Hancockii sp. nov.

Plate 41, Figs. 4-6

Fronde epiphyticae, per cellulam unicam basalem non-amplificatam affixae; filis erectis 500-1500 μ longis, 5-7 μ latis, leviter attenuatis, cellulis 3-4-plo diam. longioribus; filis sterilibus rare, filis fertilibus frequenter, ramosis; ramellis curtis, secundis, vulgo simplicibus, 2 (-pauci)-cellularibus; monosporis vulgo in ramellis curtis lateralibusque terminalibus aut sessilibus, ovoideis, 6-7 μ diam., 10-11 μ longis.

Plants epiphytic, attached to host by a single, unenlarged basal cell; erect filaments abundant and very close together, slender, 500-1500 μ long, 5-7 μ diam., slightly attenuated to apices, with cells 3-4 diameters long, cylindrical; sterile filaments rarely or almost unbranched in some specimens, more frequently in others; fertile filaments more frequently branched, with short, lateral, second branchlets in series; branchlets mostly simple, 2 (or several) celled, narrowed to 4 μ diam., the cells 1.5-2 diam. long; reproduction known only by monospores; sporangia mostly terminal on the short, lateral branchlets, sometimes sessile, ovoid, 6-7 μ diam., 10-11 μ long.

TYPE: D. 218a, growing on *Gelidium*, from shore of Puerto Refugio, Jan. 27, 1940. Herb. AHF no. 16.

No other species has been described from the Pacific coast which has the very long, simple branches and single unenlarged basal cell of this plant. Many cross sections of the host have been made in endeavoring to find penetrating filaments, but only the simple, epiphytic attachment of the single cell has been seen in the type. The filaments arise, however, densely over the whole surface of the host, innumerable simple strands at-

tached individually to the surface cells. Sterile specimens are so simple in morphology (unbranched) that at first observation they do not seem to resemble *Rhodochorton*.

In D. 381c, Tepoca Bay, February, a few filaments arising from short, prostrate filaments seem otherwise like this species, though long branching is more frequent. D. & R. 3425d, on *Gracilaria*, Guaymas, December, is a sterile example of this species.

A specimen from San Martin Island on the outer coast of Lower California, H. 626, on *Cystoseira*, resembles this species very closely in general appearance, but was tentatively named *Rhodochorton variabile* Drew by N. L. Gardner in manuscript. The fragmentary material available seems to indicate a base of creeping filaments and in other respects shows close similarity to D. 381c. These two collections may be mutually identical and yet different from *R. Hancockii*, but, for the present, material is not sufficiently ample to make positive determination. All of the plants mentioned here differ from *R. variabile* in their smaller size and in the more slender, less abundantly branched filaments. The branchlets, moreover, are secund and mostly simple, of about 2 cells; those of *R. variabile* are pinnate and mostly compound.

Rhodochorton sinicola sp. nov.

Plate 41, Figs. 1, 2

Fronde epiphyticae, 300-500 μ altae, per cellulam basalem multo-dilatatam, affixae et ex ea filis uno aut multis, prope basim copiose, superne laxe ramosis orientibus; ramis cylindricis, 4-5.6 μ diam., cellulis 3-5-aut 6-plo diam. longioribus, compositis; monosporis in ramellis, 2-cellularibus, lateralibus, secundis positus, 11-14 μ longis, ovoideis, uni-et angustiori pedicellatis; spermatangiis prope 4-5 μ longis, laxe et terminali aggregatis in ramellis brevibus lateralibusque, positus.

Plants epiphytic, 300-500 μ high, attached by a single, much-enlarged basal cell which may be embedded between the surface cells of the host; basal cell giving rise to from one to several erect filament-axes which branch abundantly near their bases, less frequently above; branches longer above, cylindrical throughout, not markedly attenuated, 4-5.6 μ diam., cells mostly 3-5, or 6 diameters long; chromatophore parietal; asexual reproduction by monospores; monosporangia borne terminally on usually 2-celled lateral secund branchlets, 11-14 μ long, ovoid, the 1-celled pedicel very much smaller in diam.; antheridia in loose, terminal clusters on short, branching lateral branchlets, ellipsoidal, about 4.5 μ long.

TYPE: D. 739, on *Dictyota*, shore of Turner's Island, July 18, 1940. Herb. AHF no. 17.

This species, with its enlarged basal cell and long, slender, free filaments, does not correspond to any known described plant. The peculiar, partly embedded basal cell and the basal branching habit together with its very slender diameter distinguish it clearly.

Family **Bonnemaisoniaceae**

Genus **ASPARAGOPSIS** Montagne

Asparagopsis Sanfordiana Harv.

Harvey, 1855, p. 544; 1858-63, pl. VI. *Asparagopsis Sanfordiana* f. *amplissima* S. & G., 1924, p. 760, pl. 22, fig. 3, pl. 41.

Abundant material of this widely distributed Pacific species was taken from a dredge-haul in Mejia channel, Puerto Refugio, 12-22 meters, D. 268, January.

A comparison of the material from the Gulf, including the rather poor specimens of Marchant's collection from Eureka, does not indicate to the author sufficient difference to merit the retention of the suggested name given above in synonymy. Examples seen from the coast of southern California likewise seem to correspond well with the typical species as figured by Harvey (1858, pl. VI). There may, however, be some query regarding the application of the same name to all of the Pacific plants which have been considered to belong here, since Harvey's type from Australia has not been re-examined and verified so far as can be determined. The gross morphological nature of our plants is, nevertheless, so distinct that they need not be confused with any other Pacific coast algae.

Family **Chaetangiaceae**

Genus **SCINAIA** Bivona

Scinaia Johnstoniae Setchell

Setchell, 1914, p. 97, pl. 11, figs. 14, 15. *Scinaia furcellata* var. *undulata* Howe, 1911, p. 502 (not *Ginannia undulata* Mont.).

Scinaia Johnstoniae is a sublittoral plant recorded thus far from southern California, the outer coast of Lower California, and from several stations in the Gulf. It is the only cylindrical, nonconstricted species known on our Pacific coast.

D. 235, cast up, Puerto Refugio, Jan.; D. 137, dredged, 4-12 m., off Tiburon Island, Jan.; D. 50, dredged, 4-6 m., Guaymas Bay, Jan.; D. 281a, dredged 12-22 m., Mejia channel, Puerto Refugio, Jan.; J. 46, dredged, Los Angeles Bay; J. 106, San Pedro Martir Island; J. 114, San Esteban Island.

Scinaia latifrons Howe

Howe, 1911, p. 500, fig. 1, pl. 28; Setchell, 1914, p. 102, pl. 11, fig. 23.

Scinaia latifrons is the broadest and most differentiated of the complanate species of the genus. The figures given by Howe are sufficient to distinguish it immediately. It has been recorded sparingly from the outer coast of the Californias, but in the Gulf seems to be very abundant in certain sublittoral localities. *S. Johnstoniae* often grows with *S. latifrons* in the same sublittoral habitats.

D. 82, dredged, 12-20 m., outside Guaymas Harbor, Jan.; D. 136, dredged, 4-32 m., off Tiburon Island, Jan.; D. 277, dredged, 12-22 m., in Mejia channel, Puerto Refugio, Jan.; M. 53, 57, cast ashore, Guaymas; Vives, La Paz.

Genus **GALAXAURA** Lamouroux

Galaxaura fastigiata Dec'ne

Kjellman, 1900, p. 64, tab. 9, figs. 1-3, tab. 20, fig. 4; Tanaka, 1936, p. 157, fig. 20.

Only two sterile specimens of this widely distributed Pacific species have been taken, both in beach-drift.

J. W. Durham, at Red Bluff Point, Tiburon Island, Dec. 2, 1940; Poindexter, at Punta Peñasco, March, 1941.

The specimens are cylindrical, smooth, and light pink to greenish in color. They fall in the generally recognized subgroup Eugalaxaura.

Galaxaura marginata (Solander) Kjellm.

Kjellman, 1900, p. 77, tab. 20, fig. 44. *Corallina marginata* Solander, in Ellis & Solander, 1786, p. 115, tab. 22, fig. 6; Børgesen, 1915, p. 106, figs. 115-117, pp. 458-459.

A single imperfect example, which seems nearest to the West Indian species *Galaxaura marginata*, was dredged in 40 meters at San Jose del Cabo, H. 601, August. It was so determined by N. L. Gardner. The periphtric assimilating cells are broadly rounded. No apiculae such as Børgesen illustrates have yet been observed.

Family **Gelidiaceae**

Genus **GELIDIUM** Lamouroux

Gelidium pusillum (Stack.) Le Jolis (in extenso)

Plate 42, Figs. 1-6

Le Jolis, 1863, p. 139; Feldmann & Hamel, 1936, p. 236, figs. 19, 20; Børgesen, 1920, p. 280, fig. 26. *Fucus pusillus* Stackhouse, 1801, tab. 6. *Fucus caespitosus* Stackhouse, 1801, tab. 12.

This variable and widely distributed small plant has been recorded from many parts of the world: the coasts of Spain, the Mediterranean and Adriatic, Australia, Easter Island, England, Japan, etc. Recent Pacific collections, among which are several specimens from the Gulf of California, have given this species a wide distribution along the western coast of America, from the Galapagos Archipelago to central California. Variation is sometimes extreme, and with our still scanty collections from this very large area it seems hardly advisable to burden the nomenclature with additional names for variations which seem largely ecologic in this plant, notwithstanding the fact that some of them may ultimately be designated as separate entities. Illustrations of the major extremes are given here together with locality citations for all specimens thus far available. From these, any given specimen may at least be conveniently placed with other plants nearest like it.

Tall forms 12-16 mm. high, with strongly flattened linear-oblong or linear-clavate blades, blunt or frequently attenuated at the ends, commonly irregularly pinnate-branched or proliferating into narrow lobes.

H. 367, 659, Galapagos Archipelago; Dodge, H. 783, Costa Rica; D. 79, middle to lower littoral, Guaymas Bay, Jan.; D. 211a, Puerto Refugio, Jan.

Forms in which the cylindrical lower parts are more conspicuous, frequently branched and having flattened, linear-clavate blades which are usually entire. Plants, on the whole, not strongly flattened.

D. 135c, lower littoral, Turner's Island, Jan.; D. 328, Gonzaga Bay, Jan.; D. & R. 3299, near Guaymas, Dec.; D. 783, southern California.

Small, depauperate forms, 5 mm. high or less.

H. 479, 479a, Galapagos Archipelago; H. 779a, Costa Rica; H. 572h, 569b, Clarion Island; D. 684, near channel at Tiburon Island, July.

These small forms frequently produce a short stubble over rock surfaces and may be associated with the following larger form which, with its shorter, broader blades and larger size, forms scattered little tufts and does not give the uniform "furry" appearance of the dwarf form.

H. 279, 315, 564, 533, Galapagos Archipelago; H. 269, 492, 572, 211, Clarion Island.

Gelidium crinale (Turn.) Lamour.

Lamouroux, 1825, p. 191; Feldmann & Hamel, 1936, p. 240, fig. 22; Okamura, Icon. Jap. Alg. III, Pl. CXLVI. *Acrocarpus crinalis* Kützing, Tab. Phyc. XVIII, tab. 33.

The several Gulf specimens, particularly D. 692, are similar to examples of this species known from the coast of California. They are frequently somewhat more flattened in the upper parts, but, on the whole, seem quite properly to belong here. Agreement with European specimens likewise is sufficiently close that they may be placed together to further extend the already wide distribution of *Gelidium crinale*.

D. 692, 702, lower littoral, Turner's Island, July; D. 322a, on shore at Gonzaga Bay, Jan.

***Gelidium microphysa* S. & G.**

Setch. & Gard., 1930, p. 151, pl. 9, fig. 31.

This outstanding small species was described from Guadalupe Island, Lower California, and until now has been known only from the type specimen. A comparison of the cross sections of the frond of the type with that of the present specimens shows that they are undoubtedly identical. This is the only species on our Pacific coast which possesses interlacing rhizoidal filaments in the cortex and medulla instead of straight ones. In other species a cross section severs these filaments at right angles, while in *G. microphysa* they are found running in all directions.

D. 726, found growing on lower littoral rocks, Turner's Island, July.

***Gelidium decompositum* S. & G.**

Setch. & Gard., 1924, p. 743, pl. 71.

J. 23, on rocks in lower littoral, San Francisquito Bay, June. Not collected since.

Gelidium decompositum is said to differ chiefly from *G. Johnstonii*, with which it is closely related, in the greater irregularity of the length of the pinnae, which are mostly very decidedly crowded together and stand more nearly perpendicular to the parts from which they arise. The plants also are smaller in all of their dimensions. The cells of the subcortex, and especially the cells of the medulla, are decidedly larger and thicker walled.

***Gelidium Johnstonii* S. & G.**

Setch. & Gard., 1924, p. 742, pls. 46a, 72, 73.

This is the largest and most abundant species in the Gulf, and, from collections made thus far, seems to be a spring annual. The material collected in January and February is very largely young, or at least im-

mature. The late July collections from Turner's Island, too, are depauperate. Johnston's collections made in June are large and luxuriant, seeming to indicate a maximum of development. Undoubtedly, it is of rather wide and general distribution on rocky shores in the upper half of the Gulf being favored by moderately cool water.

J. 27 (AHF no. 69), San Francisquito Bay, June; J. 12, San Marcos Island, June; D. & R. 3228, tide pools near Guaymas, Dec.; D. 105, reef at Turner's Island, Jan., 693, July; D. 492a, Catalina Bay, near Guaymas, Feb.; D. 403, Pond Island, Feb.; D. 387, Tepoca Bay, Feb.; D. 294, Puerto Refugio, Jan.

Gelidiella acerosa (Forsk.) Feldm. & Hamel

Feldmann & Hamel, 1934, p. 6; Okamura, 1936, p. 472, fig. 218. *Gelidiopsis rigida* (Vahl) Weber-van Bosse, 1928, p. 427, fig. 172. *Echinocaulon rigidum* Kützing, Tab. Phyc. XVIII, tab. 40, *E. spinellum*, tab. 39, *E. ramulliferum*, tab. 39.

This is the largest species in our area and is easily recognized by its robust branches, 400-700 μ diam., and wiry texture. It is of more or less tropical distribution in many parts of the world. In the Gulf it has been encountered only in the warmer waters of the southern extremity, preferring protected pools or the shallow waters of quiet lagoons.

D. 594, growing on or in coral heads on the bottom of shallow San Gabriel Bay, Espiritu Santo Island, Feb.; D. 610, on rocks in oyster-culture ponds, same locality; D. 633, in rock pools, San Jose del Cabo Bay, Feb.

Gelidiella Hancockii sp. nov.

Plate 43, Figs. 1-2

Frondes usque ad 2 cm. longae, prorsus cylindricae, pro maxima parte 200 μ diam., e partibus repentibus rhizoideo affixis, multo ramosae; ramis e superficiebus partium repentium pro maxima parte superis, ramis erectis simplicibus, apicibus acutis; tetrasporangiis in corticibus transformatis ramellorum brevium lente tumidorum aut apicium ramellorum positis.

Plants forming small, tangled tufts on rock surfaces; individual plants to 2 cm. in length, wiry, cylindrical throughout with an average diameter of about 200 μ , much branched from crooked, semicreeping parts which form rhizoidal attachments to rocks or other surfaces by means of abundant, short rhizoids which arise in a mass on the under sides; branching from prostrate parts polystichous but mostly from upper side, the erect branches mostly entire, only occasionally branching secondarily, this being

confined largely to the prostrate parts; apices acute, not attenuated; cortex and subcortex of about 3 layers of more or less isodiametrical cells surrounding a large medulla of elongated cells, the two areas not very distinct in cross sections; tetraspores produced abundantly in cortical cavities of slightly swollen short branchlets or tips of branches.

TYPE: (tetrasporic) D. 651, on middle littoral rocks, rocky point 3 mi. north of Kino, July 16, 1940. Herb. AHF no. 18.

D. 288, rocky shore, Puerto Refugio, Jan.

Gelidiella mexicana sp. nov.

Plate 43, Fig. 3

Frondes 4-6 mm. altae, floccosae; ramis cylindricis, 120-180 μ diam.; filis erectis copiosis, e partibus brevibus, prostratis, rhizoideo-affixis; apicibus acutis; tetrasporangiis nondum visis.

Plants 4-6 mm. high, forming small, dense tufts, cylindrical throughout, 120-180 μ in diam.; erect parts rising abundantly from short, prostrate parts firmly attached to the substratum by abundant short rhizoids, frequently and irregularly polystichously branched above the prostrate parts; apices acute, not attenuated; cortex and subcortex of about 3 layers of cells, not very distinct in cross section from the large medulla; tetraspores unknown.

TYPE: D. 401a, on middle littoral rocks with other small algae, Pond Island, Feb. Herb. AHF no. 19.

D. 328a, shore of Gonzaga Bay, Jan. (somewhat larger throughout, 150-200 μ diam.).

D. & R. 3227, from tide pools, Cabo Arco near Guaymas, December, may be distinct yet closely related here, but the specimens are not sufficiently mature to merit description. It is similar in size and apparently in branching but is not so closely tufted, has arching stolons of smaller diameter than the rest of the parts and attachment organs only at points opposite the erect branches, these points being spanned by short, arching stolons. More material of this form is needed to establish its identity.

Gelidiella ? *refugiensis* sp. nov.

Plate 43, Figs. 4-6

Frondes 1-1.5 cm. altae, ramis erectis divaricatisque, 150-300 μ diam., subcylindricis usque ad compressis compositae; ramificatione vulgo disticha, laxa, irregulari; partibus prostratis exiguis, per uncos disciformes parvos irregulares affixis; apicibus acutis; sporis subsphaericis indivisis (monosporis) in subcorticibus caverno excavatis ramorum, brevium, terminalium positis, 20-50 μ diam.; per foramina subcorticis emittentibus.

Plants 1-1.5 cm. high, of slender, erect, and spreading branches 150-300 μ in diameter, subcylindric to compressed; branching mainly distichous, loose, irregular; prostrate parts not extensive, apparently not stoloniferous; holdfasts of rather small, irregular attachment-disks, not conspicuous in our material; apices acute, somewhat attenuated; cortex and subcortex of about 3 layers of cells surrounding a filament-free medulla; subspherical spores borne in cavities in the subcortex of short, acute terminal branchlets which are not conspicuously swollen and correspond in general to typical tetrasporic ramuli of the genus *Gelidiella*, but spores apparently undivided (monospores) when shed, 20-50 μ diam., discharged through openings in the cortex.

TYPE: D. 237, cast up on beach at north shore of Puerto Refugio, Jan. 28, 1940. Herb. AHF no. 20.

The observation of what are apparently large monospores rather than tetraspores in these specimens leaves their true nature in doubt. The species is more or less typically *Gelidiella* in all other respects and must be placed here to await further investigation.

Genus WURDEMANNIA Harvey

Wurdemannia miniata (Drap.) Feldm. & Hamel

Feldmann & Hamel, 1936, p. 260, figs. 34-36. *Wurdemannia setacea* Børghesen, 1929, p. 268, figs. 360, 361; Kützing, Tab. Phyc. XIX, tab. 26. *Gelidium miniatum* Kützing, Tab. Phyc. XVIII, tab. 58.

This species is characterized throughout its wide area of distribution, according to Feldmann and Hamel, by its habit of forming dense mats of slender, branched erect filaments 0.5-2 cm. high. These filaments are cylindrical, irregularly branched, without an apical cell, and with a medullary cone of elongated cells.

The collections in the Gulf have yielded two sets of specimens which correspond very well to the above concept of this species. A specimen from Carmen Island, Palmer, 1870, matches especially well the description and illustrations quoted above. It forms a dense mat about 2.5 cm. high.

D. 614 from San Gabriel Bay, Espiritu Santo Island, another warm-water locality, is the same. These plants are 2-2.8 cm. high and form similar mats sometimes as large as 15-20 cm. across.

The collection of this species in the perennially warm parts of the Gulf corresponds to the habitat of the plant as found in other parts of the world.

Two other species have been found which show the same anatomical structures as *Wurdemannia*: rounded tip without apical cell, central medullary cone of elongated cells. These, however, are much larger in size and do not develop the closely matted habit. Some of them correspond perfectly with the type of *Gelidiopsis tenuis* S. & G., while the largest specimens, 8-10 cm., are very much like *Gelidiopsis variabilis*. More detailed notes on these plants will be found below.

As Feldmann and Hamel have stated (loc. cit., p. 263) "Cette Alge n'est pas une Gélidiacée; elle en diffère par sa structure de type fastigié et ses tétrasporanges zonés. Elle est généralement rangée parmi les Gigartinales, mais, en l'absence de cystocarpe, sa position systématique est encouree douteuse."

Genus GELIDIOPSIS Schmitz

Schmitz, 1895-1896, p. 143; Feldmann, 1931, p. 156; Børgesen, 1937, p. 321.

Since the original investigations of Schmitz in 1895, no authors have observed or studied cystocarps of this genus. Schmitz originally placed it with *Ceratodictyon* in the family Rhodymeniaceae. Feldmann does not offer further suggestions or elucidations on its proper position. Okamura, 1936, has likewise placed it beside *Ceratodictyon*, but in the Gracilariaceae. Børgesen, loc. cit., p. 321, has not followed these precedents and has placed it in the Gelidiaceae. This latter interpretation seems to be the best, for *Wurdemannia*, with which it is most closely allied anatomically, in the absence of knowledge of its sexual nature, is generally placed here. With this consideration in mind, we will allow it to stand in this group, awaiting more abundant knowledge of the life histories of our plants.

Gelidiopsis tenuis S. & G.

Plate 70, Fig. 1 (right)

Setch. & Gard., 1924, p. 749, pl. 22, fig. 2.

Fronds 2-4 cm. long, .5-.8 mm. in diam., cylindrical to compressed, sparsely and irregularly branched, long attenuate, semiacute; without an apical cell; medulla of elongated cells in longitudinal section; reproduction unknown.

Several collections which undoubtedly are identical with the type of *Gelidiopsis tenuis* are on hand from a number of stations in the Gulf and from Clarion Island. They are similar in structure to *Wurdemannia miniata* but are larger in all dimensions and do not form densely felted mats like that species. Though fertile material is still unknown, this

species, as Setchell and Gardner have pointed out, is sufficiently distinct to be rather readily recognized. The Gulf plants are about intermediate in size between *Wurdemannia miniata* and *Gelidiopsis variabilis*, and may be identified further by their loosely caespitose habit.

This is apparently another warm-water species. Most of our material is from the southern extremity of the Gulf and southward.

M. 104 (Univ. of Calif.; isotype, AHF no. 21), cast ashore, Santa Rosalia; H. 514, Sulphur Bay, Clarion Island; H. 605, dredged in 40 m. off San Jose del Cabo, Aug.; D. & R. 3134c, on rocks along shore, Guaymas, Dec.; D. 543, 533b, in rock pockets, Agua Verde Bay, Feb.; D. 475b, dredged in 30-36 m., Ensenada de San Francisco, near Guaymas, Feb.

Gelidiopsis variabilis (Grev.) Schmitz

Plate 70, Fig. 1 (left)

Schmitz, 1895, p. 148; De Toni, 1900, 410. *Gelidium variabile* Kützing, Tab. Phyc. XIX, tab. 23.

A very fine collection of plants which correspond in all determinable characters with this species was made from rocks below tide level, Punta San Pedro, Guaymas, D. & R. 3395, December. The plants are 8-10 cm. high, abundantly branched, the whole mass forming a rounded, caespitose clump of erect and divaricate branches. The blunt apices without an apical cell and the elongated medullary cells remind one of the genus *Wurdemannia*, but these examples are much larger and of a looser habit throughout. *Gelidiopsis variabilis* is a semitropical species known from East Africa, the Indian ocean, the East Indies, and from northern Formosa. The latter locality is at the same latitude as the station in the Gulf of California.

Though a consideration of the very wide discontinuity in distribution would seem to discount from the likelihood of our plants being identical with *G. variabilis*, the similarities are such that in the absence of fertile material it is best to place them here awaiting further investigation.

Family **Squamariaceae**

Genus **HILDENBRANDTIA** Nardo

Hildenbrandtia rosea Kützing

Kützing, 1843, p. 384; Setch. & Gard., 1924, p. 787.

Excellent tetrasporic material of this species has been detected on rocks with corallines taken from the reef at Turner's Island, D. 757b, July. The closely attached crusts are dark brown in color, irregularly lobed, and spreading to about 2 cm.

Family **Cruoriaceae****Petrocelis** sp.

A few sterile examples of a *Petrocelis* species have been noted on the surface of rocks from various stations in the Gulf. We shall have to await the detection of fertile material before determination can be made.

Family **Corallinaceae**Genus **LITHOPHYLLUM** Philippi**Lithophyllum pallescens** (Foslie) Heydr.

Plate 55, Fig. 4

Heydrich, 1901, p. 531. *Lithothamnion racemus* Hariot, 1895, p. 169 (in part), not of Lamarck. *Lithothamnion pallescens* Foslie, 1895, p. 4, figs. 11-13; 1897, p. 13; 1901, p. 20; 1909, p. 36; 1929, pl. LXIV, figs. 15-17; Lemoine, 1911, pp. 156-158, figs. 87-91. *Goniolithon* ? *pallescens* Foslie, 1898, p. 9. *Lithothamnion (Lepidomorphum) pallescens* Foslie, 1901, p. 20. *Lithophyllum californiense* Heydrich, 1901, p. 530.

Lemoine has given (1911) a fine account of the anatomy of this plant as well as a description of its habit and distribution. According to a map made by M. Diguët and transcribed by Madame Lemoine, the type locality of this species is found to be along a sublittoral bank off the west shore of the main body of Espiritu Santo Island rather than in La Paz Bay proper. It abounds in great quantity on the pearl-fishing banks and is known by the natives as *chicaron*. Recent collections have been made in this region and have yielded specimens identical with those of the type collection, part of which is preserved in the Herbarium of the University of California. D. 572 was collected from the bottom of the shallow lagoon of San Gabriel, Espiritu Santo Island. D. 593b, in 12-26 m. in San Lorenzo Channel. No other specimens can positively be assigned to this species, which would seem to be confined to warm waters in the Gulf. Of this species Foslie says, however (Sib. Exp., 1904, p. 33), "*Lithophyllum pallescens* Fosl. (including *L. californiense* Heydr.) from the Gulf of California is so closely allied to *Lithophyllum Okamurae* from the Pacific coast of Japan and several places in the Malay Archipelago, that the limit is hardly to be drawn."

Lithophyllum ? **Margaritae** (Hariot) Heydr.

Heydrich, 1901, p. 530; Lemoine, 1911, pp. 173-175, fig. 100. *Lithothamnion Margaritae* Hariot, 1895, p. 167. *Lithothamnion ele-*

gans Foslie, 1895, including forma *angulata* and f. *complanata*, p. 6, pl. 1, figs. 9, 10. *Goniolithon* (*Cladolithon*) *elegans* Foslie, 1899, p. 8. *Lithophyllum elegans* Foslie, 1909, p. 27; 1929, pl. LXIII, figs. 1, 2.

Lemoine has given careful analysis of all of the habit and structural features of this unique species, which has never yet been rediscovered. From Lemoine's map of La Paz Bay, after Diguët's records, showing the localities of the coralline banks, the "grisement" of *L. Margaritae* is indicated lying off the outer shore of Isla San Juan Nepomucens, which itself lies just off the lighthouse point a few miles north of the city of La Paz. No other dredgings have been made in that vicinity, and apparently this species is of limited distribution. Its remarkable habit and the now precisely identified type locality should make it readily recognized when collections are again made in that region.

Lithophyllum ? *trichotomum* (Heydr.) Lem.

Plate 55, Fig. 2; Plate 58, Figs. 1, 4-6; Plate 60

Lemoine, 1929, p. 45. *Lithothamnion* ? *trichotomum* Heydrich, 1901, p. 538.

Examples of Diguët's type collection sent from the Museum of Paris by Madame Lemoine are labeled: *Lithothamnion trichotomum* Heydr. = *Lithophyllum trichotomum* (Hey.) Lem. (le structure est celle des *Lithophyllum*). These specimens have been compared with recent collections and found to match material from several localities.

D. 425, in shallow lagoon at Pond Island, Feb.; D. 226, on rocky shore of west side of Puerto Refugio, Jan.; D. 619, shallow water, San Gabriel Bay, Espiritu Santo Island, Feb.; M. 15, Eureka, May.

This plant resembles in habit *Lithophyllum frutescens* (Foslie) Lem. (1911, p. 144) of the Indian and South Pacific oceans.

Two types of conceptacles have been observed, but neither carpospores nor tetrasporangia can be described. In D. 619 large superficial conceptacles which seem to be antheridial occur, 800 μ in external diameter, broadly ovate conical with a single pore in the tip of the neck. In both other collections large empty conceptacles have been found deeply embedded and connected to the surface by a long canal. They are 450-500 μ in diam. and occur in the broader portions of the fronds at the point of junction of the branches. Externally these plants may be distinguished from other known Pacific American species by their smooth, slender branches and particularly by the truncate tips which usually appear as white or light-colored "caps" to the branches.

Foslie and Howe (1906) have illustrated *Goniolithon strictum* var. *nana*, which is in many ways strikingly like the present species. Should the large conceptacles prove to be tetrasporangial, this plant would probably fall into *Goniolithon*. In this case it will be difficult to establish points of distinction between the Gulf plants, *G. frutescens* and *G. strictum*. The last two species are admittedly indistinct (Foslie & Howe, 1906, p. 131).

Lithophyllum Hancockii sp. nov.

Plate 55, Fig. 1; Plate 62, Fig. 1

Frondes crusta tenui affixae, ramos dense et irregulariter conglobatos emitentes, usque ad 7 cm. altae; ramis superne 1.5 mm. diam., verrucosis forma irregularibusque, inferne multo coalescentibus, superne liberis; conceptaculis tetrasporangiiferis profunde immersis, 240 μ diam., 110 μ altis, poro apicali aperientibus, columna centrali paraphysium e basi assurgenti et tetrasporangiis circumdata.

Plants attached to corals and stones by a thin crust, shrubby, forming densely and irregularly branched clusters to 7 cm. high and 10 cm. across; branches about 1.5 mm. diam. in upper parts, warty and irregular in form, much coalesced or anastomosed, but free in upper parts, with rounded or truncate apices, in longitudinal section showing a large hypothallic region and a sometimes feebly, sometimes well-developed perithallic layer, up to 250 μ thick; hypothallus cells in upper parts 8-11 μ broad by 18-23 μ long, symmetrically arranged in very regular concentric rows; perithallus cells usually short, square or slightly flattened to 1.5 times as long as broad, usually distinctly smaller in all dimensions than hypothallus cells and somewhat less regularly arranged; tetrasporic conceptacles deeply immersed, 240 μ diam., 110 μ high, opening with a single apical pore, with a central column of paraphyses, rising from the conceptacle floor and surrounded by tetrasporangia, these 50-60 μ by 25-30 μ .

TYPE: D. 619a, shallow water of San Gabriel Bay, Espiritu Santo Island, February 14, 1940. Herb. AHF no. 22.

This plant shows considerable resemblance to *Lithophyllum trichotomum* but may be distinguished on several points. The clusters are larger than are common in the latter species, the branching more irregular and warty, more compact and anastomosed throughout. Whereas in *L. trichotomum* the outgrowths of the basal crust are straight, erect, symmetrical structures, those of *L. Hancockii* arise as irregular lobed branches. The conceptacles are much smaller than any observed in *L. trichotomum*. It differs from *L. frutescens* in the size of the tetrasporic conceptacles and tetrasporangia.

Lithophyllum lithophylloides Heydr.

Plate 55, Fig. 3; Plate 58, Figs. 2, 3, 7; Plate 59, Figs. 9, 10; Plate 61, Fig. 1

Heydrich, 1901, p. 531, with formae *bracchiata* and *phylloides*. *Lithophyllum bracchiatum* Lemoine, 1929, p. 44. *Lithothamnion racemus* Hariot (in part) 1895, p. 169, not of Lamarck.

Specimens of Diguët's type collection, which has received the particular attention of Heydrich and Lemoine, have been re-examined in the light of recent collections. Some of the author's material has proved identical with Heydrich's form *phylloides*, and some approaches closely the slender branching form *bracchiata*. In comparing all these specimens their similarities are far more striking than their differences, particularly the internal structure. It seems best, therefore, to consider them under the same name and to illustrate here some of the degrees of variation in these plants. The size of protuberances is particularly variable as are the amount and form of branching.

Tetrasporic conceptacles range between 250 and 300 μ and correspond in all material observed.

The principal internal characters of the plants are the very small size of the thallus cells (7-12 μ in greatest diameter) and their habit of overgrowth forming successive layers of tissue through which the prominent and abundant conceptacles may be found at all levels.

D. 250, 251, dredge-haul in 21 fathoms, west side of Puerto Refugio, shell bottom, Jan. (some specimens identical with type of *L. lithophylloides* f. *phylloides*); D. 572a, bottom of shallow lagoon, San Gabriel Bay; D. 278, 279, dredged in Mejia channel, 12-22 m., Puerto Refugio, Jan.; D. 513, dredged in 16-24 m., sand bottom, Puerto Escondido, Feb.

Differences in general aspect are often due to the difference in age of surface tissues. Rapidly growing, spreading crusts are composed only of hypothallic tissue of rectangular, closely joined cells. This is brighter pink in color and smoother in texture. When perithallic tissue is developed, the surface becomes more roughened and raised into excrescences. The cells are rounded and in looser "filamentous" vertical rows. In some cases where spreading crusts are growing over old perithallic layers it seems as if two species are present. Conceptacles may be borne in either young or older crusts and are developed successively as the crusts thicken.

Lithophyllum Diguëti (Hariot) Heydr.

Plate 59, Figs. 8, 11-16

Heydrich, 1901, p. 532. *Lithothamnion Diguëti* Hariot, 1895, p. 168.

Lithothamnion dentatum Foslie, 1895, p. 4, fig. 15 (not of Hauck.). *Lithophyllum Diguëti*, Foslie, 1909, p. 26; 1929, pl. LXI, fig. 8; Lemoine, 1911, p. 120.

Two additional collections of this unique and attractive species have recently been obtained. They have been compared with a specimen of the type collection and found to agree well. Variation is prominent in the degree of branching and in the thickness and extent of the flat segments.

D. 591, dredged in 12-26 m., San Lorenzo Channel, Feb. (Diguët's type specimens came from very near this locality); D. 281, dredged in Mejia Channel, Puerto Refugio, 12-22 m., Jan.

***Lithophyllum veleroae* sp. nov.**

Plate 55, Fig. 5; Plate 56, Figs. 1-4

Frondes in forma globorum sphericorum, 4-6 cm. diam., semisolidae, laminis multifariam radiantibus anastomosantibusque compositae; conceptaculis tetrasporangiiferis immersis, 225-275 μ diam., 100-125 μ altis, columnam centralem paraphysium et porum singulum apicale ostendentibus.

Thallus forming rounded galls 4-6 cm. diam., semisolid, formed of anastomosed plates radiating in all directions; outer surface intricately designed by the wavy, intersecting double margins of the plates, the edges of each of the major anastomosing plates parted at the surface into two sharp ridges bordering a shallow channel (much as in some forms of *L. dentatum*); these channels and ridges sometimes more or less continuous, sometimes broken, give the plant a distinctive appearance; thallus composed of a massive hypothallus of more or less radiating rows of oblong-rectangular cells 16-20 μ high, grading into a usually well-developed perithallus of square or subspherical cells 9-10 μ high, in compact vertical rows; perithallus sometimes highly developed and stratified; tetrasporangial conceptacles immersed, 225-275 μ diam., low, 100-125 μ high, with a median paraphysis column and a single apical pore; tetrasporangia about 45 by 22 μ ; cystocarps and antheridia unknown.

TYPE: D. 592, dredged in 12-26 meters, San Lorenzo Channel, Espiritu Santo Island, Feb. 14, 1940. Herb. AHF no. 23.

In habit this species shows considerable similarity to *Lithophyllum dentatum* f. *dilatata* of the Irish coast (Foslie, 1929, pl. LXII, figs. 8, 9). The channeling of the margins of the anastomosed plates is stronger, however, and the marginal ridges are sharper.

***Lithophyllum decipiens* Foslie**

Plate 57, Fig. 20

Foslie, 1897, p. 20; 1900, p. 71; Mason, p. 119, pls. 17, 18.

Sections of tetrasporic material from the Gulf of California have been compared with sections of a duplicate type and found to correspond in all essential details.

This species is frequently encountered growing on beach or reef stones in the northern Gulf.

D. & R. 3373, between tide marks, Guaymas, Dec.; D. 227, on shore, Puerto Refugio, Jan.; D. 465, San Esteban Island, Feb.; D. 479, Puerto San Carlos, near Guaymas, Feb.

Genus **LITHOTHAMNION** Philippi
Lithothamnion australe Fosl. f. *americana* Foslie

Plate 56, Figs. 5-10; Plate 57, Figs. 11-16

Foslie, 1900, p. 13; Foslie, in Weber-van Bosse, 1904, pp. 25, 27, fig. 10.

Lithothamnion coralloides f. *australis* Foslie, 1895, p. 8, figs. 6, 7.

Specimens of Diguët's collection from the Gulf were the basis for the species *Lithothamnion australe* (Foslie, 1904, p. 25). They were then named f. *americana*, as other forms were proposed from the South Pacific. Some material of recent collections is undoubtedly identical with Diguët's plants from the Gulf figured by Foslie (1895). The present material, however, is sterile, and we can therefore only follow Foslie, who says: "The question whether the forms from the East-Indian Archipelago actually belong to the same species as the American form is not to be settled at present, the material partly in the main consisting of sterile specimens, partly being too small. There are several specimens in the collection in hand which are in almost full conformity with the said American form. It is, however, to be observed that specimens of rather widely different species may often resemble each other in habit as well as in structure, and accordingly cannot be defined with certainty, when sterile. Besides it cannot—as yet—be ascertained to what extent there is a connection—as to this group of the algal flora—between the East-Indian Archipelago and the Pacific Coast of America."

Three collections are at hand containing specimens referable to forms of this plant: D. 61, dredged in 4-6 meters, Guaymas Bay, Jan.; D. 593a, dredged in 12-26 m., San Lorenzo Channel, Feb.; D. 278a, dredged in 12-22 m., Mejia Channel, Puerto Refugio, Jan.

In D. 61 the material is largely uniform and compares closely to Diguët's original specimens, also to figures of form *bracchiata* from the South Pacific. In D. 593a there is great variation; some material is identical in habit with form *bracchiata*, others with form *ubiana* and form *tualensis*. Some with thickest branches resemble *Lithothamnion montereyicum*. D. 278a is a variable set similar throughout to D. 593a.

That all this variation is produced by the same species is evident in some specimens, part of which branch like form *bracchiata*, while an opposite side branches like form *ubiana*.

Genus **HETERODERMA** Foslie
Heteroderma Gibbsii (Fosl. & Setch.) Fosl.

Foslie, 1909, p. 56. *Melobesia Gibbsii* Foslie & Setchell, in Foslie, 1907, p. 26.

Lacking a satisfactory figure of the characters of the type material, the description has been expanded and clarified as follows by Mason (unpublished thesis manuscript):

Thallus crustaceous, epiphytic upon *Sargassum*, *Dictyota*, *Padina*, etc., suborbicular at first, later irregular with adjacent thalli confluent, partially monostromatic; cells square, 7-12 μ diam., or elongated parallel to the substratum, 11-16 μ long by 6-12 μ broad; cover cells rarely present in the central portion of the thallus, a hypothallic layer often present, one cell thick, with cells 2-4 μ high by 6-10 μ broad, variable; heterocysts absent in the thallus; sporangial conceptacles subconic, 250-300 μ in diam.; antheridial conceptacles 40-50 μ diam., 12-16 μ high; cystocarpic conceptacles 140-160 μ diam., 40-70 μ high.

Gibbs, 20-21, San Jose and Espiritu Santo islands, growing on *Sargassum*; H. 4, growing on *Padina*, dredged in 40 m., off San Jose del Cabo, Aug.; H. 9, same, on *Dictyota*; D. 217a, on old *Padina*, on shore, Puerto Refugio, Jan.

Before this alga was critically studied, it was called *Melobesia tenuis* by W. A. Setchell, and as such was sent to Foslie, who upon superficial examination at first considered it to be a form of *M. farinosa*. Later, however, he studied it in greater detail and found that in the size of cells and size and form of conceptacles it did not agree with either *M. farinosa* or any other known *Melobesia*; so he named it *M. Gibbsii*. When *Melobesia* was split up into two subgenera, it fell into the *Heteroderma* group. Upon the raising of *Heteroderma* to generic rank, it became *Heteroderma Gibbsii*.

Heteroderma corallinicola sp. nov.

Plate 63, Fig. 2

Frondes tenues, minutae, crustas ad superficies ramorum vetustorum. Corallinae arcte adhaerentes, monostromaticae tantum in partibus margine plerumque 2-4 stratis cellularum cuboideis 9-14 μ diam., compositae; heterocystis deuntibus; conceptaculis cystocarpiiferis aut immersis aut leviter prominentibus, 60 μ diam.; conceptaculis spermatangiiferis tetrasporangiiferisque nondum visis.

Thallus thin, minute, forming closely adherent crusts over surfaces of old branches of *Corallina*; very inconspicuous except when fruiting; monostromatic only in marginal parts, usually of 2-4 layers of square

cells, 9-14 μ diam., without heterocysts; cystocarpic conceptacles immersed or forming a slight prominence, 60 μ diam.; tetrasporangial conceptacles unknown.

TYPE: D. & R. 3328a (Field Museum; isotype, AHF no. 24), on *Corallina*, in intertidal pools, cove north of Cabo Arco, Guaymas, Dec. 19, 1939.

This species resembles *Heteroderma Gibbsii* but differs in habit and host, and particularly in cellular structure. The cells of *H. Gibbsii* are considerably smaller and often more flattened. The crusts are 10-30 μ thick, while those of *H. corallinicola* are commonly 25-40 μ thick and often reach 50 μ .

The present species would fall under Foslie's subgenus *Pliostroma*, while *H. Gibbsii* he places in subgenus *Euheteroderma*.

Genus POROLITHON Foslie

Porolithon sonorensis sp. nov.

Plate 57, Figs. 17-19; Plate 61, Fig. 2

Frondes primo laminis prostratis flabellatis, imbricate superpositis plerumque 150-200 μ crassis, et marginibus rotundis, compositae, aetate protracta laminarum, undularum, assurgentium, erectarum usque ad 1 cm. altarum, contorte anastomosantium crustam scabrosam densam formantes; heterocystis in stratis libratis in partibus crassioribus frondorum prostratorum; conceptaculis tetrasporangiiferis immersis aut subprominentibus, 175-225 μ diam., poro singulo; tetrasporangiis paraphysibusque e basi tota conceptaculorum orientibus.

Thallus at first composed of prostrate flabellate plates growing imbricately over one another, these mostly 150-200 μ thick, with rounded, light-colored margins; later, the plates becoming erect to about 1 cm. high, forming a rough crust of dense, erect undulate, intricately anastomosed flat structures; in tetrasporic plants, coalescence of individual thallus parts very complete and little erect development apparent except as upfolds or undulations of the prostrate parts; cells of central tissue of erect parts 20-25 μ long, 7-10 μ wide; cells of surface layers square or oblong, 6-9 μ diam.; heterocysts present, mostly in horizontal rows in thicker parts of prostrate thallus; tetrasporangial conceptacles immersed or subprominent, often forming rounded excrescences, 175-225 μ diam., ovate in longi-section or with a slightly flattened floor (disk), opening by a single pore without a projecting rim; tetrasporangia and paraphyses arising from whole surface of the conceptacle floor; cystocarps and antheridia unknown.

TYPE: D. 226a, on rocky shore at low tide, west side of bay, Puerto Refugio, Angel de la Guardia Island, Jan. 26, 1940. Herb. AHF no. 25.

This species is one of the very common intertidal crustaceous corallines in the northern Gulf. It has been taken on shore at several localities besides that from which the type came. D. & R. 3162, cove north of Cabo Arco, Guaymas; D. 416, 429, Pond Island; D. 465, San Esteban Island; D. & R. 3383, intertidal pools, Punta San Pedro near Guaymas, Sonora, December 22, 1939. The presence and horizontal arrangement of the heterocysts seem to allow this species to be described under the genus *Porolithon*.

Considerable resemblance in form and structure is evident between young examples of *P. sonorensis* and *Lithothamnion mesomorphum* var. *ornatum* described from sterile material from the West Indies (Foslie & Howe, 1906, p. 129).

Genus **DERMATOLITHON** Foslie

Dermatolithon veleroae sp. nov.

Plate 62, Fig. 2

Frondes tenues, prostratae usque ad assurgentes, in superficiebus conchae translucis laxae affixae, coacervationes 1 cm. latas, valde imbricatae, exiguae anastomosantes formantes, crustis individuis 75-125 μ crassis; conceptaculis tetrasporangiiferis humilibus, tholiiformibus, circa 300 μ diam. extern., 100 μ altis, poro singulo; tetrasporangiis 70-80 μ longis, columnam centram paraphysium circumvallentibus; conceptaculis cystocarpiferis forma magnitudineque tetrasporangiiferis similibus; conceptaculis spermatangiiferis 400 μ latis, 125 μ altis, superficie humili poro conico centrali ostioli excepto.

Thallus thin, prostrate to ascending, growing loosely over surface of a translucent shell and bits of attached *Ulva* as well as over crusts of its own kind, forming patches about 1 cm. broad, all very weakly attached and imbricated parts little or not at all anastomosed; crusts 75-125 μ thick, composed of a hypothallic layer largely composed of vertically elongated cells, and a perithallic superior portion of shorter, square to oblong cells; all cells 6-11 μ wide; tetrasporangial conceptacles low, dome shaped, about 300 μ outside diam., 225 μ broad by 100 μ high inside; tetrasporangia 70-80 μ long, borne around periphery of disk, the center bearing a tuft of paraphyses; cystocarpic conceptacles similar in size and shape to tetrasporangial ones; antheridial conceptacles 400 μ broad, 125 μ high, outside, low except for a central ostiolar cone.

TYPE: D. 550, on a shell picked up in middle littoral zone, Agua Verde Bay, Feb. 12, 1940. Herb. AHF no. 26.

This plant is known only from the single collection which fortunately bears all reproductive organs. It is unique in its habit on shells, though the specimen at hand shows the crusts growing up and over all objects at-

tached to the shell as well, including a small tuft of *Ulva*. This character and its loosely attached habit with tendency to ascend and form free parts make this plant distinct from any others known.

Genus **LITHOLEPIS** Foslie
Litholepis sonorensis sp. nov.
Plate 63, Fig. 1

Frondes monostromaticae, superpositae usque ad 4-stratosae, crustam continuam, arcte ad substratum adhaerentem ad superficies totas concharum magnarum duratarum tegentem, obscure cinereo-albae formante; cellulis magnitudine variabilis, plerumque recto elongatis, 13-25 μ altis; conceptaculis tetrasporangiiferis humilibus, conicis, poro singulo, circa 400 μ in diam. externe, 175 μ altis, cavitate interna 300 μ in diam., disco plano, parietibus supernis crassioribus (circa 3-stratosis) porum circumferentibus; tetrasporangiis circa 50 μ altis, discum circumvallentibus.

Thalli monostromatic, growing superposed over one another, to 2-4 layers, forming a continuous, closely adherent crust over all the surfaces of large, weathered shells, dull gray-white in color; cells variable in size, mostly elongated slightly vertically, 13-25 μ high; tetrasporangial conceptacles low, conical, with a single pore, about 400 μ external diam., 175 μ high; internal cavity 300 μ diam., with a flat disk, the upper wall thickest (about 3 layers) around pore; tetrasporangia about 50 μ long, arising from the periphery of the disk.

TYPE: D. 592x, growing on a large weathered shell, dredged in San Lorenzo Channel, Espiritu Santo Island, Feb. 14, 1940. Herb. AHF no. 27.

No species of this genus has been described from the Pacific American coasts. The large size of the thin, superposed crusts of this species, completely covering extensive surfaces, seems to be a character distinguishing it from the several known in Atlantic waters. More complete collections will be necessary, however, to verify this. The described species have not been illustrated, and it is difficult to compare habit characters from the existing descriptions.

Genus **CORALLINA** (Tournef.) Lamouroux
Corallina pilulifera Post. & Rupr.

Postels & Ruprecht, 1840, p. 20, tab. XL, fig. 101; Yendo, 1902a, p. 30, pl. III, figs. 14-16, pl. VII, figs. 14-16.

Our plants correspond most closely to form *sororia* of Ruprecht. It is a common middle and lower littoral species in the rock-cover vegetation of the northern Gulf and is abundant in many tidal pools.

D. & R. 3233, 3328, intertidal pools in vicinity of Guaymas, Dec.; D. 394, Tepoca Bay, Feb.; D. 320, Gonzaga Bay, Feb.; D. 225, Puerto Refugio, Jan.; D. 460, San Esteban Island, Feb.

Genus **AMPHIROA** Lamouroux
Amphiroa pusilla Yendo

Yendo, 1902a, p. 13, pl. I, figs. 22, 23, pl. V, figs. 11-13.

Several collections are on hand of an *Amphiroa* of variable form which in many respects seems to be referable to the Japanese plant described by Yendo. Two forms are present as well as many intermediate variants: a loosely branched, broad segmented, more or less decumbent form, and a densely tufted, erect form in which the segments are largely attenuated in the upper parts, ending in a blunt, rounded tip. These characters correspond to Yendo's description, and his figures show much resemblance to the Gulf plants. The extreme variability of our specimens and the limited knowledge of the distribution of the species must make this plant subject to much further inquiry.

The various forms make up an abundant rock cover in many shore localities in the northern Gulf: D. 717, Turner's Island, July; D. 222, Puerto Refugio, Jan.; D. 112, Tiburon Island, Jan.; D. & R. 3387, 3390, 3325, 3330, vicinity of Guaymas, Dec.

Amphiroa zonata Yendo

Yendo, 1902a, p. 10, pl. I, figs. 11-14, pl. IV, fig. 9.

Specimens of several Gulf collections correspond excellently to Yendo's descriptions and figures of this plant. Its regular, dichotomous branching and cylindrical to slightly compressed segments with very distinct transverse banding of the terminal segments are distinctive characters.

These plants are not abundant in the collections at hand, but occur occasionally in material from a number of shore localities: D. 717, Turner's Island, July; D. 222a, Puerto Refugio, Jan.; D. & R. 3386, Punta San Pedro, Guaymas, Dec.; D. 485, Catalina Bay, Guaymas, Feb.

Amphiroa rigida Lam.

Lamouroux, 1816, p. 297, tab. 11, fig. 1; Børgesen, 1915-20, pp. 182-185, figs. 171, 172 (var. *antillana*).

Following the investigations of Børgeesen concerning the history and literature of this species, I am convinced that certain Gulf specimens are to be considered here. The well-developed and ample material at hand corresponds closely with his descriptions and figures of West Indian plants which he designates as var. *antillana*. Though our material may not be identical with his, I hesitate to add to the literature a different name to designate these plants which seem best identified here.

D. 395, lower littoral tide pools, Tepoca Bay, Feb.; D. 460, lower littoral pools, San Esteban Island, Feb.; D. 485, Catalina, near Guaymas, Feb.; D. 112a, lower littoral, Turner's Island, Jan.

Genus **JANIA** Lamouroux

Jania rubens Lamour.

Lamouroux, 1816, p. 212; Harvey, 1846-51, pl. CCLII.

Although all the Gulf specimens of this genus thus far secured are sterile, the general habit correspondence with *Jania rubens* is such that it seems tentatively advisable to place our plants under this designation to await further collections and more intensive examinations.

D. 414, on shore, Pond Island, Feb.; D. & R. 3327, 3237, 3388, Guaymas, Dec.; D. 700, Turner's Island, July.

It is interesting to note the occurrence of the genus *Jania* in the Gulf as well as *Amphiroa*, neither of which is known to occur on the Pacific California coasts.

Family **Grateloupiaceae**

Genus **HALYMENIA** (C. Agardh) J. Agardh

Halymenia actinophysa Howe

Howe, 1911, p. 509, pl. 34.

A re-examination of the type specimen of this species was made and a comparison with certain broad membranous specimens from the Gulf. Two collections proved identical in all structural details, as well as in size and external appearance, with Howe's plant from La Paz. Our largest example measures 38 cm. by 29 cm. and is dark rose in color. One smaller specimen shows basal parts: a small discoid holdfast with several broad blades arising from very short (3 mm.) stipes. The blades are plane and broadly elliptical when young, becoming somewhat undulate in age.

The description and account given by Howe are very ample and need scarcely be elaborated.

D. 138, dredged in 30 m., south of Tiburon Island, near Turner's Island, Jan.; D. 347, in 22 m., off Punta Peñasco, Feb.

This species is distinct from *Halymenia abyssicola* of this paper in its thinner fronds (70-130 μ), outer cortex of only one or two layers of small cells, and absence of a thick surface jelly.

Halymenia ? *abyssicola* sp. nov.

Frondes planae membranaceae, minime 8 cm. latae, 300 μ crassae, marginibus integris, atro-roseae; glutino superficiali 25-35 μ crasso; corticibus stratis paucis cellularum minutarum dense aggregatarum, 5-7 μ diam. compositis; subcorticibus cellulis majoribus compositis; in medulla filamentis laxe intricatis et crabro conjunctiones stellae-formantes ostendentibus; (frondibus fructuosis nondum visis).

Fronds plane, membranous, basal parts unknown, at least 8 cm. broad, with an entire margin, 300 μ thick, deep rose colored; cross section showing a thick surface jelly 25-35 μ thick, a cortical tissue of a few layers of minute, closely packed cells 5-7 μ diam., a subcortex of larger cells merging into a medulla of loosely interwoven filaments with frequent stellate "ganglia" or points of junction.

TYPE: D. 433, dredged in 110-152 m. off Isla Partida, Feb. 5, 1940. Herb. AHF no. 28.

The present species is known only from the single collection of fragmentary fronds which came up from a great depth together with a dredge load of boulders. The thickness of the frond and the presence of the thick surface jelly seen in cross section make it distinct, however, from any known broad, plane, entire-margined species. Furthermore, its occurrence at such great depths is remarkable, and it seems well to put it on record for the information of future collectors. The cross-sectional structure exhibits characters corresponding most closely to those generally recognized for the genus *Halymenia*, but this arrangement can only be tentative until more ample material is available.

Halymenia ? *refugiensis* sp. nov.

Plate 44, Figs. 2, 3.

Frondes planae, membranaceae, obtuse lanceolatae, usque ad minime 11 cm. altae, 2.5 cm. latae, inferne gradatim ad bases angustas attenuatae, marginibus integris; corticibus unistratis cellulis plus minusve complanatis, 4-10 μ in diam. max. compositis; subcorticibus 2 stratis, cellulis complanatis 15-20 μ longis compositis et textis internis fila pluricellularia, 6-8 μ diam., transverse et plus minusve et directe usque ad cellulas subcorticales oppositae currentia emittentibus, textum medullarem filorum plerumque simplicium formantibus, filis stricte in longitudinem nullis; (frondibus fructuosis nondum visis).

Plants flat, membranous, blunt-lanceolate, to at least 11 cm. high, 2.5 cm. broad, with entire margins, narrowing gradually below to a very narrow base; basal attachment organs unknown, but lowermost parts compressed or flattened, 0.5 mm. wide, giving rise to two erect blades; cross section showing a single outer cortical layer of small, + — flattened cells 4-10 μ in greatest dimensions (in surface view the smaller cells are seen to be derived from the larger ones by division into 4-8 parts); sub-cortex of about 2 layers of flattened cells, 15-20 μ in length; from these subcortical cells pluricellular (2-5) filaments 6-8 μ in diam., run + — directly across to an opposite subcortical cell, forming thus a loose medullary tissue of usually unbranched, bridging filaments; no strictly longitudinal filaments present.

TYPE: D. 182, dredged in 24-44 m., Puerto Refugio, Jan. 26, 1940. Herb. AHF no. 29.

This species is known from a single, fairly complete but perhaps immature plant. The very remarkable structure of the frond, together with the external form, although allowing it to be classed rather well with *Halymenia*, sets it apart from all other known species. The medulla is unusual in the absence of longitudinal or interlacing filaments. Those present are mostly at right angles to the surface and form a sort of "pillar effect" between the cortices. Relatively few run obliquely.

Genus GRATELOUPIA C. Agardh

Grateloupia prolongata J. Ag.

J. Agardh, 1847, p. 10; Kützing, Tab. Phyc. XVII, tab. 24; De Toni, 1905, p. 1565; Setch. & Gard., 1924, p. 780, pl. 80.

On the basis of the description given by De Toni and the figure of Kützing, Setchell and Gardner placed several Gulf specimens under this name. The treatment seems acceptable in view of the type locality of the species: Pochetti, Pacific Coast of Mexico, and here additional specimens are recorded. This determination must stand in question, however, until the type specimen of *Grateloupia prolongata* can be examined with reference to the Gulf material. Yendo, 1914, records this species from Japan. He is followed in 1936 by Okamura. Yendo states that he has studied the Agardhian type and finds it agrees satisfactorily with Okamura's specimens distributed as no. 32 of *Algae Japonicae Exsiccatae* and sent out under the name *G. filicina*. He further states that in the Agardh herbarium there is a Japanese specimen sent by Farlow and named *G. prolongata* by Agardh.

From his study, Yendo concluded that the figures of Kützing (loc. cit.) represent the typical form of the species and that which is common on the coast of Japan. Returning to the specimens from the Gulf, we see that they have conspicuous proliferations arising on the surface of the flattened blades as well as along the margins. This occurs in all collections and must be considered typical of the Gulf material. On the other hand, the specimen of Okamura in the Exsiccatae set of W. A. Setchell is merely marginally pinnate; the figure of Kützing of one of Liebmann's original specimens from Mexico shows only marginal proliferations, and the descriptions and discussion given by Yendo include no mention of proliferations other than marginal ones. Some Japanese specimens in the University of California Herbarium show proliferations from the surfaces, but rarely to so great a degree as in the Gulf material. It is, therefore, to be suspected that we may be dealing with a different species in the Gulf from that known on the southern coasts of Mexico, in Japan, and perhaps elsewhere.

J. 25, lower littoral, San Francisquito Bay, June; J. 53a, San Esteban Island, April; J. 87, Isla Partida, July; D. 443, San Esteban Island, Feb.

Grateloupia ? *Hancockii* sp. nov.

Plate 69, Fig. 2

Frondes caespites rotundas formantes, 2-3 cm. altas, e disco emergentes, erectae complanatae, angustae, plerumque in medio .5-.7 mm. latae, 300-400 μ crassae, prorsus copiose margine ramosae, apicibus acutis, saepe attenuatis.

Plants forming greenish-black, rounded, caespitose clumps 2-3 cm. high, from a discoid holdfast attached to rocks and old corallines, the holdfast giving rise to several to many erect fronds; erect parts flattened, narrow, mostly about .5-.7 mm. wide in middle portions, 300-400 μ thick, abundantly branched throughout, the branches marginal, apices commonly acute, often attenuated; cross section showing a loose medulla of branched, frequently septate filaments, interlacing obliquely but + — longitudinal, these more closely packed in outer medulla, merging into the subcortex composed of about 2 layers of cells 12-15 μ diam., these adjoining the outer composed of anticlinal rows of 4-5 minute elliptical cells 5 μ or less long; fertile material unknown.

TYPE: D. 650, middle littoral rocks on point 3 mi. N. of Kino, July 15, 1940. Herb. AHF no. 30.

Only a single collection of this species is as yet known, but from the consistency, branching habit, and cross-sectional appearance, it seems most likely to be a small member of the genus *Grateloupia*. In its several characters of size and habit it is distinct from any other known species.

Grateloupia squarrulosa S. & G.

Setch. & Gard., 1924, p. 780, pls. 81, 82.

J. 60 (AHF no. 84), cast ashore, Smith Island, June. Not again collected.

Grateloupia acroidalea S. & G.

Setch. & Gard., 1924, p. 781, pl. 26, figs. 45, 46.

J. 121, on lower littoral rocks, Guaymas; M. 58 (AHF no. 82), Guaymas, May. Not again collected.

Grateloupia Howei S. & G.

Setch. & Gard., 1924, p. 782, pl. 83.

J. 113 (AHF no. 83), cast ashore, San Esteban Island, April. Not again collected.

"Closely related to *Grateloupia denticulata* Mont., but according to studies made by M. A. Howe, not identical with that species." Setchell and Gardner.

Grateloupia Johnstonii S. & G.

Setch. & Gard., 1924, p. 782, pl. 84.

J. 88 (AHF no. 81), cast ashore, Angel de la Guardia Island, July; not again collected.

"This species of *Grateloupia* seems closely related to *G. squarrulosa* but differs in thickness, color, number and character of the ultimate pinules, and the angle at which the branches arise." Setchell and Gardner.

Genus ESTEBANIA Setchell & Gardner***Estebania conjuncta* S. & G.**

Setch. & Gard., 1924, p. 783, pl. 25, figs. 25, 36, pls. 85, 86.

Several collections of this remarkable plant were made by Johnston in 1921, and one more recent record may be added to these. All are sterile. The habit illustrations of this plant are sufficient to distinguish it at once from any other Gulf species.

J. 53f, floating or entangled among other algae, San Esteban Island; J. 115, same; J. 103, San Pedro Martir Island, April; J. 130, Angel de la Guardia Island, June; D. 475g, dredged in 30-36 meters, Ensenada de San Francisco, near Guaymas, Feb.

Genus **POLYOPES** J. Agardh
Polyopes sinicola S. & G.

Setch. & Gard., 1924, p. 784, pl. 28, fig. 61, pl. 42b.

J. 38, growing on rocks in lower littoral and upper sublittoral belts, Los Angeles Bay, June; J. 85, Isla Partida, July; J. 84d, Angel de la Guardia Island, June. Not recently collected.

This species is undoubtedly a summer annual, judging from the abundance of collections made by Johnston at several stations during the summer and its complete absence from the winter collections.

Genus **PRIONITIS** J. Agardh
Prionitis Sternbergii (Ag.) J. Ag.

J. Agardh, 1851, p. 190; Kylin, 1941, p. 10, tab. 2, figs. 6, 7. *Sphaerococcus Sternbergii* C. Agardh, 1822, p. 275. *Grateloupia Sternbergii* var. *versicolor* J. Agardh, 1847, p. 10. *Grateloupia versicolor* J. Agardh, 1851, p. 181.

Kylin has recently re-examined the types of *Prionitis Sternbergii* and *Grateloupia versicolor* and has arrived at the conclusion that the two are identical.

Growing on rocks in upper sublittoral belt, J. 100, Georges Island, April; J. 119, Tortuga Island, June; J. 6, San Marcos Island, June; D. 537b, 539d, in rock pockets, middle littoral, Agua Verde Bay, Feb.; D. 727, lower littoral, Turner's Island, July (young).

Agreement is good between some of Johnston's collections and Kylin's illustration of the type of *Prionitis Sternbergii*. The narrowness of the pinnae compared with the usually lobate ones of *P. abbreviata* is one point of distinction. The main branches of the latter are also blunt-tipped lanceolate, while those of the former are usually acute and somewhat attenuated.

One poor, encrusted specimen of the winter collection (D. 537b) shows the pinnae characters as well as the habit features in general of *P. Sternbergii* and may tentatively be recorded as a winter occurrence of this species in the southern Gulf. J. 6 undoubtedly represents a typical summer form. A comparison of the known records suggests that *P. Sternbergii* is typically a warm-water species extending south along the central coast of Mexico, while *P. abbreviata* seems to be favored by cooler waters.

Prionitis abbreviata S. & G.

Setch. & Gard., 1924, p. 785, pl. 25, fig. 39, pl. 50b.

This plant is well illustrated by Setchell and Gardner and may be identified thereby. Difficulty may be encountered in distinguishing young stages from those of *Prionitis Sternbergii*, and even in adult plants there may be some confusing similarities, but in general the distinctions pointed out under that species may be relied upon.

J. 53e, on rocks, San Esteban Island, April; D. 453, Feb.; D. & R. 3404, Punta San Pedro, Guaymas, Dec.; D. 490, Catalina Bay, near Guaymas, Feb.

Prionitis mexicana sp. nov.

Plate 67, Fig. 2

Frondes 8-12 cm. altae, e disco basali parvo, teretes usque ad leviter compressae, .7-.8 mm. diam., irregulariter pinnatae; ramis longitudine variabilibus 2 mm. usque ad 6 cm. longis, diametro ea axis primae equatis, apicibus semiacutis; structura generis typica.

Fronds 8-12 cm. high, attached by a small discoid holdfast from which arise several slender, terete, to slightly compressed main axes, .7-.8 mm. diam.; branching irregularly pinnate, the branches of varying length, some short, 2-4 mm., but often long, 2-6 cm., of about the same diameter as the main axis or not conspicuously smaller; apices semiacute, not much attenuated; structure typical of the genus; reproduction unknown.

TYPE: D. 628, middle littoral on rocky reef, San Jose del Cabo, Feb. 16, 1940. Herb. AHF no. 31.

D. 29, dredged in 36-50 meters, Santa Maria Bay, outer coast of Lower California, Jan. 19, 1940.

This species is highly distinctive among the *Prionitis* plants of our region. It resembles in its slenderness *P. filiformis* of the central California coast, but differs markedly in its long-pinnate branching.

Only one of the two localities for *Prionitis mexicana* is strictly within our area, this plant probably being more abundant on the outer coast of southern Lower California than within the limits of the Gulf.

Prionitis guaymasensis sp. nov.

Plate 66, Figs. 1, 2

Frondes usque ad 7 cm. altae, rigidae, cartilagineae, a disco parvo affixae; a disco axes paucae primae assurgentes, compressae, 1.5-2 mm. latae, per occasionem furcatae, ramis multis pinnis indutis; pinnis plerumque angulis rectis emergentibus, frequenter proxime aggregatis, basim attenuatis, supra medium 0.7-1 mm. latissimis, longitudine variabilibus (5-18 mm.) per occasionem furcatis aut ramosis, apicibus semiacutis sed non attenuatis.

Fronde to 7 cm. high, rigid, cartilaginous, attached to rocks by a small disk from which one or a few main axes arise, compressed, 1.5-2 mm. broad, occasionally forked, with many pinnate branches; pinnae commonly standing at right angles to the main axis, often arising very close together, narrowed to the point of attachment, broadest beyond the middle, .7-1.0 mm., of varying length 5-18 mm., occasionally forked or branched; apices semiacute, not attenuated; reproduction unknown.

TYPE: D. & R. 3402 (Field Museum; isotype AHF no. 32), in intertidal rock pools, Punta San Pedro, near Guaymas, Dec. 22, 1939.

D. 46, on rocks near wharf, Guaymas Harbor, Jan., 1940; D. 295, on middle littoral rocks, Puerto Refugio, Jan., 1940.

This species resembles *Prionitis abbreviata* and *P. Sternbergii* in some respects, but the narrow fronds and peculiar long-pinnate branching mark it as distinct. No other Pacific species resembles this plant sufficiently to be much confused with it.

***Prionitis kinoensis* sp. nov.**

Plate 67, Fig. 1

Fronde caespitosae, 2.4 cm. altis, stipitibus curtis, atro-purpureae, copiose dichotomae, segmentis compressis, plerumque 0.6-0.8 mm. latis, internodiis infernis longioribus et frequenter dense pinnatis; ramellorum externorum pinnis egentibus; structura generis typica.

Plants caespitose, a clump 5-6 cm. diam. from a single, short stipe (.5 cm.) attached to rock surfaces, 2-4 cm. high; dark purplish in color; fronds abundantly dichotomous, especially above, the segments compressed, mostly .6-.8 mm. broad, the lower internodes longer and frequently close-pinnate; pinnae absent from outer branches; structure typical of *Prionitis*; apices blunt; reproduction unknown; texture slippery when fresh.

TYPE: D. 648, middle littoral rocks, rocky point 3 miles north of Kino, July 16, 1940. Herb. AHF no. 33.

D. 723, lower littoral rocks, Turner's Island reef, July 18, 1940.

This is the smallest and one of the most distinctive members of the genus on the Pacific coasts of North America. The thickly caespitose habit and abundant dichotomies of the narrow branches are distinctive. The pinnate character of the genus is also exhibited on the lower segments, making easier the identification of the genus of this plant, which is so different in size and form from most of the others of our coast. It is probably another summer annual, not having been found at Turner's Island in January.

Family **Callymeniaceae**
Genus **CALLYMENIA** J. Agardh
Callymenia angustata S. & G.

Plate 68, Fig. 1

Setch. & Gard., 1937, p. 77, pl. 3, fig. 6b, pl. 12, fig. 32.

Fronds up to 7 cm. high, many blades arising from a discoid holdfast; blades membranaceous and flaccid, linear-lanceolate, entire or deeply divided, with a cuneate base and a very narrow stipe, 1-2 cm. wide, 50-60 μ thick; medulla composed of loose, relatively sparse fibers irregular in diameter; cortex composed of a single layer of nearly isodiametric angular cells 5-8 μ diam., and a layer of more or less ellipsoidal cells slightly larger than the surface cells; cystocarps abundant, scattered over surface of fronds, protruding slightly on one side and prominently on the other, with an ostiole; tetrasporangia scattered over the frond in the cortex, cruciately divided; antheridia unknown.

The present more ample material allows us to add to the original description of this plant and to extend its range from the southern, outer coast of Lower California (Santa Maria Bay) to the Gulf: D. 369, dredged in 22 m., Tepoca Bay, February. This plant is apparently of rather deep sublittoral habitat, the type having been dredged in 32 meters.

The cystocarps, tetraspores, and cross-sectional appearance of the frond correspond to Kylin's recent comments on the genus *Callymenia* (1937, p. 165, p. 222, fig. 177B).

Callymenia veleroae sp. nov.

Plate 45, Fig. 1

Fronde usque ad 4 cm. altae, membranaceae, e disco basali abrupte laminae paucae erectae orientes integres, longi ellipticae basi latae-cuneatae, inferne ad stipites angustiores attenuatae, mox laciniatae et in segmentis lateralibus transformatae, 80-90 μ crassae; medullis filis intertextis compositis.

Plants to 4 cm. high, flat, membranaceous from a small disk-holdfast, giving rise abruptly to several erect blades; blades at first (young) entire, long-elliptical with a broadly cuneate base narrowing to a very slender stipe-region, early becoming split and developing further into variously and much lacerated segments, the broadest nonlacerated lower parts of blades up to 8 mm. across, spread of upper parts up to 1.5 cm.; frond in longitudinal section 80-90 μ thick, showing an outer single-layered cortex of small isodiametrical cells 5-7 μ diam., merging imperceptibly into a subcortex of irregularly arranged larger cells 10-18 μ diam. in one or

two layers; medulla narrow, rather dense of (mostly longitudinally arranged) interlacing cellular filaments about $6\ \mu$ diam., the cells 30-65 μ long; reproduction unknown.

TYPE: D. 85, dredged in 12-20 meters, outside Guaymas Harbor, Jan. 23, 1940. Herb. AHF no. 34.

A comparison of this plant with *Callymenia angustata* shows many features in common: cuneate base of blade and slender stipe region, texture and color, general structure of frond. The small size and early splitting and progressive laceration of the blades are distinctive features. Lacking fertile material, the generic determination must be somewhat tentative, but these similarities certainly suggest relationship with *C. angustata*, and in association with that species it probably may most readily be recognized. It likewise is fairly deep sublittoral in habit.

Callymenia guaymasensis sp. nov.

Plate 68, Fig. 2

Frondes 5-7 cm. altae, planae, membranaceae, stipite curta, angusta supra discum basalem; laminis flabellato expansis, profunde in segmentis multis, rotundatis, superpositis (8-15 mm.) divisis, marginibus integris aut per occasionem proliferationibus parvissimis angustis lobiformibus indutis, 60-70 μ (inferne usque ad 130 μ) crassis; medullis angustissimis, filis rudibus intertextis compositis.

Fronds 5-7 cm. high, flat, membranaceous, with a short, narrow stipe above the simple disk-holdfast; blades expanding flabellately, deeply divided above into many broad, rounded overlapping segments (8-15 mm.), margins entire or occasionally with very small, narrow lobate proliferations; frond 60-70 μ thick, up to 130 μ below by repeated periclinal division of cortical cells, above, a single-layered cortex of cells 6-7 μ diam., a subcortex of a layer of + — elliptical cells about twice as large, and a very narrow medulla of coarse, loose, cellular filaments about 5 μ diam.; reproduction unknown.

TYPE: D. 49, dredged in 4-6 meters over muddy bottom, Guaymas Bay, Jan. 22, 1940. Herb. AHF no. 35.

D. & R. 3308, drifting along shore of bay, 4 km. east of Guaymas, Dec.

This species has essentially the same frond structure as the other two *Callymenia* species of the Gulf, but here again there is an entirely different habit by which this plant may be easily distinguished. It is also sublittoral, inhabiting the mucky bottoms of shallow bays, usually badly overgrown with foraminifera shells and bryozoan colonies. Its bright rose color is much like that of the other species.

Callymenia pertusa S. & G.

Setch. & Gard., 1924, p. 746, pl. 49b.

J. 105, cast ashore at San Pedro Martir Island, April. Not again collected.

Genus CALLOPHYLLIS Kützing**Callophyllis Johnstonii S. & G.**

Setch. & Gard., 1924, p. 746, pl. 51a-b.

J. 118, on rocks in upper sublittoral belt, Tortuga Island, June. Not again collected.

Callophyllis sp.

Plate 44, Fig. 4

D. 198, collected at low tide on the shore of Puerto Refugio, is an interesting plant, apparently of this genus. The material is not in such condition as to allow it to be described, but the illustration will provide means of establishing its presence in the Gulf flora.

Family Nemastomaceae**Genus SCHIZYMENIA J. Agardh****Schizymenia Johnstonii S. & G.**

Setch. & Gard., 1924, p. 786, pl. 88. *Schizymenia violacea* S. & G., 1924, p. 786, pl. 25, figs. 37, 38, pl. 87.

From a re-examination of the types of *Schizymenia Johnstonii* and *S. violacea*, it seems more satisfactory to consider these plants the same species. The thickness and structure of the fronds, color, and habitat of the two are the same. Both type specimens were collected in the same general locality (Isla Partida and San Esteban Island are not far apart). The thickness of the frond of *S. Johnstonii* given in the original description (400 μ) is evidently that of a fertile frond. That given for *S. violacea* (230 μ) is of a sterile frond. These measurements are not comparable. The amount of protrusion of the cystocarps seems variable. Those described in *S. Johnstonii* are the more deeply embedded of the two. Other than these unconvincing differences, the type specimens are to be distinguished only by arbitrary characters of frond-shape, known to be inconstant in this genus.

Family **Solieriaceae**
 Genus **EUCHEUMA** J. Agardh
Eucheuma uncinatum S. & G.

Setch. & Gard., 1924, p. 748, pls. 67, 68. *Eucheuma Johnstonii* S. & G., 1924, p. 748, pl. 25, fig. 42, pls. 65, 66.

A re-examination of the types of *Eucheuma uncinatum* (AHF no. 64) and *E. Johnstonii* (AHF no. 65) together with specimens collected recently has aroused a question as to the distinctness of the plants so classified. The type specimen of *E. Johnstonii* appears under the same collection number (J. 84) as a specimen cited under *E. uncinatum*. The material from Mazatlan resembles the type of *E. Johnstonii* much more than that of *E. uncinatum*. Recent collections have shown further variation in the degree of branching of the fructiferous ramuli, and this variation is now considered to account for the differences exhibited by the two type specimens.

Eucheuma uncinatum is evidently quite abundant in the Gulf, judging from the several collections, especially during the spring and summer months. It is a rocky shore inhabitant of the lower littoral zone. J. 28, San Francisquito Bay, June; D. 434, San Esteban Island, Feb.; J. 54, April; J. 80, Isla Partida, July; D. 208, Angel de la Guardia Island, Jan. (very young); J. 84a, July (mature); J. 86, San Lorenzo Island, June; D. 102, Turner's Island, Jan.; J. 88b, Pond Island, June.

Genus **AGARDHIELLA** Schmitz
Agardhiella tenera (J. Ag.) Schmitz

Schmitz, 1889, p. 442; Harvey, 1852, p. 121, tab. 23A (excl. syn.); Børgesen, 1915-20, p. 361, fig. 355.

This species has been collected only on the tropical outskirts of the Gulf, a few examples being taken in the dredge from 40-meter depth off San Jose del Cabo, H. 612, August. They are rather slender examples of this species but are quite typical in both habit and structure. They reach 16 cm. in height.

Agardhiella mexicana sp. nov.

Plate 69, Fig. 1

Frondes 10-14 cm. altae, cylindricae, radiante multifarieque ramosis, axi percurrente deunte, 1.1-1.5 mm. diam., apicibus curte attenuatis, acutis; ramis ultimis tenuibus, acutis; medulla parva fibris longitudinalibus composita; tetrasporangiis zonatis, in corticis subsuperficiem; partibus sporangiiferis projecturis copiosis indutis.

Fronds 10-14 cm. high, cylindrical, branching radially in all directions, diverging at 40-50°, deliquescent, without a main axis, 1100-1500 μ diam.; apices short-attenuate, acute, with "fountain tip"; ultimate, sharp, slender branches giving the dry plant a spiny appearance; cross section showing a small core of longitudinal fibers within the medulla; cystocarps unknown; tetrasporangia zonate, in the cortex immediately below the surface; tetrasporic portions of frond provided with abundant spinulose projections.

TYPE: D. 233, dredged in 4 meters at low tide, south shore of Puerto Refugio, Jan. 28, 1940. Herb. AHF no. 36.

D. 242, cast up at high tide, north shore beach, Puerto Refugio, Jan. 28, 1940; D. 254, dredged in 12-22 meters, Mejia channel, Puerto Refugio, Jan.; D. 299, dredged in 60-80 meters over mud bottom, Gonzaga Bay, Jan.

This species is clearly distinct from any known member of the genus. The character of the tetrasporic plants has confirmed its placement here.

Genus *SARCODIOTHECA* Kylin

The three known species of this genus in our area are remarkable in their external morphology, and are clearly distinct both from each other and from other red algae. Their habit characters are so different from other Gulf plants that they may readily be identified merely by glancing at the several habit illustrations of the types. Anatomically the genus may be recognized by its complanate structure, fibrous medullary core, zonate tetrasporangia, and seriate carpospores.

Sarcodiotheca linearis S. & G.

Setch. & Gard., 1937, p. 80, pl. 5, fig. 12a-b, pl. 15, fig. 35.

The narrow, strict, infrequently branched fronds of this plant are well illustrated and described by Setchell and Gardner. It is another sublittoral species known only from the extreme southern limits of our area. The type specimen came from a depth of 40 meters in San Lucas Bay, H. 41, August (tetrasporic and cystocarpic). Recent collecting has yielded a few more specimens, D. 627, dredged in 34-50 meters off Gorda Point, February (sterile).

Sarcodiotheca elongata (S. & G.) Setchell comb. nov.

Anatheca elongata Setch. & Gard., 1924, p. 747, pl. 22, figs. 4, 5, pl. 64.

In a marginal note in his personal copy of the 1924 publication, Setchell has stated that this species is of the genus *Sarcodiotheca*. The investi-

gation was evidently first made after a study of the species of this genus reported by these same authors in 1937. Re-examination of these plants confirms the statement.

Only a single fragmentary specimen has appeared in recent Gulf collections, but is easily identified here.

The species was first collected by Johnston in beach drift on San Pedro Martir Island, April. Our present plant was taken in a 4-30-meter dredge-haul off Tiburon Island near Turner's Island, D. 140, Jan.

Sarcodiotheca dichotoma (Howe) comb. nov.

Anatheca dichotoma Howe, 1911, p. 502, pl. 29.

This species was described and illustrated sufficiently by Howe to be recognized readily. Its widely divaricate, dichotomous branching is a conspicuous distinguishing feature. Other Pacific coast species are definitely stricter in habit.

The type specimens were from La Paz, Vives 11c, 18b, 20a. Abundant sterile material has been obtained from 30-36 meters in Ensenada de San Francisco near Guaymas, D. 471, Feb.

Family **Hypneaceae**

Genus **HYPNEA** Lamouroux

Hypnea nidifica J. Ag.

J. Agardh, 1852, p. 451; 1876, p. 564. *Hypnea Marchantae* Setch. & Gard., 1924, p. 759, pl. 23, figs. 22, 23, pls. 42a, 56.

This species was originally described from Hawaii, and an investigation of Hawaiian Hypneae has convinced me that it is distinct from other species of that region. In the Herbarium of the University of California there is a fine collection of Hawaiian material containing a good number of specimens of *Hypnea nidifica*. Its loose divaricate branching is conspicuously different from the more percurrent growth of the other species. We can indeed be quite certain that we have abundant, typical material of this species, showing a broad range of variation.

Hypnea nidifica varies widely in size, but the divaricate branching habit, quite devoid of percurrent axes, is generally consistent. A gradual transition in size of branches is found among the specimens on hand, and in the coarser ones the number of stichidia is greater. A comparison of the type of *H. Marchantae* from the Gulf with coarser specimens from Ha-

waii reveals no essential differences, as they fit well into the scale of variation. Finding no consistent means of distinguishing them, the type of *H. Marchantae* is here considered to be a coarser form of *H. nidifica* and one bearing stichidia in greater number.

Recent collections in the Gulf have added greatly to the *Hypnea* assemblage known from that region, and a fine series of gradation types in *Hypnea nidifica* is now on hand. Specimens quite identical with Hawaiian forms are present and range into the coarser forms described as *H. Marchantae*. Specimens from Costa Rica and from southern California have been studied and should also undoubtedly be referred here.

D. 342, 349, dredged in 22 m., Punta Peñasco, Feb.; D. 253, dredged in 12-22 m., Puerto Refugio, Jan.; D. 469, in 30-36 m., Ensenada de San Francisco near Guaymas, Feb.; D. 377, in 22 m., Tepoca Bay, Feb.; D. 500, lower littoral rocks, Catalina Bay, near Guaymas, Feb.; D. 607, in shallow pools, San Gabriel Bay, Feb.; M. 48, cast ashore, Eureka, May.

Hypnea pannosa J. Ag.

J. Agardh, 1847, p. 14; 1852, p. 453; Kützing, Tab. Phyc. XVIII, tab. 27; Setch. & Gard., 1924, p. 758.

An examination of portions of the type material of this species from Liebmann's original collection made at St. Augustine, on the west coast of Mexico, confirms Setchell's conclusion that his *Hypnea nidulans* is distinct. The type of *H. pannosa* is that from which Kützing drew his figures, but the statement that they are natural size is incorrect and misleading. The figures show the plants enlarged 1.5-2 diameters. The true *H. pannosa* is therefore a much smaller plant than *H. nidulans* and more compactly caespitose. Though most of the caespitose *Hypneae* of our collections agree more properly with *H. nidulans*, at least one collection, D. 722, taken in July from the reef at Turner's Island, agrees well with the type of *H. pannosa*. H. 651, dredged in 40 meters off San Jose del Cabo, is similar in size and may be the same.

Hypnea nidulans Setchell

Setchell, 1924, p. 161; 1926, p. 100; Tanaka, 1941, p. 246, fig. 18.

In recent years this species, originally described from Samoa, has been recorded abundantly from many tropical Pacific stations. It is known abundantly from Japan and now is found to be frequent in the Gulf of California. One specimen in the Herbarium of the University of California from the Galapagos Archipelago seems also to be of this species.

The Gulf specimens are distinguished from *Hypnea pannosa* by their larger size and coarser texture, by their habit of creeping over pebbles and coral, and by their usually bright reddish color. Iridescence has been observed in the fresh specimens.

D. 690, 733, Turner's Island reef, July; D. 545, in rock pockets on shore, Agua Verde Bay, Feb.; D. 497, Catalina Bay, near Guaymas, Feb.; D. 430j, Pond Island, Feb.

Hypnea Esperii Bory

Bory, 1829, p. 157; Kützing, 1849, p. 759; Tab. Phyc. XVIII, tab. 26a-c; Børgesen, 1920, p. 306, fig. 48.

This is another small species similar to *Hypnea pannosa* in size. The habit is less compactly caespitose and more delicately branched throughout; the branches are cylindrical, longer, more slender, and more attenuate than in that species.

It is not well established what Bory's type of *Hypnea Esperii* really is, but the Gulf plants do correspond to the illustrations of Kützing and of Børgesen. The determinations of this species, therefore, wherever they occur, must remain uncertain.

Our specimens, particularly D. 106, agree excellently with Kützing's figure and with Børgesen's description.

The present record of its occurrence in the Gulf adds to the already wide distribution attributed to *Hypnea Esperii* in the warmer Pacific: D. 106, lower littoral, reef at Turner's Island, Jan.; D. & R. 3396d, on rocks at low-tide mark, Punta San Pedro, near Guaymas, Dec.; D. 533, in rock pockets, Agua Verde Bay, Feb.

Hypnea Johnstonii S. & G.

Setch. & Gard., 1924, p. 758, pl. 23, figs. 19-21, pl. 57.

This species is well described and illustrated by Setchell and Gardner, and is to be distinguished readily from the other Gulf species by its coarseness and by the absence of an apical cell. The tips have a group of cells instead of one apical initial.

J. 1 (AHF no. 66), Pond Island, June; J. 125, Tortuga Island, May; D. 494, Catalina Bay, near Guaymas, reef rocks, Feb.; D. 121, reef at Turner's Island, Jan.

Family **Gracilariaceae**
Genus **GRACILARIA** Greville
Gracilaria Vivesii Howe

Howe, 1911, p. 503, pls. 30, 33, figs. 1-5; Setch. & Gard., 1924, p. 750.

This species has not appeared in any of the recent collections and is known only from cast-up specimens, the type from La Paz, Vives 20e, and M. 20 from Guaymas. It may be identified by its large, broad, dichotomous-flabellate fronds. Excellent figures of both specimens have been given.

Gracilaria Johnstonii S. & G.

Setch. & Gard., 1924, p. 752, pl. 22, figs. 11-14, pl. 60. *Gracilaria sinicola*, S. & G., 1924, p. 752, pl. 62. *Gracilaria vivipara* S. & G., 1924, p. 750, pl. 24, figs. 28, 29, pl. 63.

This species, which is closely related to *Gracilaria Vivesii*, has undoubtedly been misinterpreted, owing to lack of information regarding the habitat of the plants. All of the type specimens concerned in the above synonymy have been examined, and there appears to the author no reason for segregating them specifically. The name *G. Johnstonii* is chosen to represent this entity because the type specimen is the most normal and characteristic-appearing plant of the three, though the other names precede it in the paging of the original publication. The type of *G. vivipara* is clearly only a proliferating example of this species; that of *G. sinicola* is merely a somewhat old, ragged, and curled cystocarpic specimen. Other examples of the latter from the same station are proliferating much as *G. vivipara* and are partly covered with epiphytes. Considerable variation in the width of the fronds is shown in the several specimens, ranging from 1 cm. at the forks to as much as 5 cm. The heavy, coreaceous texture is the same in all of them, and in this particular they differ from all Gulf Gracilarias except *G. Vivesii*.

No mature plants which can be referred to this species with certainty occur in the winter collections. From the evidence at hand it would appear to be a summer annual of sublittoral habitat.

Specimens are known from Smith Island, J. 61 (AHF no. 79), June; J. 108 (AHF no. 78), San Esteban Island, April; J. 62 (AHF no. 77), Isla Partida, July; J. 36, 36x, Los Angeles Bay, June.

Gracilaria lacerata S. & G.

Setch. & Gard., 1924, p. 755, pl. 51c.

Several plants of this species were collected at Guaymas, growing on rocks in the intertidal zone, D. & R. 3353, December. They are up to 10

cm. high and show good discoid holdfasts, each giving rise to several erect axes branched into irregular segments with unevenly toothed or proliferous margins. Comparison of these plants with the poor, battered types of *Gracilaria lacerata* has convincingly demonstrated their identity.

The type was found cast up at Santa Rosalia, M. 102 (AHF no. 76), May.

***Gracilaria crispata* S. & G.**

Setch. & Gard., 1924, p. 751, pl. 22, figs. 7-10, pl. 44a.

A number of examples of this species have appeared from several localities in our area. *Gracilaria crispata* is similar in its irregular appearance and uneven margins to *G. lacerata*, but is distinguished by its more abundant branching (usually somewhat more divergent), shorter internodes, and crisped, undulate margins. Abundant, congested, semiproliferous branching is generally conspicuous in the terminal portions of mature plants.

D. & R. 3397, 3398, intertidal rock pools, Punta San Pedro, Guaymas, Dec.; H. 600, dredged in 40 meters, San Jose del Cabo, Aug.; D. & R. 3232, tide pools, cove north of Cabo Arco, Guaymas, Dec.; D. 729, lower littoral rocks, Turner's Island, July; M. 51 (AHF no. 75), Eureka.

A collection is also on hand which extends the range of this species to Banderas Bay on the central coast of Mexico, H. 737, July.

***Gracilaria pinnata* S. & G.**

Setch. & Gard., 1924, p. 751, pl. 61.

J. 44 (AHF no. 80), dredged in 8-12 meters, Los Angeles Bay, June; D. 243, cast up at high tide, Puerto Refugio, Jan.; D. 272, dredged in 12-22 meters, Mejia channel, Puerto Refugio, Jan.

***Gracilaria pachydermatica* S. & G.**

Setch. & Gard., 1924, p. 753, pl. 24, figs. 30, 31.

J. 122 (AHF no. 74), on rocks in upper sublittoral belt, Tortuga Island, June. Not again collected.

***Gracilaria subsecundata* S. & G.**

Setch. & Gard., 1924, p. 755, pl. 23, figs. 26, 27, pl. 59.

M. 56 (AHF no. 73), cast ashore, Guaymas Bay, May. Not again collected.

"This species of *Gracilaria* is decidedly distinct from all of the others collected in the Gulf of California, and indeed seems to have no close relative outside the Gulf. The relatively delicate acute fronds and the diversity of methods of branching are distinguishing characters." Setchell and Gardner.

Gracilaria confervoides (L.) Grev.

Greville, 1830, p. 123; Kylin, 1930, p. 55, fig. 44, 1941, p. 20; Harvey, 1846-51, pl. 165. *Cordylecladia lemanaeformis* Setch. & Gard., 1924, p. 759 (not of Howe).

Kylin, 1941, lists both *Gracilaria confervoides* and *G. Sjostedtii* for the central coast of California. He points out in his earlier paper, 1930, the distinctions between these two species, which are very similar vegetatively. He describes *G. confervoides*, as typified by specimens from Naples, Italy, as having cystocarps with special connecting strands between the gonimoblasts and cystocarp wall. Specimens collected by Kylin at Naples and deposited in the Herbarium of the University of California were examined and found to show no connecting strands in the cystocarps. This led at first to considerable confusion in the author's mind, but the fact that the cystocarps examined were quite old and contained great numbers of mature carpospores perhaps explains the inability to find the strands, which undoubtedly are more conspicuous in younger stages.

The fibers have been observed in two examples collected in July at Turner's Island as well as in one collected in December at Guaymas. The Gulf of California plants are more delicate and slender than most forms of the widely distributed *G. confervoides*, a feature which undoubtedly led Setchell and Gardner to refer Johnston's specimens from Los Angeles Bay to *Cordylecladia lemanaeformis*. Comparison of Gulf plants with Howe's Peruvian material of *C. lemanaeformis* shows that none of our specimens are identical with his.

The delicate, slenderly branched forms of *G. confervoides* are predominant in our area. Most of the material collected thus far has been found floating, cast ashore, or has been obtained by dredging.

D. 57, in 4-6 m., Guaymas Bay, Jan.; J. 35, sublittoral, Los Angeles Bay, June; D. 366, in 22 m., Tepoca Bay, Feb.; D. & R. 3425, drifting along shore of bay, Empalme, Dec.; D. 431, dredged off Pond Island, Feb.; D. 672, cast ashore, Kino, July; D. 667, cast ashore at south channel entrance, Tiburon Island, July; D. & R. 2929, cast ashore, Kino, Nov.; 3247, floating in brackish water of Rio Mayo, Dec.; 3159, mouth of tidal stream, Playa Miramar, Guaymas, Dec.

Gracilaria Sjostedtii Kylin

Kylin, 1930, p. 55, fig. 43; 1941, p. 21.

D. 381 compares favorably in external morphology with specimens from the coast of California. Cystocarps examined have not exhibited the connecting strands between gonimoblasts and cystocarps wall which characterize *G. confervoides*. Until more collections and accurate field observations on these two plants in the Gulf are made, D. 381 is separated from *G. confervoides*. It was dredged in 22 meters at Tepoca Bay, February, and is much more robust and less branched than D. 366 from the same haul referred to *G. confervoides*.

Gracilaria compressa (Ag.) Grev.

Greville, 1830, p. 125; Harvey, 1846-51, pl. 205; J. Agardh, 1851, p. 593; Kützing, Tab. Phyc. XVIII, tab. 78; Okamura, Icones V, p. 161, pl. 242, figs. 5-10.

Specimens of several collections from Guaymas appear to agree in all essential details with this widely distributed species. Correspondence is exceedingly close with the Japanese forms illustrated by Okamura (loc. cit.).

There is considerable variation in size of the plants and diameter of the branches, but the branching habit and fleshy texture of the fresh specimens are ready means of identifying the plant.

Thus far it has been found only in the vicinity of Guaymas, abundant in shallow water or on shores of quiet bays: D. & R. 3356, 3305, 3284, 3148, Dec.; D. 59, 67, Guaymas Bay, Jan.; D. 477, Puerto San Carlos, near Guaymas, Feb.; D. & R. 3246, 3242, floating in brackish water at mouth of Rio Mayo, Dec.

Gracilaria lichenoides (L.) Harv.?

Setch. & Gard., 1924, p. 750.

A single sterile collection from Coyote Bay, Concepcion, J. 14, June, was referred to this species by Setchell and Gardner. The plants show much resemblance to the coarser forms of *G. confervoides* or *G. Sjostedtii*. The specimens have the pale, cartilaginous character so commonly associated with *G. lichenoides*, but this may largely be due to conditions under which the present plants were dried. Since no other collections have been made from that part of the Gulf, this record must remain questionable until confirmed by additional material.

Gracilaria veleroae sp. nov.

Plate 70, Fig. 2 (left)

Frondes 6-8 cm. altae, complanatae, crasso-membranaceae, basi cuneatae e disco parvo orientes, irregulariter dichotomo-flabellatae, segmentis plerumque 5-7 mm. latis, integris; internodiis curtis, 1-1.5 cm.; apicibus rotundatis; frondibus 300-400 μ crassis; cellulis internis magnis, parietibus tenuibus; corticibus essentialiter unistratosis cellulis forma laterium; cystocarpiis marginalibus, 1 mm. diam., carpostomio leviter elevato.

Fronds 6-8 cm. high, complanate, thick-membranous, cuneate at the base from a small discoid holdfast, irregularly dichotomo-flabellate, the segments mostly 5-7 mm. broad, entire, dull reddish in color; internodes short, 1.0-1.5 cm.; apices rounded; fronds 300-400 μ thick in cross section, medulla of large, thin-walled cells, cortex of essentially a single layer of brick-shaped cells about 12 by 5 μ ; cystocarps spherical, usually marginal, about 1000 μ diam., with a small, slightly raised ostiole; tetrasporangia unknown.

TYPE: D. 141a, in a 4-30-meter dredge haul, off Tiburon Island near Turner's Island, Jan. 25, 1940. Herb. AHF no. 37.

D. 83, dredged in 12-20 meters, outside Guaymas Harbor, Jan. 23, 1940; D. 265, dredged in Mejia channel, Puerto Refugio, Jan. 28, 1940; D. 371, dredged in 22 meters, Tepoca Bay, Feb. 4; D. 339, dredged in 5 meters, San Felipe Bay, Feb. 2.

In color and habit this species very closely resembles a *Rhodymenia*, and until cystocarps were found was confused with that genus. The typical gracilarioid gonimoblast development, however, is clearly indicated in sections of cystocarps of several collections.

This species seems morphologically related to the other broad, complanate Gulf species, *Gracilaria Vivesii* and *G. Johnstonii*, but is much smaller throughout than those plants.

Gracilaria Hancockii sp. nov.

Plate 65, Fig. 2

Frondes 7-15 cm. altae, tenues, inferne cylindratae, superne complanatae, axis paucis e disco basali orientibus, multifarie ramosis, basim teretibus, 800-1200 μ diam., superne complanatis usque ad 2 cm. latis, apicibus acutis attenuatisque; cystocarpiis protrudentibus e disco frondis, 1500 μ diam., carpostomio parvissimo.

Plants 7-15 cm. high, slender, cylindrical below, flattened above, from a small, solid, discoid holdfast, several main axes arising directly from the holdfast or from a very short, thick basal stipe; axes branching loosely, multifariously, terete at the base, 800-1200 μ in diam., becoming compressed to flattened above and to 2 mm. broad; apices acute, attenuated;

fronds in cross section showing a broad medullary area of large, thin-walled cells and a 2-3 layered cortex of much smaller cells; cystocarps occasional, protruding from compressed to flattened parts of fronds, 1500 μ diam., with a very small ostiole and an extensively branched, dendroid gonimoblast structure; inner pericarp of flattened cells simulating a crushed layer (a sort of "pericarpium proprium").

TYPE: D. 149, dredged in 4-32 meters off south shore of Tiburon Island near Turner's Island, Jan. 25, 1940. Herb. AHF no. 38.

D. 177, seine-haul over sand, just off south shore beach, Puerto Regugio, Jan. 26, 1940.

***Gracilaria guaymasensis* sp. nov.**

Plate 70, Fig. 2 (right)

Frondes 3-4 cm. altae, valde ramosae, axibus multis e disco basali orientibus, prorsus compressis, segmentis 1.5-2 mm. latis, dichotomis, densis; internodis 2-5 mm. longis; apicibus obtusis; cystocarpiis globosis, 1.2-1.3 mm. diam., late sessilibus aut basim constrictis, carpostomio leviter elevato.

Plants 3-4 cm. high, much branched, many axes arising from a simple, discoid holdfast, compressed to flattened throughout, the segments 1.5-2 mm. wide; branching mainly dichotomous, close, internodes 2-5 mm. long; apices blunt; outer cortical cells in cross section in a palisade, 5 by 10 μ ; cystocarps abundant on upper branches, large, globose, 1200-1300 μ diam., entirely superficial, broadly sessile or commonly constricted about the base, with a small, slightly raised ostiole; placenta typically gracilarioid, of large, elongated, thin-walled cells.

TYPE: D. & R. 3401 (Field Museum; isotype, AHF no. 39), in intertidal pools, Punta San Pedro, near Guaymas, Dec. 22, 1939.

Known only from a single collection but distinct in habit and in morphology of cystocarps from other known species.

***Gracilaria secundata* S. & G.**

Gracilaria secundata Setch. & Gard., 1937, p. 78 (not of Harvey).

Setchell and Gardner described a new species from a fragment of a tetrasporic plant and erroneously gave it a name already used by Harvey (Phyc. Austr. V, 1863, no. 432) for another species. The type of Setchell and Gardner's plant is so fragmentary that it can only be considered an interesting but indeterminable scrap.

Further collecting in the sublittoral off San Jose del Cabo may reveal sufficient material later for the establishment of a name.

Gracilaria sp.

Plate 44, Fig. 1

Fronds up to 9 cm., complanate, thick, coriaceous, from a short, terete stipe, 2-3 mm. diam., expanding cuneately into the base of the blades, irregularly, divaricately forked and lobed, the segments short, 6-8 mm. (to 15) broad, with smooth margins; fronds 300-700 μ thick, with 2-3 layered cortex of quadrate cells about 12 μ diam.; reproduction unknown.

The several examples of this plant in our collections seem surely to be of this genus but are sterile. The terete basal stipe is distinctive as are the littoral habit and the thick, coriaceous fronds. It appears to be related to the *G. Vivesii*-*G. Johnstonii* group in the Gulf, and, since it is present in so many collections, it seems well to record it in this way.

D. 118, lower littoral rocks, Turner's Island, Jan.; D. 200, Puerto Refugio, Jan.; D. 446, San Esteban Island, Feb.

Family **Dicranemaceae**Genus **DICRANEMA** Sonder**Dicranema rosaliae** S. & G.

Setch. & Gard., 1924, p. 745, pl. 22, fig. 6.

Recent collections have yielded a number of specimens of this little-known plant. Its small size (2-4 cm.) and slender diameter of the terete fronds (250-350 μ), together with the presence of a medullary core of compact, thick-walled, elongated cells, distinguish it from all other Gulf plants. Fertile material has, however, not yet been detected.

M. 103, cast ashore, Santa Rosalia; D. & R. 3426, drifting along southeast shore of bay, Empalme, Dec.; D. & R. 3309, drifting along shore east of Guaymas, Dec.; D. & R. 3362, on shore rocks, Guaymas, Dec.; D. 255a, dredged in 12-22 meters, Mejia channel, Puerto Refugio, Jan.; D. 614e, in oyster culture ponds, San Gabriel Bay, Feb. (slender, 125-250 μ diam); D. 546, on lower littoral rocks, Agua Verde Bay, Feb.

Family **Phyllophoraceae**Genus **GYMNOGONGRUS** Martius**Gymnogongrus carnosus** S. & G.

Setch. & Gard., 1924, p. 745, pl. 47a, pl. 22, fig. 1.

J. 102, cast ashore, San Pedro Martir Island, April. Not again collected.

"The combination of characters of this species is not such as to make it unmistakably a member of the genus *Gymnogongrus*. It has a Gigarti-

naceous cystocarp, and the histological characters are mainly those of *Gymnogongrus*. The very gelatinous nature of the cell-walls, however, is quite different from those of all known species of the genus." Setchell and Gardner.

Gymnogongrus sinicola sp. nov.

Plate 71, Fig. 2 (lower left)

Frondes 4-6 cm. altae, e disco simplici orientes, inferne teretes, superne leviter compressae, 2-3 mm. diam., firmae, solidae, carnosae, maxime in planitie una, dichotomo-ramosae; segmentis curtis, vulgo circa 5 mm. longis; apicibus rotundatis; structura generis.

Fronds 4-6 cm. high, from a simple holdfast, terete below, to slightly compressed above, 2-3 mm. broad, of a firm, turgid, fleshy texture, dichotomously branched, mainly in one plane; segments short, mostly about 5 mm., and slightly broader above than below; apices blunt, rounded; cross section showing a very large medulla of large, thin-walled, isodiametric cells to 200 μ diam., grading toward the periphery into the sub-cortex of small cells 40 μ to 18-20 μ ; cortex of a single palisade layer of anticlinally arranged cells measuring 8-16 μ ; reproduction unknown.

TYPE: D. 447, lower littoral rocks, San Esteban Island, Feb. 5, 1940. Herb. AHF no. 40.

D. 484, on reef rocks, Catalina Bay, outside Guaymas Harbor, Feb.; D. 213, on rocky shore, Puerto Refugio, Jan.; D. 122, reef rocks, Turner's Island, Jan.

This species may be distinguished by its rigid, thick, fleshy, usually terete fronds. Though all our material is sterile, the habit and structure seem to justify its arrangement under *Gymnogongrus*.

Gymnogongrus Hancockii sp. nov.

Plate 71, Fig. 2 (upper left)

Frondes usque ad 2 cm. altae, caespitosae, copiose-late-divaricato-dichotomoramiosae; segmentis circa 300 μ crassis, plerumque 0.8-1 mm. latis, inferne angustioribus, ad apicem curtioribus, plerumque inferne 2-3 mm. longis; apicibus bifidis aut 3-4 digitatis; cystocarpiis circa 450 μ diam., dimidio immersis, carpostomia pauca praebentibus.

Plants to 2 cm. high, of abundant, narrow, widely divaricate, dichotomous branches, caespitose, forming a small, rounded clump on rocks, of a soft, delicate texture when fresh; segments, about 300 μ thick, mostly .8-1 mm. wide, narrower below; distance between dichotomies successively shorter toward apices, mostly 2-3 mm. below; apices bifid, or 3-4

digitate; cystocarps frequent on frond surfaces, about 450 μ diam., smooth, rounded, about half embedded in frond, protruding only 200-300 μ from normal frond surface, with several ostiolar openings.

TYPE: D. 649, middle littoral rocks on point 3 miles north of Kino, July 16, 1940. Herb. AHF no. 41.

The specimens are ample and have a very distinctive habit. It is the smallest species thus far recorded from our area.

Gymnogongrus divaricatus Holmes

Plate 71, Fig. 2 (right)

Holmes, 1895, p. 255, tab. VII, fig. 3a-b; Okamura, Icones Jap. Algae VII, p. 16, pl. 310.

Specimens are known from a single locality in the Gulf, but material is ample and fertile. It seems to correspond in all essential characters with the Japanese species. The truncate or bifid frond-apices and the marginal clavate proliferations serve to identify it.

D. 94, 120, lower littoral rocks of reef at Turner's Island, Jan.

Family *Gigartinaceae*

Genus *GIGARTINA* Stackhouse

Gigartina Teedii (Roth) Lamour.

Lamouroux, 1813, p. 49, tab. 4, fig. 11; Okamura, Icones Jap. Algae I, pp. 163-165, pl. 33, figs. 9-12.

Several specimens taken from the vicinity of Guaymas correspond satisfactorily with the descriptions and figures of this widely distributed species, known heretofore from southern Europe, Brazil, and Japan. The narrow, complanate fronds, 2 mm. broad, and abundant, delicate branching distinguish it from the others of our region.

D. 47, middle littoral rocks by wharf, Guaymas Harbor, Jan.; D. & R. 3364, 3286, in shallow water, Guaymas, Dec.

Gigartina Eatoniana J. Ag.

Setch. & Gard., 1933, p. 271, pl. 51.

A few examples are at hand which seem to exhibit the characters of juvenile or immature plants of *Gigartina Eatoniana*. They show good correspondence with the type specimens as illustrated by Setchell and Gardner, and until more fully developed material is collected, they are best

referred to that species. They differ from other Gulf species of the genus by their discoid holdfasts and smooth, attenuated lower parts of the blades.

MacDougal, Puerto Libertad, Sonora, May 4, 1923 (with *Gigartina MacDougalii*); D. 91, on rocky shore, Turner's Island, Jan.

Gigartina Johnstonii sp. nov.

Gigartina Chauvinii Setch. & Gard. (not of Montagne), 1924, p. 744, pls. 46b, 70.

Frondes 12-25 cm. altae, complanatae 5-12 (-16) mm. latae, basim laxe ramoso stoloniferae; laminis primariis e stolonibus orientibus, secundariis tertiariisque marginalibus; marginibus omnibus pinnulis simplicibus vestientibus; discis laminarum projecturis papillatis indutis; apicibus acutis.

Plants 12-25 cm. high, of complanate blades 5-12 (or 16) mm. broad arising from a holdfast composed of a loose, branched, stoloniferous tangle; primary blades arising as branches from the stolons; secondary and tertiary blades successively smaller and all marginal; all margins with conspicuous acute, simple or branched, spinose pinnules; blade surfaces with shorter, more papillate projections; tips all very acute; branches narrowed but not conspicuously constricted at bases.

TYPE: D. 436, lower littoral rocks, San Esteban Island, Feb. 5, 1940. Herb. AHF no. 42.

A comparison of specimens from the Gulf collections of this plant with Peruvian examples of *Gigartina Chauvinii* has revealed that they are not identical and that the Mexican plants are worthy of a distinguishing name.

The species is common on lower littoral rocks in the upper Gulf and is known from the following stations: D. 92 (117 young), Turner's Island, Jan.; D. 189 (207 young), Puerto Refugio, Jan.; D. 311, Gonzaga Bay, Jan.; D. 436, San Esteban Island, Feb.; J. 53, April; J. 101, Georges Island, April.

Gigartina pectinata sp. nov.

Plate 64, Fig. 1

Frondes 5-30 cm. extendentes, laxe per extensiones papillarum superficium inferarum aut per stolones parvas ramosas affixae; segmentis frondium angustis, complanatis, primariis circa 3 cm. latis, distiche 3-plo ramosis, in ordine angustioribus curtisque, apicibus acutis; partibus latioribus ramorum, pinnulis copiose marginalibus, tenuibus, pectinatis.

Plants spreading 5-10 cm. in extent, attached loosely by elongation of papillae from the under surfaces or by small, branched stolon-attachments from the primary base and the prostrate blades; fronds composed of narrow, complanate segments, the primary ones about 3 cm. broad, branched distichously into about 3 orders of branches, successively narrower and shorter and apically acute; broader parts of primary and secondary branches conspicuously clothed with abundant, semiequal, slender marginal pinnules, giving a somewhat pectinate aspect to these parts; older blade-surfaces commonly with similar, shorter projections; cystocarps lateral on smaller segments, not abundant, with a dense proper pericarp; cystocarpic plants more densely branched than sterile specimens.

TYPE: D. 239, cast up on shore at high tide, north shore beach at Puerto Refugio, Jan. 27, 1940. Herb. AHF no. 43.

D. 209, lower littoral rocks, Puerto Refugio, Jan. 26, 1940; Poin-dexter, shore rocks, Punta Peñasco, March, 1941 (juvenile).

This species resembles in some respects young specimens of *Gigartina leptorhynchus* of the coast of California.

Gigartina MacDougalii sp. nov.

Plate 64, Fig. 2

Frondes 6-9 cm. altae laminis angustis complanatis e stolonibus valde ramosis, complanatis, in massam intertextis orientes; laminis complanatis basim attenuatis, semel distiche in segmenta 5-6 mm. lata et usque ad 5 cm. longa ramosis; segmentis levibus aut inferne spinulis paucis marginalibus, sed superne papillis ramosis lobatis, dense intertextisque ubique indutis.

Plants 6-9 cm. high, of narrow complanate blades from a large tangled holdfast of many narrow, flattened, much-branched stolons; blades flattened from the start, attenuated to the base, branching once distichously into segments 5-6 mm. wide and up to 5 cm. long, smooth or with a few marginal spinules in lowest parts, thickly matted above with branched and lobed papillae over all surfaces, giving these parts a spongy appearance and obscuring the flatness of the blades; cystocarps among branched papillae, with a "pericarpium proprium."

TYPE: MacDougal (Univ. Calif. Herb.; isotype, AHF no. 44), Puerto Libertad, Sonora, May 4, 1923.

The tangled holdfast of branched stolons and the matted effect of the papillae over the blades are the distinctive features of this remarkable species.

Genus **RHODOGLOSSUM** J. Agardh**Rhodoglossum Hancockii** sp. nov.

Plate 71, Fig. 1

Frondes 10-16 cm. altae, 5-8 (12) cm. latis, membranaceae, plus minusve dichotomo-divisae; segmentis latissimis, divergentibus, apicibus acutis, quibusque inferne ad stipitem, angustam, basi teretem, 1-1.5 cm. longam, 1 mm. latam, attenuatis, 1-paucis e stipite commune orientibus; marginibus integribus; laminis 200-300 μ crassis.

Fronds 10-16 cm. high, membranous, 5-8 (or 12) cm. broad, + — dichotomously divided, the segments very broad, spreading and with acute apices, narrowing abruptly at the base to a narrow, basally terete, cuneate stipe 11.5 cm. long, 1 mm. diam., one to several such stipitate blades from a short, common stipe; margins essentially smooth, entire; blades 200-300 μ thick, of a loose, fibrous medulla and a cortex of 3-5 layers of minute, + — isodiametrical cells with conspicuous intercellular connections, 5-7 μ diam., those of the outermost layer commonly somewhat anticlinally elongated; tetrasporic sori and cystocarps scattered evenly over all but the tips of their respective fronds; cystocarps completely embedded, 500-900 μ diam.; tetrasporangia in sori 500-700 μ across, completely immersed under the cortex, cruciately divided.

TYPE: D. 437, lower littoral rocks, San Esteban Island, Feb. 5, 1940. Herb. AHF no. 45.

This species was found in only one locality but was quite abundant there. It was first taken for a small *Iridophycus* species, but investigation has shown it to have the characters of the genus *Rhodoglossum*.

Family **Rhodymeniaceae**Genus **FAUCHEA** Montagne & Bory**Fauchea mollis** Howe

Howe, 1911, p. 507, pl. 32, pl. 33, fig. 6.

Study of the type specimen collected at La Paz by Vives confirms Howe's designation of the plant as most likely a *Fauchea*. The structure corresponds to Kylin's diagnosis of the genus (1931, p. 8). It has not, however, appeared in any collections since the original one.

Fauchea Sefferi Howe

Howe, 1911, p. 506, pl. 31.

This plant, another species from Vives' collections at La Paz, corresponds with Kylin's interpretation of the genus *Fauchea* (1931, p. 8). It has not been collected a second time.

Genus *BOTRYOCLADIA* Kylin*Botryocladia pseudodichotoma* var. *datilensis* var. nov.

Plate 45, Fig. 7; Plate 73, Fig. 1

A forma typica, magnitudine prorsus parviore, vesiculis densiore conglobatis divergente; cellularibus glanduliformibus 30-35 μ diam., 5-6 collocatis.

Plants smaller in size throughout than the species, with more compact arrangement of vesicles; gland cells 30-35 μ diam., in groups of 5-6.

TYPE: D. 116, lower littoral rocks, Turner's Island (El Datil) off south shore of Tiburon Island, Jan. 24, 1940 (tetrasporic). Herb. AHF no. 47.

In general habit and appearance the specimens on hand resemble the species very strongly. They are, however, smaller in size throughout and show a more compact arrangement of the vesicles. An investigation of the gland cells which Børgesen has shown to be of specific significance and is here used as a varietal distinction, reveals a difference both in size and arrangement. In the typical species they usually measure between 14 and 28 μ and are found in large aggregations, up to 25 on a single large interior cell (plate 45, fig. 6). In the Gulf material they are larger, 30-35 μ , and occur in groups of only 5-6. In view of the great similarities with the Pacific coast species and the not widely separated localities, it seems best to make only a varietal distinction.

Botryocladia Hancockii sp. nov.

Plate 45, Figs. 2-5

Frondes axibus primariis, solidis, ramosis, vesiculas elongato-saccatas, cavas, plerumque 3 cm. longas, pedicellis teretibus, 2 mm. longis, et in dimidio superno projectionibus secundariis digitiformibus cavis provisas, ferentibus; projectionibus irregularibus et magnitudine variabilis usque ad $\frac{1}{6}$ -plo longitudine vesicularum primariorum. Specimine typico mesquam completo sed distinguente.

A single cystocarpic portion known, 3.4 cm. long, consisting of one hollow, saccate branch (or vesicle) subtended by a solid, branched, terete main axis bearing also remnants of 3 other saccate parts; fronds expanding and becoming hollow about 2 mm. from the axil of each branch of the terete axis, the vesicle elongated and bearing a few secondary, hollow, fingerlike projections from the upper half, these irregular and of varying size, up to $\frac{1}{6}$ the length of the main vesicle; vesicle-wall consisting of 3 cell-layers, the innermost of large cells averaging about 70 by 200 μ , the subcortical layer of cells about 20 by 30 μ in dimensions, arranged regularly over the lateral walls of the large inner cells; the outer layer of cells incomplete, consisting of small cells 10 μ or less in diameter, partly cov-

ering the subcortical layer but more or less arranged in such a way as to leave the middle of the larger inner cells uncovered; gland cells borne occasionally in groups of 4-8 on the middle of the inner face of the large cells next to the cavity of the vesicle, pyriform, about $20\ \mu$ long; cystocarps sparsely scattered over the surface of the vesicle, smooth, hemispherical, $600\ \mu$ broad, $300\ \mu$ high, with a small pore $50\ \mu$ in diam.

TYPE: D. 561, dredged in 20-40 meters, Agua Verde Bay, Feb. 12, 1940. Herb. AHF no. 48.

This species is in many respects similar to the West Indian *Chrysiomenia Enteromorpha*, from which it differs in possessing a solid, branched axis, in the less proliferous branching of the vesicles, and in the smooth, hemispherical nature of the cystocarps.

Botryocladia uvarioides sp. nov.

Plate 45, Figs. 8-10; Plate 75, Fig. 1

Frondes usque ad 22 cm. altae, axi primaria, tereti, solida, ramis lateralibus copiosis sphericis, dense collocatis, saccatis, prorsus totaliter axes investientibus, compositae; vesiculis 2-3 mm. diam.; cellulis glanduliformibus, singillatim aut paucitatibus conglobatis, $10\ \mu$ diam.

Attachment organs unknown; plants up to 22 cm. high, consisting of a sparingly branched, solid, terete main axis with abundant, close-set lateral, spherical saccate branches almost completely covering the solid axis throughout its length; spherical vesicles usually 2-3 mm. in diam., consisting of a 3-layered wall enclosing the cavity; the innermost of large, roundish cells $50-90\ \mu$ diam.; the subcortex of cells $12-18\ \mu$ diam.; the outer cortical layer of small cells $4-6\ \mu$ diam.; gland cells fairly infrequent, often occurring singly on the inner surface of the large inner cells, or, when there are two, these not usually attached close together, not uncommonly in groups of 3-5 arising from smaller cells of the inner layer, small, $10\ \mu$, with a slender attachment; reproduction unknown.

TYPE: H. 727 & 598 (Calif. Acad. of Sciences; isotype, AHF no. 49), dredged from 40 meters off San Jose del Cabo, August 4, 1932.

H. 45, dredged in 40 meters, San Lucas Bay, Aug. 4, 1932.

In some instances the gland cells arise from peculiar stellate cells resembling those which Børgesen figures for *Coelarthrum Albertisii* (1914, pp. 405-406, figs. 390, 391).

This species corresponds in size and general appearance with *Botryocladia occidentalis* (Børg.) Kylin, but differs in the nature of the gland cells and in the close-set arrangement of the spherical vesicles. *B. uvaria* seems to represent a widespread semitropical type, geographic species or

forms of which are now recognized under several names such as *B. occidentalis* and *B. leptopoda*, and to which the present species is taxonomically equal in magnitude.

Genus **RHODYMENIA** Greville

Rhodymenia divaricata Dawson

Dawson, 1941a, p. 141, pl. 23, fig. 31.

D. 53 (AHF no. 1), dredged in 4-6 meters, mud bottom, Guaymas Bay, Jan.; D. 257, dredged from sand and coralline bottom in 12-22 meters off Mejia Island, Puerto Refugio, Jan.

Rhodymenia rosea Dawson

Dawson, 1941a, p. 141, pl. 24, figs. 32, 33.

D. 266 (AHF no. 2), dredged in 12-22 meters off Mejia Island, Puerto Refugio, Jan.

Rhodymenia Hancockii Dawson

Dawson, 1941a, p. 146, pl. 20, fig. 20, pl. 26, fig. 38.

D. 252 (Type AHF no. 3), dredged in 42 meters, west side of bay, over shell bottom, Puerto Refugio, Jan.

Rhodymenia lobata Dawson

Dawson, 1941a, p. 147, pl. 19, figs. 12, 13, pl. 28, fig. 41.

A sterile plant with extensive branched stipes, narrowly cuneate blades, narrow segments, and thin blades was dredged in 10-18 fathoms near Isabel Island, Sinaloa, Mexico, April 2, 1937. In the sterile state it cannot be distinguished from *Rhodymenia lobata*, known hitherto only from the sublittoral of central California, and is tentatively placed under that name, awaiting fertile examples.

Rhodymenia ? tepocensis sp. nov.

Plate 65, Fig. 1

Frondes 12-18 cm. altae, circa 200 μ crassae, valde complanatae, partibus inferioribus exceptis, iis ad basem subteretem copiose ramosam valde attenuatis, superne 2-3 mm. latae, remote dichotomae, in planitie una ramosae; segmentis acute ascendentibus, axillis anguste acutis; apicibus 2-6 -acute divisus.

Plants 12-18 cm. high, strongly flattened except in lowermost parts, very much attenuated to a subterete branching base, but holdfast un-

known; fronds mostly 2-3 mm. wide above, distantly subdichotomously branched in one plane, the segments sharply ascending; axils a narrow V; branches originating at very apex by development of pairs of primordia from the multicellular apical meristem, elongation retarded at apex and consequently 4-6 pointed growing tips are common and conspicuous; fronds commonly 200 μ thick, of a single cortical layer of small cells, sharply angular in surface view, flattened in cross-sectional view; medulla of large, thin-walled cells; proliferations frequent by superficial outgrowths, at first very slender, 200-250 μ , soon becoming flattened and assuming the general habit of primary axes, though much more slender and delicate throughout; fertile material unknown.

TYPE: D. 367-370, in 22 meters over sandy bottom, Tepoca Bay, Feb. 4, 1940. Herb. AHF no. 46.

D. 432, dredged in 124-152 meters 4 miles off Pond Island, Feb. 5, 1940.

In habit and structure these plants are nearest to *Rhodymenia*, but without reproductive material the generic status can be considered only tentative.

Family Champiaceae

Genus **LOMENTARIA** Lyngbye

Lomentaria catenata Harvey

Plate 74, Fig. 1

Harvey, 1857, p. 331; Okamura, *Icones Jap. Algae*, I, pl. 26. *Corallopsis excavata* Setch. & Gard., 1924, p. 756, pls. 23, 44, 48.

J. 21, Tortuga Island, June; J. 59, Isla Partida, July; J. 129, opposite Pond Island, July; D. 100, on reef at Turner's Island, Jan.; D. 449, middle littoral, San Esteban Island, Feb.

Of the five collections from the Gulf of California, including both tetrasporic and cystocarpic material, all seem indistinguishable from the hitherto Japanese species *Lomentaria catenata*. The condition of some of the dried material of Johnston's collection in 1921 was such that it was misinterpreted by Setchell and Gardner and published by them as a new species, *Corallopsis excavata*. There is, however, little or no question but that the Gulf specimens are virtually, if not precisely, the same as the Japanese specimens of *L. catenata* in the Herbarium of the University of California.

Lomentaria hakodatensis Yendo

Plate 75, Fig. 2

Yendo, 1920, p. 6. *Lomentaria sinensis* Howe, 1924, p. 139, pl. 1, fig. 1. *Hooperia Baileyana* Setch. & Gard. (not of J. Agardh), 1930, p. 153.

In the report of Setchell and Gardner on the Algae of the Revillagigedo Island Expedition a specimen from Guadalupe Island, off the coast of Lower California, is referred to *Hooperia Baileyana* J. Ag. Specimens in six collections from the Gulf of California seem identical with the Guadalupe Island specimen, and the cross sections of the 3-layered cortex bear this out. The Atlantic specimens of *Lomentaria Baileyana* have a characteristically unilateral branching habit. These branches are usually curved so as to give a slightly curly appearance to the plants, a character not at all conspicuous in the Gulf material.

The species *Lomentaria hakodatensis* occurs on the coasts of China and Japan. The cross sections of this species show a somewhat variable size in the three layers of cortical cells, though often, if not usually, the arrangement is quite the same as in *L. Baileyana*. The same close relationship is shown with the Gulf specimens, but because of the nonsecund branching habit and the more erect rather than curled nature of the branches there is virtually no means of distinguishing our plants from the western Pacific *L. hakodatensis*. Thus, lacking any real criterion for separating them, it seems best at present to refer all of them to that species.

D. 174, 232, 238, 261, dredged in 8-22 meters, Puerto Refugio, Jan.; D. 475f, dredged in 30-36 meters, Ensenada de San Francisco, near Guaymas, Feb.

***Lomentaria Drouetii* sp. nov.**

Plate 46, Figs. 1, 2; Plate 74, Fig. 2

Frondes usque ad 8 cm. altae, basi solidae, erecta et iterum ad iterum copiose ramosae usque ad systema complicatum segmentorum, gracilium, cylindricum, cavorum, nonseptatum, superne circa 400 μ diam. et apicibus acutis, efficientes; segmentis ultimis superne stratum corticale cellularum 3 x 12 μ , ordine palorum intus 3-4 strata cellularum plus minusve isodiametricarum 5-15 μ , et zonam filorum laxorum plerumque longitudinalium cavitatem vestientium ostendentibus.

Plants to 8 cm. high, arising from a small holdfast; fronds solid at base, branching erectly, increasingly, and abundantly to a complex system of slender, cylindrical, hollow, nonseptate segments, these ultimately about 400 μ in diam. and terminating in moderately acute apices; ultimate segments composed of an outer cortical layer of palisade cells, measuring about 3 by 12 μ , below which are 3-4 layers of more or less isodiametrical cells measuring from 5-15 μ , these proceeding to a zone of loose, mostly longitudinal filaments which line the cavity; cortical cells in surface view rectangular and strongly flattened in the longitudinal plane of the seg-

ment; tetraspores and cystocarps unknown; color purplish brown (Ridge-way's Taupe Brown) when dry.

TYPE: D. & R. 3135 (Field Museum), on rocks below low-tide level, shore of island at entrance to harbor, Guaymas, Dec. 2, 1939.

The hollow nature of the frond, nonseptate and bearing the longitudinal filament-zone, seems to place it in *Lomentaria*, though we have no reproductive structures as yet to verify this. In cross section this species is especially distinct. The palisade of very small cells has not been observed or found reported in any other *Lomentaria*.

Genus **CHAMPIA** Desvaux
Champia parvula (Ag.) Harv.

Setch. & Gard., 1930, p. 153. *Chylocladia parvula* Harvey, 1846-1851, pl. 210. *Lomentaria parvula* Kützing, Tab. Phyc. XV, tab. 87.

Setchell and Gardner (1930) identify a few fragments under H. L. Mason 74 from Clarion Island, Revillagigedo group, as *Champia parvula*. They say, "it seems to belong to this species attributed to the Atlantic Ocean, the Mediterranean Sea, the East Indies, and Japan." The present collections add new records to the occurrence of this species in the Pacific region.

D. 475a, dredged in 30-36 meters, Ensenada de San Francisco, near Guaymas, Feb.; D. 704, at low tide on reef at Turner's Island, July; H. 608c, dredged in 40 meters off San Jose del Cabo, Aug.

Champia disticha sp. nov.

Plate 46, Fig. 5

Frondes epiphyticae, 0.5-1.5 cm. altae, e adhesionem parva, rhizinoide, 600-1100 μ latae, cavae, ad diaphragmata tantum leviter constrictae, compressae usque ad $\frac{1}{2}$ plo diam.; segmentis quam curtiorebus quam latis; ramis distichis e marginibus orientibus, per occasionem adhaesiones accessorias rhizinoideas producentibus.

Plants epiphytic, .5-1.5 cm. high from a small rhizoidal holdfast; fronds 600-1100 μ broad, hollow throughout, with regular diaphragms and only slight constriction, compressed to $\frac{1}{3}$ the breadth of the frond, with segments much shorter than broad; branches almost entirely distichous from the margins of the flattened frond, short, acute, occasionally producing accessory rhizoidal attachments, not much constricted at their bases; segments composed of a one-layered cortex of angular, somewhat elongated cells and the typical inner, cortically attached filament series with gland cells; cystocarps and tetrasporangia unknown.

TYPE: D. 441, middle littoral, on Laurencia, San Esteban Island, Feb. 5, 1940. Herb. AHF no. 51.

D. 283, on *Corallina* in a water-filled rock-cup at low tide, Puerto Refugio, Jan., D. 219, on *Amphiroa* at same locality.

This species differs from other allied species of *Champia* in its small size, its strongly compressed nature, and distichous branching.

Champia caespitosa sp. nov.

Plate 46, Figs. 3, 4

Frondes plerumque epiphyticae, circa 2 cm. altae, caespites parvas ramorum intertextorum et per rhizinas connectas ostendentes et basi ad substrata algarum per rhizinas disciferas irregulares affixae, copiose multifarie ramosae, leviter compressae, 500 x 900 μ in sectione transversali; segmentis circa quam latis quam longis.

Plant colonies mainly epiphytic, about 2 cm. high, forming small caespitose mats of intergrown and rhizoidally joined branches, from several basal attachments to algal substrata by irregular, rhizoidal disks; individual plants almost indistinguishable because of the numerous accessory holdfasts which interlock the various parts; fronds abundantly short-branched from all sides, hollow, slightly constricted by regular diaphragms into segments usually about as long as broad, slightly compressed, the dimensions about 500 by 900 μ in cross section, composed of a single cortical layer of axially elongated cells here and there interspersed with smaller irregularly shaped cells within, and attached to which is a series of longitudinal gland-cell-bearing filaments; gland cells sometimes occurring also on the inner surface of the cortical cells; rhizoidal attachments abundantly formed by means of surface cell elongation and division; cystocarps and tetrasporangia unknown; color bluish, iridescent when fresh.

TYPE: D. 407, rocky shore, middle littoral, on articulated coral-lines, Pond Island, February 4, 1940. Herb. AHF no. 52.

D. 193a, on *Digenia*, D. 212a, on *Centroceras*, Puerto Refugio, Jan. (fragmentary).

This species in general form and structure resembles *C. parvula* rather closely, but in habit is very distinct. The abundant production of accessory rhizoidal holdfasts causes the plant colony to assume a compact, caespitose, distinctly matted aspect, which is augmented by the relative rigidity of the branches as compared to *C. parvula*. The branches differ from the generally more extended, looser ones of *C. parvula* by their shortness and more erect habit. *C. parvula*, moreover, generally has cylindrical fronds, while those of this species are slightly compressed.

Genus **GASTROCLONIUM** Kützing
Gastroclonium clavatum (Roth) Ardiss.

Plate 46, Figs. 6-8; Plate 73, Fig. 2

Ardissone, 1883, p. 322; Bliding, 1928, p. 38, fig. 29.

Five collections are on hand of a *Gastroclonium* species which in many respects shows close similarity, if not identity, with the Mediterranean *G. clavatum*.

D. 68, shallow water, Guaymas, Jan.; D. 343, in 22 meters, Punta Peñasco, Feb.; D. 404, on shore, Pond Island, Feb.; D. 440, on shore, San Esteban Island, Feb.; H. 673, San Bartolome Bay, outer coast of Lower California, Aug.

Varying degrees of vegetative development are shown among these plants, which range in size from about 2 cm. to over 10 cm. They possess the solid basal axis characteristic of the genus, though in the largest specimens this is no more extensive than in some of the smallest. Indeed, the large plants seem at first to be entirely hollow. In habit the smaller specimens resemble very closely most of the examples present in the University of California Herbarium of *G. clavatum* from the Mediterranean. The large specimens from Guaymas are more like the illustration of one of Agardh's specimens of *G. clavatum* as given by Bliding (1928).

In cross section the Mediterranean specimens usually show a 2-layered wall, while the Gulf specimens tend more toward a 3- or 4-layered wall. The latter, as well, usually have a more or less pronounced short-palisade effect in the outer layer. None of these differences is convincingly distinct or constant, however, and in view of the very close similarity in gross morphology and the lack of any specific points of distinction, it seems best to refer all of these specimens to *G. clavatum* while awaiting further information on the range and variation of these Pacific forms.

Family **Ceramiaceae**

Genus **CALLITHAMNION** Lyngbye
Callithamnion endovaginum S. & G.

Setch. & Gard., 1924, p. 771, pl. 28, fig. 62.

J. 53b, parasitic on fronds of *Grateloupia*, San Esteban Island, April; D. 488a, Catalina Bay, near Guaymas, Feb.

Callithamnion veleroae sp. nov.

Plate 50, Figs. 3-5

Frondes caespitosae, epiphyticae, usque ad 2.5 cm. altae, distiche ramosae; axi centrali non corticata et ramis primariis ostendentes; axi centrali circa 150 μ diam., in 4-ordinibus ramosa, ramis gradatim superne attenuatis, apicibus paululum ob-

tusis, omnibus acute inclinatis, e termino superno cellularum sustentantium orientibus; tetrasporangiis in lateribus adaxialibus ramellorum ultimorum seriatis, ovoid-eis, 45-55 μ diam.; cystocarpiis circa 150 μ diam., plerumque ramum secundarium terminantibus.

Plants tufted, epiphytic, to 2.5 cm. high, distichously branched, with a central, uncorticated axis and frequent primary branches; primary axis about 150 μ diam. (of cylindrical cells slightly longer than thick) with 4 orders of branches gradually attenuated upward, but apices rather blunt; cells in main axis slightly longer than broad; cells in ultimate ramuli about twice as long as broad (cells in sterile portions usually longer than those in fertile portions); all branches sharply inclined, coming off at upper end of cells bearing them; sporangia seriate on adaxial sides of ultimate branches, arising at the top of each cell as a little peg, enlarging to an ovate body; mature tetrasporangia measuring 45-55 μ , tripartite; cystocarps occasional, usually terminal on a secondary branch, about 150 μ diam. at maturity; antheridia in tufts along the adaxial side of the 3-4 cells just above axil of ultimate branches.

TYPE: D. 195, on shore, lower littoral, Puerto Refugio, Jan. 27, 1940 (tetrasporic). Herb. AHF no. 53.

D. 381f, dredged in 22 meters, Tepoca Bay, Feb. 4, 1940 (antheridial and cystocarpic).

There are no distichous *Callithamnion* species described from the North Pacific which exhibit the characters of our plants. The good fortune of having all reproductive stages gives us ample means of identifying them, though the vegetative characters are also distinctive.

Genus **ANTITHAMNION** Naegeli
Antithamnion sublittorale S. & G.

Setch. & Gard., 1937, p. 86, pl. 6, fig. 15.

H. 613, 646a, 721, epiphytic on other algae dredged in 40 meters off San Jose del Cabo, Aug.

Antithamnion pacificum (Harv.) Kylin

Kylin, 1925, p. 47, fig. 29.

D. 381e from 22 meters at Tepoca Bay, February, is indistinguishable from Kylin's illustrations (loc. cit.), and the specimens agree with his key characters for this species described from Puget Sound.

A specimen from 30-36 meters in Ensenada de San Francisco, near Guaymas, February, is evidently the same but has shorter branchlets due to their shorter cells.

Genus **PLATYTHAMNION** J. Agardh
Platythamnion tepocensis sp. nov.

Plate 72, Fig. 1

Frondes usque ad 3 cm. altae, axi primaria conspicua magni-cellulari, laxe ramosa provisae; ramulis lateralibus plerumque 500 μ longis, oppositis, superne curvatis, acute attenuatis, ramulis secundariis 30-110 μ longis, nonnullis suppressis; cellulis glandularibus frequentibus; cellulis axium primariarum superne 50-70 μ diam., inferne usque ad 150 μ aut plus diam., 1-1.5-plo longioribus.

Attachment organs unknown; plants to 3 cm. high, with a sparingly branched, conspicuous, large-celled main axis bearing well-developed lateral ramuli and reduced ramuli on upper and lower sides of axis cells, producing a complanate general aspect to the fronds; lateral ramuli averaging 500 μ long, opposite, curving upward and tapering to a sharp point, bearing opposite, acute secondary ramuli 30-100 μ long, some of these commonly suppressed, occasionally with tertiary ramuli; gland cells frequent, principally on primary and secondary ramuli; main axis cells cylindrical, 50-70 μ diam. above, to 150+ μ below, 1-1.5 times as long as wide; antheridial clusters mostly at the base and at the lower nodes of the primary ramuli; tetraspores and cystocarps unknown.

TYPE: D. 379, dredged in 22 meters, Tepoca Bay, Feb. 4, 1940. Herb. AHF no. 54.

From the nature of the branching—bearing four sets of branches on each axis cell, two well-developed lateral sets and two reduced sets, dorsal and ventral—this plant is seen to fall into the genus *Platythamnion* J. Ag. The Gulf specimens correspond to none of the previously described species from the American coasts, all of which have been figured by Kylin (1925).

Genus **GRIFFITHSIA** C. Agardh
Griffithsia pacifica Kylin

Kylin, 1925, p. 58, figs. 38, 39.

From a comparison of our material with specimens of *Griffithsia pacifica* from the coast of California we are quite certain that the Gulf material is referable to this species. Most of the author's specimens are somewhat more slender and less strongly articulated than the typical Californian plants, but D. 382 is an example which fulfills perfectly all dimensional requirements.

D. 43, 73, shallow water at low tide, Guaymas Harbor, Jan.; D. 163, rock shingle in lower littoral, south side of Tiburon Island, Jan.; D. 382, dredged in 22 meters, Tepoca Bay, Feb.

Griffithsia tenuis Ag.

C. Agardh, 1828, p. 131; Collins & Hervey, 1917, p. 135, pl. VI, figs. 38, 39; Kützing, Tab. Phyc. XII, tab. 31c-d; Børgesen, 1915-1920, p. 462, fig. 423; Okamura, Icones Jap. Algae VII, p. 2, pl. 302, figs. 1-6, pl. 303, figs. 4-7.

We have several specimens at hand which, though sterile, undoubtedly belong to this widely distributed species. Their habit is very distinctive and is well delineated by Okamura. The absence of dichotomous branching and the irregularity in the length of the lateral branches are sufficient to distinguish it.

D. 145, from 4-32 meters, south of Tiburon Island, Jan.; D. & R. 2916, epiphytic on *Sargassum*, Kino, Nov.; D. 204, 289, from rock pockets, lower littoral, Puerto Refugio, Jan. (dwarfed specimens); D. 169, in seine haul over sand just off south beach, Puerto Refugio, Jan.; D. 400, abundant on lower littoral rocks, Pond Island, Feb.; D. 345, dredged in 22 meters, Punta Peñasco, Feb.

Griffithsia multiramosa (S. & G.) Taylor

Taylor, 1939, p. 14, pl. 2. *Neomonospora multiramosa* Setch. & Gard., 1937, p. 87, pl. 4, fig. 10a-c.

This species is amply described and illustrated in the recent paper of Taylor. The specimens from which his description is drawn were dredged in 12-20 meters over sandy bottom off Punta Gorda, Schmitt 13, July 19, 1938. Those of Setchell and Gardner were dredged in 40 meters near by at San Jose del Cabo, August. Additional collections of this plant: D. 624, dredged in 34-50 meters off Gorda Point, Feb.; D. 231, trawled in 4 meters at low tide, south shore of Puerto Refugio, Jan.; D. 245, cast up on shore, Puerto Refugio, Jan.; D. 270, dredged in 12-22 meters, Mejia channel, Puerto Refugio, Jan.

This is the most slender species in our territory, the ultimate branchlets being only 15-20 μ diam., their cells 100-200 μ long.

Genus CERAMIUM (Roth) Lyngbye

Ceramium sinicola S. & G.

Setch. & Gard., 1924, p. 773, pl. 25, figs. 40, 41, pl. 75. *Ceramium bicorne* S. & G., 1924, p. 773, pl. 28, fig. 64, pl. 74.

Fronds 1-2 cm. high, dichotomously branched, attached by a creeping prostrate portion with rhizoids; the forcipate apices long, blunt, com-

pletely corticated above; internodes naked below but shorter than the corticated zones at the nodes; corticating cells not arranged in any definite order; tetrasporangia completely immersed, irregularly placed in the swollen, often once- or twice-forked terminal ramuli; tetrasporic branches at maturity usually with one or two sharp points; cystocarps sessile, surrounded by 6-8 ramuli; antheridia completely covering upper, several-times-forked, somewhat swollen ramuli.

With more adequate material on hand it has been possible to interpret the types of *Ceramium sinicola* and *C. bicornne* more fully. The comparisons show that the two sharp, apical points used in distinguishing *C. bicornne* are not specific. There may be from one to three, quite at random and depending upon certain features of the individual plant. In reviewing the type of *C. sinicola*, the presence of tetraspores "in a single whorl at the nodes" can be interpreted as such only in young branches. The irregularity of placement is generally as great as in the type of *C. bicornne*.

These plants are epiphytic, commonly on *Codium* and *Grateloupia*. Tetrasporic plants have been detected from collections made at various seasons through the year.

D. 444, San Esteban Island, Feb.; D. 298c, Puerto Refugio, Jan.; D. 389, Tepoca Bay, Feb.; D. 162, 127, 134, 128, Turner's Island, Jan.; J. 67b, Ensenada Bay, April; J. 62a, Isla Partida, July; D. & R. 3231a, 3411a, Guaymas, Dec.

***Ceramium sinicola* var. *interruptum* (S. & G.) comb. nov.**

Ceramium interruptum Setch. & Gard., 1924, p. 775, pl. 26, fig. 47.

The Setchell and Gardner illustration does not satisfactorily interpret the specimen from which it was drawn. The material of Marchant's collection is similar in all general respects to the specimens of *C. sinicola* investigated. It differs in the marked interruption in cortication just above the forkings. This character has been sought for through the specimens of *C. sinicola*, and, though nowhere else so prominent, a more or less strong tendency toward a cortical break in this region is present in most of them. Marchant's specimens appear, then, to be extreme types of this complex and, lacking other well-defined points of distinction, should better be considered as a variety of *C. sinicola*.

Epiphytic on other algae, M. 78, Eureka, May.

***Ceramium sinicola* var. *Johnstonii* (S. & G.) comb. nov.**

Ceramium Johnstonii Setch. & Gard., 1924, p. 774, pls. 76, 77.

This is another form of the *sinicola* complex which is fundamentally inseparable from the general assemblage. The type specimen is a robust

one which shows freely dichotomous branching, complete cortication, and tetrasporangia which create only a slight degree of swelling of the ramuli. The arrangement of tetraspores, cystocarps, and antheridia as well as the general structure of the plants does not suggest the advisability of maintaining specific distinction from *C. sinicola*.

Epiphytic on other algae, D. 434a, San Esteban Island, Feb.; D. 468a, same; J. 104, San Pedro Martir Island, April; J. 111, San Esteban Island, April.

***Ceramium caudatum* S. & G.**

Setch. & Gard., 1924, p. 776, pl. 27, figs. 55-57.

Cystocarps have recently been observed and may be described as follows: large, 500 μ high; spherical mass of carpospores on a short stalk surrounded by a whorl of 4-6 short branches; spores angular, measuring 35-50 μ .

Epiphytic on other algae: M. 48b, Eureka, May; D. 45, Guaymas, Jan.; D. 100a, Turner's Island, Jan.; D. 129, Turner's Island, Jan.; D. 236a, Puerto Refugio, Jan.

***Ceramium affine* S. & G.**

Plate 51, Fig. 4

Setch. & Gard., 1925, p. 172.

The species was described without tetrasporangia, but, in looking over the type specimen, these were discovered on part of it. They are wholly exerted, single at the nodes, on one side of upper branches, naked except for a hyaline envelope, 30-40 μ in diam., not producing alteration of cortex at nodes.

This species is closely related to *Ceramium caudatum*.

Mason 36 (type), Guadalupe Island, off outer coast of Lower California, April; D. 286a, Puerto Refugio, Jan.

***Ceramium fimbriatum* S. & G.**

Setch. & Gard., 1924, p. 777, pl. 26, figs. 43, 44; 1937, p. 88, pl. 7, fig. 18.

To the original description the following observations should be added: In addition to the short, thick, hair-cells arranged on the convex surface of the younger branches, filamentous hairs also may be present, arising secondarily from cells on all sides of the branches. When young and bristlelike they are slightly bulbous at the tips.

Epiphytic on other algae: D. 561b, Agua Verde Bay, Feb.; D. 413a, Pond Island, Feb.; D. 753, Turner's Island, July; D. 202, Puerto Refugio, Jan.; D. 160, Tiburon Island, Jan.; D. 565b, Espiritu Santo Island, Feb.; H. 618b, in 40 meters, San Jose del Cabo, Aug.; M. 87a, Eureka, May.

Ceramium horridum S. & G.

Setch. & Gard., 1924, p. 777, pl. 26, figs. 49, 50, pl. 79.

This is one of the more easily distinguished *Ceramium* species in the Gulf and may be identified by the figures of Setchell and Gardner. Besides the several Gulf collections listed below, examples from the Galapagos Archipelago have been seen which correspond very well.

D. 143, dredged in 4-32 meters, off the south end of Tiburon Island, Jan.; D. 256, dredged in Mejia channel in 12-22 meters, Puerto Refugio, Jan.; D. 427, 430c, Pond Island, on shore, Feb.

Ceramium codicola J. Ag.

J. Agardh, 1894, p. 23.

N. L. Gardner detected this species on *Codium* fragments dredged in 40 meters off San Jose del Cabo, H. 617, H. 644, August. Examples are also on hand from San Bartolome Bay on the outer coast of Lower California.

Ceramium serpens S. & G.

Setch. & Gard., 1924, p. 775, pl. 27, fig. 58.

D. 199 and 201 on *Laurencia*, Puerto Refugio, January, correspond in every way with the type specimen of this plant. The Setchell and Gardner figures are well drawn and will serve with the description to distinguish it.

Ceramium procumbens S. & G.

Setch. & Gard., 1924, p. 772, pl. 27, figs. 51-54.

Growing on *Gelidium*, San Francisquito Bay, J. 27a, June; J. —, on *Grateloupia*, Isla Partida, July.

This species has not again been collected. It seems to show many features in common with *C. serpens*, and the distinctions between the two are perhaps to be questioned. Additional comparative material will be necessary, however.

Ceramium paniculatum Okam.

Okamura, Icones Jap. Algae IV, p. 114, pl. 179, figs. 8-16.

D. & R. 3408 from Guaymas, December, though sterile, is not distinct in any particular from *Ceramium paniculatum* hitherto known only from Japan. The occurrence of sharp, 2-3-celled points which form on the convex sides of the forcipate branches and persist in older parts is an outstanding character and marks this species as unique in the Gulf.

Ceramium gracillimum Griff. & Harv.

Griff. & Harv. in Harvey, 1846-1851, pl. 206. *Ceramium byssoideum* Taylor, 1928, p. 190, pl. 27, figs. 20, 21. *Ceramium transversale* Collins & Hervey, 1917, p. 145; Setch. & Gard., 1930, p. 170, pl. 7, figs. 23, 24.

Taylor has recognized *Ceramium transversale* as a small form of *C. byssoideum*; Feldmann-Mazoyer places *C. byssoideum* as a variety of *C. gracillimum* (1940); Børgesen, 1934, places both *C. byssoideum* and *C. transversale* under *C. gracillimum*. Since our material from the Gulf corresponds well with topotype examples of *C. transversale* as well as European material, it seems best to place it under this name. Certain differences are apparent, however, between our material and that of other parts of the world, and distinctive characters perhaps will be found when more ample material is available for minute study.

D. 169a, Turner's Island, Jan.; H. 614c, 615, dredged in 40 meters, San Jose del Cabo, Aug.

Ceramium Camouii sp. nov.

Plate 51, Figs. 2, 3

Frondes 3-4 mm. altae, laxae dichotomae, ramis secundariis per occasionem, 30-40 μ diam., tantum nodis corticatae, apicibus non forcipatis; zonis corticatis a internodiis 100-150 μ longis separatis; tetrasporangiis verticillatis, nudis et curte pedicellatis, involucris apertis, hemisphericis, corticalibus, plerumque 125 μ latis circumdati.

Fronde 3-4 mm. high, sparingly dichotomously branched, with occasional secondary lateral branches, 30-40 μ diam., corticated only at the nodes; apices not forcipate, with a conspicuous terminal cell which after the first division cuts off cells immediately in several planes, with many slender, early deciduous hairs; cortical zones separating early, only

slightly tumid, composed of 2-3 rows of cells separated by internodes 100-150 μ long; tetrasporangia in whorls, shortly pedicellate and naked but borne in open hemispherical, cortical involucre about 125 μ broad; cystocarps unknown.

TYPE: D. 737, among other minute algae scraped from littoral rocks, Turner's Island, July 18, 1940. Herb. AHF no. 55.

The tetrasporangial characters are distinctive in this species, which is here proposed with some hesitation because of the scantiness of the type material. It is believed, however, that further summer collections in the Gulf will confirm its separation.

***Ceramium equisetoides* sp. nov.**

Plate 51, Fig. 1

Setch. & Gard., 1924, p. 778, pl. 29, figs. 70, 71, as *Ceramium* sp.

Frondes 8-15 mm. altae, dichotomo aut monopodico ramosae, 80-100 μ diam., tantum ad nodos corticatae; corticatione separata impensio in furcis superis per elongationem internodiorum latiore usque ad circa 200 μ , non-tumida, in ordinibus 4-cellularum quibusque, superne inferneque truncata; tetrasporangiis in ramulis terminalibus aut lateralibus, tumidis, plus minusve in toto corticatis, totaliter immersis.

Fronde 8-15 mm. high, dichotomously or monopodially branched, 80-100 μ in diam.; young sterile apices usually forcipate with conspicuous, basally dividing terminal cells; older fertile apices nonforcipate; cortications only at nodes, separated more and more widely in upper forks by elongation of the internodal cells until a maximum of about 200 μ is reached, nontumid, composed of about 4 rows of cells, truncate below and above; tetraspores in swollen, more or less completely corticated terminal or lateral ramuli, completely immersed, usually in a single whorl at each node; tetrasporangial branches sometimes forked but usually simple, the shorter ones resembling the sporiferous shoots (strobili) of *Equisetum*; cystocarps unknown; antheridia completely covering terminal ramuli.

TYPE: D. 479, rock-shingle beach and upper sublittoral, Puerto San Carlos, Guaymas, Feb. Herb. AHF no. 56.

D. 389a, lower littoral, Tepoca Bay, Feb.; D. 602b, shallow littoral pools, San Gabriel Bay, Espiritu Santo Island, Feb.; D. 42, growing on *Gigartina*, Guaymas Harbor, Jan.; D. & R. 3309c, 3149, 3160, littoral, Guaymas Bay, Dec.; M. 63a, growing on *Euचेuma*, Mazatlan, Mexico, May.

Genus **CENTROCERAS** Kützing
Centroceras clavulatum (Ag.) Mont.

Montagne, 1846-47, p. 140; Setch. & Gard., 1924, p. 779.

This species has been found at lower littoral shore stations in all parts of the Gulf and at various times of the year. It is evidently a common perennial there as it is in warm and temperate waters in many parts of the world.

Centroceras bellum S. & G.

Setch. & Gard., 1924, p. 779, pl. 26, fig. 48, pls. 40c, 78.

M. 85, cast ashore at Guaymas, June. Not again collected.

Family **Delesseriaceae**

Genus **BRANCHIOGLOSSUM** Kylin
Branchioglossum Woodii (J. Ag.) Kylin

Kylin, 1924, p. 8, fig. 2a. *Branchioglossum MacDougalii* Gardner, 1927, p. 103, pl. 20, fig. 4, pls. 33, 34.

Comparison of Gulf specimens with examples of *Branchioglossum Woodii* from the California coast shows hardly enough difference to distinguish the former as a separate species.

MacDougal, growing on *Sargassum*, Puerto Libertad, Nov., 1923; D. 378, dredged in 22 meters, Tepoca Bay, Feb.; D. 475e, dredged in 30-36 meters, Ensenada de San Francisco, near Guaymas, Feb.

Genus **HYPOGLOSSUM** Kützing
Hypoglossum attenuatum Gardner

Gardner, 1927, p. 104, pl. 20, fig. 3, pls. 35, 36.

MacDougal, epiphytic on *Sargassum*, Puerto Libertad, Nov., 1923; D. 267, dredged in 12-22 meters, Puerto Refugio, Jan.; D. 60, dredged in 4-6 meters, Guaymas Bay, Jan.; D. 303, dredged in 60-80 meters, Gonzaga Bay, Jan.

Genus **SORELLA** Hollenberg
Sorella pinnata Hollenberg

Plate 47, Figs. 3, 4

Hollenberg, 1943, p. 578, figs. 15, 16.

Plants 1-3 cm. high, semiprostrate in inferior parts where attached to substratum; frond segments flat, lanceolate, .5-2 mm. broad, with acute, obovate to lanceolate, irregularly arranged pinnae with an inconspicuous midrib and microscopic veins running into pinnae, monostromatic except at midrib and in lower parts; growth from an apical cell

at the point of each segment, the primary cell row with intercalary divisions; margins minutely denticulate; antheridial sori single or in pairs in apical portions of pinnae, superficial; cystocarps and tetraspores unknown.

D. 194, lower littoral on the reef, Puerto Refugio, Jan. 27, 1940.

This species resembles *Erythroglossum minimum* Okam., but is larger, has a midrib, and has more regular, more sharply acute pinnae. Rhizoids from the fronds do not develop as in *E. minimum*.

Genus GRINNELLIA Harvey

Grinnellia lanceolata sp. nov.

Plate 47, Fig. 6

Frondes usque ad 2.5 cm. altae, laminis brevi stipitatis, lanceolatis adhesionem spongiosam compositae; laminis costa delicata excepta monostromaticis, integribus, nerviis lateralibus nullis, marginibus integribus, tantum undulatis, cellula apicali indutis; ordinis cellularum primariae divisionibus nullis; soris tetrasporangiiferis supra frondem sparsa 5-15 tetrasporas tripartitas producentibus.

Plants to 2.5 cm. high, of several short-stipitate, lanceolate blades from a spongy holdfast; blades monostromatic except at the delicate midrib, undivided, without side nerves, with entire, only slightly undulate margins; frond-apices blunt, with an apical cell; primary cell row of midrib without intercalary divisions; tetrasporic sori scattered over the frond on either side of midrib zone, producing 5-15 tripartite tetraspores; cystocarps scattered over frond (no cystocarpic leaflets on type), hemispherical, with a small ostiole lacking rostrum.

TYPE: D. 626, dredged in 34-50 meters, off Gorda Point, Feb. 15, 1940. Herb. AHF no. 57.

The small size and narrow lanceolate fronds almost without marginal undulations serve to distinguish this species from the large Atlantic plant, *Grinnellia americana*, with which it seems most closely related.

Genus POLYNEURELLA gen. nov.

Frondes laminis latis, membranaceis inferne petiolatis semiteretibus, e disco simplici orientibus compositae; laminis ovatis, juvenis monostromaticis, cellula apicali crescentibus, costa nulla, venis microscopicis multis longitudinalibusque; tetrasporangiis tripartitis in soris rotundis parvisque, pustulatis e superficiebus ambis frondium orientibus, regulariter sparsis.

Plants composed of broad, rose-colored, membranous blades and branched, semiterete, petiolate parts arising from a simple discoid holdfast; blades ovate, monostromatic in younger parts, growing by means of

an apical cell, without a midrib but with many longitudinal microscopic veins; tetrasporangia tripartite, arranged in small, round sori, regularly spaced over the blades; sori arising as blisterlike swellings from both sides of the frond, the tetrasporangia developing successively from the enclosed sporiferous tissue and remaining in the enlarging sorus until maturity of the tetrasporic fronds; cystocarps unknown.

TYPE: *Polyneurella Hancockii*.

The type species differs from any members of the closely related genus *Polyneura* in the mode of branching from the basal axis system, in the entire margins of the blades, and in the absence of a macroscopic midrib in the multiple-vein system.

***Polyneurella Hancockii* sp. nov.**

Plate 47, Figs. 1, 2

Frondes usque ad 6.5 cm. altae, laminis curte stipitatis, integris, ovato-lanceolatis e disco parvo compositae; axibus semiteretibus copiose e disco prope compositis; laminis in partibus juvenis monostromaticis, cellula apicali provisus, ecostatis, venis microscopicis multis.

Plants to 6.5 cm. high, composed of numerous short-stipitate, entire, ovate-lanceolate blades 2.5 cm. wide, 5 cm. long when mature arising from a small discoid holdfast; branching of the semiterete axis abundant just above holdfast; blades monostromatic in younger parts, growing by means of an apical cell, without a midrib but with many microscopic nerves, some macroscopic in older fronds; tetrasporic sori scattered over blades, each bearing 100 or more tetrasporangia; cystocarps unknown.

TYPE: D. 184, dredged in 22-44 meters, Puerto Refugio, Jan. 28, 1940. Herb. AHF no. 58.

Genus **MYRIOGRAMME** Kylin

***Myriogramme divaricata* sp. nov.**

Plate 47, Fig. 5

Frondes usque ad 3 cm. altae, membranaceae, basim 1 mm. solido stipitatae, per adhesionem parvam semirhizoideam affixae, tantum in partibus infimis proliferatae, abrupte divaricatae, ecostatae, segmentis latis, curtis, avenosis, monostromaticis; axillis segmentorum rotundis, non angularibus; marginibus apicalibus multilobatis; crescentione e marginibus apicalibus, cellula apicali deunte; tetrasporangiis in soris parvis per partes medias et superas laminarum sparsis.

Plants to 3 cm. high, membranous, from a small, semirhizoidal holdfast below a solid, stipitate base 1 mm. or less in extent; fronds proliferous only from lowest parts, abruptly divaricate, lacking a midrib, with broad, short, veinless, monostromatic segments; axils of segments rounded, not

angular; apical margins multilobate, the lobes often appearing truncate; growth from apical margins without a terminal cell; tetraspores in small sori, scattered through middle and upper portions of the frond; cystocarps unknown.

TYPE: D. 181, dredged in 22-44 meters, Puerto Refugio, Jan. 28, 1940. Herb. AHF no. 59.

Similar to *Myriogramme minuta* Kylin (1924, p. 56, figs. 44-45) but tetraspores not confined to apical segments. *M. carnea* (Rodr.) Kylin is another close relative from which it may be distinguished by the absence of the marginal denticulations, the rounded rather than angular axils, and by the shorter, more compact-appearing segments.

Genus TAENIOMA J. Agardh

Taenioma perpusillum J. Ag.

J. Agardh, 1863, p. 1257; Okamura, *Icones Jap. Alg.* VI, p. 26, pl. 264, figs. 17-19.

This species has recently been collected both in the Gulf of California and in the Galapagos Archipelago. It was described from the west coast of Mexico, being among Liebmann's original collections from St. Augustine. Its habit and morphology are so distinctive that it can scarcely be confused with any other alga.

D. 325, lower littoral, Gonzaga Bay, Jan.; D. 392, Tepoca Bay, Feb.; D. 406b, Pond Island, Feb.; D. 540a, Agua Verde Bay, Feb.

Family DASYACEAE

Genus DASYA C. Agardh

Dasya pedicellata C. Ag.

C. Agardh, 1824, p. 211; Taylor, 1937, p. 355, pl. 54, figs. 1-4. *Dasya elegans*, Kützing, *Tab. Phyc.* XIV, tab. 59; as *D. elegans* generally.

Several specimens are on hand of an attractive sublittoral *Dasya* which seems best referred to the above species in our present limited knowledge of the Mexican plants. *Dasya pedicellata* has been reported in subtropical waters in widespread parts of the world—Mediterranean, Japan, eastern United States, West Indies, etc. Our plants conform rather well with the available figures of this species, especially with the fine ones of Taylor (*loc. cit.*). Minute study and comparison of fresh material with other species of this genus may, however, modify the status of the Gulf plants.

D. & R. 3303, cast ashore, near Guaymas, Dec.; D. 275, dredged in 12-22 meters, Mejia channel, Puerto Refugio, Jan.; D. 228, dredged in 4 meters at low tide, Puerto Refugio, Jan.; D. 475d, dredged in 30-36 meters, Ensenada de San Francisco, near Guaymas, Feb.; D. 504, dredged in 16-28 meters, Puerto Escondido, Feb.

This species is apparently exclusively sublittoral in the Gulf, judging from all collections to date. Both cystocarpic and tetrasporic plants were found in January.

Genus **JANTINELLA** Kylin

Jantinella sinicola (S. & G.) Kylin

Kylin, 1941, p. 40. *Colacodasya sinicola* Setch. & Gard., 1924, p. 770, pl. 28, fig. 63.

Growing on *Chondria acrorhizophora*, M. 43a, Eureka, May. Not again detected.

Genus **HETEROSIPHONIA** Montagne

Heterosiphonia sinicola S. & G.

Setch. & Gard., 1924, p. 770, pl. 28, figs. 59, 60, pl. 47b.

Cast ashore, Eureka, M. 49, 65, May. Not again collected.

Family **Rhodomelaceae**

Genus **CHONDRIA** C. Agardh

Chondria californica (Collins) Kylin

Kylin, 1941, p. 41, pl. 12, fig. 35. *Chondria tenuissima* f. *californica*, Collins, Holden & Setchell, Phyc. Bor. Amer. no. 636.

Specimens from one shore station show exceedingly close resemblance in color, size, and branching with the specimens distributed in the P.B.A. from La Jolla, California. Collins says, "very iridescent when growing," a conspicuous character which the Gulf plants possess.

The deep-water examples here listed are apparently of this species, to judge from form and branching, though the iridescence has not been observed.

D. 101, lower littoral rocky shore, north side of Turner's Island, Jan.; D. 146, dredged in 4-32 meters off south end of Tiburon Island; D. 255, dredged in 12-22 meters, Mejia channel, Puerto Refugio, Jan.

Chondria dasyphylla (Woodw.) C. Ag.

C. Agardh, 1822, p. 350; Børgesen, 1918, p. 258, figs. 151, 152.

Several specimens of both winter and summer collections seem better

referable to this species than to any other. This plant has been recorded from the warmer Atlantic coasts of Europe and America, the Mediterranean, the West Indies, and Japan. It is not peculiar, therefore, that it occurs in the Gulf of California.

The summer plants are the largest, up to 10 cm. high, and appear to be the most mature and typical. All agree, however, in general form of branching and in the sunken nature of the growing points.

D. & R. 3134e, on rocks along shore of Guaymas Harbor, Dec.; D. 312, lower littoral, Willard's Island, Gonzaga Bay, Jan.; D. 479b, lower littoral in shallow bay, Puerto San Carlos, near Guaymas, Feb.; D. 669, cast up at south channel mouth, Tiburon Island, July; D. 673, cast up at Kino, July.

Genus **DIGENIA** C. Agardh

Digenia simplex (Wulf.) C. Ag.

C. Agardh, 1822, p. 389; Taylor, 1928, p. 175, pl. 24, fig. 20, pl. 33, fig. 7; Setch. & Gard., 1924, p. 769; Okamura, 1936, fig. 393.

This species was first found in the Gulf as beach-drift specimens at La Paz. Its wide distribution throughout the world's subtropical seas was markedly extended by that record and may now be further extended by mention of specimens collected by Templeton Crocker on the *Zaca* Expedition of 1936 on the shores of Costa Rica.

The occurrence in the Gulf has been made better known by recent collections at several stations. It is apparently a lower-littoral plant on rocky shores throughout the area, both in winter and summer, though never very abundant.

D. 192, 298, lower littoral rocks, Puerto Refugio, Jan.; D. 728, Turner's Island, July; D. & R. 3324, in intertidal pools, cove north of Cabo Arco, Guaymas, Dec.; D. & R. 3400, Punta San Pedro, Guaymas, Dec.

Genus **LAURENCIA** Lamouroux

Laurencia paniculata (Ag.) J. Ag.

J. Agardh, 1863, p. 755; Setch. & Gard., 1924, p. 762; Yamada, 1931, p. 197, pl. 3a.

Kylin (1941, p. 42, pl. 3, fig. 38) has described a new species of *Laurencia* from the coast of California, *L. pacifica*. He cites the specimen 1092 in Phyc. Bot. Amer. sent out under the name *L. paniculata* as identical with his plant. An already difficult situation is made more complicated, and yet we are hardly nearer any solution. A large collection of

Laurenciae of the general *L. paniculata* type has been examined in the University of California Herbarium, and they suggest strongly that we are dealing with a variable group of perhaps several closely related entities which will require very careful study in nature before they become understood. For the present I am inclined to let the Gulf plants remain under the old name rather than to identify them erroneously with certain of the species found along the coast of California.

Plants corresponding to Johnston's specimen determined as *L. paniculata* by Setchell and Gardner in 1924 are the most abundant of the species in the Gulf. Winter collections predominate by far, but most of these are immature, indicating, perhaps, maximum development in spring.

Plants here designated as *L. paniculata* are more robust than any others except *P. papillosa*. They are easily distinguished from the latter by obvious differences in the papillate branching.

J. 30b, lower littoral rocks, San Francisquito Bay, June; J. 69, Isla Partida, June; D. 234, cast up at Puerto Refugio, Jan.; D. 442, lower littoral rocks, San Esteban Island, Feb.

A number of other winter collections of immature plants which probably are of this species were made at Pond Island, Guaymas, Gonzaga, Tiburon Island, and Agua Verde Bay.

Laurencia papillosa var. pacifica S. & G.

Setch. & Gard., 1924, p. 765, pl. 23, fig. 18, pl. 24, fig. 34, pl. 43a-b, pl. 54; Yamada, 1931, pl. 1.

Specimens from at least three localities agree with the earlier collections of Johnston, Marchant, and Brandegee from the Gulf. They are easily distinguished from other species of the region by their closely crowded, wartlike lateral branches. The species is apparently a summer annual, no mature plants being known from winter collections. It seems to reach its maximum development in the southern part of the Gulf.

J. 9, San Marcos Island, June; M. 38, Eureka, May; Brand., La Paz; D. 663, rocky point 3 mi. north of Kino, July; D. 716, Turner's Island, July; D. 601, San Gabriel, Espiritu Santo Island, Feb.; D. & R. 3399, Punta San Pedro, Guaymas, Dec. (young).

Laurencia obtusiuscula S. & G.

Setch. & Gard., 1924, p. 760, pl. 23, fig. 17, pl. 55. *L. obtusiuscula* var. *corymbifera* S. & G., 1924, p. 761, pl. 23, figs. 15, 16, pl. 45b. *L. obtusiuscula* var. *laxa* S. & G., 1924, p. 762, pl. 29, fig. 67, pl. 52b.

M. 40, 46, 67, cast ashore, Eureka, May; M. 41, Guaymas, May; J. 18b, on rocks in lower littoral zone, Tortuga Island, June; D. 635, middle littoral rocks, San Jose del Cabo, Feb.

The limited collections would seem to indicate a more or less tropical distribution for this species in our area. A small specimen from Santa Maria Bay on the outer coast resembles the type of var. *laxa* and suggests a distribution extending up the southern outer coast of the peninsula.

For the sake of simplicity, the named varieties are here reduced to synonymy in view of the absence of additional, and the inadequacy of the original, material.

Laurencia Johnstonii S. & G.

Setch. & Gard., 1924, p. 764, pls. 52a, 53.

Mature specimens of this plant, probably a near relative of *Laurencia obtusiuscula*, are known from summer collections in the northern Gulf. Its very dark color and relatively dense branching serve to distinguish it.

J. 30a, San Francisquito Bay, June; J. 127, on rocks in lower littoral, San Marcos Island, June; D. 203, lower littoral rocks, reef at Turner's Island, January (young), D. 749, July (mature).

Laurencia sinicola S. & G.

Setch. & Gard., 1924, p. 764, pl. 28, figs. 65, 66, pl. 50a.

M. 34, 37, growing on *Sargassum*, Eureka, May; J. 126, San Marcos Island, June. Not again collected. Apparently a summer annual.

Laurencia estebaniana S. & G.

Setch. & Gard., 1924, p. 763, pl. 24, fig. 33, pl. 45a.

J. 53c, growing on rocks at San Esteban Island, April; J. 89, Smith Island, June. Not again collected.

Laurencia Hancockii sp. nov.

Plate 50, Fig. 1

Frondes usque ad 2 cm. altae, siccitate atrae, cylindricae, prorsus graciles, rhizinis laxis curtisque affixae, valde ramosae et e basi divergentes, axi percurrenti deunte; ramelli circa 300 μ crassis, corticibus palisadiformibus deuntibus, cellulis omnibus diam. equalibus.

Plants to 2 cm. high, cylindrical, slender throughout, attached by short, loose rhizoids, much branched and divergent from the base, form-

ing no main axis; ultimate branchlets longest in lower parts, to 2.5 mm., shorter toward ends of main branches, these often curved toward their ends and the branchlets most abundant on the convex side, about 300 μ thick; cross section without a palisade cortex, with all cells of about equal diameter; radius of about 4 series; ultimate ramuli slightly constricted at base, simple, slightly clavate, their cells isodiametrical, not protruding; color black upon drying.

TYPE: D. 543a, lower littoral rock pockets, Agua Verde Bay, Feb. 12, 1940. Herb. AHF no. 60.

The very small size of this species distinguishes it readily from all others of our region and from the outer coasts as well.

Genus **POLYSIPHONIA** Greville
Polysiphonia Marchantae S. & G.

Setch. & Gard., 1924, p. 768, pl. 49a.

M. 52, 83, 84, Eureka, May; M. 66, La Paz, May; Brand. 12, La Paz; M. 50, Guaymas?, May. Specimens corresponding to these examples have not appeared in any recent collections. It seems likely that the Guaymas record is erroneous.

Polysiphonia Johnstonii S. & G.

Setch. & Gard., 1924, p. 767. *Polysiphonia sinicola*, S. & G., 1924, p. 769.

The following revised description has been drawn up by G. J. Holtenberg after re-examination of the types and other Gulf specimens.

Fronds relatively rigid, 5-10 cm. high, up to 1 mm. diam. toward the base, attached by numerous rhizoids cut off from the pericentral cells of a limited prostrate base; segments in the main branches 1.5 diam. long or less, with 5 or 6 pericentral cells, totally ecorticate; primary branches several and distinct, repeatedly branched, the branches alternate, arising at a moderately narrow angle; ultimate branchlets usually relatively close and dense; trichoblasts once or twice forked, numerous, arising one per segment in a left-hand spiral with one-fifth or one-sixth divergence, soon deciduous, leaving persistent scar-cells; branches replacing trichoblasts at irregular intervals; tetrasporangia 1- (2) per segment, 70-90 μ diam.; cystocarps numerous, globular, 450-500 μ diam., nearly sessile; antheridial branches arising as a primary branch of a trichoblast, 30-40 by 100-140 μ ; plants dull red to dark reddish brown, usually epiphytic.

Besides the specimens of Johnston, Brandegee, and Marchant cited in the 1924 publication, recent material has been taken from both lower littoral and sublittoral collections at Puerto Refugio, D. 236, 258, 284, in January. D. 284 is an example having two tetrasporangia per segment.

Polysiphonia Snyderae Kylin

Kylin, 1941, p. 35, pl. 12, fig. 34. *Polysiphonia senticulosa*, Collins, Holden & Setchell, Phyc. Bor. Amer. no. 638.

This is the commonest species in the winter collections from the Gulf. It is distinguished readily from other Gulf species except *Polysiphonia sonorensis* by its slender proportions, its four pericentral cells, and its elongated segments. It differs from *P. sonorensis* in color and habit. Kylin has given a good habit figure and ample discussion of the plant's nature and relationships.

Examples have been found in the Gulf in various habitats and in all parts of the region. It is particularly abundant and widespread in the winter collections.

Polysiphonia sonorensis Hollenberg

Hollenberg, 1942, pp. 779-780, figs. 5, 20.

Plants forming dense tufts of a terra cotta color, 4-5 cm. high, from prostrate creeping filaments; prostrate filaments 120-175 μ diam., attached by unicellular rhizoids which arise as outgrowths from the center of the pericentral cells, from which they are not cut off by a cross wall; erect branches assurgent and arising exogenously, or mostly endogenously from the prostrate branches, 70-100 μ diam., of segments mostly 1.5-2 diam. long; branching dense, the branches arising exogenously at irregular intervals (4)-10-20 or more segments apart, mostly at an acute angle with the main axis, which is usually indistinct; ultimate branches slender, 30-35 μ diam., slightly narrowed at the base, of segments mostly 1 diam. long or shorter; pericentral cells 4, ecorticate; trichoblasts abundant, arising at irregular intervals, once or twice forked, delicate, to 1 mm. long, deciduous, often leaving inconspicuous scar-cells; branches not associated with trichoblasts in origin; reproduction unknown; plants adhering moderately well to paper from which they are readily removed.

TYPE: D. & R. 3426a, drifting along southeastern shore of bay, Empalme, near Guaymas, Sonora, Dec. 23, 1939.

***Polysiphonia simplex* Hollenberg**

Hollenberg, 1942, pp. 782-783, fig. 18.

Plants saxicolous, forming dense mats often of considerable extent, with creeping, tangled basal filaments 250-360 μ diam., of segments mostly less than one diameter long, attached by unicellular rhizoids with lobed tips which are cut off by a curving wall from the proximal end of the pericentral cells; prostrate filaments giving rise in an exogenous, assurgent manner to erect branches 1-3-(7) cm. high and 160-250 μ diam., with main axes distinct and sparingly branched; branches exogenous, arising on all sides; trichoblasts 1-3 times forked, one per segment, arising in a left-hand spiral with a $\frac{1}{4}$ divergence, soon deciduous, leaving persistent scar-cells; branches replacing trichoblasts, not arising in connection with them; first trichoblast on branch arising (1)-3-4 segments from the branch-base; tetrasporangia to 70 μ diam., spirally arranged in the somewhat bulging branch tips; cystocarps ovoid, sessile, 300-350 μ diam.; antheridial branches arising from one fork of a trichoblast, measuring 100-170 by 35-40 μ , without a sterile tip; plants medium to dark brown, drying nearly black, growing in the middle to upper littoral zones.

TYPE: from Laguna Beach, Orange County, California.

Several Gulf of California plants are tentatively to be placed here, though the segments are much shorter than those in typical southern California specimens.

D. 124, Turner's Island, Jan.; D. 312, Gonzaga Bay, D. 402, Pond Island, Feb.; D. 475k, from 30-36 meters, Ensenada de San Francisco, near Guaymas, Feb.; D. 540b, Agua Verde Bay, Feb.; D. 652, rocky point near Kino, July; D. 697, 724, Turner's Island, July.

***Polysiphonia Hancockii* sp. nov.**

Plate 50, Fig. 2

Frondes usque ad 1 cm. altae, axibus 1-paucis e disco basali parvo, in parte rhizinarum corticarum e basi axis crassae orientium emergentibus; axi primaria percurrente, inferne in partibus usque ad tota corticata, erecta, rigida, basim 500 μ crassa, ramos multos laterales in incremento limitatos praebente et iis aspectum excurrente arborescentem donatantibus.

Plants to 1 cm. high, 1-several axes from a small, discoid holdfast, partly formed of cortical rhizoids arising from the base of the thick axis; no prostrate portions present; main axis percurrent, partly to fully corticated in lower parts, erect, rigid, stout, trunklike, 500 μ thick at base,

bearing many lateral ramifications of limited growth, these several times subdichotomously, multifariously branched with very short internodes, giving a strongly excurrent, arborescent appearance; fronds with four large pericentral cells per segment, becoming corticated in thicker parts toward base; cortication beginning by appearance of small cells in longitudinal rows between the pericentral cells, becoming complete only in lowermost parts; segments equilateral or more often shorter than broad; apices provided with abundant, long, much-branched trichoblasts arising exogenously, in $\frac{1}{4}$ right-hand spiral divergence toward tip, early deciduous and not present except in growing specimens; branches arising independently, replacing trichoblasts; scar-cells left by deciduous trichoblasts; tetrasporangia in single, spiral rows in somewhat swollen ultimate branchlets.

TYPE: D. 629c, epiphytic on Sargassum leaves, cast up, San Jose del Cabo, Feb. 16, 1940. Herb. AHF no. 61.

H. 610a, San Jose del Cabo, August, 1932 (hairs not present; an old, sterile specimen).

The habit of this species is especially striking because of the strongly excurrent development and the short rigid nature of the lateral branches.

Polysiphonia californica Harv.

Kylin, 1941, p. 36; Collins, Holden & Setchell, Phyc. Bor. Amer. no. 1142.

The nomenclature of these plants has been well reviewed and clarified by Kylin. This may be distinguished from other *Polysiphonia* species in the Gulf by its large number of pericentral cells, 9-10, or more.

It is not a common plant in the Gulf region, to judge from the two known collections, both brought up in the dredge.

D. 52, growing epiphytically on membranous reds, dredged in 4-6 meters, Guaymas Bay, Jan.; D. 361, in 6-20 meters at high water, Punta Peñasco, Feb.

Genus **LOPHOSIPHONIA** Falkenb.

Lophosiphonia villum (J. Ag.) S. & G.

Plate 48, Figs. 1-6

Kylin, 1941, p. 40. *Polysiphonia villum* J. Agardh, 1863, p. 941 (not *P. villum* Snyder in Collins, Holden & Setchell, Phyc. Bor. Amer. no. 246).

Kylin has reinvestigated the type specimen of this species which was

collected by Liebmann on the tropical coast of America (probably central Mexican coast) and has clarified the status of certain California plants which have been referred to this species.

The writer has re-examined a considerable number of specimens from both California and the Gulf in light of the description of *Polysiphonia villum* given by J. Agardh and is convinced that they should be identified with Liebmann's Mexican plant. The distribution of this species can be stated as embracing the coast of California, the Gulf of California, the central Mexican coast, and perhaps the Galapagos Archipelago. One specimen from the latter region seems to match some of the other examples very closely.

D. 291, lower littoral rocks, Puerto Refugio, Jan.; D. 430a, lower littoral, Pond Island, Feb.; D. 113, reef rocks, Turner's Island, Jan.; D. 737, 754, same locality, July.

Lophosiphonia mexicana sp. nov.

Plate 48, Figs. 7-10

Frondes caespitosae, 2 mm. altae, partibus prostratis per rhizinas copiosas discis adhaerentibus deuntibus formantibus, cellulis pericentralibus plerumque 6, vulgo 55 μ crassae, filis erectis 1-2 mm. longis, attenuatis sed non gracilibus, 70-80 μ diam., in partibus maximis basim usque ad 60-50 μ attenuatis cellulis in partibus angustioribus pericentralibus 6, usque ad 12 in partibus latioribus divisis.

Plants caespitose, 2 mm. high, of prostrate rooting filaments giving off erect filaments; prostrate parts forming abundant rhizoids without attachment disks, these arising in groups, one from the middle of each successive pericentral cell in a vertical row and showing conspicuous absence of breaks in the series; prostrate filaments with usually six pericentral cells, about 55 μ thick; erect filaments 1-2 mm. long, attenuated but not slender, 70-80 μ diam. in most portions, narrowing to 60-50 μ at base, with 6 pericentrals in narrower parts, these dividing to twelve in wider parts; apices with a few hairs; tetrasporangia in a slightly irregular row, 5-10 segments long in ends of erect branches.

TYPE: D. 430, scraped from lower littoral rocks with other minute algae, Pond Island, at south end of Angel de la Guardia Island, Feb. 4, 1940.

H. 238a, Sulphur Bay, Clarion Island, Revillagigedo Group, March 24, 1932. Herb. AHF no. 62.

The most distinctive character of this species is the broadening of the erect branches in their mid- and upper parts by the division of the pericentral cells to 12 from the original 6. The result is usually a complanate

tendency to these broadened parts of the branches. The general characters of the cellular structure are shown in Plate 48, Figs. 7-10.

Genus **HERPOSIPHONIA** Naegeli
Herposiphonia subdisticha Okamura

Plate 49, Fig. 2

Okamura, Icones Jap. Alg. III, p. 199, pl. 146, figs. 11-18.

Two collections of a very distinctive *Herposiphonia* have been found to agree very completely with the Japanese species *H. disticha*. The "langtriebe" alternate regularly after every third "kurztriebe." This, together with the outstanding habit shown in the illustrations, distinguishes it from any other plant on our coasts.

D. 443a, 457, on *Grateloupia*, growing on rocky, lower littoral shore, San Esteban Island, Feb.

Herposiphonia tenella (C. Ag.) Naeg.

Plate 49, Fig. 1

Naegeli, 1846, tab. VIII, fig. 2; Børgesen, 1915-20, p. 286, figs. 287, 288; p. 472, fig. 430.

Several sterile specimens of *Herposiphonia* are on hand which agree essentially with the above species. Børgesen's account of *H. tenella* and *H. secunda* emphasizes the importance of fertile material, especially antheridial, and, in view of our lack of it, it is best to place all of these closely related specimens under this name by which they can readily be recognized.

D. 135, on *Sargassum*, Turner's Island, Jan.; D. 458, San Esteban Island, Feb.; D. 543c, on *Wurdemannia*, Agua Verde Bay, Feb.; D. 546b, on *Dicranema*, Agua Verde Bay, Feb.; D. 602a, on other small algae, San Gabriel Bay, Feb.; D. 656, scraped from middle littoral rocks, near Kino, July; D. 709, 751, lower littoral rocky shore, Turner's Island, July.

Genus **PTEROSIPHONIA** Falkenberg
Pterosiphonia pennata (Roth) Falk.

Falkenberg, 1901, p. 263, tab. 2, figs. 1, 2. *Polysiphonia pennata* Kützing, Tab. Phyc. XIII, tab. 23e-f.

A few small specimens have been compared with both European and Californian specimens of this widespread species and found to agree in all essential details. None of those examined compare well with Kylin's

description of his *Pterosiphonia californica* (1941, p. 39), which is said to be coarser, with a main axis 250-300 μ thick, and with shorter and thicker lateral branchlets. The Mexican plants do not measure over 150 μ in thickness and have quite the same size and proportions as the European examples of *P. pennata*.

D. 372, dredged in 22 meters, Tepoca Bay, Feb.

Pterosiphonia dendroidea (Mont.) Falk.

Falkenberg, 1901, p. 268; Taylor, 1939, p. 16. *Polysiphonia dendroidea* Kützing, Tab. Phyc. XIII, tab. 25a-b.

A few fragments, apparently of young material of this species, occur in recent Mexican collections, partly growing with *Pterosiphonia pennata*.

Schmitt, from 12-20 meters, Punta Gorda, and from San Jose del Cabo, July 19, 1938; D. 260, dredged in Mejia channel, 12-22 meters, Puerto Refugio, Jan.; D. 372a, dredged in 22 meters, Tepoca Bay, Feb.

Genus **VELEROA** gen. nov.

Frondes graciles, minutae, sparse ramosae, axi polysiphoniacea, monopodica, cellulis pericentralibus 4, ramos laterales, magnos, determinatos, persistentes, coloratos, monosiphonios in $\frac{1}{4}$ spira instructos, emittente; tetrasporangiis in spira singula ordinatis, uno per segmentum, in partes superas, leviter turgidas axium primariarum; stichidiis propriis deuntibus.

Slender, minute, sparingly branched plants, consisting of a polysiphoniaceous, monopodial axis of four pericentral cells bearing large, determinate, persistent, colored, monosiphonous lateral branches in a $\frac{1}{4}$ spiral; tetrasporangia borne in a single spiral row, one per segment in slightly swollen upper portions of main axis; no stichidial branches produced.

TYPE: *Veleroa subulata*.

This genus is nearest to *Lophocladia* in the subfamily Lophothaliae. It differs in the occurrence of sporangia in the main axis without the development of specialized stichidial branches.

Veleroa subulata sp. nov.

Plate 72, Fig. 2

Frondes 10-15 mm. altae; cellulis pericentralibus 50-70 μ diam.; ramellis lateralibus 400-700 μ longis, 25-40 μ diam., subulatis, cellula apicali acuta.

Plants 10-15 mm. high, monopodial, with a sparingly branched, polysiphonous main axis and large, persistent monosiphonous, colored, lateral

branches; polysiphonous main axis with four pericentral cells, 50-70 μ diam., the pericentrals about 2 diam. long; lateral branches 400-700 μ long, 25-40 μ diam. at base, arranged one to a segment in a $\frac{1}{4}$ spiral, simple or with 2-3 limbs from near the base, subulate, usually somewhat curved upward, with a sharp-pointed terminal cell; tetrasporangia borne in a single spiral row of 8-15, one per segment, in slightly swollen portions of main axes a short distance below apices, about 50 μ diam. when mature.

TYPE: D. 381d, growing on a small hydroid, dredged in 22 meters, Tepoca Bay, Feb. 4, 1940. Herb. AHF no. 63.

Genus **BOSTRYCHIA** Montagne

Bostrychia radicans Mont.

Plate 49, Figs. 3, 4

Montagne, *Cryp. Guy.*, 1842, p. 419; Post. 1936, p. 13. *Bostrychia rivularis* Harvey, 1852-1858, p. 57, pl. XIV D.

An ample collection of this species was made by Drouet & Richards on the Sonora coast near Guaymas and may be expected widely on submerged wood or Mangrove roots in the bays and lagoons of the more southern regions of the Gulf. It was distinguished as *B. rivularis* by Collins and Hervey from other known American *Bostrychia* species (1917) by its ecorticate main axis. Post includes *R. rivularis* under *B. radicans*, to which she attributes very wide world distribution. The present specimens, however, are the first Pacific North American examples.

GENERAL SUMMARY AND CONCLUSION

Since the last report on the algal flora of the Gulf of California, the number of species known from that region has been almost trebled (to 273 species). Thirty species previously described from or attributed to the area have been reduced to synonymy, sixty-two more described as new. The Gulf has proved to have not only a rich and varied marine flora but one containing species of exceptional distribution.

The seasonal alternation of floras has been investigated for the first time and has proved strongly marked in the northern regions of the Gulf. A beginning has been made in ecologic investigation. The remarkable temperature conditions have been recorded and related to the distribution of algae as far as the evidence allows. Correlation between oxygen content of the water and the distribution of algae has been made with very interesting results. The infrequency of temperature and oxygen records, however, leaves much room for future investigation throughout the Gulf. Before the ecology of the marine plants of the region can be satisfactorily understood, complete series of data for all seasons will be necessary. As yet seasonal alternation of floras has been observed at only one station, Turner's Island. The rich floras of Puerto Refugio, Pond Island, San Esteban Island, Tepoca Bay, and the region of Guaymas are inadequately known ecologically and should be investigated at various times of year, particularly in spring and fall. The nature of development of algae, particularly in summer, should be investigated on all shores of the southern part of the Gulf where records now are infrequent or lacking. The sublittoral flora is still scantily known, and further dredging operations will undoubtedly be richly rewarded.

Most remarkable of the species now known from the Gulf are those exhibiting widely discontinuous distribution between the eastern and western sides of the Pacific Ocean such as *Ishige foliacea*, *Lomentaria catenata*, *Lomentaria hakodatensis*, *Ceramium paniculatum*, and *Herposiphonia subdisticha*. Further ecologic investigations of these and other such plants will undoubtedly help to broaden our views on phytogeography among the marine algae.

Cutleria Hancockii is perhaps the most unusual discovery for our region. It is the first member of the essentially Mediterranean order Cutleriales to be found on the Pacific American coasts. Other such novelties awaiting discovery will further add significance to the exceptional marine flora of this remarkable body of water.

ACKNOWLEDGMENTS

For material used in the preparation of this paper and for assistance in the study and interpretation of it, expression of gratitude is due to many.

For the opportunity of accompanying the Expedition of the *Velero III* special thanks is due Captain Allan Hancock for his generosity.

For the facilities of his laboratory, collections, and slides, as well as for financial assistance throughout the work, I am deeply indebted to Professor William A. Setchell.

Grateful acknowledgement is due, for collections of specimens, to Dr. Francis Drouet, Mr. E. F. Ricketts, Mr. Victor Johnson, and Mr. John Poindexter; for help in the study and interpretation of specimens and data, to Dr. W. A. Setchell, Dr. G. J. Hollenberg, Dr. G. M. Smith, Dr. W. R. Taylor, and Dr. A. R. Davis; for reading and criticizing the manuscript, to Dr. Lee Bonar, Dr. W. A. Setchell, Dr. Ralph Emerson, Dr. A. R. Davis, and Dr. G. M. Smith; for assistance in the preparation of the manuscripts, to Miss Maxine Christianson and Mr. N. Christianson; for the loan of type specimens, to Miss Alice Eastwood of the California Academy of Sciences and Dr. F. J. Seaver of the New York Botanical Gardens.

Acknowledgement is due Dr. H. V. Sverdrup of the Scripps Institution of Oceanography of the University of California for the use of oceanographical data from the Gulf of California, a part of which is here reproduced.

Finally, I am especially indebted for the facilities afforded me in my work by the Department of Botany of the University of California.

TABLE I

E. W. SCRIPPS—OCEANOGRAPHICAL OBSERVATIONS IN THE GULF OF CALIFORNIA, FEB. 13—MARCH 19, 1939

SVERDRUP AND STAFF

TEMPERATURE—°C.

Sta.	DEPTH IN METERS									
	0	10	25	50	75	100	150	200	250	300
1.	19.49	19.0	18.1	16.5	14.4	13.6	12.3	11.6	10.9	10.2
2.	21.30	20.9	20.8	20.6	15.8	15.0	13.3	11.9	11.2	10.5
3.	21.10	21.0	20.6	18.1	17.6	15.1	12.6	11.8	11.2	10.4
4.	19.72	19.6	19.5	17.6	15.0	13.5	12.0	11.1	10.3	9.6
5.	19.58	19.4	19.1	18.4	14.9	13.5	12.0	11.0	10.1	9.3
6.	20.38	20.2	18.8	18.1	15.7	13.7	12.3	11.7	11.3	10.8
7.	21.02	20.9	18.3	17.2	15.6	13.3	12.3	11.7	11.3	10.8
8.	21.58	21.1	19.2	18.8	15.3	13.3	12.4	11.8	11.1	10.5
9.	20.28	19.7	19.4	17.8	15.2	13.4	12.6	12.0	11.3	
10.	20.30	19.7	19.5	16.7	14.6					
11.	17.60	17.4	16.8	16.2	14.5	13.1	12.1	11.7	11.3	
12.	16.90	16.8	16.7	15.8	14.7	13.2	12.2	11.6	11.2	10.6
13.	17.70	17.6	17.6	17.3	14.7	13.7	12.3	11.3	11.0	10.4
14.	17.85	17.6	17.2	16.2	14.6	13.3	12.3	11.6	11.1	10.6
16.	17.30	17.1	16.5	15.3	13.9	12.3	11.8	11.3	10.8	10.4
17.	16.70	16.5	16.3	16.1	14.4	13.3	12.0	11.3	11.0	10.2
18.	17.20	17.0	16.7	16.6	16.3	15.3	13.0	12.0	11.5	11.0
19.	16.95	16.7	16.6	16.6	15.6	13.8	12.7	11.6	10.9	10.6
20.	16.80	16.7	16.5	16.1	16.1	14.5	12.6	12.0	11.1	10.5
21.	16.32	16.2	16.2	16.0	15.7	14.3	13.1	12.4	11.5	10.8
22.	16.30	16.4	16.4	16.2	15.1	13.8	12.5	11.6	11.0	10.4
23.	15.55	15.4	14.9	12.9	12.5	12.4	11.9	11.9		
24.	16.35	16.2	16.2	16.0	14.5	13.0	12.0	11.5	11.0	10.6
25.	16.65	16.3	16.3	15.2	14.0	13.3	12.3	11.5	10.9	10.3

TABLE I (continued)

Sta.	D E P T H I N M E T E R S									
	0	10	25	50	75	100	150	200	250	300
26.	17.75	16.3	16.3	15.1	14.3	13.4	12.5	11.6	10.8	10.3
27.	15.95	15.7	15.4	15.3	14.8	13.4	12.6	12.2	11.8	11.1
28.	15.53	15.3	15.3	15.2	14.0	13.2	12.6	12.2	11.8	11.1
29.	16.08	15.8	15.8	15.7	15.7	15.3	12.7	11.9	11.3	10.7
30.	16.10	15.9	15.6	15.6	15.6	13.8	11.9	10.7	9.8	9.0
31.	15.60	15.3	14.6	14.2	13.7	13.7	12.9	12.0		
32.	15.75	15.7	15.6	15.0	13.8	13.4	12.6	11.7	11.0	10.4
33.	16.18	16.1	15.9	15.1	14.1	13.1	12.1	11.2	10.2	9.5
34.	15.78	15.8	15.7	14.2	13.6	13.2	12.7	13.1	11.2	10.1
35.	15.20	15.0	15.0	14.8	14.2	13.2	12.6	11.7	11.1	10.4
36.	15.70	15.3	14.8	14.6	13.8	13.4	12.6	12.2	12.0	10.4
37.	15.70	15.0	15.0	14.3	14.0	13.8	12.7	11.8	11.0	10.3
38.	15.30	15.1	14.9	14.9	14.6	14.0	12.7	11.8	11.4	10.7
39.	14.38	14.2	13.6	13.2	13.0	12.7	12.1	11.7	11.0	10.9
40.	14.70	14.1	14.0	13.2	12.7	12.6				
41.	15.48	14.6	14.2	14.0	13.4	13.0	12.1	11.7		
42.	16.40	14.6	14.3	13.8	13.3	12.9	12.6	12.0	11.5	11.0
43.	15.00	14.5	14.0	13.9	13.6	13.3	12.8	12.4	11.9	11.4
44.	16.40	15.4	14.6	14.2	14.0	13.2				
45.	16.10	15.2	14.6	14.6	14.3	13.7	13.1	12.4		
46.	17.40	14.6	14.4	14.3	13.9	13.7	13.1	12.6	12.3	12.0
47.	17.70	15.2	14.3	14.2	13.9	13.7	13.0	12.4	12.3	12.0
48.	15.90	15.5	14.3	14.1	13.7					
49.	15.20	15.0	14.2	14.1	13.7					
50.	17.02	15.5	14.3	14.4						
51.	16.15	14.9	14.2	14.0						
52.	14.35	14.0	13.8	13.7	13.4	13.3	13.0	12.5	12.3	12.3
53.	15.80	14.3	14.0	13.8	13.4	13.1	12.9	12.5	12.3	12.2

TABLE II

E. W. SCRIPPS—OCEANOGRAPHICAL OBSERVATIONS IN THE GULF OF CALIFORNIA, FEB. 13-MARCH 19, 1939

SVERDRUP AND STAFF

OXYGEN ml/L

Sta.	DEPTH IN METERS										
	0	10	25	50	75	100	150	200	250	300	400
1.	5.31	5.00	3.89	1.95	0.72	0.62	0.22	0.11	0.03	0.01	0.03
2.	5.60	5.00	5.00	5.13	1.23	1.08	0.40	0.41	0.20	0.10	0.08
3.	5.08	4.78	4.60	4.20	5.60	2.00	0.39	0.17	0.09	0.04	0.09
4.	5.31	5.13	5.03	3.90	1.05	1.20	0.40	0.02	0.30	0.33	
5.	5.23	5.19	5.12	3.70	0.77	0.56	0.18	0.22	0.36	0.08	0.04
6.	5.21	5.05	5.25	4.10	1.32	0.40	0.15	0.10	0.08	0.06	0.08
7.	5.25	5.16	3.35	3.35	1.90	0.28	0.17	0.49	0.44	0.13	0.18
8.	5.10	5.08	4.98	4.40	1.00	0.46	0.20	0.13	0.08	0.05	0.04
9.	5.26	5.21	4.95	3.00	1.13	0.50	0.46	0.26	0.46		
10.	5.13	5.28	5.12	2.03	1.32						
11.	5.14	5.23	4.63	4.35	0.78	0.25	0.05	0.04	0.09		
12.	5.20	5.15	4.98	4.15	1.30	0.30	0.25	0.14	0.08	0.12	0.20
13.	5.92	5.22	5.07	4.38	0.76	0.20	0.57	0.13	0.06	0.04	0.07
14.	5.62	5.61	5.19	3.90	1.10	0.36	0.08	0.20	0.13	0.01	0.04
16.	5.62	5.53	5.31	4.70	0.70	0.22	0.10	0.07	0.06	0.06	0.12
17.	5.64	5.37	5.75	5.20	1.80	0.21	0.07	0.01	0.07	0.05	0.02
18.	5.35	5.40	5.23	5.25	4.52	2.71	0.40	0.19	0.13	0.60	0.06
19.	5.70	5.68	5.42	5.20	2.95	1.20	0.27	0.17	0.11	0.10	0.07
20.	5.50	5.44	4.90	5.32	5.34	1.62	0.22	0.16	0.15	0.12	0.07
21.	5.38	5.53	5.39	5.20	4.96	1.53	0.70	0.25	0.10	0.06	0.06
22.	5.50	5.46	5.50	5.20	2.55	0.95	0.20	0.13	0.09	0.07	0.06
23.	5.98	5.53	3.50	0.28	0.15	0.10	0.19	0.25			
24.	5.25	5.23	5.14	5.14	2.20	0.49	0.07	0.09	0.10	0.08	
25.	5.40	5.39	5.39	3.13	0.88	0.62	0.26	0.12	0.17	0.09	0.06

TABLE II (continued)

Sta.	DEPTH IN METERS										
	0	10	25	50	75	100	150	200	250	300	400
26.	5.47	5.39	5.26	2.95	1.35	0.39	0.41	0.13	0.09	0.07	0.06
27.	5.37	5.27	4.87	4.90	3.50	0.41	0.35	0.20	0.15	0.10	0.11
28.	5.28	5.33	5.26	5.14	1.63	0.32	0.26	0.16	0.09	0.14	0.04
29.	5.18	5.11	5.03	5.12	5.01	3.90	0.60	0.33	0.19	0.12	
30.	5.41	5.38	5.25	5.20	5.00	0.65	0.30	0.08	0.08	0.20	0.05
31.	6.60	6.66	4.30	3.00	2.10	2.50	1.52	0.30			
32.	6.43	6.23	5.33	4.30	1.23	0.76	2.05	0.19	0.13	0.09	0.14
33.	5.68	5.68	5.60	4.80	2.20	0.40	0.25	0.13	0.13	0.11	0.06
34.	5.73	5.70	5.60	4.68	3.84	3.25	2.45	2.13	1.16	0.32	0.07
35.	5.10	4.98	5.04	4.87	3.30	1.00	1.87	1.56	0.77	0.45	0.19
36.	5.51	5.42	5.21	4.25	3.12	3.28	2.51	2.18	1.80	0.04	0.22
37.	5.55	5.39	5.44	4.12	3.79	3.52	0.76	0.47	0.30	0.18	0.12
38.	5.33	5.52	5.13	5.19	4.60	3.00	1.36	0.56	0.50	0.28	0.30
39.	4.80	4.74	3.79	3.40	3.04	2.50	1.56	0.85	0.31	0.28	
40.	7.12	5.49	4.58	2.25	1.30	1.27					
41.		5.17	4.74	4.41	3.12	2.25	1.52	1.51			
42.	7.21	6.17	5.36	4.12	3.23	2.55	1.61	1.35	1.66	1.40	1.43
43.	6.30	6.30	4.98	4.80	4.05	3.47	2.83	1.74	1.41	1.30	
44.	8.14	6.91	5.68	4.76	3.78	2.04					
45.	8.60	7.21	5.90	5.13	3.72	2.35	1.28				
46.	8.86	5.59	5.36	4.60	3.76	3.50	2.15	1.83	1.54	1.10	1.05
47.	7.83	7.30	5.36	4.91	4.34	3.99	2.65	1.74	1.45	1.14	
48.	7.21	7.11	5.45	4.91	3.58						
49.	6.60	6.76	5.47	5.32	5.26						
50.	7.14	7.36	6.15	5.70							
51.	9.08	7.08	5.50	4.87							
52.	4.97	5.18	4.87	4.58	4.02	3.75	3.08	2.35	2.05	2.00	1.58
53.	5.43	5.44	4.90	4.27	3.56	3.13	2.74	2.32	2.04	2.02	1.64

TABLE III

E. W. SCRIPPS—OCEANOGRAPHICAL OBSERVATIONS IN THE GULF OF CALIFORNIA, FEB. 13-MARCH 19, 1939

POSITIONS OF STATIONS 1-53					
1.	22° 52' N	109° 46' 2	28.	26° 14' N	111° 01' W
2.	22° 54' N	109° 27' W	29.	26° 10' N	111° 13' W
3.	22° 56' N	109° 11' W	30.	27° 14' N	111° 10' W
4.	23° 01' N	108° 40' W	31.	27° 46' N	110° 56' W
5.	22° 58' N	108° 14' W	32.	27° 39' N	111° 06' W
6.	23° 01' N	107° 48' W	33.	27° 24' N	111° 17' W
7.	23° 05' N	107° 23' W	34.	27° 07' N	111° 30' W
8.	23° 10' N	107° 04' W	35.	27° 02' N	111° 48' W
9.	23° 10' N	106° 51' W	36.	27° 40' N	112° 19' W
10.	23° 10' N	106° 37' W	37.	27° 54' N	112° 15' W
11.	24° 46' N	108° 22' W	38.	28° 07' N	112° 10' W
12.	23° 39' N	108° 24' W	39.	29° 17' N	112° 06' W
13.	24° 32' N	108° 45' W	40.	28° 22' N	112° 04' W
14.	24° 23' N	109° 05' W	41.	29° 06' N	112° 38' W
15.	24° 20' N	109° 11' W	42.	29° 06' N	113° 00' W
16.	24° 14' N	109° 25' W	43.	29° 09' N	113° 02' W
17.	24° 09' N	109° 38' W	44.	30° 18' N	113° 13' W
18.	25° 14' N	110° 39' W	45.	30° 11' N	113° 32' W
19.	25° 18' N	110° 27' W	46.	29° 57' N	113° 55' W
20.	22° 22' N	110° 12' W	47.	29° 56' N	114° 11' W
21.	25° 23' N	109° 57' W	48.	30° 42' N	114° 22' W
22.	25° 28' N	109° 45' W	49.	30° 52' N	114° 04' W
23.	25° 33' N	109° 28' W	50.	31° 14' N	113° 40' W
24.	26° 37' N	110° 02' W	51.	13° 14' N	114° 14' W
25.	26° 35' N	110° 15' W	52.	29° 09' N	113° 29' W
26.	26° 28' N	110° 29' W	53.	28° 46' N	113° 08' W
27.	26° 20' N	110° 46' W			

LITERATURE CITED

AGARDH, C. A.

- 1820-28. Species algarum rite cognitae cum synonymis, differentiis specificis et descriptionibus succinctis. 1(1): 1-168. 1820; 1(2): 169-531. 1822; 2(1): I-LXXXVI; 1-189. 1828. Lund.
1824. Systema Algarum. XXXVIII+312 pp. Lund.

AGARDH, J. G.

1847. Nya Alger från Mexico. Oefvers. af Kongl. Vetensk.-Akad. Förhandl. 4: 5-17.
- 1851-76. Species genera et ordines Algarum. 2(1): I-XII and 1-351. 1851; 2(2): 337-720. 1852; 2(3): 701-1291. 1863; 3(1) (Epicrisis systematis floridearum): I-VII and 1-724. 1876. Lund.
- 1873-90. Till Algernas Systematik, Afd. 1. Lunds Univ. Arsskr. 9: 1-71. 1873; Afd. 2. *Ibid.*, 17: 1-134. 1882; Afd. 3. *Ibid.*, 19: 1-177. 1883; Afd. 4. *Ibid.*, 21: 1-117. 1885; Afd. 5. *Ibid.*, 23: 1-174. 1887; Afd. 6. *Ibid.*, 26: 1-125. 1890.
1889. Species Sargassorum Australiae, descriptae et dispositae, etc. Kongl. Svenska Vetensk.-Akad. Handl. 23(3): 1-133, 31 pls. with text. Stockholm.
- 1892-99. Analecta Algologica: observationes de speciebus minus cognitis earumque dispositione. Actis Soc. Physiog. Lundensis 28: 1-182. 1892; Continuatio. *Ibid.*, 29: 1-144. 1894; Continuatio II. *Ibid.*, 30: 1-98. 1894; Continuatio III. *Ibid.* N.S., 7: 1-140. 1896; Continuatio IV. *Ibid.* N.S., 8: 1-106. 1897; Continuatio V. *Ibid.* N.S., 10: 1-160. 1899.

ARDISSONE, F.

- 1883-86. Phycologia Mediterranea, I (Floridee): I-X, 1-516. 1883; II (Oosporee, Zoosporee, Schizosporee): 1-325. 1886. Varese.

BLIDING, C.

1928. Studien über die Florideenordnung Rhodymeniales. Lunds Univ. Arsskr., N.F., Avd. 2, 24(3): 4-74.

BØRGENSEN, F.

- 1913-20. Marine Algae of the Danish West Indies, I. Dansk Bot. Arkiv 1(4): 1-160; 2(2): 1-68. 1913-14. *Ibid.*, II. 3: 1-504. 1915-20.
1920. Marine Algae of Easter Island. Nat. Hist. of Juan Fernandez and Easter Island (9): 247-309. Upsala.
1934. Some Marine Algae from the Northern Part of the Arabian Sea, with Remarks on Their Geographical Distribution. Det Kgl. Danske Videnskab. Selsk. Biol. Medd. 11(6): 1-72.
1937. Contributions to a South Indian Marine Algal Flora III. Journ. Indian Bot. Soc. 16(6): 311-357.

BORNET, E., & G. THURET

- 1876-80. Notes Algologiques; recueil d'observation sur les algues. 1: 1-72, pls. 1-25. 1876; 2: 73-196, pls. 26-50. 1880.

BORY DE SAINT VINCENT, J. B.

- 1826-29. Histoire naturelle botanique, Cryptogamie. In L. I. Duperrey, Voyage autour du monde, exécuté par ordre du Roi sur la Corvette de sa Majesté, La Coquille, pendant les années 1822, 1823, 1824 et 1825. Pp. 1-96 (1827), 97-136 (1828), 137-300 (1829), Atlas, pls. 1-24 (plates dated individually) (1826-27). Paris.

COLLINS, F. S.

1909-18. The Green Algae of North America. Tufts Coll. Stud. 2(3): 79-480. 1909; First Suppl., *ibid.*, 3(2): 91-109. 1912; Second Suppl., *ibid.*, 4(7): 1-106. 1918.

1909a. New Species of Cladophora. Rhodora 11: 17-20.

COLLINS, F. S., & A. B. HERVEY

1917. The Algae of Bermuda. Proc. Amer. Acad. Arts and Sci. 53: 3-195.

COLLINS, F. S., I. HOLDEN, & W. A. SETCHELL

1895-1919. Phycotheca Boreali-Americana (Exsiccata). Fasc. I-XLVI, A-E.

DAWSON, E. Y.

1941. Field Observations on the Algae of the Gulf of California. Allan Hancock Pacific Exped. 3(7): 113-119.

1941a. A Review of the Genus Rhodymenia with Descriptions of New Species. *Ibid.*, 3(8): 121-181.

DECAISNE, J.

1842. Essais sur une classification des Algues et des Polypiers calcifères de Lamouroux. Ann. Sci. Nat., Bot. ii, 17: 297-380.

1842a. Mémoire sur les corallines ou polypieres calcifères. *Ibid.*, ii, 18: 96-128.

DERBES, A., ET A. J. J. SOLIER

1856. Mémoire sur quelques points de la physiologie des algues. C. R. Acad. Sci., Suppl. 1: 1-120.

DE TONI, G. B.

1889-1924. Sylloge algarum omnium hucusque cognitarum. 1 (Sylloge Chlorophycearum): 1-12, I-CXXXIX, 1-1315. 1889. 3 (Sylloge Fucoidearum): I-XVI, 1-638. 1895. 4 (Sylloge Floridearum) (1): I-XX, I-LXI, 1-388. 1897; (2): 387-776. 1900; (3): 775-1525. 1903; (4): 1523-1973. 1905. 6 (Sylloge Floridearum) (5, Additamenta): I-XI, 1-767. 1924. Patavii.

DREW, K. M.

1928. A Revision of the Genera Chantransia, Rhodochorton, and Acrochaetium, with Descriptions of the Marine Species of Rhodochorton (Naeg.) Gen. Emend. on the Pacific Coast of North America. Univ. Cal. Publ. Bot. 14(5): 139-224.

ENGLER, A., AND K. PRANTL

1896. Die Natürlichen Pflanzenfamilien, I, 2: i-xii, 1-580.

FALKENBERG, P.

1901. Die Rhodomelaceen des Golfes von Neapel und der angrenzenden Meeresabschnittes. Fauna und Flora des Golfes von Neapel 26: 1-754. Berlin.

FARLOW, W. G.

1889. On Some New or Imperfectly Known Algae of the United States, I. Bull. Torr. Bot. Club 16: 1-12.

1899. Three Undescribed California Algae. Erythea 7: 73-76.

FELDMANN, J.

1931. Remarques sur les genres *Gelidium* Lamour., *Gelidiopsis* Schmitz et *Echinocaulon* (Kütz.) emend. Rec. Trav. Cryptog. dédiés à L. Mangin: 151-166. Paris.

FELDMANN, J., ET G. HAMEL

1934. Observations sur quelques Gelidiacées. Rev. Gén. Bot. 46: 528-549.
 1936. Floridées de France, VII, Gelidiales. Rev. Algol. 9(1-2): 85-140.

FELDMANN-MAZOYER, G.

1940. Recherches sur les Céramiacées de la Méditerranée occidentale. 510 pp., 191 figs., 4 pls. Algiers.

FOSLIE, M. H.

1895. New or Critical *Lithothamnium*. Kgl. Norske Vidensk. Selsk. Skrifter, 1895 (2): 1-10.
 1897. On Some *Lithothamnium*. *Ibid.*, 1897 (1): 1-20.
 1898. List of Species of *Lithothamnium*. *Ibid.*, 1898 (3): 1-11.
 1899. Notes on Two *Lithothamnium* from Funafuti. *Ibid.*, 1899 (2): 1-5.
 1900. Revised Systematical Survey of the *Melobesieae*. *Ibid.*, 1900 (5): 1-22.
 1901. Bieten die Heydrich'shen Melobesien-Arbeiten einer sichere Grundlage? *Ibid.*, 1901 (2): 1-28.
 1905. New *Lithothamnium* and systematical remarks. *Ibid.*, 1905 (5): 1-9.
 1907. Algologiska Notiser IV. *Ibid.*, 1907 (6): 1-30.
 1909. Algologiska Notiser VI. *Ibid.*, 1909 (2): 1-63.
 1929. Contributions to a Monograph of the *Lithothamnium*. Edited by H. Printz. 60 pp., 75 pls. Trondhjem.

FOSLIE, M. H., & M. A. HOWE

1906. New American Coralline Algae. Bull. New York Bot. Gard. 4: 128-136.

GARDNER, N. L.

1927. New Rhodophyceae from the Pacific Coast of North America, II. Univ. Cal. Pub. Bot. 13: 235-272. *Ibid.*, III. 13: 333-368. *Ibid.*, IV. 13: 373-402. *Ibid.*, V. 13: 403-434. *Ibid.*, VI. 14: 99-138.

GEE, H.

1932. Calcium Equilibrium in Sea Water. Bull. Scripps Inst. of Oceanogr., Tech. Ser., 3(7): 145-190.

GMELIN, S. G.

1768. Historia fucorum. [10]+1-6+1-239 pp., pls. IA, B, IIA, B, III-XXXIII. Petropoli.

GREVILLE, R. K.

1830. Algae Britannicae, or Descriptions of the Marine and Other Inarticulated Plants of the British Islands, belonging to the Order Algae: with Plates Illustrative of the Genera. lxxxviii+218. Edinburgh.

HAMEL, A. et G.

1929. Sur l'hétérogamie d'une Cladophoracée, *Lola* (nov. gen.) *lubrica* (Setch. et Gard.). C. R. Acad. Sci. ii, 189: 1094-1096.

HAMEL, G.

- 1930-32. Chlorophycées des côtes françaises. Rev. Algol. 5: 1-54, 381-430. 1930-31; *ibid.*, 6: 9-73. 1931-32.
 1931-39. Phaeophycées de France. Pp. I-XLVII (1939); Fasc. 1, pp. 1-80 (1931); Fasc. 2, pp. 81-176 (1935); Fasc. 3, pp. 177-240 (1937); Fasc. 4, pp. 241-336 (1938); Fasc. 5, pp. 337-432 (1939). Paris.

HARIOT, P.

1895. Algues du Golfe de Californie recueillies par M. Diguët. Journ. de Bot. 9: 167-170.

HARVEY, W. H.

- 1846-51. Phycologia Britannica: Or a History of British Seaweeds, Containing Coloured Figures, Generic and Specific Characters, Synonyms, and Descriptions of All the Species of Algae Inhabiting the Shores of the British Islands. Pp. XLV+VI (+5), 360 pls. and text. 4 vol. London.
- 1852-58. Nereis Boreali-Americana. Smithsonian Contributions to Knowledge. Part I, 1-150. 1852; Part II, 1-258. 1853 (designated also as vol. 5 (5) of the Contributions); Part III, 1-140. 1858 (including supplement).
1855. Some Account of the Marine Botany of the Colony of Western Australia. Trans. Roy. Irish Acad. 22: 525-566.
1857. Algae. In A. Gray. List of Dried Plants Collected in Japan. In F. L. Hawks, Narrative of the Expedition of an American Squadron to the China Seas and Japan . . . in . . . 1852-54, under the command of Commodore M. C. Perry 2: 303-332. Washington.
- 1858-63. Phycologia Australica: or a History of Australian Seaweeds; and a Synopsis of All Known Australian Algae. 1: pl. 1-60. 1858; 2: pl. 61-120. 1859; 3: pl. 121-180. 1860; 4: pl. 181-240. 1862; 5: pl. 241-300. 1863. London.

HEYDRICH, F.

1897. Corallinaceae insbesondere Melobesieae. Ber. der Deutschen Botan. Gesellsch. 15: 340-370.
1901. Die Lithothamnien des Museum d'Histoire naturelle in Paris. Botan. Jahrb. für syst. Botanik 28: 529-545.

HOLLENBERG, G. J.

1942. An Account of the Species of Polysiphonia of the Pacific Coast of North America. Amer. Journ. Bot. 29: 772-785.
1943. New Marine Algae from Southern California. II. Amer. Journ. Bot., 30: 571-579.

HOLMES, E. M.

1895. New Marine Algae from Japan. Linn. Soc. Journ., Bot. 31: 248-260.

HOWE, M. A.

1905. Phycological Studies -II. New Chlorophyceae, New Rhodophyceae and miscellaneous notes. Bull. Torrey Bot. Club 32: 563-586.
1907. Phycological Studies -III. Further notes on Halimeda and Avrainvillea. *Ibid.*, 34: 491-516.
1911. Phycological Studies -V. Some Marine Algae of Lower California, Mexico. *Ibid.*, 38: 489-514.
1914. The Marine Algae of Peru. Mem. Torrey Bot. Club 15: 1-185, pls. 1-66.
1920. Algae, pp. 553-618. In N. L. Britton and C. F. Millspaugh, The Bahama Flora, vii+695 pp. New York.
1924. Chinese Marine Algae. Bull. Torrey Bot. Club 51: 133-144.

HUS, H. T. A.

1902. An Account of the Species of Porphyra Found on the Pacific Coast of North America. Proc. Cal. Acad. Sci. iii, Bot. 2(6): 173-240.

JOHNSON, D., & H. YORK

1915. The Relation of Plants to Tide Levels. Carnegie Inst. Wash. Publ. 206: 1-161.

JOHNSTONE, J.

1928. An Introduction to Oceanography. 368 pp. Liverpool.

KJELLMAN, F. R.

1900. Om Floridé-slågtet Galaxaura, dess organographi och systematik. Kongl. Svenska Vetensk.-Akad. Handl. 33(1): 1-109, 20 pls.

KÜTZING, F. T.

1843. Phycologia generalis, oder Anatomie, Physiologie und systemkunde der Tange. 458 pp., 80 pls. Leipzig.
- 1845-71. Tabulae Phycologicae oder Abbildungen der Tange. Vols. 1-20. Nordhausen.
1849. Species algarum. 922 pp. Leipzig.

KYLIN, H.

1924. Studien über die Delesseriaceen. Lunds Univ. Arsskr., N. F., Avd. 2, 20(6): 1-111.
1925. The Marine Red Algae in the Vicinity of the Biological Station at Friday Harbor, Washington. *Ibid.*, 21(9): 1-87.
1930. Über die Entwicklungsgeschichte der Florideen. *Ibid.*, 26(6): 1-103.
1932. Die Florideenordnung Gigartinales. *Ibid.*, 28(8): 1-88.
1933. Über die Entwicklungsgeschichte der Phaeophyceen. *Ibid.*, 29(7): 1-102.
1937. Anatomie der Rhodophyceen. In K. Linsbauer, Handbuch der Pflanzenanatomie, II, 2g: i-viii, 1-347, 252 figs. Berlin.
- 1937a. Über eine Marine Porphyridium-Art. Kungl. Fysiogr. Sällsk. Lund Forhandlingar, 7(10).
1940. Die Phaeophyceenordnung Chordariales. Lunds Univ. Arsskr., N. F., Avd. 2, 36(9): 1-67.
1941. Californische Rhodophyceae. *Ibid.*, 37(2): 1-51.

LAMOUREUX, J. V.

1813. Essai sur les genres de la famille des thalassiphytes non articulées. Ann. Mus. d'Hist. Nat. 20: 21-47, 115-139, 267-293, pls. 7-13.
1816. Histoire des Polypiers coralligènes flexibles, vulgairement nommés Zoophytes. lxxxiv+559 pp., 19 pls. Caen.
1825. Gelidium, in Dictionnaire classique d'Histoire naturelle 7.

LE JOLIS, A.

1863. Liste des algues marines de Cherbourg. Mém. Soc. Imp. Sci. Nat. de Cherbourg 10: 5-168.

LEMOINE, MME. P.

1911. Structure anatomique des Mélobésiées. Application à la classification. Ann. Inst. Oceanogr. (Monaco) 2(2): 1-213.
1929. Les Corallinacées de L'Archipel des Galapagos et du Golfe de Panama. Arch. Mus. d'Hist. Nat. vi, 4: 37-88.

LINK, H. F.

1820. Epistola de algis aquaticis in genera disponendis. Pp. 1-8 in Nees, Horae Physicae. Bonnae.

LINNAEUS, C.

1753. Species plantarum, exhibentes plantas rite cognitatas, ad genera relatas, cum differentiis specificis, nominibus trivialibus, synonymis selectis, locis natalibus secundum systema sexuale digestas. Ed. 1. Stockholm.

MANZA, A. V.

1940. A Revision of the Genera of Articulated Corallines. Philippine Journ. Sci. 71: 239-316.

MARTENS, G. V.

1866. Die Tange. *In*, Die Preussische Exped. nach Ost-Asien, Botan. Theil. 152 pp., 8 pls. Berlin.

MASON, L. R.

1933. The Crustaceous Corallines of the Pacific Coast of North America. Thesis manuscript in the Library of the University of California.

MONTAGNE, C.

1842. Botanique—Plantes cellulaires. Vol. VIII (x+549 pp.) of Pt. II, and Atlas II (Cryptogamie, 20 pls.) *in* R. de La Sagra's Histoire physique, politique et naturelle de l'île de Cuba. Paris.

- 1846-47. Flore d'Algerie, Phyceae, *in* J. B. Bory de St. Vincent et Durieu de Maissonneuve, Exploration scientifique de l'Algerie, Bot. 197 pp., 16 pls. Paris.

1850. Note sur la station insolite de quelques Floridées dans les eaux douces et courantes des ruisseaux de la Guyana. C. R. Acad. Sci. i., 30: 604-606.

- 1850a. Cryptogamia Guyanensis, seu plantarum cellularium in Guyana gallica annis 1835-1849 a Cl. Leprieur collectarum enumeratio universalis. Ann. Sci. Nat. iii, Bot., 14: 283-310.

NAEGELI, C.

1846. Über Polysiphonia und Herposiphonia. Zeitschr. Wiss. Bot. 4: 206-256.

OKAMURA, K.

- 1907-37. Icones of Japanese Algae. 1: 1-22, pls. 1-50. 1907-1909. 2: 1-191, pls. 51-100. 1909-1912. 3: 1-218, pls. 101-150. 1913-1915. 4: 1-205, pls. 151-200. 1916-1923. 5: 1-203, pls. 201-250. 1923-1928. 6: 1-96, pls. 251-300. 1929-1932. 7: 1-79, pls. 301-345. 1933-1937. Tokyo.

1936. Nippon Kaisan Shi (Descriptions of Japanese Algae). Pp. 1-9+1-6+1-964+1-11. Tokyo.

POST, ERIKA

1936. Systematische und pflanzengeographische Notizen zur Bostrychia-Caloglossa-Assoziation. Rev. Algol. 9: 1-84.

POSTELS, A., & F. RUPRECHT

1840. Illustrationes algarum in itinere circa orbem jussu imperatoris Nicolai I atque auspiciis Navarchi Friderici Lütke annis 1826, 1827, 1828 et 1829, celose Seniavin exsecuto in Oceano Pacifico, imprimis septentrionali ad littora Rossica Asiatico-Americana collectarum. 40 pls. St. Petersburg.

ROSENVINGE, L. K.

- 1909-31. Marine Algae of Denmark, I. Rhodophyceae. Kongel. Danske Vidensk. Selsk. Skr., vii, 7(1-4): 1-627.

SAUNDERS, D. A.

1898. Phycological Memoirs. Proc. Cal. Acad. Sci. iii, Bot. 1(4): 147-168.

SAUVAGEAU, M. C.

1899. Les Cutlériacées et leur alternance de générations. Ann. Sci. Nat. viii, 10: 265-362.
- 1900-14. Remarques sur les Sphacelariacées. Journ. de Bot. 14: 1-51. 1900; 15: 51-167. 1901; 16: 167-228. 1902; 17: 228-332. 1903; 18: 332-348. 1904; Reprint, pp. I-XII+349-634. 1914. Bordeaux.
1927. Sur le *Colpomenia sinuosa* Derb. et Sol. Bull. Sta. Biol. d'Arcachon 24: 309-353.

SCHMITZ, F.

1889. Systematische Übersicht der bisher bekannten Gattungen der Florideen. Flora 72: 435-456.
1895. Marine Florideen von Deutsch-Ostafrika. Botan. Jahrb. für syst. Botanik 21: 137-177.
1896. Bangiaceae, in A. Engler und K. Prantl, Die natürlichen Pflanzenfamilien I, 2: 307-316.

SEGAWA, S.

1935. Marine Algae of Susake, Prov. Idzu and its vicinity. Sci. Papers Inst. Algol. Res., Fac. of Sci., Hokkaido Imp. Univ. 1(1): 59-90.

SETCHELL, W. A.

1914. The *Scinia* Assemblage. Univ. Cal. Pub. Bot. 6: 79-152.
1915. The Law of Temperature Connected with the Distribution of the Marine Algae. Ann. Missouri Bot. Gard. 2: 287-305.
1920. The Temperature Interval in the Geographical Distribution of the Marine Algae. Science, n.s. 52: 187-190.
- 1920a. Stenothermy and Zone Invasion. Amer. Nat. 54: 385-389.
1922. Cape Cod in Its Relation to the Marine Flora of New England. Rhodora 24: 1-11.
1924. American Samoa, Pt. I, Vegetation of Tutuila Island. Carnegie Inst. Wash. Publ. 20 (341): 1-188.
1926. Phytogeographical Notes on Tahiti, II, Marine Vegetation. Univ. Cal. Pub. Bot. 12: 241-290.
1937. Report on the Sargassums of the Templeton Crocker Expedition of 1932. Proc. Cal. Acad. Sci. iv, 22(5): 127-158.

SETCHELL, W. A., & N. L. GARDNER

1920. The Marine Algae of the Pacific Coast of North America, Part 2, Chlorophyceae. Univ. Cal. Pub. Bot. 8: 139-374.
1922. Phycological Contributions, II-VI. New Species of: II. Myrionema; III. Comptonema; IV. Hecatonema; V. Pylaiella and Streblonema; VI. Ectocarpus. *Ibid.*, 7: 333-426.
1924. New Marine Algae from the Gulf of California. Proc. Cal. Acad. Sci. iv, 12(29): 695-949.
- 1924a. Phycological Contributions, VII. Univ. Cal. Pub. Bot. 13: 1-13.
1925. The Marine Algae of the Pacific Coast of North America, Part 3, Melanophyceae. *Ibid.*, 8: 383-898.
1930. Marine Algae of the Revillagigedo Islands Expedition of 1925. Proc. Cal. Acad. Sci. iv, 19: 109-215.
1933. A Preliminary Survey of Gigartina, with Special Reference to Its Pacific North American Species. Univ. Cal. Pub. Bot. 17: 255-340.
1937. A Preliminary Report on the Algae of the Templeton Crocker Expedition in 1932. Proc. Cal. Acad. Sci. iv, 21(2): 65-98.

SHELFORD, V. E.

1929. The Penetration of Light in Puget Sound Waters as Measured with Gas-filled Photoelectric Cells and Ray Filters. Publ. Puget Sound Biol. Sta. 7: 151-168.

SOLANDER, D.

1786. In J. Ellis and D. Solander, The Natural History of Many Curious and Uncommon Zoophytes. Pp. XII+208, 63 pls. London.

STACKHOUSE, J.

- 1795-1801. Nereis Britannica; continens species omnes Fucorum in insulis Britannicis crescentium, Fasc. 1: i-viii. 1795; Fasc. 2: ix-xviii. 1797; Fasc. 3: xix-xl+1-112 with appendix, pls. 1-17 and A-G. 1801. Bath.

SVERDRUP, H. U., & STAFF

1943. Oceanographic Observations of the Scripps Institution in 1939. Records of Obs. Scripps Inst. Oceanogr. 1(2): 65-160.

TANAKA, T.

1936. The Genus *Galaxaura* from Japan. Sci. Papers Inst. Algal. Res., Fac. of Sci., Hokkaido Imp. Univ. 1(2): 141-173.
1941. The Genus *Hypnea* from Japan. *Ibid.*, 2(2): 227-230.

TAYLOR, W. R.

1928. The Marine Algae of Florida, with Special Reference to the Dry Tortugas. Carnegie Inst. Wash., Publ. 379; Papers from the Tortugas Laboratory, 25: i-v+1-219, 3 figs., 27 pls.
1937. Marine Algae of the Northeastern Coast of North America. i-ix, 1-427, 60 pls. Ann Arbor.
1939. Algae from the Presidential Cruise of 1938. Smithsonian Contr. Knowl., Miscell. Ser. 98(9): 1-18.

THURET, G., & E. BORNET

1878. Études Phycologiques. 105 pp., 51 pls. Paris.

VICKERS, A.

1908. Phycologia Barbadosensis. Iconographie des algues marines récoltées à l'île Barbade (Antilles)—(Chlorophycées et Pheophycées). (Text by Mary H. Shaw.) Part I, Chlorophyceae, pp. 1-30, pl. 153; Part II, Phaeophyceae, pp. 33-44, pls. 1-34. Paris.

WEBER-VAN BOSSE, A.

1898. Monographie des Caulerpes. Ann. Jard. Bot. Buitenzorg 15: 243-401, pls. 20-34.
1913-28. Liste des Algues du Siboga. Siboga-Expeditie Monogr. LIX, I. Myxophyceae, Chlorophyceae, Phaeophyceae, avec le concours de M. Th. Reinbold, pp. 1-186. 1913; II. Rhodophyceae, première partie, Protofloridae, Nemalionales, Cryptonemiales, pp. 185-310. 1921; III. Rhodophyceae, seconde partie, Ceramiales, pp. 311-392. 1923; IV. Rhodophyceae, troisième partie, Gigartinales, Rhodymeniales, pp. 393-533. 1928.

WEBER-VAN BOSSE, A., & M. FOSLIE

1904. The Corallinaceae of the Siboga Expedition. Siboga-Expeditie Monogr. LVI, pp. 1-110, pls. I-XIII. Leiden.

WHIPPLE, G. C., & M. C. WHIPPLE

1911. The Solubility of Oxygen in Sea Water. Journ. Amer. Chem. Soc. 33: 362-366.

YAMADA, Y.

1931. Notes on *Laurencia*, with Special Reference to the Japanese Species. Univ. Cal. Pub. Bot. 16: 185-310.

YENDO, K.

1902. Corallinae verae of Port Renfrew. Minnesota Bot. Stud. 2(40): 711-720.
- 1902a. Corallinae verae Japonicae. Journ. Coll. Sci., Imp. Univ. Tokyo 16(2): 1-36.
1907. Fucaceae of Japan. *Ibid.*, 21(12): 1-174, pls. I-XVIII.
1920. Novae Algae Japonicae. Bot. Mag. (Tokyo) 34: 1-12.

ALGAL COLLECTION STATIONS
ALLAN HANCOCK EXPEDITION—1940

See Volume I, part 3, of this series for detailed charts of these stations.

- Sta. 1034-40. Outer Gorda Banks, Cape District, Lower California, Jan. 20, 1940. Dredging in 118-140 meters on coralline sand bottom. Position: 23° 01' N.—109° 28' W. Surface 22.7°C., bottom 16°C. D. 36.
- Sta. 1035-40. Inner Gorda Banks, Cape District, Lower California, Jan. 20, 1940. Dredging in 140-150 meters on coralline sand bottom. Position: 23° 02' N.—109° 30' W. Surface 22.7°C., bottom 16°C. D. 37.
- Sta. 1037-40. Boca de la Trinidad, Lower California, Jan. 21, 1940. Dredging in about 100 meters over coralline sand bottom. Position: 23° 38' N.—109° 29' W. Surface 22.1°C., bottom 14°C. D. 38-39.
- Sta. 1038-40. Guaymas Bay, Sonora, Jan. 22, 1940. Dredging in 4-6 meters on muddy bottom with little animal life. D. 49-61.
- Sta. Dawson 7-40. Guaymas Bay, Sonora, Jan. 23, 1940. Shore collecting in very shallow water at low tide along edges of lagoons adjacent to harbor. Bottom of loose rocks, fine sand, and muck. Principal association: *Enteromorpha*, *Padina*, *Polysiphonia*, and *Sargassum* in large masses. *Codium* and *Gracilaria* occasional. Surface 17.5°-20.0°C. D. 62-81.
- Sta. 1039-40. Outside Guaymas Bay, Sonora, Jan. 23, 1940. Dredging in 12-20 meters over bottom of broken shell and mud. *Scinaea latifrons* most abundant. D. 82-88.
- Sta. 1042-40. Turner's Island off south shore of Tiburon Island, Gulf of California, Jan. 24, 1940. Shore collecting at extreme low tide on reef along north end of island. Algae very abundant in number as well as variety. *Sargassum*, articulated corallines, *Padina*, *Colpomenia*, *Gigartina*, etc., most abundant. Surface at ship 15.6°-16°C. D. 89-135.
- Sta. 1044-40. Tiburon Island, Gulf of California, Jan. 25, 1940. Beam trawling in 4-32 meters off south shore of island, adjacent to Turner's Island. Surface 15.5°-16°C. D. 136-155.
- Sta. 1045-40. Tiburon Island, Gulf of California, Jan. 25, 1940. Shore collecting at low tide on south shore opposite Turner's Island. Beach of rock shingle covered principally by *Padina Durvillaei* and *Sargassum asymmetricum*. Rock cover otherwise mostly of articulated corallines. Surface at ship 15.5°-16°C. D. 156-166.
- Sta. 1046-40. Puerto Refugio, Angel de la Guardia Island, Gulf of California, Jan. 26, 1940. Seine haul over sand just off the beach, south shore of bay. Surface 15.5°C. D. 167-178.
- Sta. 1048-40. Same locality and date. Dredge haul in 22-44 meters. Membranaceous reds conspicuous. Surface at ship 15.5°C., bottom in 38 meters, 14°C. D. 179-188.
- Sta. 1049-40. Same locality and date. Shore collecting at low tide on rocky shore and benches, west side of bay. Algae very abundant in number and variety. No outstanding dominances, however. Surface at ship 15.5°C. D. 189-227.

- Sta. 1050-40. Same locality, Jan. 27, 1940. Trawl haul in 4 meters at low tide, south shore of bay. Surface at ship 15.5°C. D. 228-233.
- Sta. Dawson 16-40. Same locality and date. Cast up at high tide on beach, north side of bay. A great quantity of *Ulva* predominated, covering the sand completely. Surface at ship 15.5°C. D. 234-246.
- Sta. 1051-40. Same locality and date. Dredge haul in 42 meters, west side of bay, shell bottom. Surface 15°C., bottom in 38 meters 14°C. D. 247-252.
- Sta. 1056-40. Same locality and date. Dredging in 12-22 meters, in channel between Mejia Island and main body of Angel de la Guardia. Sand and coralline bottom. Surface 15°C., bottom in 38 meters 14°C. D. 253-281.
- Sta. 1053-40. Same locality, Jan. 28, 1940. Shore collecting at low tide, same place as 1049-40. Most of material scraped from surface of large rocks in middle littoral. Surface 15°C. D. 282-298.
- Sta. 1061-40. Gonzaga, Lower California, at Willard's Point, Jan. 30, 1940. Dredge and trawl haul in 60-80 meters over muddy bottom. Surface 17.8°C. D. 299-305.
- Sta. 1063-40. Same locality and date. Shore collecting on rocky shore at low tide. Algae not abundant and most rocks bare or covered with *Enteromorpha*. *Sargassum* short and young; *Padina* and *Rosenvingea* frequent. The locality was in general mucky and with little sand. Surface 17.7°-18°C. D. 306-334.
- Sta. 1066-40. Consag Rock, Gulf of California, Jan. 31, 1940. Shore collecting on small rocky reef at low tide. Rocks and water fouled by seal excrement. Nothing visible but bits of short *Ulva*. Surface 15°C. D. 335.
- Sta. 1071-40. San Felipe Bay, Lower California, Feb. 2, 1940. Dredge haul over sandy bottom near rocky shore, 5 meters. Few species evidently because of silty water and muddy bottoms. Surface 14.5°C. D. 336-339.
- Sta. 1072-40. Rock Point (Punta Peñasco), Sonora, Feb. 2, 1940. Dredging in 22 meters, sand and silt bottom, hydroids, bryozoans, etc. Surface 17.7°C. D. 340-349.
- Sta. 1073-40. Same locality, Feb. 3, 1940. Dredging near shore in 6-20 meters at high water, sand bottom. *Sargassum sinicola* abundant. Surface 17.7°C. D. 350-364.
- Sta. 1075-40. Georges Island, Gulf of California, Feb. 3, 1940. On shore at high water with *Ulva* and *Enteromorpha* predominating. Surface 17.7°C. D. 365.
- Sta. 1078-40. Tepoca Bay, Sonora, Feb. 4, 1940. Dredging from the ship in 22 meters plus, sandy bottom with abundant worm-tubes, molluscs, etc. Surface 17.7°C. D. 366-382.
- Sta. 1076-40. Same locality and date. Shore collecting at low tide on rocky reef. Richest collecting was in tide pools where articulated corallines were abundant and some *Sargassum* maturing. Elsewhere algae scarce and very short. Surface 17.7°C. D. 383-398.

- Sta. 1079-40. Pond Island at south end of Angel de la Guardia Island, Gulf of California, Feb. 4, 1940. Shore collecting at medium low tide (middle to upper littoral). Rocky shore collecting done on the outside of Pond Island toward the south; lagoon collecting along borders of the "pond" inside. Surface 16°C. D. 399-430.
- Sta. 1080-40. 4 miles off Pond Island, south of Angel de la Guardia Island, Gulf of California, Feb. 5, 1940. Dredging in 124-152 meters on coarse sand bottom. Algae present but probably brought from shallower depths. Surface 16.5°C. D. 431-432.
- Sta. 1081-40. Two miles north of Isla Partida, Gulf of California, Feb. 5, 1940. Dredging in 110-116 meters. Rock bottom. The algae were taken from the surface of the rocks although they had been broken loose and were worn by the action of the net. Surface 17.2°C. D. 433.
- Sta. 1083-40. San Esteban Island, Gulf of California, Feb. 5, 1940. Shore collecting on south shore among rocks and boulders. *Sargassum* abundant in lower littoral. Rocks mostly covered in upper and middle littoral with *Herposiphonia*. *Gigartina* abundant, also *Ulva* and *Rhodoglossum*. Surface 18.2°C. D. 434-468.
- Sta. 1087-40. Ensenada de San Francisco, near Guaymas, Sonora, Feb. 7, 1940. Dredge haul in 30-36 meters. Surface 18.9°C. D. 469-475.
- Sta. 1091-40. Puerto San Carlos, just north of Guaymas, Sonora, Feb. 8, 1940. In 3-8 feet of water near rock-shingle beach. Quiet water of shallow bay. Surface 18.9°C. D. 476-479.
- Sta. Dawson 25-40. Same locality and date. Mangrove swamp near small fresh-water stream mouth. Shallow tidal channels. D. 480-481.
- Sta. Dawson 26-40. Same locality and date. Stagnant pools from fresh-water streamlets near bay. One below Titas de Cabra peak, the other above Mangrove swamp. D. 482-483.
- Sta. 1092-40. Just outside Guaymas Harbor, Catalina, Feb. 9, 1940. Partly on sandy beach of the lagoon, partly on reef rocks. Surface 17.7°C. *Ulva* and *Hypnea* exceedingly common on the sand. *Padina* forms almost a pure stand over many yards of more rocky bottom. *Sargassum* not present except as immature stages on the reef. Only middle littoral exposed, however. D. 484-502.
- Sta. 1093-40. Puerto Escondido, Lower California, Feb. 10, 1940. Dredging in 16-28 meters over sand bottom. Surface 19-19.5°C. D. 503-515.
- Sta. 1096-40. Same locality, Feb. 11, 1940. Dredging in 28-40 meters over sand bottom. D. 516-525.
- Sta. 1104-40. Agua Verde Bay, Lower California, Feb. 12, 1940. Rocky shore at low tide. Most of collecting from small "rock pockets." Algae in general scanty and nowhere luxuriant. No mature examples of larger species. Surface 19.2°C. D. 526-551.
- Sta. 1100-40. Same locality, Feb. 12, 1940. Dredging in 20-40 meters. D. 552-561.

- Sta. 1106-40. 3 miles off San Francisco Island, Gulf of California, Feb. 13, 1940. Dredging in 88 meters over coralline and broken shell bottom. Bottom 17°C. D. 562.
- Sta. 1108-40. San Gabriel, Espiritu Santo Island, Gulf of California, Feb. 13, 1940. Shore collecting at medium tide. Most specimens taken from 5-8 feet of water by raking for coral and coralline clumps. Only conspicuous seaweed on the sand bottom was *Caulerpa sertularioides*. Beach rocks barren. Very few conspicuous species; almost pure sandy bottom except for coral clumps. Surface 21°C. D. 563-573.
- Sta. 1107-40. San Lorenzo Channel, between Espiritu Santo Island and mainland of Lower California, Feb. 14, 1940. Dredging in 12-26 meters over sand and coralline bottom. D. 574-593.
- Sta. 1110-40. San Gabriel, Espiritu Santo Island, Gulf of California, Feb. 14, 1940. Specimens taken by breaking coral clumps which are collected on bottom of sandy lagoon in 4-8 feet of water. D. 594-598.
- Sta. 1112-40. Same locality and date. Collecting in shallow lagoon and abandoned oyster-culture ponds where water is very warm and inhabited by abundant corals and tide-pool fish. Some material from rock shingle overflow from lagoon into bay. Surface at ship 21°C. D. 599-620.
- Sta. 1113-40. East of Espiritu Santo Island, Gulf of California, Feb. 15, 1940. Dredging in 104-116 meters over sand bottom. Very few corallines. Same deep-water form as at Station 1034-1035. D. 621.
- Sta. 1117-40. Off Gorda Point, Cape District, Lower California, Feb. 16, 1940. Dredging in 34-50 meters over fine gray sand. D. 622-627.
- Sta. 1115-40. San Jose del Cabo, Lower California, Feb. 16, 1940. Shore collecting at medium low tide on rocky reefs. Algae in general not abundant. D. 628-647.

ALGAL COLLECTION STATIONS

DAWSON — JULY, 1940

- Sta. Dawson 50. Rocky point just north of Kino, Sonora, July 16, 1940. Littoral rocks at medium tide. No large algae visible, only a greenish to reddish rock cover of *Ulva*, *Centroceras*, and other small species. D. 648-666.
- Sta. Dawson 51. South channel mouth, between Tiburon Island and the mainland of Sonora, July 16, 1940. Beach stones at nearly high tide, apparently cast up and held in sand. D. 667-670.
- Sta. Dawson 52. Kino, Sonora, July 14, 1940. Shore collecting along the sandy beach. Specimens all cast up. D. 671-676.
- Sta. Dawson 53. Tiburon Island, Gulf of California, 3 miles southwest of south channel mouth, July 17, 1940. Collecting in lower littoral on cobblestone beach. *Dictyota-Ishige-Sargassum-Padina* association. D. 677-686.
- Sta. Dawson 55. Turner's Island off south end of Tiburon Island, Gulf of California, July 18, 1940. Same locality as Station 1042-40, Jan. 24, 1940. Collecting on rocky reef at extreme low tide. Surface temp. 31°C. D. 688-758.

THE PRINCIPAL ALGAE FOUND AT TURNER'S ISLAND IN
JANUARY, 1940

<i>Amphiroa pusilla</i>	<i>Gigartina Eatoniana</i>
<i>Amphiroa rigida</i>	<i>Gymnogongrus sinicola</i>
<i>Botryocladia pseudodichotoma</i> var. <i>datilensis</i>	<i>Gymnogongrus divaricatus</i>
<i>Ceramium caudatum</i>	<i>Herposiphonia tenella</i>
<i>Ceramium gracillimum</i>	<i>Hypnea Esperii</i>
<i>Ceramium sinicola</i>	<i>Hypnea Johnstonii</i>
<i>Chondria californica</i>	<i>Jania rubens</i>
<i>Codium anastomosans</i>	<i>Laurencia papillosa</i> var. <i>pacifica</i> (young)
<i>Codium simulans</i>	<i>Laurencia Johnstonii</i> (young)
<i>Colpomenia sinuosa</i> f. <i>tuberculata</i>	<i>Lophosiphonia villum</i>
<i>Cladophora tiburonensis</i>	<i>Lomentaria catenata</i>
<i>Cutleria Hancockii</i>	<i>Padina Durvillaei</i>
<i>Dictyota Johnstonii</i>	<i>Polysiphonia Snyderae</i>
<i>Ectocarpus Hancockii</i>	<i>Polysiphonia simplex</i>
<i>Erythrotrichia carnea</i>	<i>Ralfsia californica</i>
<i>Eucheuma uncinatum</i>	<i>Sargassum sinicola</i>
<i>Gelidium Johnstonii</i>	<i>Ulva rigida</i>
<i>Gelidium pusillum</i>	<i>Valoniopsis pachynema</i>
<i>Gigartina Johnstonii</i>	

THE PRINCIPAL ALGAE FOUND AT TURNER'S ISLAND IN
JULY, 1940

<i>Amphiroa pusilla</i>	<i>Hildenbrandtia rosea</i>
<i>Amphiroa zonata</i>	<i>Hypnea pannosa</i>
<i>Bryopsis plumosa</i> var. <i>pennata</i>	<i>Hypnea nidulans</i>
<i>Ceramium Camouii</i>	<i>Jania rubens</i>
<i>Ceramium fimbriatum</i>	<i>Laurencia Johnstonii</i>
<i>Chaetomorpha antennina</i>	<i>Laurencia papillosa</i> var. <i>pacifica</i>
<i>Champia parvula</i>	<i>Lophosiphonia villum</i>
<i>Chondria acrorhizophora</i>	<i>Padina Durvillaei</i>
<i>Cladophora graminea</i>	<i>Padina mexicana</i>
<i>Corallina pilulifera</i>	<i>Polysiphonia simplex</i>
<i>Dictyota hesperia</i>	<i>Polysiphonia Snyderae</i>
<i>Dictyota Johnstonii</i>	<i>Prionitis kinoensis</i>
<i>Digenia simplex</i>	<i>Prionitis Sternbergii</i>
<i>Ectocarpus confervoides</i> f. <i>variabilis</i>	<i>Ralfsia pacifica</i>
<i>Erythrocladia irregularis</i>	<i>Rhodochorton sinicola</i>
<i>Gelidium Johnstonii</i>	<i>Rhodochorton microscopicum</i>
<i>Gelidium microphysa</i>	<i>Sargassum lapazeanum</i> (young)
<i>Goniotrichum elegans</i>	<i>Sargassum sinicola</i> (young)
<i>Gracilaria crispata</i>	<i>Sphaelaria Hancockii</i>
<i>Herposiphonia tenella</i>	<i>Valoniopsis pachynema</i>

LIST OF NEW NAMES AND COMBINATIONS

- Valoniopsis Hancockii* sp. nov.
Cladophora tiburonensis sp. nov.
Codium MacDougallii sp. nov.
Ectocarpus sonorensis sp. nov.
Ectocarpus Hancockii sp. nov.
Ralfsia Hancockii sp. nov.
Ralfsia pacifica sp. nov.
 Hollenberg ms.
Sphaclaria Hancockii sp. nov.
Desmarestia filamentosa sp. nov.
Desmarestia mexicana sp. nov.
Cutleria Hancockii sp. nov.
Padina mexicana sp. nov.
Sargassum Camouii sp. nov.
Sargassum MacDougallii sp. nov.
Sargassum asymmetricum sp. nov.
Porphyra Thuretii nom. nov.
 Setchell & Dawson
Rhodochorton Hancockii sp. nov.
Rhodochorton sinicola sp. nov.
Gelidiella Hancockii sp. nov.
Gelidiella mexicana sp. nov.
Gelidiella ? refugiensis sp. nov.
Lithophyllum Hancockii sp. nov.
Lithophyllum veleroae sp. nov.
Porolithon sonorensis sp. nov.
Dermatolithon veleroae sp. nov.
Litholepis sonorensis sp. nov.
Heteroderma corallinicola sp. nov.
Halymenia ? abyssicola sp. nov.
Halymenia ? refugiensis sp. nov.
Grateloupia Hancockii sp. nov.
Prionitis mexicana sp. nov.
Prionitis guaymasensis sp. nov.
Prionitis kinoensis sp. nov.
Callymenia veleroae sp. nov.
Callymenia guaymasensis sp. nov.
Agardhiella mexicana sp. nov.
Sarcodiotheca elongata comb. nov.
Sarcodiotheca dichotoma comb. nov.
Gracilaria veleroae sp. nov.
Gracilaria Hancockii sp. nov.
Gracilaria guaymasensis sp. nov.
Gymnogongrus sinicola sp. nov.
Gymnogongrus Hancockii sp. nov.
Gigartina Johnstonii nom. nov.
Gigartina pectinata sp. nov.
Gigartina MacDougallii sp. nov.
Rhodoglossum Hancockii sp. nov.
Rhodymenia ? tepocensis sp. nov.
Botryocladia pseudodichotoma var.
datilensis var. nov.
Botryocladia Hancockii sp. nov.
Botryocladia uvarioides sp. nov.
Rhodymenia divaricata sp. nov.
 (published 1941)
Rhodymenia rosea sp. nov.
 (published 1941)
Rhodymenia Hancockii sp. nov.
 (published 1941)
Lomentaria Drouetii sp. nov.
Champia disticha sp. nov.
Champia caespitosa sp. nov.
Callithamnion veleroae sp. nov.
Platythamnion tepocensis sp. nov.
Ceramium sinicola var.
interruptum comb. nov.
Ceramium sinicola var.
Johnstonii comb. nov.
Ceramium equisetoides sp. nov.
Ceramium Camouii sp. nov.
Sorella pinnata sp. nov.
 Hollenberg ms.
Grinnellia lanceolata sp. nov.
POLYNEURELLA gen. nov.
Polyneurella Hancockii sp. nov.
Myriogramme divaricata sp. nov.
Laurencia Hancockii sp. nov.
Polysiphonia Hancockii sp. nov.
Lophosiphonia mexicana sp. nov.
VELEROA gen. nov.
Veleroa subulata sp. nov.

EXPLANATION
OF
PLATES

PLATE 31

- Fig. 1. *Cladophora tiburonensis*, habit, x 30.
- Fig. 2. *Cladophora tiburonensis*, tip of a sterile branch, x 250.
- Fig. 3. *Cladophora tiburonensis*, tip of a branch bearing zoosporangia, x 250.
- Fig. 4. *Ectocarpus Hancockii*, portion of a filament of the type bearing a plurilocular sporangium, x 325.
- Fig. 5. *Ectocarpus sonorensis*, portion of a filament of the type bearing a plurilocular sporangium, x 225.
- Figs. 6-7. *Ralfsia Hancockii*, a paraphysis and a unilocular sporangium from the type, x 500.
- Fig. 8. *Sphacelaria Hancockii*, portion of a filament of the type with a propagulum, x 130.
- Fig. 9. *Valoniopsis Hancockii*, portion of the type specimen to show method of branching, x 10.

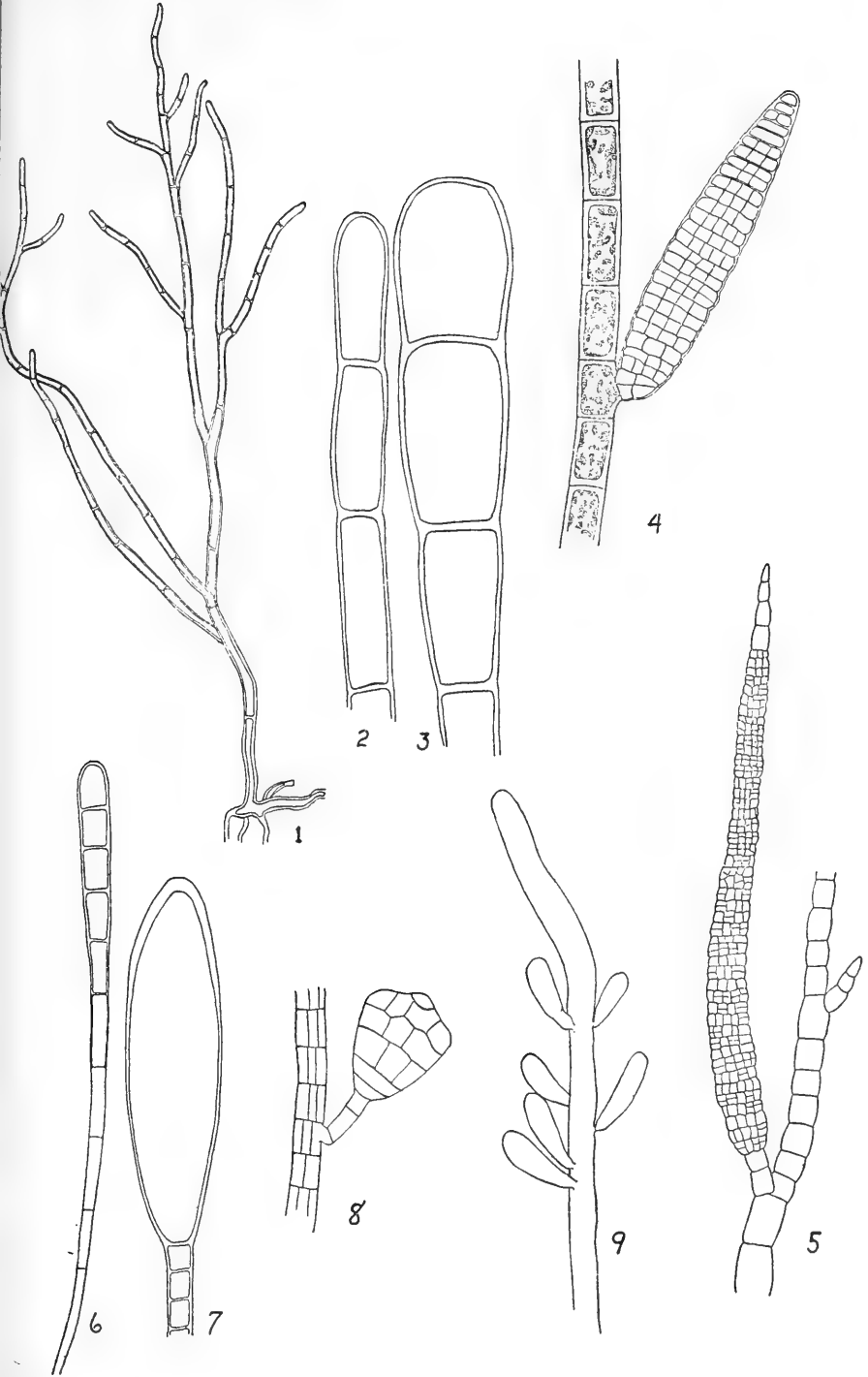

PLATE 32

Sargassum Johnstonii, variation in leaves, vesicles, and inflorescences, x 3.75.

Figs. 1-4. Dawson 555, oogonial tips.

Figs. 5-7. Drouet & Richards 2914.

Figs. 8-9. Dawson 476.

Fig. 10-12. Drouet & Richards 2914.

Fig. 13. Dawson 357a.

Figs. 14-15. Antheridial and oogonial "inflorescences" from a single plant, but sexes not mixed in receptacles.



PLATE 33

Sargassum Johnstonii and form *gracile*, variation in leaves, vesicles,
and "inflorescences," x 3.75.

- Figs. 1-2. Dawson 355.
Figs. 3-5. Form *gracile*, Dawson 340.
Figs. 6-8. Form *gracile*, Marchant 28.
Figs. 9-13. Form *gracile*, Dawson 63.
Figs. 14-16. Form *gracile*, Marchant 28a.
Figs. 17-19. Dawson 476.
Figs. 20-22. Immature, Dawson 314a.



PLATE 34

Sargassum lapazeanum, variation in leaves, vesicles, and "inflorescences," x 3.75.

- Figs. 1-8. Johnston 11.
Figs. 9-14. Johnston 10.
Figs. 15-18. Bryant 5.
Figs. 19-25. Marchant 24.
Figs. 26-30. Johnston 20.
Figs. 31-34. Marchant 21.



PLATE 35

- Figs. 1-6. *Sargassum MacDougalii*, Drouet & Richards 3342, showing variation in leaves and vesicles, x 3.75.
- Figs. 7-8. *Sargassum MacDougalii*, MacDougal, Dec. 1923, two leaf-types, x 3.75.
- Fig. 9. *Sargassum Camouii*, Johnston's specimen from near Guaymas, detail of basal holdfast disk, x 1.25.
- Fig. 10. *Sargassum sinicola*, Marchant 31, basal holdfast of small disk and short, massed rhizoids, x 1.25.
- Figs. 11-13. *Sargassum Camouii*, Durham's specimen from near Guaymas, showing typical leaf and vesicle form, x 2.

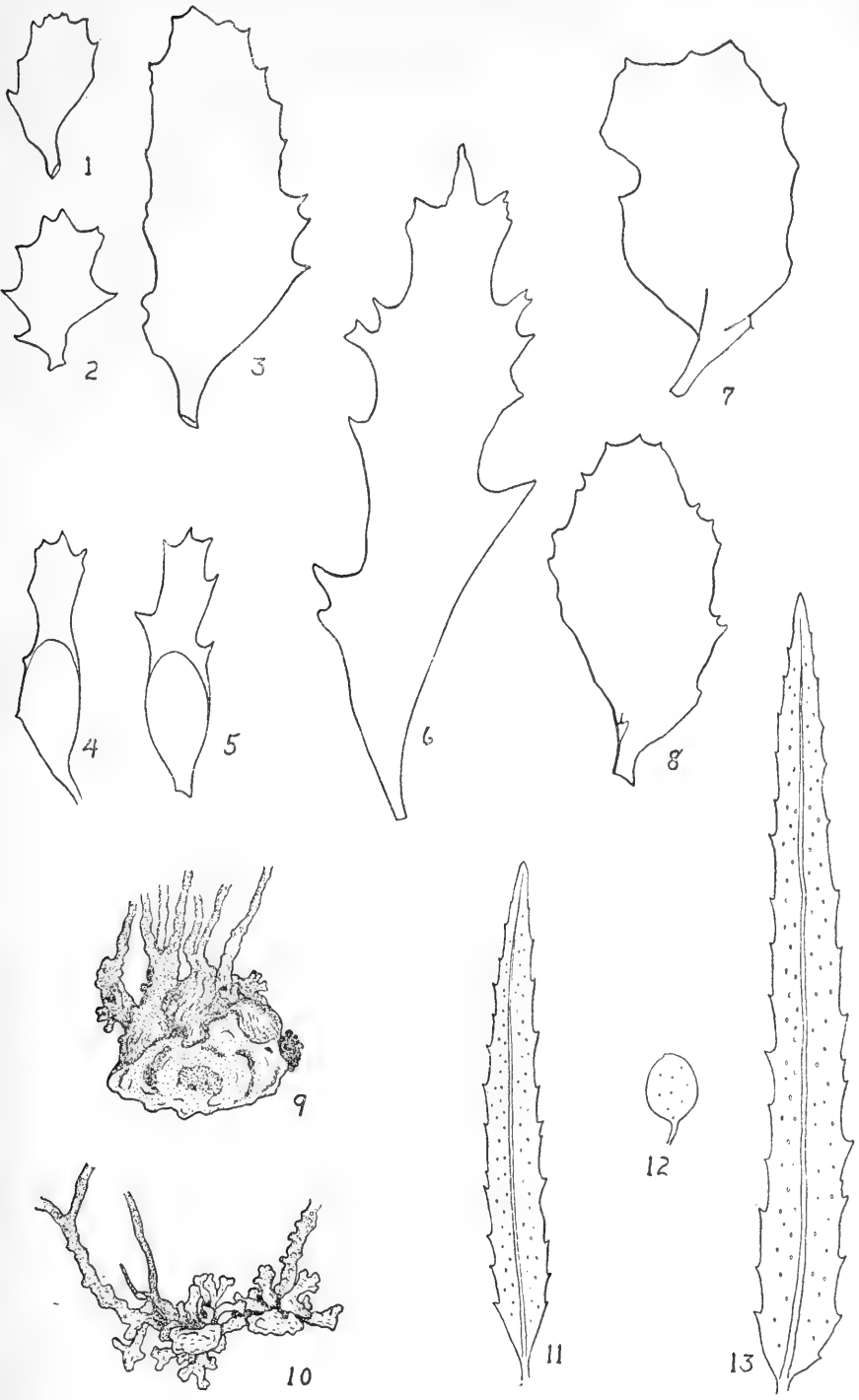

PLATE 36

Variation in leaves, vesicles, and "inflorescences," x 3.75.

Figs. 1-5. *Sargassum MacDougalii*, Drouet & Richards 3311.

Figs. 6-7. *Sargassum MacDougalii*, Drouet & Richards 3287.

Figs. 8-12. *Sargassum asymmetricum*, Dawson 221 (immature).

Figs. 13-18. *Sargassum asymmetricum*, Dawson 156.

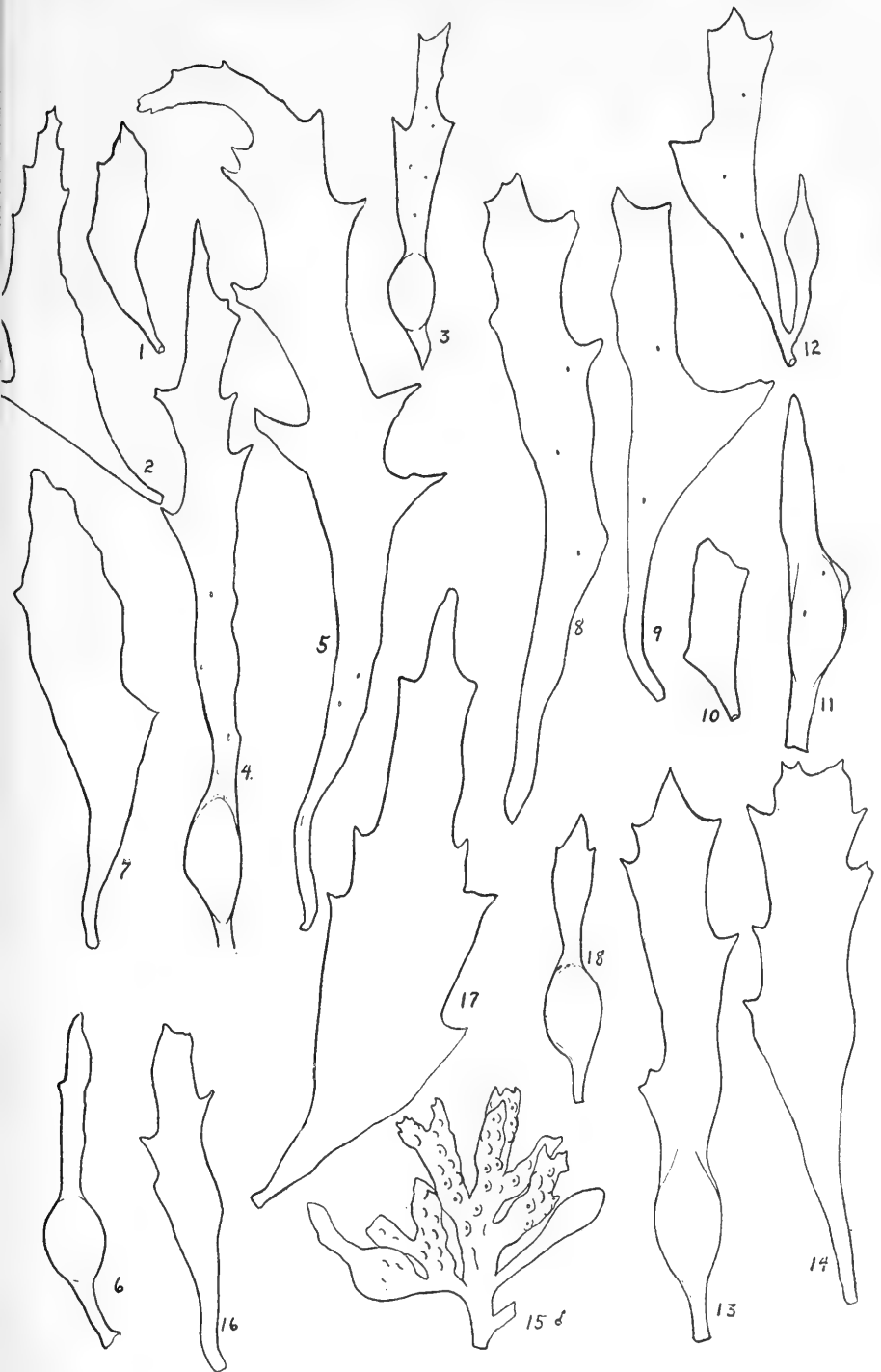

PLATE 37

Variation in leaves, vesicles, and "inflorescences," x 3.75.

- Figs. 1-7. *Sargassum acinacifolium*, Marchant 19.
Figs. 8-16. *Sargassum acinacifolium*, Johnston 75.
Figs. 17-26. *Sargassum acinacifolium*, Brandegee 2.
Figs. 27-30. *Sargassum MacDougalii*, Dawson 383 (immature).

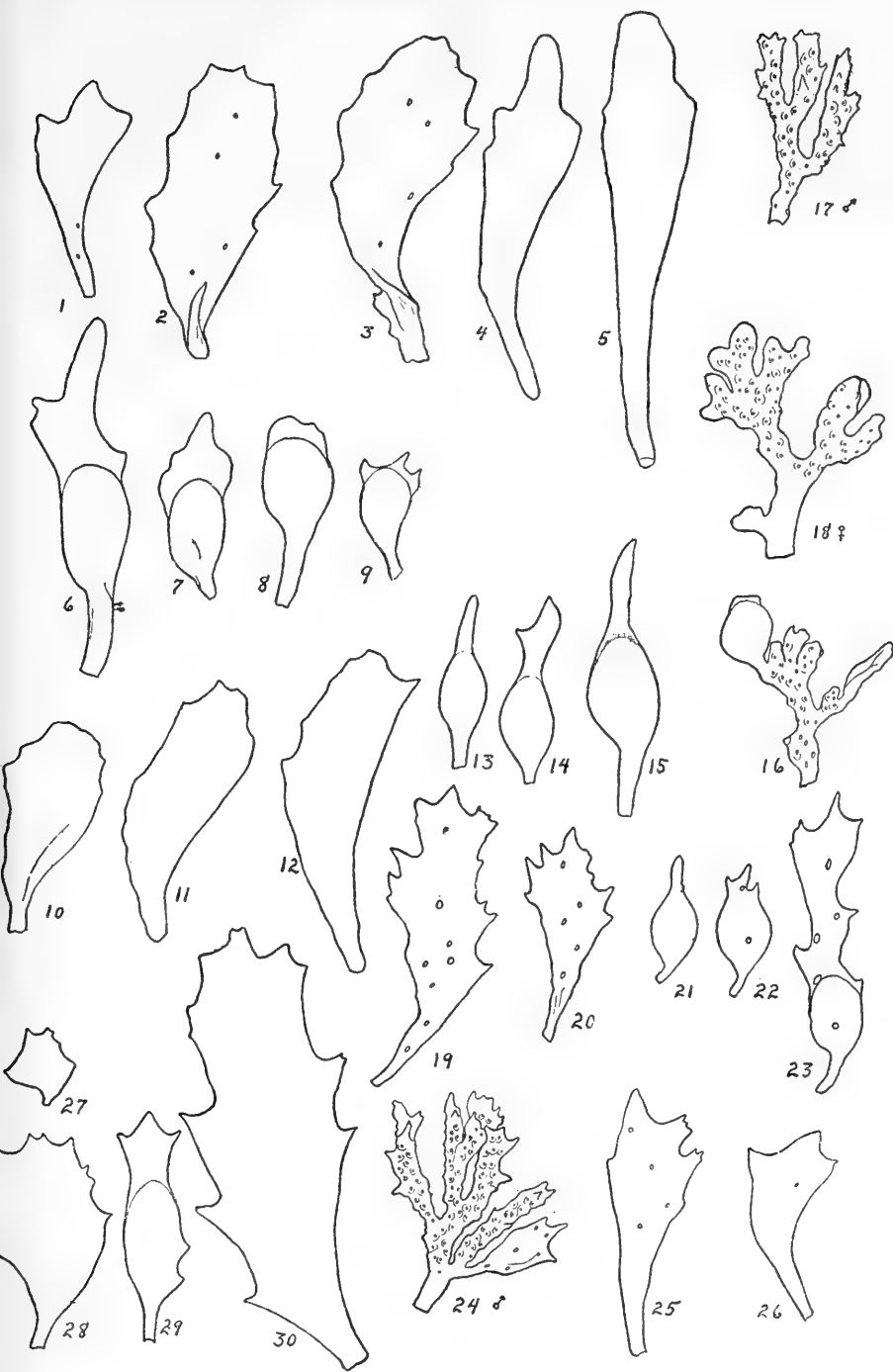

PLATE 38

Variation in leaves, vesicles, and "inflorescences," x 2.12.

- Fig. 1. *Sargassum horridum*, Marchant 22.
Figs. 2-4. *Sargassum horridum*, Marchant 17.
Figs. 5-6. *Sargassum sinicola*, Marchant 27
Figs. 7-9. *Sargassum sinicola*, Brandegee 27.
Figs. 10-11. *Sargassum sinicola*, Drouet & Richards 3141.



PLATE 39

Sargassum sinicola, variation in leaves, vesicles, and "inflorescences,"
x 2.12.

- Figs. 1-2. Marchant 11, oogonial.
Fig. 3. Marchant 20, oogonial tips.
Figs. 4-5. Dawson 357, oogonial.
Figs. 6-7. Dawson 357x, intersex.
Figs. 8-11. Variations in receptacles of several plants.

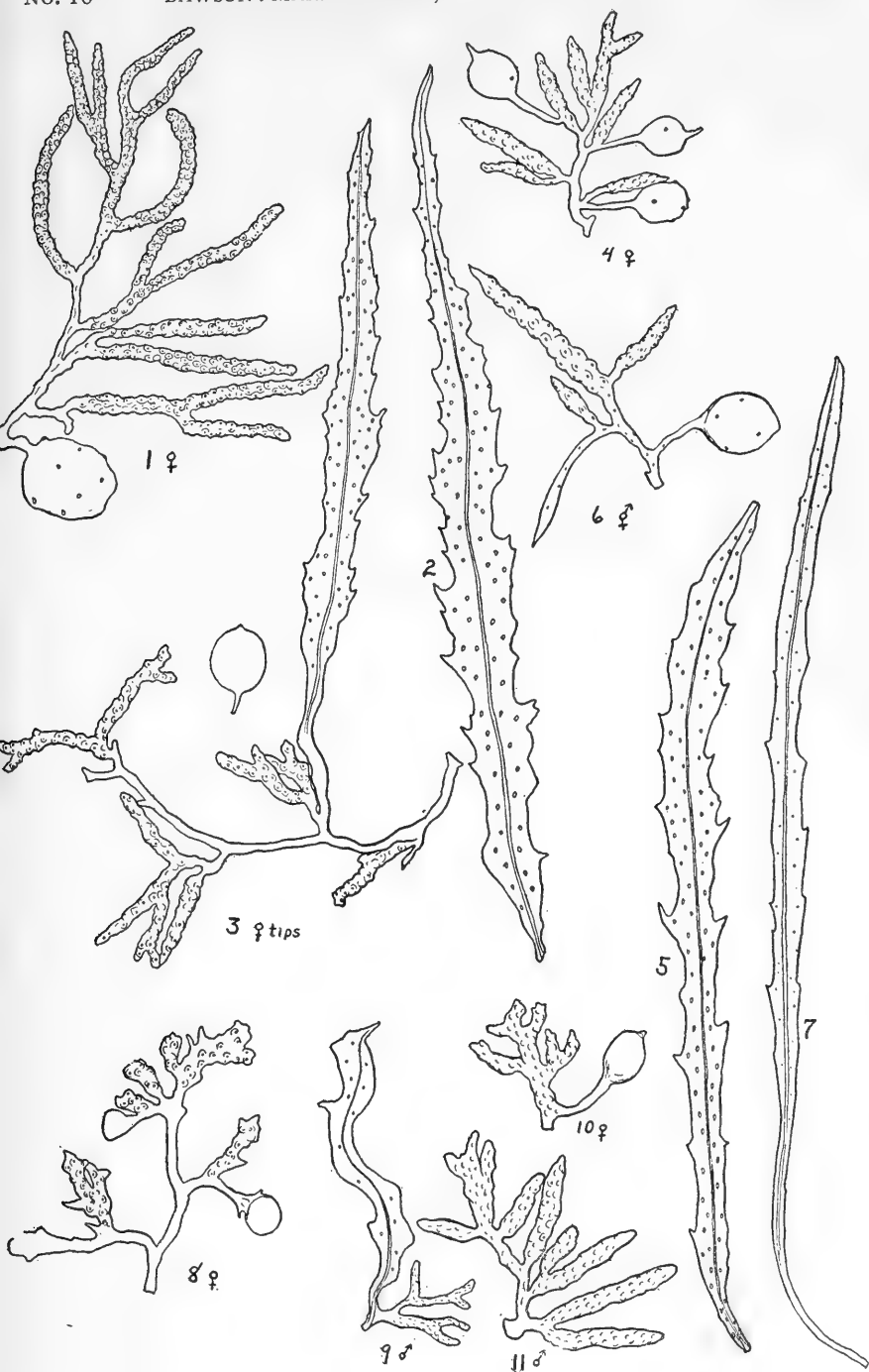

PLATE 40

Variation in leaves, vesicles, and "inflorescences," x 2.12.

- Figs. 1-7. *Sargassum herporhizum*, Johnston 72.
Figs. 8-12. *Sargassum herporhizum*, Johnston 55.
Figs. 13-19. *Sargassum Brandegeei*, Dawson 462.
Figs. 20-21. *Sargassum Brandegeei*, Dawson 141.
Figs. 22a-22b. *Sargassum Brandegeei*, Dawson 157.
Figs. 23-25. *Sargassum Brandegeei*, MacDougal, Dec. 1923.
Fig. 26. *Sargassum Brandegeei*, Dawson 383.

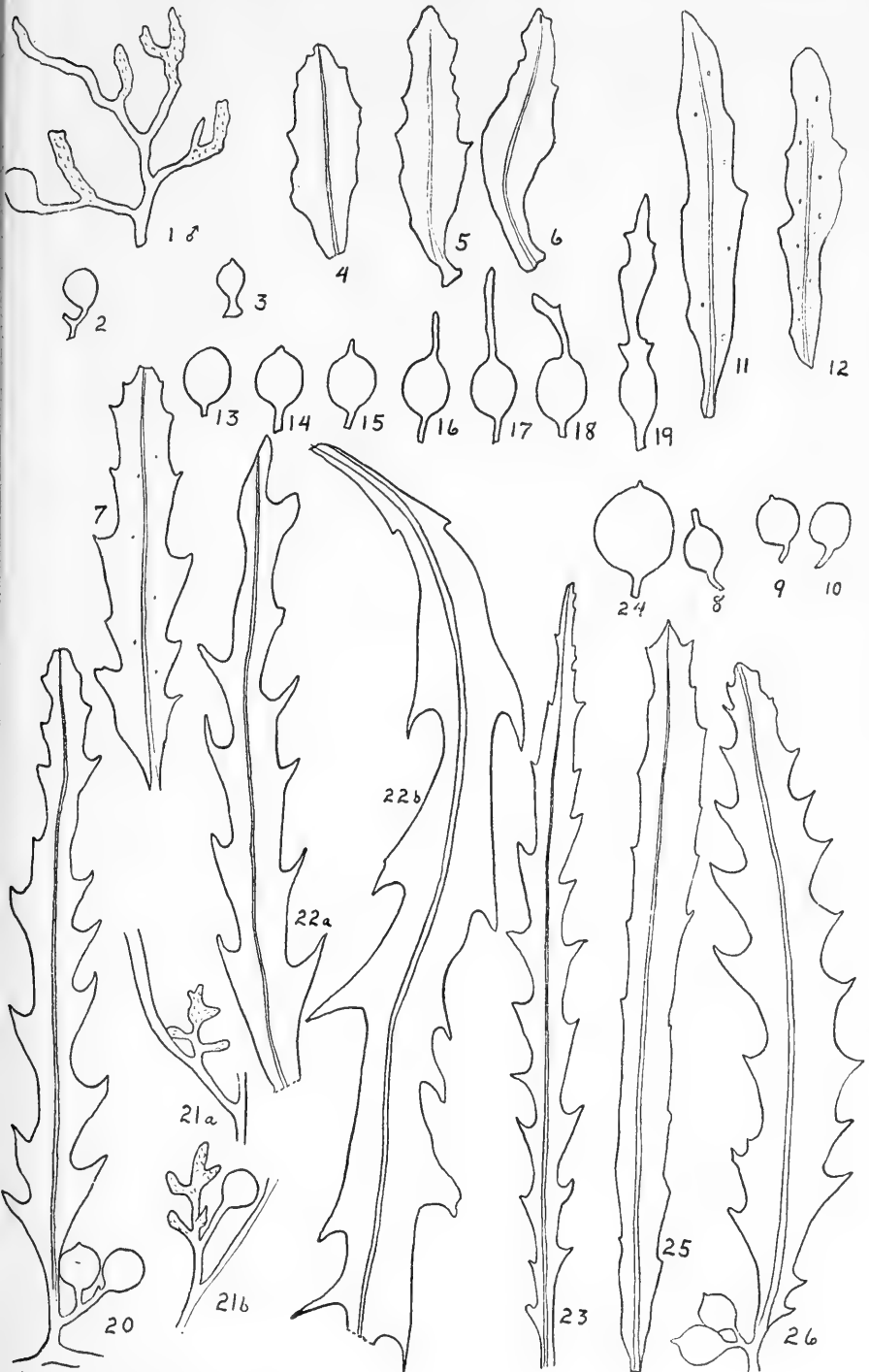

PLATE 41

- Fig. 1. *Rhodochorton sinicola*, habit, showing enlarged basal cell and method of attachment to host, x 175.
- Fig. 2. *Rhodochorton sinicola*, portion of a branch bearing a monosporangium, x 400.
- Fig. 3. *Rhodochorton microscopicum*, habit on *Polysiphonia*.
- Fig. 4. *Rhodochorton Hancockii*, habit, x 90.
- Fig. 5. *Rhodochorton Hancockii*, portion of a filament bearing monosporangia, x 500.
- Fig. 6. *Rhodochorton Hancockii*, basal part of a filament showing simple attachment to host cells, x 500.

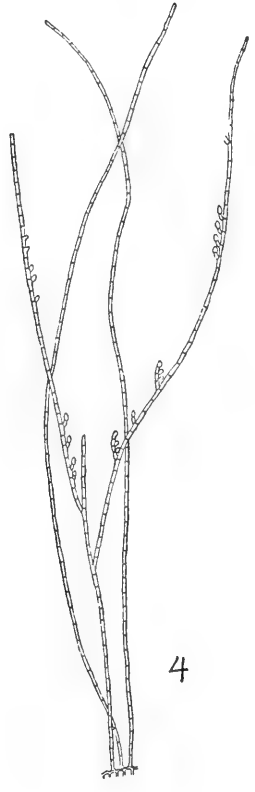
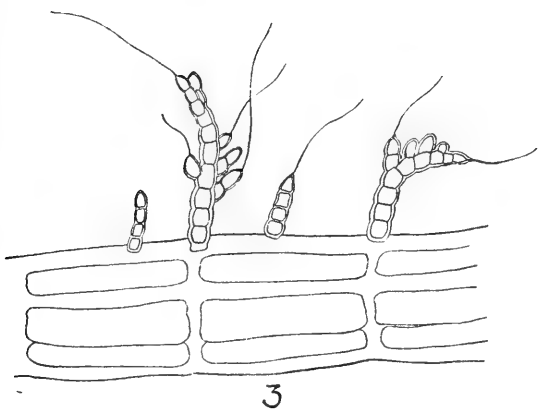
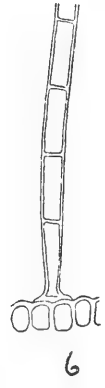
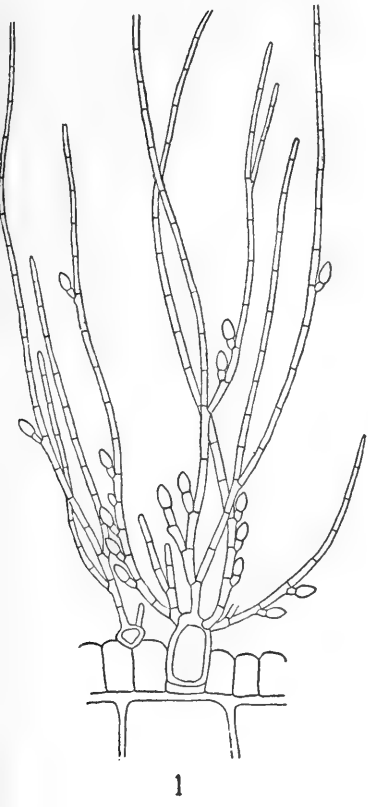

PLATE 42

Gelidium pusillum, variations in habit, x 7.

- Fig. 1. A specimen from Costa Rica collected by Dodge.
- Fig. 2. A smaller form from Costa Rica, Howell 779a.
- Fig. 3. A Gulf of California form, Drouet & Richards 3299 from Guaymas.
- Fig. 4. A depauperate form from Clarion Island, Howell 569b.
- Fig. 5. A broad-bladed form from Clarion Island, Howell 211.
- Fig. 6. The same form from the Galapagos Archipelago, Howell 297.

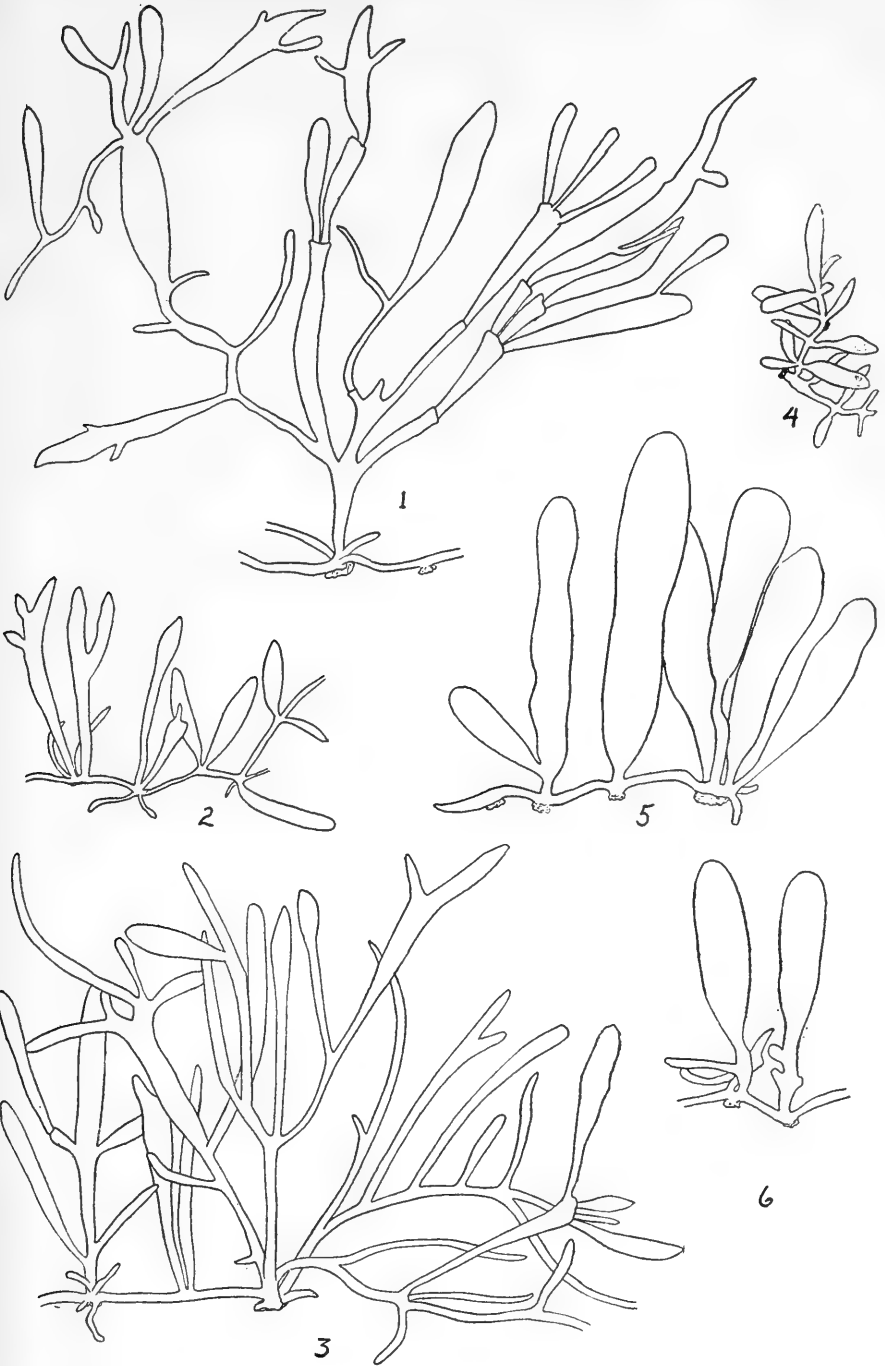

PLATE 43

- Fig. 1. *Gelidiella Hancockii*, habit of cotype specimen, x 5.
- Fig. 2. *Gelidiella Hancockii*, a tetrasporic branchlet, x 35.
- Fig. 3. *Gelidiella mexicana*, habit of type specimen, x 7.5.
- Fig. 4. *Gelidiella* ? *refugiensis*, habit of part of type material, x 6.5.
- Fig. 5. *Gelidiella* ? *refugiensis*, tip of sporangial branch showing openings through cortex, x 50.
- Fig. 6. *Gelidiella* ? *refugiensis*, a single monospore as shed, x 800.

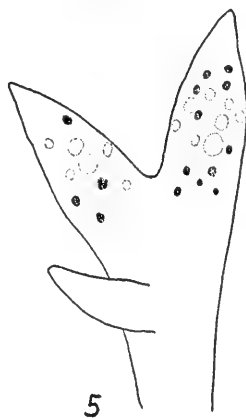
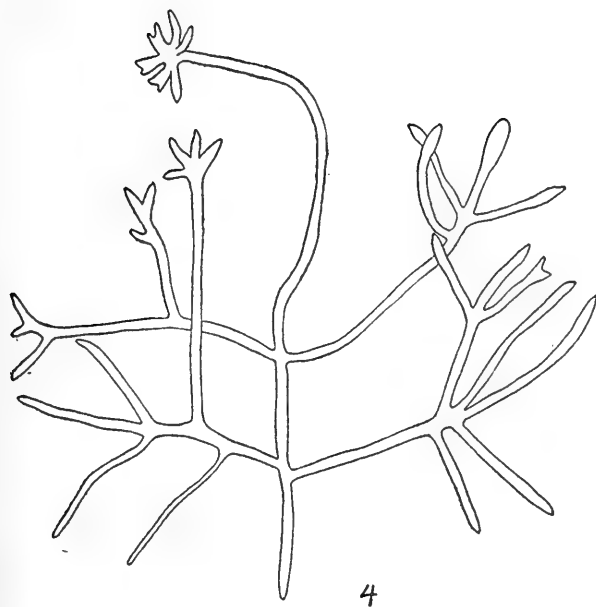
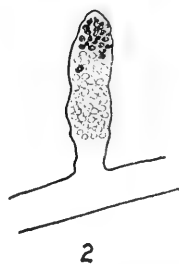
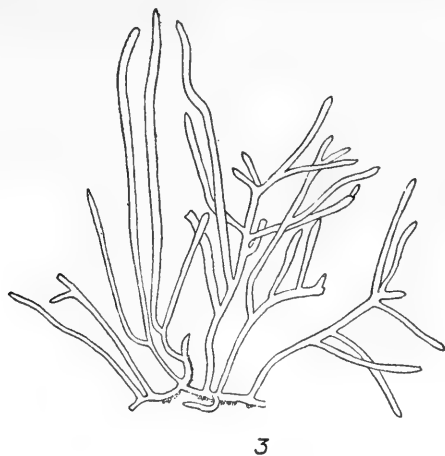

PLATE 44

- Fig. 1. *Gracilaria* sp., Dawson 200, habit, x 1.
Fig. 2. *Halymenia* ? *refugiensis*, habit of the type, x 1.
Fig. 3. *Halymenia* ? *refugiensis*, cross section of frond, x 250.
Fig. 4. *Callophyllis* sp., Dawson 198, habit, x 1.

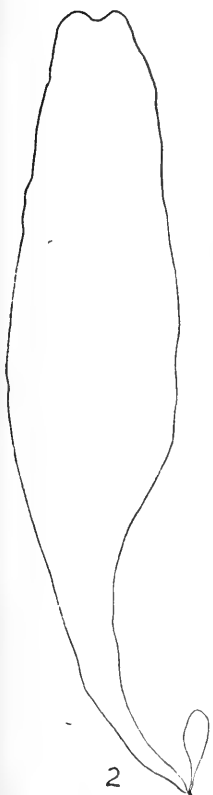
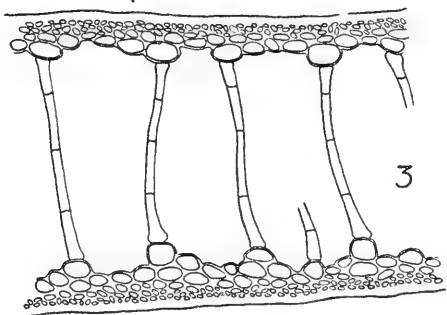
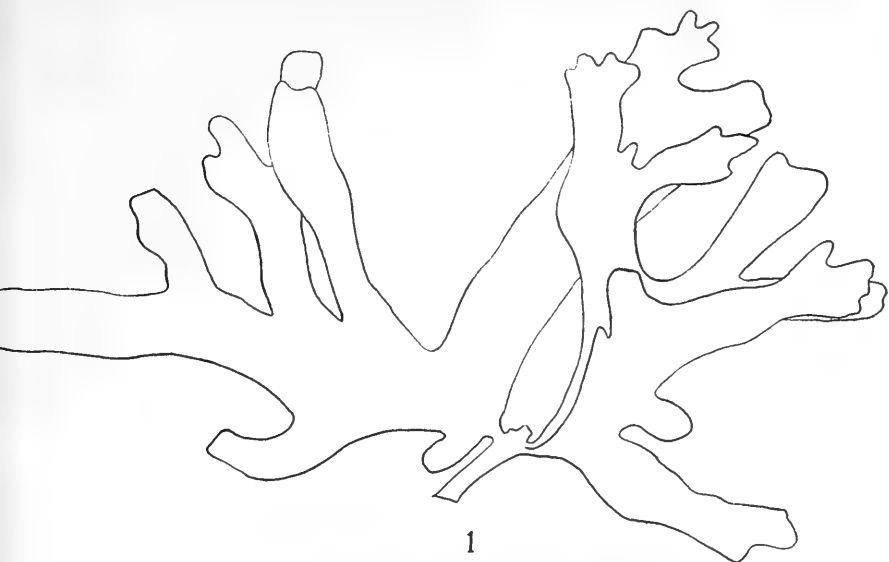

PLATE 45

- Fig. 1. *Callymenia veleroae*, habit of the type, x 4.
- Fig. 2. *Botryocladia Hancockii*, habit of the type, x 3.
- Fig. 3. *Botryocladia Hancockii*, superficial view of a cystocarp, x 11.
- Fig. 4. *Botryocladia Hancockii*, surface view of the vesicle wall showing the position of the three layers of cells, x 175.
- Fig. 5. *Botryocladia Hancockii*, a single large inner cell from the vesicle wall bearing gland cells, x 350.
- Fig. 6. *Botryocladia pseudodichotoma*, a group of gland cells, x 175.
- Fig. 7. *Botryocladia pseudodichotoma* var. *datilensis*, a group of gland cells, x 260.
- Fig. 8. *Botryocladia uvarioides*, a group of gland cells, x 425.
- Fig. 9. *Botryocladia uvarioides*, solitary gland cells, x 425.
- Fig. 10. *Botryocladia uvarioides*, gland cells borne on peculiar stellate bases, x 650.

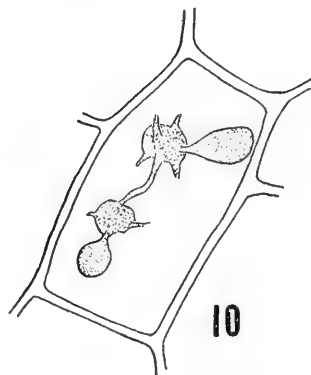
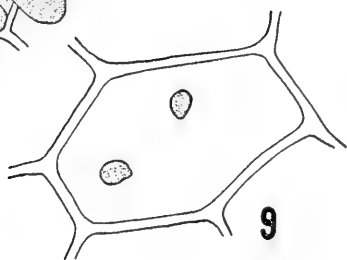
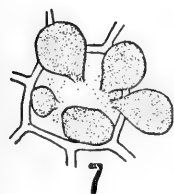
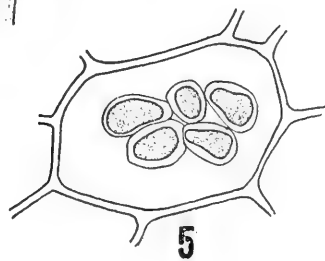
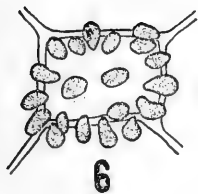
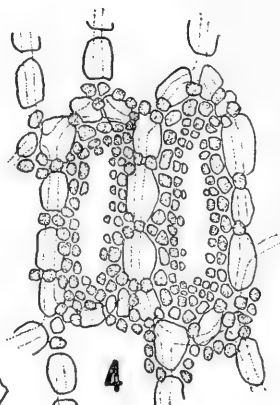
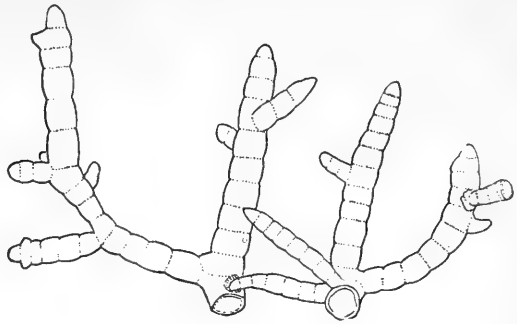
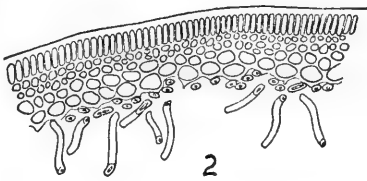

PLATE 46

- Fig. 1. *Lomentaria Drouetii*, terminal portion of a frond, x 4.
- Fig. 2. *Lomentaria Drouetii*, cross section of a portion of hollow frond, showing palisade cortex and the inner fibers, some of which are somewhat displaced, x 225.
- Fig. 3. *Champia caespitosa*, habit of portion of the type, x 7.
- Fig. 4. *Champia caespitosa*, cross section of hollow frond, x 42.5.
- Fig. 5. *Champia disticha*, habit of complete, individual plant from the type collection, x 7.5.
- Fig. 6. *Gastroclonium clavatum*, cross section of a portion of the wall of a Mediterranean plant, x 92.
- Fig. 7. *Gastroclonium clavatum*, cross section of a portion of the wall of Dawson 440, x 92.
- Fig. 8. The same of Dawson 68, x 92.



3



2



4

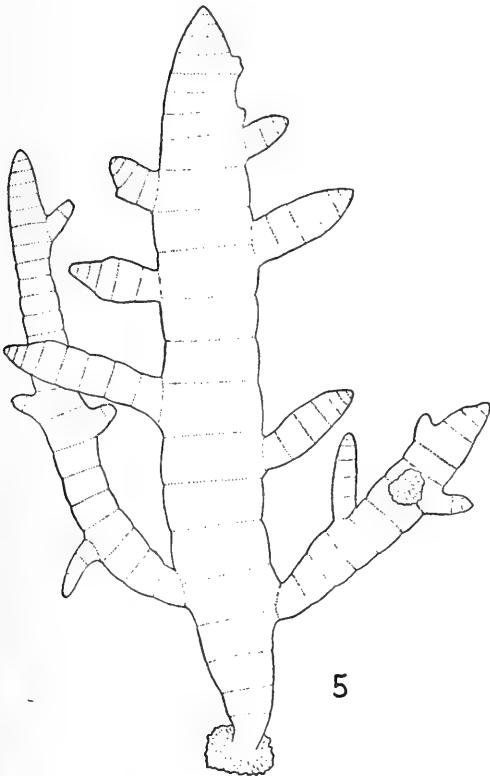

5

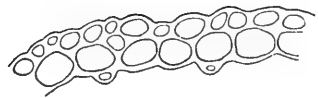

6

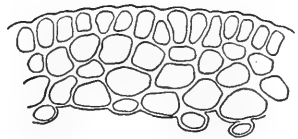

7

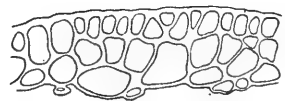

8

PLATE 47

- Fig. 1. *Polyneurella Hancockii*, habit of the type, x 1.
- Fig. 2. *Polyneurella Hancockii*, detail of apical cell, x 450.
- Fig. 3. *Sorella pinnata*, branching habit, x 11.
- Fig. 4. *Sorella pinnata*, detail of frond apex to show apical cell divisions, x 300.
- Fig. 5. *Myriogramme divaricata*, portion of a tetrasporic frond of the type, x 2.
- Fig. 6. *Grinnellia lanceolata*, habit of a specimen of the type collection, x 4.5.

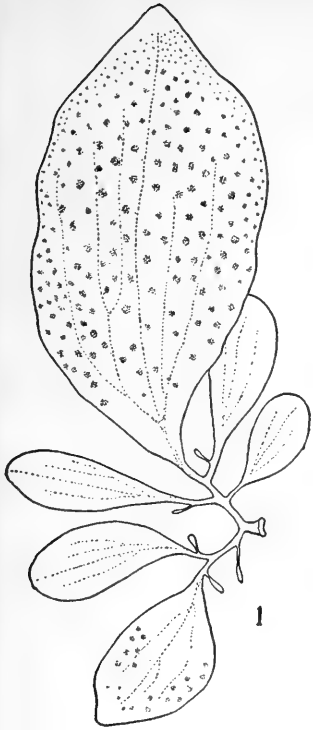

1

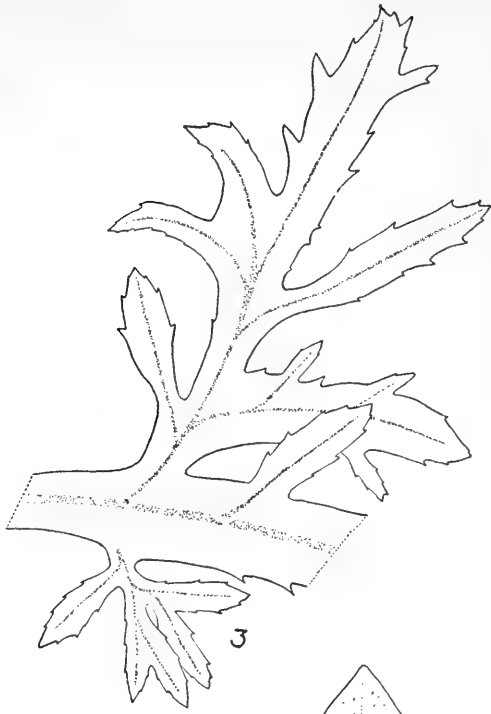

3

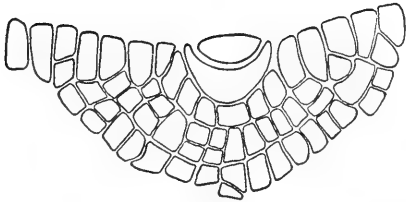

2



5

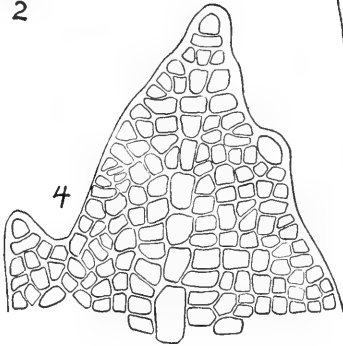

4

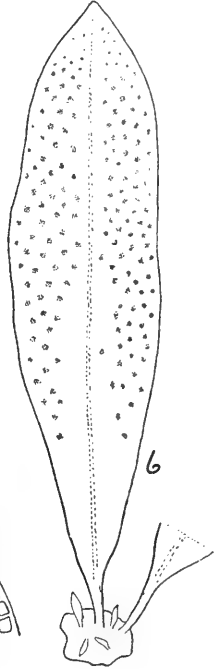

6

PLATE 48

- Fig. 1. *Lophosiphonia willum*, habit of Dawson 737, x 33.
- Fig. 2. *Lophosiphonia willum*, basal portion to show creeping filament and attachment organs, x 57.
- Fig. 3. *Lophosiphonia willum*, a tetrasporic branch with a relatively short row of tetraspores, x 92.
- Fig. 4. *Lophosiphonia willum*, growing point of a young, vigorously growing branch, x 400.
- Fig. 5. *Lophosiphonia willum*, growing point at tip of an old branch with slowing growth, showing typical development of hairs, x 400.
- Fig. 6. *Lophosiphonia willum*, detail of cellular arrangement in median optical view, x 225.
- Fig. 7. *Lophosiphonia mexicana*, detail of base and rhizoidal holdfasts of the type, x 58.
- Fig. 8. *Lophosiphonia mexicana*, detail of growing point, x 400.
- Fig. 9. *Lophosiphonia mexicana*, superficial view of cell structure to show paired appearance, x 175.
- Fig. 10. *Lophosiphonia mexicana*, apical portion of tetrasporic branch from a specimen from Clarion Island, x 250.

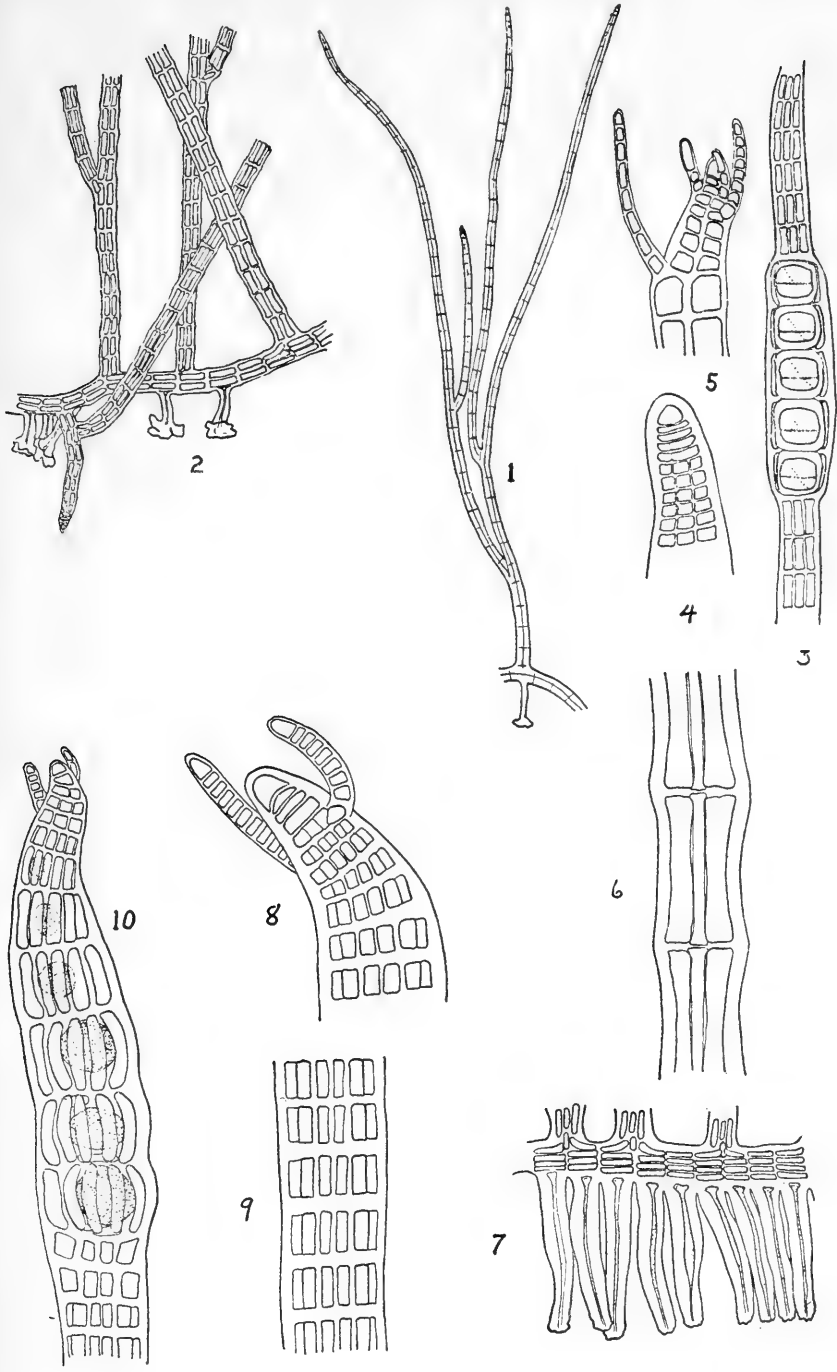
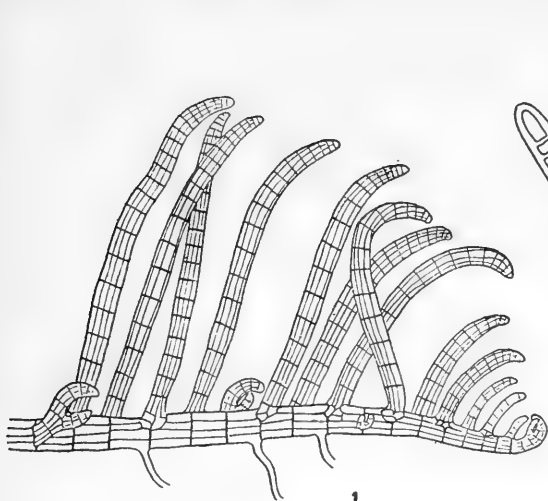

PLATE 49

- Fig. 1. *Herposiphonia tenella*, portion of a main creeping axis to show general branching habit of "langtriebe" and "kurztriebe," x 45.
- Fig. 2. *Herposiphonia subdisticha*, portion of a main axis to show branching habit of "langtriebe" and "kurztriebe," x 93.
- Fig. 3. *Bostrychia radicans*, a tetrasporic lateral branch, x 54.
- Fig. 4. *Bostrychia radicans*, portion of tip of a sterile lateral branch, x 150.



1



4

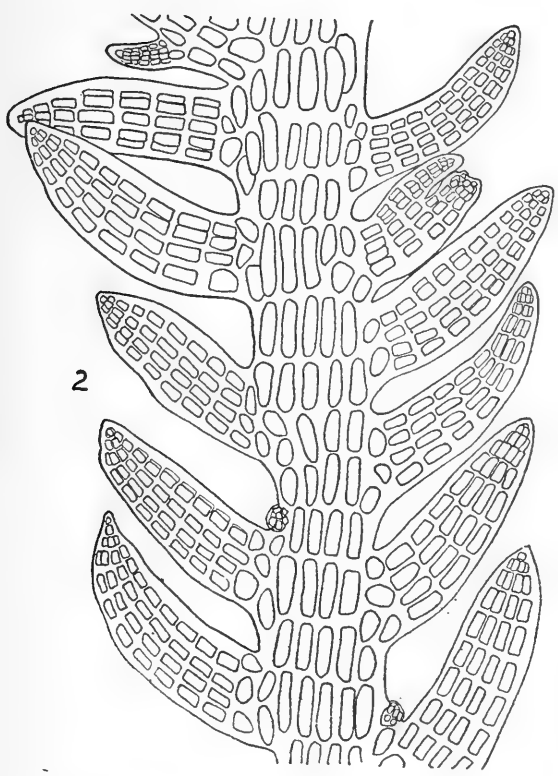

2

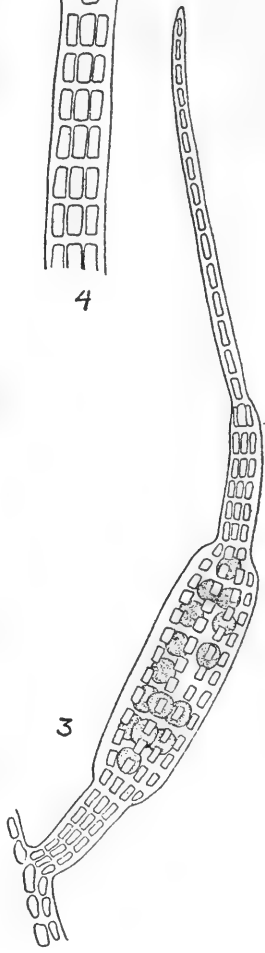

3

PLATE 50

- Fig. 1. *Laurencia Hancockii*, portion of an upper branch of the type, D. 543a, x 11.
- Fig. 2. *Polysiphonia Hancockii*, a single, branched, lateral ramulus of the type, D. 629c, x 108.
- Fig. 3. *Callithamnion veleroae*, habit of a portion of the type, D. 381f, x 45.
- Fig. 4. *Callithamnion veleroae*, portion of an antheridial frond, x 100.
- Fig. 5. *Callithamnion veleroae*, portion of a cystocarpic frond, x 125.

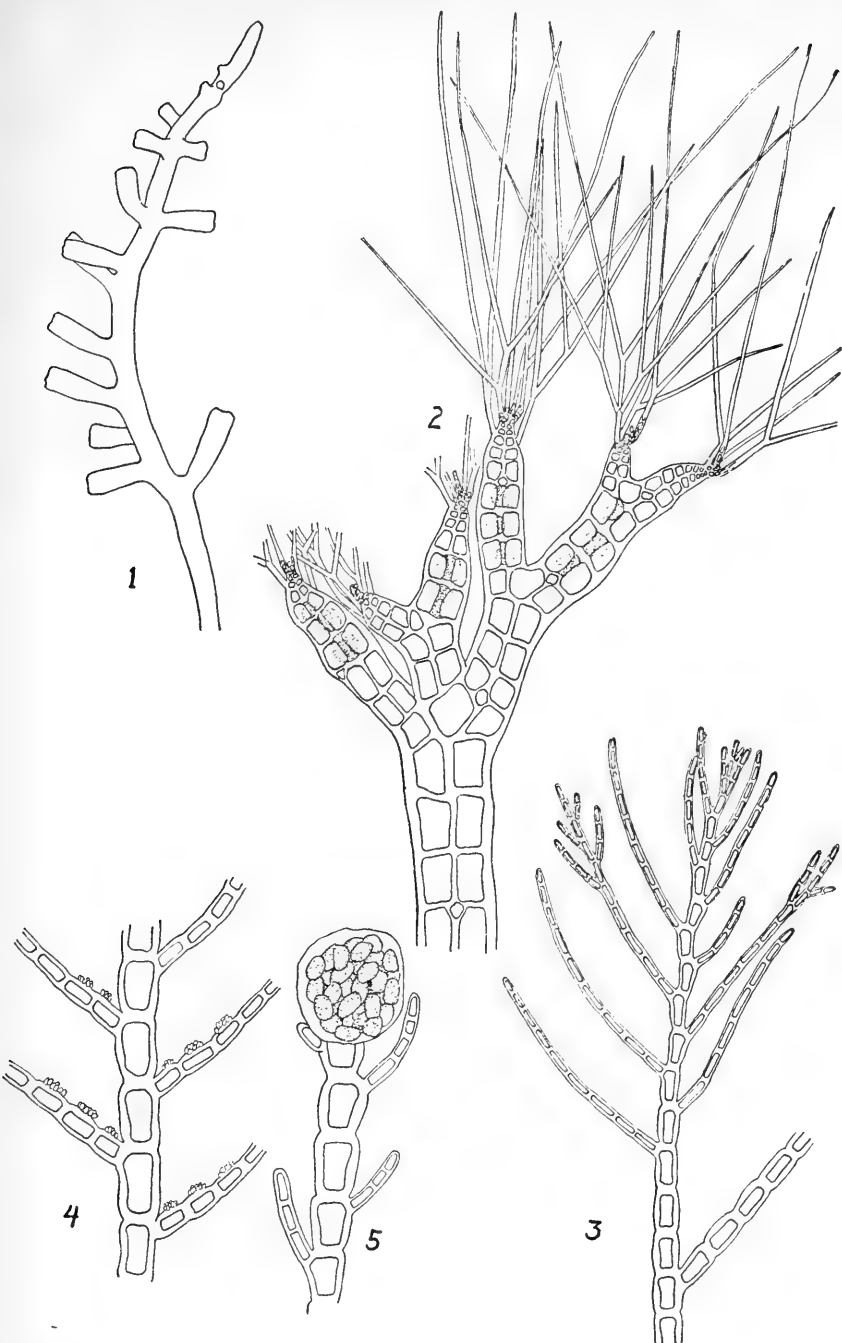

PLATE 51

- Fig. 1. *Ceramium equisetoides*, a short tetrasporangial branch, x 200.
- Fig. 2. *Ceramium Camouii*, tip of a sterile branch of the type, x 300.
- Fig. 3. *Ceramium Camouii*, portion of a tetrasporangial branch showing cortical involucre, x 300.
- Fig. 4. *Ceramium affine*, a branch of a specimen from the type collection bearing tetrasporangia, x 240.

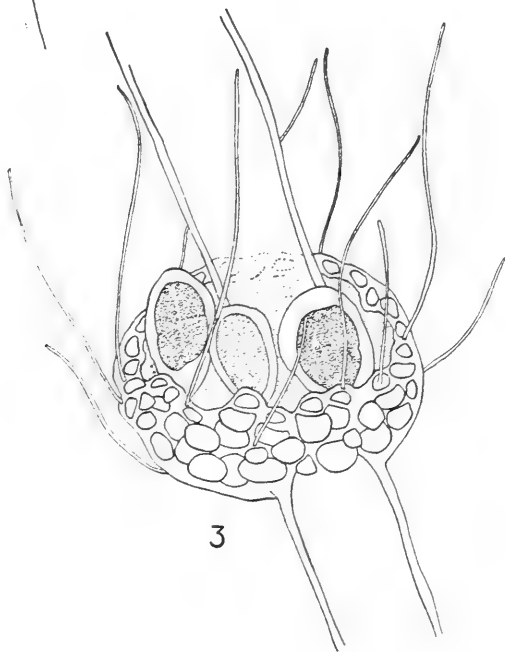
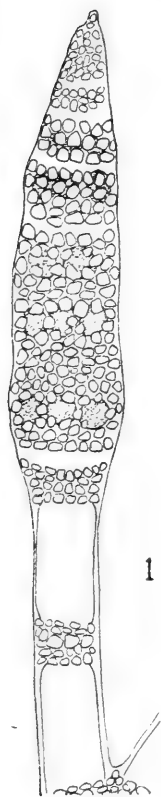
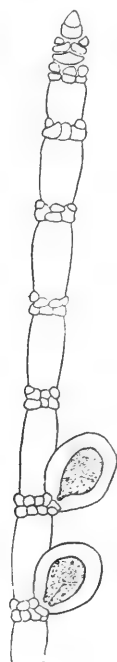
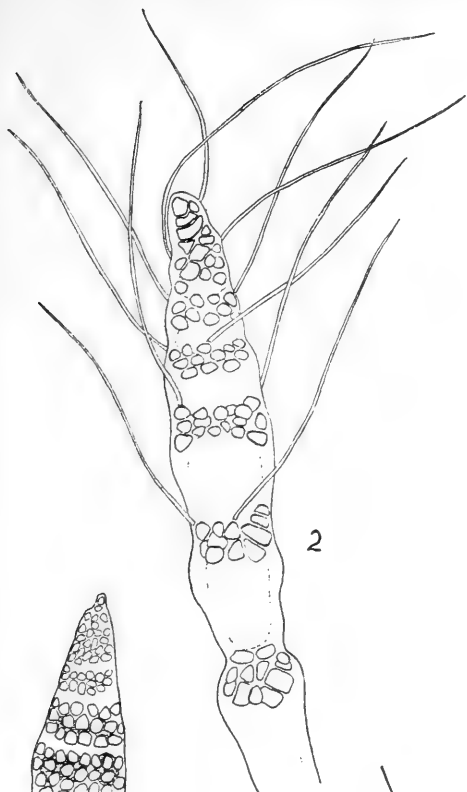
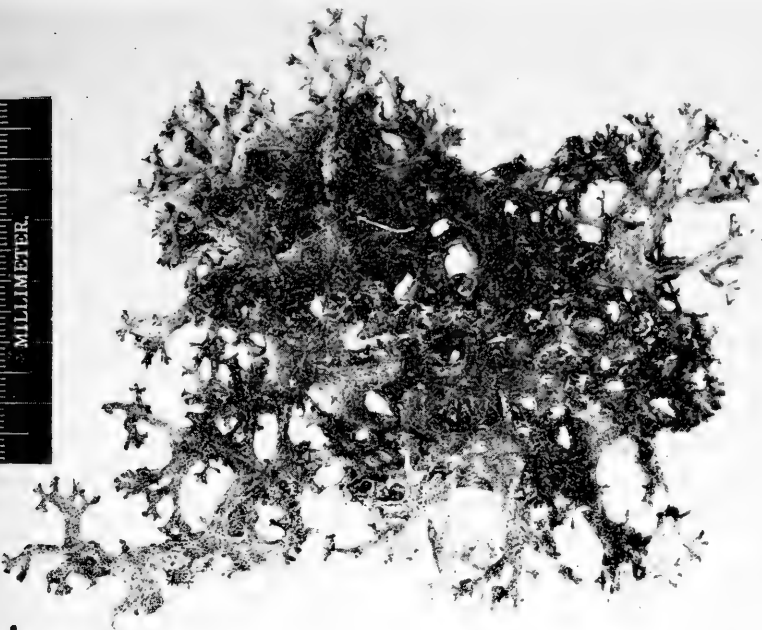

PLATE 52

Fig. 1. *Rosenvingea intricata*, Dawson 306.

Fig. 2. *Padina mexicana*, photograph of several examples of the type collection.



1

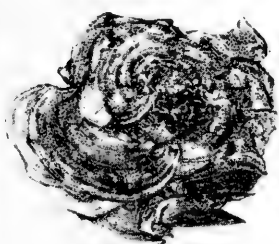

2

PLATE 53

Fig. 1. *Codium MacDougalii*, photograph of the type specimens.

Fig. 2. *Ishige foliacea*, photograph of narrow summer examples above, and broad winter examples below, all from the Gulf.

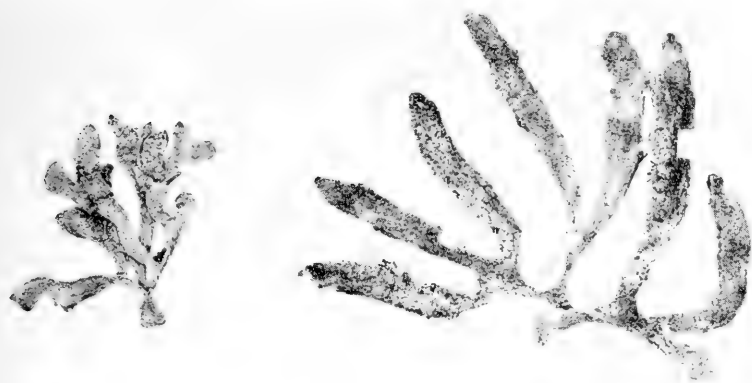

1

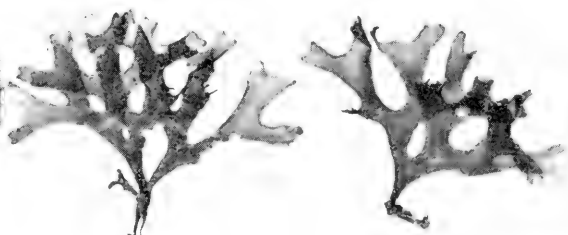
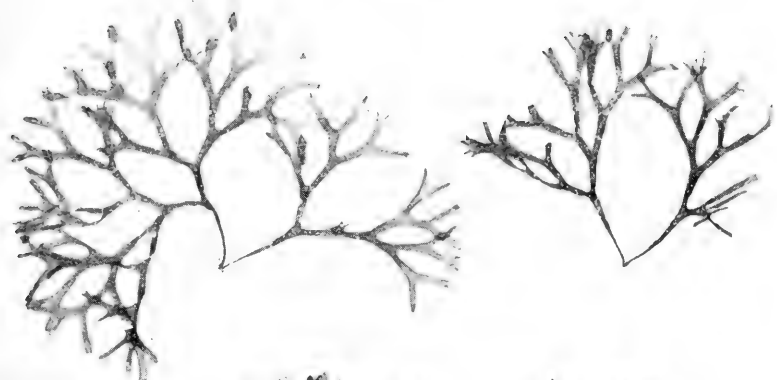

2

PLATE 54

- Fig. 1. *Cutleria Hancockii*, photograph of type specimens, gametophytic, right, and sporophytic, left.
- Fig. 2. *Ralfsia Hancockii*, photomicrograph of a cross section of the type, x 400.



PLATE 55

All Figures $\frac{2}{3}$ Natural Size

- Fig. 1. *Lithophyllum Hancockii*, the type specimen, Dawson, 619a.
Fig. 2. *Lithophyllum* ? *trichotomum*, Dawson 425.
Fig. 3. *Lithophyllum lithophylloides*, Dawson 513.
Fig. 4. *Lithophyllum pallescens*, Dawson 572.
Fig. 5. *Lithophyllum xeleroae* form, old, weathered specimen, Dawson 593.

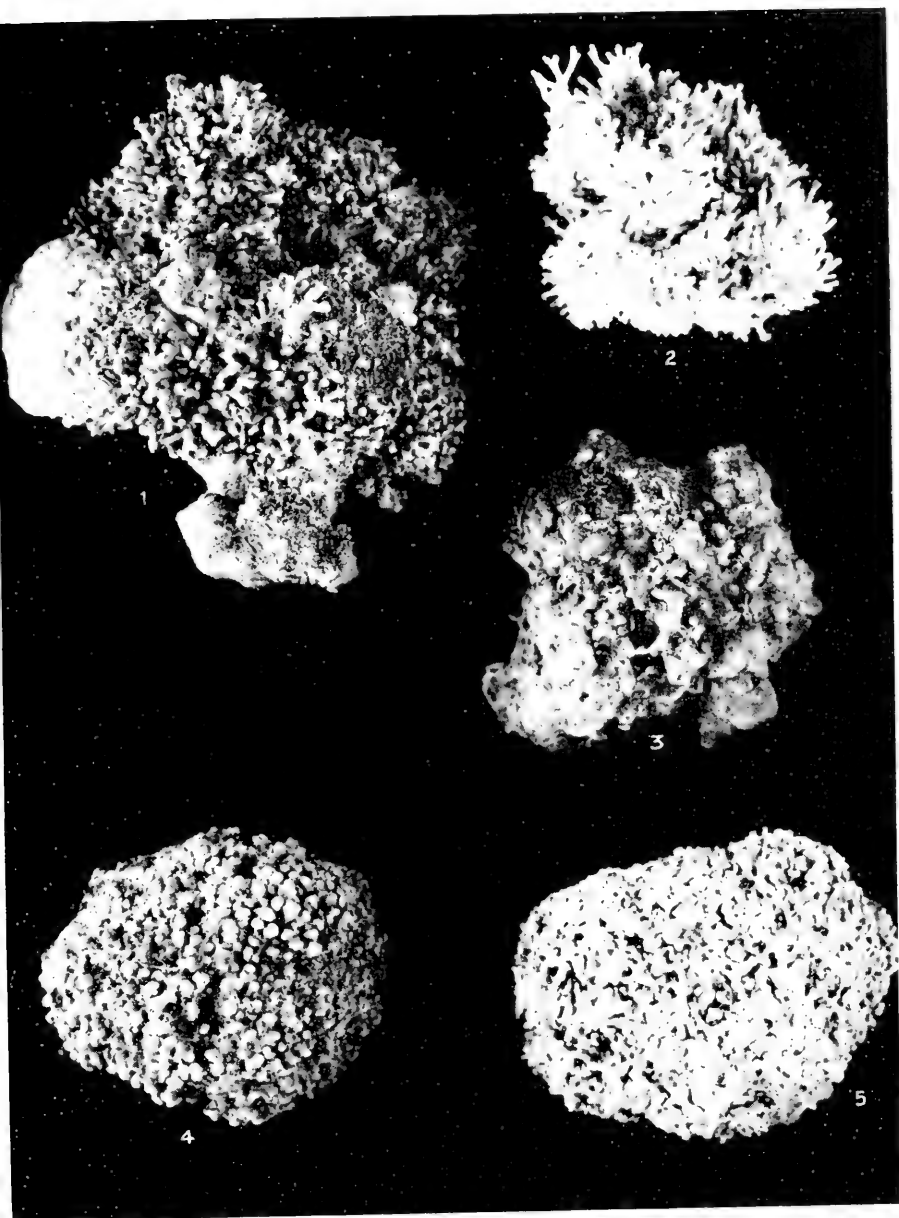

PLATE 56

All Figures Natural Size

- Figs. 1-4. *Lithophyllum veleroae*, Dawson 592.
Figs. 5-8. *Lithothamnion australe* f. *americana*, Dawson 61.
Figs. 9-10. *Lithothamnion australe*, various forms all occurring in
the same collection, Dawson 593a.

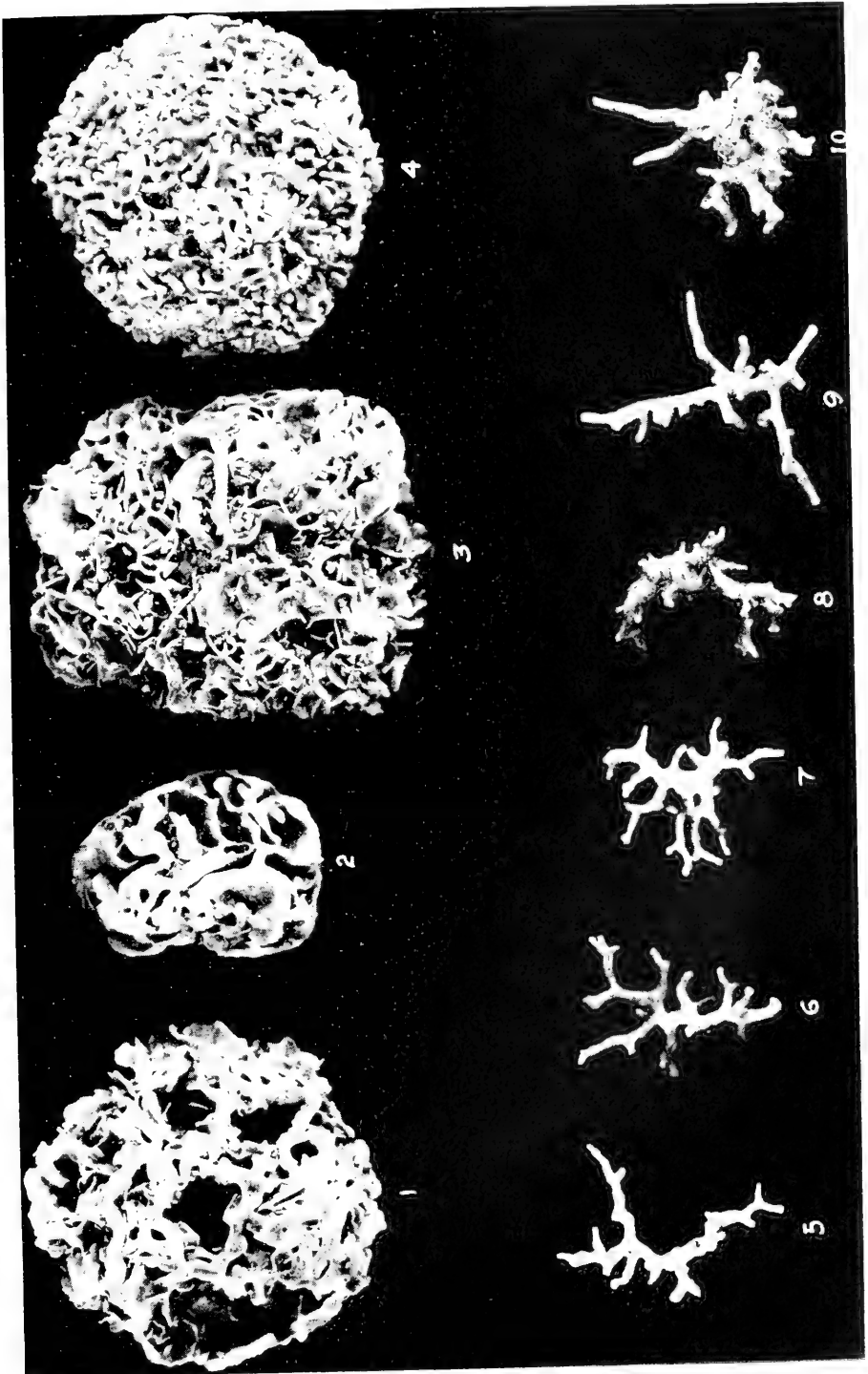

PLATE 57

All Figures Natural Size

- Figs. 11-16 *Lithothamnion australe*, various forms all occurring in
the same collection, Dawson 593a.
- Figs. 17-18. *Porolithon sonorensis*, sterile examples, Dawson 226a.
- Fig. 19. *Porolithon sonorensis*, tetrasporic example, Dawson 465.
- Fig. 20. *Lithophyllum decipiens*, Dawson 479.

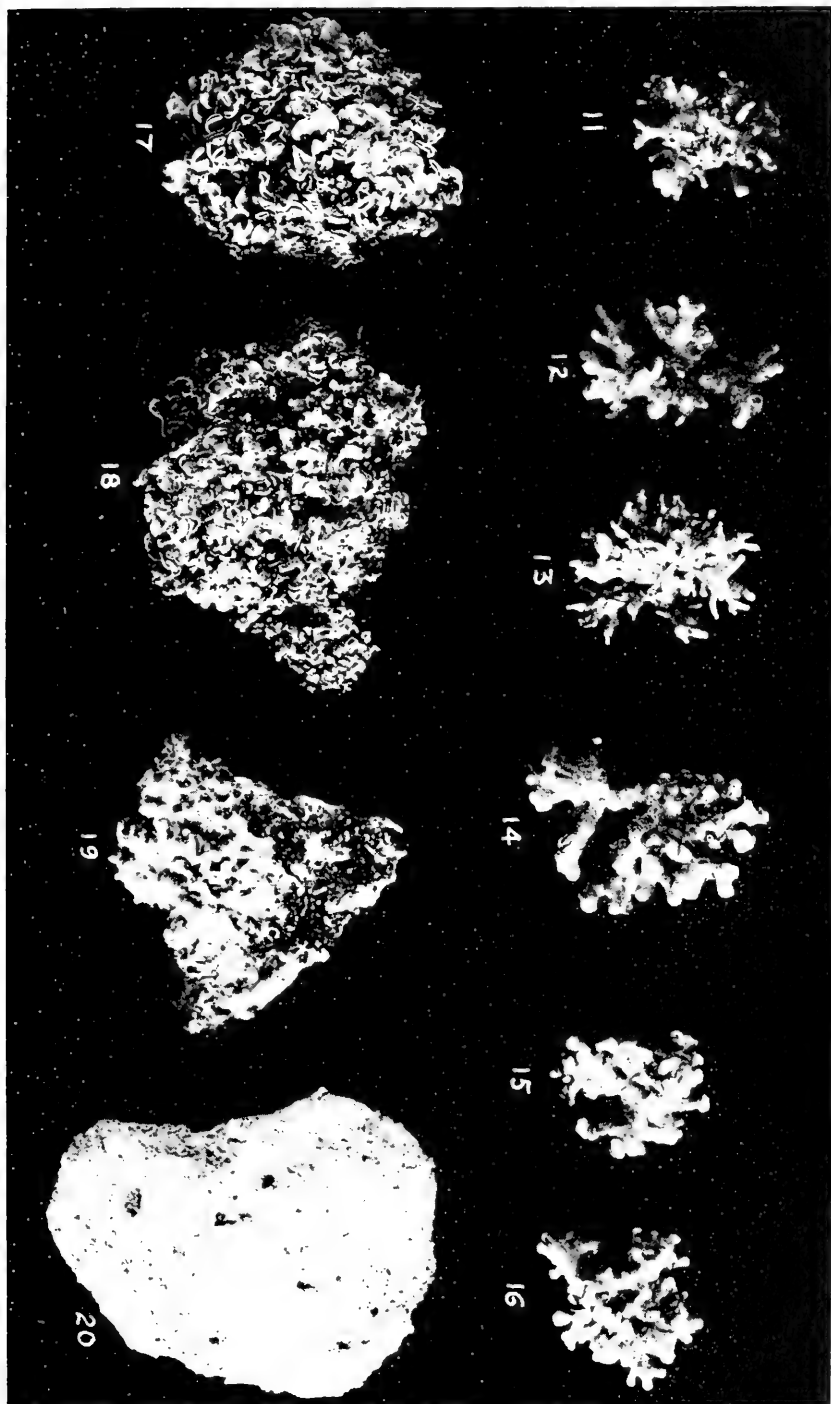

PLATE 58

All Figures Natural Size

- Fig. 1. *Lithophyllum ? trichotomum*, an example of the type collection.
- Fig. 2. *Lithophyllum lithophylloides*, an example of the type collection called by Heydrich form *bracchiata*.
- Fig. 3. *Lithophyllum lithophylloides*, an example of the type collection called by Heydrich form *phylloides*.
- Fig. 4. *Lithophyllum ? trichotomum*, Dawson 619.
- Figs. 5-6. *Lithophyllum ? trichotomum*, Dawson 226.
- Fig. 7. *Lithophyllum lithophylloides* forms, Dawson 250.

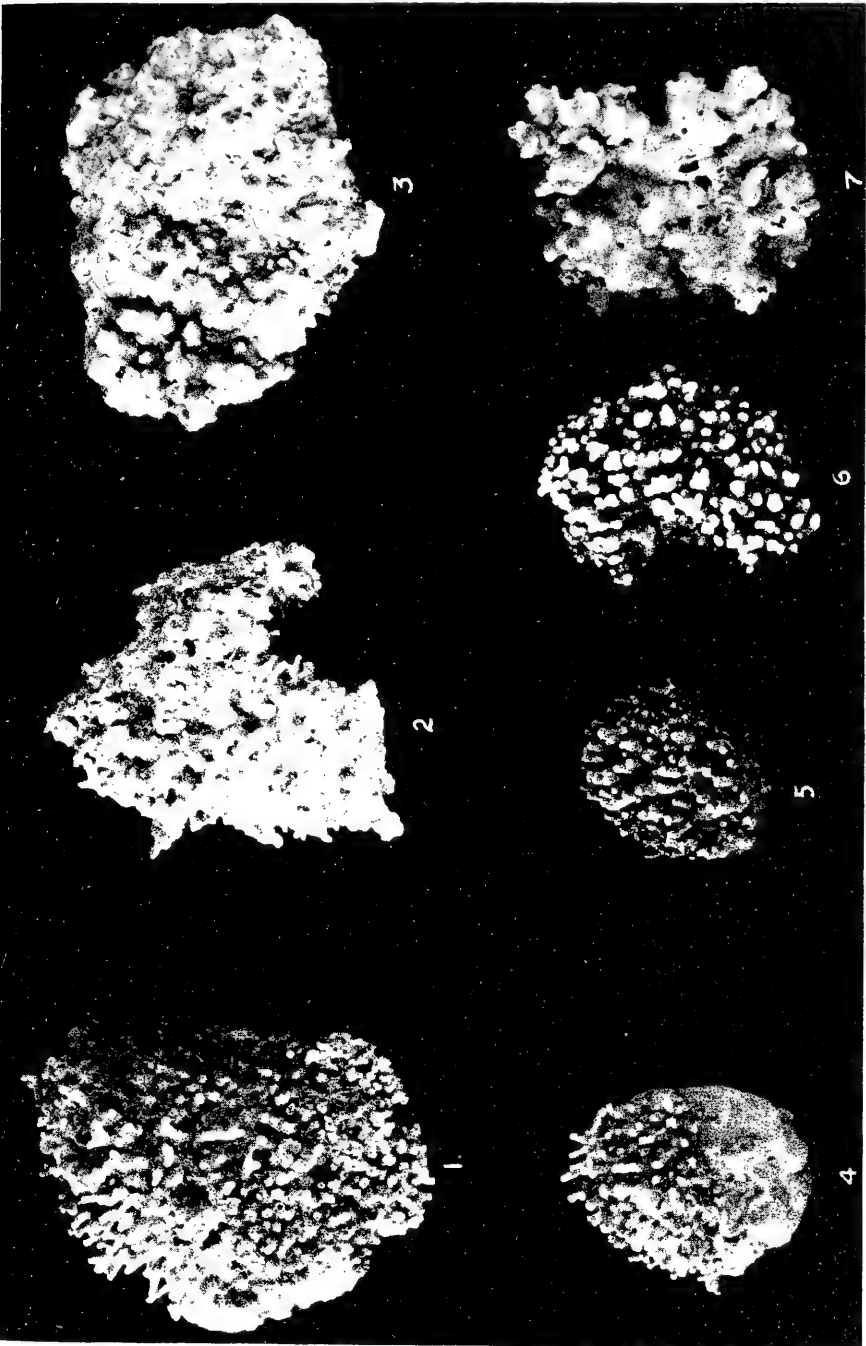
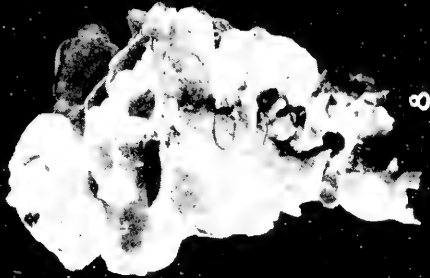

PLATE 59

All Figures Natural Size

- Figs. 8, 11-15. *Lithophyllum Digueti*, Dawson 591.
Fig. 9. *Lithophyllum lithophylloides*, Dawson 278.
Fig. 10. *Lithophyllum lithophylloides* forms, Dawson 250.
Fig. 16. *Lithophyllum Digueti*, an example from the type collection.



8

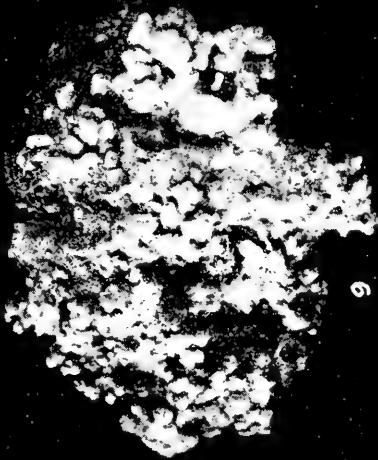

9



10



11



12



13

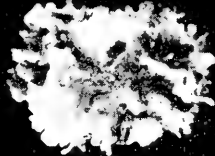

14

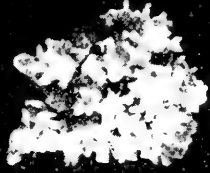

15

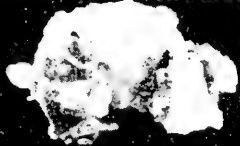

16

PLATE 60

Lithophyllum ? trichotomum, photomicrograph of a longitudinal section of an old, fertile branch, showing large empty conceptacles, Dawson 226, x 70.

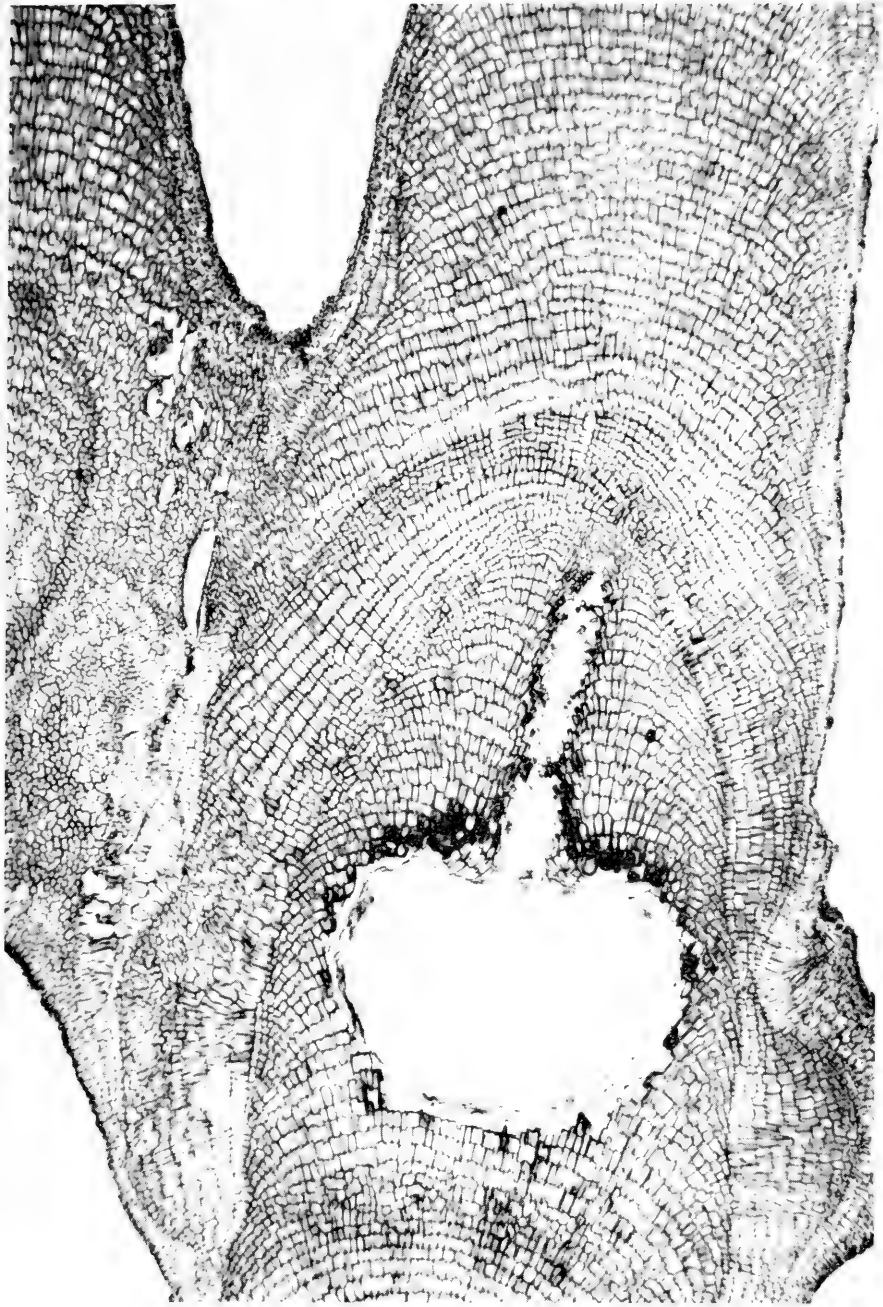
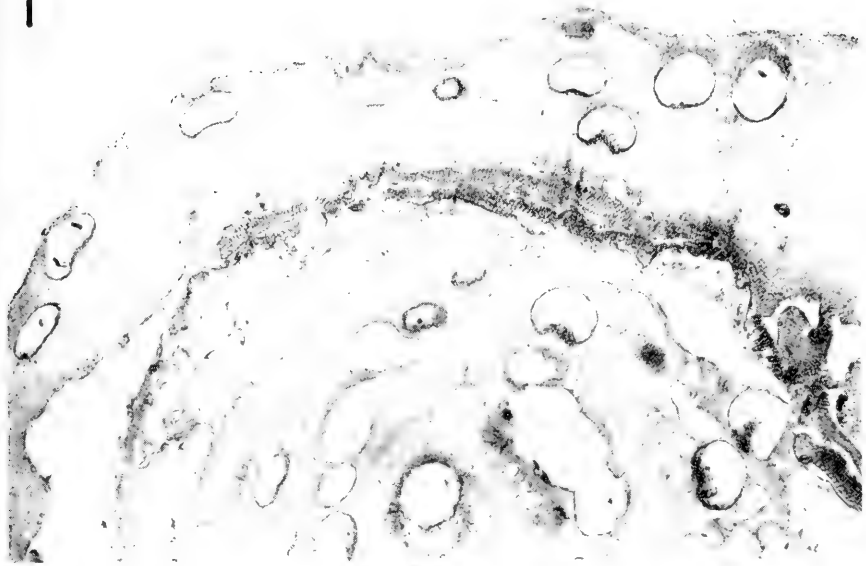

PLATE 61

- Fig. 1. *Lithophyllum lithophylloides*, photomicrograph of a section of a tetrasporic crust, Dawson 250, x 50.
- Fig. 2. *Porolithon sonorensis*, photomicrograph of a section of a tetrasporic crust of the type, Drouet & Richards 3383, x 120.

1



2

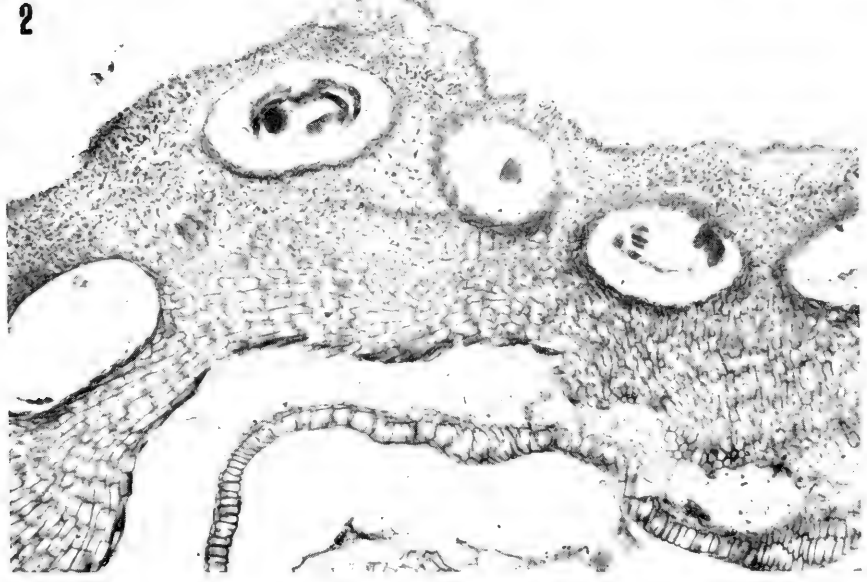

PLATE 62

- Fig. 1. *Lithophyllum Hancockii*, photomicrograph of a tetrasporangial conceptacle in a portion of Dawson 619a, x 120.
- Fig. 2. *Dermatolithon veleroae*, photomicrograph of a section of a tetrasporic conceptacle from the type material, Dawson 550, x 220.

1



2

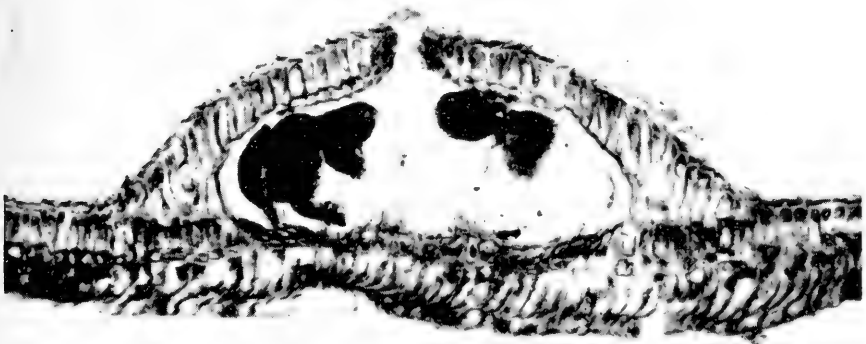

PLATE 63

- Fig. 1. *Litholepis sonorensis*, photomicrograph of a tetrasporic conceptacle of the type specimen, Dawson 290, x 330.
- Fig. 2. *Heteroderma corallinicola*, photomicrograph of an empty cystocarpic conceptacle of an example from the type collection, Drouet & Richards 3328a, x 240.

1



2

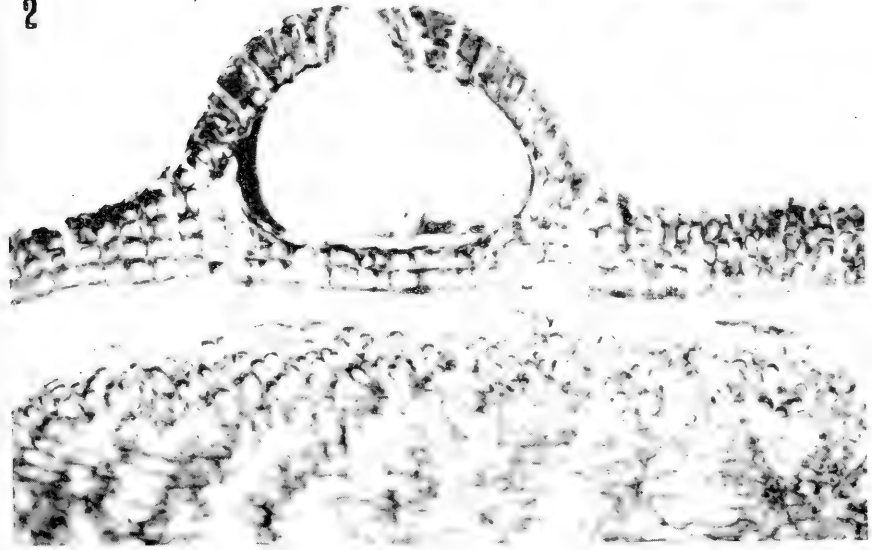

PLATE 64

- Fig. 1. *Gigartina pectinata*, photograph of a specimen of the type collection, Dawson 239.
- Fig. 2. *Gigartina MacDougalii*, photograph of two examples of the type collection.

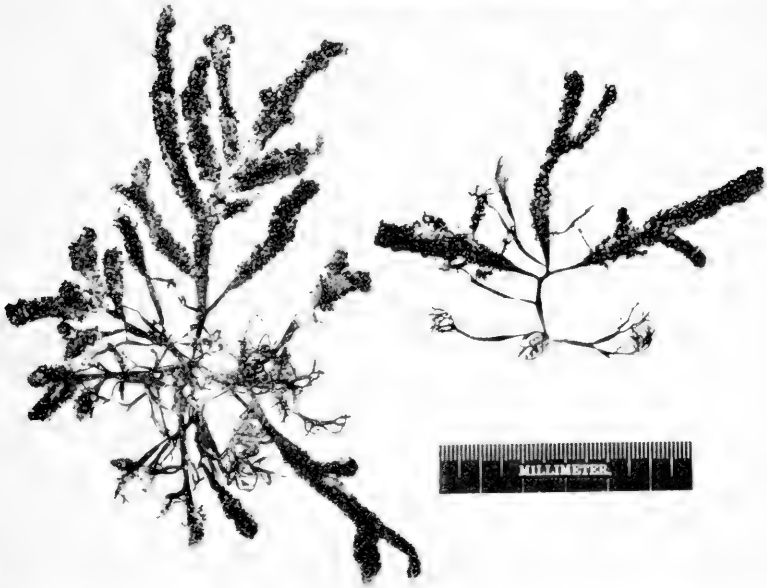
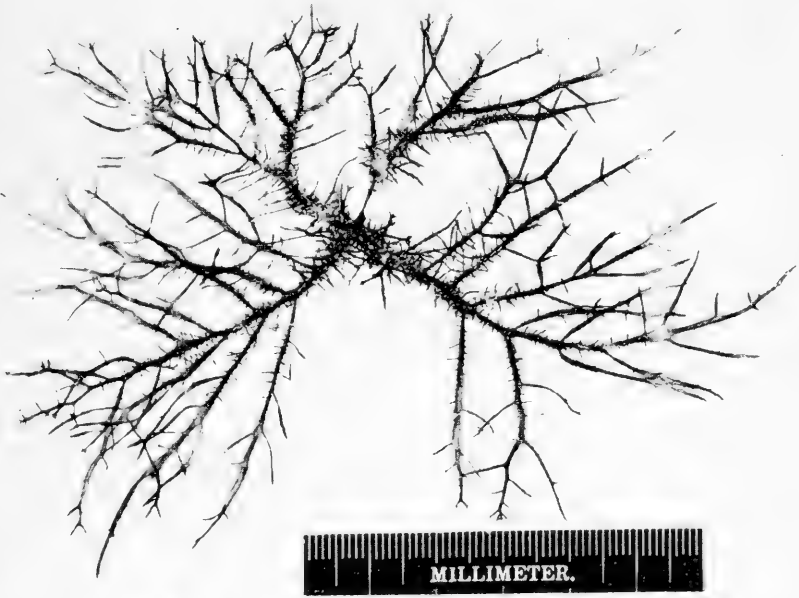

PLATE 65

- Fig. 1. *Rhodymenia ? tepocensis*, two examples of the type collection.
- Fig. 2. *Gracilaria Hancockii*, a specimen of the type collection (below) Dawson 149, and (above) Dawson 177, $\times \frac{2}{3}$.



2

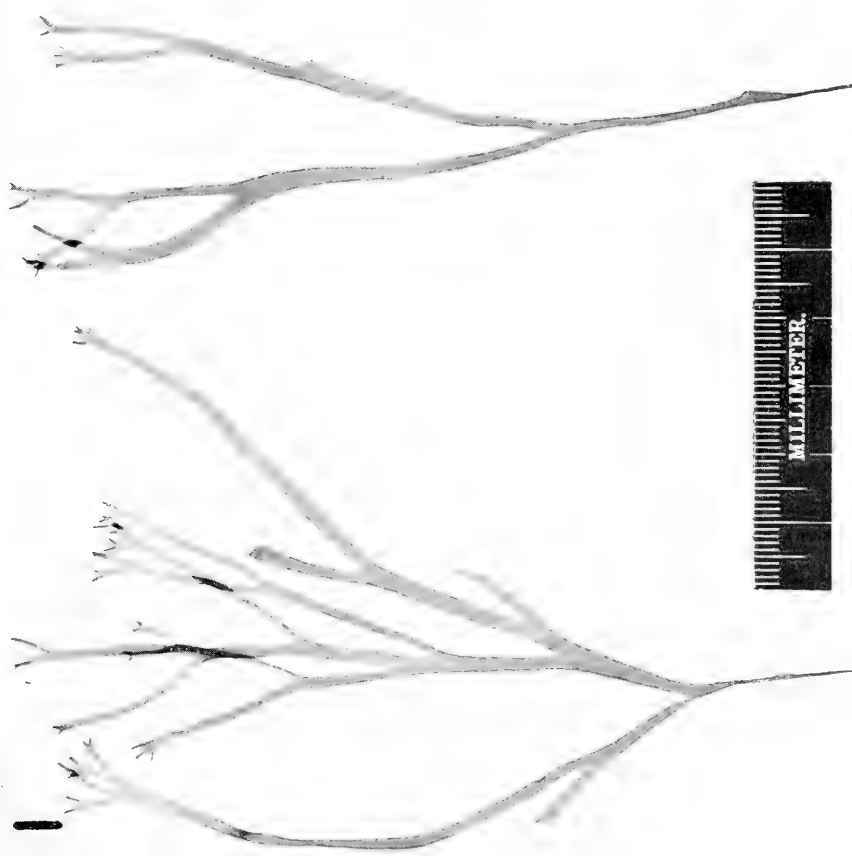

PLATE 66

Figs. 1 and 2. *Prionitis guaymasensis*, examples of several collections to show variation in size and branching.

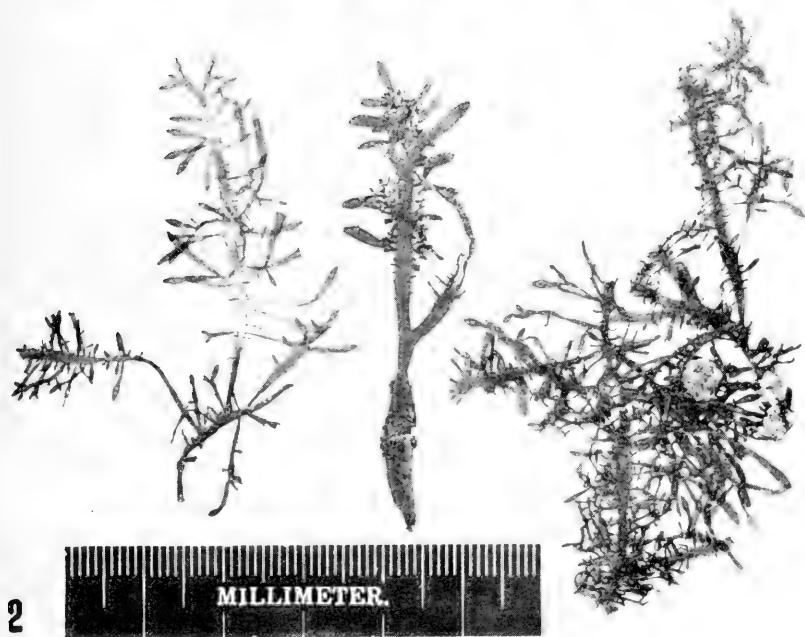
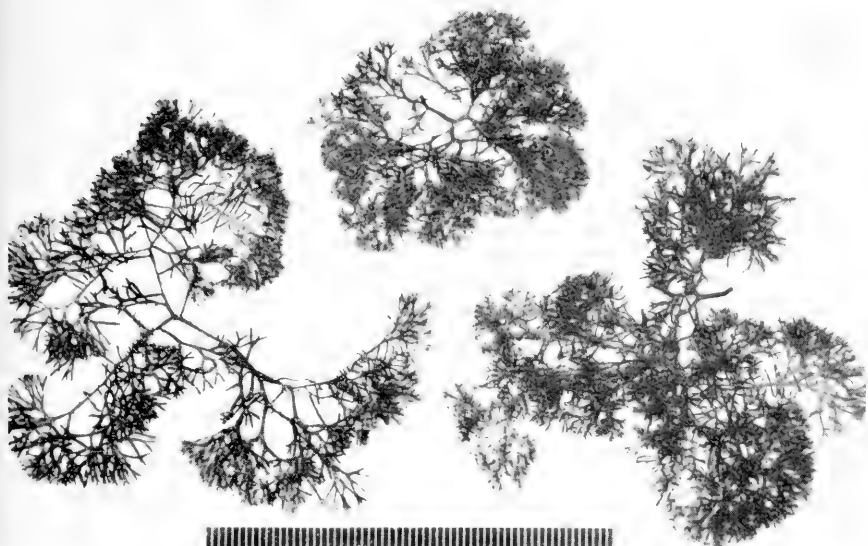

PLATE 67

- Fig. 1. *Prionitis kinoensis*, photograph of specimens of the type collection, Dawson 648.
- Fig. 2. *Prionitis mexicana*, photograph of specimens of the type collection, Dawson 628.



1



2

PLATE 68

- Fig. 1. *Callymenia angustata*, photograph of several examples of Dawson 369.
- Fig. 2. *Callymenia guaymasensis*, photograph of two specimens of the type collection, Dawson 49.



PLATE 69

- Fig. 1. *Ayardhiella mexicana*, photograph of two examples of the type collection, Dawson 233.
- Fig. 2. *Gratcloupia Hancockii*, photograph of several examples of the type collection, Dawson 650.

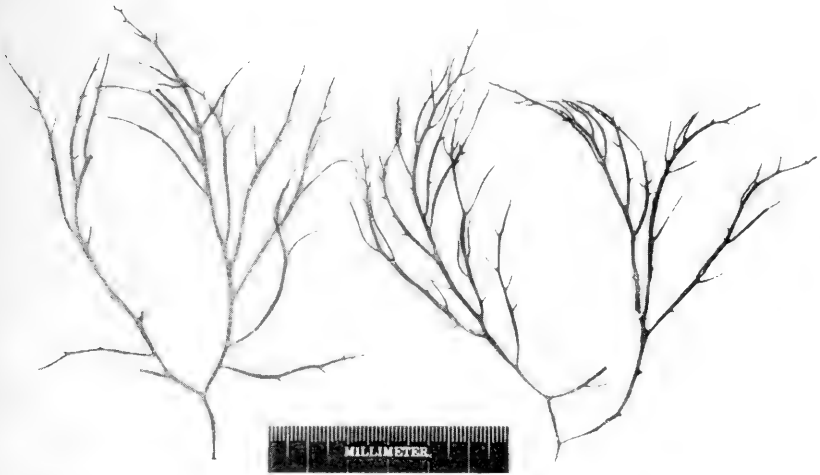

2

PLATE 70

- Fig. 1. (left) *Gelidiopsis variabilis*, part of Drouet and Richards 3395.
- Fig. 1. (right) *Gelidiopsis tenuis*, an example of Drouet and Richards 3134c.
- Fig. 2. (left) *Gracilaria veleroae*, an example of the type collection, Dawson 141a.
- Fig. 2. (right) *Gracilaria guaymasensis*, an example of the type collection, Drouet and Richards 3401.

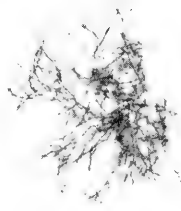
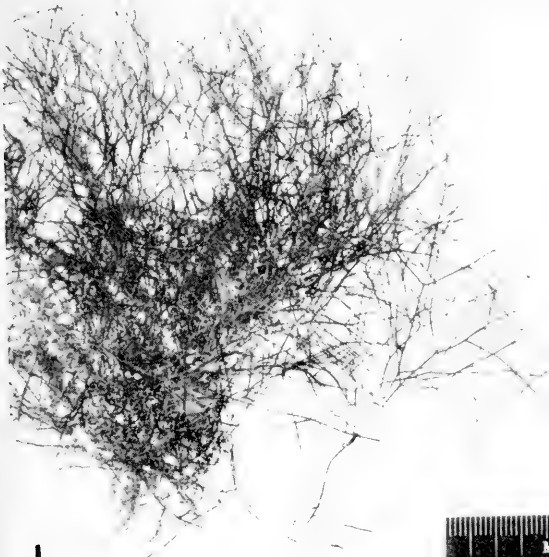

1

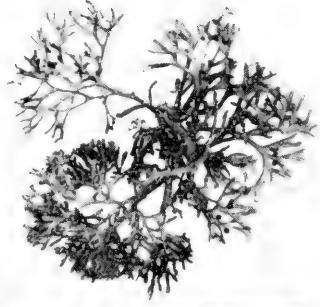
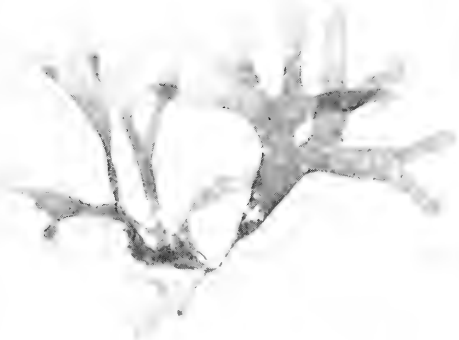

2

PLATE 71

- Fig. 1. *Rhodoglossum Hancockii*, photograph of a tetrasporic specimen of the type collection, Dawson 437.
- Fig. 2. (upper left) *Gymnogongrus Hancockii*, an example of the type collection, Dawson 649.
- Fig. 2. (lower left) *Gymnogongrus sinicola*, examples of the type collection preserved in liquid, Dawson 447.
- Fig. 2. (right) *Gymnogongrus divaricatus*, several examples of Dawson 94.

1

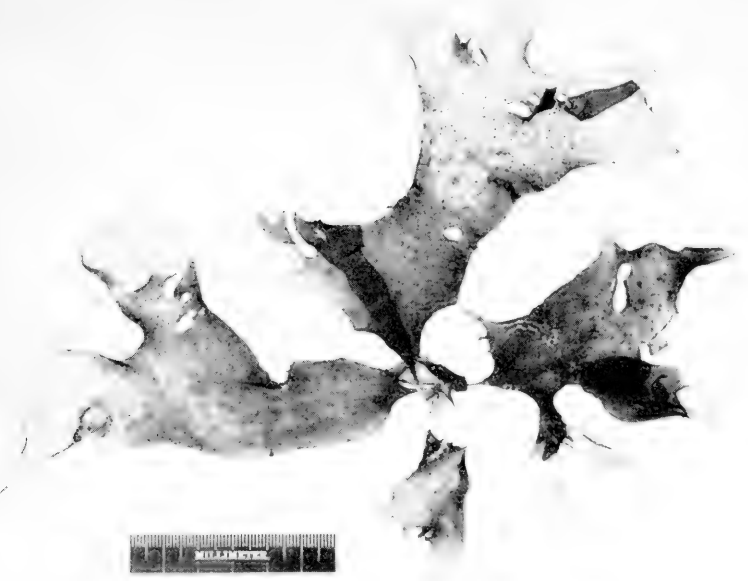

2

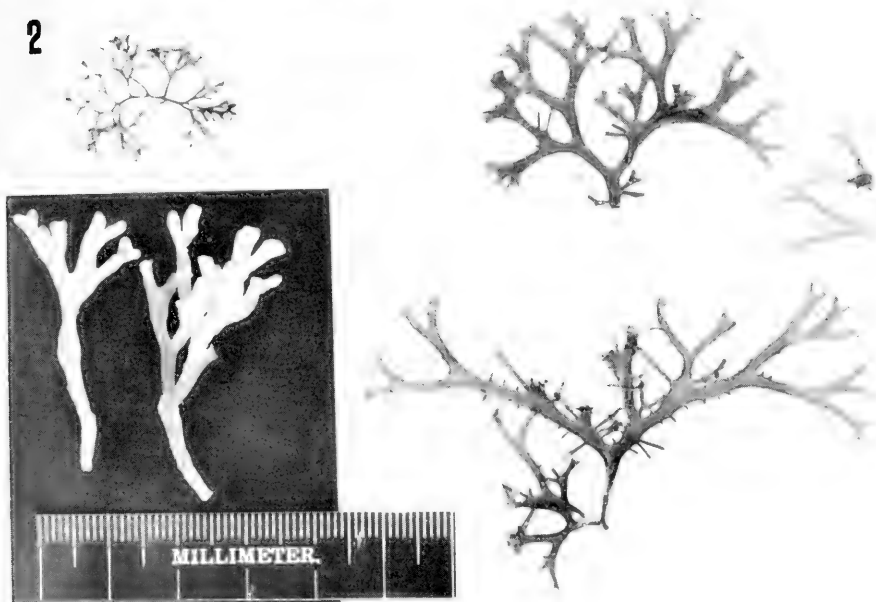

PLATE 72

- Fig. 1. *Platythamnion tepocensis*, photomicrograph of a portion of the type specimen, Dawson 379.
- Fig. 2. *T'elevoa subulata*, photomicrograph of upper portion of a tetrasporic example from the type collection, Dawson 381d.

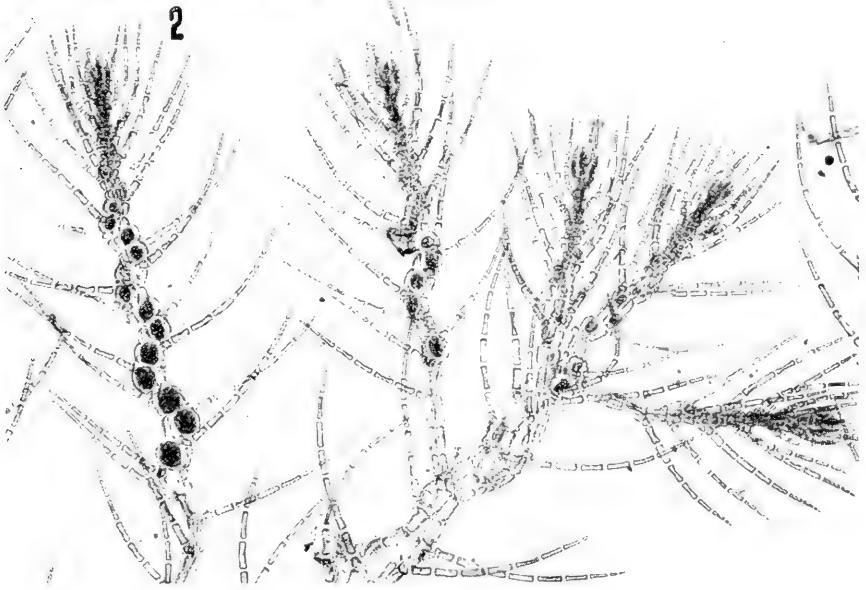

PLATE 73

- Fig. 1. *Botryocladia pseudodichotoma* var. *datilensis*, two examples of the type collection, Dawson 116.
- Fig. 2. *Gastroclonium clavatum*, examples of two Gulf collections to show extremes of variation in size.

1



2



PLATE 74

- Fig. 1. *Lomentaria catenata*, a specimen from Dawson 100.
- Fig. 2. *Lomentaria Drouetii*, a photograph of the type specimen, Drouet and Richards 3135.



Colpoc. 1
3 4 5 6 7

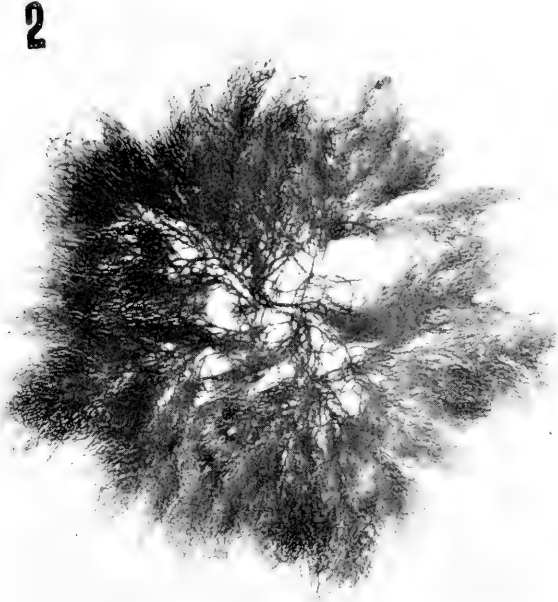

PLATE 75

- Fig. 1. *Botryocladia uvarioides*, a specimen from the type collection, Howell 598.
- Fig. 2. *Lomentaria hakodatensis*, a typical example of the species as it occurs in the Gulf.



PLATE 76

Desmarestia filamentosa, photograph of a specimen of the type collection, x $\frac{1}{2}$.



PLATE 77

Desmarestia mexicana, photograph of a specimen of the type collection, x $\frac{1}{4}$.



INDEX

Allan Hancock Foundation Publications of The University of Southern California,
Volume 3. Titles of papers and plate illustrations are in bold face.

- Acanthocarpicae**, 237
Acarospora, 38
 nigromarginata, 38
 peltastica, 38
Acarosporaceae, 38
Achlya, 102
Achnanthes, 53, 71
Acrocarpus crinalis, 259
Acropeltis australis, 139
Acroporium pungens, 9
Actinoptychus undulatus, 53, 71
Agardhiella, 288, 436
 mexicana, 288, 358, 436
 tenera, 288
Aglaozonia, 227
 melanoidea, 227
Alectoria sarmentosa, 40
Allomyces, 102
 anomala, 102
 arbuscula, 102, 107
 javanicus, 102, 107
 moniliformis, 102
Amphiroa, 199, 231, 232, 276, 277, 311
 pusilla, 276, 357
 rigida, 276, 357
 rigida var. *antillana*, 276, 277
 zonata, 276, 357
Anaptychia, 45
 podocarpa, 45
Anatheca, 290
 dichotoma, 290
 elongata, 289
Anthracotheicum canellae-albae, 184
Antithamnion, 313
 pacificum, 313
 sublittorale, 313
A Review of Genus *Rhodymenia* with Descriptions of New Species, 123
Arthoniaceae, 184
Arthothelium
 macrothecum, 184
 spectabile, 184
Asparagopsis, 257
 Sanfordiana, 257
 Sanfordiana f. *amplissima*, 257
Asterionella japonica, 53, 67, 70, 98
Asteromphalus heptactis, 53, 69, 76
Bacteriastrum, 53, 71
 elongatum, 65, 69, 71, 84
Bangiaceae, 251
Barbula, 5
 Ehrenbergii var. *mexicana*, 5, 12
 replicata, 6
 Taylorii, 1, 4, 6, 12
Bartramiaceae, 6
Biddulphia, 71
 aurita, 70, 71, 94
 mobiliensis, 53
Blastocladiales, 102
Blastocladiella, 108
 simplex, 102
 variabilis, 107
Bonnemaioniaceae, 257
Bostrychia, 336
 radicans, 336, 396
 rivularis, 336
Botryocladia, 305
 Hancockii, 305, 358, 388
 leptopoda, 307
 occidentalis, 306, 307
 pseudodichotoma, 388
 pseudodichotoma var. *datilensis*, 305, 357, 358, 388, 440
 uvaria, 306
 uvarioides, 306, 358, 388, 448
Branchioglossum, 321
 MacDougalii, 321
 Woodii, 321
Bryaceae, 6
Bryopsidaceae, 212
Bryopsis, 212
 pachynema, 206
 pennata, 212
 plumosa var. *pennata*, 212, 357
Bryum argentium, 6
Buellia, 43
 montevidensis, 43
 parasema, 186
 umbrina, 43
 xanthinula, 43, 186
Buelliaceae, 42, 186
Calliblepharis, 123
Callicostella pallida, 5, 9
Callithamnion, 312, 313
 endovaginum, 312
 microscopicum, 254
 veleroae, 312, 358, 398
Callophyllis, 287, 386
 Johnstonii, 287
Callymenia, 285
 angustata, 285, 286, 434
 guaymasensis, 286, 358, 434
 pertusa, 287
 veleroae, 285, 358, 388
Callymeniaceae, 285
Caloplaca, 42
 brachysporum, 41
 diphocia phaea, 186

- dissimilis, 42
 elegans, 42, 186
 Fernandezianum, 42
 Malmeana, 41, 186
 Muellieri, 36, 42
 murorum, 186
 rugulosa, 42
 species, 42
 Caloplacaceae, 41, 186
 Calothrix, 21
 dura, 21
 pilosa, 16, 21, 26, 30
 Calymperaceae, 4
 Calymperes, 4
 Disciforme, 4
 Donnellii, 4
 Campylopus introflexus, 3, 6
 Caulerpa, 198, 212
 pinnata f. pectinata, 213
 plumaris, 213
 racemosa, 198
 racemosa var. chemnitzia, 213
 racemosa var. uvifera, 213, 214
 sertularioides, 198, 213, 356
 sertularioides f. longiseta, 214
 van Bosseae, 212
 Caulerpaceae, 212
 Centroceras, 199, 311, 321, 356
 bellum, 321
 clavulatum, 321
 Ceramiaceae, 312
 Ceramium, 226, 315, 318, 320
 affine, 317, 400
 bicornis, 315, 316
 byssoides, 319
 Camouii, 319, 357, 358, 400
 caudatum, 317, 357
 codicola, 318
 equisetoides, 320, 358, 400
 fimbriatum, 317, 357
 gracillimum, 319, 357
 horridum, 318
 interruptum, 316
 Johnstonii, 316
 paniculatum, 319, 337
 procumbens, 318
 serpens, 318
 sinicola, 315, 316, 317, 357
 sinicola var. interruptum, 316, 358
 sinicola var. Johnstonii, 316, 358
 transversale, 319
 Cerataulina bergonii, 53, 64, 70, 94
 Ceratodictyon, 264
 Chaetangiaceae, 257
 Chaetoceros, 63, 64, 65, 68, 71
 affinis, 53, 70, 88
 approximatus, 70, 72
 atlanticus, 53, 69, 84
 coarctatus, 53, 71
 compressus, 53, 63, 64, 65, 67, 68,
 70, 73, 86
 concaivicornis, 53, 70, 84
 constrictus, 53, 64, 65, 70, 88
 costatus, 68, 69, 70, 72, 88
 curvisetus, 53, 64, 65, 67, 68, 70, 90
 danicus, 53, 71
 debilis, 53, 64, 65, 67, 70, 73, 90
 decipiens, 53, 65, 69
 didymus, 53, 64, 65, 70, 86
 eibenii, 53
 laciniosus, 53, 70
 laeve, 53
 lorenzianus, 53, 70, 86
 messanensis, 53
 peruvianus, 53, 69
 radicans, 53, 63, 64, 67, 68, 69, 70,
 73, 92
 simplex, 53, 70
 socialis, 53, 63, 67, 70, 73, 92
 subsecundus, 70, 72
 tetrastichon, 53
 Chaetomorpha, 207
 aerea, 208
 aerea forma Linum, 208
 antennina, 205, 207, 357
 Chaetophoraceae, 204
 Champia, 310, 311
 caespitosa, 311, 358, 390
 disticha, 310, 358, 390
 parvula, 310, 311, 357
 Champiaceae, 308
 Chantransiaceae, 254
 Chiocetxonaceae, 34
 Chiocetxonaceae, 34, 184
 Chlorophyceae, 201
 Chnoospora, 234, 235
 pacifica, 234
 Chnoosporaceae, 234, 235
 Chondria, 325
 acrorhizophora, 325, 357
 californica, 325, 357
 dasyphylla, 325
 tenuissima f. californica, 325
 Chroococcaceae, 15
 Chroococcus turgidus, 15, 30
 Chroococcus turgidus var. submarinus,
 16
 Chrysomenia Enteromorpha, 306
 Chylocladia parvula, 310
 Chytridiales, 102
 Cladophora, 209, 226
 albida, 209
 delicatula, 210
 graminea, 210, 212, 357
 hesperia, 211
 MacDougallii, 211
 microcladioides, 209, 210
 ovoidea, 211
 Rudolphiana, 209
 Rudolphiana f. eramosa, 209
 tiburonensis, 211, 357, 358, 360
 trichotoma, 210

- Cladophoraceae, 207
 Cladophoropsis, 206
 robusta, 206
 Clinophora, 124, 127, 131, 137, 138, 143
 Codiaceae, 214
 Codium, 118, 204, 214, 216, 217, 316, 318, 353
 amplivesiculatum, 215, 216, 217
 anastomosans, 215, 216, 218, 357
 Brandegeei, 215, 216, 217
 cervicorne, 215, 216, 217
 conjunctum, 217, 218
 contractum, 219
 cuneatum, 218, 221
 fragile, 204
 longiramosum, 215, 217
 MacDougalii, 204, 218, 358, 404
 reductum, 218
 simulans, 199, 204, 215, 216, 217, 218, 221, 357
 sinicola, 216
 tomentosum, 216
 unilaterale, 215, 216
 Coelarthrum Albertisii, 306
 Coenogoniaceae, 36, 185
 Coenogonium
 linkii, 185
 subvirescens, 36
 Colacodasya sinicola, 325
 Collemaceae, 36, 185
 Colpomenia, 118, 199, 229, 232, 353
 sinuosa, 232
 sinuosa f. deformans, 222, 233
 sinuosa f. expansissima, 233
 sinuosa f. tuberculata, 233, 357
 sinuosa f. typica, 233
 Compsonema, 222
 immixtum, 222
 Conferva aerea, 208
 Corallina, 199, 272, 273, 275, 311
 marginata, 258
 pilulifera, 275, 357
 sororia, 275
 Corallinaceae, 266
 Corallopsis excavata, 308
 Cordylecladia, 295
 lemanaeformis, 295
 Corethron
 criophilum, 54, 71
 hystrix, 69, 72, 78
 Coscinodiscus, 54, 71
 Cruoriaceae, 266
 Cutleria, 226, 227
 adpersa, 227
 Hancockii, 226, 337, 357, 358, 406
 Cutleriaceae, 226
 Cutleriales, 119
 Zanardinia prototypus, 119
 Cyanothrix
 primaria, 16, 17, 19
 Willei, 16, 17, 19
 Cyclodictyon albicans, 9
 Cystoseira, 199, 256
 Dactyliosolen, 54, 71
 mediterraneus, 70, 72
 Dasya, 324
 elegans, 324
 pedicellata, 324
 Dasyaceae, 324
 Delleseriaceae, 321
 Dendrymenia, 124, 128, 140, 141, 143, 144, 146, 149
 flabellifolia, 143, 144, 145, 147, 149
 Dendrymeniaceae, 124, 128, 135, 143, 146
 Dermatocarpaceae, 34
 Dermatolithon, 274
 veleroae, 274, 358, 422
 Desmarestia, 236, 237
 compressa, 236
 filamentosa, 236, 358, 450
 media, 236
 mexicana, 236, 358, 452
 Desmarestiaceae, 236
 Dichothrix seriata, 21
 Dicranaceae, 3
 Dicranema, 299, 334
 rosaliae, 299
 Dicranemaceae, 299
 Dictyonema sericeum, 33
 Dictyosphaeria, 198, 205
 Versluisii, 205
 Dictyota, 118, 228, 251, 256, 272, 356
 crenulata, 228
 hesperia, 228, 357
 Johnstonii, 200, 228, 229, 235, 357
 Vivesii, 229
 Dictyotaceae, 228
 Digenia, 311, 326
 simplex, 326, 357
 Ditylum brightwellii, 54, 70, 72, 94
 Echinocaulon
 ramulliferum, 261
 rigidum, 261
 spinellum, 261
 Ectocarpaceae, 220
 Ectocarpus, 220, 226
 Bryantii, 220
 confervoides f. variabilis, 220, 357
 gonodioides, 220, 221
 Hancockii, 222, 357, 358, 360
 Mitchellae, 220
 mucronatus, 220
 pusillus, 221
 sonorensis, 221, 358, 360
 Elachista pulvinata, 224
 Elachistaceae, 224
 Encoelium intricatum, 233

- Enteromorpha, 202, 353, 354
 acanthophora, 202, 203
 compressa, 202, 203
 intestinalis, 202, 203
 Marchantae, 202, 203, 204
 prolifera, 202, 203, 204
 tubulosa, 202, 203, 204
 Entocladia, 204
 cingens, 205
 codicola, 204, 205
 condensata, 204
 mexicana, 205
 Polysiphoniae, 205
 Erythrocladia, 251, 252
 irregularis, 251, 357
 subintegra, 251
 Erythroglossum minimum, 322
 Erythropeltis, 251, 252
 discigera, 252
 Erythrotrichia, 252
 californica, 252
 carnea, 252, 357
 discigera, 252
 Kylinii, 252
 polymorpha, 251, 252
 pulvinata, 252
 Estebania conjuncta, 281
 Eucampia zoodiacus, 54, 65, 70, 94
 Eucheuma, 288, 320
 Johnstonii, 288
 uncinatum, 288, 357
 Euheteroderma, 273
 Eurhodymenia, 125, 129, 140
 Eusargassum, 237
 Faucheia, 304
 Gardneri, 133
 mollis, 304
 Mortensenii, 133
 Sefferi, 304
**Field Observations on the Algae of
 the Gulf of California, 115**
 Fissidens, 1
 Hancockiana, 1, 2, 12
 mollis, 1
 Fissidens (Semilimbidium)
 Hancockiana, 2
 Fissidentaceae, 1
 Fryella Gardneri, 133
 Fucus, 199
 caespitosus, 258
 palmetta, 134
 pusillus, 258
 sertularioides, 213
 Galaxaura, 258
 fastigiata, 258
 marginata, 258
 Gastroclonium, 312
 clavatum, 312, 390, 444
 Gelidiaceae, 258, 264
 Gelidiella, 198, 263
 acerosa, 261
 Hancockii, 261, 358, 384
 mexicana, 262, 358, 384
 refugiensis, 262, 358, 384
 Gelidiopsis, 264
 rigida, 261
 tenuis, 264, 438
 variabilis, 264, 265, 438
 Gelidium, 199, 255, 258, 318
 crinale, 259, 260
 decompositum, 260
 Johnstonii, 260, 357
 microphysa, 260, 357
 miniatum, 263
 pusillum, 258, 357, 382
 variabile, 265
 Gigartina, 118, 123, 199, 229, 301, 320,
 353, 355
 Chauvinii, 302
 Eatoniana, 301, 357
 Johnstonii, 302, 357, 358
 leptorhynchus, 303
 MacDougallii, 302, 303, 358, 426
 pectinata, 302, 358, 426
 Teedii, 301
 Gigartinaceae, 301
 Ginannia undulata, 257
 Gomphosphaeria aponina, 16, 30
 Goniolithon, 268
 (Cladolithon) elegans, 267
 frutescens, 268
 pallescens, 266
 strictum, 268
 strictum var. nana, 268
 Goniotrichum, 251
 Alsidii, 251
 elegans, 251, 357
 Gonodia, 221, 224
 (Myriactis), 221
 Johnstonii, 224
 Marchantae, 224
 moniliformis, 224
 pulvinata, 224
 Gracilaria, 123, 199, 209, 256, 293, 295,
 299, 353, 386
 compressa, 199, 296
 confervoides, 295, 296
 crispata, 294, 357
 guaymasensis, 298, 358, 438
 Hancockii, 297, 358, 428
 Johnstonii, 293, 297, 299
 lacerata, 293, 294
 lichenoides, 296
 pachydermatica, 294
 pinnata, 294
 secundata, 298
 sinicola, 293
 Sjostedii, 295, 296

- subsecundata, 294
 veleroae, 297, 358, 438
 Vivesii, 293, 297, 299
 vivipara, 293
 Gracilariaceae, 293
 Graphidaceae, 34, 184
 Graphis scripta, 184
 Grateloupia, 279, 280, 281, 312, 316,
 318, 334
 acroidalea, 281
 denticulata, 281
 filicina, 279
 Hancockii, 280, 358, 436
 Howeii, 281
 Johnstonii, 281
 prolongata, 279
 squarrulosa, 281
 Sternbergii var. versicolor, 282
 versicolor, 282
 Grateloupiaceae, 277
 Griffithsia, 314
 multiramosa, 315
 pacifica, 314
 tenuis, 315
 Grinnellia, 322
 americana, 322
 lanceolata, 322, 358, 392
 Guinardia flaccida, 54, 70, 78
 Gymnogongrus, 299, 300
 carnosus, 299
 divaricatus, 301, 357, 440
 Hancockii, 300, 358, 440
 sinicola, 300, 357, 358, 440
 Haematomma punicea, 38
 Halidrys, 199
 Halimeda, 116, 214
 discoidea, 214
 Halymenia, 277, 278, 279
 abyssicola, 278, 358
 actinophysa, 277
 cinnabarina, 143
 refugiensis, 278, 358, 386
 Helicophyllaceae, 7
 Helicophyllum torquatum, 7
 Hemiaulus hauckii, 54, 69
 Herposiphonia, 334, 355
 secunda, 334
 subdisticha, 334, 337, 396
 tenella, 334, 357, 396
 Heteroderma, 272
 corallinicola, 272, 273, 358, 424
 Gibbsii, 272, 273
 Heterosiphonia, 325
 sinicola, 325
 Hildenbrandtia, 265
 rosea, 265, 357
 Hookeriaceae, 9
 Hookeriopsis diffusa, 9
 Hooperia Baileyana, 308, 309
 Hydroclathrus, 198, 234
 cancellatus, 234
 clathratus, 234
 Hydrocoleum, 23, 24
 cantharidosmum, 24, 28
 comoides, 23, 26, 28
 Hymenostomum, 6
 Hypnea, 199, 290, 291, 355
 Esperi, 292, 357
 Johnstonii, 292, 357
 Marchantae, 290, 291
 nidifica, 290, 291
 nidulans, 291, 357
 pannosa, 291, 292, 357
 Hypneaceae, 10, 290
 Hypoglossum, 321
 attenuatum, 321
 Inquirendae, 142
 Iridophycus, 304
 Ishige, 119, 234, 235, 256
 foliacea, 119, 229, 234, 235, 337, 404
 Okamurae, 119
 Okamurai, 235
 Ishigeaceae, 234
 Jania, 198, 231, 232, 277
 Jania rubens, 277, 357
 Jantiniella, 325
 sinicola, 325
 Johannesbaptistia, 16
 Gardneri, 16
 primaria, 16, 17, 20, 28
 Willei, 16
 Kallymenia, 123
 Laminariaceae, 237
 Lauderia andulata, 78
 Lauderia borealis, 70, 72, 78
 Laurencia, 199, 205, 318, 326
 estabaniana, 328
 Hancockii, 328, 358, 398
 Johnstonii, 328, 357
 obtusiuscula, 327, 328
 obtusiuscula var. corymbifera, 327
 obtusiuscula var. laxa, 327, 328
 pacifica, 326
 paniculata, 326, 327
 papillosa, 327
 papillosa var. pacifica, 326, 357
 sinicola, 328
 Lecanora varia, 185
 Lecanoraceae, 38, 185
 Lepidopilum flexifolium, 9
 Leptocylindrus danicus, 54, 64, 70, 78
 Leptogium, 36
 azureum, 36
 denticulatum, 36, 185
 marginellum, 37
 Leptotrema, 36
 mastoideum, 36
 Leucobryaceae, 3

- Leucobryum Martianum*, 3
Lichens of the G. Allan Hancock Expedition of 1934, Collected by Wm. R. Taylor, 33
Licmophora, 71, 72
 abbreviata, 71, 72
Linum, 208
Lithodesmium undulatum, 54, 70, 94
Litholepis, 275
 sonorensis, 275, 358, 424
Lithophyllum, 199, 266
 bracciata, 269, 414
 bracciatum, 269
 californiense, 266
 complanata, 267
 decepiens, 270, 412
 dentatum, 270
 dentatum f. dilatata, 270
 Digueti, 269, 416
 Diguettii, 269
 elegans, 267
 frutescens, 267, 268
 Hancockii, 268, 358, 408, 422
 lithophylloides, 269, 408, 414
 416, 420
 Lithophylloides f. bracciata, 269, 414
 Lithophylloides f. phylloides, 269, 414
 Margaritae, 266, 267
 Okamurae, 266
 pallescens, 266, 408
 racemus, 269
 trichotomum, 267, 268, 408, 414, 418
 veleroae, 270, 358, 408, 410
Lithothamnion, 267, 271
 australe, 271, 410, 412
 australe f. americana, 271, 410
 bracchiata, 271
 bracchiata f. tualensis, 271
 bracchiata f. ubiana, 271
 corraloides f. australis, 271, 410
 dentatum, 269
 Digueti, 269
 elegans, 267
 elegans f. angulata, 267
 elegans f. complanata, 267
 (*Lepidomorphum*) *pallescens*, 266
 Margaritae, 266
 mesomorphum var. ornatum, 274
 montereyicum, 271
 pallescens, 266
 racemus, 266, 269
 trichotomum, 267
Lithothamnium, 119
Lola, 208
 lubrica, 208
Lomentaria, 199, 308, 310
 Baileyana, 309
 catenata, 308, 337, 357, 446
 Drouettii, 309, 358, 390, 446
 hakodatensis, 308, 309, 337, 448
 parvula, 310
 sinensis, 308
Lophocladia, 335
Lophosiphonia, 332
 mexicana, 333, 358, 394
 villum, 332, 357, 394
Lyngbya
 aestuarii, 23
 epiphytica, 24, 25, 28
 gracilis, 25, 26, 28
 gracilis f. monilis, 25, 28
 Menegheniana, 25
 semiplena, 26, 28, 30
 versicolor, 26, 28
Macrocystis, 237
 pyrifera, 237
Macromitrium mucronifolium, 7
Malacocarpicae, 237
Marine Algae of the Gulf of California, 189
Melobesia, 272
 farinosa, 272
 Gibbsii, 272
 tenuis, 272
Meneghiniella Brandegeei, 190, 232
Merismopedia
 Gardneri, 16
 glauca, 16, 28
 glauca f. mediterranea, 16, 28
Meteoriaceae, 8
Meteoriopsis
 Anderssonii, 8
 patula, 8
Microcoleus tenerrimus, 24, 30
Micromitrium fragile, 7
Minksia
 caesiella, 185
 candida, 185
 irregularis, 185
 saxicola, 183, 184, 185
Monoblastia
 lutescens, 183, 184
 palmicola, 184
Monoblepharella, 103, 104
 Taylori, 101, 103, 107, 110, 112
Monoblepharidales, 103
Monoblephariopsis, 104
Monoblepharis, 103, 104, 105, 107
 ovigera, 104
 regignens, 104
 sphaerica, 105
 Taylori, 103, 104, 107
Mosses of the G. Allan Hancock Expedition of 1934 Collected by Wm. R. Taylor, 1
Myriactis, 221
 Sargassi, 224
Myriogramme, 323
 carnea, 324
 divaricata, 323, 358, 392
 minuta, 324

- Myrionemataceae, 222
 Myxophyceae of G. Allan Hancock
 Expeditions of 1934 Collected by
 Wm. R. Taylor, 15
 Navicula, 54, 71
 Neckeraceae, 8
 Neckeropsis
 disticha, 8
 undulata, 8
 Nemacystus, 232
 Brandegeei, 232
 Nemastomaceae, 287
 Neomonospora multiramosa, 315
 Neurocarpus, 229
 zonarioides, 229, 230
 Nitzschia
 longissima, 54, 70
 pungens var. atlantica, 70, 72, 98
 seriata, 54, 64, 65, 67, 68, 70, 98
 Nodularia fusca, 16, 17, 19
 Octoblepharum
 albidum, 4
 pulvinatum, 4
 Olpidium, 107
 Orthostichopsis tetragona, 7
 Orthotrichaceae, 7
 Oscillatoria laetevirens, 26, 28
 Oscillatoriaceae, 22
 Padina, 118, 229, 230, 272, 353, 354,
 355, 356
 Durvillaei, 199, 229, 230, 231,
 241, 353, 357
 mexicana, 231, 357, 358, 402
 Vickersii, 231
 Palmaria, 124, 131
 Palmer, Edward, 189
 Palmettae, 124, 126, 127, 133, 134, 136,
 138, 143
 Parmelia
 crinita, 39
 cristifera, 39
 latissima, 39, 185
 Soyauxii, 39
 sulphurata, 186
 tinctorum, 39
 Parmeliaceae, 39, 185
 Pelvetia, 199
 Pertusae, 124, 125, 129
 Pertusaria, 38
 Pertusariaceae, 38
 Petrocelis, 266
 Phaeophyceae, 201, 220
 Philonotis tenella, 6
 Phormidium monile, 25, 26
 Phycomyces Recovered from Soil
 Samples Collected by W. R.
 Taylor on the Allan Hancock
 1939 Expedition, 101
 Phyllophora cuneifolia, 128, 130
 intricata, 138
 Phyllophoraceae, 299
 Physcia
 adglutinata, 44
 aegilata, 44, 186
 alba, 44, 186
 minor, 44
 picta, 44
 sorediosa, 44
 Physciaceae, 43, 186
 Pilotrichaceae, 8
 Pilotrichum, 8
 Amazonum, 8
 bipinnatum, 9
 Plankton Diatoms of the Gulf of
 California Obtained by the G.
 Allan Hancock Expedition of
 1936, 47
 Plankton Diatoms of the Gulf of
 California Obtained by Allan
 Hancock Pacific Expedition of
 1937, 61
 Planktoniella sol, 53, 54, 70, 76
 Platythamnion tepicensis, 314, 358, 442
 Pleurosigma, 54, 71
 Pliostroma, 273
 Polyneurella, 322, 358
 Hancockii, 323, 358, 392
 Polyopes, 282
 sinicola, 282
 Polysiphonia, 251, 255, 329, 331, 353,
 380
 californica, 332
 dendroidea, 335
 Hancockii, 331, 358, 398
 Johnstonii, 329
 Marchantae, 205, 329
 pennata, 334
 senticulosa, 330
 simplex, 331, 357
 sinicola, 329
 Snyderae, 330, 357
 sonorensis, 330
 villum, 332, 333
 Porolithon, 273, 274
 sonorensis, 273, 274, 358, 412, 420
 Porphyridaceae, 251
 Porphyra, 253
 leucosticta, 253, 254
 perforata, 253
 perforata f. segregata, 253
 pertusa, 129
 Thuretii, 253, 254, 358
 Pottiaceae, 4
 barbula (hydrogonium) Taylorii, 4
 Pringsheimia, 205
 Marchantae, 205
 Prionitis, 282, 283, 284
 abbreviata, 282, 283, 284
 filiformis, 283
 guaymasensis, 283, 358, 430

- kinoensis, 284, 357, 358, 432
 mexicana, 283, 358, 432
 Sternbergii, 282, 283, 284, 357
 Sternbergii var. versicolor, 282
- Pseudocypbellaria**
 aurata, 38
 xantholoma, 37
- Pseudoeunotia doliolus**, 54, 67, 70, 98
- Psorogloea subensis**, 34
- Pterobryocae**, 7
- Pterosiphonia**, 334
 californica, 335
 dendroidea, 335
 pennata, 334, 335
- Pylophora cunifolia**, 128
- Pyrenulaceae**, 183
- Pyxine brachyloba**, 43
- Ralfsia**, 220, 222
 californica, 223, 357
 Hancockii, 223, 358, 360, 406
 pacifica, 222, 357, 358
 verrucosa, 222
- Ralfsiaceae**, 222
- Ramalina**, 41
 alludens, 39
 complanata, 40, 186
 dasypoga, 40
 interponens, 41
 Puiggarii, 41
 subasperata, 40
 subcalicaris, 40
 subfraxinea, 40
 Usnea, 40, 41, 186
 Usnea var. Usneoidella, 41
- Rhacopilaceae**, 7
- Rhacopilopsis trinitensis**, 10, 12
- Rhacopilum tomentosum**, 7
- Rhizidiomyces bivellatus**, 108
- Rhizoclonium lubricum**, 208
- Rhizophidium carpophilum**, 102
- Rhizosolenia**, 71
 acuminata, 70, 72, 82
 alata, 54, 69, 72, 82
 alata f. indica, 69, 72, 82
 bergonii, 69, 72, 80
 calcar avis, 54, 70, 71, 82
 delicatula, 54, 71, 80
 fragillissima, 54, 70
 imbricata, 70, 72, 80
 imbricata var. shrubsolei, 70, 72, 80
 semispina, 54, 71
 setigera, 53, 54, 70, 80
 stolterfothii, 54, 65, 70, 80
 styliiformis, 54, 69, 71, 72, 80
 styliiformis var. longispina, 69, 72, 80
- Rhodochorton**, 254, 256
 arcuatum, 255
 Hancockii, 255, 256, 358, 380
- microscopicum, 254, 357, 380
 sinicola, 256, 357, 358, 380
 variabile, 256
- Rhodoglossum**, 304, 355
 Hancockii, 304, 358, 440
- Rhodomelaceae**, 325
- Rhodomenia**, 123
- Rhodophyceae**, 190, 201, 251
- Rhodymenia**, 123, 124, 130, 133, 134, 142, 146, 148, 297, 308
 arborescens, 129, 148, 149, 160, 180
 adnata, 128, 142
 anastomosans, 128, 143
 attenuata, 127, 139, 158, 168
 australis, 127, 139, 156
 californica, 126, 135, 136, 140, 141, 160
 capensis, 127, 138
 cinnabarina, 128, 143
 coacta, 126, 132
 corallicola, 126, 134
 corallina, 123, 129, 135, 140, 146, 147, 148, 149, 160, 162, 170, 178
 cuneifolia, 125, 128, 130
 dichotoma, 128, 142
 divaricata, 128, 141, 166, 307, 385
 epimenioides, 128, 143
 erythraea, 125, 131
 eurhodymenia, 125
 flabellifolia, 128, 143, 145, 146, 147, 162
 foliifera, 127, 136
 georgica, 132
 Hancockii, 128, 146, 160, 172, 307, 358
 Howeana, 126, 135, 158
 indica, 125, 132
 intricata, 127, 138
 javanica, 128, 143
 lanceolata, 125, 130
 leptophylla, 128, 143, 144
 leptophylloides, 128, 144, 160, 174
 ligulata, 126, 134, 136
 linearis, 127, 137, 143
 liniformis, 126, 136
 lobata, 129, 147, 158, 176, 307
 lobulifera, 127, 137, 170
 mamillaris, 128, 143
 novazelandica, 127, 136, 164
 occidentalis, 128, 142
 pacifica, 128, 142, 160
 palmata, 123, 126, 130, 131, 132, 133, 156
 palmatififormis, 126, 132, 133
 palmetta, 125, 126, 132, 134, 136, 140, 156
 palmatififormis, 128, 140, 141, 164
 palmipedata, 129, 149, 160, 168
 pertusa, 124, 125, 129, 130, 156

- peruviana, 125, 130
 prolificans, 127, 138
 punctata, 126, 132
 rhizoides, 128, 146, 147, 160, 172
 rhizoidifera, 128, 143
 rosea, 128, 141, 166, 307, 358
 sanguinea, 125, 130
 Schmittii, 127, 139
 Setchellii, 126, 133
 Skottsbergii, 128, 143, 144, 145, 146,
 162, 174
 spinulosa, 126, 132
 stenoglossa, 127, 138
 stipitata, 125, 130
 tepocensis, 307, 358, 428
Rhodymeniaceae, 304
Rivulariaceae, 21
Roccella, 36
 Babingtonii, 34, 36, 185
 dicipiens, 35
 difficilis, 35
 portentosa, 35
Roccellaceae, 34, 185
Rosenvingea, 354, 402
 intricata, 233, 402
Sarcodiotheca, 289
 dichotoma, 290, 358
 elongata, 289, 358
 linearis, 289
Sargassaceae, 237
Sargassum, 115, 117, 118, 189, 198, 199,
 220, 224, 225, 229, 232, 237, 238,
 272, 315, 321, 334, 353, 354, 355, 356
 acinacifolium, 238, 242, 244, 372
 asymmetricum, 238, 242, 244, 353,
 358, 370
 Brandegeei, 239, 249, 378
 Bryantii, 242, 243
 californicum, 246, 248
 Camouii, 224, 238, 246, 247, 248,
 358, 368
 cylindrocarpum, 246, 247
 guardiense, 240
 herporhizum, 239, 249, 378
 horridum, 224, 239, 245, 247, 374
 insulare, 242, 243
 Johnstonii, 238, 239, 240, 362
 Johnstonii f. gracile, 240, 241, 364
 Johnstonii f. laxius, 240, 241
 lapazeanum, 224, 238, 241, 242, 243,
 357, 366
 Liebmanni, 250
 MacDougallii, 238, 241, 242, 243,
 245, 358, 368, 370, 372
 Marchantae, 245, 247
 paniculatum, 246, 248
 polyacanthum f. americanum, 246,
 248
 sinicola, 199, 239, 245, 246, 247,
 354, 357, 368, 374, 376
Schizothrix Hancockii, 22, 23, 30
Schizothrix f. submersa, 23
Schizymenia, 119, 287
 Johnstonii, 287
 violacea, 287
Schröderella delicatula, 71, 72
Scinaia, 257
 furcellata var. undulata, 257
 Johnstoniae, 257, 258
 latifrons, 258
Scytonema fuliginosa, 21
Scytosiphon, 233
Scytosiphonaceae, 232
Sematophyllaceae, 9
Sematophyllum caespitosum, 10
Skeletonema costatum, 54, 65, 67, 70, 73,
 76
Solieriaceae, 288
**Some Lichens from the American
 Tropics Collected by Wm. R.
 Taylor**, 183
Sorella, 321
 pinnata, 321, 358, 392
Sphaerococcus, 123
 corallinus, 128, 148
 flabellifolius, 144, 147
 ligulatus, 134
 linearis, 137
 palmettoides, 135
 Sternbergii, 282
Sphacelaria, 224, 252, 255
 brevicornis, 225
 cornuta, 225
 furcigera, 224
 Hancockii, 225, 357, 358, 360
 novae-caledoniae, 226
Sphacelariaceae, 224
Spirogyra, 208
Spirulina
 socialis, 27
 subtilissima, 27
 tenerrima, 27, 30
Sporochneaceae, 232
Squamariaceae, 265
Stephanopyxis, 54
 turris, 71, 72, 76
Sticta
 aurigera, 37
 mougeotiana, 37
 mougeotiana var. xantholoma, 37
Stictaceae, 37
Stictina
 Weigellii, 38
 Weigellii var. beauvoisii, 38
Surirella, 71, 72
Synchytrium, 107
Syrhopydon incompletus, 4
Taenioma, 324
 perpusillum, 324
Taxithelium planum, 9, 10

- Teloschistaceae, 42
 Teloschistes
 exilis, 42
 flavicans, 43
 Thalassionema nitzschioides, 54, 64,
 65, 68, 70, 96
 Thalassiosira
 condensata, 54, 71
 decipiens, 54, 70, 76
 rotula, 54, 71, 76
 Thalassiothrix
 acuta, 54
 frauenfeldii, 54, 69, 96
 heteromorpha, 54, 55, 65
 longissima, 54, 69, 96
 mediterranea, 71
 Thelotremaceae, 36
 The Marine Algae of the Gulf of
 California, 189
 Tildenia, 21
 Triceratium, 71, 72
 Trypetheliaceae, 184
 Trypethelium aeneum, 184
 Ulva, 201, 275, 354, 355, 356
 angustata, 201
 dactylifera, 201
 lactuca, 202
 rigida, 202, 357
 teniata, 201
 Ulvaceae, 201
 Usnea, 40, 41
 Usneaceae, 39, 186
 Valonia confervoides, 206
 Valoniaceae, 205
 Valoniopsis, 206, 207
 Hancockii, 207, 358, 360
 pachynema, 206, 207, 357
Velero III, 117, 123, 191, 195
 Veleroa, 335, 358
 subulata, 335, 358, 442
 Vesicularia amphibola, 10
 Wurdemannia, 198, 263, 264, 265, 334
 miniata, 189, 263, 264, 265
 setacea, 263
Zaca, 61, 190, 195, 201, 326
 Zanardinia, 119, 227
 collaris, 119, 227
 prototypus, 119, 227
 Zygo carpicae, 237



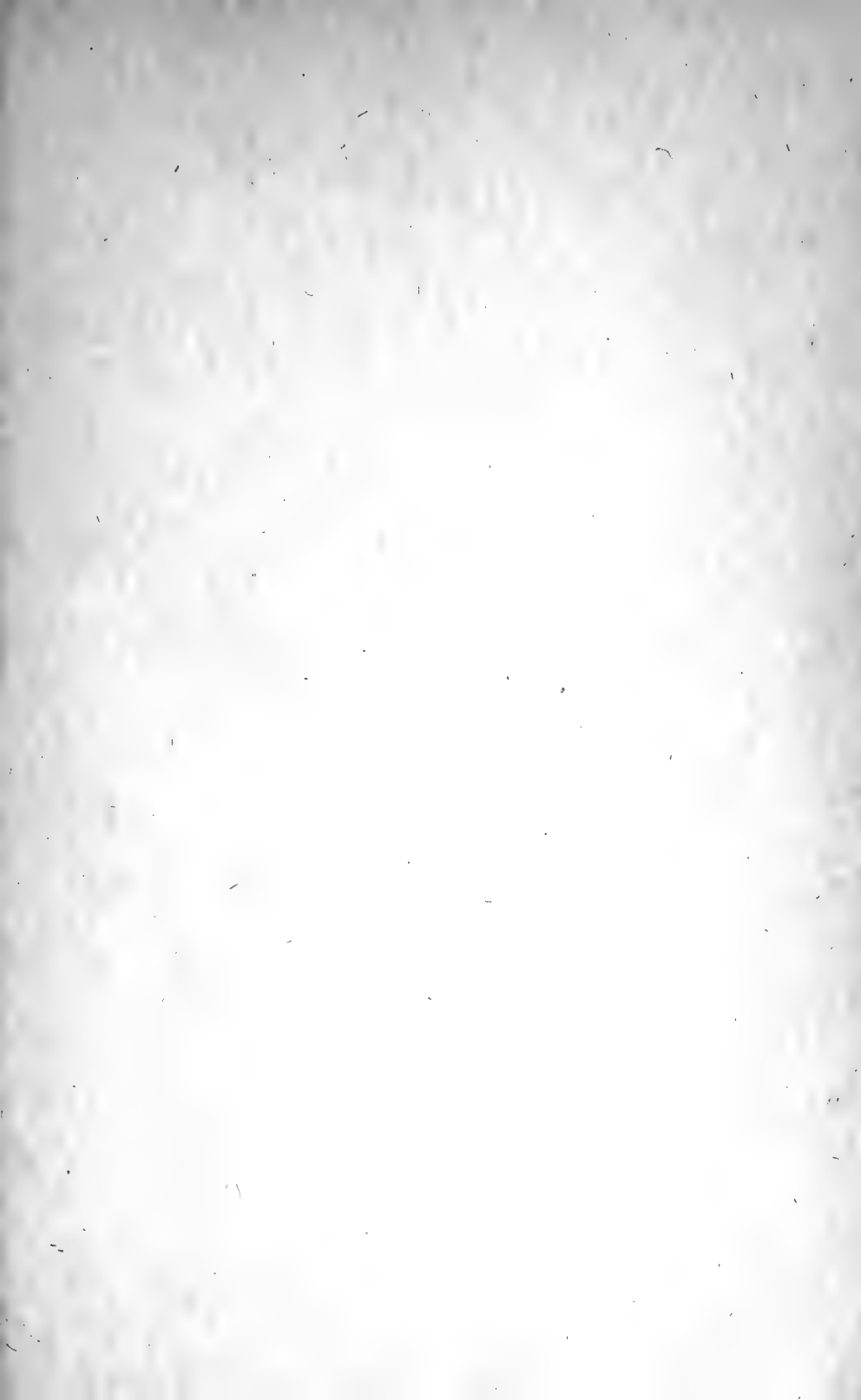



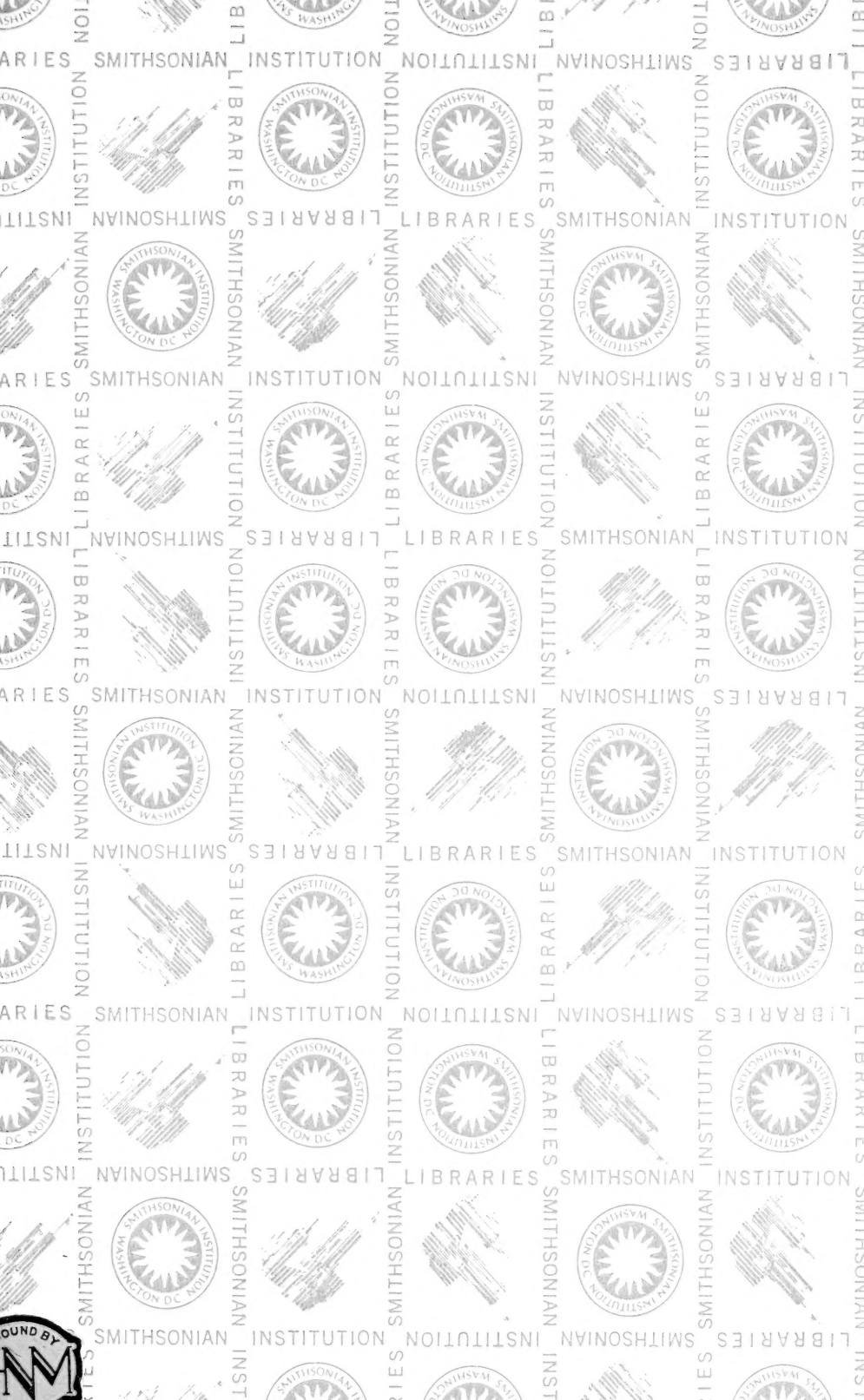

SMITHSONIAN INSTITUTION LIBRARIES



3 9088 01379 4953