



This is a digital copy of a book that was preserved for generations on library shelves before it was carefully scanned by Google as part of a project to make the world's books discoverable online.

It has survived long enough for the copyright to expire and the book to enter the public domain. A public domain book is one that was never subject to copyright or whose legal copyright term has expired. Whether a book is in the public domain may vary country to country. Public domain books are our gateways to the past, representing a wealth of history, culture and knowledge that's often difficult to discover.

Marks, notations and other marginalia present in the original volume will appear in this file - a reminder of this book's long journey from the publisher to a library and finally to you.

Usage guidelines

Google is proud to partner with libraries to digitize public domain materials and make them widely accessible. Public domain books belong to the public and we are merely their custodians. Nevertheless, this work is expensive, so in order to keep providing this resource, we have taken steps to prevent abuse by commercial parties, including placing technical restrictions on automated querying.

We also ask that you:

- + *Make non-commercial use of the files* We designed Google Book Search for use by individuals, and we request that you use these files for personal, non-commercial purposes.
- + *Refrain from automated querying* Do not send automated queries of any sort to Google's system: If you are conducting research on machine translation, optical character recognition or other areas where access to a large amount of text is helpful, please contact us. We encourage the use of public domain materials for these purposes and may be able to help.
- + *Maintain attribution* The Google "watermark" you see on each file is essential for informing people about this project and helping them find additional materials through Google Book Search. Please do not remove it.
- + *Keep it legal* Whatever your use, remember that you are responsible for ensuring that what you are doing is legal. Do not assume that just because we believe a book is in the public domain for users in the United States, that the work is also in the public domain for users in other countries. Whether a book is still in copyright varies from country to country, and we can't offer guidance on whether any specific use of any specific book is allowed. Please do not assume that a book's appearance in Google Book Search means it can be used in any manner anywhere in the world. Copyright infringement liability can be quite severe.

About Google Book Search

Google's mission is to organize the world's information and to make it universally accessible and useful. Google Book Search helps readers discover the world's books while helping authors and publishers reach new audiences. You can search through the full text of this book on the web at <http://books.google.com/>

UC-NRLF



\$8 100 190

SEP 17 1907

LIBRARY
OF THE
UNIVERSITY OF CALIFORNIA.

Class

UNIVERSITY OF CALIFORNIA

LIBRARY
OF THE

~~DEPARTMENT OF PHYSICS~~

Received *10/18/07*

Accessions No. *320* Book No. *6*

LOWER DIVISION

LOWER DIVISION

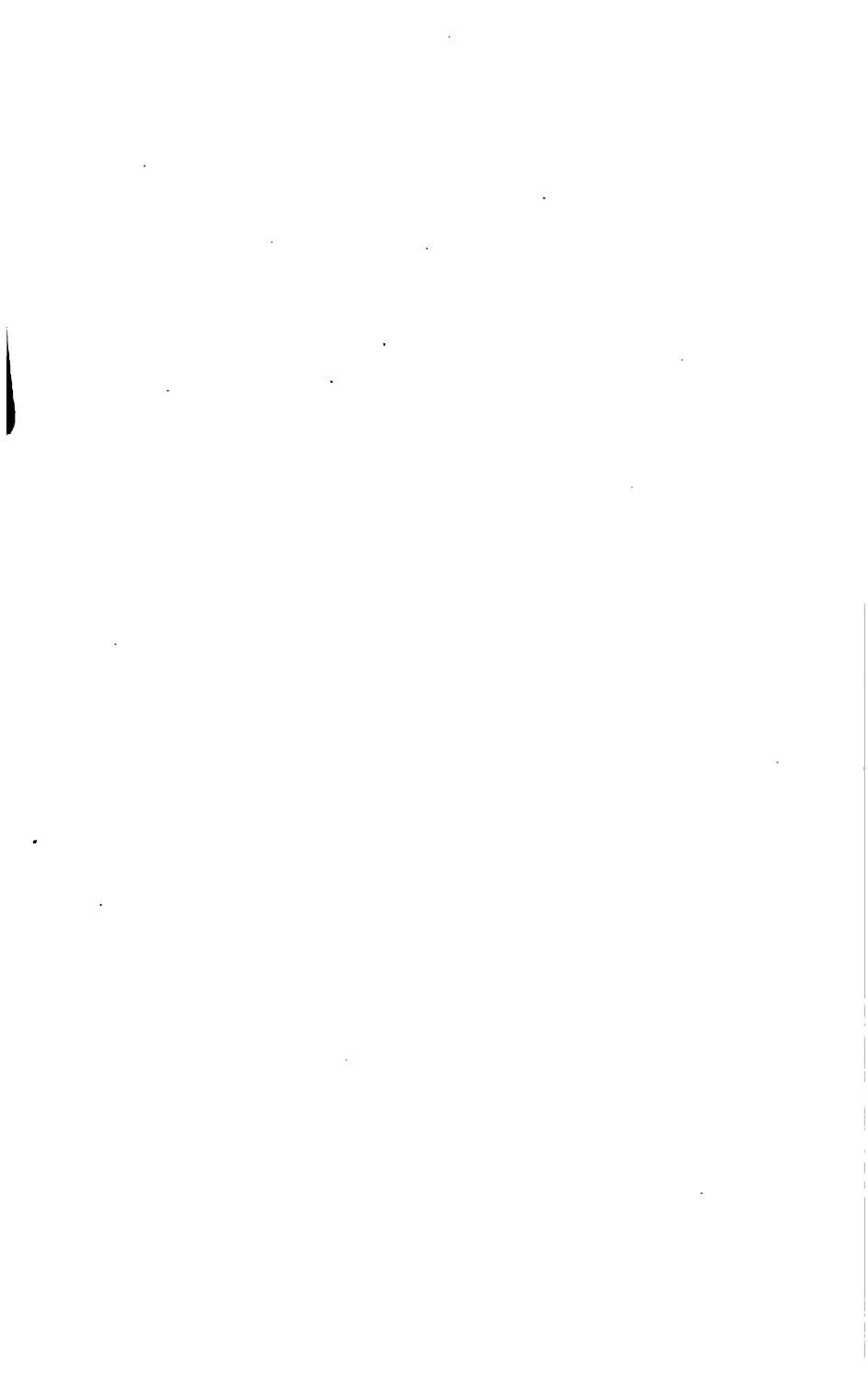



A MANUAL
OF
EXPERIMENTS IN PHYSICS

LABORATORY INSTRUCTION
FOR COLLEGE CLASSES

BY

JOSEPH S. AMES, Ph.D.

ASSOCIATE PROFESSOR OF PHYSICS IN JOHNS HOPKINS UNIVERSITY

AND

WILLIAM J. A. BLISS, Ph.D.

ASSOCIATE IN PHYSICS IN JOHNS HOPKINS UNIVERSITY



NEW YORK ··· CINCINNATI ··· CHICAGO
AMERICAN BOOK COMPANY

Q. C. 27
A 6

~~Physiology~~

Copyright, 1898, by HARPER & BROTHERS.

All rights reserved.

W. P. 5

P R E F A C E

THERE are two reasons why the study of Physics should be included in every college course: one is, because it teaches certain intellectual methods, certain modes of exact thought which are not required by other sciences in their elementary stages; the second is, because it teaches methods of accurate observation and measurement. Physics, as well as any science, may be studied entirely in the class-room; and profit may be derived from seeing performed by the instructor demonstrations of the fundamental experiments, and from following out the logical processes and methods based upon these; but it should not be thought that this is the entire aim of Physics. Every student should be taught in the laboratory how to measure those quantities which are involved in the statements of the laws of nature, and should be given an opportunity of verifying as many of these laws as possible.

One can divide into three classes those students who undertake laboratory work in Physics; and the requirements of these classes are by no means the same. At the present time the largest proportion of elementary students of Physics are taking the courses as part of their preparation for other sciences, in particular medicine and engineering; an increasing number are taking them simply in the course of their liberal education; while a comparatively small number look forward to continuing their work either as investigators or as teachers. It is obvious that there are certain laboratory exercises and methods which, while

absolutely necessary to a future physiologist or chemist, might be omitted in a system of general education, and might not be so important from purely physical considerations as some experiment of a similar but more fundamental character.

In preparing this text-book for use in Physical Laboratories, the needs of all three of these classes of students have been borne in mind, how successfully it is not possible to say. The only experiments described are quantitative, because it is assumed that purely qualitative ones are demonstrated in the lecture-room. Those experiments which are suited to a definite student or to a definite class must be selected by the instructor; and it is impossible to give any precise statement as to which are best adapted for any particular purpose. It has been impossible, of course, to include all the experiments which might be desired; but it is hoped that no important principle or piece of apparatus has been slighted.

The object of an experiment in Physics is not simply to teach a student to measure quantities and to verify the laws of nature; it should also lead him to look closely into the methods made use of, the theory of the instruments, the various sources of error, the possible deductions and applications of the principles involved. The importance, too, cannot be overstated of insisting upon the student learning neat and systematic methods of making, recording, and reporting observations. With these ends in view, each experiment, as described in this book, is divided into seven parts:

1. *Object of Experiment.*—This is simply a single paragraph stating the chief object of the exercise.

2. *General Theory.*—In this section is given a brief statement of the general theory of the physical laws involved in the experiment, and the general principles made use of in the methods of measurement. No particular forms of apparatus are described, but the essential details of the necessary processes are given.

3. *Sources of Error.*—Under this head are given the most important difficulties in the experiment, the most frequent causes of error, and the essential precautions.

4. *Apparatus.*—This is a list of the instruments and appliances required for the exercise, together with, in certain cases, a brief description of the instruments themselves.

5. *Manipulation.*—This is a full statement of the details of the experiment, with explicit directions as to quantities and methods.

6. *Illustration.*—There is given in nearly every case the result of an actual experiment performed in the manner described in the body of the exercise. These illustrations are meant to serve as guides to students in making their reports, as well as to show practically how accurate the experimental methods are.

7. *Questions and Problems.*—These are questions suggested by the experiment, and problems serving to illustrate the principles involved in it.

The object of this particular division and arrangement of each experiment has been twofold. The main one was the hope that the student might be induced to prepare himself for performing the experiment by a preliminary reading of the principles and methods involved. The second object was to avoid the danger, so far as possible, of making the descriptions apply to one particular set of apparatus.

In the use of this book an experiment should be assigned a student some days before he is to perform it; and he ought not to be allowed to take time from the regular laboratory hours for the preliminary study, which should be done elsewhere. He should get the necessary apparatus from the stock-room, which should be in charge of a custodian of apparatus, and should set up the apparatus himself. Records should be made in a systematic, permanent form; and the results should be deduced, not in the laboratory, but at other times, and should be reported to an instructor regularly (once a week or fortnight) in a suitable book. Those of the questions and problems which

an instructor desires answered should also receive attention in this report-book. It is often advisable for two students to work together while performing an experiment, and in some cases it is absolutely necessary; if this is done, each student should take an independent set of records and should hand in a separate report.

There is great difficulty in assigning the credit for any particular experiment or form of apparatus; but in every case where it is possible suitable acknowledgment has been made in a foot-note. Special thanks are, however, due to four former assistants in the Physical Laboratory of the Johns Hopkins University: Dr. W. S. Day and Mr. H. S. Uhler, who have taken great pains at various times in working out the details of many of the experiments; Mr. C. W. Waidner, for the substance of Appendix III. on galvanometers; and Dr. N. E. Dorsey, for a description of the clock-circuit contact devised by him, which is given in Appendix II. The drawings have all been made by one of our students, Mr. W. S. Gorsuch, Jr., to whom we are greatly indebted for his skill and promptness.

J. S. AMES.

W. J. A. BLISS.

JOHNS HOPKINS UNIVERSITY, *January, 1898.*

TABLE OF CONTENTS

GENERAL INTRODUCTION

	PAGE
C. G. S. System.....	2
Physical Measurement.....	2
Accuracy of Result.....	3
Graphical Methods.....	6
General Instructions.....	9

PRELIMINARY EXPERIMENTS

1. A rough determination of each of the three fundamental quantities—length, mass, and time.....	15
2. To determine the internal volume, or "capacity," of a bulb. <small>NOTE.—To measure areas and regular volumes.</small>	22
3. To determine the number of centimetres in one inch.....	26
4. To learn the method of using a vernier.....	30
5. Use of vernier caliper.....	34
6. Use of micrometer caliper.....	39
7. Use of the spherometer.....	43
8. Use of the dividing-engine.....	49
9. To measure the pitch of the screw of a micrometer microscope	55
10. Use of comparator or cathetometer.....	58
11. To determine by the method of vibrations the position of equilibrium of the pointer of a balance.....	61

**EXPERIMENTS IN MECHANICS AND PROPERTIES
OF MATTER**

	PAGE
INTRODUCTION TO MECHANICS AND PROPERTIES OF MATTER..	67
Units and definitions.....	67
12. To determine the linear velocity and acceleration of a rapidly moving body.....	70
13. To determine angular velocity and acceleration.....	79
14. To determine the mass of a body by inertia	85
15. To verify the Principle of the Conservation of Linear Momentum.....	90
16. To show:	
1. That if different forces act upon the same body, the acceleration, is directly proportional to the force.	
2. That if the same force acts upon bodies of different masses, the acceleration is inversely proportional to the mass ..	98
17. To verify the law of centrifugal motion, that a force $m r \omega^2$ is required to make a mass m move in a circle of radius r with a constant angular velocity ω	105
18. To verify the laws of harmonic motion.....	111
19. To verify the law of moments.....	118
20. To verify the laws of equilibrium of three forces acting at one point. <small>NOTE.—On the use of spring-balances</small>	122
21. To verify the laws of equilibrium of parallel forces in the same plane.....	129
22. To verify the laws of equilibrium of an extended rigid body under the action of three forces.....	133
23. To determine experimentally the centre of gravity of a weighted bar.....	136
24. To determine the "mechanical advantage" and "efficiency" of a combination of pulleys.....	141
25. To determine the coefficient of friction between two polished wooden surfaces.....	146
26. To determine the mass of the hard rubber cylinder whose volume was found in Experiment 5.....	151
The theory of a chemical balance.....	151
Reading a barometer.....	157
27. To verify Hooke's Law and to determine "Young's Modulus" for a given substance by stretching a wire.....	168
28. To determine the coefficient of rigidity for iron	168
A method of measuring intervals of time exactly.....	168
29. To verify the laws of fluid pressure.....	179

	PAGE
30. To determine the density of a liquid by means of "balancing columns." <i>NOTE</i> —Capillary corrections.....	188
31. To determine the density of a solid by means of a chemical balance. Archimedes's principle.....	189
32. Use of Nicholson's hydrometer and determination of the density of some small solid.....	198
33. To determine the density of a small solid by Jolly's balance.	197
34. To determine the density of a floating body.....	201
35. To measure the surface-tension of pure and impure liquid surfaces.....	204
36. To measure the density of a gas.....	206
37. To prove that Boyle's Law holds for air approximately.....	209

EXPERIMENTS IN SOUND

INTRODUCTION TO SOUND.....	217
38. A study of "stationary" vibrations.....	218
1. Long flexible cord.....	218
2. Water tank.....	222
39. To verify the formula for the frequency of a stretched string or cord when vibrating transversely.....	226
To study the laws of harmony.....	232
<i>NOTE</i> .—To measure the frequency of a tuning-fork.	
40. To determine the velocity of sound in air by means of stationary waves in a resonance tube.....	233
41. To determine the velocity of longitudinal vibrations in a brass rod by Kundt's method.....	239
42. To compare the velocity of longitudinal waves in brass and in iron.....	243
43. To study the different modes of vibration of a column of gas	246

EXPERIMENTS IN HEAT

INTRODUCTION TO HEAT.....	253
Use of a mercury thermometer.....	254
44. To test the fixed points of a mercury thermometer.....	259
45. To determine the coefficient of linear expansion-of a solid rod or wire.....	265
46. To measure the apparent expansion of a liquid.....	271
47. To determine the mean coefficient of cubical expansion of glass between 0° and 100° C.....	274
<i>NOTE</i> .—To measure the absolute expansion of a liquid.	

	PAGE
48. To measure the increase of pressure of air at constant volume when the temperature is increased. Air thermometer.	278
49. To determine the specific heat of a metal— <i>e. g.</i> , lead or brass.	282
50. To determine the specific heat of turpentine	288
51. To determine the "melting-point" of paraffine.	291
52. To determine the latent heat of fusion of water.	295
53. To determine the boiling-point of benzene.	300
54. To determine the latent heat of evaporation of water at 100° C.	302
55. To verify the law of saturated vapor	306
56. To plot the "cooling curve" of a hot body.	311

EXPERIMENTS IN ELECTRICITY AND MAGNETISM

INTRODUCTION TO ELECTRICITY AND MAGNETISM.	317
Units and definitions: General directions.	317
57. To plot the fields of force around various electrified bodies. .	321
58. A study of electrostatic induction by means of the gold-leaf electroscope.	325
59. To repeat Faraday's "Ice Pail" experiment.	328
60. A study of an electrical induction machine.	332
61. 1. To show that the capacity of a condenser composed of two parallel plates varies inversely as the distance between its plates.	334
2. To determine the dielectric-constant of some dielectric, such as glass.	334
62. To map a "current sheet".	340
63. To plot the magnetic field of force.	344
1. Of a magnet and the earth together.	
2. Of the magnet alone.	
64. To measure the magnetic inclination or dip.	349
65. To compare the intensities of fields of magnetic force.	356
66. To measure the horizontal intensity (H) of the earth's magnetic field.	359
67. To prove that the resistance of a uniform wire varies directly as its length.	365
68. To determine roughly the effect upon resistance of alterations in length, cross-section, temperature, and material of a conductor.	371
69. To measure a resistance by the Wheatstone wire-bridge method	375
70. To measure the resistance of a mirror-galvanometer by Thomson's method, using a "Post-office Box".	381
71. To measure the resistance of a cell by Mance's Method.	385

TABLE OF CONTENTS

xi

	PAGE
72. To measure the specific resistance of solutions of copper sulphate by Kohlrausch's Method.....	388
73. To compare electromotive forces by the high-resistance method.....	392
74. To compare electromotive forces by the "condenser method" NOTE.—Use of ballistic galvanometer.	396
75. To determine the "galvanometer constant" of a tangent galvanometer. Water voltameter.....	402
76. To determine <i>G</i> or <i>H</i> by the deposition of copper.....	409
77. To determine the mechanical equivalent of heat by means of the heating effect of an electric current. Joule's law.....	414
78. To determine the "Magnetic Dip" by means of an "earth inductor".....	420

EXPERIMENTS IN LIGHT

INTRODUCTION TO LIGHT.....	427
79. To compare the intensities of illumination of two lights by means of a Joly photometer.....	428
80. To verify the laws of reflection from a plane mirror.....	431
1. Plane waves.	
2. Spherical waves.	
81. To verify the laws of reflection from a spherical mirror.....	436
1. Real image.	
2. Virtual image.	
82. To verify the laws of refraction at a plane surface.....	442
1. Plane waves.	
2. Spherical waves.	
83. To measure the index of refraction of a solid which is made in a plate with plane parallel faces.....	446
84. To verify the laws of refraction through a spherical lens....	449
85. To construct an astronomical telescope.....	455
86. To construct a compound microscope.....	457
87. To measure the angle between two plane faces of a solid.... The adjustment of a spectrometer.....	459
88. To study the deviation produced by a prism. To measure the angle of minimum deviation.....	469
89. To measure the index of refraction of a transparent solid made in the form of a prism.....	474
90. To study color-sensation.....	476
91. To measure the wave-length of light by means of a grating.	477

APPENDIX I

LABORATORY EQUIPMENT

	PAGE
Aspirator pump.....	488
Platform air-pump.....	488
Drying tubes.....	484
Distilled water.....	484
Clock circuit.....	484
Sets of chemicals.....	488
Supplies.....	488
Books of reference.....	488
Glass-blower's table.....	489
Laboratory tables.....	489
Balances.....	489
Galvanometers.....	489
Storage-batteries.....	489

APPENDIX II

LABORATORY RECEIPTS AND METHODS

Cleaning glass.....	491
Cleaning mercury.....	491
To fill a barometer tube with mercury.....	494
Amalgamating zinc.....	495
Amalgamating copper.....	495
"Universal wax".....	496
Cements.....	496
Damping keys and magnets.....	496
Sensitizing mixture.....	498
Silvering mirrors.....	498
Mercury cups.....	498
Open iron resistance-boxes.....	498
Sliding resistances.....	499
Mercury trays.....	499
Simple glass-blowing.....	499
Standard cells.....	501

APPENDIX III

GALVANOMETERS

Tangent galvanometers.....	504
The differential galvanometer.....	504

TABLE OF CONTENTS

xiii

	PAGE
The ballistic galvanometer.....	505
D'Arsonval galvanometers.....	505
Proportionality of deflection with current.....	506
Choice of a galvanometer.....	507
Controlling magnet.....	507
The suspended system.....	508
Magnets.....	510
The staff.....	511
Mirrors.....	511
Suspension fibres.....	512
Astaticism.	
1. Horizontal systems.....	512
2. Vertical systems.....	518
Sensibility.....	514

TABLES

1. Mensuration.....	517
2. Mechanical units.....	517
3. Elastic constants of solids.....	518
4. Densities.....	518
5. Surface tension.....	520
6. Acceleration due to gravity.....	520
7. Correction for large arcs of vibration.....	521
8. Capillary depression of mercury in glass.....	521
9. Barometric corrections.	
1. Correction for temperature.....	522
2. Correction for variation in g	522
10. Frequencies of middle octave.....	523
11. Velocity of sound.....	523
12. Average coefficients of linear expansion between 0° and 100° C.....	523
13. Average coefficients of cubical expansion of liquids.....	524
14. Average specific heats.....	524
15. Specific heats of gases.....	524
16. Fusion constants.....	524
17. Vaporization constants.....	525
18. Vapor-pressure of water.....	525
19. Vapor-pressure of mercury.....	526
20. Heats of combination.....	526
21. Thermal conductivities.....	527
22. Dielectric constants (electrostatic system).....	527



A MANUAL
OF
EXPERIMENTS IN PHYSICS

GENERAL INTRODUCTION

To understand properly any phenomenon implies two things: a study of the sequence of events, the cause and effect; and a determination of exactly how much is involved of each quantity which is concerned in the phenomenon. We cannot understand any phenomenon unless we can measure it.

In order to measure quantities certain standards or units must be chosen, in terms of which to express the numerical values. It is shown in any treatise on Physics that every quantity which enters into the phenomena of matter in motion can be reduced to a certain amount of matter, a certain space, and a certain interval of time (see "Physics,"* Art. 7). Consequently it is necessary to adopt standards of quantity of matter, of space, of time, which will serve as mechanical units. Similarly it is necessary to select units in terms of which to measure electrical and magnetic quantities.

* Here, as elsewhere in this book, this reference is to "Theory of Physics," by J. S. Ames, and published by Harper & Brothers: 1897.

C. G. S. System. The units of length, of matter, and of time which have been adopted by the scientific world (see "Physics," Art. 8) are the following :

Unit of Length. The centimetre, the one-hundredth portion of the length of a metal rod which is kept in Paris when it is at the temperature of melting ice. On this unit are based the square and cubic centimetres, as units of area and volume.

Unit of Quantity of Matter. The gram, the one-thousandth portion of the quantity of matter in a lump of platinum which is kept in Paris. (The gram is very approximately the quantity of matter in one cubic centimetre of distilled water at the temperature when it is most dense, *i.e.*, 4° C.).

Unit of Time. The mean solar second, an interval of time such that 86,400 of them equal the mean solar day, *i.e.*, the average length of the solar day for one year.

On these mechanical units are based the subsidiary units of speed, velocity, acceleration, force, energy, etc. The electrical and magnetic units will be defined later.

This particular system of units is called the C. G. S. system, from the initial letters of centimetre, gram, second; and in terms of these or of units derived from them all physical quantities should be expressed. That is, a length, whenever it occurs, should be measured in centimetres; all masses should be measured in grams; and all intervals of time in seconds. These units are perfectly arbitrary, but there is no reason to suppose that the standards will ever change; and having received the sanction of all civilized countries and all scientists, they should be used in expressing every measurement. Moreover, they are very convenient, since they are the foundation of decimal systems, and not systems in which the smaller and larger measures are related in arbitrary ratios, as the foot and inch.

Physical Measurement. The object of a physical experi-

ment is in general to measure a quantity either directly or indirectly. Thus, a length can be measured directly by means of a centimetre rule; but the density of a body, that is, the number of grams in one cubic centimetre, is measured indirectly, since to determine the density measurements must be made of quantities which are connected with density by a physical relation which can be expressed in a mathematical formula. In every case, however, a series of measurements must be made of certain quantities, either the quantities which are themselves desired or those which enter into a certain formula, stating some physical definition or law.

It is obviously impossible to know whether any one of the observed measurements gives the *true* value of the quantity, and the separate measurements will in general differ among themselves. We are, therefore, led to inquire how we can best use these differing determinations so as to deduce from them as close an approximation to the truth as possible, and also to learn how great an error we are liable to in the result thus obtained.

While paying special attention, however, to the more minute portions of a measurement, care must be taken to make no mistake in recording the numbers which express the larger part of the measurement. Thus, in measuring a length of 5.21 cm. the student is far more liable to make a careless mistake in reading 4 or 6 instead of 5 than to make an inaccurate reading of the 21. The error in the "whole number" must be most carefully guarded against.

Accuracy of Result. If a long series of readings of the same quantity has been made, the same care being given each individual measurement, the arithmetical mean of these readings is the most probable value of the quantity; and by comparing this mean value with the individual readings a great deal may be learned as to the degree of accuracy of the method used and the observations. The general process is to write the readings in a vertical col-

umn, and in another column write the differences between each of these and the mean, placing + or - before each difference according as that measurement is greater or less than the mean. The difference for any reading is called the "residual" for that observation; and if the residuals are large, it is evident that there is much more uncertainty as to the accuracy of the mean value than if the residuals are small. It is evident, too, that if only a few observations are taken, the accuracy of the mean value is not so great as it would be if a long series were taken. Consequently it should be possible from a consideration of the magnitude of the residuals and the number of times the measurement is repeated to form a definite idea of the probable error to which the mean value is liable. The theory of this determination is given in the "Method of Least Squares," a mathematical process based upon the theory of probabilities. It is sufficient here to state that this method shows that, if we define as the "Probable Error" a magnitude such that the actual error of the mean is more likely to be less than this rather than greater, then the probable error of the mean of n observations is $0.6745\sqrt{\frac{s}{n(n-1)}}$, where s is the sum of the squares of the residuals. The probable error of any one of the n observations is $0.675\sqrt{\frac{s}{n-1}}$, showing that the probable error of the mean is less than that of any observation in the ratio of $1:\sqrt{n}$.

If x is the *true* value of a certain quantity, and if a is the mean value of a series of measurements of that quantity, the true meaning of the "probable error" can be expressed mathematically thus:

$$a + e > x > a - e,$$

where e is written for the probable error. In words, the true value of a quantity lies between the mean of the observations plus the probable error and the mean minus the

probable error. In stating the result of the series of measurements, it is ordinarily said that the value of x is $a \pm e$, with the interpretation of e as given above.

When the object of the experiment is to deduce the value of a quantity from measurements of other quantities connected with it by a formula, it is possible to calculate the probable error of the final result if the probable errors of the individual quantities which are substituted in the formula are known. Thus, if it is wished to determine the probable error in the product of two quantities whose *true* values are x and y , and which have been measured with the result that x is found to be $a \pm e_1$, and y is found to be $b \pm e_2$, where e_1 and e_2 are the probable errors of a and b respectively, the product of the measurements, ab , is compared with the product $(a \pm e_1)(b \pm e_2)$. The difference is $\pm a e_2 \pm b e_1 \pm e_1 e_2$, but $e_1 e_2$ is so small a quantity numerically that it may be neglected in comparison with the first two quantities. Thus the uncertainty of a is e_1 , that of b is e_2 , and that of ab is $a e_2 + b e_1$. Writing this e , we have

$$e = ae_2 + be_1$$

or

$$\frac{e}{ab} = \frac{e_1}{a} + \frac{e_2}{b}.$$

$\frac{e}{ab}$, expressed in hundredths, is the "percentage" that e is

of ab ; $\frac{e_1}{a}$ is similarly the percentage that e_1 is of a , etc.

Consequently, the percentage error of a product is the *sum* of the percentage errors of the factors; and the rule can obviously be extended to any number of factors. Therefore, to determine the error of a calculated quantity, express the probable error of each factor entering into the formula as so many per cent. of that factor, add the percentage probable errors of all the factors, and the sum is the percentage probable error of the product. The numerical value of the probable error may be at once calcu-

lated from the percentage probable error; thus, if the product of the means of the observed quantities is 10.05 with a probable *percentage* error of 0.5, the probable error is $\pm 10.05 \times 0.005$ or ± 0.05 .

If in the formula the sums of certain products enter, the probable error of each product must be calculated separately, and their sum gives the probable error of the calculated quantity.

Two most important facts are apparent from the above theory of the probable error of a product.

1. If in the formula which enters in the experiment a factor appears to the m th power, the percentage probable error of this factor introduces in the product a percentage probable error m times as large as it would if it entered to the first power only, because percentage errors are added. Therefore a quantity which appears in the formula as squared or cubed must be measured with much greater care than a quantity which appears in the same product only to the first power.

2. If, owing to special difficulty in measuring a certain quantity, the probable error thereby introduced is liable to be large, care must be concentrated upon this quantity, and its probable error must be reduced as much as possible by repeated measurements. The other quantities which enter into the formula may often be measured comparatively roughly, without appreciably affecting the error introduced by the one whose value is obtained with difficulty.

Graphical Methods. In many experiments the object is either to verify a law stating the relation which exists between two quantities or to discover one if it exists. In expressing the result of such experiments, it is always best to have recourse to graphical methods.

Thus, suppose it is a question of the verification of Boyle's law for gases, viz., "at constant temperature the product of the pressure and volume of a given amount of gas remains constant."

Let the measured pressures and corresponding volumes be

Pressures	Volumes
82.1	12.03
88.2	11.20
96.2	10.26
105.5	9.35
118.9	8.31
135.5	7.29
160.1	6.17
105.	

Draw two lines at right angles to each other, one horizontal and the other vertical. Consider distances from the vertical line measured horizontally to mean volumes, and distances above the horizontal line to mean pressures, according to any arbitrary scale which we may find convenient. Obviously, any point of the region between the lines represents a certain definite state of pressure and volume, since it

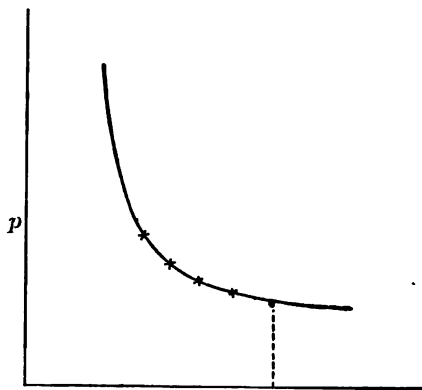

FIG. 1

is at a definite distance from each of the two lines. In the experiment we observe the gas in a number of states, in each of which we measure its pressure and volume. For each such state there is then a corresponding point on the diagram, which we mark with a cross (x). Moreover, since the gas passed continuously from one of these states to another, we could have found any desired number of points, forming an unbroken chain between any two of those actually measured. This we denote by drawing an unbroken curve connecting the individual points

observed. Furthermore, we know that each of our observations is liable to error, whereas it is unlikely that there are sudden changes in the behavior of the gas at the points observed. We therefore draw our curve so that it is "smooth," even though it does not exactly pass through each observed point; but we try to leave as many of these points above it as below it. Finally, we mark along the horizontal line the scale according to which horizontal distances denote volumes and a similar scale of pressures along the vertical line. Distances along the horizontal line are sometimes called "abscissæ," and vertical distances "ordinates."

Another illustration is afforded by the measurement of the change in volume of water as its temperature is raised, starting from such a temperature that the water is in a solid condition, and ending at a temperature so high that the water is vaporized. In the figure volumes are measured by ordinates and temperatures by abscissæ. The scale

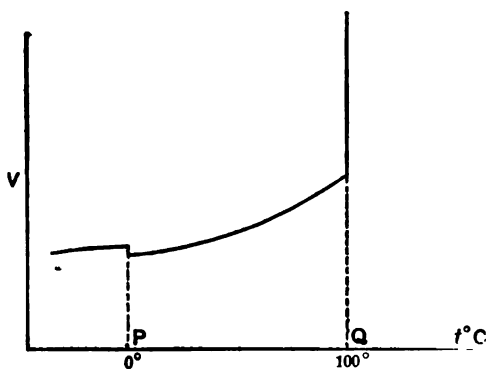

FIG. 2 .

of temperature is so chosen that 0° Centigrade comes at P and 100° at Q ; then points to the left of P correspond to temperature below 0° C.

It is often a good plan in plotting graphically a series of observations to draw

around the point which records a particular observation a small circle with a radius equal to the estimated probable error of that observation. Then in drawing a curve through the various points it may be at once seen whether the distances of points from the curve, which always arise

if the curve is made "smooth," exceed the limits of accuracy of the experiment. Obviously, considerable discretion is needed in drawing these observation curves, but ambiguity seldom arises.

General Instructions. It is of the utmost importance that the student should learn to record his observations clearly and systematically, and to this end the following rules should be observed :

1. All observations should be recorded in a suitable note-book at the time they are made—loose sheets are often lost or mislaid. These records should be made neatly and according to some scheme which has been thought out previous to the actual experiment. It is often convenient to rule vertical lines, and place different measurements of the same quantity in one column, so that they may be compared or averaged.

2. The *actual observations* should be recorded. In no case should a mental calculation be made, and only its result noted ; all calculations, however simple, should be done at a later time. The laboratory note-book should always show the original observations. Thus, if the zero-point of an instrument is wrong, allowance should not be made in the observations, but the actual error and the actual observation should both be recorded.

3. A carefully prepared report of each experiment should be written in ink in another book, and this should be handed to the instructor for his inspection and comments. In the following chapters of this manual forms will be given under each experiment, which should be followed as far as possible by the student in making his report.

4. Both in the actual record and in the subsequent report care should be taken in so entering the figures that they indicate the precise accuracy of the measurements. For instance, if four observers measure the same length and note it as follows, A as 5 metres, B as 5.0 metres, C as 5.00 metres, D as 5.000 metres, the supposition is that A is certain of the length as being 5 metres rather than 4

or 6, but that he does not know whether the length may not be a fraction of a metre greater or less than 5; B is certain that the length is not 5.1 or 4.9 metres, but he does not know whether it may not be some hundredths of a metre greater or less than 5 metres; C is certain that the length is not 5.01 or 4.99 metres, but it may vary some thousandths of a metre from 5; D, however, is certain that the length cannot differ from 5 metres by a thousandth of a metre. If all four observers have used the same means of measurement, and if it is known that these are accurate enough to ascertain the length only to within one hundredth of a metre, then A is a most careless observer, B is less so, D is untrustworthy because he overstates the accuracy, while C states the result correctly. It is fully as bad to be an observer like D as to be like B.

The same rule applies to a result calculated from measured quantities; each figure should have a definite meaning, and any uncertainty as to a result should be expressed. Thus 5.002 ± 0.001 means that the observer is uncertain of the final 2 in 5.002 to within one figure, *i. e.*, it may be anywhere between 3 and 1. The accuracy of an experiment cannot be increased by carrying out the result of a division or of a multiplication to additional places of decimals; and the accuracy of any calculated result is limited by that of the original measurements, as has been explained in the section on "Accuracy of Result."

It is often convenient in expressing a large or a small quantity to use a factorial method; thus, instead of 54600000. it is better to write 5.46×10^7 , and instead of 0.0000018 to write 1.8×10^{-6} .

5. Before any particular experiment is performed, the student should read carefully the description of the method and manipulation as given in the manual, and should consider especially what quantities are the most difficult to measure, which should be measured most accurately (see p. 6), and what particular precautions must be taken. In using any instrument the readings should be made with

the utmost accuracy attainable, unless careful consideration has shown that this is unnecessary, owing to the unavoidable error which may enter in another measurement in the same experiment.

6. It is a general rule that if the scale of any instrument is divided into small divisions, the reading should be made by estimation to *one-tenth* of one of these smallest divisions. In such an estimation it must be remembered that the true boundaries between the divisions are infinitely narrow lines, and that the broad marks actually made are intended to spread as much on one side as on the other. We must therefore mentally divide into tenths the space between the *middle* of the marks, and not that between the edges.

7. In the report which is handed to the instructor, the student should give answers to the questions and problems, and should also carefully explain how he has avoided or considered each of the sources of errors mentioned in the general description of the experiment. It should be needless to add that logarithms should always be used, and that numerical calculations should not be recorded in the report.

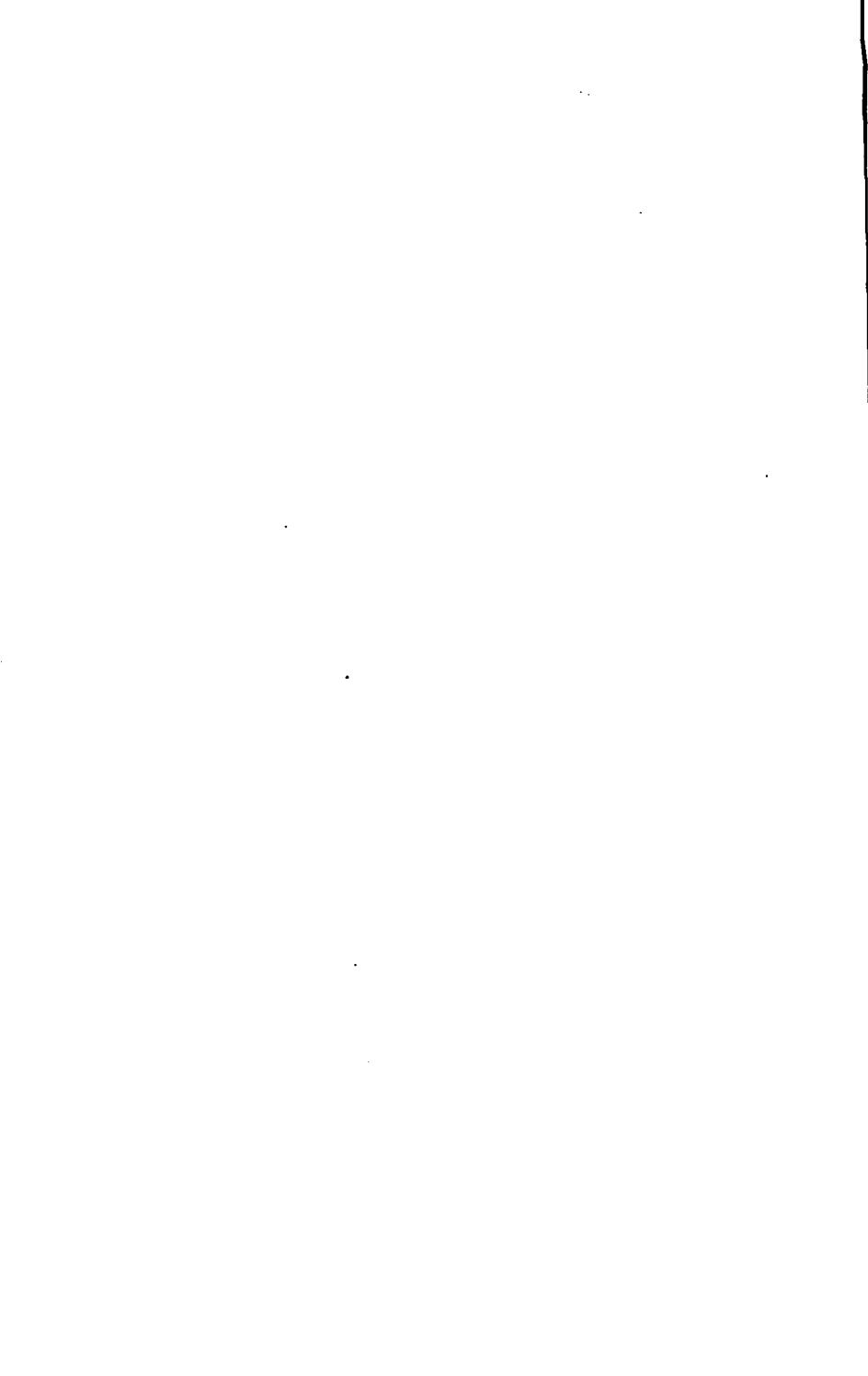

PRELIMINARY EXPERIMENTS

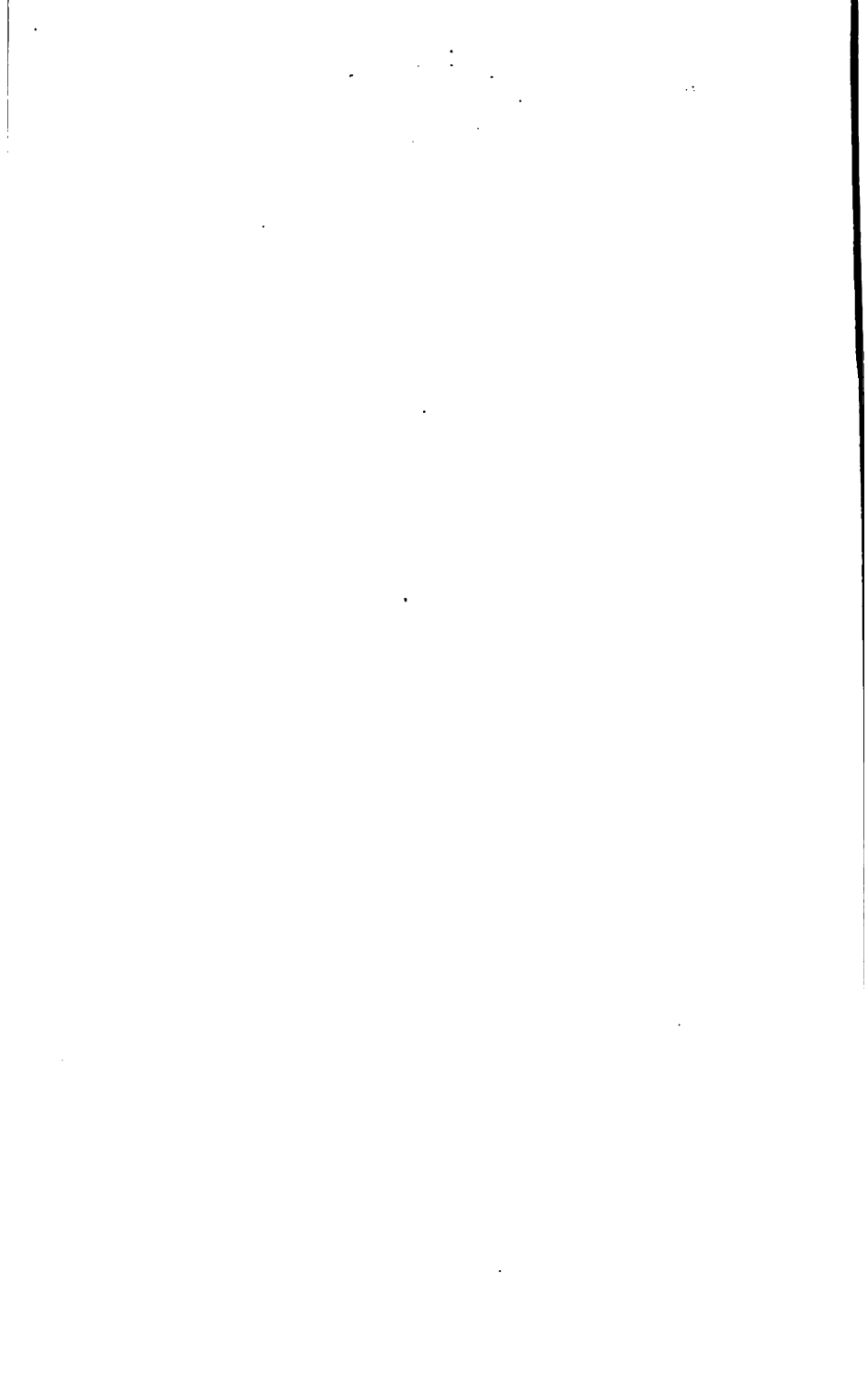



EXPERIMENT 1

(PART 3 REQUIRES TWO OBSERVERS)

Object. A rough determination of each of the three fundamental quantities—length, mass, and time. (See “Physics,” Art. 7.)

1. To Measure the Length of a Straight Line

General Theory. A straight graduated bar is held parallel to the line, and the points on the scale which are “opposite” the ends are read. By “opposite” is meant connected with them by straight lines perpendicular to the scale and to the desired length. The difference in the readings gives the desired length.

Sources of Error.

1. The scale and line may not be parallel.
2. Care must be taken to determine the points on the scale which are exactly “opposite” the ends of the line.
3. There may be defects in the measuring bar itself, due to faulty graduation, warping, or wear.

Apparatus. A sheet of paper upon which a straight line is carefully ruled, the ends of the line being sharply defined; a metre bar.

Manipulation. Examine the metre bar; see that it is straight, and that there are no evident defects in the ruling. Lay the sheet of paper on a smooth table in a good light. Place the bar along the line to be measured, and turn both paper and bar until there is a good light on the scale and also on the line. Turn the bar on its edge, so as to bring the graduated scale as close as possi-

pound weight in one pan and a gram weight which you think approximately equal to it in the other. If this turns out to be too small, double it; if too large, halve it. Find thus at once two masses, one greater and the other less than a pound. Try next a weight half-way between these two extremes, and continue similarly until a change of $\frac{1}{10}$ of a gram shifts the pointer from one side to the other.

Estimate the fraction of $\frac{1}{10}$ g. which will be necessary to obtain an accurate balance, and note the mass of a pound thus found. Now interchange the weights from one pan to the other, placing the pound on the side in which the grams were, and *vice versa*; and note whether any change must be made in the equivalent of a pound in grams as found before. If there is a difference, take the mean of the two quantities. This corrects the third error. The student will have to assume his weights to be accurate. They are tested when necessary by weighing each large weight in turn with those smaller than itself, and finally comparing one of the set with a standard.

ILLUSTRATION

Oct. 5, 1896

Pound in right pan, gram weights in left, 1 lb. = 453.55 grams.

Pound in left pan, gram weights in right, 1 lb. = 453.65 grams.

Mean 453.60 grams.

3. To Determine the Period of a Pendulum with an Ordinary Watch

General Theory. The "period" of a pendulum is the time which elapses between one passage through a given point of its swing and the next transit when it is moving in the *same* direction. Since the instant it passes through its central portion is more sharply defined than any other, because the motion of the pendulum is fastest then, a period is best measured between one transit through the middle point of its swing and the next in the same direction. Since the time of one period is very short, we increase the accuracy of the experiment by measuring the time of a large number of successive periods, say fifty.

Sources of Error.

1. If the central point of the swing is not marked by a sharp line back of it, and if the passage of the pendulum across this line is not always viewed from the same direction, the interval of time measured may not be a period, because there is no way of fixing the point at which transits should be observed.
2. Care is necessary to read the watch accurately and note the exact time of the transits.

Apparatus. A metal ball; thread; a metal clamp attached to a firm support about two metres from the floor and with the jaws vertical; a watch with a second-hand.

Manipulation. A bicycle ball may be used as a pendulum by attaching it to a thread about a metre long, making three loops tightly around it at right angles to one another, and fastening the intersection with a little wax. Suspend the thread from a clamp as shown. For a line of reference use a second vertical thread tied to a nail or other firm support close behind the pendulum and stretched by hanging from it any convenient weight, such as a knife.

With the pendulum at rest one observer, A, places his eye in such a line that the two threads coincide, taking care to note some distant object, *e. g.*, a line on the opposite wall, or the edge of a door, which is in the same line; so that, if he moves, he can return to the same position as before. The other, B, sits at a table with the watch open before him and a note-book convenient. A starts the pendulum swinging in a vertical plane through a small arc—1 cm. each side is enough. Holding his eye in the right position

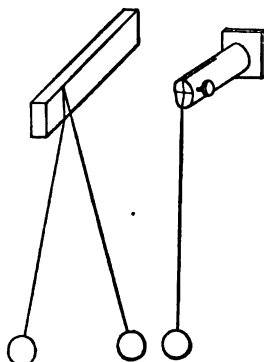

FIG. 6—Bad*

FIG. 7—Good

* This drawing is taken from Worthington, "Physical Laboratory Practice."

he observes the transits of the pendulum thread across the fixed thread. When both observers are ready, A warns B, and as one thread passes the other he gives a sharp tap with a knife or pencil on the cover of his note-book. B notes the reading of his watch at the instant of the tap, which he should be able to do correctly to within half a second. A counts each transit in the same direction up to fifty. As fifty is approached he calls out the numbers 48, 49, as a warning, and taps again just as the fiftieth period is finished. B notes the instant of the tap again.

Take five sets of fifty each in this manner. Then let A and B interchange and take five more.

Deduce the period from each and average.

ILLUSTRATION

Oct. 5, 1896

TIME OF 50 VIBRATIONS

	Start		Finish		Interval in seconds	Period in seconds
	h.	m. s.	h.	m. s.		
Mr. B reads the watch.	2:	31: 27	2:	33: 1½	94.5	1.89
		38: 31½		35: 4½	98.	1.86
		35: 40		37: 16	96.	1.92
		37: 48½		39: 17	98.5	1.87
		39: 25		40: 59	94.	1.88
						Mean 1.884

Greatest deviation from mean is 2 per cent.

	Start		Finish		Interval in seconds	Period in seconds
	h.	m. s.	h.	m. s.		
Mr. A reads the watch.	2:	42: 58½	2:	44: 28	94.75	1.895
		44: 51		46: 24½	98.5	1.87
		46: 50½		48: 23½	98.	1.86
		48: 44		50: 18	94.	1.88
		50: 35½		52: 9½	94.25	1.885
						Mean 1.878

Greatest deviation from mean is 1 per cent.

Mean of both observers: 1.88.

NOTE.—Refinements upon these methods of measuring the three fundamental quantities will be introduced later. The student should note, however, that the sources of error pointed out above under each heading are common to all methods, and it will be assumed hereafter that the student is

aware of them, and their enumeration will not be repeated under the heading "Sources of Error" in future experiments. The student must never forget to guard against them, though not specifically told to do so.

Questions and Problems.

1. Exactly how much error would be produced in the measurement of the length of the line, if the line and scale were inclined to each other by 1° ?
2. What is meant by "density"? How could you determine the density of a circular cylinder of wood?
3. Can you explain why difference in the lengths of the balance arms is corrected by "double weighing"?
4. What modifications of the balance would you suggest in order to make one which would be more delicate?
5. Calculate the "probable error" of the mean period of the pendulum.
6. Why does the amplitude of the pendulum slowly decrease? Does the period change as this happens?

EXPERIMENT 2

Object. To determine the internal volume, or "capacity," of a bulb. (See "Physics," Art. 8.)

General Theory. A large glass bulb with capillary stem is cleaned, dried, and weighed. It is then filled up to a certain point with water or some other liquid and weighed again. The difference in weight is that of the mass of water or liquid necessary to fill the tube up to the mark. Knowing the temperature of the water or liquid, the density—*i. e.*, the mass of a cubic centimetre—is found in the Tables, and the capacity of the bulb and stem up to the scratch is deduced.

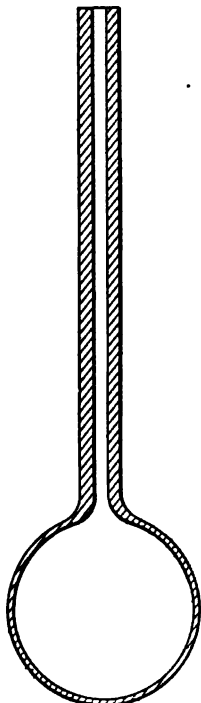

FIG. 8

Sources of Error.

1. The liquid—*e. g.*, water—may contain bubbles of air.
2. The mass of the liquid is determined as the difference of two masses. Each of these must therefore be measured with extreme accuracy.

Apparatus. A glass bulb with capillary stem—about 300 cc. is a convenient size; platform scales and weights as in Experiment 1; centigrade thermometer; Bunsen burner. Chromic acid, alcohol, and ether are needed for cleansing purposes.

Manipulation. The bulb must be cleaned inside and out quite carefully. The best

method is to wash it with chromic acid; then remove the acid and rinse with pure water; then remove the water and rinse with alcohol and ether.

The small amounts of the liquids necessary to clean the bulb can best be introduced by heating the bulb by one's hands (or by a flame, *if the flame is not brought near the ether or alcohol*), thus expelling some air, and then by introducing the opening of the tube under the surface of the liquid and cooling the bulb.

To remove the liquids the bulb may be turned with the tube pointed downward; and, if the bulb be heated, the liquid will flow out. After the alcohol and ether have been removed, it is necessary to dry the bulb. To do this, join it to the drying-tube apparatus; exhaust and allow dry air to enter, then exhaust, let more enter, etc., until the bulb is entirely dry. This process may often be hastened by heating the bulb gently by means of a Bunsen burner.

The bulb should now be weighed as is explained in Experiment 1. This weighing must be particularly accurate.

To fill the bulb with some liquid—*e. g.*, water—the following plan is best: Make a funnel out of a clean glass tube, about 6 cm. long, 2 cm. diameter, closed by a tight-fitting clean wooden cork at one end; by means of a cork-borer make a hole in this cork just large enough to fit tightly over the stem of the bulb. Leave the opening of the stem just above the cork; and support the bulb in a clamp-stand and pour in water, from which air has been removed, if necessary, by boiling.

Heat the bulb by a Bunsen burner, thus causing air to bubble out through the liquid in the funnel; cease heating; and,

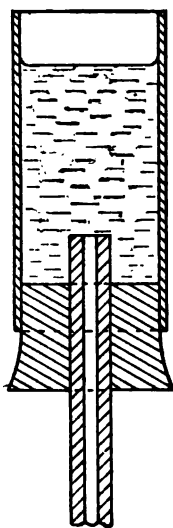

FIG. 9

as the bulb cools, the liquid will rush in (consequently do not heat the bulb too high).

By repeating the heating and cooling the entire bulb and stem may be filled with the liquid. (A last bubble of air is liable to stick to the mouth of the tube, but it can be removed by scraping it off with the point of a knife.) Place the bulb one side, to cool and come to the temperature of the room. (This may take an hour, and in the meantime the student may take up some other experiment.) When this stage is reached, remove the funnel; shake out enough water to bring the level of the surface down to within a few centimetres of the bulb; dry the exterior carefully, weigh as before. Note the temperature of the air near the scale-pan and assume this to be the same as that of the water. Make a fine scratch with a file at the top of the column of water in the stem. Empty the bulb; dry it; pass a cork, only bored part way through, over the end to keep out the dust, and put the bulb away carefully for use in future experiments.

Deduce the mass of water contained in the bulb and stem up to the scratch, and by the aid of the tables of densities calculate the capacity up to this point.

ILLUSTRATION

Oct. 26, 1896

Mass of bulb empty, 80.95 g. }
 Mass of bulb full, 56.16 g. } Mass of water, 25.21 g.

Temperature, 19.4° c.

Mass of 1 cc. of water at 19.4° is 0.998.

Hence, capacity of bulb and stem to scratch at 19.5° is $\frac{25.21}{.998} = 25.25$ cc.

Since the volume of a glass vessel increases by about 0.000026 of its amount for each degree centigrade rise in temperature, the capacity at 0° of the bulb is 25.25 (1. - 0.000026 × 19.5) = 25.24 cc.

NOTE.—The method given above for the determination of volumes is the one universally used for determining the capacity of a vessel of irregular form, or of one whose internal dimensions cannot easily be measured. Where greater accuracy is desired, mercury is used in the place of water.

The volume of irregular solids is found in a similar manner by the following process: Any convenient narrow glass vessel large enough to hold the object is filled with water up to a mark by means of a burette, so that the exact volume of water may be noted. The vessel is then emptied and dried and the object placed in it. Water is again run in from the burette until it reaches the same mark. The difference in the volumes of water needed in the two cases is the volume of the object. A sinker must be used for light objects; and, if the sinker also is of irregular shape, its volume must be found in a similar manner. The volume of objects whose dimensions are easily measured is of course best found by calculation.

Areas which cannot be readily calculated from their dimensions are measured by transferring them to smooth, uniform card-board, by pricking the outlines with a very fine point. The area is then cut out and weighed on delicate balances, and another piece of the same card-board of regular dimensions is also weighed. From the area of the latter, which can be calculated, and the relative weights, the unknown area is easily found.

The average area of the cross-section of a tube is found by weighing the amount of mercury necessary to fill an accurately measured length of the tube. If the mass is m , the density ρ , and the length l , the average cross-section is $\frac{m}{l\rho}$. By using a short thread of mercury and determining its exact length in each successive portion of the tube, the tube can be "calibrated"—that is, any variations in the cross-section ascertained.

Questions and Problems.

1. Why, in determining the volume of an irregular solid, as just described, is not the solid put in the vessel while it contains the water?
2. Standard gold is an alloy—11 parts gold, 1 part copper. Calculate its density.
3. On mixing 68 cc. of sulphuric acid with 24 cc. of water, 1 cc. is lost by mutual penetration. Calculate the density of the mixture.

EXPERIMENT 8

Object. To determine the number of centimetres in one inch.

General Theory. This is to measure the same length by two rules, one divided in centimetres, the other in inches, and then to take the ratio of the numerical values of the length in the two units.

Sources of Error.

These are practically the same as those of the first part of Experiment 1.

Apparatus. Two rules, each one metre long, the one graduated in centimetres and millimetres, and the other in inches and fractions of an inch.

Manipulation.—METHOD 1. *By Coincidence.*—Place the rules side by side on a steady table, with their upper sur-

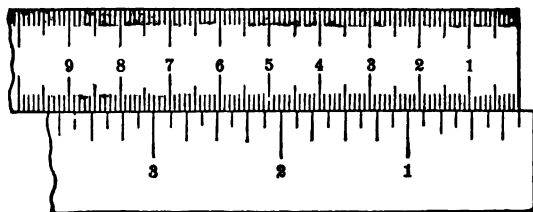

FIG. 10

faces at the same level, and with their graduated edges in close contact. It is best to place the rules on a table facing a window; but in any case care must be taken to see that they are illuminated directly, not sidewise. Slide one

scale along the other until the axis of a division on the inch scale is exactly opposite the axis of a division on the centimetre one. Choose clearly defined, narrow divisions near the ends of the two scales, but never measure from the ends themselves. See that the divisions chosen are well ruled, perpendicular to the edge. Holding the rules very tightly together with their upper surfaces in the same horizontal plane, find two other divisions, one on each scale, the axes of which coincide exactly. This pair should be chosen more than twenty inches from the first pair which were placed opposite each other. In determining when one scale division is opposite another, sight along their axes with the eye a little above them; do not view the lines from the side.

The distance between the two pairs of divisions is the same, but is expressed in different units on the two rules. Note the numbers of the two divisions on the inch rule. Their difference is the difference in inches. Do likewise for the centimetre scale, and deduce the distance in centimetres. Thus calculate the number of centimetres in one inch. Report the numbers of the divisions actually read, as well as the differences, as is shown below. Repeat four times, using different distances and portions of the rules, and find the mean of the results. This is the desired ratio, as given by this experiment.

METHOD 2. *By Estimation.*—In this method an arbitrary number of inches is measured in centimetres. Place two divisions of the scales opposite each other, as in the beginning of part one; but, instead of searching for two more that coincide exactly, note on the centimetre scale the exact position of a division of the inch scale, which is any definite number of inches—say thirty—from the first. In doing this, estimate the tenths of a millimetre by the eye, if the desired inch mark falls between two millimetre marks. Note the readings on both scales and the differences as before, and repeat four times, using the same number of inches but different parts of both rules. From the

mean number of centimetres thus found to be equivalent to the given number of inches, deduce again the ratio of an inch to a centimetre or the number of centimetres in one inch.

Average the results by the two methods.

ILLUSTRATION

METHOD 1

Nov. 1, 1896

	1st Mark	2d Mark	Interval	Cm. in 1 in.
Inch Rule	26.75	4.00	22.75	2.541
Cm. Rule	67.8	10.00	57.8	
Inch Rule	81.50	8.00	28.50	2.540
Cm. Rule	77.4	5.00	72.4	
Inch Rule	34.0	2.00	32.00	2.541
Cm. Rule	88.3	7.00	81.8	
Inch Rule	88.125	1.00	37.125	2.540
Cm. Rule	95.8	1.00	94.8	
				Mean, 2.5405

METHOD 2

	1st Mark	2d Mark	Interval	
Inch Rule	83.00	8.00	80.00	76.14
Cm. Rule	96.14	20.00		
Inch Rule	84.00	4.00	80.00	76.22
Cm. Rule	98.22	17.00		
Inch Rule	81.00	1.00	80.00	76.18
Cm. Rule	94.18	18.00		
Inch Rule	35.00	5.00	80.00	76.19
Cm. Rule	87.19	11.00		
Inch Rule	82.00	2.00	80.00	76.25
Cm. Rule	90.25	14.00		
			Mean, 80.00 in. = 76.20 cm. or 1 in. = 2.540 cm.	

Mean of two methods, 1 in. = 2.5403 cm.

Questions and Problems.

1. Why is it better to compare distances as great as twenty inches or more ?
2. In the second method why is the given way better than to choose an arbitrary number of centimetres and measure their length in inches ?
3. Why is it better not to measure from the ends of the rules ?
Why not use the same scale division over several times ?
4. Is there any objection to using two rules of different materials, *e. g.*, iron and brass ?

EXPERIMENT 4

Object. To learn the method of using a vernier.

General Theory. With many instruments measurements are taken by means of an index which slides along a graduated scale. This scale may be straight, as in a caliper or barometer, or circular, as in a sextant. In the simplest instruments of this kind there is only one mark on the sliding index, and the position of the index is read from the scale division nearest to this mark. When the mark falls between two divisions of the scale, the fractions of a division are estimated by the eye, as in the second part of Experiment 3. To obtain this fraction with greater accuracy, the index of delicate instruments is provided with additional marks, forming a series of equal divisions, on one or both sides of the principal mark. Such a scale on the index is called a "vernier"; and the principal mark, the "zero of the vernier," because in a perfect instrument it comes directly opposite the zero of the main scale when the quantity which the instrument is designed to measure is zero—*e. g.*, in a caliper when the jaws are closed on each other with no object between. It will avoid confusion to remember that the zero of the vernier replaces the single mark on simpler instruments, and that the other marks are merely to be used in determining more accurately the position of this principal mark.

Positive Vernier is the most usual form of instrument. The vernier scale numbers on the sliding index increase in the same direction from the zero of the vernier as the ascending numbers on the main scale. Such a vernier is

called "positive," and for convenience of description we will assume this direction to be from left to right. The vernier divisions differ in length from those of the main

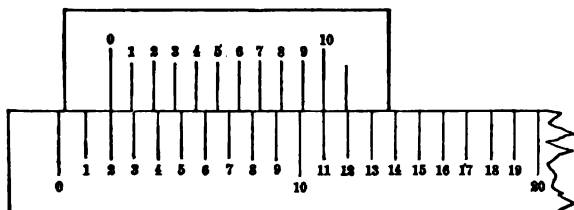

FIG. 11

scale, but a whole number, n , of vernier divisions is always made to equal $n \pm 1$ scale divisions. We will describe the kind of vernier in which the vernier divisions are shorter, and will first consider the case in which 10 vernier divisions equal 9 scale divisions. Let the length of a vernier division be represented by v , and the length of a scale division by s .

Then in this particular vernier,

$$10 v = 9 s,$$

$$\therefore v = 9/10 s,$$

$$\therefore s - v = s - 9/10 s = 1/10 s.$$

In words, this equation says that one scale division is longer than one vernier division by $1/10 s$. Suppose, now, that we start with the case in which the index mark, or zero of the vernier, corresponds with a certain definite division line of the scale—say the line number 2, for example. If we look at the scale to the right of this mark, we see that the first vernier division falls short of coinciding with a scale division by $1/10 s$. The second vernier division falls short of coinciding with a scale division by $2/10 s$, the third by $3/10 s$, etc. It is plain, then, that as we move the vernier along the scale to the right, when the zero of the vernier has passed $1/10 s$ beyond any line of the scale the first vernier division line will coincide with a line of the scale. If we move it along $2/10 s$ from

the starting-point, the second line on the vernier will be in coincidence, and so on. Therefore, if we wish to know how many times $1/10 s$ the zero of the vernier is beyond a division line of the scale, we have only to find the number of the first line of the vernier that is in coincidence with a line of the scale, and that number will give the number of tenths of a scale division desired. If no vernier division is in exact coincidence with a scale division, the two divisions which lie on either side of coincidence must be noted, and by estimation one can calculate what vernier division *would* coincide if the vernier scale were more finely subdivided.

This theory can be generalized for this kind of a vernier as follows:

Let n vernier divisions equal $n-1$ scale divisions. That is:

$$n v = (n-1) s,$$

$$\therefore v = \frac{n-1}{n} s \therefore s - v = s - \frac{n-1}{n} s = \frac{1}{n} s.$$

$s - v$ is called the "least count," which in this case is $\frac{1}{n} s$. If n is 10, as above, and s a millimetre, the least count is .1 mm.

The theory of a vernier in which the vernier divisions are longer than the scale divisions, or of a vernier whose divisions increase numerically in a direction opposite to those of the scale, presents no difficulties. The first step in using an instrument with a vernier is to determine the least count and the kind of vernier, positive or negative,

Apparatus. Wooden model of a vernier on a large scale.

Manipulation. 1. Find the least count of the vernier.

Slide the vernier along the scale until the zero of the vernier coincides exactly with any arbitrary division on the main scale. Find another mark on the vernier which exactly coincides with one on the scale. Let it be the p^{th} . Let there be q divisions of the main scale between the same two marks. Then

$$p v = q s \therefore v = q/p s = \left(1 - \frac{p-q}{p}\right) s.$$

Therefore $(p-q)/p = 1/n$, least count.

Find the least count of the model in this way :

2. Practice reading the vernier and also estimating tenths by the eye. Set the vernier at random, and, covering all but the index with a piece of paper, estimate by the eye the exact reading of the index to tenths of a scale division. Next find the coinciding division on the vernier, and from it determine again the tenths of a division. Tabulate as below and compare the readings by the eye and by the vernier. Repeat twenty times and report all readings.

ILLUSTRATION

Oct. 5, 1908

I

Zero of vernier coincides with 7 cm. on scale.

10 " " " " 10 " "

$$p = 10, q = 9. \text{ Least count} = \frac{10 - 9}{10} = 1/10 \text{ centimetre.}$$

II

Reading by Eye	Whole Number on Scale	Coinciding mark of Vernier	Fraction by Vernier	Reading by Vernier
6.7	6	8	$8 \times 1/10 = .8$	6.8
7.2	7	1	$1 \times 1/10 = .1$	7.1
etc.	etc.	etc.	etc.	etc.

Questions and Problems.

1. Suppose the 6th vernier division most nearly coincides with a scale division, but falls on the side nearest the zero of the scale, and that it is estimated to be $1/4$ as far from coincidence as the 5th division. What is the exact fractional reading, the least count being $1/10$ cm. ?
2. Give a formula applicable to such cases in general.
3. What effect would a slight irregularity in the position of the marks on the main scale have on the vernier reading, and how can error from this source be best avoided ?

EXPERIMENT 5

Object.—USE OF VERNIER CALIPER.—To measure the linear dimensions of some small object and to calculate its volume.

General Theory. The volume of a circular cylinder is $\pi r^2 l$, if r is the radius and l the height; consequently, in order to determine the volume, r and l must be measured. As r enters to the second power, however, and l to the first only, it is evident that special attention must be paid to the measurement of r .

There are various instruments which can be used to measure lengths accurately, but none is so generally used

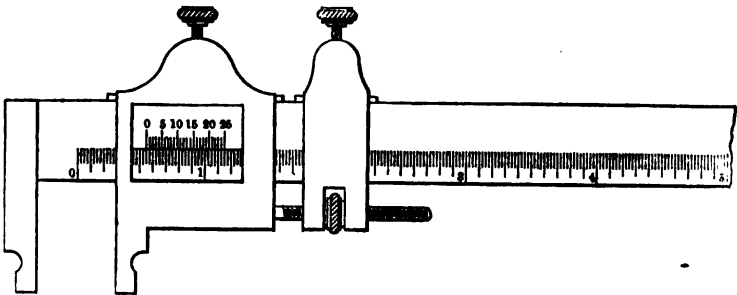

FIG. 12

as a vernier caliper. It consists of two parts—a graduated “limb,” with one fixed jaw at right angles to it, and a sliding index which carries a second jaw accurately parallel to the first, and which is free to move along the limb unless it is clamped. The index carries a vernier, and the position of the zero of the vernier on the scale indicates the dis-

tance between the two jaws. (The caliper in the figure has an attachment to the sliding vernier, which is designed for making finer adjustments. In using it unclamp both screws and slide the vernier jaw nearly into contact. Then clamp the screw in the sliding attachment, but not the vernier screw, and make the final adjustment by the "tangent screw" between the two parts. Then clamp the vernier screw.)

Sources of Error.

1. The two jaws may not be exactly parallel.
2. The linear dimensions to be measured may not be exactly parallel to the scale on the limb.
3. Too great pressure may strain the caliper and bend the jaws so that they are no longer parallel, though they spring back when the object is removed, and the error is not noticed in subsequent zero readings. Pressure may also change the dimensions measured, as, for instance, in measuring the diameter of a hollow cylinder or of a tube.
4. The same dimensions may be greater or smaller at different parts of the object.

Apparatus. A hard rubber cylinder to measure; a vernier caliper; reading lens; metre bar.

Manipulation. Compare the scale on the limb with the metre bar and learn what the unit is. If there is an inch scale on one side and a centimetre scale on the other, use both. Deduce the least count of each vernier. Clean all dust or dirt from the inner faces of the jaws.

In all measurements it is as important to know accurately the reading for the beginning of the length measured as it is to know that for the end. In this case the beginning is the position of the zero of the vernier on the scale when the movable jaw is in contact with, and parallel to, the fixed jaw, and this must be determined quite as accurately as the position of the index when the object to be measured is placed between the jaws. This first reading is called the determination of the zero of the instrument, or simply the "zero reading," and a similar set of zero

readings must be taken on every instrument throughout the course.

To Obtain the Zero Reading. Loosen the clamping screws so that the movable jaw is free to slide along the limb, but not to rock on it; slide the jaws gently into contact; hold the caliper between the eye and the light, and, looking between the jaws, bring them lightly but completely into contact along their whole length, if possible; clamp the jaw by means of its screw; see that the jaws remain in contact when the screw is clamped. Read and note the exact position of the vernier on the scale of the limb, determining the fractions of a scale division by the vernier, as learned in Experiment 4. (Read both the inch and centimetre scales, if both are given on the caliper, and reduce all fractions to decimals.)

A lens should always be used in reading, and the instrument should be held facing a window, if possible. It will often be found that the divisions of the two scales shift relatively to one another, according to the direction from which they are viewed. Care must be taken, therefore, to look at them in directions parallel to the marks on the two scales, or to look down on the instrument perpendicularly. This shifting with the point of view is called "parallax," and must be guarded against whenever a vernier is used, and in many similar cases (*e. g.*, Experiment 8).

The whole number of the reading is always given by the scale division next below the zero of the vernier, and the vernier reading of the fraction is always *added* to this. Hence, if in the zero reading the zero of the vernier comes below the zero of the scale, the division next below it is -1 . If the vernier reading is then, say, $.7$, the whole zero reading is $-1 + 0.7$ or $-.3$, and so on.

To Measure the Length. Having obtained the zero reading, loosen the screws, move the jaw, and insert the cylinder, so as to measure a diameter at one of its ends. Turn the cylinder in the caliper and see whether in any direction the diameter seems to be a maximum. If it is, meas-

ure in this direction. Hold the cylinder so that its axis is at right angles to the limb, and note carefully that the points in contact with the jaws are diametrically opposite and at exactly the same distance from the end. The diameter to be measured should be exactly parallel to the inner edge of the limb. If from an imperfection in the instrument the jaws were not in contact along their whole length in taking the zero reading, see that the same points which then touched are the ones now touching the cylinder. Push the jaws together until the cylinder is just loosely held between them; then clamp the screw, and read and note the position of the zero of the vernier as before (on both scales if there are two). Measure similarly the diameter at the other end, taking in each case the maximum diameter. Try and close the jaws with the same pressure in each reading.

Take a new zero reading and repeat the measurement of the same two diameters. Repeat the readings twice more on diameters at right angles to those already measured. Average the zero readings, and also the four diameters measured at each place, and, subtracting the former, get the mean diameter of each section. Average these to get the mean diameter of the cylinder. (Do the same for the readings taken in inches.)

Proceed in the same way to get the length of the cylinder, measuring it three times, taking a zero reading each time, and again using both scales, if there are two. Note the number of the cylinder and description or number of the caliper. Finally calculate the volume of the cylinder.

NOTE.—If the cylinder is hollow it will be necessary to measure the internal diameter also. Bring the outer edges of the tips of the caliper's jaws into contact with the inner surface of the cylinder, the line joining the edges being accurately at right angles to the axis of the cylinder. The scale reading is then the internal diameter minus the thickness of both jaws. The latter thickness may be found by measuring it with another caliper. Make four readings at each end, and record.

ILLUSTRATION.—CYLINDER No. 1. CALIPER No. 3

Oct. 7, 1894.

Zero Reading		DIAMETER				Other End	
Cm.	In.	Marked End		Other End			
		Cm.	In.	Cm.	In.		
0.07	0.081	4.49	1.775	4.50	1.79		
0.06	0.083	4.48	1.78	4.51	1.785		
0.08	0.085	4.51	1.77	4.53	1.77		
0.07	0.083	4.50	1.78	4.49	1.775		
Mean, 0.07	0.083	4.49	1.776	4.50	1.780		

Hence, diameter $\left\{ \begin{array}{l} \text{marked end, 4.49 cm., 1.748 in.; mean, 4.49 cm.} \\ \text{other end, 4.48 cm., 1.747 in.; mean, 4.48 cm.} \end{array} \right.$

Thickness of jaws, 0.5 cm.

The cylinder was hollow, and of internal diam. = 8.29 + 0.5 cm.
= 8.79 cm.

(The student must give the details of this measurement, just as they are given above for the external diameter.)

Zero Reading		LENGTH				Length	
Cm.	In.	Reading on Length		Length			
		Cm.	In.				
0.08	0.086	5.79	2.285				
0.07	0.083	5.80	2.290				
0.06	0.083	5.78	2.290				
Mean, 0.07	0.084	5.79	2.285				
			2.251	=	5.72		

Mean of results by two scales, 5.72

$$\therefore \text{Vol.} = 3.1416 \times 5.72 \left\{ \left(\frac{4.48}{2} \right)^2 - \left(\frac{8.79}{2} \right)^2 \right\} = 23.54 \text{ cc.}$$

Questions and Problems.

1. What advantage is there, other than mere convenience, in having different units of length on the same instrument?
2. Would a theoretically perfect caliper give the same result for the same dimension of the same object at all times? Why?
3. Why was the diameter of the cylinder measured eight times on each scale and the length only three?
4. In which dimension do you think you have made the least proportional error?

EXPERIMENT 6

Object.—USE OF MICROMETER CALIPER.—To measure the linear dimensions of some small object—*e. g.*, the thickness of a wire, a piece of glass, a sphere, etc.

General Theory. A micrometer, or screw caliper, consists essentially of a screw whose pitch is uniform and whose motion in its nut may be accurately noted. In the ordinary form of instrument the screw is rigidly attached at one end to the inner end of a hollow cylinder or “barrel,” so that as the barrel is turned the screw is turned in its nut. There is a scale running lengthwise on the nut,

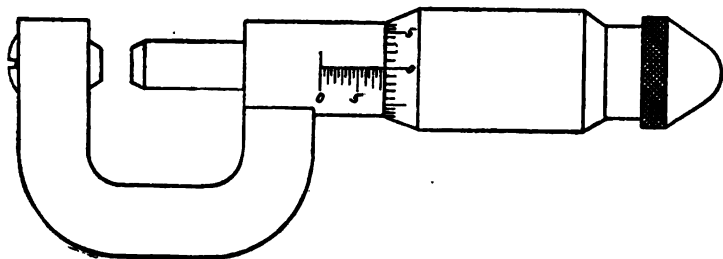

FIG. 13

which is so divided as to correspond to the distance which the screw advances each whole turn—*i. e.*, the scale divisions equal the pitch of the screw. The edge of the barrel moves backward and forward along the edge of this scale as the screw is turned, and so whole turns of the screw may be noted. Fractional turns may be noted by the divisions which are engraved on the edge of the barrel, and which pass across the fixed line running lengthwise of the nut.

The screw ends in a flat face, called the tooth, and as the screw is turned this tooth may be made to approach or recede from another flat face, which is rigidly attached to the nut by the framework of the instrument. Hence, if the two teeth are first placed in contact, and then separated so as to just contain some solid, the number of turns of a screw and the fraction of a turn may be observed by noting the readings on the edge of the barrel and along the nut. The pitch of the screw is always a standard one—*e. g.*, 1 or $1/2$ mm., $1/16$ or $1/32$ in., etc., and which particular one it is can be determined by a rough comparison with a standard rule or with a plate of known thickness.

Sources of Error.

1. The faces of the teeth may not be parallel, and may not be perpendicular to the axis of the screw.
2. The linear dimensions to be measured may not be exactly parallel to the screw.
3. The pitch of the screw may not be exactly the same in all parts.
4. Pressure changes the shape of the caliper, and may strain the jaws apart without the screw being turned. Too great pressure may also change the dimension to be measured.

Apparatus. A micrometer caliper; a piece of plane, parallel glass; a reading-lens.

Manipulation. Compare the scale on the nut with millimetres by marking on the straight edge of a piece of paper the exact length of ten divisions (not half-divisions, if such are marked) of the scale along the nut, and laying it off on the metre bar. Record the equivalent in millimetres of one division of the scale. Each such division marks one or more complete turns of the barrel; to determine how many, start with any chosen mark of the barrel opposite the line of reference drawn lengthwise on the nut, and turn the barrel any number of complete turns, counting the number of whole division marks on the nut which have been passed over. From this calculate the fraction of a division of the instrument passed over by the edge of the

barrel, when the latter is turned through one division of the scale upon it. (If the scale on the edge of the barrel has two sets of numbers upon it—*e. g.*, 1.6, 2.7, 3.8, etc.—one turn will be found to correspond to one-half a division of the nut, and the lower of the two numbers is to be used when the edge of the barrel is in the first half of a division, and the higher when it is in the second half.) Use the same precautions against dirt, parallax, and non-parallelism of the surfaces of the teeth as in Experiment 5. The best caliper has a ratchet at the end, which enables the contact to be made always with approximately the same pressure, which is indicated by the same number of clicks of the ratchet, turned very slowly and counted as soon as the surfaces touch. (Five clicks mark a safe and convenient pressure.)

Make a zero reading, bringing the teeth into contact by means of the ratchet and counting the number of clicks after they touch. The integer of the reading is given by that division of the nut which is nearest to the edge of the barrel, but not covered by it; and the decimal fraction of a turn, by that point of the scale on the edge of the barrel which is opposite the line of reference on the nut. Read to tenths of the division on the edge. (If the edge is below the zero mark, give a negative sign to the integral part of the reading, keeping the fraction always positive; see illustration.) Next, insert the object to be measured, closing the teeth on it with the same number of clicks of the ratchet after contact as in the zero reading, and taking care that the dimension to be measured lies in a line perpendicular to the faces of the teeth. Take separate readings, with a zero reading for each.

If the object of the experiment is to measure a given thickness, make all the measurements in the same place: but if the object is to find the average thickness of various points—*e. g.*, the diameter of a wire—measure in as many directions and places as possible.

Note and report the number of the instrument used, and

any mark or number serving to identify the object measured.

ILLUSTRATION

Oct. 12, 1892

PLATE OF GLASS No. 1. MICROMETER CALIPER "M 60"

Zero Reading	Reading on Glass	Thickness	Zero Reading	Reading on Glass	Thickness
-1 .978	8.151	8.178	-1 .968	8.149	8.181
-1 .977	8.151	8.174	-1 .969	8.151	8.182
-1 .972	8.151	8.179	-1 .965	8.149	8.184
-1 .974	8.152	8.178	-1 .968	8.149	8.181
-1 .971	8.151	8.180	-1 .967	8.148	8.181
-1 .978	8.153	8.175	-1 .968	8.147	8.179
-1 .969	8.150	8.181	-1 .966	8.146	8.180
-1 .972	8.150	8.178	-1 .967	8.150	8.188

Mean, 8.1796 mm.

Probable error of one observation = ± 0.0024 mm.

" " " the result = ± 0.0006 mm.

\therefore Probable thickness is $8.1796 \pm .0006$ mm.

Questions and Problems.

1. To how many significant figures are you entitled to carry out your result, and why?
2. What error is your measurement liable to which you could not compensate for by taking more observations? How could you detect and diminish it?
3. Does the scale on the nut of the micrometer caliper have to be as accurate as that on the limb of the vernier caliper? Why?



EXPERIMENT 7

Object.—USE OF THE SPHEROMETER.—To measure the thickness of some small object, such as a plate of glass.

General Theory. A spherometer is an instrument made essentially on the same principle as a micrometer caliper. It consists of a screw which turns in a nut supported by three legs, as shown.

There is a scale rigidly fastened to the nut and parallel to it; and the screw carries a disk perpendicular to itself, whose edge is divided into equal intervals. The fixed scale is so divided as to correspond to whole turns of the screw. The three legs, the screw, and the fixed scale are all parallel, and perpendicular to the plane which is fixed by the extremities of the three legs.

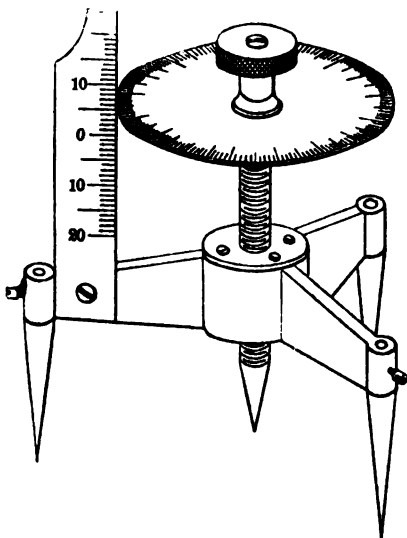

FIG. 14

By placing the instrument on a plane surface the position of the screw can be recorded when its extremity is in that plane, and then its position can also be noted when it is raised so as to allow some solid to be introduced under it.

In this way the thickness of a plate can be measured, if the pitch of the screw is known. It may be assumed in general that the pitch is a standard one—*e. g.*, 1 mm., 1/16 in., etc.—and the particular one which it is can be determined by a rough comparison with a centimetre or an inch rule. If the pitch, however, is arbitrary, its value must be determined by the use of a plate of known thickness. The instrument may also be used to measure the curvature of a spherical surface, as is explained in any larger manual. (See Stewart and Gee, vol. i.; Glazebrook and Shaw.)

Sources of Error.

1. The screw may not be perpendicular to the plane of the extremities of the legs.
2. The fixed scale may not be parallel to the screw.
3. The pitch of the screw may not be the same in all parts.
4. The disk may not be exactly perpendicular to the axis of the screw.
5. The divisions on the fixed scale may not agree exactly with whole turns of the screw.

Apparatus. Spherometer; large glass plane surface; a piece of plane, parallel glass; a reading-lens.

Manipulation.—NOTE.—In using the spherometer raise or lower the screw by turning the milled head. *Do not* turn it by means of the disk.

Compare the vertical fixed scale with a millimetre one, and note the value of one of its divisions. Note the number of divisions on the disk, and see if, when the disk is opposite a division of the vertical scale, its reading is zero, as it should be. Next, by actual trial, find what divisions of the vertical scale correspond to whole turns and what to half turns or several turns; that is, determine the pitch of the screw. Now turn the disk slowly, and observe carefully whether it rises or falls as it is turned in such a way that successively *greater* numbers on the disk pass the edge of the vertical scale. If it rises as increasing numbers come to the edge, that number on the disk which has just

passed the edge indicates the fraction of a turn which has been made since the disk passed the mark on the vertical scale next *below* (below in position, not numerically). This fraction is therefore to be *added* to the scale division in order to get the exact reading.

If, on the other hand, the disk falls as the numbers increase, the fraction indicated by it is to be subtracted from the whole number, as given by the scale division next *above*, for it means that the disk has fallen that fraction since passing the mark next above. In other words, the fraction marked by the scale on the disk is given a positive sign in the first case and a negative in the second. The sign of the integer of the index is positive, of course, when the disk is above the zero of the fixed scale, and negative when it is below. The number of the integer is to be taken, as stated, from the mark next *below* the disk in the first kind of instrument, from the mark next above in the last. In determining the position of the disk on the scale always sight along the upper surface of the former, and in like manner sight along the graduated surface of the scale to determine the fraction of a turn indicated by the disk. Read the scale on the latter to the tenth of its smallest divisions.

Having become thoroughly familiar with the instrument, measure with it the thickness of some thin object, as a piece of plate-glass. For the sake of comparison, it is well to use the same piece of glass as was measured in Experiment 6.

In the case of the spherometer the point measured from—*i. e.*, the zero of the measurement—is the plane of the three outer feet. To get the zero reading, it is necessary therefore to set the extremity of the screw precisely in this plane, and to record the position of the disk when it is so set. Place the instrument on the plane surface which comes with it, and raise or lower the screw until the instrument rests squarely on it as well as on the feet. If the central foot is in the least below the plane of the other three, the instrument can be made to rock or to spin on

the screw-point. The screw must then be so adjusted that it just does not rock. To do this exactly, begin with the screw a little too high, and lower very slowly, trying the stability continually, until you notice the first trace of rocking; then note the disk reading. Now turn back very slowly and stop when the rocking just stops; note the reading again and repeat, turning backward and forward until you have reduced the uncertainty as to the exact point to the smallest range possible; then take the average of the two extremes between which you are in doubt. Finally, complete the reading of the zero by noting the integer on the vertical scale. Be very careful to give both the integer and the fraction their right signs in your memoranda. Repeat the measurement ten times, moving the screw each time considerably out of position in order to secure ten entirely independent determinations. It may be well to take five of the zero readings at the beginning and five at the end of the experiment.

Now raise the screw and insert the object, taking care that it is clean, so that its lower surface lies in the plane of the fixed feet—*i. e.*, flat on the glass plane. Lower the screw so that its point is just in contact with the upper surface. Make the exact adjustment as before by rocking. Note the reading on both scales, and give each its right sign. Make three independent settings, then turn the object the other side up and make three more. Note which position gives apparently the smaller thickness for the object, and complete the measurement by taking enough readings to make a set of ten observations with the object in that position. (Do not include the observations on the opposite side in calculating the mean.)

Record as below. Give the number of the instrument, and a mark or number to identify the object.

If the reading on the disk is not zero when it is exactly at a scale division of the fixed scale, care must be taken not to make an error of a whole division of the vertical scale on this account. A little common-sense will avoid

it, just as one would avoid a mistake of a whole minute in timing with a watch whose second-hand passed the 60 a little before or after the minute-hand passed its mark.

ILLUSTRATION

Oct. 7, 1892

PLATE-GLASS No. 1. SPHEROMETER, M 183

Zero Reading		On Glass		Thickness
Vertical	Disk	Vertical	Disk	
5.5	-.8261	18.5	-.1415	8.1847 turns
5.5	-.8260	18.5	-.1421	
5.5	-.8245	18.5	-.1435	
5.5	-.8255			
5.5	-.8279	18.5	-.1424	
5.5	-.8264			
5.5	-.8278	Other Side Up		
5.5	-.8280	Vertical	Disk	
5.5	-.8289	18.5	-.0824	
5.5	-.8292	18.5	-.0806	
5.5	-.8292	18.5	-.0848	
Mean, 5.5	-.8271	18.5	-.0826	8.2945 turns

This last giving the greater thickness, the experiment was finished with the other side up.

On Glass		Thickness
Vertical	Disk	
18.5	-.1427	8.1888 turns
18.5	-.1428	
18.5	-.1428	
18.5	-.1429	
18.5	-.1448	
18.5	-.1454	
18.5	-.1452	
Mean of all ten, 18.5	-.1438	

Greatest deviation from the mean is 1 part in 60,000.

It was found by trial that the disk fell when turned in the direction of increasing numbers, hence the minus sign is given to the disk reading. Also by comparison with a millimetre scale the pitch of the screw was found to be 1 mm.

\therefore 8.1888 turns = 8.1888 mm. = thickness of plate-glass No. 1.

(Experiment 6 gave the thickness of this same piece of glass as 8.1796, or .0042 mm. less. This is probably due to the measurements being taken at different parts of the glass.)

If the pitch of the screw is not known, it can be determined by placing a standard rule under the microscope parallel to the screw, and noting how many turns of the screw move the microscope through a known number of centimetres. (See Experiment 9.) If the pitch of the screw is known, the instrument may be used to measure the distance between two points or lines by placing the straight line between these points (or lines) parallel to the screw, and noting how many turns of the screw will move the microscope through the distance.

Sources of Error.

1. The pitch of the screw may not be the same in all parts.
2. The scale parallel to the screw may not correspond to it exactly.
3. The screw, the scale, and the "ways" may not be parallel.
4. The line whose length is measured may not be parallel to the screw.
5. The nut may fit the screw loosely—*i. e.*, may have "back-lash"—in which case for a small motion of the screw in one direction there might be no motion of the nut.

Apparatus. The dividing-engine; an inch scale seven or eight inches long.

Manipulation. In dividing-engines, as actually used, the screw is placed horizontal, and there is a fixed platform under the microscope, which is itself adjustable horizontally and vertically. The nut is split in halves, which can be held apart by a lever or spring, and which must be held together by a clamp in order to bind the screw.

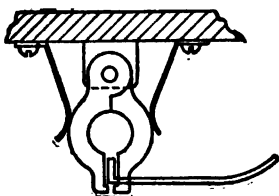

FIG. 16

Assuming that the pitch of the screw corresponds with the scale parallel to it, and that the scale is a metric (or any standard) one, the instrument may be used to measure a distance along a line—*e. g.*, the distance apart of two dimensions on an inch rule—and the following description gives the details of this measurement:

First determine the pitch of the screw. To do this, loosen the nut by raising the lever, and slide the carriage out of the way to one end or the other. Then compare the scale with a centimetre rule.

The next step is to place the edge of the inch rule on the platform parallel to the screw. Do this, approximately, by the eye, but more exactly by means of the microscope. Slide the carriage until the microscope stands over the inch rule, and "focus" the instrument on the surface of the rule. In a microscope which is not properly focused the part of the object viewed, which seems to be directly under the cross-hairs, will vary in position if the eye is moved laterally across the eye-piece; this is said to be due to "parallax." To avoid this, focus the *eye-piece first*, by sliding it in and out of the tube until the cross-hairs—not the image of the object—are perfectly distinct; then focus on the object by moving the whole microscope up and down in its holder, being very careful not to disturb the adjustment of the eye-piece in so doing. When the focus is complete, test by moving the eye across the eye-piece, and do not be satisfied with the adjustment until there is no relative motion of the cross-hairs and the surface of the rule. Now adjust the level of the rule until the surface is in perfect focus as the microscope is moved over its entire length; then, keeping the level unchanged, turn the rule until, as the microscope is moved lengthwise, the edge of the rule (or some line on the rule perpendicular to the divisions) coincides in all points with the point of intersection of the cross-hairs. These two adjustments place the edge of the rule parallel to the screw. Now loosen the screw which holds the microscope sleeve, and draw the microscope across the rule a short distance, so that the division lines are in the field of view; finally, clamp the microscope screw and readjust the focus if it is necessary.

The instrument is now ready for use. Slide the carriage until the point of intersection of the cross-hairs appears a little to the right of an inch mark near the right-hand end

of the scale, and the index on the nut rests exactly on a mark of its own scale. Turn the handle so that the zero on the disk is directly opposite the fixed mark. Now close the nut by releasing the lever and pushing it down. The reason why the index must be set exactly on a mark, and the disk turned exactly to zero before closing the nut, is that otherwise the threads of the screw and nut would not fit into each other, and might be seriously damaged in being forced together. Now turn the screw very slowly until the cross-hairs coincide with the exact middle of a chosen mark on the inch rule, not the end. If you accidentally pass it, turn back until well to the right of it again, and bring the hair into coincidence from the right side. Likewise through the experiment always move the hair on to the mark from the same side. The object of this is to take up the "back-lash," or looseness of the nut on the screw, owing to the wear, which allows the screw to be rotated part of a turn before moving the nut. Read the *whole number* of smallest divisions on the scale by means of the index attached to the nut, and the fractional part on the scale of the disk.

Turn the screw back until the cross-hairs are well off the mark, and make three more independent determinations of the exact position of this same mark. Note all four readings and the number of the mark on the inch scale. Throw the nut out of gear, slide the carriage down to the other end of the inch scale, throw the nut into gear, and take four readings, in exactly the same manner, on a division of the inch scale near that end. It will be convenient to choose a division which marks a whole number of inches from the first. (Be very careful again before throwing the nut in gear to see that the index is on a mark and the disk turned to zero.) A given number of inches have thus been measured in terms of turns of the screw. Repeat the same measurements four times, using the same number of inches, but measuring between different marks so as to neutralize any error in the graduation of the inch scale used. Report as below.

ILLUSTRATION

Oct. 26, 1892

DIVIDING-ENGINE "M 7"

By comparison with a millimetre scale 100 divisions of the scale of the instrument are found to equal 100 mm.; therefore the pitch of the screw is 1 mm. to the turn. The larger-numbered divisions correspond to ten turns, or a centimetre each. The disk is divided into 100 divisions, each of which = .01 turn, or .001 cm.

AN INCH MEASURED IN CENTIMETRES BY DIVIDING-ENGINE

Inch Scale	Engine Scale in Cm.		Inch Scale	Engine Scale in Cm.	
	Index	Disk		Index	Disk
0.125	14.4	.0744	6.125	29.7	.0202
0.125	14.4	.0745	6.125	29.7	.0196
0.125	14.4	.0742	6.125	29.7	.0194
0.125	14.4	.0743	6.125	29.7	.0201
Mean, 0.125	14.4	.0744	6.125	29.7	.0198

$$\therefore 6 \text{ in.} = 29.7198 - 14.4744 \text{ cm.} = 15.2454 \text{ cm.}$$

0.5	15.7	.0455	6.5	30.9	.0885
0.5	15.7	.0455	6.5	30.9	.0886
0.5	15.7	.0453	6.5	30.9	.0885
0.5	15.7	.0455	6.5	30.9	.0884
Mean, 0.5	15.7	.0455	6.5	30.9	.0885

$$\therefore 6 \text{ in.} = 30.9885 - 15.7445 \text{ cm.} = 15.2440 \text{ cm.}$$

0.75	14.7	.0277	6.75	29.9	.0787
0.75	14.7	.0276	6.75	29.9	.0786
0.75	14.7	.0278	6.75	29.9	.0785
0.75	14.7	.0277	6.75	29.9	.0788
Mean, 0.75	14.7	.0277	6.75	29.9	.0787

$$\therefore 6 \text{ in.} = 29.9787 - 14.7277 \text{ cm.} = 15.2460 \text{ cm.}$$

0.25	14.9	.0881	6.25	30.2	.0278
0.25	14.9	.0882	6.25	30.2	.0281
0.25	14.9	.0880	6.25	30.2	.0280
0.25	14.9	.0881	6.25	30.2	.0279
Mean, 0.25	14.9	.0881	6.25	30.2	.0280

$$\therefore 6 \text{ in.} = 30.2278 - 14.9881 \text{ cm.} = 15.2448 \text{ cm.}$$

$$\text{Mean, } 6 \text{ in.} = 15.2448 \text{ cm.}$$

$$\text{Hence, } 1 \text{ in.} = 2.5408 \text{ cm.}$$

Greatest deviation of an individual "setting" is 1 part in 100,000.

Greatest deviation of a measurement from final mean is 1 part in 10,000.

Questions and Problems.

1. Mention three or more advantages possessed by the preceding method of taking measurements of relatively long distances over that which keeps the nut in gear while passing from one extreme division to the other.
2. If the disk scale and the inch scale are perfect in all respects, would the expansion of the nut and screw, consequent upon a rapid, long-continued motion of the one along the other, cause the results of this experiment to be too large or too small? Explain theoretically in detail.
3. For what purpose was the dividing-engine designed? Show briefly how it works when used for this purpose—*i.e.*, outline the principles involved.

EXPERIMENT 9

Object. To measure the pitch of the screw of a micrometer microscope.

General Theory. Micrometer microscopes are of two types: in one the frame holding the cross-hairs is moved perpendicularly across the axis of the microscope by means of a screw; in the other, the whole microscope is moved at right angles to its length by a screw. The screw in both instruments is provided with an index marking the

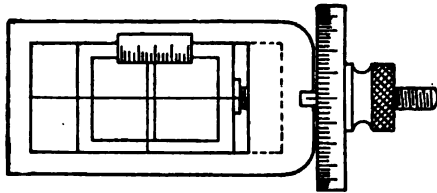

FIG. 17

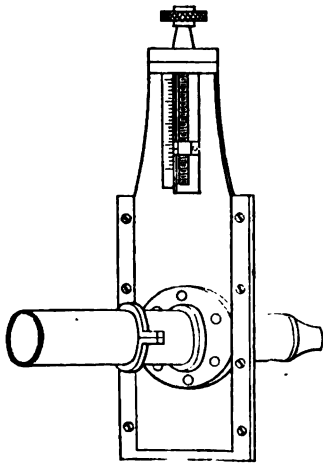

FIG. 18

whole number of turns and a finely divided disk, or "head," marking the fractions of a turn; and the method of measuring the pitch is exactly that made use of in the measurement of a length with the dividing-engine. (See Experiment 8.) A standard rule is adjusted parallel to the screw, the microscope is focused on its divisions, and the number of turns is measured which is required to carry the cross-hairs a known number of scale divisions.

Sources of Error.

1. The length of the standard rule may not be parallel to the screw.
2. The dimensions of the standard rule may not be all equal.
3. The pitch of the screw may be different in different parts.

Apparatus. A micrometer microscope and stand; a standard rule.

Manipulation. The particular instrument used must be carefully examined, and the different clamps or screws which stop or permit particular motions must be thoroughly mastered. The standard rule must be adjusted accurately parallel to the micrometer screw, exactly as in the previous experiment. (The longer the standard rule or the longer the screw, so much the more accurately can this be done.) Then a known number of scale divisions must be measured in terms of the pitch of the screw, in doing which each setting must be repeated twice and care must be taken to avoid the "back-lash" of the nut.

Repeat the observations, using different portions of the screw and different portions of the standard rule.

It is sometimes difficult to identify the particular division of the rule on which the cross-hairs are focused; but, by slipping a pin or a pointed piece of paper along the rule until it is also in the field of view, this difficulty may be obviated. Note the temperature, and correct for the expansion of the standard rule, because its length is given for a particular temperature.

ILLUSTRATION

Oct. 20, 1896

MICROMETER EYE-PIECE ON COMPARATOR "M 4"

*Temperature 22° C. B. & D. Metre Bar.**Distance measured on Standard Rule, 2 Divisions.*

Screw Settings	
1st Mark	2d Mark
0.608	5.101
0.601	5.099
0.607	5.100
<u>0.6058</u>	<u>5.1000</u>

Hence, 4.4947 turns = 2 divisions
 1 turn = 0.4450 division

(The details of other observations are omitted here, but must be supplied by the student in the report of his experiment.)

Summary, 1 turn = 0.4450 division

" 1 " = 0.4436 "

" 1 " = 0.4442 "

" 1 " = 0.4457 "

Mean result, 1 turn = 0.4444 division

Greatest deviation from mean is 1 part in 550. The B. & D. metre bar has a length 100.0180 at 17° C., and it expands 0.000018 of its length for a rise in temperature of 1° C. The divisions measured were between millimetre lines.

Hence, 1 division = 0.100018 (1 + 5 × 0.000018) cm.
 = 0.10008 cm.

Hence, 1 turn of screw at 22° C = 0.4445 mm.

(It is evident that in this case the probable error exceeds the temperature correction; but it is useful to understand the process of correction.)

Questions and Problems.

1. State and explain several advantages possessed by a microscope that is moved bodily by a screw which are not possessed by a microscope whose cross-hairs are moved by a screw.
2. Would changes in temperature affect the readings on the disk scale if it expanded uniformly in all directions? Give some advantages and some disadvantages of a disk of large radius.
3. State some defects of micrometer screws.
4. What is meant by "calibrating" a screw?
5. Would the value of the pitch as obtained by the foregoing method vary with the focal length of the microscope? Why?

EXPERIMENT 10

Object. To measure by comparison with a standard rule a horizontal or vertical length. Use of comparator or cathetometer.

General Theory. A comparator or cathetometer consists

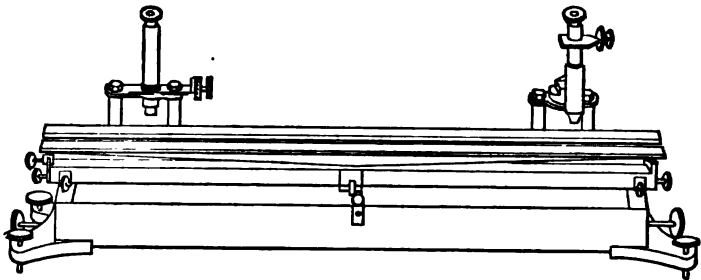

FIG. 10

essentially of a massive framework provided with one or two micrometer microscopes or telescopes. The framework is so made that these instruments can slide along it in a straight line. The two microscopes or telescopes are carefully adjusted parallel to each other, and perpendicular to this line of motion. The length to be measured is placed exactly parallel to this line of motion; the two microscopes or telescopes are focused on the extremities of the length; the standard rule, which has also been adjusted parallel to the line of motion, is now placed in the field of view of the microscopes or telescopes so that its divided surface is exactly in focus; the positions of the two sets of cross-hairs are noted, and their distance apart

gives the length desired in terms of the standard rule. If the cross-hairs do not coincide with divisions on the rule, their distances from the nearest divisions may be measured by means of the micrometer eye-pieces, whose pitches must of course be previously measured.

In some types of instruments there is but one microscope or telescope, and the standard rule is engraved along the line of motion of the microscope or telescope. With these instruments the reading is made in turn on the extremities of the length, and the difference is noted.

In another type of cathetometer there are two telescopes on the vertical stand, and the scale is engraved on this along the line of motion.

Sources of Error.

1. The microscopes or telescopes must be exactly perpendicular to the line of motion.
2. The line of motion may not be a straight line.

Manipulation. The adjustments of the comparator are practically the same as those described in the last two experiments, but one additional adjustment is necessary: the length to be measured and the standard rule must be placed side by side, exactly parallel and with their surfaces in a plane perpendicular to the axes of the microscopes, so that each may be in focus when

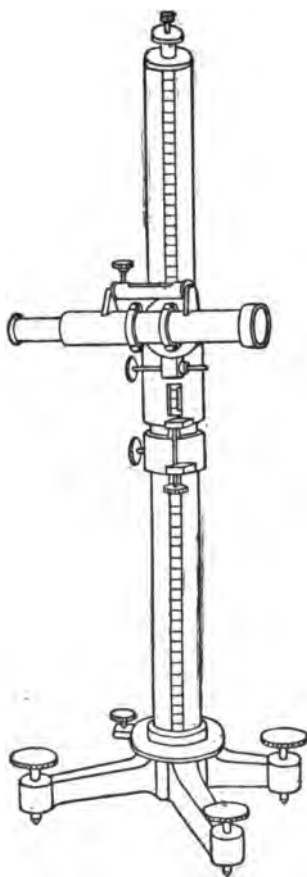

FIG. 20

the platform carrying them is rolled sidewise, bringing the two lengths successively under the microscopes.

This adjustment must be made before the measurements are begun, and can easily be secured by proper screws on the instrument or by using suitable wedges or blocks. In some instruments the platform carrying the two lengths is not movable, but the shaft carrying the two microscopes can be turned around its axis, and the microscopes be thus brought to focus upon each in turn.

The cathetometer is, almost without exception, used to measure vertical distances, and in order to adjust the line of motion of the telescopes exactly vertical, the instruments are provided with levels and levelling screws. For a complete discussion of these adjustments, see Stewart and Gee, vol. i. The length to be measured and the standard rule can be adjusted parallel to the line of motion of the instrument, and at equal distances away from the eye-pieces of the telescopes; and the lengths are in general compared by causing the cathetometer to rotate around an axis parallel to the line of motion. (In certain instruments the standard rule is adjusted permanently by the maker parallel to the line of motion of the telescopes or microscopes; and in others, as noted above, the standard rule is engraved along the line of motion.)

The temperature of the standard rule should be noted and correction made.

EXPERIMENT 11

Object. To determine by the method of vibrations the position of equilibrium of the pointer of a balance.

General Theory. The indications of many instruments are made by means of a marker of some kind swinging over

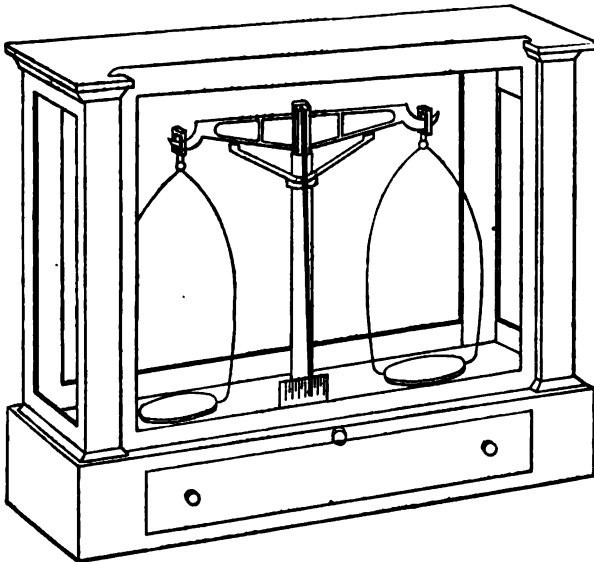

FIG. 21

a fixed scale. Instances of this are the pointer of a balance and the needle of a galvanometer. In all these instruments, when sensitively made, the indicator swings back and forth many times before it finally comes to rest at a definite

point, which marks the position of equilibrium. Time would be wasted in waiting for it to stop, and in any case the indications of the moving pointer are, as will be shown, more trustworthy than those of one which has come to rest, because the latter may not be in the true position of equilibrium, owing to friction. It is therefore important to learn to tell the precise position of equilibrium, and to practise reading with the pointer moving. We do this by noting the extremes of its swings. In deducing the point of equilibrium from these readings, it must be remembered

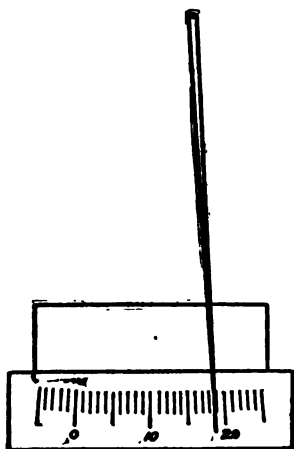

FIG. 22

that the swings are continually decreasing in amplitude. Consequently, if x is the point of equilibrium, and $(x + a)$ a reading of the right end of the swing, and each swing is e divisions less than the last swing, the next left swing will only carry it to a point $a - e$ beyond the point of equilibrium—i.e., to a point $(x - (a - e))$; and the point of equilibrium is half-way between the left swing and the mean of the two right swings, just before and after the left one. A little consideration will

show that no matter how many consecutive swings are noted, if an odd number are taken so that the last swing is on the same side as the first, the point half-way between the mean of all the left-hand and the mean of all the right-hand readings is the point of equilibrium.

Sources of Error.

1. The scale division read must be the one directly back of the pointer at its turning-points, a condition difficult to satisfy.
2. The vibration must not be disturbed after being once begun.
3. The "damping" of the vibration must not be too great, otherwise e cannot be assumed to be a constant.

Apparatus. Chemical balance in glass-case; small mirror.

Manipulation. Lower the balance on to the knife-edges by means of the screw in the front of the case. Set the balance swinging by fanning one of the scale-pans very gently with the hand, so that the pointer moves over not more than four or five divisions. Close the balance-case. Note the turning-points of the swing to the tenth of a scale division. (If the zero of the scale is marked in the middle, disregard the figures marked and call the mark farthest to the left of it zero.) Note as many swings as possible before the pointer comes to rest, taking the last on the same side as the first. Determine the point of equilibrium from the first three swings, and also from the first five, the first seven, and so on. Finally, note where the pointer actually stops, and show how closely the several ways of determining the point of equilibrium agree in their result:

In order not to make an error in viewing the pointer from different directions as it swings, place a small piece of mirror immediately back of the pointer; and, as it swings, move your eye so that the pointer always covers its reflection in the mirror. After you have once begun to read the swings do not raise the front of the case until the pointer has come to rest, as a draught of air might spoil the experiment. Take care in starting the swing you do not set the scale-pans moving in any other way than up and down from the beam from which they hang.

Do the experiment twice, with the same amplitude of swing; and twice more—once with an amplitude of seven or eight, and once with an amplitude over ten. When finished, *raise the beam off the knife-edges* by means of the screw, and leave the case closed.



FIG. 23

ILLUSTRATION

BALANCE "M 825"

Oct. 29, 1894

Turning-points		No. Swings	Mean Turning-points		Points of Rest calculated
Left	Right		Left	Right	
8.6					
	12.6				
8.9		3	8.7 +	12.6	10.6 +
	12.2				
9.8		5	8.9 +	12.4	10.6 +
	11.9				
9.6		7	9.1	12.2 +	10.6 +
	11.5		.		
9.9		9	9.8 -	12.0 +	10.6 +
	11.8				
10.1		11	9.4	11.9	10.6 +
	11.1				
10.8		18	9.5 +	11.8 -	10.6 +
	10.9				
10.4		15	9.6 +	11.6 +	10.6 +

The pointer came to rest at 10.6.

Report similarly the other experiments directed.

Questions.

1. Why must the scale-pans hang quietly on the beam to get the point of equilibrium properly?
2. What effect does the presence of an observer have upon a sensitive balance?
3. Is there any analogy between the vibrations of a balance and those of a pendulum?

EXPERIMENTS
IN
MECHANICS AND PROPERTIES OF
MATTER

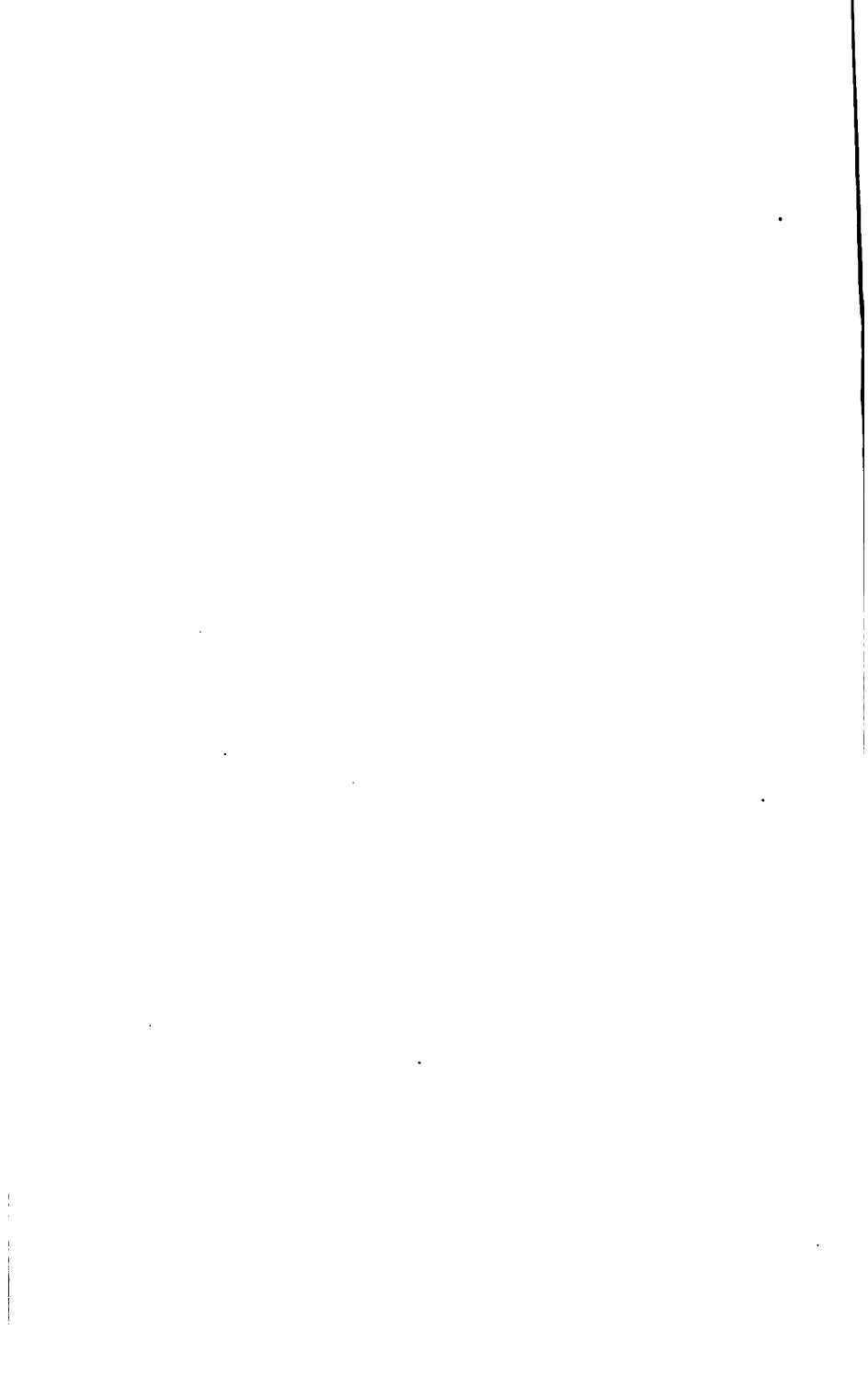

INTRODUCTION TO MECHANICS AND PROPERTIES OF MATTER

Units and Definitions. The only units made use of in Mechanics and Properties of Matter are the centimetre, the gram, the second, and others derived immediately from these fundamental ones. It may be useful to give the names and definitions of these units. (The names and value of other mechanical units which are sometimes used are given at the end of the volume in the tables.)

Quantity	Symbol Defining Equation	Unit	Definition
Length.....	x	Centimetre, cm.	See p. 2.
Area.....	x^2	Square centimetre, cm. ²	
Volume.....	x^3	Cubic centimetre, cm. ³ or cc.	
Mass.....	m	Gram, g.	See p. 2.
Time.....	t	Second, sec.	See p. 2.
Density.....	$\rho = m/x^3$		
Angle.....	$\theta = \frac{\text{arc}}{\text{radius}}$	Radian	Angle such that ratio of arc to radius is 1.
Linear speed.....	$s = x/t$	1 cm. per sec.
Linear velocity...	v	Unit speed in def- inite direction.
Linear accelera- tion.	$a = v/t$	Change of velocity 1 unit per sec. If direction is unchanged, 1 cen- timetre per sec.
Angular speed....	$\omega = \theta/t$	1 radian per sec.

Quantity	Symbol Defining Equation	Unit	Definition
Angular velocity..	Unit speed around definite axis.
Angular acceleration.	$a = \omega/t$	Change of angular velocity 1 unit per sec.
Linear momentum	mv	Such a motion that mass \times linear velocity equals 1 — <i>s. g.</i> , 1 g. moving with a velocity of 1 cm. per sec.
Force.....	$F = ma$	Dyne	Such a force that if "acting" by itself on a body whose mass is m would give it an acceleration such that $ma = 1$ — <i>s. g.</i> , if acting on 1 g. in its direction of motion it would, in 1 sec., increase the speed by 1 cm. per sec.
Moment of inertia	$I = \Sigma mr^2$		
Angular momentum.	$I\omega$		
Moment of force.	$L = Fl$		Force \times lever-arm.
Work and energy.	$W = Fx = LS$	Erg	Such an amount of work that force \times distance of motion in direction of force equals 1 — <i>s. g.</i> , 1 dyne doing work through 1 cm.
Work and energy.	Joule	10^7 ergs.
Power or activity.	$P = W/T$	Watt	1 Joule per sec.

Object of Experiments. The experiments in the following section of the manual may be roughly classified in two groups: viz., 1, those designed to teach the student how to measure with accuracy lengths, masses, and intervals of time; and, 2, those designed to teach him by actual observation the properties of matter and the laws which express mathematically the behavior of matter under various conditions.

The fundamental properties of matter are inertia, weight, and elasticity; and it is shown in treatises on physics that, as a consequence of these properties, matter behaves in a definite way under definite conditions. The mathematical formulæ which express these modes of action involve masses, lengths, and times; and so, in order to verify the laws, exact measurements of these three quantities must be made.

EXPERIMENT 12

Object. To determine the linear velocity and acceleration of a rapidly moving body. (See "Physics," Art. 18.)

General Theory. If a body moves very rapidly the accurate determination of the distance passed over in a given time can no longer be made by means of a watch. The principal methods of measuring the time in such cases all depend upon the comparison of the intervals which are to be measured with the time in which a standard tuning-fork of known period makes one vibration. The chief end of the present experiment is to illustrate this method of measuring time.

A block of wood is arranged at the top of suitable vertical ways so that when released it will fall in a straight line without twisting in any way. A heavy tuning-fork of known period is rigidly clamped so that as it vibrates its prongs move

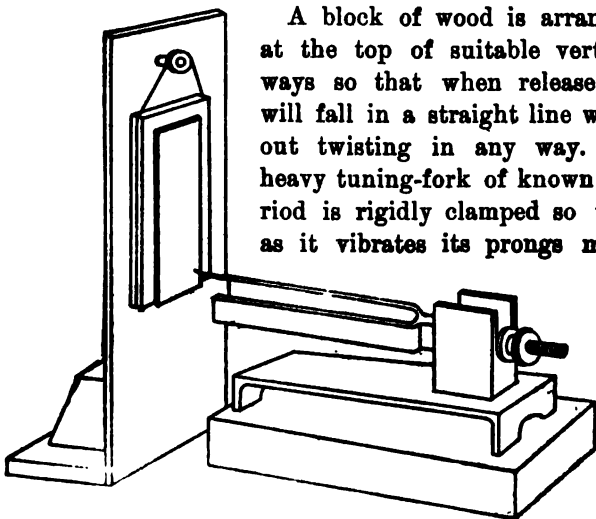
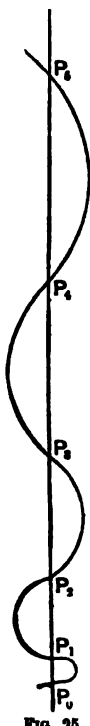

FIG. 24

to and fro horizontally. To one of these prongs is attached a suitable stylus, and a strip of smoked glass or other surface upon which the stylus can leave a trace is fastened firmly on the front of the falling block. When the tuning-fork is set in vibration and moved forward so that the stylus touches the prepared surface, it leaves a horizontal trace so long as the block is at rest. When the block is released and falls, the result is a wavy line, as shown in the figure. If the fork is now stopped and the block drawn up with the surface still in contact with the stylus a straight vertical line is drawn, marking the medial line of the vibrations of the stylus. If the points where this straight line intersects the wavy one are marked P_1, P_2, P_3 , etc., it is evident that the distances P_1P_3, P_3P_5, P_5P_7 , and similarly P_2P_4, P_4P_6 , etc., are each traversed in the time taken by the stylus to make one complete vibration. Therefore if the period of the fork is known, it is possible to at once determine the *average* velocity between any two of these points by measuring the distance between them along the straight line. Or, without knowing the period of the fork, the average velocity at different parts of the fall can be compared. Hence :



1. Let x = the distance between any two points where the curve crosses the straight line in the same direction, and let n = the number of vibrations of the fork marked between the points; then, if T is the period of the fork, and s the average speed with which the distance x was traversed, $s = \frac{x}{nT}$.

2. If x and x' are spaces at different parts of the motion traversed in an equal number of periods,

$$s = \frac{x}{nT}, \quad s' = \frac{x'}{nT} \quad \therefore \frac{s}{s'} = \frac{x}{x'}$$

3. If, now, x_1, x_2, x_3 , etc., are the spaces traversed in *suc-*

cessive intervals of n vibrations each, and s_1, s_2, s_3 , etc., are the average speeds for these intervals, then $s_2 - s_1$ is the increase in speed in an interval nT . Hence, if a_1, a_2 are the average accelerations in these intervals of time,

$$a_1 = \frac{s_2 - s_1}{nT} = \frac{x_2 - x_1}{n^2 T^2}, \quad a_2 = \frac{x_3 - x_2}{n^2 T^2}, \text{ etc.}$$

Hence, if the acceleration is constant,

$$s_2 - s_1 = s_3 - s_2 = s_4 - s_3 = \text{etc.} = anT;$$

or, $x_2 - x_1 = x_3 - x_2 = x_4 - x_3 = \text{etc.} = an^2 T^2$.

4. Finally, if the acceleration is uniform, and if s is the speed at a point P , and if P', P'', P''' , etc., are points passed at successive intervals of n vibrations after P , and x', x'', x''' , etc., the distance $\overline{PP'}, \overline{PP''}$, etc., then

$$x' = snT + \frac{1}{2}an^2 T^2,$$

$$x'' = 2snT + \frac{1}{2}an^2 T^2,$$

$$x''' = 3snT + \frac{1}{2}an^2 T^2, \text{ and}$$

$$x'' - 2x' = an^2 T^2, \quad x''' - 3x' = 3an^2 T^2.$$

$$\therefore \frac{x'' - 2x'}{x''' - 3x'} = \frac{1}{3}.$$

Hence the student should make the following observations :

1. Obtain the period of the fork from an instructor and determine the average speed for two different intervals of, say, three vibrations each, as far apart as possible, as in 1 above.

2. Calculate the ratio of the speeds for the two intervals without assuming the period known.

3. Measure the spaces passed over in successive intervals of, say, three vibrations each and show whether the acceleration is uniform.

4. Select as long an interval as can be found upon the trace which can be divided into three intervals of the same number of complete vibrations each, and show that the relation proved above holds. Since the spaces are long, the irregularities in the acceleration, due to jars and local roughness in the ways, ought not to affect the result, and this part of the experiment may therefore be taken as a proof that under uniform acceleration the space passed over in " t " seconds is $x = st + \frac{1}{2}at^2$.

The outline of the process is then as follows: Three or four traces are obtained as above, and the best two are selected for measurement. Each of these in turn is placed on the dividing-engine and the medial line adjusted parallel to the cross-hairs. The positions of the intersections are then read successively the entire length of the curve. The readings of the odd and the even intersections on the same curve are noted separately and form two independent series, for each of which the above relations should be deduced separately.

The drawing of the medial straight line may be dispensed with in the following manner: After the plate is removed from the block the middle point of the horizontal trace, made before the block started, is marked with a fine cross, and similarly a point at the farther end of the curve, which appears to be where the curve would cross the middle line if it were down. The curve being adjusted so that the cross-hairs pass through each of these points, the line of measurement will be along the medial line to an approximation close enough for the present experiment.

Sources of Error.

1. The stylus always has to have more or less spring, and the motion of its free end is therefore not quite the same as that of the fork to which it is attached.
2. Unless the ways in which the block slides are very well made it is difficult to draw the block back so that the stylus at rest traces a line directly down the middle of the curve, and it is no easier merely to indicate such a line by marks at the top and bottom as described. Hence the interval between two intersections in the same direction—as P_1 , P_2 —is often not exactly a period.
3. The actual period of the fork is not the same as it would be without the stylus; and, moreover, it varies with the position of the latter. It should, therefore, for accurate purposes be determined with the stylus adjusted just as it is to be used.

Apparatus. A block of wood arranged to fall between vertical guides; a heavy tuning-fork of low pitch mounted horizontally on a firm stand; string; a box of matches; a

dividing-engine, or else a metre-bar supported horizontally in two clamp-stands; and a flat block of wood to support the plate while it is measured. To receive the trace, may be used: either a long strip of glass, smoked with camphor burned in a watch-crystal or other shallow pan; or, paper sensitized to show a trace when an electric current passes through it. For this second method the front of the falling-block must be covered with metal foil connected to a binding-post, and 25 cc. of sensitizing solution (see "Laboratory Receipts"); a storage-battery, or other source of a considerable current, and enough wire for connections are also necessary.

The block of wood should be slightly wedge-shaped, so that it projects forward at the top, in order to insure a continuous trace during the fall. The stylus should be firmly attached to the prong of the fork, and should bend down a little at the tip. A stiff bristle is often used, but a better one may be made out of a very narrow strip of thin glass drawn out to a point. The width of the glass strip is vertical when it is attached to the fork, and the point of the stylus is not carried down by the plate as much as if it were as flexible in a vertical direction as it has to be in the direction in which the fork vibrates. If the electric method is used, the stylus must be soldered to the fork and may be a reasonably flexible needle, the rounded head resting against the paper, or copper wire (about No. 28 in size), used double, with the bend for a drawing-point.

Manipulation.—**SMOKED GLASS.**—Fasten the plate of glass to the face of the falling-block with "Universal." If the face of the block itself does not tilt forward at the top, incline the glass by placing a match stick between it and the wood at the top. Set fire to the camphor in the pan provided for it, and hold the glass surface over it, moving it to and fro until it is covered all over with a thin, uniform layer of soot. Tie a string to the top of the block, pass it over the peg at the top of the guides, and fasten it so as to hold the block at a height sufficiently great to leave it a fall of more than the length of the glass plate, and so that

the stylus on the fork will come just a little above the bottom of the plate. Place the fork in position with the stylus close to but not touching the plate, and with the prongs horizontal and the direction of vibration parallel to the plate. (If the stand provided for the fork is not high enough to admit of a trace the entire length of the glass plate, it must, of course, be raised by blocks.)

The best way to set the heavy fork into vibrations of an amplitude great enough to make good waves the entire length of the glass is to pass two or three turns of common cotton string around the ends of the prongs, cross the ends of the string, and pull on them, so as to draw the tips of the prongs together, until the string snaps.

When the apparatus is all ready, one observer sets the fork in vibration, as above, and pushes it up carefully so that the stylus just leaves a slight trace against the smoked surface. The other stands with match in hand and burns the string supporting the block the instant the stylus is in position. After the block has fallen, stop the fork, and, if practicable, draw up the plate in exactly the line it fell, so that the stylus at rest makes a straight line down the middle of the curve. It may take several trials before a good trace is secured. Repeat the experiment until four or five good curves have been obtained, using the other glass plates also if necessary.

Select the best two curves, place them in turn under the dividing-engine, and adjust the plate so that the medial line of the curve is exactly parallel to the path of the cross-hairs, and note the reading of each intersection of the curve with the axis, as described in the theory of the experiment. Record the readings of alternate intersections in different columns, so that the difference between two successive readings in the same column is the distance fallen in a whole and not in a half period.

Or else the metre-bar supported in the clamp-stands may be used for measurement. Arrange the bar in the clamps accurately parallel to the table, with the edge verti-

cal and at such a height that the glass plate mounted on a flat wooden block can just be slipped under it without the soot being rubbed. The height of the bar should be adjusted very accurately, so as to avoid rubbing the trace on the one hand and the danger of parallax in the reading on the other. (The adjustment may best be made with the help of another plate of glass of the same thickness and the block of wood.) When the bar is properly placed, lay the plate flat on the block and slide it under, adjusting it so that the medial line is *exactly* under the front edge of the bar along its entire length. (If no line was drawn down the middle of the curve, the ends of such an imaginary line should be marked as described in the theory of the experiment, and both marks should be exactly under the front edge of the bar.) Read the exact position of the intersections to tenths of a millimetre. This is done most accurately by standing behind the bar, looking over the top and down along the line of the graduations on each side of the intersection. Record the readings in two columns, as described above.

SENSITIZED PAPER.—The method is the same as for smoked glass, except in the following details. An electromotive force of ten or twelve volts is needed. One terminal of the battery is connected with the fork, the other, by means of a long, light wire, to the binding-post on the falling-block. The paper, which should be fairly smooth but unsized, must be freshly soaked in the solution and laid, while still wet, flat on the foil-covered face of the block. The metre-bar need not be supported in the clamp-stands, but can be laid directly on the paper; and the measurements should be made as described above.

After the measurements along the medial line are made, obtain the frequency at the fork from an instructor, and make the four following calculations, as described in the General Theory of the Experiment. (Do not make these calculations during laboratory hours.)

1. The average speed during the third and the next to the last complete period.

2. The ratio of the average speeds in the above two cases, without assuming the period of the fork known.

3. Show whether the acceleration was uniform throughout. If it appears not to be, state whether you think there was a real variation; if so, what caused it; and, if not, why is the curve not uniform?

4. Prove the relation $x = st + \frac{1}{2}at^2$, using each series in each trace as described.

ILLUSTRATION

April 26, 1897

LINEAR VELOCITY AND ACCELERATION

Glass Plate Smoked by Camphor. Measurements made on Dividing-engine

Readings	Distance Fallen in Interval $3T$	Increase in this Distance between two Successive Intervals
P_1 9.16	$P_7 - P_1 = x_1 = 1.53$	
P_3 9.49	$P_9 - P_3 = x_2 = 2.20$	$x_2 - x_1 = 67$
P_5 9.99	$P_{11} - P_5 = x_3 = 2.90$	$x_3 - x_2 = 70$
P_7 10.69	$P_{13} - P_7 = x_4 = 3.64$	$x_4 - x_3 = 74$
P_9 11.69	$P_{15} - P_9 = x_5 = 4.41$	$x_5 - x_4 = 77$
P_{11} 12.89	$P_{17} - P_{11} = x_{11} = 5.20$	$x_{11} - x_7 = 79$
P_{13} 14.38	$P_{19} - P_{13} = x_{13} = 6.01$	$x_{13} - x_{11} = 81$
P_{15} 16.10	$P_{21} - P_{15} = x_{15} = 6.78$	$x_{15} - x_{13} = 72$
P_{17} 18.09	$P_{23} - P_{17} = x_{17} = 7.28$	$x_{17} - x_{15} = 49$
P_{19} 20.34	$P_{25} - P_{19} = x_{19} = 7.79$	$x_{19} - x_{17} = 56$
P_{21} 22.88	$P_{27} - P_{21} = x_{21} = 8.22$	$x_{21} - x_{19} = 43$
P_{23} 25.32		
P_{25} 28.18		
P_{27} 31.05		

Frequency of fork, 70.

\therefore period = 0.0143 sec.

1. The average speed during the 8d interval = $\frac{2.90}{8T} = 67$ cm. per sec.

The average speed during the 10th interval = $\frac{7.99}{8T} = 186$ cm. per sec.

2. The ratio of the speeds in these intervals is $\frac{7.99}{2.90} = 2.75$.

3. The acceleration as shown in the third column varied from $\frac{81}{8T}$ to $\frac{43}{8T}$. The great lack of uniformity was probably a real variation due to the rude guides used, though part of it may be accounted for by the swaying of the block of wood, which made its path a curve instead of the straight line represented by the medial line of the plate.

4. Starting from P_1 the distances traversed in $4T$, $8T$, and $12T$, respectively, are :

$$P_3 - P_1 = s' = 2.53$$

$$P_{17} - P_1 = s'' = 8.98$$

$$P_{25} - P_1 = s''' = 18.97$$

$$\therefore \frac{s''' - 3s'}{s'' - 2s'} = \frac{11.88}{8.87} = 2.94$$

which proves the relation : $s = at + \frac{1}{2}at^2$ to within $\frac{6}{294} = 2\%$, about.

The student should give similarly his readings and deductions for the alternate points, P_5 , P_9 , etc., and for the other trace which he is directed to measure.

Questions and Problems.

1. Calculate linear speed of a point on the equator of the earth at midday and at midnight. Radius of orbit is 92,000,000 miles.
2. A stone is dropped over a cliff into water; the sound is heard after 10 seconds (velocity of sound = 33,300); find the height of the cliff.
3. A train passes a station with a speed of 50 kilometres per hour. On passing the next station, 2 kilometres away, its speed is 40 kilometres per hour. Calculate the acceleration, assuming it to be constant.
4. A train has a speed of 60 kilometres per hour. A gun is fired from the train so as to hit an object exactly opposite the window. If the velocity of the bullet is 100 metres per second, calculate the direction of aim. Rain is falling with the speed of 4 metres per second; calculate the path of a drop on the window-pane.
5. If an acceleration is 500 in yards and minutes, find its value in centimetres and seconds.
6. A train acquires, 8 minutes after starting, a velocity of 64 kilometres per hour. If the acceleration is constant, what is the distance passed over in the 5th second?
7. Show that, when a body is thrown upward, it has, at a height h , the same speed, whether it is rising or falling.
8. If a body falls in a vertical circle from any point of the circumference to the lowest point, along the chord joining the two points (or along any path), it will have the same speed at the bottom. Prove this theoretically.
9. The driving-wheel of a locomotive is 1.5 metres in diameter; it makes 250 revolutions per minute. What is the mean linear speed of a point on the periphery? What is the speed for a point on top? For a point on bottom?

EXPERIMENT 18

(TWO OBSERVERS ARE REQUIRED)

Object. To determine angular velocity and acceleration.
(See "Physics," Art. 22.)

General Theory. A wheel with a flat rim is rigidly attached to a horizontal axle, which is free to turn in bearings mounted on a platform at a height of eight or ten feet above the floor. The axle projects over the edge of the platform

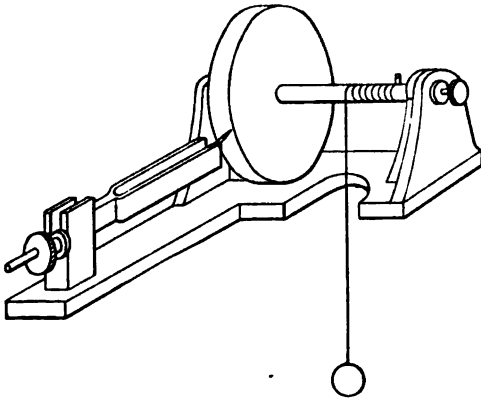

FIG. 26

and has a cord wound around it, to one end of which is attached a heavy weight. When the weight is released and falls, angular acceleration is produced in the axle and wheel. [If α be the acceleration, M the falling mass, r the radius of the axle, and I the moment of inertia of the

wheel and axle, $Ia = Mgr - f$, where f is the friction expressed as a moment opposing the rotation of the axle.]

If the rim of the wheel be covered by a strip of paper, either smoked or soaked in a sensitizing solution, a trace may be obtained upon it by means of a stylus attached to a vibrating fork, as in the last experiment. If the fork is at rest as the axle is revolved while the weight is being wound upon it, a straight line will be drawn on the paper. If the fork be made to vibrate horizontally as the weight falls, it will trace a wavy line which crosses the straight one at every half-period of the fork. Hence the distance between two successive points where the curve crosses in the same direction will be the distance, x , a point on the rim of the wheel has travelled in that period. If Θ be the angle of rotation in the same interval, and R the radius of the rim of the wheel :

$$\Theta = \frac{x}{R}.$$

If T be the period of the fork and ω the average angular velocity :

$$\omega = \frac{\Theta}{T} = \frac{x}{RT}.$$

Similarly, if x be the length between two crossings separated by n periods of the curve, the average angular velocity during the interval is

$$\omega = \frac{x}{RnT}.$$

The paper with the trace upon it is taken off the fly-wheel and measured, just as in the previous experiment. From the measurements may be deduced properties for motion of rotation corresponding to those deduced before for motion of translation, and in a similar manner, *i.e.* :

1. The average angular velocity, ω , for any given interval of an integral number of periods.
2. The ratio of the angular velocities, ω and ω' , for two intervals at different parts of the motion.

3. The mean angular acceleration for each successive interval of any desired length containing an integral number of periods.

4. The relation may be proved between the angle of rotation Θ , in a given time t , the angular velocity Ω at the beginning of this time, and the acceleration during the time, to wit :

$$\Theta = \Omega t + \frac{1}{2} a t^2.$$

The proof is exactly similar to that for linear motion in the previous experiment, and depends upon showing that

$$\frac{\Theta''' - 3\Theta'}{\Theta'' - 2\Theta'} = 3,$$

where Θ' , Θ'' , and Θ''' are the angles through which the wheel rotates in intervals, nT , $2nT$, $3nT$ respectively from any chosen instant near the beginning of the motion.

[The work done against friction in one turn may also be found from another trace obtained in the following manner :

The fork is set in vibration as before, but the stylus is not pressed against the paper until the instant that the cord is loosed from the axle, so that the falling weight imparts no further acceleration to the wheel. If the moment of inertia of the wheel be considerable and the friction small, the angular velocity will remain practically constant for one or two turns. This maximum angular velocity, Ω , may be determined upon removing the paper by counting the number of complete periods in one revolution of the wheel. Let this number be m . Then

$$\Omega = \frac{2\pi}{mT}.$$

The energy is then $\frac{1}{2} I \Omega^2$; and, if the wheel makes N turns before coming to rest and the work done against friction in each turn be W :

$$W N = \frac{1}{2} I \Omega^2.$$

N may be found by timing the interval, t , between the

moment of pressing the stylus against the fly-wheel and the moment the wheel stops. For the average angular velocity during this period is $\frac{1}{2}\Omega$:

$$\therefore 2\pi N = \frac{1}{2}\Omega t.$$

$$\therefore W = \frac{2\pi I \Omega}{t}.$$

From this value of W the moment of friction, f , may be calculated. For $f2\pi = W$. $\therefore f = W/2\pi$.]

Sources of Error.

Same as in previous experiment.

[The moment, Mgr , of the falling weight cannot be determined very accurately, as the cord often slips upon the axle, and the radius, r , of the axle is not exactly the arm of the moment, unless the place where the cord is wound is so long that only one layer is necessary.]

Apparatus. Fly-wheel mounted firmly in horizontal bearings on a platform two or three metres high, with the axle projecting; weight of about five kilograms; strong cord two or three metres long; four or five strips of paper, just long enough to go around the wheel, and lap enough to hold; camphor, and pan for burning it, or beaker of sensitizing solution, as in last experiment; dividing-engine or metre-bar and supports, as in last experiment; heavy tuning-fork, with proper stylus and cotton string, as in last experiment; universal; flat block of wood.

Manipulation. Smoke the paper and mount it on the fly-wheel with a *very little* universal. Be careful to see that the paper is tight and smooth and lapped in the proper direction, so that as the stylus crosses the joint it will pass from the upper to the lower layer of the lap. Adjust the fork so that its prongs vibrate in a horizontal line and at a height such that, when the stylus is brought into contact with the revolving wheel, the portion of the rim which it touches will be running away from and not towards the stylus. Attach the weight to the cord and wind it on the axle. Do not tie it on, but leave the loose end of the cord so that

it will fall off when the rest has unwound. One observer then holds the weight still at the top and lets go as soon as the other has started the fork and placed it in contact with the paper on which the trace is to be made. Stop the fork without moving it the instant the loose end of the cord leaves the axle, and stop the wheel also as soon as it has made one or two more turns, during which the fork leaves a straight trace down the middle of the previous wavy one.

It will be found that the wheel makes a number of complete revolutions during the fall of the weight; and, consequently, the vibrating stylus leaves its wavy trace several times over the same part of the paper. There need be no confusion, however, in measuring the intersections, since each separate curve can readily be followed and disentangled from the others.

[When four or five good traces have been secured in this manner, vary the experiment so as to measure the work done against friction. Do not place the stylus against the paper until just as the loose end of the cord drops off, and leave it in vibration for one or two revolutions only. Note with a watch the time it takes the wheel to come to rest after the stylus touches it. Measure the diameter of the wheel with the metre-bar and that of the axle with the vernier calipers.]

Select the best two traces obtained in the first part of the experiment; stretch them carefully on a block of wood, and measure the points of intersection of the curve along the medial line with a metre-rod, as described in the previous experiment.

[Next count the number of periods of the fork in one revolution of the wheel on the traces made in the second manner. Obtain the period of the fork and the moment of inertia of the wheel from an instructor, and weigh the falling weight on the platform scales.]

From the data thus obtained make the deductions indicated in the theory of the experiment.

ILLUSTRATION

(The mode of recording the first part of the experiment is exactly similar to the illustration in the preceding experiment.)

Jan. 7, 1897

The work done against friction in one turn was found as follows:

$$T = \text{period of fork} = .0506 \text{ seconds.}$$

$$I = \text{moment of inertia of wheel} = 2.00 \times 10^4.$$

Several traces were made as directed, by pressing the stylus against the paper just as the end of the string became loose. The number of waves in one revolution of the wheel were counted in three of these, and found to be 82.5, 82.6, 83.0 respectively; mean, 82.7 = m .

Hence the angular velocity while the trace was made was:

$$\Omega = \frac{2\pi}{mT} = \frac{2 \times 3.1416}{82.7 \times .0506} = 88.0 \text{ radians per second.}$$

The time in which the wheel came to rest after the stylus was pressed against it was 61, 63, and 62 seconds; mean, 62 seconds.

Hence the work done against friction in one turn is:

$$W = \frac{2\pi\Omega}{t} I = \frac{2 \times 3.1416 \times 88}{62} \cdot 2 \times 10^4 = 7.68 \times 10^6 \text{ ergs.}$$

Questions and Problems.

1. Explain why a common hoop does not fall over as it runs along the ground.
2. As a wheel of a carriage turns, what is the connection between the linear velocities of its axle and its upper and lower tire? Let the radius be 50 centimetres and the speed of the carriage 5 miles per second.
3. A man can bicycle 12 miles an hour on a smooth road; downward force with each foot in turn is 20 pounds; the length of stroke is 1 foot; driving-wheel has circumference 12 feet. How much work is done per second?
4. Calculate the horse-power transmitted by a rope passing over a wheel 15 feet in diameter, which makes 1 revolution in 2 seconds, the tension in the rope being 100 pounds.

EXPERIMENT 14

(TWO OBSERVERS ARE REQUIRED)

Object. To determine the mass of a body by inertia. A direct comparison of its inertia with that of a number of standard masses. (See "Physics," Art. 26.)

General Theory. Two bodies are said to have the same mass, if, when acted upon by the same impulse, each is given the same velocity. A simple method of testing this

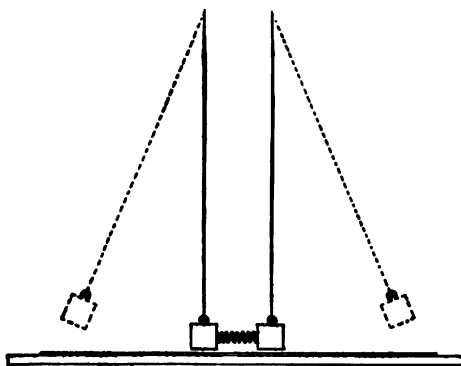

FIG. 27

equality of mass is to suspend the two bodies from cords, place a compressed spring between them, release the spring and compare their velocities. As is proved theoretically (see Experiment 15), the velocity with which such a suspended body will start off is proportional to the distance through which it swings before coming to rest and returning on its path, provided the radius of the circle in which it swings—*i. e.*, the length of the supporting cord—is long.

The method, then, is to suspend by a long string the body whose mass is desired, and by its side suspend by a string of equal length a body whose mass is known (*e.g.*, any one of a set of gram weights, or a can containing such weights); compress a spring between them, release it, and measure the two swings. If they are equal, the two masses are equal. If they are not equal, the known mass may be replaced by another, or it may be altered by a known amount, until the corresponding swings are equal.

Sources of Error.

1. Parallax is very difficult to avoid, since a considerable clearance has to be allowed between the pointer and the scale.
2. A correction must be made for the difference in mass of the vessels themselves.
3. It is difficult to apply the impulse to each can in a line passing through its centre of mass; and a part of the impulse goes to make the cans rotate. The linear momentum could, therefore, only be the same for each can in case the rotational momentums were the same.

Care is necessary to make the error from this source negligibly small.

Apparatus. Two tin cans just large enough to contain the cylinders measured in Experiment 5; a spool of strong thread; a box of gram weights, 100 g. to 0.01 g.; a spring-clamp, such as is constantly used to pinch a rubber tube; a clamp-stand and short metal rod; a metre-bar, or, better, a scale curved into a circular arc of a radius equal to the length of the threads suspending the cans. In order to bring the centre of mass in each can at the same level, the one intended for weights should have a false bottom at the proper height. Each can should have a vertical pointer, and three holes pierced at equal distances around the top, so that it can be suspended by three threads and will hang even. Each thread may conveniently have a wire hook on the end to hook into the holes in the can.

The three threads are tied together at the top and hang from a thread of suitable length provided with a wire hook

at the other end. The three suspending threads for each can have to be of exactly the same length or the can will not hang even; and the suspensions for both cans must also be of equal length.

Manipulation. By means of the hooks on the suspensions hang the cans empty from little loops of thread placed in a convenient position in the same horizontal line. Adjust the height of the loops so that the pointers on the cans are about at the level of the eye, the observer either standing or sitting, as may be convenient. Place the loops far enough apart so that there is just space enough between the cans for the spring when compressed. Compress the spring-clamp, tie it with thread, and hang it loosely on the bar held in the clamp-stand.

The figure shows the spring compressed and released.

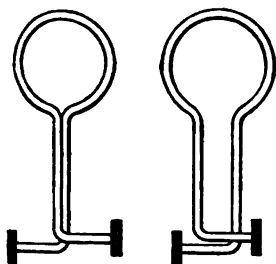

FIG. 2.

Adjust the whole apparatus so that the cans rest firmly against the flat faces of the spring in a line joining their centres, and be very careful that neither can is pushed out of the position in which it would naturally hang if the spring were not there. Adjust the clamp-stand so that the impulse to each can is delivered a little below its centre of figure.

Place the scale horizontally directly behind the pointers of the cans and as close to them as may be, without their grazing it in swinging.

When the apparatus is set up, note the positions of the pointers on the scale, being careful to avoid parallax as far as possible. One observer places himself in readiness to note the turning-point of the swing of one can, and the other observer does the same for the other can. The thread is then burned and the spring released. A few preliminary trials are usually needed to adjust the scale and the amount the spring should be compressed so as to send

the cans as far as possible without sending them off the scale. The readings should be made to millimetres each time, and tenths, if possible. Note and record the point of rest and the extremity of the swing of the pointer on each can, and deduce the arc over which the can is driven by the impulse. Add weights to the can which is driven farthest, until the initial velocities become the same. When believed to be the same, a trial should be made with exchanged observers.

Note the difference of mass in the cans as found in this manner and correct the result of the final experiment.

Place the cylinder in one can and weights in the other, changing the weights until the swing is the same for each. As before, when the swings are nearly the same, the observers should change places, so as to lessen the effect of individual errors. Note the weights in the can and correct for the difference in mass of the two cans.

ILLUSTRATION

April 21, 1897

COMPARISON OF TWO MASSES BY INERTIA

Points of Rest		Turning-points		Swings		Weights in Left Can	Weight too Great or too Small
Right	Left	Right	Left	Right	Left	Grams	
45.0	55.9	4.9	98.2	40.1	42.8	0	Too small
44.8	55.8	1.8	94.4	48.0	39.1	2	Too great
44.9	56.1	3.2	98.2	41.7	42.1	1	In doubt
44.6	55.8	2.6	97.7	42.0	41.9		
44.7	55.9	2.9	97.8	41.8	41.9		
44.9	56.2	3.0	97.9	41.9	41.7		
45.1	56.8	2.8	98.4	42.3	42.1	½	In doubt
44.9	56.0	2.9	98.4	42.0	42.4		
44.7	55.5	2.4	97.7	42.3	42.2		
44.9	54.8	2.9	97.3	42.0	42.5		
44.7	55.2	2.6	97.4	42.1	42.2	.7	Nearest
45.0	56.9	2.7	98.8	42.3	42.1		
44.5	55.6	2.3	97.5	42.2	41.9		
44.8	55.9	2.9	97.7	41.9	41.8		

Hence the mass of the right can is .7 gram greater than that of the left, as close as one can tell.

FINAL EXPERIMENT—CYLINDER IN RIGHT CAN

Points of Rest		Turning-points		Swings		Weights in Can	Weight too Great or too Small
Right Can	Left Can	Right	Left	Right	Left		
44.7	55.5	Off the scale	65.6	Over 50	10.1	50	Too great
45.0	55.9	29.7	Off the scale	15.3	Over 50	25	Too small
44.9	54.8	5.7	76.2	39.2	21.4	87	Too great
44.8	55.8	12.7	90.3	32.1	35.0	31	Too small
44.7	55.3	10.1	86.7	34.6	31.5	38	Too great
44.9	56.1	11.8	90.2	38.6	34.1	39	Doubtful, but apparently too small
45.0	56.2	11.1	90.0	38.9	33.8		
44.6	55.8	10.9	89.6	33.7	33.8	32.5	Too great
44.5	55.6	10.7	89.3	33.8	33.7		
44.7	55.9	11.1	88.3	33.6	32.4	31.5	Too small
44.8	55.9	11.8	88.2	33.5	32.3		
44.9	56.2	12.6	90.1	32.1	33.9	32.2	Appears to be the closest obtainable
45.0	56.3	12.7	90.4	32.8	34.1		
45.1	56.3	11.3	90.2	33.3	33.9	32.2	
44.6	55.7	11.0	89.1	33.6	33.4		
44.9	56.0	11.7	89.1	33.2	33.1	32.2	
44.7	55.8	10.7	90.1	34.0	34.3		

The mass of the cylinder is therefore = 32.2 - .7 grams = 31.5 grams.
 The range of uncertainty is between 30.9, which is undoubtedly too small, and 31.8, which is undoubtedly too great.

EXPERIMENT 15

(TWO OBSERVERS ARE REQUIRED)

Object. To verify the Principle of the Conservation of Linear Momentum. (See "Physics," Arts. 27, 28, 29.)

General Theory. There are two simple experiments which serve as illustrations of this principle: one is, when two bodies are allowed to impinge on each other; the other, when two bodies separated by a compressed spring are thrown apart by allowing the spring to extend, care being taken in each case to avoid the action of any external influence, such as gravity.

1. IMPACT. TWO BODIES.

The law of the conservation of linear momentum states that if two bodies impinge directly—*i. e.*, when moving along the line connecting their centres so that there is no spinning after they strike—the sum of their momentums must be the same immediately before and after impact—*i. e.*, $mv + MV = mv' + MV'$, where the small letters are the mass and the velocity of one ball and the large letters those of the other, v' and V' being the velocities immediately after impact, v and V those immediately before. (The coefficient of restitution is defined as :

$$e = \frac{\text{Velocity with which the balls move away from each other}}{\text{Velocity with which the balls approach each other}} = \frac{v' - V'}{V - v}$$

The simplest method of producing definite velocities is to suspend the body by means of a long string and allow it

to swing in a vertical circle. (See "Physics," Art. 69.) If the body is suspended from O by a cord of length OP , so as to be free to move in a vertical circle of this radius, and if it is then allowed to drop from a point A of this circle, it will have at the bottom of its path, P , the same speed that a body would have if it fell through the same vertical distance BP . That is, $V^2 = 2g BP$. But by

geometry, $BP = \frac{AP^2}{2OP}$. Therefore

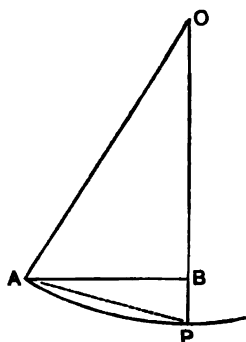

FIG. 29

the velocity of the falling ball at the bottom of its path is always proportional to AP , the chord connecting P with the point from which the ball is dropped. Since only comparatively small arcs of the circle are used in this experiment, it is not necessary to distinguish between the arc and the

chord; and it can with sufficient accuracy be said that the velocity of the falling ball at the bottom of its path is proportional to the number of divisions of the arc it sweeps over in falling; and this can be varied at will. Similarly, if a ball is started by a blow from its lowest position it will rise over an arc whose length is proportional to its starting velocity.

The simplest mode, then, of verifying the law is to suspend two small spherical bodies side by side by strings of equal length; and, leaving one hanging freely, to draw the other one side in the plane of the strings, and then let it fall and strike the other. The velocities are in the same straight line—*i. e.*, of the centres; they can be measured, and so may the masses. The line of centres is horizontal, and gravity plays no part during impact.

A more complicated apparatus is shown in Fig. 30, which may be used for the purposes of this experiment, or in place of that described in Experiment 14.

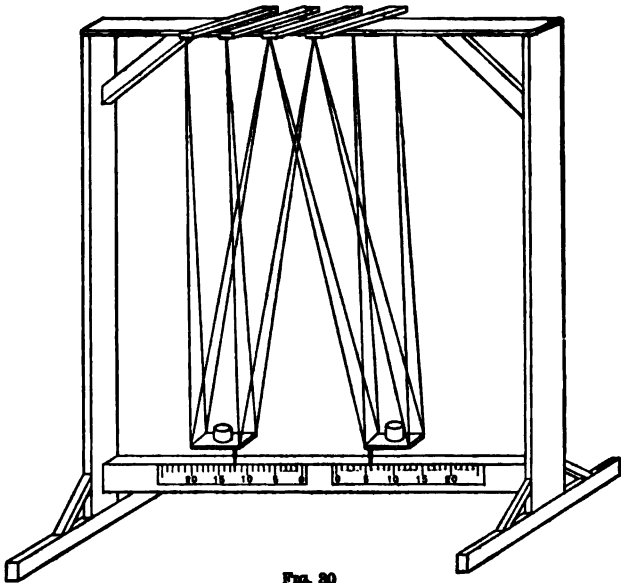

FIG. 30

2. COMPRESSED SPRING. THREE BODIES.

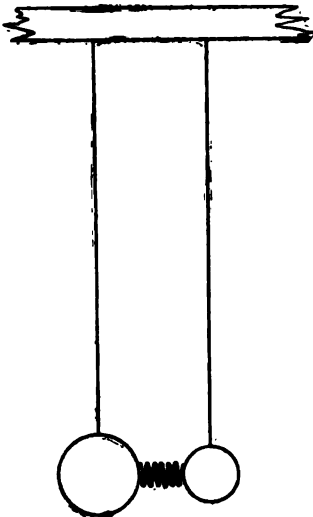

FIG. 31

In this method, two bodies suspended by strings, as in Part 1, are kept from touching by a compressed spring. This spring may be held compressed by a thread, and should itself be suspended by a long string.

If the thread is now burned, the spring will expand and throw the two bodies apart with a definite velocity, which may be measured as in Part 1. If the spring moves one way or another, its velocity should also be calculated. Then, since the three bodies are at rest be-

fore the thread is burned, the expression of the law of the conservation of linear momentum is that

$$m_1 v_1 + m_2 v_2 + m_3 v_3 = 0,$$

if m_1, m_2, m_3 are the three masses, and v_1, v_2, v_3 the corresponding velocities at the instant the spring expands. (The same law would apply to later instants if gravity had no influence.)

In general, the momentum of the spring may be omitted; and, in any case, the spring can be fastened to one of the bodies so as to move off with it, if it is desired.

Sources of Error.

1. The line of motion of the impact may not be along the line of centres.
2. The line of motion may not be perfectly horizontal.
3. The radii of the circles may not be the same.
4. Care must be taken to adjust the path of both bodies so that they do not rub against the scale at any point.

Apparatus. — METHOD 1. — A support from which two ivory balls or two cylinders of lead may be suspended so

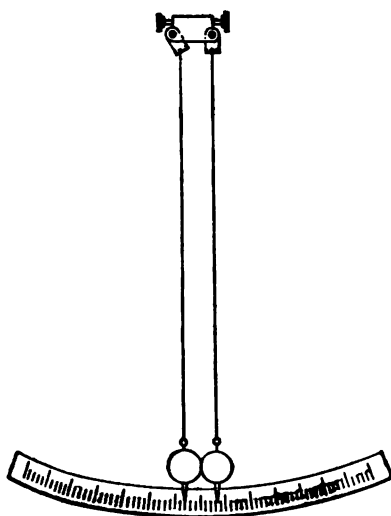

FIG. 33

as just to touch when hanging at rest. Each ball or cylinder has a brass pointer screwed into its lowest point, which moves over the divisions of a graduated circular arc when the ball is swinging. Each ball is suspended by two strings, whose length may be so regulated that both balls hang just above the graduated arc, and that their pointers move as close as possible to this arc over its whole length

without touching at any point. Further, by regulating the length of the strings the balls may be placed closer together or farther apart. The whole apparatus is supported on levelling-screws.

A small and a large ivory ball are needed for the experiment, and also two lead cylinders or balls. The balls are attached by tips which screw into their tops. Other articles needed are two stiff cards, about four centimetres square; a balance and weights accurate enough to weigh 0.1 gram.

METHOD 2.—As in Method 1, with the addition of a spring, either a spring pinch-cock, such as is used for rubber tubing, or a small coiled spiral spring; thread; matches.

Manipulation.—**METHOD 1.** *Case A.*—Two ivory balls; the larger at rest, the smaller dropped.

Level the stand so that the balls hang as close to the zero of the scale as possible. By means of the screws at the top regulate the length of the strings so that

1. The balls touch very lightly, and the centres of both are on the same arc, parallel to the graduated circle.
2. The brass pointers move close to the circular arc without rubbing as the balls swing.
3. These pointers, when at rest, are at equal distances from the zero, and on opposite sides.

Both balls should then hang vertically at the lowest point of their respective arcs of motion.

When both are perfectly still, read their positions on the scale. Call readings to left of zero minus. One observer raises the small ball, and with one of the cards holds it so that the pointer lies precisely on a division of the scale. Be careful that the ball is not twisted in any way, so that when freed it will not be set spinning. It may take several trials before the student learns to do this skilfully, and also before the other observer learns at exactly what point to watch for the end of the swing of the struck ball. To get this point precisely, he should hold a piece of card

edgewise against the scale, so that the pointer of the ball can just clear the top of it. By repeated trials the card is set so that the ball reverses its motion almost exactly over it. Make ten good readings of the turning-point of the *struck* ball, not counting the preliminary trials. Then, in a precisely similar way, make ten readings also of the point to which the dropped ball goes after impact. Always drop the ball from exactly the same point.

Report as shown in the illustration.

Case B.—Proceed as in Case A, but drop the large ball.

Case C.—Use the lead cylinders, dropping either; but let it be the same throughout.

Weigh the balls and cylinders to within 0.1 gram. Add the masses of the brass caps on the ends of the cords to the respective balls. These may be learned from an assistant. Be very careful about the algebraic signs throughout. Verify the relation that

$$mv + M V = m v' + M V'$$

Calculate e , the “coefficient of restitution,” for the ivory and lead balls.

METHOD 2.—The adjustments and precautions are exactly as in Method 1, and so need not be described. It is evident, however, that it is impossible to compress the spring each time to the same amount, and so successive readings cannot be averaged.

ILLUSTRATION

Nov. 15, 1895

Masses. Ivory balls—No. 1, 68.42 g.; No. 8, 82.57 g.
 Lead cylinders—No. 1, 400 g.; No. 2, 382 g.
 Right cap, 2.75 g.; left cap, 2.50 g.

Case A. No. 8 hung on left cord and dropped from -20 .
 Masses and caps—No. 1, 71.17 g.; No. 8, 85.07 g.
 Zeros—No. 1, 1.20; No. 8, -1.25 .
 \therefore Arc through which No. 8 falls is 18.75.
 No. 1 at rest.

Hence, $e = 18.75$,

$$V = 0.$$

Points Reached after Impact	
No. 3	No. 1
- 4.625	12.00
- 4.625	12.25
- 4.75	12.125
- 4.75	12.25
- 5.00	12.00
- 4.75	12.00
- 4.75	12.125
- 4.75	12.00
- 5.00	12.00
- 4.75	12.00
Mean, - 4.70	12.10

∴ Arc made by No. 3 after impact—*i. e.*, $V' = -(4.70 - 1.25) = -3.45$

Arc made by No. 1 after impact—*i. e.*, $V' = 12.10 - 1.20 = 10.90$.

Momentum before impact = $18.75 \times 35.07 = 657.5$.

Momentum after impact = $(10.90 \times 71.17) - (3.45 \times 35.07) = 654.7$.

Difference = $2.8 = .4\%$

$$e = \frac{10.90 + 3.45}{18.75} = 0.76.$$

Case B. Report similarly.

Case C. Report similarly.

Questions and Problems.

1. The energy of a body whose mass is m and which is moving with a velocity v is $1/2 mv^2$. It is a law of nature that energy is conservative. Calculate the energy before and after impact and account for the difference.
2. If a man is placed on a horizontal, *perfectly smooth* table, how could he move himself in a horizontal direction?
3. Why is there no "external influence" in this experiment?
4. If density of earth is 5.56, calculate its momentum.
5. A base-ball, whose mass is 300 grams, when moving 10 metres per second, is struck squarely by a bat and then has a speed of 20 metres per second; calculate the impulse and the average force if the contact lasts $1/50$ second.
6. Two equal masses are at rest side by side. One moves from rest under a constant force F , the other receives at the same instant an impulse I in the same direction. Prove that they will again be side by side at time $2I/F$.
7. When a horse drags a cart or a canal-boat, if action equals reaction, why is not the horse held fast?

8. The mass of a gun is 4 tons, that of the shot 20 pounds, the initial velocity of the shot is 1000 feet per second, what is the initial velocity of the gun? What is the effect of the gases so far as momentum is concerned?
9. A 30-gram rifle-bullet is fired into a suspended block of wood weighing 15 kilograms. If the block is suspended by a string of length 2 metres, and is moved through an angle of 20° , calculate the velocity of the bullet.

EXPERIMENT 16

Object. To show: 1. That if different forces act upon the same body, the acceleration is directly proportional to the force.

2. That if the same force acts upon bodies of different masses, the acceleration is inversely proportional to the mass. (See "Physics," Arts. 30, 31.)

General Theory. If a body whose mass is m is moving under the action of any external influence with an acceleration a , the product ma is called the "external force," and is taken as the measure of the external influence; because if, under this same influence, a mass m' is moving with an acceleration a' ,

$$m'a' = ma.$$

This fact is to be tested by experiment. The simplest means at our command of producing forces is to make use of the fact that a body whose mass is m falls freely towards the earth with an acceleration g , a constant at any one place for all bodies. That is, a body of mass m is always acted upon by a force downward mg , which is called its weight (g , in Baltimore, is nearly 980; and its value in other places is given in the Tables).

The general method is to apply different weights to the same body and measure its acceleration, and to apply the same weight to different bodies and to measure their accelerations. The instrument used is called Atwood's machine. It consists essentially of a very light wheel, with a grooved rim arranged to turn in a vertical plane with as little friction as possible, and set upon a tall column. A long cord

passes over the wheel and carries at its ends two cylinders of equal mass. Neglecting the weight of the cord, the resultant force acting upon either cylinder is, therefore, zero, since the downward force of gravity is exactly counterbalanced by an equal upward tension in the cord, due to the weight of the other equal mass. The cylinders will, therefore, remain at rest unless some additional force is applied to one or the other; or they will continue to move with uniform velocity when such a velocity has once been imparted to them, neglecting the effect of friction.

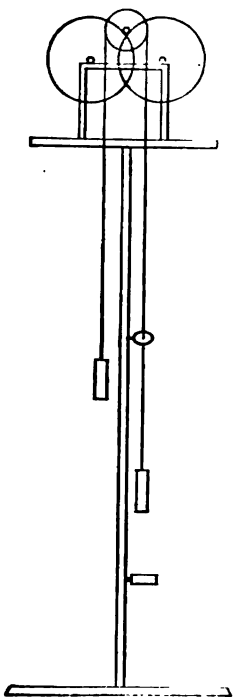

FIG. 33

Forces are applied to the system in the following manner: One of the cylinders is drawn to the top of the pillar, and a hinged platform, arranged for the purpose, is adjusted beneath it and held by a catch. While the cylinder is thus supported, a small bar of known mass, called a "rider," which projects on each side considerably beyond the cylinder, is placed upon it. The catch is now pulled away, the platform drops, and the mass on this side moves down while the other rises. At a distance beneath the platform, which may be varied at pleasure, is placed a ring, through which the cylinder can pass freely, but not the rider. There is a second platform which may be adjusted at any desired distance below the ring, and which stops the motion.

The force which imparts motion to the system when the hinged platform is released is evidently only the weight of the rider, while the mass moved is the entire mass of the system—that is, the sum of the two equal masses plus the rider. (Allowance must also be made for the fact that the

wheel itself is turned. It is extremely difficult to make this allowance unless the slipping of the cord is accurately known.)

The system will then move under a uniform acceleration until the rider is removed; and after that, since the external force is removed, the acceleration is zero, and the velocity remains constant until the motion is stopped by the lower platform. In the present experiment the ring is placed immediately above the lower platform at the very end of the motion. If t is the time taken by the system in moving from the starting platform to the ring, the whole motion being under the uniform acceleration a , and the distance from the platform to ring being x , it is known that $x = 1/2 at^2$ or $a = 2x/t^2$. Therefore, by measuring the distance x , and observing t , the acceleration a can be determined. Hence,

1. To show that the acceleration varies as the force, the mass being constant: Place two riders, one much heavier than the other, upon the cylinder that is to move down, and determine the acceleration. Let it be a . The external force is the sum of the weights of the two riders. Then leave only the heavier rider on the cylinder that moves down, placing the lighter one upon the other cylinder. Determine the acceleration again and call it a' . The external force is in this case the difference of the weights of the two riders, while the total mass moved is the same.

Then, if m_1 and m_2 are the masses of the riders, $\frac{a}{a'}$ should be $\frac{m_1 + m_2}{m_1 - m_2}$, if the acceleration varies directly as the force.

2. To show that the acceleration varies inversely as the mass moved, the force being constant: Determine the acceleration of the equal cylinders with any suitable rider. Let it be a . Replace the equal cylinders by two other equal cylinders, but of a mass different from the first, and determine the acceleration again with the same rider. Let it be a' . Then, if M is the mass of each of the first pair,

and M' the mass of each of the second, m being the mass of the rider,

$\frac{a}{a'}$ should be $= \frac{2M' + m}{2M + m}$, if the acceleration varies inversely as the mass moved.

Sources of Error.

1. Friction and the resistance of the air are forces opposing the motion in each case. The actual resultant force upon the system is, therefore, the difference between the weight of the rider and the sum of these forces. The true statement in the first experiment would therefore be $\frac{a}{a'} = \frac{(m_1 + m_2)g - f}{(m_1 - m_2)g - f'}$, where f and f' are the opposing forces in the two portions of the experiment. But since f and f' are very difficult to determine, the experiment is so devised as to make them small, and therefore they can be omitted from the formula.
2. The resultant force has to set in motion the wheel as well as the weights and cord. Hence, if I is the moment of inertia of the fly-wheel, α its angular acceleration, and r its radius, a fuller statement of the equation of motion is

$$\text{force} = (2M + m) a + \frac{I\alpha}{r},$$

$$= (2M + m) a + \frac{Ia}{r^2}, \text{ if there is no slipping.}$$

Hence, in the second part of the experiment,

$$\frac{a}{a'} = \frac{2M' + m + \frac{I}{r^2}}{2M + m + \frac{I}{r^2}}. \text{ The correction in this case can be made}$$

if I and r are known, and if there is no slipping.

3. The time enters to the square in the formula, and is, moreover, very hard to determine, as it is quite short; and care must therefore be concentrated on it.

Apparatus. An Atwood's machine; two riders of different weights, and two different pairs of cylinders; strong thread, or very light cord; a stop-watch.

Manipulation. Adjust the cord to exactly the right length, so that one mass will rest upon the top platform while the

other just clears the floor or the base of the machine. Hang the heavier pair of cylinders on the cord; pass the latter over the wheel in the groove, and replace the bell-jar covering the wheel and its supports, if there is one. Place the lower platform as far down as possible, and the ring at such a height over it that the rider has just time to be lifted before the motion stops; thus the motion under acceleration is as long as possible. Adjust the whole apparatus so that one cylinder rests squarely on the top platform, and, when it falls, passes through the ring without touching. This is best done by levelling-screws, with which the base of the apparatus should be provided.

1. To show that the acceleration varies directly as the force, the mass moved being constant :

Raise the cylinder on the side of the platforms and ring, and support it on the upper platform. Place both riders upon it. Release the catch and start the watch the instant the platform drops. Stop it at the sound of the click when the rider strikes the ring. Repeat ten times.

Repeat the experiment, placing the heavier rider on this cylinder and the lighter upon the other. Weigh the two riders on a platform-balance.

Let the mean durations of fall be t and t' . Then, since the distance fallen is the same, $\frac{a}{a'} = \frac{t'^2}{t^2}$. This should equal

$$\frac{m_1 + m_2}{m_1 - m_2}$$

2. To show that the acceleration varies inversely as the mass, the force being constant :

Use the lighter rider and the same cylinders, and repeat the observations as before ten times. Repeat again with the same rider and the pair of smaller cylinders. Weigh the two pairs of cylinders on a platform-balance.

Then, if t and t' are the intervals of time, $\frac{a}{a'} = \frac{t'^2}{t^2}$, and, therefore, $\frac{t'^2}{t^2}$ should equal $\frac{2M' + m_2}{2M + m_2}$.

ILLUSTRATION

April 15, 1897

1. To prove that acceleration varies directly as the force.

Riders Separated	Riders Together
Force = $17\text{ g} - 10\text{ g} = 7\text{ g}$ dynes	Force = $17\text{ g} + 10\text{ g} = 27\text{ g}$ dynes
t	t'
5.8	3.0
6.0	3.0
6.0	2.8
6.0	2.8
5.8	3.0
6.0	2.8
5.8	3.0
6.0	3.2
6.0	3.0
6.0	3.0
5.94	2.96

Hence, $t^2 = 35.3$

Hence, $t'^2 = 8.76$

and $a = \frac{2x}{35.3}$

and $a' = \frac{2x}{8.76}$

$$\therefore \frac{a'}{a} = \frac{35.3}{8.76} = 4.03.$$

The ratio of the forces is: $\frac{27}{7} = 3.86$.

The discrepancy, which equals $\frac{17}{400} = 4\%$, is in the right direction to be accounted for by friction, which would tend to diminish both forces equally, and would therefore show its effect most with the smaller force.

Futhermore, the probable error of t is about $\frac{1}{4}\%$, and of t' nearly $1\frac{1}{4}\%$, which makes the probable error of a'/a about 4% , since t and t' both enter as squares.

2. To prove that acceleration is inversely proportional to mass:

Larger Cylinders	Smaller Cylinders
t	t'
5.0	3.6
5.0	4.0
5.4	3.6
5.0	3.6
5.2	3.6
5.0	3.8
5.0	4.0
5.0	3.6
5.4	3.6
5.0	3.6
5.10 Mean.	3.70 Mean.

Hence, $t^2 = 26.0$

Hence, $t'^2 = 13.7$

and $a = \frac{2x}{26.0}$

and $a' = \frac{2x}{13.7}$

$$\therefore \frac{a}{a'} = \frac{260}{137} = 1.90.$$

Mass of larger cylinders is 275 grams each.

Mass of smaller cylinders is 137.5 grams each.

Rider in each case 10 grams.

$\frac{2M + m}{2M' + m} = \frac{285}{560}$. Inverse ratio = $\frac{560}{285} = 1.96$, which shows an agree-

ment fully as close as would be expected.

Questions and Problems.

1. Calculate the tension in the rope which draws a carriage weighing 1 kilogram up an incline of 30° with an acceleration of 1 metre per second.
2. If a nation uses 40 metres as unit length, 3 seconds as unit time, and 100 pounds as unit mass, what is the value of the unit force in this system in terms of dynes?
3. A body is moving with a speed of 4 kilometres per hour, what force in dynes will bring it to rest in 5 seconds?
4. A particle is projected upward at an angle of 30° to the horizontal, with a speed of 70 metres per second. Find the time before the particle again reaches the horizontal. Find the horizontal distance.
5. What pressure will a man who weighs 70 kilograms exert on the floor of an elevator which is descending with an acceleration of 100 centimetres per second? Discuss the tension in an elevator rope when rising; when falling. Discuss stress on car-couplings when the train is starting, and when it is in uniform motion.
6. The ram of a pile-driver weighs 250 kilograms. It falls 7 metres and drives a pile 20 centimetres. Calculate resistance (if uniform).

EXPERIMENT 17

Object. To verify the law of centrifugal motion, that a force $m r \omega^2$ is required to make a mass m move in a circle of radius r with a constant angular velocity ω . (See "Physics," Art. 35.)

General Theory. Two spheres of different masses, connected by a cord, are placed free to slide along a horizontal rod which pierces their centres. This rod is rotated rapidly around a vertical axis, and the position of the spheres is sought, in which they will remain in equilibrium, and will not fly to one end or the other of the rod. If m_1 and m_2 are the masses of the two spheres, and r_1 and r_2 the radii of the circular paths of their centres when there is equilibrium, then

$$m_1 r_1 \omega^2 \text{ should equal } m_2 r_2 \omega^2,$$

because they both have the same angular velocity, and each exerts on the other the force necessary to make it move in a circle.

Therefore, since r_1 and r_2 can be measured, $m_1/m_2 = r_2/r_1$ can be determined, and the result compared with that obtained by the use of a balance.

Sources of Error.

1. Friction of the balls on the rod can never be entirely gotten rid of.
2. The rod must be accurately horizontal and the axis of rotation vertical, or else gravity will tend to move the balls one way or the other.

3. Care must be taken not to rock the apparatus while rotating it.
4. The wire or cord connecting the masses has inertia also, and an excess of length of it on either side of the axis aids the tendency to move in that direction.

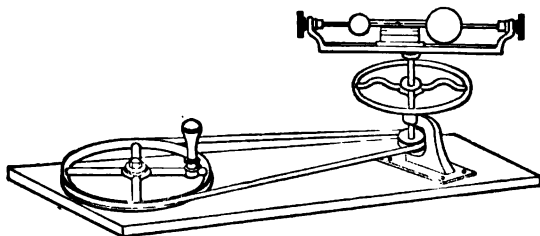

FIG. 34

Apparatus. A whirling-table; two steel L-squares; two wooden clamps; a metre-bar; a large vernier caliper is also convenient in measuring the diameter of the spheres, though the metre-bar and L-squares can be used. The fly-wheel of the whirling-table is rotated by means of a hand driving-wheel about an accurately vertical axis. A frame is clamped rigidly to the axle of the fly-wheel, and carries a stiff, straight, horizontal brass rod, on which two wooden spheres are free to slide. The two spheres are connected by a fine brass wire carrying a pointer, which moves over a scale fixed to the frame, parallel to the brass rod. The apparatus is so adjusted that the brass rod is accurately at right angles to the axis of rotation; and, therefore, if the axis is exactly vertical, the force of gravity has no effect upon the motion of the two spheres.

Manipulation. Clamp the apparatus firmly to a table in a good light, taking care to make the axis of rotation vertical. If the point where the axis of rotation meets the scale is not already marked on the scale, determine it by rotating the frame rapidly, and noting what point remains perfectly at rest. A good way to test this is by making a small pencil dot at the point which seems to the unaided eye to be at rest. If, on rotation, the point makes a little circle, rub it out and try again, until the true posi-

tion of the axis has been determined to the tenth of a millimetre.

Pull the spheres apart, so that the wire connecting them is stretched and both are free to move either way. Note the position of the pointer on the scale to the tenth of a millimetre. Rotate the apparatus rapidly, and note which sphere flies out. Call one sphere m_1 , the other m_2 , and record the reading of the pointer just made under a column marked m_1 or m_2 , according as it is m_1 or m_2 which flies out; this is shown in the illustration. Make another trial with the spheres moved so that the one that flew out moves in a smaller circle, and record again in the appropriate column the reading of the pointer before rotation. By similar successive trials the position of equilibrium is soon found. When it has been apparently reached, test by finding how much either way the spheres may be moved without affecting the equilibrium. If the friction of the rod is small, the place of equilibrium ought to be very well defined. If it is not, note the point where m_1 just moves out, and the point where m_2 just moves out, and call the true position a point half-way between.

Repeat the determination five times.

By noting the reading of the pointer, its distance from the axis may be at once calculated. It then remains to measure the distances along the wire from the centre of each sphere to the pointer. This may be done by measuring the diameter of each sphere and the distances from the pointer to the farther sides of the two spheres.

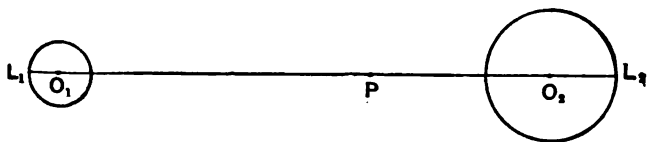

FIG. 35

In the diagram P is the pointer; L_1 and L_2 are the outer sides of the sphere; O_1 and O_2 , their centres. The quantities to be measured are $\overline{PL_1}$ and $\overline{PL_2}$ (and $\overline{L_1L_2}$ as a

check), and the two diameters. From these measurements and a knowledge of the distance from the axis to the pointer P , if P is the reading of the index when there is equilibrium, r_1 and r_2 may be calculated.

To measure the distances PL_1 , etc., a caliper may be formed of the metre-rod and the two L-squares, and used as follows :

Place the L-squares on the metre-bar so that the thin sides of the L 's form two parallel jaws at right angles to the bar, the distance between which is easily varied by sliding one or the other along the bar. While one observer holds the spheres apart so that the wire is stretched tight, the other closes the caliper made as above upon the *outer* extremities of the diameters of the spheres which continue the line of the wire—*i. e.*, L_1 and L_2 in the figure. Be very careful that the metre-bar is accurately parallel to the desired length, and that the edges of the L-squares are accurately perpendicular to the bar. Note the distance, $\overline{L_1L_2}$, thus found; and, as the measurement is extremely difficult, repeat at least five times. Similarly measure $\overline{PL_1}$ and $\overline{PL_2}$, taking five readings of each; and if $\overline{PL_1} + \overline{PL_2}$ is not equal to $\overline{L_1L_2}$, take the mean as the correct length of $\overline{PL_1} + \overline{PL_2}$ and divide the error evenly between the two terms. This gives $\overline{PL_1}$ and $\overline{PL_2}$. L_1O_1 and L_2O_2 , the radii of the spheres, may most easily be found by means of a large vernier caliper, great care being taken to measure the diameters as close to the brass rod as possible. Five readings of each should be taken, and there is no object in reading the vernier closer than 1/10 mm. If no caliper large enough is available, determine the distance from P to the near points of the spheres just as $\overline{PL_1}$ and $\overline{PL_2}$ were determined, and thus find the diameters. Be careful to measure all the lengths in the same unit. Having determined r_1 and r_2 , calculate the ratio of m_1 to m_2 , and get from an instructor the true value as measured on a balance.

ILLUSTRATION—VERIFICATION OF LAW OF CENTRIFUGAL MOTION

Axis found to be 51.8.

Nov. 4, 1884

Sphere m_1 Moved Out				
1st	2d	3d	4th	5th
27.0	30.5	30.0	31.0	31.2
28.0	30.8	31.0	31.3 (?)	31.2 (?)
30.0	30.9	31.1	31.2 (?)	31.1 (?)
31.0 (?)	no motion	31.2	31.1	30.0 (?)
30.5	31.3 (?)	31.2 (?)	30.0
30.8	31.2	31.2	no motion
30.9	31.3	no motion
31.0	no motion
31.1
no motion
Sphere m_2 Moved Out				
1st	2d	3d	4th	5th
32.0	31.5	31.8 (?)	32.0	31.5
....	31.2	31.5	31.4
....	31.1	31.4	31.3
31.5	31.0	31.3 (?)	31.2
31.3 (?)	30.9	31.6	31.4 (?)	31.1 (?)
31.4	no motion	31.5 (?)	31.4 (?)	31.1
....	no motion
....	31.5	31.4
31.3	no motion	no motion
no motion

Readings for Equilibrium	Hence, Distance of Pointer from Axis
P	PO
1st...31.2	20.1
2d...30.9	20.4
3d...31.4	19.9
4th...31.3	20.0
5th...31.1	20.2
Mean :	20.1

Dimensions of Apparatus						
$L_1 L_2$	PL_1	PL_2	PL_1+PL_2	PL_2	PL_1	Diameters m_1 m_2
471.2	371.1	99.8			61.3 103.4
471.5	371.3	99.7			61.4 103.2
471.3	371.2	99.9	mean value,	mean value,	61.3 103.3
471.4	371.0	99.9			61.5 103.5
471.1	370.9	99.6			61.2 103.1
471.3	371.1	99.8	470.9			99.9

Whence, radii are :

$$\overline{L_1 O_1} = 30.6. \quad \overline{L_2 O_2} = 51.7.$$

$$r_2 = \overline{OP} + \overline{PL_2} - \overline{L_2 O_2} = 20.1 + 99.9 - 30.6 = 89.4.$$

$$r_1 = \overline{PI_1} - \overline{L_1 O_1} - \overline{OP} = 371.1 - 51.7 - 20.1 = 299.3.$$

$$\therefore \frac{m_2}{m_1} = \frac{r_1}{r_2} = 3.82.$$

By the balance $m_2/m_1 = 3.29$.

Questions and Problems.

- Why is it not desirable to read the vernier on the vernier caliper to the utmost accuracy in measuring the diameters of the spheres?
- If, in the experiment, the frame were accidentally tilted so that the rod sloped downward from the larger to the smaller sphere, would the ratio found be the true ratio of the masses, or smaller or larger? Why?
- Is there any such force as "centrifugal force"?
- If, while the frame is revolving, the cord or wire were cut, what would happen? Why?
- Deduce the tension of the wire just as the balls begin to move. What is the linear speed of each ball at this moment?
- Prove that when the spheres are in the position of equilibrium, $m_1 v_1 + m_2 v_2 = 0$, where v_1 and v_2 are the linear velocities. Can you give any reason why this should be so?
- A pail of water, whose mass is 1 kilogram, is swung in a vertical circle $r = 10$ centimetres. What is the tension at top and bottom of path, if the angular velocity at top is 5? How many turns per second suffice to keep the water in the pail?
- A skater describes a circle of radius 10 metres, with a speed 5 metres per second. At what angle must he be inclined to the vertical?

EXPERIMENT 18

(TWO OBSERVERS ARE REQUIRED)

Object. To verify the laws of harmonic motion. (See "Physics," Arts. 21, 25, 51.)

General Theory. Harmonic motion is defined as being such that the acceleration is always towards a fixed point, and varies directly as the displacement from that point. Thus, the longitudinal vibration of a spiral spring is harmonic motion, because the acceleration varies directly as the elongation of the spring, and is always in such a direction as to tend to bring the spring back to the position it would have if not vibrating—*i. e.*, to the position of equilibrium.

Again, the rotational vibrations of a flat-coiled spring, such as a watchspring, are harmonic, because the angular acceleration varies directly as the angle of twist, and is always in such a direction as to tend to bring the spring towards its position of equilibrium.

If the displacement from the position of equilibrium is called x or θ , according as it is a distance or an angle; and if the acceleration is called a or α , according as it is linear or angular, the condition for harmonic motion is

$$\left. \begin{array}{l} \text{linear } a = -cx \\ \text{angular } \alpha = -c\theta \end{array} \right\}$$

where c is some constant depending upon the inertia and stiffness of the vibrating system. It is easily proved also that the vibrations of a system in harmonic motion have a constant period,

$$T = 2\pi\sqrt{\frac{l}{c}},$$

which is independent of the amplitude if it is small.

I. *Harmonic Motion of Translation.*—Since the acceleration at any instant is equal to a constant times the displacement, $a = -cx$, the force of restitution must be proportional to the displacement also, because force varies as the acceleration. In particular, consider the longitudinal vibrations of a spiral spring under the influence of gravity. Let the spring carry a body whose mass is M , and let its own mass be m ; let it be suspended vertically. If the reading of a pointer on the spring is O when the spring is at rest, then, when in its vibrations the pointer is at a point x below O , the force of restitution *upward* is proportional to x , $F = Kx$. Consequently, if instead of allowing the spring to vibrate, a force downward is applied so as to produce the displacement x , the force applied must be Kx . Therefore, if any force F produces a displacement x , F should equal Kx , where K is a constant for all displacements, and measures the “stiffness” of the spring. In other words, the displacement is proportional to the stretching force; this is called “Hooke’s Law”; and, conversely, any system which obeys Hooke’s law will perform harmonic vibrations if it is disturbed from its position of equilibrium.

It may be proved by actual experiment that the displacements of a spiral spring, a pendulum, a tuning-fork, a stretched string like a violin string, etc., are proportional to the force, and hence their free motions are harmonic.

Since, then, $F = Kx$, the acceleration may be determined if the mass moved is known. In the above case of the spiral spring of mass m carrying a body of mass M , it may be proved by theory that the effect of the inertia of the spring is exactly as if the mass M were increased by $1/3 m$, if the spring is evenly wound.

$$\text{Hence, } F = (M + 1/3 m) a,$$

$$\text{and } a = -\frac{K}{M + 1/3 m} x.$$

Hence, the constant c , as defined above ($a = -cx$), equals

$$\frac{K}{M + 1/3 m}.$$

Hence the period,

$$T = 2\pi\sqrt{\frac{M + 1/3 m}{K}}.$$

K may be found by directly measuring the displacement produced by a given force, as described above; T and M and m may also be measured, and this law may be verified.

The important facts are:

1. A system obeying Hooke's law makes harmonic vibrations.
2. The period varies as the square root of the mass moved.

II. *Harmonic Motion of Rotation.*—The angular acceleration $a = -c\theta$; consequently, in order to turn the system through an angle θ , a moment L must be applied, such that

$$L = k\theta,$$

where k is the same for all angles and measures the stiffness of the spring. It may be easily measured by noting the angular displacement produced by a given moment. Conversely, any system satisfying this condition will make harmonic vibrations—*e.g.*, a watchspring, a compass-needle, a twisting wire, a vibrating balance, etc.

The angular acceleration is equal to the moment of the force divided by the moment of inertia—*i. e.*, $L = Ia$.

Hence, $a = \frac{k\theta}{I}$; and, therefore, $c = \frac{k}{I}$. But $T = 2\pi\sqrt{\frac{I}{c}}$;

hence, $T = 2\pi\sqrt{\frac{I}{k}}$.

The important facts in this case are:

1. A system obeying Hooke's law makes harmonic vibration.
2. The period varies as the square root of the moment of inertia. Therefore, we have a convenient method of comparing moments of inertia.

In the following exercise the linear vibrations of a spiral spring and the rotational vibrations of a flat-coiled spring will be studied.

The following facts will be verified by experiment:

1. The linear displacement of the spring is proportional to the stretching force.
2. The vibrations have a period which is independent of the amplitude, provided it is small.
3. The period of vibration varies as the square root of the mass moved.
4. The angular displacement of the flat spring is proportional to the moment.
5. The vibrations of the flat spring also have a period which is independent of the amplitude, provided it is small.
6. The period of vibration varies as the square root of the moment of inertia $I = \sum mr^2$; and so it can be varied by placing different masses at the same distance from the axis, or by placing the same mass at different distances.

Sources of Error.

1. If the wire is stretched too much, Hooke's law is not obeyed, and hence the theory does not apply.
2. If there is too much friction, either external or internal, the vibrations die down rapidly and cease to be isochronous.
3. Displacements must be taken great enough to make the probable error of one setting small in comparison with the entire displacement.

Apparatus. For translation: An evenly wound spiral spring; a metre-rod; two heavy weights; two light ones; a watch. (In the laboratory of the Johns Hopkins University the spring used is one which is commonly used to close heavy doors. Its mass is 450 grams; and the heavy weights used are 5 and 6 kilograms, the light ones 400 and 600 grams. The stiffness is such that 300 grams produces an elongation of about 1 centimetre.)

For rotation: Special apparatus, as shown in Fig. 36. It consists of a flat coiled spring in a horizontal plane, one end

fastened to a fixed support, the other to a vertical axle which is free to rotate, and to which are fastened a horizontal wheel and a horizontal rod carrying sliding weights; cord; weights; pulley.

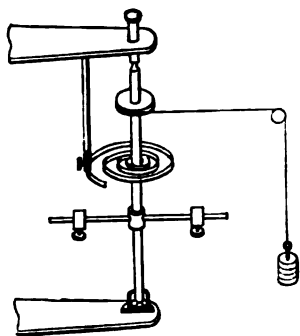

FIG. 36

Manipulation. 1. *Translation.*— Weigh the spiral spring and suspend it vertically from a fixed support; place back of it the metre-rod, and fasten a fine wire to the lower end of the spring at right angles to it, so that it may serve as an index along the scale. Hang

a heavy weight from the spring, taking care to see that the weight is great enough to separate the spirals; note the reading; add a small weight, m_1 ; note the difference in reading, h_1 ; add another weight, m_2 ; again note the difference, h_2 . Then, if $F = Kx$,

$$\frac{m_1 g}{h_1} \text{ should equal } \frac{m_2 g}{h_2}.$$

Calculate K .

Do the same, using the second heavy weight in place of the first. Calculate K again. It should be constant.

2. With either heavy weight hanging from the spring, set it vibrating *vertically*, and measure the period, as in Experiment 1, at intervals of 50 vibrations, while the amplitude slowly dies down.

Measure the weight of the hanging mass on a platform balance.

Call it M_1 . Call the period T_1 .

3. Do the same with the second heavy weight. Call its mass M_2 and the period T_2 . Then, if m is the mass of the spring

itself, T_1/T_2 should equal $\sqrt{\frac{M_1 + 1/3 m}{M_2 + 1/3 m}}$.

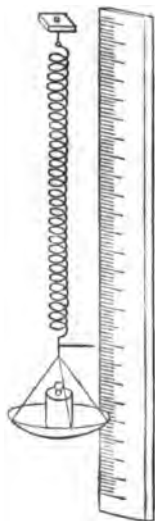

FIG. 37

4. *Rotation.*—By means of the string, pulley, and peg in the fixed horizontal wheel of the rotation apparatus, apply a small weight to the wheel, thus producing a moment around the axis. By means of a circular divided scale measure the angle of displacement. Call the weight m_1 and the angle θ_1 ; then, if r is the radius of the fixed wheel, $m_1 gr = k\theta_1$, if $L = k\theta$. m_1 should be great enough to make θ_1 large in comparison with the error of setting.

Apply a different small weight, m_2 , and measure the total angular displacement, θ_2 . Then, $(m_1 + m_2) gr = k\theta_2$.

Calculate k . It should remain constant.

Add other weights, and measure the displacements.

Plot in a curve the angular displacements and corresponding weights.

5. Clamp equal sliding weights on the horizontal rod at equal distances from the axis. Set the system in small vibrations, and measure the period as the amplitude dies down. It should remain very nearly constant. Let the masses be M_1 each, and their distances from the axis r_1 . Call the period of vibration T_1 .

6. Add equal sliding weights, M_2 , to each side of the rod, and make the average distance of the whole mass, $M_1 + M_2$, from the axis the same as before, r_1 . Measure the period of vibration; call it T_2 . The moment of inertia in this vibration is greater than before by the amount $2M_2 r_1^2$; consequently, the period T_2 should be less than T_1 . (If the moment of inertia of the fixed cylinder and of the spring

itself is I' , then T_1/T_2 should equal $\sqrt{\frac{2M_1 r_1^2 + I'}{2(M_1 + M_2) r_1^2 + I'}}$.

An instructor should know the value of I' .)

Again, remove the two weights M_2 , and clamp the two weights M_1 at a different distance from the axis, r_2 . Measure the period T_3 . If $r_2 > r_1$, $T_3 > T_1$, because the moment of inertia has increased.

(The quantities M_1 and M_2 in this and the previous section have no connection with those denoted by the same symbols in sections 2 and 3.)

ILLUSTRATION

I.—HARMONIC MOTION OF TRANSLATION

1. Mass	Position of Pointer	Elongation
5369 g.	85.75
+ 200	85.11	0.64
+ 200	84.47	1.28

T

- 2. First 50 vibrations, 0.85 sec.
- Second 50 vibrations, 0.84 "
- Third 50 vibrations, 0.85 "
- Fourth 50 vibrations, 0.84 "

Mean, 0.845 "

- 3. Mass of spring, 463 = $m \therefore \frac{1}{2}m = 154.3$.
- $M_1 = 5369$; $M_1 + \frac{1}{2}m = 5523.3$; $T_1 = 0.845$.
- $M_2 = 5951$; $M_2 + \frac{1}{2}m = 6105.3$; $T_2 = 0.885$.

$$\left(\frac{T_2}{T_1}\right)^2 = 1.097; \frac{M_2 + \frac{1}{2}m}{M_1 + \frac{1}{2}m} = 1.105.$$

II.—HARMONIC MOTION OF ROTATION.

4. Grams attached to Pulley	Angular readings
50	86.6°
+ 20	+ 4.6
+ 20	+ 4.65
+ 20	+ 4.5
+ 20	+ 4.75
etc.	etc.

T

- 5. First 10 vibrations, 1.68 sec. $r_1 = 10$ cm.
- Next 15 vibrations, 1.70 "
- Next 20 vibrations, 1.69 "

Mean, 1.690 "

6. Mass	<i>r</i>	<i>T</i>
$M_1 + M_2$	10	2.005 sec.
M_1	10	1.690 "
M_2	14	2.182 "

Questions and Problems.

- 1. How would you prove experimentally that the vibrations of a pendulum are harmonic ?
- 2. Draw analogy between mass and moment of inertia.
- 3. How could you determine the moment of inertia of the apparatus itself in the rotation experiment if the moment of inertia of the two masses m_1 at distance r_1 is $2m_1r_1^2$?

EXPERIMENT 19

Object. To verify the law of moments—viz., that the proper definition of a moment around an axis is the product of the force by the perpendicular distance from the axis to the line of action of the force. (See “Physics,” Art. 43.)

General Theory. The simplest method of verifying this law is to secure equilibrium of an extended body by three forces, and measure the moments as defined above. If the definition is correct, the algebraic sum of the moments should equal zero.

Thus, if a board is pivoted at P , and if, by means of two strings attached to nails at N_1 and N_2 , forces F_1 and F_2 in

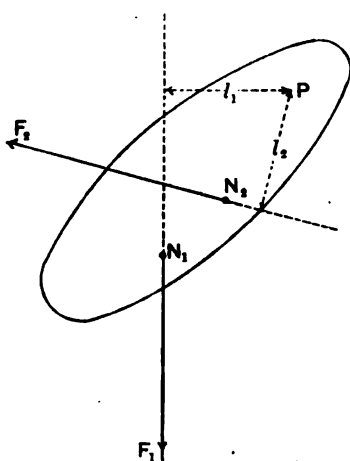

FIG. 38

the plane of the board are applied so as to tend to turn the board in opposite directions around the pivot, there are only three forces acting on the board (if the board lies in a horizontal plane, or if the peg passes through the centre of gravity of the board in case it is vertical)—viz., the two, F_1 and F_2 , and the reaction of the pivot-peg. Taking moments around P , by the above definition the moment of F_1 equals $F_1 l_1$; that

of F_2 , $F_2 l_2$; and if the forces F_1 and F_2 are such that the board is in equilibrium, then $F_1 l_1$ and $F_2 l_2$ should be numerically equal. This may be verified by direct experiment. The moment of the reaction of the pivot-peg around the point P is of course zero.

Sources of Error.

1. It is quite difficult to measure the perpendicular distances l_1 and l_2 .
2. In whatever way the board is supported or suspended, friction always enters as an indeterminate force, though by proper care it can be made small.

Apparatus. Two spring balances; cord; two metre-rods; an L-square; a nail, or a heavy weight with hook.

Manipulation. Pierce two small holes through the metre-bar at points near its ends; pass strings through each and make loops; support the metre-rod on edge at its middle point

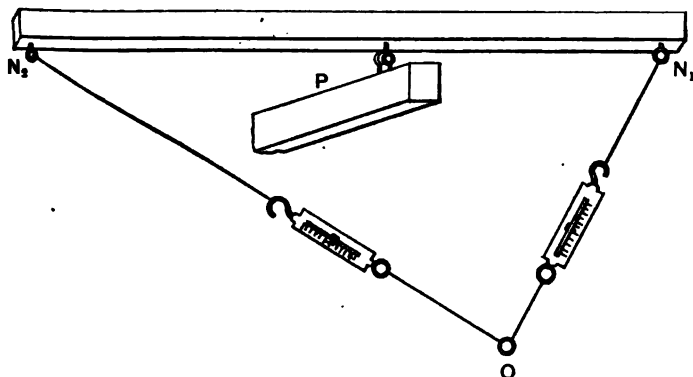

FIG. 39

P by means of a pivot of some kind, a knife-edge resting on a stool, or a string joined to a high support above. Join the two loops at the ends N_1 and N_2 , to some nail below, O , by means of strings, putting a spring-balance between each loop and the nail, so as to measure the forces. (Another convenient method is to fasten the strings ON_1 and ON_2 to a heavy weight, which may be moved along the table

below, thus altering the forces.) This may, perhaps, be best done by joining N_1 to O (through the balance), and then twisting the other cord ON_2 around the nail at O until the rod has a suitable position. It is best to make the forces as large as possible, and to put in the balances with their hooks down.

Measure the forces F_1 and F_2 as recorded on the balances, taking care to avoid friction of the scale-pointer against the scale, and to place the balances as accurately as possible in the lines $\overline{ON_1}$ and $\overline{ON_2}$.

By means of the L-squares and the other metre-rod, measure the perpendicular distances l_1 and l_2 from P to $\overline{N_1O}$ and $\overline{N_2O}$. Do this by placing one arm of the square along the metre-rod, the other along the string $\overline{ON_1}$ (or $\overline{ON_2}$) and sliding the two along the string until the metre-rod passes through P . Be sure that the strings are straight between O and N_1 and N_2 , and that the edge of the metre-rod passes accurately through P .

Change the length of the string ON_2 , thus altering the forces and lever-arms, and measure the quantities again. Do this three times in all, turning the metre-rod over in some experiments.

Show that $F_1 l_1 = F_2 l_2$.

ILLUSTRATION

LAW OF MOMENTS

First Position

Forces		Lever-arms		Moments*	
F_1	F_2	l_1	l_2	$F_1 l_1$	$F_2 l_2$
$8\frac{1}{8}$	$8\frac{1}{8}$	42.2	45.7	189.7	189.1
$8\frac{1}{8}$	$8\frac{1}{8}$	42.5	45.2
Mean, $8\frac{1}{8}$	$8\frac{1}{8}$	42.35	45.45	Difference, .6 or $\frac{1}{2}$ of 1%.	

Second Position, etc.

Questions and Problems.

1. Why were moments taken around P , and not around N_1 or N_2 , or O ?
2. What effect does any bending of the rod have?
3. Why is it advisable to use large forces?
4. Why does friction affect the result when moments are taken around a pivot?
5. If it is wished to upset a tall column by means of a rope of given length, pulled from the ground, where should it be applied?
6. A uniform pendulum-rod is pulled aside by a force applied horizontally at its lower end equal in amount to one-half the weight of the whole rod. Calculate the angle which the pendulum makes with the vertical when there is equilibrium.

EXPERIMENT 20

(TWO OBSERVERS ARE REQUIRED)

Object. To verify the laws of equilibrium of three forces acting at one point. (See "Physics," Art. 60.)

General Theory. If a point P is held in equilibrium by three forces; the conditions are that if the three forces are added geometrically they form a closed triangle; or, ex-

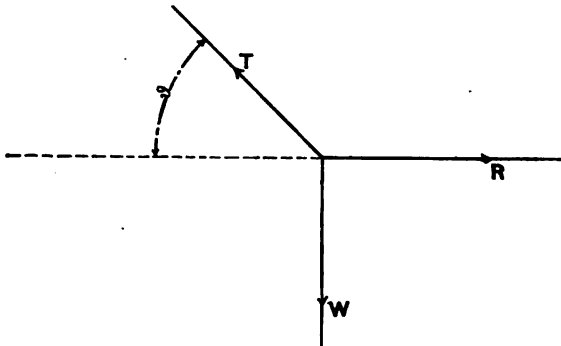

FIG. 40

pressed in other words, the sum of the components of the forces resolved in any direction must equal zero. In particular, if two of them are at right angles to each other, and if the third makes an angle \mathcal{S} with the line of one of the others, as is shown in the figure,

$$T \sin \mathcal{S} - W = 0,$$

$$T \cos \mathcal{S} - R = 0.$$

This particular arrangement of forces may be secured easily in the laboratory by hanging a weight from a point

and balancing it by two forces in the directions T and R . These may be measured and so may S ; and, consequently, the law may be verified.

A second perfectly general method is to tie three strings together at a point; fasten a spring-balance to each string; pull them in different directions, and register the forces, both in amount and direction, when the point is in equilibrium. A good way of doing this last is to place a sheet of paper behind the strings, lay off the directions of the forces on this, and construct their sum graphically.

Another method (see "Physics," Art. 36) is to pass a cord over two pulleys which have horizontal axes and are in the same plane; suspend a weight from each end, and looping a third weight over the string between the two pulleys, note the directions and the amounts of the forces which hold in equilibrium the point where the third weight is fastened. This may best be

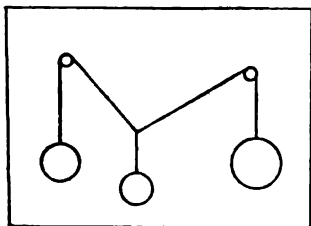

FIG. 41

done, as above, by a graphical method.

A full description of the first method is given below.

Sources of Error.

1. It is difficult to measure S , or its cosine or sine.
2. Great care must be taken to keep R perpendicular to W .
3. The angles must be kept constant during the measurements.

Apparatus. Two spring-balances; a weight of about two kilograms; a stick about forty centimetres long, with a nail-head at each end; a ball of twine; a steel L-square; a metre-rod.

Manipulation. Tie a piece of twine to the weight and determine the weight of the latter by hanging it on a spring-balance. Tie one end of a short piece of twine to a nail, or through a hole in a vertical wall or frame (as shown at A in the figure). Tie the other end to the ring of the spring-

balance, leaving about ten or fifteen centimetres of string between the balance and the nail or hole. Tie the weight to the hook of the balance by a string nearly a metre long. Rest one end of the stick against the side of the wall or frame. Loop the twine, which carries the weight, once or twice around the nail at the other end, at such a point that the stick will stand out almost at right angles to the vertical wall or frame. Finally adjust the whole so that the nail-head on which the stick rests against the wall does not slip, and so that the stick is exactly at right angles to the wall, as may be shown by the square.

There is equilibrium at the point P between W , the weight acting vertically, T , the tension of the cord acting along \overline{PA} and measured by the spring-balance, and R , the resistance of the prop acting out from the wall along \overline{BP} .

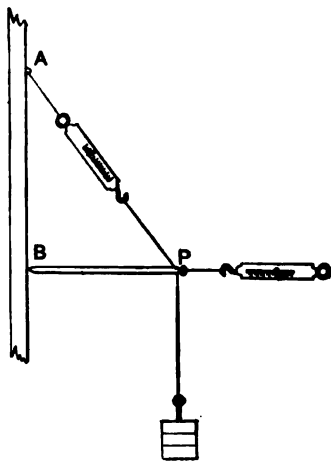

FIG. 42

Read the spring-balance accurately. Measure as accurately as possible, by means of the metre-bar, the lengths of the sides of the triangle PBA , or of a triangle similar to it. In doing this, remember that A is the point where the line \overline{PA} (produced if necessary) meets the vertical wall; and B is the point in the line \overline{PB} vertically below A , while P is the part of the nail around which the twine is wound. Care should be taken to measure a straight line precisely between these points. The line \overline{PB} should be at right angles to the line \overline{AB} .

When these measures have been made, attach a string to the hook of the second spring-balance and loop the other end around the nail P , taking great care not to disturb anything in so doing. While one observer keeps his eye

on the index of this balance and pulls out with gradually increasing force exactly in the line \overline{BP} extended, the other watches the nail on which the stick is pivoted and calls "Read" the moment it is pulled away from the wall.

The reading of the second scale at this moment should be exactly equal to R . The stick will drop before the pressure against the wall is quite zero unless it is supported in some manner. This may be done by holding the steel L-square in the angle of the wall and stick, below the stick, thus keeping it truly horizontal until it is pulled away. The friction is diminished if a bicycle-ball is placed between the stick and the L-square.

The two balances should then be compared to see if they give the same readings for the same forces.



FIG. 43

This may be done by hooking the two together and seeing if they agree when pulled apart.

Repeat the experiment three times, making the proportions of the triangle PBA different each time.

If the suspended weight is not very large in comparison with the weight of the horizontal stick, a correction must be made for the latter. If W_1 is the weight of the stick, its effect is exactly the same as if the stick had no weight, and the weight W were increased by $\frac{1}{2}W_1$. This is evident by taking moments of all the forces around the point B .

1. Remembering that \overline{AB} is vertical and \overline{BP} perpendicular to it, calculate from the dimensions of the triangle the vertical and horizontal components of T , and show that they, together with R and W , fulfil the conditions of equilibrium. Report as below.

2. Prove graphically that the forces are in equilibrium, using a scale of not less than $1/4$ inch to the pound.

NOTE.—On the Use of Spring-balances to Measure Forces other than those Acting Vertically Downward on the Hook.—A balance is so graduated as to give correctly the weight of an object hung upon its hook. If the weight hung upon the hook is W , the reading of the balance is \underline{W} ; but the force

acting upon the balance is $\overline{W} + \overline{\lambda}$, where $\overline{\lambda}$ is the weight of the hook, index, etc., of the balance itself. If, then, the weight were suspended by a cord over a frictionless pulley, and held there by the spring-balance placed horizontally, the weight of the hook, etc., would no longer act on the spring, and the reading would consequently be $\overline{W} - \overline{\lambda}$. If the spring-balance were now carried downward until it pulled vertically down, the hook, etc., would not only not weigh themselves on the spring, but would counterbalance $\overline{\lambda}$ units of the weight \overline{W} besides. The reading of the balance would, therefore, be $\overline{W} - 2\overline{\lambda}$. If R_1 , R_2 , and R_3 are the readings of the balance in the three cases, $\overline{W} = R_1 = R_2 + \overline{\lambda} = R_3 + 2\overline{\lambda}$. A little consideration will show that when the direction of the cord away from the hook makes an angle θ , with a direction vertically downward, the tension of the cord is

$$\frac{R + (1 - \cos \theta) \overline{\lambda}}{2}$$

Hence, in all measurements of forces with a spring-balance, turn the hook of the balance towards the force to be measured, and add $(1 - \cos \theta) \overline{\lambda}$ to the reading. To find $\overline{\lambda}$ for a given balance, suspend the ring from a nail, hang a weight on the hook and read. Turn the balance wrong side up, put the hook over the nail, and, hanging the weight from the ring, read again. The difference between the readings is $\overline{B} - 2\overline{\lambda}$, where \overline{B} is the weight of the whole balance, which should be found by weighing it on another. This can best be done by first weighing the balance plus a weight on the second balance, and then the weight alone, since a spring-balance often does not measure very small forces accurately.

ILLUSTRATION

Oct. 30, 1894

TO VERIFY THE LAWS OF EQUILIBRIUM OF THREE FORCES ACTING AT THE SAME POINT

Balances used, No. 11 in \overline{AP} . No. 14 in \overline{BP} .

Correction for weight of hook in No. 11:

Weight suspended from hook = 5.125.

Weight suspended from ring = 5.25.

$$\therefore B - 2\overline{\lambda} = 0.125 \text{ lbs.}; \therefore \overline{\lambda} = 1/2 (B - 0.125).$$

Weight and No. 11 suspended from hook of No. 14 = 5.50

Weight alone suspended from hook of No. 14 = 5.125

$$\therefore \text{Weight of No. 11} = B = 0.875$$

$$\therefore \overline{\lambda} = 1/2 (0.875 - 0.125) = 0.125.$$

Hence the correction to No. 11 used in the line \overline{AP} which makes an angle $90^\circ - \theta$ with the vertical = $+0.125 (1 - \sin \theta)$.

The weight of the hook No. 14 was similarly found to be = $+0.125$. Hence the correction for the reading in No. 14 in the line \overline{BP} , where it makes an angle $\theta = 90^\circ$ with the vertical, is:

$$+0.125 (1 - \cos 90^\circ) = +0.125.$$

The two balances were compared by pulling them against each other, and the readings on both were found to be the same exactly.

The laws to be verified are :

1. $T \sin \theta = W$.
2. $T \cos \theta = R$.

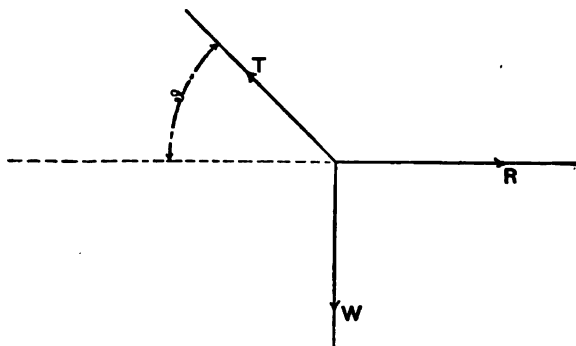

FIG. 44

No. of Experiments	Length of Sides in Centimetres				
	\overline{PA}	\overline{PB}	\overline{AB}	$\therefore \sin \theta$	$\cos \theta$
1	86.1	42.5	74.9	.870	.494
2	71.2	42.4	57.2	.808	.595
3	79.8	42.8	67.1	.846	.588

No. of Experiments	T (obs.) lbs.	R (obs.) lbs.	T (corr.) lbs.	R (corr.) lbs.	$\therefore T \cos \theta$ lbs.	$\therefore T \sin \theta$ lbs.
1	5.875	2.75	5.89	2.875	2.90	5.12
2	6.875	3.625	6.40	3.75	3.81	5.14
3	6.000	3.125	6.02	3.25	3.21	5.09
						5.117 mean

By actual weighing on the spring-balances $W = 5.125$ lbs.

Greatest deviation of R from $T \cos \theta$ is $1\frac{1}{4}\%$.

Greatest deviation of W from $T \sin \theta$ is $.6\%$.

Questions and Problems.

1. In what unit are the forces expressed in the above illustration, and what relation does it bear to the C. G. S. unit ?
2. What would be the result if the cord were not fastened at P, but could slip ? What would be the value of T in terms of W ?

3. Why should a spring-balance be hung from a nail or fixed support, if possible?
4. Prove that when a kite is flying, the string cannot be perpendicular to the kite.
5. Show that three forces, 5, 6, and 12 dynes, cannot be in equilibrium.
6. Three forces, 5, 12, 15, are in equilibrium; calculate the angles between them.
7. In a single-span bridge made, as shown, 6 metres high and 16 metres long, what is the vertical pressure on each pier and the horizontal thrust when 1000 kilograms are suspended from the top point?
8. When a person sits in a hammock, what is the tension on each rope?
9. What is the advantage in the tow-line of a canal-boat being long?
10. A heavy particle suspended by a cord of length 100 centimetres is moving uniformly in a horizontal circle of radius 10 centimetres, what is the angular speed?

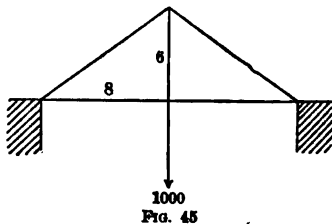

EXPERIMENT 21

Object. To verify the laws of equilibrium of parallel forces in the same plane. (See "Physics," Art. 63.)

General Theory. If an extended body is in equilibrium under the action of any number of parallel forces in the same plane, the mathematical conditions are:

1. The algebraic sum of the forces equals zero.
2. The algebraic sum of the moments around any axis perpendicular to the plane of the forces is zero.

In verifying these laws it is most convenient to make the forces vertical, because vertical forces may be produced by hanging weights. To produce forces which are vertically upward, and so can balance weights, two methods are possible; one is to support the body from above by means of spring-balances, the other is to let the body rest on platform-balances.

Sources of Error.

1. It is difficult to make all the forces parallel.
2. It is sometimes exceedingly difficult to determine the exact lines of action of the forces and to measure their distance from the axis around which moments are measured.
3. The spring-balance, whether of the platform kind or of the more usual extension form, does not afford a very accurate means of measuring forces, since there is always considerable friction in the balance, and the elasticity of the spring changes with use.
4. The student must always observe the zero-point of a spring-balance carefully, as it is hardly ever correct.

Apparatus. Two spring-balances; a spirit-level; a metre-bar; two weights of about five pounds each; a single pulley;

twine. (The experiment should be done at a table which has a wooden frame over it.)

If platform-balances are to be used, two small platform-balances; a metre-rod; two knife-edges; thread; three pound weights; a spirit-level.

Manipulation. Weigh the metre-bar and find its centre of gravity by determining *accurately*—*i.e.*, to a millimetre—the point on the scale where a supporting thread must be put for the bar to hang perfectly level. Hang the pulley from a hook in the horizontal bar of the frame as close up as possible. Pass a long string through the pulley, and tie one end to the ring of one of the spring-balances; fasten the other end so that there are about fifteen centimetres of string between the balance and pulley. Hang the other spring-balance directly

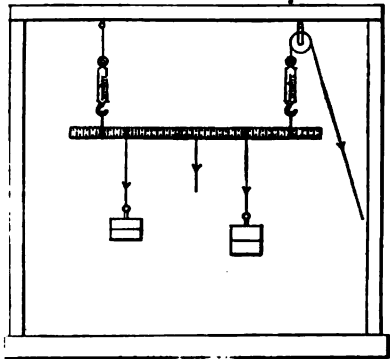

FIG. 45

by a string from another hook less than a metre from the first, so as to be at about the same height as the first.

Weigh the two weights, unless they are standard ones. Hang each on a string which has a loop at the end, just loose enough to slide easily over the bar; and fasten two similar loops to the hooks of the spring-balances. Hang the weights on the bar, and the bar from the balances, placing its width vertical, so as to make the bending as small as possible. Slide the weights into any desired positions on the bar, and move the spring-balance loops until the strings of these are approximately vertical. Now, by means of the long string passing over the pulley, raise or lower that end of the bar until it hangs exactly level, and make it fast in this position. Make any slight change necessary in the position of the loops to make all the forces

exactly vertical—*i. e.*, all parallel to the line of action of the weight of the bar. Finally, read the forces indicated by the balances, and the points on the bar where the four forces (besides its own weight) are applied. (If gram weights are used, it will be necessary to reduce all the forces to the same units, and the most convenient is the weight of one gram.)

Make four experiments, varying as much as possible the positions of the two weights and the balance that is not hung from the pulley, placing the latter between the two weights in one case. Record as below.

ILLUSTRATION

EQUILIBRIUM OF PARALLEL FORCES

Oct 30, 1894

Forces acting up are considered +.

Moments tending to turn the bar so that the zero end moves up are considered +; moments are measured around zero of bar.

EXPERIMENT 1

	Forces		Lever-arms	Moments
	Ounces	Grams		
T ₁	+ 7.75	+ 219	9.1 cm.	- 1998
T ₂	+ 6.75	+ 191	94.8 cm.	- 17981
W ₁	- 200	81.0 cm.	+ 6200
W ₂	- 100	81.9 cm.	+ 8190
Weight of bar	- 112.4	50.1 cm.	+ 5681
	Sum of forces, - 2.4		Sum of moments, +	97

The sum of the forces is thus shown to equal zero to within $\frac{2.4}{410}$, or not quite .6%.

The sum of the moments is zero to within $\frac{97}{19900}$, or about .05%.

The student should report similarly the other experiments directed.

Alternative Methods. I. Instead of the fixed spring-balance, a platform-balance may be used, such as those intended for weighing parcel-mail. Support it at a sufficient height to allow weights to be hung upon the bar resting on it. Place upon it a wooden rest with a sharp horizontal edge on top, such as is used with a sonometer. Note the weight indicated and deduct from future readings.

Rest the metre-bar horizontally on this edge (instead of

supporting it from the spring-balance, as described above); hang the two weights from the bar as before, and attach the string passing over the pulley. Level the bar as before and read the two balances and the points of application of the forces. Record as above.

II. Platform-balances may similarly be substituted for both spring-balances. The only objection is that it is difficult to level the bar if the forces on the two balances are very different. Remember to correct both balances for the weight of the rests placed upon them.

Questions and Problems.

1. Which is the more important adjustment in the above experiment, that the bar be level or that the forces applied by the strings be strictly vertical? Are both essential?
2. Has the fact that the cords that pull up press on the bottom of the bar, and those that pull down press on the top, any effect on the validity of the experiment? Why?
3. If nails were driven in a wide board at random and a number of parallel forces applied one at each nail, and all perpendicular to the edge of the board and in its plane, would the distance of the nails from either edge have any effect?
4. A man and a boy carry a weight of 20 kilograms between them by means of a pole 2 metres long, weighing 5 kilograms. Where must the weight be placed so that the man may bear twice as much of the whole weight as the boy?
5. A rod, whose weight is 5 kilograms and whose length is 100 centimetres, is supported on a smooth peg at one end and by a vertical string 15 centimetres from the other end. Calculate the tension of the string.

EXPERIMENT 22

Object. To verify the law of equilibrium of an extended rigid body under the action of three forces. (See "Physics," Art. 62.)

General Theory. It may be proved that the conditions of equilibrium of an extended rigid body under the action of three forces are:

1. The lines of action of the three forces will, if prolonged, all meet in the same point.
2. The forces are such that their lines of action all lie in one plane; and, if they are added geometrically, they will form a closed triangle.

A simple method of verification is to suspend any body by means of a cord whose two ends are fastened to two different points of the body, and which passes over a nail; a plumb-line dropped from the nail should pass through the centre of gravity of the body.

Sources of Error.

It is sometimes difficult to determine the point where the forces meet, especially if the peg is large.

Apparatus. A long rod which carries two or more bobs (see Experiment 23); cord; a plumb-line; some suitable projecting hook or nail.

Manipulation. Fasten the two ends of a piece of cord, about two metres long, to the rod at points near its ends. This may be done by tying suitable knots, or by running the cord through the rod if it is hollow, and preventing its

slipping by means of a loop. Suspend the rod from a nail or peg, making two or more turns of the cord around the nail so as to prevent slipping; if necessary, knot the cord.

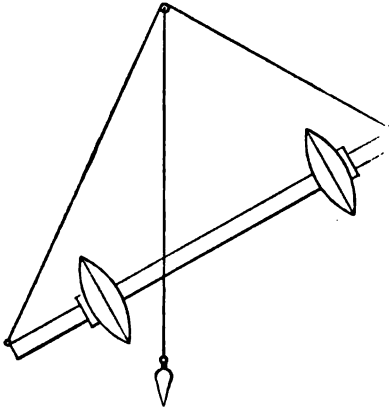

FIG. 47

Drop a plumb-line from the nail, and mark the position on the rod where this line would intersect its axis, if it could traverse it.

Change the length of the cord, the points of suspension, etc., and note the points where the plumb-line intersects the axis. They should all be the same.

Remove the string and determine the centre of gravity of the rod by balancing it on a knife-edge, as explained in the succeeding experiment.

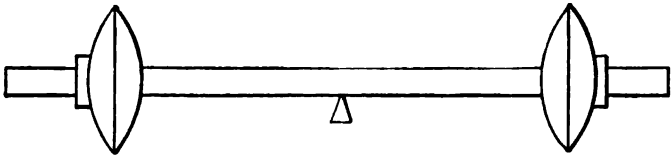

FIG. 48

Questions and Problems.

1. A rod, of length 1 metre and of weight W , is hinged at A to a vertical wall. Its upper end B is connected by a horizontal cord to the wall, so that the rod makes with the wall the angle θ . A weight W' is suspended from B . Calculate the tension in the string the direction and amount of the force at the hinge. (Principle of a derrick.)
2. A rod hangs from a hinge on a vertical wall and rests against a smooth floor. Calculate the pressure on the floor and the force on the hinge.

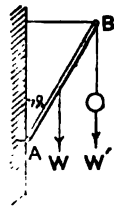

FIG. 49

3. A rigid rod is acted on by forces, as shown. What is the resultant?
4. Calculate the direction and amount of the reaction at the pivot in the last problem of Experiment 19.

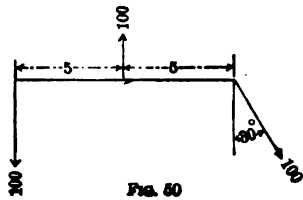

FIG. 60

EXPERIMENT 28

Object. To determine experimentally the centre of gravity of a weighted bar. (See "Physics," Arts. 78, 38, 40, 55.)

General Theory. The centre of gravity of any body (or system of bodies) is the point *in space* with reference to it through which its weight (or that of the system) acts for all positions. In other words, considering the action of the earth on all the minute portions of the body, it is the "centre" of the resultant of all these parallel forces, or the point through which the resultant will pass, no matter how the body is turned.

If, then, a rigid body is balanced by a supporting cord or on a knife-edge, so that it is in equilibrium, the centre of gravity must lie in the same vertical line as the point of support; otherwise there would be a moment and a consequent rotation. By turning the body so as to be balanced from another point, another line is determined in which the centre of gravity must lie; and, therefore, the intersection of these two lines fixes the point itself. In this way the centre of gravity of any board, however irregular, may be found by means of a string, two nails, and a plumb-line.

It may be proved that the centre of gravity of any system of bodies coincides with its centre of mass; and the mathematical conditions for the centre of mass are that

$$x = \frac{m_1 x_1 + m_2 x_2 + \text{etc.}}{m_1 + m_2 + \text{etc.}},$$

$$y = \frac{m_1 y_1 + m_2 y_2 + \text{etc.}}{m_1 + m_2 + \text{etc.}},$$

$$z = \frac{m_1 z_1 + m_2 z_2 + \text{etc.}}{m_1 + m_2 + \text{etc.}},$$

where m_1, m_2 , etc., are the separate masses, and x_1, x_2 , etc., are the perpendicular distances of the masses from any fixed plane; y_1, y_2 , etc., are distances from a second plane at right angles to the first; z_1, z_2 , etc., distances from a third plane perpendicular to the other two; $\bar{x}, \bar{y}, \bar{z}$ being the distance of the centre of mass from these three planes.

In particular, consider a uniform rod carrying two or more bobs. The centre of mass of the rod itself is its middle point; and, since everything is symmetrical about the axis of the rod, the centre of mass of the rod and bobs together must lie somewhere on this axis. Take as a plane from which to measure distances one perpendicular to the rod at one end; call the masses of the two bobs and the rod itself m_1, m_2, m_3 , and the distances of the bobs and the centre of the rod from the plane at the end x_1, x_2, x_3 . Then \bar{x} , the distance of the centre of mass from the plane at the end, is

$$\bar{x} = \frac{m_1 x_1 + m_2 x_2 + m_3 x_3}{m_1 + m_2 + m_3}.$$

This may be verified by actual experiment by balancing the rod from a cord or on a knife-edge.

Sources of Error.

1. There may be difficulty in determining the centre of mass of each bob.
2. When balanced, the centre of gravity is in the same vertical plane as the point of support, not necessarily in the same plane perpendicular to the axis of the rod.
3. The supporting edge or thread must be as fine as possible.

Apparatus. A round uniform bar, graduated the greater part of its length, and provided with three weights, which may be clamped upon it at any desired points; twine; a support from which the bar may be suspended so as to hang free (or a knife-edge on which it may be balanced); scales and weights for weighing the bar and its bobs, capable of weighing 2000 grams to the accuracy of one gram; a vernier caliper; a level.

Manipulation. Weigh the bar and each of the bobs separately, taking pains to identify the bobs. With the vernier caliper determine the thickness of each bob, and hence the position of its centre of figure with regard to the plane surface at one side of it—*i. e.*, the correction to be made to the point where this face cuts the bar in order to get the position of the centre of figure in subsequent experiments. (Since the weights have a flat boss on one side only, they are slightly unsymmetrical, but for the purposes of this experiment the centre of the symmetrical part alone may be taken as approximately the centre of figure of the whole.)

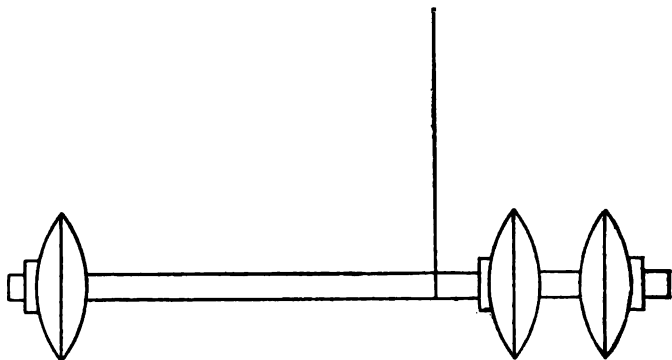

FIG. 51

Suspend the bar without any weights upon it from a frame over a table or from a projecting nail by a single tight loop of twine, and slip the loop along until the bar hangs perfectly level; or balance it on a knife-edge. When the supporting string is so placed as to hold the bar exactly level, and the loop is truly perpendicular to the axis of the bar, the centre of gravity of the latter must lie in the same vertical plane as the loop. Hence the position of the loop on the scale gives the distance of the centre of gravity from the right section of the bar marked by the zero of the scale. Read and note this position of the loop on the bar.

Now clamp the bobs in any desired position on the bar, noting carefully the reading of the flat surface of one side;

and, for convenience, place this side towards the decreasing numbers of the bar (so that the correction giving the position of the centre of figure of the weights will always be positive). Suspend the bar again and determine its centre of gravity as before. Repeat with three different positions of the weights. In each case, in making the report, *calculate* the position of the centre of gravity from the weights of the separate masses and their positions, and compare this with the experimental result. In making the calculation, the weight of the bar should, of course, be considered as acting at the centre of gravity found experimentally for it alone; and the movable weights may each be considered as acting at the centre of figure of the symmetrical portion. Report as below.

ILLUSTRATION

Nov. 1, 1896

Weight of bar, 208 grams. Centre of gravity of bar, 50.3.

Bobs	Weight	\overline{AB}	\overline{BC}	Hence \overline{AO}
1	1081 gr.	.2 cm.	1.6 cm.	1.0 cm.
2	1540 gr.	.2 cm.	1.8 cm.	1.1 cm.
3	1918 gr.	.2 cm.	1.9 cm.	1.15 cm.

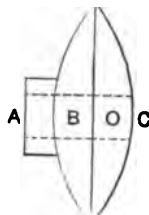

FIG. 52

Positions of Bobs

No. of Experiment	Edge (1)		Edge (2)		Edge (3)		Centre of Gravity Obs.	Centre of Gravity Calculated
	Centre	Centre	Centre	Centre	Centre	Centre		
1	10.0	11.0	37.2	38.8	90.75	91.9	54.1	54.2
2	81.2	82.2	47.8	48.9	6.7	7.85	40.0	40.0
3	81.2	82.2	78.7	79.8	6.7	7.85	50.1	50.0
4	81.2	82.2	78.7	79.8	95.0	96.15	85.6	85.7

Greatest deviation is $\frac{1}{4}$ of 1%.

Questions and Problems.

1. What effect would it have on the experimental position of the centre of gravity as compared with that calculated, if owing to defective casting one weight had a large hole in the side towards the lower numbers on the bar?
2. A uniform wire ABC is bent at B to an angle 60° , and is suspended from A . \overline{AB} is 10 centimetres long. Calculate length \overline{BC} , so that when the whole is in equilibrium, \overline{BC} will be horizontal.

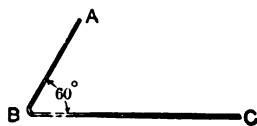

FIG 53

3. A circular table rests on three legs attached to three points of the circumference at equal distances apart. A weight is placed on the table. In what position will the weight be most likely to upset the table, and what is the least value of the weight which when placed there will upset it ?
4. A circular hole, 10 centimetres in radius, is cut out of a circular disk 50 centimetres in radius, the centre of the hole being 10 centimetres from that of the disk. Calculate the centre of gravity of the remaining disk.
5. Two bodies "attracting" each other with a force varying directly as their masses and inversely as the squares of their distances apart move towards each other. Where will they meet ?
6. Two bodies, whose masses are 100 and 200, are connected by a light wire, and are thrown in such a way that the centre of gravity has a speed 10 metres per second, and that the system revolves around the centre of gravity twenty times per minute. Calculate the entire kinetic energy.

EXPERIMENT 24

(TWO OBSERVERS ARE REQUIRED)

Object. To determine the “mechanical advantage” and “efficiency” of a combination of pulleys. (See “Physics,” Art. 72.)

General Theory. The “mechanical advantage” of a pulley, or combination of pulleys, is defined as the ratio of the force which tends to draw the lower pulley down, to that which must be applied to the free end of the cord passing around the pulleys in order to exactly balance the first force. The “efficiency” is the ratio of work done against the force acting down on the lower pulley to that done by the force applied to the cord, when the pulley is raised at a uniform rate. (If no friction were overcome, the efficiency would be 1.)

Several cases may be considered.

Case 1.—The cord is fastened to a horizontal support and passes in turn over a movable and a fixed pulley, the three branches of the cord being parallel.

Case 2.—The cord is fastened to the hook on the top of a free pulley, and passes in turn over a fixed pulley, the free pulley and the fixed pulley again, the four branches of the cord being parallel.

It is obvious that, if the lower pul-

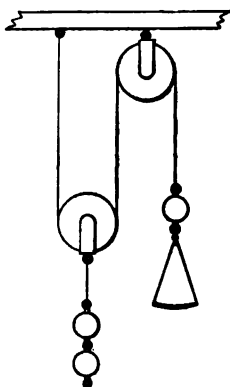

FIG. 54

ley is in equilibrium, the tension of the cord is the same in all its branches, and that the force down on the lower pulley must equal the product of the tension in the cord by the number of branches of the cord leaving that pulley.

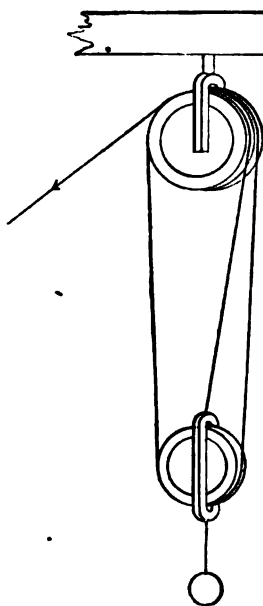

FIG. 55

The difficulty in the actual measurement enters from the fact that the motion of the pulleys may be influenced by friction, and so this effect must be done away with. The method of doing this is as follows: Pull the free end of the cord with a force sufficient to produce *uniform* motion of the free pulley upward; this force is equal to the equilibrium force plus the force of friction; then, by diminishing the pull on the

cord, exert just enough force to allow the pulley to fall with the same uniform motion as that with which it rose; this force equals the equilibrium force minus the force of friction. Therefore, the average of the two forces is the equilibrium force.

In measuring the efficiency, the actual force producing uniform motion upward may be measured; and the ratio of the work done against the force on the lower pulley, F_2 , to that done by this upward force on the cord, F_1 , is evidently given by

$$\frac{W_2}{W_1} = \frac{F_2 \times l_2}{F_1 \times l_1} = \frac{F_2}{F_1 \times \text{No. of branches of cord leaving pulley}}$$

l_2 being the distance the weight is raised, and l_1 the distance the "free end" of the cord moves down.

Sources of Error.

1. The motion may not be uniform (this introduces an error owing to the acceleration).
2. The line of motion may not be maintained constant.
3. The friction may be different in different positions.
4. The pulleys and spring-balances themselves have weight.
5. The axles of the pulleys may not pass accurately through the centres.

Apparatus. Two single and one double pulley; stout fishing-line; three weights of about ten pounds each; two spring-balances.

Manipulation. Arrange in succession the pulleys and the suspended weight as in Case 1 and Case 2 above, attaching a spring-balance, hook up, to the free end of the cord. Pull vertically down on the balance. Record the readings necessary to secure uniform motion up and down; call them f_1 and f_2 . It is often best for one observer to devote his entire attention to the balance, keeping its motion uniform, and for the other to make the reading of the pointer. These are not the true forces, because readings on a spring-balance are true only when it is used vertically with hook down. Consequently, these readings made with the hook up are too small by an amount $2h$, twice the weight of the hook. This quantity may be determined as follows: Suspend a weight from the hook, the ring being hung on a nail, make the reading; invert the balance, hanging the hook on a nail and suspending the weight from the ring, make the reading; the difference between these two readings is equal to the weight of the whole balance minus twice the weight of the hook alone. To measure f_1 , then, perform the experiment just described, using any weight; and, in addition, weigh the whole balance on a second balance which has been compared with the first to see if the two scales agree. Having thus determined h , the true equilibrium force is

$$\frac{f_1 + f_2}{2} + 2h.$$

EXPERIMENT 25

Object. To determine the coefficient of friction between two polished wooden surfaces.

General Theory. The coefficient of friction between two given surfaces is usually denoted by μ , and is defined by the ratio F_1/F_2 , where F_1 is the force necessary to move one surface over the other at a constant speed, and F_2 is the force pressing the surfaces together. μ is usually different for different speeds, and the value found in this experiment is that which relates to very slow motion. It is sometimes called the coefficient of *static* friction.

If two surfaces are pressed together with a force F_2 , it will require a force $F_1 = \mu F_2$ to produce a uniform motion; therefore, to produce an acceleration a , a force will be required equal to $ma + F_1$. This additional force, F_1 , is called the "force of friction," and it equals the product of the "coefficient of friction" by the force pressing the two bodies together. For a definite speed, μ depends only on the condition and material of the two surfaces, and not on the area over which the pressure is distributed.

If a body of mass m rests on an inclined plane which makes an angle θ with the horizontal, the force pressing its lower surface against the plane is $N = mg \cos \theta$. The force tending to make it slide down is $R = mg \sin \theta$. The force which opposes the sliding is the friction. When the plane is nearly horizontal, the friction will be sufficient to bring the body to rest, if it is set in motion down the plane. But as the plane is more and more inclined, the force down the plane becomes greater; and the amount

of friction necessary to keep the body from moving faster and faster, when once set in motion, is also greater. Finally, for a certain value of θ the friction reaches its limit; and the body when set in motion continues to move faster

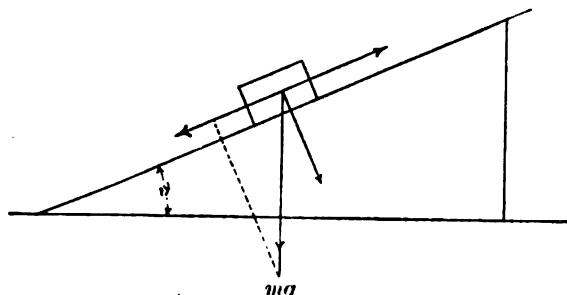

FIG. 58

and faster. Evidently, where θ has such a value that the motion of the body just remains uniform, the force down the plane exactly equals friction for very slow motion—*i. e.*, if α is this “slipping angle,” $mg \sin \alpha = F_1$; but F_2 in this position equals $mg \cos \alpha$, and

$$\text{hence, } \mu = \frac{\sin \alpha}{\cos \alpha} = \tan \alpha,$$

i. e., the coefficient of friction for very slow motion is equal to the tangent of the inclination at which one body just slides over the other.

Sources of Error.

1. Owing to inequalities in the boards, the friction is not the same in all places, and so the carriage will start slipping at different inclinations.
2. Great care and judgment must be used in determining when there is no acceleration.

Apparatus. An inclined plane consisting of a smooth, wooden board, hinged to a base which fits over the corner of the table. At the other end of the board is hinged a support in which are a large number of holes at different

heights. A block rests upon the table and is provided with two iron prongs, one of which is fitted into a hole of the perforated support, and thus fixes the inclination of the plane. By varying the distance of the block from the angle and the hole by which the support is held, the inclination is adjustable with the greatest accuracy. A heavy weight should be placed on the base, which fits over the table, so as to steady the apparatus; and another may be placed on the movable block if it is found to slip out (an elastic band will generally prevent this). Two wooden carriages with polished under surfaces of different areas; a weight of over five pounds to go on the carriage; a metre-

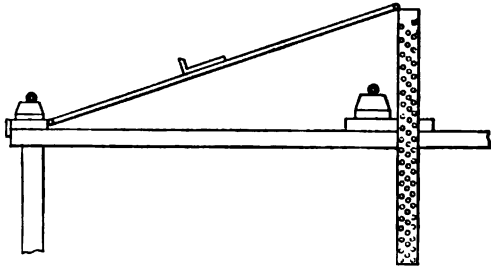

FIG. 59

bar; plumb-line and steel square are also needed. (A small ball hung by a thread makes a very good plumb-line.)

Manipulation. Place the weight on one of the carriages and adjust the inclination of the plane until the carriage just slides, when gently started, without either increasing its velocity or stopping. Then measure the angle which the plane makes with the horizontal. To do this, clamp the plumb-line as near the top of the plane as possible by laying a weight upon it, letting the bob hang well down below the top of the table, and tie in it a small knot at a point just above the level of the table. Put the square and the metre-bar together, so that one side of the square is perpendicular to the bar. In this way hold the bar at right angles to the plumb-line and find the point in the

upper surface of the inclined plane at the same level as the knot. Measure the distance from this point to the knot, call it \overline{LN} ; measure the distance along the plumb-line from the knot to the upper surface of the plane, call it \overline{MN} .

Then, $\tan \alpha = \frac{\overline{MN}}{\overline{LN}} = \mu$, the coefficient of friction between the two given surfaces.

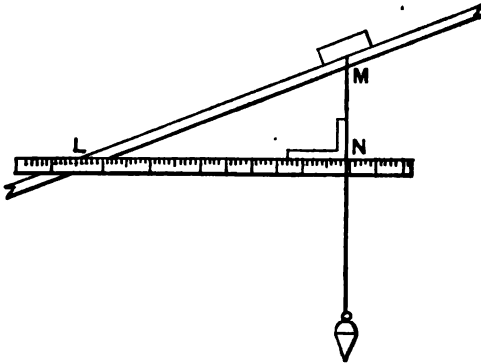

FIG. 60

Having made one determination of μ , change the inclination and begin again, making four experiments in all.

Make another series of four experiments with the same weight but with the other carriage, the area of whose base is different; and a third series with another weight. Record each as below.

ILLUSTRATION

Nov. 10, 1894

Coefficient of friction between polished pine surface of plane and polished oak of carriage :

Larger Carriage : 5-lb. Weight.

\overline{MN}	\overline{LN}	$\therefore \mu$
26.4 cm.	66.0 cm.	.400
26.8 cm.	66.8 cm.	.401
26.7 cm.	67.0 cm.	.399
26.5 cm.	65.7 cm.	.403
		Mean. .401

Questions and Problems.

1. What is the effect upon the friction between a wheel and its axle, of increasing (1) the diameter of the axle, (2) the length of the parts in contact?
2. Prove that if a heavy body is to be drawn up an inclined plane, the force required to do so is least when the angle between that plane and the line of force equals the angle of friction, $\tan^{-1}\mu$.
3. Would an ordinary brick be less liable to slide down an inclined plane when placed on one face than if placed on another?
4. A shaft is 4 centimetres in diameter, and is making 120 turns per minute. It requires a weight of 100 kilograms at the end of a lever a metre long to keep the "Prony Brake" from moving. Calculate the activity of shaft. What becomes of the energy?

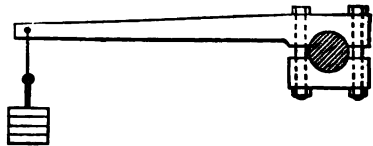

FIG. 61

5. A body of mass 10 is set in motion by an impulse 10,000 along a horizontal rough table whose coefficient of friction is 0.1. At the end of two seconds it meets a smooth inclined plane. How high will it rise?
6. A bullet, whose mass is 100 grams, is fired from a gun whose barrel is 75 centimetres long, with a velocity 400 metres per second. Assuming the powder pressure to be uniform, calculate the force on the bullet and time taken to traverse the barrel. It enters a wall 200 centimetres thick with a speed 880 metres per second, and leaves it with a speed 200 metres per second. What is the average resistance of the wall, and how long did it take to pass through?

EXPERIMENT 26

Object. To determine the mass of the hard rubber cylinder whose volume was found in Experiment 5. The use of a chemical balance. Reading a barometer. (See "Physics," Arts. 71, 129, 175.)

General Theory of the Chemical Balance. The analytical or chemical balance differs from scales designed for a less accurate comparison of masses chiefly in the care with which it is made, and in the introduction of devices for observing much smaller differences in the equality of the masses in the two pans and for making more delicate changes in the weights used. It consists essentially of three parts: 1. The pillar, or central support. 2. The beam, a rigid framework of metal resting upon the pillar, and so designed as to combine the greatest possible lightness with the least possible bending under the weights for which it is designed. 3. The scale-pans and the metal frames by which they are hung from the beam.

The usefulness of a balance depends on the following conditions: 1. It must be true—that is, when the masses in the two pans are equal to the degree of accuracy for which the instrument is to be used, the pointer which indicates the inclination of the beam must return to the position in which it was when the pans were empty. This position is called the "zero" of the balance.

2. It must be stable—that is, the beam must have a definite position of equilibrium for a definite small difference in the equality of the masses.

3. It must be sensitive—that is, for a small difference in the equality of the masses the deflection must be large.

The sensitiveness of a fine balance is secured as follows : The beam is supported on the pillar by means of a knife-edge. This is a triangular prism of steel set in the beam with the edge down. To decrease still further the friction as the beam tilts, the ends of the knife-edge rest upon horizontal surfaces of glass or agate set in the top of the pillar. The scale-pans are similarly hung from knife-edges placed one at each end of the beam, parallel to the central knife-edge and at equal distances from it. This insures that the weight of each scale-pan and its contents acts vertically in a line whose distance from the axis about which the beam rotates is the horizontal distance between the central knife-edge and the one from which the pan is hung. These distances on each side, measured when the beam is horizontal, are called the "arms" of the balance. Let

a = length of right arm of balance.

b = length of left arm of balance.

m_r = mass in right pan of balance.

m_l = mass in left pan of balance.

M = mass of beam.

p_r = mass of right pan, etc., when empty.

p_l = mass of left pan, etc., when empty.

d = distance of centre of gravity of beam from central knife-edge.

If the scale-pans are removed, the position of equilibrium of the beam is evidently such that its centre of gravity is vertically below the knife-edge. This is the position which is described above as the beam being "horizontal."

Let the inclination of the beam when the pans are hung upon it empty be α_0 . Then $Mgd \sin \alpha_0 = (p_l b - p_r a) g \cos \alpha_0$, if α_0 is considered positive when the left end tips down. Whence,

$$\tan \alpha_0 = \frac{p_l b - p_r a}{Md}.$$

Add the masses m_r and m_l to the pans ; let them be nearly

equal, and let α_1 be the inclination of the beam. Then, as above,

$$\tan \alpha_1 = \frac{(p_1 + m_1)b - (p_2 + m_2)a}{Md}$$

$$\therefore \tan \alpha_1 - \tan \alpha_0 = \frac{m_1 b - m_2 a}{Md}$$

But if H is the height of the knife-edge above the horizontal scale at the base of the pillar, and if x_0 and x_1 are

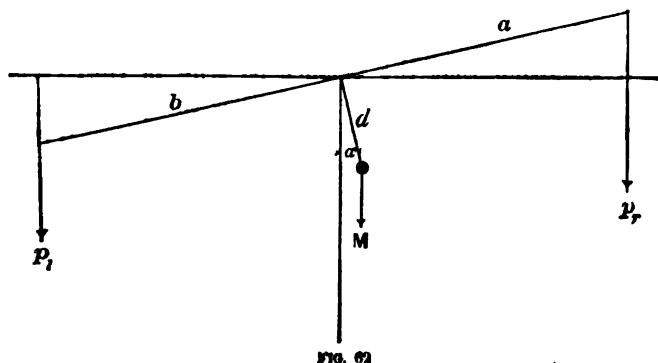

the readings of the pointers with pans empty and loaded, then

$$\tan \alpha_1 - \tan \alpha_0 = \frac{x_1 - x_0}{H}$$

$$\therefore x_1 - x_0 = H \frac{m_1 b - m_2 a}{Md}$$

Hence it is evident that to make the balance sensitive—*i. e.*, to make $x_1 - x_0$ as great as possible for a given difference $m_1 - m_2$, the following conditions must be fulfilled:

1. The arms a and b must be as long as possible.
2. The beam must be as light as possible.

3. The distance of the centre of gravity of the beam from the knife-edge must be small. But if it becomes zero, $x_1 - x_0$ will be infinite, and the balance will be unstable. Even in the best balances the beam bends when the load becomes greater, so that d increases, and hence the sensitiveness decreases.

4. H should be great, and consequently the beam supporting the pillar should be high.

The condition that the balance be stable is, from the same equation, that d be not zero or negative—i. e., that the centre of gravity of the beam be not at the knife-edge or above it. In either case the beam alone is in unstable equilibrium, and the slightest difference in the weights hung upon it would tip it over entirely. For this reason the knife-edge is set in the beam very slightly above the middle of the framework.

The condition that the balance be true is that, when $m_1 = m_2$, $x_1 = x_0$; that is, for equal masses the pointer must return to the position which it has with pans empty. Therefore,

$$m_1 a - m_2 b = 0; \text{ i. e. } a = b.$$

Hence the arms of the balance must be equal or the balance will not be true.

In the use of a balance for accurate determinations the arms are not assumed equal, but a correction for difference in length is made by weighing the body first in one pan, then in the other. Let w be the mass of the body, m_1 the weights which have to be placed in the left pan, and m_2 those which have to be placed in the right pan to balance w when the body is in turn in the right and left pan.

Then,

$$w a - m_1 b = 0. \quad \therefore w = m_1 \frac{b}{a}$$

$$w b - m_2 a = 0. \quad \therefore w = m_2 \frac{a}{b}$$

$$\therefore w = \sqrt{m_1 m_2}.$$

(If m_1 and m_2 are very nearly equal, $\frac{m_1 + m_2}{2}$ is a close approximation to the quantity $\sqrt{m_1 m_2}$.) This is known as "Gauss's Method of Double Weighing."

With a sensitive balance it is usually impossible to bring the pointer exactly back to zero with the weights at command. Suppose the smallest change possible to be .001

gram, and that this carries the pointer from a position x_1 to the left of x_0 to x_2 to the right. Then, if w is the mass of the object, which we will suppose in the right pan, and m_1 the weights in the left pan when the pointer was at x_1 ,

$$\frac{x_0 - x_1}{wa - m_1 b} = \frac{H}{Md} = \frac{x_2 - x_0}{(m_1 + .001)b - wa}$$

$$\therefore \frac{x_0 - x_1}{wa - m_1 b} = \frac{x_2 - x_1}{.001 b}$$

$$\therefore wa = \left(m_1 + .001 \frac{x_0 - x_1}{x_2 - x_1} \right) b$$

If w_1 denotes the exact mass in the left pan which would counterbalance the object placed in the right pan,

$$wa = w_1 b$$

$$\therefore w_1 = m_1 + .001 \frac{x_0 - x_1}{x_2 - x_1};$$

i. e., since the weights available do not enable one to place exactly w_1 grams in the pan, m_1 are put in first, then $m_1 + .001$ and w_1 is calculated by interpolation. In a similar way w_2 , the exact counter-balancing mass for the right-hand pan, is determined; and the correct mass is $w = \sqrt{w_1 w_2}$, or $\frac{w_1 + w_2}{2}$.

In order to protect the knife-edge from wear, a support for the beam may be raised by a screw in the balance-case at the foot of the pillar. This support holds the beam on each side of the knife-edge and lifts the latter off the agate bearings. This must always be done when a change is being made in the contents of the pans and even when the balance is not to be used for only a few minutes. The sliding front of the case should not even be raised or lowered while the beam rests on the edge. It is evident that accurate weighing requires that this support should always replace the knife-edge in exactly the same position each time it is lowered on the agate surfaces. Otherwise the zero of the balance may be changed every time the support is used.

The weights to be used with a chemical balance usually come in sets containing weights from .01 gram up. The fractional weights are marked either as so many milligrams (denoted by m.), centigrams (c.), or decigrams (d.). Even if no letter is given, there is seldom any confusion, since a comparison of the size of the pieces and the numbers upon them gives a clew to the unit in which each is expressed. The best fractional weights are made of platinum, though aluminum ones are often used and have the advantage of larger size. Never under any circumstances handle a weight with the fingers. The value of a weight is easily altered by several milligrams by touching it once. Always use the pincers.

Some sets contain weights of .001 gram; but usually a "rider" of greater size is used instead. A "rider" consists of a fine platinum wire of a definite weight, shaped so that it will stay astride the beam of the balance at any point where it may be placed. The top of the beam is grooved at various points, such that the horizontal distance between the central knife-edge and a vertical line through the groove is a fixed proportion of the length of the arm of the balance—usually so many tenths. Hence, if a rider weighing .01 gram, for instance, is placed in the groove marked as being at a distance from the knife-edge of three-tenths of the arm of the balance, it will be equivalent to a mass of $.01 \times 3/10 = .003$ grams placed in the pan. The rider may be moved from one groove to the next by a carrier operated from the outside of the case without raising the sliding front. With a balance-beam grooved in tenths and a centigram rider, a change of .001 of a gram can thus be made. The value of the rider, if not known, can be found by comparison with the other weights in the set. It can always be assumed that a rider furnished with gram weights is a very simple multiple of a centigram or a milligram.

NOTE.—The mass of the cylinder found above ($w = \sqrt{w_r w_1}$ or $\frac{w_r + w_1}{2}$) is its apparent mass in the air. Since any body immersed in a fluid is buoyed

up by a force equal to the weight of the fluid it displaces, the weights and the cylinder are both apparently lighter than they would be in a vacuum. Since 8.4 grams of brass have a volume of 1 cubic centimetre, the volume of air displaced by the weights can be calculated at once. The volume displaced by the cylinder is known by its measurements in Experiment 5. Hence, by finding in suitable tables the mass of a cubic centimetre of air at the temperature and pressure of that in the case, one can calculate the loss in weight of the weights, which should be subtracted from the apparent amount necessary to balance the cylinder; also the loss of the cylinder, which should be added.

Barometer Reading. The pressure of the atmosphere is always measured by the height in centimetres of the column of

mercury which it will support when the mercury stands in a tube closed at the top, having a very high vacuum above the mercury, while the lower end of the tube dips in a basin of mercury. Such an instrument is called a "barometer." The height is measured vertically from the level of the top of the mercury in the cistern open to the air to the top of the convex surface of the mercury in the closed tube. It is read by means of a scale upon the metal case surrounding the tube. The zero of the scale is the tip of an ivory point dipping into the cistern; the position of the top of the column is given in fractions of a millimetre by a vernier engraved on a sliding index, whose zero must be made to coincide with the top of the column by a screw admitting of a



FIG. 63

very delicate adjustment.

The necessary conditions are :

1. The scale must be vertical. This is secured by hanging the barometer from a loop

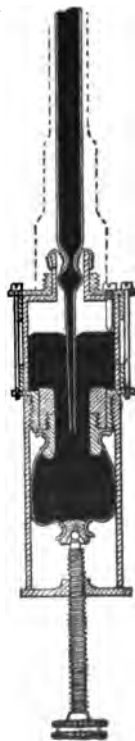

FIG. 63a

at the top, the scale being engraved so as to be vertical when the instrument hangs freely.

2. The top of the mercury in the cistern must be at the zero of the scale—*i. e.*, it must just touch the tip of the ivory point. The height of the mercury in the basin is adjusted by a screw at the bottom, which compresses the sack containing the mercury and so raises its level. The tip of the pointer must touch the mercury so lightly that the dimple caused by it is just not visible.

3. The zero of the vernier must be accurately in the same horizontal plane as the top of the mercury column. The zero of the vernier is always the lower edge of a brass ring that slides on the barometer tube. The opposite side of the edge of the ring may be seen through the glass tube, and is made so as to be exactly in the same horizontal plane as the front edge. Hence, if one sights under the front edge from a direction such that the back edge is just hidden, and then lowers the ring until these edges appear to just touch the top of the column, this top will be in the same horizontal plane with them. This may be done by lowering the ring until light can just not be seen between it and the mercury.

4. This reading, h , gives in scale divisions of the metal case the height of the barometer column in terms of mercury at the temperature of the thermometer fastened to the barometer.

Hence, if

ρ is the density of mercury at $t^\circ C$,

l is the length of one scale division at $t^\circ C$,

g the acceleration of gravity in the laboratory, the pressure of the atmosphere is $p = \rho ghl$.

If a barometer at the sea-level in latitude 45° (where $g = g_{45}$) were to contain mercury at the temperature 0° , the height H in centimetres registered by it, which would correspond to an *equal* pressure p , is given by the equation $\rho_0 g_{45} H = \rho ghl$.

But $\rho_0 = \rho (1 + \beta t)$ where β is the coefficient of cubical expansion of mercury.

$l = (1 + \alpha t)$ if α is the coefficient of linear expansion of the metal scale, assuming the scale to be correct at 0° .

$$\therefore H = \frac{hg}{g_{45}} \frac{1 + \alpha t}{1 + \beta t}$$

The quantities $\frac{g}{g_{45}}$ and $\frac{1 + \alpha t}{1 + \beta t}$ are given in tables, so H may be calculated from h . H is called the "corrected height," because it gives the height to which the barometer would rise when measuring the same pressure under standard conditions. The figures for densities of gases, etc., in tables are always given in terms of these corrected heights; and every reading of the laboratory barometer must be corrected.

TO WEIGH THE PIECE OF HARD RUBBER.

General Method. The general method of the present experiment is as follows: The object to be weighed is placed in the right pan of the balance, and weights to balance it in the left. After the pointer has been brought back as close to its zero position as possible with the weights at command, including the rider, the exact weight is calculated by interpolation, as shown above, between the two nearest positions of the pointer on either side of the zero position. (The readings for these positions of equilibrium are of course made by the method of vibrations. See Experiment 11.) Call the mass thus found for the object w .

The object is then transferred to the left pan, and its mass again determined. Call it w_r . Then $w = \sqrt{w_l w_r} = \frac{w_l + w_r}{2}$.

Finally, the true mass must be calculated, taking into account the buoyancy of the air.

Sources of Error.

1. Same as those of Experiment 1, Part 8. The effect of draughts of air is much more important, and the balance-case must

always be closed before the position of the pointer is finally observed.

2. Friction at the knife-edge, due to its having been blunted by a jar or to a spot of rust. This is shown by a decreased sensitiveness, and also by the zero of the balance changing.
8. The pans must not be allowed to swing. (See Experiment 11.)

Apparatus. A chemical balance and box of gram weights (50 grams to .01 gram, with "rider"). The same cylinder as was measured in Experiment 5.

Manipulation. See that the scale-pans are free and clean. If they are not, call the attention of an instructor unless they are readily cleaned with a small brush, such as comes in the box of weights. Level the balance, if necessary. Lift the "rider" with the pincers, and hang it on the carrier inside the case. Lower the support which holds the beam off the knife-edges. Set the balance swinging over two or three divisions of the scale and determine the point of equilibrium with the pans empty, as in Experiment 11. (One set of readings of five consecutive turning-points is sufficient.) The point of equilibrium with pans empty as thus found is the zero of the balance. (If, owing to any cause, one pan is much heavier than the other, pieces of paper may be added to the lighter one.)

Raise the support so as to lift the balance off the knife-edges; place the cylinder in the right pan and weights to balance it in the left, *always using the pincers to lift weights. Never add or remove a weight from a balance-pan without first raising the balance off the knife-edges.* Serious damage is done to a balance by neglect of this rule, and also to a box of weights when they are handled without pincers.

Proceed as in Experiment 1, Part 3, to find a mass so close to that of the cylinder that the smallest change in the position of the rider (.001 gram) is sufficient to move the pointer from one side of its zero position to the other. Then close the case, and by the method of vibrations determine the point of the scale about which the pointer now vibrates. Let the reading on this point of the scale

be x_1 . Now make the change of .001 gram so as to carry the pointer over to the other side of the zero. Find the new point of rest by vibrations. Let it be x_2 . Let the original zero of the pointer be x_0 . Then if m_1 is the mass of weights in the left pan, the apparent mass of the cylinder is $w_1 = m_1 + .001 \frac{x_0 - x_1}{x_2 - x_1}$. In reading the weights com-

posing m_1 , it is well to do it in two independent ways: (1) Read the weights on the balance-pan, (2) read the weights absent from the box of weights. When weights are removed from a scale-pan, always replace them in their proper positions in the box.

Interchange the cylinder and the weights, and find the balancing mass in reversed pans. Let it be w_r . Redetermine the zero of the balance to see that it has not changed.

Finally, note the reading of the barometer in the laboratory and the temperature in the balance case. Calculate w .

ILLUSTRATION

Nov. 3, 1896

Determination of mass of cylinder No. 1.

Balance used, M. 824. Box of weights, M. 81.

The beam of this balance is graduated to tenths of the arm. The rider in the set of weights is .01 gram.

Zero of balance at start, 8.9 ; at end, 8.95 ; mean, 8.92 = x_0 .

Cylinder in Right Pan.

Balancing mass = m_1 .

Weights in Pan	Rider	Total	Pointer
81.06	At .6 mark,	81.066	8.6 = x_1
81.06	At .7 mark,	81.067	9.1 = x_2

∴ Apparent mass of cylinder in this pan is :

$$w_1 = 81.066 + .001 \frac{.32}{.50} = 81.0666 \text{ grams.}$$

Cylinder in Left Pan.

Balancing mass = m_r .

Weights in Pan	Rider	Total	Pointer
81.06	At .7 mark,	81.067	9.2 = x_1
81.06	At .8 mark,	81.068	8.7 = x_2

$$\therefore w_r = 81.067 + .001 \frac{.28}{.50} = 81.0676 \text{ grams.}$$

Barometer, 763.8 mm. Temperature in balance-case = 18.5° C.

$$\therefore w = \sqrt{w_1 w_2} = \frac{w_1 + w_2}{2} \text{ approximately} = 31.0671 \text{ grams.}$$

Weight of rubber cylinder No. 1 in air of temperature 18.5° at 763.8 mm. pressure = 31.0671 grams, as measured by brass weights.

The brass weights displace $\frac{81}{8.4}$ cc. of air, because 8.4 is the density of brass. Since the air at 763.8 mm. and 18.5° weighs .001217 gram per cc., the real weight counterbalancing the cylinder is only $31.0671 - \frac{81}{8.4} \times 0.001217 = 31.0626$ grams.

But the volume of the cylinder was found to be 23.54 cc. in Experiment 5. It has lost $23.54 \times 0.001217 = 0.0286$ gram by the buoyancy of the air. Its true mass is, therefore,

$$31.0626 + 0.0286 = 31.0912 \text{ grams.}$$

The correct manner of recording a weighing is as follows:

L (left pan)	R (right pan)
20 + 10 + 1 + 0.05 + 0.01	Cylinder
+ rider at 6 = + 0.006	
6.2	11.8
6.0	11.1
5.8
6.0	11.2

Mean, 8.6, etc.

Questions and Problems.

1. What is the ratio of the arms of the balance in this experiment?
2. Discuss advantages of long and short arm balances.
3. Where should the centre of gravity of the balance be?
4. How can a balance be made more sensitive? How more stable?
5. Discuss the effect of an increase in the value of g , and also an increase in the temperature upon the sensitiveness and stability of a balance.
6. The arms of a false balance are in the ratio of 20 to 21. What will be the gain or loss to a salesman if he asks \$1 00 per pound for goods which apparently weigh 5 pounds?

EXPERIMENT 27

Object. To verify Hooke's Law and to determine "Young's Modulus" for a given substance by stretching a wire. (See "Physics," Arts. 79, 83.)

General Theory. 1. Hooke's Law states that, within certain limits, the strain produced by any force is proportional to that force. In particular, if a wire is stretched in turn by different forces, the elongations produced vary directly as the forces. If F is the force which produces an elongation Δl , then

$F/\Delta l$ is a constant.

2. For a wire of any given material—*e. g.*, brass—the elongation depends upon the cross-section and the original length in such a way that, if σ is the cross-section, and l the original length, $\Delta l = \frac{1}{E} \frac{Fl}{\sigma}$, where E is a constant for a given material; or, $E = \frac{F}{\Delta l} \frac{l}{\sigma}$.

E is called "Young's Modulus for Stretching," and can be determined by measurements of the four quantities involved. F , l , σ can be measured directly by ordinary means, but Δl is a small quantity and requires special accuracy. There are two methods available: one, to magnify the elongation by means of a lever and scale; the other, to use some delicate means of measuring lengths, such as a vernier.

The simplest method is to suspend two wires of the same material side by side from the same support; let one carry the scale, the other the vernier; add weights to one and measure the relative elongation. This method has the advantage of avoiding any error due to changes of tempera-

ture in the room, which, of themselves, would change the length of the wire; it also avoids any possible error due to giving away of the supporting clamp.

Sources of Error

1. There are changes of temperature in the wire which is stretched, owing to its sudden elongation. (See "Physics," Art. 170.)
2. The scale and vernier may be accidentally displaced over each other.
3. The limit of elasticity must not be exceeded.
4. All kinks must be removed from the wires.

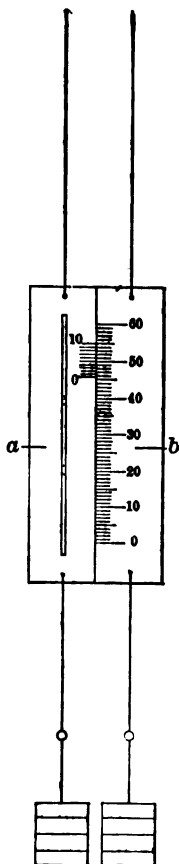

FIG. 64

Apparatus. Two long wires of the given substance, hung from a fixed support on the wall near the ceiling, at such a distance apart that two vertical scales, one attached to each wire, have their graduated edges in close contact. Supports for weights are attached to the bottom of each scale, and a five-pound weight is placed permanently on each to keep the wires straight.

Extra five-pound weights are also provided to be hung upon one wire so as to produce the stretching force.

FIG. 64A—SECTION a-b

One of the scales is a millimetre scale, and the wire to which it is attached carries the same weight throughout the experiment, and so remains fixed; the other scale is a vernier, sliding over the first. A guide, soldered to the fixed scale, moves in a groove in the vernier scale and keeps them parallel; and an elastic band passed over both keeps them in the same plane. A metre-bar, a steel L-square, and a micrometer caliper are also needed at the end of the experiment.

Manipulation. 1. To show that $\frac{F}{\Delta l} = \text{constant}$. See that one weight is hung on each wire, and that the scales hang parallel. If any change has to be made in the weights allow three minutes to elapse before taking a reading, so that the wires may assume their normal length under this stretching force. With a magnifying-glass read very carefully the position of the zero of the vernier scale on the fixed scale. Estimate the tenths of a vernier division. Mark the weights and place No. 1 on the carrier of the wire to be stretched—the one with the vernier scale. After three minutes, note the new reading of the vernier. Now add weight No. 2, and after three minutes more read the vernier again. Continue by adding No. 3 and noting the stretch again. Next, remove No. 3, and after three minutes read. Remove similarly in turn No. 2 and No. 1. Repeat the above cycle three times. Weigh each weight to within a gram on the platform scales. Δl being the change in length when a weight F is added or removed, show that $\frac{F}{\Delta l}$ is a constant for all elongations observed.

2. To determine "Young's Modulus." With the L-square and metre-bar measure the length of the wire to the point where it is attached to the scale. (The height of the support above a mark on the wall behind the two scales may be measured once for all by an instructor and marked on the wall.) Measure the diameter at as many different places as can be reached and in different directions, ten times in all. In this way determine l and σ , the original length and the cross-section.

ILLUSTRATION

"YOUNG'S MODULUS" FOR BRASS

Dec. 16, 1896

Specimen experimented upon: Brass wire of "Young's Modulus Apparatus."

Weights: 1 = 2880, 2 = 2278, 3 = 2851 grams.

Readings with Different Weights on Carrier.

Initial Weight	+1	+1+2	+1+2+3	+1+2	+1	Initial
8.90	4.71	5.41	6.14	5.38	4.71	8.91
8.91	4.71	5.42	6.17	5.42	4.70	8.91
8.91	4.70	5.43	6.19	5.40	4.70	8.90
Mean, 8.91	4.71	5.42	6.17	5.40	4.70	8.91

Part 1.—Hooke's Law:

	$\frac{\Delta l}{\text{cm.}}$	F Dynes	$\frac{F}{\Delta l}$
1 added.080	2389 × 980	298 × 100 × 980
1 removed ..	-.079	-2389 × 980	302 × 100 × 980
2 added.071	2278 × 980	320 × 100 × 980
2 removed ..	-.070	-2278 × 980	325 × 100 × 980
3 added.075	2851 × 980	318 × 100 × 980
3 removed ..	-.077	-2851 × 980	305 × 100 × 980
Mean...	310 × 100 × 980

Greatest deviation from Hooke's Law, 4%. This may be due to the straightening of the wire, as the first elongation is so great.

Part 2.—Vertical distance of lower end of wire above mark on wall = 0.8 cm. Distance from mark to upper end of wire = 272 cm.

$$\therefore \text{Length of wire} = 272.0 - 0.8 = 271.7 \text{ cm.} = l.$$

Diameter of Wire.

Zero of Micrometer	Wire	
-.0041	0.1000 cm.	$\pi r^2 = 8.1416 \times (.0520)^2 = .0085,$
-.0041	.1003 "	
-.0042	.1004 "	
-.0042	.1008 "	<i>i. e.,</i> $\sigma = .0085 \text{ sq. cm.}$
-.0041	.1000 "	
-.0042	.1000 "	
-.0042	.0988 "	$\frac{F}{\Delta l} = 310 \times 10^3 \times 980.$
-.0040	.1002 "	
-.0040	.1000 "	
-.0040	.1000 "	$E = \frac{F l}{\Delta l \pi r^2}$
Mean, -.00411	Mean, 0.09999 cm.	$= 31 \times 980 \times 10^4 \times \frac{271.7}{.0085}$
	\therefore Diameter = 0.10410 cm. (0.04	$= 9.7 \times 10^{11}.$
	is as accurate as need be, owing to	
	uncertainty in $F/\Delta l$.)	

Questions and Problems.

1. Is E constant for all forces of any magnitude? Does it apply to compression as well as stretching?
2. What kind of vibrations will a stretched wire make if set in motion longitudinally? Why?
3. What happens if a great compressing force is applied longitudinally to a steel cylinder, (1), of small radius? (2), of large?
4. A wire is elongated 12 millimetres by a force of 4 kilograms. If a different length of the same wire is elongated 20 millimetres by the same force, what is the ratio of the lengths of the two wires? What change in cross-section, instead of in length, would have produced the same effect?
5. How can a uniform rectangular beam of iron, 10 metres long, mass 1000 kilograms, be made as *stiff* as possible?
6. A horse is hitched to a loaded wagon by a long extensible spring. How does the work done in just starting the wagon depend upon the elasticity of the spring?
7. A rubber band is stretched between two points, A and B . If A is kept fixed, and the end B moved to a position B' , the band being kept straight, prove that the work done depends only on the distances of B and B' from A , *not* on the *path* followed by the end. (B' may be farther from A than B , or nearer.) Explain the exceptional case, when, during the motion, the band meets a smooth peg and so is bent around it, the line from A to B' becoming thus a broken line.

EXPERIMENT 28

(TWO OBSERVERS ARE ADVISABLE)

Object. To determine the coefficient of rigidity for iron. To learn a method of measuring intervals of time exactly. (See "Physics," Art. 82.)

General Theory. If there are two series of events in each of which the same phenomena recur at regular intervals, and it is desired to compare these intervals, the most delicate means known to science is the "Method of Coincidences."

Suppose, for instance, that it is desired to find the period of a pendulum by means of a clock which beats seconds, and which is, as usual, not provided with any means for indicating a fraction of a second, the natural method is to count the number of seconds taken by the pendulum in making a given number of vibrations. But it is evident that one cannot ascertain the entire interval closer than one whole second, which at once sets a low limit to the accuracy of the method unless a great number of observations are timed, or unless one selects such a number of periods of the pendulum that the interval to be timed is exactly an integral number of seconds. The latter method is that of coincidences, which it is proposed to describe here.

By making an arbitrary mark near the centre of the swing of the pendulum and observing its transits by the mark, and listening to the clock, one soon notices that, while the pendulum usually passes the mark between the ticks of the clock, at regular intervals the two events occur exactly simultaneously so far as the eye can tell. By starting at

such a "coincidence" and counting the number of ticks and number of periods of the pendulum made until the next exact coincidence, one would time a number of periods which occupied very closely an integral number of seconds. The determination would be accurate to within the very small fraction of a second below which the eye and ear could not detect a departure from coincidence.

The method, as described above, can evidently be used for comparing the periods of any periodic phenomena, no matter what their relative length may be. The refinements which are usually associated with the name of "Method of Coincidences" apply, however, only when the periods are very nearly commensurate—that is, such that if τ be one of the periods and T the other, $\tau = NT \pm \epsilon$, where N is a whole number and ϵ a very small fraction of a second.

After a coincidence, one of the systems whose periods are being compared will evidently fall behind the other, since NT seconds after coincidence they will be separated by an interval ϵ ; $2NT$ seconds after, by an interval 2ϵ ; and so on. Finally they will be separated by an interval very approximately equal to T —i. e., the vibrations of shorter period will have gained one whole period nearly on the other. Another coincidence will then occur which will appear to the senses exact, unless, when T is divided by ϵ , a fraction remains which is greater than the shortest interval of time the senses can detect. That is to say, for the coincidence to appear exact T must $= m\epsilon$, where m is a whole number, to within a very small fraction of a second. We will then have

$$m\tau = mNT \pm m\epsilon = (mN \pm 1) T.$$

$$\therefore \tau = \frac{mN \pm 1}{m} T.$$

Hence, by finding the whole number N by a comparatively rough trial, and then by counting the number of vibrations between coincidences made by the system whose period is τ , one can dispense entirely with noting the number of vibrations made by the other system.

If it is more convenient to count the number of vibrations of the other system between coincidences, one can do so just as well. Let it be p . Then

$$p = mN \pm 1; \text{ or } m = \frac{p \mp 1}{N}$$

$$\therefore \tau = \frac{pN}{p \pm 1} T.$$

This equation and the one on the preceding page simply express the fact that, in the time observed, one body has made one more vibration than the other.

If ϵ is much smaller than the senses can detect there will evidently be a number of apparent coincidences successively, for one vibration will have to gain several intervals ϵ on the other before the difference can be detected. In such a case the first and last of the successive coincidences is noted, and the exact coincidence is taken to be half-way between.

If, on the other hand, ϵ is greater than the smallest interval the senses can detect, there will still be approximate coincidences whenever the more rapid vibration has gained one whole period; but these coincidences will no longer appear exact, though the method can still be used unless ϵ is quite large.

To apply this method to a concrete case, let it be used in determining the coefficient of rigidity of a certain material, either brass or iron, by means of the torsional vibrations of a wire made of the substance. (See "Physics," Art. 82.)

If a wire of a certain substance be held fast at one end it will take a certain definite moment L to twist the other end through an angle ϑ . Theory, as well as experiment, shows that, if r is the radius of the wire and l its length,

$$L = \frac{\pi r^4}{2l} n\vartheta,$$

unless ϑ is too great, n being a constant which depends on the material and condition of the wire. It is called the "coefficient of rigidity" of the given substance.

Let the wire be clamped to a fixed support at its upper

end so as to be suspended vertically. To its lower end let there be clamped a flat disk, whose moment of inertia around the axis of the wire is I . This forms a "torsion pendulum." If the disk is twisted through a certain angle and then let go, it will oscillate about its position of equilibrium. When, during the vibration, it is displaced through the angle ϑ , the moment with which the wire tends to untwist will be $L = \frac{\pi r^4 n}{2l} \vartheta$.

Hence, if α is the angular acceleration,

$$\alpha I = L, \text{ or } \alpha = \frac{\pi r^4 n}{2I l} \vartheta,$$

which shows at once that the motion of the pendulum will be a simple harmonic one of period

$$T = 2\pi \sqrt{\frac{2I l}{\pi r^4 n}}$$

$$\text{Whence, } n = \frac{8\pi I l}{T^2 r^4},$$

l and r can be measured directly. The moment of inertia, I , of the torsion pendulum should be calculated from its dimensions and mass, if possible, or else obtained of the instructor; T is determined by comparison with a seconds clock by the method of coincidences as follows:

The wire of the torsion pendulum is made fairly long—over a metre—and the approximate period found by counting *both* the number of periods of the pendulum and the ticks of the clock between several coincidences, one after the other. The period will in general be found not to be very nearly an integral number of seconds.

In order to be able to use the method of coincidences to advantage, it is then necessary to make the period as closely as possible a whole number of seconds by changing the length of the wire. It will be seen by the formula above that the period varies as the square root of the length of wire. Bearing this in mind, calculate the change in length of the wire necessary to make the period an integral number of seconds, assuming the approximate period

to be exactly right. Shorten the wire to the calculated length; then find the exact period by the method of coincidences, noting on the dial of the clock the number of seconds p between coincidences. By the formula above :

$$T = \frac{Np}{p \pm 1} \quad T_1 = \frac{Np}{p \pm 1}, \text{ since } T_1 = 1 \text{ second. } N, \text{ that whole num-}$$

ber which expresses the period most closely, is easily found by timing a few swings. Whether the + or - sign is to be used depends upon which gains on the other, the clock or the pendulum. If, after a coincidence, the pendulum drops behind, its period is evidently longer than the whole number of seconds, and hence the - sign is used, and *vice versa*. It must be noted that the coincidences are to be taken when the pendulum passes its mark in one direction only—not on the return swing.

Sources of Error.

1. The same precautions are necessary as in Experiment 1, Part 3. in order to insure that the transits observed are always those at the same point of the swing exactly.
2. Unless the whole apparatus is made on a large scale, the wire will have to be very fine or the vibrations will be too rapid. A fine wire must be very carefully treated to avoid kinks. Moreover, the radius enters to the fourth power, and must, therefore, be determined with the greatest possible care by repeated measurements all along the wire. Further, the wire should always be shortened when being adjusted, not lengthened; because, where it has been clamped a kink has been made.
3. Care is necessary to start the torsional vibration so that the pendulum does not swing as well as twist.

Apparatus. A torsion pendulum; wire at least 100 centimetres long; brass ring or bar; micrometer caliper; metre-bar.

Manipulation. Straighten the wire, remove all kinks, and clamp it firmly at the upper end in the support near the seconds clock. Attach the carrier with whatever load may be furnished tightly to the other end, making the length of the wire between the points where it is held considerably

over a metre—say 120 centimetres. Attach a long pointer of fine wire to the bottom of the pendulum, bend the end of the pointer vertically down, and arrange in line with it a vertical thread and some other mark of reference as a line of sight in observing the transits, just as in Experiment 1. (Ask the instructor to start the clock.)

Start the torsional vibrations through about forty degrees. Several trials may be necessary before this can be done without setting the pendulum swinging. The best way is to start with a much larger torsion than is finally desired, and then to stop the swings with light touches of the finger, which also decrease the torsional vibrations.

One observer notes the transits of the pendulum pointer past the thread, being careful to keep the line of sight always the same; he also listens to the ticks of the clock, and gives a sharp tap the instant they coincide. The other observer watches the clock-dial carefully (or the hands of his own watch, if the clock has no dial), and notes the second of the tap, and also, after that is made sure of, the minute and hour. Observer No. 1 meanwhile counts the transits of the pendulum *in the same direction*, still listening to the clock. When the next exact coincidence occurs he taps sharply again, notes quickly on paper the number of periods of the pendulum made between coincidences, and begins counting the transits again for the next interval. Observer No. 2 again notes the second, minute, and hour of the tap. Continue similarly until five successive coincidences are noted.

Four intervals between coincidences have thus been found, and the number of swings of the torsion pendulum in each noted. Calculate the period as thus determined. Let it be T' . Measure l' , the length of the wire between the fixed points. Then calculate l , the length the wire should have

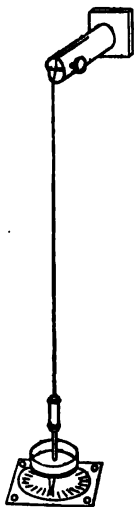

FIG. 65

in order that the period may be exactly the integral number of seconds next below T —i. e., if $T' = 8.24$, let $T = 8$, for example. Remember that $l = l' \frac{T'^2}{T^2}$. Shorten the wire as closely as possible to this length. A good way is to mark on the wire under the support with a pencil—*not a scratch*—the difference of length necessary, and raise the wire through the support until it clamps it at the mark exactly.

Readjust the pointer and line of sight if necessary. Prepare to note the exact second of coincidences just as before, though it is no longer necessary to count the swings of the pendulum. Note thus a series of consecutive coincidences—say eleven; then allow some definite number—say nine—to pass unnoticed; then note eleven more, or whatever may have been the number noted in the first series. If there is doubt as to the number of coincidences which were not noted, it can be readily calculated from the interval of time between the first and last coincidence of the first series. It may be used to determine N , the nearest whole number to the period, and to note which is gaining on the other.

To find the exact interval between coincidences from the data, proceed as follows: Let t_1, t_2, t_3 , etc., be the times of the first set of coincidences; t'_1, t'_2, t'_3 those of the last set. Then the approximate interval of the coincidences is the average of $\frac{t_{11} - t_1}{10}$ and $\frac{t'_{11} - t'_1}{10}$. Call it p' . It is known, furthermore, that between t_1 and t'_1 there are a *whole* number of such intervals, which is evidently the nearest whole number to $\frac{t'_1 - t_1}{p'}$. ($\frac{t'_1 - t_1}{p'}$ would itself be exactly a whole number if there were no slight errors anywhere in the observations. The object here is to eliminate these slight errors.) This whole number represents the exact number of intervals between the times t_1 and t'_1 . There will evidently be the same number between t_2 and t'_2, t_3 and t'_3 , and so on. From each of these pairs, therefore, a determination of the length of the interval can be obtained, and

the mean of these determinations is the most probable value of the interval between coincidences to be found from the data of the experiment. Call it p .

Calculate the period from the formula $T = \frac{pN}{p \pm 1}$.

Measure at least twice, by means of the metre-bar, the length of the wire between the points where it is held by the carrier and by the support. Measure the diameter of the wire at twenty different places with the micrometer caliper.

Obtain from the instructor the moment of inertia of the carrier, and add to it the moment of inertia of the load placed upon it calculated from the mass and dimensions of the parts.

[It is a very useful exercise, for students who have the time, to determine the moment of inertia of the carrier by experiment. To do this, remove the load and measure the period exactly as above with the carrier alone. If the length of the wire has to be changed again, to make the period approximately commensurate with seconds, calculate what the period with the carrier alone would have been with the length of wire unchanged. Call it T' . Then, if I' is the moment of the carrier alone,

$$\frac{T'}{T} = \sqrt{\frac{I'}{I}}$$

But if I'' is the moment of inertia of the load, which can be calculated, $I = I' + I''$.

$$\therefore \frac{T''}{T} = \sqrt{\frac{I'}{I' + I''}} \quad \therefore I' = I'' \frac{T''^2}{T^2 - T''^2}$$

The experiment is written for two observers, but one can do it alone. He can find the approximate period with a stop-watch, and, when the period is adjusted to be nearly an exact number of seconds, he can find the time between coincidences by making a mark on a sheet of paper at the exact moment of coincidence and another at each succeeding tick until he can catch the time from the dial of the clock. He can then count back by means of his marks to the second when the coincidence was observed.

ILLUSTRATION

RIGIDITY OF IRON WIRE

Dec. 10, 1896

To Find Approximate Period of Torsion Pendulum for a Length of 128 Centimetres

Times of Coincidences	Intervals (Seconds)	No. of Periods of Pendulum in these Intervals	Period
H. M. S. 2 14 32			
15 14	42	5	8.40
16 21	67	8	8.38
17 08	42	5	8.40
17 45	42	5	8.40
Mean....	8.40

Hence, to make the period 8 seconds exactly, it should have a length = $\left(\frac{8}{8.4}\right)^2 \times 128 = 111.5$.

Length measured, after clamp was adjusted, and found to be exactly 111.8 centimetres.

To Find Exact Period

Times of Coincidences		Interval between Corresponding Coincidences in each Set
Set I.	Set II.	
H. M. S. 2 44 6	H. M. S. 3 52 46	4120 secs.
47 35	56 16	4121 "
51 11	59 51	4120 "
54 10	4 8 11	4141 "
57 59	6 26	4107 "
8 1 31	9 58	4107 "
4 59	13 14	4095 "
8 28	16 24	4076 "
11 48	19 59	4091 "
14 58	23 30	4112 "
18 28	26 58	4110 "
Mean	4109 secs.

In Set I., 10 intervals between coincidences = 2064 seconds.

In Set II., 10 intervals between coincidences = 2052 "

Mean, 2058 seconds.

Hence the interval between coincidences is about 206 seconds.

Dividing 4109 by 206, the result is 19.9. The nearest whole number is 20, which must be the number of intervals between corresponding coincidences in Set I. and Set II.

$\therefore 20$ intervals = 4109. $\therefore 1$ interval = $p = 205.5$.

In the time between the two sets of coincidences it was found that the pendulum made 10 swings in 79 seconds. Hence, $N = 8$. After each coincidence the pendulum was found to get gradually ahead of the clock. Hence,

$$T = \frac{8 \times 205.5}{205.5 + 1} = 8 \cdot \frac{2055}{2065} = 7.961 \text{ seconds.}$$

The length of the wire was measured twice more and found to be 111.2, 111.4 centimetres. Mean, 111.3 centimetres, as before.

The "bob" of the pendulum consisted of a carrier loaded with a rectangular bar and a ring of brass. The moment of inertia of the carrier alone was found by a separate experiment to be $90.63 = I_1$.

The dimensions of the ring were: External diameter, 6.85 centimetres; internal, 5.50 centimetres; mass, 40.1 grams.

\therefore Its moment of inertia = $I_2 = 40.1 \frac{(8.18)^2 + (2.75)^2}{2} = 858.7$.

The dimensions of the bar were: Length, 5.16 centimetres; breadth, 0.62 centimetre; mass, 16.5 grams.

\therefore Its moment of inertia = $I_3 = 16.5 \frac{(5.16)^2 + (0.62)^2}{12} = 87.1$.

\therefore The entire moment of inertia of the pendulum is:

$$I = I_1 + I_2 + I_3 = 481.4.$$

Diameter of wire:

0.2500 mm.

0.2501 "

0.2500 "

0.2498 "

0.2499 "

0.2499 "

0.2498 "

0.2498 "

0.2499 "

0.2498 "

\therefore radius = 0.01249 cm.

Mean, 0.2499 mm.

\therefore The coefficient of rigidity of the given specimen of iron wire is:

$$n = \frac{8\pi l I}{l^2 r^4} = \frac{8\pi \times 111.3 \times 481.4}{(.01249)^4 \times (7.961)^3} = 8.7 \times 10^{11}.$$

Questions and Problems.

1. If the carrier in your experiment weighs 41 grams, what would be the radius of the hollow cylinder of the same mass which could be substituted for it without changing the period? (Neglect the thickness of the cylinder.)
2. What is this radius called?
3. What would be the radius of a very thin hollow sphere containing the same mass of brass which could be similarly substituted if one cubic centimetre of brass weighs 8.4 grams and the moment of inertia of a sphere about a diameter is $\frac{2}{5} Mr^2$?
4. A piece of shafting, 10 metres long, 5 centimetres radius, is twisted through 1° by a certain moment. How may the shaft be changed so that the twist will be 80° ?
5. If this same shaft is made three times as long, and of twice the diameter, what twist will be produced by the same force applied tangentially?

EXPERIMENT 29

Object. To verify the laws of fluid pressure, $p = \rho gh$ and force $F = pA$. (See "Physics," Art. 89.)

General Theory. It is proved from theoretical considerations that the pressure due to a vertical height h of a fluid of density ρ is $p = \rho gh$, if g is the acceleration due to gravity.

The general method of verification is to lower a hollow cylinder, closed at one end, into a liquid, and to measure the force required to sink it a given depth. The force upward equals the pressure on the closed end multiplied by the area; and if a weight mg makes the cylinder sink a distance h , the force $A\rho gh$ must equal mg ,

$$\text{or } m = A\rho h.$$

This may be verified by causing the cylinder to sink to different depths, and measuring the corresponding weights, by using cylinders of different sections, and by using liquids of different densities.

Sources of Error.

1. Capillary action makes it difficult to read the exact depth of the cylinder.
2. The metal cans may not be exact cylinders.
3. It is difficult to make the cylinders float exactly vertical, and so the scale marked on the cylinder may not occupy the same position during the experiment.
4. The scales may not be accurate, and may not agree on the two cylinders.

Apparatus. Two hollow metal (or wooden) cylinders, closed at one end, of different cross-sections, each about 20 centimetres long, with equally spaced horizontal divis-

ions ruled on them; a deep battery-jar; one pound of lead shot, of two or three millimetres diameter; a vernier caliper; kerosene.

Manipulation. Measure the diameters of the two cylinders, and test the accuracy of their construction. Test also the accuracy of the scales. Nearly fill the jar with tap water, and by means of shot so load the two cylinders that they will just float upright in the water. It may be

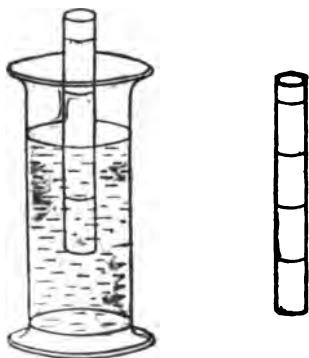

FIG. 66

necessary to redistribute the shot by means of a long wire, so as to make the cylinders float exactly vertical. Add shot, grain by grain, until each cylinder floats so that a division mark comes exactly at the surface of the water. (This may often be best tested by looking up at the mark from below the surface.) When making this adjustment, press the cylinders

from time to time deeper into the water with the finger and allow them to rise slowly, thus keeping the surfaces wet.

Then add enough shot to each cylinder to make it sink one more division; add grain by grain, and count the number added, estimating, if necessary, the fraction of a shot which would make an exact adjustment.

Add enough more to sink each cylinder another division, counting the number added; continue for as many divisions as possible.

Record the number of shot in each case; they should be the same for each one of the cylinders, if $p = \rho gh$, for the mass of each shot is approximately the same, and so the weights are in the same ratio as the number of the shot; and it should, from the formula, require the same weight to sink the cylinders each additional distance h . Take the mean for each cylinder. Assuming the divisions to be

equal, the pressures which correspond to equal depths of the same liquid are measured by the weight of these shot, and $n_1 : n_2$ should equal $A_1 : A_2$. Or if n_1 and n_2 are the number of the shot, $n_1 : n_2$ should equal $A_1 : A_2$.

Float either cylinder in a similar way in a different liquid of density ρ' —e. g., kerosene oil—and measure the mean number of shot necessary to lower it through one division. If the mean number is n'_1 , and n_1 is the mean number in the first liquid, the following relation should hold :

$$n_1 : n'_1 = \rho : \rho'$$

ρ and ρ' may be found in the tables, or may be measured directly in the following experiment :

ILLUSTRATION

Dec. 5, 1896

VERIFICATION OF $p = \rho gh$ AND OF $pA = F$

In Water, $\rho = 1$

1st Cylinder, Radius 0.55+ inch	2d Cylinder, Radius 0.77+ inch	
85 shot	72 shot	Ratio of areas, $\frac{240}{121} = 1.98.$
86 "	78 "	Ratio of forces, $\frac{726}{360} = 2.02$
86 "	78 "	But the divisions of the second cylinder were slightly longer than those of the first.
87 "	72 "	
86 "	78 "	
Mean, 86 shot	72.6 shot	

Greatest deviation from mean less than 8%.

In Kerosene Oil, $\rho' = 0.788$

1st Cylinder, Radius 0.55+ inch	
28.0 shot	Ratio of densities, 0.788. Ratio of pressures, $\frac{360}{288} = 0.786.$
28.5 "	
28.0 "	
28.5 "	
28.0 "	
Mean, 28.3 shot	

Questions and Problems.

1. What error will be made in the above experiment if the floating bodies are slightly conical? What if they do not float vertical?
2. What is the effect of the atmospheric pressure?

3. How was any work done? Show how it may be calculated.
4. The pressure at the bottom of a lake is three times that at a depth of 2 metres. What is the depth of the lake? (Atmospheric pressure = 76 centimetres of mercury.)
5. A sphere, 1 metre radius, is just immersed under water. What is the total force upward?
6. Show that the total thrust on the five faces of a cube filled with a liquid equals three times the weight of the liquid, omitting atmospheric pressure.
7. A cube, 10 centimetres on each edge, is filled half with water, half with mercury. Calculate the force on the bottom and on each of the sides.
8. A vertical tank having its base in a horizontal plane is to be filled with water from a source in that plane. The area of the cross-section is 5 square metres, the height is 10 metres. Calculate the work required to fill it. Does this depend upon the position of the inlet pipe?

EXPERIMENT 30

Object. To determine the density of a liquid by means of "balancing columns." (See "Physics," Art. 91.)

General Theory. The height to which a liquid will rise in a tube varies directly as the pressure and inversely as the density, but does not depend upon the area of the tube. This fact can be made use of to compare the density of the two liquids. Two methods will be described: one for use with liquids which do not mix or act chemically on each other—*e. g.*, mercury and water; the other, for use with any two liquids.

1. If the two liquids are contained, as shown, in a U-tube, and if the liquid of density ρ_1 stands at a height h_1 above the surface of separation of the two liquids, and the liquid of density ρ_2 stands at a height h_2 above the same level, then, since the pressure is the same in both arms of the tube at this level,

$$\rho_1 g h_1 = \rho_2 g h_2,$$

or

$$\rho_1 / \rho_2 = h_2 / h_1.$$

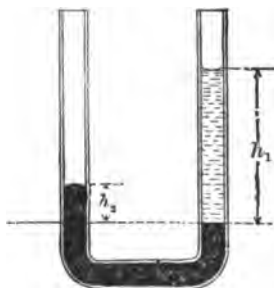

FIG. 67

If, now, the level at which the liquid stands in each tube be changed considerably by pouring in an additional amount of one of the liquids, and h'_1 and h'_2 are the new heights of the free surfaces above the new surface of separation,

$$\frac{\rho_1}{\rho_2} = \frac{h'_2}{h'_1}.$$

$$\therefore \frac{\rho_1}{\rho_2} = \frac{h'_2 - h_2}{h'_1 - h_1}.$$

(By taking the second set of observations the correction for capillarity is eliminated.)

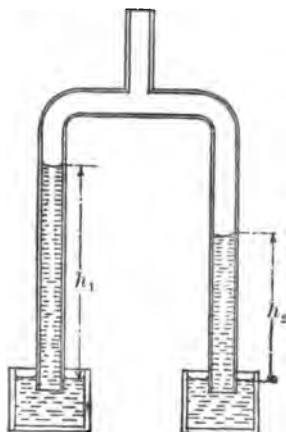

FIG. 68

2. If by suction the two liquids are drawn up into two glass tubes joined by a T-tube at the top, and if the heights of the liquids above their respective free surfaces are h_1 and h_2 , then, since there is the same difference of pressure acting on each,

$$\rho_1 h_1 = \rho_2 h_2,$$

or

$$\rho_2 / \rho_1 = h_1 / h_2;$$

and also, as in (1), if a second set of readings be taken at changed levels,

$$\frac{\rho_1}{\rho_2} = \frac{h'_2 - h_2}{h'_1 - h_1}.$$

Consequently, if the density of one of the liquids is known, that of the other can be calculated.

Sources of Error.

1. Corrections may be necessary owing to capillarity.
2. The scale and tubes must be parallel and approximately vertical.
3. The pinch-cock in Method 2 must not leak, otherwise the pressure will change.

METHOD 1.—FOR LIQUIDS WHICH DO NOT MIX

Apparatus. A wooden stand holding a glass U-tube, about two centimetres in diameter, open at both ends; a metre-bar is held between the parallel branches of the U, the latter and the bar being vertical; a steel L-square and level; a thermometer; mercury and water are the most convenient liquids to compare by this method, and about 250 grams of clean mercury in a lip-beaker, and clean tap water should be used; a wooden tray should be obtained in this and all

other experiments where mercury is used, and the whole apparatus should be set up in it.

Manipulation. Pour enough mercury into the tube to rise to a height of about four centimetres in each branch. With the aid of the L-square and level, adjust the stand so that the U-tube and metre-bar are vertical. To do this, place the level on one limb of the square and set the other in turn against the front and the edge of the metre-bar. Pour water into one arm until it rises to about two-thirds the height of the tube. By a thread lower the thermometer first into the mercury and then into the water, and note the temperature of each. The thermometer should be at least a minute in each before being read. Take two long, narrow pieces of paper, each with straight, smooth, parallel edges. Turn one end of each into a paper tube, just fitting over one of the glass tubes. The other end should project over

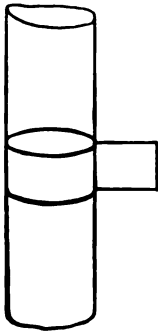

FIG. 70

the scale, so that its upper edge marks exactly the plane of the top of the paper tube. Slip one end of the indices thus made over each branch of the U and adjust to the level of the liquid surfaces in the same manner as the barometer index is adjusted. Thus determine α_1 , the reading of the level of the top of the water column. The edge of the paper is horizontal if it reads the same at both edges of the bar. Measure

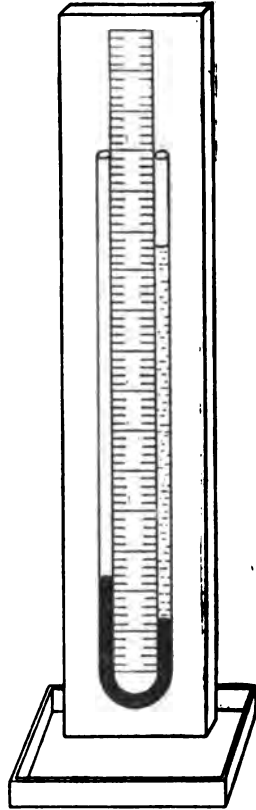

FIG. 69

to the *bottom* of the hollow, or meniscus. In a similar manner determine x_2 , the reading of the level of the bottom of the water column, measuring to the top of the mercury meniscus; and likewise x_3 , the reading of the level of the top of the mercury in the other tube.

Pour in enough water to fill the tube nearly to the top. Read again the level of the same three surfaces. Call them x'_1, x'_2, x'_3 . Finally, redetermine the temperatures. Then, if ρ and D are the densities of mercury and water at their respective temperatures,

$$\frac{\rho}{D} = \frac{(x'_1 - x_1) - (x'_2 - x_2)}{(x'_3 - x_3) - (x'_2 - x_2)}.$$

NOTE.—If only one reading is made on the height of a liquid in a tube, and if the tube is narrow enough for the surface of the liquid to be much curved, a correction has to be applied equal to the distance through which the surface tension would raise or depress the liquid in the given tube with reference to the level at which it would stand in a very large vessel. This is equal to $h = \frac{2T \cos \mathcal{S}}{r\rho g}$ for capillary tubes, where T is the surface tension of the given surface; \mathcal{S} , the angle at which it meets the walls of the tube; r , the radius of the tube; ρ , the density of the liquid; and g , the acceleration of gravity.

When h is positive, the liquid is raised above the level of a large vessel, and *vice versa*. T and \mathcal{S} differ very widely with the purity of the liquids and cleanness of the tube; and the formula is departed from as the meniscus ceases to be spherical and becomes flat on top—*i. e.*, in tubes of over two millimetres in diameter.

For tubes of seven or eight millimetres the student may assume the following values:

$$\begin{array}{l} \text{Water-air, . . . } h = \frac{.18}{\text{diameter}} \text{ cm.} \\ \text{Mercury-water, } \left. \vphantom{\begin{array}{l} \text{Water-air} \\ \text{Mercury-air} \end{array}} \right\} h = \frac{1.06}{\text{diameter}} \text{ cm.} \\ \text{Mercury-air, } \end{array}$$

Measure the tube and see if the correction is large enough to affect the results just obtained.

A table is also given at the end of the volume for the correction of mercury in glass tubes.

METHOD 2 (HARE'S METHOD).—FOR LIQUIDS WHICH MIX OR AFFECT EACH OTHER CHEMICALLY

Apparatus. Two small glass jars or beakers; two glass tubes, each about a metre long and one centimetre or more

in diameter, bent at the bottom as shown in the figure, so that 60 to 90 centimetres of each can lie right along the edges of a metre-bar placed between them, while the lower

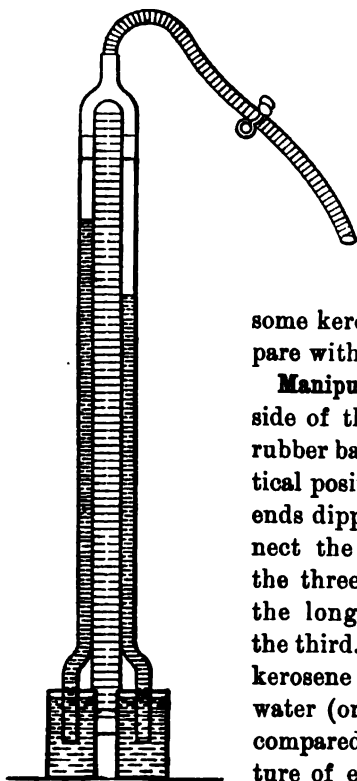

FIG. 71

ends dip in glass jars placed one each side of the bar and close to it; a steel L-square and level; a thermometer; a clamp-stand; a three-way glass connector; two short pieces of rubber tubing, and one piece half a metre or over in length, with a pinch-cock on it;

some kerosene or other liquid to compare with water.

Manipulation. Fasten the tubes each side of the metre-bar with string or rubber bands. Support them in a vertical position in the clamp-stand, the ends dipping in the glass jars. Connect the tubes to two branches of the three-way connector, and fasten the long rubber tube tightly over the third. Having filled one jar with kerosene and the other with clean tap water (or whatever liquids are to be compared), determine the temperature of each, leaving the thermometer in each at least one minute. Now

open the pinch-cock and suck the liquids up so that they stand at convenient heights in each tube. Close the cock tight, and determine the level of the top of the liquid in each jar and each tube. Use a piece of paper with a straight-edge as described in Method 1. Read the level of the liquid in the centre of the tubes and jars, not at the edges.

Change the level in each tube as much as possible, and read the levels again. Then, if ρ_1 is the density of the liq-

uid whose heights have been $x_1 - x_2$ and $x'_1 - x'_2$, and ρ_2 that of the liquid whose heights have been $x_3 - x_4$ and $x'_3 - x'_4$,

$$\frac{\rho_2}{\rho_1} = \frac{(x'_1 - x_1) - (x'_2 - x_2)}{(x'_3 - x_3) - (x'_4 - x_4)}$$

Repeat the whole experiment four times, changing the height of the liquids in the tubes each time. Finally, note the temperature again.

ILLUSTRATION

DENSITY OF MERCURY BY METHOD 1

Dec. 21, 1895

Temperature of mercury at beginning, 17.8° ; at end, 20.2° ; mean, 19° .

Temperature of water at beginning, 18° ; at end, 20.4° ; mean, 19.2° .

Density of water at $19.2^\circ = D = 0.99855$.

Diameter of tube = 0.8 centimetre.

x_1	x'_1	x_2	x'_2	x_3	x'_3	$\frac{\rho}{D} = \frac{(x'_1 - x_1) - (x'_2 - x_2)}{(x'_3 - x_3) - (x'_4 - x_4)}$
61.21	77.25	2.11	1.71	6.46	7.27	18.56
68.78	81.17	1.94	1.56	6.86	7.42	18.55
72.82	85.26	1.88	1.41	7.06	7.59	18.58
70.98	83.36	1.85	1.48	6.99	7.52	18.52
Mean,	18.54

$$\therefore \rho = 18.54 D = 18.54 \times 0.99855 = 18.52.$$

\(\therefore\) The density of mercury at 19° is found to be 18.52.

Questions and Problems.

1. Why are you directed to take the temperature of the mercury before that of water?
2. What is the weight supported by the clamp-stand in Method 2?
3. What corrections would be necessary under each of the following conditions: Mercury tube much smaller bore than water tube; tubes and bars not vertical but parallel to one another; neither vertical nor parallel; cross-section of tubes irregular; insoluble particles of dirt, such as broken glass, etc., in the liquids; one liquid volatile in Method 2.
4. In Method 1 what would happen if more water were poured in than the weight of all the mercury in the tube?

EXPERIMENT 81

Object. To determine the density of a solid by means of a chemical balance. Archimedes' principle. (See "Physics," Art. 92.)

General Theory. When a solid is completely immersed in a liquid (surrounded on all sides), it is buoyed up with a force equal to the weight of the liquid displaced. This is Archimedes' principle.

This buoyant force may be determined by weighing the solid first in air, next when in the liquid; for the difference is the force desired. If the density of the liquid is known, the volume of the solid can be calculated, because it equals the mass of the displaced liquid, as just determined, divided by the density of the liquid. But as the mass and the volume of the solid are now both known, its density may be at once found by dividing one by the other.

Of course a liquid must be chosen whose density is known and which does not in any way act on the solid; if the solid floats in the liquid it may be made to sink by loading it with a heavy weight, due allowance being made for this in the observations and calculations. Special measures must be adopted for certain substances which are granular or very porous.

Sources of Error.

1. There is always capillary action on the thread or wire which supports the solid in the liquid.
2. Air-bubbles may cling to the solid.
3. Friction and capillary action between the object and the sides of the vessel must be guarded against.

Apparatus. A chemical balance and box of weights, 50 grams to .01 gram, with rider; the cylinder measured in Experiment 5 and a beaker large enough to hold it when completely submerged in water, but small enough to go on a pan of the balance; a brass stand designed to be placed over the balance-pan and to rest entirely upon the bottom of the case so that the beaker may be set upon it without its weight acting upon the balance; half a metre or so of very fine wire or thread and a thermometer; camel's-hair brush.

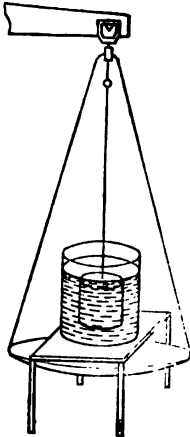

FIG. 72

Manipulation. Weigh the cylinder very carefully, as in Experiment 26. (If the same cylinder has already been previously weighed it need not be weighed again.) Place the stand in position and the empty beaker upon it. Hang the cylinder from the hook over the balance-pan by means of the wire, so that it does not touch (or come very near to) the sides or bottom of the beaker, but can be completely submerged when the beaker is filled with water. Adjust the wire so that as little as possible of it will be under water, and, if possible, so that only one strand will pass through the surface of the water, so as to avoid capillary effects. In this position weigh the cylinder and the supporting harness, and thus find the weight of the harness. Remove the beaker, leaving the cylinder hanging; fill it with enough water to completely submerge the cylinder when it is replaced later; place it under the receiver of an air-pump, and exhaust the air from the water. Water from which the air has recently been expelled by boiling may be used to advantage and need not be exhausted of air under the pump. See that the beaker is dry outside, replace it on the stand, and hang the cylinder inside it again, so as to be completely submerged in the water. Take the tem-

perature of the water and remove all air-bubbles which may cling to the cylinder.

The balance will be found much less sensitive than when the cylinder was in air; the cause is the capillary action of the water on the wire. The sensitiveness can be increased in the following manner, and the weight of the cylinder in the water measured: Find the exact weight in the pan necessary to bring the pointer to equilibrium at a point five divisions to the left of the zero found for the balance, and also the weight necessary to bring it to equilibrium five divisions to the right of the zero. Both weights should be found to tenths of a milligram, and their mean will be the weight necessary to bring the pointer to its zero—*i. e.*, the correct weight of the cylinder in the water. Finally, determine the temperature of the water again.

Then if W_1 = weight of cylinder + wire in air,

W_2 = " " " in water + weight of wire.

$W_1 - W_2$ = loss of weight of cylinder in water (neglecting loss of weight of wire in water),
= weight of water displaced by cylinder.

Let V = volume of 1 gram of water at given temperature,

then $V(W_1 - W_2)$ = volume of the cylinder.

From the volume of the cylinder thus found and its weight in vacuo as previously measured, its density may at once be calculated.

ILLUSTRATION

Jan. 13, 1897

DENSITY OF HARD RUBBER

Cylinder 1. Box of weights, M 342. Balance, M 253.

Zero of balance was 10.87.

Weight necessary to balance cylinder + wire in air :

With 81.801 grams in left pan, pointer read 10.89

" 81.802 " " " " " " 18.68

$\therefore W_1 = 81.801 + \left(\frac{48}{324} \text{ of } 0.001\right) = 81.8011 \text{ grams.}$

To find the mass of the cylinder suspended in water + that of the wire:

The zero was redetermined and found to be 8.49. Hence the weights necessary to bring pointer to 3.49 and 13.49 were found.

7.587 grams in pan, pointer read 13.8

7.588 " " " " " 14.4

∴ 7.5874 grams would bring it to 13.5 —

7.581 grams in pan, pointer read 3.2

7.582 " " " " " 4.8

∴ 7.5812 grams would bring it to 3.5 +

∴ The mean of 7.5812 and 7.5874 grams would bring it to the zero-point 8.49—i. e., 7.5843 grams, which is the weight sought = W_2 .

Temperature of water at starting = 16.6°, at end 17.0°.

Mean temperature = 16.8°.

Vol. of 1 gram of water at 16.8° = 1.00101 cubic centimetres.

$$W_1 = 31.3011$$

$$W_2 = 7.5812$$

∴ 23.7199 = weight of water displaced.

∴ $23.7199 \times 1.00101 =$ vol. of cylinder = 23.7439 cubic centimetres.

Mass of cylinder in vacuo = 31.001 grams.

∴ Its density is $\frac{31.001}{23.744} = 1.3004$.

Questions and Problems.

1. Compare the volume of the cylinder found as above with that obtained for the same cylinder in Experiment 5.
2. What is the total weight on the brass stand while the cylinder is being weighed in the water?
3. How could densities be determined with a platform-balance?
4. 80 cubic centimetres of lead, 20 cubic centimetres of cork, 10 cubic centimetres of iron are fastened together and suspended in water from a balance. What is the apparent weight?
5. A solid weighs 8 grams in water, 9 grams in air. What is its weight in vacuo? Temperature is 0° C. and pressure 76 centimetres of mercury.
6. A brick is dropped into a vessel containing mercury and water. What will be its position of equilibrium?

EXPERIMENT 32

Object. Use of Nicholson's hydrometer and determination of the density of some small solid, such as a coin. (See "Physics," Art. 93.)

General Theory. A Nicholson's hydrometer is simply a floating body which has pans designed to carry a small body, first in the air and then in the liquid. If the weight is known which will submerge the hydrometer to a definite point, then the difference between this and the weights which, together with the small solid, bring the hydrometer to the same point, when the solid is in the air or in the liquid, give the weight of the solid in the air and its apparent weight when in the liquid. Consequently, by Archimedes' principle its density may be calculated, if that of the liquid is known. If the solid is one which would itself float on the liquid, it may be confined below the surface by a wire cage permanently attached to the bottom of the hydrometer.

Sources of Error.

The same as in the preceding experiment.

Apparatus. A Nicholson's hydrometer and tall glass jar; a box of small weights, 5 grams to .01 gram; a small brush with a long handle, or a piece of cotton wool tied on a stiff wire; a five-cent piece, or any small coin or other light object of like size, the density of which is to be determined; a thermometer; a card-board or paper cover for the jar.

As ordinarily made, a Nicholson's hydrometer is a water-tight, hollow cylinder of metal, usually with conical ends.

At one end there is a long, thin stem carrying a small platform at the top, and at the other end is hung a heavy conical weight to hold the cylinder upright when floating in water. There is a mark around the stem about half-way up. The conical weight is flat or slightly hollowed on top, so that it can hold the object whose density is to be determined.

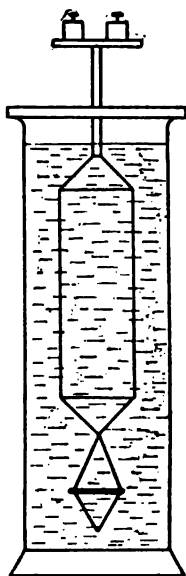

FIG. 73

Manipulation. Clean the stem of the hydrometer with a little caustic soda or potash, and rinse under a water-tap; fill the jar with clean water, which has been previously boiled and allowed to cool, and place the hydrometer in it; remove all air-bubbles with the brush or cotton, and cover with the card-board, making in the latter a slit to the centre, wide enough to prevent the stem rubbing against it. Take the temperature of the water. Dip under water the entire stem of the hydrometer to a point well above the mark upon it, so as to wet it; and try and keep the stem wet during the ex-

periment. Let the hydrometer rise to its natural position again, and add enough weights to bring the mark down just below the surface of the water; then slowly remove weights until the mark is exactly level with the surface. If too much weight happens to be removed, add weights until the mark is below the surface and try again. If, finally, the smallest weight which can be removed changes the mark from below to above the surface, estimate the fraction that would have to be added to bring about an exact balance at the surface. Let the weight thus found be w_1 grams.

Take off the weights, place the coin in the pan, and then add exactly enough weights to bring the mark again to the water-level, determining this weight just as in the first case. Let it be w_2 grams.

Now remove the coin (leaving the weights on the pan) and place it on the cone at the bottom of the hydrometer, being very careful to allow no air to be caught under it, and also to remove any air-bubbles on the instrument. Additional weights will now have to be put in the upper pan to bring the mark to the surface. Let the *total* amount in the pan necessary to do this be w_3 grams, which should be determined in exactly the same way as w_1 and w_2 .

Finally, redetermine the temperature, and let V = the volume of one gram of water at the mean temperature of the experiment.

Then $w_2 - w_1$ = weight of coin in air.

$w_3 - w_2$ = weight of water displaced by coin.

$(w_3 - w_2)V$ = volume of water displaced by coin,
= volume of coin.

Then $\frac{w_2 - w_1}{(w_3 - w_2)V}$ is the density of coin if the buoyancy of the air is neglected.

Be very careful throughout not to allow the hydrometer to rub against the glass or card-board cover, not to let air-bubbles collect on the stem, and not to wet the upper pan of the instrument or the weights.

ILLUSTRATION

HYDROMETER

Jan. 14, 1897

Density of a Nickel Five-cent Piece.

Weight in pan without coin: 9.52 grams did not quite raise mark to surface, 9.51 grams were too little. $\therefore w_1 = 9.515$ grams.

Nickel in upper pan: 4.82 grams too little, 4.83 grams too much.
 $\therefore w_2 = 4.825$ grams.

Nickel in lower pan: 4.900 grams just brought mark to surface.
 $\therefore w_3 = 4.900$ grams.

\therefore Weight of nickel = $9.515 - 4.825 = 5.190$ grams.

Loss of weight of nickel in water = $4.900 - 4.825 = 0.575$ grams.

Temperature of water at starting = 13.4° ; at end, 16° ; mean = 14.7° .

Volume of 1 gram of water at $14.7^\circ = 1.00069$ cubic centimetres.

\therefore Density of the nickel five-cent piece = $\frac{5.190}{0.575 \times 1.00069} = 9.02$.

NOTE.—This should not be mistaken for the density of nickel itself, since the five-cent piece is an alloy of nickel with copper.

Questions and Problems.

1. What would be the effect of a considerable change in the temperature of the water during the experiment?
2. What effect has capillarity on this method of determining density?
3. If the surface tension of water is 74 dynes per centimetre, and the stem of the hydrometer 3 millimetres in diameter, how much less weight in the pan is necessary to sink the hydrometer to the mark than if there were no surface tension?
4. What are the advantages of the slim stem ? Of the conical ends?

EXPERIMENT 38

Object. To determine the density of a coin or other small solid by means of Jolly's balance. (See "Physics," Art. 93.)

General Theory. A Jolly's balance is, essentially, a long, fine spiral spring, suspended from a fixed arm so as to hang in front of a vertical scale graduated on a long strip of mirror. The spring carries at its lower end two small weight-pans, the lower of which is always immersed in water in a glass vessel placed on a small platform provided for it.

A white bead on the wire supporting the top pan serves to mark the position of the bottom of the spring relatively to the scale division — *i. e.*, the extension of the spring. The mirror on which the scale is engraved is on the front of a hollow vertical column, and the arm which supports the spring is carried by a rod which slides inside the column and may be clamped at any desired height. The height of the platform can also be adjusted.

The principle of its use is essentially that of Nicholson's hydrometer; a certain weight extends the

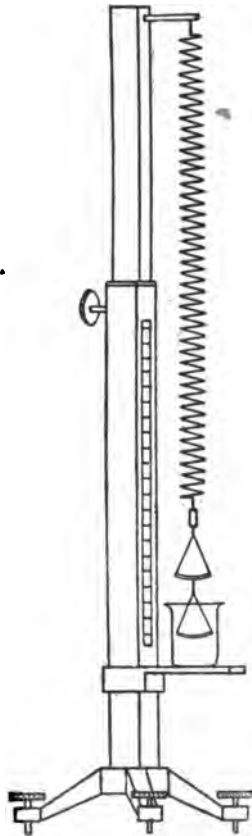

FIG. 74

spring a definite amount, the solid in air plus a measured weight extends it the same amount, the solid in the liquid plus another measured weight also extends it the same amount; hence the weight of the solid in air and in the liquid may be determined and the density calculated.

There is, however, one point of superiority of Jolly's balance over the hydrometer: a spiral spring obeys Hooke's Law quite closely for small elongations—*i. e.*, the elongation is proportional to the change in the stretching force, and so, if no weight in the box of weights is small enough to make an exact adjustment of the spring, the fraction of the weight which would have done so may be calculated from a measurement of how far the smallest weight extends the spring.

Sources of Error.

The same as in the two preceding experiments.

Apparatus. A Jolly's balance; a box of weights, 10 to .01 grams; a small beaker; a thermometer; a small brush; a silver coin or other small solid.

Manipulation. Set up the apparatus where there is a good light on the scale, and level it so that the spring hangs parallel to the scale and the image of the bead is on the scale when the eye is held in such a position that the bead just covers its image. Fill the beaker nearly full of water which has been boiled, and put it on the platform. Place about six grams on the upper pan (the weight of the coin being less than six) and adjust the height of the top of the spring and the platform, so that the lower pan hangs well under water about the middle of the beaker, and so that the white bead does not come below the engraved scale. Take the temperature of the water. Placing the eye so that the bead just covers its image, note the position of the top of the latter on the scale to within a tenth of the smallest division. Note, similarly, the position of the top of the bead for two other weights different from the first—*e. g.*, 6.1 and 6.2 grams—but make no change great enough to necessitate readjusting the height of the top of

the spring. Remove the weights, holding with a finger the spring extended; place the coin in the upper pan and add weights enough to bring the bead exactly to the first of the positions previously observed. If, in the final adjustment to this end, the smallest change possible with the weights at hand carries the bead beyond the desired position, estimate the exact fraction which would carry it there, from the knowledge previously obtained as to the elongation produced by a small weight. The difference between the weight previously found and the one thus found necessary, in addition to the coin, to produce the same extension is evidently the weight of the coin. Similarly, find the weight of the coin, using as the standard position each of the other positions of the bead noted before the coin was introduced.

Remove the coin from the upper pan (keeping the spring extended) and place it in the pan under water, being careful not to catch a bubble of air under it. Add weights to the upper pan until the bead is brought once more into each of the three positions noted successively. In each case the difference between the weights needed in addition to the coin when the latter is in the upper pan and when it is in water is the loss of weight of the coin in water.

Take the temperature again at the close of the experiment. Be very careful throughout to keep air-bubbles from collecting on any part of the apparatus under water, and to keep the upper pan and its contents dry.

ILLUSTRATION

Jan. 13, 1897

DENSITY OF COIN SILVER BY JOLLY'S BALANCE, DETERMINED FROM A SILVER DIME.

Position of Bead	Weights, without Coin	Weights, with Coin in Air	Weights, with Coin in Water	Weight of Coin	Loss in Water
	Grams	Grams	Grams	Grams	Grams
423.1	6 000	8.824	4.084	2.176	0.210
425.3	6 100	8.924	4.129	2.176	0.205
427.4	6 200	4.020	4.227	2.180	0.207
Mean.	2.177	0.207

Greatest deviation from mean is about $8\frac{1}{2}\%$.

Initial temperature of water, 16.6° ; final, 17.4° ; mean, 17.0° .

Volume of 1 gram of water at 17° , 1.00106, which may be taken as 1, within the range of error of this experiment.

\therefore Volume of 0.207 grams of water = volume of coin = 0.207 cubic centimetres.

$$\therefore \text{Density of coin silver} = \frac{2.177}{0.207} = 10.5.$$

Questions and Problems.

1. What percentage of error in the density of a coin would be made if a bubble of air $1/10$ the size of the coin were caught under it in this experiment?
2. Why is the lower pan kept under water throughout?
3. What would be the effect of a considerable change in the temperature of the water during the experiment?

EXPERIMENT 34

Object. To determine the density of a floating body.
(See "Physics," Art. 94.)

General Theory. If a body is floating in any liquid, the weight of the liquid displaced equals, by Archimedes' principle, the weight of the body itself. So, if v is the volume of the liquid displaced, ρ the density of the liquid, and v' and ρ' the volume and density of the floating body,

$$v\rho g = v'\rho'g,$$

or

$$\rho' = \rho v/v'.$$

Consequently, if the floating body has a shape which admits of accurate measurement, and if the density of the liquid is known, that of the floating body can be at once determined.

In this experiment a rectangular block of wood will be floated in water.

Sources of Error.

1. The main source of error is the difficulty of measuring exactly how much of the block of wood is under water.
2. The weight of the block may be increased by the water soaking in.

Apparatus. A rectangular block of wood which has been soaked in paraffine; a large battery-jar; a metre-rod; a thermometer.

Manipulation. Measure the dimensions of the block of wood by means of the metre-rod. If its edges, which are parallel, all have the same length, by means of a sharp pencil mark millimetre lines along the edge which will be ver-

tical when the block is placed in water. Fill the battery-jar with tap water; read its temperature; set the block floating, and note the reading of the water on the marked edge of the block; remove the block and measure accurately the distance along the edge from the bottom corner to the point where the water stood. (Estimate to tenths of a millimetre.) The ratio of the volume of the water displaced to that of the block equals that of this height just measured to the length of the entire edge if the block is perfectly rectangular.

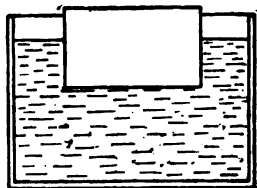

FIG. 75

Repeat, turning the block over after having carefully dried it. Place the block again in its first position and repeat the observations. Take the temperature of the water again.

ILLUSTRATION

Dec. 20, 1896

DENSITY BY FLOTATION

Block measured and found to be rectangular.

Length of Edge	Length of Edge in Water
5.24 cm.	3.18 cm.
5.23 "	3.16 "
5.23 "	3.20 "
5.25 "	3.17 "
Mean, 5.24 cm.	Mean, 3.18 cm.

Mean temperature of water, 18° C. ∴ density is 1 within the limits of accuracy of the experiment.

$$\therefore \text{density of wood, } \rho' = \frac{3.18}{5.24} = 0.607.$$

Questions and Problems.

1. A block of brass, 10 centimetres thick, floats on mercury. How much of its volume is above the surface, and how many centimetres of water must be poured above the mercury so as to reach the top of the block?
2. An iron spherical shell, 5 millimetres thick, floats half immersed in water at 4° C. Calculate the diameter of the shell.

EXPERIMENTS IN MECHANICS AND PROPERTIES OF MATTER 208

3. A block of wood weighing 1 kilogram, whose density is 0.7, is to be loaded with lead so as to float with 0.9 of its volume immersed. What weight of lead is required (1) if the lead is on top? (2) if the lead is below?
4. A floating body projects $\frac{1}{5}$ of its volume above water at 4°C. , what proportion would project at 80°C. ? What is the density of a liquid from which $\frac{1}{8}$ of its volume would project?

EXPERIMENT 35

Object. To measure the surface-tension of pure and impure liquid surfaces. (See "Physics," Art. 97.)

General Theory. By definition, the surface-tension T is the force which acts across one centimetre of a liquid surface. There are many methods by which it may be determined, but only two are in the least suitable for elementary laboratories, and these will be merely indicated here, not described in full.

1. *Method of Capillary Tubes.*—This method is suitable for *pure* liquids which wet the solid forming the tube—*e. g.*, water in glass. The method is to draw out a fresh capillary tube so that its inner surface is free from all dirt, and, after it has been well soaked in distilled water, to place it vertical, keeping one end under the surface of the water and measuring the height to which the column of water rises inside. It

is easily seen that, if

h is this vertical height,

ρ is the density of the liquid ;

r is the radius of the tube *at the top of the liquid column* ;

g is the acceleration due to gravity ;

$$h = \frac{2T}{\rho g r}, \text{ or } T = \frac{\rho g r h}{2}.$$

These quantities can be measured as follows :

r , by means of a micrometer eye-piece, the tube being carefully broken off at the proper point.

h , by means of a scale, or by a hook shaped as shown. This can be made of a metal wire or of a piece of glass. It is fastened to the



FIG. 76

capillary tube so that the lower point just comes up from below to the free surface of the liquid in the basin, and the distance between the upper point and the surface of the liquid in the capillary tube is measured by a cathetometer; the distance between the two points can be determined once for all by a cathetometer or dividing-engine.

ρ and g may be found in tables; and hence T may be calculated.

2. *Method of Ring and Balance.*—If a metal ring is suspended horizontally from one arm of a balance so that the plane of its lower side is exactly parallel to a surface of a liquid, the ring may be lowered into the liquid, then raised, and the additional force necessary to tear it away from the liquid measured by means of the balance.

If r is the radius of this ring, the force required is proportional to rT ; and so the surface-tension of many surfaces may be compared. This method is particularly suitable for the study of the effect of the presence of grease, dirt, etc., upon the surface-tension of water.

ILLUSTRATION
SURFACE-TENSION OF DISTILLED WATER Jan. 15, 1897

Tube No. 1		Tube No. 2	
h	$2r$	h	$2r$
80.47	0.0799	80.48	0.0788
80.47	0.0798	80.49	0.0799
80.48	0.0798	80.50	0.0800
80.48	80.51
Mean, 80.475	0.0798	Mean, 80.495	0.0796

Temperature, 16° , $\rho = 0.999$

$g = 980.$

By first tube, $T = 71.62$

By second tube, $T = 72.28$

Mean, 71.95

EXPERIMENT 36

Object. To measure the density of a gas.

General Theory. The most obvious method of measuring the density of a gas is to weigh a known volume of it on a balance — *i. e.*, to weigh a hollow sphere empty and then when filled with gas, and to measure the volume of the sphere. The difficulty is in securing and keeping a vacuum in the sphere. It is, however, the method which will be described in detail.

Other methods which are more suitable for chemical purposes, or which give comparative results, may be found in special treatises.

Sources of Error.

1. It is impossible to secure a perfect vacuum, and allowance should be made for this.
2. It is possible that the stopcocks may leak during the weighing.
3. It is difficult to measure the volume accurately.
4. The temperature of the enclosed gas is difficult to determine.

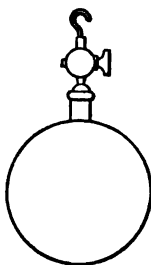

FIG. 77

Apparatus. A hollow brass sphere with stopcock and hook; an air-pump, such as a good aspirator water-pump; rubber tubing; thread; metre-rod; two L-squares.

Manipulation. By means of the metre-rod and L-squares measure the external dimensions of the sphere in as many directions as possible; weigh it, with the stopcock removed, on the platform-balance; and calculate the internal volume, assuming the density of brass to be $\rho = 8.4$. For, if r is the external radius, m the mass, and v the internal volume,

$$\left(\frac{4}{3}\pi r^3 - v\right)\rho = m.$$

(This measurement might, of course, be made more accurately by filling the sphere with water at a known temperature, and measuring its temperature and mass.)

Put the stopcock on the sphere, and by means of rubber tubing join it to the aspirator-pump. Soft rubber tubing should be used; and all joints should be tied tightly with linen thread and then coated with shellac. Exhaust the air by allowing the pump to run for about twenty minutes; close the stopcock; remove the sphere from the pump; weigh it by means of a high balance, from one of whose pans it can hang. Call the mass m_1 . Open the stopcock and allow the air to enter slowly into the sphere; when it has ceased to enter weigh again and call the weight m_2 . (These weighings must be done on each arm of the balance in turn, and with extreme accuracy.)

The water-pump used exhausts to within a pressure of a few centimetres of mercury; hence $m_2 - m_1$ is the weight of the air inside the sphere, because the buoyancy of the atmosphere produces no effect in this difference. Note the barometric pressure and temperature. The density of air, then, at this pressure and temperature is

$$D = \frac{m_2 - m_1}{v}$$

Repeat the measurements of m_2 and m_1 , and again note the temperature and pressure.

ILLUSTRATION
DENSITY OF AIR

Dec. 21, 1896

Pressure, 75.62 centimetres.	Temperature, 17.5° C.
External Diameter of Sphere	Weight without stopcock, 601.7 grams.
15.23 cm.	∴ $(\frac{4}{3}\pi 7.6^3 - v)8.4 = 601.7$.
15.18 "	∴ $v = 1781$ cubic centimetres.
15.16 "	Weight empty, with stopcock,
15.24 "	$m_1 = 620.106$ grams.
15.20 "	Weight full of air, with stopcock,
Mean, 15.200 cm.	$m_2 = 622.279$ grams.
	∴ $m_2 - m_1 = 2.178$ grams.
	∴ $D = \frac{m_2 - m_1}{v} = 0.00123$.

Questions and Problems.

1. Assuming that the aspirator-pump produces a vacuum such that the pressure is 2 centimetres of mercury, make the necessary correction in the calculation, assuming the approximate value of the density, 0.00122, to be accurate enough for the purpose. (See "Physics," Art. 108.)
2. Calculate the mass of 1 cubic metre of dry air and 1 cubic metre of air saturated with water vapor, the temperature being 20° C., and the pressure 76 centimetres of mercury. (See "Physics," Art. 107.)

EXPERIMENT 37

Object. To prove that Boyle's Law holds approximately for air. (See "Physics," Art. 108.)

General Theory. It has been found by experiment that if the temperature is kept constant, the pressure of a gas is directly proportional to its density. This is Boyle's Law. Expressed in an equation, it is

$p = k\rho$, if temperature is constant, or, substituting for ρ its value m/v ,

$pv = km$, if temperature is constant, where k is a constant for a definite gas at a definite temperature.

To verify this law it is necessary simply to measure the pressures and corresponding volumes of a given amount of a gas under such conditions that the mass and temperature do not change; and the products of p and v should have the same numerical value. A quantity of gas—*e. g.*, air—is enclosed in a glass tube, one end of which is sealed, by having some liquid like mercury (which vaporizes only slightly) fill and close the rest of the tube. The volume may be calculated from measurements of the length and cross-section of the tube; and so may the pressure, by determining the difference in level of the mercury surfaces in the closed tube and the one open to the pressure of the atmosphere.

Thus, if the tube is as shown in the figure, the air being confined in the closed branch, the pressure on it is the atmospheric pressure + ρgh , where h is the

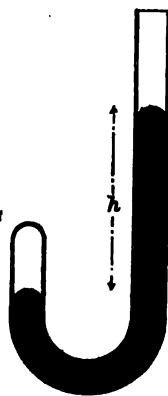

FIG. 78

difference in vertical height between the two surfaces of the liquid, and ρ is the density of the liquid, the + sign being taken if the open column is higher than the other, the - sign if it is lower. This apparatus is designed to study pressures greater than one atmosphere.

Sources of Error.

1. It is sometimes difficult to prevent bubbles of air from entering or leaving during the experiment.
2. When a gas is compressed its temperature rises greatly; and conversely.
3. If the glass tube is not perfectly clean the mercury sticks to it, and the tube must be tapped before reading until the surface becomes convex.

Apparatus. A barometer tube bent into the form of a U, the closed branch being considerably the shorter, and the space between the branches just wide enough to hold a metre-bar. The whole is mounted on a stand so that the bar and both branches of the U are parallel and vertical. The student also needs a steel L-square and level, a thermometer, a funnel, a mercury-tray, and enough mercury to fill a length of about a metre of the U-tube—*i. e.*, 600 or 700 grams for a tube of 8 millimetres' diameter.

Manipulation. Set up the apparatus in the mercury-tray, being careful to see that the tube, funnel, and mercury are clean. If the latter has a little dirt on it, it may often be improved by making a cone-shaped bag of a piece of glazed paper, pricking a few pinholes in the bottom, and filtering the mercury through these, not allowing the last few drops to escape. Set the metre-bar vertical, as described in Experiment 30. Pour enough mercury into the open branch of the U to close the bend and rise seven or eight centimetres in the open branch. There is now imprisoned in the closed branch the mass of air to be experimented on; and great care must be taken not to change the quantity by allowing any to escape or a bubble more

to enter. Note the temperature of the air by lowering the thermometer into the mercury, which is a good conductor of heat, and also by hanging it alongside the closed branch containing air. Read and note the barometer, taking care to see that the mercury in the basin just reaches the index. (See Experiment 26.) Do not "correct" the reading. Determine the level of the top of the interior of the closed tube with the straight-edge of a slip of paper, as described in Experiment 30. Measure to a point below the apex of that surface about $\frac{1}{3}$ of the height of the curved surface which closes the top. Similarly, by means of the strip of paper, determine the level of the top of each of the two mercury columns. Make all readings to the tenth of a millimetre. Note the precaution to tap the tubes, so as to shake the top of the mercury columns a little before reading. The pressure on the air is obviously the barometric pressure + that due to a column of mercury whose height equals the vertical height between the surfaces of the two columns.

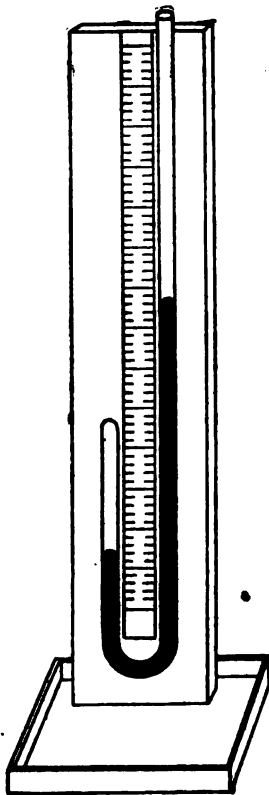

FIG. 79

Change the volume and pressure of the enclosed air by pouring in very carefully and slowly enough mercury to raise the level in the open tube about ten centimetres. Be careful not to let any air in or out of the closed end in doing so. Note the level of the mercury columns as before. (The level of the top of the closed space should not change unless the tube slips in its clamps.)

Repeat, similarly, five or six times more, adding about ten centimetres each time to the height of the mercury in the open tube. Finally, read the barometer and take the temperature of the enclosed air again.

Measure the total length of tube filled with mercury in the last experiment. Pour all the mercury into a separate clean vessel previously weighed and weigh it.

Plot the measurements in a curve, the volumes being abscissæ, the pressures ordinates.

ILLUSTRATION

Jan. 20, 1897

TO PROVE THAT BOYLE'S LAW IS APPROXIMATELY TRUE FOR AIR—

 $pv = km$ AT CONSTANT TEMPERATURE

Barometer at beginning, 77.025 cm. }
 " " end, 77.015 " } "uncorrected."
 Mean, 77.02 cm. }

Temperature of air, 16.5° at beginning; 17.4° at end.

Temperature is, therefore, constant approximately.

In the following table A is the cross-section of the tube, assumed to be uniform, ρ the density of mercury at 17°, and g gravity.

p , the pressure, is the barometric pressure + that due to the column of mercury in the tube.

Top of Closed Tube	Top of Mercury in Closed Tube	V	Top of Mercury in Open Tube	p	pv
15.29	8.26	$12.08 \times A$	8.83	$82.09 \rho g$	$987.5 \times \rho g A$
....	4.09	$11.20 \times A$	15.27	$88.20 \rho g$	$987.9 \times \rho g A$
....	5.08	$10.26 \times A$	24.19	$96.18 \rho g$	$986.8 \times \rho g A$
....	5.94	$9.85 \times A$	34.51	$105.59 \rho g$	$987.3 \times \rho g A$
....	6.98	$8.81 \times A$	48.85	$118.89 \rho g$	$988.0 \times \rho g A$
....	8.00	$7.29 \times A$	66.46	$135.48 \rho g$	$987.6 \times \rho g A$
....	9.12	$6.17 \times A$	92.24	$160.14 \rho g$	$988.1 \times \rho g A$
Mean,	$987.6 \times \rho g A$

Since ρg and A are constant, the greatest departure from the mean is .8 or .09%. The law is, therefore, shown to hold for air to that degree of accuracy for pressures of from 1.08 to 2.1 atmospheres.

NOTE.—For studying the behavior of air at pressures less than that of the atmosphere it may be confined in a tube, as shown in figure 80. To accomplish this, hold the tube closed end down; fill it nearly full of mercury; put a finger over the open end; carefully invert and place the open end in a deep basin of

mercury. The imprisoned air bubbles up to the top of the tube, and its volume and pressure may be changed at will by raising the tube. They may

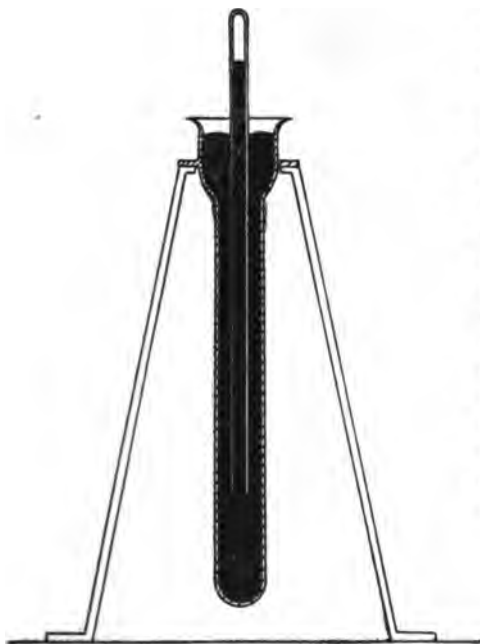

FIG. 80

be easily measured, the only instrument needed being a metre-rod. Another form of instrument which may be used to study the properties of the air, at pressures both greater and less than that of the atmosphere, is shown in figure 81. It consists of two glass tubes, about 20 centimetres long, connected by a flexible rubber tube; the end of one is sealed, and mercury is poured into the open end of

the other so as to imprison some air in the closed tube. The two glass tubes are held in clamps which can be moved along a vertical scale.

In this way the surface of the mercury in the open tube may be brought either above or below that in the closed tube. The pressure and volume may be thus varied at will, and, as they can be measured, Boyle's Law can be verified.

Questions and Problems.

1. Reduce the pressure in your last experiment to dynes per square centimetre.
2. From the length of tube filled

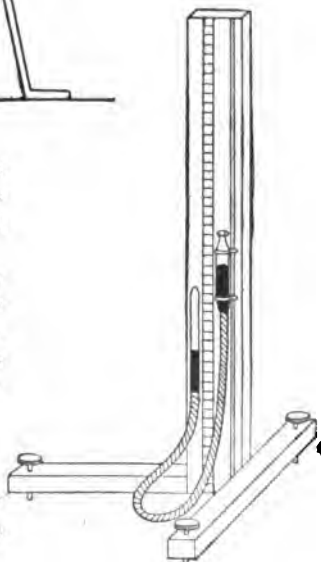
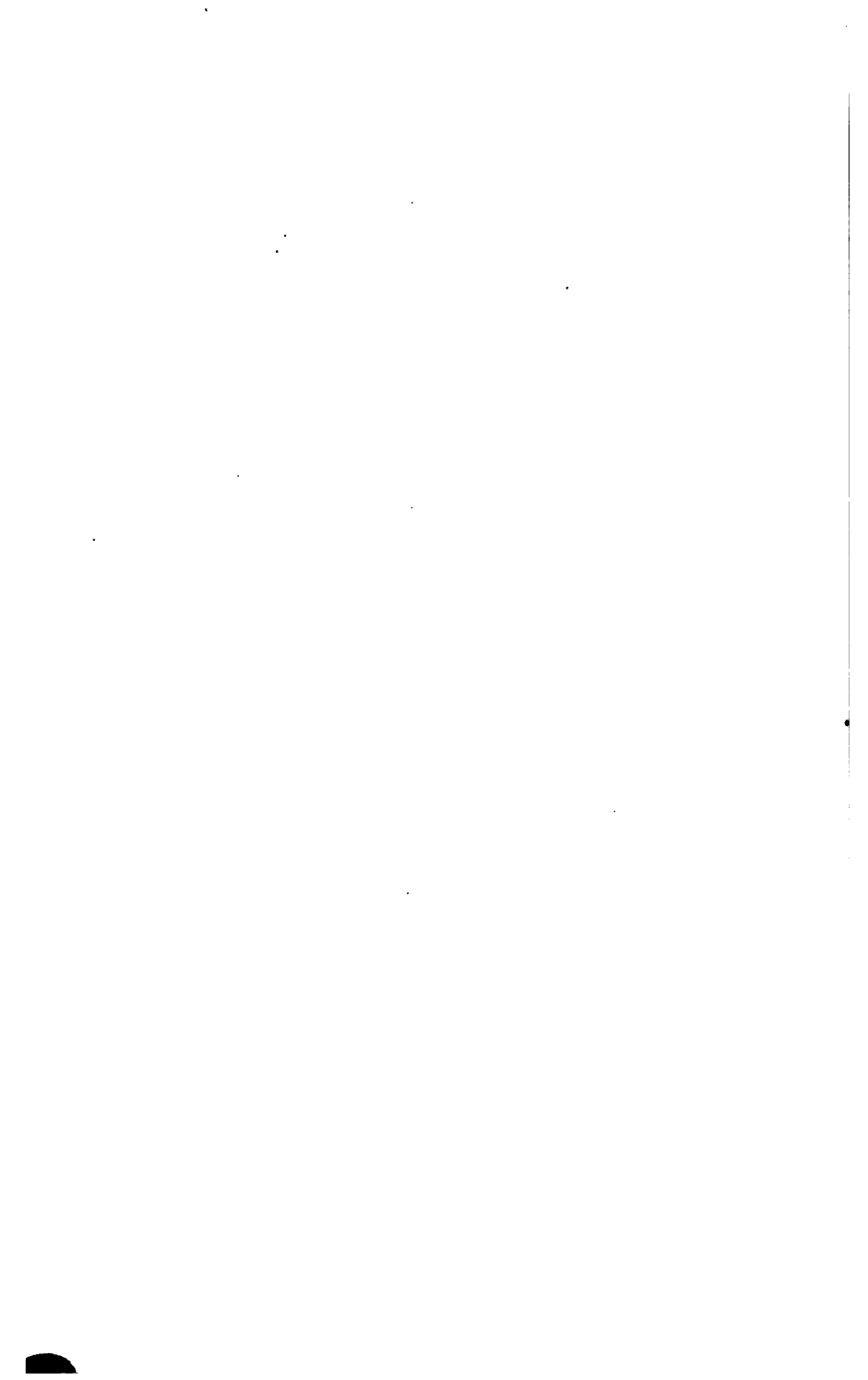

FIG. 81

with mercury ($\rho = 13.54$ at 20°) and the weight of the mercury, calculate A and reduce the volume of air to cubic centimetres.

3. From a knowledge of the density of air at a definite temperature and pressure (see tables) calculate k for air at the temperature of your experiment.
4. Which is the essential condition for accurate measurements in this experiment, that the bar be vertical or parallel to the branches of the U-tube?
5. A barometer has a cross-section 2 square centimetres, and is so long that, as the mercury stands at 76 centimetres, there is a vacuum space 10 centimetres long. Some air is allowed to enter, and the mercury falls 10 centimetres. What was the volume of the air before it entered?
6. In a vessel whose volume is 1 cubic metre there are placed the following amounts of gas: (1) Hydrogen, which occupies 1 cubic metre at atmospheric pressure; (2) nitrogen, which occupies 3 cubic metres at pressure of 2 atmospheres; (3) oxygen, which occupies 2 cubic metres at pressure of 3 atmospheres. Calculate the pressure of the mixture.
7. A glass tube, 60 centimetres long, closed at one end, is sunk open end down to the bottom of the ocean. When drawn up it is found that the water has penetrated to within 5 centimetres of the top. Calculate the depth of ocean, assuming the density to be constant. (Principle of Lord Kelvin's sounding apparatus.)
8. A barometer contains traces of air, and when the mercury is 70 centimetres high the "vacuum space" is 20 centimetres long; on lowering the tube into its tank so that the column of mercury is 67 centimetres high, the "vacuum space" is 12.5 centimetres. What is the true barometric pressure?

EXPERIMENTS IN SOUND



INTRODUCTION TO SOUND

Units. Sound, being a sensation, cannot be expressed as a certain number of units, but the vibrations and waves which produce sound are purely mechanical processes, and so they must be measured in mechanical units. (The frequencies of several musical scales may be found in the tables at the end of this Manual.)

Object of Experiments. The experiments of this section may be divided into two groups—viz., the study of vibrations and the measurement of the velocity of sound-waves in certain bodies. There are no essential difficulties in the experiments, as they involve measurements of length, mass, and time only. In Experiments 39 and 42 a moderate ability to distinguish differences of pitch is necessary; and it is desirable for a student who is wholly devoid of this sense of pitch to perform these with one who is more musically constituted.

EXPERIMENT 38

(TWO OBSERVERS ARE REQUIRED)

Object. A study of "stationary" vibrations. (See "Physics," Art. 138.)

1. Transverse Vibrations of a Cord

General Theory. A cord is held fixed at its two ends under a definite tension. Transverse vibrations are impressed at one end and travel to the other, where they are reflected; and two trains of exactly similar waves travelling in opposite directions are thus produced.

When the length of the waves is such that the distance between the fixed points is an integral number of half wave-lengths, "stationary vibrations" are produced, in which the "nodes," or still points, are those where the two trains are at each instant tending to move the cord in opposite directions. The nodes break up the cord into an integral number of vibrating segments, each of which is $1/2$ a wave-length long. The connection between the number of vibrations per second and the number of such segments in the length of the cord can then be studied. Thus, if v is the velocity of transverse waves in the cord, λ the wave-length of the particular set of waves, n the frequency of the vibration, L the length of the cord, N the number of vibrating segments,

$$\lambda = 2L/N,$$

$$v = n\lambda = 2nL/N.$$

For a definite value of N , n must have a certain value which can be measured, and so v can be calculated. As long as the tension remains constant, the velocity v should also.

If the tension in the cord is changed, the velocity of transverse waves changes; and theory shows that the velocity should vary directly as the square root of the tension. (See "Physics," Art. 142.)

These transverse vibrations may be produced by fastening the cord to one prong of a tuning-fork, in which case n , the frequency, remains constant, and the tension must be varied so as to produce different values of N ; or by setting the stretched cord in vibration by means of one's hands, in which case the tension remains constant and the frequency is varied at will. The latter method is the one to be more fully described below.

Sources of Error.

1. The tension may not remain constant.
2. The vibrations may not be harmonic.
3. The length may change.

Apparatus. A long spiral spring; a canvas bag; several weights—*e. g.*, 1 kilogram, 2 kilograms; a clamp-stand; a stop-watch; a metre-bar; a plumb-line.

Manipulation. The closely wound spiral spring of wire, six or seven metres long, is fastened at the top so as to hang clear of obstruction in a room with a very high ceiling, or in a stairway. The bag in which different weights may be placed is hung on the end. Place about one kilogram in the bag, and, while the spring is hanging free, insert it at a point near the bottom in a clamp, which will maintain the tension and the length constant. Catch hold of the spring, the thumb and forefinger being just above the clamp, the rest of the hand helping to hold the clamp still. With a sidewise movement of the finger only, send transverse waves up the spring at regular intervals. These waves are reflected at the upper end, and, if the motion of the hand is so timed that an integral number of vibrations is made in the time it takes the wave to travel to the top and back, stationary vibrations are set up.

First, time the motion so that the whole spring moves

back and forth together—*i. e.*, there is no node between the fixed points at each end. Keep the hand moving at exactly the same rate, and time a number of vibrations great

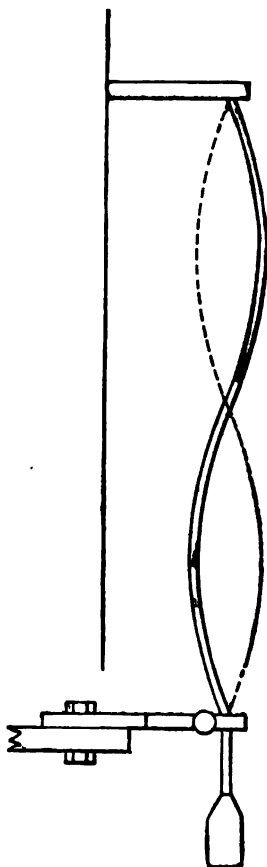

FIG. 82

enough to take an interval of over a minute. Let one student measure the time exactly with a stop-watch, while the other student moves the spring and counts aloud the motion of his finger as indicated by the sense of feeling. If the motion is very rapid he should count 1, 2, 3, 4; 1, 2, 3, 4, etc., each set of four being marked by the other observer. Whence, find N_1 the number of vibrations per second with the spring moving in one segment. Repeat the measurement of N_1 three times more.

Now move the hand faster, so that stationary waves are formed with a node half-way between the fixed points. Determine N_2 in the same manner as N_1 . Similarly, find the frequencies of vibrations which have three and four vibrating segments.

Loosen the clamp, put all the weights in the bag, clamp again, and repeat the experiment.

Measure L with a plumb-line and metre-bar.

The tension of the spring is (in the average for its whole length) equal to the weight on the end plus $1/3$ the weight of the spring. Weigh the weights used and the spring.

From the two experiments show that if T is the tension in the first set of observations, and T' that in the second, the two relations hold :

1. If P is constant, v is the same for all wave-lengths.
2. $\frac{v'}{v} = \sqrt{\frac{T'}{T}}$; i. e., the velocity varies as the square root of the tension.

ILLUSTRATION

Feb. 2, 1897

STATIONARY VIBRATIONS

Length of spring between fixed points = 708 centimetres.

I. Mass of spring, 1215 grams.

No. of Segments N	No. of Vibrations Timed	Interval	$\therefore \kappa$	$\lambda = \frac{2 \times 708}{N}$	$v = \kappa \lambda$
1	40	57.4	0.688	1416	974.2
		58.2			
		58.0			
		59.0			
		Mean, 58.15			
2	100	74.4	1.858	708	961.4
		78.8			
		78.0			
		78.4			
		Mean, 78.65			
3	150	73.4	2.046	472	965.8
		78.2			
		78.0			
		78.6			
		Mean, 78.8			
4	200	72.8	2.716	354	961.5
		74.0			
		74.2			
		78.6			
		Mean, 78.65			

The greatest deviation from the mean is less than 1%.

The weight hung on the end of the spring was 994 grams.

$$\therefore \text{Tension} = \left(994 + \frac{1215}{8}\right)g = 1899g = T.$$

II. The weight hung on the end of the spring was now increased to 1990 grams. \therefore Tension = $\left(1990 + \frac{1215}{8}\right)g = 2395g = T''$.

N	No. of Vibrations Timed	Interval	$\therefore n$	$\lambda = \frac{2 \times 704}{\lambda}$	$v = n\lambda$
1	50	52.0	0.947	1416	1841
		58.0			
		58.2			
		58.0			
		Mean, 58.8			
2	100	58.4	1.888	708	1838
		58.2			
		58.0			
		52.8			
		Mean, 58.1			
3	150	54.0	2.788	472	1814
		58.8			
		58.6			
		54.2			
		Mean, 58.9			
4	300	54.4	8.690	354	1806
		58.8			
		54.0			
		54.6			
		Mean, 54.2			
				Mean,	1823

The greatest deviation from the mean is about 1%.

Further, $\frac{v}{v'} = \frac{1838}{965.7}$ should equal $\sqrt{\frac{2395}{1899}} = \sqrt{\frac{T''}{T}}$; i. e., 1.87 should equal 1.81, showing a departure from an accurate verification of the law of about 4.4%. This is probably due to the fact that the law applies rigidly only to perfectly flexible uniform cords which are vibrating through very small amplitudes.

2. Surface Vibrations in a Tank of Water

General Theory. Vibrations are produced in a tank of water by means of a paddle (or otherwise), and the connection between the length of the vibrating segment and

the frequency of the vibration is studied. As in Case 1, if v is the velocity of surface waves, λ the wave-length of the waves which set up the vibration, n the frequency of the vibration, L the length of the tank, N the number of nodes (for in this case each end is a loop),

$$\lambda = 2L/N,$$

$$v = n\lambda = 2nL/N.$$

n , L , N can be measured, and hence v can be calculated for a train of waves of a definite wave-length ($\lambda = 2L/N$) in water of a definite depth. The velocity for waves of different length may be found by varying N .

Similarly, by changing the depth of the water in the tank the velocity under these new conditions may be measured.

Sources of Error.

1. The vibrations may not be exactly stationary.
2. Care is necessary in counting the number of nodes when the waves are short.

Apparatus. A tank with glass sides; a paddle with a square blade a little smaller than the inside cross-section

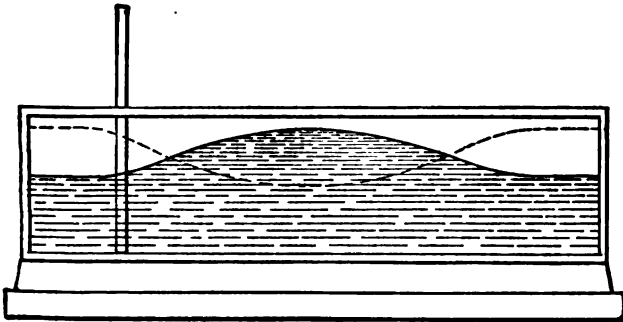

FIG. 83

of the tank; a stop-watch. (The tank at Johns Hopkins University is 140.6 centimetres inside length, by about 35 centimetres depth and 10 centimetres width.)

Manipulation. Fill the tank with water to a depth of 12 centimetres. Set up stationary vibrations of various lengths, as described below. In each case find n , the fre-

quency, by means of the stop-watch, counting the number of vibrations for as long a period as the waves last in perfect form. Do this four times. Note the number of nodes N .

1. Create vibrations in which there is one node by raising one end of the tank and setting it down very gently. By properly timing the lowering, perfectly stationary vibrations can be obtained. (It will probably be necessary to try several times before a perfect wave is obtained.) The vibrations are stationary when there is a node at a perfectly fixed point at the middle of the tank, which does not move to and fro or up and down at all, while the water rises at one end of the tank exactly at the same time it falls at the other end.

2. Set up with the paddle stationary vibrations of a much shorter wave-length—*i. e.*, such that there are three or more nodes in the length of the tank. The best way to do this is to hold the paddle by the top of the blade, one hand on each side of the handle, the thumb pressing against the side towards the body, and two or three fingers against the other side, all pointing down the blade. Now stand facing the end of the tank, lower the paddle almost to the bottom with the blade nearly upright, and rest the hands one on each side of the tank. Move the paddle to and fro in the direction of the length of the tank with a motion of the fingers only. Hold the paddle so loosely that it is carried to and fro with the water by each wave, and time the pressure of the fingers so as to assist this motion slightly each time. It is therefore necessary to begin at once with a motion of about the right frequency, which can then be gradually adjusted to the exact frequency necessary to give absolutely stationary vibrations. The test is as before, that there is no motion of nodes or loops lengthwise of the tank. If a crest travels back and forth, or is irregular in its position, the vibrations are not quite stationary.

n can best be found by counting the motions of the *hands*, not the water; the student plying the paddle determines this number by his sense of feeling; and, if the

motion is very rapid, counts only 1, 2, 3, 4; 1, 2, 3, 4, etc., and another observer makes a mark for each set of four.

Repeat the experiment with a depth of about twenty-four centimetres in the tank, using waves of the same length as before.

Calculate the velocity of the waves of each length in the shallow and in the deeper water, and show whether the velocity is the same for waves of different length and water of different depth, and, if not, what effect these conditions have. Record the experiment as in the illustration for Part 1, noting that different depths take the place of different tensions.

Questions and Problems.

1. In what respects do water-waves differ from sound-waves?
2. What part of a sound-wave corresponds to a crest?
3. Can you find any explanation in your experiment for the fact that waves approaching a shore always turn so as to present a front approximately parallel at all points to the shore line? Illustrate with a diagram.



EXPERIMENT 39

(This experiment requires in the student a slight ability to distinguish pitch.)

Object. To verify the formula that the frequency of a stretched string or cord when vibrating transversely is

$$n = \frac{1}{2l} \sqrt{\frac{T}{\sigma\rho}},$$

where l is the length, T the tension, σ the cross-section, and ρ the density. (See "Physics," Art. 142.)

General Theory. 1. To prove that a cord under constant tension has a frequency inversely proportional to its length. It is possible to keep a cord under constant tension by means of a weight, and to vary the length of the vibrating portion by means of bridges or frets; thus the string can be brought into unison with various standard tuning-forks, and the relation between the frequency and length determined.

2. To prove that if the length of the cord be kept constant but the tension varied, the frequency varies directly as the square root of the tension. Two methods may be used: either to bring the pitch into unison with standard forks by varying the tension, or putting the cord under a definite tension to vary the length of a second cord, whose tension is kept constant until their pitches are in unison; then to use a different tension for the first cord and to determine the new length of the second cord which will bring the two into unison again.

In this second method the frequencies vary inversely as the length of the second cord, and so their ratio is known.

3. Since the frequency is known in (1) for a definite length and tension, the density may be calculated from the formula and compared with the known value for the cord.

It should be noted that this experiment is simply a repetition of the preceding experiment, Part 1, for vibrations too rapid to be counted directly.

Sources of Error.

1. The tension may change the density.
2. The tension may not equal the stretching weight exactly.
3. It is necessary to hold the wires closely against the frets, otherwise the lengths are unknown.

Apparatus. Two monochords (or sonometers) with wires about .03 centimetre radius; four weights (3500 grams, two of 5500 grams, 7000 grams are convenient); a metre-rod; a micrometer caliper; a box of tuning-forks, frequencies about 256–512.

Manipulation. The sonometer consists of a long wooden resonator-box, over which is stretched a wire whose length may be altered by means of two bridges that slide on a

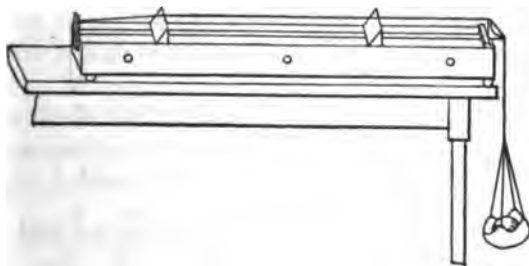

FIG. 84

guide running lengthwise of the box. The wire is attached to a brass peg at one end of the box, passes over the bridges, and over a bent lever at the opposite end, hinged so as to move freely in a vertical plane. To the end of the wire beyond the lever is attached the stretching weight.

Part 1. Set up one sonometer as shown in the illustration. Hang the heaviest weight on the wire, and keep the tension thus produced the same throughout this part of the experiment. Strike the fork of lowest pitch (*ut*, 256 vibrations) on the knee, rest it on the resonator-box, and change the bridges until the wire when plucked gives exactly the same note as the fork. Pluck the wire half-way between the bridges, and deaden the vibrations against the fret by pressing down with a finger on the wire just back of the fret farthest from the weight. When the string is nearly in tune, count the beats between its note and that of the fork, and change the bridges until they are no longer heard. When the note is exactly that of the fork, measure the length of the vibrating part of the wire between the two bridges and note it. Repeat, having first removed one bridge entirely and replaced it at an entirely different position.

Repeat the experiment similarly with the octave of the first fork, and also with one of the intermediate forks.

The arms of the lever are intended to be of equal length. To guard against a possible error from this source (which would make the tension on the part of the wire on the sonometer different from that of the part from which the weight hangs) take the lever off, reverse it, and repeat the experiment.

Show that the frequency of the vibrations of the string is inversely proportional to its length—*i. e.*, if n_1, n_2, n_3 are the frequencies of the three forks used, and l_1, l_2, l_3 are the lengths of wire in unison with them, $\frac{n_1}{n_2} = \frac{l_2}{l_1}$ and $\frac{n_1}{n_3} = \frac{l_3}{l_1}$, or, more simply, $n_1 l_1 = n_2 l_2 = n_3 l_3$.

Part 2. The heaviest weight is still hanging from the first sonometer. Place the bridges on it as far apart as possible, and keep the distance between them precisely the same throughout this part of the experiment. Set up the second sonometer with a stretching weight of about 5500 grams. Vary the distance between the bridges on

this until the two wires are exactly in unison, testing by beats, as in Part 1. When exactly in unison measure the length of wire between the bridges of the second sonometer and note it. Change the position of the bridges on the second sonometer and repeat. Repeat, similarly, with the two lower weights on the first sonometer. Reverse the lever on the first sonometer and repeat again.

Since the frequency of a wire, as proved in Part 1, varies inversely as its length, the frequency of the first sonometer is in each case inversely proportional to the length of wire on the second sonometer when in unison with it—*i. e.*, $n_1 l_1 = n_2 l_2 = n_3 l_3$, where n is the frequency common to both sonometers and l is the length of the wire in the second.

Hence, show that, if T_1, T_2, T_3 are the tensions of the first wire,

$$\frac{n_1}{n_2} = \sqrt{\frac{T_1}{T_2}}; \quad \frac{n_1}{n_3} = \sqrt{\frac{T_1}{T_3}};$$

i. e.,

$$\frac{n_1^2}{T_1} = \frac{n_2^2}{T_2} = \frac{n_3^2}{T_3},$$

or

$$l_1^2 T_1 = l_2^2 T_2 = l_3^2 T_3.$$

Part 3. Measure ten diameters of the wire on the first sonometer with the micrometer caliper, and calculate from the measurements of Part 1 the density of the wire. Compare this value with the one given in the tables.

NOTE.—The frequency of a standard fork may be obtained by comparing it directly with a standard clock, making use of the method of coincidences. (See Experiment 28.) By suitable means the clock may be made to illuminate once a second a small round opening directly behind a prong of the vibrating fork; so that, as time goes on, more and more of the opening appears uncovered, covered again, etc., periodically, exactly like the gaining of the torsion-pendulum on the clock. The same formula may be applied, and thus the period of the fork deduced.

ILLUSTRATION

Feb. 15, 1897

TRANSVERSE VIBRATIONS OF A STRETCHED WIRE

Part 1.

To prove $n_1 l_1 = n_2 l_2 = n_3 l_3$.

Fork	Frequency n	Length of Wire	nl
Ut_3	256	59.8	15330
		59.8	
		(Lever reversed)	
		60.0	
		60.0	
		Mean, 59.9	
Mt_2	320	46.65	15050
		46.75	
		(Lever reversed)	
		47.40	
		47.85	
		Mean, 47.04	
Ut_1	512	80.1	15460
		80.2	
		(Lever reversed)	
		80.2	
		80.4	
		Mean, 80.2	
			Mean, 15360

Greatest deviation from mean is less than 2%.

Part 2.

To prove $\frac{n_1^2}{T_1} = \frac{n_2^2}{T_2} = \frac{n_3^2}{T_3}$, or $l_1^2 T_1 = l_2^2 T_2 = l_3^2 T_3$.

Tension in Dynes on Wire No. 1 T	Length of Wire No. 2 l	$l^2 T$
$3500 \times g$	78.8	$2202 \times 10^4 \times g$
	79.0	
	(Lever reversed)	
	79.2	
	79.9	
	Mean, 79.8	
$5580 \times g$	68.8	$2226 \times 10^4 \times g$
	68.6	
	(Lever reversed)	
	68.2	
	68.2	
	Mean, 68.45	
$7000 \times g$	56.9	$2275 \times 10^4 \times g$
	56.7	
	(Lever reversed)	
	57.1	
	57.2	
	Mean, 57.0	
		Mean, 2284 $\times 10^4 \times g$

Greatest deviation from mean is 2%.

Part 3.

Diameter of wire, .824, .826, .829, .829, .828, .829, .832, .831, .830, .829 millimetre. Mean = .8329 centimetre.

$n = 512$, $l = 80.2$, $T = 7000$ g., cross-section = $\pi \times (.0165)^2$, density $\rho = 8.89$.

NOTE.—A student with a good ear for pitch will find it a useful exercise to study the interval between the notes of the musical scale as follows:

Find, by one trial only, the length of wire in unison with each of the forks, giving the principal notes of the scale—i. e., not sharps or flats—including the octave of the lowest note.

Calculate and express decimally the ratio between the lengths of wire giving successive notes. Which intervals are semitones?

Select from the box the three notes Ut_2 , Mi_2 , and Sol_2 . Sound them together and note the harmony. Calculate the ratio of the length of wire giving Mi and Sol to that giving Ut . Sound, similarly, Ut_1 , Re_1 , Mi_1 . What is the effect? Calculate the ratio to Ut again.

What is the combination Ut_2 , Mi_2 , Sol_2 (C_1 , E_1 , G_1)?

What other similar combinations are there in the diatonic scale?

What would be the length of wire giving Sol_2 on the chromatic scale? (See "Physics," Art. 162.)

Questions and Problems.

1. If the two arms of the lever are as 9:10, what would be the percentage difference between the true tension of the wire and the tension calculated from the suspended weights if the longer arm is horizontal?
2. Would an error from this source affect the accuracy of Part 1 or of Part 2?
3. What effect has a rise of temperature upon the pitch, intensity, quality of (1) a piano-string? (2) An organ-pipe?
4. Describe the effect of a sounding-board upon a piano-string. Is there any effect upon the duration of the vibration?
5. The third harmonics of two notes have the ratio 16:20. What is the ratio of their fundamentals?

EXPERIMENT 40

(TWO OBSERVERS ARE REQUIRED)

Object. To determine the velocity of sound in air by means of stationary waves in a resonance tube. (See "Physics," Art. 147.)

General Theory. When an organ-pipe, closed at one end and open at the other, is sounding, if V is the velocity of sound-waves in the gas, n the frequency of the vibration, L the length of the pipe (corrected for the open end), the possible values of n are given by

$$V = n_1 4L,$$

$$V = n_2 \frac{4}{3}L,$$

$$V = n_3 \frac{4}{5}L.$$

Consequently, if a fork whose frequency is n is vibrating, a number of different tubes will resound to it. n will be the fundamental frequency of the shortest of these tubes, the second partial for the next longer, the fourth partial for the third in length, etc. Hence, if l_1, l_2, l_3 , etc., are the lengths of these tubes, $v = n \cdot 4l_1 = n \cdot \frac{4l_2}{3} = n \cdot \frac{4l_3}{5}$.

$$\therefore l_1 = \frac{l_2}{3} = \frac{l_3}{5}, \text{ or } l_2 = 3l_1, l_3 = 5l_1, \text{ etc.},$$

and

$$l_2 - l_1 = 2l_1 = \frac{v}{2n} = \frac{\lambda}{2},$$

$$l_3 - l_1 = 4l_1 = \frac{v}{n} = \lambda, \text{ etc.}$$

—i. e., the difference in length between two successive

lengths of tube which resound to the same note is one-half the wave-length of the wave in the tube.

To verify this fact the following method is devised: A sounding tuning-fork is held at the mouth of a tube whose length can be varied; the greatest length of tube for which resonance occurs is noted, and the tube is slowly shortened until each successive length for which there is resonance is ascertained. A number of determinations of the half wave-length are thus obtained.

The pitch of the fork being known, the velocity in air is determined from the relation $v = n\lambda$. By repeating the experiment with other forks the effect of the frequency on the velocity (if any) can be noted.

(In an open organ-pipe the position of the loop at the open end is not exactly at the end, but beyond it, at a distance approximately equal to the radius of the pipe.)

Sources of Error.

1. The loudness of the fork gradually diminishes, and care is necessary to distinguish this from a decrease in loudness due to the resonance of the tube becoming less.

Apparatus. A long glass resonance-tube, with a small side tube attached near one end. Rubber tubes are joined to this branch tube. (The tube at the Johns Hopkins University is 144 centimetres long, and the listening-tube is connected about 10 centimetres from the top. The internal diameter is 28 millimetres.) The bottom of the tube is tapered so as to join with a length of rubber-tubing connecting with the water-tap, near which the experiment must be done. Rubber tubing of sufficient length for this purpose is needed; also a thread with a small plumb-bob; a metre-bar; and a set of forks containing at least two of 250 vibrations and over. (In another form of apparatus the resonance-tube is lowered vertically into a deep basin of water, thus changing the length of the column of air.)

Caution. Be careful not to wet the tuning-forks.

Manipulation. Stand the tube near the sink and connect with the tap by means of the rubber tube. Adjust the resonance-tube by the plumb-line so that it is approximately vertical. Turn the water on in order to drive out the air in the rubber tube and fill about a centimetre at the bottom of the glass tube. Place in the ears the listening-tubes which are joined to the small side tube. Strike the *ut*₃ tuning-fork (or the lowest of the two selected for the experiment) against the knee, and, holding it at the mouth of the tube with the plane in which the two prongs lie vertical, turn the water on so that it rises quite rapidly in the tube. The sound in the ear will be found to vary in intensity as the water rises, and one hand must be kept on the stopcock and the water turned off the instant the sound is at its loudest. The approximate height of the water for resonance having thus been found and marked by a little strip of wet paper placed on the tube, disconnect the tube from the tap and allow the water to flow out slowly into the sink. The vibrating fork must be held over the tube while the water is flowing out. Do not, however, allow the water to flow out too slowly, for the change in intensity of the sound may become so gradual that the maximum is not readily noted by the ear. Stop the flow again the moment the sound begins to diminish, and lay the strip of paper again with one edge at the level of the top of the

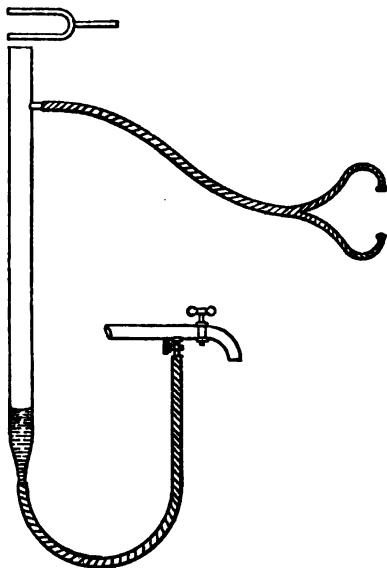

FIG. 85

of the

water column. Raise and lower the level of the water similarly until you are convinced that you have laid the strip exactly at the level which corresponds to maximum resonance in the tube. Measure the distance from this strip to the upper edge of the tube or to any fixed level in the tube.

Repeat the observation twice, removing all marks between the trials so as to secure perfectly independent determinations. Take the mean as the correct distance for maximum resonance of the top of the *water* column below the top of the tube (or the fixed level).

Starting with the water level at this point, turn on the water and let it again rise rapidly in the tube. The sound of the fork will become at first weaker, reach a minimum, and then again increase to a maximum. Turn the water off, as before, the moment this maximum is passed; mark it and proceed to determine the distance from the edge of the tube or the fixed level, as in the previous case, making three independent determinations. Take the temperature of the air in the tube. If the tube is long enough, find, similarly, a third point of resonance. The distance between successive maxima is $\frac{\lambda}{2}$.

Repeat with *ut*₄ the octave of the fork already tried, or some other fork of a pitch considerably higher than the first.

Calculate the velocity of sound in air of the temperature of that in the tube, as explained above. $v = n\lambda = n'\lambda'$, $\frac{\lambda}{2}$, and $\frac{\lambda'}{2}$ are given by the above experiments; and either the frequency of the fork is marked upon it or else its name; and in the latter case the frequency may be found in the tables.

Reduce the value of the velocity in air thus obtained to its value at 0° by noting that the velocity diminishes approximately 60 centimetres per second per degree centigrade as the temperature falls. (More accurately,

$$v_0 = v \sqrt{\frac{273}{273 + t^\circ}}$$

ILLUSTRATION

Feb. 1, 1897

VELOCITY OF SOUND IN AIR

Fork Ut_3 , 256 vibrations per second. 20° C.

No. of Node from Bottom	Distance Below Upper Edge of Tape	Mean Distance	$\frac{\lambda}{2}$
1st.	97.2, 98.8, 97.5 cm.	97.7 cm.	66.7 cm.
2d.	81.1, 80.4, 81.6 "	81.0 "

Variation is about 1%.

Fork Ut_6 , 512 vibrations per second. 20° C.

Node	Distance Below Tape	Mean	$\frac{\lambda}{2}$
1st.	114.2, 118.5, 114.9 cm.	114.2 cm.	88.2 cm.
2d.	80.6, 81.2, 81.8 "	81.0 "	88.5 "
3d.	46.6, 48.1, 47.7 "	47.5 "	82.6 "
4th.	14.7, 14.9, 15.1 "	14.9 "
			Mean, 88.1 cm.

Variation is about 1%.

From Ut_3 , $V = 2 \times 66.7 \times 256 = 84,100$ cm. per sec.From Ut_6 , $V = 2 \times 88.1 \times 512 = 83,900$ " " "Mean, 84,000 cm. per sec., velocity at 20° C. \therefore Velocity at zero = 82,800 " " "

Questions and Problems.

1. Allowing for the error of your experiment, does it indicate any difference between the velocities of long and short waves in the column of air?
2. In your second experiment, of what length of tube is Ut_4 , the fundamental, and of what lengths is it the 2d, 4th, and 6th partials?
3. How much beyond the end of the tube in each case is the loop which is usually described as being at the open end of an organ pipe?
4. In calculating the length of a pipe to give a certain note, would the correction for this error at the open end be the same for any note?
5. Calculate the change of velocity in air due to rise of temperature 0° to 20° . Will the velocity change with the barometric pressure?
6. Describe an experiment which proves that the velocity of sound is greater in a solid than in air.

7. If a mass of air were confined in a closed vessel of constant volume, would changes in the temperature affect the velocity of sound in it?
8. Allowing for the diameter of the tube, what must be the length of an open tube whose diameter is 6 centimetres, and which is filled with air, to respond most loudly to a tuning-fork of 390 vibrations per second?

EXPERIMENT 41

Object. To determine the velocity of longitudinal vibrations in a brass rod by Kundt's Method. (See "Physics," Art. 158.)

General Theory. A brass rod is clamped at its middle point, and set in longitudinal vibration; one end of the rod is provided with a small disk, which fits in a resonance-tube coaxial with the rod. Consequently, if the resonance-tube is of suitable length, the gas in it will be set in vibration by the vibrations of the brass rod. The frequencies are the same for the two vibrations; and, if the length of the vibrating segments (*i. e.*, half the length of the waves which produce the vibrations in the gas) can be measured, the *ratio* of the velocity of longitudinal waves in brass and in the gas can be determined; for

$$\begin{aligned}V_1 &= n\lambda_1, \\V_2 &= n\lambda_2. \\ \therefore V_1/V_2 &= \lambda_1/\lambda_2.\end{aligned}$$

If the gas in the tube is air, the velocity in it may be assumed to be known from the preceding experiment.

In the vibrating rod there is a loop at each end and a node at the middle point; and so the wave-length of the longitudinal waves in the rod is twice the length of the



FIG. 86

rod. The positions of the nodes and loops in the column of gas may be recorded by a little fine, dry powder, such as

cork dust, sprinkled lightly in the tube; for, when there are sharply defined nodes and loops, the dust gathers in definite heaps marking those points. If the powder is very light it will fly away from the nodes, leaving bare places in the tube; while, if the powder is heavier, it will remain inert at the nodes and will collect in transverse ridges at the loops. (These transverse ridges are due to differences in pressure, caused by the air flowing to and fro between the fine particles.) There is never any ambiguity as to where the nodes are; because, if the resonance-tube is closed, both ends of the column of air are nodes, and so it is easily seen which other points are nodes.

Sources of Error.

1. The brass rod is heated by the rubbing to a temperature not readily determined. The velocity found by the experiment cannot, therefore, be reduced to standard conditions.
2. The friction of the gas against the sides of the glass tube changes slightly the velocity in the gas.
3. The frequency of the vibration of the brass rod is not exactly what it would be if it were vibrating freely.
4. The brass rod may not be clamped in such a way as to be held at the exact node of the vibration.

Apparatus. A glass tube 2 or 3 centimetres in diameter; a piston which fits the tube tightly, attached to a rod about 50 centimetres long; a brass rod 3 or 4 millimetres in diameter, with a piston on one end fitting the tube only loosely; a vise; a small piece of rough cloth and some resin; a metre-bar; supports for the tube; cork dust or lycopodium powder.

Manipulation. Arrange the apparatus as shown in the figure, clamping at its middle point in the vise the rod which is to vibrate, and which carries the smaller piston. Before putting the tube in place scatter *small* amounts of the dust as evenly as possible inside it. The loose piston must not be very near the mouth of the tube. Set up longitudinal vibrations in the clamped rod by stroking it with the resined cloth. The note is better if the cloth is pulled entirely off the end of the bar. Push the tight piston in or out until

the ridges of cork dust become as sharp as possible. Measure the distances between the nodes. To do this it is not advisable to measure between two adjacent nodes, but between two as far apart as possible.

Measure from the face of the fixed piston to a sharply defined node near the other piston. The distance between two adjacent nodes is then easily calculated, and is equal to $\frac{\lambda}{2}$.

Tap the tube so as to destroy the ridges and repeat, making in a similar manner four determinations of λ . Measure the entire length of the brass rod and find the temperature of the air in the tube.

(The velocity of sound in air at zero degrees may be taken as 332 metres per second, to which .6 metre should be added for each degree above zero.)

The velocity of another gas than air may now be found by allowing it to flow through the tube slowly so as to fill it, finding $\frac{\lambda'}{2}$ the distance between the ridges, whence the velocity in this gas $V' = \frac{\lambda'}{\lambda} V$.

ILLUSTRATION

Feb. 8, 1897

VELOCITY OF SOUND IN BRASS

Length of bar = 60.9 centimetres. $\therefore \lambda = 121.8$ centimetres.

Temperature inside the tube = 19° . \therefore Velocity of sound in air, 843.8 metres per second.

No. of Loops between Nodes Measured	Distance	$\lambda/2$	λ
9	58.5	5.944	11.89
10	58.7	5.87	11.74
11	64.8	5.89	11.78
10	58.6	5.86	11.72
			Mean, 11.78

$$\therefore V_1 = 843.8 \times \frac{121.8}{11.78} = 8554 \text{ metres per second} = \text{velocity of sound in brass.}$$

Questions and Problems.

1. Deduce the frequency of the note given out by the brass rod.
2. Given that the density of brass is 8.4, deduce its elasticity in dynes per centimetre. (See "Physics," Art. 148.)
3. What would happen if the rod were clamped at another point than its middle?
4. What would happen if the clamp were too broad?
5. Could the velocity of sound in water be found by this method, using a proper substitute for cork dust?
6. Is the velocity of transmission along the brass rod of the vibrations in this experiment the same as the velocity of transmission of the vibrations in Experiment 89 along the brass wire? Explain fully.

EXPERIMENT 43

Object. To compare the velocity of longitudinal waves in brass and in iron. (See "Physics," Art. 157.)

General Theory. Two wires—one brass, the other iron—are stretched side by side and set in longitudinal vibration. The lengths are then adjusted until the pitches of the two vibrations are the same. If v_1 is the velocity of longitudinal waves in the brass wire, and l_1 the length of the brass wire, and v_2 and l_2 similar quantities for the iron wire, then, since the frequencies are the same,

$$v_1/v_2 = l_1/l_2$$

Source of Error.

The main source of error comes from the inability of the observer to decide when the two strings are in unison.

Apparatus. A large sonometer with brass and iron wires; clamps; metre-rod; two pieces of cloth, and resin. The large sonometer is similar in principle to those already described in Experiment 39, but can carry two or more wires. The two wires, the brass and the iron, are placed under tension by means of pegs similar to those used to tighten the wires in pianos. The pegs are turned by a key which fits them; and the wire, being thus wound around them, can be tightened to any degree desired. At each end of the sonometer are stationary clamps, in which both wires are firmly held after being tightened, so as to prevent slipping at the pegs and loss of tension. There is also, one movable clamp for each wire. The jaws of all the clamps, fixed and movable, are lined with lead, so as not to cut

the wire. A fixed centimetre scale, 150 centimetres long, runs the entire length of the sonometer.

Manipulation. Stretch the wires so that they are firm and straight; but there is no need of having them very tense. Place a clamp on each wire, with one edge against the scale, and tighten the clamp-screws.

Stroke both wires with the resined cloths, holding the clamp still; and then change the position of the clamp on one until the note given out by both wires is the same. When the notes are nearly the same, move only about one millimetre at a time until they appear to be exactly in uni-



FIG. 87

son. Note the scale-reading of the side of the clamp on each wire next to the part of the wire which was made to vibrate; then continue to move the same clamp as before in the same direction, and note where a difference in the notes can again be distinguished. The mean of the two readings thus made on the same wire is then taken as the correct reading, as corresponding to unison of the two wires. Measure the lengths of the two wires. Repeat four times, taking different lengths of wire in each case.

Calculate the ratio of the velocity in iron to that in brass, and determine the absolute velocity in iron from that in brass, as found in Experiment 41.

ILLUSTRATION
VELOCITY OF SOUND IN IRON

Feb. 19, 1897

Fixed End of Both Wires	Movable Clamp		Lengths		<u>Iron</u> <u>Brass</u>
	Brass Wire	Iron Wire	Brass	Iron	
0	66.9	100.0	66.9	100.0	1.495
0	80.0	119.8	80.0	119.8	1.491
0	50.0	74.6	50.0	74.6	1.492
150	80.8	47.1	69.2	102.9	1.487
150	60.0	15.9	90.0	184.1	1.490
Mean,	1.491

\therefore Velocity of longitudinal waves in iron = $1.491 \times$ velocity in brass
 $= 1.491 \times 3554$ metres per second (by Experiment 41) = 5291 metres per second.

Questions and Problems.

1. Does the result of the experiment depend on the tension of the wires? the size of the wires? the temperature of the wires? Why?
2. Why cannot beats be heard in this experiment?

EXPERIMENT 48

(TWO OBSERVERS ARE REQUIRED)

Object. To study the different modes of vibration of a column of gas. (See "Physics," Art. 146.)

General Theory. The column of air in a tube open at both ends is set in vibration by a siren placed near one end. A siren consists essentially of a circular disk in

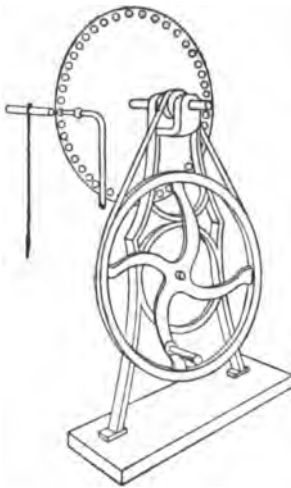

FIG. 88

which, at regular intervals near the edge, small holes are made; and, when a blast of air is blown through the holes as the disk revolves, the air is set in vibration with a frequency equal to the number of pulses which come through the disk in one second. The siren is set up in front of the resonance-tube; and, by altering the speed of the disk, different rates of vibration can be noted, to each of which the column of air responds.

A column of air open at both ends can vibrate in various ways, such that there are successively 1, 2, 3, etc., nodes in its length; and the frequencies of the vibrations to which it responds are, therefore, in the same ratio. Further, if

the frequencies and the lengths of the vibrating segments are known absolutely, the velocity of sound-waves can be determined as in Experiment 40.

Sources of Error.

1. The belt connecting the disk with the wheel by which it is rotated may slip and the frequency be less than that indicated by the speed of the handle.
2. It is difficult to keep the speed absolutely constant, and it cannot, therefore, be determined accurately.

Apparatus. Siren ; bellows ; rubber tubing ; short piece of glass tubing about 6 millimetres diameter ; clamp-stands ; resonance-tube, a glass tube about 70 centimetres long and 3 centimetres in diameter ; watch.

The rubber tubing should be joined to the bellows, and in its other end the short glass tube inserted, so as to serve as a mouth-piece for the air-blast.

Manipulation. Place the resonance-tube in a clamp-stand so that it is perpendicular to the disk, with one end opposite a hole. On the other side of the same hole fix the blast-tube so that the air is blown directly down the resonance-tube. Blow the bellows and revolve the siren, gradually increasing the speed until the tube resounds. Then keep the speed as constant as possible, and time by the second-hand of your watch fifty turns of the handle which revolves the disk. Stop the siren. Begin again and repeat the determination three times.

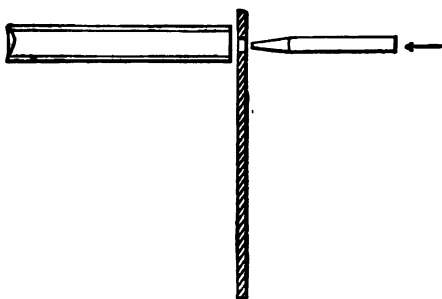

FIG. 89

Next, increase the speed beyond that necessary to give

the lowest tone of the tube, and find, as before, the speed necessary to produce the next higher note to which the tube resounds. Make three trials again. Increase the speed still further and find a third note; and continue the experiment until a speed is reached which cannot be conveniently kept constant long enough to count.

It is necessary to time a greater and greater number of turns of the handle in each case—say, 100 for the second note, 150 for the third, and so on, or else the interval becomes too short to be accurately timed. Take the temperature in the tube.

Stop the bellows. Revolve the handle very slowly and count the number of turns made by the disk while the handle revolves ten times. Do this three times. Deduce n_1 , the number of turns made by the disk to one of the handle. Count the number of holes in the disk. Let it be n_2 . Then, if the handle is turned at a speed of N turns per second, the number of holes which pass the blast per second—*i. e.*, the pitch of the note—is Nn_1n_2 .

Measure the length of the tube. Draw diagrams to illustrate where the nodes and loops are in each case, and state which note is the fundamental of the tube, and which partial corresponds to each of the others. Show in each case the relation of the pitch to the fundamental.

Deduce the velocity of sound in each case and average. The loop at the open end of an organ-pipe is at a distance beyond the end equal approximately to the radius of the tube, and due allowance must be made for this.

ILLUSTRATION

Feb. 9, 1897

SIREN

Turns of Handle	Turns of Disk	
10	56	∴ 1 turn of handle produces 5.67 turns of disk. ∴ $n_1 = 5.67$.
10	57	
10	57	

There are 45 holes in disk—*i. e.*, $n_2 = 45$. ∴ One turn of the disk per second corresponds to a pitch of $n_1n_2 = 255$.

Frequencies Giving Resonance

	Lowest	2d	3d	4th
No. of turns timed, 50		100	150	200
Time in seconds,	58.0	58.6	51.2	50.4
	54.8	58.8	51.4	50.6
	53.7	58.4	52.8	51.2
	52.7	54.0	51.6	50.8
Mean, 52.45	58.7	51.75	50.75	
Frequency, $\frac{50 \times 255}{52.45} = 241$	475.1	789.0	1005.0	

Mean frequency corresponding to lowest pitch is $\frac{50 \times 255}{52.16} = 242$.

Length of tube, 68.2 cm.; radius, 2 cm. $\therefore \lambda = 140.4$.

Velocity of sound, $242 \times 140.4 = 34,000$ cm.

Questions and Problems.

1. Why is the pitch shown in this experiment likely to differ more from the theoretical value the higher it is?
2. Why does not the tube resound for all notes?

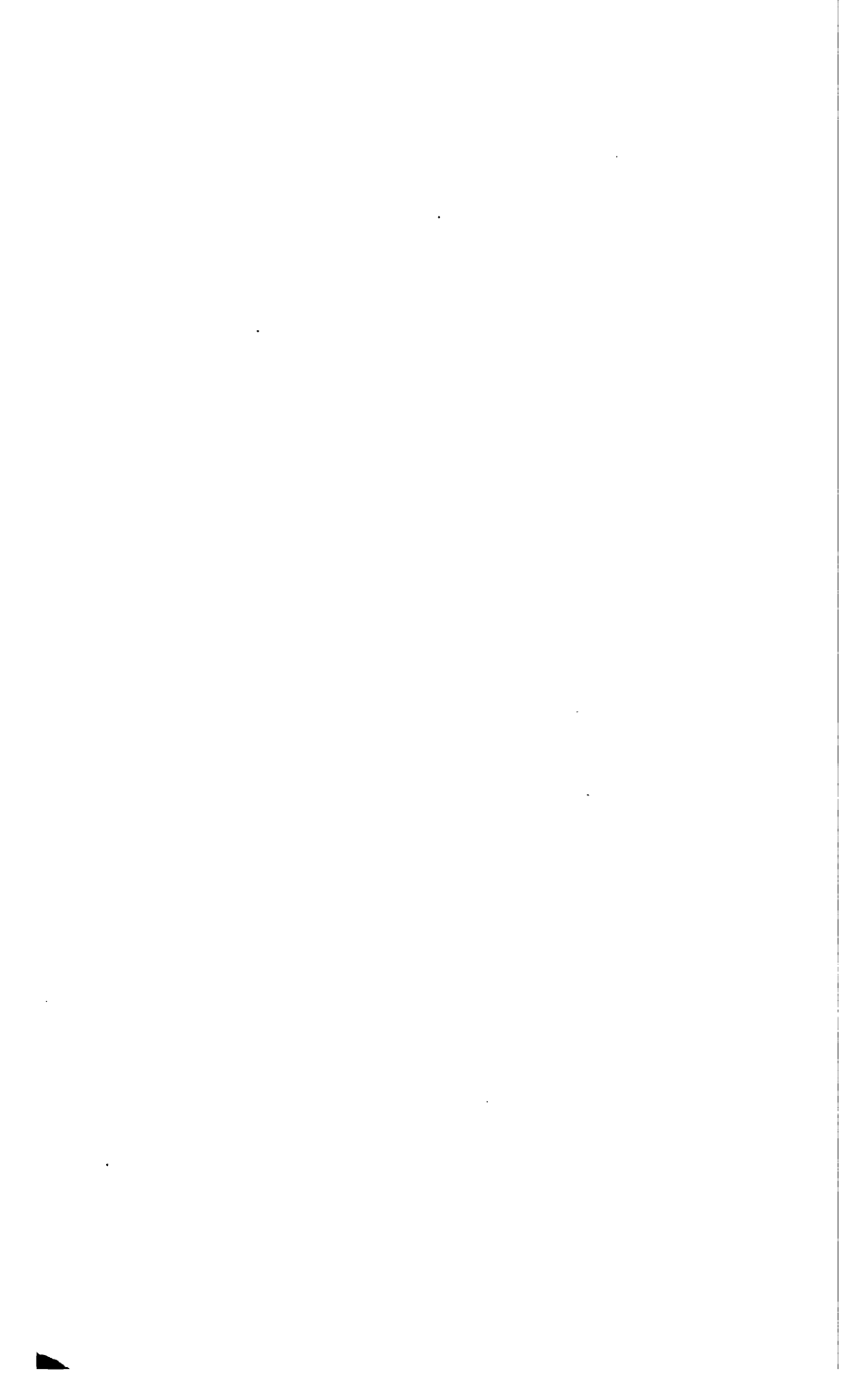

EXPERIMENTS IN HEAT

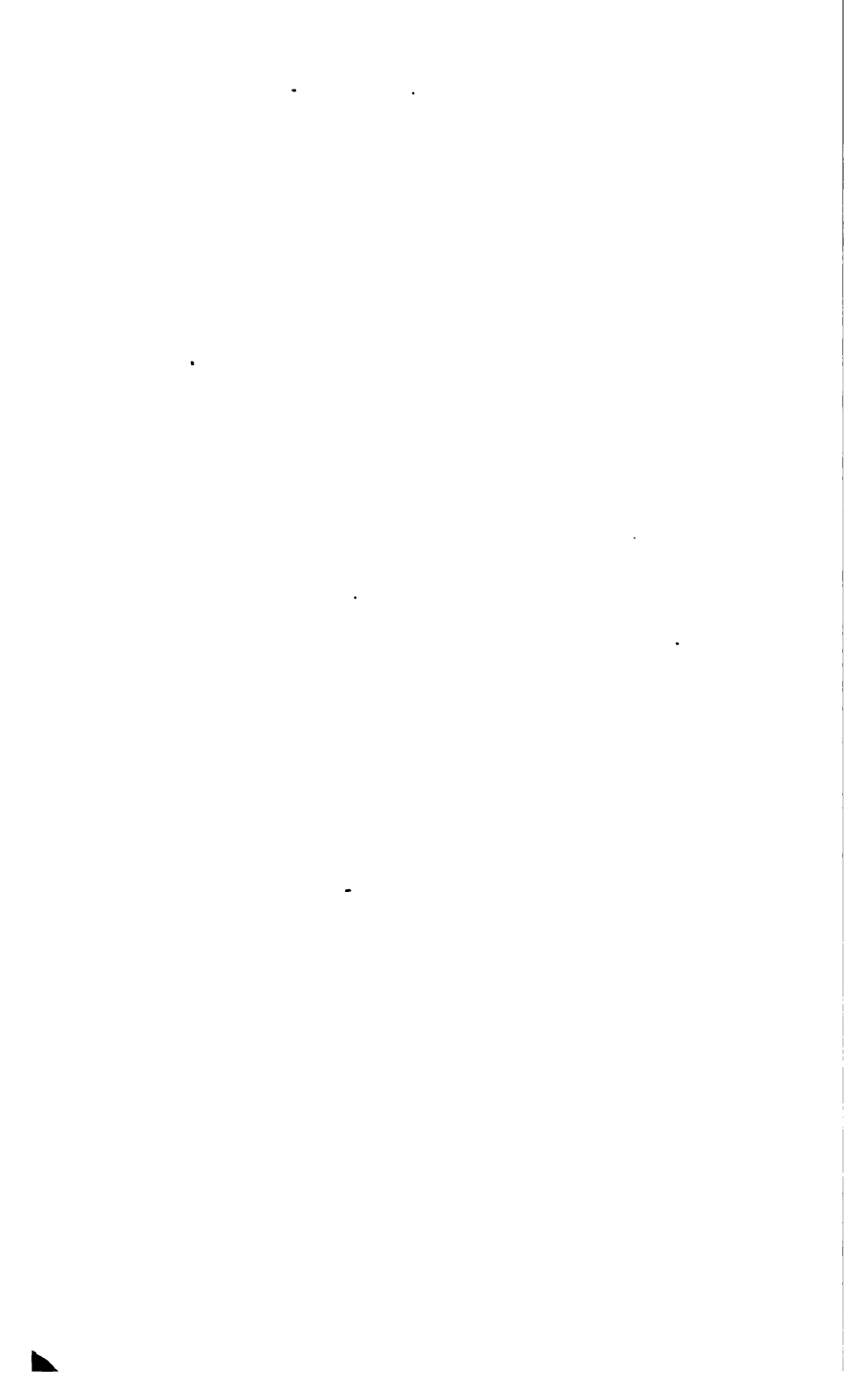

INTRODUCTION TO HEAT

Units and Definitions. As is shown in treatises on Physics, the main "effects of heat" are changes in volume, in temperature, and in state or condition; and all these effects are due to the addition of energy to the minute portions of matter in the body which experiences the heat-effect. Naturally, therefore, amounts of heat-energy should be measured in ergs; but in almost every case this would be impossible. Consequently, a subsidiary unit of energy is adopted which admits of ready use, and which can be measured in terms of ergs. This subsidiary unit is the amount of heat-energy required to raise the temperature of one gram of water from 10° to 11° C. It is called the "thermal unit," or a "calorie"; and its value in terms of the erg has been determined by experiment to be

$$1 \text{ calorie} = 4.2 \times 10^7 \text{ ergs.}$$

By actual experiment it is found that the amount of heat-energy required to raise the temperature of one gram of water one degree centigrade is not exactly one calorie at all temperatures; but the variations are so slight that in preliminary experiments, such as those in the following section, they may be neglected.

To measure temperature the centigrade scale is used; and the thermometer in universal use is the mercury-in-glass one. The centigrade scale is one on which the temperature of melting ice is called 0° , and that of the vapor rising from boiling water 100° , provided the pressure of the vapor is 76 centimetres of mercury under standard conditions (*i. e.*, when the barometric reading is 76 centimetres "corrected," as explained in Experiment 26).

* A mercury-in-glass thermometer is an instrument whose reading must be subject to many corrections if accuracy is to be obtained.

The chief corrections may be thus summarized:

1. The bore of the tube may be irregular. The correction for this may be found by a process of calibration by means of a thread of mercury. (See Experiment 2.)

2. The scale which is marked on the instrument may be irregular, or it may be so placed as not to coincide exactly with the position of the mercury column at definite temperatures. The correction at 0° and 100° may be determined as is shown in Experiment 44; and the errors at other points may be learned by comparing the instrument with some standard thermometer whose errors are known. (If the thermometer is made of a kind of glass whose properties are known, its errors may be deduced from observations on it by itself.)

3. The effect of pressure, both external and internal, on the volume of the bulb must be noted. This effect is very noticeable if the thermometer is used first vertically and then horizontally, or if it dips deeply in a liquid. The exact correction may be determined by subjecting the bulb to various pressures and measuring the effects; in most cases of laboratory thermometers this correction is negligible. This effect also causes a difference between readings made when the mercury column is falling and when it is rising, owing to differences in capillary pressure. Owing to this fact, readings should be made when the mercury is either always rising or always falling, preferably the former; and in any case the stem of the thermometer should be tapped gently before a reading is made.

4. The change in the volume of the bulb owing to molecular changes in the glass is most important. This change appears in two ways: there is a slow decrease in volume of the glass, which continues for years after a thermometer is made, and which is shown by the gradual rise of the mercury column when the temperature is maintained constant

—*e. g.*, the rise of the 0° point; and also, if the temperature of the instrument is varied from 0° to any point t° and then back to 0° , the mercury column will always stand lower than at first, owing to the fact that the glass lags behind the change in temperature and the volume of the glass does not return to its previous value for some days, perhaps weeks. This “depression of the zero point” depends upon the temperature to which the instrument has been exposed, upon the time of exposure, and upon the rapidity of the return to 0° C.

Owing to this fact it has been found convenient to define temperature as follows: let v_{100} be the reading at 100° C., v_0 the reading at 0° after the exposure of the thermometer to the temperature t° , v_t the reading at t° , then

$$t^\circ = 100 \frac{v_t - v_0}{v_{100} - v'_0},$$

where v'_0 is the reading at 0° after the thermometer has been heated to the temperature 100° (it is nearly equal to v_0).

Although the mercury-in-glass thermometer is the one in universal use, it is not the standard instrument. The civilized countries of the world have agreed to accept as the standard thermometer one filled with dry hydrogen at the initial pressure of 100 centimetres of mercury. To reduce the readings of the mercury thermometer to the standard hydrogen thermometer, corrections must be learned by direct comparison of the two instruments once for all, and these can then be applied in all subsequent readings.

Object of Experiments. The experiments in the following section are measurements of expansion and of quantities of heat-energy. Every experiment involves a measurement of temperature, and there is no physical measurement quite so difficult to make accurately. The chief difficulties in the measurement of temperature may be thus summarized:

1. *Error of the Instrument, as Described in the Previous Article.*—In the accurate use of a thermometer all the cor-

rections must be made; but for ordinary purposes it is sufficient to standardize the scale at 0° and 100° , calling the readings at these temperatures v_0 and v_{100} , and to define the temperature at any other reading v , as

$$t = 100 \frac{v - v_0}{v_{100} - v_0}.$$

2. *Stem-correction.*—The portion of the thermometer which is not immersed in the body whose temperature is desired is at a different temperature in general, and so the mercury column does not record the correct temperature. This error may sometimes be avoided by enclosing the entire thermometer in a glass tube, and filling this with water at the same temperature as that of the substance in which the bulb is placed. In general, however, some correction must be applied, *assuming* the average temperature of the projecting stem to be somewhere between the temperature of the bulb and that of the room. Thus, if t° , is the true temperature of the bulb, t_1° , that of the surrounding air or room, the average temperature of the stem will be between these two (it is practically impossible to say exactly what); call it t° . Let a be the coefficient of apparent linear expansion of mercury in glass, and let the mercury column project h degrees, then the stem correction is evidently $ha(t_1^{\circ} - t^{\circ})$.

3. *Error in Reading.*—In reading a thermometer great care must be exercised to look at the mercury column in a direction perpendicular to the scale. In some thermometers it is possible to get a reflection of the scale divisions in the mercury by looking a little from one side; and the divisions and their images may be brought into line by moving the eye, thus securing the proper direction. (See Experiment 33.) In other cases the student must use what care he can to make the correct reading.

4. *Error Due to Radiation.*—Great care must be taken to keep the thermometer from interchanging heat-energy by any means (but particularly by radiation) with other bodies than the one whose temperature is desired. To avoid this

danger, screens of non-transparent, non-conducting substances should be interposed between the thermometer and neighboring bodies.

5. *Capillary Error*.—Before making a reading always tap the thermometer gently.

In measuring quantities of heat-energy errors due to thermometers enter, but the main difficulty is caused by transfer of the energy in other ways than in the one desired. Thus there is constant danger of loss of heat-energy by radiation, conduction, and convection, which can be largely prevented, however, by suitable precautions. Further, allowance must always be made for the heat-energy which is necessarily consumed in any change of temperature of the vessels which contain the substances mainly involved in the heat-transfer. In the description of each experiment attention will be directed to these possible dangers, and methods of correction will be given.

One direction cannot be emphasized too much: *Stir constantly* any liquid whose temperature is desired. The stirring should not be violent, otherwise it may itself cause a rise of temperature; it should, however, be thorough and unceasing.

Bunsen - burner. The gas - burner which is ordinarily used in laboratories for heating purposes is the Bunsen-burner, which is so devised as to allow the gas when it enters to mix with suitable amounts of air, and thus it secures violent combustion. Screws or stopcocks are introduced so as to regulate the flow of both gas and air, and they should be

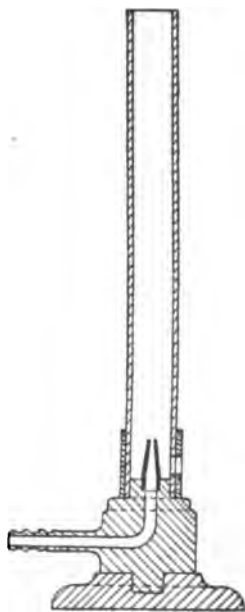

FIG. 90

so adjusted as to cause a blue cone about $1\frac{1}{2}$ inches high to burn *quietly* above the mouth of the burner, the surrounding colorless flame being about 5 inches high. The hottest portion of the flame is just outside the tip of the blue cone. If the flow of gas or air is suddenly disarranged, the flame may "strike back" and burn in the tube at the point where the gas enters. (This is liable to so heat the burner as to cause the rubber tubing to burn.) When this happens it is best to put the burner out and relight.

EXPERIMENT 44

Object. To test the fixed points of a mercury thermometer. (See "Physics," Art. 168.)

The thermometer, once tested, should be used in all later experiments.

General Theory. The general discussion of a mercury thermometer is given in the introduction; and it is seen that the two standard temperatures on the centigrade scale are those of the equilibrium of ice and water, and of water and steam, under standard conditions of pressure. These temperatures are called 0° and 100° ; and the readings of the scale of a thermometer at these temperatures must be carefully determined. The obvious method is to place the thermometer in turn in a mixture of ice and water and in the steam rising from boiling water. If the pressure of the steam is not the standard one, due correction can be made. The temperature of equilibrium of ice and water is unaffected by slight changes in pressure; and that of steam rising from boiling water is changed at the rate of an increase of 0.1° for an increase in pressure of 2.68 millimetres of mercury.

Sources of Error.

1. The ice or water may be impure.
2. In determining the freezing-point it is very difficult to get the entire mass of water exactly at 0° . There may be, consequently, warmer water near the bulb of the thermometer.
3. The pressure around the thermometer may not be that recorded on the barometer.
4. There may be loss or gain of heat in the thermometer by radiation.

1. To Determine the 0° Point on the Centigrade Scale

Apparatus. A centigrade thermometer. (Note the number.)

FOR METHOD A.—A long, wide test-tube; a stout wire stirrer, bent at one end into a ring, just large enough to move freely over the bulb and stem of the thermometer; a cork to fit the test-tube; a deep glass or metal vessel; a supply of distilled water and of coarse common salt (NaCl); ice or snow.

FOR METHOD B.—A stand, from which to hang the thermometer; one large and one small beaker, or a set of copper calorimeters; a cover and stirrer for the smaller of these vessels; three long corks; sufficient cracked ice or snow to fill the larger vessel.

Manipulation. METHOD A.*—Bore a hole in the centre of the cork to fit the thermometer tightly, and a slit on one side for the handle of the stirrer. Wash the thermometer, the stirrer, and the inside of the test-tube carefully in distilled water. Fill the tube with distilled water to such a height that the thermometer can be submerged well above the zero mark, but not so high that the water in the tube is not entirely covered by the freezing mixture when the tube is put into the larger vessel. Insert *loosely* in the test-tube the cork and the thermometer, and turn the latter so that the stirrer does not hide the scale. Place a layer of salt and ice at least two centimetres thick on the bottom of the larger vessel, then insert the test-tube and pack around the test-tube alternate layers of ice and salt. Stir the water in the test-tube continually. When a cap of ice begins to form on the inside of the tube and crystals of ice float in the water about the thermometer, begin to record the readings of the latter about once a minute, always stirring. Be careful not to let the entire mass of water in the tube freeze solid. To read the thermometer, lift it by means

* This method is due to Professor Ostwald, of Leipzig.

of the cork, which should be loose in the tube as directed, until the top of the mercury just shows above the water and ice in the tube, the test-tube itself being raised far enough out of the freezing mixture to admit of reading the thermometer in this position. Take pains to have the line of sight perpendicular to the thermometer. Read to one-tenth of a division on the thermometer scale, as quickly as possible, and at once lower the thermometer in the test-tube and the latter back into the freezing mixture. When the position of the mercury has remained the same for five successive readings, it may be assumed that the water in the test-tube and the mercury of the thermometer have both attained the temperature at which distilled water freezes under natural conditions—*i. e.*, 0° C. The mean of the last five readings is, therefore, the true zero on the thermometer scale. Take out the test-tube, allow the ice that has formed in it to melt, and then repeat. Take the mean of the two results. If this is θ_0° , the *correction* to the thermometer at 0° is $-\theta_0^{\circ}$.

METHOD B.—Wash the thermometer, the stirrer, the inside of the smaller vessel, and the ice in tap water. Support the smaller vessel inside of the larger on three corks. Fill the larger with ice, cracked to the size of chestnuts. Support the thermometer in the centre of the inner vessel, with the stirrer fitting over it. Fill the inner vessel one-half with ice, and add distilled water up to the brim. Stir continually, and occasionally raise the thermometer, until you can just read it, and lower again quickly into the ice and water. As soon as the mercury has fallen to 1° , note the reading every minute until it has remained stationary for five minutes, and take the final reading as the zero of the thermometer. Repeat the experiment, having meanwhile taken out the thermometer and allowed it to warm, so as to start again with a reading above 1° . Take the mean of the two results as the correct reading of the ther-

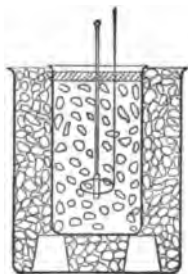

FIG. 91

mometer at 0° C. If this reading is θ_0° , the *correction* to the thermometer at 0° is $-\theta_0^{\circ}$.

2. To Determine the 100° Point on the Centigrade Scale

Apparatus. A copper vessel, with a water-tight bottom, has its feet firmly fastened in position by a plate of copper, and from one side near its top projects a short copper tube.

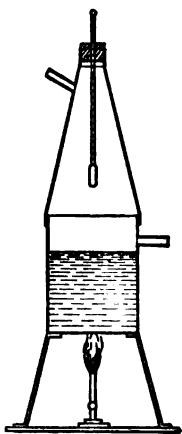

FIG. 92

Into the top of this vessel can be fitted tightly a cone-shaped copper pipe, with its base of the same diameter as the vessel, and with its vertex placed upward. The vertex of the cone is cut off so that it admits a cork. Near the top of the cone is a small projecting tube similar to that of the vessel. This entire piece of apparatus is called a "hypsometer."

Manipulation. Fill the lower vessel with water to within two centimetres of the side tube. Close this tube by stuffing into it a roll of paper or a piece of cork. Fit the upper part of the hypsometer very tightly to the lower part, but do not close the tube near the top. Push the thermometer, whose zero mark has just been tested, through the hole in the cork at the top of the instrument until ninety-nine and one-half scale divisions are hidden below the upper surface of the cork. The thermometer should fit closely into this hole to prevent its falling, and also to hinder the escape of steam around the thermometer, which would make observations upon it more difficult. Adjust the cork until the thermometer is vertical, and turn the thermometer around into that position in which the scale divisions are most distinct and easily read. The preceding adjustments will keep the bulb of the thermometer well out of the boiling water, at the same time allow free circulation of the steam around almost the entire column of mercury. Place a single Bunsen-burner, attached

by rubber tubing to a gas-pipe, under the hypsometer. When the water has been boiling freely for some time, and the top of the mercury column has become stationary, read the barometer, as explained in Experiment 26, in Mechanics. Note carefully, estimating to tenths of the smallest division, the position of the top of the mercury column in the thermometer. After two minutes repeat this reading, and immediately afterwards note the barometric pressure again. Take the mean of these pairs of results, keeping the barometric and thermometric readings separate. Call the mean thermometer reading θ .

The variation in the temperature of the steam with the pressure is given above; hence, calculate the true temperature of the steam at the pressure read from the barometer, *correcting* the observed height for the temperature of the mercury in the barometer and for the latitude. The difference between this value and the observed scale-reading is the correction for the observed mark of the thermometer.

Finally, allow the thermometer to cool to about the temperature of the room. Then place it in ice and again test the freezing-point.

ILLUSTRATION

THERMOMETER No. 50

Jan. 5, 1892

Freezing-point—Method A

Last five readings:

Experiment 1		Experiment 2
-0.3		-0.2
.85		.25
.25		.2
.8		.2
.8		.2
Mean, -0.3		Mean, -0.2

$$\text{Mean} = -0.25 = \theta_0^\circ.$$

Boiling-point

Thermometer in steam, 99.6, 99.5. Mean, 99.55 = θ .

Barometer corrected for temperature and latitude, 75.7, 75.6.

Mean pressure during experiment, 75.65.

Temperature of steam at 75.65 pressure, $100 - \frac{760 - 756.5}{28.8} = 99.87^\circ = t$.

Hence

$\theta_0 = -0.25^\circ$. \therefore Correction at zero = $+0.25^\circ$.

$\theta_b = 99.55^\circ$. $t_b = 99.87^\circ$. \therefore Correction at boiling-point = $+0.32^\circ$.

The true temperature, when the thermometer reads 100° , is:

$$t^\circ = \frac{100 + .25}{99.55 + .25} \times 99.87 = 100.32^\circ.$$

Correction at 100 is $+0.32^\circ$.

To find change of freezing-point after boiling (Method A):

Trial 1		Trial 2
-0.4		-0.5
.35		.55
.4		.45
.4		.5
.4		.5
Mean, -0.4		Mean, -0.5

Mean = -0.45° ,

showing that boiling has lowered the zero point by 0.3° .

Questions and Problems.

1. What is the true temperature when your thermometer reads 40° ?
2. Is the calculation just made of the correction at intermediate points accurately true? If not, why is it inaccurate?
3. A thermometer is so graduated as to read 10° in melting ice and 70° in steam at normal pressure; what is the temperature on the centigrade scale when the reading on this thermometer is 50° ?
4. Which experiment should be performed first, determining the zero reading or the boiling-point?

EXPERIMENT 45

Object. To determine the coefficient of linear expansion of a solid rod or wire. (See "Physics," Art. 169.)

General Theory. By definition, the average coefficient of linear expansion of a substance between two temperatures t_1° and t_2° is

$$\frac{l_2 - l_1}{l_1(t_2 - t_1)} = \alpha,$$

where l_1 and l_2 are the lengths of a linear dimension at t_1° and t_2° , respectively. Consequently, the method is to measure the change in the length of the rod or wire between the two temperatures and to substitute in the formula.

The *change* in the length, $l_2 - l_1$, is the quantity which is in general the most difficult to measure, owing to its minuteness, and particular care must be devoted to its measurement. The general method is to have the rod or wire so fastened to one end of a lever that the least change of length of the rod or wire produces a great motion of the other end of the lever, and this can be read with accuracy. The rod or wire is then immersed in succession in baths of different known temperature—*e. g.*, water or steam—and if the original length of the rod or wire is known the coefficient of expansion may be at once calculated.

Sources of Error.

1. The rod or wire may not be exactly at the temperature of the surrounding gas or liquid.
2. There may be some slipping of the lever.

3. The rod or wire may not be at the same temperature throughout its entire length.
4. The greatest error enters through the measurement of the shorter lever arm.

Apparatus. METHOD 1.—“Expansion of metal-rod apparatus,” consisting of a rod supported in a cylinder with steam connections, lever, scale, etc.; kerosene-oil can, in which to boil water; thermometer; metre-rod; rubber tubing; Bunsen-burner.

The “expansion of metal-rod apparatus” consists essentially of a metal rod supported horizontally in a cylindrical jacket through which steam may be passed. One end of the rod rests firmly against a fixed steel point; while the

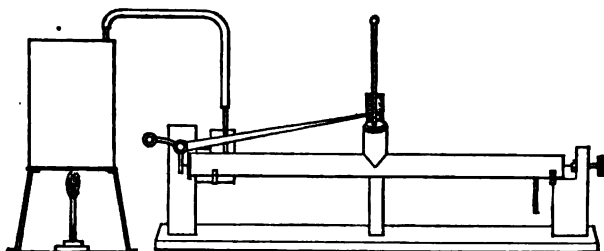

FIG. 93

other end, which is free to move, rests against one end of a lever. Consequently, any change in length of the rod is at once indicated by a motion of the lever arm, which moves over a finely divided scale. If the magnifying power of the lever is known, the actual change in length of the rod can be calculated.

Manipulation. Join the boiler to the steam-jacket by a short piece of rubber tubing, and provide for the escape of steam from the jacket by another longer piece of tubing. See that the rod rests against the steel point, and that the lever and scale are properly adjusted.

Insert a thermometer in the steam-jacket and note the temperature t_1 , and the scale reading of the lever. Fill the boiler half full of water and set boiling. When the

thermometer indicates a fixed temperature note this and call it t_2 . Note also the scale reading. Remove the Bunsen-burner and allow the rod to cool. When the temperature has returned to its former value note the scale reading. Let the mean difference of the scale readings at the two temperatures t_2 and t_1 be h . The actual elongation of the rod can be calculated from a knowledge of the lengths of the arms of the lever. Measure these with the greatest care and let their ratio be p . Then the elongation $l_2 - l_1$ equals h/p . The original length of the rod may be learned from an instructor, or in some cases it may be measured directly. Then the average coefficient of linear expansion may be calculated from the formula

$$\alpha = \frac{l_2 - l_1}{l_1(t_2 - t_1)}.$$

Apparatus. METHOD 2.—“Expansion of wire apparatus,” consisting of a wire supported in a long, vertical glass tube, with steam connections, lever, steel scale, clamp-stand, etc.; kerosene can; thermometer; rubber tubing; Bunsen-burner.

The “expansion of wire apparatus” consists essentially of a long, vertical glass tube closed at both ends, and so arranged that steam may be passed in at the top and out at the bottom. The wire to be tested is double the length of the tube, and both ends are passed through the cork at the top and fastened to a bar passing across the end of the tube. The bend of the wire at the bottom goes around a pulley, to which is attached an arm carrying a hook passing loosely through the

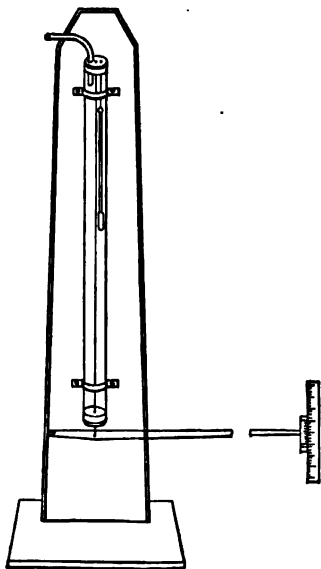

FIG 24

cork at the bottom. A long lever is hung upon the hook so that the arm one side is six or seven times longer than the other. The shorter arm is held firmly at its end under a sharp edge fixed firmly to the stand supporting the tube. This edge is the fulcrum, and the long arm of the lever carries a metal vernier at right angles to it at its extreme end. A clamp-stand can be adjusted to hold the steel scale vertical and parallel to this metal vernier and as close to it as possible. The elongation of the wire is evidently magnified in the ratio: $\frac{\text{Distance fulcrum to vernier.}}{\text{Distance fulcrum to hook.}}$

Manipulation. METHOD 2.—Connect the glass tube at the top of the instrument with the escape-pipe of the boiler by means of a short, straight piece of rubber tubing. Measure accurately the distances between the fulcrum and the vernier and the fulcrum and the hook, and calculate the ratio. Place the steel scale in a clamp-stand back of the vernier and note how finely the vernier reads, as explained in Experiment 4, in Mechanics. It is convenient, when the whole instrument has been adjusted, to raise the scale until one of its divisions is coincident with the zero division on the vernier. The wire is not accessible for measurement, and the length may be obtained from the instructor.

Before heating the water note very carefully the temperature (t_1) of the inside of the tube, as indicated by the enclosed thermometer. Note the position on the scale of the zero division of the vernier. Pass steam from the boiler through the tube containing the wire; and, when the thermometer inside the tube ceases to indicate any change of temperature, read it carefully, correcting for inaccuracies in its scale, etc. Call this temperature t_2 . Again note the position on the scale of the zero division of the vernier. The difference between this reading and the like one before made is the number of scale divisions over which the zero division of the vernier has passed while the wire has had its temperature raised from t_1° to t_2° .

This distance should be expressed as a decimal fraction of a centimetre. Remove the Bunsen flame and allow the instrument to cool to the temperature of the room. While this is taking place the student should deduce the value in centimetres ($l_2 - l_1$) of the increase in length of the wire from the ratio of the lever-arms, combined with the difference between the initial and final readings of the vernier.

Calculate the average coefficient of linear expansion. Calculate also the coefficient as referred to 0°C .

ILLUSTRATION

Jan. 30, 1890

COEFFICIENT OF LINEAR EXPANSION OF BRASS WIRE

Corrected Temperature

$$\left. \begin{array}{l} t_2 = 98.4^\circ \text{C.} \\ t_1 = 18.6^\circ \text{C.} \end{array} \right\} l_1 = 105.28 \text{ cm.}$$

*Vernier Readings*At 18.6° , 5.28 cm.At 98.4° , 0.71 "

Length of shorter lever-arm = 8.11 cm.

" " whole lever = 89.87 "

$$l_2 - l_1 = \frac{8.11 \times 4.57}{89.87} = 0.1586,$$

$$\alpha = \frac{l_2 - l_1}{l_1(t_2 - t_1)} = 0.00001894.$$

Questions and Problems.

1. Does the cross-section of the wire, whether it be hollow, square, circular, large or small, influence its coefficient of linear expansion, and, if so, how?
2. Give some objections to measuring $l_2 - l_1$ while the temperature of the wire was *rising* from t_1° to t_2° .
3. Is there any relation between heat and energy or work, and, if so, what is it? How is this known?
4. Explain in detail the correction which would have to be applied to the above formula if the glass tube rested upon a support under its lower end instead of being firmly bound at its upper end.
5. Why is the steam let into the tube from its *upper* end?
6. A steel boiler has a surface 10 square metres at 15°C ., what is the increase in area when its temperature becomes 90°C .?

7. A clock, which has a pendulum made of brass, keeps correct time at 20° ; if the temperature falls to 0° C., how many seconds per day will it gain or lose?
8. If 45° C. is the maximum temperature to which railway rails are liable, calculate the space which should be left between their ends if they are 15 metres long and are laid down at 20° C.

EXPERIMENT 46

Object. To measure the apparent expansion of a liquid.
(See "Physics," Art. 176.)

General Theory. Since a liquid must always be held in a solid, if the temperature of the containing vessel is raised the *apparent* increase in volume of the liquid is the true increase diminished by the increase of the solid. The simplest mode of measurement is to have the liquid contained in a large bulb which is provided with a capillary stem, the volume of the bulb and the bore of the stem being known.

The liquid is made to stand at a certain height in the tube when the temperature is 0° C., and the change in height when the temperature is increased to t° is noted. If v_0 is the original volume of the liquid at 0° , v the apparent volume at t° , the coefficient of apparent expansion β is given by the equation

$$v = v_0(1 + \beta t),$$

or
$$\beta = \frac{v - v_0}{v_0 t}.$$

But $v - v_0$ is the apparent change in volume—that is, it is the increase in height of the liquid in the tube multiplied by the cross-section of the tube.

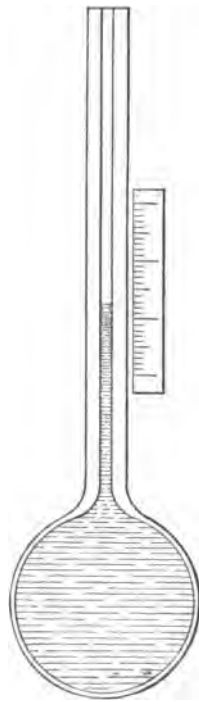

FIG. 95

The volume of the bulb and the bore of the tube may be measured as in Experiment 2.

Sources of Error.

1. These are practically the same as in Experiment 2.

Apparatus. The bulb used in Experiment 2; a large beaker of ice; a 10-centimetre rule; a Bunsen-burner, tripod, and asbestos dish; clamp-stand; thermometer; stirrer; 30 cubic centimetres of glycerine.

Manipulation. Fill the glass bulb used in Experiment 2 with glycerine exactly as there described, and leave the surface of the liquid in the stem at a height of about 2 centimetres above the bulb when it is placed vertical in a beaker of ice. Support it in a clamp-stand, so as to be surrounded on all sides by ice. When the temperature has fallen to 0° , as is indicated by the liquid in the stem reaching a definite position, record this position by sticking to the tube a bit of paper which has a sharp edge. Remove the bulb, and notice the apparent change in volume of the liquid as it assumes the temperature of the room. Fill the beaker with water, and place it on the asbestos dish which is on the tripod. Support the bulb upright in the water, taking care not to wet or remove the bit of paper. Raise the temperature of the beaker of water by means of the Bunsen-burner until some temperature about 25° C. is reached, if this temperature does not raise the liquid too high in the tube. Keep a thermometer in the water, and stir constantly; keep the temperature constant at 25° for a few minutes, if possible, and record the height of the liquid in the stem by means of a second bit of paper; record the temperature. Remove the burner and the bulb; and by means of the decimetre scale measure the distance apart of the two positions determined at the temperatures 0° and t° .

From a knowledge of the bore of the tube and the volume of the bulb, calculate β .

ILLUSTRATION

APPARENT EXPANSION OF GLYCERINE

Dec. 15, 1896

Volume of bulb at 0° , 25.24 cc.

Radius of bore of stem, 0.099 cm.

Hence, cross-section = 0.0806 sq. cm.

Temperature, $t^{\circ} = 25^{\circ}$.

Rise of surface in stem, 10.1 cm.

$$\therefore v - v_0 = 10.1 \times 0.0806 = 0.81 \text{ cc.}$$

$$\therefore \beta = \frac{v - v_0}{v_0 t} = \frac{0.81}{25.24 \times 25} = 0.00048.$$

EXPERIMENT 47

Object. To determine the mean coefficient of cubical expansion of glass between 0° and 100° C. (See "Physics," Art. 176.)

General Method. If a liquid is contained in a glass bulb, the apparent expansion of the liquid is less than the absolute by the expansion of the glass. Consequently, if the apparent expansion of a liquid whose absolute expansion is known can be measured, the expansion of the glass can be calculated. Such a liquid is pure mercury, whose mean coefficient of expansion between 0° and 100° C. is 0.0001816.

In practice a glass bulb whose mass is known is filled with mercury at 0° C.; the bulb is then heated to a known temperature—*e. g.*, to 100° C.—and the mercury which escapes is caught and weighed; the bulb is then weighed again, and the mass of the mercury remaining in the bulb is thus calculated.

Let M = mass of mercury left in bulb at temperature t° ,

m = " " " expelled from 0° to t° .

Call ρ_t = density of mercury at t° ,

ρ_0 = " " " " 0° ,

v_t = volume of glass bulb at t° ,

v_0 = " " " " " 0° .

The coefficient of cubical expansion of glass = $\alpha = \frac{v_t - v_0}{v_0 t}$.

But $v_t = \frac{M}{\rho_t}$, $v_0 = \frac{m + M}{\rho_0}$, and $\rho_0 = \rho_t(1 + \beta t)$,

where $\beta = 0.0001816$.

Hence

$$\frac{v_1 - v_0}{v_0 t} = \frac{M\beta - \frac{m}{t}}{M + m} = \alpha,$$

and so α can be calculated.

Sources of Error.

These are the same as in Experiment 2. •

Apparatus. A "weight-thermometer," consisting of an elongated glass bulb, to which is joined a capillary tube; mercury; mercury-tray; porcelain crucible; hypsometer and rubber-cork with one opening; all the apparatus for cleaning and filling a bulb, as in Experiment 2.

Manipulation. The weight-thermometer must be cleaned, weighed, and filled with mercury exactly as in Experiment 2. A mercury tray must be used to hold the clamp-stand and bulb, in order to catch the mercury in case any is spilled. If there are any traces of air in the bulb the mercury must be carefully boiled in such a way that bubbles of mercury vapor run up one side of the bulb at a time. This can be easily brought about by heating the bulb uniformly for a time, and then keeping the flame at one point of it until bubbles form there and roll up. When the bulb and stem are completely free from air let it cool without removing the cup at the top. When its temperature has fallen to about that of the room, immerse it, still suspended from the clamp-stand, in a beaker of crushed ice or snow. Leave it thus for at least fifteen minutes, always keeping the funnel half full of clean, dry mercury, and occasionally stirring the mixture of ice and water. During this time carefully clean a small porcelain crucible and then weigh it as accurately as possible. Without removing the thermometer from the mixture, quickly remove the funnel from its top,

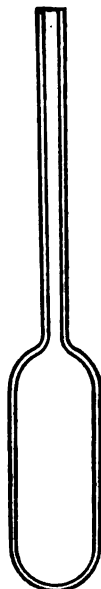

FIG 96.

allowing the excess of mercury to escape into the beaker. If a globule of mercury should happen to stick to the top of the thermometer-tube immediately scrape it off with a knife-blade. Remove the thermometer from the mixture, holding the bulb in the hand, and catch in the crucible all the mercury which is then driven out by the heat of the hand. When the mercury ceases to come out from the tube fasten the weight-thermometer vertically in a hypsometer by a rubber cork which holds the thermometer *very tightly*. Boil the water, and catch in the crucible the mercury which overflows while the mercury in the thermometer expands. The simplest way is to hold the crucible by the side of the tube and scrape the mercury into it. When the mercury ceases to overflow, remove the burner and allow the thermometer to cool.

Note the barometric pressure, correct it for the temperature and latitude, and deduce from it the temperature of the steam.

Weigh the thermometer with the mercury left in it as soon as it is cool enough to be handled comfortably. Also weigh the crucible with the escaped mercury.

Let t° = the temperature of the steam, as calculated.

w = mass of empty weight-thermometer.

c = " " " crucible.

w' = " " weight-thermometer + mercury left in it after heating to t° .

c' = " " crucible + collected mercury.

Hence $m = c' - c$, mass of mercury expelled from the thermometer,

and $M = w' - w$ " " " left in thermometer,

and $\therefore \frac{v_t - v_0}{v_0 t} = \frac{M\beta - \frac{m}{t}}{M + m}$, the coefficient of cubical expansion of the glass, can be calculated.

ILLUSTRATION

May 3, 1889

CUBICAL EXPANSION OF GLASS

 $t^{\circ} = 101.28^{\circ}$, calculated from barometer. $w = 27.081$ grams. $w' = 289.263$. $\therefore M = 262.282$. $c = 4.588$ " $c' = 8.690$. $\therefore m = 4.116$.

$$\therefore \alpha = \frac{M\beta - \frac{m}{t}}{M + m} = \frac{262.282 \times 0.000162 - \frac{4.116}{101.28}}{266.348} = 0.0000265.$$

Questions and Problems.

1. Explain in brief how the above result can be used to find the mean coefficient of expansion of any liquid.
2. Is there any relation between the coefficients of linear and cubical expansion of the same substance; and, if so, what is it?
3. Describe a method for determining the absolute coefficient of expansion of mercury.
4. Describe a method by which a weight-thermometer may be used to measure temperature.
5. A cylinder of iron 50 centimetres long floats upright in mercury. If the temperature rises from 0° to 100° C., how far will the cylinder sink?
6. A glass test-tube contains 50 cubic centimetres of mercury at 10° C. If the temperature is raised to 80° C., what is the *apparent* volume of the mercury?

EXPERIMENT 48

Object. To measure the increase of pressure of air at constant volume when the temperature is increased. (See "Physics," Arts. 177, 178, 179.)

General Theory. If the volume of a given amount of air is kept constant, but the temperature varied, the pressure will change according to the law,

$$p = p_0(1 + \beta t);$$

where p_0 is the pressure at 0°C. ,

p_t " " " " at $t^\circ \text{C.}$,

β is a constant, and is called the "coefficient of expansion of the gas at constant volume." (It is known that β is the same for all gases—Charles's Law—and that its value is the same as the coefficient of cubical expansion at constant pressure.)

The general method is to enclose the gas in a bulb which has a long, bent stem, as shown, the open end of the stem being connected by a rubber tube to a vessel containing mercury. By raising or lowering this vessel the mercury may be made to rise or fall in the stem connected with the bulb; so, however the pressure of the gas changes,

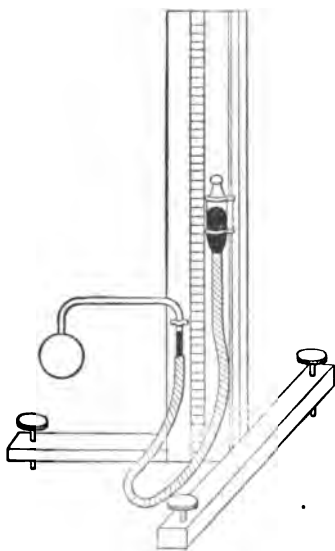

FIG. 97

the volume may be kept the same. Further, by measuring the differences in height of the surfaces of the mercury in the two arms, the pressure on the gas may be measured.

The gas is then subjected to different temperatures, and the corresponding pressures measured, while the volume is kept constant.

Sources of Error.

1. The air may not be dry.
2. Bubbles of air may cling inside the rubber tube and cause trouble by escaping.
3. The stem of the bulb is not at the same temperature as the bulb.
(In accurate work allowance must be made for this.)
4. Allowance should also be made for the expansion of the bulb.

Apparatus. Air thermometer-bulb, rubber tubing, mercury reservoir on stand; mercury-tray; beaker of ice; special boiler; Bunsen-burner; tripod; thermometer.

Manipulation. The bulb has been filled by an instructor with dry air, and the apparatus should not be disturbed during the experiment.

Set up the "air thermometer" in a mercury-tray; hang a mercury thermometer on the frame between the two mercury columns, and surround the bulb with cracked ice so as to reduce the temperature to 0° . As the gas contracts, the pressure decreases; and care must be taken to keep lowering the vessel of mercury so as not to allow the mercury to be drawn over into the bulb. By means of the movable basin bring the mercury surface in the stem to a fixed mark, either a scratch or a point inserted in the glass. Keep the mercury at this point during the entire experiment. When the temperature has fallen to 0° , as is indicated by no further change in the mercury in the open tube, record the difference in height of the two mercury surfaces. Displace the movable vessel and readjust. Do this three times in all. Call the mean difference of the two surfaces h_0 . If the free surface is higher than the surface in the stem of the bulb, the pressure on the gas

in the bulb is $p_0 = h_0 \rho g + \text{atmospheric pressure}$. Read the barometer and the mercury thermometer attached to the air thermometer. "Correct" both h_0 and the barometric height.

Remove the ice, and place the bulb in a special boiler in which water can be raised to boiling, and so steam can be made to surround the bulb. When steam is issuing freely from the boiler, record the difference in height of the two mercury columns, h_{100} , the volume of the gas being kept the same as before: make three settings. Read the mercury thermometer again, and also the barometer. The pressure of the gas, $p_{100} = \rho g h_{100} + \text{atmospheric pressure}$. "Correct" the readings as before. Calculate the temperature of the steam from the barometer reading.

Therefore, if β' is the "apparent" coefficient in glass,

$$p_{100} = p_0(1 + 100\beta'),$$

and

$$\beta' = \frac{p_{100} - p_0}{100p_0}.$$

The absolute coefficient equals β' , plus the coefficient of expansion of the glass.

Now remove the boiler, allow the bulb to cool, and, keeping the volume of the gas the same as during the rest of the experiment, measure the pressure when the bulb has reached the temperature of the room. From this pressure calculate the temperature.

ILLUSTRATION

EXPANSION OF DRY AIR

Nov. 24, 1896

0°

Difference in height, - 8.75 cm. Temperature of mercury, 22.2°.

Corrected, - 8.74 "

Barometer height, " 76.59 "

$$\therefore p_0 = 72.85 \times 13.6 \times 980.$$

Boiling-point, 100.23°

Difference in height, + 22.85 cm. Temperature of mercury, 23.3°.

Corrected, + 22.75 "

Barometer height, " 76.59 "

$$\therefore p_{100} = 99.84 \times 13.6 \times 980.$$

$$\therefore \beta' = \frac{p_{100} - p_0}{p_0 \cdot 100.22} = 0.00862$$

$$\text{Correction for glass} = 0.00008$$

$$\text{Absolute coefficient of expansion} = 0.00865$$

Questions and Problems.

1. Calculate R for oxygen, hydrogen, nitrogen.
2. Form product $R \times$ "molecular weight."
3. Calculate J , "mechanical equivalent," from R , C_p , C_v .
4. If hydrogen fills a glass tube containing 500 cubic centimetres, open at one point, at temperature 20°C ., pressure 76 centimetres of mercury, how much gas in grams will escape if the temperature is raised to 100°C . ?
5. How much work is done by 1 gram of hydrogen, if it expands from volume 500 cubic centimetres to volume 1000 cubic centimetres, the pressure being constant, the temperature at starting being 20° ? What must be the rise in temperature to produce this expansion ? How much heat has been furnished ?
6. Calculate on the kinetic theory the average speed of a molecule of H , of O , of N , at 0°C . and pressure 76 centimetres.
7. The formula for steam is H_2O ; 20 cubic centimetres of H and 20 cubic centimetres of O are mixed ; an electric spark is passed ; what is the resulting volume, the initial and final temperature and pressure being the same ?

EXPERIMENT 49

Object. To determine the specific heat of a metal—*e. g.*, lead or brass, cut in small pieces. (See “Physics,” Art. 184 *a.*)

General Theory. By definition, the specific heat of any substance is the number of calories necessary to raise the temperature of one gram of it one degree centigrade. This is different for different temperatures of the substance, and so the average specific heat through a certain number of degrees is usually measured. It may be assumed within the limits of errors of this experiment that the specific heat of water is constant; and hence by the definition of the calorie its value is one.

If M grams of a metal at temperature T_0° are quickly placed in m grams of water at temperature t_0° , the water being contained in a calorimeter whose “water-equivalent” is α , the final temperature t° reached after equilibrium is such that, if s is the specific heat of the metal,

$$Ms(T_0^\circ - t^\circ) = (m + \alpha)(t^\circ - t_0^\circ),$$

if no heat energy is gained from or lost to surrounding bodies.

By “water-equivalent” is meant the number of calories required to raise the temperature of the calorimeter, the stirrer, and the thermometer one degree. Owing to the small numerical value of the specific heat of the calorimeter, α is a small quantity; and its value can be determined by a preliminary experiment, the method used being one which is not so accurate as that of the main experiment. The method is this: Pour m_1 grams of water in the calorimeter; measure its temperature, t_1° (keeping the stirrer

and thermometer in it); add a known mass (m_2) of water at a higher temperature, T_1° ; and let the final temperature of equilibrium be T° . Then, since the specific heat of water is 1,

$$(a + m_1)(T - t_1) = m_2(T_1 - T): \\ \therefore a = m_2 \frac{T_1 - T}{T - t_1} - m_1.$$

This value may be substituted in the first formula, and s thus determined.

Sources of Error.

1. Heat energy may be lost by radiation, conduction, or evaporation. If the radiation is considerable, it may be allowed for in either of two ways. (See Experiments 52 and 54.)
2. There may be a drop in temperature as the metal is transferred from the heater to the water.
3. There may be differences between the two thermometers.
4. The metal may not be quite dry.

Apparatus. A hypsometer without the conical top; a copper dipper fitting on top of this; two centigrade thermometers; one large and one small nickel-plated calorimeter; a stirrer; a large cork to fit the larger calorimeter; a pasteboard cover for the dipper; a beaker-glass; about 200 grams of shot or 100 grams of brass wire cut in fine sections; tripod with asbestos plate; Bunsen-burner, etc.

Manipulation. 1. *Preliminary.*—Determining the water-equivalent for the smaller calorimeter.

Thoroughly dry the smaller calorimeter and its stirrer, and find their combined mass by weighing on a platform-balance. Call this mass m' . By means of the large cork with a hole in its centre fit the smaller calorimeter inside the larger, with their axes coin-



FIG. 98

ciding and their upper edges flush, as represented in the diagram.

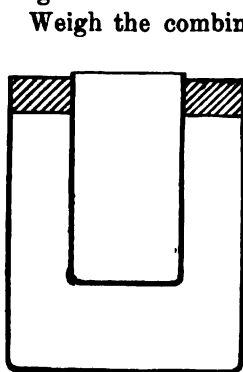

FIG. 99

Weigh the combined apparatus, and add enough water to fill the inner calorimeter about one-quarter full. Let the mass of the water added be m_1 grams. Keep the stirrer in the inner calorimeter. Put one of the thermometers into the inner calorimeter, with the bulb near the bottom, and cover the opening with a piece of paper or cardboard. After the mercury column has been observed to remain stationary for several minutes, read the temperature. Apply the proper corrections to this reading, and call the temperature thus found t_1° . This should be the temperature of the inner calorimeter.

Fill with water a beaker-glass whose capacity is at least equal to that of the smaller calorimeter, and heat it to about $t_1^\circ + 15^\circ$. Quickly fill the calorimeter about two-thirds full of this heated water, noting the exact temperature (T_1°) of the water just before pouring it into the calorimeter. Before reading this temperature the water must, of course, be well stirred to insure its being at a uniform temperature throughout. After the water has been poured into the calorimeter, stir it gently but thoroughly, noting the temperature (T) after a few seconds, when equilibrium seems to have been reached. Then remove the thermometer, and weigh the smaller calorimeter and stirrer with the water it contains. The mass thus found, diminished by $m' + m_1$, is the mass (m_2) of water used, and so α , the water-equivalent, may be calculated from the formula,

$$\alpha = m_2 \frac{T_1 - T}{T - t_1} - m_1.$$

Dry the calorimeter and stirrer, and determine α twice

more, correcting all the observed temperatures for the errors of the thermometer. Average the three values of a .

2. *Experiment Proper.*—Determining the specific heat of lead or brass. Pour enough water into the boiler to rise to within a short distance of the bottom of the dipper, and commence heating it. Weigh out on the platform-balance about 200 grams of small dry shot or 100 grams of pieces of brass wire. Let the exact mass be M grams. Pour the metal pieces into the dipper on top of the boiler, and cover it with a cap made of a piece of card-board. Plug up the escape-tube in the side of the boiler, so that the steam will be forced out only between the flange of the dipper and the upper edge of the boiler. The second thermometer, which has not yet been used, must be set vertical, with its bulb surrounded by the metal and its stem through the cap of the dipper. While the water in the boiler is being heated and vaporized, weigh out about 50 grams of water in the smaller calorimeter. This may be done by placing weights equal to about $(m' + 50)$ grams on one scale-pan of a balance, and the calorimeter and stirrer on the other pan, and then pouring water into the calorimeter until the scale balances. Let the exact mass of the water be m grams.

Adjust the smaller calorimeter in the larger one, as explained above. Insert in the water the thermometer used in finding the water-equivalent, with its bulb near the bottom, and cover the vessel with a cap; note the temperature of the water. Note the reading (T_0°) of the thermometer in the dipper when it has reached its highest temperature, which it will retain as long as the boiler works properly. Next, quickly remove the cap and thermometer from the dipper, raise the cap of the calorimeter, and very rapidly, but carefully, pour the hot metal into the calorimeter. Instantly replace the cap on the calorimeter, and thoroughly stir the water with the stirrer. Let the temperature of the water just before the metal is trans-

ferred be t_0° , and let the highest temperature reached after the hot metal has been poured in be t° .

Repeat the experiment proper three times in all, correct- ing all temperatures, and always using perfectly dry metal. Read the thermometer to at least tenths of a degree.

$$\text{Specific heat} = s = \frac{(m + a)(t - t_0)}{M(T_0 - t)}$$

ILLUSTRATION

March 10, 1881

SPECIFIC HEAT OF LEAD

1. *Water-Equivalent*

1st	2d	3d
$m_1 = 80.0$ grams	80.0 grams	80.0 grams
$m_2 = 60.15$ "	62.25 "	58.75 "
$T_1 = 81.55^\circ$ C.	85.1° C.	83.1° C.
$T = 26.8^\circ$ C.	29.6° C.	27.9° C.
$t_1 = 18.4^\circ$ C.	19.6° C.	18.9° C.
$a = 4.08^\circ$	4.05°	3.98°

Mean, $a = 4.02^\circ =$ water-equivalent of calorimeter.

2. *Specific Heat of Lead* $(m' = 42.24$ grams)

1st	2d	3d	4th	5th
$M = 212.18$ grs.
$m = 51.18$ "	50.28 grs.	49.63 grs.	58.21 grs.	52.45 grs.
$T_0 = 98.7^\circ$ C.	99.40° C.	99.1° C.	98.8° C.	98.6° C.
$t = 28.7^\circ$ C.	28.0° C.	27.4° C.	29.7° C.	27.7° C.
$t_0 = 20.8^\circ$ C.	19.1° C.	18.5° C.	21.6° C.	19.4° C.
$s = 0.0314^\circ$	0.0319°	0.0318°	0.0317°	0.0312°

Mean, $s = 0.0315^\circ$.

Questions and Problems.

1. Explain in full the derivation of the above formula for s .
2. In finding the water-equivalent of the calorimeter, why was it necessary to fill the beaker-glass *full* of water?
3. Give a reason for keeping the *same* thermometer in the calorimeter throughout the experiment.
4. Is the highest temperature reached by the metal the same as the true boiling-point of water under the existing conditions?
5. Could this method be used if there were chemical action between the lead and the water? Give reasons.
6. Calculate the error introduced in s if an error of 0.1° were made in reading t , t_0 , or T_0 .

7. If 1 gram of water and 1 gram of mercury are heated in turn over the same burner, which will boil in the least time, if their initial temperatures are 0°C . ?
8. A litre of water whose temperature is 0°C . is mixed with a litre of water whose temperature is 100° ; what will be the final temperature?

ILLUSTRATION

Nov. 12, 1887

SPECIFIC HEAT OF TURPENTINE

$$\alpha = 19.97$$

$$\left. \begin{array}{l} M = 54.72 \text{ grams.} \\ m = 28.18 \text{ " } \\ t_0 = 97.2^\circ \text{ C.} \\ T = 49.8^\circ \text{ C.} \\ T_0 = 20.4^\circ \text{ C.} \end{array} \right\} \therefore s_1 = 0.465$$

$$\left. \begin{array}{l} M = 50.21 \text{ grams.} \\ m = 27.46 \text{ " } \\ t_0 = 97.5^\circ \text{ C.} \\ T = 51.0^\circ \text{ C.} \\ T_0 = 20.8^\circ \text{ C.} \end{array} \right\} \therefore s_2 = 0.456$$

$$\left. \begin{array}{l} M = 57.21 \text{ grams.} \\ m = 30.02 \text{ " } \\ t_0 = 97.8^\circ \text{ C.} \\ T = 56.5^\circ \text{ C.} \\ T_0 = 30.1^\circ \text{ C.} \end{array} \right\} \therefore s_3 = 0.472$$

$$\left. \begin{array}{l} M = 52.24 \text{ grams.} \\ m = 26.38 \text{ " } \\ t_0 = 97.4^\circ \text{ C.} \\ T = 52.0^\circ \text{ C.} \\ T_0 = 24.6^\circ \text{ C.} \end{array} \right\} \therefore s_4 = 0.451$$

$$\left. \begin{array}{l} M = 58.83 \text{ grams.} \\ m = 32.56 \text{ " } \\ t_0 = 98.3^\circ \text{ C.} \\ T = 52.9^\circ \text{ C.} \\ T_0 = 19.8^\circ \text{ C.} \end{array} \right\} \begin{array}{l} \therefore s_5 = 0.460 \\ \hline \text{Mean, } 0.461 \end{array}$$

Questions and Problems.

1. Explain in detail the derivation of the above formula for s .
2. Describe a method for the determination of specific heats in which there is no need for a correction due to the water-equivalent of the calorimeter or to radiation.

EXPERIMENT 51

Object. To determine the "melting-point" of paraffine. (See "Physics," Art. 187.)

General Theory. When a solid is heated, its temperature rises gradually until it begins to melt (or vaporize), and while the solid is changing into the liquid state the temperature either remains constant or changes at an abnormal rate. All crystals and most pure substances keep their temperature unchanged while the process of fusion is in progress, *provided the mixture of solid and liquid is well stirred.* For such substances the fusion- or melting-point is the temperature at which the solid and liquid are in equilibrium together. (See Experiment 44.) Obviously, such substances, as they pass from the liquid into the solid state, begin to solidify at the "fusion temperature."

However, when waxes and certain other bodies which become "pasty"—such as plumbers' solder—begin to melt, the temperature does not remain constant, but continues to change during the entire process until they are liquefied completely; and if they are cooled when in the liquid state the temperature at which they begin to solidify is not that at which they previously began to melt. The average of these two temperatures is definite for any one substance, however; and this is called the fusion-point.

To determine this temperature for paraffine, therefore, it is simply necessary to observe the temperature at which it begins to melt and that at which it begins to solidify after having been melted. (Naphthaline has been recommended as a suitable substance to use in this experiment in place of paraffine. It has a definite melting-point, but its odor

when melting is most disagreeable, and so it should be melted under a hood.)

Sources of Error.

1. The true temperature of the paraffine may not be recorded by the thermometer.
2. Errors may be introduced by radiation, if the temperature differs much from that of the room, or if the apparatus is exposed to the radiation from very hot bodies.

Apparatus. Some small pieces of paraffine wax; a centi-grade thermometer; a large beaker-glass; a large test-tube; an iron tripod; an asbestos plate; a piece of glass tubing about fifteen centimetres long and six millimetres in diameter; a Bunsen-burner, with rubber tubing; wire stirrers, etc.

Manipulation. Heat the glass tube uniformly on all sides, by twirling it around in a Bunsen flame until it becomes quite soft; draw it out of the flame and pull it out into a long capillary tube about one millimetre in internal diameter. Break off the capillary tube so as to leave about four centimetres beyond the point where it widens out into the tube proper, and bend the capillary point into a hook, as shown. Fill the capillary tube entirely with paraffine, either by placing fragments of the wax in the upper wide part of the tube, and heating the tube in hot water, allowing the wax to run down into the capillary part, or by liquefying the wax in any suitable vessel and drawing it up into the capillary tube by suction. Fill the beaker-glass with tap water and place it on the asbestos plate upon the tripod. Bind the thermometer to the wide part of the glass tube by means of thread or a rubber band, so that its bulb is below the middle of the capillary tube. Place them in a test-tube, together with a wire bent so as to form a stirrer. Suspend the test-tube vertically in a beaker of water, submerging the greater part of the capillary tube. Heat the water gradually, and note carefully, estimating to tenths of the smallest scale division the temperature at which



FIG. 100

the solid paraffine commences to liquefy, which will be shown by its losing the opaque, whitish color and becoming transparent and colorless. *Stir the water constantly in both test-tube and beaker.* If bubbles of air obscure the capillary tube by sticking to it, remove them by stroking the tube with the wire stirrer. When all of the submerged wax has melted, remove the flame and allow the water to cool. Continue to stir, and note at what temperature the whitish color reappears in the paraffine. The arithmetical mean of the two temperatures thus found is called the melting-point of the paraffine. Repeat this process of heating and cooling four times in all, taking the average each time, and finally taking the mean of all four results.

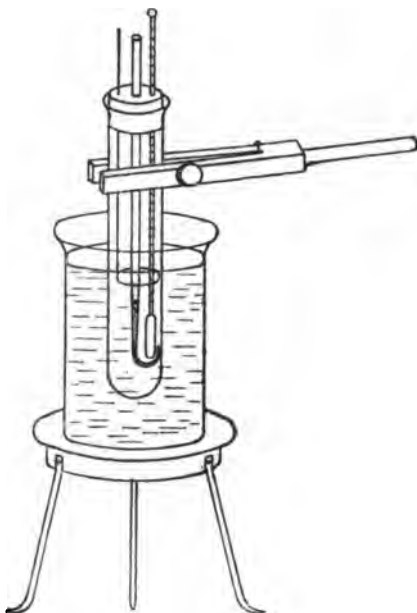

FIG. 101

If the thermometer has large corrections for its fixed points, their influence upon the above-noted temperature must be calculated, and the resulting corrections applied to the observed temperature to get its true value.

ILLUSTRATION

Sept. 4, 1891

MELTING-POINT OF PARAFFINE

Heating	Cooling	Mean	} Average, 53.83°.
52.8°	54.8°	53.8°	
53.0°	54.4°	53.7°	
53.2°	54.6°	53.9°	
53.3°	54.5°	53.9°	

Thermometer No. 48 } 0° mark too low by 0.4°.
 { 100° " " high " 0.6°.

$$\text{Corrected temperature} = \frac{100}{99.4 - 0.4} (53.83 - 0.4) = 53.96^\circ.$$

Questions and Problems.

1. Mention two or more objections to performing the above experiment by simply immersing the bulb of the thermometer in liquid paraffine and noting the temperature when it solidifies and again when it fuses by reheating.

EXPERIMENT 52

(TWO OBSERVERS ARE REQUIRED)

Object. To determine the latent heat of fusion of water.
(See "Physics," Art. 189.)

General Theory. The latent heat of fusion is defined as the number of units of heat required to convert one gram of a substance from the solid into the liquid state, *without change of temperature*. A known mass of ice is melted by putting it in water whose mass and temperature are also known; and the consequent fall in temperature of the water is noted. The energy required to melt the ice and raise the temperature of the water thus formed to that of the mixture is given out by the calorimeter and the water it contains, provided there is no external radiation or conduction.

Let α = water-equivalent of calorimeter and stirrer.

m = mass of water in the calorimeter before the ice is put in.

M = mass of ice melted.

L = latent heat of ice.

T° = temperature of water and calorimeter before the ice is put in.

Θ° = temperature of water and calorimeter just after the ice is all melted.

Then, if there are no extraneous losses or gains of energy,

$$(\Theta + L)M = (m + \alpha)(T - \Theta).$$

$$\therefore L = \frac{(m + \alpha)(T - \Theta)}{M} - \Theta.$$

The above deduction of the formula is based on the as-

sumption that there are no other exchanges of heat than those between the ice, the water, and the calorimeter. This assumption is not justified unless special precautions are taken to avoid heat being added to the calorimeter and its contents, or taken from them, by the air and surrounding objects. If the initial temperature of the water is equal to that of the surrounding air, then, when the ice is added, the temperature of the water will be lowered, and consequently heat will flow into the mixture from the air, and the final temperature will be too high. This difficulty may be avoided by making the initial temperature of the water greater than that of the room, and so choosing the amounts of water and ice used that the final temperature will be just as much below that of the air as the initial temperature was above it. Thus the amount of heat radiated by the water and the calorimeter, while cooling to the temperature of the air and surrounding bodies, is counterbalanced by the amount of heat absorbed while cooling from the temperature of the air to that finally reached, provided the *rate* of fall be the same above and below the temperature of the air. (Experience shows that 20° C. is a good range through which to cool the water by adding ice.)

Time will be saved by knowing beforehand the amount of ice necessary to bring about the fall in temperature of 20° C. This may be calculated from the above formula by assuming the approximate latent heat of ice to be known. (If the approximate value of L were not known, it could be found by a preliminary experiment similar to this one, but leaving out the radiation correction.) Assume $L = 80$ approximately; and if t° is the temperature of the air where the experiment is performed, and m the number of grams of water to be used, the number of grams M' of ice necessary to cool it from $T^{\circ} = t^{\circ} + 10$ to $\Theta^{\circ} = t^{\circ} - 10$ is given by the formula.

$$(\Theta + 80)M' = 20(m + a); \text{ whence } M' = 20 \left(\frac{m + a}{\Theta + 80} \right) = 20 \frac{m + a}{t + 70}.$$

An approximate value of a may be found by multiplying

the mass of the calorimeter and stirrer by 0.095, which is the specific heat of copper. Consequently, M' may be calculated. Therefore, approximately, the above masses of ice and water should be used so as to avoid having to take account of radiation when the cooling takes place from $(t^\circ + 10^\circ)$ to $(t^\circ - 10^\circ)$.

Sources of Error.

1. There still may be losses or gains of heat energy by radiation or conduction.
2. The ice may not be dry.
3. Care must be taken not to lose water by splashing while stirring or putting in the ice.
4. The ice must be kept below the surface of the water.

Apparatus. A large-size nickel-plated calorimeter; a circular stirrer covered with wire gauze; a vessel large enough to enclose the calorimeter; a thermometer; some ice; drying-paper; cotton-wool; a large beaker, in which to heat water; a tripod; asbestos dish; Bunsen-burner, etc.

Manipulation. The water-equivalent of the calorimeter and its stirrer must be either determined as in the two pre-

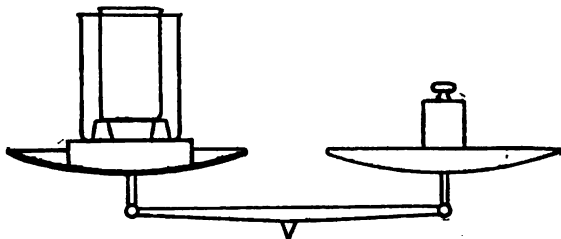

FIG. 102

vious experiments, or calculated from a knowledge of their mass and material, in which case their specific heats may be found in tables.

Then proceed with the experiment in the following manner: Carefully weigh the calorimeter and stirrer together on the platform-balance. Call the mass m' . Fill the calorimeter about two-thirds full of water, leaving the stirrer

in, and weigh again. This mass, less m' , is the mass of water needed to fill the calorimeter two-thirds full. (If there is a fraction of a gram, only the nearest whole number may be noted.) This whole number is m , the mass of water which is to be used in the final experiment. Note the temperature t° of the room near the balances with the thermometer to be used in the rest of the experiment. From m and t° calculate M' , as explained above. Empty and thoroughly dry the calorimeter and stirrer. Rest the calorimeter on three corks of equal height inside the beaker. Fill the space between the calorimeter and glass with cotton-wool. Make a level pad of cotton-wool on the scale-pan and place on it the beaker, with the calorimeter, thermometer, and stirrer inside. Counterpoise this whole mass (K) with weights. Add weights equal to m grams to the counterpoise already in the scale-pan. Heat more than m grams of water to about $(t + 20)$ degrees in any suitable vessel.

While the water is being warmed break into pieces, the size of small chestnuts, a good deal more than M' grams of ice. The cracked ice may be kept from melting by putting it in a covered beaker, which is floated deeply in a larger vessel full of ice and water. The quantities of ice and water just mentioned need not be weighed, but roughly estimated. When everything is ready, pour the heated water into the calorimeter until the mass $K + m$ is exactly balanced, using a pipette to make the final adjustment. Add weights equal to the whole number nearest M' grams to the $K + m$ grams already on the scale-pan. Stir the water continually but gently; and, when its temperature is a *little* above $(t + 10)$ degrees begin to add *dry* pieces of ice, always placing them *under* the gauze of the stirrer. Keep on stirring and add the ice slowly, but never let all the ice in the calorimeter melt before more is put in. Note T° , the temperature of the calorimeter, at the very instant before the first piece of ice enters. The ice should be thoroughly dried by wiping it with cold drying-paper; and it should never be allowed to touch any warm object, such as

the hand. Continue to add dry pieces of ice until the scales are very nearly balanced. Test the balance often by pressing down with a finger the pan holding the calorimeter, so as to feel how much more ice is needed. Stir the mixture gently and continuously, noting from time to time the fall in temperature. When the mass in the calorimeter has become only a very little too small add one piece of dry ice, and note the temperature (Θ°) of the mixture at the very instant the last piece of ice disappears. Now make whatever slight change may be necessary in the weights in the other pan to bring about an exact balance. Call the total weight thus found W . Then the exact mass of ice put in and melted is $W - (K + m)$ grams = M . Substitute m , M , Θ , and T in the formula and calculate the latent heat of ice. Repeat the experiment and tabulate the results as below.

ILLUSTRATION

LATENT HEAT OF FUSION OF ICE

Oct. 24, 1894

Calculation for M'

$$\left. \begin{array}{l} m' = 270.96 \text{ grams} \\ m = 1021.03 \text{ " } \\ t = 28.7^\circ \text{ C.} \end{array} \right\} \therefore M' = \frac{20(1021 + 0.095 \times 271)}{28.7 + 70} = 228 \text{ grams.}$$

Experiment 1

$\alpha = 25.7$
 $m = 1021$ grams
 $M = 224.07$ "
 $T = 34.6^\circ \text{ C.}$
 $\Theta = 14.4^\circ \text{ C.}$
 $L = 80.08$

Experiment 2

25.7
 1045 grams.
 222.61 "
 38.6° C.
 14.0° C.
 80.01

Mean = 80.02

Questions and Problems.

1. Why is it necessary to have the stirrer covered with gauze and to place the ice beneath it?
2. If in a copper calorimeter of mass 100 grams, which contains 1000 grams of water at 80° C. , there be dropped 10 grams of ice at 0° C. , what is the final temperature?
3. If 10 grams of lead at 100° C. be put into a Bunsen ice calorimeter, what change in volume will the mercury index indicate?
4. How many ergs are required to make 1 gram of ice pass from -10° C. to 60° C. , the atmospheric pressure being 76 centimetres of mercury?



EXPERIMENT 53

Object. To determine the boiling-point of benzene. (See "Physics," Art. 194.)

General Theory. The boiling-point of a liquid is the temperature at which ebullition takes place freely under a given pressure; or, what is the same thing, it is the temperature of equilibrium of the vapor and liquid at the given pressure. To determine it, a liquid is made to boil freely, and a thermometer is immersed in the vapor (not in the liquid), and its temperature is read.

Sources of Error.

1. The most serious source of error is loss of heat by radiation.
2. The pressure on the vapor must remain constant.
3. Irregular boiling should be avoided as far as possible by putting in the liquid a few pieces of sharp-pointed glass, and by heating gradually.

Apparatus. A boiling apparatus, consisting, as shown, of one test-tube held inside another, the inner having two holes in it—one in the side near the top, the other at the bottom; a condenser, consisting of a tube or flask surrounded by a water-jacket; a large beaker; stirrer; Bunsen-burner, tripod, etc.; a roll of asbestos; 20 cubic centimetres of benzene; thermometer; clamp-stand.

Manipulation. *Caution.*—The vapor of benzene is most inflammable, therefore be sure that all connections are tight.

Arrange the apparatus near a water tap and sink.

Insert the roll of asbestos in the inner test-tube, so as to make a lining to it; put a thermometer through the cork,

and also a glass tube leading to the condenser. Place the benzene in the bottom of the outer test-tube, and lower into place the inner tube, holding it by means of a tight-fitting cork so that it does not touch the liquid. Support the larger test-tube in a clamp-stand, and place around it a water-bath — *e. g.*, a beaker filled with water, supported on an asbestos dish and tripod. Join the inner test-tube to a Liebig's condenser, and attach to the other end of the condenser a small Florence flask to catch the condensed liquid. It may be well to have this flask surrounded as far as possible by cold water. Connect the water-jacket of the condenser to the water tap and sink, and turn the water slowly on.

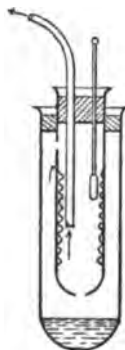

FIG. 108

By means of a Bunsen-burner raise the temperature of the water-bath until the benzene is boiling freely; stir the water constantly by means of a stirrer. When the thermometer reaches a steady state, read it carefully. Turn out the Bunsen-burner; read the barometer; then relight the burner, and make another reading.

Remove the asbestos lining from the inner test-tube, and measure the boiling-point again, and account for the observed change.

ILLUSTRATION

April 28, 1896

BOILING-POINT OF BENZENE

a. With Asbestos		b. Without Asbestos
80.3° ± .2		81.0°
<u>80.4° ± .1</u>		<u>81.0°</u>
Mean, 80.35°		Mean, 81.0°

Barometer, 75.76 centimetres.

Questions and Problems.

1. Explain in full the influence of radiation in this experiment.
2. What is the effect of dissolved substances upon the boiling-point? Upon the vapor-pressure? Upon the temperature of the vapor?
3. What is the influence of the material and smoothness of the walls upon boiling and upon condensation?

EXPERIMENT 54

(TWO OBSERVERS ARE REQUIRED)

Object. To determine the latent heat of evaporation of water at 100° C. (See "Physics," Art. 195.)

General Theory. The latent heat of evaporation is by definition the number of calories required to make one gram of a liquid pass into the state of vapor at a definite temperature; conversely, this number of calories is given up by the vapor if one gram condenses to liquid at the same temperature. Consequently, if m grams of steam are condensed at t_0° by being passed into M grams of water, whose initial temperature is T_0° , the temperature of the water will rise to a temperature t° , where, if a is the water-equivalent of the calorimeter, and L the latent heat of steam at t_0° , t satisfies the equation

$$m(L + t_0 - t) = (M + a)(t - T_0).$$

The temperatures and masses may all be measured, and so L can be determined, for

$$L = \frac{M + a}{m}(t - T_0) - (t_0 - t).$$

Particular precautions must be taken to guard against interchange of heat energy with surrounding bodies.

Sources of Error.

1. If the steam is not quite dry as it enters the water, a great error is introduced.
2. There are always losses due to radiation and conduction.
3. The pressure on the steam should be kept constant.

Apparatus.* Two calorimeters—large and small—one fastened in the other by a cork; a cover for the inner one; a condensing vessel to go in the smaller calorimeter; stirrer; thermometer; rubber tubing; boiler; glass water-trap; Bunsen-burner. The condensing vessel, into which the steam is to be admitted, consists of a metal can on legs, which rests inside the smaller calorimeter.

Manipulation. Determine the water-equivalent, a , of the inner calorimeter, condenser, and stirrer, either by actual experiment or calculation. Weigh the calorimeter and its appliances empty and dry; then fill it about two-thirds full of water, allowing none to enter the condenser, and weigh again. Record both weightings and deduce the mass, M , of water in the calorimeter. Place the smaller calorimeter inside the larger, and put on the cover, leaving both tubes of the condenser projecting—the one to connect with the boiler, the other as an opening into the air of the room—so that the pressure inside the condenser may be as closely as possible that denoted by the barometer.

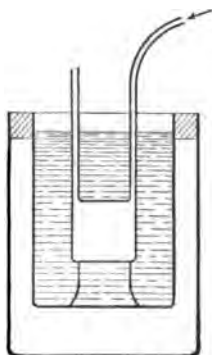

FIG. 104



FIG. 105

Set up the boiler as near the calorimeter as possible, and connect it to the condenser with rubber tubing. Insert in this connecting tube a glass trap, made as in the figure, and designed to catch any water that may be condensed. The trap must be vertical, and placed so that a short piece of rubber joined to it fits directly on to the condenser. Wrap the connecting tube and trap in cotton-wool. Place a board between the calorimeter and the boiler and burner. When the apparatus is set up as described, light

* This form of apparatus was suggested by Professor Schuster, of Manchester, England.

the burner, disconnect the trap from the condenser, and turn the trap away from the calorimeter, so that the steam may not strike the latter until it is desired to make the connection again. When steam has been issuing freely from the tube long enough to heat it thoroughly, measure the temperature, T° , of the water in the calorimeter, note the time on a watch or clock, and at once make the connection with the condenser. Stir constantly, and read the temperature from time to time, recording the minutes and seconds. When the temperature has risen to about 50° or 60° C., deftly remove the steam-tube and note the time. Note the exact temperature at the time of removal of the steam-tube.

Allow the water to stand for five minutes, stirring constantly and noting the change of temperature at intervals of thirty seconds. Remove the calorimeter from its outer vessel, weigh, and thus calculate the amount of steam which has condensed, m . The temperature of the steam as it enters, t_0° , may be calculated from the reading of the barometer. It will be noticed that the temperature of the water continues to rise for some time after the steam-pipe is disconnected, owing to the time taken for the temperature within and without the condenser to become the same. Then the temperature falls gradually. The rate of fall—*i. e.*, the decrease in temperature per second—is approximately a measure of the rate of loss of heat by radiation, while the temperature of the water was rising. Consequently, the product of the time taken by the temperature of the water to rise from T_0 to its highest value by the *rate of fall* is a correction which must be added to the highest temperature reached, in order to give the temperature which would have been reached if there had been no loss by radiation during this rise. Let t° be this corrected highest temperature, then

$$L = \frac{M + a}{m} (t - T_0) - (t_0 - t).$$

Repeat the experiment, using different amounts of water and different temperatures.

NOTE.—A graphical method of making the radiation correction just described is as follows:

Plot the times from the instant steam is admitted as abscissas, and the temperatures as ordinates. The curve connecting the points will be as shown. The highest recorded temperature is given by the highest point of the curve; and the radiation correction is found by producing backward the line of cooling, which is approximately straight. The point where this line intersects the temperature axis gives the temperature which would have been reached if there had been no radiation.

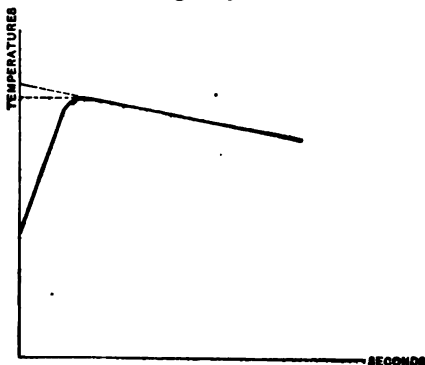

FIG. 106

ILLUSTRATION

May 3, 1897

LATENT HEAT OF STEAM

Experiment I	Experiment II	
$M = 70.665$	$M = 70.930$	
$\alpha = 18.19$	$\alpha = 18.19$	
$m = 8.180$	$m = 5.690$	
$T_0 = 17.0^\circ \text{C.}$	$T_0 = 1.5^\circ$	} So chosen as to avoid radiation correction.
$t_0 = 100^\circ$	$t_0 = 100^\circ$	
$t = 68^\circ + 4^\circ = 72^\circ$	$t = 40.6^\circ$	
$\therefore L = 535$	$\therefore L = 536$	

Questions and Problems.

1. Explain the energy changes—kinetic and potential—when 1 gram of ice is melted and then boiled.
2. Explain under what conditions ice can be made to pass directly into the form of vapor.
3. Explain mathematically why the radiation curve gives the same result as the calculation.
4. Describe and explain the action of an ice-making machine.
5. If the sphere and balance-pan of a Joly steam calorimeter be of platinum and weigh 10 grams, what will be the increase in weight if, before steam is admitted, the sphere contains 10 grams of ice at 0°C. ?
6. A cryophorus contains 50 grams of water at 0°C. ; how much ice is formed when 1 gram of water is evaporated?

EXPERIMENT 55

Object. To verify the law of saturated vapor. (See "Physics," Arts. 192, 193.)

General Theory. If a liquid and its vapor are in equilibrium at a definite temperature, the pressure of the vapor is independent of the volume occupied. In other words, for a definite temperature of saturated vapor there is a definite pressure, and *vice versa*.

There are two methods by which this law may be verified: 1. By measuring the boiling-point of the liquid; for it may be shown to be constant at any definite pressure. (See Experiment 44.) 2. By actually measuring the pressure produced by saturated vapor at any definite temperature, the volume being varied.

In carrying out this second method, the direct plan is to force some of the liquid into a barometer so that it floats on the top of the mercury column, and to measure the pressure by the difference between the heights of a true barometer and the mercury column on which the liquid rests. The temperature may be kept constant by suitable baths, and the volume of the vapor may be varied by causing the mercury column to rise and fall relatively to the top of the tube. The formula for the pressure is given in full below.

Sources of Error.

1. There may be traces of gas, particularly air, mixed with the vapor.
2. The vapor may not be at the temperature of the bath.
3. Expansion and compression of a gas always change its temperature unless they are done very slowly.

Apparatus. There are two forms of the apparatus :

1. A long clean glass tube closed at one end is filled almost entirely with mercury. Air and all other gases were expelled when the apparatus was made, and afterwards a little water was introduced which remains in the space above the mercury, partly as liquid and partly as water vapor, the latter being always saturated, since more water would evaporate were it not. The other end of the tube is bent up and left open. A metre scale is put between the tubes so that the level of the mercury in each may be measured. The open end is connected with a siphon and pinch-cock, so that mercury may be siphoned in or out of the tube, and the volume of the vapor increased or decreased at will by the consequent change of level of the mercury surfaces. The upper end of the closed tube is surrounded by a wider tube, to be filled with water of any desired temperature. The wide tube contains a thermometer and stirrer to measure the temperature and make it uniform throughout.

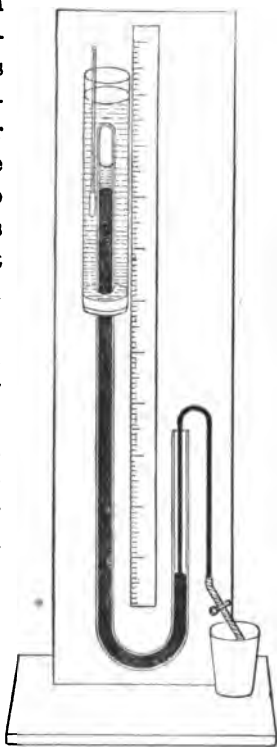

FIG. 107

2. A long, straight, clean barometer tube is supported vertically with its lower end immersed in a reservoir of mercury. Air, etc., were expelled as in the other apparatus, and ether was introduced, which now fills the tube above the mercury, partly as liquid and partly as saturated ether vapor. There is a water reservoir with thermometer and stirrer, as in the other apparatus, about the closed end of the tube to regulate its temperature. The volume oc-

cupied by the ether and its vapor is increased or diminished by raising the tube out of the mercury or lowering it into it. A metre-rod is used to measure the heights, and a clamp-stand to hold the tube.

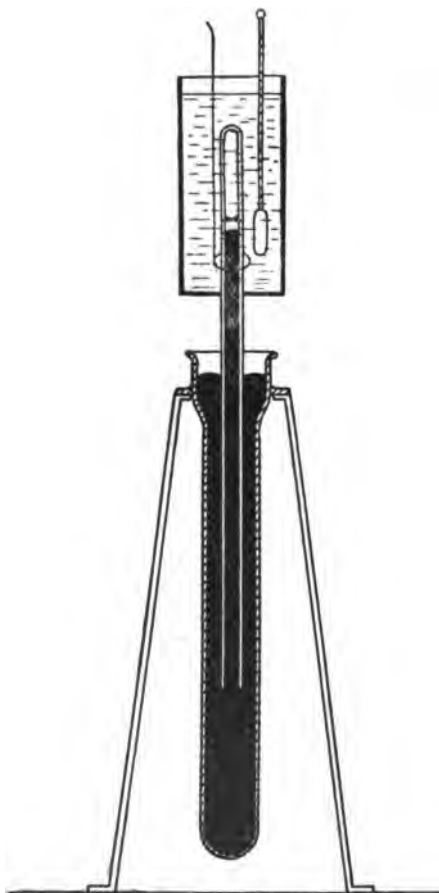

FIG. 108

Manipulation. Arrange the apparatus over a mercury-tray, so that the closed tube and millimetre scale are truly vertical. Fill the water reservoir around the upper end of the tube with tap water, and hang the thermometer in it. Hang another thermometer in the air near the lower end of the closed tube. Fill the open tube in Apparatus 1 (push down the tube in Apparatus 2) until most of the vapor is condensed. Do this slowly, so as to avoid great changes of temperature. Stir the water in the reservoir and watch the thermometer until

it becomes stationary. Call the temperature T° . Read the barometer, and, after stirring again and noting that the temperature is still the same, note the difference in height of the mercury columns in the two tubes (in Appa-

ratus 2 the height in the tube above the free surface), and also the height of the liquid above the mercury inside the closed tube. Use a piece of paper as described in Experiment 29 to make these measurements accurately. Then, if

h = height of mercury in closed tube above that in the open tube,

h' = height of liquid above mercury,

H = "corrected" barometer reading,

T = temperature in water reservoir,

t = temperature of lower thermometer,

ρ = density of mercury at t° ,

ρ' = density of the liquid at T° ,

the pressure of the vapor will be given by the formula

$$p = (13.6H - h\rho - h'\rho')980 \text{ dynes per square centimetre.}$$

Stir the water in the reservoir constantly, and siphon out enough mercury to increase the volume above the mercury by 20 centimetres. (In Apparatus 2 raise the tube to this extent.) Wait ten minutes at least before reading the new difference of level, stirring meanwhile; and if the temperature of the water in the reservoir falls, add enough hot water to bring it back exactly to T° again. When this temperature has been permanently obtained with the new volume, make the same series of readings as before—*i. e.*, the temperatures on the two thermometers, and the heights, h and h' .

Increase the volume again in the same way as much as can be done without evaporating all the liquid on top of the mercury. (There must be some liquid present as such, or the vapor will no longer be saturated.) Wait ten minutes or more again, restore the temperature T° by adding hot water if necessary, and repeat the readings as before.

Repeat the whole of the above process with the reservoir at the temperatures 60° and 80° ; but at 80° one increase of volume will be sufficient. Take the barometric reading again at the close of the experiment. Correct for any great errors in the thermometer and calculate the vapor-pressures.

ILLUSTRATION

LAW OF SATURATED VAPOR

Feb. 5, 1895

p is constant for different volumes if the temperature is constant.

Water-vapor

$$p = (18.6H - \rho h - \rho' h')980.$$

Corrected, $H = 75.83$ at beginning. } Mean, $H = 75.83$.
 " $H = 75.81$ at end. }

Case (A). $T^\circ = 19.8^\circ$ C. (corrected).

$$t^\circ = 19.8^\circ.$$

$$\rho' \text{ at } 19.8^\circ = 0.998; \rho = 13.55.$$

h	h'	$h\rho + h'\rho'$	Dif. from Mean
74.82	1.26	+ 1008.32	- .81
74.28	3.72	1010.13	+ 1.00
74.29	2.59	1009.15	+ .02

Mean, 1009.13

Hence it is evident that the pressure has remained constant to within 1 part in 1000, its value being

$$p = (75.83 - 74.2)18.6 \times 980 = 1.63 \times 18.6 \times 980.$$

Case (B). $T^\circ = 60.2^\circ$. $t^\circ = 19.4^\circ$.

$$\rho' = 0.983. \quad \rho = 13.54.$$

h	h'	$h\rho + h'\rho'$	Differences
60.98	1.33	827.53	- .41
60.95	2.41	828.21	+ .27
60.89	3.15	828.09	+ .15

Mean, 827.94

Again, the pressure has remained constant, its value being

$$p = (75.83 - 60.9)18.6 \times 980 = 14.93 \times 18.6 \times 980.$$

Case (C). $T^\circ = 80.1^\circ$. $t^\circ = 19.4^\circ$.

$$\rho' = 0.973. \quad \rho = 13.54.$$

h	h'	$h\rho + h'\rho'$	Differences
40.26	1.15	546.50	+ .09
40.18	2.63	546.32	- .09

Mean, 546.41

Hence $p = (75.83 - 40.2)18.6 \times 980 = 35.63 \times 18.6 \times 980$.

(Plot the observations, and draw a curve through the points.)

Questions and Problems.

1. Why does the temperature fall below T° when the volume is increased, and rise when it is decreased?
2. Would the pressure stay the same if the volume were increased after all the liquid had evaporated?
3. What change would take place?

EXPERIMENT 56

(TWO OBSERVERS ARE REQUIRED)

Object. To plot the "cooling curve" of a hot body in a space surrounded by walls at a constant lower temperature: 1. When the surface of the body and the walls are of polished metal. 2. When they are blackened. (See "Physics," Art. 206.)

General Theory. The rate of radiation of a body depends upon the nature of its surface, and upon the temperature and nature of surrounding bodies. The simplest method of comparing the radiation of different bodies under different conditions is to compare the rates at which their temperatures change—*i. e.*, to study their "cooling curves." Such a curve is obtained by observing the temperature of the body at small intervals of time, and plotting the observations—the intervals of time reckoned from any fixed instant as abscissæ, the corresponding temperatures as ordinates.

The two most interesting cases are a polished body surrounded by another polished surface, and a blackened body surrounded by another blackened one. To make the results comparable, the temperatures of the outer bodies should be kept constant and the same; and the initial temperatures of the two inner bodies should be the same.

Sources of Error.

1. The surfaces may not be at the temperatures of the thermometers used.
2. Losses of heat may occur by radiation otherwise than to the outer bodies—by conduction or by evaporation.

Apparatus. Three thermometers; two large and two small calorimeters with corks to hold the latter in the

former, one set being bright and clean and the other blackened; covers and stirrers for the smaller calorimeters; a glass jar large enough to hold both large calorimeters, a stirrer for it, and flat corks on which to stand the calorimeters; ballast to put in the bottom of the large calorimeters to keep them steady; a vessel, etc., for heating water; a watch.

Manipulation. Heat plenty of water. Place the ballast in the large calorimeters, and then the corks in which are fitted the small calorimeters. Stand the calorimeters on the corks in the bottom of the glass jar. Take the temperature of the room, and fill the glass jar to three-fourths the height of the calorimeters with water of that temperature, mixing some of the heated water with tap water for that purpose. Be careful not to splash water so that it might run down between the small and large calorimeters. Fit the covers of the small calorimeters with thermometers and stirrers, and see that they go on easily. Place the watch open on the table.

When all else is ready, and the water is boiling, pour enough into each small calorimeter to fill them to the same height—two-thirds full is enough. Fill the polished one first, and then, immediately after, the other; and let another observer put the cover on each the moment it is filled, turning the thermometers so that one man can observe both.

As quickly as possible, when both are filled and covered, Observer 1 reads the thermometer, and taps on the table with his pencil when the mercury in one passes the first degree mark as it falls, then turns to the other thermometer and taps similarly for that, calling "black" or "bright" each time, according to which calorimeter it is in. Observer 2 reads the watch, and puts down the minute and second under the name of the proper thermometer. Observer 1 stirs both vessels, and continues to tap for each thermometer every two degrees just as the mercury crosses the mark, always naming the thermometer; and Observer 2 notes the time of each tap in the proper column. As soon as the fall in temperature becomes slow enough, Observer 1 should

give the temperature-reading itself, as well as the name of the thermometer; and, though this may not be possible with the first one or two readings, it will be easy to count back and see what temperatures the times noted correspond to. Continue the experiment until both have cooled down to about 40° C. Stir the water in the outer jar occasionally, and take its temperature every five minutes at least; and if it gets warmer than the room, pour in a little cold water.

Report as below, and plot the "cooling curves" on co-ordinate paper, using the same axes for both, and dotting one curve to distinguish it.

ILLUSTRATION
LAW OF RADIATION

Jan. 24, 1896

Polished Calorimeter			Temperature ° C.	Black Calorimeter			Water in Battery-jar ° C.
Time				Time			
H.	M.	S.		H.	M.	S.	
3	21	05	84	3	21	05	22.5
3	21	20	82			
3	22	40	80	3	21	45	
3	24	25	78	3	22	55	
3	26	05	76	3	24	20	
3	27	40	74	3	25	55	
3	29	35	72	3	27	25	
3	31	40	70	3	29	00	
3	33	55	68	3	30	45	
3	36	20	66	3	32	28	
3	39	00	64	3	34	15	
3	41	35	62	3	36	05	23.5
3	44	10	60	3	38	05	
3	47	05	58	3	40	25	
3	50	18	56	3	42	30	
3	53	40	54	3	45	15	23.75
3	57	15	52	3	48	08	
4	1	30	50	3	51	30	24.0
4	6	22	48	3	54	45	
4	11	55	46	3	58	35	24.4
4	17	40	44	4	2	50	24.5
4	24	25	42	4	7	45	
4	32	28	40	4	13	30	24.5

When the black calorimeter was at 40° the other one was at 45.5° C.

Cooling Curves

———— Blackened calorimeter.
 - - - - - Polished calorimeter.

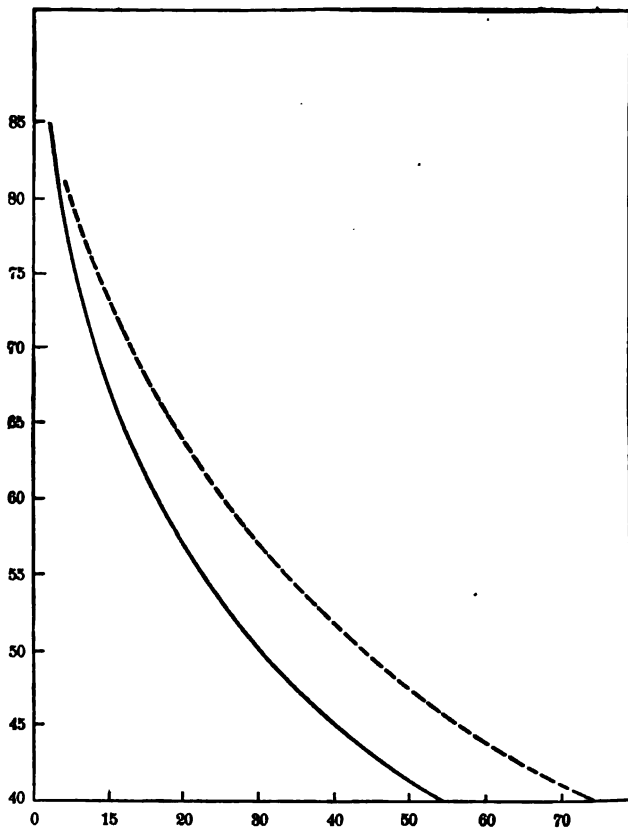

FIG. 109

Abscissæ. Minutes after 3 h. 20 m.

Questions and Problems.

1. Which cooled the faster, the black or polished calorimeter?
2. How would the experiment have been affected if the inner surface of the large blackened calorimeter had been polished?
3. Would the cooling have been faster or slower if the small calorimeters had been put out in the open air of the room without the outer vessels, water, etc.? Why?

EXPERIMENTS
IN
ELECTRICITY AND MAGNETISM

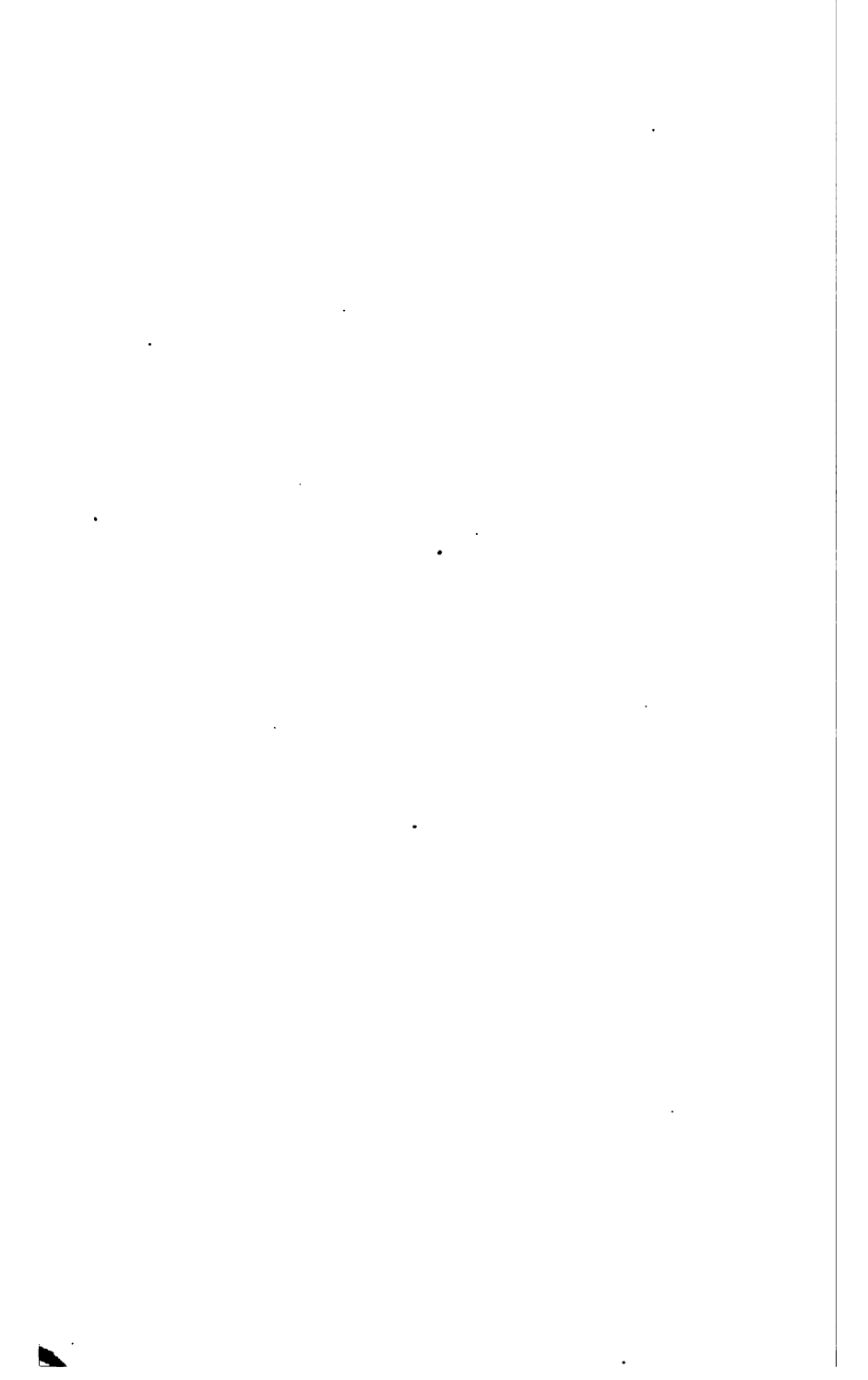

INTRODUCTION TO ELECTRICITY AND MAGNETISM

Units and Definitions. The actual measurement of all electric and magnetic quantities finally resolves itself into measurements of mass, time, and distance; and, therefore, in their expression the C. G. S. system should be used. The definition of the unit of electrification and of a unit magnetic pole, however, must be based upon electrical or magnetic properties. There are three systems of such units in use; but, as the relations between them are known, it is simply a matter of convenience as to which is used in any case. The definition which serves as the basis of the first system, which is called the "electrostatic system," is this: If two equal electrical charges are at a distance apart of one centimetre *in air*, and if their quantity is such that the force between them is one dyne, each of these charges shall be called the unit charge. Upon this definition are based that of unit difference of potential—*viz.*, that existing between two points such that one erg of work is required to carry a unit charge from one to the other; also, that of unit capacity—*viz.*, a conductor has a capacity one if when charged with a quantity one its potential is one, or if charged with quantity x , its potential is x ; for the capacity C is by definition such that the charge $e = CV$, where V is the potential.

The definitions which serve as the basis of the second system, which is called the "electromagnetic system," are these: If two equal magnetic poles are at a distance apart of one centimetre *in air*, and if their strengths are such that the force between them is one dyne, each pole shall be

called a unit pole; also, if a steady electric current is flowing in a conductor bent in the form of a circle of radius r centimetres, and if the force on a unit magnetic pole at the centre of the circle is $2\pi/r$ dynes, then this current shall be called a unit current—*i. e.*, a unit quantity of electricity “flows by” in one second. This evidently takes a different quantity of electricity as the unit from that used in the electrostatic system; and upon it are based definitions of unit difference of potential, unit capacity, unit resistance, etc.—*e. g.*, on this system a unit resistance is that of a conductor such that if an electromagnetic unit difference of potential be maintained at its two ends, an electromagnetic unit of current will flow through it.

It is found by actual experiment that one electromagnetic unit of quantity = v electrostatic units, where $v = 3 \times 10^9$ very nearly.

It follows, then, at once, that
 one electromagnetic unit of potential = $1/v$ electrostatic units of potential,
 one electromagnetic unit of capacity = v^2 electrostatic units of capacity,
 one electromagnetic unit of resistance = $1/v^2$ electrostatic units of resistance.

It is found by actual experience that neither of these systems is convenient for daily use, and so a system has been adopted called the “Practical System.” The units are defined as follows: The unit quantity, called the “coulomb,” is such that if it is passed through a solution of silver nitrate (prepared in a definite way) an amount of silver will be deposited equal to 0.0011180 grams. The unit difference of potential, called the “volt,” is such that the potential difference of a standard Clark cell at 15° C. is 1.434 volts. The unit resistance, called the “ohm,” is that of a column of mercury at 0° C., 106.3 centimetres long, of uniform cross-section, and containing 14.4521 grams. The unit current, called the “ampere,” is such that, if it flows for one second, one coulomb passes. The unit capacity, called

the "farad," is that of a conductor which, when charged to 1 volt, contains 1 coulomb.

It is found by direct comparison that within the limits of accuracy of experiment

1 coulomb	=	10^{-1}	electromagnetic units.
∴ 1 ampere	=	10^{-1}	“ “
1 volt	=	10^9	“ “
1 ohm	=	10^9	“ “

(Hence, a potential difference of 1 volt at the ends of a conductor, whose resistance is 1 ohm, will produce a flow of 1 ampere.)

1 farad = 10^{-9} electromagnetic units.

'The "micro-farad" is 0.0000001 of a farad—*i. e.*,
= 10^{-18} electromagnetic units.

Since the energy of a charge is $\frac{1}{2}$ quantity \times potential, the energy of 1 coulomb at potential 1 volt is 10^7 times the energy of 1 electromagnetic unit of charge at 1 electromagnetic unit of potential, but by definition of this last quantity the energy of an electromagnetic unit quantity at that potential is 1 erg. Hence the energy of 1 coulomb at 1 volt is 10^7 ergs, or 1 joule (see p. 68).

The energy furnished by a current i in one second is i^2R ; hence, the energy furnished in one second by 1 ampere flowing through 1 ohm is 10^7 ergs, or 1 joule—*i. e.*, the activity of such a current through such a conductor is 1 watt.

Object of Experiments. All the experiments in this section may be divided into two classes: one consists in the general study of electric and magnetic phenomena; the other, in the accurate determination of various quantities, such as magnetic moments, electric currents, resistances, etc. As stated before, in all these experiments the only quantities directly measured are lengths, masses, and intervals of time; but owing to the fact that magnetic and electric phenomena are involved, special precautions are necessary.

1. In electrostatic experiments, moisture must be carefully guarded against.

2. In order to discharge a body thoroughly, remove it from the neighborhood of other charged bodies, and pass the flame of a Bunsen-burner rapidly over it.
3. In magnetic experiments, care must be taken to avoid the influence of bodies containing iron—*e. g.*, window-weights, brackets, beams, common red bricks, etc.
4. In the study of electric currents the need of making good contact everywhere cannot be too much emphasized. Wires should never be twisted together at the ends, but should be either soldered or joined by a metal connector or mercury-cup.

All plugs of a resistance-box must always be pushed in again after any *one* has been removed.

5. All wires leading to and from instruments should be so wrapped around each other that there is no appreciable area between the current going up one wire and down the other.
6. Reference is made to Appendix III., "Galvanometer," for remarks on the proper use of the instrument.
7. The resistance of every conductor changes when a current is passed through it, owing to rise in temperature; therefore currents should be kept on for as short times as possible, and all other heating effects should be avoided.
8. To make less current pass through a given instrument, three methods are open: (a) To use fewer cells in the battery, and so have a smaller E. M. F. (b) To insert resistance in the circuit, thus making the current smaller although the total E. M. F. is the same. (c) To put a "shunt" around the instrument—*i. e.*, to insert *in parallel* with it a certain resistance. In this case, if r_1 is the resistance of the instrument and r_2 that of the shunt, the current through the instrument equals $\frac{r_2}{r_1+r_2}$ times the total current flowing.

ELECTROSTATICS

EXPERIMENT 57

Object. To plot the fields of force around various electrified bodies. (See "Physics," Arts. 222, 228, 230.)

General Theory. A line of electrostatic force is defined as a line such that at each point its direction is that in which would move a mobile, positive charge placed at that point. In other words, it is the path a positive charge would follow if the body carrying the charge had no inertia. Again, if a small elongated body which is charged + at one end and - at the other is placed at any point of the electric field, free to rotate, it will turn and place itself tangential to the line of force at its centre.

To map the lines of force, then, at any point of the field, the simplest method is to hold by an insulating support a small elongated conductor—*e. g.*, a bit of moistened thread, or even a non-conductor, if it is pointed, *e. g.*, a bit of paper in the form of a needle, so that it is free to turn—for under induction the small body becomes charged + at one end, - at the other, and so will take a position along the line of force. If the pointer is free only to turn around an axis, it will set itself along the component of the force which lies in the plane perpendicular to this axis.

An equipotential surface is perpendicular to lines of force; and so, if the field of force has been drawn, the surfaces may be easily constructed.

Sources of Error.

1. If the charges on neighboring bodies change, the direction of the field of force will change.

2. If the pointer receives too great a charge it will modify the field.

Apparatus. Two tin cans or other metallic bodies of large surface; two flat wooden boxes filled with paraffine for use as insulating stands; a pointer consisting of an insulating handle carrying a light paper vane strung on a stretched silk fibre, as shown. The fibre is passed through a hole at the centre of the vane, which is about 1.5 centimetres long, and is attached to the prongs of the handle, which is easily made of glass rod or tubing. A drop of wax on the fibre keeps the vane from sliding along it. The vane can then rotate freely in a plane at right angles to the fibre.

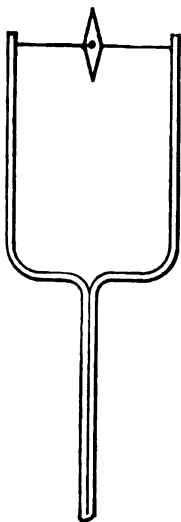

FIG. 110

Three sheets of paper are needed, the size used at Johns Hopkins University being about 60×45 centimetres. An electric machine must be near by to charge the can.

Manipulation. *Field about a Single Charged Conductor.*

—If the surface of the paraffine in the stands is very dirty, scrape it clean with the back of a knife. Place a can on one of the stands in a position to be assigned by the instructor. Divide one of the sheets into two halves by a pencil line, and in the middle of one half draw in outline a horizontal section of the can and stand; in the other, a vertical section. The drawings should be about half-size. Keeping the can in the assigned position, hold it against one of the knobs of the machine until it is highly charged. Place it on the table near the drawing of the horizontal section. Hold the pointer so that the fibre is vertical. Bring it close to the can, so that one tip of the vane almost touches the side. Mark the point on the diagram and the direction of the vane. Draw the pointer slowly away in

such a direction as to move the vane always in the direction in which it points—*i. e.*, allow the vane to move as it would if free to follow the line of force, but keep it in the same horizontal plane. Watch the motion very carefully, and repeat several times, until the path of the line of force is definitely located and fixed in the mind. Then draw the line on the diagram.

Take another point on the surface of the can in the same horizontal plane about half a centimetre away, and draw in a similar manner the line starting from that point. Continue similarly around the can until the starting-point is reached. In this way a complete horizontal section of the field of force will be obtained. Recharge the can whenever necessary.

To study the vertical section, hold the pointer with the fibre horizontal, and bring the vane as closely as possible to a point of the can where it touches the stand. Mark the position, and draw the line of force as in the case of the horizontal lines. Next take a point on the surface of the can half a centimetre above the first and in the same vertical plane, draw the line of force, and repeat similarly until lines have been drawn leaving the same vertical section of the can at points half a centimetre apart, all the way around, to the line where the surface of the can and the stand again meet. This completes the vertical section.

Two Bodies Charged Alike.—Place two cans on their stands and bring them near each other, about 5 centimetres apart. Draw a sketch of the horizontal section of the two in the middle of one side of a sheet of paper, and a vertical section in the middle of the other side of the same sheet. Charge both at the same knob of the machine and replace in the positions drawn.

Starting with the pointer near one can, draw the horizontal line of force from that point until it can be traced no farther, or until it ends on the other can. In the latter case, mark very carefully the position where it ends. Draw other lines in the horizontal section from points half a centimetre

apart all around the first can, and also fill in lines for the second can from portions of the same horizontal section at which no lines from the first end.

When the horizontal section is complete, draw the vertical section in a similar manner.

Two Bodies Oppositely Charged.—Draw the two sections of the two cans again in the same positions on the third sheet of paper. Charge them at different knobs of the machine, and, placing them in the positions drawn, trace again as before the horizontal and vertical sections of the field of force.

Finally, label each sheet and draw in ink—red, if available—five equipotential surfaces for each case.

An interesting variation is to plot the field about the knobs of the machine itself.

Questions and Problems.

1. Why does the pointer set itself along the line of force? Is the paper pointer a conductor?
2. What further observations, if any, would be necessary to determine from your diagrams the actual direction of the force at any point of the field?
3. Show by a diagram in your book how the field in each case of two cans would differ if one of the cans was uncharged.
4. Do any lines of force start from the inside of the can? and, if so, what is their direction?
5. How does recharging the can affect the lines of force and the equipotential surfaces?
6. Do lines of force pass through a conductor?

EXPERIMENT 58

Object. A study of electrostatic induction by means of the gold-leaf electroscope.

General Theory. Read "Physics," pp. 283-300.

Source of Error.

Leakage must be carefully guarded against.

Apparatus. Two gold-leaf electroscopes ("Physics," p. 276); a piece of copper wire about 30 centimetres long; a rod of ebonite, glass, or sealing-wax; a piece of fur or silk.

Manipulation. Clean carefully the metal plates of the electroscopes. Note carefully in each of the following cases all movements of the gold leaves, describe them fully, and explain. Whenever the gold leaves are described as being charged, determine and state what has become of the electricity of opposite sign. The charge produced on an ebonite rod when it is rubbed with silk or fur is by definition called "negative."

(1) Rub the rod very slightly. Touch it to the knob and then remove it. Describe and explain.

(2) Rub the knob itself, remove the rubber, describe and explain.

(3) Discharge by joining the knob to the earth with the hand. Bring down the charged rod near enough to make the leaves diverge well, but not so much that either touches the side of the bottle. If one does touch, discharge the electroscope by touching it with the finger and begin again. Touch the knob with the finger while holding the rod still. Remove first the rod, then the finger. Describe and explain.

(4) Repeat, but remove first the finger, then the rod. Describe and explain. Does it make any difference whether the rod is held nearer to the leaves or to the knob?

(5) Leaving the electroscope charged, bring in turn the rod, the rubber, and the palm of the hand down towards the knob from above. Do not touch the knob in any case. Describe and explain.

(6) Repeat, but approach the objects to the leaves.

(7) Discharge and recharge as before, but note carefully the exact distance between the knob and the nearest point of the rod when the finger is removed. Bring the rod down slowly and describe and explain the motion of the leaves while the rod is farther from the knob than the charging distance, when it reaches this distance, and when it is brought nearer.

(8) Connect the knobs of the electroscopes by means of the copper wire, and separate them as far as possible. Call the left electroscope A, the right B. Approach the rod to the knob of A from the left. Describe and explain.

(9) Holding it near, but to the left of A, touch A with the finger, and remove first the finger, then the rod. Show by a diagram the charges on leaves and knob of both A and B and on the wire. Explain.

(10) Discharge. Bring up the rod to the same position near A as before, but charge by touching B. Give diagram of charges again. Explain. Would the charges left on the whole system differ in any way if, in charging, the rod were brought near different points? if the electroscope were touched at different points? Why?

(11) Charge the system with the rod held 2 centimetres to the left of A. Remove the rod and describe and explain what happens when it is again approached to within 1 centimetre. Give diagrams of charges when rod is 3 centimetres, 2 centimetres, and 1 centimetre to the left of A.

(12) Repeat, bringing the rod down towards the middle point of the wire, and give diagrams where it is 3, 2, and 1 centimetres above it.

In each diagram draw three equipotential surfaces (including that of 0, +1 and -1, if they occur) and five lines of force from each knob.

NOTE.—In this and all similar experiments the student should be careful in answering each section to give a brief description of what was done, and not merely give the number of the sections and a description of what happened. The instructor has not time to refer to the directions to find the process that gave the result described.

Questions and Problems.

1. A sphere of radius 5 centimetres is at potential -6; it is then joined to another sphere of radius 10 centimetres, while its potential is kept constant. What are the final charges on the two spheres? How much work has been done, and how has it been done?
2. If the potential had not been kept constant, what would have been the final potential and charges? Discuss the initial and final energy.

EXPERIMENT 59

Object. To show, after the method of Faraday's "Ice Pail" experiment (see "Physics," Art. 232), that:

1. If a charged body is placed inside a closed conductor, a charge of opposite sign is induced on the inner surface of the conductor and one of like sign on the outer, the two induced charges being equal in amount to each other and to the charge on the body.

2. That an electric charge at rest within or without a closed conducting surface can produce no force or induced charge on the other side, unless the equal and opposite charge which must always exist somewhere is itself on that other side.

Apparatus. A small tin can and one large enough to contain it, the bottom of the latter being covered with a layer of paraffine; a cylinder of wire gauze; two tin plates; an insulating stand; two gold-leaf electroscopes; 60 centimetres of copper wire; a small sphere, or other conductor without points, about the size of a 50-gram weight, hung upon a silk thread about 25 centimetres long; access to an electrical machine; a rod and rubber, as in Experiment 58.

Manipulation. Place the smaller tin can on the insulating stand, and connect it with one electroscope by means of the wire. Do

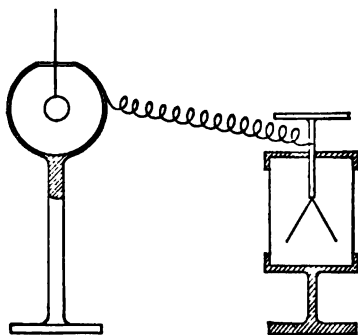

FIG. 111

not let the wire touch the table or any other conductor. Charge the other electroscope as in Experiment 58. Excite the electrical machine, separate the knobs, and test the sign of the electricity upon one of them by charging from it the sphere and bringing it near the free electroscope, the kind of whose charge is known. Note the sign of the charge, and always charge the sphere the same way by turning the machine in the same direction and using the same knob.

1. Completely discharge the can and electroscope attached by "earthing" them with the finger. Charge the ball, and lower it into the can, being very careful not to touch the can, wire, or electroscope with the hand or the ball.

(a) What is the sign of the charge of the electroscope leaves? (Test with the rubbed rod.)

(b) Remove the ball without touching the can, and test the sign of its charge by means of the free electroscope. Has the charge of the ball been changed?

(c) Is there any trace of a charge on the electroscope and can?

(d) Explain logically what conclusion you can draw as to the charge induced on the can when the ball was inside it.

(e) Describe exactly what would have happened had the can, etc., been "earthed" for a moment while the ball was in it, and what would have been their condition after the ball was removed. If you do not know, try the experiment.

(f) Start again with the can and electroscope entirely discharged. Charge the sphere again, lower it slowly into the can, touch it against the bottom, and let it roll around so as to insure contact. Finally, remove the ball. Describe and explain the motions of the gold leaves throughout the process.

(g) Is there any charge left upon the ball?

(h) What further conclusions besides those of (d) can you now draw as to the signs and amounts of the induced charges?

(i) Place the smaller can inside the larger, and the larger on an insulated stand. Connect the larger with the electro-

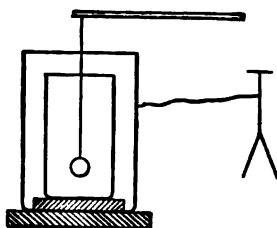

FIG. 112

roscope. The paraffine insulates the cans at the bottom, and they must not be allowed to touch elsewhere. Discharge the cans and electroscopes. Lower the charged ball slowly into the inner can, and finally touch it and let it roll around the bottom. Describe and explain the motion of the gold leaves.

(j) What would have happened if the inner can had been "earthed" for a moment while the ball was inside?

(k) What would have happened had the inner can been "earthed" for a moment, as above, but the ball removed without touching it to the can? Try the experiment, if necessary.

2. Place a tin plate upon the insulating stand.

(l) Discharge the electroscopes, put it on the plate, surround it with the wire screen, and cover with the other tin plate. Connect the closed conducting surface thus found with one knob of the electrical machine, and charge it until sparks can be drawn from it. Is any effect produced on the electroscopes?

(m) Discharge the cage, take off the top, and lower into it the sphere highly charged. Be careful not to let the sphere touch anything. Earth the cage with the finger, then remove the finger, and finally touch the ball to the cage. Describe and explain the indications of the gold leaves at every step of the above process, showing where the opposite charge to that upon the ball is situated.

(n) Place the electroscopes outside the cage, as close to it as possible. Discharge it completely, and carefully remove or discharge any bodies in its neighborhood that might be charged. Charge the ball highly, and lower it into the cage. Repeat, touching the outside of the cage with the

finger while the ball is lowered. Describe the indications at each step and explain, showing, as before, the positions of the opposite charge.

Questions and Problems.

1. A sphere 3 centimetres radius is placed in a space where the potential is 6. It is joined to the earth for a moment, and then removed from the region. What is its charge?
2. Two insulated spheres, each 5 centimetres radius, are connected by a long wire. One is in a space whose potential is 6, the other in a space at potential 8. What is the potential and charge of each sphere?
3. Why does a charged body inside a closed conductor induce a charge on a body outside unless the closed conductor is "earthed," while a charged body outside can produce no effect inside whether the cage is "earthed" or not?

EXPERIMENT 60

Object. A study of an electrical induction machine.

Apparatus. A Voss machine (a Holtz, Wimshurst, or any induction machine will answer); an electroscope, with rod and rubber for charging it; a "proof-plane," which may readily be made of a small coin fastened with wax on the end of a glass rod; a high-resistance galvanometer, with leads of copper wire sufficiently long to reach to the machine; two metres of cotton string.

Manipulation. Draw a diagram of the machine in your note-book. Charge the electroscope by means of the rod. Excite the machine; stop it *without allowing it to turn backward* when it stops. Charge the "proof-plane" by induction from one of the knobs—*i. e.*, by bringing it near the knob and touching it with the finger for a moment. Do not allow a spark to pass to it. Test the sign of the charge of the "proof-plane" with the electroscope, and note on your diagram the sign of the charge. Test every metal part of the machine, including both knobs, the brushes, condensers, cross-bar, buttons on the revolving plate, and the tin-foil pasted on the back plate. Keep the revolving plate in the same position exactly throughout; and if it becomes necessary to renew the charge on the machine, stop turning when the plate is again exactly at the right point.

Next, test the sign of a button just before and just after it passes each of the brushes. From these observations explain briefly the operation of the machine.

What is the function of the tin-foil on the stationary wheel? Of the cross-bar? Of the condensers?

Place the electroscope 50 centimetres from one of the knobs of the machine, and push the two knobs of the machine together until sparks pass as the wheel is slowly revolved. Note the behavior of the electroscope as the wheel is turned, and state briefly what inference you can draw as to what goes on in the ether around the machine.

What is the greatest distance at which you can notice any effect on the electroscope? What do you infer as to the state of a mass of metal, such as the plumbing of a house, just before, during, and just after a flash of lightning in the neighborhood?

Separate the knobs and connect each to one terminal of the galvanometer by means of the wire. Turn the machine at a speed just high enough to get a small deflection, say 1 centimetre, on the galvanometer. Count the turns of the wheel made in a minute. Repeat, using three times the speed, and note the deflection again. Is the current, as shown by the galvanometer, proportional to the speed? Wet the string and connect to the galvanometer through it instead of through the wire. Turn the machine at either of the two speeds already observed. Is the deflection changed by the insertion of the wet string? Reverse the direction of turning the machine and note the effect on the deflection.

Note in particular that the machine produces a current which can deflect a galvanometer needle, and that this current increases with the speed—*i. e.*, the difference of potential maintained between the knobs, and decreases as the resistance through which it must pass increases.

Questions and Problems.

Draw the lines of force for an electrophorus at each of the four steps: charged, cover on, joined to earth, cover removed.

EXPERIMENT 61

(TWO OBSERVERS ARE REQUIRED)

Object. 1. To show that the capacity of a condenser composed of two parallel plates varies inversely as the distance between its plates. 2. To determine the dielectric-constant of some dielectric, such as glass. (See "Physics," Arts. 237, 239.)

General Theory. The "capacity" of a condenser is defined as the ratio of the charge upon one of its surfaces to the difference of potential between them. In symbols

$$C = \frac{e}{v_1 - v_2}.$$

If we have a means of charging a condenser to the same potential difference under various conditions, and can in each case measure e , we can show how the capacity varies under these conditions. For instance, if we have a condenser consisting of two parallel plates, and vary the distance between them, while $v_1 - v_2$ is kept the same, we can show that the capacity is inversely as the distance by measuring e in each case.

The best method of comparing the charges is to make use of the fact that, if a portion of one of the plates near its centre is made movable, the force pulling it towards the other plate is

$$F = \frac{2\pi\sigma^2 A}{K},$$

where σ is the surface density of the charge,

A is the area of the movable portion or disk,

K is the dielectric-constant of the medium between the two plates,

Hence, if this force is measured for different distances apart of the plates and is found to have the values F_1 and F_2 ,

$$\frac{F_1}{F_2} = \frac{\sigma_1^2}{\sigma_2^2}$$

and

$$\frac{e_1}{e_2} = \frac{\sigma_1 A}{\sigma_2 A} = \sqrt{\frac{F_1}{F_2}}$$

As usually arranged, the disk is cut out of the upper plate, and the force on the movable disk is measured by attaching it to the arm of a balance and noting the weight on the other pan necessary to just prevent the disk from being pulled down. The difference of potential between the plates is made the same in each case by connecting each plate to the corresponding plate of a second trap-door electrometer. By keeping the distance apart of the plates in this second electrometer the same, and its counterpoise the same throughout, its disk will drop for exactly the same difference of potential in every trial. If we connect the plates of the condenser to the poles of an electric machine and excite the machine, when the disk on the subsidiary electrometer drops it indicates that the given potential difference is reached. By changing the weights in the pan of the balance of the variable electrometer we can adjust it so that the plates of the two electrometers fall together. In this manner the force is measured at the instant the plates reach the given difference of potential. Hence,

1. If the distance between the plates of the condenser is varied, the ratio $\frac{C_1}{C_2}$, which equals $\frac{e_1}{e_2}$, and is measured by

$\sqrt{\frac{F_1}{F_2}}$, may be proved to equal $\frac{d_2}{d_1}$ —i. e., the square root of

the force, being proportional to the capacity, should be inversely proportional to the distance between the plates.

2. By placing a thick plate of glass or other dielectric between the plates—the total distance being the same as

in one of the experiments with air—the variation in the capacity (and consequently in the force) can be noted.

NOTE.—The constant of the dielectric composing the plate may be determined in this way. For theory shows that if F is the force on the movable disk, when there is a thickness d of air between the plates, and F' the force when there is a thickness d'' of air, and d' of another dielectric, then, if K' is the dielectric-constant of the dielectric, and K of air,

$$\sqrt{\frac{F'}{F}} = \frac{\frac{1}{\frac{d''}{K} + \frac{d'}{K'}}}{\frac{1}{\frac{d}{K}}}; \text{ whence } K' = \frac{d' \sqrt{\frac{F'}{F}}}{d - d'' \sqrt{\frac{F'}{F}}},$$

since $K=1$. (The experiment requires too much care for the ordinary student, however.)

Sources of Error.

1. If the plates of the "guard-ring" of the electrometer are not parallel, the formulæ do not hold.
2. The distance between the plates enters to the square, and, being a small quantity, is difficult to measure accurately.

Apparatus. Two "guard-ring" electrometers: the upper plate of each may be made out of a metal disk set upon a metal tripod. The centre of the disk is cut out carefully and attached by light wires to one arm of a tall

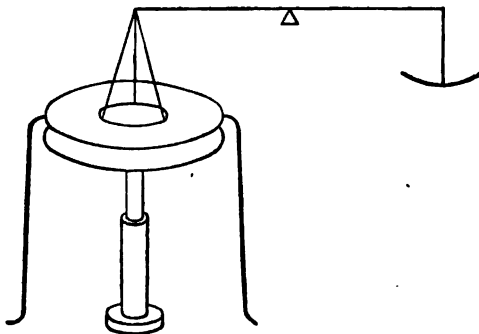

FIG. 118

balance, the clearance between the cut-out piece and the fixed "guard-ring" being made as small as possible. A second disk of about the same diameter as the guard-ring is fastened firmly to the end of a shellacked glass tube, which is held in a clamp-stand. For the electrometer in which the distance is to be varied, the lower plate should preferably be provided with an insulating-stand, which allows it to be readily raised or lowered while its plane is kept horizontal. The tripod and the stand of the lower plate should both be provided with levelling screws. A "trap-door" electrometer, in which the movable part of the upper plate is hinged at one side and kept from falling by a spring or sliding counterpoise, is convenient for the second instrument. A level; vernier caliper; box of weights, 100 grams to 0.01 gram; a thick glass plate, wider than those of the electrometer; and an electric induction-machine and wires are also necessary.

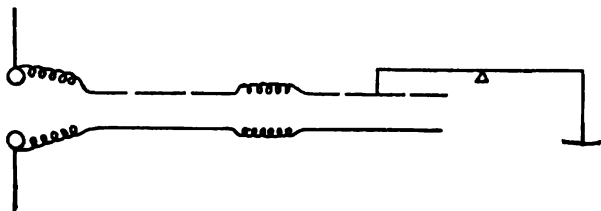

FIG. 114

Manipulation. Set up the apparatus as shown in the diagram. Adjust the plates of the condenser so that they are one centimetre apart. Remove the tripod which holds the upper plate, or "guard-ring"; level the lower plate; replace the tripod, and level the guard-ring. Make the wire connections as shown. Adjust the movable disk so that its under surface is accurately in the plane of the under surface of the guard-ring when the beam is horizontal. This may be done approximately by means of the levelling screws on the balance and by blocks if necessary. Such a balance should be provided with screw-stops to limit the tilt of the beam, and the final adjustment may

be made by placing a weight in the pan greater than that necessary to counterpoise the disk, and then supporting the weight-arm by the screw-stop, so that the disk is exactly in position. If the disk does not hang level, it may be adjusted by bending slightly the wires by which it is suspended. See that the disk is free to move without friction. Find the weight which, when placed in the pan, will balance the disk while the apparatus is uncharged. Place a small number of grams—*e. g.*, 6—in the pan in addition to this balancing weight and excite the machine. Adjust the counterpoise of the secondary electrometer so that the disk falls about simultaneously with that of the other when thus weighted. This adjustment is then left unchanged during the remainder of the experiment.

Adjust the weight in the weight-pan of the balance until the disks fall exactly together. If one disk has a greater mass than the other, care must be taken to note the first trace of motion in the heavier disk. When adjusted, note the weight in the pan, and, deducting that necessary to balance the weight of the disk, deduce the force. Measure with the caliper the distance between the plates at five equidistant points around the circumference, and average, to get the distance of the disk above the lower plate.

Repeat with distances of 2 centimetres and 3 centimetres approximately between the plates. Level the lower plate and guard-ring each time, but on no account touch the counterpoise of the second electrometer.

Pass the flame of a Bunsen-burner over both surfaces and all around the edge of the glass plate, being careful not to crack it by keeping the flame too long on one spot. Place the glass plate on the lower plate of the condenser, level as before, and determine the force on the disk. Explain fully why it is greater than when the plates were separated by a thickness of air equal to the combined thickness of the glass and air in this experiment.

ILLUSTRATION

Variation of the capacity of a condenser with the distance apart of its plates. (The dielectric is air.)

Weight necessary to balance the disk when uncharged = 128.60 grams.

Distance between Plates in Centimetres	Weight in Pan	Force, F
1.10, 1.12, 1.22. Mean, 1.15 = d_1	184.00	5.40 grams.
2.02, 2.02, 2.04. Mean, 2.03 = d_2	180.50	1.90 "
2.99, 2.93, 2.96. Mean, 2.96 = d_3	129.55	.95 "

$$\therefore \sqrt{\frac{F_1}{F_2}} = \sqrt{\frac{5.40}{1.90}} = 1.69. \quad \frac{d_2}{d_1} = 1.77. \quad \text{Difference, 5 \%}$$

$$\sqrt{\frac{F_2}{F_3}} = \sqrt{\frac{1.90}{.95}} = 1.41. \quad \frac{d_3}{d_2} = 1.46. \quad \text{Difference, 4 \%}$$

This difference is well within the limit of accuracy of the experiment.

Questions and Problems.

1. A condenser of two circular disks 20 centimetres in diameter, and separated by a sheet of mica 0.1 centimetre thick, is charged to potential 2. What sized sphere would have the same capacity?
2. Calculate the capacity of a Leyden jar whose capacity is 15 centimetres, and the height of whose coatings is 20 centimetres, the thickness of the glass being 0.1 centimetre. (Apply formula for parallel plates.)
3. A Leyden jar of capacity 1000 is charged to potential 10, another of capacity 500 is charged to potential 5; the outer coatings are put to earth and the knobs are connected. Calculate initial and final energy, and explain their difference.
4. Two condensers are made exactly alike, each consisting of an inner and outer concentric sphere, radii 10 and 12 centimetres. One has sulphur as the dielectric; the other, air. The former is charged with 100 units; and then the two are connected, inner sphere to inner, outer to outer. What are the charges on each, and the potential?

ELECTRIC CURRENTS AND MAGNETISM

EXPERIMENT 62

Object. To map a "current sheet." (See "Physics," Art. 296.)

General Theory. If an electric current enters a conducting sheet—*e. g.*, a layer of conducting liquid spread over a glass plate, a piece of tin-foil—at one point, and leaves it at an opposite one, the flow through the sheet is spread out and may be said to follow certain lines, called "lines of flow." At right angles to these lines there will be lines of constant potential, because in a conductor there is always flow from high potential to low, and a line along which there is no flow—*i. e.*, a line at right angles to a line of flow—must be a line of constant potential. These lines of constant potential may be easily mapped by either of two methods to be described below; and so, if they are known, the lines of flow may be drawn at right angles to them.

One method of mapping the equipotential lines is to join two wires to a galvanoscope, one to each binding-post; then, keeping the terminal of one wire fixed at some point on the current sheet, to move the terminal of the other wire over the sheet, tracing out points for which no deflection is observed in the galvanoscope.

This method cannot be used if the current sheet is not steady but varying (such a current as is obtained from an induction-coil); but a difference of potential between two

points in such a current may be detected by a telephone, used in place of the galvanoscope in the former method.*

In either of these ways lines of constant potential and the lines of flow may be mapped at different points of the current sheet.

Source of Error.

The lines of flow may change during the experiment, owing to changes in concentration, etc.

Apparatus. A small induction-coil; a shallow, water-tight box, with a plane glass bottom, to the under side of which a sheet of co-ordinate paper is pasted; a telephone; a storage circuit; wires; a loose sheet of co-ordinate paper of the same size as that on the box, and a very small quantity of common salt.

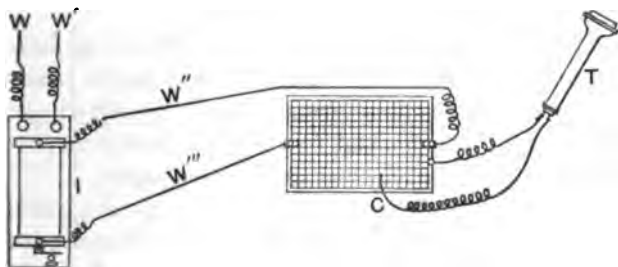

FIG. 115

Manipulation. Arrange the apparatus as shown. I is an induction-coil; W, W', the primary or storage circuit; W'', W''', the secondary circuit, which should be made of very long wires; T, the telephone.

Pour tap water into the box until its bottom is covered to a uniform depth of a little less than one centimetre. Dissolve a pinch of salt in the water in the box, thoroughly stirring the solution. The positions of the telephone terminals are determined with reference to the co-ordinate paper which is pasted to the under side of the box, and whose rulings are clearly visible through the glass

* This form of the experiment is due to Professor Crew, of Evanston, Ill.

bottom. The simplest way of recording the successive positions of the telephone terminals is to transfer their co-ordinates directly to the sheet of paper similar to that on the bottom of the box. Start with one telephone terminal fixed at an arbitrary but definite point by clamping it to the side of the tank, not far from either one of the electrodes, where the circuit enters or leaves. Note its position on the loose sheet. Place the diaphragm of the telephone near the ear, and at the same time move the other telephone terminal through the liquid over the bottom of the box. Always keep the end of the terminal perfectly straight and perpendicular to the bottom of the box. A drumming sound will be audible, whose intensity varies as the terminal is moved from point to point. Try to concentrate the attention upon the sound in the telephone by ignoring the buzz of the interrupter; and for this reason it is very desirable to have the induction-coil as far off, and its noise as much muffled, as possible. Note the successive positions occupied by the movable terminal when no sound can be heard in the telephone, and record them with reference to the axes on the loose sheet of co-ordinate paper.

To find these positions systematically, move the free telephone terminal along a co-ordinate line near and parallel to either *side* of the box. Approach the point of no sound, or of minimum vibration, from both directions, in turn, along this line, until its exact position is ascertained and recorded. Now find, in like manner, a point of no sound on a co-ordinate line one centimetre farther away from the same side of the box and parallel to the line first chosen. Continue in this way until an edge of the box is encountered. Draw a curve through the points thus found, which is the equipotential through the point marked by the fixed terminal.

Next, place the fixed telephone terminal at a point one centimetre (or more) from its initial position. Again find and record the position of points of no sound on equidistant parallel straight lines, and draw the equipotential through

them. Finally, repeat the processes just described until the whole surface of the bottom of the box has been traversed—*i. e.*, until the fixed terminal has been moved around half of the box, from one electrode to the other. Then draw, at short intervals (*e. g.*, one centimetre apart at the middle), curves cutting the equipotentials at right angles. Indicate the “lines of flow” by arrow-heads.

As a variation of this experiment, place a symmetrical piece of metal in the middle of the box, and plot the equipotential curves. Make the depth of the water just sufficient *not* to cover the metal.

ILLUSTRATION

Feb. 18, 1895

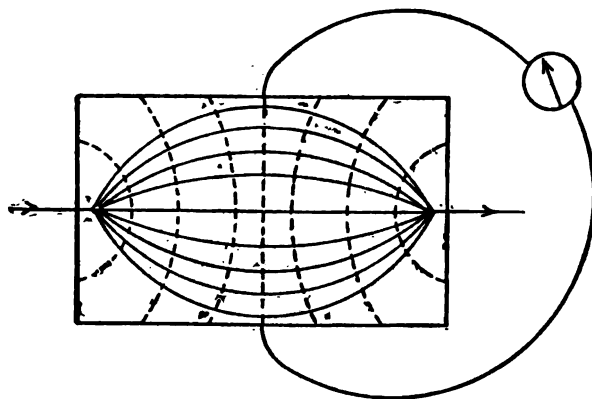

FIG. 116

Questions and Problems.

1. Explain by the aid of a diagram what would happen if the current were intercepted by placing a plate of glass across a part of the liquid.
2. Could this experiment be performed with pure water in the box? Why?
3. Why is it that only a *minimum* sound can be found in some places?
4. If equal quantities of electricity did not pass every section of the electrolytic conductor in the same time, what would be the result? Show the analogy between electricity and an incompressible fluid.

EXPERIMENT 68

Object. To plot the magnetic field of force:

1. Of a magnet and the earth together.
2. Of the magnet alone.

General Theory. If a magnetized needle is supported so as to be free to turn, and is placed in a magnetic field, it will set itself tangent to the line of force at its centre. If the needle is short enough, the difference between the straight line joining its extremities and the curve of the line of force may be neglected. Hence, if a large magnet be placed in the centre of a sheet of paper, and a small pocket-compass be placed at any point of the sheet, the position of the ends of the needle may be marked; and the line joining the ends is then a small part of the local line of force. By moving the compass on, so that one end of the needle again falls upon the point just marked for the other, another section of the line of force may be plotted; and so on until the line meets the magnet or the edge of the paper. Another line may then be drawn similarly.

If the magnet and the piece of paper are stationary, the field plotted will be that due to the earth and magnet combined, since the force at any point is always the resultant of the force due to the two. We can, however, eliminate the effect of the earth in influencing the direction of the line of force at any point in the following manner: The magnet is secured to the sheet of paper, and the latter is placed free to move upon a table, so that it can be turned in any direction as required, carrying with it the magnet upon it. The compass is placed where it is desired to be-

gin the plotting of the field. The needle will not lie in a north-and-south line unless it so happens that the local line of force due to the magnet alone is north and south. For, if the force due to the magnet alone is in any other direction, there will be a component turning the needle out of the line in which the earth alone would hold it; consequently, if the needle happens to lie north and south, it is known at once that the field of the magnet alone at that point is north and south; and therefore the extremities of the compass-needle are points on the line of force of the magnet alone, as well as of the earth alone. If, as is usually the case, the needle does not point north and south, the paper, together with the magnet and compass upon it, can be turned until the needle does so point. In other words, the magnet and its field are rotated until the line of force of the magnet at the desired place is north and south. The extremities of the needle are then marked on the paper, the compass is moved on, and the next section of the line is plotted similarly. Since the paper with the magnet fixed upon it is always turned so that the direction of the line of force on the paper is the same as that of the earth, the direction of each little section is the same as if the earth were not there; and the whole field as plotted is that of the magnet alone.

Sources of Error.

1. Owing to the size of the compass-case it is impossible to place the marks exactly at the end of the needle as they should be.
2. Owing also to the size of the case the difference between the curve of the line of force and the straight line between the points marked is considerable.
3. If, on the other hand, too small a compass is used, the direction of the needle is not as easy to note.
4. The experiment must be done on a level surface, and the compass so tipped as to prevent the needle from striking the top or bottom of its case.

Apparatus. Two sheets of paper, each one-half the size of the sheets in Experiment 57, in Electrostatics; a bar

magnet ; a small pocket-compass ; two pins ; thumb-tacks ; a thread about one metre long.

Manipulation. (1) *Resultant Field of Magnet and Earth.*
—Choose a place away from masses of iron of any kind. Fasten one sheet with the tacks to a smooth table or drawing-board. (If a drawing-board is used it should be firmly secured, so that its position will not change during the experiment.) Remove the bar magnet to a distance and draw with the help of the compass an east-and-west and a north-and-south line through the centre of the paper. Place the magnet on the centre of the sheet with its axis east and west on the line already drawn. Trace the outline of the magnet on the paper, in case it should be disturbed, marking which is its north and which its south pole. (N. B. The *north* pole is that which seeks the north and repels the north-pointing pole of the compass.) Begin at any convenient point and mark off twenty points on the outline of the magnet, each of which will be made the starting-point for one of the lines of the field as drawn. Place the points much closer together at the poles than near the middle.

Place the compass close to the magnet so that it points to one of the marked points. Mark the position of the other end of the compass-needle as nearly as the case of the compass will allow. Move the compass so that the end of the needle nearest the magnet is as close as the case will allow to the point just marked, and points towards it. Mark the opposite end of the needle as before. Continue similarly until you reach the magnet again or the edge of the paper. Mark from time to time the way the arrow-head of the compass is turned. Finally, draw a smooth curve through the points marked.

When one line is thus drawn, proceed similarly to locate the one from the next marked point on the boundary of the magnet, and continue until the whole field is drawn.

Two points will be found in diametrically opposite corners of the field, where the force due to the earth and that

due to the magnet are exactly equal and opposite, and the position of the needle is therefore indeterminate. Locate these points as closely as the size of the compass permits, drawing extra lines of force in that neighborhood.

(2) *Field of Magnet Alone.*—Remove the bar magnet to a distance, and set two straight pins vertically in the table to mark a north-and-south line. The pins must be far enough apart to admit of the sheet of paper on which the field is to be plotted being laid on the table and rotated between them. The best way to lay off the line is to set the compass about the middle of it, sight very carefully along the needle, and stick the farther pin in position. Sight again along the needle and set the nearer pin so that it exactly hides the farther one. Then join the two pins by a thread, running about one centimetre above the paper.

Place the magnet on the centre of the sheet and fasten it with "universal" or other soft wax. Draw its outline again as a precaution. Lay off twenty points around it as in Part 1, as starting-points in plotting the field. Place the compass near one of the starting-points. Shift the paper until the pivot of the compass lies exactly in the north-and-south line marked by the thread. Now rotate the paper until the needle lies under the thread. If, in doing so, the needle turns away from the point selected as the beginning of the line, shift the compass on the paper sideways until it points towards it, and move the whole paper again without turning until the pivot is again under the thread. Continue similarly until the desired starting-point and the pivot of the needle are exactly in the north-and-south line marked by the thread, and the needle also lies exactly in this line. When this is secured mark the position of the end of the needle away from the magnet as in Part 1, and proceed in a precisely similar manner to find another point on the same line of force. In doing so, the point just marked, the pivot of the needle, and the direction of the needle must be brought under the thread. When all the points on a line are plotted, draw a curve

through them and indicate by an arrow the direction in which a north pole would move along the line.

When lines have been drawn similarly from points all around the magnet, take both sheets home and draw the equipotential surfaces with red ink. Locate the equipotentials around the neutral points in Part 1 very carefully. In the rest of the field a comparative few will answer.

Date and sign the sheets, and fold them to fit in the report books. Answer the questions in the report books as usual.

Questions and Problems.

1. Explain the peculiarities in the equipotential surfaces around the neutral points.
2. Knowing the strength of the earth's field at the place where the experiment was performed, how would you calculate the strength of either pole of the magnet from the direction of the line of force at any point on your diagram of Part 1? Assume the poles to be equal.
3. Why cannot two or more lines of force intersect?
4. How could a field due to a single pole be mapped? Show by a sketch what would be the direction of the lines of force.
5. Would there be any difference between a north and a south pole?

EXPERIMENT 64

Object. To measure the magnetic inclination or dip.

General Theory. The magnetic inclination is the angle which the line of magnetic force, due to the earth, makes with the horizontal at any point on the earth. To measure this, it is necessary to so suspend a magnetic needle that it is perfectly free to turn about a vertical and also a horizontal axis, and to determine the angle it makes with a horizontal plane. Another method is to suspend a magnetic needle so that it is free to turn about an axis which is perpendicular to the magnetic meridian, and to measure the angle below the horizon made by the direction which it takes.

The difficulties in this experiment may be described as follows :

1. The axis around which the needle turns may not pass directly through the centre of the circle on whose circumference the scale is divided.

In this case the extremities of the pointers do not measure the angles correctly ; but if the scale is divided as shown, the reading of one extremity of the needle will be as much too great as that of the other is too little. This is apparent from the figure in which the dotted line represents the true diameter. Therefore the average of the readings of the two extremities gives the correct angle.

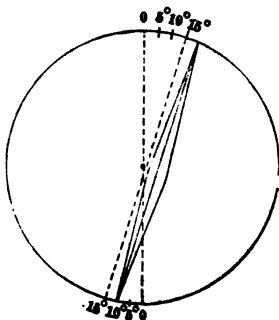

FIG. 117

2. The centre of gravity of the needle may not coincide with its axis of rotation, in which case the needle will be influenced in its position when it is turning about an axis perpendicular to the magnetic meridian.

If the centre of gravity comes at a point, P, in a line perpendicular to the axis of figure of the needle, correction may be made by reversing the needle—*i. e.*, in the figure—changing from position 1 to position 2; for, in the first case, the fact of the centre of gravity being at P tends to make the dip less by a certain angle, while in the second position it tends to increase it by the same angle.

If the centre of gravity comes at a point, Q, in the axis of figure of the needle, correction must be made by remagnetizing the needle, so that the poles are reversed. This changes the magnet from position 3 to position 4; and in these two cases the influence of the position of the centre of gravity is equal, but opposite.

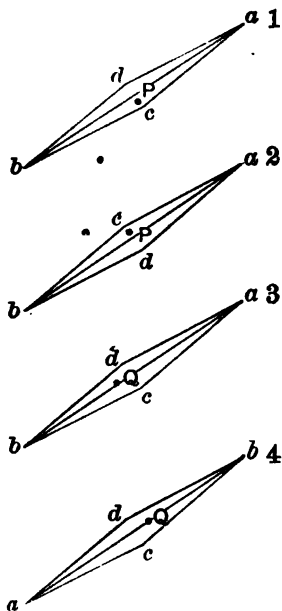

FIG. 113

Therefore, in the general case, when the centre of gravity is in any unknown position, it is necessary to make the needle assume the three positions shown in 1, 2, and 4, and to take the average angle of dip.

3. The axis of figure of the needle may not coincide with the magnetic axis—*i. e.*, the line joining the two poles of the needle. In this case the extremities of the needle do not record the true dip. As is shown in Figure 119, in one position *a* is too high and *b* too low; but if the needle is reversed in its bearings, the magnetic axis does not change its direction, but *a* comes as much too low as before it

was too high, and *b vice versa*. Therefore, taking the mean position of the needle, direct and reversed, corrects for this error.

It follows that the general method involves these four steps:

1. Place the needle horizontal.
2. Locate the magnetic meridian.
3. Place the needle in this meridian, with its axis of rotation perpendicular to it.
4. Make the readings as just described.

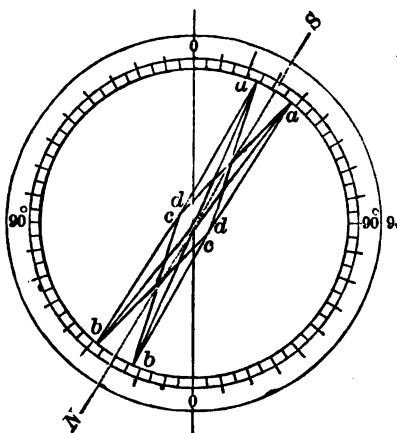

FIG. 119

Sources of Error.

1. Friction in the bearings and slipping of the clamps are the principal sources.
2. The above-mentioned difficulties in the use of the needle must all be carefully overcome.
3. After remagnetization the magnetic axis may not coincide with its former position.

Apparatus. A dip-circle and a small reading-lens. The dip-circle consists essentially of a well-balanced magnetic needle, pivoted with its axis approximately through the centre of a divided circle and at right angles to the plane of the same. This circle is arranged to move both about a horizontal and about a vertical axis. These axes pass through the centres of graduated circles at right angles to their respective planes; and these circles are divided into degrees of arc by marks which are numbered from zero to ninety. There are, besides, several screws on a dip-circle, the uses of which will be explained in the appropriate places, as they are needed in this experiment.

Manipulation. To simplify the explanation, let the three circles be distinguished in the following manner: Let the

circle which contains the needle be designated as "the movable circle"; let the vertical circle be called simply "the semicircle," because it is graduated only over half of

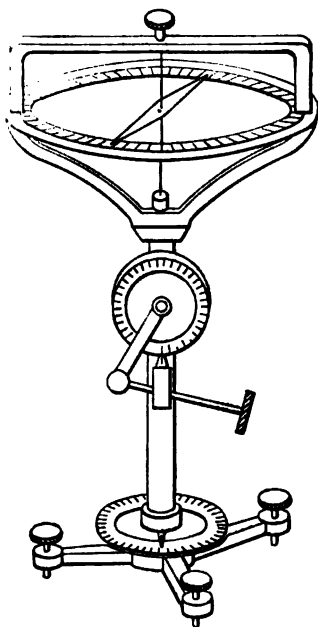

FIG. 120

its circumference; and let the fixed horizontal circle be known as "the fixed circle." Make the adjustments as follows: Place the dip-circle on the table and slip the screw-feet into grooves prepared for this purpose. Remove all magnetic substances from the neighborhood of the table which supports the dip-circle. If the needle does not move freely in its bearings, or if it is too loose, adjust the screw which regulates the pivot, and clamp it by means of the nut.

1. To place the needle horizontal. Loosen the screw which projects from the plane of the semicircle below its arc, and which, when tightened, firmly clamps it to the vertical axis of the whole instrument. Grasp the large milled head on the opposite side of the semicircle, and turn it until the zero of the semicircle appears to coincide with its index. Clamp the semicircle tightly by means of the screw just noticed, and complete this adjustment by turning the "tangent screw" beneath the semicircle until its zero mark coincides exactly with the index. (View the scales of the circles through the lens in making all accurate adjustments or readings.) Turn the three screws which form the feet of the dip-circle until the plumb-line hangs in the middle of its ring. Turn the upper part of the dip-circle around its vertical axis through about ninety degrees, and adjust the screw-feet

until the plumb-line again passes through the centre of the ring. Continue to turn the dip-circle through the quadrants and to adjust its feet until the thread passes approximately through the middle of the ring in all positions of the instrument—*i. e.*, until the dip-circle is practically level. The axis of the needle is now truly vertical.

2. To locate the magnetic meridian. Although the grooves in the table are intended to prevent any movement of the instrument, it is best to hold the fixed circle firmly in position while turning the movable circle around either its horizontal or its vertical axis. For convenience, turn the movable circle about its vertical axis until the needle points somewhere near either of its zero divisions. (Pound on the table with your fist, thus jarring the needle and giving it freedom of motion, so that it may assume its proper position.) Read both ends of the needle, estimating to tenths of a degree, and take the arithmetical mean of these positions. For consistency, call all readings around the horizontal scales in one direction from the zero marks positive, and prefix a negative sign to all readings in the opposite direction—*e. g.*, clockwise +, anti-clockwise —. Loosen the screw which holds the needle in its bearings, remove it, turn it over and replace it, thus causing it to be reversed relatively to the scale for the movable circle. Again set the needle to vibrating, and when it comes to rest note the positions of its ends and take the half-sum of the readings thus obtained. Take the mean of these two positions of the needle, direct and reversed; let it be α . Then a diameter of the movable circle which passes through the scale at this angle, α , marks the magnetic north-and-south line.

Turn the instrument around its vertical axis through an angle, α , as shown by the fixed circle at the base. This places the horizontal axis of the semicircular scale directly in the magnetic meridian.

3. To place the needle in the magnetic meridian and its axis of rotation perpendicular to it. Keeping the index

on the fixed circle unchanged, unclamp the semicircle and rotate the movable circle about its horizontal axis until the index of the semicircle coincides exactly with either one of its ninety-degree divisions—that is, turn it through a right angle, and clamp it. (Whenever the plane of the movable circle is in a vertical position the clamp-screw must be turned very hard to overcome the tendency of the circle to slip into an oblique position due to the moment acting upon it.) The needle is now approximately in the magnetic meridian. Beat on the table and then record the positions of both ends of the needle, as indicated by the movable circle. Next turn the instrument around its vertical axis exactly 180° from its initial or zero position, and note the readings of the ends of the needle. Turn the movable circle around its horizontal axis through two right angles, so that the index of the semicircle coincides with its other ninety-degree division. Be very careful not to move the index of the fixed circle in making this adjustment. Jar the instrument and read the ends of the needle. Again revolve the dip-circle around its vertical axis through 180° —*i. e.*, back to its first position—and record the positions of the ends of the needle.

Now, as before explained, reverse the needle relatively to the movable circle. Repeat all of the operations described in the last paragraph, and record the four pairs of results so obtained.

4. Ask an instructor to reverse the magnetization of the needle; and, after this reversal has been accomplished, repeat the entire set of adjustments and readings described in the preceding paragraphs. Before levelling, turn the instrument around its vertical axis through 180° , so that the zero division of the fixed circle which was not used before as the principal reference-mark shall now be so used. This will vary the conditions of the experiment slightly. Take the arithmetical mean of the thirty-two readings of the ends of the needle and record it as the true dip.

ILLUSTRATION

Feb. 11, 1895

DIP AT BALTIMORE

Index zero = + 1.1°

Direct.

Needle Readings Left { 80.5°, 80.1° { 70.8°, 71.0°		Needle Readings Right { 79.7°, 79.6° { 71.8°, 71.8°	
--	--	---	--

Reversed.

Needle Readings Left { 80.0°, 80.1° { 71.0°, 71.1°		Needle Readings Right { 79.2°, 79.4° { 71.8°, 71.1°	
--	--	---	--

Remagnetized.

Index zero = - 8.2°

Direct.

Needle Readings Left { 72.8°, 72.4° { 57.0°, 56.2°		Needle Readings Right { 72.2°, 72.2° { 56.9°, 57.9°	
--	--	---	--

Reversed.

Needle Readings Left { 71.1°, 71.6° { 56.9°, 56.7°		Needle Readings Right { 71.3°, 71.4° { 57.9°, 57.2°	
--	--	---	--

$$\text{Dip} = \frac{2240}{32} = 70.00^\circ$$

Questions and Problems.

1. Give a practical method for diminishing the error due to the sticking of the needle in its bearings when it is allowed to come to rest.
2. What are meant by the "magnetic elements," and how do they vary with the time and place of observation?

EXPERIMENT 65

Object. To compare the intensities of fields of magnetic force. (See "Physics," Art. 269.)

General Theory. If a magnet be suspended free to oscillate about an axis perpendicular to a field of force, the period of vibration is

$$T = 2\pi\sqrt{\frac{A}{MR}}$$

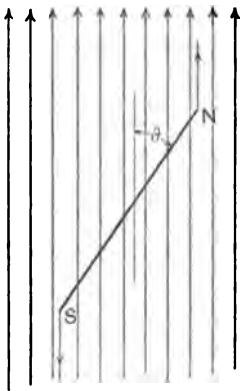

FIG. 121

where A is the moment of inertia of the magnet about its axis of vibration, M is the magnetic moment, R is the intensity of the magnetic field, M and A are constants for a given magnet, if it is not jarred or otherwise altered magnetically.

Therefore, if this same magnet is suspended so as to make oscillations in another field of force whose intensity is R_1 , and if the period of vibration is T_1 , then

$$T_1 = 2\pi\sqrt{\frac{A}{MR_1}}$$

and hence

$$\frac{R_1}{R} = \frac{T^2}{T_1^2}$$

In this experiment, therefore, the same magnet is to be made to perform oscillations in different fields of force; and their intensities may be compared by measuring the periods of vibration in the different fields.

Sources of Error.

1. If anything happens to the vibrating magnet, its magnetic moment will be changed. Therefore avoid all jars, changes in temperature, contact with other magnets, etc.
2. The supporting fibre must be as free as possible from torsion.

Apparatus. A bar-magnet, about 3 centimetres long; a large glass jar; a piece of silk fibre; a sheet of paper or a piece of pasteboard; and a glass tube, the length of which is somewhat greater than any diameter of the glass jar.

Manipulation. Make a stirrup of a short strip of paper, and suspend it from the middle of the glass tube by means of the fibre. Place the tube across any diameter of the upper open end of the jar so that the stirrup and fibre hang near the middle of the jar. The fibre should be of such a length as to support the stirrup about five centimetres above the bottom of the jar. When the torsional oscillations of the fibre have practically ceased, place the magnet in the stirrup. Take great care not to drop or abuse the magnet in any way, or else all of the results will be vitiated. There must not be any magnetic substance in the neighborhood of the jar other than the one magnet under consideration. If the magnet under the action of the earth's field alone turns around abruptly, reversing its position, it must be taken out of the stirrup and replaced with its ends interchanged relatively to the stirrup. This is done to avoid producing undue torsion in the suspending fibre. Then carefully balance the magnet in a horizontal plane, and cover the jar with the sheet of paper to hinder draughts of air around the magnet. Cause the magnet to vibrate (not swing) in very small arcs about the fibre as a *fixed* vertical axis, and record the number of seconds which elapse while the magnet makes one hundred complete oscillations. Follow the method of Experiment 1.

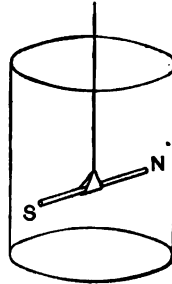

FIG. 122

It is best to mark two vertical lines on opposite sides of the jar, and then make the fibre come in between them. In this way the exact period may be measured. Repeat this reading several times, and deduce the mean period of vibration.

Move the jar and magnet to different parts of the room, or rooms, if there are several adjoining, and in a similar manner measure the period of vibration. Do this in particular near the following places :

1. A brick wall. 2. A window-sash, if there are window weights. 3. A gas or steam pipe. Also at points, some five feet apart, on a line leading through a doorway.

Assuming the intensity to be known at some standard position, calculate the intensity at each of the other positions, and plot the results on a diagram of the rooms.

Questions and Problems.

1. How does the presence of large masses of iron in the neighborhood of the oscillating magnet affect the results?
2. Explain why *small* vibrations must be used.
3. Explain what would happen if an astatic system, the two magnets of which are not quite parallel, were suspended and set vibrating. What is the position of equilibrium with reference to the magnetic meridian?
4. A dipping-needle makes 116 oscillations in a certain time when vibrating in the magnetic meridian, and 100 oscillations in an equal interval of time when its plane of vibration is perpendicular to the magnetic meridian. Calculate the dip.

EXPERIMENT 66

Object. To measure the horizontal intensity (H) of the earth's magnetic field. (See "Physics," Arts. 269, 270.)

General Theory. The horizontal intensity of the earth's magnetic field is the horizontal component of the force due to the earth which would act upon a unit north-pole if placed at the given point on the surface of the earth.

It is shown in treatises on physics (see "Physics," Art. 271) that it is possible to measure the magnetic intensity of any field of force by two experiments.

1. Suspend a bar-magnet so that it is free to oscillate about an axis perpendicular to the field of force; its period of vibration is

$$T = 2\pi\sqrt{\frac{A}{RM}},$$

where A is the moment of inertia around the axis of oscillation, M is the magnetic moment, R is the magnetic intensity of the field.

2. Place the bar-magnet at rest, perpendicular to the

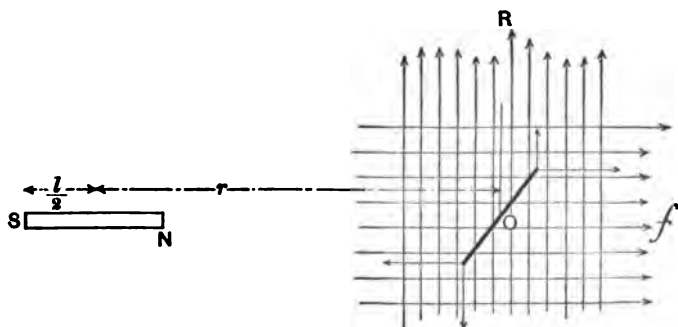

FIG. 123

field of force, and at a distance, r , from its centre in the line of its axis suspend a small magnetic needle, so as to be free to turn about an axis which is perpendicular to the field of force and to the axis of the bar-magnet. Then the angle of deflection, α , of the needle is such that

$$\frac{M}{R} = \frac{r^3 \tan \alpha}{2}, \text{ or, more exactly, } \left(r^2 - \frac{l^2}{4}\right)^2 \frac{\tan \alpha}{2r},$$

if l is the length of the bar-magnet.

From these two formulæ R may be calculated.

The general method, then, in this experiment is, first, to suspend the bar-magnet free to vibrate about a vertical axis—then, if H is the horizontal intensity,

$$T = 2\pi \sqrt{\frac{A}{HM}};$$

secondly, to suspend a small magnetic needle, free to turn about a vertical axis, and to place the bar-magnet in a horizontal plane magnetically due east or west of the needle. If the deflection of the needle is ϑ ,

$$\frac{M}{H} = \frac{r^3 \tan \vartheta}{2}, \text{ or, more exactly, } \left(r^2 - \frac{l^2}{4}\right)^2 \frac{\tan \vartheta}{2r}.$$

Sources of Error.

1. The second formula above is derived on two assumptions—that the distance, r , is immensely great in comparison with the lengths of either magnet, and that the magnetism of the bar-magnet is concentrated at its two poles. Neither of these assumptions is true.
2. The distance, r , is difficult to measure exactly.

Apparatus. “A magnetometer”; a cylindrical bar-magnet; a reading-telescope; scale and adjustable stand; a wooden metre-bar; a fishtail-burner with rubber tubing; a piece of string. The magnetometer consists essentially of a small, short magnetic needle fastened at right angles to a small plane mirror, which is suspended vertically by means of a delicate silk fibre. The needle hangs horizontally inside a box with plane glass sides, and the fibre passes up through a vertical glass tube to an adjustable metal head.

Manipulation. 1. To measure MH ,

$$T = 2\pi \sqrt{\frac{A}{MH}}; \text{ hence, } MH = \frac{4\pi^2 A}{T^2}.$$

The moment of inertia (A) of the bar-magnet should be obtained from an assistant. Measure at least three times the length (l) of the bar-magnet, by direct comparison with a *wooden* metre-bar. Handle the magnet very carefully. Hang the bar-magnet in a paper stirrup at the end of a long fibre. (See preceding experiment.) The magnet must be well balanced horizontally, and the thread must be free from torsion. Surround the magnet with a large glass jar and cover it with a sheet of paper or of pasteboard, so as to prevent draughts of air around the magnet. Of course, a slit must be cut in this cover to allow free motion of the suspending thread. Make sure there are no magnetic substances in the neighborhood of the apparatus. Give the magnet a very small angular displacement from its position of equilibrium, and determine by the method of Experiment 1 the period of vibration of the magnet. To do this properly, as explained in Experiment 1, it is necessary to make a sharp vertical line on each side of the glass jar, and so place it that the fibre which suspends the magnet comes in between these lines; then the exact interval of one period may be easily determined. If the arc of vibration is not small, allowance for the fact must be made. (See Tables.)

Repeat several times this process of counting the vibrations, and deduce the mean value of the period T .

2. To measure $\frac{M}{H}$,

$$\frac{M}{H} = \frac{r^2 \tan \vartheta}{2}, \text{ or, more exactly, } \left(r^2 - \frac{l^2}{4}\right) \frac{\tan \vartheta}{2r}.$$

The tangent of the angle of deflection is best measured by fastening a light plane mirror to the magnetic needle, and measuring its deflection by means of a telescope and scale, as is shown in the figure. It is evident that the scale-reading, p , which is caused by a deflection, ϑ , of the

mirror, corresponds to an angle 2θ between the lines drawn to the mirror from the telescope and the scale division. (See "Physics," Art. 307.) If p is the scale-reading, and n the distance from the zero of the scale at the telescope to the mirror,

$$\tan 2\theta = \frac{p}{n} = \frac{2 \tan \theta}{1 - \tan^2 \theta}.$$

But in these measurements $\tan \theta$ is small, and so its square may be neglected compared with 1, and $\tan \theta = \frac{1}{2} \frac{p}{n}$.

The magnetometer is fastened upon a long wooden frame in such a position that the centre of its needle is equi-

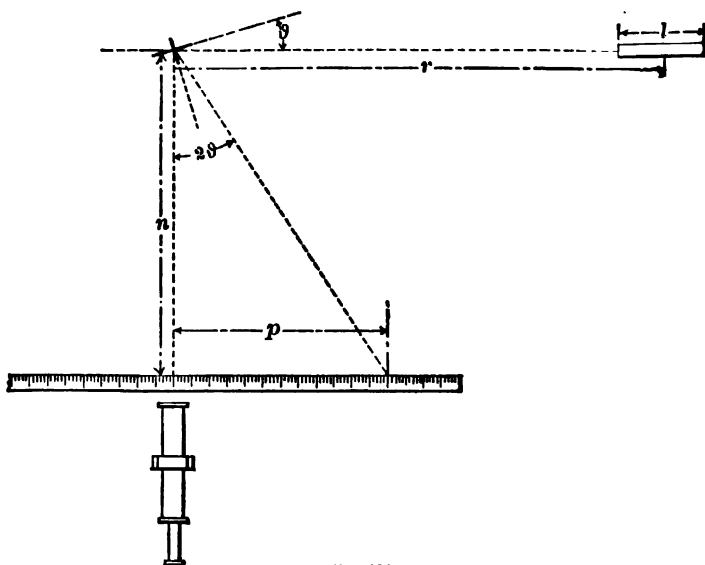

FIG. 124

distant from the centres of two screws near the ends of the frame. The groove in the upper surface of this frame should be at right angles to the magnetic meridian. To secure this position, place a large compass on a stand whose top is on a level with the mirror and at a distance from it of not less than one metre. Sight along the axis

of the compass-needle, and move the compass-box until the centre of the mirror is in the line of vision. The centres of the needle in the magnetometer and in the compass are then in the magnetic meridian. Mark the position of one end of the compass-needle by means of a pin or tack stuck up in the stand. Then measure, by means of a tightly stretched string, the distances of the centres of the screws at the ends of the magnetometer frame from the pin or tack. Keeping the centre of the magnetometer altogether unchanged in position, turn its frame around in a horizontal plane until the distances just mentioned are exactly equal. Then the frame will be normal to the magnetic meridian passing through the centre of the mirror. Set a reading-telescope on the stand with its axis in line with the pin or tack and the middle of the mirror. Clamp an inverted millimetre scale to the front of the telescope support, so that it projects about the same distance on both sides of that instrument. Then ask an instructor to adjust the telescope, gas-light, etc. Finally, make the scale parallel to the magnetometer frame. (Connect by threads two points near the ends of the scale, which are equidistant from its middle, to the centre of the mirror, and adjust the scale until these distances are equal, as before explained for the frame.)

When these preliminary adjustments have been made, place the bar-magnet some considerable distance away (20 feet, say) and note the position on the scale of the vertical cross-hair in the telescope. In general, the mirror continually swings a little, so that the reading must be found by the method of vibrations, as explained in Experiment 11. Now place the bar-magnet in the groove of the magnetometer frame, with one of its ends in close contact with the near side of either one of the fixed screws before mentioned—*e. g.*, the west one. Record the mean position of the vertical cross-hair; the difference between this reading and the one just made gives the deflection, in centimetres, of the needle, caused by the presence of the bar-

magnet. Interchange the positions of the ends of the bar-magnet, and note the resulting deflection. In like manner record the deflections when the bar-magnet is placed against the other (east) fixed screw and then reversed. Take the arithmetical mean of these four deflections and call it p . Next measure, by means of a piece of string or a metre-bar, the exact horizontal distance between the centre of the magnetometer-needle and that scale division which is nearest to it—*i. e.*, approximately the one directly under the axis of the telescope tube, or line of vision. Express this distance in centimetres, and denote it by n . Finally, measure the mean distance between the edges of the two screws by means of the metre-bar. Do this several times; and, from a knowledge of the mean value and of l , the length of the bar-magnet, calculate r .

Substitute the experimental values of l , n , p , r , and T , together with the known values of A and π , in the formula, and calculate H .

ILLUSTRATION

March 3, 1891

MEASUREMENT OF H

100 vibrations in 1288 seconds	}	∴ $T = 12.86$.
" " " 1291 "		
" " " 1284 "		
Magnet east, mean deflections	}	∴ $p = 18.9$ cm.
" west " "		
20.1 cm.		
19.0 cm.		
17.8 cm.		
18.7 cm.		
$r = 87.4$ cm. $n = 140.2$ cm. $l = 9.6$ cm. $A = 278$ C. G. S. units. Hence, $H = 0.197$ C. G. S. units.		

Questions and Problems.

1. Calculate M , m , and A for the bar-magnet, using the data of your experiment.
2. Why must a *wooden* metre-bar be used?

EXPERIMENT 67

Object. To prove that the resistance of a uniform wire varies directly as its length. (See "Physics," Art. 254.)

General Theory. Ohm's Law states that if i be the current flowing through a given conductor or several conductors joined so that the current passes through them successively, and if E is the difference of potential between any two points on this current, then $\frac{E}{i} = \text{a constant}$ as long as the conductor is not changed in the least by rise of temperature, etc. This constant is called the "resistance" of the circuit between those points, and, being denoted by R , we have

$$\frac{E}{i} = R, \text{ or } E = Ri.$$

Whence, for a constant current the difference of potential between any two points is proportional to the resistance between them. The difference of potential can be measured, as will be described below; and the object of this experiment is to prove that the resistance varies directly as the length of the conductor at whose ends the potential difference is measured, if the wire is of uniform cross-section.

To measure the difference in potential, the E. M. F., between any two points—*e. g.*, M and S —of a uniform wire through which the current is passing, the following method is used: Connect the two points M and S by wires to a galvanometer whose deflections, if small, are proportional to the current through it. If the resistance of the galvanometer circuit is made extremely large, the current taken

away from that through the uniform wire will be too small to produce any sensible effect on the fall of potential in the

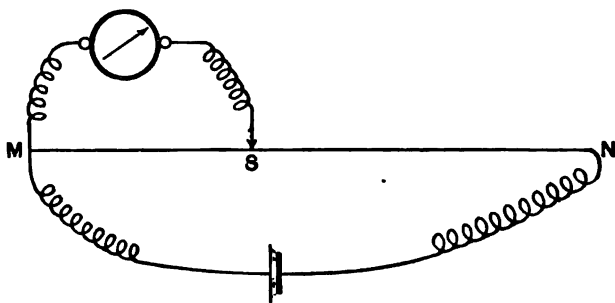

FIG. 125

wire, and its variations will be minute as S is moved along the wire; but these variations may still be large enough to be detected by the galvanometer if it is sensitive. This current, however, through the galvanometer is caused by the E. M. F. between M and S , the two points on the wire, and is proportional to it by Ohm's Law, because the resistance of the galvanometer circuit is practically constant. Therefore, the deflection in the galvanometer measures the E. M. F. between its terminals, which may be made to span different lengths of the uniform wire through which the constant current is passing.

The general method, then, is to keep one terminal of the galvanometer permanently connected to the end of the uniform wire, M , and to read the deflections of the needle as the other terminal, S , is moved along the wire from M to N . The deflections are proportional to the E. M. F. between M and S ; and this is proportional to the resistance R between M and S along the wire. The length, MS , may be measured, and if the resistance varies directly as the length, the deflection should be proportional to the corresponding length. Consequently, if the lengths measured from M are plotted as abscissæ, and the corresponding deflections as ordinates, the series of points should

lie on a straight line passing through the origin of co-ordinates.

The student must distinguish carefully between the steady deflection and the first outward swing or "throw" of the galvanometer. The steady deflection is the difference between the position of equilibrium when there is no current flowing and the position of equilibrium with the given current. It is not necessary to wait for the needle to come entirely to rest in either case; but the point of rest is found by the method of vibrations, as in Experiment 11, as soon as the range of vibration has diminished to one or two centimetres.

The battery circuit contains a resistance by which the current through the uniform wire can be regulated to a value at which it will remain fairly constant.

A key, K' , is placed in the battery circuit, and another, K , in the galvanometer branch. These are usually combined in one instrument, as shown in Fig. 126. A , B , and C are three strips of brass, and D is a brass button on the hard-rubber base

E . C and D are connected by wires, one to each of the two posts shown at G in the

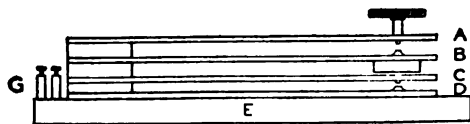

FIG. 126

figure. A and B are similarly connected to another pair of posts not shown. A block of hard rubber separates A and B at one end and keeps the other ends apart also, unless contact is purposely made by pressing down on the knob. B and C are separated by blocks of rubber at both ends, and can never be brought into contact. C and D are separated at one end only, just as A and B are, but contact cannot be made at the open end until after A and B are pressed together; consequently, if the strips A and B are connected by means of their posts as a key in the battery circuit, and C and D similarly in the galvanometer circuit, the battery circuit is always closed first and the

galvanometer circuit afterwards. Such a key is called a "Wheatstone's Bridge Key," and is most convenient in this experiment and essential in subsequent ones.

Sources of Error.

1. If the battery is used continuously its electromotive force decreases, and, consequently, the current in the wire diminishes.
2. If the current passes continuously through the bridge wire, it is heated, and its resistance increases.
3. Care must be taken at each observation to make good electrical connections by means of the sliding contact. Grease or rust at the point of contact may increase the resistance of the galvanometer branch so that the deflection is greatly diminished.

Apparatus. A high-resistance galvanometer; Wheatstone's wire-bridge and key; one or two battery-cells of constant electromotive force (Daniel's cells will answer); a resistance-box of as much as 100 ohms for the battery circuit, and one of 1000 or more for the galvanometer circuit. (These resistances need not be accurately known.)

Manipulation. Connect the apparatus as is shown in Fig. 127. If not familiar with the galvanometer, ask an instructor to show you how it is put in working order. Make r' , the resistance in the battery circuit, about 100 ohms.

Place the sliding contact so that the entire length of the wire is included between the two galvanometer terminals. In this position the deflection of the galvanometer will be the greatest obtained during the experiment, and the resistances r and r' should be so adjusted that when both keys are closed the steady deflection is not more than one-tenth the distance from the mirror to the scale and not much less than this amount; r , the resistance in the galvanometer circuit, should not be less than 500 ohms.

Open both circuits. Place the contact about 10 centimetres from M , the fixed terminal of the galvanometer. Note on the scale parallel to the wire the exact reading of

the point where contact is made, and also observe and note any difference between the terminal, M , and the zero of the scale. Determine the zero of the galvanometer, taking three swings one side and two the other, if it is not at rest. Close both keys, and, holding them down firmly, determine the new point of rest, by vibrations as before if the needle does not come to rest. As soon as it is observed

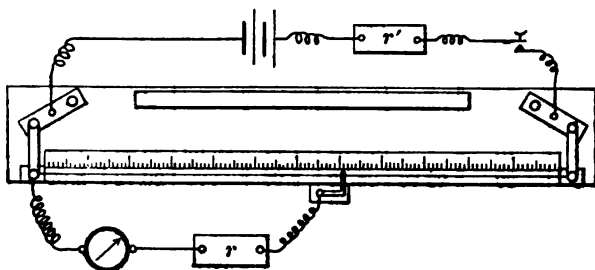

FIG. 127

and noted, release the keys and open the circuits, so that the current may not flow longer than necessary. Shift the contact to a point 20 centimetres from M , and repeat. Continue similarly to the other end of the wire and then return, taking the same points exactly in reverse order. The zero of the galvanometer should be redetermined every two, or at most three, observations. Calculate the steady deflections from the readings, and take the mean of the two observed for the same point. Reverse the direction of the current by interchanging the wires joined to the cell, and repeat the experiment. Plot the lengths of wire between M and the various points as abscissæ, and the mean deflections as ordinates.

ILLUSTRATION

March 23, 1898

Resistance in battery circuit, 100 ohms; in galvanometer circuit, 1200 ohms.

Reading of point where wire is attached to terminal, M , + 0.2 centimetre.

Reading of Sliding Contact S	Length of Wire MS	Galvanometer Readings in Centimetres						
		Original			Returning			Mean Deflection
		Zero	Current on	Deflection	Zero	Current on	Deflection	
10.2	10	23.68	24.61	0.93	24.74	1.05	0.99
20.2	20	25.64	1.97	23.69	25.68	1.99	1.98
30.2	30	23.66	26.72	3.06	26.72	3.02	3.04
40.2	40	27.66	3.98	23.71	27.73	4.02	4.00
50.2	50	23.70	28.59	4.89	28.70	5.01	4.95
60.2	60	29.71	6.03	23.68	29.85	5.67	5.85
70.2	70	23.65	30.72	7.07	30.40	6.73	6.90
80.2	80	31.72	8.06	23.67	31.61	7.94	8.00
90.2	90	23.67	32.75	9.08	32.66	9.00	9.04
100	99.8	33.68	9.96	23.66	33.60	9.94	9.95

Questions and Problems.

1. How would a great change of temperature at the point where the sliding contact touches the wire affect the readings of the galvanometer?
2. What would be the effect of variations in the pressure with which contact was made?
3. In what way is the error caused by the battery running down diminished in doing the experiment as directed?
4. Would you expect any difference in accuracy at different parts of the bridge wire, and where would you expect this experiment to show most accord with theory?

EXPERIMENT 68

(TWO OBSERVERS ARE REQUIRED)

Object. To determine roughly the effect upon resistance of alterations in length, cross-section, temperature, and material of a conductor.

General Theory. Ohm's Law states that if a current, i , is flowing through a conductor, the difference of potential, E , between any two points A and B of that conductor is



FIG. 128

connected with i by a relation which may be expressed $\frac{E}{i} = R$, a constant for the given portion AB . R is called the resistance of the conductor between A and B , and it is evident that it will vary for different conductors. It may be proved that if the conductor is in the form of a cylinder of length, l , and cross-section, σ ,

$$R = \rho \frac{l}{\sigma},$$

where ρ is a constant for a given material—(e. g., copper at 10°)—but if the material is changed in any way, replaced by another, hammered, heated, magnetized, etc., ρ the “specific resistance”—or “resistivity” as it is called—will change.

The object of this experiment is to verify these facts in a somewhat rough manner. The method adopted will be like that used in the preceding experiment. Various con-

ductors—of different lengths, cross-sections, materials, temperatures—will be joined in series, and, a current being passed through them, the difference of potential at the terminals of the various sections will be measured by a high-resistance galvanometer. The measured values of E will be proportional to the values of R .

Sources of Error.

1. The current must be kept constant.
2. The contacts must be good and constant.
3. There must be no accidental change in temperature.

Apparatus. A high - resistance mirror - galvanometer; wire connections; two dial resistance-boxes; a battery of cells; a key; a board on which are fastened in series 5 copper wires of equal length, one being of less diameter than the others and two joined abreast, 1 german-silver wire, 2 iron wires; all the wires being of the same length, and the german-silver and iron wires being of the same diameter as one of the copper wires. One of the iron wires is

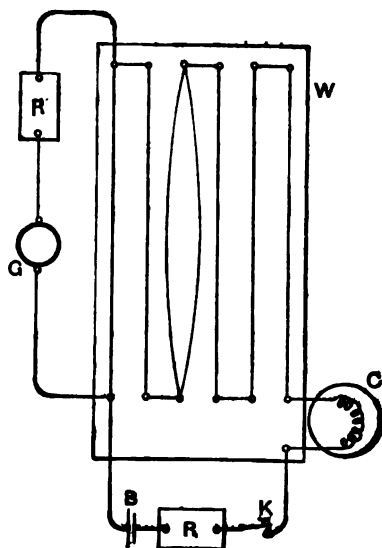

FIG. 129

wound in a spiral and so arranged as to dip into an oil-bath, whose temperature may be altered at will. Thermometer; Bunsen-burner; tripod; asbestos dish.

Manipulation. Arrange the apparatus as shown. B is the battery of cells; R, R' are resistance-boxes; K is a contact key; G is the galvanometer; W is the board of wires; C is the temperature cell.

Place the oil-bath on an asbestos dish and tripod, and raise its tem-

perature to about 100°. Maintain the temperature as constant as possible during the entire experiment.

Join the galvanometer terminals to the ends of one length of the larger copper wire, and adjust the resistances R and R' (keeping R' as large as possible) until the deflection produced when the key is closed is about 5 scale divisions. Join the galvanometer terminals in turn to—

(a) One length of the larger copper wire ; (b) two lengths of the larger copper wire in series ; (c) two lengths of the larger copper wire in parallel ; (d) one length of the smaller copper wire ; (e) one length of the german-silver wire ; (f) one length of the iron wire at the temperature of the room ; (g) one length of the iron wire at the temperature of the bath.

In each case press the key and read the permanent deflection. Then reverse the order of experiment and thus repeat the measurements. Note the temperatures of the room and the bath.

Measure the diameter of the wires, and verify the law that the resistance varies inversely as the cross-section, and that when joined in parallel $\frac{1}{R} = \frac{1}{R_1} + \frac{1}{R_2}$.

Deduce the ratio of the specific resistances of copper, iron, and german-silver.

Deduce the rate of increase of the resistance of iron with the temperature.

ILLUSTRATION

Feb. 6, 1896

COMPARISON OF RESISTANCES

Copper wire, length l , diameter 0.04 cm., mean deflection	15.1 cm.
“ “ “ l , “ 0.08 cm., “ “	4.2 cm.
“ “ “ l , “ 0.08 cm.,	
2 in series, “ “	8.4 cm.
2 in parallel, “ “	2.1 cm.
German-silver wire, length $\frac{l}{2}$, diameter 0.08 cm., mean	
deflection.....	32.6 cm.

Iron wire, length l , diameter 0.08 cm.

Temperature 18° , mean deflection..... 24.4 cm.

“ about 98° , “ “ 86.8 cm.

Specific resistance of copper = ρ .

“ “ “ german-silver = 15.5ρ .

“ “ “ iron = 5.8ρ .

If α = “ temperature coefficient ” of iron, $87=24(1+80\alpha)$.

$\therefore \alpha = 0.0062$.

Questions and Problems.

1. A current of intensity, 10, is divided and flows through two conductors—one of resistance 10^9 , the other of resistance 10^{11} ; how much heat in calories is developed in each in one hour? If one branch is 5 times as long as the other, both being of the same material, what is the ratio of the rises in temperature?
2. Is it better to have the coils of a resistance-box long and thick or short and thin? Why?
3. An incandescent lamp has a resistance of 20 ohms and requires a current 0.9 ampere. Can it be worked by suitably grouping 50 cells, each of which has an E. M. F. of 1 volt and an internal resistance of 2 ohms? $(1 \text{ ampere} = \frac{1 \text{ volt}}{1 \text{ ohm}})$.

EXPERIMENT 69

Object. To measure a resistance by the Wheatstone wire-bridge method. (See "Physics," Art. 257.)

General Theory. A Wheatstone bridge is a combination of conductors, as shown—*viz.*, a quadrilateral with its opposite corners joined. This bridge is adapted for measuring resistances in the following manner: a galvanoscope (a simple type of which is shown in the illustration) is

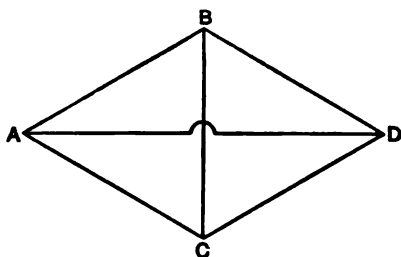

FIG. 130

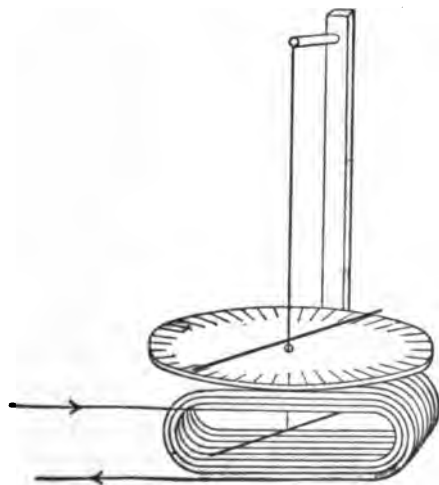

FIG. 131

placed in one diagonal branch, a cell in the other. Then, if r_1 , r_2 , r_3 , r_4 are the resistances of the four side branches, $r_1 r_4 = r_2 r_3$ if the resistances are so adjusted that no current flows through the galvanoscope. The bridge is then said to be "balanced." This adjustment may be made by altering the

resistances of the arms. So if r_1, r_3, r_4 are known resistances, r_2 may be determined.

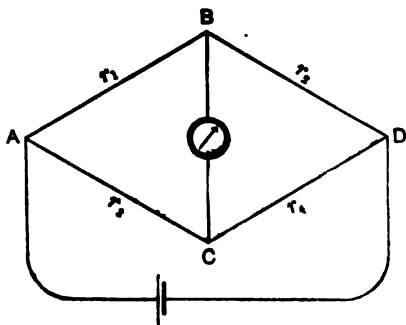

FIG. 182

One method of adjustment, known as the "wire-bridge" method, is to make the branches, AC and CD , continuous portions of a uniform wire, so that r_3/r_4 equals the ratio of the two lengths, AC and CD , l_3/l_4 . Then, in order to balance the bridge with the known

resistance, r_1 , and the unknown one, r_2 , the method is to move the terminal of the galvanoscope, C , along the wire until there is no deflection of the instrument. Then

$$r_1/r_2 = l_3/l_4,$$

or

$$r_2 = r_1 l_4 / l_3.$$

r_1 , of course, includes the resistance between the galvanometer terminal, B , and the battery terminal, A ; r_3 includes the resistance from C to A , etc. Consequently, the uniform wire $l_3 + l_4$ must end in massive metal blocks, whose resistance may be neglected; and all the connecting wires in the four arms should be short and of large cross-section.

Another mode of arranging the bridge is to use what is called the "Post-office Box" method, in which three known resistances are balanced against the unknown one. This method will be described in full in the next experiment.

The known resistance, r_1 , is generally a "resistance-box," consisting of many coils of wire placed in a box, the terminals of each coil being joined to large metal blocks. These blocks are mounted on an insulating base, such as ebonite or marble, and are separated by an air gap which may be closed by means of brass plugs. These coils of

wire are wound double, as shown, so as to have no self-induction (see "Physics," Art. 287), and the value of the resistance of each one is supposed to be accurately known and marked on the box. There are many precautions which must be taken in using a resistance-box, and the most important may be thus summarized:

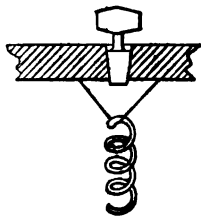

FIG. 133

1. The temperature must be kept constant, otherwise the resistance will change, and the insulating base will also expand and loosen the plugs.

2. The plugs and openings must be carefully cleaned, otherwise there is additional resistance introduced.

3. The surface of the box and metal blocks must be kept dry and clean, otherwise there is leakage. (It is best to cover a valuable box with a glass case like a balance case.)

4. Whenever a plug is put in or withdrawn, the top of the box bends slightly, and the contact of all the other plugs is altered. Therefore, each time one plug is changed, all the others should be pushed into position again by a twisting motion.

5. In time the plugs wear away, and unless they are so shaped that their necks come below the top surface of the metal blocks "shoulders" will gradually form on them, and then there is no longer good contact.

6. Each plug is ground so as to fit its own opening, and therefore plugs should never be misplaced. While they are out of their holes they should be put in regular places and kept clean.

7. The box must never be used in any circuit where there is even the possibility of a current larger than a few tenths of an ampere passing through it. Never use a good box with a storage-battery.

Sources of Error.

1. Changes in temperature must be carefully guarded against; they may arise from the hand, the current, or external bodies.

2. Good contact at all junctions is essential; and the bridge-wire key must make both good and sharp contact.
3. Allowance must be made, if necessary, for the wires connecting the boxes, etc., to the terminal binding-posts of the bridge to which the battery and galvanometer are joined.
4. The bridge wire may not be uniform; and, in any case, care must be taken to make the error introduced at the ends as small as possible.
5. The bridge wire must not be scraped by the contact key.
6. If mercury contacts are used, the metal poles which dip into the mercury-cups must be pressed firmly against the bottom plates.

Apparatus. A mirror-galvanometer; a Wheatstone wire bridge and sliding contact; a battery of constant cells; two large resistance-boxes—one accurate, the other not necessarily so; a Wheatstone bridge key; and the unknown resistance.

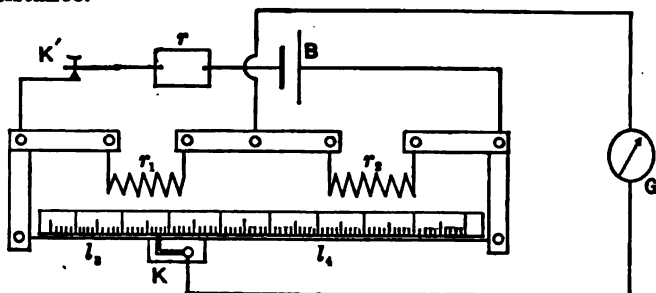

FIG. 184

Manipulation. Arrange the apparatus as shown. G is the galvanometer; r_2 , the unknown resistance; r_1 , the known resistance; B , the cells; K' and K , keys (or combined in one); r , the inaccurate resistance-box. Keep the sliding contact at the middle of the bridge wire while finding the approximate value of the unknown resistance, as follows: Start with the resistance in the battery circuit (r) so large that the spot of light will not be deflected off the galvanometer scale for all values of r_1 , which may be used. Make r_1 zero; close the battery key, K' , first, and then K ; note the direction of the deflection of the spot of light. Next make r_1

very large, and observe the deflection, always closing K' before K . If the connections are properly made, and the apparatus is in good condition, these deflections will be in opposite directions. Now try two values of r_1 which are nearer together and for which the deflections are opposite, and continue in this manner until very narrow limits are obtained—say, within 2 or 3 ohms. (Of course r , the resistance in the battery circuit, must be diminished repeatedly, as the limiting case of no deflections is approached.) Keeping r_1 fixed at the smaller of the two values thus determined, slide the galvanometer terminal along the bridge wire to that point at which no deflection is noticeable. Do not have the battery circuit closed for a greater length of time than is necessary to allow the current to become steady and to read the deflections. To find the point of no deflection accurately, increase any slight deflection in the following manner: Make the resistance, r , in the battery circuit zero; close the battery circuit, and tap the galvanometer key as the band of light approaches the middle point of its path. Repeat several times this “forcing of vibrations” as the image of the light on the scale approaches in the same direction its point of rest, and note whether the deflections are increased or diminished. In this way the direction of the current through the galvanometer may be ascertained even while the mirror is swinging. When at length it seems impossible to force the vibrations in either direction, open the circuits, and read very carefully the values of l_3 and l_4 , the lengths of the two sections of the bridge wire, estimating to tenths of a millimetre. If no deflection of the galvanometer is produced when the sliding contact is moved over a certain small length of the bridge wire, take as the correct reading the middle point of this length.

But, now, $r_2 = \frac{l_4}{l_3} r_1$. The resistance r_1 is read off the resistance-box as so many ohms; l_3 and l_4 are measured in the same units of length, consequently the unknown resistance may be calculated in ohms.

Interchange r_1 and r_2 , and repeat the foregoing operations so as to obtain another value of r_2 .

Interchange the battery and galvanometer, and find experimentally two more values for r_2 , corresponding to the two possible positions of r_1 and r_2 . In this second arrangement K must be closed before K' , for the bridge key has become that of the battery circuit, and must, as usual, be closed first.

Record the mean of these four results as the true value of the unknown resistance.

ILLUSTRATION

Jan. 12, 1895

MEASUREMENT OF RESISTANCE

No. of Exp.	r_1	l_3	l_4	$\therefore r_2$
1	21 ohms	58.87 cm.	46.13 cm.	17.98 ohms
2	23 "	55.84 "	44.66 "	18.56 "
3	20 "	52.59 "	47.41 "	18.03 "
4	22 "	55.19 "	44.81 "	17.86 "

Mean, 18.1 ohms

Resistance of given coil = 18.1 ohms.

Questions and Problems.

1. Reduce your result to electromagnetic units (C. G. S.).
2. If the mean cross-section of l_3 were greater than that of l_4 , explain the error which would be introduced in r_2 .
3. What electrical phenomena prevent the current from starting at its normal value the very instant the battery circuit is closed?
4. Is it strictly necessary to have a battery of *constant* cells? Why?
5. Give a reason for keeping the battery circuit open as much as possible.
6. Deduce the formula for expressing the condition that there shall be no current in the galvanometer, when the galvanometer and cell are interchanged.
7. Would there be any advantage in introducing known resistances at the ends of the bridge wire, between the ends and the two battery terminals?

EXPERIMENT 70

Object. To measure the resistance of a mirror-galvanometer by Thomson's Method, using a "Post-office Box."

General Theory. A "Post-office Box" is a plug resistance-box with the coils arranged in a particular way, and having binding-posts at points *A*, *B*, *C*, and *D*, as shown. The two sets of coils, 10, 100, 1000, *AB* and *BD*, are called the "ratio arms." The method of use for measuring an unknown resistance is to join *A* and *D* through the battery, *B* and *C* through the galvanoscope, and *A* and *C* through the unknown resistance (r_3). Then *AB* is r_1 , *BD* is r_2 , and *DC* is r_4 , as in the previous experiment. It is at once evident how the unknown resistance r_3 may be

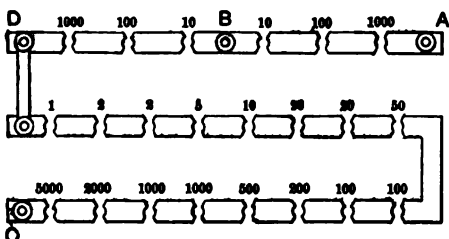

FIG. 135

determined by suitably altering r_1 , r_2 , and r_4 . There is, however, a definite mode of procedure which is advisable.

1. Make $r_1 = r_2 = 1000$; and, beginning with $r_4 = 5000$, alter it by steps of 1000, 100, 10, 1, until two values are obtained which

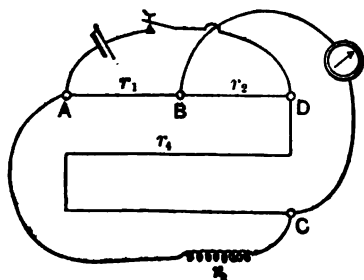

FIG. 136

produce opposite deflections of the galvanoscope. Let these two values be, for illustration, 46 and 47. Then $46 < r_3 < 47$.

2. Make $r_1 = 100$, $r_2 = 1000$, and find two values of r_4 , between 460 and 470, which will produce opposite deflections. Let them be 463 and 464. Then, since $\frac{r_3}{r_4} = \frac{r_1}{r_2} = \frac{1}{10}$, r_3 must lie between 46.3 and 46.4, or $46.3 < r_3 < 46.4$.

3. Make $r_1 = 10$, $r_2 = 1000$, and find two values of r_4 , between 4630 and 4640, which will produce opposite deflections. Let them be 4634 and 4635. Then, since $\frac{r_3}{r_4} = \frac{r_1}{r_2} = \frac{1}{100}$, r_3 must lie between 46.34 and 46.35, or $r_3 = 46.34 +$.

The next figure may be estimated by a comparison of the deflections produced by 4634 and 4635.

To measure the resistance of a galvanometer, two methods are possible: one is to place it in the branch AC , and measure its resistance as just described, by means of a galvanoscope; another is to place it in the branch AC , but to replace the galvanoscope in the branch BC by a contact key. The theory of this second method, called "Thomson's Method," is as follows: As the current flows around

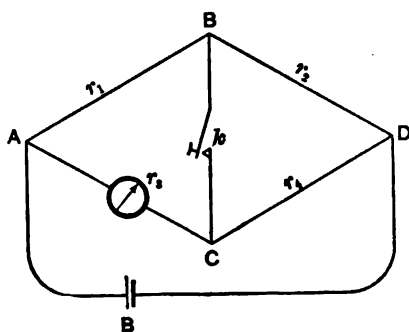

FIG. 137

from A to D , there will be, of course, a deflection of the galvanometer in the branch AC , but if the bridge is "balanced" by suitably altering r_1 , r_2 , and r_4 , so that the points B and C have the same potential, no change in the galvanometer deflection will be made

when the conductor joining B to C is made or broken, because no current will flow from B to C . Therefore, the

method is so to alter r_1 , r_2 , and r_4 that, when a key in the branch BC is made and broken, there is no change in the galvanometer deflection. In that case,

$$\frac{r_1}{r_2} = \frac{r_3}{r_4}$$

But r_3 is the galvanometer resistance, G .

$$\therefore G = \frac{r_1 r_4}{r_2}$$

Sources of Error.

These are the same as in the previous experiment. It should be noted that, since there is always a current through the galvanometer, the needle is always deflected, and so does not stand in a position in relation to the coils in which it is most easily affected by a change in the current. Therefore, it is often necessary to bring the needle back towards its normal position by means of a magnet which may be placed near the galvanometer.

Apparatus. A mirror-galvanometer; a post-office box; a battery of constant cells; two contact-keys; a magnet; wire; an ordinary dial resistance-box.

Manipulation. Arrange the apparatus as shown, putting a key, K , in the branch BC , and a key, K' , and dial resistance, r' , in the battery circuit, AD . Adjust r' , the resistance in the battery circuit, so that when r_1 and r_2 are 1000 each, and when the battery key, K' , alone is closed, the band of light is deflected through about ten centimetres.

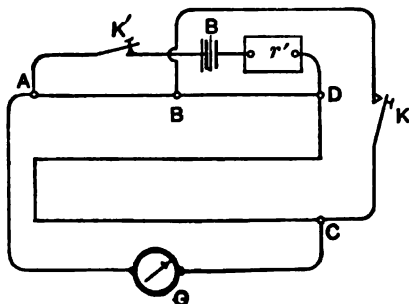

FIG. 138

In taking all the following readings, first close the battery key, K' ; note the steady deflection of the galvanometer mirror, and then observe whether this deflection is in-

creased or diminished by closing the cross-circuit key, K . Of course, the vibrations of the needle may be forced by tapping the key, K , at proper intervals; and the sensitiveness may be increased by altering r' , or bringing a magnet near, so as to neutralize part of the action of the steady current in case it carries the spot of light off the scale. If making the circuit containing K causes no change in the deflection, then no current flows through this branch, BC , and the Wheatstone net is "balanced."

However, when r_1 and r_2 are each 1000, the resistance, r_4 , usually cannot furnish such a value as will satisfy the relation, $G = \frac{r_1 r_4}{r_2}$ exactly; consequently, a small current will flow through the branch BC , and will increase or diminish the current through the galvanometer, according as r_4 is too small or too large. Keeping the ratio arms, r_1 and r_2 , 1000, find two values for r_4 differing by one ohm such that the *changes* in the steady deflections are in opposite directions. Now, make $r_1 = 100$, $r_2 = 1000$ ohms, and proceed exactly as directed above. Then make $r_1 = 10$, keeping $r_2 = 1000$, and again balance the bridge.

ILLUSTRATION

March 12, 1886

RESISTANCE OF GALVANOMETER			
r_2	r_1	r_4	$\therefore G$
1000	1000	46 - 47	46 - 47
1000	100	468 - 469	46.8 - 46.9
1000	10	4688 - 4684	46.88 - 46.84

Hence, $G = 46.88 \pm$ ohms.**Questions and Problems.**

1. Is it better to use for B a single cell of small E. M. F., with r' proportionally small, or to have a battery of comparatively high E. M. F. with a correspondingly large resistance?
2. What is the essential condition to be satisfied in either case?
3. Why cannot the deflections of the galvanometer mirror be reversed, as could be done in the preceding experiment?

EXPERIMENT 71

Object. To measure the resistance of a cell by Mance's Method. (See "Physics," Arts. 242, 257.)

General Theory. The resistance of an electrolyte or a cell (*e. g.*, a Daniell's cell) does not remain constant as a current flows through it, owing to changes in the liquids and at the metal electrodes, and therefore any measurement of it must be made quickly. There are several methods for its measurement, two of which will be described—one in this experiment, and the other in the following one.

Resistance of a Cell. Mance's Method.—If the cell, *B*, is placed in the branch, *AC*, of the bridge, and a key, *K*, inserted in place of the battery in the branch, *AD*, there will, of course, always be a current through the galvanometer, and its needle will be deflected. But if, on making and breaking the key, *K*, there is no change in this deflection, the

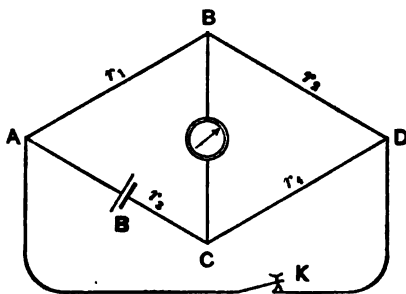

FIG. 139

bridge must be "balanced"—*i. e.*, $r_1 r_4 = r_2 r_3$; for in this condition the current through the galvanometer is independent of the E. M. F. in the branch *AKD*, and so will be the same when the key is opened and when it is closed.

Hence, if B is written for r_3 ,

$$B = \frac{r_1 r_4}{r_2}.$$

The adjustments, then, are obvious; and either a wire bridge or a post-office box might be used. A third method, however, will be described, simply for variation. This method is to use three separate plug-boxes for r_1 , r_2 , and r_4 , and adjust them until the bridge is balanced.

Sources of Error.

1. The same remarks apply here as in the two previous experiments.
2. The polarization of the cell must be avoided if possible.

Apparatus. A high-resistance galvanometer; a constant cell; three plug resistance-boxes; one dial resistance-box; a key; a magnet.

Manipulation. Arrange the apparatus as shown, putting the dial-box in the galvanometer branch. Connect the cell,

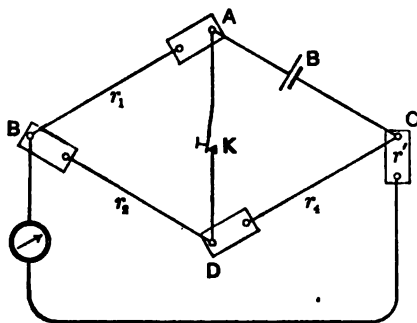

FIG. 140

B , to the adjacent resistance-boxes by very short, thick wires. Keep r_4 constant at 1000 ohms throughout the experiment. Start with $r_1 = 20$ ohms and $r_2 = 10,000$ ohms. Adjust r' , the resistance in the galvanometer branch, so that when the key is

open the image of the source of light is on the galvanometer scale near either one of its ends. If necessary, bring the spot of light back on the scale by means of the magnet, or by putting a shunt around the galvanometer. Keeping r_2 fixed, vary r_1 until two values are found differing by one ohm, such that the corresponding changes in the permanent

deflection, which occur when K is closed, are in opposite directions. Usually these values of r_1 will be less than 20 ohms. In general, r' (or the resistance of the shunt) must be varied slightly with the other resistances, so as to maintain the steady deflection at the amount above mentioned. Change r_1 to two ohms less than the smaller of the numbers just obtained, and keep it fixed at this value. Then adjust r_2 until no change in the steady deflection of the mirror is caused by closing the key. If a change in the deflection always occurs when the key is opened or closed, determine two values of r_2 , one of which increases, the other decreases the deflection, and choose the one which gives the least change. Under this condition no current (or a minimum one) flows through the branch containing the key, K , so that $B = \frac{r_1 r_4}{r_2}$. Whence, calculate and record the resistance of the given cell.

ILLUSTRATION

March 12, 1886

RESISTANCE OF DANIELL'S CELL

First approximation, with $r_3 = 10,000$ and $r_4 = 1000$ ohms, gave $11 < r_1 < 12$, or $B = 1.1 +$ ohms.

Finally, with $r_4 = 1000$ and $r_1 = 9$, the least deflection occurred when $r_2 = 7706$; hence, $B = 1.16 +$ ohms.

Questions and Problems.

1. Explain, *using symbols*, how an overwhelming error might be introduced into the final result by putting a comparatively large known resistance in the branch containing the cell?
2. Why cannot a Wheatstone wire bridge be used to advantage in this experiment?
3. Upon what quantities does the internal resistance of a cell depend, and how?

EXPERIMENT 72

Object. To measure the specific resistance of solutions of copper sulphate by Kohlrausch's Method. (See "Physics," Art. 244.)

General Theory. If, instead of using a direct steady current with a Wheatstone bridge, an alternating or varying current (*e. g.*, one from an induction-coil) is used, the balance of the bridge can no longer be tested by a galvanoscope, but a telephone may be used in its place, as it responds to slightly varying differences in potential. The general arrangement is the same as before. To produce a varying current an induction-coil may be used or any kind of an interrupter in a direct current, such as a commutator or scraping contact. The advantage of an alternating current with an electrolyte is that there is little if any electrolysis or polarization.

The specific resistance of any conductor is defined as being that of a cube of the substance 1 centimetre on each edge. Consequently, if the substance is in the form of a cylinder of cross-section σ and length l , and if ρ is its specific resistance, the resistance of the cylinder is $\rho \frac{l}{\sigma}$.

Any form of the bridge may be used, but the method employing three separate boxes will be described. Instead of using a single box, r_1 , in one arm of the bridge, it is sometimes best to put in another very high resistance-box, r_1' , parallel with it. For the combined resistance of the

two is R , where $\frac{1}{R} = \frac{1}{r_1} + \frac{1}{r_1'}$; and so, if r_1 is nearly equal

to the desired resistance, R can easily be made exactly equal to it.

Sources of Error.

1. The greatest uncertainty enters from difficulty in detecting the minima in the telephone.
2. The temperature must be kept extremely constant.
8. Polarization should be absolutely prevented.

Apparatus. A small induction-coil; a storage circuit; two telephones; a thermometer; two exactly equal resistances of about 100 ohms each; two good plug resistance-boxes, the one containing low-resistance coils and the other high-resistance coils; some crystals of copper sulphate; a glass funnel; a piece of filter paper; a large beaker-glass; and the electrolytic cell. This cell consists essentially of a suitably mounted cylindrical glass tube, the ends of which are closed by copper disks, called electrodes. The distance between these electrodes may be varied so that they form the ends of the column of liquid contained in the glass tube.

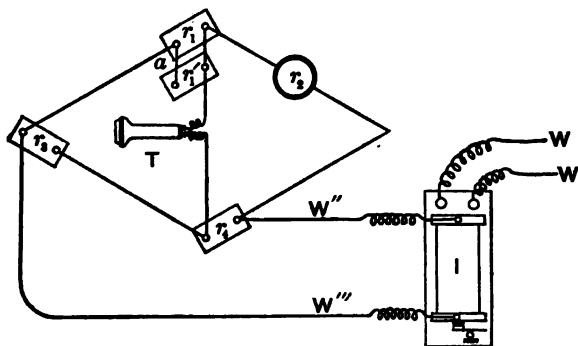

FIG. 141

Manipulation. Set up the apparatus as shown. r_2 is the electrolytic cell; r_1, r_1' , the low and high resistance-boxes respectively, which are joined in "parallel" or "multiple arc"; r_3, r_4 , the equal resistances; and T the telephone circuit. The wires (W'', W''') of the secondary circuit must

be suspended in the air so far as possible, to prevent short circuiting. The induction-coil (I) must be placed on the sill outside of a window as far from the observer as convenient, in order to muffle the distracting sound of the interrupter. The amount of copper sulphate required depends upon the size of cell to be used, and should be indicated by an instructor. Pulverize the crystals and make five and ten per cent. solutions (by weight), using tap water as the solvent. After the copper sulphate is thoroughly dissolved, filter the solution so as to remove impurities. Pour a part of either one of the solutions into the electrolytic cell, and set the electrodes parallel to each other at the ends of the column of liquid. Put an infinite resistance in the plug-box (r_1') which contains the high-resistance coils—*i. e.*, throw it out of the circuit by unbinding an end of the wire (a), which joins the two boxes. Vary r_1 , first by hundreds, then by tens, and finally by units, until an approximate value of the electrolytic resistance (r_2) is found, as will be indicated by a minimum vibration in the telephone. Using this result as a guide, regulate the distance apart of the electrodes and the quantity of liquid in the cell, so that its resistance is a *few ohms less* than that of either of the equal arms (r_3, r_4) of the Wheatstone bridge.

Now suspend the thermometer vertically alongside the glass tube of the cell. Then adjust the electrodes very carefully, so that their opposing surfaces are parallel, at the same time that the electrolyte completely fills the space between them, but does not extend beyond them. After this, do not alter in the least the relative positions of the parts of the electrolytic cell, and avoid, as much as possible, changes in the temperature of any part of the apparatus. Find two values of r_1 , differing by one ohm, between which the unknown resistance lies. Join the other plug resistance-box (r_1'), in parallel by the connecting wires, and vary the resistances in the plug-boxes until the bridge is balanced as nearly as possible—*i. e.*, until there is

no sensible vibration in the telephone. Better results are obtained by using two telephones—one for each ear.

Finally, record the mean temperature of the solution as indicated by the thermometer outside the cell, and measure the mean distance (l) between the electrodes. Empty the cell, wash it with tap water, and measure the resistance of the other solution in the manner just described. When no current passes through the telephone branch, $r_2 = \frac{r_4}{r_3} R = \frac{r_1 r_1'}{r_1 + r_1'}$, ohms, since $r_3 = r_4$. Also, $r_2 = \rho \frac{l}{\sigma}$; consequently, the specific resistance, $\rho = \frac{r_1 r_1' \sigma}{l(r_1 + r_1')} \times 10^9$ C. G. S. units. The internal cross-section of the tube (σ) is a constant furnished with the cell.

ILLUSTRATION

April 2, 1896

RESISTANCE OF COPPER SULPHATE

Mean temperature = 18° C. $\sigma = 19.50$ sq. cm. $r_3 = r_4 = 100$ ohms.

$r_1 = 98$ ohms	}	$\therefore \rho_s = 5.48 \times 10^{10}$.	$r_1 = 97$ ohms	}	$\therefore \rho_{16} = 3.20 \times 10^{10}$.
$r_1' = 4000$ "			$r_1' = 4200$ "		
$l = 84.84$ cm.			$l = 57.70$ cm.		

Questions and Problems.

1. What is the advantage of an alternating current over a direct current in this experiment?
2. Should the interrupter of the induction-coil emit a high or a low note to cause the most abrupt minima in the telephone?
3. Of what metal should the electrodes be made to give the best results? Why?
4. What physical causes are there why the specific resistance of an electrolyte should vary with the temperature?
5. If there are N cells available, each of E. M. F., E and resistance r , how should they be joined so as to give a maximum current through a conductor whose resistance is R ? How much energy is supplied in one second, and how is it spent?

EXPERIMENT 78

Object. To compare electromotive forces by the high-resistance method. (See "Physics," Art. 278.)

General Theory. Since by Ohm's Law, $i = \frac{E}{R}$, and since the deflections of any one galvanometer are the same for the same current, the E. M. F.'s of two cells may be compared by placing each in turn in circuit with the galvanometer and a resistance-box, and varying the resistances until the deflections are the same. Then, if R_1 and R_2 are the entire resistances in each circuit which correspond to E_1 and E_2 , $\frac{E_1}{E_2} = \frac{R_1}{R_2}$, because the currents are equal.

A galvanometer - needle is never quite symmetrically placed in the coils, and so, if a current is reversed, the direct and reversed deflections may not agree exactly. To multiply, then, the number of readings and eliminate as many errors as possible, it is best to reverse the current through the galvanometer and repeat the observations.

A good form of current reverser, or commutator, known as Pohl's, is shown in the drawings. It consists of a board with six metal cups containing mercury, and four binding-posts, the cups and posts being connected by conductors as shown. A rocker is supported as shown so as to make connection from C_1 to C_2 and C'_1 to C'_2 , or from C_2 to C_3 and C'_2 to C'_3 . The two metallic ends of the rocker are separated by an ebonite handle.

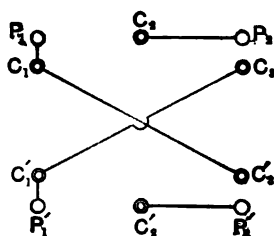

FIG. 142

When connection is made from C_1 to C_2 and C'_1 to C'_2 , P_1 and P_2 are in metallic connection, as are also P'_1 and P'_2 . If, however, the rocker is tipped over so as to join C_2 to C_3 and C'_2 to C'_3 , P_1 is joined to P'_2 and P'_1 to P_2 ; and consequently a current flowing from P_1 to P_2 , through the galvanometer, to P'_2 , to P'_1 , and through the cell to P_1 , will have its direction through the galvanometer reversed.

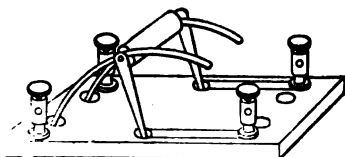

FIG. 142a

Sources of Error.

1. Two deflections can never be made to agree *exactly*.
2. The commutator must be clean, and the copper rocker must be well amalgamated, so as to make good and constant connection.
3. The resistance of the battery and the connecting wires is in general neglected, hence it should be made small and kept the same in the two experiments.

Apparatus. A sensitive mirror-galvanometer; two plug resistance-boxes, containing low and high resistance-coils

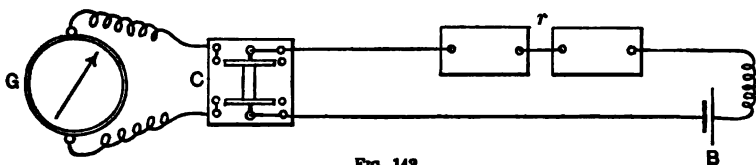

FIG. 143

respectively; a commutator (Pohl's); and several cells of different kinds.

Manipulation. Arrange the apparatus as shown. G is the galvanometer; B is the cell; C is the commutator; the two resistances joined in series are shown at r .

Start with the circuit incomplete by removing the rocker of the commutator from the mercury-cups. First use a single Daniell's cell as the source of E. M. F.—*i. e.*, for the battery B . Make the resistance r very large—say,

10,000 ohms. Then complete the circuit by replacing the commutator bridge, and note roughly the resulting deflection of the galvanometer mirror. Vary the amount of the effective resistance in the boxes until the image on the scale of the source of light is deflected to a division near, but not beyond, either end of the scale. Keep the resistance fixed and record its value. If this resistance is much less than 5000 ohms, it must be increased at the cost of the magnitude of the deflections. Remove the commutator bridge, note the zero point of the galvanometer by the method of vibration; replace the bridge and note the deflection produced. These deflections should be read by the "method of vibrations," and the arithmetical mean of at least four deflections thus obtained must be recorded.

Next reverse the current through the galvanometer by the aid of the commutator. Again take the mean of the same number of deflections, which will be, of course, in the opposite direction to those just recorded. It may be necessary in order to obtain deflections of the desired magnitude to readjust r , in which case its new value must be recorded.

Substitute for the Daniell's cell one or more cells of a different kind. Repeat the entire process just explained, being careful to adjust the respective resistances so that the deflections have the *same* values, both in magnitude and direction, as the corresponding ones found for the Daniell's cell. This equality should be attained to within the difference made by a change of *one* ohm in the resistance.

If R' is the resistance of the galvanometer, r_1 and r'_1 the mean resistances for the right and left deflections with the Daniell's cell, and r_2 and r'_2 the resistances for the right and left deflections with the other cell, then

$$\frac{E_1}{E_2} = \frac{R' + r_1}{R' + r_2} = \frac{R' + r'_1}{R' + r'_2}.$$

The value of R' can be learned from an instructor, or may be directly determined; and the resistance of the battery, commutator, and wires may be neglected.

Calculate the ratio of the electromotive forces of the cells used, keeping the resistances corresponding to the left deflections separate from those for right deflections. Report the mean of the two determinations of the ratio E_1/E_2 , thus found, as the final result for each cell.

It is sometimes convenient to keep the resistance constant and to allow the current to vary. Then, assuming the deflections d_1 and d_2 to be proportional to the currents, which is reasonably true if they are small, the relation between the E. M. F.'s is $E_1/E_2 = d_1/d_2$. This process is often called the "equal-resistance method" to distinguish it from the "equal-deflection method" explained above.

ILLUSTRATION

Feb. 2, 1884

E. M. F. OF CELLS

$R' = 120.7$ ohms. For the Daniell's cell, $r_1 = 8000$ ohms.

To obtain the same mean deflection with a Leclanché cell, $r_2 = 12080$ and 11984 for left and right deflections respectively.

$$\frac{E_1}{E_2} = \frac{8120}{12150} = 0.668 \text{ left deflections.}$$

$$\frac{E_1}{E_2} = \frac{8120}{12100} = 0.671 \text{ right deflections.}$$

Mean, $\overline{0.670}$

Questions and Problems.

1. Calculate the E. M. F. of the cells in volts, in C. G. S. electro-magnetic units, and in C. G. S. electrostatic units on the assumption that the E. M. F. of a Daniell's cell is 1.08 volts.
2. What is the theoretical advantage of the "equal-deflection method" over the "equal-resistance method"?
3. Discuss, in brief, the sources of error arising from the cells furnishing a current.
4. Upon what does the E. M. F. of a cell depend?

EXPERIMENT 74

Object. To compare electromotive forces by the "condenser method." (See "Physics," Arts. 235-237.)

General Theory. If a condenser of capacity C is charged to a difference of potential E , the quantity of charge on either plate is

$$Q = EC.$$

As will be explained below, Q can be measured by discharging the condenser through a ballistic galvanometer. The method, then, is to charge the same condenser to the potentials E_1 and E_2 of the cells, and to measure the corresponding quantities Q_1 and Q_2 . Then,

$$E_1/E_2 = Q_1/Q_2.$$

A ballistic galvanometer is designed to measure *quantities*, not currents—*i. e.*, not i , but the product it , where t is the number of seconds the current of intensity i flows. The needle must have a long period of vibration, and the discharge must take place quickly. (See Chapter "Galvanometers.") The sine of half the angle through which the mirror of a ballistic galvanometer is thrown by the sudden passage of a quantity of electricity around the coil is a measure of this quantity. Also, for small arcs the sines are proportional to the deflections in scale divisions of the band of light. In symbols, $Q = kd$. The swings of the mirror are "damped" by the resistance of the air, by induced currents, and by the viscosity of the fibre which suspends the mirror. Therefore the deflection (d), which would have occurred had there been no damping, is equal to the observed initial "fling" (d_1) of the band of light, increased by a correction term. The approximate value of this correction

may be obtained by the following considerations: Let d_2 denote the number of scale divisions passed over by the band of light in moving from its zero position to the first turning-point in the opposite direction to that of the initial fling, d_1 . The difference between d_1 and d_2 is caused by the damping of the mirror while it is making two *semi-vibrations*, $-d_1$ and $+d_2$. But these vibrations are so nearly equal that the retardation for either one of them may be taken as half that of both — *i. e.*, as $\frac{1}{2}(d_1 - d_2)$. Consequently, $\bar{d} = d_1 + \frac{1}{2}(d_1 - d_2)$.

Similarly, before the mirror completes its oscillation in the *same* direction as the initial swing, it has made four nearly equal semi-vibrations ($-d_1, +d_2, -d_2, +d_3$); so that in this case $\bar{d} = d_1 + \frac{1}{4}(d_1 - d_3) = d_1 + \frac{1}{4}\delta$.

Of course there is less error involved in assuming an equality of damping for two semi-vibrations than for four, but since d_3 can usually be read more accurately and easily than d_2 , it follows that the correction $\frac{1}{4}\delta$ is the more advantageous in practice.

Therefore

$$\frac{E_1}{E_2} = \frac{d_1 + \frac{1}{4}\delta}{d'_1 + \frac{1}{4}\delta'}$$

In using a ballistic galvanometer it is sometimes a minute or more before the needle comes to rest again after a fling, or it may be kept constantly vibrating slightly, owing to magnetic or mechanical disturbances. To obviate this difficulty, always discharge the condenser at an instant when the needle is at one of the turning-points of its small vibrations, and note the deflection, *not* from the true zero, but from the turning-point. The needle may be brought approximately to rest by a “damping key.”

Various keys have been arranged to charge and discharge a condenser. The requirements are that by one motion the battery which is charging the condenser may be thrown out of circuit, and the two plates joined through the galvanometer. For this purpose the key must have three binding-posts and two contacts, as shown in Figs. 144 and

145. When the key is pressed down, the two plates of the condenser are joined to the cell; by releasing the spring the key flies up and makes contact with the galvanometer terminal, so that the condenser is discharged through it.

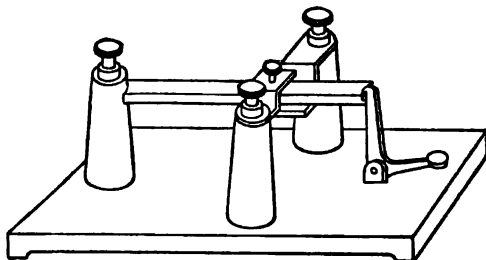

FIG. 144

Sources of Error.

1. The capacity of a condenser depends slightly upon the time of charge, and the quantity discharged varies also with the time of discharge.
2. There must be no leakage through or over the key.

Apparatus. A ballistic galvanometer; a condenser; a discharge-key; a standard Clark cell; a battery, the E. M. F. of which is desired; a damping-key, dry-cell, and coil.

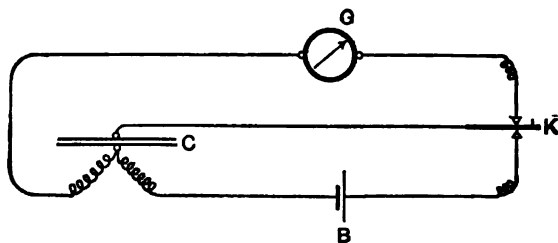

FIG. 145

Manipulation. Arrange the apparatus as shown, first using the standard Clark cell as the source of electromotive force. Arrange the coil of the damping circuit at a convenient place near the galvanometer needle and approximately parallel to the coils of the instrument. Connect it with the damping-key and dry-cell, as in Fig. 145*a*, placing the key where it can be most conveniently

reached while observing the instrument. Pressure on one lever of the key will deflect the needle in one direction; and on the other, in the opposite. If the needle is vibrating, it may be stopped by applying pressure alternately on one and on the other lever, so as to counteract the swing each time. If the damping is too powerful, move the coil farther from the needle.

When the lever of the discharge-

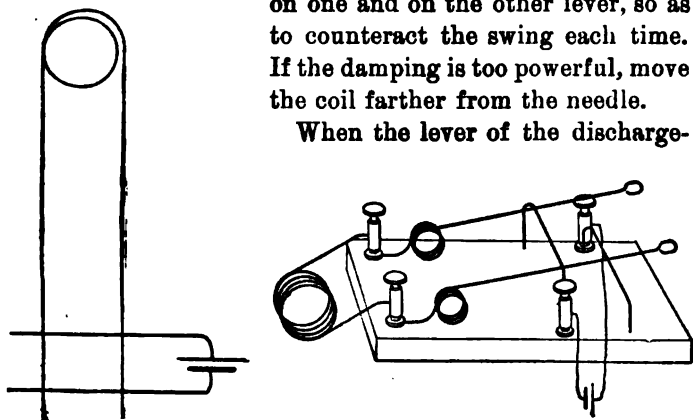

FIG. 145a

key touches the lower stop, the key is said to be in the "charge" position. When the lever touches the upper stop, the key is said to be in the "discharge" position. When the lever touches neither stop, the key is said to be in the "insulate" position. Keep the discharge-key in the insulate position while setting up the apparatus.

Record the initial temperature of the Clark cell as indicated by the thermometer on its case. Push down the lever of the key to the charge position by means of its insulating-knob, and keep it so for about one minute. During this time bring the needle as nearly to rest as possible. The exact time of charging should be noted. At the expiration of the chosen interval, when the needle is at a turning-point of its vibration, instantly, without hesitating at the insulate position, discharge the condenser through the galvanometer by pressing the trigger. Record the fling and the first swing of the mirror back in the same direction. After this, while the mirror is coming to rest,

thoroughly discharge the condenser by simultaneously earthing both plates through the fingers. Now set the key in the insulate position, then charge and repeat the process just explained so as to obtain another pair of readings. Always charge the condenser for the same length of time. In this manner take ten observations at least, and denote the mean 1st and 2d deflections by d_1 and d_3 respectively, and $d_1 - d_3$ by δ .

Once more note the temperature of the cell, and average this value with the like quantity read at the start.

Replace the Clark cell by the battery of three cells, the E. M. F. of which is unknown. Join the cells in series, and find the corresponding deflections d'_1 and δ' , both of which must be the arithmetical means of the same number of readings as were involved in d_1 and δ . The times for charging must be the same in this as in the preceding case. Substitute the values of d_1 , d'_1 , δ , δ' , together with the E. M. F., E of the standard cell, in the equation given above, and calculate the E. M. F. of the given battery as a whole. Next, join the three cells in parallel, and measure the E. M. F. Also calculate the E. M. F. of each cell of the battery, on the assumption that all the cells are equal. The absolute value of E , the E. M. F. of the Clark cell, for the recorded mean temperature will be furnished by an instructor.

Before putting away the apparatus, study the influence of the time of charging the condenser upon the quantity of electricity received by it. Let the chosen times be about 1, 15, 30, 60, and 120 seconds. Record the corresponding corrected deflections, each of which should be the average of two or more readings. Finally, study the phenomenon of "electric absorption" by keeping the condenser in circuit with the battery for five minutes and then discharging, at once insulating and discharging again at the end of one minute, insulating again and discharging again at the end of one minute, and so on, until no further fling can be observed. Record the fling for each discharge.

ILLUSTRATION

April 15, 1895

Mean temperature of Clark cell = 20.8° C.; hence, $E = 1.428$ volts.

	d_1	d	E. M. F.
Clark cell.....	4.1	0.8	1.428 volts.
3 Gonda cells in series.....	14.2	0.8	4.92+ volts.
3 Gonda cells in parallel....	4.9	0.2	1.65 volts.

Mica Condenser—Time of Charging

	1 sec.	15 sec.	30 sec.	1 min.	2 min.
Corrected deflections.....	14.0	14.2	14.3	14.4	14.4

Residual Charges at Intervals of One Minute

Corrected deflections.....	14.4	3.2	0.9	0.0
----------------------------	------	-----	-----	-----

Questions and Problems.

1. Assuming $C = \frac{1}{2}$ microfarad, calculate the mean quantity of electricity which was discharged through the galvanometer, giving the answer in coulombs, in electromagnetic units (C. G. S.), and in electrostatic units.
2. Mention the essential characteristics of a good ballistic galvanometer.
3. Give an experimental method for comparing the capacities of two condensers, also one for measuring C absolutely.

EXPERIMENT 75

Object. To determine the "galvanometer constant" of a tangent galvanometer. (See "Physics," Arts. 246, 278.)

General Theory. It is proved in treatises on Physics that, if a steady current of intensity i is passed around a tangent galvanometer when its coils are in the magnetic meridian, the needle will be deflected through an angle θ such that

$$i = \frac{H}{G} \tan \theta,$$

where H is the horizontal component of the earth's magnetic force at that point, and G is a constant for a given instrument. G depends only upon the size and number of turns of wire of the galvanometer. If the instrument has n circular turns of radius r , all of the same size, and placed closely side by side, $G = 2\pi nr$.

(A simple form of a tangent galvanometer is shown in the illustration.)

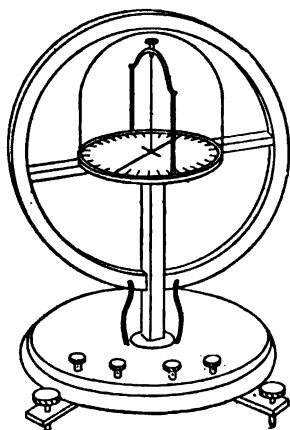

FIG. 146

If a current is passed through any electrolyte, a quantity of matter is liberated which is proportional to the quantity of electricity carried over, and also to the chemical equivalent of the matter liberated. (Faraday's Laws.) The quantity (number of grams) liberated by a unit current in one second is called the electro-chemical equivalent

of that substance; and its value is known for most substances (which can exist as electrolytes)—*e. g.*, the electrochemical equivalent of hydrogen is 0.00010352 grams, and as the density of hydrogen under standard conditions is 0.0000895, the volume of hydrogen liberated by a unit current flowing for one second is 1.156 cubic centimetres.

The values of the masses or volumes for any other element may be calculated at once by means of Faraday's Laws.

Therefore, if the same current is passed in series through a tangent galvanometer and a voltameter (an instrument devised to measure quantities liberated by the passage of a current through electrolytes), the quantity of matter liberated may be measured; this gives the current which has passed; the angle of deflection of the galvanometer-needle may be measured, and therefore $\frac{H}{G}$ may be calculated. If H is known (see Experiment 65), G may be at once determined.

Two methods will be described, in one of which a gas voltameter is used, and in the other a copper voltameter.

Gas voltameters are of two kinds. In one, the two gases liberated at the cathode and anode are kept separated. Thus, in the instrument shown, if the electrolyte is a solution of sulphuric acid, hydrogen will collect in the tube

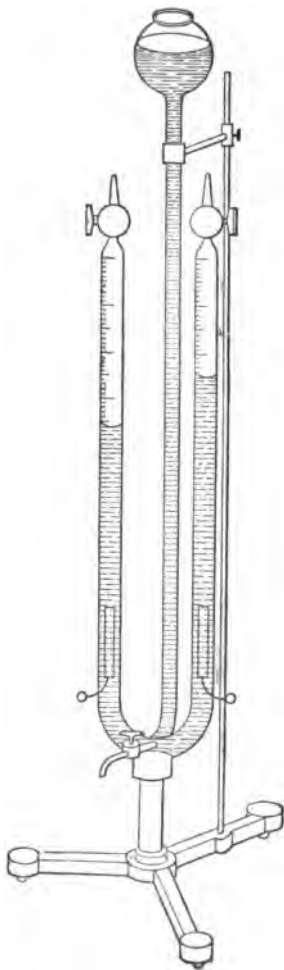

FIG. 147

over the cathode, oxygen over the anode. (The oxygen is not quite pure.)

In the other kind of gas voltameter the two gases formed at the two poles are given off in the same tube, and therefore mix as they rise through the liquid.

If the tubes in which the gases are collected are filled with the electrolyte at the beginning of the experiment, the volumes of water displaced by the gases as the current passes measure the volumes of the gases; and so the number of grams may be calculated if the pressure and temperature are known.

The use of the copper voltameter will be described in the next experiment.

Sources of Error.

1. The pressure of the gases must be accurately read, taking into account the fact that the gases are wet.
2. A steady current must be maintained.
3. The commutator which is used to reverse the current through the galvanometer, and thus correct for some of its errors of construction, must have its poles clean so as not to alter the resistance when it is turned.
4. All wires carrying currents should be so twisted around each other as to produce no magnetic effect—i. e., always twist together two wires which are carrying the same current in opposite directions.

Apparatus. A tangent galvanometer; a compass; a water voltameter; an iron coil resistance-box; a commutator; a storage circuit; a centigrade thermometer, and a large beaker-glass.

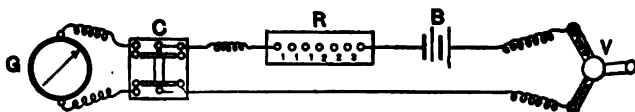

FIG. 148

Manipulation. Set up the apparatus as shown. V is the voltameter; G, the galvanometer; C, the commutator; R, the iron wire resistance; B, the storage cells.

Adjust the galvanometer in the magnetic meridian by

means of a compass (or using the magnet of the galvanometer itself as a guide, if its pointer is long enough). Fill the voltameter with dilute sulphuric acid, made by adding 5 grams of sulphuric acid (H_2SO_4) to each 100 cubic centimetres of water. Allow the current of electricity to flow while regulating the galvanometer and the resistance R , so that the deflections of the galvanometer are nearly equal to 30° . Usually, under these conditions, the gases are evolved at a desirable rate, but if it should happen that the liberation is too slow, the conductivity of the solution may be increased by adding a little more sulphuric acid.

Break the circuit by means of the commutator, and open the upper tap (or taps) to permit the enclosed gases to escape. Next fill the open tube so full that the liquid rises above the taps, and then jar the voltameter until every visible bubble of gas is driven out. Close the upper taps; note the zero position of the galvanometer, reading both ends of the index. Close the circuit through the commutator, and note the *exact second* at which the current is made. Also note the resulting deflection of the galvanometer, and quickly reverse the current through the galvanometer so as to obtain a deflection in the opposite direction. Continue to read pairs of opposite deflections, at intervals not greater than five minutes, until the tubes contain a little less than their volume of gas.

The volume of gas in the voltameter is indicated by the position of the top of the column of liquid in the burette with reference to the scale divisions which are etched on the outside of the glass tube. For convenience in measuring the volume and pressure of the enclosed gases, it is well to keep the level of the free surface of the solution in the open tube a little below that of the meniscus of the liquid in the burette. This may be accomplished very easily by opening the lower tap from time to time and allowing the necessary quantity of liquid to flow out of the voltameter into the beaker-glass, or by lowering the bulb which is connected by means of rubber tubing. (If the

apparatus is different, the water may be removed by a siphon.) When the desired volume of gas is set free, break the circuit by the aid of the commutator, and note the exact time to the second at which this is done. The difference between this reading and the like one taken at the start is the interval of time (T seconds) during which the current (i) decomposed the electrolyte into hydrogen and oxygen. Tap on the burette near the electrodes with a finger so as to cause the bubbles which stick to the inner surfaces of the voltameter below the tap of the liquid to rise and mix with the main volume of gas. Then hang the thermometer vertically alongside the burette, and while it is assuming the temperature of the enclosed gases vary the quantity of water in the open tube until, when the burette is truly vertical, the free surfaces of the liquid are at exactly the same level in it and in the closed tube (in one of the two tubes if it is a double-tube voltameter). Record the volume of gas (V) in the burette as indicated by the position on the scale of the *under* side of the meniscus. Of course the usual precautions to avoid parallax must be taken. In a similar way bring the free surface in the open tube to the level of the water in the other tube in case the voltameter is a double-tube one, and read the volume of the enclosed gas. Note the temperature of the gases (t° C.) and immediately read the mercurial barometer "correcting" the observed height.

The volume of gas under standard conditions is given by the expressions $v_0 = \frac{PV}{76} \frac{1}{1 + 0.003665 t}$; $P = h' - p'$, where p' is the tension of aqueous vapor, at t° C., in centimetres of mercury, and h' is the "corrected" height of the barometer. A unit current in one second liberates 1.156 cubic centimetres of hydrogen, and therefore 0.578 cubic centimetres of oxygen under standard conditions. Hence, if it is a single tube voltameter, the volume of the combined gases liberated by a current in T seconds under standard conditions must be

$$v_0 = 1.734 i T.$$

But
$$v_0 = \frac{P V}{76} \frac{1}{1 + 0.003665 t}.$$

$$\therefore i = \frac{V(h' - p')}{76 \times 1.734 \times T(1 + 0.003665 t)}.$$

Moreover,
$$i = \frac{H}{G} \tan \theta.$$

Consequently,

$$\frac{G}{H} = \frac{76 \times 1.734 \times T(1 + 0.003665 t)}{V(h' - p')} \tan \theta.$$

If the voltameter is a double-tube one, the volume of the hydrogen under standard conditions liberated by a current i in T seconds must be

$$v_0 = 1.156 i T.$$

If V is the observed volume of the hydrogen, it follows at once that

$$\frac{G}{H} = \frac{76 \times 1.156 \times T(1 + 0.003665 t)}{V(h' - p')} \tan \theta.$$

(Further, if V' is the volume of the oxygen, V should equal $2 V'$.)

If the tangent galvanometer is a standard one, G may be calculated, because it equals $\frac{2\pi n}{r}$, where n is the number of turns of wire and r is the radius of the coil, both measurable quantities. In this case H may be determined. If H is known, G may be calculated at once.

ILLUSTRATION

May 6, 1897

GALVANOMETER CONSTANT BY GAS VOLTAMETER

Observed cubic centimetres of hydrogen, 47.5, 18.2° C., 77.2 cm.

Corrected, 44.24.

Time, 7 m. 52 sec. = 472 sec.

$$\therefore i = \frac{44.24}{472 \times 1.156} = 0.0810.$$

θ , mean of ten observations, 36.4°.

$$\frac{H}{G} = \frac{i}{\tan \theta} = \frac{0.0810}{\tan 36.4^\circ} = \frac{0.0810}{0.7373} = 0.110.$$

$$H = 0.196. \quad \therefore G = \frac{0.196}{0.110} = 1.84.$$

Questions and Problems.

1. What are Faraday's and Joule's laws concerning electrolytes?
2. Calculate the value of ϵ used in your experiment, in amperes and also in the electrostatic system.
3. Is G a simple number, or what is it?
4. Does the tension of the vapor above the liquid in the burette become greater or less as the concentration of the solution is increased?
5. From a knowledge of the electro-chemical equivalent of hydrogen and the heat of combination of hydrogen and oxygen calculate how much energy is required to carry a unit quantity of electricity through the water voltameter. What is the least E. M. F. which will enable a current to pass through the voltameter?
6. If the current in the above experiment had been furnished by Daniell's cells, how much zinc would have been dissolved? How much copper would have been deposited?

EXPERIMENT 76

Object. To determine G or H by the deposition of copper. (See "Physics," Arts. 246, 278.)

Copper Voltmeter. A copper voltmeter consists of a solution of copper-salt in water, into which dip an anode and cathode of copper. When a current is passed through, copper is deposited on the cathode, and it increases in weight while the anode decreases. (These two changes should be equal and opposite.) It has been found by experiment that the electro-chemical equivalent of copper (from copper sulphate) is 0.003261; and, therefore, if the increase in weight, m , of the cathode is known while a current i has passed for t seconds,

$$m = 0.003261 \, it,$$

and so i may be determined.

Sources of Error.

1. Copper dissolves in copper sulphate unless special precautions are taken.
2. There must be no leakage across the top of the instrument.
3. The commutator must be clean.
4. The current must remain steady.

Apparatus. Tangent galvanometer; commutator; iron coil resistance-box; sliding resistance to keep the current constant, either wire or liquid; storage cells; wires; copper voltmeter with an extra plate; glass jar.

The voltmeter consists, essentially, of an ebonite top which bears three copper-plates dipping in a glass jar containing the



FIG. 149

electrolyte. The two outside plates are connected by a copper strip, but the inner one is insulated from them and can be screwed in or out of the cap. This inner plate is always made the cathode; the outer ones the anode.

Manipulation. Make a clean solution of the following constituents in the proportion: 100 grams of water, 15 grams of copper sulphate (CuSO_4), 5 grams of sulphuric acid, and 5 grams of alcohol. About 600 cubic centimetres of water will make enough of the solution to fill the jar to a convenient depth. (Alcohol is easily oxidized, so that it annuls the action of certain secondary products which form at the anode and tend to polarize the cell.) If the copper sulphate crystals are at all large, crush them to powder, so that the solvent may act more readily upon them. Next clean the cathode with extreme care by rubbing it with emery or fine sand-paper until every portion of the plate is as bright as possible. Never touch the clean surface of the plate with the bare fingers, but hold it by the screw at its upper end, or grasp it with a piece of clean paper. Wash the cathode by allowing water from a tap to flow over its surface, and dry thoroughly by pouring alcohol over it. Weigh the plate as accurately as possible on a convenient balance; record its mass; and keep it wrapped in clean paper until needed. In like manner the anode plates and the trial cathode plate must be polished and washed (not weighed, however), but for them such care as was bestowed upon the weighed plate is unnecessary. Screw the *trial* plate between the anode plates to their support, and fix it roughly parallel to them. Ascertain the direction of flow of the positive current by putting the ends of the battery circuit wires in the copper sulphate solution, and note which one becomes brighter by having metallic copper deposited upon it. This is the negative pole of the battery, and must be joined (directly or indirectly) to the cathode binding-post. Adjust the galvanometer in the magnetic meridian, immerse the three plates in the solution, join the apparatus, as shown in the diagram, and start the cur-

rent. Regulate the resistance, R , so that the deflections of the galvanometer in either direction are equal to about 30° . It is best to have the E. M. F. of the storage battery circuit such that, when the preceding conditions are ful-

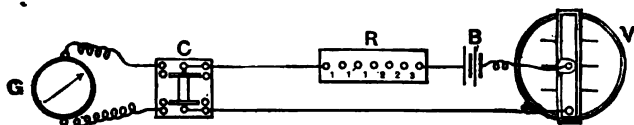

FIG. 180

filled, the total metallic resistance of the circuit is, at least, equal to ten ohms. Break the circuit by means of the commutator, C , and substitute the weighed cathode for the trial one, remembering never to touch it at any point which will be beneath the surface of the liquid in the voltameter. Make the circuit, noting both the *exact second* at which the current starts to flow and the resulting deflection of the galvanometer needle. Reverse the current through the coil as rapidly as possible, and note the deflection. Repeat the process of reading pairs of opposite deflections every few minutes—*s. g.*, five, always noting both ends of the index. Keep the current accurately constant by means of the sliding resistance. If, at any time, it changes very much, the experiment must be begun anew; otherwise continue the readings for at least an hour and a half. Let the deflection noted last be in the opposite direction to the first, so as to have equal numbers of left and right deflections. Finally, break the circuit by removing the commutator, noting the precise second at which this is done, say t seconds later than the instant of starting the current. Carefully remove the cathode plate from the voltameter; wash it thoroughly by allowing water to flow gently over its surface, and dry it by using alcohol as explained above. Once more weigh this plate as accurately as possible, and let its gain in mass be m grams.

A unit current (C. G. S. electromagnetic system) deposits 0.003261 grams of copper in one second. Hence,

the mass of copper electrolyzed by a current i in t seconds is equal to $0.003261 it = m$ grams. Substitute in the equation the experimental values of m and t , and determine i .

For the tangent galvanometer $i = \frac{H}{G} \tan \theta$ C. G. S. electromagnetic units. Finally, therefore, substitute for $\tan \theta$ and i their values, and determine H/G .

1. To find G , obtain the value of H from an instructor, and substitute it in the value of H/G .

2. To find H , calculate G from the dimensions of the galvanometer coil, if possible, and employ the above relation between G and H to obtain the latter.

ILLUSTRATION

May 7, 1897

GALVANOMETER CONSTANT

By Copper Voltmeter

Mass of cathode, 4h. 5m. 30s., 59.885 grams.

" " " 4h. 56m. 30s., 60.985 "

51m. 1.650 grams.

$$\therefore i = \frac{1.65}{0.00326 \times 51 \times 60} = 0.165 \text{ C. G. S. units.}$$

Galvanometer Deflections

Time	Current Direct		Current Reversed	
	N. Pole	S. Pole	N. Pole	S. Pole
H. M. S.	Degrees	Degrees	Degrees	Degrees
4 5 30	51.7	51.8	51.6	51.7
4 11 30	51.6	51.7	51.6	51.7
4 16 30	51.8	51.9	51.7	51.8
4 21 30	51.9	52.0	51.8	51.9
4 26 30	51.7	51.8	51.6	51.7
4 31 30	51.6	51.7	51.5	51.6
4 36 30	51.5	51.6	51.4	51.5
4 41 30	51.7	51.7	51.6	51.6
4 46 30	51.8	51.9	51.7	51.8
4 51 30	51.6	51.7	51.5	51.6
4 56 30	51.7	51.8	51.6	51.7
....	51.7	51.8	51.6	51.8

Mean, 51.7°.

$$\text{Hence, } \frac{H}{G} = \frac{i}{\tan \theta} = \frac{0.165}{\tan 51.7^\circ} = \frac{0.165}{1.2863} = 0.108. \quad \text{But } H = 0.196.$$

$$\text{Hence, } G = \frac{0.196}{0.108} = 1.84.$$

Questions and Problems.

1. What assumptions are made to deduce the formula $i = \frac{H}{G} \tan \theta$?
2. What is the advantage in having *two* anode plates and *one* cathode plate?
3. Explain how a compass-needle could be used to find the direction of flow of a positive current, if the latter were strong enough.
4. Express the current in your experiment in amperes, and also in the electrostatic system.
5. From a knowledge of the heats of combination of zinc sulphate and copper sulphate calculate the E. M. F. of a Daniell's cell.

EXPERIMENT 77

Object. To determine the mechanical equivalent of heat by means of the heating effect of an electric current.

General Theory. If E C. G. S. units is the difference of potential between the ends of a wire carrying a current i C. G. S. units, the amount of energy necessary to maintain the current in the wire for one second is Ei ergs. If the resistance of the wire is R C. G. S. units, $i = \frac{E}{R}$ or $E = iR$;

and hence the expenditure of energy per second is i^2R ergs. If the coil is stationary and enclosed in a calorimeter filled with water, this energy must all be expended in heating the calorimeter and its contents, with the exception of the energy which escapes by radiation. If the water-equivalent of the calorimeter, stirrer, coil, and thermometer is α , if it contains m grams of water, and if it be heated from t_1 to t_2 degrees while the current is flowing, the energy received by it in heat is $(m + \alpha)(t_2 - t_1)$ calories.

By the mechanical equivalent of heat is meant the ratio between the ordinary mechanical unit of energy, the erg, and the heat unit of energy, the calorie. Calling this ratio J , the definition may be stated thus: When one calorie is converted into mechanical energy it becomes J ergs. (See "Physics," Art. 180.)

If suitable precautions are taken, so that no energy escapes from the calorimeter, and none is received by it except from the electric current in the coil, and if the above change in temperature of the calorimeter and its contents takes place in t seconds, $(m + \alpha)(t_2 - t_1)$

calories = $i^2 R t$ ergs, or, reducing both sides to ergs,
 $(m + a)(t_2 - t_1)J = i^2 R t$. Whence $J = \frac{i^2 R t}{(m + a)(t_2 - t_1)}$.

The general method of the experiment is therefore as follows: A current is passed through a suitable coil of fine German-silver wire, enclosed in a calorimeter filled with water, for a time t sec., which is carefully noted, as is also the rise in temperature, $t_2^\circ - t_1^\circ$, of the calorimeter and its contents. The current is measured by including in the circuit a copper voltameter, just as in the preceding experiment. It must be noted, however, that it is even more important in this case to keep the current constant, for the heating effect is proportional to i^2 , whereas the copper deposited is proportional to i , and it is a mathematical fact that the mean of the squares of the successive values of a quantity which varies is not equal to the square of the mean of these values. For this reason some obvious indicator, such as a galvanometer, must also be included in the circuit. The constant of the galvanometer need, however, be known only approximately, as it is used merely to show whether the current remains constant and for one other purpose, to be indicated further on. The actual measure of the current is obtained from the copper voltameter. In order to aid in keeping the current exactly constant, a sliding resistance is also placed in the circuit.

The water-equivalent of the calorimeter and the weight of water it contains are determined as is usual in heat experiments. (See Experiment 49.) The resistance of the coil is determined by a Wheatstone bridge. In order to insure that any possible leakage of the current through the water may be taken into account, the resistance should be measured with the coil in water up to the level used in the experiment. Error from this source is further guarded against by making use of the fact that water cannot be electrolyzed unless there is a difference of potential of over 1.6 volts between the terminals which dip into it. Hence, by using a coil of very low resistance, but of fine enough

wire to be heated by a low current, the experiment can be so arranged that there need not be 1.6 volts' difference of potential anywhere inside the calorimeter. A coil whose resistance is about 0.9 ohms, and a current of 1.5 amperes—not more—will give very good results. For this reason, also, the constant of the galvanometer has to be roughly known in order that the current may not be allowed to exceed this amount.

Sources of Error.

1. The very low resistance is hard to determine accurately.
2. The usual errors in using a copper voltameter and in all heat experiments have to be guarded against.

Apparatus. A small and large calorimeter as described in Experiment 49, with a stirrer for the smaller one. The coil of wire is a loosely wound spiral of 82 centimetres of No. 22 German-silver wire, soldered to two stout copper terminals which pass through the cover of the small calorimeter, and which end in binding-posts. A thermometer; copper voltameter; an iron wire resistance; a sliding resistance; key suitable for a heavy current; the tangent galvanometer of the previous experiment (any other instrument which will indicate the approximate value of the current will answer); a storage-battery circuit giving an E. M. F. of 10 or 12 volts; distilled water; a watch. During the early part of the experiment a Wheatstone bridge (either slide wire or post-office box), key, battery, mirror-galvanometer, and a "wire connector" are also needed.

Manipulation. Place in a beaker on ice enough distilled water to more than fill the small calorimeter. Carefully dry the small calorimeter and stirrer, and weigh them without the top. Fill the calorimeter with distilled water to such a depth that, when the cover is put on, the coil will be entirely under water. Insert the coil, press the cover down, attach it in a Wheatstone bridge by short, very stout wires, and determine the resistance to within 0.01 ohm.

Disconnect the lead-wires from the coil, connect them to each other tightly by means of the wire connector, and thus determine the resistance of the lead-wires themselves, and subtract it from the resistance just found so as to get the resistance of the coil alone. Clean and weigh the cathode plate of the voltameter. Set up the apparatus as shown in the diagram, with the *trial* plate of the voltameter in place. B is the storage-battery; R is an iron wire resistance; S is the sliding resistance; G is the tangent galvanometer; C is the calorimeter and coil; K is the

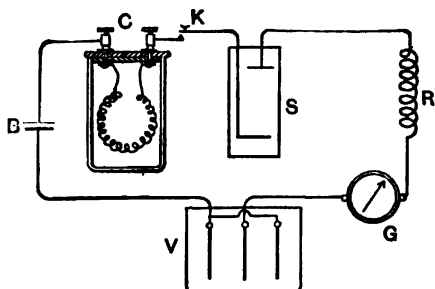

FIG. 151

key; and V is the voltameter. Close the circuit and regulate the resistance, R, so that the galvanometer shows approximately 1.5 amperes, and not over. (The constant of the instrument should be obtained from the instructor unless already determined in a previous experiment.) Break the circuit, remove the trial plate, and note whether as set up it was the cathode; and, if not, change the connections so that the middle plate will be the cathode.

Note the temperature of the room near the place of experiment. Empty the water in the calorimeter and fill with distilled water at a temperature about 12 degrees lower than that of the air, up to the same mark as before. The correct temperature can be obtained by mixing distilled water from the regular laboratory supply with that cooled for the purpose. Weigh carefully. Dry and replace the coil and cover, being careful to see that its spirals do not touch one another. Connect the coil in the circuit as before, and put in the weighed plate of the voltameter. Stir the water and read the temperature of the thermometer placed inside the calorimeter; close the key and note the exact

time. *Stir continuously*, and watch the galvanometer carefully, keeping the needle absolutely in the same position throughout the experiment by regulating the current with the aid of the sliding resistance. Read the thermometer from time to time; and, as it approaches a temperature as much above that of the room as the initial temperature was below, prepare to break the current. When the exact temperature is reached, break the current, and read the time and the temperature exactly simultaneously. Wash, dry, and weigh the cathode plate of the voltameter. From the data calculate J , remembering that 1 ohm = 10^9 C. G. S. units. With a coil whose resistance is 0.9 ohm and a current of 1.5 amperes, the temperature of 100 cubic centimetres of water will be raised about 20° C. in a little over an hour, which gives an idea of the time the current must be on.

ILLUSTRATION

May 10, 1896

MECHANICAL EQUIVALENT OF HEAT

Mass of calorimeter and stirrer = 69.68 grams.

“ “ “ full of water and stirrer = 189.13 “

Mass of water = m = 69.44 grams.

Water-equivalent of calorimeter :

$$a = 69.68 \times 0.095 = \underline{6.63}$$

$$\therefore m + a = \underline{76.06}$$

Resistance of coil and leads = 0.934 ohms.

“ “ leads alone = 0.084 “

“ “ coil, = 0.900 ohms.

$\therefore R = 0.9 \times 10^9$ C. G. S. units.

Temperature of room, 19.4° .

Current was made at 8h. 25m. 0s. Temperature of water, 22°

“ “ broken at 5h. 1m. 0s. “ “ “ 29.7°

Time current was on, 1h. 36m. 0s. = 5760s. Increase, 20.5°

Weight of voltameter plate after, 61.234 grams.

“ “ “ “ before, 59.180 “

Copper deposited = 2.104 grams.

$$\therefore \text{The current } i = \frac{2.104}{0.00826 \times 5760} = 0.1125 \text{ C. G. S. units.}$$

$$\therefore J = \frac{(0.1125)^2 \times .9 \times 10^9 \times 5760}{76.06 \times 20.5} = 4.21 \times 10^7.$$

Questions and Problems.

1. What is the mean activity of the current in the coil during the experiment?
2. The resistance of an incandescent lamp filament is 55 ohms, and the E. M. F. between its ends is 110 volts (both when the lamp is lit); how many such lamps can be lit by a dynamo giving 10 horse-power, assuming 90% of the energy to be expended in the lamps?

EXPERIMENT 78

(TWO OBSERVERS ARE REQUIRED)

Object. To determine, by means of an "earth inductor," the inclination of the magnetic force of the earth to the horizontal, usually called the "Magnetic Dip." (See "Physics," Art. 286.)

General Theory. An "earth inductor" consists essentially of a coil of wire capable of rotation through 180° about an axis in its own plane. The axis may be made either vertical or horizontal at pleasure, since the bearings in

which the axle turns are set in a frame which may be attached to a fixed stand in either position.

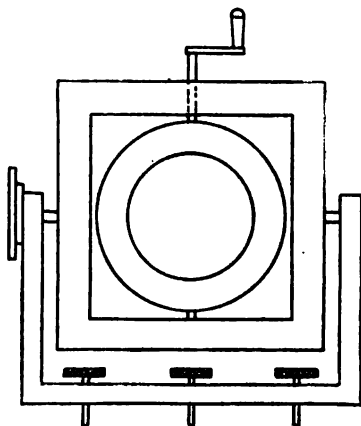

FIG. 152

Consider the coil to be placed first in a vertical plane perpendicular to the magnetic meridian, and with the axis of rotation truly vertical. The resultant magnetic force of the earth may be represented by a number of straight lines threading the coil at an angle of ϑ° to the horizontal, ϑ being the magnetic dip. If F is the magnitude of this resultant, there are said to be F "lines of magnetic force" passing through each square centimetre of a plane at right angles to the direction of the force; and, there-

fore, $F \cos \vartheta$ pass through each square centimetre of a vertical plane at right angles to the magnetic meridian. Hence, if A is the average area of a turn of the coil, the number of lines threading it is $N = AF \cos \vartheta$.

Now rotate the coil through 180° . There are N lines of magnetic force passing through it as before, but in an opposite direction relatively to the coil. Hence, each turn of the coil has cut through $2N$ lines of force; and, if there are n turns in the coil, the circuit of which it is a part has had the number of lines of force threading it in the original direction changed by

$$2Nn = 2nAF \cos \vartheta.$$

Experiments show that while the number of lines of force passing through a closed circuit is changing a current flows in the wire such that, if Q be the total quantity of electricity which flows around the circuit while the current lasts, and $N_1 - N_0$ the change in the number of lines, $Q = \frac{N_1 - N_0}{R}$, where R is the resistance of the entire circuit.

Hence, if the coil of the earth inductor be made part of a closed circuit, the quantity of electricity which will pass around it when turned through 180° , as described above, will be,

$$Q_1 = \frac{2nAF \cos \vartheta}{R}.$$

If, now, the frame be turned so that the coil lies in a horizontal plane with the axis in a horizontal line in the magnetic meridian, $AF \sin \vartheta$ lines will thread it. Hence, when it is rotated 180° , the quantity of electricity passing around the circuit will be,

$$Q_2 = \frac{2nAF \sin \vartheta}{R}.$$

$$\therefore \tan \vartheta = \frac{Q_2}{Q_1}.$$

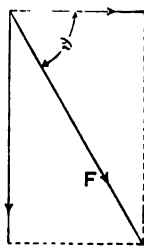

FIG. 153

Hence, to determine \mathcal{S} , we have to measure the ratio of $\frac{Q_2}{Q_1}$, which is done, as in Experiment 74, by including a ballistic galvanometer in series with the coil.

The conditions for measuring a quantity of electricity by a ballistic galvanometer require that the entire quantity shall pass before the needle moves from rest appreciably. This is secured by making the revolution as rapid as possible.

Sources of Error.

Accuracy in this experiment requires:

1. That the coil when in a vertical position be rotated through 180° , from a position in a plane exactly perpendicular to the magnetic meridian into the reverse position in the same plane.
2. That the coil when in a horizontal position be rotated through 180° , from one position in a plane exactly horizontal into the reverse position in the same plane.
3. That in each case the revolution be completed before the galvanometer needle starts appreciably from rest.
4. That the observations in the two positions follow each other before any change can take place in the sensitiveness of the galvanometer or strength of its magnetic field.
5. That the resistance of the circuit remain the same.

Apparatus. An earth inductor; ballistic galvanometer; damping-circuit, with its proper key and battery; spirit-level and L-square; compass; clamp-stand and piece of card-board; plane mirror.

Manipulation. Set up the earth inductor on a firm table, with the frame vertical and screwed tight to the fixed stand, so that the coil, when it rests against one of the metal stops which limit its rotation, is, as closely as can be told by the eye, perpendicular to a horizontal north-and-south line. Make the plane of the coil accurately vertical by means of the levelling-screws, testing it with the spirit-level and L-square. Fasten a plane mirror flat against the face of the brass bobbin on which the wire is wound, if there is not already one on the instrument.

Cut a narrow slit in the card-board, and by the aid of the compass place the slit vertical, due north in a horizontal line from the piece of mirror and eight or ten feet away. Place a light behind the slit either at its upper or lower half, and look through the other half of the slit at the mirror in a line directly parallel to the needle of the compass, which should be placed between. (The line of the needle may be magnified by two large pins placed upright due north and south of it.) Now adjust the plane of the coil exactly so that when it rests against its stops the bright slit is reflected back to itself, and hence to the eye placed behind it. Now place the mirror flat against the opposite face of the coil, and rotate the latter on its axis until it stops against the other screw which limits its motion. View the mirror again through the slit along the compass-needle, and turn the limiting-screw in or out until the coil is stopped with its plane exactly perpendicular to the north-and-south horizontal line.

The coil is now adjusted for the first set of observations. Connect it in series with the ballistic galvanometer, twisting the lead-wires around one another so as to include as little area between them as possible outside of the coil.

One observer now prepares to read the galvanometer, which he does exactly as in Experiment 74, giving a signal to the other observer each time when he has noted the zero and when he is ready to note the throw. At the signal, the other observer rotates the handle as quickly as he can without danger of jarring the instrument out of adjustment, and stops it *exactly* in contact with the screw adjusted for that purpose. He holds it firmly there while the first observer notes the throw, and also the second swing in the same direction, as in Experiment 74. The swing of the needle should now be damped; and when the first observer is again ready another signal is given and the coil turned back in the reverse direction, through 180° exactly. Take twenty readings in this way.

Now unfasten the frame from the stand and revolve it

until it is in a horizontal position. With the coil tight against one of the stops place a level on its upper face, and level it by the screws on the stand without touching either stop, as you have already carefully adjusted them so as to allow a revolution of exactly 180° . Reverse the coil and test the other face, which should also be perfectly level unless the stops have been jarred out of place. When the instrument is adjusted, take twenty observations in this position just as in the other.

ILLUSTRATION

April 10, 1897

MAGNETIC DIP

<i>Axis vertical</i>			<i>Axis horizontal</i>	
Deflections			Deflections	
Left	Right		Left	Right
2.62	2.70		7.85	7.80
2.70	2.67		7.80	7.80
2.70	2.65		7.40	7.40
2.60	2.60		7.85	7.85
2.65	2.65	
....		Mean, 7.85	7.85
Mean, 2.66	2.64		Mean, 7.85	
Mean, 2.65				

$$\tan \delta = \frac{Q_2}{Q_1} = \frac{7.85}{2.65} = 2.77 +.$$

$$\therefore \delta = 70^\circ 10'.$$

EXPERIMENTS IN LIGHT



INTRODUCTION TO LIGHT

Units and Definitions. As is explained in treatises on Physics, light is a sensation due to waves in the ether; and the only quantities which can be measured in absolute units are those which involve length and time. All lengths should be measured in centimetres; but, since the wave-lengths of those ether waves which produce vision are extremely minute, they are generally expressed in a certain fraction of a centimetre which is called an Ångström unit. This unit is 0.0000001 centimetre, or 10^{-8} centimetres; thus, the wave-length of a certain line in the spectrum of sodium, called D , is 5896.357 Ångström units. A table of standard wave-lengths will be found in the Tables.

Object of Experiments. The experiments in this section have two objects: 1. To verify certain of the laws of ether waves—*e. g.*, laws of reflection and refraction. 2. To measure certain quantities, such as the indices of refraction of certain solids, the focal lengths of lenses, the wave-length of light.

EXPERIMENT 79

(THIS EXPERIMENT SHOULD BE MADE IN A DARKENED ROOM)

Object. To compare the intensities of illumination of two lights by means of a Joly photometer. (See "Physics," Art. 297.)

General Theory. A Joly photometer consists of two small rectangular blocks of paraffine, about 4 centimetres square and 1 centimetre thick, placed side by side, so as to form a block 2 centimetres thick. If the intensity of the illumination on one of the faces is more than that on the other, the fact is manifest by a difference in brightness of the paraffine on the two sides of the separating surface; whereas, if the intensity is the same, there is no difference in brightness.

The method, then, is to place the two sources of light, one on each side of the paraffine block, and, keeping one in a fixed position, alter that of the other until there is no difference in brightness of the two halves. If the distances of the two sources from the photometer are r_1 and r_2 , and if the illuminating powers are I_1 and I_2 , then

$$I_1 : I_2 = r_1^2 : r_2^2.$$

For, since the intensity of light varies inversely as the square of the distance, and since in this case the intensity at the photometer due to each source of light is the same, the illuminating power of the sources must vary *directly* as the square of the distance.

Sources of Error.

1. The two halves of the paraffine photometer may not be alike in quality or thickness.

2. The illuminating power of the two sources must be kept constant.
3. If the lights are of different colors, there is difficulty in comparing their intensities.
4. All extraneous light must be kept from reaching the paraffine blocks.

Apparatus. A Joly photometer; a fish-tail burner; a candle; two tin screens, with equal rectangular openings; a metre-rod.

Manipulation. Mount the photometer, the candle, and the gas-flame so that they are in the same horizontal line, the photometer being between the two lights, with the di-

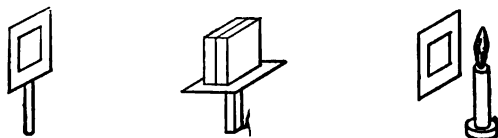

FIG. 154

viding surface perpendicular to the line joining them. Place the two lights about 80 centimetres apart, and hold, by means of suitable clamps, a tin screen immediately in front of each light, on the side towards the photometer, at such a height that the opening exposes equal areas of the brightest part of each flame to the photometer.

View the photometer from the end, so as to see both the halves equally well. Move it nearer one of the lights, and, observing the effect, place it finally in such a position that the illuminations of the two halves are apparently equal. Measure the distances from the openings in the tin screens to the plane of separation of the two halves.

Displace the photometer, and repeat the observation and measurements. Turn the photometer 180° around a vertical axis, and repeat the experiment, making three observations in each position. Call the means r_1 and r_2 .

Place the two lights at a different distance apart, and repeat the experiment as above. Call the means R_1 and R_2 .

The illuminating powers, I_1 and I_2 , should then satisfy the two equations,

$$\frac{I_1}{I_2} = \frac{r_1^2}{r_2^2} = \frac{R_1^2}{R_2^2}.$$

Calculate I_1/I_2 from the two equations.

ILLUSTRATION				May 2, 1896
COMPARISON OF EDISON LAMP AND GAS-FLAME				
r_1	r_2	R_1	R_2	
33.0	42.0	23.0	28.0	
33.5	41.5	22.5	27.5	
33.5	41.5	22.5	27.5	
Mean, 33.3	41.7	Mean, 22.3	27.7	
$\frac{r_2^2}{r_1^2} = 1.56.$		Mean, 1.55.	$\frac{R_2^2}{R_1^2} = 1.54 +.$	

Questions and Problems.

1. Describe a photometer which depends upon the equality of two penumbras.
2. Why are the measurements taken to the opening in the screens, and not to the flames themselves?
3. What difficulties are introduced by the flames having different colors?
4. Discuss the conditions for a standard of illumination.

EXPERIMENT 80

Object. To verify the laws of reflection from a plane mirror. (See "Physics," Arts. 306, 308.)

General Theory. There are two cases to be considered—(1) reflection of plane waves, (2) reflection of spherical waves.

1. *Plane Waves.*—The laws, as deduced from the wave-theory, are that the reflected waves are plane, and that their normal lies in the same plane as the normals to the surface and to the incident waves; also, the angles made with the normal to the surface by the normals to the incident and reflected waves are equal.

2. *Spherical Waves.*—The law to be verified is that the reflected waves are spherical, seeming to come from a centre on the opposite side of the surface from the source of waves, the centres of the incident and reflected waves being in a straight line perpendicular to the surface, and at equal distances from it.

(Read "Physics," Art. 302.)

As waves of any kind, plane or curved, advance in any direction in an isotropic medium, such as air or water, the disturbance at any point, P , of the wave front, as it exists at a definite instant, produces disturbances at later times at points P_1 , P_2 , etc., where P , P_1 , P_2 , etc., all lie in a line normal to the wave front. This is called the rectilinear propagation of light, and can be verified by

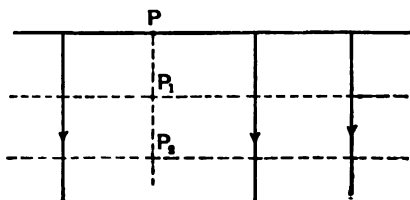

FIG. 156

any shadow experiment. To trace a particular line of disturbances (called a "ray"), the following method may be adopted: Make P a centre of disturbances (*e. g.*, a point of light, a pin brightly illuminated); place a small obstacle, such as a pin, at a random point, P_1 , then there

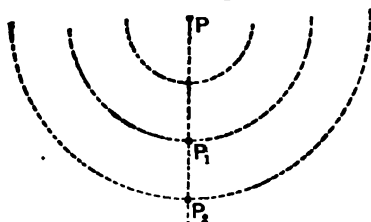

FIG. 156

will be no disturbance at a point P_2 , in the line PP_1 , because the line of disturbance—the ray PP_1 —has been stopped at P_1 . Consequently, if an observer moves his eye in such a direction as to make the pin at P_1 hide the bright point at P , he will be sighting along the line PP_1P_2 —*i. e.*, he will be tracing the ray PP_1P_2 .

The fundamental property of a plane wave is that all its "rays" are parallel; therefore, to trace the progress of a series of plane waves, it is sufficient to follow the path of any one ray.

In studying the reflection of plane waves, then, the general plan is to follow the path of the waves by tracing the progress of a ray, both before and after reflection. This is done by placing two pins so that the line joining them falls obliquely upon the mirror; then, looking at the reflected

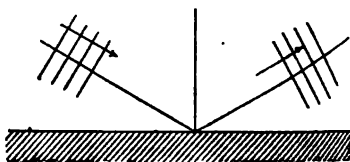

FIG. 157

images, moving the eye so that the pin farthest away is hidden by the other, and fixing this direction of sight by two other pins. The two pairs of pins give the directions of the normals to the incident and reflected plane waves by tracing the path of one particular ray.

In the case of spherical waves (see Fig. 158) proceeding from a source O (*e. g.*, a pin brightly illuminated), the centre of the reflected waves, O' , is called a "virtual" image; and

its position may be accurately located by using a transparent mirror, such as a piece of glass, or by scratching off a small horizontal slit from the silvering of an ordinary mirror, for a pin may be moved around back of the mirror until it is exactly in the spot where the virtual image seems to be. This agreement may be tested by seeing that there is no parallax between the pin and the image—i.e., that, when the eye is moved sidewise, the two remain coincident.

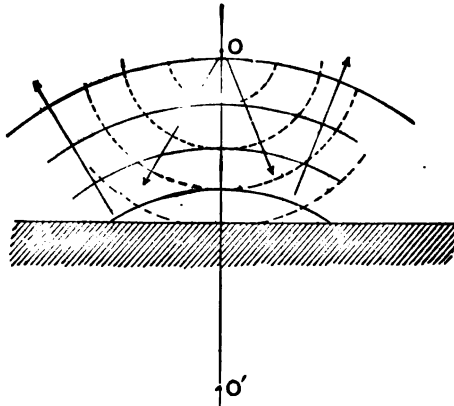

FIG. 158

Sources of Error.

1. The mirror may not be plane.
2. There may be more than one reflecting surface, and so confusion may arise.
3. The illuminated bodies must be sharp and distinct.

Apparatus. A small rectangular block of wood; plane silvered mirror, with a horizontal slit removed; a drawing-board; paper; pins. (A plane glass mirror will do in place of the silvered one.)

Manipulation. Place the drawing-board on a table, and a piece of paper on the board; draw a straight line across the middle of the paper, and place the mirror so that the reflecting surface coincides with this line and is perpendicular to the board. This may be done by fastening the mirror to a rectangular block of wood by means of rubber bands, and then placing the block suita-

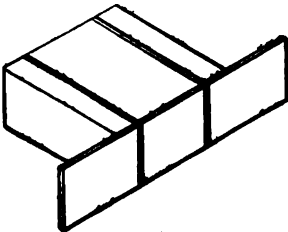

FIG. 159

bly. Place two pins vertical in the board at such distances that the line joining them falls obliquely upon the mirror.

1. By means of two other pins locate a line such that, when looking along it at the reflection of the first pair of pins, the image of one hides that of the other. Move the mirror one side, and draw two straight lines, one passing through each pair of pins. These should intersect at a point of the base-line which marks the reflecting surface. From this point draw a line perpendicular to the base-line, and compare the angles made with this line by the two lines

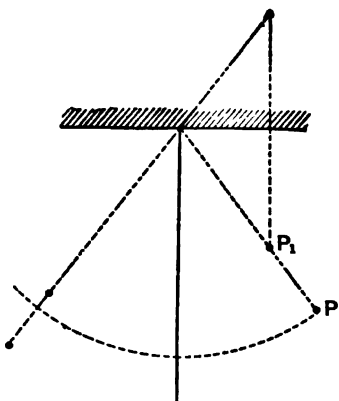

FIG. 159a

through the pins. This may be done by drawing around the point of intersection a circle of radius 10 or 15 centimetres, and comparing the lengths of the intersected arcs. The angle of incidence should equal the angle of reflection.

2. Replace the mirror in its position along the base-line, taking care to place the mirror so that a transparent portion projects beyond the block and is met by normals dropped from the two pins. Locate by means of two pins the virtual images of the first two pins mentioned in part 1. Do this very carefully, taking pains to avoid all parallax between a pin and a virtual image. It is best to make the points of the pins coincide, because the smaller the objects are, the better can their coincidence be determined.

In order to determine the position of the virtual image, it is not absolutely necessary to have a transparent portion of the mirror; for if a pin is placed parallel to the length of the mirror, with its point in a normal to the mirror at its edge, its image will just reach to the edge of

the mirror, and a second pin may be so placed (behind the mirror) as to seem to form an unbroken line with the image, when viewed from a point in the normal to the mirror at its edge.

Having fixed the positions of the two images, draw a straight line joining them. The two images should be at the same distances

back of the mirror as the original two pins are in front of it; and the line joining the two images should be the prolongation, backward, of the reflected ray.

Repeat both experiments, using different angles of incidence.

(Methods will be given later for testing the mirror, to see if it is plane. See p. 441.)

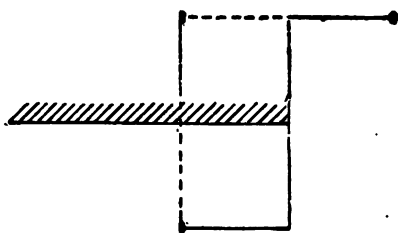

FIG. 100

Questions and Problems.

1. What would be the effect in the two experiments if the mirror had been concave or convex? Show by drawings.
2. How may the thickness of a piece of glass be determined by means of images formed by reflection from its two surfaces?
3. Give the drawings for the images formed by two plane mirrors inclined to each other at an angle of 45° .
4. What is the smallest plane mirror in which a man may see his entire figure?
5. Show by graphical construction the reflection from a plane mirror of spherical waves which are *converging* apparently to a point at a distance h behind the mirror.

EXPERIMENT 81

(THIS EXPERIMENT SHOULD BE MADE IN A DARKENED ROOM)

Object. To verify the laws of reflection from a spherical mirror. (See "Physics," Arts. 311-317.)

General Theory. For any spherical mirror, concave or convex, and for any train of waves, converging, diverging, or plane, the same formula applies with a proper understanding as to the signs. It is this: $C_i + C_r = 2C$, if C_i is the curvature of the incident waves, C_r the curvature of the reflected waves, C the curvature of the mirror; the quantities, C_i and C_r , have a + or - sign according as the centres of the waves are on the same side of the mirror as its centre of curvature or on the opposite.

Expressed in terms of distances from the mirror to the centres of the spherical surfaces this formula becomes

$$\frac{1}{u} + \frac{1}{v} = \frac{2}{r},$$

where u is the distance from the mirror to the centre of the incident waves, v is the distance from the mirror to the centre of the reflected waves, r is the distance from the mirror to its centre of curvature, with the same understanding as to the signs of u and v as before for C_i and C_r .

This formula leads to a graphical construction for images, which is here illustrated by two cases:

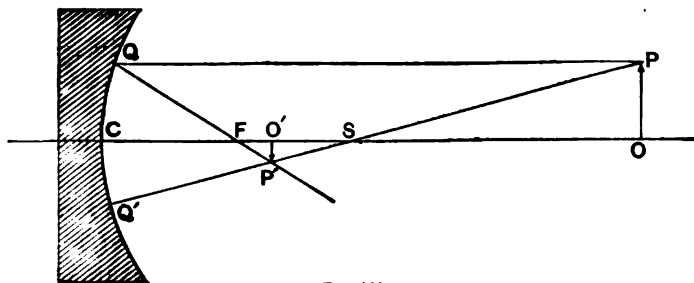

FIG. 161

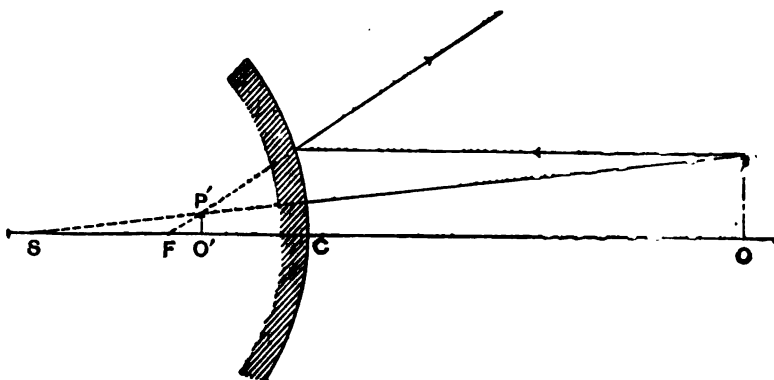

FIG. 162

where S is the centre of the mirror, $\overline{CS} = r$,

OP is the object, $\overline{CO} = u$,

O'P' is the image, $\overline{CO'} = v$.

It will be noticed from the formula,

$$\frac{1}{u} + \frac{1}{v} = \frac{2}{r},$$

1. If $u = \infty$, i. e., if plane waves are incident, $v = r/2$. This point, F, shown above, is called the principal focus.
2. If surface is concave,

v is +, i. e., there is a real image, if $u > \frac{r}{2}$,

v is -, i. e., there is a virtual image, if $u < \frac{r}{2}$.

3. If surface is convex,

v is always +, *i. e.*, there is always a virtual image, so long as the waves are diverging from a real object—*i. e.*, so long as u is negative.

If u is +, *i. e.*, if the waves are converging, v may be —, and so the image may be real.

To verify these laws of reflection, a brightly illuminated object—*e. g.*, a pin—is placed in front of the mirror, so that a line passing through it and the centre of curvature of the spherical surface will intersect the mirror near its middle point; the position of the image, virtual or real, is found by moving a second pin until there is no parallax between it and the image of the first—*i. e.*, until they do not shift relatively to one another when the eye is moved sidewise while looking at them. They then evidently occupy exactly the same position, and neither is behind nor in front of the other. In finding the position of a virtual image, it is necessary, of course, to have a strip of the silvering removed from the mirror so as to have a transparent portion.*

A real image may also be located by making the reflected waves fall upon a screen, and moving the screen until the image is as sharp as possible. By having an object of a known size the magnification may be thus determined; for the size of the image may also be measured.

Sources of Error.

1. Unless the incidence is normal—*i. e.*, unless the line joining the centre of curvature to the source of the light meets the central portion of the mirror—the above laws do not hold.
2. The object must have a sharp outline, so as to admit of accurate focusing.

Apparatus. A concave and a convex mirror; a gas-burner; pins or needles, with suitable stands; metre-rod.

Manipulation. Adjust the mirror so that the line joining its middle point to its centre of curvature is horizontal and so that the transparent slit is horizontal.

* This plan was suggested by Mr. Wilberforce, of the Cavendish Laboratory, Cambridge, England.

1. *Real Image. Concave Mirror.*—Get an inverted reflection of the gas-flame in the concave mirror by moving the flame backward or forward, and locate the image approximately by means of a piece of paper used as a screen.

This fixes the fact that the flame is beyond the principal focus ($u > r/2$). Place the pin in its stand near where the flame is, and move the flame one side so as to illuminate it. Adjust the pin quite accurately, so that its extremity lies in the horizontal line joining the centre of curvature of the mirror to its middle point. Place the other pin (or needle) in a stand, at the same level as the first, and move it until its extremity coincides with the *image* of the first pin. This position has been approximately determined by the image of the flame on the paper screen.

Another method is to illuminate a piece of wire gauze by a flame, and receive its image on a suitable screen. The dimensions of the wire gauze and its image may be measured by a caliper, and the magnification calculated.

Measure the distances from the middle point of the mirror to the object and image. Keeping the illuminated pin (or gauze) stationary, move the pin (or screen) which locates the image, and redetermine its position. Do this three times. Call the means of the three sets of readings u_1 and v_1 .

In a similar manner, place the first pin at a different distance, u_2 , and determine the corresponding v_2 . Do this for three distances.

Finally, move the illuminated pin until it coincides with its own image, and measure its distance from the mirror. In this case $u = v$. Hence, $u = v = r$.

Therefore the following equations should be verified :

$$\frac{1}{u_1} + \frac{1}{v_1} = \frac{1}{u_2} + \frac{1}{v_2} = \frac{1}{u_3} + \frac{1}{v_3} = \frac{2}{r}$$

2. *Virtual Image. Concave or Convex Mirror.*—By means of the gas-flame find a position for which there is no real image. Place the pin or needle close to the flame, and alter its position until the image of its point is seen

distinctly, apparently through the slit which has been removed from the silvered surface. Locate the exact position of the image by means of a second pin or needle, carefully avoiding parallax. (To make the second needle more visible, it is best to hold back of it a white screen, such as a piece of paper.)

Measure the distances from the mirror to the object and image, and repeat twice, without moving the object. If the mean distances are x_1 and y_1 , $u = -x_1$, $v = y_1$ for a convex mirror; and $u = x_1$, $v = -y_1$ for a concave mirror. Hence, in both cases,

$$-\frac{1}{x_1} + \frac{1}{y_1} = \frac{2}{r}.$$

In a similar manner, measure the distances for two other positions of the illuminated pin, and call them x_2 , y_2 , and x_3 and y_3 . (r cannot be measured by a simple direct experiment for a convex mirror.)

Verify the fact that

$$-\frac{1}{x_1} + \frac{1}{y_1} = -\frac{1}{x_2} + \frac{1}{y_2} = -\frac{1}{x_3} + \frac{1}{y_3}$$

and calculate r from the three separate measurements. Take the mean.

ILLUSTRATION

CONCAVE MIRROR

May 2, 1906

1. Real Image

u	v	r
25	46	32.4 cm.
30	35.5	33.5 "
31	34.8	32.8 "
33.4	32.4	32.4 "

Mean, 32.40 cm.

2. Virtual Image.

In a similar manner

CONVEX MIRROR

In a similar-manner.

Questions and Problems.

1. What connection is there between the focal length of a concave mirror and the size of the image formed of an object at a distance?
2. If a telescope is focused on a distant object, and is then turned so as to see the image of this object as formed in a slightly concave or convex mirror, will it be in focus? How will it be if it is a plane mirror? Illustrate by diagrams.
3. What is spherical aberration? How can it be guarded against in mirrors?
4. Under what conditions will a convex mirror produce a real image? Give a diagram illustrating the answer.

EXPERIMENT 82

Object. To verify the laws of refraction at a plane surface. (See "Physics," Arts. 319-323.)

General Theory. As before in the case of reflection, there are two cases to be considered: 1. Refraction of plane waves. 2. Refraction of spherical waves.

Since the incident and refracted waves are in different media—*e. g.*, air and glass—it is, in general, impossible to trace the rays and mark the images directly, as was done in Experiment 80. The obvious method is to locate the direction of the waves before they enter and after they leave the refracting medium, and to mark the points where any definite ray enters and leaves; this will give the direction of the ray and waves inside the refracting medium. If this is done for more than one ray corresponding to any point, the image of this point may be determined.

The laws of refraction at a plane surface are as follows:

1. *Plane Waves.*—The refracted waves are themselves plane; and if the normal to the surface makes an angle

ϑ_1 with the normal to the incident waves, and ϑ_2 with the normal to the refracted waves,

the ratio, $\frac{\sin \vartheta_1}{\sin \vartheta_2}$, is a constant for

the two media and for the train of waves used. (If the wavelength is changed, this ratio changes; and, consequently, for white light the ratio is not exactly definite.)

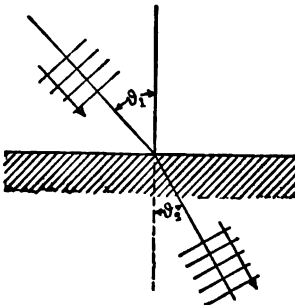

FIG. 188

This ratio is independent of the angle of incidence, and is called the "index of refraction of the second medium with reference to the first."

2. *Spherical Waves*.—If spherical waves proceed from a point at a distance h above a plane surface, the refracted waves will also be spherical, with a virtual centre at a distance h' above the surface, and so situated that it and the source are in the same straight line normal to the surface, the length, h' , being such that

$$h' = \mu h$$

where μ is the index of refraction of the refracting medium.

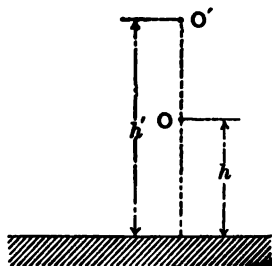

FIG. 184

Sources of Error.

1. The surface may not be plane.
2. Since the above laws for spherical waves hold for normal incidence only, care must be taken to make use only of that portion of the refracting surface around the foot of the normal let fall from the source of light.

Apparatus. A plate of glass with plane parallel sides (or a glass prism); a drawing-board; paper; pins. (The pins should be so long that they project above the plate or prism.)

Manipulation. Place the board on a table, the paper on the board, and the piece of glass with its refracting surfaces perpendicular to the board. Mark the position of the two refracting surfaces by pencil lines. Place two pins so that the line joining them falls obliquely on the refracting surface; but do not let this line differ much from the normal.

1. By means of two other pins locate the direction of the ray as it emerges from the second surface. Draw the incident and emerging rays, and join by a straight line the two points where the two rays meet the lines marking the

refracting surfaces. This line is the path of the refracted ray, and, consequently, fixes the direction of plane waves when refracted.

The sines of the angles θ_1 and θ_2 could be measured; but the accuracy attainable is not great enough to warrant the labor.

If the piece of glass used has parallel faces, the emerging and incident rays should be parallel; but one is not the continuation of the other unless the incidence is normal.

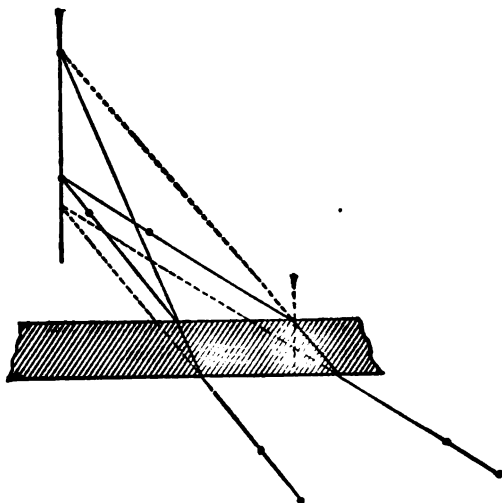

FIG. 165

If the piece of glass used is a prism, the emerging ray is deviated through a certain angle, which should be noted in the drawing. If the angle of the prism is great enough, show that there may be total reflection inside the prism, and draw the rays from theoretical considerations, if there is not time for the actual experiment.

2. In a similar manner locate the incident, emerging, and refracted rays for a different angle of incidence, keeping one of the first pair of pins fixed and moving the second slightly.

Prolong backward the *refracted* rays found in this and the preceding experiment; they should meet in a point which is the virtual image of the pin which has remained fixed. The line joining this point of intersection with the fixed pin should be normal to the surface, and h' should equal μh .

Prolong backward also the two *emerging* rays in the two experiments; these should meet in a point, which is the one from which the waves sent out by the fixed pin seem to come as they emerge. If the piece of glass has parallel sides, this point will be in the same normal as the pin and its refracted image; if it is a prism, it and the refracted image will lie in a normal to the second face of the prism. This image of the emerging waves may be located experimentally by means of a pin which is so placed on the same side as the fixed pin as to coincide in position with the image. To do this, it is necessary for the piece of glass to have a sharp, flat upper face, and for the fixed pin to project above the piece of glass. The point as determined experimentally should agree with that found graphically.

Questions and Problems.

1. Explain the action of spherical aberration in the case of flat plates and prisms.
2. Devise some experiment by which the critical angle may be measured.
3. What properties of a train of waves change as it passes from one medium into another?
4. Construct graphically the image of a train of converging waves whose centre lies inside the refracting surface.

EXPERIMENT 83

Object. To measure the index of refraction of a solid which is made in a plate with plane parallel faces. (See "Physics," Art. 324.)

General Theory. It was shown in the preceding experiment that, if spherical waves are emitted by a source O at a distance h from a plane surface separating two transparent media, the waves refracted into the second medium will seem to come from a centre, O' , where the line $\overline{OO'}$ is perpendicular to the plane surface, and O' is at such a distance, h' , from it that $h' = \mu h$, μ being the index of refraction of the second medium with reference to the first.

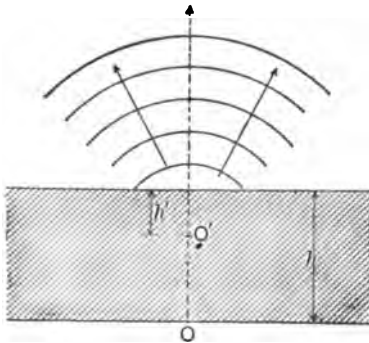

FIG. 166

Therefore, if a point, O , on one face of a plate of glass is sending out waves, those which emerge into the air from the other face will seem to come from a point O' , where $\overline{OO'}$ is a line perpendicular to this face, and the distances from O and O' to the surface, called h and h' respectively, are such that $h' = \mu_1 h$, μ_1 being the index of refraction of the air with reference to the glass. But if μ is the index of refraction of the glass with reference to air, $\mu = 1/\mu_1$, hence,

$$\mu = h/h' = \frac{h}{h - \overline{OO'}}$$

The distance h can be measured by a vernier or micrometer caliper, and $\overline{OO'}$ can be easily measured in the following manner: If a microscope whose axis is perpendicular to the plane surface is focused so as to see the source O , it is in such adjustment that, if the plate were removed, it would be in focus for a source at O' ; therefore, if the plate is removed, the microscope must be lowered a distance $\overline{OO'}$, in order to again see the source O .

Sources of Error.

1. The axis of the microscope may not be exactly perpendicular to the plane surface.
2. The surface may not be exactly plane.
3. The source of light must be *on* the face of the glass, not near it.

Apparatus. A plate of glass with plane parallel faces; a low-power microscope which is movable in a sleeve, such as a microscope of a comparator or dividing-engine; a millimetre scale ruled on paper; vernier caliper.

Manipulation. In choosing a suitable microscope, select one which does not require the objective to be placed closer than 1 or 2 centimetres to the object. Place the ruled paper on a platform under the microscope, and hold it fixed by means of some "universal wax." Be sure that the portion viewed is perfectly flat, and perpendicular to the axis of the microscope; focus carefully on a line. Place the glass plate over the scale and press it closely against the scale, being sure that the plate is perpendicular to the axis of the microscope, and that it touches the mark which has just been focused in the microscope. Raise the microscope in its sleeve until the same line as seen before is again in focus. The distance it is raised should be measured with the greatest care, and for this purpose a scale should, if possible, be engraved on the side of the microscope. Another method is to gum to the microscope tube, when it is focused directly on the scale, a piece of paper with a straight edge placed along the edge of the sleeve,

and to measure by a short paper millimetre scale the distance from this mark to the edge of the sleeve after the microscope has been raised so as to focus through the glass. This adjustment should be repeated many times, removing the glass, lowering the microscope so as to focus directly on the scale, then introducing the glass, raising the microscope, etc., making measurements each time.

Having thus obtained the distance $\overline{OO'}$, measure by means of the vernier caliper h , the thickness of the glass at the point through which the scale was viewed. This reading should be made twice or three times, but not more accurately than $\overline{OO'}$ has been measured.

From a knowledge of $\overline{OO'}$ and h , calculate μ .

$$\mu = \frac{h}{h - \overline{OO'}}$$

ILLUSTRATION

INDEX OF REFRACTION OF GLASS

May 8, 1897

h	$\overline{OO'}$	
0.895	0.81	
0.895	0.82	
0.895	0.81	
<hr style="width: 100%; border: 0.5px solid black;"/>	<hr style="width: 100%; border: 0.5px solid black;"/>	
Mean, 0.895	0.818	$\mu = \frac{895}{818} = 1.54 -$

Questions and Problems.

1. What would be the difficulty if the microscope had a very short focus?
2. Is there any necessity of the plate being flat on both sides?

EXPERIMENT 84

(THIS EXPERIMENT SHOULD BE MADE IN A DARKENED ROOM)

Object. To verify the laws of refraction through a spherical lens. (See "Physics," Arts. 328-339.)

General Theory. For any spherical lens—*i. e.*, a lens whose surfaces are portions of spherical surfaces—and for any train of waves (of definite period), the same formula applies, if the lens is thin, with a proper understanding as to the signs. It is this,

$$C_i + C_e = C_r.$$

C_i is the curvature of the incident waves;

C_e is the curvature of the emerging waves;

C_r is a constant for any one lens and any definite train of waves with constant period.

C_r is always to be considered positive ;

C_i is *positive* if the centre of the incident waves and the centre of curvature of the first surface they meet are on opposite sides of this surface ;

C_e is *positive* if the centre of the emerging waves and the centre of curvature of the second surface are on opposite sides of this surface.

Expressed in terms of distances from the lens, this formula becomes

$$\frac{1}{u} + \frac{1}{v} = \frac{1}{f},$$

where u is the distance from the lens to the centre of the incident waves,

v is the distance from the lens to the centre of the emerging waves,

f has the obvious meaning of being the value of v

when u is infinite, or the value of u which will make v infinite. In other words, if plane waves fall upon a lens, the centre of the emerging waves is at the distance f from the lens, and is called the principal focus; or, if the waves as they emerge are plane, the centre of the incident waves is at a distance f from the lens. (Proper regard must be had for the meaning of the fact that f is always positive.)

The graphical construction of images which follows from this formula is illustrated by two cases:

I.

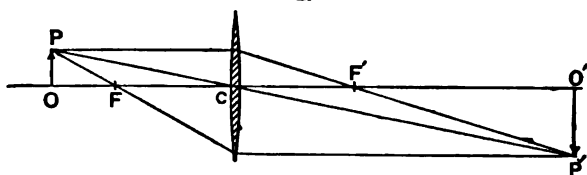

FIG. 167

II.

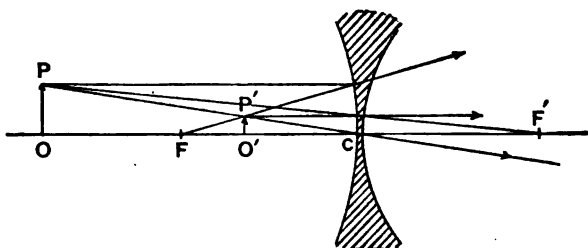

FIG. 168

In case I., a double convex lens, $\overline{OC} = u$, and is +; $\overline{O'C} = v$, and is +; $\overline{CF} = f$.

In case II., a double concave lens, $\overline{OC} = u$, and is -; $\overline{O'C} = v$, and is +; $\overline{CF} = f$.

With a double convex lens, it is evident that u is always + if the waves come from a real object; hence, v is + if $u > f$; *i. e.*, the image is real, because the emerging waves converge.

v is - if $u < f$; *i. e.*, the image is virtual, because the emerging waves diverge.

With a double concave lens, it is evident that u is always —, if the waves come from a real object; hence, v is always positive; i. e., the image is virtual, because the waves diverge.

It is evident from geometry that the “linear magnification” is the ratio of v to u .

To verify these laws of lenses, the same general plan as in Experiment 81 (spherical mirror) is followed. If the image is real, it can be located by means of a screen. If, however, the image is virtual, a somewhat different plan must be adopted. It is this, cut the lens in halves by a plane passing through the axis of the lens; then the image may be seen *through* the half-lens, and a pin may be so placed as to coincide with it, the pin being seen *past* the edge of the lens, *not* through it.*

It would be well to have the lenses and objects so mounted as to be at the same height, and to be movable along a fixed beam parallel to the axis of the lens.

Sources of Error.

1. The portions of a lens used must be those near its axis.
2. If possible, light of one wave-length should be used, as white light does not give sharp foci.
3. One half a lens is rarely exactly like the other.

Apparatus. A concave lens; a convex lens; a half-concave lens; a half-convex lens; pins or knitting-needles in suitable stands; gas-flame; screen; wire-gauze; metre-rod.

Manipulation. The lenses, as used, should always be mounted so that their axes are horizontal; and the different objects used should all be placed along a straight line.

1. *Real Image.*—Set up the convex lens, and place the gas-flame in such a position that a real image is formed on a screen suitably placed. Put the wire-gauze in front of the flame, and move the screen until the image of the gauze

* This plan was suggested by Mr. Wilberforce, of the Cavendish Laboratory, Cambridge, England.

is as sharp as possible. Measure the distances between the lens and the gauze and the lens and the image. Move the screen, redetermine the image, measure again. Do this three times in all. Let the mean distances be u_1 and v_1 . Measure also the size of the image by means of a caliper.

Place the gauze at a different distance and determine its image. Call the corresponding mean distances u_2 and v_2 . Do this for a third distance.

Then the following relation should hold :

$$\frac{1}{u_1} + \frac{1}{v_1} = \frac{1}{u_2} + \frac{1}{v_2} = \frac{1}{u_3} + \frac{1}{v_3}.$$

Calculate f from the three measurements and take the mean.

Measure the size of the gauze (one linear dimension will do), and calculate the "linear magnification."

(In one experiment keep the gauze and screen in the positions which give a sharp image, and move the lens until u and v are interchanged, and a second sharp image is formed. Measure the magnification of this second image, and also the distance through which the lens has been moved.)

2. *Virtual Image*.—Mount the half-lens, either concave or convex, with its edge vertical, and by means of the flame find a position for which there is no real image. Place near that position a pin or needle, held horizontally parallel to the lens, perpendicular to its edge, so that the point of the pin comes exactly opposite the middle of the lens; that is, place the pin so that its point lies on the axis and the pin itself is perpendicular to the axis and the edge. Illuminate the pin, and view it *through* the lens; the virtual image is on the same side of the lens as is the pin, and its position may be determined by moving a second pin, suitably held, until its point seems to coincide with the point of the image. The eye must look directly along the axis of the lens, and the second pin must be moved until

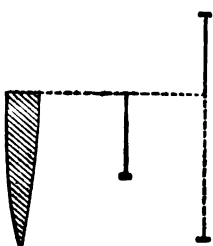

FIG. 109

it seems to be continuous with the image of the first pin, their points apparently touching. Measure the distances from the lens to the pins, and make the setting of the second pin twice more. Let the mean distances be x_1 and y_1 ; then for a double convex lens

$$u = x_1, v = -y_1,$$

and for a double concave lens

$$u = -x_1, v = y_1.$$

In both cases, then,

$$\frac{1}{x_1} - \frac{1}{y_1} = \text{a constant.}$$

Move through a short distance along the axis the first pin which serves as an object, and make two more sets of observations for two new positions. Let the distances be x_2 and y_2 , x_3 and y_3 . Then verify the relation

$$\frac{1}{x_1} - \frac{1}{y_1} = \frac{1}{x_2} - \frac{1}{y_2} = \frac{1}{x_3} - \frac{1}{y_3}.$$

Calculate f , the focal length of the lenses used.

Draw diagrams in each case showing the formation of the image.

ILLUSTRATION

May 10, 1894

CONVEX LENS

1. *Real Image*

u	v	f
44.1	88.5	20.7
87.1	46.8	20.6
81.7	59.7	20.7

Mean, $\overline{20.67}$

2. *Virtual Image*

In similar manner.

CONCAVE LENS

In similar manner.

Questions and Problems.

1. What is chromatic aberration? How does it affect the foci of lenses? Would colored glass be of advantage?

2. Explain the use of diaphragms in photographic lenses, microscopes, etc.
3. Draw a "ray" at random on one side of a lens, and construct its continuation on the other side.
4. Deduce the focal length of (1) two double-concave lenses, (2) one double-concave and one double-convex lens, placed close together. Do this graphically.
5. What advantage has a long-focus lens over one of short focus in the magnification of a very distant object?
6. Describe a method by which the focal length of (1) a convex lens, (2) a concave lens, may be measured by means of a telescope and metre-rod.
7. If the distance between the object and its real image is kept constant, but the lens moved through a distance d in order to interchange u and v , and thus produce a second image of the object, calculate the connection between d and the focal length of the lens.

EXPERIMENT 85

Object. To construct an astronomical telescope. (See "Physics," Art. 341.)

General Theory. An astronomical telescope consists essentially of two double-convex lenses—one of long focus, the other of short. The two are placed with their axes continuous; the lens of long focus is turned towards the object to be viewed, and is therefore called the "object-glass"; and the observer, looking through the other lens, called the "eye-piece," sees an image of the image formed by the first lens. The lenses are so placed that the principal focus of the object-glass coincides with the principal focus

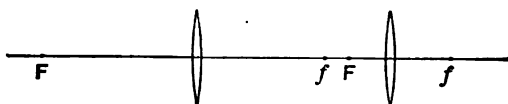

FIG. 170

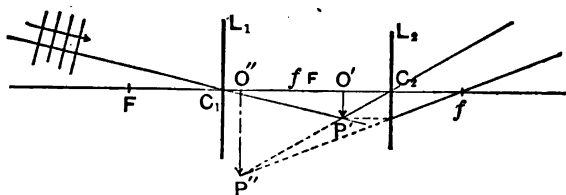

FIG. 170a

focus of the eye-piece, or comes a short distance inside the focus towards the eye-piece; and therefore the eye sees a virtual inverted image of the object.

The "magnifying power" is the ratio of the angle subtended at the eye of the observer by the final image formed by the eye-piece to that subtended by the object itself;

and this ratio can be proved to be equal to the ratio of the focal length of the object-glass to that of the eye-piece.

Sources of Error.

1. An object far distant should be viewed.
2. Spherical and chromatic aberration may cause difficulties.

Apparatus. Two double-convex lenses—one of focal length 15 or 20 centimetres, the other of less than 5 centimetres; suitable stands; a pin or a piece of gauze in a stand.

Manipulation. Place the lenses some distance apart, with their axes horizontal and continuous; turn the combination so that the lens of longer focus is facing some distant object (if the object is viewed through a window, open it). Locate the position of the image formed by the object-glass; this may be done by placing the pin or gauze so as to coincide with it. Move up the second (short-focus) lens until, looking through it, there is seen an inverted image of the distant object (and at the same time a direct image of the pin or gauze).

It should be noted that the angle subtended is much magnified. If other lenses are available, another telescope should be formed and its magnifying power compared with that of the first, the focal lengths being compared at the same time.

Draw accurate diagrams illustrating (1) the formation of the images; (2) the paths of the extreme rays which enter the object-glass from any point of the object, so as to form an idea as to how great a portion of the eye-piece is absolutely essential.

Questions and Problems.

1. How can such a telescope as this be made by the introduction of a lens or lenses to produce a direct instead of an inverted image?
2. Draw a diagram for a telescope made up of a concave mirror and eye-piece.
3. Discuss relative advantages of a reflecting and a refracting telescope.

EXPERIMENT 86

Object. To construct a compound microscope. (See "Physics," Art. 340.)

General Theory. A compound microscope consists of two short-focus double-convex lenses, placed with their axes co-

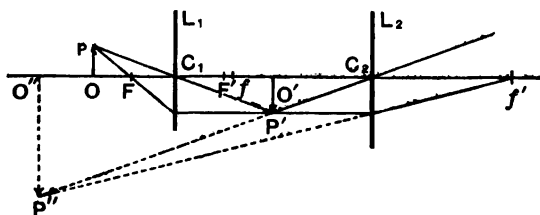

FIG. 171

inciding. The lens which is turned towards the object to be viewed is called the "objective"; the other, the eyepiece; and they are so placed with reference to each other that, when an object is just outside the principal focus of the objective, its image is formed immediately inside the principal focus of the eye-piece. Therefore, a virtual inverted image of the object is seen by the observer.

The magnifying power is the ratio of the linear dimensions of the final image to those of the object; and it may be proved to vary inversely as the product of the focal length of the eye-piece and that of the objective.

Sources of Error.

Chromatic and spherical aberration produce error.

Apparatus. Two short-focus double-convex lenses on suitable stands; a millimetre scale ruled on white paper; a pin or wire gauze on a suitable stand.

Manipulation. Place the two lenses some distance apart, with their axes horizontal and coincident; place the paper scale on a level with this axis, and just outside the focus of one of the lenses. This can be done by first placing the lens some distance—*e. g.*, 20 centimetres—away, and noting the image by the eye or by a screen; then bringing the lens up nearer to the scale until the image is 30 or 40 centimetres from the lens. Determine by means of the pin or gauze the position of the real image formed by the objective, and bring up the eye-piece until an inverted image of the scale is seen through it.

Notice the magnification, and observe how this changes as the scale itself is moved relatively to the objective, and also when the distance apart of the two lenses is changed.

Draw diagrams illustrating:

1. The formation of the image.
2. The paths of the extreme rays entering the objective from any point of the object.
3. The variation in the magnifying power as the distance apart of the lenses is altered, and also as the object is made to recede from the objective.

Questions and Problems.

1. What effect would be produced if the space between the object and the objective were filled with water and were illuminated by light coming from beyond the object?
2. Is there any limit to the magnification of an object?—*i. e.*, can any two points of an object, no matter how near together, be finally seen distinctly separated?

EXPERIMENT 87

(THIS EXPERIMENT SHOULD BE MADE IN A DARKENED ROOM)

Object. To measure the angle between two plane faces of a solid—*e. g.*, a crystal or a prism. The adjustment of a spectrometer.

General Theory of a Spectrometer. A spectrometer is an instrument primarily designed to measure the angle between the directions of two beams of light. In order to accomplish this end, it must be most carefully adjusted, and the following method is recommended :

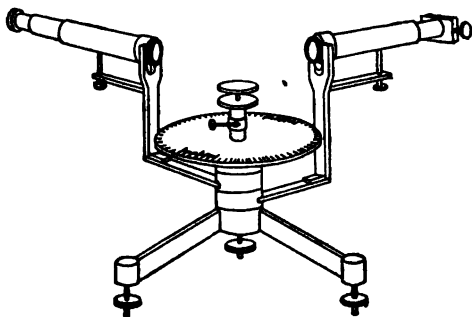

FIG. 172

As appears from the illustration, a spectrometer consists primarily of a vertical axis around which are movable in horizontal planes two circular platforms and two metal tubes. One of these tubes is a telescope made up of two converging lenses, the object-glass and eye-piece ; the other tube is called the "collimator," and contains at the outer end a metal slit with straight parallel edges, and at the inner end a converging lens so placed that the slit is at its principal focus. All these various parts are movable in

several ways: the level of at least one of the circular tables can be altered by means of three levelling-screws; the axes of the telescope and collimator may be raised or lowered; the eye-piece tube of the telescope contains cross-hairs which may be adjusted, as may, also, the eye-piece itself; the slit of the collimator can be revolved around the axis of the collimator, and it can also be pushed in or out of the tube. The position of the tables, the telescope, and the collimator, at any instant, may be read off and recorded from scales and indices attached to the various parts.

The spectrometer (or goniometer) may be used to measure accurately the angle between two surfaces, or between lines perpendicular to two surfaces. To do this, the instrument must be so adjusted that the axes of the telescope and collimator and the lines which are perpendicular to the two surfaces are all four at right angles to the vertical axis of the instrument. The focus of the collimator and telescope must furthermore be adjusted so that the spherical waves diverging from the slit of the collimator are transformed into plane waves in passing out through its lens, and so that plane waves falling on the object-glass of the telescope are brought to a focus at the cross-hairs. These adjustments should be carried out in the following order and manner:

1. *To focus the telescope.*—Remove it from its clamps; remove the eye-piece tube, and shift the position of the cross-hairs until they are distinctly in focus for the eye of the observer; replace the eye-piece tube; direct the telescope towards some extremely distant object—*e. g.*, a star, or a spire some miles away—and then push the eye-piece tube in or out until the image of the object falls exactly upon the cross-hairs—*i. e.*, until there is no parallax between them. This focuses the telescope for plane waves.

2. *To focus the collimator.*—Replace the telescope in its clamps; turn and elevate the telescope and collimator until their axes are approximately in the same straight line; turn the slit horizontal (or place a fine hair across its middle point); adjust the slit by pushing it out or in,

and raising or lowering the collimator until, when the slit is illuminated by a flame or by being pointed towards the daylight, it is sharply in focus on the cross-hairs. It may be well to revolve the entire collimator (or the slit-tube) around its own axis through 180° to see if the slit remains on the cross-hairs, as it should if the instrument is well made.

This adjustment places the slit in the focus of the collimator lens, so that, when the slit is illuminated, plane waves emerge from the collimator. It also places the axes of the telescope and collimator in the same straight line.

3. *To adjust either the telescope or the collimator so that its axis is perpendicular to the axis of the instrument.*—To do this, some polished plane surface—*e. g.*, the face of a prism—must be placed vertically on the central table of the instrument at such a height as to be at the level of the telescope or collimator, and it must first be adjusted so that its normal (*i. e.*, a line perpendicular to its plane) is itself perpendicular to the axis of the instrument. This first step is performed in the following manner :

(a) Turn either telescope or collimator around the axis of the instrument, being careful not to change the levelling-screws of the tubes until the normal of the plane surface nearly bisects the angle between the telescope and collimator.

(b) Alter the position of the plane surface by the levelling-screws of the table on which it rests until, when the slit (still horizontal) is illuminated, its reflection from the plane surface falls exactly upon the cross-hairs of the telescope.

The normal to the plane surface is now perpendicular to the axis of the instrument.

Now, leaving the plane surface absolutely untouched, it is possible to adjust the axis of either the telescope or the collimator perpendicular to it.

If the telescope has a Gaussian eye-piece—that is, if the side of the eye-piece is cut away so as to allow the insertion of a thin piece of glass between the eye-piece and the cross-hairs—it is best to adjust the telescope perpendicular to the plane surface. The method is as follows :

Insert the piece of glass at an angle of 45° with the axis of the telescope, as is shown in the figure; place a lamp or gas-flame at the side of the opening, so that the light falls upon the glass-plate; this illuminates the cross-hairs brightly. Now turn

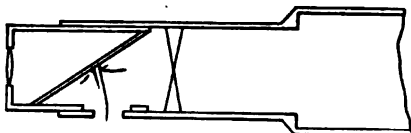

FIG. 173

the telescope until it is approximately perpendicular to the plane surface on the central table; and raise or lower the telescope by the levelling-screw, until there is seen through the eye-piece a *reflected* image of the bright cross-hairs. This image must be made by means of the levelling-screw of the telescope to coincide with the cross-hairs themselves; and it is obvious that the telescope is then perpendicular to the plane surface, and therefore perpendicular to the axis of the instrument.

If the telescope has no Gaussian eye-piece, it is best to adjust the collimator perpendicular to the plane surface; and the method is the same in principle as that used with the Gaussian eye-piece. The collimator must be turned until it is approximately perpendicular to the plane surface; turn the slit vertical and open it rather wide by the side-screw; illuminate it by means of a gas-flame, but cut off half the slit by interposing a piece of tin or card-board; then adjust the collimator by its levelling-screw until the *reflected* image of the illuminated half of the slit appears on the tin or card-board. By carefully adjusting the screw, the central point of the slit may be made to coincide with the image of itself; and then the axis of the collimator is perpendicular to the plane surface, and therefore perpendicular to the axis of the instrument.

If the telescope has no Gaussian eye-piece, it is best to adjust the collimator perpendicular to the plane surface; and the method is the same in principle as that used with the Gaussian eye-piece. The collimator must be turned until it is approximately perpendicular to the plane surface; turn the slit vertical and open it rather wide by the side-screw; illuminate it by means of a gas-flame, but cut off half the slit by interposing a piece of tin or card-board; then adjust the collimator by its levelling-screw until the *reflected* image of the illuminated half of the slit appears on the tin or card-board. By carefully adjusting the screw, the central point of the slit may be made to coincide with the image of itself; and then the axis of the collimator is perpendicular to the plane surface, and therefore perpendicular to the axis of the instrument.

If the telescope is perpendicular to the axis of the instrument, it can be turned so as to be pointed obliquely towards the plane surface, and the collimator can be turned so as to make approximately the same angle with the plane surface on the opposite side of its normal. Illuminate the

slit (still horizontal), and raise or lower the collimator by the levelling-screw until the reflected image of the slit coincides with the cross-hairs of the telescope. The axis of the collimator is now perpendicular to the axis of the instrument.

If the collimator is adjusted perpendicularly to the plane surface, it is the telescope which must be adjusted until the reflected image of the slit coincides with the cross-hairs, and then it is also perpendicular to the axis of the instrument.

The spectrometer itself is now in adjustment.

If the instrument is to be used to study the dispersion of a grating or prism, or if it is to be used to measure the angles of a prism, the surfaces of the prism or grating must be themselves adjusted so that their normals are perpendicular to the axis of the instrument. This can be done according to the general plan described in 3a and 3b, by placing the grating or prism on the central table and altering its level by the three levelling-screws until the reflected image of the illuminated slit coincides with the cross-hairs of the telescope. This makes the normal of the reflecting surface perpendicular to the axis of the instrument. To make the normal to the second face of the prism also perpendicular to the axis of the instrument, the slit must be reflected in it and its image made to coincide with the cross-hairs. But in the adjustment of this second face by the levelling-screws of the platform, the first face is thrown out of adjustment unless the prism is placed on the platform as is shown in the figure—

i. e., unless the three faces are perpendicular to the lines joining the three screws. In this position, the position of any one face may be altered without changing the plane of the face already adjusted. Thus, if the face A has been adjusted, screw

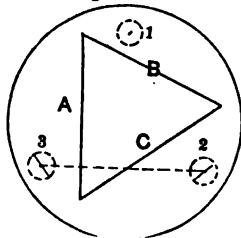

FIG. 174

1 can be turned without affecting the plane of A. After the second face has been adjusted, however, it may be necessary to readjust the first face.

Considerable thought is required as to exactly the best position on the central platform for the grating or prism, according to the use to which it is to be put ; but by careful consideration the most suitable position can be determined.

In certain spectrometers the telescope and collimator are fixed so that they cannot be turned around the axis of the instrument ; and, although in this case the adjustment of the instrument is more difficult, the general principles are those which have been made use of in the discussion of the ordinary form of instrument.

To Measure the Angle of a Prism.

A solid which is bounded in part by two plane faces which are not parallel forms a prism. The line of intersection of these faces, considered produced if necessary, is called the "edge" of the prism. The prism should be placed upon the table of a spectrometer, with the edge parallel to the axis of the instrument following the directions just given. There are then three methods of proceeding :

1. If the telescope has a Gaussian eye-piece, the cross-hairs may be illuminated, and the telescope turned until it is in succession perpendicular to the two plane faces. The angle through which the telescope has been turned equals $180^\circ - A$, where A is the angle of the prism.

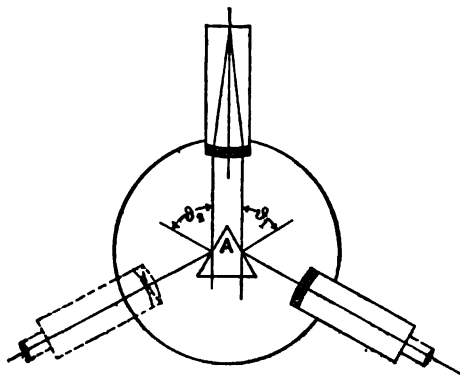

FIG. 175

2. Place the collimator so that when the slit is illuminated by a flame or lamp the light as it emerges from the lens falls upon *both* the plane faces, being divided into two sections, as it were, by the edge. Each of these sections is reflected

from the corresponding face; and the direction of each may be determined by the telescope. The angle through which the telescope must be turned, in order that the image of the slit may fall on the cross-hairs, first when reflected from one face and then from the other, may be proved to be $2A$, where A is the angle of the prism. For it is apparent from Fig. 175 that $\vartheta_1 + \vartheta_2$ equals the angle between the normals to the two faces, and, therefore, equals $180^\circ - A$; but, as the telescope is turned from one reflected beam to the other, it moves through an angle $360^\circ - 2(\vartheta_1 + \vartheta_2)$, or $2A$.

3. If the platform on which the prism rests has a scale on its edge, by means of which its position may be read, the following method may be used: Place the collimator so that light is reflected from one face only of the prism, and focus the telescope upon the reflected beam; then, keeping the collimator and telescope fixed, turn the table which holds the prism until the second face of the prism reflects light from the collimator down the telescope. The angle through which the prism has been turned is $180^\circ \pm A$, depending upon the direction in which it has been turned, as is evident from the diagram.

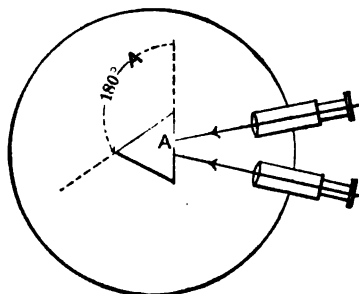

FIG. 175

Sources of Error.

1. The faces of the prism may not be plane.
2. The two halves of the collimator lens may not be alike, which would introduce an error in Method 2.
3. The divided scale may not be uniform.
4. The centre of the circular scale may not coincide with the axis of the instrument. This must be corrected for, by making readings at both ends of the index which extends across the scale. (See Experiment 64, Dip Circle.)
5. The clamping-screws may not hold, and so every reading should be repeated.

Apparatus. Spectrometer; prism; fish-tail gas-burner.

Manipulation. Place the prism on the spectrometer table,

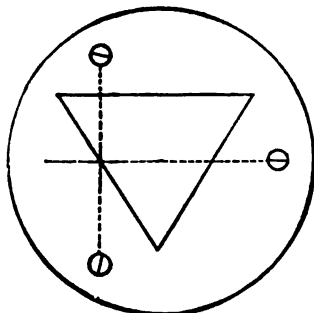

FIG 177

as shown, and adjust the instrument carefully, using the method described in the introduction. In making any final adjustment of the telescope, it is best to clamp it with the screw, and complete the adjustment by means of a small screw and spring attached to the clamping-screw. This screw and spring are called the "tangent-screw."

METHOD 1. Gaussian Eye-pieces. — Adjust the glass mirror in the telescope tube, and place the telescope so that its axis is approximately perpendicular to one face of the prism. Holding a gas-flame near the opening into the side of the telescope, turn the latter until the reflected cross-hairs coincide with the actual cross-hairs. (Do not, of course, alter the levelling-screws.) In making this final adjustment, clamp the telescope arm and use the tangent-screw. Read the position of the telescope by means of its index and scale. Some instruments have verniers and others have microscopes and micrometer screws. In any case, make three settings and readings, and take the mean. If there are two verniers or microscopes, read both each time.

Keeping the prism table fixed, turn the telescope arm until it is approximately perpendicular to the other face of the prism. By means of the flame illuminate the cross-hairs and adjust the telescope exactly perpendicular to this face. Make, as before, three settings and readings, and take the mean. Then make three more readings on the first face, and average with those made before.

The difference between the mean readings is $180^\circ - A$, where A is the angle of the prism.

Turn the table which holds the prism through about

90°, and repeat the measurements. Again turn the table 90°, and repeat. This is done because it is possible that the scale may not be uniformly divided on all sides.

Take the mean of the measurements.

METHOD 2. Prism and Collimator Stationary.—Turn the collimator arm until its axis apparently bisects the angle between the two faces. (If the collimator arm cannot be turned, turn the prism table.) Turn the slit until it is vertical, if it is not so already, and place a gas-flame in front of it. Determine by means of the eye the approximate directions of the beams reflected from the two faces. Place the telescope so as to receive these reflected beams in turn, and by means of the tangent-screw adjust until the image of the slit falls exactly on the cross-hairs. Make three settings and readings in each position, using both verniers or microscopes, and take the means. After setting on the image formed by reflection from the second face, turn the telescope arm back, and make three more readings on the image reflected from the first face. Average the mean of these readings with the first set. The difference of the means equals $2A$.

Turn the prism table in succession through 90° and 180°, and make similar readings. Take the mean of the three sets of measurements.

METHOD 3. Telescope and Collimator Stationary.—Turn the collimator arm until it makes an angle of about 30° with the normal to one face of the prism. (If the collimator arm cannot be turned, turn the prism table.) Illuminate the slit by a flame, and turn the telescope arm until the *reflected* image of the slit falls upon the cross-hairs. Make the final adjustment by means of the tangent-screw. Clamp the telescope, and keep it and the collimator fixed during the rest of the experiment. Read the position of the prism table, using both verniers; unclamp the table, reset, and make another reading; do this three times. Make these final adjustments with the tangent-screw attached to the table, not the one attached to the telescope. Turn the

table until an image of the slit formed by reflection from the other face is seen on the cross-hairs. Make a reading for the position of the table; unclamp, reset, and make another reading. Do this three times, and take the mean. Unclamp the table, turn it back into its previous position, and make three more readings of the reflection from the first face. Average the mean of these with the mean of the first three readings. The difference between these mean readings is $180^\circ \pm A$. Be careful not to set at any time on a refracted image.

Place the collimator arm at approximately an angle of 45° , with the normal to the surface; and repeat the readings, as described above. Do this also for some other angle.

Take the mean of the determinations for A , using as many methods as possible.

ILLUSTRATION

ANGLE OF A PRISM		May 3, 1897
	1st Face	2d Face
METHOD 2.—Vernier A ...	$886^\circ 2' 00''$	$95^\circ 50' 00''$
“ B ...	$156^\circ 2' 00''$	$275^\circ 50' 00''$
		Difference
		$119^\circ 48' 00''$
		$119^\circ 48' 00''$
		Mean, $119^\circ 48' 00''$

$$\therefore \text{Angle of prism} = \frac{1}{2}(119^\circ 48') = 59^\circ 54' 00''.$$

	1st Face	2d Face	Difference
METHOD 3.—Vernier A ...	$839^\circ 58' 50''$	$219^\circ 55' 00''$	$119^\circ 58' 50''$
“ B ...	$159^\circ 58' 50''$	$89^\circ 55' 10''$	$119^\circ 58' 40''$
			Mean, $119^\circ 58' 45''$

$$\therefore \text{Angle of prism} = 180^\circ - 119^\circ 58' 45'' = 60^\circ 1' 15''.$$

2d trial, different part of scale,	$59^\circ 46' 20''$
3d “ “ “ “ “	$59^\circ 55' 10''$
	Mean, $59^\circ 54' 15''$

Hence, angle of prism is $59^\circ 54'$.

Questions and Problems.

1. Give reasons why one of the above methods is more accurate than the others.
2. Give reasons why readings taken on different parts of the scale should differ so widely. Describe possible errors which may arise when a scale is ruled.

EXPERIMENT 88

(THIS EXPERIMENT SHOULD BE MADE IN A DARKENED ROOM)

Object. To study the deviation produced by a prism. To measure the angle of minimum deviation. (See "Physics," Arts. 322, 344.)

General Theory. The deviation is defined as being the angle by which the direction of the emerging waves differs from that of the incident ones, when plane waves fall upon

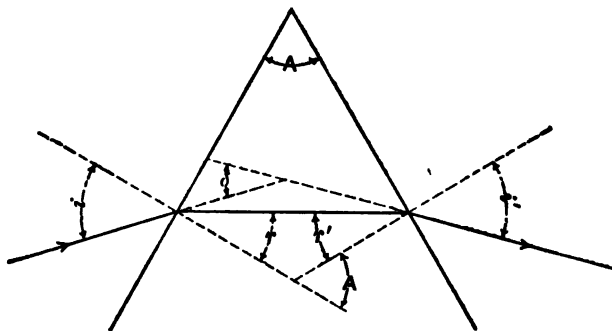

FIG. 178

a prism. It is evident from the figure that the deviation $\delta = i + e - A$, and since e varies with μ , the index of refraction, δ varies with the angle of incidence, the angle of the prism, the material of the prism, and the wave-length of the light. In this experiment the first and the last of these two facts will be verified. It is also proved by theory that for a definite prism and for a definite train of waves there is a certain angle of incidence for which the deviation is a minimum. This is called the "angle of

minimum deviation" for the given prism and light. This fact will also be proved in this experiment, and the angle will be measured.

The method is to place the prism on the table of the spectrometer, and so arrange the collimator that light from it falls upon one face of the prism, and is refracted into it and out of the other face; then the direction of the emerging light may be studied by the telescope. The angle of incidence may be varied by turning the prism table; and, if light of several wave-lengths is to be studied, the slit may be illuminated with white light; while, if the angle of minimum deviation is to be measured for any particular wave-length, a sodium-flame may be used, for it gives light which is approximately homogeneous.

Sources of Error.

1. The most common source of error is the confusion arising from reflected images, if the prism is small.
2. The minimum is always difficult to observe because the change is so slow; for a considerable change in angle of incidence will produce only a slight change in deviation.

Apparatus. Spectrometer; prism; gas-flame or incandescent electric light; Bunsen-burner; a piece of fused salt (NaCl) supported on a suitable stand.

Manipulation. Place the prism on the table of the spectrometer and adjust the instrument.

1. *To Study Deviation of Waves of Different Wave-length.*—Turn the prism table so that, when the slit of the collima-

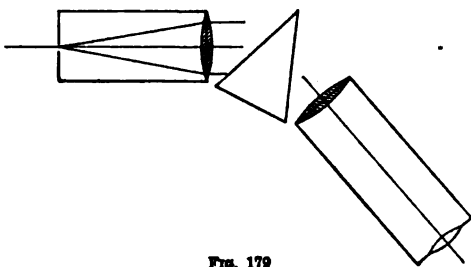

FIG. 179

tor is illuminated, light will enter and pass through the prism. Make the angle between the axis of the collimator and the normal to the face of the prism

about 30° . (The collimator should, of course, be on the side of the normal towards the base of the prism, so that the entering light is refracted towards the base.) Illuminate the slit, placed vertically, by the gas-flame, the electric lamp, or by light coming from the sky, if this is possible. By means of the unaided eye locate the refracted light. This can best be done by turning the prism table slightly and noticing the change, carefully guarding against any possibility of observing a reflected image instead, by covering different surfaces of the prism with a small piece of paper. Note the order of colors in the refracted light, and record them in the order of their deviation. Now turn the telescope arm until the refracted light enters the tube. Again note the order of the colors, and account for it.

2. *To Study the Effect of Changing the Angle of Incidence.*—Darken the room and replace the source of light before the slit by a sodium-flame. This consists of a small piece of fused salt, supported just in the edge of the middle part of a Bunsen-flame by a support and wire. Care should be taken to see that the yellowest portion of the flame illuminates the slit. A yellow image of the slit should now be seen in the telescope. Make the angle of incidence as great as possible by turning the prism table, and receive the refracted light in the telescope. Note, roughly, the angles of deviation and incidence (to within 5°). Decrease the angle of incidence by steps of about 10° or less, and note the corresponding angles of deviation. Continue as far as possible. Plot the results.

It will be noticed that there is a certain angle of incidence such that any further decrease in the angle will make the angle of deviation reverse the direction of its change. This angle of incidence should be located quite carefully, by making slight changes and noting their effect.

3. *To Measure the Angle of Minimum Deviation.*—Bring the telescope to the angle which corresponds to minimum deviation as determined approximately in Part 2 of the

experiment. Then, by minute motions of the prism table and corresponding ones of the telescope, make the angle of incidence such that the refracted image is on the cross-hairs of the telescope when the deviation is exactly a minimum. This final adjustment should be made by clamping the telescope and using the tangent screw. Read the position of the telescope, using both verniers or microscopes. Displace the prism table and telescope slightly, and repeat the measurement. Do this three times in all, and take the mean of the readings.

There are now two ways of proceeding. One is to remove the prism ; turn the telescope arm until the telescope and collimator are in line, as is shown by the image of the slit being on the cross-hairs ; read the position of the telescope, and take the difference between this reading and the one made at minimum deviation, for this is obviously the angle of deviation. The other, and the better, is to turn the prism table around through approximately 180° , so that the edge points in an opposite direction to that which it did before ; then, to find, by means of the telescope, the position of minimum deviation of the prism turned this way. make the reading, as above, three times, and take the difference between this reading and that made when the deviation was a minimum on the other side. This difference is evidently twice the angle of minimum deviation, *if the readings mark the angle through which the telescope has been turned*. In certain instruments the verniers are attached to the prism table ; so that, when the latter is turned, the verniers measure the angle of rotation. The telescope is rigidly fastened in such instruments to the circular scale, over which the verniers move. The difference between the vernier readings in the two positions of minimum deviation would then be $180^\circ - D$, where D is the angle of minimum deviation.

If it is possible, repeat the entire experiment, using a different portion of the scale. Call the mean of the two results for the angle of minimum deviation D .

In a similar manner *observe* the minimum deviation for a lithium-flame, and compare it with the value just found for a sodium-flame. Is it different? If so, is it greater or less?

N. B.—It should be noted that Parts 1 and 2 of this experiment do not require a spectrometer, but simply a prism and a slit—the latter can be made by cutting an opening in a blackened metal screen.

ILLUSTRATION

May 10, 1897

ANGLE OF MINIMUM DEVIATION OF SOFT-GLASS PRISM

Sodium Light

	1st Position	2d Position	Difference
Vernier <i>A</i> ...	186° 57' 00"	48° 26' 00"
" " ...	186° 55' 00"	48° 22' 00"
" " ...	186° 60' 00"	48° 24' 00"
Mean,	186° 57' 20"	48° 24' 00"	188° 33' 20"
Vernier <i>B</i> ...	6° 57' 00"	228° 26' 00"
" " ...	6° 55' 00"	228° 22' 00"
" " ...	6° 60' 00"	228° 24' 00"
Mean,	6° 57' 20"	228° 24' 00"	188° 33' 20"

Mean, 188° 33' 20"

Minimum deviation, $D = 180^\circ - 188^\circ 33' 20'' = 41^\circ 26' 40''$.

(In this instrument the verniers move with the prism table.)

Questions and Problems.

1. What is meant by chromatic aberration? How may it be corrected approximately?
2. What is meant by saying that the spectrum produced by a prism is "irrational"?
3. Describe an experiment to determine the absorption spectrum of any liquid. Also describe an experiment to investigate "anomalous dispersion."
4. What is the exact process by means of which a prism spectro-scope identifies or records the spectrum of a gas? Does it give wave-lengths?
5. Why is it almost essential to make two readings for the angle of minimum deviation, one on each side of the collimator axis, especially in the case of a small prism?
6. What would be the application of Döppler's principle to light? How could it be tested by observations made on the light reaching the earth from the sun?

EXPERIMENT 89

Object. To measure the index of refraction of a transparent solid made in the form of a prism. (See "Physics," Art. 322.)

General Theory. It is proved in treatises on Physics that, if A is the angle of a prism, and D the angle of minimum deviation for the same prism for waves of a certain wavelength, then the index of refraction, μ , for this light is,

$$\mu = \frac{\sin \frac{A + D}{2}}{\sin \frac{A}{2}}.$$

Therefore, if A and D are known, μ may be calculated.

Sources of Error.

Those of the preceding two experiments.

Apparatus. Same as for the last experiment.

Manipulation. Measure A and D , as described in the two preceding experiments, taking particular precaution to use the same angle of the prism in the two measurements. It is well to mark it in some way—*e. g.*, by a pencil mark on the top, not on the faces. Do this at least three times. Take the means, and substitute in the above formula.

ILLUSTRATION

May 10, 1897

INDEX OF REFRACTION OF SOFT-GLASS PRISM FOR SODIUM-LIGHT

Angle of prism..... $A = 59^{\circ} 46' 20''$
 " " minimum deviation, $D = 41^{\circ} 37' 00''$ for sodium-light.

$$\therefore \mu = \frac{\sin \frac{A + D}{2}}{\sin \frac{A}{2}} = 1.553.$$

Questions and Problems.

1. Explain in detail why the following parts are used in a spectroscope : (a) the slit ; (b) the collimating lens ; (c) the prism ; (d) the object-glass of the telescope ; (e) the eye-piece.
Which could be dispensed with ?
2. In studying the spectrum of a star, what apparatus is required ?

EXPERIMENT 90

Object. To study color-sensation. (See "Physics," Art. 361.)

General Theory. There are several theories of color-sensation—the Young-Helmholtz, the Hering, the Franklin—but none can be regarded as entirely satisfactory. Apart from all theory, however, it is possible to prove that by the combination of certain color-sensations an entirely different sensation may be produced. Three colors are, in general, selected, which, when combined upon the retina of the eye (not combined like a mixture of paints), will produce a sensation of white or gray; and the effect of combining these color-sensations in different proportions and with different amounts of white and black is studied. The one requirement is that all the sensations which are to be combined should be produced simultaneously on the retina of the eye. This may best be secured by placing colored disks in the form of sectors of circles upon a top which has a flat upper surface, and spinning the top rapidly. Then, if the top is brightly illuminated by sunlight, and if the observer looks intently at the colored sectors, his eye will receive different color-sensations which are practically simultaneous. The one serious source of error is in not having the colored disks illuminated strongly enough.

With each set of apparatus, as furnished by the instrument maker, come explicit directions, which need not be repeated here.

EXPERIMENT 91

(THIS EXPERIMENT SHOULD BE MADE IN A DARKENED ROOM)

(TWO OBSERVERS ARE REQUIRED)

Object. To measure the wave-length of light by means of a grating. (See "Physics," Art. 365.)

General Theory. The simplest form of grating is made by ruling parallel straight lines by means of a diamond-point at equal distances apart on a piece of plate-glass. In order to get good results there should be several thousand lines per inch, and the grating should be two or three inches long at least. If plane waves of a single wave-length fall normally upon such a grating, there will be several streams of emerging light determined by the condition that

$$a \sin \vartheta = n\lambda,$$

where a is the "grating-space"—*i. e.*, the length of the ruled surface of the grating divided by the entire number of lines ruled in this length; λ is the wave-length of the incident light; n is any whole number, 0, 1, 2, 3, etc.; and ϑ is the angle made with the normal to the grating by the direction of one of the diffracted emerging beams of light. Consequently, there will be light leaving the grating at the angles $\vartheta_0, \vartheta_1, \vartheta_2$, etc., where

$$a \sin \vartheta_0 = 0$$

$$a \sin \vartheta_1 = \lambda$$

$$a \sin \vartheta_2 = 2\lambda, \text{ etc.}$$

The quantity, n , is said to mark the "order of the spectrum."

To measure λ for any train of waves, it is necessary to

know a , n , and the corresponding value of θ . The most accurate method to obtain θ is obviously to place the grating on the table of a spectrometer, perpendicular to the axis of the collimator; to illuminate the slit with the light whose wave-length is known, thus causing plane waves to fall normally upon the grating; and to locate and measure θ by means of the telescope and its verniers. Another method, not so accurate, but much simpler, is this: Cause plane waves to fall normally upon the grating by means of a slit and convex lens; place a metre-bar parallel to the grating, but some distance back of it; and determine some line on this bar which, with a point at the centre of the grating, fixes the direction in which the eye must look in order to receive one of the diffracted emerging beams. This evidently gives a means of measuring θ for a definite value of n . The grating-space, a , is, in general, known from the pitch of the dividing-engine which ruled the grating. If, however, it is not known, two methods to measure it are possible: one is to measure it directly by comparison with a standard centimetre rule (a most difficult task); the other is to assume as definitely known the value of λ for some light—*e. g.*, any one of the Fraunhofer lines—and to measure the value of θ for it, thus giving $a \left(= \frac{n\lambda}{\sin \theta} \right)$.

Sources of Error.

1. The slit must be exactly in the focus of the collimating lens.
2. The face of the grating must be perpendicular to the axis of the lens.
3. The lines of the grating should be parallel to the slit.
4. In measuring θ , great care must be taken to keep one point of the grating constantly in the line of vision.
5. There is trouble generally from the spherical aberration of the lens.

Apparatus. Slit; short-focus convex lens; grating; sodium-flame; 2 metre-bars; telescope; clamp-stands.

Manipulation. Make the slit quite narrow by means of its screw, and cover it with strips of opaque paper except

for about 1 centimetre at its centre. Then proceed as follows: To place the slit in the focus of the lens, the best plan is to focus the telescope on a distant object; then, placing the lens in front of the illuminated slit, to view the slit through the lens by means of the telescope, and to move the lens until the slit is seen clearly on the telescope cross-hairs. (This is the ordinary spectrometer adjustment.) Turn the slit vertical, if it is not already so.

Place the grating at the same height as the lens, a few centimetres away and as closely perpendicular to the axis of the lens as the eye can judge; turn it in its own plane so that the ruled lines are parallel to the slit. Place back of the slit a metre-bar, and make it as closely as possible parallel to the grating and at nearly

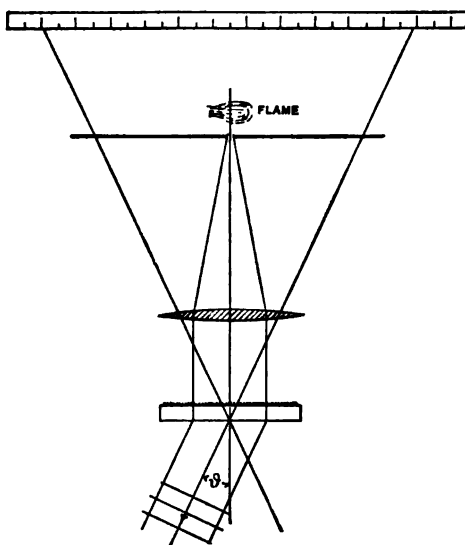

FIG. 180

the same level. Now illuminate the slit with the sodium-flame; and, on looking through the grating towards the lens, a yellow image of the slit will be seen for certain positions of the eye. By first looking normally through the grating, and then more and more obliquely, there will be seen the various "orders" of the spectrum corresponding to $n = 0, 1, 2, 3$, etc., which will be, of course, symmetrical on the two sides of the normal. To determine the angles at which these images are observed, proceed as follows: Make some faint mark at the middle point of the top edge of the grating, such as a fine pointer of paper;

and, keeping this in the line of vision, look through the grating obliquely in such a direction as to see one of the images. Let a second observer move a vertical edge of paper along the front face of the metre-bar until the edge comes exactly in the line of vision. Record the reading. and make two more determinations, being careful to pay attention only to the central portion of the image, not to the extremes, because they may be distorted by spherical aberration. Call the mean reading d_1 .

Now look through the grating obliquely from the opposite side of the normal, and determine the direction of the diffracted image of the same order as before. Call the mean reading d_2 . Take the difference, $d_2 - d_1$.

Do this for as many orders as possible.

Remove the slit, flame, and lens, and measure as accurately as possible the perpendicular distance from the ruled surface of the grating to the metre-bar. Call it h . Then, for any order, $\tan \vartheta = \frac{1}{2} \frac{d_2 - d_1}{h}$; and so $\sin \vartheta$ may be calculated.

In this way calculate $\sin \vartheta$ for as many orders as possible, at least for $n = 1$ and $n = 2$. An instructor will give the value of the grating-space; and so λ may be deduced from each set of measurements.

ILLUSTRATION

May 10, 1897

MEASUREMENT OF WAVE-LENGTH OF SODIUM LIGHT

Grating-space, $a = 0.0001759$ centimetres.Order of spectrum, $n = 2$.

$$d_2 = 77.1; d_1 = 24.5; h = 29.5.$$

$$\tan \vartheta = \frac{77.1 - 24.5}{2 \times 29.5} = 0.8911 +.$$

$$\therefore \sin \vartheta = 0.665 +.$$

$$\therefore \lambda = \frac{a \sin \vartheta}{n} = 0.0000586 + \text{ centimetres.}$$

$$= 5860 \text{ \AA} \text{ngstr\AA} \text{m units.}$$

The correct value is 5893.

Questions and Problems.

1. What is the advantage of having a large number of lines on the grating? What of having a large number *per centimetre*?
2. What differences are there between spectra produced by gratings and those produced by prisms?
3. Describe a method of using a *reflecting grating*—that is, one whose lines are ruled on a polished metallic surface.



APPENDIX I

LABORATORY EQUIPMENT

THERE are several useful pieces of apparatus and useful arrangements with which every laboratory should be provided, and which should form, as it were, part of the permanent equipment of the laboratory. A few of these will be mentioned.

Aspirator Pump. Such a pump, to be driven by water from a tap under pressure, should be joined to various taps in the laboratory. A sketch is given of a most efficient one, which, with water under a pressure of 30 pounds, will give a vacuum of less than 2 centimetres.

This pump may also be used as a compression pump, if the end from which the water is escaping is fitted into a closed space from which the air cannot escape; for the water may be allowed to escape through a trap; and the pressure of the confined air, which thus increases constantly, may be used for various purposes.

Platford Air-pump. A hand air-pump provided with a plane brass platform and a glass bell-jar with ground edge should be constantly ready for use. One of its main purposes is to enable a student to exhaust air from water, which is to be used for density determinations.

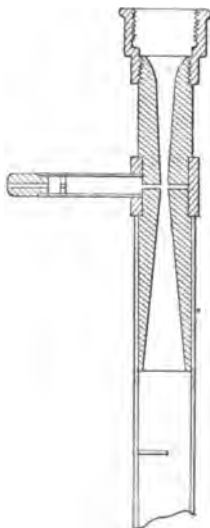

FIG. 181

Drying Tubes. In order to facilitate the drying of glass tubes and bulbs, permanent drying tubes should be fastened to a shelf near an aspirator pump. They need consist only of a sulphuric-acid bottle, into which the inlet

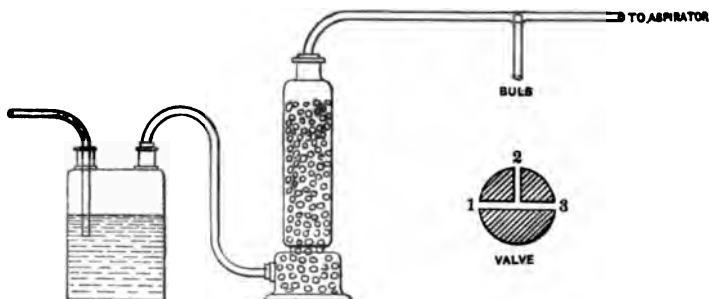

FIG. 182

tube dips, and from which a tube passes to a calcium-chloride bottle, out of the top of which a tube leads to a three-way cock. The other two branches of this cock are joined to the aspirator pump and to the bulb to be dried, as is shown. The three-way cock consists of a T-tube with a ground-glass stopper at the junction, into which are bored two holes at right angles to each other, as shown. When the cock is turned so that the opening 2 faces the aspirator, and 3 the bulb, air will be exhausted from the bulb; if now the valve is turned so that 2 faces the drying tubes and 1 the bulb, dry air will enter the bulb. This process may be continued indefinitely. To stop dust, it is prudent to place a loose plug of cotton-wool in the tube by which the object to be dried is connected.

Distilled Water. Every laboratory should be provided with an apparatus for distilling water. One may be easily constructed, but it is as well perhaps to buy one from an instrument maker. It should be fastened to a wall, and kept running almost constantly. The apparatus, of course, needs cleaning from time to time.

Clock Circuit. Every physical laboratory should be provided with a good clock and a number of electric clocks

driven by this central one. The central clock should have a compensating pendulum with a heavy bob, and it should be of such a length as to beat seconds or half-seconds—*i. e.*, its period should be two seconds or one second. The nut by which the position of the bob is regulated should have a fairly large, divided head, and to the bob should be fastened a pointer resting on this head, so that the change in the length of the pendulum can be measured. This clock should be rigidly fastened to the wall of the building, and should be regulated and rated by astronomical observations.

If, by a suitable arrangement, the pendulum closes an electric circuit for a very short time once during each complete vibration, or once during each half-vibration, an electromagnet included in the circuit may be used for moving the hands of a clock. This is the principle of the electric clock. As many of these as desired can be run from the one central clock, and, since they are all driven by the same pendulum, they will all have the same accuracy—*viz.*, that of the central clock. The main trouble is with the arrangement for closing the circuit by means of the pendulum. Various forms of contacts have been devised, but the simplest and the one most generally used is the “mercury contact.”

In this arrangement the circuit is completed through the pendulum rod. To its lower extremity is fastened a narrow piece of platinum, whose plane is in the plane of vibration. Below this, when in its position of equilibrium, is the open end of a glass horn containing mercury, which is so mounted that it can be rotated about a pivot in the centre of the arc of the pendulum. The end of this horn is quite narrow in the direction of vibration, and is placed as near the centre of the arc as possible, and in such a position that the globule of mercury formed there, when the other end of the horn is raised, shall at each half-vibration of the pendulum be cut by the platinum edge. If one terminal of an electric circuit, including an electric clock, be connected with the bearings on which the pendu-

lum swings, and the other extremity be connected with the mercury in the horn, then the circuit will be closed at each swing of the pendulum, and the electric clock will record the half-vibrations of the central clock. The horn must be placed so that the pendulum cannot touch the glass, no matter at what angle it may be inclined. The circuit should be open when it is not in use, and an arrangement should be made for opening and closing the circuit without opening the case of the clock. This may be done by means of a key included in the circuit, or by means of a wheel and ratchet which, by lowering the outer end of the horn, allows the mercury to run back and thus break the circuit.

If intervals of time that are exactly equal are needed, as in rating a tuning-fork, this contact is not satisfactory. The mercury globule has a tendency to vibrate, and it is very difficult to get it exactly in the centre of the pendulum arc. Hence, on the whole, the contact now to be described is to be preferred. It is very easily made and adjusted, and one used for over a year for determining the frequency of forks by Michelson's method has given perfect satisfaction. It is easily understood from the figure.

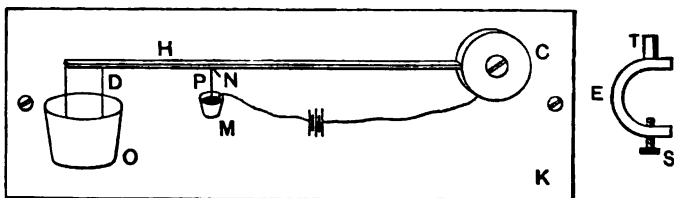

FIG. 183

H is a weak steel watch-spring, soldered to the collar C, which can be clamped to the clock-case in any desired position by means of a screw. To H is soldered a platinum point (P), perpendicular to the flat surface of the spring; and perpendicular to both H and P is soldered the point (N) of a fine steel sewing-needle. M is a mercury-cup; D is a vane of mica that dips into oil in the cup O, and is intended to damp the vibrations of the

spring. The oil-cup O, the mercury-cup M, and the collar C are all fastened to a piece of brass that is screwed to the back of the clock-case near the top of the pendulum-rod, and in such a position that the spring is horizontal, and the needle, N, projects horizontally and comes near the centre of the arc of the pendulum-rod. The mercury-cup is insulated from this piece of brass. E is a light brass collar that can be fastened to the pendulum-rod by means of the brass screw S. To the back of this collar is soldered a short piece of flat steel, T, that projects towards the back of the clock. The plane of T is perpendicular to the plane of vibration of the pendulum, and is inclined to the horizon at an angle of about 20° or 30° . The horizontal needle and T are well polished on both sides, and are of such lengths that, when the collar is in place on the rod and the pendulum is at rest, T laps over the needle by an amount just sufficient to insure the lifting or depressing (as the case may be) of the needle at each swing of the pendulum. The collar is placed on the rod at such a height that the upper edge of T is a little higher than the needle when the pendulum is at rest. One terminal of the electric-clock circuit is connected to the mercury-cup M, and the other to the brass plate K, which is in metallic connection with the point P. Then, as the pendulum swings in one direction, it depresses P into the mercury and closes the circuit; as soon as it passes, the circuit is opened by the force of the spring; as the pendulum swings in the opposite direction it raises P slightly, which does not affect the circuit, as it is already open. Hence, when this contact is used, the electric clocks record the complete vibrations of the pendulum; and, therefore, N need not be centred accurately. If the vane in the "dash-pot," D, works properly, the vibrations of the spring will be "dead beat." When this form of contact is used, a key should be placed in the circuit so that it may be opened when the electric connection is not desired.

In every case, the current through the clock should be

small, as otherwise the mercury rapidly oxidizes. If a large current is needed, its circuit should be closed by a relay, worked by the feeble clock circuit.

Sets of Chemicals. Certain chemicals should be kept on shelves ready for use at any moment; and there are others which should be kept in a stock-room and dispensed to the students in small quantities. Lists are given of each:

<i>Laboratory</i>	<i>Stock-room</i>
Sulphuric acid.	Mercury.
Hydrochloric acid.	Benzene.
Chromic acid.	Ether.
Bichromate of potassium, 1.2 kilos.	Copper sulphate, C. P.
Sulphuric acid, 3.6 "	Zinc sulphate, C. P.
Water, 8 "	Calcium chloride.
Nitric acid (in small quantities).	Caustic potash, C. P.
Alcohol.	Caustic soda (com.)
Salt.	Kerosene.
Copper Sulphate.	Fused salt.

Supplies. Certain supplies should be kept constantly on hand. It is impossible to give a complete list; but a few of the most important should be mentioned:

Files—triangular and round.	Clamp-stands.
Sand-paper.	Rubber tubing—common and pure.
Emery-paper.	Wooden blocks, assorted sizes.
Drying-paper.	Glass tubing, " "
Wire—copper, brass, and iron.	Iron weights, " "
Cork borers.	Thread—linen and silk.
Corks—wooden and rubber.	Sealing-wax.
	String—good linen and also cotton.

Books of Reference. There are a few books of reference which should be at the disposal of students. These may be conveniently kept on a shelf near an assistant's table:

Stewart and Gee, "Experimental Physics."
 Glazebrook and Shaw, "Practical Physics."
 Nichols, "Laboratory Manual of Physics."
 Kohlrusch, "Physical Measurements."
 "Smithsonian Tables of Constants."
 7-place Logarithm Tables.

Glass-blower's Table. A table with a metal top, fitted with bellows and glass-blowing burner, is a great convenience; and all glass-blowing should be done upon it, if possible.

Laboratory Tables. Suitable tables for physical laboratories may be made by any carpenter. All that is necessary is a steady wooden table, about 6 feet by 3 feet, with a frame of 2 inches by 4 inches carried over the table about 3 feet above it from end to end. This frame should be supplied with nails, pegs, and holes. It is sometimes advisable to have a shallow trough cut around the top of the table near its edge, so that any mercury which is spilled may be caught.

Balances. Platform - balances, sensitive to 0.1 gram, should be available for use in every laboratory-room; and sets of nickel-plated weights, 1 kilo to 1 gram, should be placed beside them.

Other balances, more accurate than these, should also be provided. If there are many students in the laboratory, it is unwise to furnish fine weights with the balances. It is a better plan to have each student, or pair of students if they work in pairs, rent from the stock-room a good box of weights, 100 grams to 0.01 gram with riders; for otherwise the injury to the weights and the number of those lost are of considerable importance.

Galvanometers. There should be mirror-galvanometers of various types, according to the purposes for which they are needed, provided and attached to the walls in suitable places. The question of construction and selection of galvanometers is so important that a separate chapter is devoted to it.

Storage-batteries. There is no part of the equipment of a modern laboratory which is more useful than storage-cells. These may be procured of the agents, and full directions for their installation come with them. Every room in the laboratory should have at least one line of wires leading to and from the battery-room.

In using storage-cells, care must be taken not to short-circuit them; and open iron or german-silver resistance coils should be used when current is taken from them. An ordinary plug resistance-box is likely to be burned out if the storage-cell current is passed through it.

APPENDIX II

LABORATORY RECEIPTS AND METHODS

Cleaning Glass. The best method to clean glass—*e. g.*, the interior of a bulb—is to wash it in turn with chromic acid, distilled water, alcohol. Sometimes a mixture of alcohol and ether is used in place of the alcohol alone. Caustic potash or soda will clean certain things; but they themselves adhere to glass, and must be removed by the most thorough rinsing with water.

In some cases it is necessary to use hydrochloric acid, or even nitric acid (or a mixture of the two), but this rarely happens; and, if nitric acid is used, the operation must be carried on under a hood, so as to remove the noxious fumes.

Chromic acid consists of

- 8 parts water;
- 1.2 parts bichromate of potassium;
- 3.6 parts sulphuric acid.

It may be used again and again for cleansing purposes.

Cleaning Mercury. The methods necessary to clean mercury depend upon the nature and amount of the impurities.

If the mercury is pure—*i. e.*, has no amalgams on it, but is dusty or wet—it may be cleaned by first drying it by drying-paper and then filtering it through a cone formed of *glazed* paper, pin-holes being made in the bottom. Care must be taken not to allow the last portion of the mercury to pass through.

If the mercury is impure, there are two methods of cleaning: 1, purely chemical; 2, by distillation in a vacuum.

The chemical process is as follows:

The mercury is first shaken violently with dilute sulphuric acid, to which, from time to time, drops of a solution of potassium bichromate are added. It is then thoroughly rinsed in water under a tap, partly dried by drying-paper, and allowed to pass in fine drops through a column of dilute nitric acid (6 to 10 per cent.), about 80 centimetres high. This is best done by making a trap at the lower end of a wide, long glass tube, setting it vertical, pouring in some clean mercury, filling the rest of the tube with the acid, and pouring in the mercury at the top through a funnel which has a stop-cock, or which is drawn out into a fine tube. The mercury now falls in minute drops, which collect at the bottom and gradually pass out through the trap into a vessel placed to receive it.

To distill the mercury in a vacuum, a suitable still must be placed in some permanent situation. One which has proved useful is shown in Figure 184. (The design is due to Professor Smith, of Oxford.) It consists of a large mushroom-shaped glass bulb, in which there is a little trough around the edge, a long glass tube being joined to the trough at one point, and a larger glass tube being joined to the bottom of the bulb. The first of these tubes is about 100 centimetres long, and has a trap near its lower end; while the larger tube is about 70 centimetres long, and is joined at its lower end by a flexible stout rubber tube to a large open reservoir, which may be raised or lowered. Wire gauze is wrapped around the lower part of the bulb, and it is heated by a ring gas-burner, with small openings on its top side. The whole apparatus is firmly fastened by clamps and supports to some solid wall.

The method of use is as follows: The open reservoir is filled with mercury, which is fairly clean; and the extremity of the trap, in which the other tube ends, is attached to a good air-pump—*e. g.*, an aspirator. As the pump is worked, mercury rises up into the bulb, and more should be poured into the reservoir. When the pressure

in the bulb, as indicated by the mercury column, is about 2 centimetres, light the ring burner, and let it heat the mercury in the bulb gently. The mercury reservoir should be so adjusted that the top surface in the bulb comes more than 3 centimetres below the edge of the rim. As the air-pump continues to work, minute drops of mercury may soon be noticed condensing on the top of the bulb and

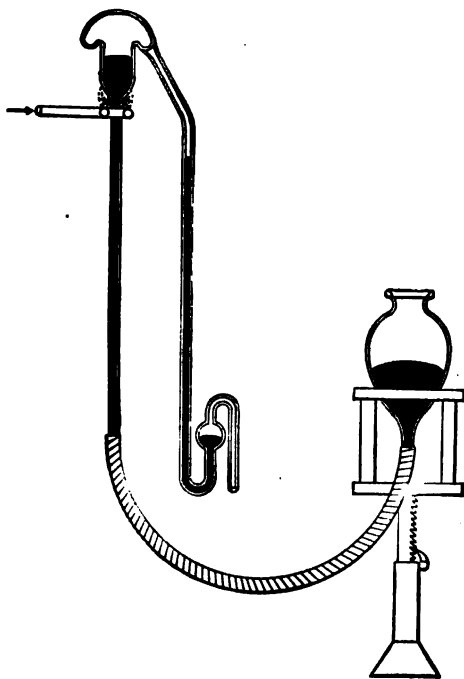

FIG 184

collecting in the shallow trough. Enough will soon collect to flow over into the long tube connected with it. This mercury will collect in the trap at the bottom, and soon back up a short distance; and at this moment the connection with the pump must be broken, otherwise the mercury might overflow into the pump. When the trap is opened to the air the mercury in it will rush back up

the tube, and stand at the barometric height above the free surface in the trap. The mercury will now continue to vaporize, condense, and flow out of the long tube. A suitable clean bottle, into which no dust or dirt can enter, should be prepared to receive it as it escapes.

The still is now in operation, and the mercury to be cleaned can be poured into the open reservoir from time to time, care being taken to dry the mercury before it is put in and to keep the levels properly adjusted.

A mercury-still should be cleaned carefully at least once a year; and it is best, if possible, to have two stills working side by side, the second one being supplied with the mercury distilled by the first.

A tray should, of course, be prepared below the still, so as to catch the mercury in case the glass breaks or the receiving-bottle overflows.

To Fill a Barometer Tube with Mercury. In many experiments it is necessary to have a glass tube which is closed at one end completely filled with mercury, so that when inverted and dipped, open end down, into a basin of mercury there shall be no air in the tube. There are two processes by which this may be done.

The tube should be carefully cleaned and supported, closed end down. A long capillary tube may be drawn having a small reservoir at one end, into which mercury may be poured. This capillary tube should be placed in the larger tube so as to reach to its bottom, and mercury should be slowly admitted through it, care being taken to exclude air bubbles. This process of exclusion may be greatly helped by putting a small ring of glass around the capillary tube, which will rise on top the mercury, and keep the tube from touching the wall. In this way the mercury will slowly rise in the tube and push out the air ahead of it.

A better method is to place the tube, closed end down, in a piece of cast-iron tubing of suitable length, which has a screw-cap at its lower end. The glass tube is separated

from the iron by a packing of dry sand, and two or three Bunsen-burners are directed at the bottom and sides of the iron pipe. Mercury is poured in slowly and boiled gently; and in an hour or more the tube may be filled. When this is done it may be removed and inverted, care being taken to allow no air to enter during the process. The best plan is to cover the forefinger with a piece of black rubber—*e. g.*, a piece of dental rubber—press this tightly against the open tube, squeezing out a drop of mercury, and then to invert.

Fumes of mercury are injurious to the health; and so, when possible, a trap should be made at the open end of the tube by bending it over and dipping it under the surface of mercury in a shallow basin. This trap will stop the mercury vapor, and yet will allow air to bubble through it. By stopping the heating, mercury may be driven back into the tube, and the process completed. When the tube is filled the basin may be removed and the tube safely inverted.

Amalgamating Zinc. All zinc rods and plates used in cells must be amalgamated with mercury, so as to prevent local action. The process is as follows: Clean the zinc carefully with dilute sulphuric acid by dipping the zinc repeatedly in a battery-jar containing the acid, using a piece of cloth tied to the end of a stick as a mop, if necessary; then pour a few drops of mercury upon the zinc, while holding it over a glass tray, and spread the mercury as uniformly as possible over the zinc by means of a cloth and stick, repeating this process until the zinc has a clear, bright surface at all points. Keep the mercury which runs off the zinc in the glass tray, and use it for amalgamating other zincs.

Amalgamating Copper. Electric connections are often made by dipping copper wires into cups of mercury; and, in order to insure good connection, the copper terminals must be amalgamated with mercury. This is done as follows: Pour nitric acid into a bottle which has a glass

stopper and add a few drops of mercury, thus forming mercuric nitrate (there should be an excess of mercury in the acid); clean the copper wire and dip it for a moment into the liquid, or by means of a splinter of wood wet the wire with the liquid; the wire becomes blackened, but if wiped off by a cloth will appear brightly amalgamated.

A test of perfect amalgamation is that the extremity of the wire be able to raise a small drop of mercury off the table.

“Universal Wax.” A most useful soft wax is made by thoroughly mixing and *working together* 1 part by weight of Venetian turpentine and 4 of beeswax. The wax should then be colored red by mixing best English red vermilion with it. This wax can be used to hold almost any two substances together; but it is soft and yields to any considerable stress.

Cements, etc. Sealing-wax is often used to fasten various things to glass—*e. g.*, an iron tube to a glass one—and the only precaution necessary is to heat the glass thoroughly so as to destroy some of its glaze and then to rub the rod of sealing-wax over it, thus forming a thin layer of wax on the glass before trying to make the glass stick to the iron or other substance. After this preliminary layer is obtained, others may be added, and they will make an air-tight joint. (The metal must also be heated.)

Sealing-wax makes a water-tight joint, but dissolves in contact with kerosene.

Damping Keys and Magnets. It is often inconvenient to wait for the vibrations of a galvanometer needle to die down, so that the instrument may be used again; and to hasten this process several methods have been devised, two of which will be described here.

One is to place close behind the coils of the galvanometer a few turns of wire parallel to the coils, and to join these turns through a “damping key” to a cell of some kind. This key is a simple form of commutator, and consists (as shown) of two inclined wire springs which may be

pressed down so as to move between two horizontal wires. The connections are made as shown, the terminals of the coil of wire being in the two springs, and the battery being joined to the two horizontal wires. If now one spring is pressed down so as to make contact with the lower wire, the other spring being in contact with the upper, a current is sent

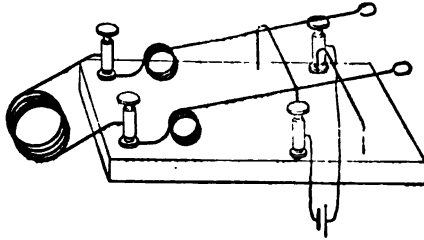

FIG. 185

through the coils of wire in a particular direction, which is reversed if the relative position of the two springs is reversed. Therefore by tapping in turn, first on one spring, then on the other, a series of impulses may be given the galvanometer needle, and, if these are properly timed, the needle may be brought to rest very quickly. The strength of the damping may be varied by altering the distance of the coil from the galvanometer needle.

The other method depends upon the fact that when a coil of wire is moved along a magnet currents are induced in it depending upon the direction and rate of motion. A magnet is accordingly made in the shape of a long narrow U, and it is clamped by one of its arms to a wooden frame

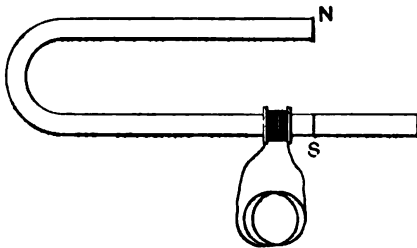

FIG. 186

which may be fastened to the wall or to a table; over the other arm slips a brass collar on which are wound fifty or a hundred turns of fine wire. The extremities of this wire are joined directly

to the coil of wire placed parallel to the galvanometer coils. By sliding the brass collar first in one direction and then in the other the needle may be brought to rest almost instantly.

around the tube two pieces of damp paper with straight edges facing each other, but a slight distance apart, so as to include the scratch in the gap between; then, by means of a finely pointed flame, start a crack at the scratch and carry it around the tube.

2. *To Bend Glass Tubing.*—Hold the tube horizontal in a flame from a fish-tail burner—not a Bunsen-flame—and turn continually and rapidly around its axis until it begins to be soft; then let the tube bend slowly under its own weight, by letting go one end; or, at least, if force is used, use very little, and take care to make a smooth bend.

3. *To Draw a Capillary Tube.*—Take a piece of tubing about 7 or 8 millimetres in diameter and 20 centimetres long, and heat it in a Bunsen-flame, keeping it turning continually. When the central portion has become red and quite soft, withdraw it sidewise from the flame; and, *after it is out* of the flame, rapidly extend the ends, thus drawing the tube into any capillary size desired.

4. *To Make a Small Opening in the Side of a Tube.*—Cork up all openings of the tube, and by means of a finely pointed flame—*e. g.*, from a blow-pipe—carefully heat one point on the wall of the tube. It will soon become soft, and the air inside expanding will blow the soft wall out, thus making an opening whose size depends largely upon the area which was heated by the flame.

5. *To Join Two Tubes of the Same Size Together.*—It is necessary that the two tubes should be of the same kind of glass, otherwise, although they may stay joined for a few hours, they will surely crack apart. Close the end of one tube by means of a cork; heat the other end and the end of the second tube in the hot blue flame of a blast-lamp, turning one by each hand and holding the two ends almost touching. When both are quite red, withdraw them from the flame, place the two ends squarely against each other; blow slightly down the open end of the tube so as to force the hot walls at the junction slightly outward; place the

junction again in the flame, and by repeated heating, blowing, and extension make a smooth joint.

6. *To Join One Tube to the Side of Another.*—Cork both ends of the tube to whose side the other tube is to be fastened; make a hole in its side as described above, taking care to make the opening nearly as large as, but no larger than, the cross-section of the tube which is to be joined. Break off the ragged edges of the opening, and join the tube exactly as described in the last section.

Standard Cells. The best standard cells are those made according to the specifications of the International Electrical Congress, 1893. These are published in the Proceedings of the National Academy of Sciences, 1895. The cells are called Clark cells, and have an E. M. F. of 1.434 volts at 15° C.

Another standard cell is the Daniell. It consists of a glass jar which holds a porous cup; the porous cup contains a solution of zinc sulphate into which dips a rod of zinc, and is surrounded by a solution of copper sulphate into which dips a copper rod. In setting up the cell the following precautions are necessary:

The porous cup should be cleaned by being boiled in water and then allowed to soak in cold water.

The zinc rod should be well amalgamated.

The copper rod should be cleaned and polished by sandpaper and tap water.

The zinc-sulphate solution consists of 44.7 grams of crystals of C. P. zinc sulphate (or 25.08 grams of the anhydrous salt) dissolved in 100 cubic centimetres of distilled water.

The copper-sulphate solution consists of 39.4 grams of C. P. copper sulphate dissolved in 100 cubic centimetres of distilled water.

The zinc rod should be put in the porous cup; then the zinc-sulphate solution poured around it to a depth of one or two inches; the cup should now be placed in the glass jar, the copper rod inserted, and the copper-sulphate solu-

tion carefully poured in to a depth slightly *less* than that of the zinc sulphate in the porous cup. (No copper sulphate must splash into the porous cup.)

Short-circuit the cell for fifteen minutes, then let it stand on open circuit for five minutes. It is now ready for use and will give an E. M. F. of 1.105 volts within .2 of one per cent.

The cell should not remain set up for more than two or three hours. In taking apart, remove the porous cup, rinse the outside under a tap, and pour the zinc solution back into the stock-bottle, unless the zinc rod is blackened, in which case throw it away; then pour the copper-sulphate solution back into the stock-bottle, and dry and clean the zinc and copper rods.

APPENDIX III

GALVANOMETERS

GALVANOMETERS are of two types: in one the coils of wire are fixed and the magnet movable; in the other the magnets are fixed and the coil of wire movable. The first type is ordinarily called the "Thomson reflecting galvanometer"; the second, the "D'Arsonval galvanometer," although its principle was also first made use of by Sir William Thomson (now Lord Kelvin) in the siphon recorder. Sections of each of these types are given in the figures.

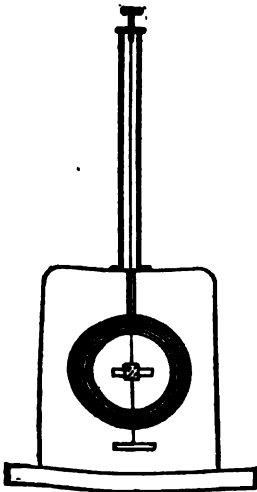

FIG. 187

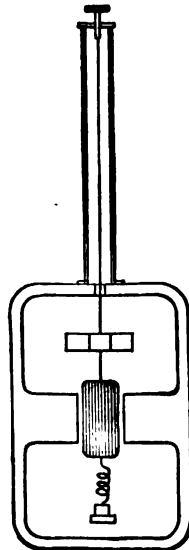

FIG. 188

In this chapter a description will be given of galvanometers designed for special use—*e. g.*, tangent, ballistic, differential instruments; details of the construction of the various parts, coils, needle-systems, fibres, etc.; and instruction as to testing and use.

Tangent Galvanometers. This type of instrument consists of one or more turns of wire wound in a circle whose radius is large compared with the length of the magnetic needle placed at the centre. If the plane of the coil is in the magnetic meridian, we have for equilibrium, if there are n coils of radius r , $i = \frac{H}{G} \tan \theta$, where $G = \frac{2\pi n}{r}$; it is called the galvanometer constant. If it is used as a mirror galvanometer, $i = \frac{H}{G} \theta$, very nearly, since the deflection is small.

In the deduction of this formula it has been assumed that the magnetic force of the current on the needle is the same whatever be the angle θ . This cannot be assumed unless the length of the needle be small compared with the diameter of the coil.

One of the great advantages of a tangent galvanometer is that it enables one to measure currents in absolute units, and it should, therefore, be constructed in such a manner that its constant can be accurately calculated. The rings on which tangent galvanometers are wound are usually made of brass, and turned up in a lathe with rectangular grooves for the winding. (These brass forms frequently contain sufficient iron to cause large disturbances on account of the induced magnetization.)

The Differential Galvanometer. This type of reflecting galvanometer is composed of two coils which act in opposite directions upon a magnetic needle. The two coils are usually made of equal resistance, and so placed with respect to the magnetic needle that, if the same current pass through each coil, the deflection will be zero. In some forms of these galvanometers these conditions are

realized by winding the coil with a strand of two equal wires. A better method is that found in some forms of Thomson galvanometers, in which a portion of one coil is wound as a small auxiliary coil which can be displaced towards or away from the needle, and the action of the two coils thus made equal.

The Ballistic Galvanometer. This form of reflecting galvanometer is used to measure quantities of electricity, and hence is employed in the study of the distribution of magnetism, the flow of magnetic induction through any circuit, the discharge of condensers, etc.

It can be shown that the total quantity of electricity that passes through the galvanometer is proportional to the sine of half the angle of deflection, provided that the moment of inertia of the suspended system is so great that it has not moved appreciably from its position of equilibrium before the current has died down to zero.

In order to correct the throw of the ballistic galvanometer for damping we must multiply $\sin \frac{1}{2}\theta$ by $1 + \frac{1}{2}\lambda$, if the damping is small, where λ is a quantity depending on the construction of the instrument. If the needle be set in vibration and $a_1, a_2 \dots a_n$ be the lengths of successive swings, $\lambda = \frac{1}{n-1} \log. \frac{a_1}{a_n}$, and hence is called the "logarithmic decrement."

From the above consideration we see that the damping in a ballistic galvanometer should be made small, especially that due to the resistance of the air, the exact effect of which is very uncertain.

D'Arsonval Galvanometers. The essential parts of this type of galvanometer are a coil suspended in a magnetic field by means of a very fine wire or strip, which serves at the same time to convey the current to the coil and to furnish the couple which opposes the rotation. The current is usually led away from the bottom of the coil by means of a loose spiral or loop of fine wire, and sometimes by an accurately centred wire dipping into a mercury cup. In

order to obtain great sensibility we must have (1) small torsion in the suspension wires or strips, (2) a strong magnetic field, and (3) a coil giving the maximum turning moment with the least moment of inertia.

Since the torsion varies as r^4 , it diminishes rapidly with decrease in the size of the wire; this must not be carried too far, however, for ultimately the resistance of the suspension becomes too large a part of the total resistance. The bifilar suspension has been used in instruments of this type with great success. Thin phosphor-bronze strips have been used by many makers. Temperature changes, however, produce a change in the zero, owing to the variation of the coefficient of torsion with temperature.

The small traces of iron found in the wire and insulation of the suspended coil (even when special precautions have been taken in drawing the wire and insulating it) exert a "magnetic control" which has prevented the use of strong magnetic fields, inasmuch as it increases as the square of the field strength. Hence, high sensibilities have been sought by diminishing the diameter of the suspending wire and the use of comparatively weak fields. In some instruments the moving coil is surrounded by a very thin silver tube to increase the damping. It has been shown that the best form of coil is one whose horizontal cross-section is two circles tangent at the axis of suspension.

Proportionality of Deflection with Current. In all accurate work, where a reflecting galvanometer is used to measure currents, the law connecting the deflection and current must be found experimentally, and the results expressed in the form of a curve called the "calibration curve" of that instrument. For practical work, however, it is desirable to have an instrument in which the deflections are very nearly proportional to the current. Special precautions must therefore be taken in the design of the instrument, or else a scale with divisions of different lengths suited to the peculiarities of the instrument may be used.

Choice of a Galvanometer. In localities subject to magnetic disturbances the D'Arsonval type of instrument, which is now made of extremely high sensibility, possesses many advantages. Where, however, the very greatest sensibility is required, as in bolometer and platinum thermometer measurements, the Thomson galvanometer must be used. The proper choice of galvanometer resistance depends on the work for which it is intended. If the galvanometer is to be used for the measurement of resistance in a Wheatstone bridge circuit, the best resistance for the galvanometer in order to attain the highest sensibility depends on the resistance in the other circuits. Speaking generally, a low-resistance galvanometer is best when low resistances are to be compared, and a high-resistance galvanometer for the comparison of potentials and high resistances. If the galvanometer resistance is five times greater or less than the best galvanometer resistance, the sensibility is only reduced about 25%. It is well to remember that a galvanometer may be too sensitive for the purpose at hand.

For use in measuring electromotive forces by the "high-resistance" method, a galvanometer with a high resistance should be chosen; while for most ballistic work a low-resistance instrument is better.

For use in thermo-electric work and with bolometers low-resistance galvanometers must be selected.

Controlling Magnet. The action of the directing magnet may be best shown by means of a diagram. Let \overline{OH} represent in direction and magnitude the horizontal intensity

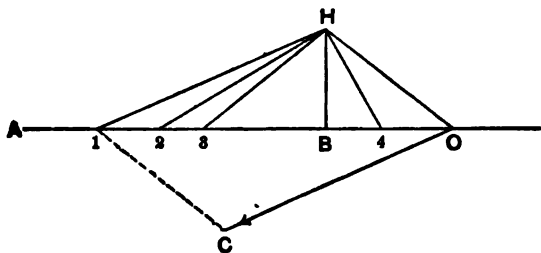

FIG. 189

of the earth's field, and \overline{OA} the direction in which the system should stand.

If, then, \overline{OC} represents in direction and magnitude the action of the directing magnet on the suspension system, the resultant will be represented by $\overline{O1}$. In order to lengthen the period of vibration, the directing magnet will have to be placed so that this resultant is small.

Since $\overline{H1}$ is equal and parallel to \overline{OC} , the action of the directing magnet can be represented by $\overline{H1}$. In order to diminish the resultant controlling moment, $\overline{O1}$, the action of the directing magnet, $\overline{H1}$, must be diminished—*i. e.*, the magnet moved farther from the suspension system; but to keep the resultant along the line \overline{OA} , the magnet must be turned from $\overline{H1}$ towards $\overline{H2}$. In this way the resultant becomes in succession $\overline{O1}$, $\overline{O2}$, $\overline{O3}$, as the directing magnet is moved farther away and takes the direction $\overline{H1}$, $\overline{H2}$, $\overline{H3}$. When the position \overline{HB} is reached, the directing magnet must be turned in the same direction as before, but now, in order to make the resultant $\overline{O4}$, its action on the system must be slowly increased from \overline{HB} to $\overline{H4}$, etc. (*i. e.*, the magnet must now be brought nearer to the suspension system). By moving the magnet very slowly when this position is reached, the control \overline{OB} , $\overline{O4}$, etc., may be made as small as desired. In passing through \overline{OH} , the direction in which the system stands will be reversed.

The Suspended System. Among the first questions that have to be considered in the construction of the magnet system is that of astaticism, whether it be necessary, and what are its advantages and disadvantages.

Consider a suspended system made of two sets of magnets. Let M_u = magnetic moment of upper set of magnets.

M_l = magnetic moment of lower set of magnets.

H_u = strength of controlling field at upper set of magnets.

H_l = strength of controlling field at lower set of magnets.

G_u = strength of field due to current in upper coil.

G_l = strength of field due to current in lower coil.

δ = resulting permanent deflection.

We then have, if the two fields are perpendicular to each other,

$$\tan \vartheta = \frac{G_u M_u + G_l M_l}{H_u M_u + H_l M_l}.$$

In order that the sensibility may be great, $\tan \vartheta$ must be as great as possible for a given current through the galvanometer—*i. e.*, the numerator of the above expression must be large and the denominator small. The sensibility may therefore be increased almost indefinitely by weakening the controlling field.

In an astatic system the upper and lower magnets are set in opposition—*i. e.*, $H_u = -H_l \equiv R$, say—and the coils are so joined up that they both tend to produce a deflection in the same direction—*i. e.*, $G_u = G_l \equiv G$. We therefore have for an astatic system,

$$\tan \vartheta = \frac{G(M_u + M_l)}{R(M_u - M_l)}.$$

Hence, in this case, to secure great sensibility use strong magnets—*i. e.*, make $M_u + M_l$ great—and make them as nearly equal as possible—*i. e.*, make $M_u - M_l$ small.

Non-astatic systems are more easily constructed, and by means of a controlling magnet equally great sensibilities may be attained, but they cannot be used where there are local magnetic disturbances; for, to attain the high sensibility required, the strength of the controlling field must be so far reduced that the zero becomes unsteady. If a system were perfectly astatic, it would be in equilibrium in any position in a uniform magnetic field, and would be uninfluenced by a uniformly varying field; hence in localities subject to magnetic disturbances the only system that can be satisfactorily employed is an astatic one.

Several types of astatic suspension systems are shown in the following diagrams:

Fig. (1) shows a multiple magnet system built up of ten short magnets made from small sewing-needles or tempered watch-springs. These magnets are first fastened by means of shellac to a thin piece of mica, which is afterwards at-

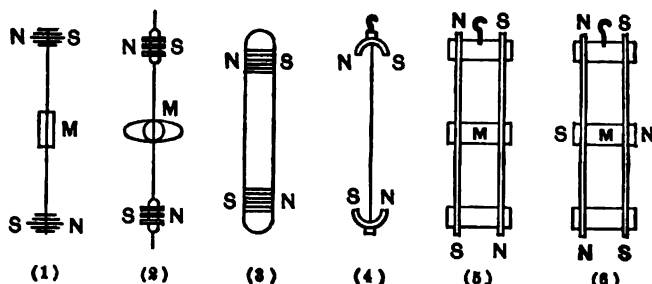

FIG. 190

tached to a thin, straight staff, preferably glass tubing suitably drawn out. In building up the system hard shellac should be used, as wet shellac often distorts the system in drying, and thus destroys the astaticism. A light mirror, *M*, is then fastened to the staff.

Fig. (2) is similar in construction to (1) with a mica vane back of the mirror to increase the damping.

Fig. (3) shows a system easily constructed and which damps rapidly. The magnets are fastened upon a long lamina of mica.

Fig. (4) is a system in which the magnets are of the form of a split cylindrical bell, or horseshoe shape. These systems have a large moment of inertia, and are frequently used in ballistic galvanometers. Systems of this kind are damped by surrounding the magnets with copper in which currents are induced.

Figs. (5) and (6) show the vertical magnet systems used first by Weiss and Broca.

Magnets. The astaticism of the system cannot be expected to remain very long unless the magnets are very permanent. The permanency of a magnet depends not alone upon the quality of the steel, but also upon the temper, which should be different for different kinds of steel. The best temper for any particular specimen of steel can only be decided by experiment. After the magnets have been ground to the required size and tempered, they should be strongly magnetized, then boiled in water for several

hours; if this process of magnetizing and boiling be repeated several times, the magnetization approaches a maximum and is very permanent. On account of the difficulties encountered in securing a high degree of astaticism, the time and trouble taken to prepare the magnets will be well spent. Watch-springs, properly tempered, make excellent magnets. Sewing-needles will also be found satisfactory, but the very best magnets are those made of tungsten steel. By the use of tungsten-steel magnets the sensibility may be very nearly doubled.

Small magnets, like those required for galvanometer systems, can be tempered by laying them in a groove in a piece of charcoal and heating with a blow-pipe until a cherry red is reached, when they should be quickly dropped into water or mercury. The magnets for the Weiss and Broca systems can be made of needles or tempered piano-wire. In order to secure straight pieces the wire must be heated uniformly and tempered under tension; this can best be accomplished by means of an electric current. It is best to prepare these magnets, also, by successively magnetizing and boiling.

The Staff. The staff upon which the magnets are mounted can be prepared by heating a glass tube in a Bunsen-flame and drawing it out very fine. Care must be taken to select a straight piece. The hook should be made of very fine wire and attached to the glass staff by means of shellac.

Mirrors. Good mirrors for galvanometer magnet systems may be made by silvering thin microscope cover glass, from which pieces of the desired size may be cut by means of a diamond point. If these small mirrors are to be used with a telescope and scale a number of them should be cut out and tested before they are mounted on the staff, for, unless they are perfectly plane, the definition will be bad. These very thin mirrors should be mounted on the staff with some soft wax, such as "universal," in order to prevent distortion. If a spot of light on a ground-glass scale is to be used, then a lens of the proper focal length must be

placed in front of the mirror, or the lens may be dispensed with and a concave mirror used.

Suspension Fibres. Good fibres can be obtained from Japanese floss-silk, which should be well washed to remove the gum. A single fibre of silk (one-half of an ordinary cocoon fibre) will easily support several grams. The diameter of these fibres varies from about 0.0008 centimetre to 0.0015 centimetre. They will be found satisfactory in all cases except for galvanometers in which the highest attainable sensibility is sought, in which case the torsion of the fibre becomes a serious factor. In this case it must be unduly lengthened, or, what is better, one may resort to quartz fibres. Quartz has a much higher coefficient of rigidity than silk, but as the torsion varies as the fourth power of the diameter, and quartz fibres can be obtained so fine as to be beyond the power of the microscope, their torsion may be made negligible. These fibres are made by heating quartz and then shooting it out with a bow and arrow. In all cases, on account of steadiness, compactness, etc., it will be found more satisfactory to use short, fine fibres than to diminish the torsion by lengthening out the fibre.

Astaticism. The two essential requisites for astaticism are that the magnets shall be of equal magnetic moment and shall be parallel.

1. *Horizontal Systems.*—After having completed the system it should be suspended in a glass tube and astaticized before being placed in the galvanometer. On first suspending the system it will be found that one of the sets of magnets controls; this set should be slightly weakened by successive approaches of a magnet, until the system stands east and west. If the period is then not as great as desired, one of the sets of magnets must be slightly twisted around the staff in such a direction that the same set as before again controls. This set is again slightly weakened until the system once more stands east and west. This process must be continued until the period of the

system is sufficiently great. Each time the controlling magnet is weakened the magnetic moments of the two sets of magnets are made more nearly equal, and each time they are twisted they are brought more nearly into the same plane. The twisting of one set of magnets around the glass staff upon which they are mounted can best be accomplished by laying the system on a plane surface, placing a small wedge under the end of one set of magnets and heating it until the shellac becomes viscous.

The length of the period which must be obtained depends upon the sensibility required and the location of the instrument. When very great sensibilities are required, the system must be astaticized to a long period, for by doubling the period the sensibility is increased four times. On the other hand, if the location of the galvanometer is in the neighborhood of electric railways, transformers, machine-shops, etc., where large masses of iron are moved, it will often be necessary to astaticize to a long period, not for the purpose of attaining high sensibility, but to reduce to a minimum the effect of outside magnetic disturbances. The length of period also depends upon the moment of inertia of the system. With systems weighing from 20 milligrams to 50 milligrams, a period of 15 to 20 seconds is about as great as can be maintained for any length of time.

2. *Vertical Systems.*—Systems of type (4) were first successfully used by Weiss, who attained great sensibilities. They consist of two or more long magnets fastened to a thin lamina of mica, and suspended so that the magnetic axis of the magnets shall be vertical. Each magnet, if its magnetic axis is vertical, will be in neutral equilibrium with respect to a horizontal field. The astaticism of these systems does not depend, as in the horizontal magnet systems, upon the equality of the magnetic moments of the two magnets, and they therefore have the advantage that a slight weakening of one of the magnets does not destroy the astaticism, provided the magnetic axes remain parallel. These

systems, when constructed, should be suspended in an astaticizing tube, when it will be seen which set of poles controls. The system should then be placed upon a plane surface, and the controlling poles pressed nearer together; the period is then again taken. By a series of steps of this kind, which is often long and tedious, the system may be astaticized until it becomes aperiodic. These systems will be found very satisfactory in places subject to local magnetic disturbances.

On account of the difficulty in getting the magnets of the Weiss system perfectly parallel, Broca has proposed his *consequent pole* vertical system, in which the parallelism is not of so much importance. Before mounting these magnets on the system, they are suspended from their centre in a horizontal position, and the consequent pole displaced towards the centre by stroking with the same magnet used to magnetize it. Obviously, if this pole is exactly at the centre, the magnet will be in neutral equilibrium in any position in a uniform magnetic field. Two, or four, such needles are then mounted on a thin lamina of mica, and the astaticism completed as for the Weiss systems. Such systems may be used with one, two, or three pairs of bobbins. If used with three pairs of bobbins, the diameter of the central bobbin should be equal to $\sqrt{2} \times$ diameter of the outer bobbins. For galvanometers having equal resistance, that with one pair of bobbins is 1.4 times as sensitive as that with two; with three pairs of bobbins, it is about twice as sensitive as with two pairs of bobbins. Hence, on account of its greater simplicity, that with one pair is to be preferred.

Sensibility. There are several factors that enter into the sensibility of a galvanometer, among which may be mentioned:

The magnetic constant of the coils, depending on the form, winding, etc.; the magnet system; the method of observing the deflections.

The sensibility is defined as the current required to produce 1 millimetre deflection on a scale 1 metre distant,

when the period is 10 seconds. If this current is observed for any other period, T , it is reduced to a 10-seconds period by multiplying by $\frac{T^2}{100}$. (The magnetic moment of a magnet varies inversely as the square of its period.)

It is obviously unfair, however, to the heavy systems to compare a light system and a heavy system at the same period of 10 seconds, as a heavy system can generally be used at a longer period.

The resistance of the galvanometer is another factor entering into the sensibility. In order to compare galvanometers with coils of the same form and volume, but wound with wire of different sizes, the sensibility (as defined above) may be reduced to that of a galvanometer of the same type, whose resistance is 1 ohm, by multiplying by \sqrt{R} ; for, assuming that the thickness of the insulation bears a fixed ratio to the diameter of the wire,

the sensibility \propto number of turns.

the resistance \propto (number of turns)²;

i. e., the sensibility $\propto \sqrt{R}$.

The sensibility may be obtained as follows:

E is a standard cell, or one whose E. M. F. is approximately known; R_1 and r , two resistances in series (R_1 generally 10,000, and r the 1-ohm coil of an or-

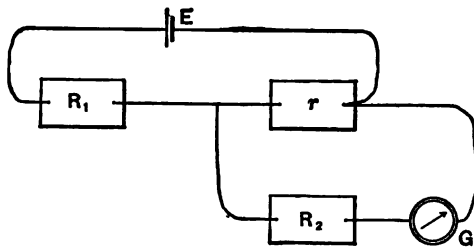

FIG. 191

ordinary resistance-box; if G is a high-resistance galvanometer, then R_1 may have to be 100,000 ohms).

R_2 is a resistance connected in series with the galvanometer.

R_g = resistance of galvanometer.

δ = deflection observed on scale 1 metre distant,

Q = current to produce 1 millimetre deflection.

$$\begin{aligned}
 C &= \frac{Er}{R_1 + \frac{r(R_2 + R_g)}{r + R_2 + R_g}} \left(\frac{R_g}{R_2 + R_g} \right) \frac{1}{R_g} \cdot \frac{1}{\delta} \\
 &= \frac{Er}{R_1} \frac{1}{R_2 + R_g} \cdot \frac{1}{\delta} \text{ (approximately).}
 \end{aligned}$$

ILLUSTRATION

$E = 1.4$ volts.

$R_1 = 10,000$ ohms; $r = 1$ ohm.

$R_2 = 3000$ ohms; $R_g = 8$ ohms.

Deflection $\left\{ \begin{array}{l} \text{right, } 56, \\ \text{left, } 50. \end{array} \right.$

Period = 10 seconds.

Scale distance = 75 centimetres.

$$C = \frac{1.4 \times 1 \times 75}{10^4 \times 8 \times 10^3 \times 58 \times 100} = 6.6 \times 10^{-10} \text{ amperes.}$$

This system was a Weiss system, made of two No. 12 sewing-needles, 27 millimetres long, 1.5 millimetres apart. Mirror was about 4 millimetres \times 2 millimetres, and weighed 8 milligrams.

Galvanometer contained 4 bobbins, each 18 millimetres external diameter, and 4 millimetres internal diameter, containing 500 turns of wire. Three sizes, 36, 38, 30, of copper wire were used in winding the bobbins. Resistance of each bobbin was 12 ohms

TABLES

I

MENSURATION

Circle: radius, r ; circumference, $2\pi r$; area, πr^2 .

Ellipse: axes, $2a$ and $2b$; area, πab .

Sphere: radius, r ; surface, $4\pi r^2$; volume, $\frac{4}{3}\pi r^3$.

Ellipsoid: axes, $2a$, $2b$, $2c$; volume, $\frac{4}{3}\pi abc$.

Spherical segment: radius, r ; height, a ; area, $2\pi ra$.

Cylinder: radius, r ; height, a ; surface, $2\pi ra + 2\pi r^2$; volume, $\pi r^2 a$.

Circular cone: radius of base, r ; height, a ; surface, $\pi r\sqrt{r^2 + a^2} + \pi r^2$;
volume, $\frac{1}{3}\pi r^2 a$.

II

MECHANICAL UNITS

Length

1 inch	= 2,540 centimetres.
1 centimetre	= 0.3937 inch.
1 mile	= 160931 centimetres = 1.61 kilometres.
1 kilometre	= 0.6214 mlle.

Area

1 square inch	= 6.451 square centimetres.
1 square centimetre	= 0.1550 square inch.

Volume

1 cubic inch	= 16.386 cubic centimetres.
1 gallon	= 4548 cubic centimetres = 277.46 cubic inches
1 cubic centimetre	= 0.0610 cubic inch.
1 litre	= 1.7608 pints.

Mass

1 pound	= 453.59 grams.
1 ounce	= 28.35 grams.
1 gram	= 0.03527 ounce = 0.002205 pound.

Force

1 poundal	= 13825 dynes.
1 gram's weight	= 980 "
1 pound's weight	= 444518 "

Work and Energy

1 foot-pound	= 1.383×10^7 ergs = 1.383 joules.
	= 0.1383 kilogram-metres.
1 kilogram-metre	= 7.233 foot-pounds.

Power or Activity

1 horse-power	= 746 watts.
	= 33000 foot-pounds per minute.
1 watt	= 0.0018406 horse-power.

III

ELASTIC CONSTANTS OF SOLIDS

	Bulk-modulus	Coefficient of Rigidity	Young's Modulus
Brass.....	10×10^{11}	3.7×10^{11}	10.4×10^{11}
Glass.....	4×10^{11}	2.4×10^{11}	6×10^{11}
Iron (wrought)..	14.6×10^{11}	7.7×10^{11}	19.6×10^{11}
Steel.....	18.4×10^{11}	8.2×10^{11}	22×10^{11}

IV

DENSITIES

Solids

Aluminium.....	2.58	Iron, wrought.....	7.86
Brass.....(about)	8.5	Lead.....	11.3
Brick.....	2.1	Nickel.....	8.9
Copper.....	8.92	Oak.....	0.8
Cork.....	0.24	Pine.....	0.5
Diamond.....	3.52	Platinum.....	21.50
Glass, common.....	2.6	Quartz.....	2.65
" heavy flint.....	3.7	Silver.....	10.53
Gold.....	19.8	Sugar.....	1.6
Ice at 0° C.....	0.91	Tin.....	7.29
Iron, cast.....	7.4	Zinc.....	7.15

Mean density of earth is 5.5270.

Liquids

Alcohol at 20° C.....	0.789	Mercury.....	18.596
Carbon bisulphide.....	1.29	Sulphuric acid.....	1.85
Ethyl ether at 0° C.....	0.785	Water at 4° C.....	1
Glycerine.....	1.26	Sea water at 0° C.....	1.026

Water at other temperatures, see below.

Gases at 0° C. and 76 centimetres of Mercury Pressure

Air, dry.....	0.001293	Hydrogen.....	0.0000895
Ammonia.....	0.000770	Nitrogen.....	0.001257
Carbon dioxide.....	0.001974	Oxygen.....	0.001480
Chlorine.....	0.008183		

Water at Different Temperatures

Degrees		Degrees	
0 C.....	0.999878	16 C.....	0.999004
1	0.999883	17	0.998839
2	0.999973	18	0.998668
3	0.999998	19	0.998475
4	1.000000	20	0.998272
5	0.999992	21	0.998065
6	0.999969	22	0.997849
7	0.999933	23	0.997623
8	0.999882	24	0.997386
9	0.999819	25	0.997140
10	0.999739	26	0.996886
11	0.999650	27	0.996659
12	0.999544	28	0.996332
13	0.999430	29	0.996000
14	0.999297	30	0.995777
15	0.999154	31	0.99547

V

SURFACE TENSION

Liquids with Air

Liquid	Temperature	T, in Dynes per Cm.
	Degrees	
Alcohol, Ethyl.....	20 C.	21.7
Benzene.....	15	28.8
Glycerine.....	17	63.14
Mercury.....	20	450
Olive-oil.....	20	31.7
Petroleum.....	20	23.9
Water.....	0	76.6
Water.....	20	74

VI

ACCELERATION DUE TO GRAVITY

	Latitude	<i>g</i>
Equator.....	0° 0'	978.07
Sandwich Islands.....	20° 52'	978.85
Tokio.....	35° 41'	979.94
Lick Observatory.....	37° 20'	979.92 (reduced to sea-level)
Washington, D. C.....	38° 53'	980.10
Allegheny, Pa.....	40° 28'	980.15 (reduced to sea-level)
Chicago.....	41° 49'	980.37 " " " "
Montreal.....	45° 31'	980.75
Paris.....	48° 50'	980.97
Kew.....	51° 28'	981.20
Berlin.....	52° 30'	981.27

VII

CORRECTION FOR LARGE ARCS OF VIBRATION

If observed period of vibration is T for arc of swing α , the period for an arc infinitely small is $(T - KT)$, where $K = \frac{1}{4} \sin^2 \frac{\alpha}{4} + \frac{5}{64} \sin^4 \frac{\alpha}{4}$.

α	K	α	K
Degrees		Degrees	
0	0	20	0.00190
5	0.00012	28	0.00251
8	0.00080	26	0.00822
11	0.00058	29	0.00400
14	0.00093	32	0.00487
17	0.00138	35	0.00583

VIII

CAPILLARY DEPRESSION OF MERCURY IN GLASS

Height of Meniscus in Millimetres

| 0.4 | 0.6 | 0.8 | 1 | 1.2 | 1.4 | 1.6 | 1.8

Corrections to be Added

Diameter								
mm.	mm.	mm.	mm.	mm.	mm.	mm.	mm.	mm.
4	0.88	1.22	1.54	1.98	2.87
5	0.47	0.65	0.86	1.19	1.45	1.80
6	0.27	0.41	0.56	0.78	0.98	1.21	1.43
7	0.18	0.28	0.40	0.53	0.67	0.82	0.97	1.18
8	0.20	0.29	0.38	0.46	0.56	0.65	0.77
9	0.15	0.21	0.28	0.33	0.40	0.46	0.52
10	0.15	0.20	0.25	0.29	0.33	0.37
11	0.10	0.14	0.18	0.21	0.24	0.27
12	0.07	0.10	0.13	0.15	0.18	0.19
13	0.04	0.07	0.10	0.12	0.13	0.14

IX

BAROMETRIC CORRECTIONS

1. *Correction for Temperature*

Mercury—Brass scale correct at 0° C.

Temperature	73	74	75	76	77	78	79
Degrees							
15 C.	0.178	0.181	0.183	0.186	0.188	0.191	0.198
16	0.190	0.193	0.196	0.198	0.201	0.203	0.206
17	0.202	0.205	0.208	0.210	0.213	0.216	0.218
18	0.214	0.217	0.220	0.223	0.226	0.229	0.231
19	0.226	0.229	0.232	0.235	0.238	0.241	0.244
20	0.238	0.241	0.244	0.247	0.251	0.254	0.257
21	0.250	0.253	0.256	0.260	0.263	0.267	0.270
22	0.261	0.265	0.269	0.272	0.276	0.279	0.283
23	0.273	0.277	0.281	0.284	0.288	0.292	0.296
24.	0.285	0.289	0.293	0.297	0.301	0.305	0.309

Corrections are to be subtracted from observed readings—*viz.*, if reading at 19° is 76 centimetres, the "corrected" reading is $76 - 0.235 = 75.765$ centimetres.

2. *Correction for Variation in g.*

Latitude	73	74	75	76	77	78	79
35° or 55°	0.065	0.066	0.066	0.067	0.068	0.069	0.070
40° or 50°	0.032	0.033	0.033	0.034	0.035	0.035	0.035
45°	0	0	0	0	0	0	0

X

FREQUENCIES OF MIDDLE OCTAVE

Name	Interval	Standard Frequency	König's Frequency	Tempered Intervals
Do, Ut ₃ , C	1	261	256	1 $2^{\frac{1}{12}} = 1.05946$
Re D	1.125	293.6	288	$2^{\frac{2}{12}} = 1.12246$ $2^{\frac{3}{12}} = 1.18921$
Mi E	1.25	326.25	320	$2^{\frac{4}{12}} = 1.25992$
Fa F	1.333	348	341 $\frac{1}{2}$	$2^{\frac{5}{12}} = 1.33484$ $2^{\frac{6}{12}} = 1.41421$
Sol G	1.5	391.5	384	$2^{\frac{7}{12}} = 1.49881$ $2^{\frac{8}{12}} = 1.58740$
La A	1.667	435	427 $\frac{1}{2}$	$2^{\frac{9}{12}} = 1.68179$ $2^{\frac{10}{12}} = 1.78180$
Si B	1.875	489.4	480	$2^{\frac{11}{12}} = 1.80775$
Do 2C	2	522	512	2

XI

VELOCITY OF SOUND

	Degrees	Cm. per Sec.		Degrees	Cm. per Sec.
Air	0 C.	33,250	Water.....	4 C.	140,000
Hydrogen	0	128,600	Brass.....	..	350,000
Illuminating gas..	0	49,040	Copper.....	20	356,000
Oxygen.....	0	81,720	Glass.....	..	506,000
Alcohol (absolute).	8.4	126,400	Iron.....	..	509,800
Petroleum.....	7.4	189,500	Paraffine.....	16	180,400

XII

AVERAGE COEFFICIENTS OF LINEAR EXPANSION BETWEEN 0° AND 100° C.

Aluminium. 0.000028	Gold..... 0.000014	Platinum... 0.000009
Brass..... 0.000018	Iron (soft). 0.000012	Silver..... 0.000019
Copper..... 0.000017	Iron (cast). 0.0000105	Steel..... 0.000011
Glass..... 0.000009	Lead..... 0.000029	Tin..... 0.000022
Zinc.....	0.000029	

XIII

AVERAGE COEFFICIENTS OF CUBICAL EXPANSION OF LIQUIDS

Alcohol.....	0°-80° C.	0.00105	Mercury ..	0°-100° C.	0.0001818
Ethyl ether ..	0°-83°	0.00210	Turpentine	9°-106°	0.00105

XIV

AVERAGE SPECIFIC HEATS

Alcohol.....	0.615	Lead	0°-100°	0.0815
Aluminium ..	0°-100°	0.2185	Mercury....	20°- 50°	0.0833
Brass.....	0.09	Paraffine....	0.688
Copper.....	0°-100°	0.0938	Platinum...	0°-100°	0.0323
German-silver	0.0946	Silver.....	0°-100°	0.0568
Glass.....	0.20	Tin.....	0°-100°	0.0559
Gold.....	0.0816	Turpentine	0.467
Ice.....	0.504	Zinc.....	0.0985
Iron.....	0°-100°	0.1130			

XV

SPECIFIC HEATS OF GASES

	C_p	C_v	γ
Air.....	0.238	0.171	1.40 +
Chlorine.....	0.121	1.33
CO ₂	0.201	0.165	1.30
Hydrogen.....	8.406	2.419	1.41
Mercury (vapor).....	1.67
Nitrogen.....	0.244	1.41
Oxygen.....	0.217	1.41 -

XVI

FUSION CONSTANTS

	Fusion Point	Latent Heat of Fusion
Aluminium.....	600° C.
Copper.....	1050°
Gold.....	1045°
Ice.....	0°	80
Iron.....	1400°-1600°	28-33
Lead.....	325°	5.86
Mercury.....	- 39°	2.82
Platinum.....	1775°	27.2
Silver.....	954°	24.7
Sulphur.....	115°	9.87
Zinc.....	415°	28

XVII

VAPORIZATION CONSTANTS

	Boiling-Point	Latent Heat
	Degrees	
Alcohol (ethyl).....	78.4 C.	209
Carbon dioxide.....	- 80	72 at - 25°
Chloroform.....	61.90	58.5
Cyanogen.....	- 20.7	108 at 0°
Ether (ethyl).....	34.9	90
Hydrogen.....	- 248
Mercury.....	357	62
Oxygen.....	- 184
Sulphur.....	444.53
Water.....	100	585.9

XVIII

VAPOR-PRESSURE OF WATER

Temperature	Pressure in Centime- tres of Mercury	Temperature	Pressure in Centime- tres of Mercury
Degrees		Degrees	
- 5 C.	0.816	98 C.	70.718
0	0.457	99	73.816
5	0.651	99.2	73.846
10	0.914	99.4	74.880
20	1.736	99.6	74.917
30	3.151	99.8	75.457
40	5.486	100	76.000
50	9.198	100.2	76.547
60	14.888	100.4	77.096
70	23.831	100.6	77.650
80	35.487	100.8	78.207
90	52.547	101	78.767
95	63.836	102	81.609
97	68.188	110	107.54

XIX

VAPOUR-PRESSURE OF MERCURY

In Millimetres—Regnault and Hertz (a); Ramsay and Young (b)

Degrees	a	b	Degrees	a	b
0 C.	0.0002	300 C.	18.25	17.02
10	0.0005	310	25.12
20	0.0018	320	34.9	81.96
30	0.0029	330	45.4
40	0.007	0.008	340	58.8
50	0.014	0.015	350	75.8
60	0.028	0.029	360	96.7
70	0.051	0.052	370	123.0	123.9
80	0.098	0.098	380	155.2	157.4
90	0.163	0.160	390	194.5	196.0
100	0.265	0.270	300	242.2	246.8
110	0.470	310	299.7	304.6
120	0.779	0.719	320	368.7	373.7
130	1.24	330	450.9	454.4
140	1.93	1.763	340	548.4	548.6
150	2.93	350	663.2	658.0
160	4.33	4.013	360	797.7
170	6.41	370	954.7
180	9.23	8.535	380	1139.7
190	13.07	390	1346.7

XX

HEAT OF COMBINATION

1 gram of substance combines with equivalent O or SO₂

Substance	Compound	Calories
Iron.....	FeO	1352.6
Carbon.....	CO ₂	7800
Copper.....	CuO	585.3
	CuSO ₄	2687
Sulphur.....	SO ₂	2200
Silver.....	Ag ₂ O	27.3
Hydrogen.....	H ₂ O	34800
	H ₂ SO ₄	96450
Zinc.....	ZnO	1814
	ZnSO ₄	3538

XXI

THEMAL CONDUCTIVITIES

Silver.....	1.8	Water.....	.002
Copper.....	.96	Glass.....	.0005
Iron.....	.20	Wool.....	.00012
Stone.....	.006	Paper.....	.000094
Ice.....	.008	Air.....	.000049

XXII

DIELECTRIC CONSTANTS (ELECTROSTATIC SYSTEM)

Substance	K	Substance	K
Glass.....(about)	6	Water.....	76
Mica.....	8	Alcohol.....	26
Paraffine.....	2	Turpentine.....	2.4
Rubber.....	2.5	Petroleum.....	2.1
Shellac.....	8	Hydrogen.....	0.9998
Sulphur.....	2.7	Illuminating gas.....	1.0004
Wood.....	3	Carbon dioxide.....	1.0004
		(Vacuum).....	0.9994

XXIII

ELECTROLYSIS CONSTANTS

Element	Atomic Weight	Valency	Chemical Equivalent
Chlorine.....	35.37	1	35.37
Copper (cupric).....	63.18	2	31.59
Hydrogen.....	1	1	1
Iron (ferric).....	55.88	3	18.63
Lead.....	206.89	2	103.20
Oxygen.....	15.96	2	7.98
Potassium.....	39.08	1	39.08
Silver.....	107.66	1	107.66
Sodium.....	23	1	23
Zinc.....	64.88	2	32.44

ELECTRO-CHEMICAL EQUIVALENTS

Chlorine.....	0.008675	Iron (ferric).....	0.001982
Copper (cupric)....	0.003261	Oxygen.....	0.000828
Hydrogen.....	0.00010852	Silver.....	0.011180
Zinc, 0.00338.			

XXIV

STANDARD RESISTANCES

Siemens unit	= 0.9408 international ohms.
B. A. unit	= 0.9863 " "
Legal ohm (1884)	= 0.9972 " "
International ohm (1893) = 1	" "
	= 106.8 centimetres of mercury, cross-section 1 square millimetre, at 0° C.

XXV

SPECIFIC CONDUCTIVITY, REFERRED TO MERCURY

Aluminium (soft).....	82.85	Nickel (soft).....	8.14
Copper (pure).....	59	Platinum.....	14.4
Iron.....	9.75	Silver (soft).....	62.6
Mercury.....	1	Tin.....	7

RESISTANCE, IN OHMS AT 0° C. OF WIRE 100 CM. LONG, 1 MM. DIAMETER

		Rate of Change in Resistance per Degree Centigrade
Aluminium.....	0.08699	0.00888
Copper.....	0.02062	0.00888
German-silver.....	0.2660	0.00044
Iron.....	0.1284	0.00055
Mercury.....	1.198	0.00072
Platinum.....	0.1150
Silver.....	0.02019	0.00877

XXVI

E. M. F. OF COMMON CELLS

Name	E. M. F.
Voltaic (zinc, acid, copper).....	0.98 volta
Daniell (zinc, acid, copper-sulphate, copper).....	1.09 "
Grove (zinc, acid, nitric acid, platinum).....	1.70 "
Bunsen (zinc, acid, nitric acid, carbon).....	1.86 "
Chromate (zinc, acid, chromic acid, carbon).....	2 "
Leclanché.....	1.46 "
Edison-Lalande.....	0.70 "
Dry cell.....	1.8 "
Chloride of Silver.....	1.08 "

XXVII

INDICES OF REFRACTION

Substance	Wave-length	Index	Temperature
	Centimetres		Degrees
Air, pressure 76 cm.....	0.0000589	1.0002922	0 C.
" " " ".....	0.0000485	1.0002943	0
" " " ".....	0.0000434	1.0002962	0
Helium, " ".....	0.0000589	1.000043	..
Hydrogen, " ".....	0.0000589	1.000140	0
Nitrogen, " ".....	0.0000589	1.000297	0
Oxygen, " ".....	0.0000589	1.000272	0
Alcohol.....	0.0000589	1.363	15
Chloroform.....	0.0000589	1.449	15
Carbon bisulphide.....	0.0000589	1.624	25
" ".....	0.0000485	1.648	25
Water.....	0.0000589	1.334	16
".....	0.0000485	1.338	16
".....	0.0000434	1.341	16
Rock salt.....	0.0000589	1.5441	24
" ".....	0.0000485	1.5331	24
" ".....	0.0000434	1.5607	24
Flint glass.....	0.0000589	1.651	..
" ".....	0.0000485	1.665	..
" ".....	0.0000434	1.677	..
Crown glass.....	0.0000589	1.517	..
" ".....	0.0000485	1.524	..
" ".....	0.0000434	1.529	..

XXVIII

WAVE-LENGTHS IN CENTIMETRES

<i>K</i>	0.00003933825	<i>E</i> ₂	0.00005269723
<i>H</i>	0.00003968625	<i>E</i> ₁	0.00005270500
<i>g</i>	0.00004226904	<i>D</i> ₂	0.00005890186
<i>G</i>	0.00004308000	<i>D</i> ₁	0.00005896357
<i>F</i>	0.00004861527	<i>C</i>	0.00006563045
<i>b</i> ₁	0.00005188791	<i>B</i>	0.00006870183

XXIX

NUMERICAL CONSTANTS

$$\pi = 3.14159; \log_{10}\pi = 0.497149.$$

$$\sqrt{\pi} = 1.772; \quad 1/\sqrt{\pi} = 0.5642.$$

$$\pi^2 = 9.8696; \quad 1/\pi^2 = 0.10132.$$

The base of the natural system of logarithms,

$$e = 2.7183; \log_{10}e = 0.434394;$$

$$\log_e x = \frac{\log_{10} x}{\log_{10} e} = 2.302585 \log_{10} x.$$

$$\frac{1}{e} = 0.368.$$

XXX

NUMERICAL TABLES

n	n ²	\sqrt{n}	1/n	n	n ²	\sqrt{n}	1/n
2	4	1.414	50000	28	784	5.291	35714
3	9	1.732	83333	29	841	5.385	34483
4	16	2.000	25000	30	900	5.477	33333
5	25	2.236	20000	31	961	5.568	32258
6	36	2.449	16667	32	1024	5.657	31250
7	49	2.646	14286	33	1089	5.745	30303
8	64	2.828	12500	34	1156	5.831	29412
9	81	3.000	11111	35	1225	5.916	28571
10	100	3.162	10000	36	1296	6.000	27778
11	121	3.317	90909	37	1369	6.083	27027
12	144	3.464	83333	38	1444	6.164	26316
13	169	3.606	76923	39	1521	6.245	25641
14	196	3.742	71429	40	1600	6.325	25000
15	225	3.873	66667	41	1681	6.403	24390
16	256	4.000	62500	42	1764	6.481	23810
17	289	4.123	58824	43	1849	6.557	23256
18	324	4.243	55556	44	1936	6.633	22727
19	361	4.359	52632	45	2025	6.708	22222
20	400	4.472	50000	46	2116	6.782	21739
21	441	4.583	47619	47	2209	6.856	21277
22	484	4.690	45455	48	2304	6.928	20833
23	529	4.796	43478	49	2401	7.000	20408
24	576	4.899	41867	50	2500	7.071	20000
25	625	5.000	40000	51	2601	7.141	19606
26	676	5.099	38462	52	2704	7.211	19231
27	729	5.196	37037	53	2809	7.280	18868

NUMERICAL TABLES—(Continued)

n	n ²	√n	1/n	n	n ²	√n	1/n
54	2916	7.348	18519	77	5929	8.775	12987
55	3025	7.416	18182	78	6084	8.832	12821
56	3136	7.483	17857	79	6241	8.888	12658
57	3249	7.550	17544	80	6400	8.944	12500
58	3364	7.616	17241	81	6561	9.000	12346
59	3481	7.681	16949	82	6724	9.055	12195
60	3600	7.746	16667	83	6889	9.110	12048
61	3721	7.810	16393	84	7056	9.165	11905
62	3844	7.874	16129	85	7225	9.220	11765
63	3969	7.937	15873	86	7396	9.274	11628
64	4096	8.000	15625	87	7569	9.327	11494
65	4225	8.062	15385	88	7744	9.381	11364
66	4356	8.124	15152	89	7921	9.434	11236
67	4489	8.185	14925	90	8100	9.487	11111
68	4624	8.246	14706	91	8281	9.539	10989
69	4761	8.307	14493	92	8464	9.592	10870
70	4900	8.367	14286	93	8649	9.644	10753
71	5041	8.426	14084	94	8836	9.695	10638
72	5184	8.485	13889	95	9025	9.747	10526
73	5329	8.544	13699	96	9216	9.798	10417
74	5476	8.602	13514	97	9409	9.849	10309
75	5625	8.660	13333	98	9604	9.899	10204
76	5776	8.718	13158	99	9801	9.950	10101

LOGARITHMS 1000 TO 1100.

	0	1	2	3	4	5	6	7	8	9
100	00 000	043	087	130	173	217	260	303	346	389
101	432	475	518	561	604	647	689	732	775	817
102	860	903	945	988	030	072	115	157	199	242
103	01 284	326	368	410	452	494	536	578	620	662
104	703	745	787	828	870	912	953	995	036	078
105	02 119	160	202	243	284	325	366	407	449	490
106	531	572	612	653	694	735	776	816	857	898
107	938	979	019	060	100	141	181	222	262	302
108	03 342	383	423	463	503	543	583	623	663	703
109	743	782	822	862	902	941	981	021	060	100

	0	1	2	3	4	5	6	7	8	9	123	456	789
10	0000	0043	0086	0128	0170	0212	0253	0294	0334	0374	Use preceding Table		
11	0414	0453	0492	0531	0569	0607	0645	0682	0719	0755	4 8 11	15 19 23	26 30 34
12	0792	0828	0864	0899	0934	0969	1004	1038	1072	1106	3 7 10	14 17 21	24 28 31
13	1139	1173	1206	1239	1271	1303	1335	1367	1399	1430	3 6 10	13 16 10	23 26 29
14	1461	1492	1523	1553	1584	1614	1644	1673	1703	1732	3 6 9	12 15 18	21 24 27
15	1761	1790	1818	1847	1875	1903	1931	1959	1987	2014	3 6 8	11 14 17	20 22 25
16	2041	2068	2095	2122	2148	2175	2201	2227	2253	2279	3 5 8	11 13 16	18 21 24
17	2304	2330	2355	2380	2405	2430	2455	2480	2504	2529	2 5 7	10 12 15	17 20 22
18	2553	2577	2601	2625	2648	2672	2695	2718	2742	2765	2 5 7	9 12 14	16 19 21
19	2788	2810	2833	2856	2878	2900	2923	2945	2967	2989	2 4 7	9 11 13	16 18 20
20	3010	3032	3054	3075	3096	3118	3139	3160	3181	3201	2 4 6	8 11 13	15 17 19
21	3222	3243	3263	3284	3304	3324	3345	3365	3385	3404	2 4 6	8 10 12	14 16 18
22	3424	3444	3464	3483	3502	3522	3541	3560	3579	3598	2 4 6	8 10 12	14 15 17
23	3617	3636	3655	3674	3692	3711	3729	3747	3766	3784	2 4 6	7 9 11	13 15 17
24	3802	3820	3838	3856	3874	3892	3909	3927	3945	3962	2 4 5	7 9 11	12 14 16
25	3979	3997	4014	4031	4048	4065	4082	4099	4116	4133	2 3 5	7 9 10	12 14 15
26	4150	4166	4183	4200	4216	4232	4249	4265	4281	4298	2 3 5	7 8 10	11 13 13
27	4314	4330	4346	4362	4378	4393	4409	4425	4440	4456	2 3 5	6 8 9	11 13 14
28	4472	4487	4502	4518	4533	4548	4564	4579	4594	4609	2 3 5	6 8 9	11 12 14
29	4624	4639	4654	4669	4683	4698	4713	4728	4742	4757	1 3 4	6 7 9	10 12 13
30	4771	4786	4800	4814	4829	4843	4857	4871	4886	4900	1 3 4	6 7 9	10 11 13
31	4914	4928	4942	4955	4969	4983	4997	5011	5024	5038	1 3 4	6 7 8	10 11 12
32	5051	5065	5079	5092	5105	5119	5132	5145	5159	5172	1 3 4	5 7 8	9 11 12
33	5185	5198	5211	5224	5237	5250	5263	5276	5289	5302	1 3 4	5 6 8	9 10 12
34	5315	5328	5340	5353	5366	5378	5391	5403	5416	5428	1 3 4	5 6 8	9 10 11
35	5441	5453	5465	5478	5490	5502	5514	5527	5539	5551	1 2 4	5 6 7	9 10 11
36	5563	5575	5587	5599	5611	5623	5635	5647	5658	5670	1 2 4	5 6 7	8 10 11
37	5682	5694	5705	5717	5729	5740	5752	5763	5775	5786	1 2 3	5 6 7	8 9 10
38	5798	5809	5821	5832	5843	5855	5866	5877	5888	5899	1 2 3	5 6 7	8 9 10
39	5911	5922	5933	5944	5955	5966	5977	5988	5999	6010	1 2 3	4 5 7	8 9 10
40	6021	6031	6042	6053	6064	6075	6085	6096	6107	6117	1 2 3	4 5 6	8 9 10
41	6128	6138	6149	6160	6170	6180	6191	6201	6212	6222	1 2 3	4 5 6	7 8 9
42	6232	6243	6253	6263	6274	6284	6294	6304	6314	6325	1 2 3	4 5 6	7 8 9
43	6335	6345	6355	6365	6375	6385	6395	6405	6415	6425	1 2 3	4 5 6	7 8 9
44	6435	6444	6454	6464	6474	6484	6493	6503	6513	6522	1 2 3	4 5 6	7 8 9
45	6532	6542	6551	6561	6571	6580	6590	6599	6609	6618	1 2 3	4 5 6	7 8 9
46	6628	6637	6646	6656	6665	6675	6684	6693	6702	6712	1 2 3	4 5 6	7 7 8
47	6721	6730	6739	6749	6758	6767	6776	6785	6794	6803	1 2 3	4 5 5	6 7 8
48	6812	6821	6830	6839	6848	6857	6866	6875	6884	6893	1 2 3	4 4 5	6 7 8
49	6902	6911	6920	6928	6937	6946	6955	6964	6972	6981	1 2 3	4 4 5	6 7 8
50	6990	6998	7007	7016	7024	7033	7042	7050	7059	7067	1 2 3	3 4 5	6 7 8
51	7076	7084	7093	7101	7110	7118	7126	7135	7143	7152	1 2 3	3 4 5	6 7 8
52	7160	7168	7177	7185	7193	7202	7210	7218	7226	7235	1 2 2	3 4 5	6 7 7
53	7243	7251	7259	7267	7275	7284	7292	7300	7308	7316	1 2 2	3 4 5	6 6 7
54	7324	7332	7340	7348	7356	7364	7372	7380	7388	7396	1 2 2	3 4 5	6 6 7

	0	1	2	3	4	5	6	7	8	9	123	456	789
55	7404	7412	7419	7427	7435	7443	7451	7459	7466	7474	1 2 2	3 4 5	5 6 7
56	7482	7490	7497	7505	7513	7520	7528	7536	7543	7551	1 2 2	3 4 5	5 6 7
57	7559	7566	7574	7582	7589	7597	7604	7612	7619	7627	1 2 2	3 4 5	5 6 7
58	7634	7642	7649	7657	7664	7672	7679	7686	7694	7701	1 2 2	3 4 4	5 6 7
59	7709	7716	7723	7731	7738	7745	7752	7760	7767	7774	1 1 2	3 4 4	5 6 7
60	7782	7789	7796	7803	7810	7818	7825	7832	7839	7846	1 1 2	3 4 4	5 6 6
61	7853	7860	7868	7875	7882	7889	7896	7903	7910	7917	1 1 2	3 4 4	5 6 6
62	7924	7931	7938	7945	7952	7959	7966	7973	7980	7987	1 1 2	3 3 4	5 6 6
63	7993	8000	8007	8014	8021	8028	8035	8041	8048	8055	1 1 2	3 3 4	5 5 6
64	8062	8069	8075	8082	8089	8096	8102	8109	8116	8122	1 1 2	3 3 4	5 5 6
65	8129	8136	8142	8149	8156	8162	8169	8176	8182	8189	1 1 2	3 3 4	5 5 6
66	8195	8202	8209	8215	8222	8228	8235	8241	8248	8254	1 1 2	3 3 4	5 5 6
67	8261	8267	8274	8280	8287	8293	8299	8306	8312	8319	1 1 2	3 3 4	5 5 6
68	8325	8331	8338	8344	8351	8357	8363	8370	8376	8382	1 1 2	3 3 4	4 5 6
69	8388	8395	8401	8407	8414	8420	8426	8432	8439	8445	1 1 2	2 3 4	4 5 6
70	8451	8457	8463	8470	8476	8482	8488	8494	8500	8506	1 1 2	2 3 4	4 5 6
71	8513	8519	8525	8531	8537	8543	8549	8555	8561	8567	1 1 2	2 3 4	4 5 5
72	8573	8579	8585	8591	8597	8603	8609	8615	8621	8627	1 1 2	2 3 4	4 5 5
73	8633	8639	8645	8651	8657	8663	8669	8675	8681	8686	1 1 2	2 3 4	4 5 5
74	8692	8698	8704	8710	8716	8722	8727	8733	8739	8745	1 1 2	2 3 4	4 5 5
75	8751	8756	8762	8768	8774	8779	8785	8791	8797	8802	1 1 2	2 3 3	4 5 5
76	8808	8814	8820	8825	8831	8837	8842	8848	8854	8859	1 1 2	2 3 3	4 5 5
77	8865	8871	8876	8882	8887	8893	8899	8904	8910	8915	1 1 2	2 3 3	4 4 5
78	8921	8927	8932	8938	8943	8949	8954	8960	8965	8971	1 1 2	2 3 3	4 4 5
79	8976	8982	8987	8993	8998	9004	9009	9015	9020	9025	1 1 2	2 3 3	4 4 5
80	9031	9036	9042	9047	9053	9058	9063	9069	9074	9079	1 1 2	2 3 3	4 4 5
81	9085	9090	9096	9101	9106	9112	9117	9122	9128	9133	1 1 2	2 3 3	4 4 5
82	9138	9143	9149	9154	9159	9165	9170	9175	9180	9186	1 1 2	2 3 3	4 4 5
83	9191	9196	9201	9206	9212	9217	9222	9227	9232	9238	1 1 2	2 3 3	4 4 5
84	9243	9248	9253	9258	9263	9269	9274	9279	9284	9289	1 1 2	2 3 3	4 4 5
85	9294	9299	9304	9309	9315	9320	9325	9330	9335	9340	1 1 2	2 3 3	4 4 5
86	9345	9350	9355	9360	9365	9370	9375	9380	9385	9390	1 1 2	2 3 3	4 4 5
87	9395	9400	9405	9410	9415	9420	9425	9430	9435	9440	0 1 1	2 2 3	3 4 4
88	9445	9450	9455	9460	9465	9469	9474	9479	9484	9489	0 1 1	2 2 3	3 4 4
89	9494	9499	9504	9509	9513	9518	9523	9528	9533	9538	0 1 1	2 2 3	3 4 4
90	9542	9547	9552	9557	9562	9566	9571	9576	9581	9586	0 1 1	2 2 3	3 4 4
91	9590	9595	9600	9605	9609	9614	9619	9624	9628	9633	0 1 1	2 2 3	3 4 4
92	9638	9643	9647	9652	9657	9661	9666	9671	9675	9680	0 1 1	2 2 3	3 4 4
93	9685	9689	9694	9699	9703	9708	9713	9717	9722	9727	0 1 1	2 2 3	3 4 4
94	9731	9736	9741	9745	9750	9754	9759	9763	9768	9773	0 1 1	2 2 3	3 4 4
95	9777	9782	9786	9791	9795	9800	9805	9809	9814	9818	0 1 1	2 2 3	3 4 4
96	9823	9827	9832	9836	9841	9845	9850	9854	9859	9863	0 1 1	2 2 3	3 4 4
97	9868	9872	9877	9881	9886	9890	9894	9899	9903	9908	0 1 1	2 2 3	3 4 4
98	9912	9917	9921	9926	9930	9934	9939	9943	9948	9952	0 1 1	2 2 3	3 4 4
99	9956	9961	9965	9969	9974	9978	9983	9987	9991	9996	0 1 1	2 2 3	3 3 4

24
15 / 3600
36

	0'	6'	12'	18'	24'	30'	36'	42'	48'	54'	1	2	3	4	5
0°	0000	0017	0035	0052	0070	0087	0105	0122	0140	0157	3	6	9	12	15
1	0175	0192	0209	0227	0244	0262	0279	0297	0314	0332	3	6	9	12	15
2	0349	0366	0384	0401	0419	0436	0454	0471	0488	0506	3	6	9	12	15
3	0523	0541	0558	0576	0593	0610	0628	0645	0663	0680	3	6	9	12	15
4	0698	0715	0732	0750	0767	0785	0802	0819	0837	0854	3	6	9	12	15
5	0872	0889	0906	0924	0941	0958	0976	0993	1011	1028	3	6	9	12	14
6	1045	1063	1080	1097	1115	1132	1149	1167	1184	1201	3	6	9	12	14
7	1219	1236	1253	1271	1288	1305	1323	1340	1357	1374	3	6	9	12	14
8	1392	1409	1426	1444	1461	1478	1495	1513	1530	1547	3	6	9	12	14
9	1564	1582	1599	1616	1633	1650	1668	1685	1702	1719	3	6	9	12	14
10	1736	1754	1771	1788	1805	1822	1840	1857	1874	1891	3	6	9	12	14
11	1908	1925	1942	1959	1977	1994	2011	2028	2045	2062	3	6	9	11	14
12	2079	2096	2113	2130	2147	2164	2181	2198	2215	2232	3	6	9	11	14
13	2250	2267	2284	2300	2317	2334	2351	2368	2385	2402	3	6	8	11	14
14	2419	2436	2453	2470	2487	2504	2521	2538	2554	2571	3	6	8	11	14
15	2588	2605	2622	2639	2656	2672	2689	2706	2723	2740	3	6	8	11	14
16	2756	2773	2790	2807	2823	2840	2857	2874	2890	2907	3	6	8	11	14
17	2924	2940	2957	2974	2990	3007	3024	3040	3057	3074	3	6	8	11	14
18	3099	3107	3123	3140	3156	3173	3190	3206	3223	3239	3	6	8	11	14
19	3256	3272	3289	3305	3322	3338	3355	3371	3387	3404	3	5	8	11	14
20	3420	3437	3453	3469	3486	3502	3518	3535	3551	3567	3	5	8	11	14
21	3584	3600	3616	3633	3649	3665	3681	3697	3714	3730	3	5	8	11	14
22	3746	3762	3778	3795	3811	3827	3843	3859	3875	3891	3	5	8	11	14
23	3907	3923	3939	3955	3971	3987	4003	4019	4035	4051	3	5	8	11	14
24	4067	4083	4099	4115	4131	4147	4163	4179	4195	4210	3	5	8	11	13
25	4226	4242	4258	4274	4289	4305	4321	4337	4352	4368	3	5	8	11	13
26	4384	4399	4415	4431	4446	4462	4478	4493	4509	4524	3	5	8	10	13
27	4540	4555	4571	4586	4602	4617	4633	4648	4664	4679	3	5	8	10	13
28	4695	4710	4726	4741	4756	4772	4787	4802	4818	4833	3	5	8	10	13
29	4848	4863	4879	4894	4909	4924	4939	4955	4970	4985	3	5	8	10	13
30	5000	5015	5030	5045	5060	5075	5090	5105	5120	5135	3	5	8	10	13
31	5150	5165	5180	5195	5210	5225	5240	5255	5270	5284	2	5	7	10	12
32	5299	5314	5329	5344	5358	5373	5388	5402	5417	5432	2	5	7	10	12
33	5446	5461	5476	5490	5505	5519	5534	5548	5563	5577	2	5	7	10	12
34	5592	5606	5621	5635	5650	5664	5678	5693	5707	5721	2	5	7	10	12
35	5736	5750	5764	5779	5793	5807	5821	5835	5850	5864	2	5	7	10	12
36	5878	5892	5906	5920	5934	5948	5962	5976	5990	6004	2	5	7	9	12
37	6018	6032	6046	6060	6074	6088	6101	6115	6129	6143	2	5	7	9	12
38	6157	6170	6184	6198	6211	6225	6239	6252	6266	6280	2	5	7	9	11
39	6293	6307	6320	6334	6347	6361	6374	6388	6401	6414	2	4	7	9	11
40	6428	6441	6455	6468	6481	6494	6508	6521	6534	6547	2	4	7	9	11
41	6561	6574	6587	6600	6613	6626	6639	6652	6665	6678	2	4	7	9	11
42	6691	6704	6717	6730	6743	6756	6769	6782	6794	6807	2	4	6	9	11
43	6820	6833	6845	6858	6871	6884	6896	6909	6921	6934	2	4	6	8	11
44	6947	6959	6972	6984	6997	7009	7022	7034	7046	7059	2	4	6	8	10

	0'	6'	12'	18'	24'	30'	36'	42'	48'	54'	1	2	3	4	5
45°	7071	7083	7096	7108	7120	7133	7145	7157	7169	7181	2	4	6	8	10
46	7193	7206	7218	7230	7242	7254	7266	7278	7290	7302	2	4	6	8	10
47	7314	7325	7337	7349	7361	7373	7385	7396	7408	7420	2	4	6	8	10
48	7431	7443	7455	7466	7478	7490	7501	7513	7524	7536	2	4	6	8	10
49	7547	7558	7570	7581	7593	7604	7615	7627	7638	7649	2	4	6	8	9
50	7660	7672	7683	7694	7705	7716	7727	7738	7749	7760	2	4	6	7	9
51	7771	7782	7793	7804	7815	7826	7837	7848	7859	7869	2	4	5	7	9
52	7880	7891	7902	7912	7923	7934	7944	7955	7965	7976	2	4	5	7	9
53	7986	7997	8007	8018	8028	8039	8049	8059	8070	8080	2	3	5	7	9
54	8090	8100	8111	8121	8131	8141	8151	8161	8171	8181	2	3	5	7	8
55	8192	8202	8211	8221	8231	8241	8251	8261	8271	8281	2	3	5	7	8
56	8290	8300	8310	8320	8329	8339	8348	8358	8368	8377	2	3	5	6	8
57	8387	8396	8406	8415	8425	8434	8443	8453	8462	8471	2	3	5	6	8
58	8480	8490	8499	8508	8517	8526	8536	8545	8554	8563	2	3	5	6	8
59	8572	8581	8590	8599	8607	8616	8625	8634	8643	8652	1	3	4	6	7
60	8660	8669	8678	8686	8695	8704	8712	8721	8729	8738	1	3	4	6	7
61	8746	8755	8763	8771	8780	8788	8796	8805	8813	8821	1	3	4	6	7
62	8829	8838	8846	8854	8862	8870	8878	8886	8894	8902	1	3	4	5	7
63	8910	8918	8926	8934	8942	8949	8957	8965	8973	8980	1	3	4	5	6
64	8988	8996	9003	9011	9018	9026	9033	9041	9048	9056	1	3	4	5	6
65	9063	9070	9078	9085	9092	9100	9107	9114	9121	9128	1	2	4	5	6
66	9135	9143	9150	9157	9164	9171	9178	9184	9191	9198	1	2	3	5	6
67	9205	9212	9219	9225	9232	9239	9245	9252	9259	9265	1	2	3	4	6
68	9272	9278	9285	9291	9298	9304	9311	9317	9323	9330	1	2	3	4	5
69	9336	9342	9348	9354	9361	9367	9373	9379	9385	9391	1	2	3	4	5
70	9397	9403	9409	9415	9421	9426	9432	9438	9444	9449	1	2	3	4	5
71	9455	9461	9466	9472	9478	9483	9489	9494	9500	9505	1	2	3	4	5
72	9511	9516	9521	9527	9532	9537	9542	9548	9553	9558	1	2	3	4	4
73	9563	9568	9573	9578	9583	9588	9593	9598	9603	9608	1	2	2	3	4
74	9613	9617	9622	9627	9632	9636	9641	9646	9650	9655	1	2	2	3	4
75	9659	9664	9668	9673	9677	9681	9686	9690	9694	9699	1	1	2	3	4
76	9703	9707	9711	9715	9720	9724	9728	9732	9736	9740	1	1	2	3	3
77	9744	9748	9751	9755	9759	9763	9767	9770	9774	9778	1	1	2	3	3
78	9781	9785	9789	9792	9796	9799	9803	9806	9810	9813	1	1	2	2	3
79	9816	9820	9823	9826	9829	9833	9836	9839	9842	9845	1	1	2	2	3
80	9848	9851	9854	9857	9860	9863	9866	9869	9871	9874	0	1	1	2	2
81	9877	9880	9882	9885	9888	9890	9893	9895	9898	9900	0	1	1	2	2
82	9903	9905	9907	9909	9912	9914	9917	9919	9921	9923	0	1	1	2	2
83	9925	9928	9930	9932	9934	9936	9938	9940	9942	9943	0	1	1	1	2
84	9945	9947	9949	9951	9952	9954	9956	9957	9959	9960	0	1	1	1	1
85	9962	9963	9965	9966	9968	9969	9971	9972	9973	9974	0	0	1	1	1
86	9976	9977	9978	9979	9980	9981	9982	9983	9984	9985	0	0	1	1	1
87	9986	9987	9988	9989	9990	9990	9991	9992	9993	9993	0	0	0	1	1
88	9994	9995	9995	9996	9996	9997	9997	9997	9998	9998	0	0	0	0	0
89	9998	9999	9999	9999	9999	1.000	1.000	1.000	1.000	1.000	0	0	0	0	0

nearly nearly nearly nearly nearly

	0'	6'	12'	18'	24'	30'	36'	42'	48'	54'	1	2	3	4	5
0°	1.000	1.000 nearly	1.000 nearly	1.000 nearly	1.000 nearly	9999	9999	9999	9999	9999	0	0	0	0	0
1	9998	9998	9998	9997	9997	9997	9996	9996	9995	9995	0	0	0	0	0
2	9994	9993	9993	9992	9991	9990	9990	9989	9988	9987	0	0	0	1	1
3	9986	9985	9984	9983	9982	9981	9980	9979	9978	9977	0	0	1	1	1
4	9976	9974	9973	9972	9971	9969	9968	9966	9965	9963	0	0	1	1	1
5	9962	9960	9959	9957	9956	9954	9952	9951	9949	9947	0	1	1	1	2
6	9945	9943	9942	9940	9938	9936	9934	9932	9930	9928	0	1	1	1	2
7	9925	9923	9921	9919	9917	9914	9912	9910	9907	9905	0	1	1	2	2
8	9903	9900	9898	9895	9893	9890	9888	9885	9882	9880	0	1	1	2	2
9	9877	9874	9871	9869	9866	9863	9860	9857	9854	9851	0	1	1	2	2
10	9848	9845	9842	9839	9836	9833	9829	9826	9823	9820	1	1	2	2	3
11	9816	9813	9810	9806	9803	9799	9796	9792	9789	9785	1	1	2	2	3
12	9781	9778	9774	9770	9767	9763	9759	9755	9751	9748	1	1	2	3	3
13	9744	9740	9736	9732	9728	9724	9720	9715	9711	9707	1	1	2	3	3
14	9703	9699	9694	9690	9686	9681	9677	9673	9668	9664	1	1	2	3	4
15	9659	9655	9650	9646	9641	9636	9632	9627	9622	9617	1	2	2	3	4
16	9613	9608	9603	9598	9593	9588	9583	9578	9573	9568	1	2	2	3	4
17	9563	9558	9553	9548	9542	9537	9532	9527	9521	9516	1	2	3	4	4
18	9511	9505	9500	9494	9489	9483	9478	9472	9466	9461	1	2	3	4	5
19	9455	9449	9444	9438	9432	9426	9421	9415	9409	9403	1	2	3	4	5
20	9397	9391	9385	9379	9373	9367	9361	9354	9348	9342	1	2	3	4	5
21	9336	9330	9323	9317	9311	9304	9298	9291	9285	9278	1	2	3	4	5
22	9272	9265	9259	9252	9245	9239	9232	9225	9219	9212	1	2	3	4	6
23	9205	9198	9191	9184	9178	9171	9164	9157	9150	9143	1	2	3	5	6
24	9135	9128	9121	9114	9107	9100	9092	9085	9078	9070	1	2	4	5	6
25	9063	9056	9048	9041	9033	9026	9018	9011	9003	8996	1	3	4	5	6
26	8988	8980	8973	8965	8957	8949	8942	8934	8926	8918	1	3	4	5	6
27	8910	8902	8894	8886	8878	8870	8862	8854	8846	8838	1	3	4	5	7
28	8829	8821	8813	8805	8796	8788	8780	8771	8763	8755	1	3	4	6	7
29	8746	8738	8729	8721	8712	8704	8695	8686	8678	8669	1	3	4	6	7
30	8660	8652	8643	8634	8625	8616	8607	8599	8590	8581	1	3	4	6	7
31	8572	8563	8554	8545	8536	8526	8517	8508	8499	8490	2	3	5	6	8
32	8480	8471	8462	8453	8443	8434	8425	8415	8406	8396	2	3	5	6	8
33	8387	8377	8368	8358	8348	8339	8329	8320	8310	8300	2	3	5	6	8
34	8290	8281	8271	8261	8251	8241	8231	8221	8211	8202	2	3	5	7	8
35	8192	8181	8171	8161	8151	8141	8131	8121	8111	8100	2	3	5	7	8
36	8090	8080	8070	8059	8049	8039	8028	8018	8007	7997	2	3	5	7	9
37	7986	7976	7965	7955	7944	7934	7923	7912	7902	7891	2	4	5	7	9
38	7880	7869	7859	7848	7837	7826	7815	7804	7793	7782	2	4	5	7	9
39	7771	7760	7749	7738	7727	7716	7705	7694	7683	7672	2	4	6	7	9
40	7660	7649	7638	7627	7615	7604	7593	7581	7570	7559	2	4	6	8	9
41	7547	7536	7524	7513	7501	7490	7478	7466	7455	7443	2	4	6	8	10
42	7431	7420	7408	7396	7385	7373	7361	7349	7337	7325	2	4	6	8	10
43	7314	7302	7290	7278	7266	7254	7242	7230	7218	7206	2	4	6	8	10
44	7193	7181	7169	7157	7145	7133	7120	7108	7096	7083	2	4	6	8	10

N. B.—Numbers in difference columns to be subtracted, not added.

	0'	6'	12'	18'	24'	30'	36'	42'	48'	54'	1	2	3	4	5
45°	7071	7059	7046	7034	7022	7009	6997	6984	6972	6959	2	4	6	8	10
46	6947	6934	6921	6909	6896	6884	6871	6858	6845	6833	2	4	6	8	11
47	6820	6807	6794	6782	6769	6756	6743	6730	6717	6704	2	4	6	9	11
48	6691	6678	6665	6652	6639	6626	6613	6600	6587	6574	2	4	7	9	11
49	6561	6547	6534	6521	6508	6494	6481	6468	6455	6441	2	4	7	9	11
50	6428	6414	6401	6388	6374	6361	6347	6334	6320	6307	2	4	7	9	11
51	6293	6280	6266	6252	6239	6225	6211	6198	6184	6170	2	5	7	9	11
52	6157	6143	6129	6115	6101	6088	6074	6060	6046	6032	2	5	7	9	12
53	6018	6004	5990	5976	5962	5948	5934	5920	5906	5892	2	5	7	9	12
54	5878	5864	5850	5835	5821	5807	5793	5779	5764	5750	2	5	7	9	12
55	5736	5721	5707	5693	5678	5664	5650	5635	5621	5606	2	5	7	10	12
56	5592	5577	5563	5548	5534	5519	5505	5490	5476	5461	2	5	7	10	12
57	5446	5432	5417	5402	5388	5373	5358	5344	5329	5314	2	5	7	10	12
58	5299	5284	5270	5255	5240	5225	5210	5195	5180	5165	2	5	7	10	12
59	5150	5135	5120	5105	5090	5075	5060	5045	5030	5015	3	5	8	10	13
60	5000	4985	4970	4955	4939	4924	4909	4894	4879	4863	3	5	8	10	13
61	4848	4833	4818	4802	4787	4772	4756	4741	4726	4710	3	5	8	10	13
62	4695	4679	4664	4648	4633	4617	4602	4586	4571	4555	3	5	8	10	13
63	4540	4524	4509	4493	4478	4462	4446	4431	4415	4399	3	5	8	10	13
64	4384	4368	4352	4337	4321	4305	4289	4274	4258	4242	3	5	8	11	13
65	4226	4210	4195	4179	4163	4147	4131	4115	4099	4083	3	5	8	11	13
66	4067	4051	4035	4019	4003	3987	3971	3955	3939	3923	3	5	8	11	14
67	3907	3891	3875	3859	3843	3827	3811	3795	3778	3762	3	5	8	11	14
68	3746	3730	3714	3697	3681	3665	3649	3633	3616	3600	3	5	8	11	14
69	3584	3567	3551	3535	3518	3502	3486	3469	3453	3437	3	5	8	11	14
70	3420	3404	3387	3371	3355	3338	3322	3305	3289	3273	3	5	8	11	14
71	3256	3239	3223	3206	3190	3173	3156	3140	3123	3107	3	6	8	11	14
72	3090	3074	3057	3040	3024	3007	2990	2974	2957	2941	3	6	8	11	14
73	2924	2907	2890	2874	2857	2840	2823	2807	2790	2773	3	6	8	11	14
74	2756	2740	2723	2706	2689	2672	2656	2639	2622	2605	3	6	8	11	14
75	2588	2571	2554	2538	2521	2504	2487	2470	2453	2436	3	6	8	11	14
76	2419	2402	2385	2368	2351	2334	2317	2300	2284	2267	3	6	8	11	14
77	2250	2233	2215	2198	2181	2164	2147	2130	2113	2096	3	6	9	11	14
78	2079	2062	2045	2028	2011	1994	1977	1959	1942	1925	3	6	9	11	14
79	1908	1891	1874	1857	1840	1822	1805	1788	1771	1754	3	6	9	12	14
80	1736	1719	1702	1685	1668	1650	1633	1616	1599	1582	3	6	9	12	14
81	1564	1547	1530	1513	1495	1478	1461	1444	1426	1409	3	6	9	12	14
82	1392	1374	1357	1340	1323	1305	1288	1271	1253	1236	3	6	9	12	14
83	1219	1201	1184	1167	1149	1132	1115	1097	1080	1063	3	6	9	12	14
84	1045	1028	1011	993	976	958	941	924	906	889	3	6	9	12	14
85	0872	0854	0837	0819	0802	0785	0767	0750	0732	0715	3	6	9	12	15
86	0698	0680	0663	0645	0628	0610	0593	0576	0558	0541	3	6	9	12	15
87	0523	0505	0488	0471	0454	0436	0419	0401	0384	0366	3	6	9	12	15
88	0349	0332	0314	0297	0279	0262	0244	0227	0209	0192	3	6	9	12	15
89	0175	0157	0140	0122	0105	0087	0070	0052	0035	0017	3	6	9	12	15

N.B.—Numbers in difference columns to be subtracted, not added.

NATURAL TANGENTS

	0'	6'	12'	18'	24'	30'	36'	42'	48'	54'	1	2	3	4	5
0°	.0000	.0017	.0035	.0052	.0070	.0087	.0105	.0122	.0140	.0157	3	6	9	12	14
1	.0175	.0192	.0209	.0227	.0244	.0262	.0279	.0297	.0314	.0332	3	6	9	12	15
2	.0349	.0367	.0384	.0402	.0419	.0437	.0454	.0472	.0489	.0507	3	6	9	12	15
3	.0524	.0542	.0559	.0577	.0594	.0612	.0629	.0647	.0664	.0682	3	6	9	12	15
4	.0699	.0717	.0734	.0752	.0769	.0787	.0805	.0822	.0840	.0857	3	6	9	12	15
5	.0875	.0892	.0910	.0928	.0945	.0963	.0981	.0998	.1016	.1033	3	6	9	12	15
6	.1051	.1069	.1086	.1104	.1122	.1139	.1157	.1175	.1192	.1210	3	6	9	12	15
7	.1228	.1246	.1263	.1281	.1299	.1317	.1334	.1352	.1370	.1388	3	6	9	12	15
8	.1405	.1423	.1441	.1459	.1477	.1495	.1512	.1530	.1548	.1566	3	6	9	12	15
9	.1584	.1602	.1620	.1638	.1655	.1673	.1691	.1709	.1727	.1745	3	6	9	12	15
10	.1763	.1781	.1799	.1817	.1835	.1853	.1871	.1890	.1908	.1926	3	6	9	12	15
11	.1944	.1962	.1980	.1998	.2016	.2035	.2053	.2071	.2089	.2107	3	6	9	12	15
12	.2126	.2144	.2162	.2180	.2199	.2217	.2235	.2254	.2272	.2290	3	6	9	12	15
13	.2309	.2327	.2345	.2364	.2382	.2401	.2419	.2438	.2456	.2475	3	6	9	12	15
14	.2493	.2512	.2530	.2549	.2568	.2586	.2605	.2623	.2642	.2661	3	6	9	12	16
15	.2679	.2698	.2717	.2736	.2754	.2773	.2792	.2811	.2830	.2849	3	6	9	13	16
16	.2867	.2886	.2905	.2924	.2943	.2962	.2981	.3000	.3019	.3038	3	6	9	13	16
17	.3057	.3076	.3096	.3115	.3134	.3153	.3172	.3191	.3211	.3230	3	6	10	13	16
18	.3249	.3269	.3288	.3307	.3327	.3346	.3365	.3385	.3404	.3424	3	6	10	13	16
19	.3443	.3463	.3482	.3502	.3522	.3541	.3561	.3581	.3600	.3620	3	6	10	13	17
20	.3640	.3659	.3679	.3699	.3719	.3739	.3759	.3779	.3799	.3819	3	7	10	13	17
21	.3839	.3859	.3879	.3899	.3919	.3939	.3959	.3978	.4000	.4020	3	7	10	13	17
22	.4040	.4061	.4081	.4101	.4122	.4142	.4163	.4183	.4204	.4224	3	7	10	14	17
23	.4245	.4265	.4286	.4307	.4327	.4348	.4369	.4390	.4411	.4431	3	7	10	14	17
24	.4452	.4473	.4494	.4515	.4536	.4557	.4578	.4599	.4621	.4642	4	7	10	14	18
25	.4663	.4684	.4706	.4727	.4748	.4770	.4791	.4813	.4834	.4856	4	7	11	14	18
26	.4877	.4899	.4921	.4942	.4964	.4986	.5008	.5029	.5051	.5073	4	7	11	15	18
27	.5095	.5117	.5139	.5161	.5184	.5206	.5228	.5250	.5272	.5295	4	7	11	15	18
28	.5317	.5340	.5362	.5384	.5407	.5430	.5452	.5475	.5498	.5520	4	8	11	15	19
29	.5543	.5566	.5589	.5612	.5635	.5658	.5681	.5704	.5727	.5750	4	8	12	15	19
30	.5774	.5797	.5820	.5844	.5867	.5890	.5914	.5938	.5961	.5985	4	8	12	16	20
31	.6009	.6032	.6056	.6080	.6104	.6128	.6152	.6176	.6200	.6224	4	8	12	16	20
32	.6249	.6273	.6297	.6322	.6346	.6371	.6395	.6420	.6445	.6469	4	8	12	16	20
33	.6494	.6519	.6544	.6569	.6594	.6619	.6644	.6669	.6694	.6720	4	8	13	17	21
34	.6745	.6771	.6796	.6822	.6847	.6873	.6899	.6924	.6950	.6976	4	9	13	17	21
35	.7002	.7028	.7054	.7080	.7107	.7133	.7159	.7186	.7212	.7239	4	9	13	18	22
36	.7265	.7292	.7319	.7346	.7373	.7400	.7427	.7454	.7481	.7508	5	9	14	18	23
37	.7536	.7563	.7590	.7618	.7646	.7673	.7701	.7729	.7757	.7785	5	9	14	18	23
38	.7813	.7841	.7869	.7897	.7926	.7954	.7983	.8012	.8040	.8069	5	10	14	19	24
39	.8098	.8127	.8156	.8185	.8214	.8243	.8273	.8302	.8332	.8361	5	10	15	20	24
40	.8391	.8421	.8451	.8481	.8511	.8541	.8571	.8601	.8632	.8662	5	10	15	20	25
41	.8693	.8724	.8754	.8785	.8816	.8847	.8878	.8910	.8941	.8972	5	10	16	21	26
42	.9004	.9036	.9067	.9099	.9131	.9163	.9195	.9228	.9260	.9293	5	11	16	21	27
43	.9325	.9358	.9391	.9424	.9457	.9490	.9523	.9556	.9590	.9623	6	11	17	22	28
44	.9657	.9691	.9725	.9759	.9793	.9827	.9861	.9896	.9930	.9965	6	11	17	23	29

NATURAL TANGENTS

	0'	6'	12'	18'	24'	30'	36'	42'	48'	54'	1	2	3	4	5
45°	1.0000	0035	0070	0105	0141	0176	0212	0247	0283	0319	6	12	18	24	30
46	1.0355	0392	0428	0464	0501	0538	0575	0612	0649	0686	6	12	18	25	31
47	1.0724	0761	0799	0837	0875	0913	0951	0990	1028	1067	6	13	19	25	32
48	1.1106	1145	1184	1224	1263	1303	1343	1383	1423	1463	7	13	20	26	33
49	1.1504	1544	1585	1626	1667	1708	1750	1792	1833	1875	7	14	21	28	34
50	1.1918	1960	2002	2045	2088	2131	2174	2218	2261	2305	7	14	22	29	36
51	1.2349	2393	2437	2482	2527	2572	2617	2662	2708	2753	8	15	23	30	38
52	1.2799	2846	2892	2938	2985	3032	3079	3127	3175	3222	8	16	23	31	39
53	1.3270	3319	3367	3416	3465	3514	3564	3613	3663	3713	8	16	25	33	41
54	1.3764	3814	3865	3916	3968	4019	4071	4124	4176	4229	9	17	26	34	43
55	1.4281	4335	4388	4442	4496	4550	4605	4659	4715	4770	9	18	27	36	45
56	1.4826	4882	4938	4994	5051	5108	5166	5224	5282	5340	10	19	29	38	48
57	1.5399	5458	5517	5577	5637	5697	5757	5818	5880	5941	10	20	30	40	50
58	1.6003	6066	6128	6191	6255	6319	6383	6447	6512	6577	11	21	32	43	53
59	1.6643	6709	6775	6842	6909	6977	7045	7113	7182	7251	11	23	34	45	56
60	1.7321	7391	7461	7532	7603	7675	7747	7820	7893	7966	12	24	36	48	60
61	1.8040	8115	8190	8265	8341	8418	8495	8572	8650	8728	13	26	38	51	64
62	1.8807	8887	8967	9047	9128	9210	9292	9375	9458	9542	14	27	41	55	68
63	1.9626	9711	9797	9883	9970	0057	0145	0233	0323	0413	15	29	44	58	73
64	2.0503	0594	0686	0778	0872	0965	1060	1155	1251	1348	16	31	47	63	78
65	2.1445	1543	1642	1742	1842	1943	2045	2148	2251	2355	17	34	51	68	85
66	2.2460	2566	2673	2781	2889	2998	3109	3220	3332	3445	18	37	55	74	92
67	2.3559	3673	3789	3906	4023	4142	4262	4383	4504	4627	20	40	60	79	99
68	2.4751	4876	5002	5129	5257	5386	5517	5649	5782	5916	22	43	65	87	108
69	2.6051	6187	6325	6464	6605	6746	6889	7034	7179	7326	24	47	71	95	118
70	2.7475	7625	7776	7929	8083	8239	8397	8556	8716	8878	26	52	78	104	130
71	2.9042	9208	9375	9542	9714	9887	0061	0237	0415	0595	29	58	87	115	144
72	3.0777	0961	1146	1334	1524	1716	1910	2106	2305	2506	32	64	99	129	161
73	3.2709	2914	3122	3332	3544	3759	3977	4197	4420	4646	36	72	108	144	180
74	3.4874	5105	5339	5576	5816	6059	6305	6554	6806	7062	41	82	122	162	203
75	3.7321	7583	7848	8118	8391	8667	8947	9232	9520	9812	46	94	139	186	232
76	4.0108	0408	0713	1022	1335	1653	1976	2303	2635	2972	53	107	161	214	267
77	4.3315	3662	4015	4374	4737	5107	5483	5864	6252	6646	62	124	186	248	310
78	4.7046	7453	7867	8288	8716	9152	9594	0045	0504	0970	73	146	219	292	365
79	5.1446	1929	2422	2924	3435	3955	4486	5026	5578	6140	87	175	262	350	437
80	5.6713	7297	7894	8502	9124	9758	0405	1066	1742	2432	Difference - columns cease to be useful, owing to the rapidity with which the value of the tangent changes.				
81	6.3138	3859	4596	5350	6122	6912	7920	8548	9305	0263					
82	7.1154	2066	3002	3962	4947	5958	6996	8062	9158	0285					
83	8.1443	2636	3863	5166	6427	7769	9152	0579	2052	3572					
84	9.5144	0677	9.845	10.02	10.20	10.39	10.58	10.78	10.99	11.20					
85	11.43	11.66	11.91	12.16	12.43	12.71	13.00	13.30	13.62	13.95					
86	14.30	14.67	15.06	15.46	15.89	16.35	16.83	17.34	17.89	18.46					
87	19.08	19.74	20.45	21.20	22.02	22.90	23.86	24.90	26.03	27.27					
88	28.64	30.14	31.82	33.60	35.50	38.19	40.92	44.07	47.74	52.08					
89	57.29	63.66	71.62	81.85	95.49	114.6	143.2	191.0	286.5	573.0					

INDEX

- ABERRATION, Chromatic, 453, 473**
Aberration, Spherical, 441, 445
Absorption, Electric, 400
Acceleration, Angular, Measurement of, 79
Acceleration, Linear, Measurement of, 70
Advantage, Mechanical, 111
Air-pump, Platform, 483
Amalgamating Zinc and Copper, 495
Ampere, 318
Angle, Measurement of, 121, 149, 464
Ångström Unit, 427
Anode, 403
Archimedes' Principle, 189
Arcs, Corrections for Large, 521
Area, Measurement of, 25
Aspirator, 483
Astaticism, 512
Atwood's Machine, 98

" BACK-LASH," 50, 52
Balance, Theory and Use of, 17, 61, 151 *et seq.*, 489
Ballistic Galvanometer, 396
Barometer-corrections, Tables, 522
Barometer, To Fill a, 494
Barometer, To Read a, 157
Boiling-point, 262, 300
Boiling-point, Tables of, 525
Books of Reference, 488
Boyle's Law, 209
Broca, System of Magnets, 514
Bunsen-burner, 257

CALIPER, Micrometer, 39
Caliper, Vernier, 34
Calorie, 253
Calorimeter, 284
Capacity, Electrical, 317, 334
Capillary Correction, 186, 521
Capillary Tubes, 204
Cathetometer, 58
Cathode, 408
Cells, E. M. F., Tables of, 528
Cells, Standard, 501
Cements, 496
Centigrade Scale, 255
Centimetre, 2
Centrifugal Motion, 105
Chemicals, Useful, 488
Clark Cell, 318, 501
Cleaning Glass, 28, 491
Clock-circuit and Contact, 484
Coincidences, Method of, 168
Collimator, 459
Color-sensation, 476
Combination, Heat of, 526
Commutator, Pohl's, 392
Comparator, 58
Condenser, 334, 396
Conductivity, Heat, Tables of, 527
Controlling Magnet, 507
Cooling Curve, 311
Coulomb, 318
Current-sheet, 340
Curvature, Measurement of, 44

DAMPING-KEY, 397, 399, 496
D'Arsonval Galvanometer, 503, 505
Density of Gas, 206
Density of Liquid, 188 *et seq.*
Density of Solid, 189 *et seq.*, 193, 197, 201
Density, Tables of, 518
Deviation, 469
Deviation, Minimum, Angle of, 471
Dielectric Constant, 334, 336
Dielectric Constant, Tables of, 527
Dip-circle, 349
Dip, Magnetic, 349, 420
Discharge-key, 398
Dispersion, 470, 473

- Resistance of an Electrolyte, Mance's Method, 385
 Resistance of Uniform Wire, 365
 Resistance, Specific, 371, 388
 Resistance, Specific, Tables of, 528
 Resistance, Variation of, with Changes of Temperature, 371
 Resistances in Parallel, Multiple Arc, 388
 Resistances, Sliding, 499
 Resistances, Standard, Tables, 528
 Restitution, Coefficient of, 90
 Rider of Balance, 156
 Rigidity, Coefficient of, 168
- SATURATED Vapor, Law of, 306
 Scale, Musical, 232, 523
 Second, 2
 Sensibility of Galvanometer, 514
 Sensitized Paper, 76, 498
 Shunt, 320, 388
 Silvering Mirrors, 498
 Siren, 246
 Smoked Glass, 74
 Sonometer, 227
 Sound, Velocity of, in Air, 236
 Sound, Velocity of, in Rods, 239
 Sound, Velocity of, in Wires, 243
 Specific Heat of a Solid, 282
 Specific Heat of Turpentine, 288
 Specific Heat, Tables of, 524
 Spectrometer, Adjustments of, 459
 Spectroscope, 475
 Spectrum, 471, 477
 Spherometer, 43
 Spring-balance, the Use of a, 125
 Standard Conditions of a Gas, 406
 Stationary Vibrations, 218
 Still, Mercury, 492
 Still, Water, 484
 Supplies, Useful, 488
 Surface-tension, Measurement of, 204
 Surface-tension, Tables, 520
- TABLE, Laboratory, 489
 Telescope, Construction of, 455
 Temperature, Definition of, 255
 Thermometer, Air, 279
 Thermometer, Mercury, Corrections of, 254
 Thermometer, Mercury, Errors of, 255
- Thermometer, Weight, 275
 Thomson's Method—Galvanometer Resistance, 389
 Time, Measurement of, 18, 70, 168
 Tuning-fork, 70, 229
- UNITS, Electrical, 317, 318, 319
 Units, Mechanical, 67
 Units, Mechanical, Tables of, 517, 518
 "Universal" Wax, 496
- VACUUM, Reduction of Weights to, 156
 Vapor-pressure, 306
 Vapor-pressure, Mercury, Water, Tables of, 525, 526
 Velocity, Angular, Measurement of, 79
 Velocity, Linear, Measurement of, 70, 91
 Velocity of Sound in Air, 236
 Velocity of Sound in Brass, 239
 Velocity of Sound in Iron, 243
 Velocity of Sound, Tables of, 523
 Vernier, Theory and Use of a, 30 *cf seq.*, 34
 Vibrations, Method of, 61, 394
 Vibrations of Air in Organ-pipe, 233, 246
 Vibrations of Cord, Transverse, 218, 226, 243
 Vibrations of Rod, 239
 Vibrations of Spiral Spring, 111
 Vibrations of Water, Surface, 222
 Virtual Image, 432, 439, 452
 Volt, 818
 Voltmeter, Copper, 409
 Voltmeter, Gas, 403
 Volume, Measurement of, 22, 24
- WATER-EQUIVALENT, 282
 Watt, 68, 319
 Wave-length of Light, 477, 529
 Wave-length of Sound, 218
 Weighing, 17, 160
 Weiss, System of Magnets, 513
 Wheatstone Bridge, 375, 381, 386
 Wheatstone Bridge Key, 367
 Whirling-table, 106
- YOUNG'S Modulus, 163

THE END



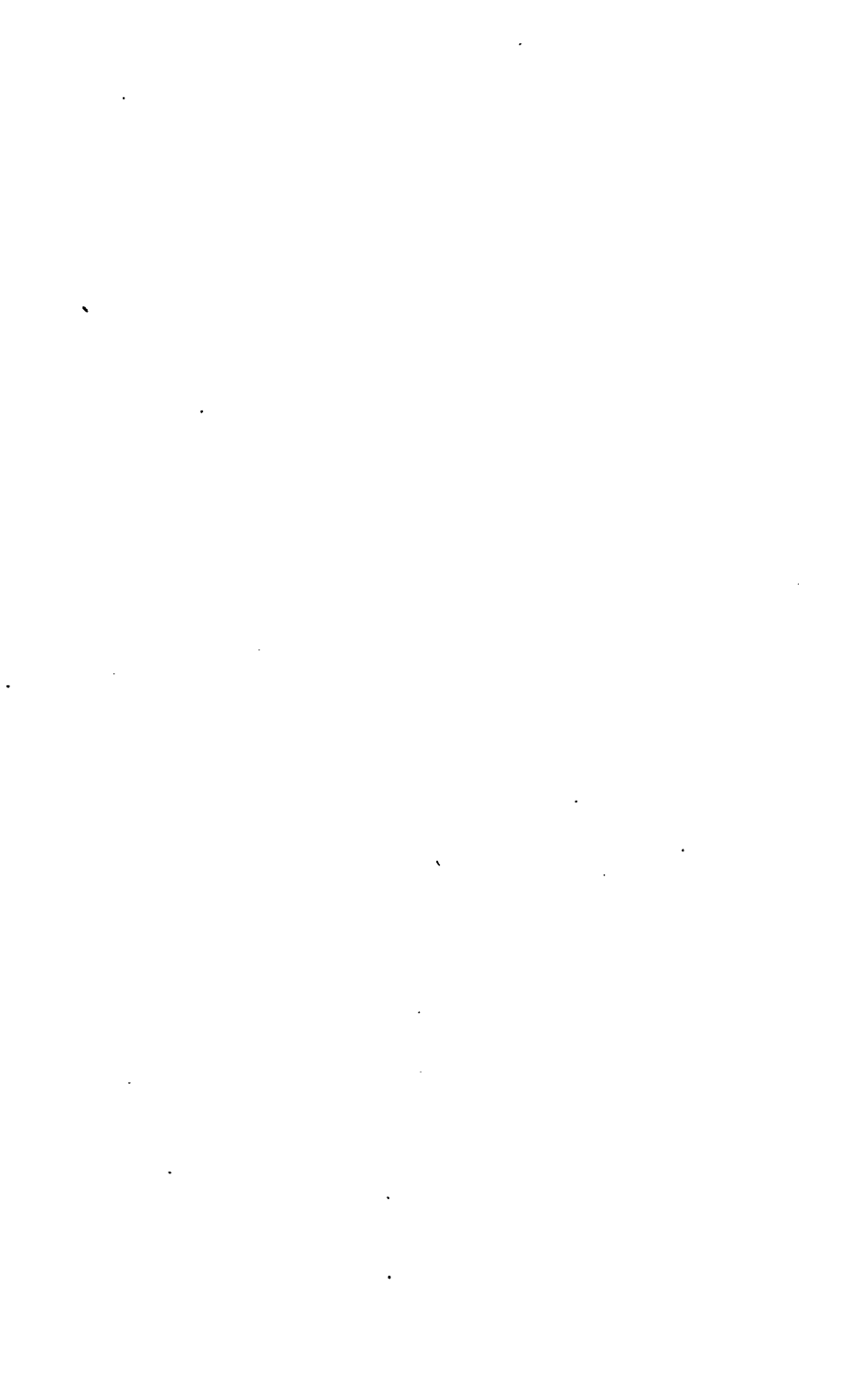



18⁰

UNIVERSITY OF CALIFORNIA LIBRARY

This book is DUE on the last date stamped below.

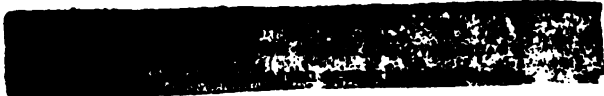

OCT 16 1947

OCT 17 1947

LD 21-100m-12,46 (A2012s16) 4120

YC 91218

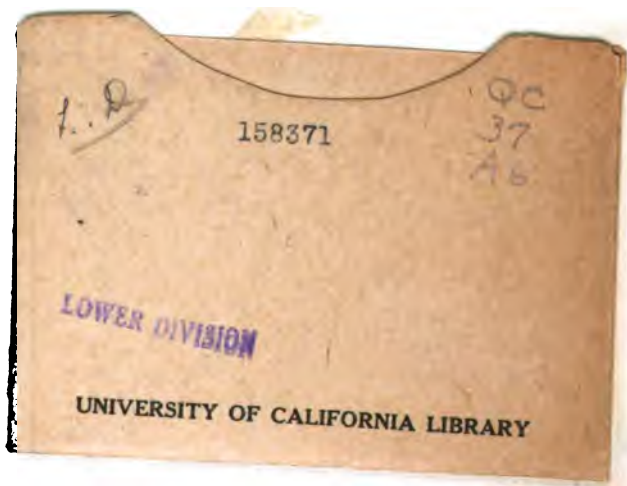

1.2

158371

*QC
37
A6*

LOWER DIVISION

UNIVERSITY OF CALIFORNIA LIBRARY

